

Service Manual Trucks

Group 37

Electrical Schematic:

Engine ECU,

Cummins ISX

VNL, VNM

From Build Date 9.98



PV776-370-98198/1

VOLVO

BATTERY 12 VOLT
IGNITION 12 VOLT
ACCESSORY 12 VOLT

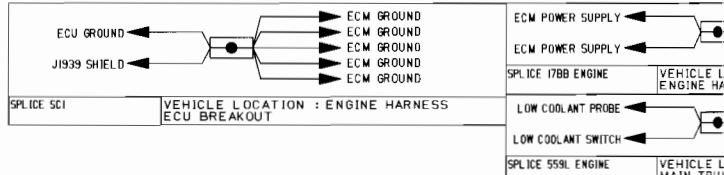
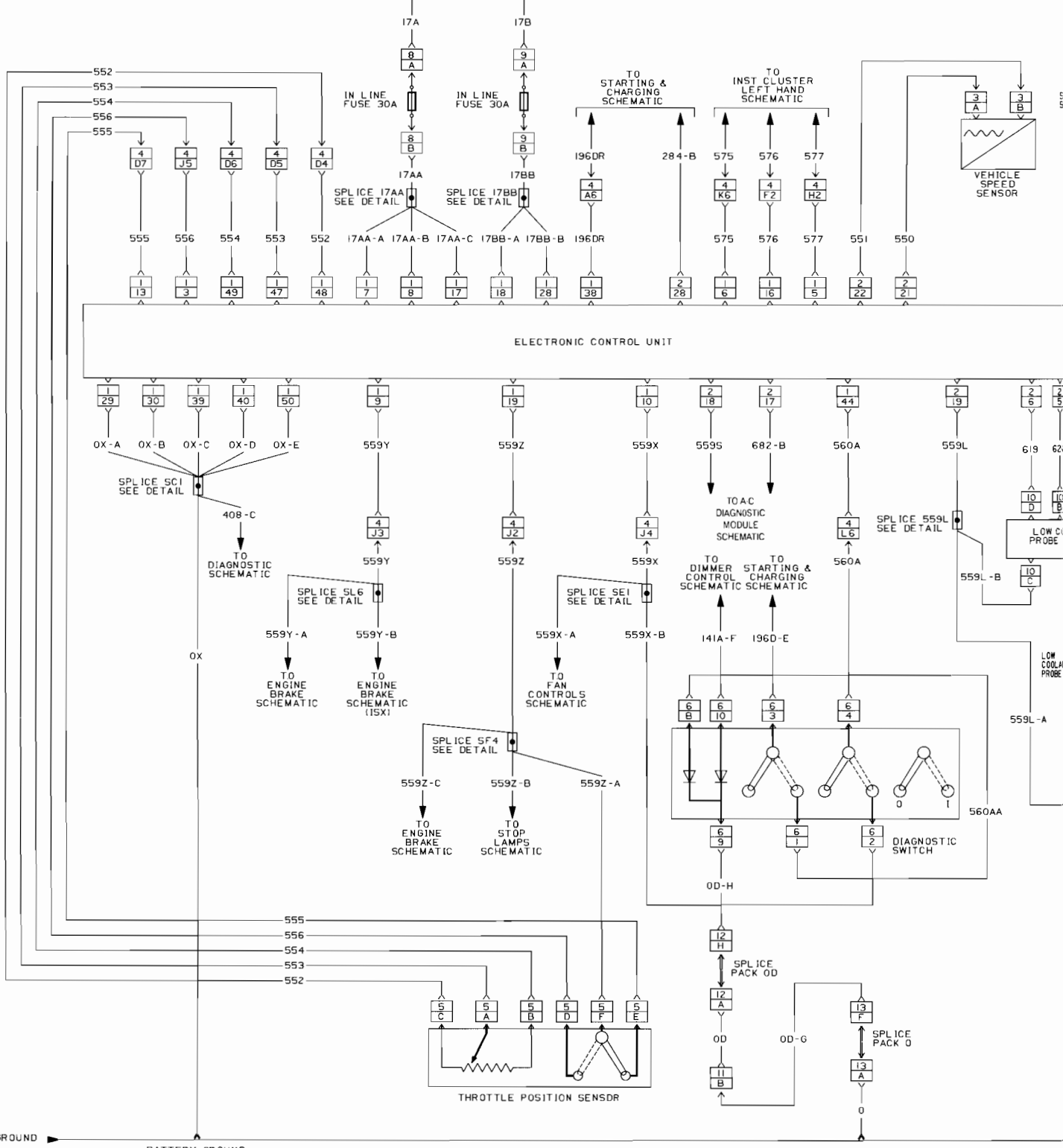

Engine ECU, Cummins ISX - VNL, VNM

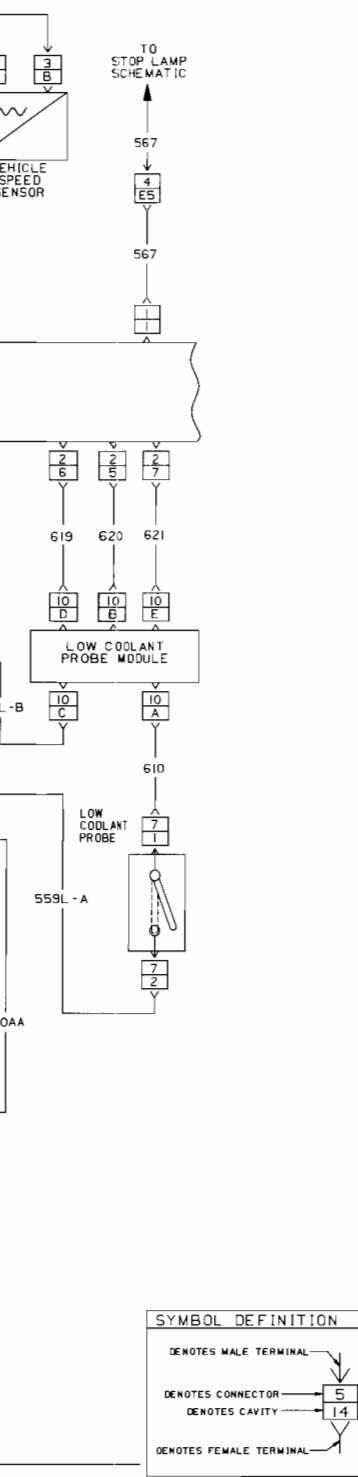

CONNECTOR AND SPLICE INFORMATION
CONNECTORS VIEWED FROM CABLE ENTRY

**CONNECTOR 1
ENGINE ECU**

TABLE OF CONTENTS		
CAVITY	CIRCUIT	FUNCTION
1	567	SERVICE BRAKE RELEASED
3	556	OFF IDLE
5	577	MAINTENANCE LAMP ON
6	575	STOP LAMP ON
7	17AA-A	ECM POWER SUPPLY
8	17AA-B	ECM POWER SUPPLY
9	559Y	DASHBOARD RETURN 2
10	559X	DASHBOARD RETURN 1
13	555	ON IDLE
16	576	WARNING LAMP ON
17	17AA-C	ECM POWER SUPPLY
18	17BB-A	ECM POWER SUPPLY
19	559Z	CAB RETURN
28	17BB-B	ECM POWER SUPPLY
29	0X-A	ECM SUPPLY RETURN
30	0X-B	ECM SUPPLY RETURN
38	196DR	KEY ON
39	0X-C	ECM SUPPLY RETURN
40	0X-D	ECM SUPPLY RETURN
44	560A	DIAGNOSTICS ENABLE
47	553	CAB THROTTLE POSITION
48	552	THROTTLE +5V SUPPLY
49	554	THROTTLE +5V RETURN
50	0X-E	ECM SUPPLY RETURN

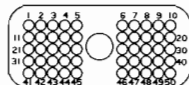

**CONNECTOR 2
ELECTRONIC CONTROL MODULE FEED**

TABLE OF CONTENTS		
CAVITY	CIRCUIT	FUNCTION
5	620	COOLANT DETECTED
6	619	COOLANT NOT DETECTED
7	621	COOLANT LEVEL +5V SUPPLY
17	682-B	AC PRESSURE NOT HIGH
18	559S	AC PRESSURE RETURN
19	559L	COOLANT LEVEL RETURN
21	550	VEHICLE SPEED (+)
22	551	VEHICLE SPEED (-)
28	284-B	START COMMAND

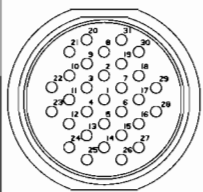

**CONNECTOR 3
SPEED SENSOR**

TABLE OF CONTENTS		
CAVITY	CIRCUIT	FUNCTION
A	550	VEHICLE SPEED INPUT
B	551	VEHICLE SPEED RETURN



**CONNECTOR 4
ENGINE HARNESS PASS THROUGH**

TABLE OF CONTENTS		
CAVITY	CIRCUIT	FUNCTION
A6	196DR	IGNITION SIGNAL
D4	552	THROTTLE POSITION SUPPLY
D5	553	THROTTLE POSITION INPUT
D6	554	THROTTLE POSITION RETURN
D7	555	IDLE VALIDATION
E5	567	SERVICE BRAKE RELEASED
F2	576	CAUTION LAMP
F2	577	ENGINE FLUIDS LAMP
J2	559Z	GROUND
J3	559Y	GROUND
J4	559X	GROUND
J5	556	THROTTLE VALIDATION INPUT
K6	575	STOP ENGINE WARNING LAMP
L6	560A	DIAGNOSTICS ENABLE

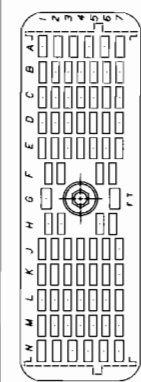

**CONNECTOR 5
THROTTLE POSITION SENSOR**

TABLE OF CONTENTS		
CAVITY	CIRCUIT	FUNCTION
A	553	THROTTLE POSITION INPUT
B	554	THROTTLE POSITION RETURN
C	552	THROTTLE POSITION SUPPLY
D	556	THROTTLE VALIDATION INPUT
E	555	IDLE VALIDATION
F	559Z-A	GROUND



**CONNECTOR 6
DIAGNOSTIC SWITCH**

TABLE OF CONTENTS		
CAVITY	CIRCUIT	FUNCTION
B	560AA	DASH ILLUMINATION
I	560AA	DASH ILLUMINATION
2	559X-B	GROUND
3	196D-E	12 VOLT SUPPLY
4	560A	DIAGNOSTICS ENABLE
9	OD-H	GROUND
10	141A-F	DASH ILLUMINATION

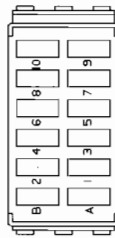

**CONNECTOR 7
LOW COOLANT PROBE**

TABLE OF CONTENTS		
CAVITY	CIRCUIT	FUNCTION
1	610	ENGINE COOLANT LEVEL FEED
2	559L	GROUND



**CONNECTOR 8
INLINE FUSE**

TABLE OF CONTENTS		
CAVITY	CIRCUIT	FUNCTION
A	17A	12 VOLT SUPPLY
B	17AA	12 VOLT SUPPLY



**CONNECTOR 9
INLINE FUSE**

TABLE OF CONTENTS		
CAVITY	CIRCUIT	FUNCTION
A	17B	12 VOLT SUPPLY
B	17BB	12 VOLT SUPPLY



**CONNECTOR 10
LOW COOLANT PROBE MODULE**

TABLE OF CONTENTS		
CAVITY	CIRCUIT	FUNCTION
A	610	ENG. COOLANT SWITCH SIGNAL
B	620	COOLANT LEVEL NORMAL
C	559L-B	GROUND
D	619	GROUND
E	621	COOLANT LEVEL MODULE FEED



**CONNECTOR 11
OPTION CONNECTOR**

TABLE OF CONTENTS		
CAVITY	CIRCUIT	FUNCTION
B	OD	GROUND



**CONNECTOR 12
SPLICE PACK OD**

TABLE OF CONTENTS		
CAVITY	CIRCUIT	FUNCTION
A	OD	GROUND
H	OD-H	GROUND



**CONNECTOR 13
SPLICE PACK O**

TABLE OF CONTENTS		
CAVITY	CIRCUIT	FUNCTION
A	O	GROUND
F	OD-G	GROUND



CHAN	
EFFECTIVE DATE	DESCRIPTION

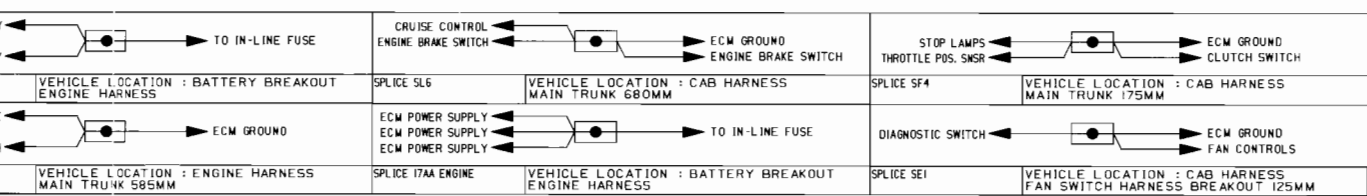
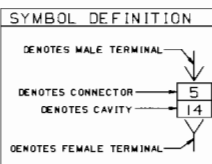
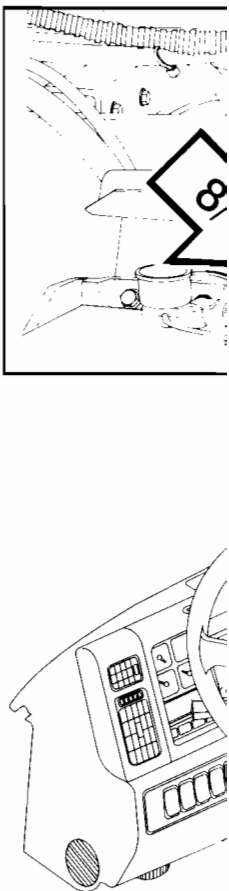

CHANGE HISTORY
DESCRIPTION

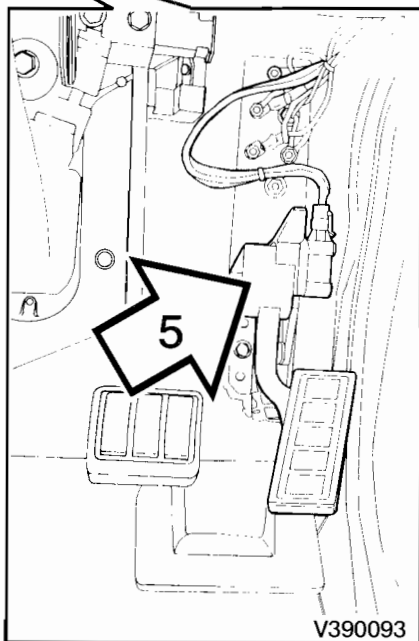
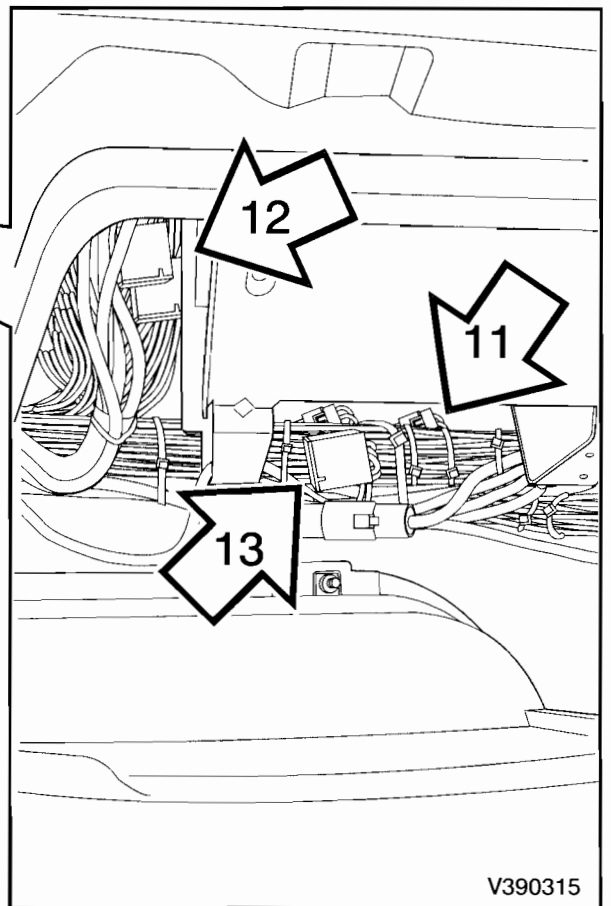
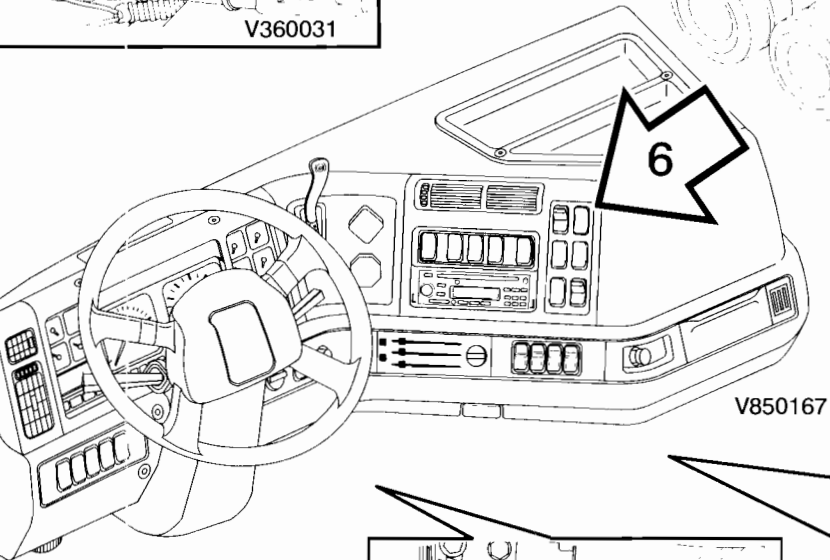
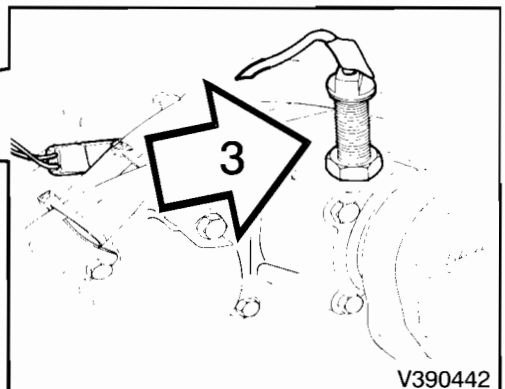
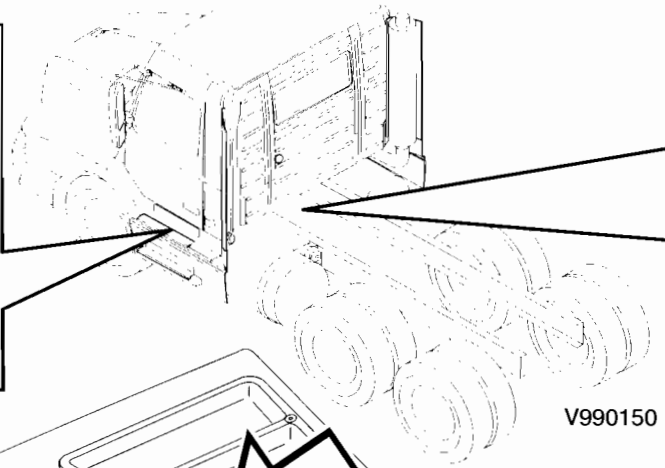
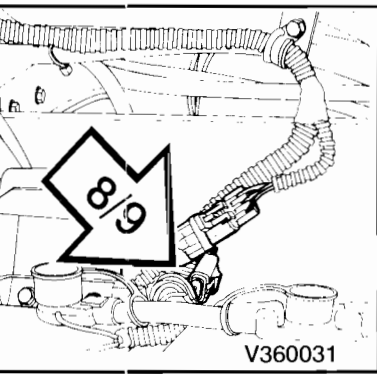
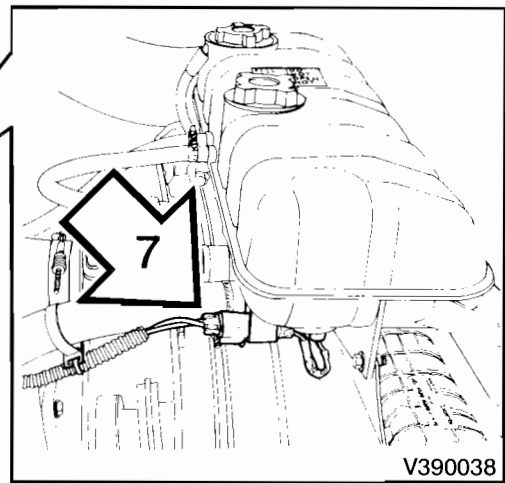
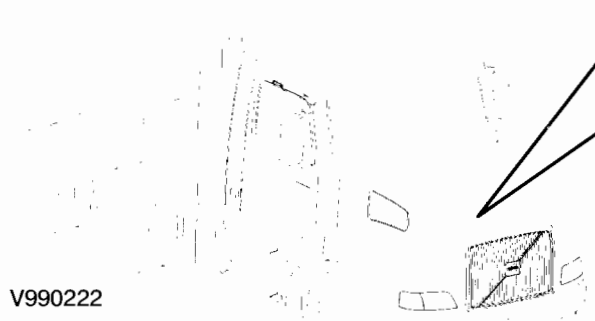

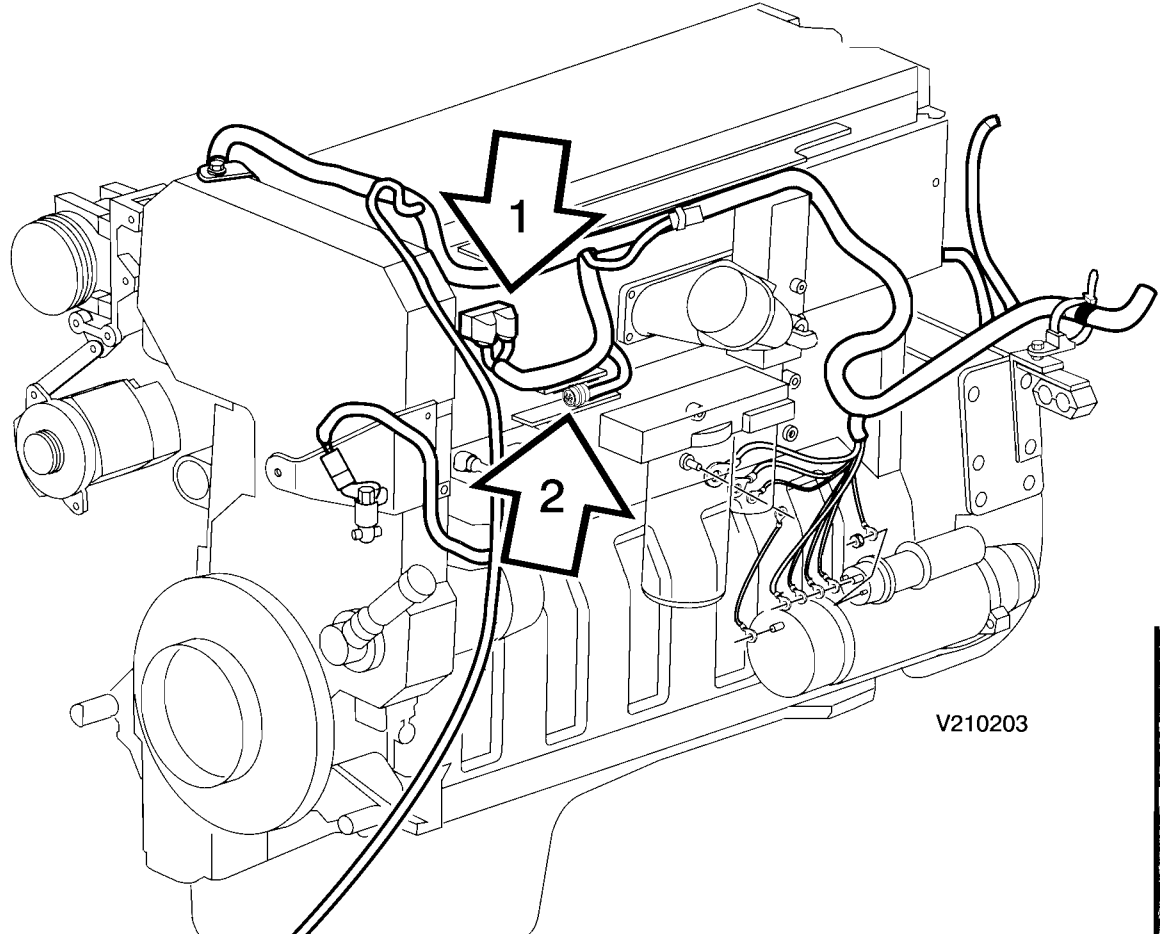

V210203

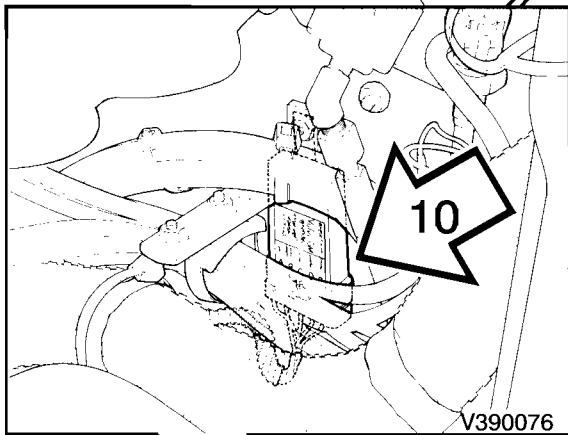

V390076

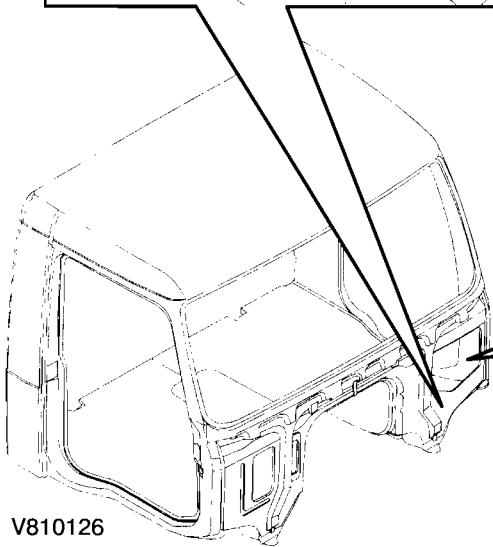

V810126

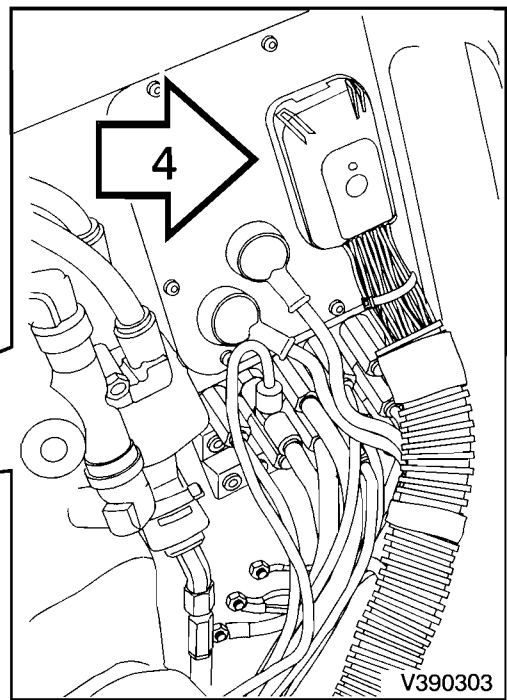

V390303