

# Operation & Maintenance Manual

SEAM015304T

## PC35R-8 PC45R-8

### HYDRAULIC EXCAVATOR

SERIAL NUMBERS PC35R-37582 and up  
PC45R-5938

#### WARNING

Unsafe use of this machine may cause serious injury or death. Operators and maintenance personnel must read this manual before operating or maintaining this machine. This manual should be kept near the machine for reference and periodically reviewed by all personnel who will come into contact with it.

#### NOTICE

Komatsu has Operation & Maintenance Manuals written in some other languages. If a foreign language manual is necessary, contact your local distributor for availability.

# KOMATSU

# 1. FOREWORD

---

This manual provides rules and guidelines which will help you use this machine safely and effectively. Keep this manual handy and have all personnel read it periodically. If this manual has been lost or has become dirty and can not be read, request a replacement manual from Komatsu or your Komatsu distributor.

If you sell the machine, be sure to give this manual to the new owners.

Continuing improvements in the design of this machine can lead to changes in detail which may not be reflected in this manual. Consult Komatsu or your Komatsu distributor for the latest available information of your machine or for questions regarding information in this manual.

This manual may contain attachments and optional equipment that are not available in your area. Consult Komatsu or your Komatsu distributor for those items you may require.

## WARNING

- **Improper operation and maintenance of this machine can be hazardous and could result in serious injury or death.**
- **Operators and maintenance personnel should read this manual thoroughly before beginning operation or maintenance.**
- **Some actions involved in operation and maintenance of the machine can cause a serious accident, if they are not done in a manner described in this manual.**
- **The procedures and precautions given in this manual apply only to intended uses of the machine. If you use your machine for any unintended uses that are not specifically prohibited, you must be sure that it is safe for you and others. In no event should you or others engage in prohibited uses or actions as described in this manual.**
- **Komatsu delivers machines that comply with all applicable regulations and standards of the country to which it has been shipped. If this machine has been purchased in another country or purchased from someone in another country, it may lack certain safety devices and specifications that are necessary for use in your country. If there is any question about whether your product complies with the applicable standards and regulations of your country, consult Komatsu or your Komatsu distributor before operating the machine.**
- **The description of safety is given in SAFETY INFORMATION on page 0-4 and in SAFETY from page 1-1.**

### **CALIFORNIA**

#### **Proposition 65 Warning**

**Diesel engine exhaust and some of its constituents are known to the State of California to cause cancer, birth defects, and other reproductive harm.**

### **CALIFORNIA**

#### **Proposition 65 Warning**

**Battery posts, terminals and related accessories contain lead and lead compounds, chemicals known to the State of California to cause cancer and birth defects or other reproductive harm.**

**Wash hands after handling.**

## EMISSION CONTROL WARRANTY

### EMISSION CONTROL WARRANTY STATEMENT (APPLIES TO CANADA ONLY)

#### 1. Products Warranted

Komatsu America International Company, Komatsu Mining Systems Inc. and Komatsu Utility Corporation (collectively "Komatsu") produce and/or market products under brand names of Komatsu, Dresser, Dressta, Haulpak and Galion. This emissions warranty applies to new engines bearing the Komatsu name installed in these products and used in Canada in machines designed for industrial off-highway use. This warranty applies only to these engines produced on or after January 1, 2000. This warranty will be administered by Komatsu distribution in Canada.

#### 2. Coverage

Komatsu warrants to the ultimate purchaser and each subsequent purchaser that the engine is designed, built and equipped so as to conform, at the time of sale by Komatsu, with all U.S. Federal emission regulations applicable at the time of manufacture and that it is free from defects in workmanship or material which would cause it not to meet these regulations within five years or 3,000 hours of operation, whichever occurs first, as measured from the date of delivery of the engine to the ultimate purchaser.

#### 3. Limitations

Failures, other than those resulting from defects in materials or workmanship, are not covered by this warranty. Komatsu is not responsible for failures or damage resulting from what Komatsu determines to be abuse or neglect, including, but not limited to: operation without adequate coolant or lubricants; over fueling; over speeding; lack of maintenance of lubricating, cooling or intake systems; improper storage, starting, warm-up, run-in or shutdown practices; unauthorized modifications of the engine. Komatsu is also not responsible for failures caused by incorrect fuel or by water, dirt or other contaminants in the fuel. Komatsu is not responsible for non-engine repairs, "downtime" expense, related damage, fines, all business costs or other losses resulting from a warrantable failure.

### KOMATSU IS NOT RESPONSIBLE FOR INCIDENTAL OR CONSEQUENTIAL DAMAGES.

This warranty, together with the express commercial warranties, are the sole warranties of Komatsu. **THERE ARE NO OTHER WARRANTIES, EXPRESS OR IMPLIED, OR OF MERCHANTABILITY OR FITNESS FOR A PARTICULAR PURPOSE.**

## GARANTIE SUR LE CONTRÔLE DES ÉMISSIONS

### ÉNONCÉ DE GARANTIE SUR LE CONTRÔLE DES ÉMISSIONS (APPLICABLE AU CANADA SEULEMENT):

#### 1. Produits garantis:

Komatsu America International Company, Komatsu Mining Systems Inc. et Komatsu Utility Corporation (collectivement Komatsu) produisent et/ou font la mise en marché de produits portant les noms de marque Komatsu, Dresser, Dressta, Haulpak et Galion. Cette garantie sur les émissions s'applique à tous les nouveaux moteurs portant le nom Komatsu, installés dans ces produits et utilisés au Canada dans des machines conçues pour utilisation industrielle non-routière. Cette garantie s'applique seulement sur les moteurs produits à partir du 1er Janvier 2000. Cette garantie sera administrée par la distribution de Komatsu au Canada.

#### 2. Couverture:

Komatsu garantit à l'acheteur ultime et chaque acheteur subséquent que le moteur est conçu, construit et équipé en toute conformité, au moment de la vente par Komatsu, avec toutes les Réglementations fédérales américaines sur les émissions applicables au moment de la fabrication et qu'il est exempt de défauts de construction ou de matériaux qui auraient pour effet de contrevenir à ces réglementations en dedans de 5 ans ou 3000 heures d'opération, mesuré à partir de la date de livraison du moteur au client ultime.

#### 3. Limitations:

Les bris, autres que ceux résultant de défauts de matériaux ou de construction, ne sont pas couverts par cette Garantie. Komatsu n'est pas responsable pour bris ou dommages résultant de ce que Komatsu détermine comme étant de l'abus ou négligence, incluant mais ne se limitant pas à: l'opération sans lubrifiants ou agent refroidissants adéquats; la suralimentation d'essence; la survitesse; le manque d'entretien des systèmes de lubrification, de refroidissement ou d'entrée; de pratiques non-propices d'entreposage, de mise en marche, de réchauffement, de conditionnement ou d'arrêt; les modifications non-autorisées du moteur. De plus, Komatsu n'est pas responsable de bris causés par de l'essence inadéquate ou de l'eau, des saletés ou autres contaminants dans l'essence. Komatsu n'est pas responsable des réparations non-relées au moteur, des dépenses encourues suite aux temps d'arrêts, des dommages relatifs, amendes, et de tout autre coût d'affaires ou autres pertes résultant d'un bris couvert par la garantie.

### KOMATSU N'EST PAS RESPONSABLE DES INCIDENTS OU DOMMAGES CONSÉQUENTS.

Cette garantie, ainsi que les garanties expresses commerciales, sont les seules garanties de Komatsu. **IL N'Y A AUCUNE AUTRE GARANTIE, EXPRESSE OU SOUS-ENTENDUE, MARCHANDABLE OU PROPICE A UNE UTILISATION PARTICULIÈRE.**

**INFORMATION IMPORTANTE SUR LE MOTEUR**  
 CE MOTEUR EST CONFORME AUX NORMES AMÉRICAINES DE L'EPA (ANNÉE DU MODÈLE) ET DE LA CALIFORNIE POUR LES MOTEURS LARGES NON-ROUTIERS À IGNITION PAR COMPRESSION. CE MOTEUR EST CERTIFIÉ POUR OPERATION À ESSENCE DIESEL.

**AVERTISSEMENT**  
 DES BLESSURES PEUVENT RÉSULTER ET LA GARANTIE S'ANNULER SI LES RPM DU TAUX D'ESSENCE OU L'ALTITUDE EXCÈDENT LES VALEURS MAXIMALES PUBLIÉES POUR CE MODÈLE ET SON APPLICATION.

**IMPORTANT ENGINE INFORMATION**

THIS ENGINE CONFORMS TO YYYY MODEL YEAR U.S. EPA REGULATION AND THE CALIFORNIA REGULATIONS LARGE NON ROAD COMPRESSION IGNITION ENGINES. THIS ENGINE IS CERTIFIED TO OPERATE ON DIESEL FUEL.

<b>WARNING</b> INJURY MAY RESULT AND WARRANTY IS VOIDED IF FUEL RATE RPM OR ALTITUDES EXCEED PUBLISHED MAXIMUM VALUES FOR THIS MODEL AND APPLICATION.		SERIAL NO.	
ENGINE MODEL		DISPLACEMENT	LITERS
ENGINE FAMILY		FIRING ORDER	1 - 5 - 3 - 6 - 2 - 4
EXHAUST EMISSION CONTROL SYSTEM			
ADV. LOAD OUTPUT	Kw ( HP)		RPM
VALVE LASH COLD (mm)	IN. EX.	FUEL RATE AT ADV.	mm <sup>3</sup> /STROKE
IDLE SPEED	RPM	FAMILY EMISSION LIMIT	
INITIAL INJECTION TIMING	DEG. BTDC	DATE OF MANUFACTURE	
		KOMATSU LTD. MADE IN JAPAN	

- MODÈLE DU MOTEUR
- FAMILLE DU MOTEUR
- SYSTÈME DE CONTRÔLE DES ÉMISSIONS D'ÉCHAPPEMENT
- CHARGE DE SORTIE ADV.
- PORTÉE DE VALVE À FROID (mm)
- VITESSE STATIQUE
- RÉGLAGE DE L'ALLUMAGE - INJECTION INITIALE
- DEG. BTDC

- NO. SÉRIE
- DÉPLACEMENT
- LITRES
- SÉQUENCE DE MISE À FEU
- mm<sup>3</sup>/BATTEMENT
- TAUX D'ESSENCE À ADV.
- LIMITE D'ÉMISSION DE LA FAMILLE
- DATE DE FABRICATION

KOMATSU LTD.  
FABRIQUÉ AU JAPON

**ENGINE DATAPLATE - ENGLISH / FRENCH**





## 2. SAFETY INFORMATION

---

Most accidents are caused by the failure to follow fundamental safety rules for the operation and maintenance of machines. To avoid accidents, read, understand and follow all precautions and warnings in this manual and on the machine before performing operation and maintenance.

To identify safety messages in this manual and on machine labels, the following signal words are used.

-  **DANGER** - This word is used on safety messages and safety labels where there is a high probability of serious injury or death if the hazard is not avoided. These safety messages or labels usually describe precautions that must be taken to avoid the hazard. Failure to avoid this hazard may also result in serious damage to the machine.
  
-  **WARNING** - This word is used on safety messages and safety labels where there is a potentially dangerous situation which could result in serious injury or death if the hazard is not avoided. These safety messages or labels usually describe precautions that must be taken to avoid the hazard. Failure to avoid this hazard may also result in serious damage to the machine.
  
-  **CAUTION** - This word is used on safety messages and safety labels for hazards which could result in minor or moderate injury if the hazard is not avoided. This word might also be word for hazards where the only result could be damage to the machine.
  
- NOTICE** - This word is used for precautions that must be taken to avoid actions which could shorten the life of the machine.

Safety precautions are described in SAFETY from page 1-1.

Komatsu cannot predict every circumstance that might involve a potential hazard in operation and maintenance. Therefore the safety messages in this manual and on the machine may not include all possible safety precautions. If any procedures or actions not specifically recommended or allowed in this manual are used, you must be sure that you and others can do such procedures and actions safely and without damaging the machine. If you are unsure about the safety of some procedures, contact Komatsu distributor.

## **3. INTRODUCTION**

---

### **3.1 INTENDED USE**

This Komatsu HYDRAULIC EXCAVATOR is designed to be used mainly for the following work:

- Digging work
- Smoothing work
- Ditching work
- Loading work

See the section "12.13 WORK POSSIBLE USING HYDRAULIC EXCAVATOR" for further details.

### **3.2 FEATURES**

- Employment of LCD monitor
- Employment of short-pitch rubber shoe for higher operator comfort
- Use of common undercarriage parts for easy exchange of rubber and steel shoes
- Employment of bucket tooth of vertical pin type
- Employment of semi-wrist control lever for easier operation
- Low noise and stylish form and coloring facilitate operations without problem even in residential areas.
- Work equipment which operates faster and generates less shocks
- Wide range of attachments for superb versatility
- Replacement period of hydraulic oil filter element lengthened from 250 hours to 500 hours by employment of the hybrid element (Replacement period of hydraulic oil lengthened accordingly from 2000 hours to 4000 hours)

### **3.3 BREAKING IN THE MACHINE**

Your Komatsu machine has been thoroughly adjusted and tested before shipment. However, operating the machine under severe conditions at the beginning can adversely affect the performance and shorten the machine life.

Be sure to break in the machine for the initial 100 hours (as indicated by the service meter.)

During breaking in:

- Idle the engine for 5 minutes after starting it up.
- Avoid operation with heavy loads or at high speeds.
- Avoid sudden starts, sudden acceleration, sudden steering and sudden stops except in cases of emergency.

The precautions given in this manual for operating, maintenance, and safety procedures are only those that apply when this product is used for the specified purpose. If the machine is used for a purpose that is not listed in this manual, Komatsu cannot bear any responsibility for safety. All consideration of safety in such operations is the responsibility of the user.

Operations that are prohibited in this manual must never be carried out under any circumstances.

## 4. LOCATION OF PLATES, TABLE TO ENTER SERIAL NO. AND DISTRIBUTOR

---

### 4.1 MACHINE SERIAL NO. PLATE POSITION

On the left front of the frame.

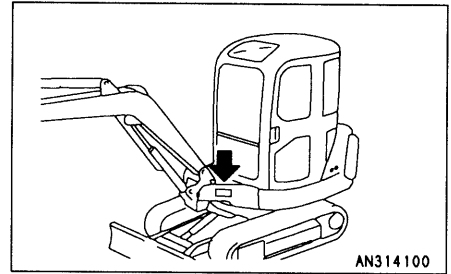

### 4.2 ENGINE SERIAL NO. PLATE POSITION

The engine serial No. plate is on the top of the engine cylinder head cover and on the air cleaner bracket.

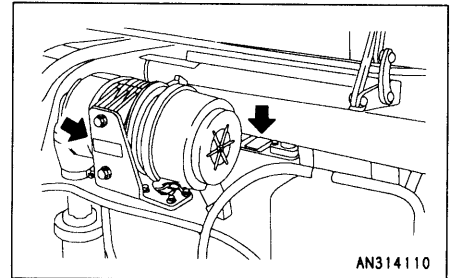

### 4.3 TABLE TO ENTER SERIAL NO. AND DISTRIBUTOR

Machine serial No.:	
Engine serial No.:	
Distributor name:	
Address:	Phone:
Service personnel for your machine:	

REMARKS

## 5. CONTENTS

---

1. Foreword .....	0- 1
2. Safety information .....	0- 4
3. Introduction .....	0- 5
4. Location of plates, table to enter serial No. and distributor .....	0- 6

### SAFETY

6. General precautions .....	1- 2
7. Precautions during operation .....	1- 7
7.1 Before starting engine .....	1- 7
7.2 Operating machine .....	1- 9
7.3 Transportation .....	1-16
7.4 Battery .....	1-17
7.5 Towing .....	1-19
7.6 Lifting operations .....	1-19
7.7 Window washer fluid .....	1-19
8. Precautions for maintenance .....	1-20
8.1 Before carrying out maintenance .....	1-20
8.2 During maintenance .....	1-24
9. Position for attaching safety labels .....	1-29

### OPERATION

10. General view .....	2- 2
10.1 General view of machine .....	2- 2
10.2 General view of controls and gauges .....	2- 3
11. Explanation of components .....	2- 4
11.1 Machine monitor .....	2- 4
11.2 Switches .....	2- 9
11.3 Control levers and pedals .....	2-12
11.4 Engine food .....	2-15
11.5 Front window (Machines equipped with cab) .....	2-17
11.6 Sliding door (Machines equipped with cab) .....	2-19
11.7 Hammer for emergency escape (Machines equipped with cab) .....	2-20
11.8 Fuses .....	2-20
11.9 Fusible link .....	2-21
11.10 Cap, cover with lock .....	2-21
11.11 Manual pocket .....	2-22
11.12 Tool box .....	2-22
11.13 Dust indicator .....	2-22

<b>12. Operation</b> .....	2-23
12.1 Check before starting engine .....	2-23
12.2 Starting engine .....	2-32
12.3 Operations and checks after starting engine .....	2-34
12.4 Moving machine off .....	2-36
12.5 Steering machine .....	2-39
12.6 Stopping machine .....	2-41
12.7 Swinging .....	2-42
12.8 Operation of work equipment .....	2-43
12.9 Prohibitions for operation .....	2-44
12.10 Precautions for operation .....	2-47
12.11 Precautions when traveling up or down hills .....	2-48
12.12 How to escape from mud .....	2-50
12.13 Work possible using hydraulic excavator .....	2-51
12.14 Replacement of bucket .....	2-53
12.15 Parking machine .....	2-56
12.16 Check after finishing work .....	2-57
12.17 Stopping engine .....	2-57
12.18 Check after stopping engine .....	2-58
12.19 Locking .....	2-58
12.20 Handling rubber shoes (Rubber shoes only) .....	2-59
<b>13. Transportation</b> .....	2-64
13.1 Loading, unloading work .....	2-64
13.2 Method of lifting machine .....	2-66
13.3 Precautions for loading and securing machine .....	2-68
13.4 Precautions for transportation .....	2-69
<b>14. Cold weather operation</b> .....	2-70
14.1 Precautions for low temperature .....	2-70
14.2 Precautions after completion of work .....	2-72
14.3 Preparing the cab heater (Machines equipped with cab) .....	2-72
14.4 After cold weather .....	2-72
<b>15. Long-term storage</b> .....	2-73
15.1 Before storage .....	2-73
15.2 During storage .....	2-74
15.3 After storage .....	2-74
<b>16. Troubleshooting</b> .....	2-75
16.1 Phenomena that are not failures .....	2-75
16.2 Method of towing machine .....	2-75
16.3 Precautions on particular jobsites .....	2-75
16.4 If battery is discharged .....	2-76
16.5 Other trouble .....	2-80

## MAINTENANCE

<b>17. Guides to maintenance</b> .....	3- 2
<b>18. Outlines of service</b> .....	3- 4
18.1 Outline of oil, fuel, coolant .....	3- 4
18.2 Outline of electric system .....	3- 7
18.3 Outline of hydraulic system .....	3- 8
<b>19. Wear parts list</b> .....	3- 9
<b>20. Use of fuel, coolant and lubricants according to ambient temperature</b> .....	3-10
<b>21. Standard tightening torques for bolts and nuts</b> .....	3-14
21.1 Introduction of necessary tools .....	3-14
21.2 Torque list.....	3-15
<b>22. Periodic replacement of safety critical parts</b> .....	3-16
<b>23. Maintenance schedule chart</b> .....	3-19
23.1 Maintenance schedule chart .....	3-19
23.2 Maintenance interval when using hydraulic breaker.....	3-21
<b>24. Service Procedure</b> .....	3-22
24.1 Initial 250 hours service .....	3-22
24.2 When required .....	3-23
24.3 Check before starting .....	3-45
24.4 Every 100 hours service .....	3-49
24.5 Every 250 hours service .....	3-50
24.6 Every 500 hours service .....	3-52
24.7 Every 1000 hours service .....	3-63
24.8 Every 2000 hours service .....	3-65
24.9 Every 4000 hours service .....	3-66

## SPECIFICATIONS

<b>25. Specifications</b> .....	4- 2
---------------------------------	------

**OPTIONS, ATTACHMENTS**

<b>26. General precautions</b> .....	5- 2
26.1 Precautions related to safety .....	5- 2
26.2 Precautions when installing attachments .....	5- 3
<b>27. Handling bucket with hook</b> .....	5- 4
27.1 Checking for damage to bucket with hook.....	5- 4
27.2 Prohibited operations .....	5- 4
27.3 Precautions during operations .....	5- 4
<b>28. Using seat belt</b> .....	5- 5
<b>29. Operation of car radio (Machine equipped with cab)</b> .....	5- 7
29.1 Explanation of controls .....	5- 7
29.2 Operation method.....	5- 9
29.3 Precautions for use.....	5-11
29.4 Specifications .....	5-12
<b>30. Operation of window washer (Machine equipped with cab)</b> .....	5-13
30.1 Operation of window washer .....	5-13
30.2 Check and refilling of window washer fluid.....	5-14
<b>31. Introduction of attachments</b> .....	5-14
31.1 Specifications and uses.....	5-14
31.2 Combinations table of attachments.....	5-15
31.3 Selection of track shoes (steel shoe, road liner) .....	5-16
31.4 Consumable parts of bucket.....	5-17
31.5 Handling of power angle/power tilt blade .....	5-18
31.6 Precautions for operating with hydraulic breaker .....	5-21
31.7 Operation of machine which can be equipped with attachments .....	5-24

# SAFETY

 **WARNING**

**Read and follow all safety precautions. Failure to do so may result in serious injury or death.**

This safety section also contains precautions for optional equipment and attachments.



## 6. GENERAL PRECAUTIONS

**⚠ WARNING:** For reasons of safety, always follow these safety precautions.

### SAFETY RULES

- Only trained and authorized personnel can operate and maintain the machine.
- Follow all safety rules, precautions and instructions when operating or performing maintenance on the machine.
- Do not operate the machine if you are not feeling well, or if you are taking medicine which will make you sleepy, or if you have been drinking. Operating in such a condition will adversely affect your judgement and may lead to an accident.
- When working with another operator or with a person on worksite traffic duty, be sure that all personnel understand all hand signals that are to be used.
- Always follow all rules related to safety.

### SAFETY FEATURES

- Be sure that all guards and covers are in their proper position. Have guards and covers repaired if damaged.
- Use safety features such as safety lock levers ① (Installed on only left side, if machine is equipped with cab) and the seat belt properly.
- Never remove any safety features. Always keep them in good operating condition.  
**Safety lock lever → See "12.16 PARKING MACHINE".**  
**Seat belt → See "27. USING SEAT BELT".**
- Improper use of safety features could result in serious bodily injury or death.

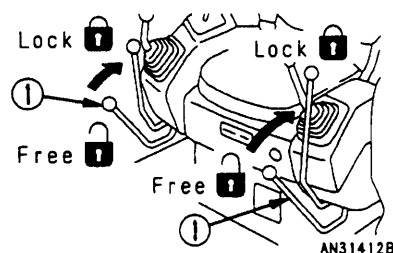

### CLOTHING AND PERSONAL PROTECTIVE ITEMS

- Avoid loose clothing, jewelry, and loose long hair. They can catch on controls or in moving parts and cause serious injury or death.
- Also, do not wear oily clothes, because they are flammable.
- Wear a hard hat, safety glasses, safety shoes, mask or gloves when operating or maintaining the machine. Always wear safety goggles, hard hat and heavy gloves if your job involves scattering metal chips or minute materials particularly when driving pins with a hammer and when cleaning the air cleaner element with compressed air. Check also that there is no one near the machine.
- Check that all protective equipment functions properly before using.

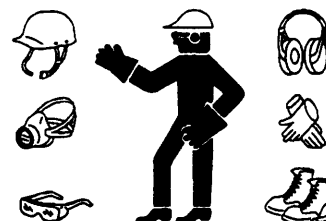

### UNAUTHORIZED MODIFICATION

Any modification made without authorization from Komatsu can create hazards. Before making a modification, consult your Komatsu distributor. Komatsu will not be responsible for any injury or damage caused by any unauthorized modification.

**⚠ WARNING:** Failure to follow these safety precautions may lead to a serious accident.

### ALWAYS APPLY LOCK WHEN LEAVING OPERATOR'S SEAT

- When standing up from the operator's seat, always place the safety lock levers ① securely in the LOCK position. If you accidentally touch the levers when they are not locked, the work equipment may suddenly move and cause serious injury or damage.
- When leaving the machine, lower the blade and ripper completely to the ground, set the safety lock levers ① to the LOCK position, then stop the engine. Use the key to lock all the equipment. Always remove the key and take it with you.

**Work equipment posture → See "12.15 PARKING MACHINE".**

**Locking → See "12.19 LOCKING"**

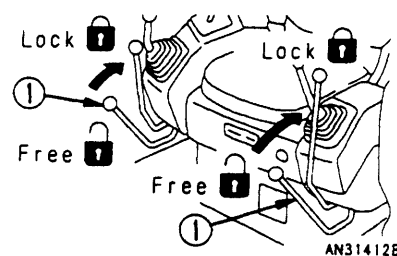

### MOUNTING AND DISMOUNTING

- Never jump on or off the machine. Never get on or off a moving machine.
- When getting on or off the machine, always face the machine and use the handrails and steps.
- Never hold any control levers or lock levers when getting on or off the machine.
- To ensure safety, always maintain three-point contact (both feet and one hand, or both hands and one foot) with the handrails and steps to ensure that you support yourself.
- If there is any oil, grease, or mud on the handrails or steps, wipe it off immediately. Always keep these parts clean. Repair any damage and tighten any loose bolts.
- Never stand on the engine hood, which is slippery and dangerous.
- When getting on or off the machine, or when moving along the top of the track, if you hold the handrail inside the door when moving on top of the track shoe, and the door lock is not locked securely, the door may move and cause you to fall.

Always lock the door securely.

**Method of locking door → See "11.6 SLIDING DOOR".**

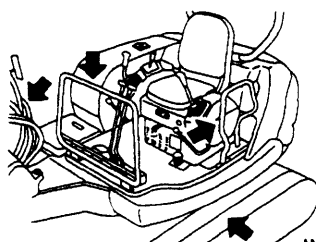
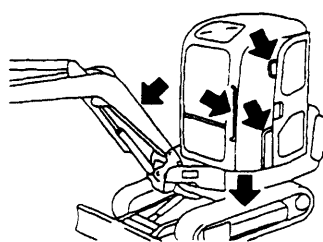

### PRECAUTIONS FOR OPENING AND CLOSING SLIDING DOOR

It is very dangerous if fingers are caught in the sliding door.

Open and close the sliding door with its knob.

When closing the sliding door, in particular, take care not to get your fingers and hand caught between it and the cab pillar.

**FIRE PREVENTION FOR FUEL AND OIL**

Fuel, oil, and antifreeze can be ignited by a flame. Fuel is particularly flammable and can be hazardous.

Always observe the following:

- Keep any flame or lighted cigarette away from flammable fluids.
- Stop the engine and do not smoke when refueling.
- Tighten all fuel and oil caps securely.
- Use well-ventilated areas for adding or storing oil and fuel.
- Keep oil and fuel in the determined place and do not allow unauthorized persons to enter.



A0055020



A0055030



A0055040

**PRECAUTIONS WHEN HANDLING AT HIGH TEMPERATURE**

- Immediately after operations are stopped, the engine oil and hydraulic oil are at high temperature and are still under pressure. Attempting to remove the cap, drain the oil or water, or replace the filters may lead to serious burns. Always wait for the temperature to go down, and follow the specified procedures when carrying out these operations.
- To prevent hot water from spurting out, stop the engine, wait for the water to cool, then loosen the cap slowly to relieve the pressure before removing the cap.  
(When checking if the water temperature has gone down, put your hand near the front face of the radiator and check the air temperature. Be careful not to touch the radiator.)
- To prevent hot oil from spurting out, stop the engine, wait for the oil to cool, then loosen the cap slowly to relieve the pressure before removing the cap.  
(When checking if the oil temperature has gone down, put your hand near the front face of the hydraulic tank and check the air temperature. Be careful not to touch the hydraulic tank.)



A0055050

### ASBESTOS DUST HAZARD PREVENTION

Asbestos dust can be hazardous to your health if it is inhaled.

Komatsu does not use asbestos in its products, but if you handle materials containing asbestos fibers, follow the guidelines given below:

- Never use compressed air for cleaning.
- Use water to keep down the dust when cleaning.
- If there is danger that there may be asbestos dust in the air, operate the machine from an upwind position whenever possible.
- Use an approved respirator if necessary.



A0055060

### CRUSHING OR CUTTING PREVENTION

Do not enter, or put your hand or arm or any other part of your body between movable parts such as the work equipment and cylinders, or between the machine and work equipment.

If the work equipment is operated, the clearance will change and this may lead to serious damage or personal injury.

If it is necessary to go between movable parts, always lock the levers and be sure that the work equipment cannot move. For details, see "8. PRECAUTIONS FOR MAINTENANCE".



A0066090

### FIRE EXTINGUISHER AND FIRST AID KIT

Always follow the precautions below to prepare for action if any injury or fire should occur.

- Be sure that fire extinguishers have been provided and read the labels to ensure that you know how to use them.
- Provide a first aid kit at the storage point. Carry out periodic checks and add to the contents if necessary.
- Know what to do in the event of a fire or injury.
- Decide the phone numbers of persons (doctor, ambulance, fire station, etc.) to contact in case of an emergency. Post these contact numbers in specified places and make sure that all personnel know the numbers and correct contact procedures.

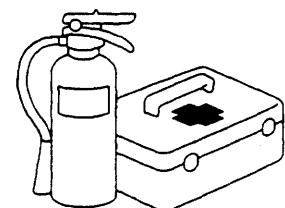

A0055070

**PRECAUTIONS FOR ATTACHMENTS**

- When installing and using an optional attachment, read the instruction manual for the attachment and the information related to attachments in this manual.
- Do not use attachments that are not authorized by Komatsu or your Komatsu distributor. Use of unauthorized attachments could create a safety problem and adversely affect the proper operation and useful life of the machine.
- Any injuries, accidents, product failures resulting from the use of unauthorized attachments will not be the responsibility of Komatsu.

**VENTILATION FOR ENCLOSED AREAS**

Exhaust fumes from the engine can kill.

- If it is necessary to start the engine within an enclosed area, or you handle fuel, flushing oil, or paint, open the doors and windows to ensure that you provide adequate ventilation to prevent gas poisoning.
- If opening the doors and windows still does not provide adequate ventilation, set up fans.

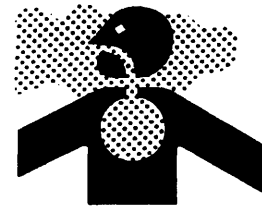

A0055060

**PRECAUTIONS WITH CAB GLASS**

If by mistake the cab glass on the work equipment side should crack, there is danger of direct contact between the operator's body and the work equipment. This is extremely dangerous. If the glass is cracked, stop operations immediately and replace the glass.

**EMERGENCY EXIT FROM OPERATOR'S CAB**

- If it should become impossible to open the door, break the window glass with the attached hammer, then escape.
- When escaping, remove the broken pieces of the glass from the sash so that you will not cut yourself with them. Take care not to slip on the broken and scattered pieces.

Part No. of hammer: 20U-54-25910

Escaping method → See "11.7 HAMMER FOR EMERGENCY ESCAPE".

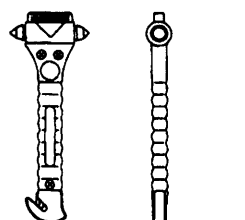

Hammer AE301608

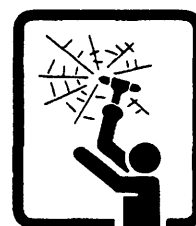

AE301610

## 7. PRECAUTIONS DURING OPERATION

**⚠ WARNING:** Failure to follow these safety precautions may lead to a serious accident.

### 7.1 BEFORE STARTING ENGINE

#### SAFETY AT WORKSITE

- Before starting operations, thoroughly check the area for any unusual conditions that could be dangerous.
- Check the terrain and condition of the ground at the worksite, and determine the best and safest method of operation.
- Make the ground surface as hard and horizontal as possible before carrying out operations. If the jobsite is dusty, spray water before starting operations.
- If you need to operate on a road, protect pedestrians and cars by designating a person for worksite traffic duty or by installing fences and putting up No Entry signs around the worksite.
- If water lines, gas lines, or high-voltage electrical lines may be buried under the worksite, contact each utility and identify their locations. Be careful not to sever or damage any of these lines.
- Check the ground condition and the depth and flow of water before operating in water or crossing a river. NEVER be in water which is in excess of the permissible water depth.  
Permissible water depth → See "12.10 PRECAUTIONS FOR OPERATION".

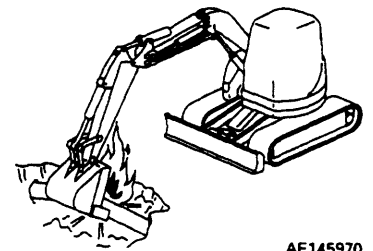

AE145970

#### CHECKS BEFORE STARTING ENGINE

Carry out the following checks before starting the engine at the beginning of the days work. Failure to carry out these checks may lead to serious injury or damage.

- Completely remove all flammable materials accumulated around the engine and battery, return all fuel containers to their proper place, remove all parts and tools from the operator's compartment, and remove any dirt from the mirrors, handrails, and steps.  
Walk-around checks → See "12.1.1 WALK-AROUND CHECK".
  - Check the coolant level, fuel level, and oil level in the hydraulic tank, check for clogging of the air cleaner, and check the electric wiring.  
Checks before starting → See "12.1.2 CHECK BEFORE STARTING".
  - Adjust the operator's seat to a position where it is easy to carry out operations, and check for wear or damage to the seat belt and seat belt mounting equipment.  
Adjusting operator's seat → See "12.1.3 ADJUSTING BEFORE STARTING OPERATION".  
Seat belt → See "28. USING SEAT BELT".
  - Check that the gauges work properly, and check that the control levers are all at the NEUTRAL position.  
Method of checking operation of gauges →  
See "12.1.4 OPERATIONS AND CHECKS BEFORE STARTING ENGINE".
  - Check that the mirrors and window glass provide a clear view.
- If the above inspections show any abnormality, carry out repairs immediately.



A0055020

**WHEN STARTING ENGINE**

- Walk around your machine again just before mounting it, and check for people and objects that might be in the way.
- Never start the engine if a warning tag has been attached to the blade control lever.
- When starting the engine, sound the horn as an alert.
- Start and operate the machine only while seated.
- An additional worker may ride in the machine only when sitting in the passenger seat. Do not allow anyone to ride on the machine body.
- Do not short circuit the starting motor circuit to start the engine. It is not only dangerous, but will also cause damage to the equipment.

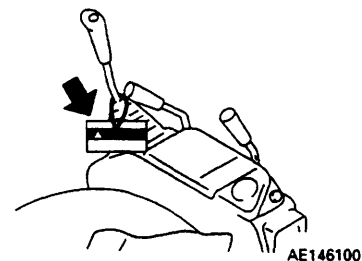
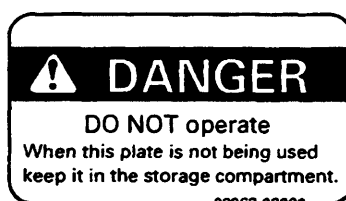

**▲ WARNING:** Failure to follow these safety precautions may lead to a serious accident.

## 7. PRECAUTIONS DURING OPERATION

### 7.2 AFTER STARTING ENGINE

#### CHECKS AFTER STARTING ENGINE

Failure to carry out the checks properly after starting the engine will lead to delays in discovery of abnormalities, and this may lead to serious injury or damage to the machine.

When carrying out the checks, use a wide area where there are no obstructions. Do not allow anyone near the machine.

- Check the operation of the gauges and equipment, and check the operation of the blade, ripper, brakes, travel system, and steering system.
- Checks for any abnormality in the sound of the machine, vibration, heat, smell, or gauges; check also that there is no leakage of air, oil, or fuel.
- If any abnormality is found, carry out repairs immediately.  
If the machine is used when it is not in proper condition, it may lead to serious injury or damage to the machine.

#### PRECAUTIONS WHEN STARTING OFF

Check the direction of the track frame before operating the travel lever.

- When the blade is at the rear of the machine, the operation of the travel lever is reversed, so operate the machine carefully.  
**Method of steering machine → See "12.4 MOVING MACHINE OFF".**

Before moving the machine off, check again that there are no persons or obstacles in the surrounding area.

- When moving the machine off, sound the horn to warn people in the surrounding area.
- Always sit in the operator's seat when driving the machine.
- Fasten your seat belt securely.
- The operator must not let any other person sit anywhere except in the assistant's seat.
- Always close the door of the operator's cab and check that the door is locked in position securely.

Travel in reverse direction

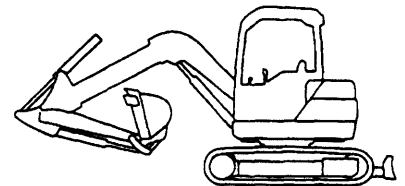

AE145981

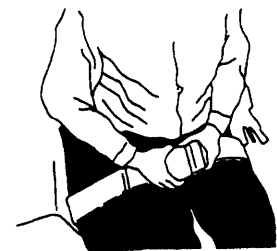

AE305800

#### CHECK WHEN CHANGING DIRECTION

To prevent serious injury or death, always do the following before moving the machine or doing the leveling work.

- Before changing between forward and reverse, reduce speed and stop the machine.
- Before operating the machine, sound the horn to warn people in the area.
- Check that there is no one near the machine. Be particularly careful to check behind the machine.
- When operating in areas that may be hazardous or have poor visibility, designate a person to direct worksite traffic.
- Ensure that no unauthorized person can come within the direction of turning or direction of travel.  
Always be sure to carry out the above precautions even when the machine is equipped with mirrors.

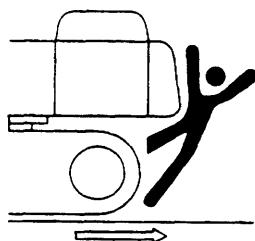

A0067190

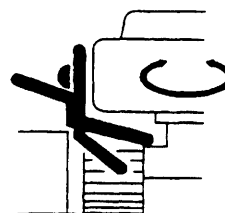

A0067200



### PRECAUTIONS WHEN TRAVELING

- Never turn the key in the starting switch to the OFF position when traveling. It is dangerous if the engine stops when the machine is traveling, because it becomes impossible to operate the steering.
- It is dangerous to look around you when operating. Always concentrate on your work.
- It is dangerous to drive too fast, or to start suddenly, stop suddenly, turn sharply, or zigzag.
- If you find any abnormality in the machine during operation (noise, vibration, smell, incorrect gauges, air leakage, oil leakage, etc.), move the machine immediately to a safe place and look for the cause.
- Set the work equipment to a height of 40 – 50 cm (16 – 20 in) from the ground level and travel on level ground.
- When traveling, do not operate the work equipment control levers. If the work equipment control levers have to be operated, never operate them suddenly.
- Do not operate the steering suddenly. The work equipment may hit the ground surface and cause the machine to lose its balance, or may damage the machine or structures in the area.
- When traveling on rough ground, travel at low speed, and avoid sudden changes in direction.
- Avoid traveling over obstacles as far as possible. If the machine has to travel over an obstacle, keep the work equipment as close to the ground as possible and travel at low speed. Never travel over obstacles which make the machine tilt strongly (10° or more).
- When traveling or carrying out operations, always keep your distance from other machines or structures to avoid coming into contact with them.
- NEVER be in water which is in excess of the permissible water depth.  
**Permissible water depth → See "12.10 PRECAUTIONS FOR OPERATION".**
- When passing over bridges or structures on private land, check first that the structure is strong enough to support the mass of the machine. When traveling on public roads, check first with the relevant authorities and follow their instructions.

Travel posture

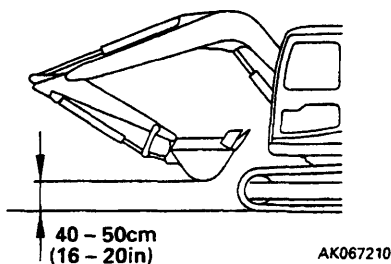

INCORRECT

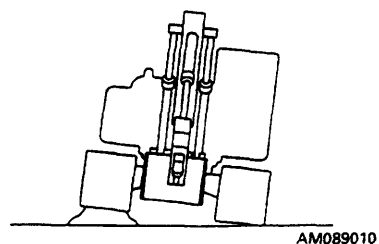

**▲ WARNING:** Failure to follow these safety precautions may lead to a serious accident.

## 7. PRECAUTIONS DURING OPERATION

### TRAVELING ON SLOPES

- Traveling on slopes could result in the machine tipping over or slipping to the side.
- When traveling on slopes, keep the blade approximately 20 – 30 cm (8 – 12 in) above the ground. In case of emergency, quickly lower the bucket to the ground to help the machine to stop.
- Do not turn on slopes or travel across slopes. Always go down to a flat place to perform these operations.

**Method of traveling on slopes → See "12.11 PRECAUTIONS WHEN TRAVELING UP OR DOWN HILLS".**

- Do not travel on grass, fallen leaves, or wet steel plates. Even slight slopes may cause the machine to slip to the side, so travel at low speed and make sure that the machine is always traveling directly up or down the slope.
- If the engine stops on a slope, place the travel lever at the neutral position and lower the bucket to the ground. Do not operate the steering. There is danger that the machine will turn under its own weight.

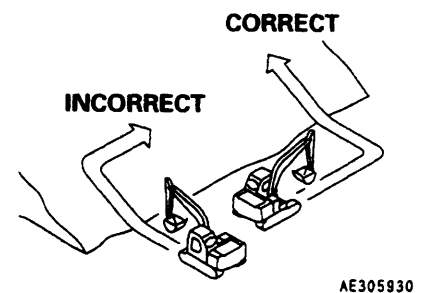
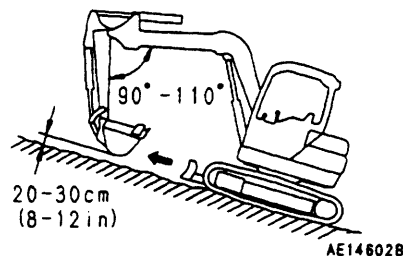
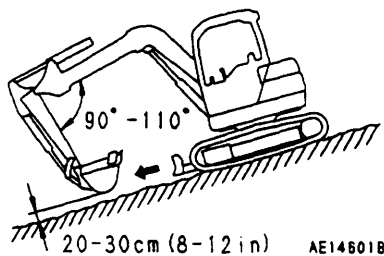

### PROHIBITED OPERATIONS

- Do not dig the work face under an overhang. This may cause the overhang to collapse and fall on top of the machine.
- Do not carry out deep digging under the front of the machine. The ground under the machine may collapse and cause the machine to fall. Take emergencies into consideration and set with the travel motor at the rear and the track (undercarriage) at right angles to the road shoulder before digging to enable the machine to move back quickly. If the ground under the machine collapses and there is no time to drive in reverse, do not suddenly raise the arm and boom. In some cases, it may in fact be safer to lower the arm and boom.
- Do not swing the work equipment to the side when it is carrying a heavy load. The stability to the side is less than the stability to the front, so there is danger that the machine may turn over.
- Limits on use

To prevent accidents caused by breakage of the work equipment or tipping over of the machine under excessive load, do not use the machine in excess of its capacity. Always be sure to keep within the maximum specified load and safe angle determined for the structure.

INCORRECT

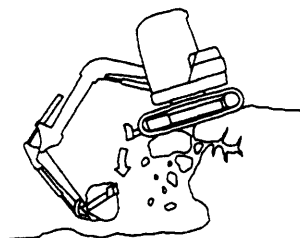

INCORRECT

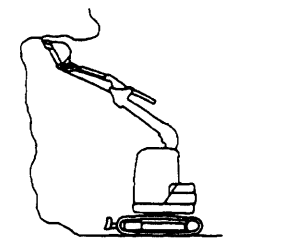

**PRECAUTIONS WHEN OPERATING**

- Be careful not to approach too close to the edge of cliffs.
- Carry out only work that is specified as the purpose of the machine.  
Carrying out other operations will cause breakdowns.  
**Specified operations → See "12.13 WORK POSSIBLE USING HYDRAULIC EXCAVATOR".**
- Do the following to ensure good visibility.
  - When operating in dark places, turn on the working lamps and front lamps, and install lighting at the jobsite if necessary.
  - Do not carry out operations in fog, mist, snow, or heavy rain, or other conditions where the visibility is poor. Wait for the weather to clear so that visibility is sufficient to carry out work.
- Always do as follows to prevent the work equipment from hitting other objects.
  - When operating in tunnels, under bridges, under electric wires, or other places where the height is limited, be extremely careful not to let the bucket, boom, or arm hit anything.
  - To prevent accidents caused by hitting other objects, always operate the machine at a speed which is safe for operation, particularly in confined spaces, indoors, and in places where there are other machines.
  - Never pass the bucket over the head of any worker or over the operator's cab on a dump truck.

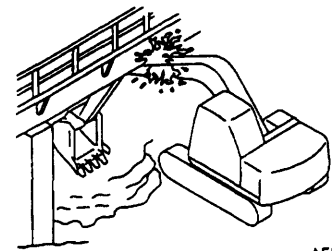

AE305810

**DO NOT GO CLOSE TO HIGH-VOLTAGE CABLES**

- Do not let the machine touch overhead electric cables. Even going close to high-voltage cables can cause electric shock. Always maintain the safe distance given below between the machine and the electric cable.
- To prevent accidents, always do as follows.
  - On jobsites where there is danger that the machine may touch the electric cables, consult the electricity company before starting operations to check that the actions determined by the relevant laws and regulations have been taken.
  - Wear rubber shoes and gloves. Lay a rubber sheet on top of the operator's seat, and be careful not to touch the chassis with any exposed part of your body.
  - Use a signalman to give warning if the machine approaches too close to the electric cables.
  - If the work equipment should touch the electric cable, the operator should not leave the operator's compartment.
  - When carrying out operations near high voltage cables, do not let anyone come close to the machine.
  - Check with the electricity company about the voltage of the cables before starting operations.
  - Keep the following safety distance between the machine and an electric cable.

	Voltage	Min. safety distance
Low voltage	100 - 200 V	2 m
	6,600 V	2 m
Very high voltage	22,000 V	3 m
	66,000 V	4 m
	154,000 V	5 m
	187,000 V	6 m
	275,000 V	7 m
	500,000 V	11 m

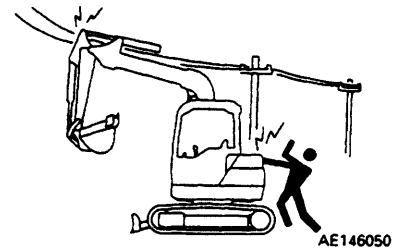

**OPERATE CAREFULLY ON SNOW**

- When working on snow or icy roads, even a slight slope may cause the machine to slip to the side, so always travel at low speed and avoid sudden starting, stopping, or turning. There is danger of slipping particularly on uphill or downhill slopes.
- With frozen road surfaces, the ground becomes soft when the temperature rises, so the travel conditions become unstable. In such cases be extremely careful when traveling.
- When there has been heavy snow, the road shoulder and objects placed beside the road are buried in the snow and cannot be seen, so always carry out operations carefully. When traveling on snow-covered slopes, never apply the brakes suddenly. Reduce the speed and use the engine as a brake while applying the foot brake intermittently (depress the brake intermittently several times). If necessary, lower the bucket to the ground to stop the machine.
- The load varies greatly according to the characteristics of the snow, so adjust the load accordingly and be careful not to let the machine slip.

**WORKING ON LOOSE GROUND**

- Do not operate the machine on soft ground. It is difficult to get the machine out again.
- Avoid operating your machine too close to the edge of cliffs, overhangs, and deep ditches. If these areas collapse under the mass or vibration of your machine, it could fall or tip over and this could result in serious injury or death. Remember that the soil after heavy rain, blasting, or earthquakes is weakened in these areas.
- Earth laid on the ground and the soil near ditches is loose. It can collapse under the mass or vibration of your machine and cause your machine to tip over.
- Install the head guard (FOPS) when working in areas where there is danger of falling stones.
- Install the ROPS and wear the seat belt when working in areas where there is danger of falling rocks or of the machine turning over.

**PRECAUTIONS WHEN WORKING ON SLOPES**

- When working on slopes, there is danger that the machine may lose its balance and turn over when the swing or work equipment are operated. Always carry out these operations carefully.
- Do not swing the work equipment from the uphill side to the downhill side when the bucket is loaded. This operation is dangerous.
- If the machine has to be used on a slope, pile the soil to make a platform that will keep the machine as horizontal as possible.

**Piled soil on slope → See "12.12 PRECAUTIONS WHEN TRAVELING UP OR DOWN HILLS".**

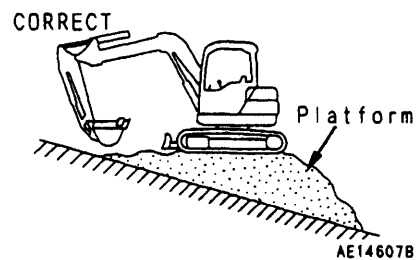
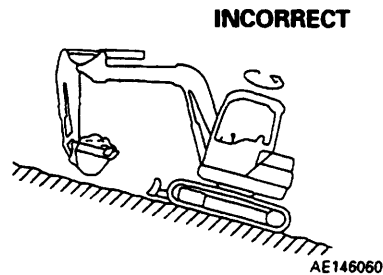

### PARKING MACHINE

- Park the machine on level ground where there is no danger of falling rocks or landslides, or of flooding if the land is low, and lower the work equipment to the ground.
- If it is necessary to park the machine on a slope, set blocks under the tracks to prevent the machine from moving, then dig the work equipment into the ground.
- After stopping the engine, operate the right work equipment control lever several times to the RAISE and LOWER positions to release the remaining pressure in the hydraulic circuit.
- When parking on public roads, provide fences, signs, flags, or lights, and put up any other necessary signs to ensure that passing traffic can see the machine clearly, and park the machine so that the machine, flags, and fences do not obstruct traffic.  
**Parking procedure → See "12.15 PARKING MACHINE".**
- When leaving the machine, set the safety lock lever ① to the LOCK position, stop the engine, and use the key to lock all the equipment. Always remove the key and take it with you.  
**Work equipment posture → See "12.15 PARKING MACHINE".**  
**Locks → See "12.19 LOCKING".**
- Always close the door of the operator's compartment.

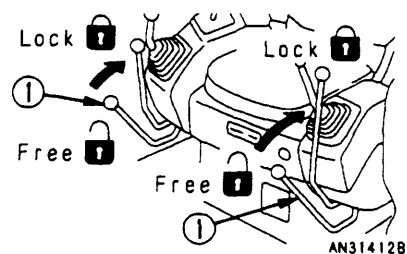
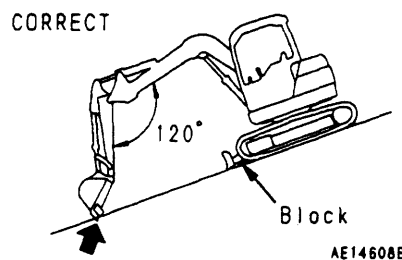

### PRECAUTIONS IN COLD AREAS

- After completing operations, remove all water, snow, or mud stuck to the wiring harness, connector ①, switches, or sensors, and cover these parts.  
If the water freezes, it will cause malfunctions of the machine when it is next used, which may lead to unexpected accidents.
- Carry out the warming-up operation thoroughly. If the machine is not thoroughly warmed up before the control levers are operated, the reaction of the machine will be slow, and this may lead to unexpected accidents.
- Operate the control levers to relieve the hydraulic pressure (raise to above the set pressure for the hydraulic circuit and release the oil to the hydraulic tank) to warm up the oil in the hydraulic circuit. This ensures good response from the machine and prevents malfunctions.
- If the battery electrolyte is frozen, do not charge the battery or start the engine with a different power source. There is danger that this will ignite the battery.  
When charging or starting the engine with a different power source, melt the battery electrolyte and check for leakage of battery electrolyte before starting.  
**Battery charge rate → See "14. COLD WEATHER OPERATION".**

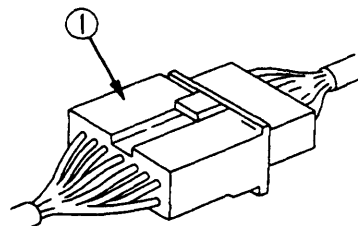

## 7.3 TRANSPORTATION

### PRECAUTIONS FOR TRANSPORTATION

- When transporting the machine, follow the relevant rules and regulations, and take steps to ensure safety.
- When selecting the transportation route, take into consideration the maximum width, height, and weight of the machine when loaded on the trailer.  
**Height, width, weight when loaded → See "13. TRANSPORTATION".**
- When passing over bridges or structures on private land, check first that the structure is strong enough to support the weight of the machine. When traveling on public roads, check first with the relevant authorities and follow their instructions.
- For machines equipped with a cab, always lock the door securely.
- The machine can be divided into units for transportation, so please contact your Komatsu distributor when transporting.  
**Transportation posture → See "13. TRANSPORTATION".**

## 7.4 BATTERY

### BATTERY HAZARD PREVENTION

Battery electrolyte contains sulphuric acid, and batteries generate hydrogen gas, so mistaken handling can lead to serious injury or fire. For this reason, always observe the following precautions.

- Never bring any lighted cigarette or flame near the battery.
- When working with batteries, ALWAYS wear safety glasses and rubber gloves.
- If you spill acid on your clothes or skin, immediately flush the area with large amounts of water.
- Battery acid could cause blindness if splashed into the eyes. If acid gets into your eyes, flush them immediately with large quantities of water and see a doctor at once.
- If you accidentally drink electrolyte, drink a large quantity of water or milk, beaten egg or vegetable oil. Call a doctor or poison prevention center immediately.
- Before working with batteries, stop the engine and turn the starting switch to the OFF position.
- Avoid short-circuiting the battery terminals (between the positive ⊕ terminal and negative ⊖ terminal) through accidental contact with metal objects, such as tools.
- When installing the battery, connect the positive ⊕ terminal first, and when removing the battery, disconnect the negative ⊖ terminal (ground side) first.
- When removing or installing, check which is the positive ⊕ terminal and negative ⊖ terminal, and tighten the nuts securely.  
If the battery electrolyte is near the LOWER LEVEL, add distilled water. Do not add distilled water above the UPPER LEVEL.
- When cleaning the top surface of the battery, wipe it with a damp cloth. Never use gasoline, thinner, or any other organic solvent or cleaning agent.
- Tighten the battery caps securely.
- If the battery electrolyte is frozen, do not charge the battery or start the engine with a different power source. There is danger that this will ignite the battery.  
When charging or starting the engine with a different power source, melt the battery electrolyte and check for leakage of battery electrolyte before starting.
- Always remove the battery from the chassis before charging it.

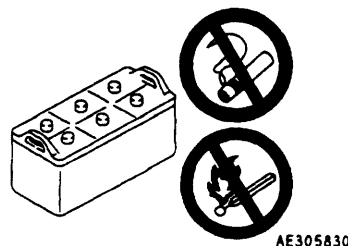
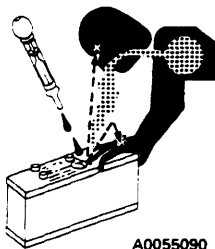



### STARTING WITH BOOSTER CABLES

If any mistake is made in the method of connecting the booster cables, it may cause a fire, so always do as follows.

- Carry out the starting operation with two workers (with one worker sitting in the operator's seat).
- When starting from another machine, do not allow the two machines to touch.
- When connecting the booster cables, turn the starting switch OFF for both the normal machine and problem machine.
- Be sure to connect the positive  $\oplus$  cable first when installing the booster cables. Disconnect the ground or negative  $\ominus$  cable first when removing them.
- The final ground connection is the connection of the ground to the engine block of the problem machine. However, this will cause sparks, so be sure to connect it as far as possible from the battery.

**Starting procedure when using booster cables → See "16.4 IF BATTERY IS DISCHARGED".**

- When removing the booster cables, be careful not to let the booster cable clips touch each other or to let the clips touch the machine.

**INCORRECT**

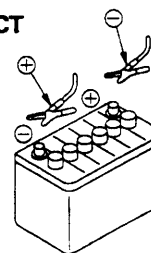

A0067320

### CHARGING BATTERY

If the battery is handled incorrectly when it is being charged, there is danger that the battery may explode, so follow the instructions in HANDLING BATTERY and in the instruction manual for the charger, and always observe the following precautions.

- Carry out the charging in a well-ventilated place, and remove the battery caps. This disperses the hydrogen gas and prevents explosion.
- Set the voltage on the charger to match the voltage on the battery to be charged. If the voltage setting is wrong, it will cause the charger to overheat and catch fire, and this may lead to an explosion.

Connect the positive  $\oplus$  charging clip of the charger to the positive  $\oplus$  terminal of the battery, then connect the negative  $\ominus$  charging clip to the negative  $\ominus$  terminal of the battery. Be sure to tighten both terminals securely.

- If the battery charge is less than 1/10 of the rated charge, and high speed charging is carried out, set to a value below the rated capacity of the battery.

If there is an excessive flow of charging current, it may cause leakage or evaporation of the electrolyte, which may catch fire and explode.

**INCORRECT**

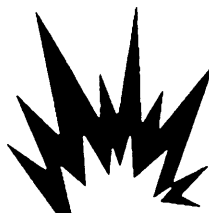

A0055110

## 7.5 TOWING

### WHEN TOWING

- Injury or death could result if a disabled machine is towed incorrectly or if there is a mistake in the selection of the wire rope, so always do as follows.
- Do not tow in a different way from the method given in the section "16.2 METHOD OF TOWING MACHINE".
- Always wear leather gloves when handling wire rope.
- When carrying out the preparation for towing with another worker, agree on signals before starting the operation.
- If the engine on the problem machine will not start or there is a failure in the brake system, please contact your Komatsu distributor for repairs.
- It is dangerous to tow a machine on a slope, so choose a place where there is a gradual slope. If there is no place with a gradual slope, carry out work to make the slope as small as possible.
- If a problem machine is towed by another machine, ALWAYS use a wire rope with a sufficient towing capacity for the weight of the problem machine.
- Do not use a wire rope which has cut strands (A), kinks (B), or reduced diameter (C).

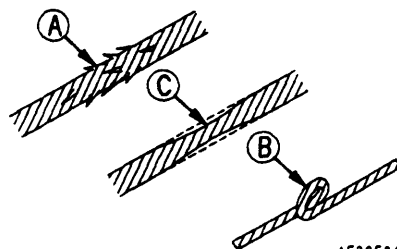

AE305840

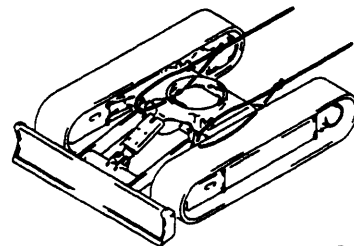

AE146090

## 7.6 LIFTING OPERATIONS

### PROHIBITIONS FOR LIFTING OPERATIONS

Do not use the work equipment to carry out lifting operations. In particular, do not do the following.

- Do not weld a hook to the bucket to lift a load.
- Do not fit a wire rope to the bucket teeth to lift a load.
- Do not wind a wire rope directly around the boom or arm to lift a load.

## 7.7 WINDOW WASHER FLUID

### TYPE OF WINDOW WASHER FLUID

Use window washer fluid of ethyl alcohol type.

The vapor of window washer fluid of methyl alcohol type may contain elements harmful to humans. Since the window washer fluid tank is installed inside the machine, use window washer fluid of ethyl alcohol type.

## 8. PRECAUTIONS FOR MAINTENANCE

**⚠ WARNING:** For reasons of safety, always follow these safety precautions.

### 8.1 BEFORE CARRYING OUT MAINTENANCE

#### NOTIFICATION OF FAILURE

Carrying out maintenance not described in the Komatsu operation and maintenance manual may lead to unexpected failures.  
Please contact your Komatsu distributor for repairs.

#### WARNING TAG

- ALWAYS attach the "DO NOT OPERATE" warning tag to the blade control lever in the operator's cab to alert others that you are working on the machine. Attach additional warning tags around the machine if necessary.
- If others start the engine, or touch or operate the blade control lever while you are performing service or maintenance, you could suffer serious injury or death.

Warning tag Part No. 09963-03000

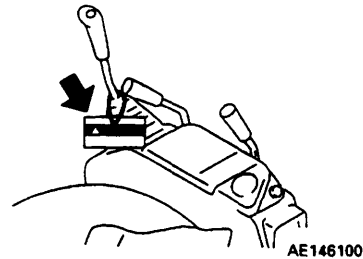
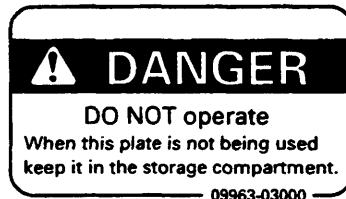

#### CLEAN BEFORE INSPECTION AND MAINTENANCE

- Clean the machine before carrying out inspection and maintenance. This will ensure that dirt does not get into the machine and will also ensure that maintenance can be carried out safely.
- If inspection and maintenance are carried out with the machine still dirty, it will be difficult to find the location of problems, and there is also the danger that you will get dirty or mud in your eyes, and that you will slip and injure yourself.
- When washing the machine, always do as follows.
  - Wear non-slip shoes to prevent yourself from slipping on the wet surface.
  - When using high-pressure steam to wash the machine, always wear protective clothing. This will protect you from being hit by high-pressure water, and cutting your skin or getting mud or dust into your eyes.
  - Do not spray water directly on to the electrical system (sensors, connectors) ①. If water gets into the electrical system, there is danger that it will cause defective operation and malfunction.

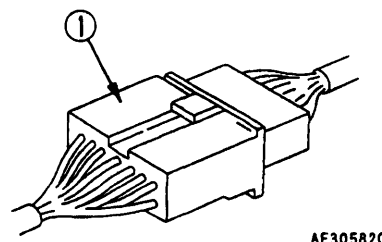
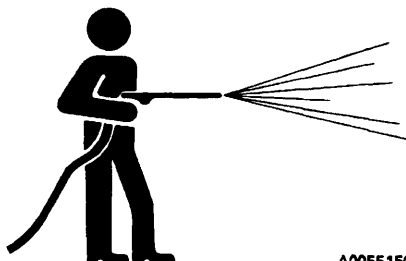

**⚠ WARNING:** Failure to follow these safety precautions may lead to a serious accident.

## 8. PRECAUTIONS FOR MAINTENANCE

### KEEP WORK PLACE CLEAN AND TIDY

Do not leave hammers or other tools lying around in the work place. Wipe up all grease, oil, or other substances that will cause you to slip. Always keep the work place clean and tidy to enable you to carry out operations safely.

If the work place is not kept clean and tidy, there is danger that you will trip, slip, or fall over and injure yourself.

### APPOINT LEADER WHEN WORKING WITH OTHERS

When repairing the machine or when removing and installing the work equipment, appoint a leader and follow his instructions during the operation.

When working with others, misunderstandings between workers can lead to serious accidents.

### RADIATOR WATER LEVEL

- When inspecting the radiator water level, stop the engine, and wait for the engine and radiator to cool down. Check the water level in the sub-tank. Under normal conditions, do not open the radiator cap.
- If there is no sub-tank, or the radiator cap must be removed, always do as follows.
- Wait for the radiator water temperature to go down before checking the water level. (When checking if the water temperature has gone down, put your hand near the engine or radiator and check the air temperature. Be careful not to touch the radiator or engine.)
- Release the internal pressure before removing the radiator cap, and remove the radiator cap slowly.

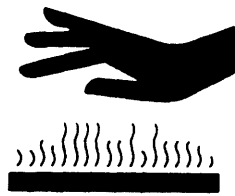

A0055050

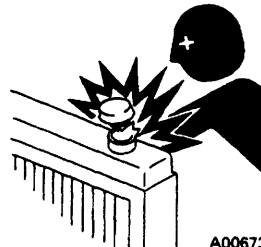

A0067380

### STOP ENGINE BEFORE CARRYING OUT INSPECTION AND MAINTENANCE

- When carrying out inspection and maintenance, park the machine on level ground where there is no danger of falling rocks or land slides, or of flooding if the land is low, then lower the work equipment to the ground and stop the engine.
- Operate the right-hand work equipment control lever several times to the RAISE and LOWER positions to release the remaining pressure in the hydraulic circuit, then set safety lock levers ① (Installed on only left side, if machine is equipped with cab) to the LOCK position.
- Put blocks under the track to prevent the machine from moving.
- The worker carrying out the maintenance should be extremely careful not to touch or get caught in the moving parts.

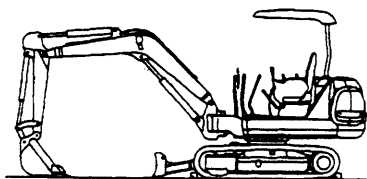

Blocks

AM31417B

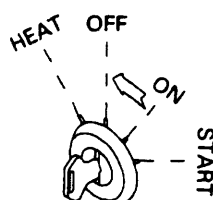

AM089160

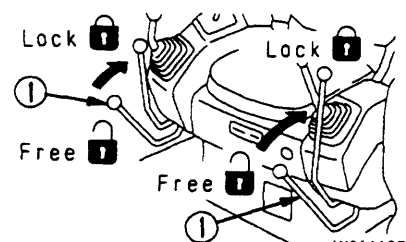

AN31412B

### PROPER TOOLS

Use only tools suited to the task. Using damaged, low quality, faulty, or makeshift tools could cause personal injury.

Broken pieces of chisels or hammers could fly into your eyes and blind you.

**Tools → See "21.1 INTRODUCTION OF NECESSARY TOOLS".**



A0055120

### PERIODIC REPLACEMENT OF SAFETY CRITICAL PARTS

Hoses and other parts of the fuel, hydraulic, and brake system are critical parts for ensuring safety, so they must be replaced periodically.

Replacement of safety critical parts requires skill, so please ask your Komatsu distributor to carry out replacement.

- Replace these components periodically with new ones, regardless of whether or not they appear to be defective.

These components deteriorate over time, and can cause fire because of oil leakage or failure in the work equipment system.

- Replace or repair any such components if any defect is found, even though they have not reached the time specified.

**Replacement of safety critical parts →**

**See "22. PERIODIC REPLACEMENT OF SAFETY CRITICAL PARTS".**

### USE OF LIGHTING

- When checking fuel, oil, or battery electrolyte, always use lighting with anti-explosion specifications.

If such lighting equipment is not used, there is danger of explosion.

- If work is carried out in dark places without installing lighting, there is danger of injury, so always install proper lighting.

- Even if it is dark, do not use a lighter or flame instead of lighting. There is danger of starting a fire, and if the battery gas ignites, it may cause an explosion.

- When using the machine as the power supply for the lighting, follow the instructions in this Operation and Maintenance Manual.

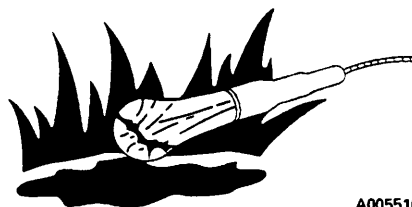

A0055160

**PREVENTION OF FIRE**

There is danger of the fuel and battery gas catching fire during maintenance, so always follow the precautions below when carrying out maintenance.

- Store fuel, oil, grease, and other flammable materials away from flame.
- Use non-flammable materials as the flushing oil for cleaning parts. Do not use diesel oil or gasoline. There is danger that they will catch fire.
- Never smoke when carrying out inspection or maintenance. Always smoke in the prescribed place.
- When checking fuel, oil, or battery electrolyte, always use lighting with anti-explosion specifications. Never use lighters or matches as lighting.
- When carrying out grinding or welding operations on the chassis, remove any flammable materials to a safe place.
- Be sure that a fire extinguisher is present at the inspection and maintenance point.



A0055020

## 8.2 DURING MAINTENANCE

### PERSONNEL

Only authorized personnel can service and repair the machine. Do not allow unauthorized personnel into the area. If necessary, employ an observer.

Extra precaution should be used when grinding, welding, and using a sledge-hammer.

### ATTACHMENTS

- Appoint a leader before starting removal or installation operations for attachments.
- Do not allow anyone other than the workers close to the machine or attachment.
- Place attachments that have been removed from the machine in a safe place so that they do not fall. Put a fence around the attachments, and set up No Entry signs to prevent unauthorized persons from coming close.



A0055130

### WORK UNDER THE MACHINE

- Stop the machine on firm, level ground, and always lower all work equipment to the ground before performing service or repairs under the machine.
- Always block the track shoes securely.
- It is extremely dangerous to work under the machine if the track shoes are off the ground and the machine is supported only by the work equipment. Never work under the machine if the machine is poorly supported.



A0055140

### WORK ON TOP OF MACHINE

- When carrying out maintenance on top of the machine, make sure that the footholds are clean and free of obstructions, and follow the precautions below to prevent yourself from falling.
  - Do not spill oil or grease.
  - Do not leave tools lying around.
  - Mind your step when you are walking.
- Never jump down from the machine. When getting on or off the machine, always use the steps and handrails, and maintain three-point contact (both feet and one hand or both hands and one foot) at all times.
- Use protective equipment if necessary.



AD305870

**⚠ WARNING:** Failure to follow these safety precautions may lead to a serious accident.

## 8. PRECAUTIONS FOR MAINTENANCE

### LOCKING INSPECTION COVERS

When carrying out maintenance with the inspection cover open, lock it securely with a lock bar. If maintenance is carried out with the inspection cover open and not locked in position, it may close suddenly if knocked or blown by the wind, and may cause injury to the operator.

### MAINTENANCE WITH ENGINE RUNNING

To prevent injury, do not carry out maintenance with the engine running. If maintenance must be carried out with the engine running, carry out the operation with at least two workers and do as follows.

- One worker must always sit in the operator's seat and be ready to stop the engine at any time. All workers must maintain contact with the other workers.
- When carrying out operations near rotating parts, there is danger of being caught in the parts, so be extremely careful.
- When cleaning inside the radiator, set safety lock levers ① (Installed on only left side, if machine is equipped with cab) to the LOCK position to prevent the work equipment from moving.
- Do not touch any control levers. If any control lever must be operated, always give a signal to the other workers to warn them to move to a safe place.
- Never touch the fan blade or fan belt with any tool or any part of your body. There is danger of serious injury.

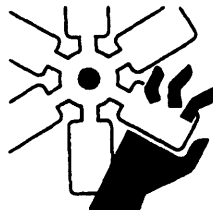

A0055210

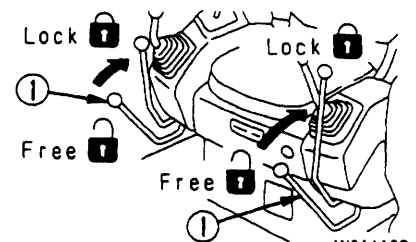

AN31412B

### DO NOT DROP TOOLS OR PARTS INSIDE MACHINE

- When opening the inspection window or tank oil filler to carry out inspection, be careful not to drop any nuts, bolts, or tools inside the machine. If such parts are dropped into the machine, it will cause breakage of the machine, mistaken operation, and other failures. If you drop any part into the machine, always be sure to remove it from the machine.
- When carrying out inspection, do not carry any unnecessary tools or parts in your pocket.

### PRECAUTIONS WHEN USING HAMMER

When using a hammer, always wear safety glasses, safety helmet, and other protective clothing, and put a brass bar between the hammer and the part being hammered. If hard metal parts such as pins, edges, teeth, or bearings are hit with a hammer, there is danger that broken pieces might fly into your eyes and cause injury.

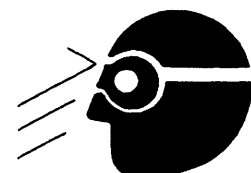

AE305880



### REPAIR WELDING

Welding operations must always be carried out by a qualified welder and in a place equipped with a proper equipment. Gas is generated, and there is danger of fire or electrocution when carrying out welding, so never allow any unqualified personnel to carry out welding.

The qualified welder must follow the precautions given below.

- Disconnect the battery terminals to prevent explosion of the battery.
- Remove the paint from the place being welded to prevent gas from being generated.
- If hydraulic equipment or piping, or places close to these are heated, flammable vapor or spray will be generated, and there is danger of this catching fire, so avoid applying heat to such places.
- If heat is applied directly to rubber hoses or piping under pressure, they may suddenly burst, so cover them with fireproof sheeting.
- Always wear protective clothing.
- Ensure that there is good ventilation.
- Clear up any flammable materials, and make sure that there is a fire extinguisher at the workplace.

### PRECAUTIONS WITH BATTERY

When repairing the electrical system or when carrying out electrical welding, remove the negative ⊖ terminal of the battery to stop the flow of current.

**Handling battery → See "16.4 IF BATTERY IS DISCHARGED".**

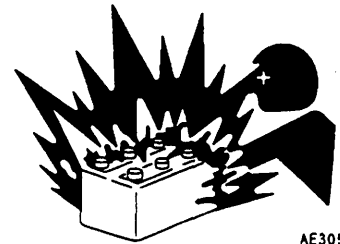

AE305890

### WHEN ABNORMALITY IS LOCATED

- If any abnormality is found during inspection, always carry out repairs. In particular, if the machine is used when there is any abnormality in the brakes or work equipment systems, it may lead to serious accident.
- Depending on the type of failure, please contact your Komatsu distributor for repairs.

### RULES TO FOLLOW WHEN ADDING FUEL OR OIL

If any flame is brought close to fuel or oil, there is danger that it will catch fire, so always follow the precautions below.

- Stop the engine when adding fuel or oil.
- Do not smoke.
- Spilled fuel and oil may cause you to slip, so always wipe it up immediately.
- Always tighten the cap of the fuel and oil fillers securely.
- Always add fuel and oil in a well-ventilated place.



A0055020



A0055030



A0055040

**⚠ WARNING:** Failure to follow these safety precautions may lead to a serious accident.

## 8. PRECAUTIONS FOR MAINTENANCE

### PRECAUTIONS WHEN USING HIGH-PRESSURE GREASE TO ADJUST TRACK TENSION

- Grease is pumped into the track tension adjustment system under high pressure. If the specified procedure for maintenance is not followed when making adjustment, valve ① may fly out and cause damage or personal injury.
- When loosening grease drain valve ①, never loosen it more than one turn.
- Never put your face, hands, feet, or any other part of your body directly in front of any grease drain valve.

Adjusting track tension → See "24.2 WHEN REQUIRED".

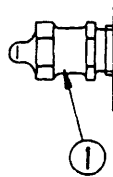
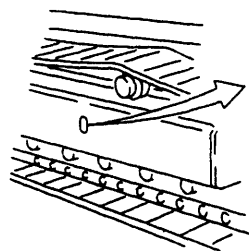

A8307180



A0055200

### HANDLING HIGH-PRESSURE HOSES

- If oil or fuel leaks from high-pressure hoses, it may cause fire or defective operation, which may lead to personal injury or damage. If any damaged hoses or loose bolts are found, stop work and contact your Komatsu distributor for repairs.
- Replacing high-pressure hoses requires a high level of skill, and the torque is determined according to the type of hose and size, so please do not carry out replacement yourself. Ask your Komatsu distributor to carry out replacement.

### PRECAUTIONS WITH HIGH-PRESSURE OIL

When inspecting or replacing high-pressure piping or hoses, always check that the pressure in the hydraulic circuit has been released. If the circuit is still under pressure, it will lead to serious injury or damage, so always do as follows.

- For details of the method of releasing the pressure, see "8.1 BEFORE CARRYING OUT MAINTENANCE, STOP ENGINE BEFORE CARRYING OUT INSPECTION AND MAINTENANCE". Never carry out inspection or replacement before releasing the pressure completely.
- Wear safety glasses and leather gloves.
- If there is any leakage from the piping or hoses, the piping, hoses, and the surrounding area will be wet, so check for cracks in the piping and hoses and for swelling in the hoses. If it is difficult to locate the leakage, always please contact your Komatsu distributor for repairs.
- If you are hit by a jet of high-pressure oil, consult a doctor immediately for medical attention.

INCORRECT



A0055180

CORRECT

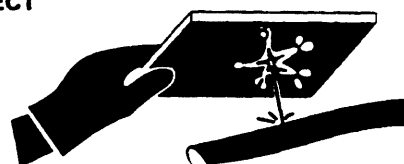

A0055190

### PRECAUTIONS WHEN CARRYING OUT MAINTENANCE AT HIGH TEMPERATURE

Immediately after stopping operations, the engine coolant, oil at all parts, the exhaust manifold, and the muffler are at high temperature.

In this condition, if the cap is removed, or the oil is drained, or the filters are replaced, this may result in burns or other injury. Wait for the temperature to go down, then carry out the inspection and maintenance in accordance with the procedures given in this manual.

**Cleaning inside of cooling system → See "24.2 WHEN REQUIRED".**

**Checking coolant level, oil level in hydraulic tank → see "24.3 CHECK BEFORE STARTING".**

**Checking lubricating oil level, adding oil → see "24.3-7 PERIODIC MAINTENANCE".**

**Changing oil, replacing filters → see "24.5-9 PERIODIC MAINTENANCE".**



A0055050

### CHECKS AFTER INSPECTION AND MAINTENANCE

Failure to carry out inspection and maintenance fully, or failure to check the function of various maintenance locations may cause unexpected problems and may even lead to personal injury or damage, so always do as follows.

- Checks when engine is stopped
  - Have all the inspection and maintenance locations been checked?
  - Have all the inspection and maintenance items been carried out correctly?
  - Have any tools or parts dropped inside the machine? It is particularly dangerous if they get caught in the lever linkage.
  - Has water and oil leakage been repaired? Have bolts been tightened?
- Checks when engine is running
 

For details of checks when the engine is running, see **"8.2 DURING MAINTENANCE, MAINTENANCE WITH ENGINE RUNNING"**, and be extremely careful to ensure safety.
- Do the inspection and maintenance locations work normally?
- Is there any oil leakage when the engine speed is raised and load is applied to the hydraulic system?

### WASTE MATERIALS

To prevent pollution, particularly in places where people or animals are living, always follow the procedures given below.

- Never dump waste oil in a sewer system, rivers, etc.
- Always put oil drained from your machine in containers. Never drain oil directly onto the ground.
- Obey appropriate laws and regulations when disposing of harmful objects such as oil, fuel, coolant, solvent, filters, and batteries.

**INCORRECT**

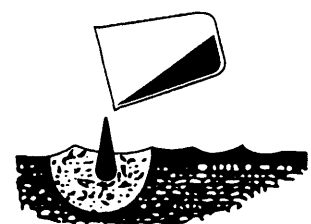

A0055220

## 9. POSITION FOR ATTACHING SAFETY LABELS

Always keep these labels clean. If they are lost or damaged, attach them again or replace them with a new label.

There are other labels in addition to the safety labels listed as follows, so handle them in the same way.

Safety labels may be available in languages other than English. To find out what labels are available, contact your Komatsu distributor.

### 9.1 POSITION FOR ATTACHING SAFETY LABELS

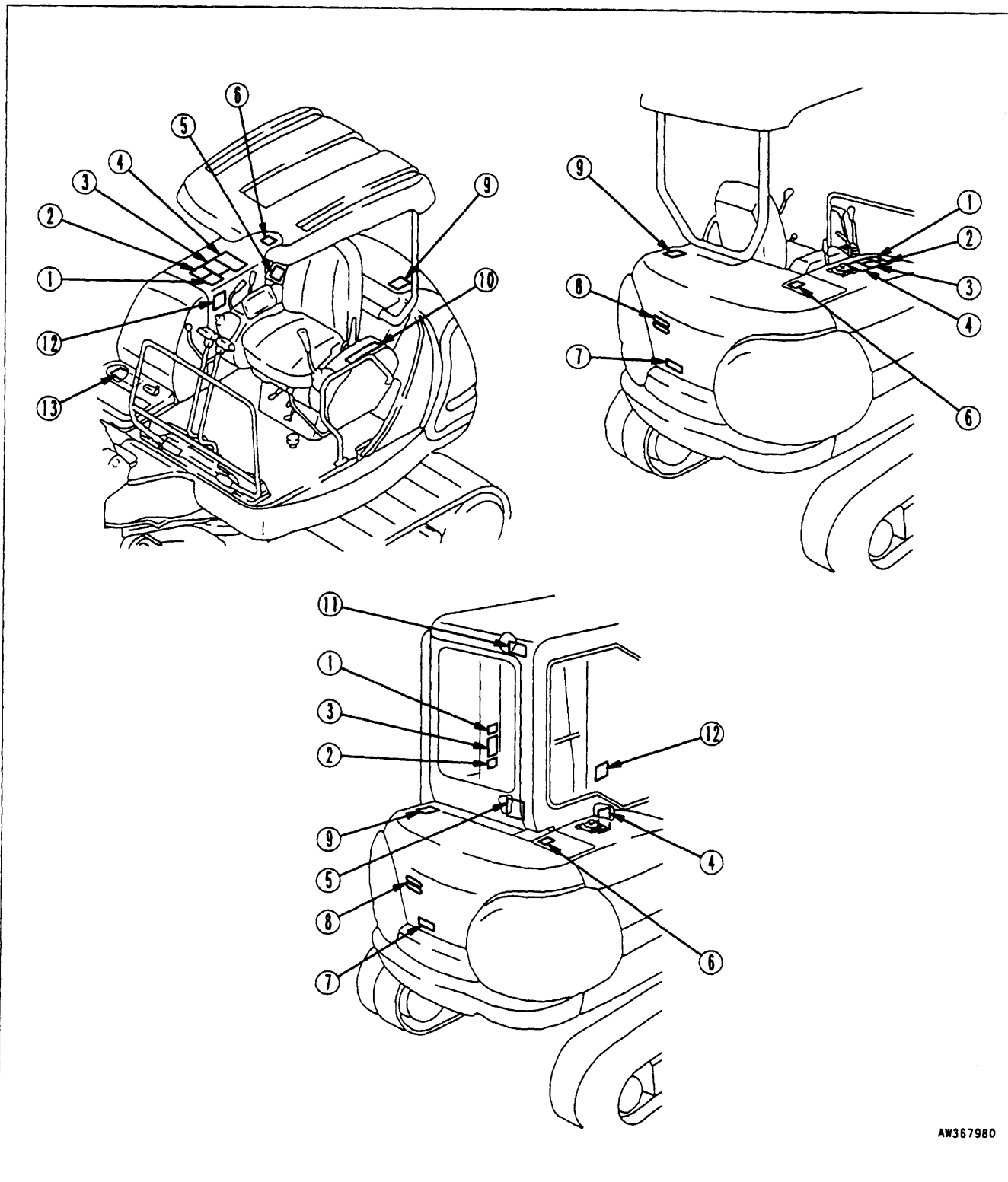

AW367980

## 9. POSITION FOR ATTACHING SAFETY LABELS

1. Warnings for leaving operator's seat  
(09654-03001)

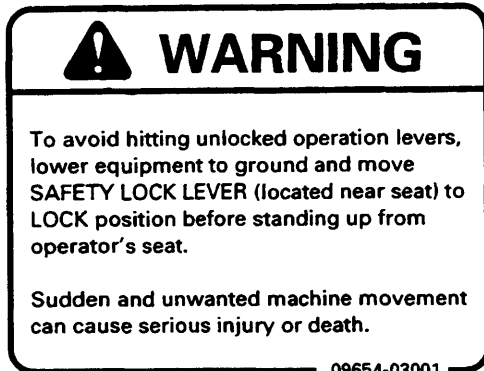

3. Warnings before operating machine  
(09802-33000)

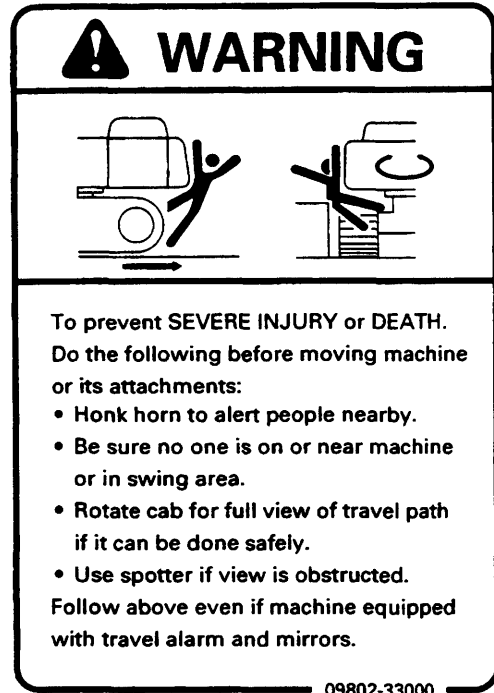

2. Warnings when adjusting track tension  
(09657-03001)

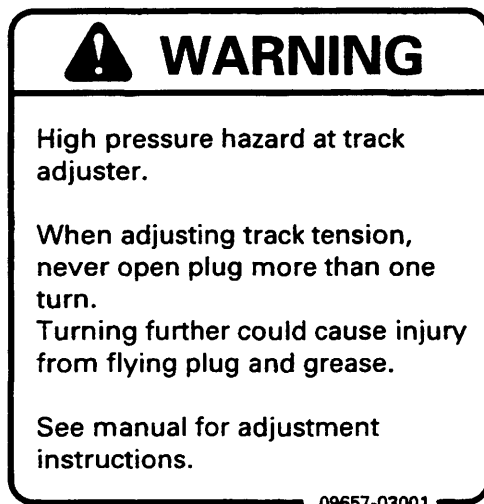

4. Warnings for operation, inspection and maintenance (09651-03001)

**⚠ WARNING**

Improper operation and maintenance can cause serious injury or death.

Read manual and labels before operation and maintenance.  
Follow instructions and warnings in manual and in labels on machine.

Keep manual in machine cab near operator.  
Contact Komatsu distributor for a replacement manual.

09651-03001

6. Warnings for hot water (09668-03001)

**⚠ WARNING**

Hot water hazard.

To prevent hot water from spurting out:

- Turn engine off.
- Allow water to cool.
- Slowly loosen cap to relieve pressure before removing.

09668-03001

7. Warnings when opening or closing engine hood (21W-98-21480)

**⚠ CAUTION**

WHILE ENGINE IS RUNNING

1. DO NOT OPEN COVER
2. KEEP AWAY FROM FAN AND FAN BELT

21W-98-21480

5. Warnings for high voltage (09801-03000)

**⚠ DANGER**



Hazardous voltage hazard.  
Serious injury or death can occur if machine or attachments are not kept safe distance away from electric lines.

Line voltage	Safe Disatnce
6.6 kv	At least 10 ft (3 m)
66.0 kv	At least 16 ft (5 m)
275.0 kv	At least 33 ft (10 m)

09801-03000

8. Keeping out of turning area (20M-98-73130)

**⚠ DANGER**

**KEEP OUT OF TURNING AREA**

9. POSITION FOR ATTACHING SAFETY LABELS

9. Warnings for high temperature hydraulic oil (09653-03001)

**! WARNING**

Hot oil hazard.

To prevent hot oil from spurting out:

- Turn engine off.
- Allow oil to cool.
- Slowly loosen cap to relieve pressure before removing.

09653-03001

11. Warnings when opening front window (Machine equipped with operator's cab only) (09803-03000)

**! WARNING**

When raising window, lock it in place with lock pins on both sides.

Falling window can cause injury.

09803-03000

10. Use the safety lock lever when engaging or disengaging the safety lock (20T-98-72530)

**! WARNING**

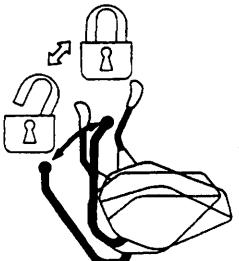

USE THE SAFETY LOCK LEVER WHEN ENGAGING OR DISENGAGING THE SAFETY LOCK. DO NOT USE THE WORKING EQUIPMENT LEVER.

THERE IS DANGER THAT THE WORK EQUIPMENT WILL SWING IF THE WORK EQUIPMENT CONTROL LEVER IS TOUCHED.

20T-98-72530

12. Operation pattern (09822-03000)

**! WARNING**

In order to prevent an accident resulting in injury or death caused by error-operation, confirm the machine motion and indicated operating pattern, when operating machine.

Pay attention to the circumference and operate slowly when confirming the machine motion.

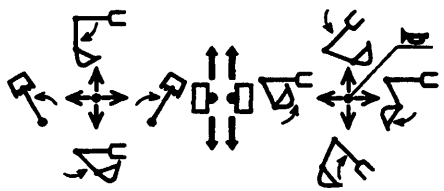

09822-03000

13. Warning for battery (09664-30083)

**! WARNING**

**POISON. causes severe burns**  
Contains sulfuric acid. Avoid contact with skin eyes or clothing. In event of accident flush with water and call a physician immediately. **KEEP OUT OF REACH OF CHILDREN**

**EXPLOSIVE GASES**  
Cigarettes flames or sparks could cause battery to explode. Always shield eyes and face from battery. Do not charge or use booster cables or adjust post connections without proper instruction and training. **KEEP VENT CAPS TIGHT AND LEVEL**

A210  
09664-30083

# **OPERATION**



# 10. GENERAL VIEW

## 10.1 GENERAL VIEW OF MACHINE

If directions are indicated in this section, they refer to the directions shown by the arrows in the diagram below.

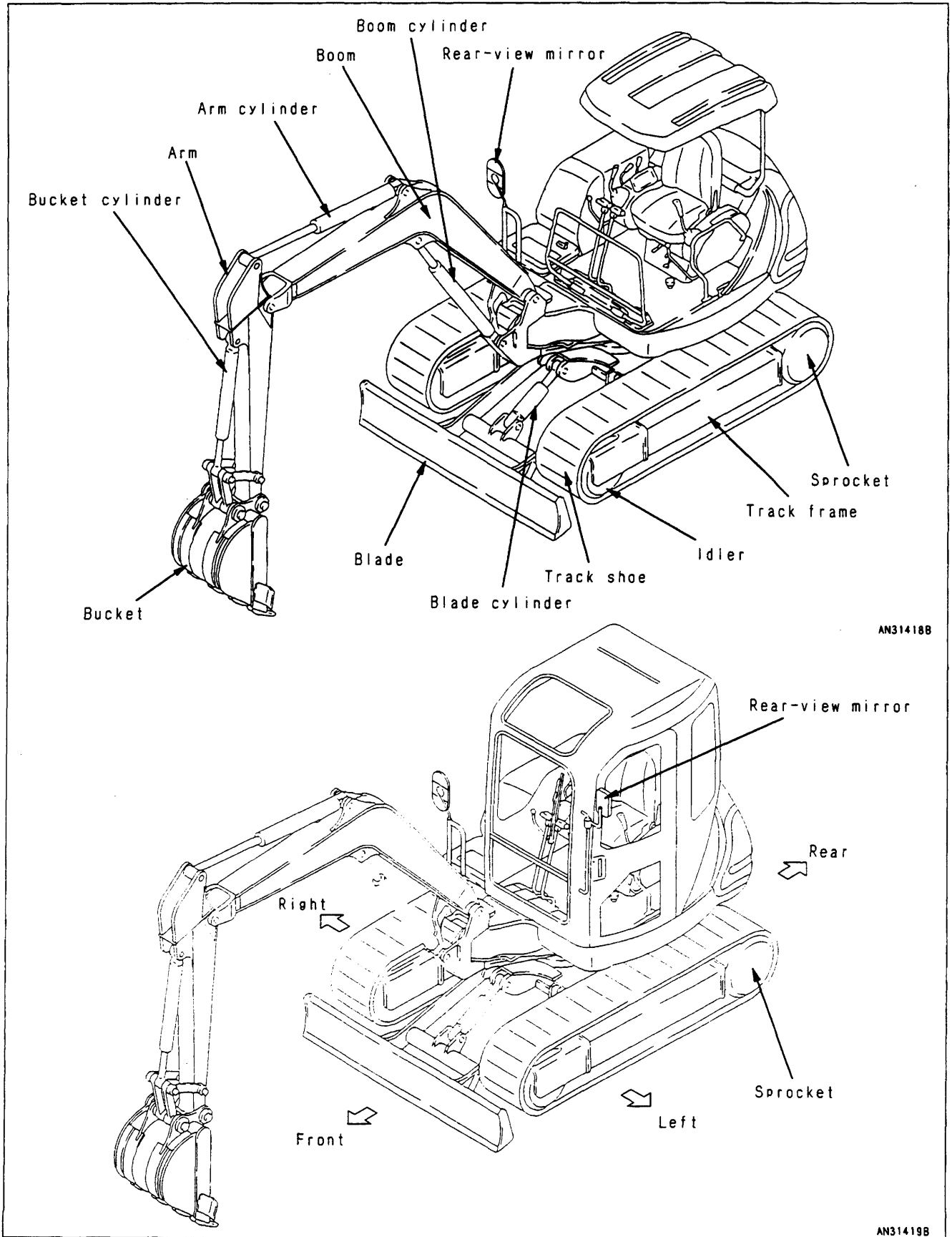

10.2 GENERAL VIEW OF CONTROLS AND GAUGES

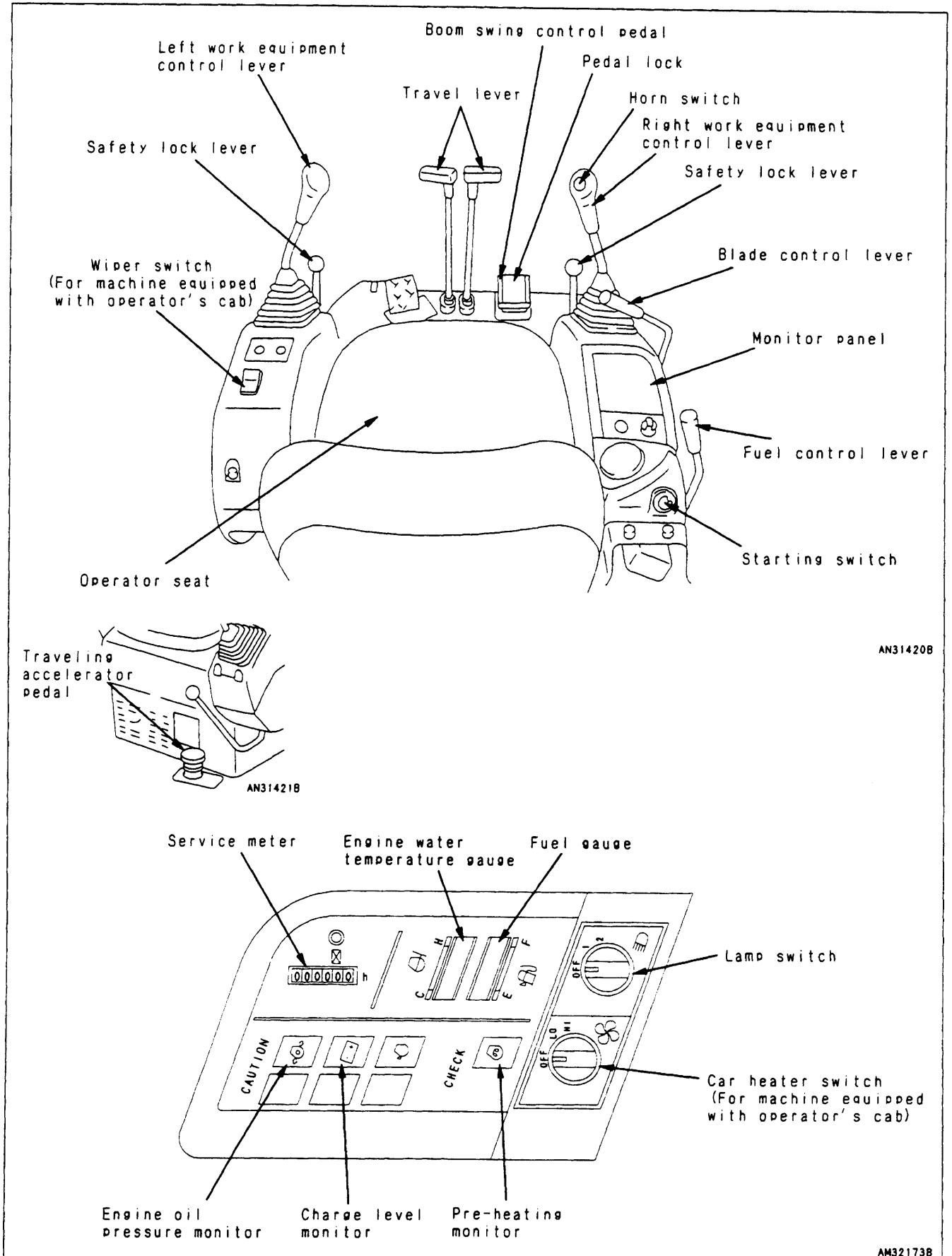

# 11. EXPLANATION OF COMPONENTS

The following is an explanation of the devices needed for operating the machine.

To carry out suitable operations correctly and safely, it is important to understand fully the methods of operating the equipment and the meanings of the displays.

## 11.1 MACHINE MONITOR

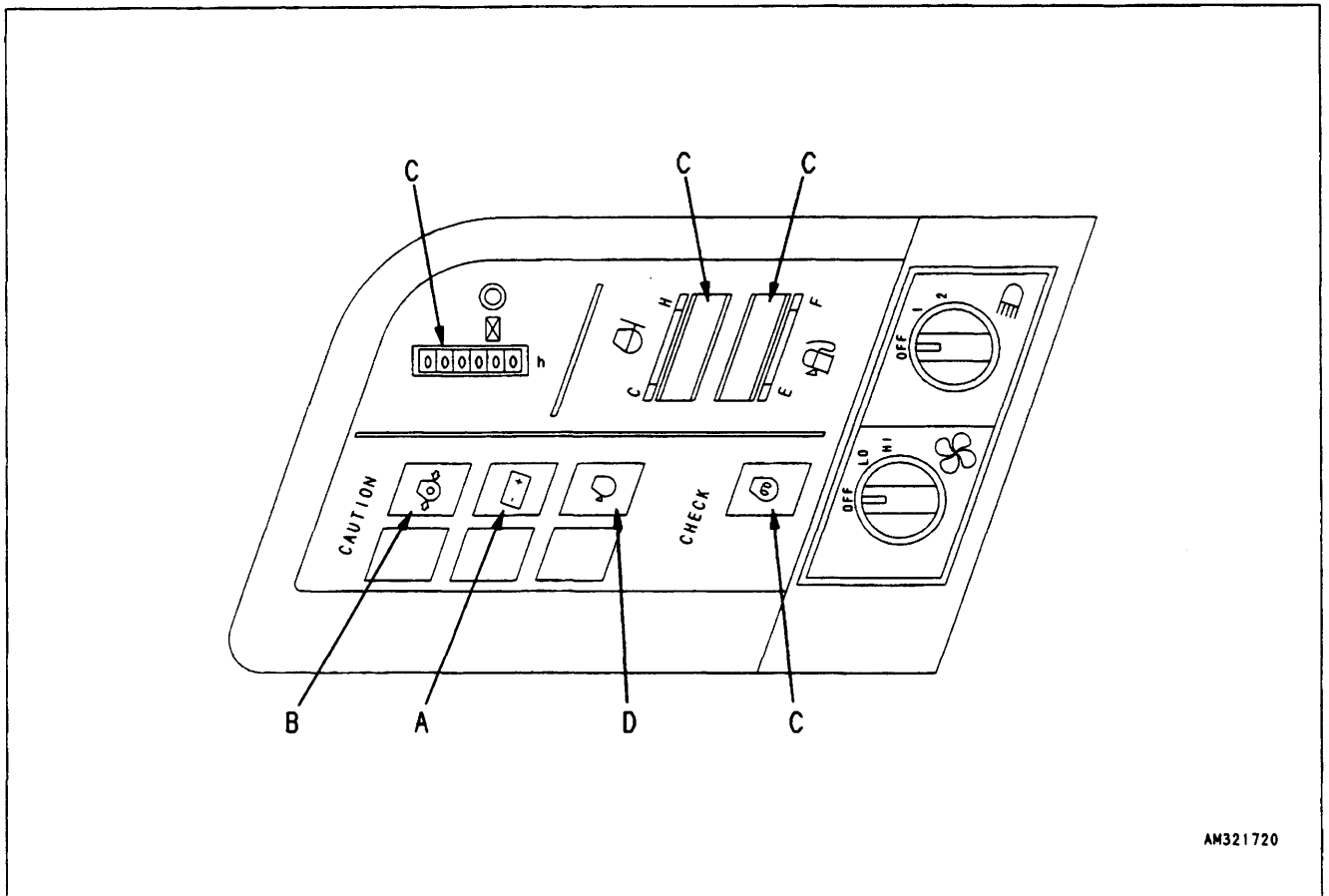

AM321720

### NOTICE

When carrying out checks before starting, do not simply rely on the monitor. Always refer to the periodic maintenance items or "12. OPERATION" to carry out the checks.

**A. CAUTION ITEMS (11.1.1)** **CAUTION**

**If these monitor items light up, check and repair the appropriate location as soon as possible.**

These are items which need to be observed while the engine is running. If any abnormality occurs, items which need to be repaired as soon as possible are displayed.

If there is any abnormality, the appropriate monitor lamp will flash to indicate the location of the abnormality and the buzzer will sound.

**B. EMERGENCY STOP ITEMS (11.1.2)** **CAUTION**

**If these monitor items light up, stop operations immediately, then check and repair the appropriate location.**

These are items which need to be observed while the engine is running. If any abnormality occurs, items which need to be repaired immediately are displayed.

If there is any abnormality, the appropriate monitor lamp will flash to indicate the location of the abnormality and the buzzer will sound.

**C. METER DISPLAY PORTION (11.1.3)**

This portion consists of pre-heating monitor, service meter, engine water temperature gauge and fuel gauge.

**D. NO MONITOR FUNCTION PORTION**

Although engine oil level monitor illustration is shown on the monitor panel, the machine does not have this function.

## 11. EXPLANATION OF COMPONENTS

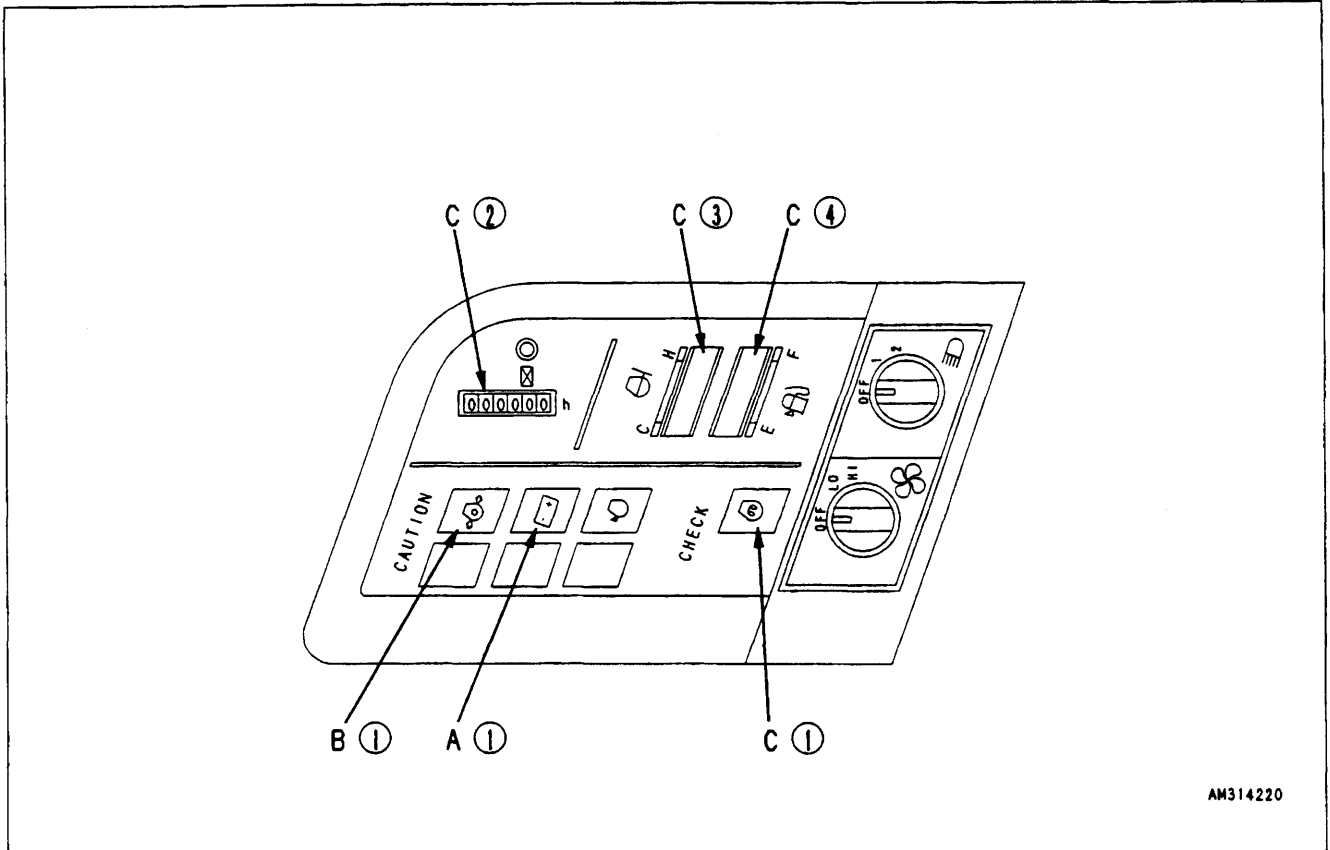

AM314220

### 12.1.1 A: CAUTION ITEMS

#### CAUTION

If the caution monitor lamp lights up, repair the problem as soon as possible.

#### 1. CHARGE LEVEL

This monitor indicates an abnormality in the charging system while the engine is running.

If the monitor lamp lights up, check the V-belt tension. If any abnormality is found, see "16.5 OTHER TROUBLE".

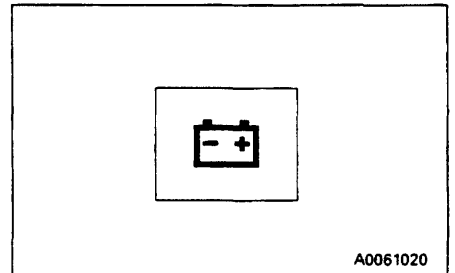

A0061020

#### REMARK

- While the starting switch is ON, the lamp will remain lit and will go off once the engine is started.
- When the engine is started or stopped with the starting switch at the ON position, the lamp may light up and the buzzer may sound momentarily, but this does not indicate any abnormality.

**11.1.2 B: EMERGENCY STOP ITEMS****CAUTION**

If any monitor lamp lights up, stop the engine or run it at low idling, and take the following action.

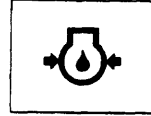

A0061010

**1. ENGINE OIL PRESSURE**

If the engine oil pressure drops below the normal pressure, the monitor lamp lights up. At this item, stop the engine and inspect it according to "16.5 OTHER TROUBLE."

**REMARK**

This lamp lights up when the start switch is turned on, and goes off when the engine starts. When the engine is started, this lamp may go off and the buzzer may sound momentarily, however, this does not indicate a problem.

**11.1.3 C: METER DISPLAY PORTION****1. ENGINE PRE-HEATING MONITOR**

This monitor lamp indicates the pre-heating time required when starting the engine at an ambient temperature below 0°C.

The monitor lamp lights when the starting switch is turned to HEAT position and flashes after about 18 seconds to show that the pre-heating is completed.

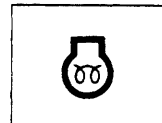

A0061050

## 11. EXPLANATION OF COMPONENTS

### 2. SERVICE METER

This meter shows the total operation hours of the machine. Set the periodic maintenance intervals using this display. The service meter advances while the engine is running - even if the machine is not traveling.

While the engine is running, operation display ① at the top inside of the meter will light to show that the meter is advancing.

The meter will advance by 1 for each hour of operation regardless of the engine speed.

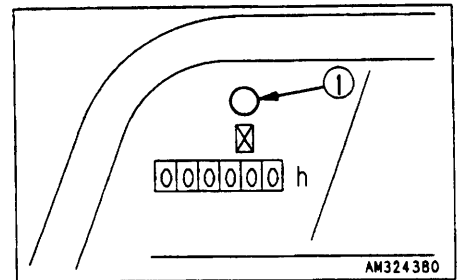

### 3. ENGINE WATER TEMPERATURE GAUGE

This displays the engine cooling water temperature. During normal operation, the lamp should light up in the green range.

If the lamp in the red range lights up during operation, run the engine at low idling and wait for the temperature to go down to the green range.

After starting the engine, warm up it until the green range lights up.

If the red range lights up, the alarm buzzer sounds.

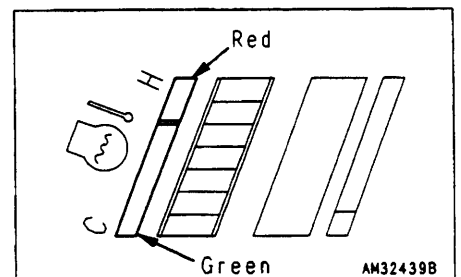

### 4. FUEL GAUGE

This shows the fuel level in the fuel tank. During normal operation, the lamp should light up in the green range.

If the lamp in the red range lights up during operation, there is less than 8.0 liters (2.08 US gal, 1.76 UK gal) of fuel remaining, so check and add fuel.

The correct level may not be displayed for a short time after the starting switch is turned to the ON position, but this is not an abnormality.

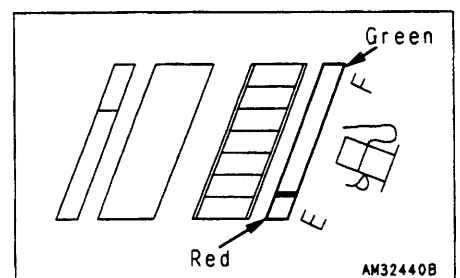

## 11.2 SWITCHES

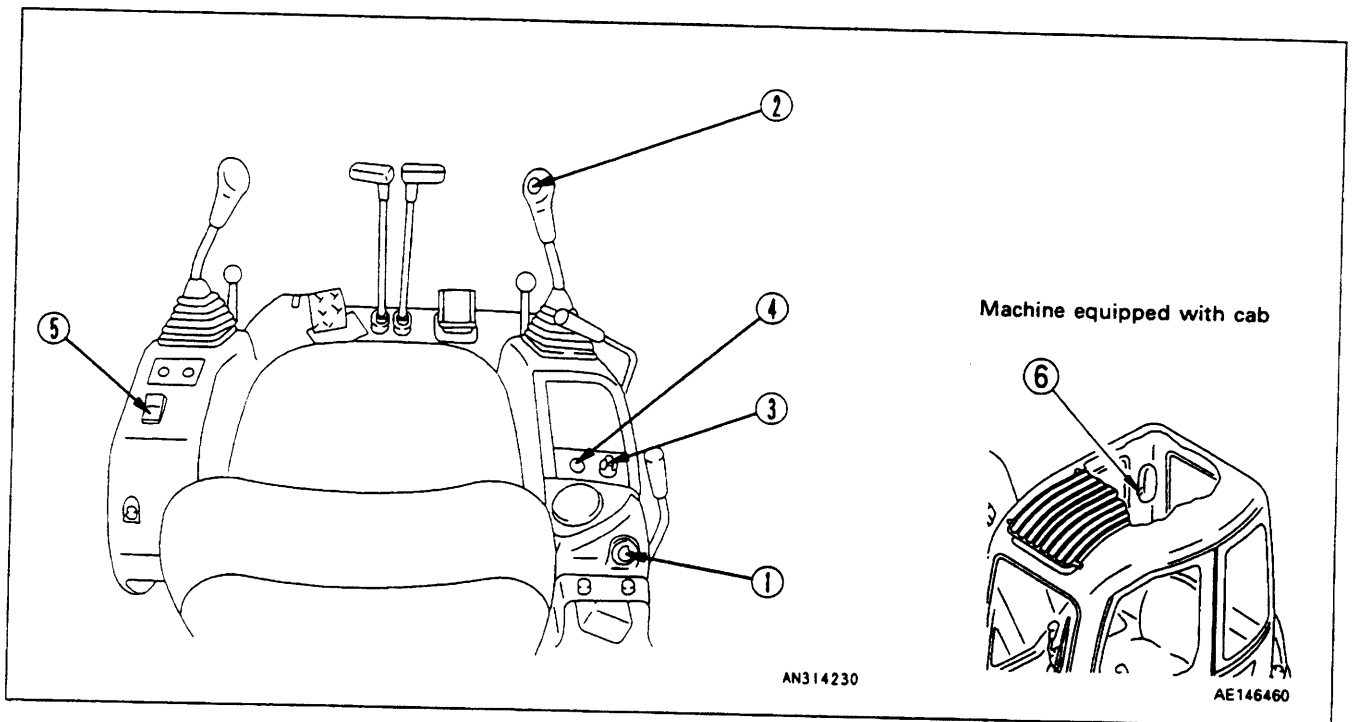

### 1. STARTING SWITCH

This switch is used to start or stop the engine.

#### OFF position

The key can be inserted or withdrawn. Except for the cab lamp, the switches for the electric system are all turned off and the engine is stopped.

#### ON position

Electric current flows in the charging and lamp circuits. Keep the starting switch key at the ON position while the engine is running.

#### START position

This is the engine-start position. Keep the key at this position during cranking. Immediately after starting the engine, release the key which will automatically return to the ON position.

#### HEAT (preheat) position

When starting the engine in winter, set the key to this position. When the key is set to the HEAT position, the pre-heating monitor lights up. Keep the key at this position until the monitor lamp flashes. Immediately after the pre-heating monitor flashes, release the key. The key automatically returns to the OFF position. Then, start the engine by turning the key to the START position.

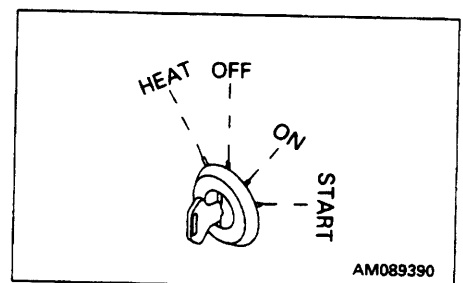

AM089390



## 11. EXPLANATION OF COMPONENTS

### 2. HORN SWITCH

If the center of the right work equipment control lever knob is pressed, the horn sounds.

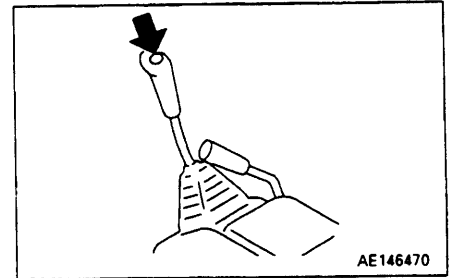

### 3. LAMP SWITCH

This lights up the head lamps and the panel lamp.

Position 1: Panel lamp lights up.

Position 2: Head lamps and panel lamp light up.

Position OFF: Lamps go off.

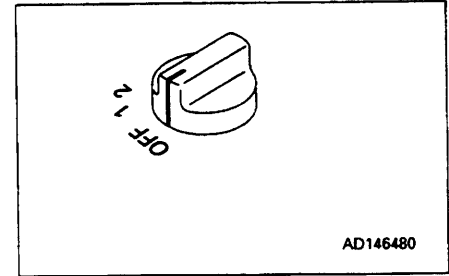

### 4. CAB HEATER SWITCH (MACHINES EQUIPPED WITH CAB)

This switch is used to heat the operator's compartment. The flow rate of the hot air can be set to two levels.

Hi position: Strong

Lo position: Weak

OFF position: Cab heater is stopped.

The cab is heated by hot water from the engine, so if the engine cooling water temperature is low, the cab will not heat up.

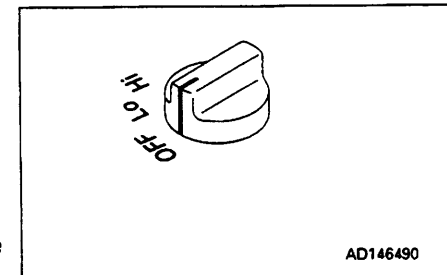

### 5. WIPER SWITCH (MACHINES EQUIPPED WITH CAB)

This switch actuates the front window wiper.

① OFF: The wiper stops.

② ON: The wiper moves continuously.

#### REMARK

If the window washer system is installed, the washer fluid is sprayed out when the wiper switch is pushed in further from the ON position.

Be careful of the following when operating this system.

- Do not keep the switch pressed at the washer spray position for more than ten seconds continuously.
- Do not press the switch to the washer spray position if the washer fluid container is empty.

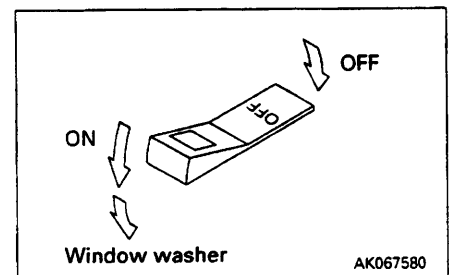

**6. CAB LAMP SWITCH**

This lights up the cab lamp.  
ON position: Lights up

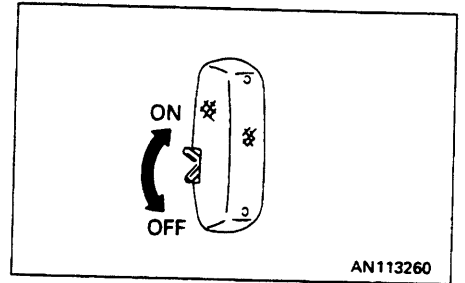

AN113260

### 11.3 CONTROL LEVERS AND PEDALS

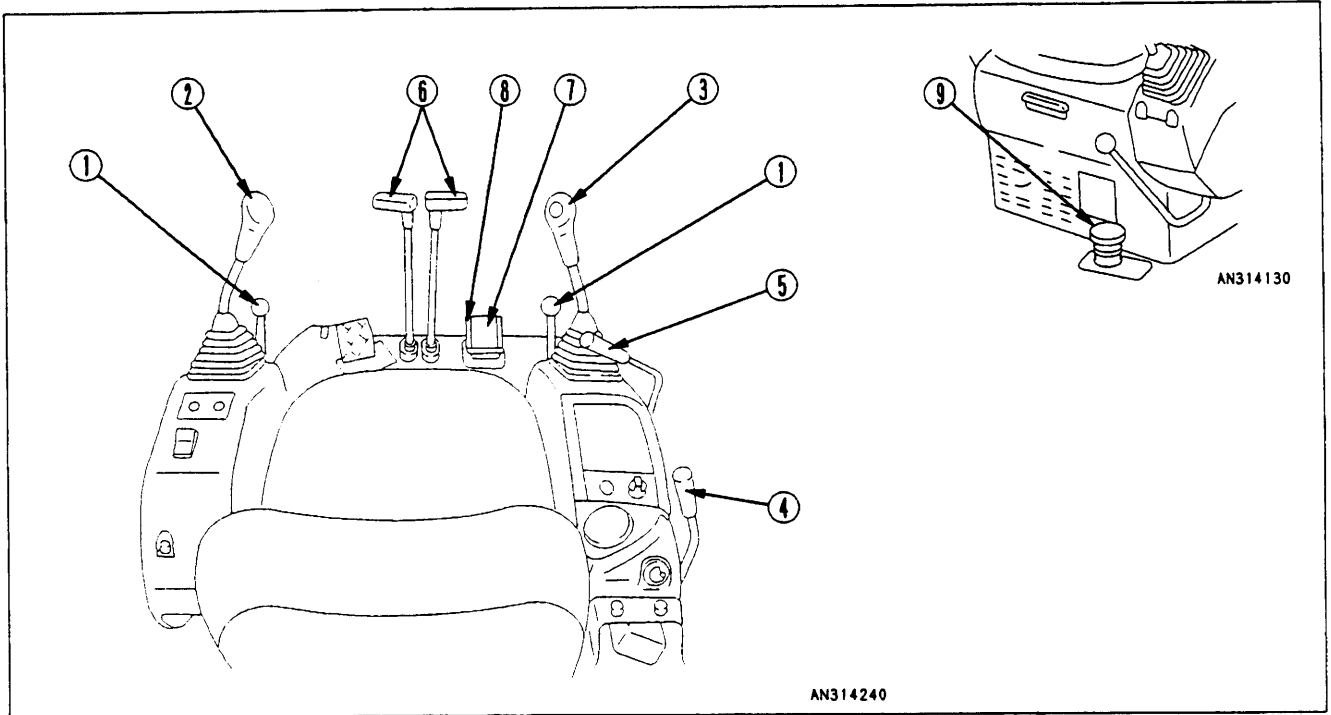

#### 1. SAFETY LOCK LEVER (FOR BOTH LEFT AND RIGHT SIDE WORK EQUIPMENT CONTROL LEVERS AND TRAVEL LEVERS)

**REMARK**

In machines equipped with cab, the safety lock lever is installed on the left side only.

**WARNING**

- When leaving the operator's seat, set the safety lock lever to the LOCK position. If the control lever is not locked, and it is touched by mistake, this may lead to serious accidents.
- If the safety lock lever is not placed securely in the LOCK position, the control lever may not be properly locked. Confirm that it is set as shown in the figure.
- Even if the safety lock lever is set to the LOCK position, the traveling mechanism and blade are not locked.
- When pulling up the safety lock lever, take care not to touch the work equipment control levers. If the safety lock lever is not pulled up to the end, the work equipment and upper structure can move, and that is dangerous.

Machine equipped with canopy

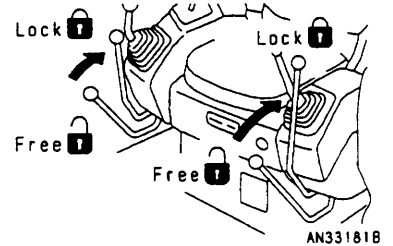

Machine equipped with cab

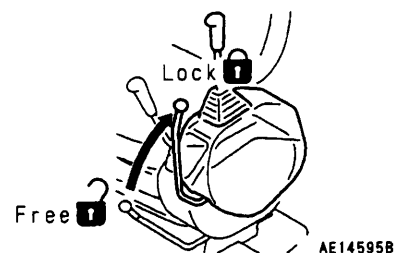

**WARNING**

When pushing down the lock lever, take care not to touch the work equipment lever.

- This device is used to lock the work equipment, upper structure and travel levers. In case of machines equipped with canopy, if either lock lever is pulled up, the lever stand on that side jumps up and both work equipment control levers are locked.
- In case of machines equipped with cab, if the left-hand lock lever is pulled up, the left-hand lever stand jumps up and both work equipment control levers are locked. The right-hand lock lever is fixed and cannot be operated.
- This lock lever locks the mechanism hydraulically. Accordingly, the work equipment control levers can be shifted, even if this lock lever is set to the LOCK position, but the work equipment and swing motor does not move.

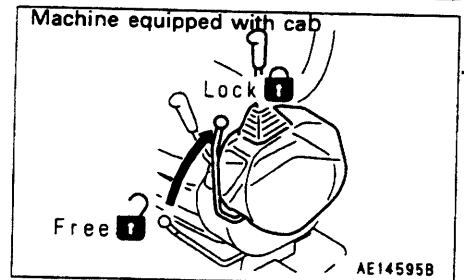
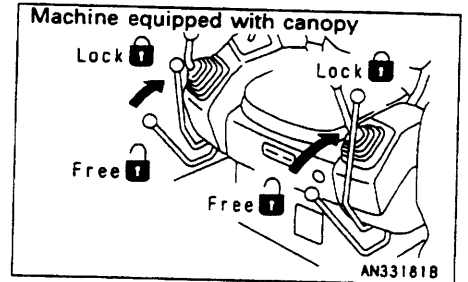

**2. LEFT WORK EQUIPMENT CONTROL LEVER**

This lever is used to operate the arm and upper structure.

- |                  |               |
|------------------|---------------|
| Swing operation  | Arm operation |
| Ⓐ Swing to right | Ⓒ Arm IN      |
| Ⓑ Swing to left  | Ⓓ Arm OUT     |
| N (Neutral)      |               |

When the lever in this position, the upper structure and the arm will be retained in the position in which they stop.

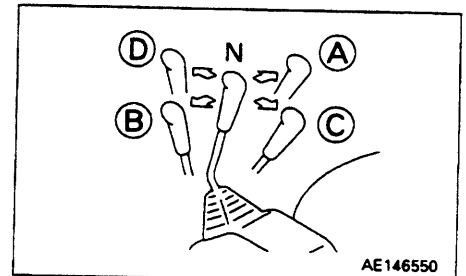

**3. RIGHT WORK EQUIPMENT CONTROL LEVER**

This lever is used to operate the boom and bucket.

- |                |                  |
|----------------|------------------|
| Boom operation | Bucket operation |
| ① RAISE        | ③ DUMP           |
| ② LOWER        | ④ CURL           |
| N (Neutral)    |                  |

When the lever in this position, the boom and the bucket will be retained in the position in which they stop.

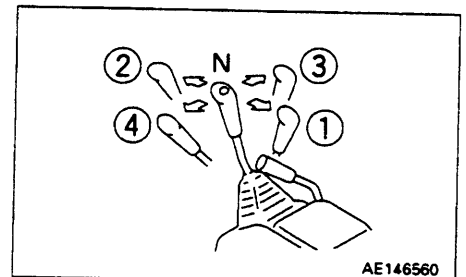

**4. FUEL CONTROL LEVER**

This lever is used to control the engine speed and output.

- ① Low idling position: Push the lever fully.
- ② High idling position: Pull the lever fully.

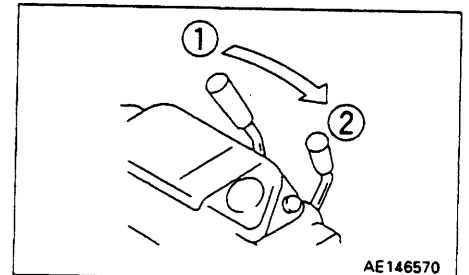

**5. BLADE CONTROL LEVER**

**NOTICE**

This lever is not locked even when the lock lever is at the LOCK position, so when not operating the blade, be careful not to touch this lever.

This lever is used to control the blade.

- ① LOWER
  - ② RAISE
- N (Neutral): Blade is stopped and held in this position.

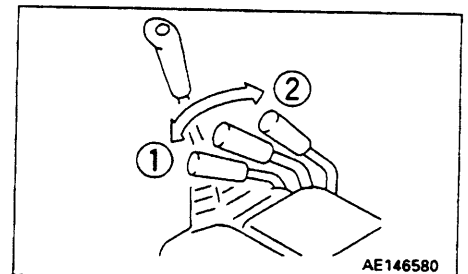

6. TRAVEL LEVERS

**⚠ WARNING**

When the track frame is directed back, the operation of the travel lever is reversed.  
 When operating the travel lever, confirm the direction of the track frame (It is directed forward when the blade is in front of the operator's seat).

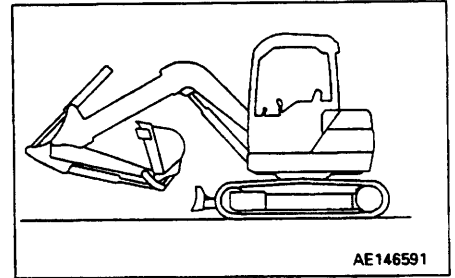

- ① FORWARD:  
The lever is pushed forward
- ② REVERSE:  
The lever is pulled back
- N (Neutral): The machine stops

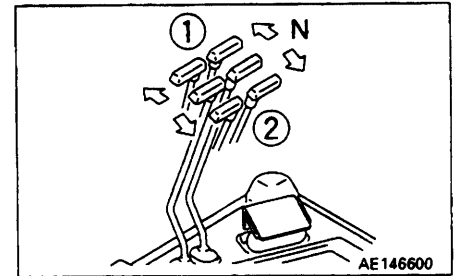

7. PEDAL LOCK (For boom swing pedal)

**⚠ WARNING**

When boom swing operation is not required, lock the boom with the pedal lock.  
 If the operation pedal is accidentally pressed while it is not locked, a serious accident may occur.

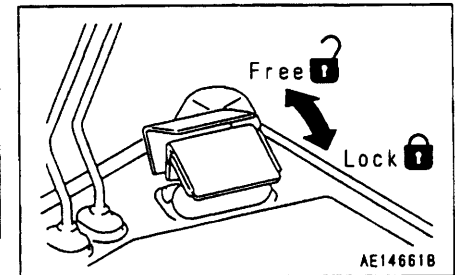

This device is used to lock the boom swing pedal. If the plate is laid over the pedal, the pedal is locked.

9. BOOM SWING CONTROL PEDAL

This pedal is used to swing the boom.

- ①: Boom swings to the right.
- ②: Boom swings to the left.
- N (Neutral): Boom is stopped and held in this position.

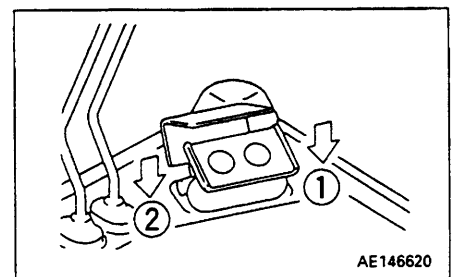

9. TRAVELING ACCELERATOR PEDAL

If the pedal is depressed, the machine speed will increase.

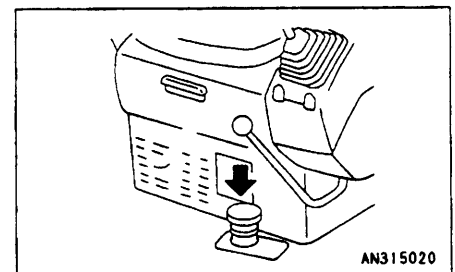

## 11.4 ENGINE HOOD

### ⚠ CAUTION

When carrying out inspection or maintenance inside the engine hood, always use the hood support lever to keep the engine hood open.

1. Pull engine hood knob ① to release the lock.

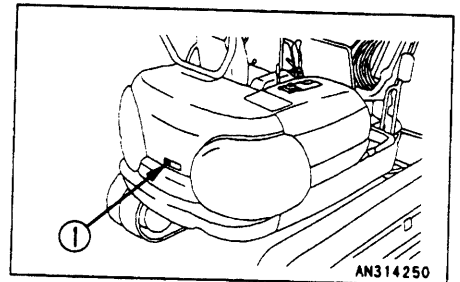

2. Push hood ② up, then fix the hood in position with hood support lever ③.

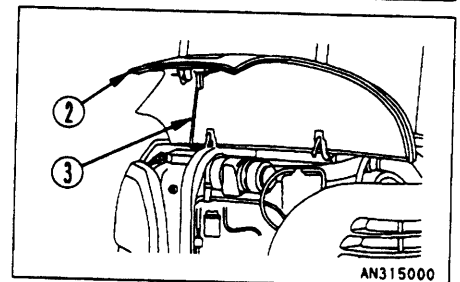

3. To close hood ②, remove hood support lever ③, secure it firmly in the lever lock, then lower the hood slowly and push the hood down to apply the lock.

### NOTICE

For vandalism protection, be sure to keep the hood locked, except for when it needs to be opened for a particular reason.

It is possible to check if the lock is applied by looking at the direction of the key groove in the open knob.

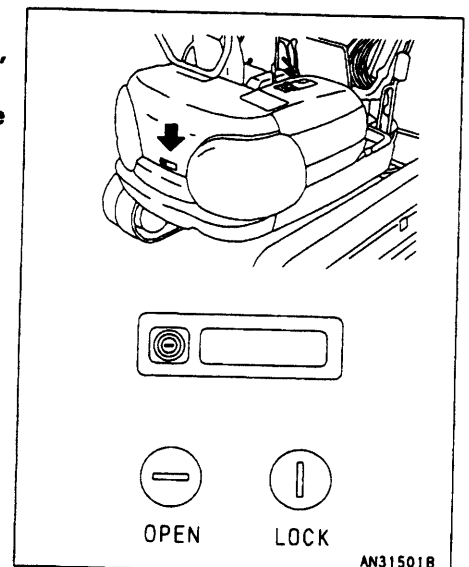

## 11. EXPLANATION OF COMPONENTS

### REMARK

If engine hood lock button ① should be broken and the engine hood cannot be opened, reset the lock according to the following procedure.

1. Remove cover ② from the engine hood. It is made of vinyl and can be removed by hand.
2. Push catcher ③ seen through the hole of the cover with a screwdriver, etc. to remove it from stopper ④.  
Ask one of our distributors for adjustment or repair of lock button ①.
3. After repairing lock button ①, install cover ②.

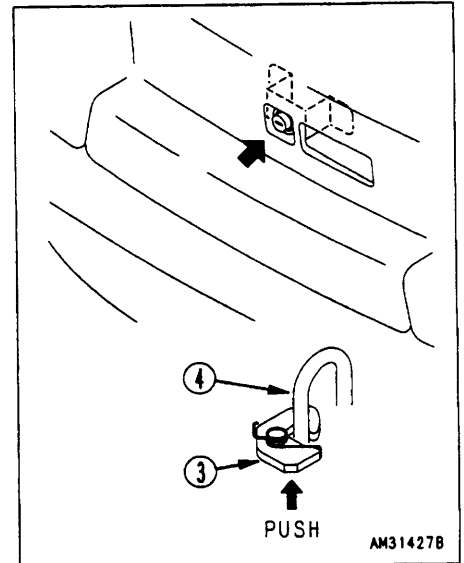
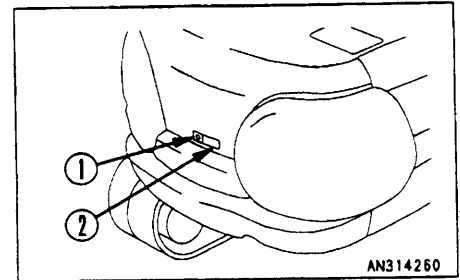

## 11.5 FRONT WINDOW (MACHINES EQUIPPED WITH CAB)

**WARNING**

When opening the front window, always hold the grip firmly with both hands and pull up. If you use only one hand, your hand may slip and get caught.

It is possible to store (pull up) the front window (top) in the roof of the operator's compartment.

### When opening

**WARNING**

When the front window is open, there is danger that it will fall, so always lock it with left and right lock pins (A).

1. Stop the machine on flat ground, lower the work equipment to the ground, and stop the engine.
2. Set the lock lever for the work equipment control levers securely to the LOCK position.
3. Disconnect the wiring for the wiper motor from socket (B).

### NOTICE

If it is attempted to open the front window without disconnecting the wiring, the wiring will be torn off.

4. Pull lock pins (A) at the top left and right sides of the front window to the inside to release the lock.

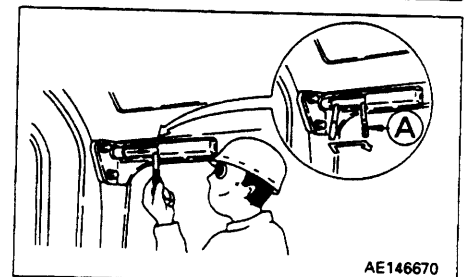
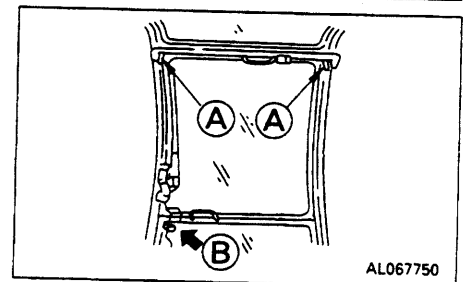
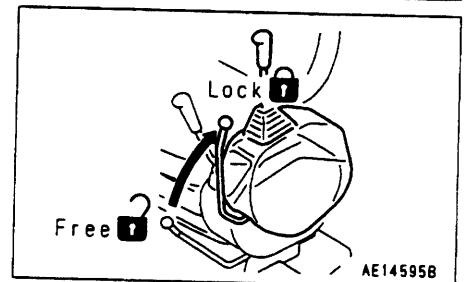
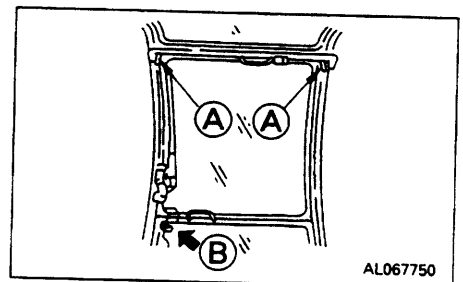



## 11. EXPLANATION OF COMPONENTS

- From the inside of the operator's cab, hold the bottom grip with the left hand and the top grip with the right hand, pull up the window, and push it in fully until it is locked by catch ③.

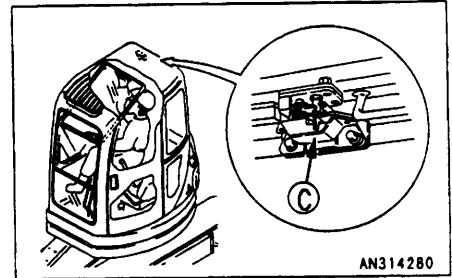

- Lock with lock pins ① on the left and right sides.

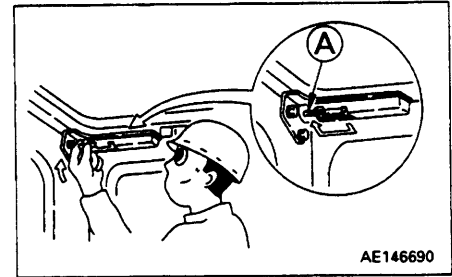

### When closing

#### **WARNING**

When closing the window, lower it slowly and be careful not to get your hand caught.

- Place the work equipment on a flat ground and stop the engine.
- Securely lock the safety lock lever.

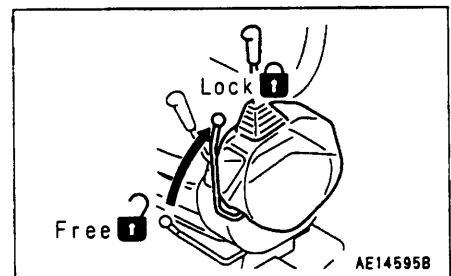

- Release the lock pin ①.

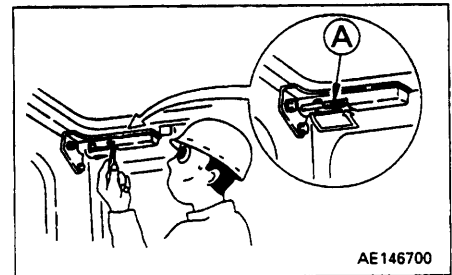

- Hold the grip at the bottom of the front window with your left hand and the grip at the top with your right hand, release the lock of catch ③ with your right thumb, then pull the top grip slowly and lower the front window. When releasing the lock of catch ③, push release lever ④ in the direction of the arrow to release the lock.

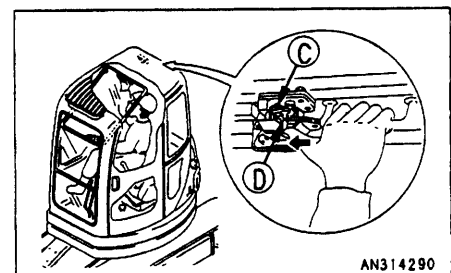

5. Lock securely with lock pins (A) at the left and right sides.
6. Connect the wiper motor wiring to socket (B).

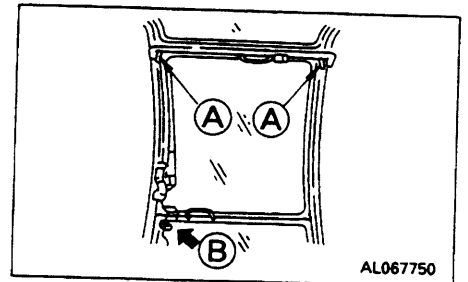

**Removing front window (bottom)**

With the front window open, remove lock pins , and the bottom part of the front window can be removed.

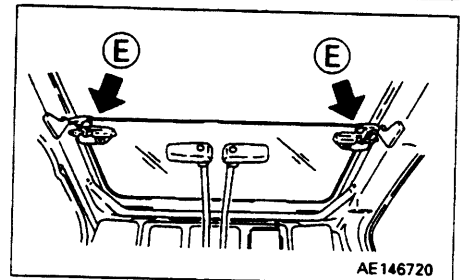

Store the removed bottom part of the front window at the rear of the operator's cab.

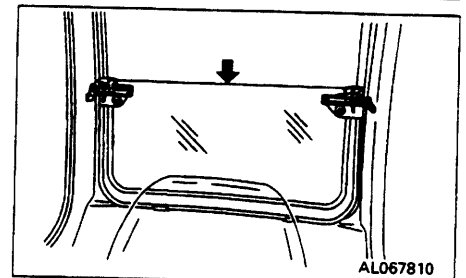

**11.6 SLIDING DOOR (MACHINES EQUIPPED WITH CAB)**

**WARNING**

It is very dangerous if fingers are caught in the sliding door. Open and close the sliding door with its knob. When closing the sliding door, in particular, take care not to get your fingers and hand caught between the door and the cab pillar.

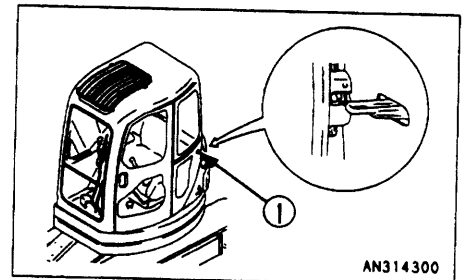

**CAUTION**

Confirm that the sliding door of a machine equipped with cab is locked when it is either open or closed. Be sure to open or close the sliding door on a flat place. Avoid opening or closing the sliding door on a slope, since its operating effort may change suddenly.

● **Door lock**

When closing the door, pull back the handle to release lock (1), then pull the door forward.

## 11. EXPLANATION OF COMPONENTS

### 11.7 HAMMER FOR EMERGENCY ESCAPE (MACHINES EQUIPPED WITH CAB)

In case it becomes impossible to open the door, a hammer ① to be used for escape from the cab is installed.

When escaping, break the window glass with hammer ①.

#### NOTICE

When escaping, remove the broken pieces of the glass from the sash so that you will not cut yourself with them. Take care not to slip on the broken and scattered pieces.

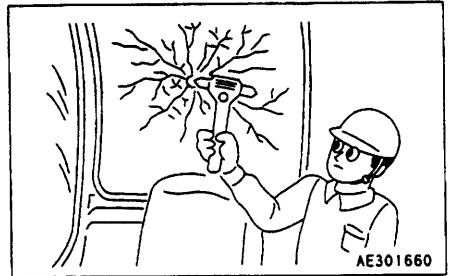
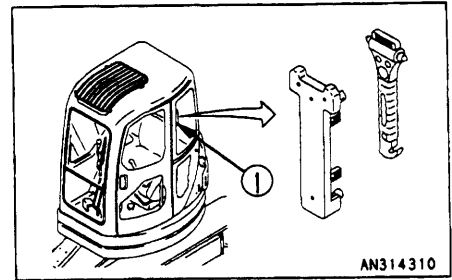

### 11.8 FUSES

#### NOTICE

When replacing a fuse, be sure to turn off the power (turn the starting switch to the OFF position).

The fuses protect the electric parts and wires from being burnt.

If any fuse is corroded and covered with white powder or there is play between a fuse holder and the fuse in it, replace the fuse.

Replace each fuse with one having the same capacity.

Capacity of each fuse and circuit where it is used.

#### Fuse capacity and name of circuit

No.	Fuse capacity	Name of circuit
①	30 A	Spare fuse
②	10 A	Engine control system, Valve to lock work equipment control lever
③	20 A	Monitor panel, *Windshield wiper, *Heater, Decelerator (Option), Horn, *Window washer (Option), *Room lamp, *Car radio (Option)
④	20 A	Working lamp, Travel changeover valve, Alternator, Alarm buzzer
⑤	30 A	Engine control system

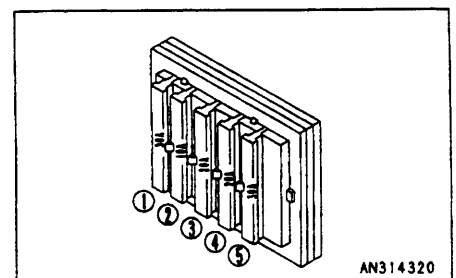

The items marked with \* are special parts for the machine equipped with cab.

### 11.9 FUSIBLE LINK

If the power does not come on when the starting switch is turned to the ON position, the wire-shaped fusible link ① may be cut, so remove the cover ② on the right side of the chassis, and check or replace.

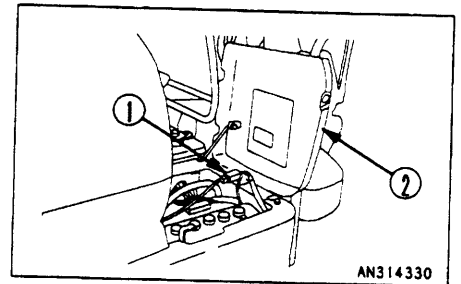

#### REMARK

A fusible link is a large fuse wire installed in a circuit where there is a large current flowing.

It acts in the same way as a normal fuse to prevent electrical components and wiring from burning out if there is an abnormal current.

### 11.10 CAP, COVER WITH LOCK

The fuel filler, operator's cab, engine hood and battery cover are fitted with locks.

Use the starting switch key to lock or unlock these places.

#### 11.10.1 METHOD OF OPENING AND CLOSING CAP WITH LOCK (For the fuel tank filler port)

##### To open the cap

1. Insert the key into the cap.
2. Turn the key counterclockwise, align the match mark on the cap with the rotor groove, then remove the cap.

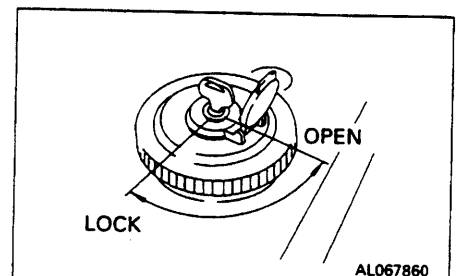

##### To lock the cap

1. Turn the cap into place.
2. Turn the key clockwise and take the key out.

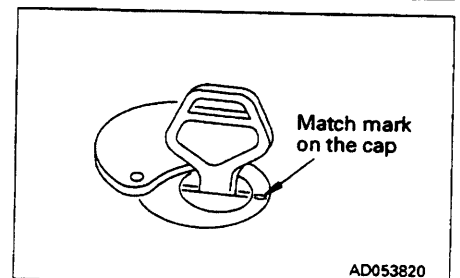

Insert the key as far as it will go. If the key is turned before it is inserted all the way, it may break.

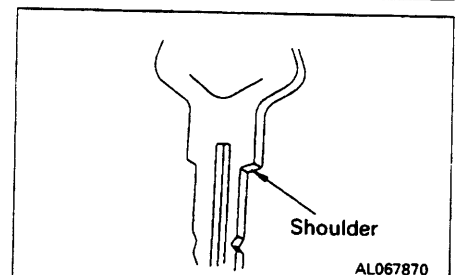

## 11. EXPLANATION OF COMPONENTS

### 11.10.2 OPENING AND CLOSING METHOD OF COVER WITH LOCK

#### When opening (locked cover)

1. Insert the key.
2. Turn the key counterclockwise and pull the cover knob, and the cover open.

#### When locking

1. Close the cover and insert the key.
2. Turn the key clockwise, then pull out the key.

### 11.11 MANUAL POCKET

A pocket to store the operation manual is installed on the back of the operator's seat. Keep the operation manual in this pocket so that you can read it when you need it.

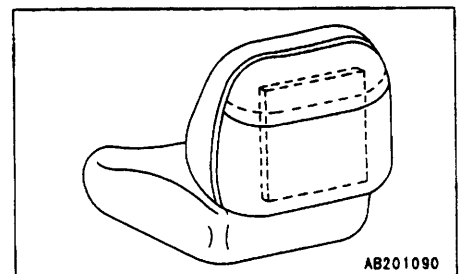

### 11.12 TOOL BOX

Store the tools in this box.

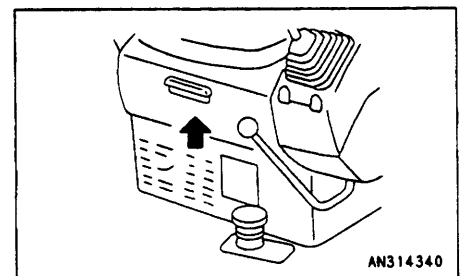

### 11.13 DUST INDICATOR

This device indicates that the air cleaner element is clogged.

If the element is clogged, the red piston can be seen in the transparent part ①. In this case, clean the element immediately.

After cleaning the element, push button ② of the indicator to return the red piston to its housing.

This indicator is installed to the air cleaner pipe in the engine hood.

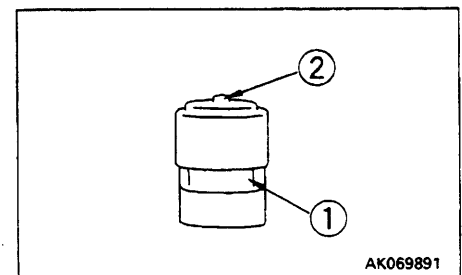

## 12. OPERATION

### 12.1 CHECK BEFORE STARTING ENGINE

#### 12.1.1 WALK-AROUND CHECK

**⚠ WARNING**

If you open the engine hood, always lock the hood in position securely with hood support lever ①.

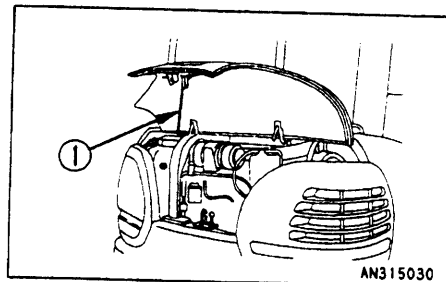

**⚠ WARNING**

Leakage of oil or fuel, or accumulation of flammable material around high temperature parts, such as the engine muffler may cause fire.

Check carefully, and if any abnormality is found, repair it or contact your Komatsu distributor.

Before starting the engine, look around the machine and under the machine to check for loose nut or bolts, or leakage of oil, fuel, or coolant, and check the condition of the work equipment and hydraulic system. Check also for loose wiring, play, and collection of dust at places which reach high temperatures.

Always carry out the items in this section before starting the engine each day.

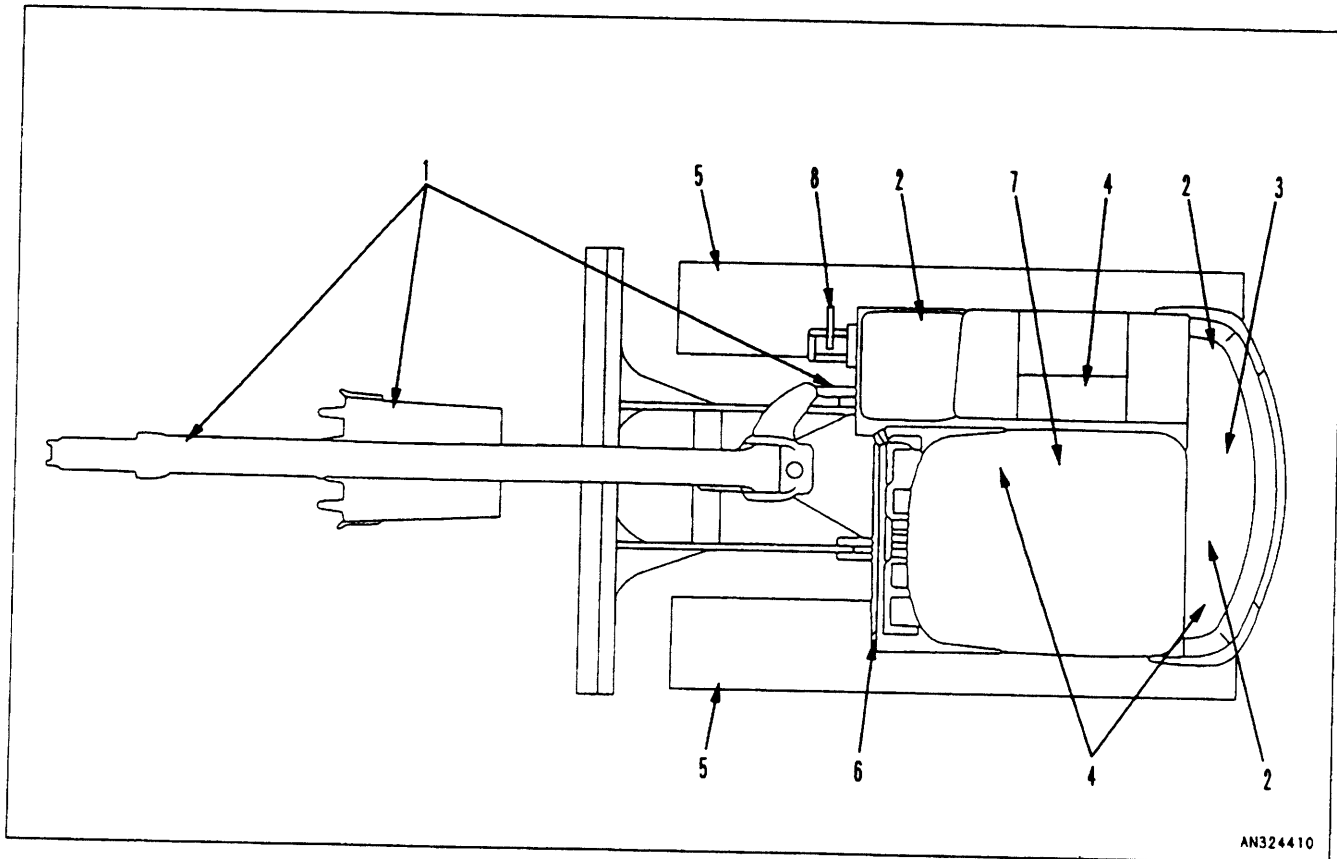

## 12. OPERATION

---

- 1. Check for damage, wear, play in work equipment, cylinders, linkage, hoses**  
Check that there are no cracks, excessive wear, or play in the work equipment, cylinders, linkage, or hoses. If any abnormality is found, repair it.
- 2. Remove dirt and dust from around engine, battery, radiator**  
Check if there is any dirt or dust accumulated around the engine or radiator. Check also if there is any flammable material (dead leaves, twigs, grass, etc.) accumulated around the battery or high temperature engine parts, such as the engine muffler or turbocharger. Remove all such dirt or flammable material.
- 3. Check for leakage of water or oil around engine**  
Check that there is no leakage of oil from the engine or leakage of water from the cooling system. If any abnormality is found, repair it.
- 4. Check for oil leakage from hydraulic equipment, hydraulic tank, hoses, joints**  
Check that there is no oil leakage. If any abnormality is found, repair the place where the oil is leaking.
- 5. Check the undercarriage (track, sprocket, idler, guard) for damage, wear, loose bolts, or leakage of oil from rollers**
- 6. Check for damage to handrail, loose bolts**  
Repair any damage and tighten any loose.
- 7. Check for damage to gauges, monitor, loose bolts**  
Check that there is no damage to the gauges and monitor in the operator's cab. If any abnormality is found, replace the parts. Clean off any dirt on the surface.
- 8. Check and cleaning of rear view mirror**  
Check the rear view mirror for breakage. If it is broken, replace it. Keep the mirror surface clean and adjust its angle so that the scene behind can be seen clearly from the operator's seat.

### 12.1.2 CHECK BEFORE STARTING

Always carry out the items in this section before starting the engine each day.

#### CHECK COOLANT LEVEL, ADD WATER

**⚠ WARNING**

Do not open the radiator cap unless necessary. When checking the coolant, always check the radiator reserve tank when the engine is cold.

1. Open the engine hood and check that the cooling water level is between the FULL and LOW marks on radiator reserve tank ① (shown in the diagram on the right). If the water level is low, add water through the water filler of reserve tank ① to the FULL level.
2. After adding water, tighten the cap securely.
3. If the sub-tank is empty, check for water leakage and check the water level in the radiator. If the water level is low, add water to the radiator first, then to the sub-tank.

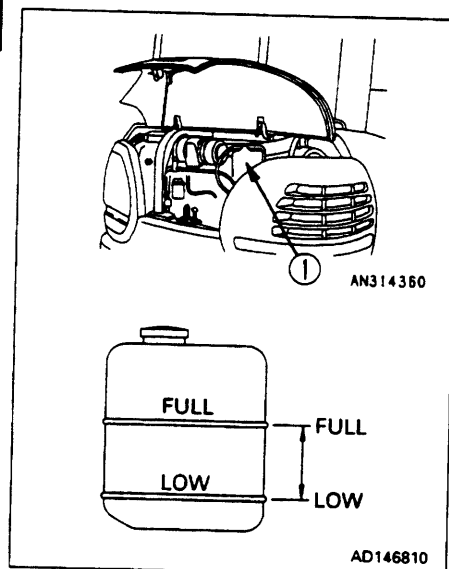

#### CHECK OIL LEVEL IN ENGINE OIL PAN, ADD OIL

1. Open the engine hood.
2. Remove dipstick ⑥ and wipe the oil off with a cloth.
3. Insert dipstick ⑥ fully in the oil filler pipe, then take it out again.
4. The oil level should be between the H and L marks on dipstick ⑥.  
If the oil level is below the L mark, add engine oil through oil filler ⑦.

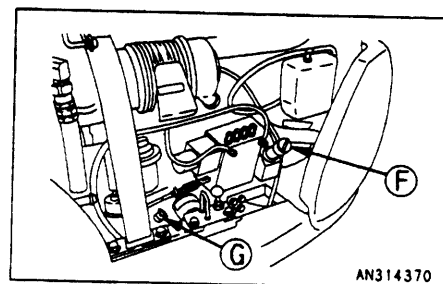

#### NOTICE

For details of the oil to use, see "20. USE OF FUEL, COOLANT AND LUBRICANTS ACCORDING TO AMBIENT TEMPERATURE".



## 12. OPERATION

---

5. If the oil is above the H mark, drain the excess engine oil from drain plug (P), and check the oil level again.
6. If the oil level is correct, tighten the oil filler cap securely and close the engine hood.

### REMARK

When checking the oil level after the engine has been operated, wait for at least 15 minutes after stopping the engine before checking.

If the machine is at an angle, make it horizontal before checking.

### CHECK FUEL LEVEL, ADD FUEL

#### WARNING

When adding fuel, never let the fuel overflow. This may cause a fire. If spilling fuel, thoroughly clean up any spillage.

1. Insert the key in starting switch (1), and turn it to the ON position to light up the monitor.
2. Check the fuel level on fuel gauge (2). If the fuel level is low, add fuel through filler port (F).

Fuel capacity: 50 ℓ (13.2 US gal, 11.0 UK gal)

### NOTICE

For details of the fuel to use, see "20. USE OF FUEL, COOLANT AND LUBRICANTS ACCORDING TO AMBIENT TEMPERATURE".

3. After adding fuel, tighten the cap securely.

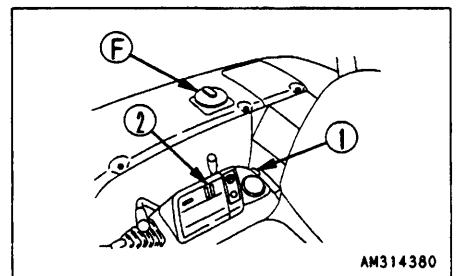

### REMARK

If breather hole (3) on the cap is clogged, the pressure in the tank will drop and fuel will not flow. Clean the hole from time to time.

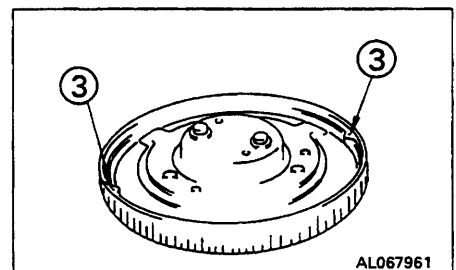

## CHECK OIL LEVEL IN HYDRAULIC TANK, ADD OIL

**⚠ WARNING**

When removing the oil filler cap, oil may spurt out, so turn the cap slowly to release the internal pressure before removing the cap.

1. If the work equipment is not in the condition shown in the diagram on the right, start the engine, run the engine at low speed, lower the blade, retract the arm and bucket cylinders, then lower the boom, set the bucket teeth in contact with the ground, and stop the engine.

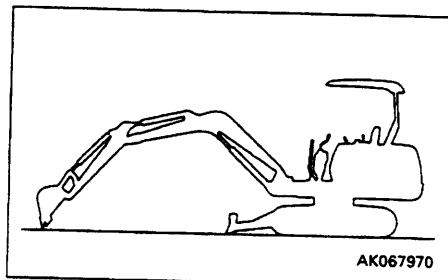

2. Remove cover ① and check sight gauge ③. The oil level is normal if between the H and L marks.

**NOTICE**

Do not add oil if the level is above the H line. This will damage the hydraulic equipment and cause the oil to spurt out.

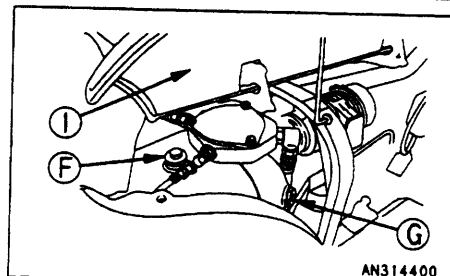

3. If the level is below the L mark, add oil through oil filler ④.

**NOTICE**

For details of the oil to use, see "20. USE OF FUEL, COOLANT AND LUBRICANTS ACCORDING TO AMBIENT TEMPERATURE".

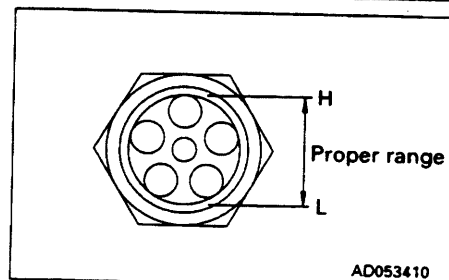
**⚠ WARNING**

If oil has been added to above the H mark, stop the engine and wait for the hydraulic oil to cool down, then drain the excess oil from the drain plug.

**REMARK**

The oil level will vary depending upon the oil temperature.

Accordingly, use the following as a guide:

- Before operation: around L level  
(Oil temperature 10 to 30°C (50 to 86°F))
- Normal operation: around H level  
(Oil temperature 50 to 80°C (122 to 176°F))

## 12. OPERATION

### 4. Apply pressure to the hydraulic tank.

Extract each cylinder of the boom, arm and bucket to the end, and remove the oil filler cap, then install the cap again and apply pressure to the tank.

### NOTICE

If pressure is not applied to the hydraulic tank, the pump will suck air which has several bad effects on the device.

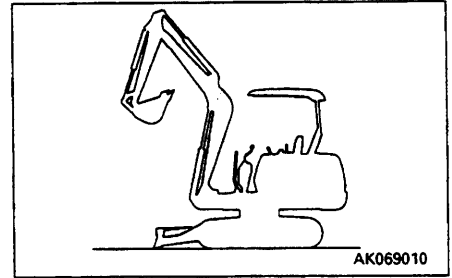

### CHECK DUST INDICATOR

1. Open the engine hood and check that the red piston is not showing in dust indicator ①.
2. If the red piston has appeared, clean or replace the element immediately.  
For details of the method of cleaning the element, see "24.2.1 CHECK, CLEAN AND REPLACE AIR CLEANER ELEMENT".
3. After checking, cleaning, and replacing, press the knob of dust indicator ① to return the red piston to its original position.

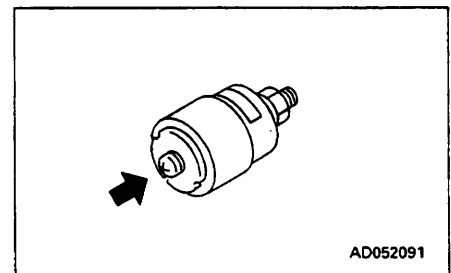
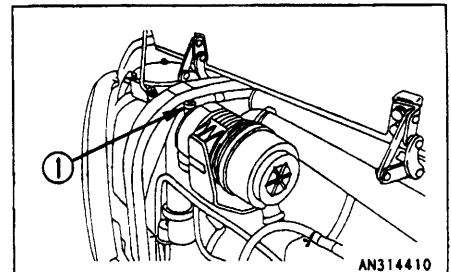

### CHECK WATER SEPARATOR

If red ring ① of the water separator is at the bottom of case ②, there is no water.

If red ring ① is floating, there is water up to the bottom of the ring, so drain the water as follows.

- Use a water separator filter wrench.
1. Open the engine hood.
  2. Set handle ③ to the CLOSED position.
  3. Using the filter wrench, loosen ring ④, then remove case ② and throw out the water inside it.
  4. Set case ② in position, then tighten ring ④ to install it.
  5. Set handle ③ to the OPEN position.
  6. Drain any water or sediment from the fuel tank. For details, see "24.2.3 DRAIN WATER, SEDIMENT FROM FUEL TANK".

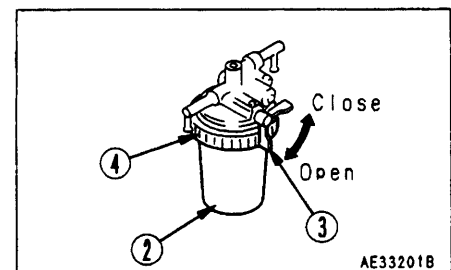
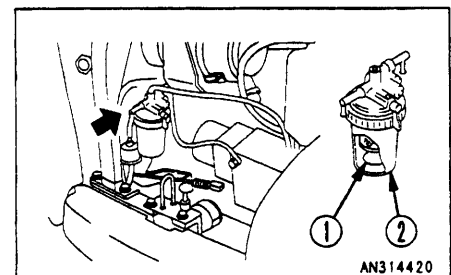

### 12.1.3 ADJUSTING BEFORE STARTING OPERATION

**CAUTION**

Adjust the seat position at the beginning of each shift or when operators change.

#### FORE-AND-AFT ADJUSTMENT OF OPERATOR'S SEAT

The seat and the left and right console boxes slide to the front and rear.

Move lever ① to the right, set the operator's seat at the desired position, then release the lever.

Fore-and-aft adjustment: 80 mm (3.2 in) (5 stages)

Adjust the position of the operator's seat to match the operation. For example, when carrying out deep digging operations, slide the seat to the front to improve the view below the front of the machine.

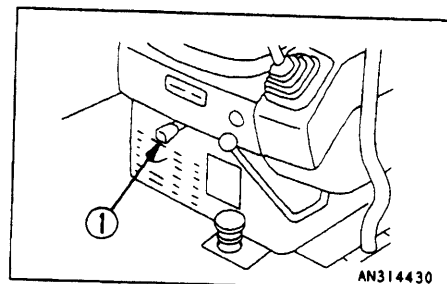

### 12.1.4 OPERATIONS AND CHECKS BEFORE STARTING ENGINE

**WARNING**

If the control lever is touched by accident, the work equipment or the machine may move suddenly. When leaving the operator's compartment, always set the safety lock lever securely to the LOCK position.

1. Check that safety lock lever ① is at the LOCK position.
2. Check the position of each lever.

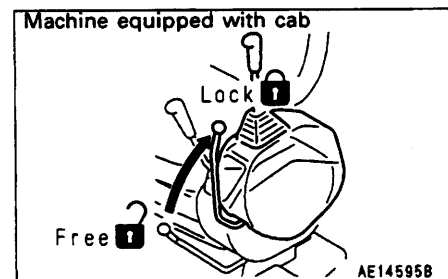
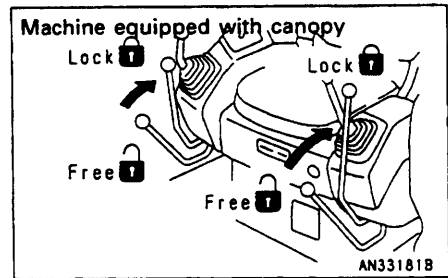
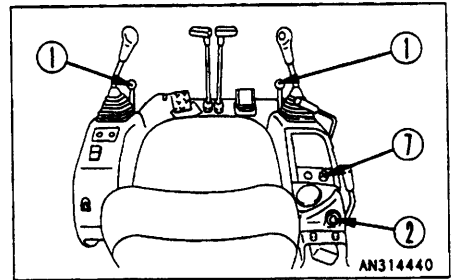

3. Insert the key in starting switch ②, turn the key to the ON position, then carry out the following checks.

- (1) The buzzer sounds for about one second and the all monitors and meters light up.

If the monitors or gauges do not light up or the buzzer does not sound, there is probably a broken bulb or disconnection in the monitor wiring, so contact your Komatsu distributor for repairs.

About 3 seconds later, only the following meters stay lit and the other ones go off.

- Engine oil pressure monitor ③
- Charge level monitor ④
- Engine water temperature monitor ⑤
- Fuel level monitor ⑥

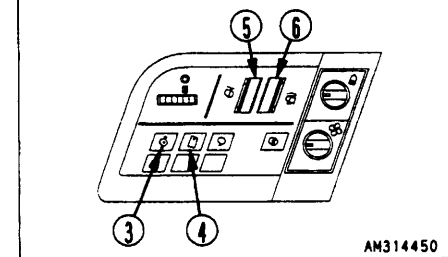
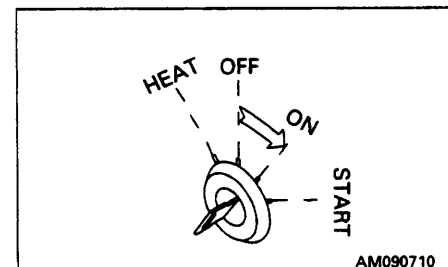

- (2) Turn lamp switch ⑦ to turn on the head lamps. If the lamps do not light up, there is probably a broken bulb or disconnection in the wiring, so contact your Komatsu distributor for repairs.

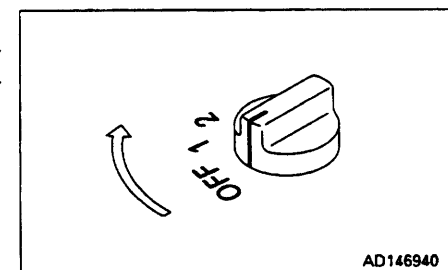

(3) Push horn switch ⑩ to confirm that the horn will sound.

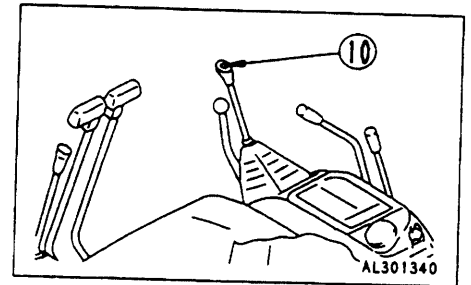

## 12.2 STARTING ENGINE

### 12.2.1 NORMAL STARTING

**WARNING**

Check that there are no persons or obstacles in the surrounding area, then sound the horn and start the engine.

**NOTICE**

Do not keep the starting motor rotating continuously for more than 20 seconds.

If the engine will not start, wait for at least 2 minutes before trying to start the engine again.

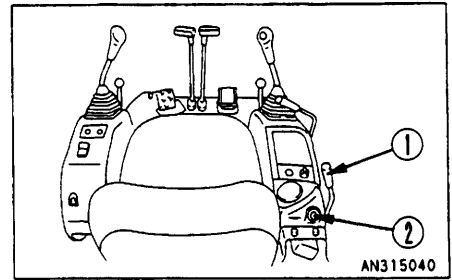

1. Pull fuel control lever ① to the center position between LOW IDLING and HIGH IDLING.

**REMARK**

While the engine is warm, it can start with the fuel control lever at the LOW IDLING position.

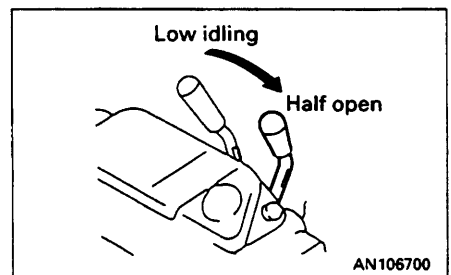

2. Turn the key in starting switch ② to the START position. The engine will start.

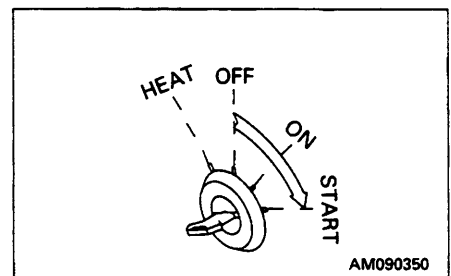

3. When the engine starts, release the key in starting switch ②. The key will return automatically to the ON position.

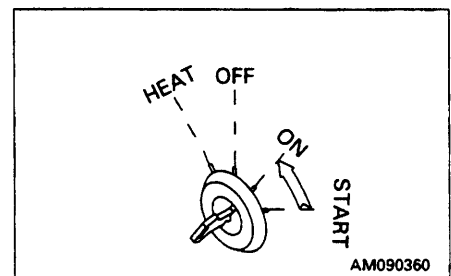

## 12.2.2 STARTING IN COLD WEATHER

**WARNING**

Check that there are no persons or obstacles in the surrounding area, then sound the horn and start the engine.

**NOTICE**

Do not keep the starting motor rotating continuously for more than 20 seconds.

If the engine fails to start, repeat steps from 2 and after waiting for about 2 minutes.

When starting in low temperatures, do as follows.

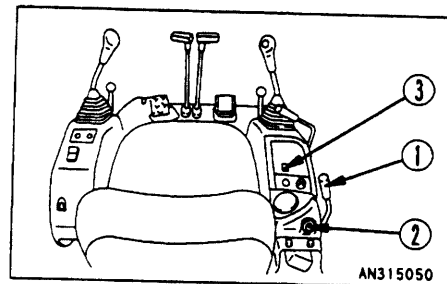

1. Pull fuel control lever ① to the HIGH IDLING position.

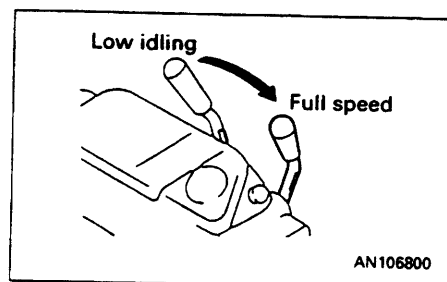

2. Hold the key in starting switch ② at the HEAT position, and check that preheating monitor ③ lights up. After approx. 18 seconds, preheating monitor ③ goes out to inform that the preheating is completed.

The monitor and gauge also light up when the key is at the HEAT position, but this does not indicate any abnormality.

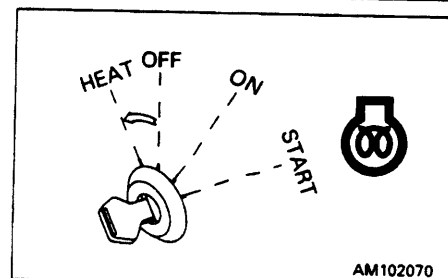

3. When preheating monitor ③ goes out, turn the key in starting switch ② to the START position to start the engine.

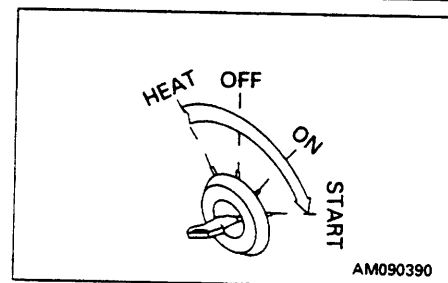

4. When the engine starts, release the key in starting switch ②. The key will return automatically to the ON position.

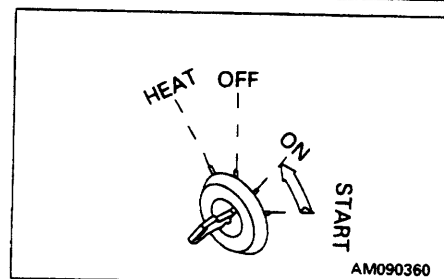



### 12.3 OPERATIONS AND CHECKS AFTER STARTING ENGINE

**⚠ WARNING**

- **Emergency stop**  
If there has been any abnormal actuation or trouble, turn the starting switch key to the OFF position. The electrical system and engine will stop. Then contact your Komatsu distributor for inspection.
- If the work equipment is operated without warming the machine up sufficiently, the response of the work equipment to the movement of the control lever will be slow, and the work equipment may not move as the operator desires, so always carry out the warming-up operation. Particularly in cold areas, be sure to carry out the warming-up operation fully.

**NOTICE**

The most suitable temperature for the hydraulic oil is 50 – 80°C, but in order to extend the life of the machine, the temperature must be raised to at least 20°C before starting work.

**NOTICE**

Do not suddenly operate the levers when the hydraulic oil temperature is below 20°C.

**NOTICE**

Do not suddenly accelerate the engine before the warming-up operation is completed.

Do not run the engine at low idling or high idling continuously for more than 20 minutes.

If it is necessary to run the engine at idling, apply a load from time to time or run the engine at a mid-range speed.

After starting the engine, do not immediately start operations. First, carry out the following operations and checks.

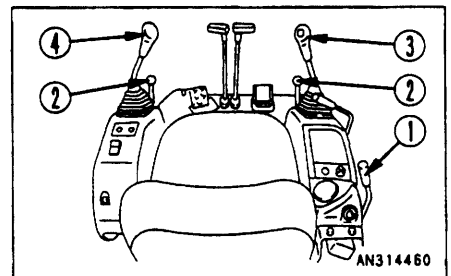

1. Pull fuel control lever ① to the center position between LOW IDLING and HIGH IDLING and run the engine at medium speed for about 5 minutes with no load.

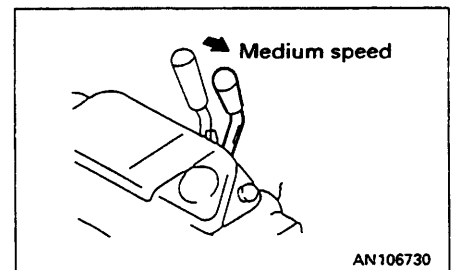

2. Set safety lock lever ② to the FREE position, and raise the bucket from the ground.

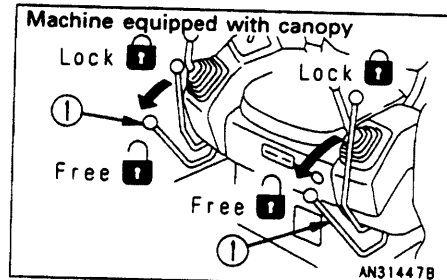

3. Operate bucket control lever ③ and arm control lever ④ slowly to move the bucket cylinder and arm cylinder to the end of the stroke.

4. Carry out bucket and arm operation for 5 minutes at full stroke, alternating between bucket operation and arm operation at 30 second intervals.

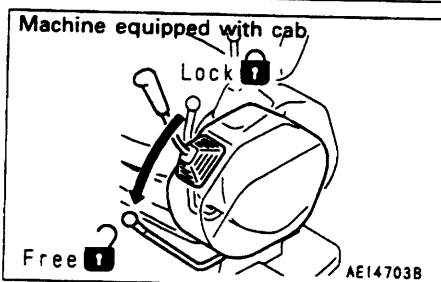

5. Run the engine idle at a high speed for one minute, then keep the bucket cylinder extracted or retracted for five minutes with the engine at the high-idling speed.

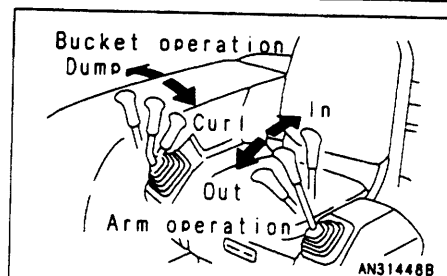

#### NOTICE

When the work equipment is retracted, take care that it does not interfere with the machine body or ground.

6. After carrying out the warming-up operation, check that each gauge and monitor lamp is in the following condition.
- Engine water temperature gauge ⑤. Inside green range
  - Fuel gauge ⑥. Inside green range
  - Engine oil pressure monitor ⑦. OUT
  - Charge level monitor ⑧. OUT
7. Check that there is no abnormal exhaust gas color, noise, or vibration. If any abnormality is found, repair it.
8. Set safety lock lever ② to the LOCK position and check that it is impossible to operate the swing and work equipment with the left and right work equipment control levers.

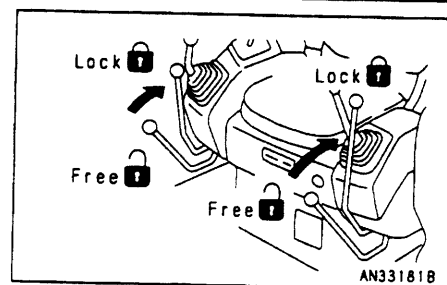
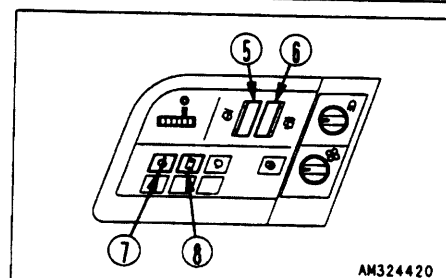

## 12.4 MOVING MACHINE OFF

### 12.4.1 MOVING MACHINE FORWARD

**WARNING**

- Before operating the travel levers, check the direction of the track frame. If the blade is at the rear, the operation of the travel levers is reversed.
- When moving off, check that the area around the machine is safe, and sound the horn before moving.
- Clear all personnel from the machine and the area.
- Clear all obstacles from the path of the machine.

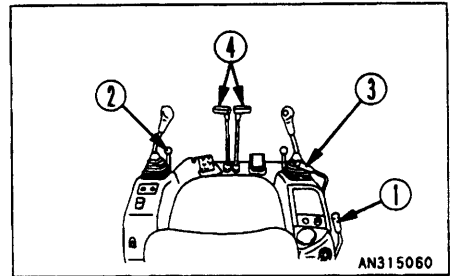

1. Pull fuel control lever ① towards the high idling position to increase the engine speed.

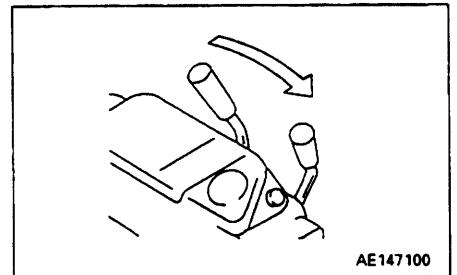

2. Set lock lever ② in the FREE position, fold the work equipment, and raise it 40 – 50 cm (16 to 20 in) from the ground.

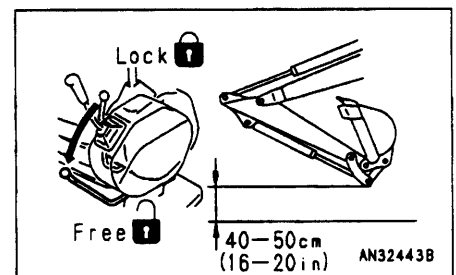

3. Pull blade control lever ③ to raise the blade.

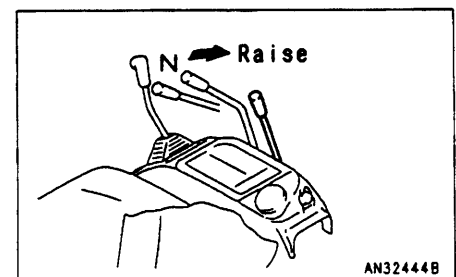

4. Operate both travel levers ④ as explained below.
- When the blade is in front of the machine  
Tilt lever ④ forward slowly to start the machine.

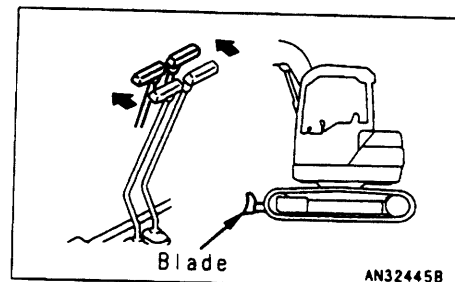

- When the blade is at the rear of the machine  
Tilt lever ④ backward slowly to start the machine.

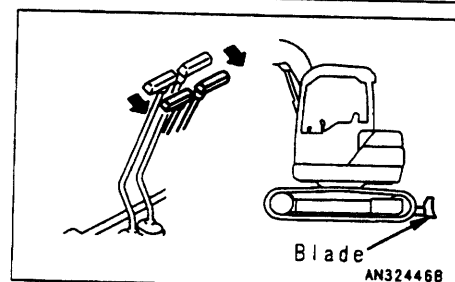

### 12.4.2 MOVING MACHINE BACKWARD

#### ⚠ WARNING

- Before operating the travel levers, check the direction of the track frame. If the blade is at the rear, the operation of the travel levers is reversed.
- When moving off, check that the area around the machine is safe, and sound the horn before moving.
- Clear all personnel from the machine and the area.
- Clear all obstacles from the path of the machine.
- Use extreme care when reversing the machine. Note there is an blind spot behind the machine.

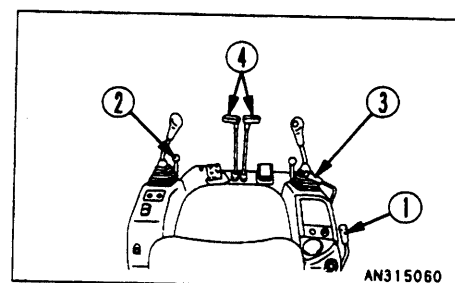

1. Pull fuel control lever ① towards the high idling position to increase the engine speed.

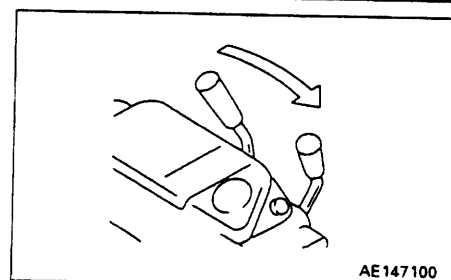

2. Set lock lever ② in the FREE position, fold the work equipment, and raise it 40 – 50 cm (16 to 20 in) from the ground.

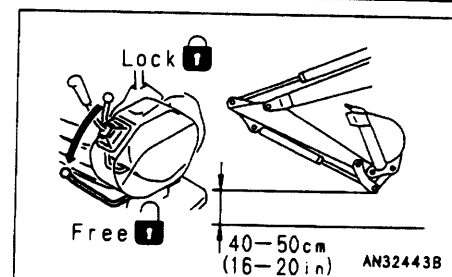

## 12. OPERATION

3. Pull blade control lever ③ to raise the blade.

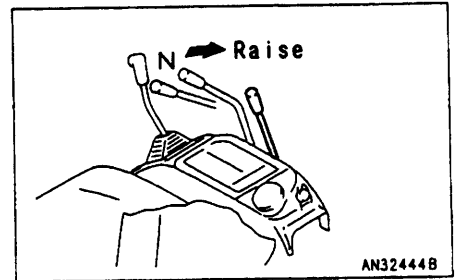

4. Operate both travel levers ④ as explained below.

- When the blade is in front of the machine  
Tilt lever ④ backward slowly to start the machine.

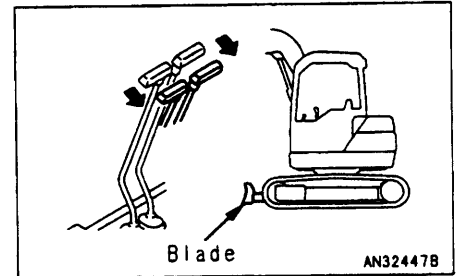

- When the blade is at the rear of the machine  
Tilt lever ④ forward slowly to start the machine.

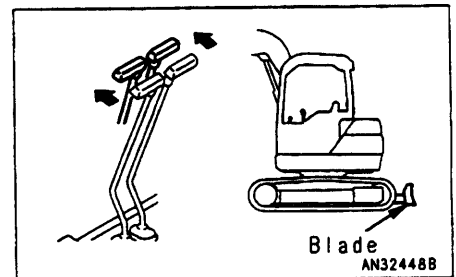

## 12.5 STEERING MACHINE

### 12.5.1 STEERING (CHANGING DIRECTION)

#### ⚠ WARNING

Before operating the travel levers, check the position of the sprocket. If the blade is at the rear, the operation of the travel levers is reversed.

Use the travel levers to change direction.

Avoid sudden changes of direction as far as possible. In particular, when carrying out counter-rotation (spin turn), stop the machine first before turning.

Operate two travel levers ① as follows.

#### Changing direction of machine when stopped

When turning to the left:

Push the right travel lever forward to travel left when traveling forward; and pull it back to turn left when traveling in reverse.

#### REMARK

When turning to the right, operate the left travel lever in the same way.

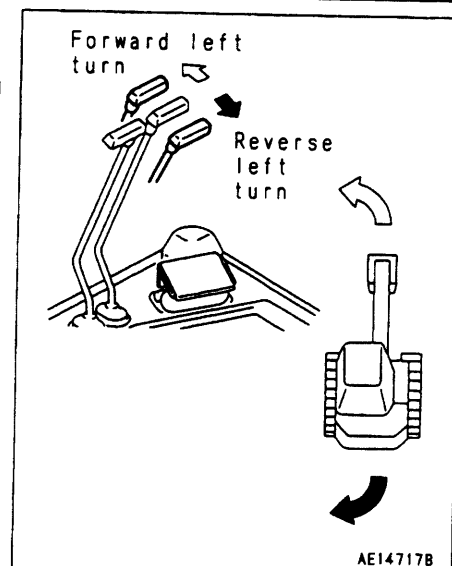
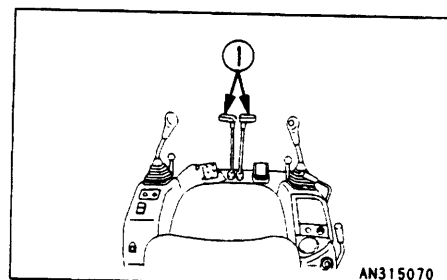

AE14717B

#### Steering when traveling (left and right travel levers both operated in same direction)

When turning to the left:

If the left travel lever is returned to the neutral position, the machine will turn to the left.

#### REMARK

When turning to the right, operate the right travel lever in the same way.

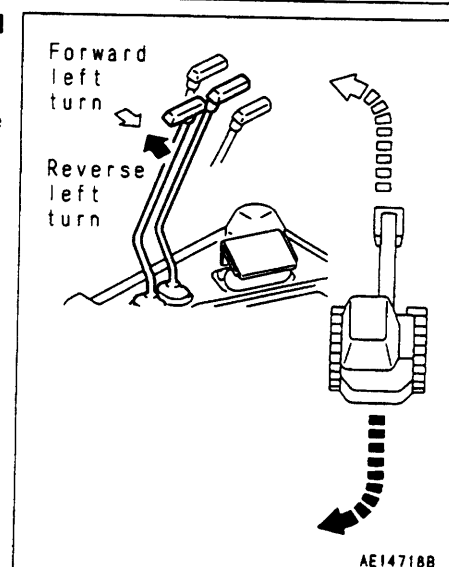

AE14718B

## 12. OPERATION

---

### When making counter-rotation turn (spin turn)

When turning left using counter-rotation, pull the left travel lever back and push the right travel lever forward.

### REMARK

When turning right using counter-rotation, pull the right travel lever back and push the left travel lever forward.

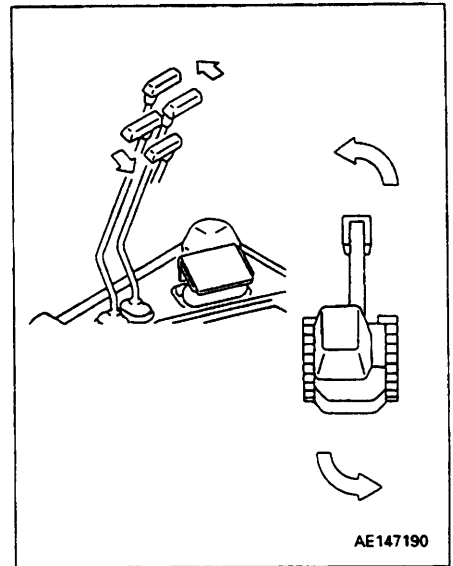

## 12.6 STOPPING MACHINE

**CAUTION**  
 Avoid stopping suddenly. Give yourself ample room when stopping.

**WARNING**  
 When stopping the machine, select flat hard ground and avoid dangerous places. If it is unavoidably necessary to park the machine on a slope, insert blocks underneath the track shoes. As an additional safety measure, thrust the bucket into the ground.

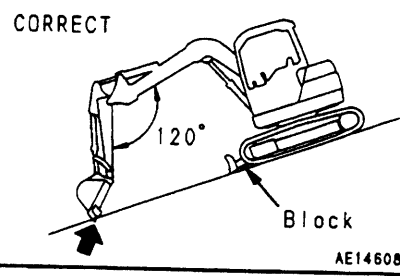

**WARNING**  
 If the control lever is touched by accident, the work equipment or the machine may move suddenly, and this may lead to a serious accident. Before leaving the operator's compartment, always set the safety lock lever securely to the LOCK position.

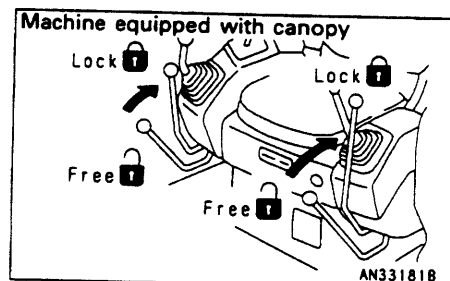

- Put the left and right travel levers ① in the neutral position, then stop the machine.

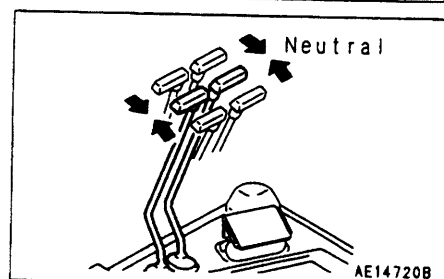
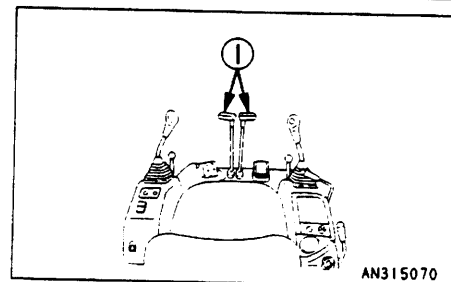
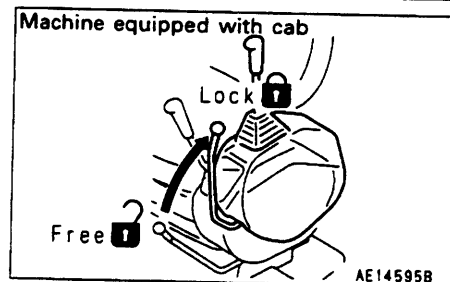



## 12.7 SWINGING

**⚠ WARNING**

When operating the swing, check that the area around the machine is safe.

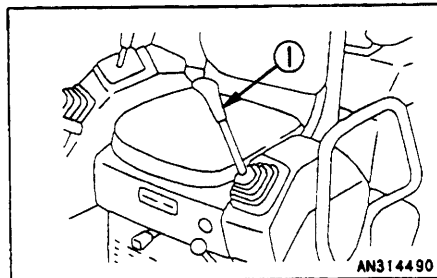

1. Operate left-hand work equipment control lever ① to swing the machine.
2. When swinging on a slope, lower the engine speed and operate the swing lever little by little. When the bucket is loaded, in particular, do not operate sharply.

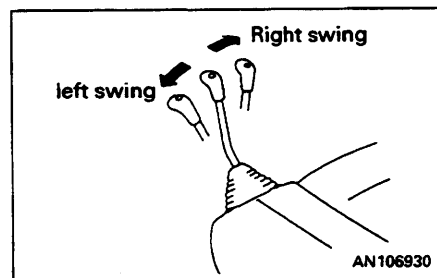

### REMARK

When the bucket is loaded, if the left-hand work equipment control lever is operated, the parking brake is released and the machine swings for a moment. This does not mean trouble.

## 12.8 OPERATION OF WORK EQUIPMENT

The work equipment is operated with the left and right work equipment levers, boom swing control pedal and blade control lever.

The left work equipment lever is used for arm operation and swinging, the right work equipment lever for boom and bucket operation, the boom swing control pedal for swinging the boom, and the blade control lever for operating the blade.

The movements of the lever and work equipment are as shown in the drawings on the right. When the levers are released, they automatically return to the neutral position and the work equipment is held in place.

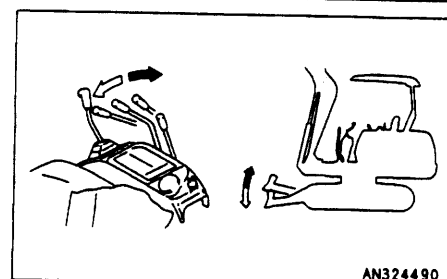
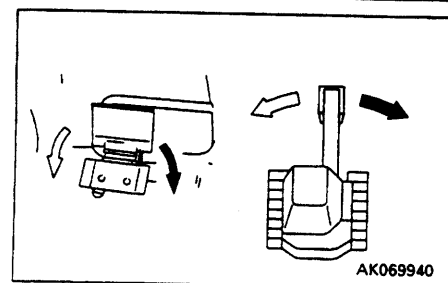
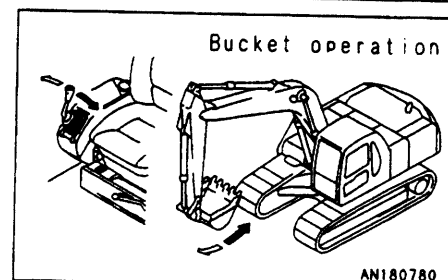
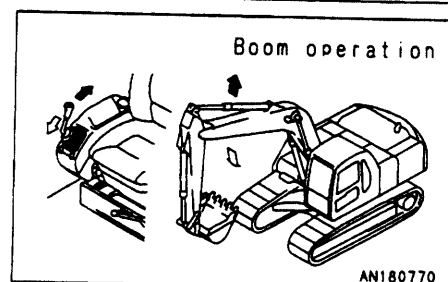
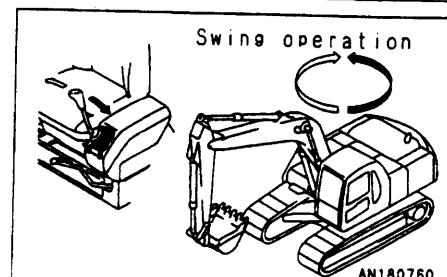
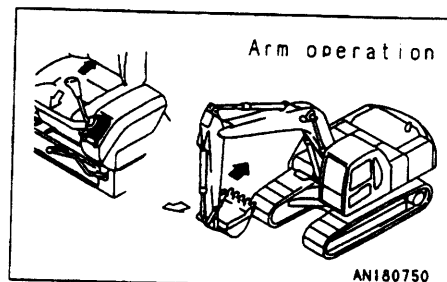

## 12.9 PROHIBITIONS FOR OPERATION

**⚠ WARNING**

- If it is necessary to operate the work equipment control lever when the machine is traveling, stop the machine before operating the work equipment control lever.
- Never operate the machine on a rock bed (hard or soft rock).

### Prohibited operations using swing force

Do not use the swing force to compact soil or break earth mounds or walls.

When swinging, do not dig the bucket teeth into the soil. These operations will damage the work equipment.

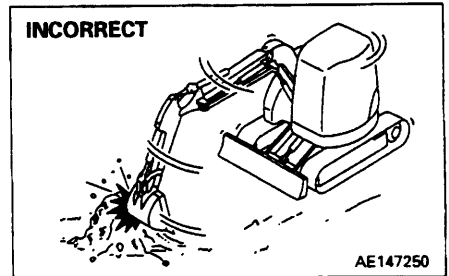

### Prohibited operations using travel force

Do not leave the bucket dug into the ground and use the travel force to excavate. This will bring excessive force to bear on the rear of the machine.

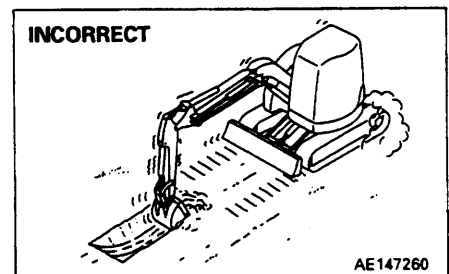

### Precautions when operating hydraulic cylinders to end of stroke

If the cylinder is operated to the end of its stroke during operations, force will be brought to bear on the stopper inside the cylinder, and this will reduce the life of the machine. To prevent this, always leave a small safety margin when operating the cylinders.

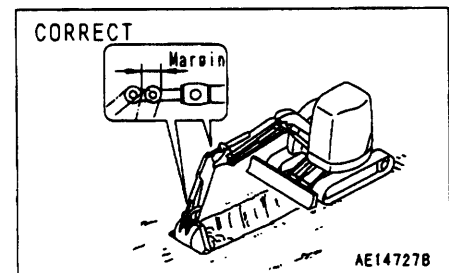

### Prohibited operations using dropping force of bucket

Do not use the dropping force of the bucket as a pickaxe, breaker, or pile driver. This will bring excessive force to bear on the rear of the machine, and will not only damage the machine, but is also dangerous.

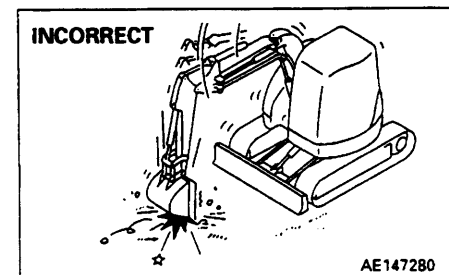

**Prohibited operations using dropping force of machine**

Do not use the dropping force of the machine for digging.

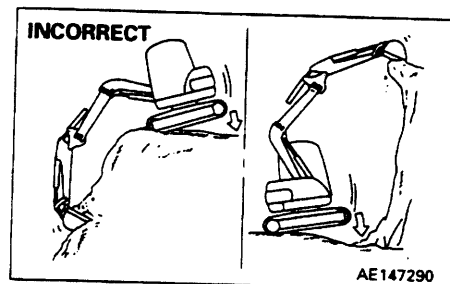

**Digging rocky ground**

It is better to excavate hard rocky ground after breaking it up by some other means. This will not only reduce damage to the machine but make for better economy.

**Avoid hitting blade**

Be careful not to hit the blade against rocks or boulders. This will cause premature damage to the blade or cylinders.

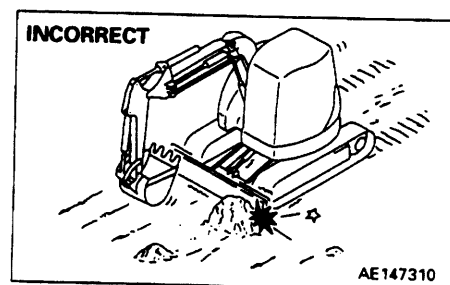

**Be careful when folding in work equipment**

When folding in the work equipment to the travel or transportation posture, be careful not to let the bucket hit the blade.

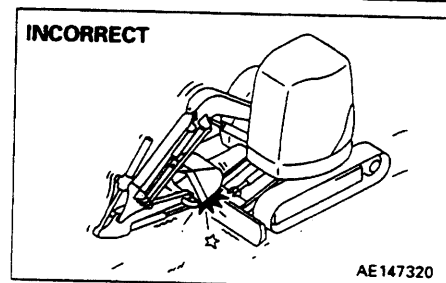

## 12. OPERATION

---

### Support blade on both sides

When using the blade as an outrigger, never support the machine with only one end of the blade.

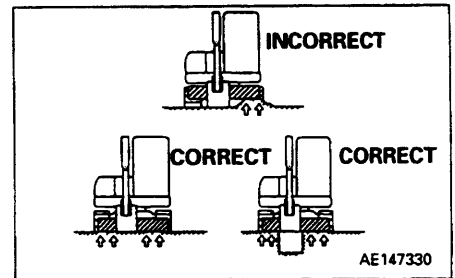

### Be careful of blade during backhoe operations

When carrying out deep digging operations with the blade at the front, be careful not to let the boom cylinder hit the blade. Always position the blade at the back unless it is needed at the front.

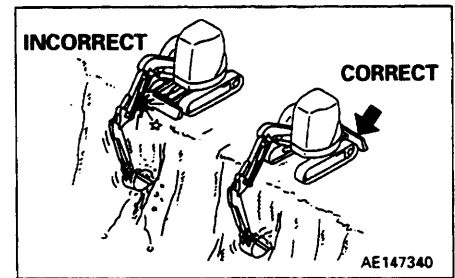

## 12.10 PRECAUTIONS FOR OPERATION

### PRECAUTIONS WHEN TRAVELING

When traveling over obstacles such as boulders or tree stumps, the machine (in particular, the undercarriage) is subjected to a large shock, so reduce the travel speed and travel over the obstacle at the center of the tracks. As far as possible, remove such obstacles or avoid traveling over them.

### PERMISSIBLE WATER DEPTH NOTICE

When driving the machine out of water, if the angle of the machine exceeds 15°, the rear of the upper structure will go under water, and water will be thrown up by the radiator fan. This may cause the fan to break.

Be extremely careful when driving the machine out of water.

Do not drive the machine in water deeper than of the center of carrier roller ①.

Supply grease to the parts which have been under water for a long time until the used grease is projected out of the bearings (around the bucket pin, in particular).

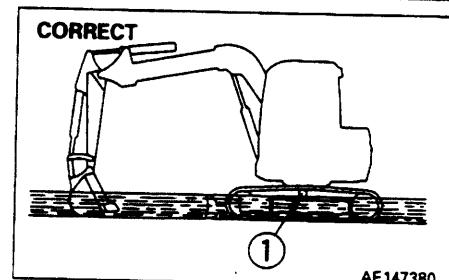
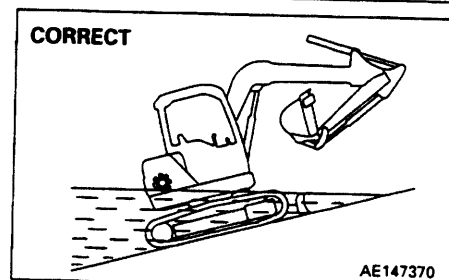
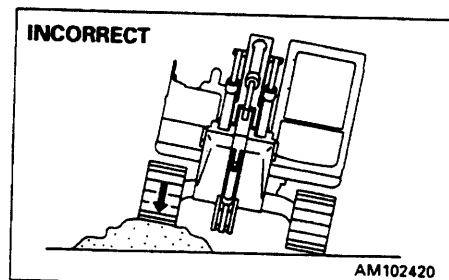

## 12.11 PRECAUTIONS WHEN TRAVELING UP OR DOWN HILLS

### ⚠ WARNING

- When traveling, raise the bucket approx. 20 - 30 cm (8 - 12 in) from the ground.  
Do not travel downhill in reverse.
- When traveling over ridges or other obstacles, keep the work equipment close to the ground and travel slowly.
- It is dangerous to turn on slopes or to travel across slopes. Always go down to a flat place to perform these operations. It may be longer, but it will ensure safety.
- If the machine starts to slide or loses stability, lower the bucket immediately and brake the machine.
- Turning or operating the work equipment when working on slopes may cause the machine to lose its balance and turn over, so avoid such operations. It is particularly dangerous to swing downhill when the bucket is loaded. If such operations have to be carried out, pile soil to make platform on the slope so that the machine can be kept horizontal when operating.
- Do not travel on slopes of over 30° as there is danger that the machine may overturn.

- 1) When traveling down steep hills, use the travel lever and fuel control lever to keep the travel speed low. When traveling down slopes of more than 15°, set the work equipment in the posture shown in the figure on the right, and lower the engine speed.

### REMARK

Drive down slopes with the blade on the upper side. If the machine travels down with the blade on the lower side, the tracks are loosened and they may jump over the pitch.

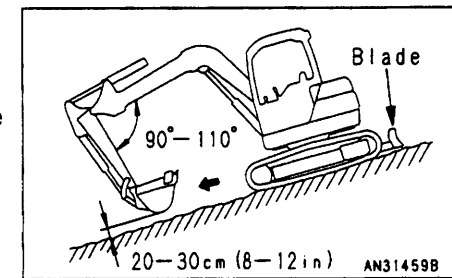
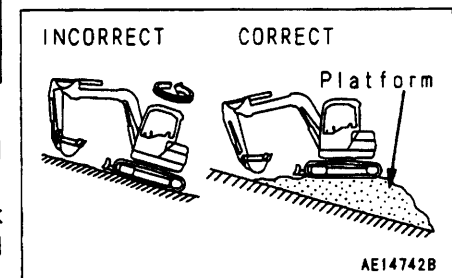
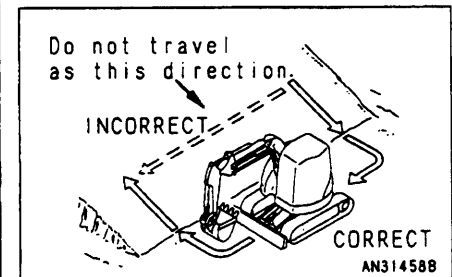
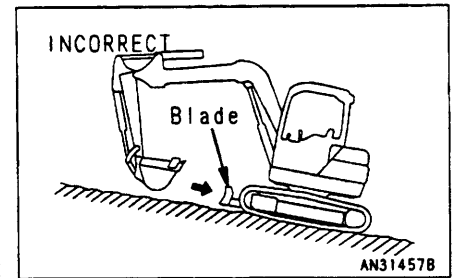
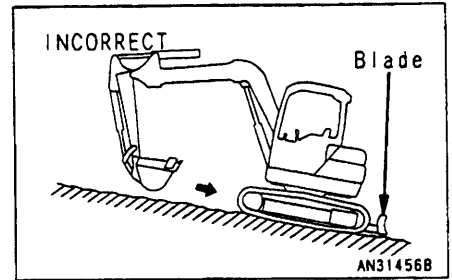

- 2) When traveling up a steep hill of more than 15°, set the work equipment in the posture shown in the diagram on the right.

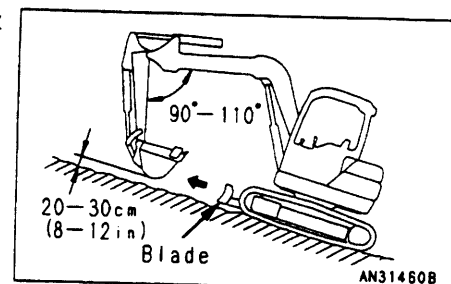

#### **Braking when traveling downhill**

To brake the machine during downhill runs, put the travel lever in the neutral position. This will cause the brake to be automatically applied.

#### **If shoes slip**

When traveling uphill, if the shoes slip or it is impossible to travel uphill using the force of the track only, it is possible to use the pulling force of the arm to help the machine travel uphill.

#### **If engine stops**

If the engine stops when traveling uphill, move the travel levers to the neutral position, lower the bucket to the ground, stop the machine, then start the engine again.

#### **Precautions on slopes**

If the engine stops when the machine is on a slope, never use the left work equipment control lever to carry out swing operations. The upper structure will swing under its own weight.



## 12.12 HOW TO ESCAPE FROM MUD

Always operate carefully to avoid getting stuck in mud. If the machine does get stuck in mud, use the following procedures to get the machine out.

### 12.12.1 WHEN ONE SIDE IS STUCK

When only one side is stuck in mud, use the bucket to raise the track, then lay boards or logs and drive the machine out. If necessary, put a board under the bucket also.

#### NOTICE

When using the boom or arm to raise the machine, always have the bottom of the bucket in contact with the ground. (Never push with the teeth). The angle between the boom and arm should be 90° to 110°.

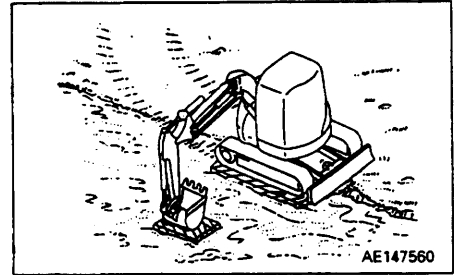

### 12.12.2 WHEN BOTH SIDES ARE STUCK

When the tracks on both sides are stuck in mud and the machine will not move, lay boards as explained above, and dig the bucket into the ground in front. Then pull in the arm as in normal digging operations and put the travel levers in the FORWARD position to pull the machine out.

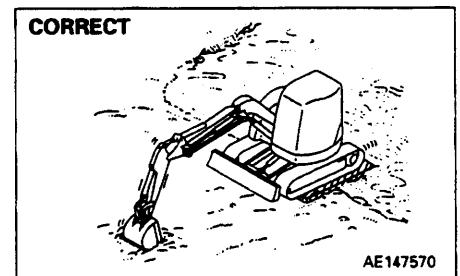

## 12.13 WORK POSSIBLE USING HYDRAULIC EXCAVATOR

In addition to the following, it is possible to further increase the range of applications by using various attachments.

### 12.13.1 BACKHOE WORK

When condition of the machine is as shown in the diagram at right, each cylinders maximum pushing excavation force is obtained when the bucket cylinder and link, arm cylinder and arm are at 90°.

When excavating, use this angle effectively to optimize your work efficiency.

The range for excavating with the arm is from a 45° angle away from the machine to a 30° toward the machine.

There may be some differences depending on the excavation depth, but try to use within the above range rather than going all the way to the extreme end of the cylinder stroke.

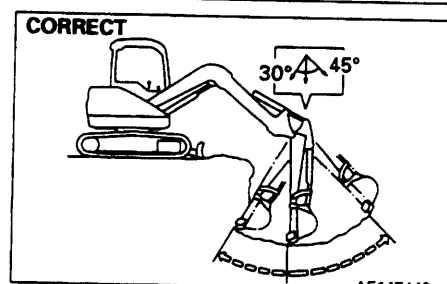
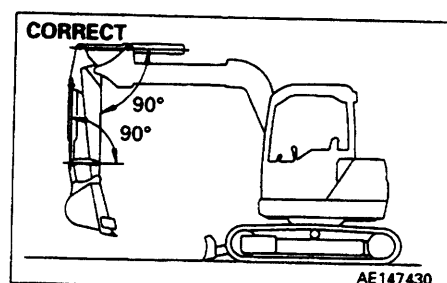

### 12.13.2 DITCHING WORK

Ditching work can be performed efficiently by attaching a bucket to match the width of the ditch and then setting the tracks parallel to the line of the ditch to be excavated.

To excavate a wide ditch, first dig out both sides and then finally remove the center portion.

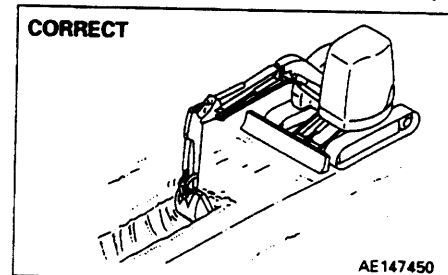

### 12.13.3 LOADING WORK

In places where the swing angle is small, work efficiency can be enhanced by locating the dump truck in a place easily visible to the operator.

Loading is easier and capacity greater if you begin from the front of the dump truck body than if loading is done from the side.

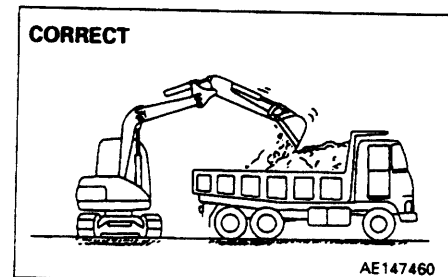

### 12.13.4 SMOOTHING WORK

When refilling after excavation and when smoothing the ground surface, use the blade.

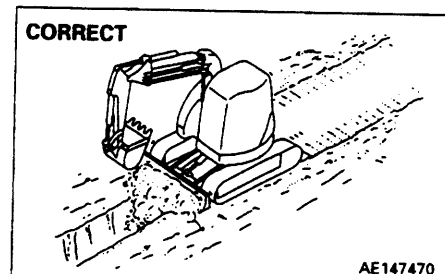

## 12. OPERATION

---

### 12.13.5 SIDE DITCHING

The machine can be used for side ditching in a confined worksite by combining the swing and boom swing operations.

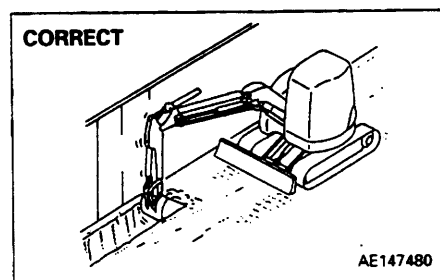

## 12.14 REPLACEMENT OF BUCKET

### ⚠ WARNING

- When knocking the pin in with a hammer, metal particles may fly and cause serious injury, particularly if they get into your eyes. When carrying out this operation, always wear goggles, helmet, gloves, and other protective equipment.
- When the bucket is removed, place it in a stable condition.

Stop the machine on a firm, flat surface. When performing joint work, make clear signals to each other and work carefully for safety's sake.

### 12.14.1 REMOVAL OF BUCKET

1. Lower the work equipment to the ground with the bucket back down.

#### REMARK

When removing the pins, place the bucket so that it is in light contact with the ground.

If the bucket is lowered strongly to the ground, the resistance will be increased and it will be difficult to remove the pins.

#### NOTICE

After removing the pins, make sure that they do not become contaminated with sand or mud and that the seals of bushing on both sides do not become damaged.

2. Remove mounting bolts ② of link pin retainer ①, and remove retainer ①.
3. Remove link pin ③.
4. Remove arm top pin ④ according to steps 2 - 3.
5. Lower the work equipment slowly to remove the bucket.

#### REMARK

At this time, make sure that spacer ⑤ and play preventive ring ⑥ do not drop out and become damaged.

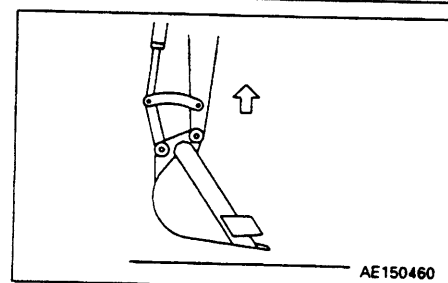
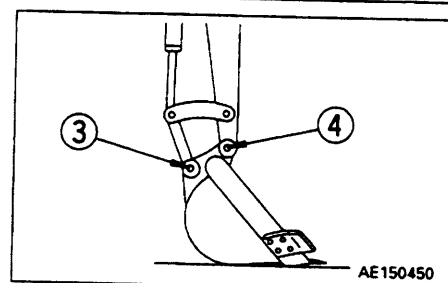
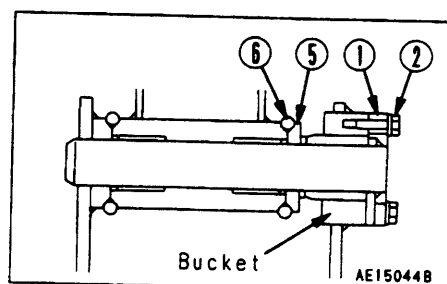

**12.14.2 INSTALLATION OF BUCKET**

When installing the bucket, apply molybdenum disulfide lubricant (NLGI No. 1 or equivalent) to the sliding surfaces of the pin and ring.

1. Wipe off any mud from the ring boss and sliding surfaces.
2. Lower the bucket to the ground with the bucket back down. Align the holes for arm pin ④.

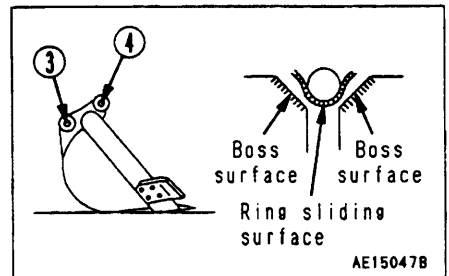

3. Insert pin ④ in bucket boss ⑦, spacer ⑤, play preventive ring ⑥, arm boss ⑧ and play preventive ring ⑨ in order in the arrow direction.
4. When inserting pin ④, align the dent of pin ④ with the projection of spacer ⑤, the groove of retainer ① with the lock plate of pin ④, and the bolt of retainer ① with the tap hole of the bucket. Tighten bolts ② temporarily.

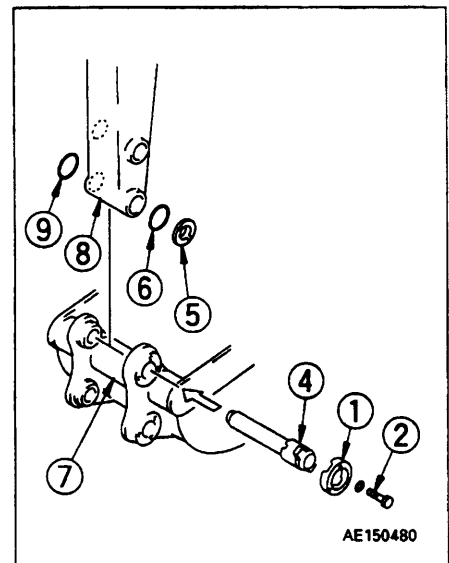

**NOTICE**

Set the lock plates of pins ③ and ④ as shown at right.

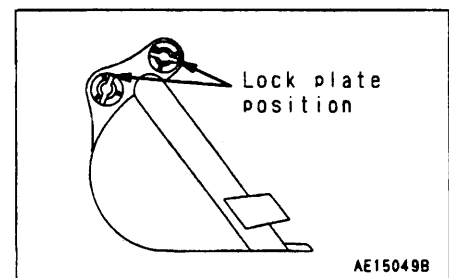

5. Lift the work equipment to free the bucket.
6. Extract the bucket cylinder and align link mounting pin ③. (Do not fit play preventive rings ⑥ and ⑨ at this time.)

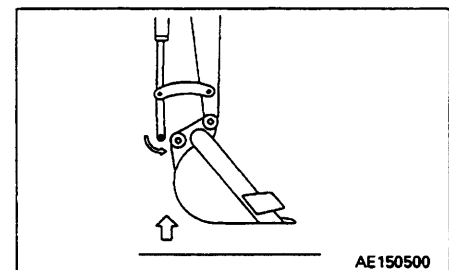

7. Insert pin ③ in bucket boss ⑦, spacer ⑤, play preventive ring ⑥, and bucket link ⑪ in order in the arrow direction. Finally, fit pin ③ together with bucket link ⑪ and play preventive ring ⑨. At this time, align the lock bolt hole.
8. Install retainer ① according to step 4.
9. Tighten bolts ② (six pieces in total) of arm top pin ④ and link mounting pin ③.

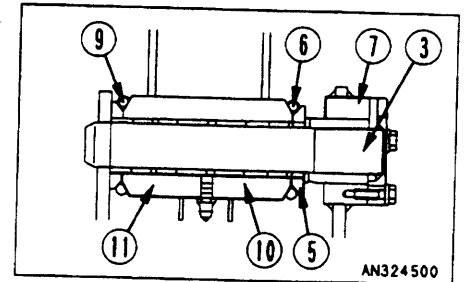

Tightening torque: 58.8 – 73.5 N·m (6.0 – 7.5 kgf·m, 43.4 – 54.2 lbft)

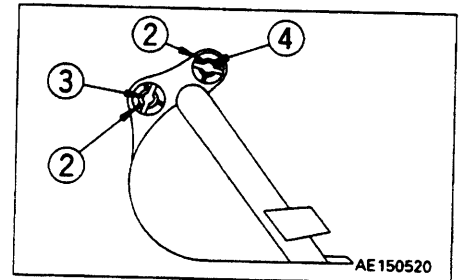

## 12.15 PARKING MACHINE

**CAUTION**

Avoid stopping suddenly. Give yourself ample room when stopping.

**WARNING**

When stopping the machine, select flat hard ground and avoid dangerous places. If it is unavoidably necessary to park the machine on a slope, insert blocks underneath the track shoes. As an additional safety measure, thrust the bucket into the ground.

CORRECT

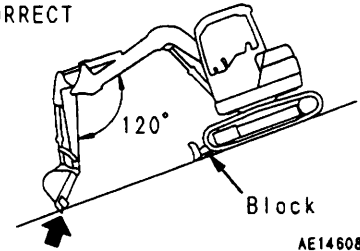

**WARNING**

If the control lever is touched by accident, the work equipment or the machine may move suddenly, and this may lead to a serious accident. Before leaving the operator's compartment, always set the safety lock lever securely to LOCK position.

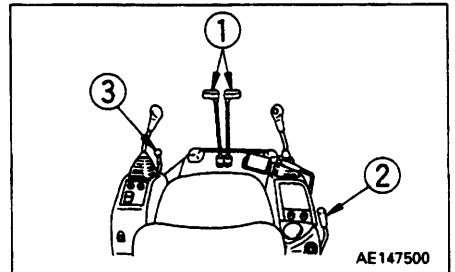

1. Put left and right travel levers ① in the neutral position.

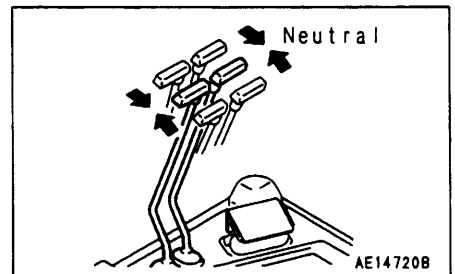

2. Lower the engine speed to low idling by fuel control lever ②.

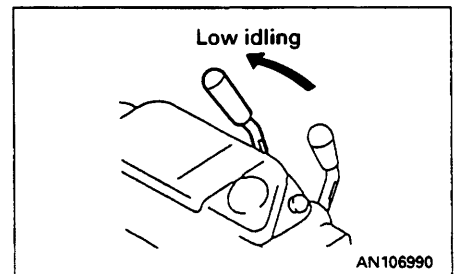

3. Lower the bucket horizontally until the bottom touches the ground.

4. Lower the blade to the ground.

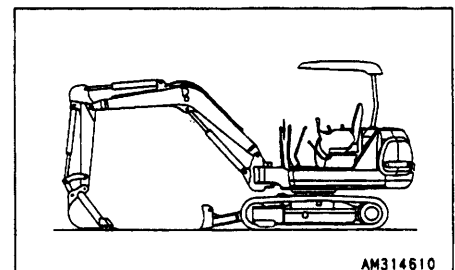

- Set safety lock lever ③ in the LOCK position.

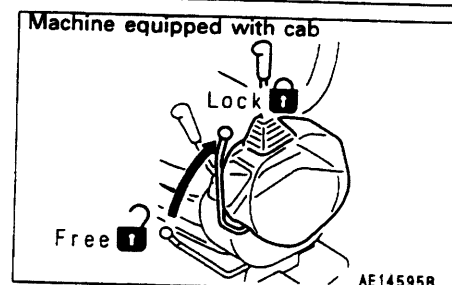
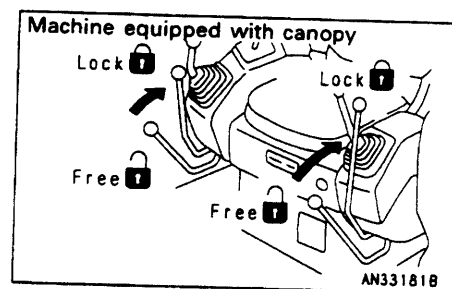

## 12.16 CHECK AFTER FINISHING WORK

Check the engine water temperature, engine oil pressure and fuel level on the monitor.

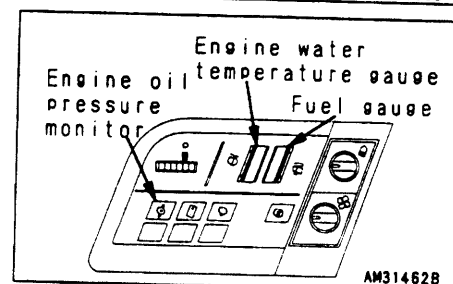

## 12.17 STOPPING ENGINE

### NOTICE

If the engine is abruptly stopped before it has cooled down, engine life may be greatly shortened. Consequently, do not abruptly stop the engine apart from an emergency.

In particular, if the engine has overheated, do not abruptly stop it but run it at medium speed to allow it to cool gradually, then stop it.

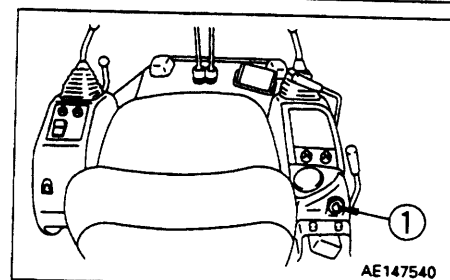

- Run the engine at low idling speed for about 5 minutes to allow it to gradually cool down.
- Turn the key in starting switch ① to the OFF position and stop the engine.
- Remove the key from starting switch ①.

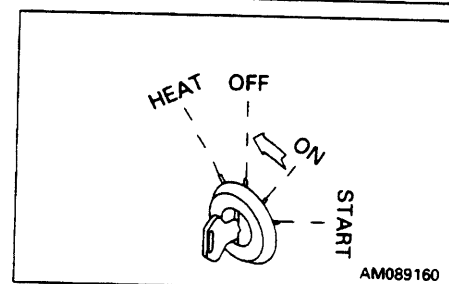



### 12.18 CHECK AFTER STOPPING ENGINE

1. Walk around the machine and check the work equipment, paint-work, and undercarriage, and check also for leakage of oil or water. If any abnormalities are found, repair them.
2. Fill the fuel tank.
3. Check the engine compartment for paper and debris. Clean out any paper and debris to avoid a fire hazard.
4. Remove any mud stuck to the undercarriage.

### 12.19 LOCKING

Always lock the following places.

- ① Door of operator's cab (machines equipped with cab)  
Always remember to close the window.
- ② Fuel tank filler port
- ③ Engine hood
- ④ Battery cover

#### REMARK

Use the starting switch key to open and close all these places.

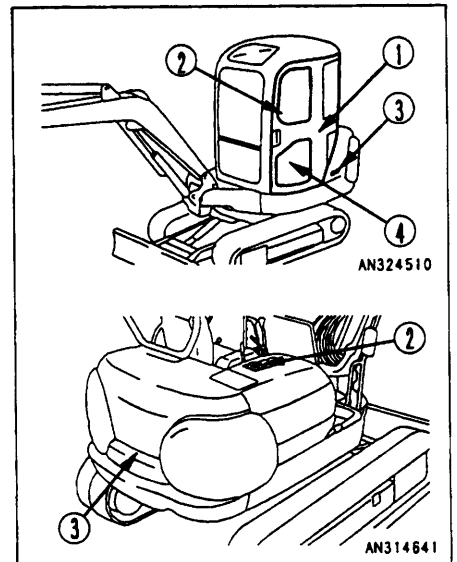

## 12.20 HANDLING OF RUBBER SHOE AND ROAD LINER (PC45R) (MACHINES WITH RUBBER SHOES OR ROAD LINER)

### 12.20.1 GOOD USE OF RUBBER SHOES AND ROAD LINER

The rubber shoes and road liner have excellent features which the steel shoes do not. If they are used similarly to the steel shoe, however, their features cannot be applied fully. Use them properly according to the condition of the jobsite and the type of work.

#### Comparison among rubber shoe, road liner and steel shoe

	Rubber shoe	Road liner	Steel shoe
Low vibration	◎	◎	△
Smooth travel (No creaks)	◎	○	○
Low noise	◎	◎	△
Does not damage pavement	◎	◎	△
Easy handling	◎	◎	△
Damaged easily	△	○	◎
Large traction force	◎	◎	◎

- ◎ Very good
- Good
- △ Fair

Rubber shoes and road liners have many merits caused by the specific performance of their materials, but their lack of strength is a weak point. Accordingly, if you understand the features of rubber shoes and road liners and observe the prohibited work and precautions for handling, they will last long and their merits will be fully utilized.

Before using rubber shoes or road liners, be sure to read "12.20.3 PRECAUTIONS FOR USING RUBBER SHOES AND ROAD LINERS".

### 12.20.2 GUARANTEE OF RUBBER SHOE AND ROAD LINER

If rubber shoes or road liners are damaged and the customer is liable for that damage as in the following cases, the guarantee is not applied to that rubber shoes or the road liners; The customer did not check or adjust the track tension correctly or operated the machine "in a place where rubber shoes or road liners may be broken with corners of steel plates, side ditches, blocks, crushed stones, rocks, steel bars, steel scrap, etc."

### 12.20.3 PRECAUTIONS FOR USING RUBBER SHOES AND ROAD LINERS (PC45R)

#### Prohibited operations

Do not perform the following operations.

- If the machine is operated or swung on crushed stones, extremely uneven and hard rockbed, steel bars, steel scraps or near edges of steel plates, rubber shoes and road liners may be damaged.
- If the machine is operated on a riverbed, etc. where there are many boulders of various sizes, the boulders may be caught in the rubber shoes and road liners to damage or remove the latter. If the rubber shoes and road liners slip when the machine is used for dozing, their lives are shortened.
- Take care that oil, fuel, chemical solvents, etc. does not make prolonged contact to the rubber shoes and road liners. If any adheres, wipe it off immediately. Do not drive the machine on a road where there are pools of oil, etc.
- When leaving the machine unused for a long period (more than three months), store it in place where it will not be exposed to direct sunlight and rain.
- Do not drive the machine on a hot place such as a fire, a steel plate left under the direct sunlight, hot asphalt, etc.
- If either track is raised with the work equipment and the other track is operated, the rubber shoe may come off or may be damaged.
- When the rubber parts of the road liner are so worn or broken that the head of the mounting bolts are scratched, replace the shoe immediately. If the bolt heads are broken, the bolt cannot be removed.
- When using the road liners, be sure to install them to the all links on both sides. If they are installed to only a part of the links, their durability is greatly lowered.

#### 12.20.4 PRECAUTIONS FOR USE

When working with rubber shoes or the road liners, observe the following.

- Do not perform a pivot turn on a concrete road.
- Avoid sharp steering which can wear and damage rubber shoes and road liners quickly.
- Avoid turning in a place where there is a large level difference. Ride over a level difference at right angles to it to prevent removal of the shoes.
- If the machine body is raised by using the work equipment, lower it slowly.
- Avoid working on materials containing oil (oilcakes of soybeans, corns, rape seeds, etc.) or wash the machine after working on them.
- Avoid working on salt, ammonium sulfate, potassium chloride, potassium sulfate, double superphosphate of lime, or wash the machine after working on them, since they lower the adhesion of the rubber and core.
- When handling salt, sugar, wheat, soybeans, if rubber shoes or road liners have a deep cut, a lug of the rubber, etc. may be mixed in them. Accordingly, repair all broken rubber parts before handling them.
- Do not operate the machine by pressing it against a concrete bank, wall, etc.
- The rubber shoes and road liners slip easily on wet steel plate or on roads covered with snow or ice. When driving or working on a slope, take care to prevent slipping.
- If rubber shoes and road liners are used in a very cold areas, their properties will change and their lives are shortened.

## 12. OPERATION

- Use rubber shoes in the temperature range from  $-25^{\circ}\text{C}$  to  $+55^{\circ}\text{C}$  and road liners from  $-25^{\circ}\text{C}$  to  $+65^{\circ}\text{C}$  for the reason of its physical properties.
- Take care not to damage rubber shoes and road liners with the bucket during operation.
- Keep rubber shoes at a proper tension to prevent them from being removing. If tension is low, it will come off under the following conditions. Take care working under such conditions, even if the shoe tension is proper.

1. Do not steer the machine in places where there are large level differences (about 20 cm (8 in) or larger) at curbs, rocks, etc. When riding over a level difference, drive at right angles to it.

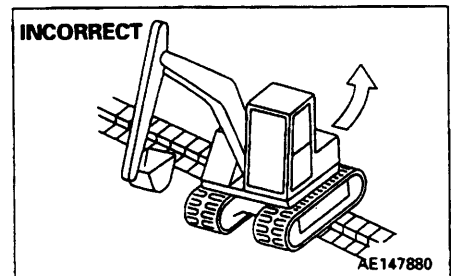

2. When climbing up a slope in reverse, do not steer the machine at the point between the flat ground and the slope. If you must steer on that point, steer very slowly.

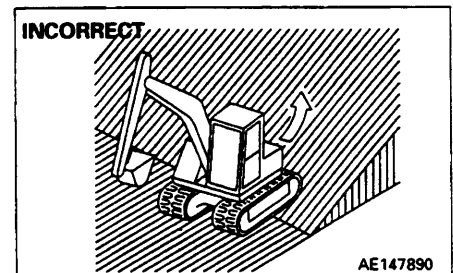

3. Avoid driving the machine with either side on a slope or an elevated part (to slant the machine body to about 10 degrees or more) and the other side on a flat ground. Drive with both sides on the same level so as not to damage the rubber shoes and road liners.

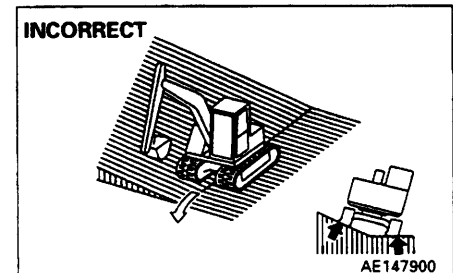

4. If the machine is operated as explained in 1 – 3 above, the rubber shoe is slackened. Do not steer the machine in the positions shown in the figure.

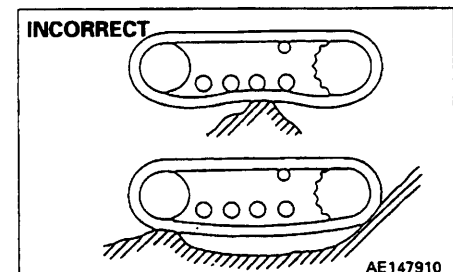

(Mechanism of rubber shoe coming off track)

1) When traveling over an obstacle, a gap is formed between the track roller and the rubber shoe.  
In this condition, the rubber shoe may come off.

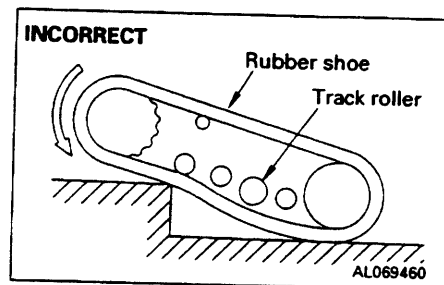

2) If the machine travels further in reverse, a gap is formed among the track roller, idler and the rubber shoe.

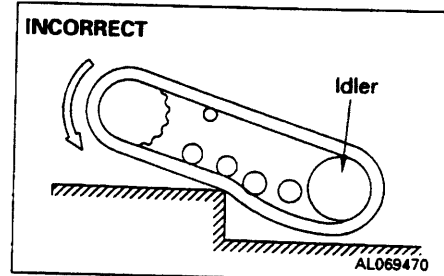

- When turning in a condition where the rubber shoe cannot move to the side because of the object it is passing over, or because of some other object.

- When the idler or track roller are out of alignment with the core because of movement of the rubber shoe out of alignment.

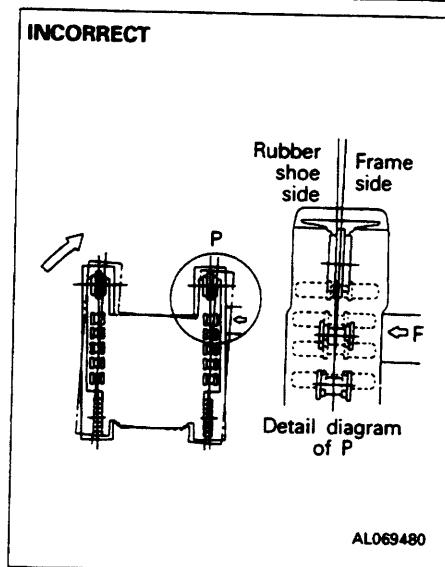

- If the machine travels in reverse in this condition, the rubber shoe will come off.

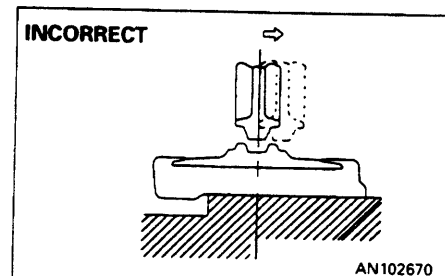

- If the machine is turned in this condition, the rubber shoe will come off.

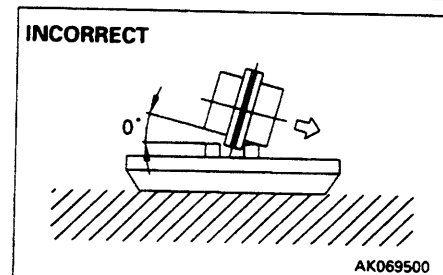

## 13. TRANSPORTATION

When transporting the machine, observe all related laws and regulations, and be careful to assure safety.

### 13.1 LOADING, UNLOADING WORK

#### ⚠ WARNING

- Loading or unloading the machine can be a dangerous operation, so be particularly careful.  
When loading or unloading the machine, run the engine at low idling and travel at low speed.
- Make sure the ramp has sufficient width, length and thickness to enable the machine to be safely loaded and unloaded. If the ramp sags appreciably, reinforce it with blocks, etc.
- When loading and unloading the machine, park the trailer on a flat firm roadbed. Keep a fairly long distance between the road shoulder and the machine.
- Remove the mud from the undercarriage to prevent the machine from slipping to the side on slopes. Be sure the ramp surface is clean and free of grease, oil, ice and loose materials.
- Never change the direction of travel when on the ramps. If it is necessary to change direction, drive off the ramps and correct the direction, then drive on to the ramps again.
- When turning the machine on the trailer, the machine's footing is unstable, so carry out the operation slowly.

#### ⚠ CAUTION

Always check that the sliding door on the cab specification machine is locked, regardless of whether it is open or closed. Do not open or close the door on ramps or on a platform. This may cause a sudden change in the operating force.

When loading or unloading, always use ramps or a platform and carry out the operations as follows.

1. Properly apply the brakes on the trailer and insert blocks beneath the tires to ensure that it does not move. Then fix the ramps in line with the centers of the trailer and the machine. Be sure that the two sides are at the same level as one another.

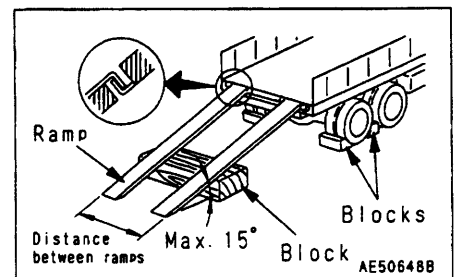

#### NOTICE

Make the angle of the ramps a maximum of 15°.

Set the distance between the ramps to match the center of the tracks.

2. Raise the engine speed with the fuel control lever.
3. Set the upper structure and lower structure in parallel with each other.
4. Drive the machine toward the ramp and lower the work equipment as low as possible within the range where it will not touch the trailer.

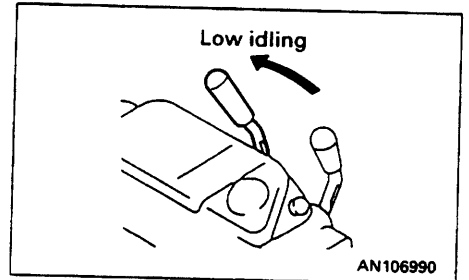

Do not operate the accelerator pedal.  
Never operate any lever other than the travel lever on the ramps.

5. Place the specified position of the trailer correctly.  
If the work equipment is installed, drive up the trailer forward.  
If the work equipment is not installed, drive up the trailer in reverse.

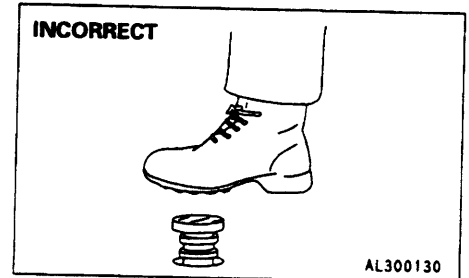



## 13.2 METHOD OF LIFTING MACHINE

 **WARNING**

- Do not lift the machine with a worker on it.
- When lifting the machine, use wire ropes sufficiently strong for the machine weight.
- Do not lift the machine in a different position from the position shown in the following procedure. If it is lifted in a different position, it may be unbalanced.
- Do not lift the machine with the lower structure swung. When lifting it, set the work equipment to the sprocket side, and set the lower and upper structures in parallel with each other.
- When lifting the machine, balance it, being especially careful of the center of gravity.

### NOTICE

- For the weight, see "25. SPECIFICATIONS".
- The specification values are for a standard model. The lifting method of the machine depends on the attachments and options mounted on it. If any attachment or option is mounted, consult your Komatsu distributor.

When lifting the machine, carry out the operation as follows on flat ground.

1. Start the engine and swing the upper structure until the blade is in the rear of the machine body.
2. Raise the blade to the end.
3. Extract the bucket cylinder, arm cylinder and boom cylinder to the end, then set the lock lever to the LOCK position.
4. Set the boom swing pedal to the neutral position without swinging the boom at all, then set the pedal lock to the LOCK position.
5. Stop the engine and confirm that there is nothing around the operator's seat, then get off the machine.  
If the machine is equipped with cab, close the door and front glass of the cab securely.

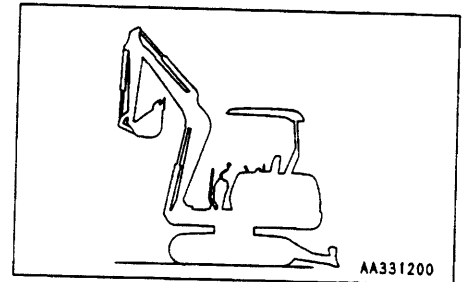

6. Install shackles to the lifting holes (two places) on both ends of the blade and the lifting holes (two places) of the boom, then install the wire ropes.

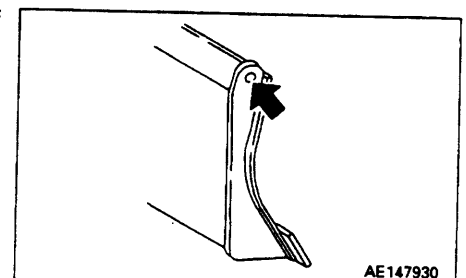

Be sure to use the four brackets.  
Do not lift the machine with the boom or the upper structure swung.

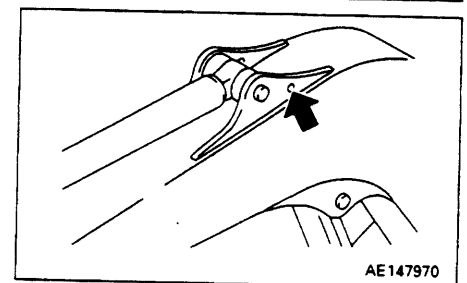

## 13. TRANSPORTATION

- When lifting, set the hanging angle of the wire ropes to 30 – 40°.
- After the machine leaves the ground, stop lifting once. After the machine is stabilized, lift it up slowly.

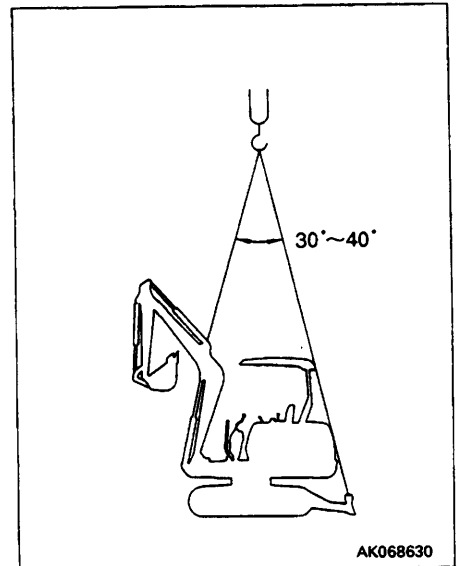

### 13.3 PRECAUTIONS FOR LOADING AND SECURING MACHINE

#### WARNING

Load the machine on a level and hard place. Secure a sufficient distance between the road shoulder and the machine.

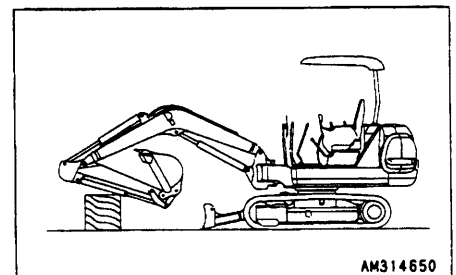

After placing the machine on the specified position of the trailer, secure it according to the following procedure.

- Lower the blade.
- Extract the bucket cylinder and arm cylinder to the end, then lower the boom slowly.
- Stop the engine and pull out the starting key.
- Lock each control lever with the safety lock lever securely.
- Place wood blocks against the front and rear of the track shoes so that the machine will not move during transportation, then secure with chains or wire ropes. In particular, prevent the machine from slipping sideways.

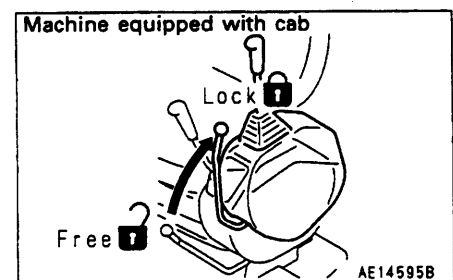
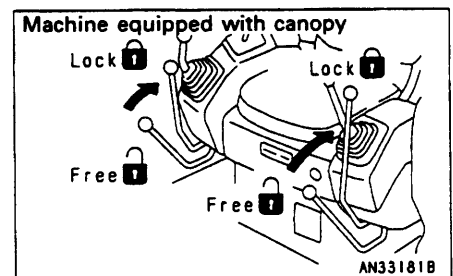

#### NOTICE

Place a wood block to either end of the bucket cylinder to prevent the bucket cylinder from touching the floor to be damaged during transportation.

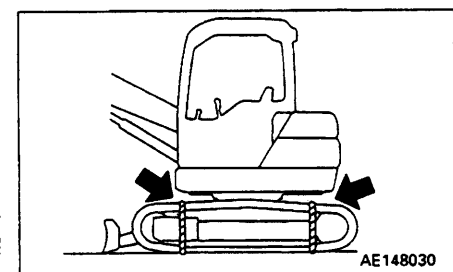

## 13.4 PRECAUTIONS FOR TRANSPORTATION

 **WARNING**

- Determine the route for transporting the machine by taking into account the width, height and weight of the machine.
- Always check that the door on the cab is closed and locked before transporting the machine.

### NOTICE

Be sure to retract the antenna of the radio (optional for cab-spec. machine).

Obey all state and local laws governing the weight, width and length of a load. Observe all regulations governing wide loads.

# 14. COLD WEATHER OPERATION

---

## 14.1 PRECAUTIONS FOR LOW TEMPERATURE

If the temperature becomes low, it becomes difficult to start the engine, and the coolant may freeze, so do as follows.

### 14.1.1 FUEL AND LUBRICANTS

Change to fuel and oil with low viscosity for all components. For details of the specified viscosity, see "20. USE OF FUEL, COOLANT AND LUBRICANTS ACCORDING TO AMBIENT TEMPERATURE".

### 14.1.2 COOLANT

 **WARNING**

**Keep antifreeze fluid away from an open flame. Never smoke when using antifreeze.**

#### NOTICE

- Never use methanol, ethanol or propanol based antifreeze.
- Absolutely avoid using any water leak preventing agent irrespective of whether it is used independently or mixed with an antifreeze.
- Do not mix one antifreeze with a different brand.

For details of the antifreeze mixture when changing the coolant, see "24.2 WHEN REQUIRED".

Use a Permanent Antifreeze (ethylene glycol mixed with corrosion inhibitor, antifoam agent, etc.) meeting the standard requirements as shown below. With permanent antifreeze, no change of coolant is required for a year. If it is doubtful that an available antifreeze meets the standard requirements, ask the supplier of that antifreeze for information.

Standard requirements for permanent antifreeze

- SAE ..... J1034
- FEDERAL STANDARD ..... O-A-548D

#### REMARK

Where no permanent antifreeze is available, an ethylene glycol antifreeze without corrosion inhibitor may be used only for the cold season. In this case, clean the cooling system twice a year (in spring and autumn). When refilling the cooling system, add antifreeze in autumn, but do not add any in spring.

## 14.1.3 BATTERY

**⚠ WARNING**

- To avoid gas explosions, do not bring fire or sparks near the battery.
- Battery electrolyte is dangerous. If it gets in your eyes or on your skin, wash it off with large amounts of water, and consult a doctor.

When the ambient temperature drops, the capacity of the battery will also drop. If the battery charge ratio is low, the battery electrolyte may freeze. Maintain the battery charge as close as possible to 100%, and insulate it against cold temperature so that the machine can be started easily the next morning.

**REMARK**

Measure the specific gravity and calculate the rate of charge from the following conversion table.

Rate of charge	Temp. of fluid	20°C (68°F)	0°C (32°F)	-10°C (14°F)	-20°C (-4°F)
	100%	1.28	1.29	1.30	1.31
90%	1.26	1.27	1.28	1.29	
80%	1.24	1.25	1.26	1.27	
75%	1.23	1.24	1.25	1.26	

### 14.2 PRECAUTIONS AFTER COMPLETION OF WORK

To prevent mud, water, or the undercarriage from freezing and making it impossible for the machine to move on the following morning, always observe the following precautions.

- Mud and water on the machine body should be completely removed. This is to prevent damage to the seal caused by mud or dirt getting inside the seal with frozen drops of water.
- Park the machine on hard, dry ground. If this is impossible, park the machine on wooden boards. The boards help protect the tracks from being freezed in soil and the machine can start next morning.
- Open the drain valve and drain any water collected in the fuel system to prevent it from freezing.
- As the battery capacity drops markedly in low temperatures, cover the battery or remove it from the machine, keep it in a warm place, and install it again the next morning.
- If electrolyte level is found low, add distilled water in the morning before beginning work. Do not add the water after the day's work so as to prevent fluid in the battery from freezing in the night.

### 14.3 PREPARING THE CAB HEATER (MACHINES EQUIPPED WITH CAB)

If the ambient temperature drops, use the cab heater.

- When using the cab heater, turn valve ① on the water manifold counterclockwise to open it.
- When leaving the cab heater unused for a long time, turn valve ① clockwise to close it.

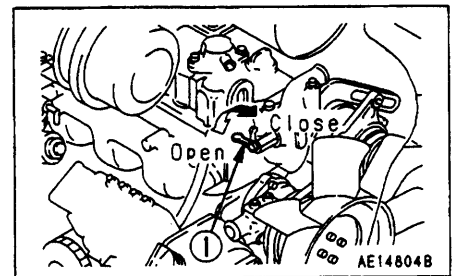

### 14.4 AFTER COLD WEATHER

When season changes and the weather becomes warmer, do as follows.

- Replace the fuel and oil for all parts with oil of the viscosity specified.  
For details, see "20. USE OF FUEL, COOLANT AND LUBRICANTS ACCORDING TO AMBIENT TEMPERATURE".
- If for any reason permanent antifreeze cannot be used, and an ethyl glycol base antifreeze (winter, one season type) is used instead, or if no antifreeze is used, drain the cooling system completely, then clean out the inside of the cooling system thoroughly, and fill with fresh water.

## **15. LONG-TERM STORAGE**

### **15.1 BEFORE STORAGE**

#### **NOTICE**

To protect the cylinder rod when the machine is not being used, set the work equipment in the posture shown in the diagram. (This prevents rusting of the cylinder rod)

When putting the machine in storage for a long time, do as follows.

- After every part is washed and dried, the machine shall be housed in a dry building. Never leave it outdoors. In case it is indispensable to leave it outdoors, park the machine on the well-drained concrete and cover it with canvas etc.
- Completely fill the fuel tank, lubricate and change the oil before storage.
- Apply a thin coat of grease to metal surface of the hydraulic piston rods.
- Disconnect the negative terminals of the battery and cover it, or remove it from the machine and store it separately.
- If the ambient temperature is expected to drop below 0°C, always add antifreeze to the cooling water.
- Lock each control lever and pedal with the lock lever and pedal lock.
- If the machine can be equipped with attachments, set the stop valve to the LOCK position. Fit a plug to each elbow.
- If the machine can be equipped with attachments, set the changeover valve to the CRUSHER AND GENERAL ATTACHMENT position.

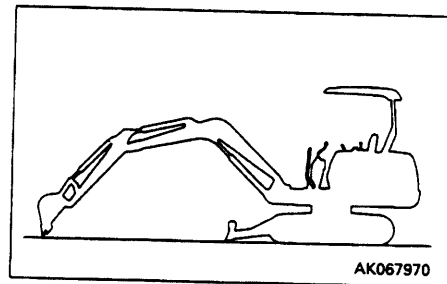



## 15.2 DURING STORAGE

 **WARNING**

**If it is unavoidably necessary to carry out the rustpreventive operation while the machine is indoors, open the doors and windows to improve ventilation and prevent gas poisoning.**

Operate the engine and move the machine for a short distance once a month so that a new film of oil will be coated over movable parts and component surfaces. At the same time, also charge the battery.

When operating the work equipment, wipe off the grease applied to the hydraulic cylinder rod.

After operating the work equipment, apply grease again.

## 15.3 AFTER STORAGE

### NOTICE

**If the machine is stored without carrying out the monthly rust prevention operation, request your Komatsu distributor for service.**

Carry out the following procedure when taking the machine out of long-term storage.

- Wipe off the grease from the hydraulic cylinder rods.
- Add oil and grease to all places.

## 16. TROUBLESHOOTING

### 16.1 PHENOMENA THAT ARE NOT FAILURES

Note that the following phenomena are not failures:

1. When the arm is pulled in, the speed of movement will drop momentarily when the arm is more or less vertical.
2. The arm speed will drop momentarily when the bucket teeth are more or less horizontal.
3. When starting or stopping the swing, noise will be emitted from the brake valve.
4. When going down a steep slope at low speed, a noise will be emitted from the travel motor.

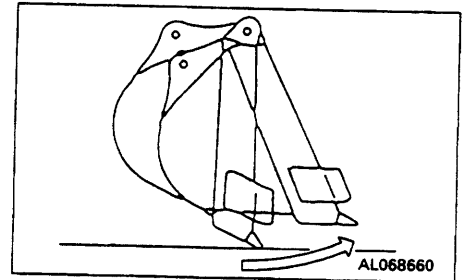
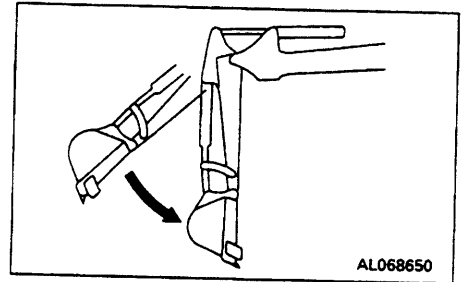

### 16.2 METHOD OF TOWING MACHINE

#### ⚠ WARNING

When towing the machine, use a wire rope that has ample strength for the weight of the machine that is being towed.

If the machine sinks in mud and cannot get out under its own power, or if the drawbar pull of the excavator is being used to tow a heavy object, use a wire rope as shown in the diagram on the right. Place pieces of wood between wire ropes and body to prevent damage to ropes and body.

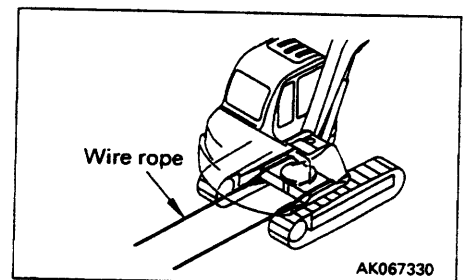

### 16.3 PRECAUTIONS ON PARTICULAR JOBSITES

- When digging in water, if the water gets on to the work equipment mounting pins, add grease to bucket links (A), (B), (C), (D) and (E) for each operation.
- When carrying out heavy duty digging and deep digging operations, add grease to bucket links (A), (B), (C), (D) and (E) (total: 5 points) before each operation. After greasing, operate the bucket several times, then add grease again.

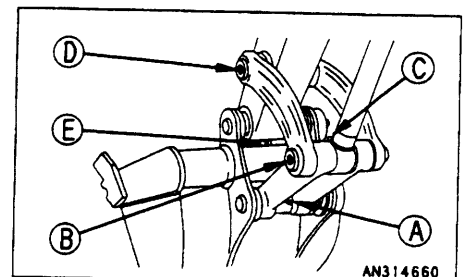

## 16.4 IF BATTERY IS DISCHARGED

**⚠ WARNING**

- When checking or handling the battery, stop the engine and turn the starting switch key to the OFF position before starting.
- Before starting the engine, wipe off the dust from the top of the battery with a wet cloth.
- The battery generates hydrogen gas, so there is danger of explosion. Do not bring lighted cigarettes near the battery, or do anything that will cause sparks.
- Battery electrolyte is dilute sulphuric acid, and it will attack your clothes and skin. If it gets on your clothes or on your skin, wash it immediately off with large amounts of water. If it gets in your eyes, wash it out with fresh water, and consult a doctor.
- When handling battery, always wear protective goggles.
- When removing the battery, first disconnect the cable from the ground (normally, from the negative  $\ominus$  terminal). When installing, install the positive  $\oplus$  terminal first. If a tool touches the cable connecting the positive terminal and the chassis, there is danger that it will cause sparks.
- If the terminals are loose, there is danger that the defective contact may generate sparks that will cause an explosion. When installing the terminals, install them tightly.
- When removing or installing, check which is the positive  $\oplus$  terminal and negative  $\ominus$  terminal.
- If the battery is replaced, secure it. If it is not secured, its terminals may be loosened and sparks will be made.

When removing, disconnect the cable from the ground terminal first.

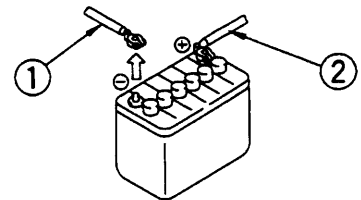

When installing, connect the cable to the positive  $\oplus$  terminal first.

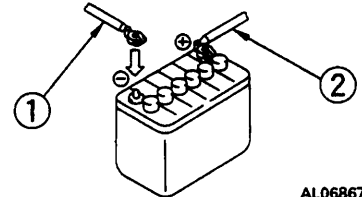

AL068670

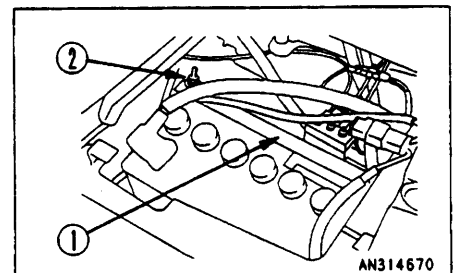

AN314670

### 16.4.1 REMOVING AND INSTALLING BATTERY

- When removing the battery, disconnect the grounded cable (from the negative  $\ominus$  terminal side, in general) first. If the terminal and the machine body is connected by a tool, etc., dangerous sparks will be made.
- When installing the battery, connect the grounded cable at last.
- After the battery is replaced, secure it with battery fitting ①.

Tightening torque of mounting nut ②

Nut and fitting	Double nut
6.86 – 7.84 N·m (0.7 – 0.8 kgf·m, 5.1 – 5.8 lbft)	14.7 – 34 N·m (1.5 – 3.5 kgf·m, 10.8 – 25.3 lbft)

**NOTICE**

Secure the battery, and confirm that it does not move. If it moves, secure it again.

**16.4.2 STARTING ENGINE WITH BOOSTER CABLE**

When starting the engine with a booster cable, do as follows:

**Precautions when connecting and disconnecting booster cable****⚠ WARNING**

- When connecting the cables, never contact the positive  $\oplus$  and negative  $\ominus$  terminals.
- When starting the engine with a booster cable, always wear safety glasses.
- Be careful not to let the normal machine and problem machine contact each other. This prevents sparks from generating near the battery which could ignite the hydrogen gas given off by the battery. If hydrogen gas explodes, it could cause serious injury.
- Make sure that there is no mistake in the booster cable connections. The final connection is to the revolving frame, but sparks will be generated when this is done, so connect to a place as far as possible from the battery. (However, avoid connecting the cable to the work equipment, as conduction is poor.)
- Use care when removing the cables from the machine that has been started. Do not allow the cable ends to contact each other or the machine, to avoid hydrogen explosion.

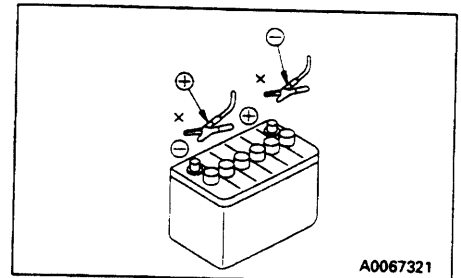

A0067321

**NOTICE**

- The size of the booster cable and clip should be suitable for the battery size.
- The battery of the normal machine must be the same capacity as that of the engine to be started.
- Check the cables and clips for damage or corrosion.
- Make sure that the cables and clips are firmly connected.

### **Charging battery while still mounted on machine**

- There is danger that an abnormal voltage may be applied to the alternator and damage it, so remove the wires from the battery terminals when charging.
- Remove all the battery filler caps when charging to release the gas that is generated.
- If the battery overheats (the electrolyte exceeds 45°C), stop the charging temporarily.
- After completing charging, stop the charging immediately. If charging is continued after the charging is completed, the following problems will occur.
  - 1) Overheating of battery
  - 2) Reduction in battery electrolyte level
  - 3) Problems with battery
- When connecting the battery, be sure to connect the wires properly. Never connect (⊕ to ⊖ or ⊖ to ⊕). Connecting the wires wrongly will cause damage to the alternator and other parts.
- Except when checking the battery electrolyte level or measuring the specific gravity, always remove the cables connected to the battery before handling the battery.

**Connecting the booster cables**

Keep the starting switch at the OFF position.

Connect the booster cable as follows, in the order of the numbers marked in the diagram.

1. Make sure that the starting switches of the normal machine and problem machine are both at the OFF position.
2. Connect one clip of booster cable (A) to the positive (+) terminal of the problem machine.
3. Connect the other clip of booster cable (A) to the positive (+) terminal of the normal machine.
4. Connect one clip of booster cable (B) to the negative (-) terminal of the normal machine.
5. Connect the other clip of booster cable (B) to the engine block of the problem machine.

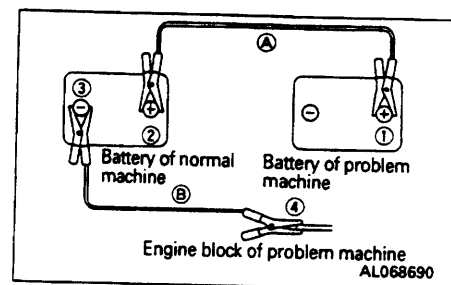
**Starting the engine**

1. Make sure the clips are firmly connected to the battery terminals.
2. Start the engine of the normal machine and keep it to run at high idling speed.
3. Turn the starting switch of the problem machine to the START position and start the engine. If the engine doesn't start at first, try again after 2 minutes or so.  
Refer to "12.2 STARTING ENGINE".

**Disconnecting the booster cables**

After the engine has started, disconnect the booster cables in the reverse of the order in which they were connected.

1. Remove one clip of booster cable (B) from the engine block of the problem machine.
2. Remove the other clip of booster cable (B) from the negative (-) terminal of the normal machine.
3. Remove one clip of booster cable (A) from the positive (+) terminal of the normal machine.
4. Remove the other clip of booster cable (A) from the positive (+) terminal of the problem machine.

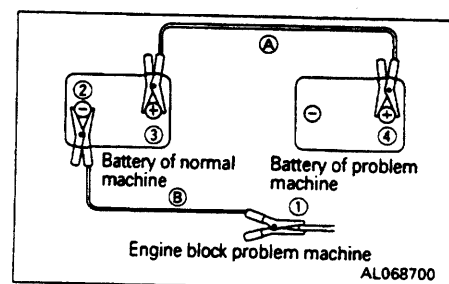

## 16.5 OTHER TROUBLE

### 16.5.1 ELECTRICAL SYSTEM

- ( ): Always contact your Komatsu distributor when dealing with these items.
- In cases of abnormalities or causes which are not listed below, please contact your Komatsu distributor for repairs.

Problem	Main causes	Remedy
Lamp does not glow brightly even when the engine runs at high speed	<ul style="list-style-type: none"> <li>● Defective wiring</li> <li>● Defective adjustment of fan belt tension</li> </ul>	<ul style="list-style-type: none"> <li>● Check, repair loose terminals, disconnections</li> <li>● Adjust fan belt tension For details, see EVERY 250 HOURS SERVICE</li> </ul>
Lamp flickers while engine is running		
Charge lamp does not go out even when engine is running	<ul style="list-style-type: none"> <li>● Defective alternator</li> <li>● Defective wiring</li> </ul>	<ul style="list-style-type: none"> <li>● Replace</li> <li>● Check, repair</li> </ul>
Abnormal noise is generated from alternator	<ul style="list-style-type: none"> <li>● Defective alternator</li> </ul>	<ul style="list-style-type: none"> <li>● Replace</li> </ul>
Starting motor does not turn when starting switch is turned to ON	<ul style="list-style-type: none"> <li>● Defective wiring</li> <li>● Insufficient battery charge</li> </ul>	<ul style="list-style-type: none"> <li>● Check, repair</li> <li>● Charge</li> </ul>
Pinion of starting motor keeps going in and out	<ul style="list-style-type: none"> <li>● Insufficient battery charge</li> </ul>	<ul style="list-style-type: none"> <li>● Charge</li> </ul>
Starting motor turns engine sluggishly	<ul style="list-style-type: none"> <li>● Insufficient battery charge</li> <li>● Defective starting motor</li> </ul>	<ul style="list-style-type: none"> <li>● Charge</li> <li>● Replace</li> </ul>
Starting motor disengages before engine starts	<ul style="list-style-type: none"> <li>● Defective wiring</li> <li>● Insufficient battery charge</li> </ul>	<ul style="list-style-type: none"> <li>● Check, repair</li> <li>● Charge</li> </ul>
Pre-heating monitor does not light	<ul style="list-style-type: none"> <li>● Defective wiring</li> <li>● Defective monitor</li> </ul>	<ul style="list-style-type: none"> <li>● Check, repair</li> <li>● Replace</li> </ul>
Oil pressure monitor does not light up when engine is stopped (starting switch at ON position)	<ul style="list-style-type: none"> <li>● Defective monitor</li> <li>● Defective oil pressure switch</li> </ul>	<ul style="list-style-type: none"> <li>● Replace</li> <li>● Replace</li> </ul>

**16.5.2 CHASSIS**

- ( ): Always contact your Komatsu distributor when dealing with these items.
- In cases of abnormalities or causes which are not listed below, please contact your Komatsu distributor for repairs.

<b>Problem</b>	<b>Main causes</b>	<b>Remedy</b>
Speed of travel, swing, boom, arm, bucket is slow	<ul style="list-style-type: none"> <li>● Lack of hydraulic oil</li> </ul>	<ul style="list-style-type: none"> <li>● Add oil to specified level, see CHECK BEFORE STARTING</li> </ul>
Pump generates abnormal noise	<ul style="list-style-type: none"> <li>● Clogged element in hydraulic tank strainer</li> </ul>	<ul style="list-style-type: none"> <li>● Clean, see EVERY 4000 HOURS SERVICE</li> </ul>
Does not swing	<ul style="list-style-type: none"> <li>● Swing lock pin not removed</li> </ul>	<ul style="list-style-type: none"> <li>● Remove pin</li> </ul>
Excessive rise in hydraulic oil temperature	<ul style="list-style-type: none"> <li>● Loose fan belt</li> <li>● Lack of hydraulic oil</li> </ul>	<ul style="list-style-type: none"> <li>● Adjust fan belt tension, see EVERY 250 HOURS SERVICE</li> <li>● Add oil to specified level see CHECK BEFORE STARTING</li> </ul>
Track comes off	<ul style="list-style-type: none"> <li>● Track too loose</li> </ul>	<ul style="list-style-type: none"> <li>● Adjust track tension, see WHEN REQUIRED</li> </ul>
Abnormal wear of sprocket		
Bucket rises slowly, does not rise	<ul style="list-style-type: none"> <li>● Lack of hydraulic oil</li> </ul>	<ul style="list-style-type: none"> <li>● Add oil to specified level, see CHECK BEFORE STARTING</li> </ul>



16. TROUBLESHOOTING

16.5.3 ENGINE

- ( ): Always contact your Komatsu distributor when dealing with these items.
- In cases of abnormalities or causes which are not listed below, please contact your Komatsu distributor for repairs.

Problem	Main causes	Remedy
Engine oil pressure monitor lights up	<ul style="list-style-type: none"> <li>● Engine oil pan oil level is low (sucking in air)</li> <li>● Clogged oil filter element</li> <li>● Defective tightening of oil pipe joint, oil leakage from damaged part</li> <li>● Defective monitor lamp</li> </ul>	<ul style="list-style-type: none"> <li>● Add oil to specified level, see CHECK BEFORE STARTING</li> <li>● Replace cartridge, see EVERY 500 HOURS SERVICE</li> <li>(● Check, repair)</li> <li>(● Replace lamp)</li> </ul>
Steam is emitted from top part of radiator (pressure valve)	<ul style="list-style-type: none"> <li>● Cooling water level low, water leakage</li> <li>● Loosen fan belt</li> <li>● Dirt or scale accumulated in cooling system</li> <li>● Clogged radiator fin or damaged fin</li> <li>● Defective thermostat</li> <li>● Loose radiator filler cap (high altitude operation)</li> </ul>	<ul style="list-style-type: none"> <li>● Add cooling water, repair, see CHECK BEFORE STARTING</li> <li>● Adjust fan belt tension, see EVERY 250 HOURS SERVICE</li> <li>● Change cooling water, clean inside of cooling system, see WHEN REQUIRED</li> <li>● Clean or repair, see EVERY 500 HOURS SERVICE</li> <li>(● Replace thermostat)</li> <li>● Tighten cap or replace packing</li> </ul>
Red range on engine water temperature gauge lights up	<ul style="list-style-type: none"> <li>● Defective thermostat</li> </ul>	<ul style="list-style-type: none"> <li>(● Replace thermostat)</li> </ul>
White range on engine water temperature gauge lights up	<ul style="list-style-type: none"> <li>● Defective thermostat</li> </ul>	<ul style="list-style-type: none"> <li>(● Replace thermostat)</li> </ul>
Engine does not start when starting motor is turned	<ul style="list-style-type: none"> <li>● Lack of fuel</li> <li>● Air in fuel system</li> <li>● Defective fuel injection pump or nozzle</li> <li>● Starting motor cranks engine sluggishly</li> <li>● Preheating monitor does not light up</li> <li>● Defective compression                             <ul style="list-style-type: none"> <li>○ Defective valve clearance</li> </ul> </li> </ul>	<ul style="list-style-type: none"> <li>● Add fuel, see CHECK BEFORE STARTING</li> <li>● Repair place where air is sucked in, see EVERY 500 HOURS SERVICE</li> <li>(● Replace pump or nozzle)</li> <li>— See ELECTRICAL SYSTEM</li> <li>(○ Adjust valve clearance)</li> </ul>

**ENGINE (cont'd) (16.5.3)**

<b>Problem</b>	<b>Main causes</b>	<b>Remedy</b>
Exhaust gas is white or blue	<ul style="list-style-type: none"> <li>● Too much oil in oil pan</li> <li>● Improper fuel</li> </ul>	<ul style="list-style-type: none"> <li>● Add oil to specified level, see CHECK BEFORE STARTING</li> <li>● Change to specified fuel</li> </ul>
Exhaust gas occasionally turns black	<ul style="list-style-type: none"> <li>● Clogged air cleaner element</li> <li>● Defective nozzle</li> <li>● Defective compression</li> </ul>	<ul style="list-style-type: none"> <li>● Clean or replace, see WHEN REQUIRED</li> <li>(● Replace nozzle)</li> <li>(● See defective compression above)</li> </ul>
Combustion noise occasionally makes breathing sound	<ul style="list-style-type: none"> <li>● Defective nozzle</li> </ul>	<ul style="list-style-type: none"> <li>(● Replace nozzle)</li> </ul>
Abnormal noise generated (combustion or mechanical)	<ul style="list-style-type: none"> <li>● Low grade fuel being used</li> <li>● Overheating</li> <li>● Damage inside muffler</li> <li>● Excessive valve clearance</li> </ul>	<ul style="list-style-type: none"> <li>● Change to specified fuel</li> <li>● Red range of engine water temperature gauge lights up as above</li> <li>(● Replace muffler)</li> <li>(● Adjust valve clearance)</li> </ul>

# **MAINTENANCE**

## **17. GUIDES TO MAINTENANCE**

---

**Do not carry out any inspection and maintenance operation that is not given in this manual.**

**Perform maintenance work on hard, flat ground.**

**Check service meter:**

Check the service meter reading every day to see if the time has come for any necessary maintenance to be carried out.

**Komatsu genuine replacement parts:**

Use Komatsu genuine parts specified in the Parts Book as replacement parts.

**Komatsu genuine oils:**

Use Komatsu genuine oils and grease. Choose oils and grease with proper viscosities specified for ambient temperature.

**Always use clean washer fluid:**

Use automobile window washer fluid and be careful not to let any dirt get into it.

**Always use clean oil and grease:**

Use clean oil and grease. Also, keep containers of the oil and grease clean. Keep foreign materials away from oil and grease.

**Keeping the machine clean:**

Always keep the machine clean. This makes it easier to find parts causing problems. Keep in particular grease fittings, breathers and oil level gauges clean and avoid foreign matters from getting in them.

**Be careful of hot water and oil:**

Draining hot oils and coolants and removing their filters immediately after the engine stops are hazardous. Allow the engine to cool.

If the oil has to be drained when it is cold, warm up the oil to a suitable temperature (approx. 20 – 40°C) before draining it.

**Checking foreign materials in drained oil and on filter:**

After oil is changed or filters are replaced, check the oil and filters for metallic particles and foreign materials. If large quantities of metallic particles or foreign materials are found, consult your Komatsu distributor.

**Fuel strainer:**

If your machine is equipped with a fuel strainer, do not remove it while fueling.

**Oil change:**

Check or change oils in the places where dust is scarce to keep foreign materials away from oils.

**Warning tag:**

Attach the warning tag to the starting switch or other appropriate control lever to avoid someone who is not aware of the circumstances from starting the engine.

**Obey precautions:**

During the operation, always obey the precautions on the safety label attached to the machine.

**Welding instructions:**

- Turn off the engine starting switch.
- Do not apply more than 200 V continuously.
- Connect grounding the cable within 1 m from the area to be welded.
- Avoid seals or bearings from being between the area to be welded and the position of grounding point.
- Do not use the area around the work equipment pins or the hydraulic cylinders as the grounding point.

**Fire prevention:**

Use nonflammable cleaner or light oil for cleaning parts. Keep flame or cigarette light away from light oil.

**Clamp faces:**

When O-rings or gaskets are removed, clean the clamp faces and replace the O-rings and gaskets with new ones. Be sure to fit O-rings and gaskets when assembling.

**Objects in your pockets:**

Keep your pockets free of loose objects which can fall out and drop into the machinery; especially when you work on the machinery while bending over it.

**Checking undercarriage:**

When working in rocky areas, check for damage to the undercarriage and for looseness, flaws, wear and damage in bolts and nuts. Loosen the track tension a little when working in such areas.

**Precautions when washing machine:**

- Never spray steam or water directly on the connectors and mechatronics parts.
- Do not allow water to get on the monitors and controllers inside the operator's cab.
- Never spray steam or water directly at the radiator or oil cooler portions.
- Acryl is used for the rear face, roof, and left face of the cab specification machine, so do not wipe it with any dirty cloth or chemical (thinner, gasoline, etc.). If any of these parts is scratched, polish it with a compound. When cleaning it, use water and a clean cloth to remove all the mud and dirt.

**Pre-and post-work checks:**

Before starting work in mud, rain, snow or at seashore, check plugs and valves for tightness.

Wash the machine immediately after the work to protect components from rusting.

Lubricate components more frequently than usual. Be sure to lubricate work equipment pins daily if they are submerged in water.

**Dusty worksites:**

When working at dusty worksites, do as follows:

- Inspect the dust indicator to see whether the air cleaner is blocked up. Clean the air cleaner at shorter intervals than specified.
- Clean the radiator core frequently to avoid clogging.
- Clean and replace the fuel filter frequently.
- Clean electrical components, especially the starting motor and alternator, to avoid accumulation of dust.

**Avoid mixing oils:**

Never mix oils of different brands. If you have only oil which is a different brand from the one that is used in the machine, do not add it but replace all the oil.

## 18. OUTLINES OF SERVICE

---

- Use Komatsu genuine parts for replacement.
- When changing or adding oil, do not use a different type of oil.
- Unless otherwise specified, the oil and coolant used at the time of shipment from the factory are as shown in the table below.

Item	Kind of fluid
Engine oil pan	SAE 15W-40 API classification CD
Swing machinery case Final drive case PTO gear case	SAE 30 API classification CD
Hydraulic tank	SAE 10W API classification CD
Fuel tank	ASTM D975 No. 2 (However, ASTM D975 No. 1 is used for the winter season (October to March))
Radiator	Komatsu Super Coolant (AF-ACL) 30% added to water
Grease for automatic greasing	NLGI No. 2

### 18.1 OUTLINE OF OIL, FUEL, COOLANT

#### 18.1.1 OIL

- Oil is used in the engine and work equipment under extremely severe conditions (high temperature, high pressure), and it deteriorates with use.  
Always use oil that matches the grade and temperature for use given in the Operation and Maintenance Manual. Even if the oil is not dirty, always replace the oil after the specified interval.
- Oil corresponds to blood in the human body, so always be careful when handling it to prevent any impurities (water, metal particles, dirt, etc.) from getting in.  
The majority of problems with machine are caused by the entry of such impurities.  
Take particular care not to let any impurities get in when storing or adding oil.
- Never mix oils of different grades or brands.
- Always add the specified amount of oil.  
Having too much oil or too little oil are both causes of problems.
- If the oil in the work equipment is not clear, there is probably water or air getting into the circuit.  
In such cases, please contact your Komatsu distributor.
- When changing the oil, always replace the related filters at the same time.
- We recommend you to have an analysis made of the oil periodically to check the condition of the machine. For those who wish to use this service, please contact your Komatsu distributor.

### 18.1.2 FUEL

- The fuel pump is a precision instrument, and if fuel containing water or dirt is used, it cannot work properly.
- Be extremely careful not to let impurities get in when storing or adding fuel.
- Always use the fuel specified in the Operation and Maintenance Manual.  
Fuel may congeal depending on the temperature when it is used (particularly in low temperature below-15°C), so it is necessary to change to a fuel that matches the temperature.
- To prevent the moisture in the air from condensing and forming water inside the fuel tank, always fill the fuel tank after completing the day's work.
- Before starting the engine, or when 10 minutes have passed after adding fuel, drain the sediment and water from the fuel tank.
- If the engine runs out of fuel, or if the filters have been replaced, it is necessary to bleed the air from the circuit.

### 18.1.3 COOLANT

- River water contains large amounts of calcium and other impurities, so if it is used, scale will stick to the engine and radiator, and this will cause defective heat exchange and overheating.  
Do not use water that is not suitable for drinking.
- When using anti-freeze, always observe the precautions given in the Operation and Maintenance Manual.
- Komatsu machines are supplied with Komatsu original anti-freeze in the coolant when the machine is shipped.  
This anti-freeze is effective in preventing corrosion of the cooling system.  
The anti-freeze can be used continuously for two years or 4000 hours. Therefore, it can be used as it is even in hot areas.
- Anti-freeze is inflammable, so be extremely careful not to expose it to flame or fire.
- The proportion of anti-freeze to water differs according to the ambient temperature.  
For details of the mixing proportions, see "24.2.2 CLEAN INSIDE OF COOLING SYSTEM."
- If the engine overheats, wait for the engine to cool before adding coolant.
- If the coolant level is low, it will cause overheating and will also cause problems with corrosion from the air in the coolant.

### 18.1.4 GREASE

- Grease is used to prevent twisting and noise at the joints.
- The nipples not included in the maintenance section are nipples for overhaul, so they do not need grease.  
If any part becomes stiff after being used for long time, add grease.
- Always wipe off all of the old grease that is pushed out when greasing. Be particularly careful to wipe off the old grease in places. Where sand or dirt sticking in the grease would cause wear of the rotating parts.

### 18.1.5 STORING OIL AND FUEL

- Keep indoors to prevent any water, dirt, or other impurities from getting in.
- When keeping drum cans for a long period, put the drum on its side so that the filler port of the drum can is at the side. (To prevent moisture from being sucked in)  
If drum cans have to be stored outside, cover them with a waterproof sheet or take other measures to protect them.
- To prevent any change in quality during long-term storage, be sure to use in the order of first in - first out (use the oldest oil or fuel first).

### 18.1.6 FILTERS

- Filters are extremely important safety parts. They prevent impurities in the fuel and air circuits from entering important equipment and causing problems.  
Replace all filters periodically. For details, see the Operation and Maintenance Manual.  
However, when working in severe conditions, it is necessary to consider replacing the filters at shorter intervals according to the oil and fuel (sulfur content) being used.
- Never try to clean the filters (cartridge type) and use them again. Always replace with new filters.
- When replacing oil filters, check if any metal particles are stuck to the old filter. If any metal particles are found, please contact your Komatsu distributor.
- Do not open packs of spare filters until just before they are to be used.
- Always use Komatsu genuine filters.



## 18.2 OUTLINE OF ELECTRIC SYSTEM

- If the wiring gets wet or the insulation is damaged, the electric system leaks and this could result in hazardous malfunction of the machine.
- Services relating to the electric system are (1) check of fan belt tension, (2) check of damage or wear in the fan belt and (3) check of battery fluid level.
- Never remove or disassemble any electric components installed in the machine.
- Never install any electric components other than those specified by Komatsu.
- Be careful to keep the electric system free of water when washing the machine or when it rains.
- Since the controller for the control system may cause malfunction due to external wave interference, before installing a radio receiver and a walkie-talkie or citizen band, consult your Komatsu distributor.
- When working on the seashore, carefully clean the electric system to prevent corrosion.
- When installing a car cooler or any other electrical equipment, connect it to an independent power source connector. The optional power source must never be connected to the fuse, starting switch, or battery relay.

### 18.3 OUTLINE OF HYDRAULIC SYSTEM

- During operation and immediately after operation is ended, the temperature of the hydraulic system still remains high.  
In addition, high hydraulic pressure is applied to the system. Take care when inspecting and maintaining the hydraulic system.
  - Stop the machine on level ground, lower the bucket to the ground, then set so that there is no pressure applied to the cylinder circuit.
  - Always stop the engine.
  - Immediately after operations, the hydraulic oil and lubricating oil are at high temperature and high pressure, so wait for the oil temperature to go down before starting maintenance.  
Even when the temperature goes down, the circuit may still be under internal pressure, so when loosening the plug or screw, or the hose joint, do not stand in front of the part. Loosen it slowly to release the internal pressure before removing it.
  - When carrying out inspection or maintenance of the hydraulic circuit, always bleed the air from the hydraulic tank to remove the internal pressure.
- Periodic maintenance includes the inspection of the hydraulic oil level, replacement of the filter and refilling of hydraulic oil.
- When the high pressure hose, etc. is removed, check the O-ring for damage. If necessary, replace it.
- After the hydraulic filter element and strainer are cleaned or replaced, or after the hydraulic system is repaired or replaced or the hydraulic piping is removed, bleed air from the hydraulic circuit.

## 19. WEAR PARTS LIST

Wear parts such as the filter element, bucket tooth, etc. are to be replaced at the time of periodic maintenance or before their abrasion limits.

The wear parts should be changed correctly in order to use the machine economically.

For part change, Komatsu genuine parts of excellent quality should be used.

When ordering parts, please check the part number in the parts book.

The parts in parentheses are to be replaced at the same time.

Item	Part No.	Part Name	Q'ty	Replacement frequency
Hydraulic oil filter	201-60-71180 (07000-02135)	Element (O-ring)	1 (1)	Every 500 hours service
Engine oil filter	YM129150-35151	Oil filter assembly	1	Every 500 hours service
Fuel filter	YM129100-55650	Element	1	Every 500 hours service
Feed pump pre-filter	YM129052-55630	Filter	1	Every 500 hours service
Air cleaner	YM119808-12520	Element	1	—
Standard bucket (Vertical pin) (PC30R, PC35R)	20T-70-72320 (20T-70-71950) (20T-70-71960)	Tooth (Pin) (Lock)	4 (4) (4)	—
	(20S-70-71330) (20S-70-71340) (20P-70-71350) (20P-70-71360)	Side cutter (left) Side cutter (right) (Bolt) (Nut)	1 1 (6) (6)	—
Standard bucket (Vertical pin) (PC40R, 45R)	20T-70-72320 (20T-70-71950) (20T-70-71960)	Tooth (Pin) (Lock)	4 (4) (4)	—
	20U-70-13241 20U-70-13251 (20U-70-13270) (203-32-51220)	Side cutter (left) Side cutter (right) (Bolt) (Nut)	1 1 (8) (8)	—
Blade (PC30R, PC35R)	20S-71-81120	Edge (welded)	1	—
Blade (PC40R, PC45R)	20T-71-81120	Edge (welded)	1	—

## 20. USE OF FUEL, COOLANT AND LUBRICANTS ACCORDING TO AMBIENT TEMPERATURE

### PROPER SELECTION OF FUEL, COOLANT AND LUBRICANTS

RESERVOIR	KIND OF FLUID	AMBIENT TEMPERATURE								CAPACITY				
		-22 -30	-4 -20	14 -10	32 0	50 10	68 20	86 30	104 40	°F	°C	Specified	Refill	
Engine oil pan	Engine oil										<b>SAE 30</b>		PC35R 7.4 ℓ	PC35R 6.9 ℓ
											<b>SAE 10W</b>		1.92 US gal 1.62 UK gal	1.79 US gal 1.51 UK gal
											<b>SAE 10W-30</b>		PC45R 8.6 ℓ	PC45R 8.0 ℓ
											<b>SAE 15W-40</b>		2.23 US gal 1.89 UK gal	2.08 US gal 1.76 UK gal
Final drive case (each)	Engine oil										<b>SAE 30</b>		PC35R 0.7 ℓ	PC35R 0.7 ℓ
											<b>SAE 30</b>		0.18 US gal 0.15 UK gal	0.18 US gal 0.15 UK gal
Hydraulic system	Engine oil										<b>SAE 10W</b>			
											<b>SAE 10W-30</b>		63 ℓ	33ℓ
											<b>SAE 15W-40</b>		16.3 US gal 13.8 UK gal	8.5 US gal 7.2 UK gal
Fuel tank	Diesel fuel										<b>ASTM D975 No.2</b>		50 ℓ	—
											<b>*1</b>		13.2 US gal 11.0 UK gal	
Cooling system	Water	<b>Add antifreeze</b>										PC35R 6.8 ℓ	—	
											<b>SAE 10W-30</b>		1.76 US gal 1.49 UK gal	
											<b>SAE 15W-40</b>		PC45R 7.5 ℓ	
											<b>SAE 10W-30</b>		1.95 US gal 1.65 UK gal	

\*1: ASTM D975 No. 1

## 20. USE OF FUEL, COOLANT AND LUBRICANTS ACCORDING TO AMBIENT TEMPERATURE

### REMARK

- When fuel sulphur content is less than 0.5%, change oil in the oil pan every periodic maintenance hours described in this manual.

Change oil according to the following table if fuel sulphur content is above 0.5%.

Fuel sulphur content	Change interval of oil in engine oil pan
0.5 to 1.0%	1/2 of regular interval
Above 1.0%	1/4 of regular interval

- When starting the engine in an atmospheric temperature of lower than 0°C, be sure to use engine oil of SAE10W, SAE10W-30 and SAE15W-40, even though an atmospheric temperature goes up to 10°C more or less in the day time.
- Use API classification CD as engine oil and if API classification CC, reduce the engine oil change interval to half.
- There is no problem if single grade oil is mixed with multigrade oil (SAE10W-30, 15W-40), but be sure to add single grade oil that matches the temperature in the table.
- We recommend Komatsu genuine oil which has been specifically formulated and approved for use in engine and hydraulic work equipment applications.

Specified capacity: Total amount of oil including oil for components and oil in piping.

Refill capacity: Amount of oil needed to refill system during normal inspection and maintenance.

ASTM: American Society of Testing and Material

SAE: Society of Automotive Engineers

API: American Petroleum Institute

**20. USE OF FUEL, COOLANT AND LUBRICANTS ACCORDING TO AMBIENT TEMPERATURE**

No.	Supplier	Engine Oil [CD or CE] SAE10W, 30, 40 10W30, 15W40 (The 15W40 oil marked * is CE.)	Gear Oil [GL-4 or GL-5] SAE80, 90, 140	Grease [Lithium-Base] NLGI No. 2	Anti-freeze Coolant [Ethylene Glycol Base] Permanent Type
1	KOMATSU	EO10-CD EO30-CD EO10-30CD EO15-40CD	GO90 GO140	G2-LI G2-LI-S	AF-ACL AF-PTL AF-PT (Winter, one season type)
2	AGIP	Diesel sigma S Super dieselmulti- grade *Sigma turbo	Rotra MP	GR MU/EP	-
3	AMOCO	*Amoco 300	Multi-purpose gear oil	RYKON premium grease	-
4	ARCO	*Arcofleet S3 plus	Arco HD gear oil	Litholine HEP 2 Arco EP moly D	-
5	BP	Vanellus C3	Gear oil EP Hypogear EP	Energrease LS-EP2	Antifreeze
6	CALTEX	*RPM delo 400 RPM delo 450	Universal thuban Universal thuban EP	Marfak all purpose 2 Ultra-duty grease 2	AF engine coolant
7	CASTROL	*Turbomax *RX super CRD	EP EPX Hypoy Hypoy B Hypoy C	MS3 Spheerol EPL2	Anti-freeze
8	CHEVRON	*Delo 400	Universal gear	Ultra-duty grease 2	-
9	CONOCO	*Fleet motor oil	Universal gear lubricant	Super-sta grease	-
10	ELF	Multiperformance 3C Performance 3C	-	Tranself EP Tranself EP type 2	Glacelf
11	EXXON (ESSO)	Essolube D3 *Essolube XD-3 *Essolube XD-3 Extra *Esso heavy duty Exxon heavy duty	Gear oil GP Gear oil GX	Beacon EP2	All season coolant
12	GULF	Super duty motor oil *Super duty plus	Multi-purpose gear lubricant	Gulfcrown EP2 Gulfcrown EP special	Antifreeze and coolant
13	MOBIL	Delvac 1300 *Delvac super 10W-30, 15W-40	Mobilube GX Mobilube HD	Mobilux EP2 Mobilgrease 77 Mobilgrease special	-

**20. USE OF FUEL, COOLANT AND LUBRICANTS ACCORDING TO AMBIENT TEMPERATURE**

No.	Supplier	Engine Oil [CD or CE] SAE10W, 30, 40 10W30, 15W40 (The 15W40 oil marked * is CE.)	Gear Oil [GL-4 or GL-5] SAE80, 90, 140	Grease [Lithium-Base] NLGI No. 2	Anti-freeze Coolant [Ethylene Glycol Base] Permanent Type
14	PENNZOIL	*Supreme duty fleet motor oil	Multi-purpose 4092 Multi-purpose 4140	Multi-purpose white grease 705 707L White - bearing grease	Anti-freeze and summer coolant
15	PETROFINA	FINA kappa TD	FINA potonic N FINA potonic NE	FINA marson EPL2	FINA tamidor
16	SHELL	Rimula X	Spirax EP Spirax heavy duty	Alvania EP grease	-
17	SUN	-	Sunoco GL5 gear oil	Sunoco ultra prestige 2EP Sun prestige 742	Sunoco antifreeze and summer coolant
18	TEXACO	*Ursa super plus Ursa premium	Multigear	Multifak EP2 Starplex 2	Code 2055 startex antifreeze coolant
19	TOTAL	Rubia S *Rubia X	Total EP Total transmission TM	Multis EP2	Antigel/antifreeze
20	UNION	*Guardol	MP gear lube LS	Unoba EP	-
21	VEEDOL	*Turbostar *Diesel star MDC	Multigear Multigear B Multigear C	-	Antifreeze

## 21. STANDARD TIGHTENING TORQUES FOR BOLTS AND NUTS

### 21.1 INTRODUCTION OF NECESSARY TOOLS

The following tools are needed when carrying out maintenance.

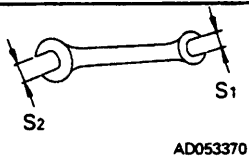
No.	Name of tool	Part No.	Remarks
1	Wrench set	09000-30006	Applicable width across flats ( $S_1 - S_2$ ) 8 mm - 10 mm, 12 mm - 14 mm 13 mm - 17 mm, 19 mm - 22 mm 24 mm - 27 mm, 30 mm - 32 mm
			 <p style="text-align: right;">AD053370</p>
2	Screw driver	09033-00190	Interchangeable flat-head and cross-head type
3	Hexagon wrench	09007-00836	Applicable width across flats 8 mm
4	Grease pump	07952-80002	For greasing work
5	Nozzle	07951-11400	PC45R For rubber shoe (For the machine equipped with rubber shoes)
6	Grease cartridge	07950-90403	(Lithium base grease, 400 g)

If any of the above tools are broken, please order them from your Komatsu distributor.

The following tools are required for removal and installation of the road liner. Place an order for them from your Komatsu distributor.

No.	Name of tool	Part No.	Remarks
1	Hexagon wrench	09007-01040	Applicable width across flats 10 mm (PC45R)
2	Hexagon socket	KOKEN TOOL 16106-16 10 mm or equivalent	(PC45R)



### 21.2 TORQUE LIST

Unless otherwise specified, tighten the metric bolts and nuts to the torque shown in the table.

The tightening torque is determined by the width across the flats **(b)** of the nut and bolt.

If it is necessary to replace any nut or bolt, always use a Komatsu genuine part of the same size as the part that was replaced.

Nm (newton meter): 1Nm  $\approx$  0.1 kgm  
 $\approx$  0.74 lbft

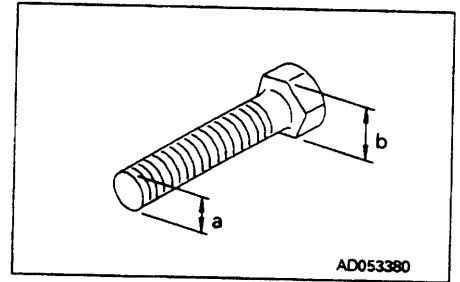

Thread diameter of bolt (mm) (a)	Width across flat (mm) (b)	AD054300		
		N·m	kgf·m	lbft
6	10	13.2 ± 1.4	1.35 ± 0.15	9.73 ± 1.03
8	13	31.4 ± 2.9	3.2 ± 0.3	23.2 ± 2.1
10	17	65.7 ± 6.8	6.7 ± 0.7	48.5 ± 5.0
12	19	112 ± 9.8	11.5 ± 1.0	82.6 ± 7.2
14	22	177 ± 19	18.0 ± 2.0	131 ± 14
16	24	279 ± 29	28.5 ± 3	206 ± 21
18	27	383 ± 39	39 ± 3	282 ± 29
20	30	549 ± 58	56 ± 6	405 ± 43
22	32	745 ± 78	76 ± 8	549 ± 58
24	36	927 ± 98	94.5 ± 10	684 ± 72
27	41	1320 ± 140	135 ± 15	973 ± 100
30	46	1720 ± 190	175 ± 20	1270 ± 140
33	50	2210 ± 240	225 ± 25	1630 ± 180
36	55	2750 ± 290	280 ± 30	2030 ± 210
39	60	3280 ± 340	335 ± 35	2420 ± 250

#### NOTICE

When tightening panels or other parts having tightening fixtures made of plastic, be careful not to use excessive tightening torque: doing so will damage the plastic parts.

## **22. PERIODIC REPLACEMENT OF SAFETY CRITICAL PARTS**

To ensure safety at all times when operating or driving the machine, the user of the machine must always carry out periodic maintenance. In addition, to further improve safety, the user should also carry out periodic replacement of the parts given in the table. These parts are particularly closely connected to safety and fire prevention.

With these parts, the material changes as time passed, or they easily wear or deteriorate. However, it is difficult to judge the condition of the parts simply by periodic maintenance, so they should always be replaced after a fixed time has passed, regardless of their condition. This is necessary to ensure that they always maintain their function completely.

However, if these parts show any abnormality before the replacement interval has passed, they should be repaired or replaced immediately.

If the hose clamps show any deterioration, such as deformation or cracking, replace the clamps at the same as the hoses.

When replacing the hoses, always replace the O-rings, gaskets, and other such parts at the same time.

Ask your Komatsu distributor to replace the safety critical parts.

**SAFETY CRITICAL PARTS**

No.	Safety critical parts for periodic replacement	Q'ty	Replacement interval	
1	Fuel hose (Fuel tank – Feed pump pre-filter)	1	Every 2 years or 4000 hours, whichever comes sooner	
2	Fuel hose (Feed pump pre-filter – Feed pump)	1		
3	Fuel hose (Feed pump – Fuel filter (With water separator))	1		
4	Fuel hose (Fuel filter – Injection pump)	2		
5	Fuel hose (Fuel filter – Fuel tank)	1		
6	Spill hose (among nozzles)	PC35R		2
		PC45R		3
7	Spill hose (Nozzle – Injection pump)	1		
8	Spill cap	1		
9	Hydraulic hose (Main pump delivery)	1		
10	Hydraulic hose (Boom cylinder)	4		
11	Hydraulic hose (Arm cylinder)	4		
12	Hydraulic hose (Bucket cylinder)	4		
13	Seat belt (Option)	1	Every 3 years	

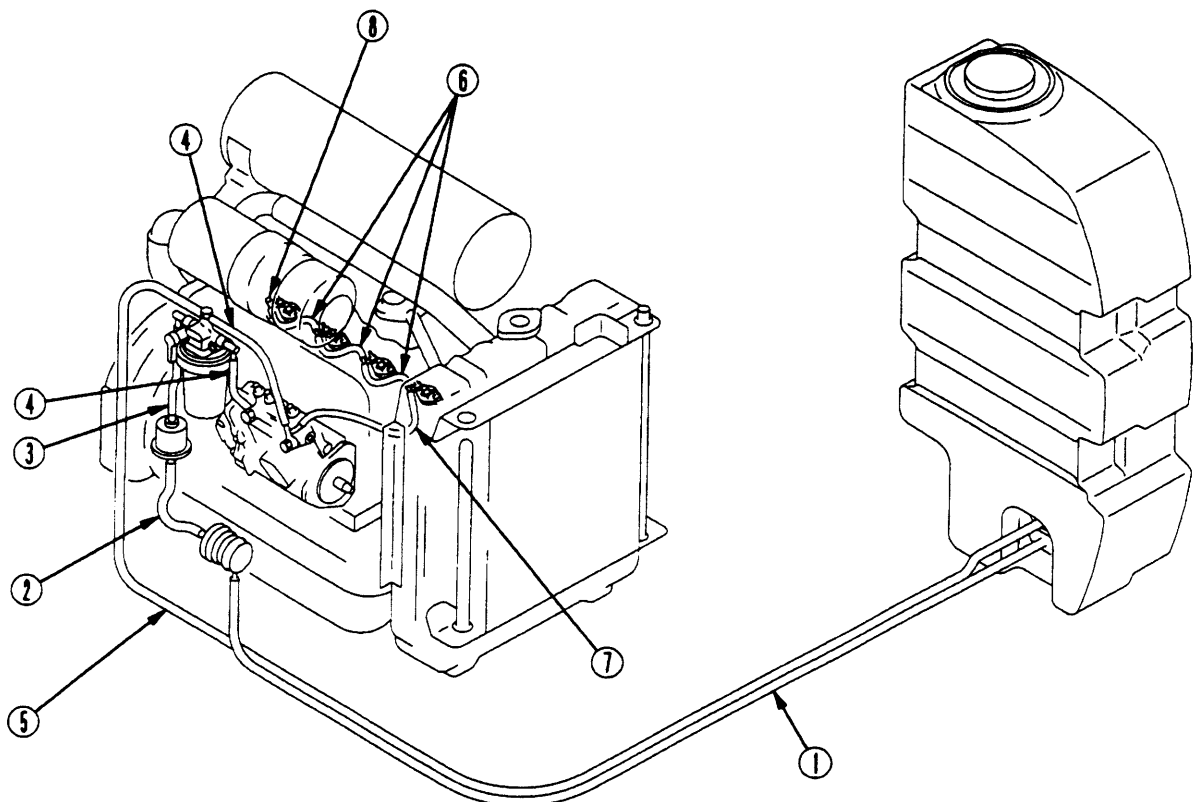

## 22. PERIODIC REPLACEMENT OF SAFETY CRITICAL PARTS

---

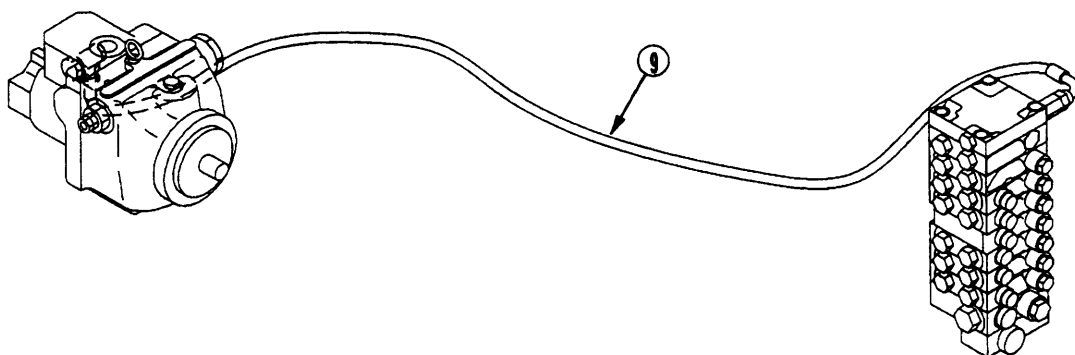

AM314690

## 23. MAINTENANCE SCHEDULE CHART

### 23.1 MAINTENANCE SCHEDULE CHART

SERVICE ITEM	PAGE
<b>INITIAL 250 HOURS SERVICE (only after the first 250 hours)</b>	
Check engine valve clearance, adjust	3-65
<b>WHEN REQUIRED</b>	
Check, clean and replace air cleaner element	3-23
Clean inside of cooling system	3-26
Drain water, sediment form fuel tank	3-30
Check electric wirings	3-30
Check of rubber shoes, road liners (Machine equipped with rubber shoes, road liners (PC45R))	3-31
Check and adjust track tension (Machine equipped with rubber shoes)	3-33
Replace rubber shoes (Machine equipped with rubber shoes)	3-35
Check and adjust of track tension (Machine equipped with steel shoes, road liners (PC45R))	3-38
Replace bucket teeth (vertical pin type)	3-41
Inspection of bucket play adjustment mechanism	3-44
<b>CHECK BEFORE STARTING</b>	
Check coolant level, add water	3-45
Check oil level in engine oil pan, add oil	3-45
Check fuel level, add fuel	3-46
Check oil level in hydraulic tank, add oil	3-47
Check dust indicator	3-48
Check water separator	3-48
<b>EVERY 100 HOURS SERVICE</b>	
Lubricating	3-49
● Swing pinion (1 point)	3-49
● Swing circle (1 point)	3-49
● Boom swing cylinder foot pin (1 point)	3-49
● Bucket cylinder rod end (1 point)	3-49
● Link coupling pin (1 point)	3-49
● Bucket – Link coupling pin (1 point)	3-49
● Arm – Bucket coupling pin (1 point)	3-49
● Arm – Link coupling pin (1 point)	3-49

**23. MAINTENANCE SCHEDULE CHART**

<b>SERVICE ITEM</b>	<b>PAGE</b>
<b>EVERY 250 HOURS SERVICE</b>	
Change oil in engine oil pan	3-50
Check fan belt tension, adjust	3-51
<b>EVERY 500 HOURS SERVICE</b>	
Replace engine oil filter cartridge	3-52
Replace fuel filter cartridge (With water separator)	3-54
Replace feed pump pre-filter	3-56
Check oil level in final drive case, add oil	3-57
Replace hydraulic filter element	3-59
Clean, check radiator fins	3-60
Check level of battery electrolyte	3-61
● Boom-swing cylinder rod end (1 point)	3-62
● Boom cylinder foot pin (1 point)	3-62
● Blade cylinder foot pin (1 point)	3-62
● Blade foot pin (2 points)	3-62
● Blade cylinder rod end (1 point)	3-62
● Boom foot pin (2 points)	3-62
● Boom swing bracket pin (1 point)	3-62
● Arm cylinder foot pin (1 point)	3-62
● Boom cylinder rod end (1 point)	3-62
● Boom - Arm coupling pin (1 point)	3-62
● Arm cylinder rod end (1 point)	3-62
● Bucket cylinder foot pin (1 point)	3-62
<b>EVERY 1000 HOURS SERVICE</b>	
Change oil in final drive case	3-63
<b>EVERY 2000 HOURS SERVICE</b>	
Check alternator, starting motor	3-65
Check engine valve clearance, adjust	3-65
<b>EVERY 4000 HOURS SERVICE</b>	
Check oil in hydraulic tank, clean strainer	3-66

### 23.2 MAINTENANCE INTERVAL WHEN USING HYDRAULIC BREAKER

For machines equipped with a hydraulic breaker, the hydraulic oil deteriorates faster than for normal bucket digging operations, so set the maintenance intervals as follows.

- Replacing hydraulic filter element**  
 On new machines, replace the element after the first 100 to 150 hours, then carry out further replacement of the element according to the table on the right.
- Changing oil in hydraulic tank**  
 Change the oil according to the table on the right.

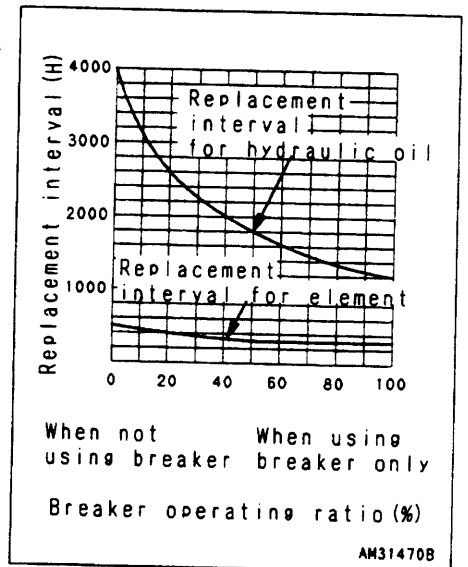

## **24. SERVICE PROCEDURE**

---

### **24.1 INITIAL 250 HOURS SERVICE**

Carry out the following maintenance only after the first 250 hours.

- **CHECK ENGINE VALVE CLEARANCE, ADJUST**

For details of the method of replacing or maintaining, see the section on EVERY 2000 HOURS SERVICE.



## 24.2 WHEN REQUIRED

### 24.2.1 CHECK, CLEAN AND REPLACE AIR CLEANER ELEMENT

#### WARNING

- Never clean or replace the air cleaner element with the engine running.
- When using pressure air to clean the element wear safety glasses or goggles to protect the eyes.

#### Checking

Whenever the red piston in dust indicator ① appears, clean the air cleaner element.

#### NOTICE

Do not clean the element before the dust indicator ① indicates red.

If the element is cleaned frequently before the dust indicator indicates red, the true performance of the air cleaner is not used and the cleaning efficiency is lowered.

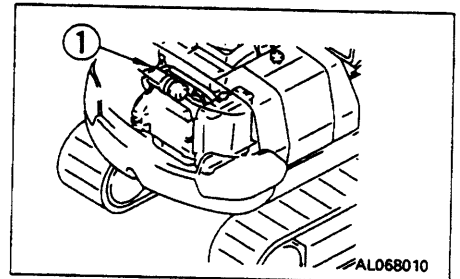

#### Cleaning or replacing outer element

1. Open the engine hood at the rear of the machine, loosen clip ②, remove dust cup ③.
2. Throw away the dust inside dust cup ③ and clean the inside of the cup.
3. Take out element ④ and cover the air connector at the end of the air cleaner body with a clean cloth or tape.
4. Clean the inside of the air cleaner body.

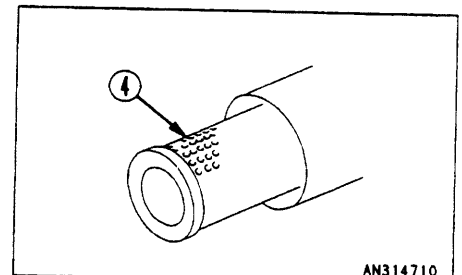
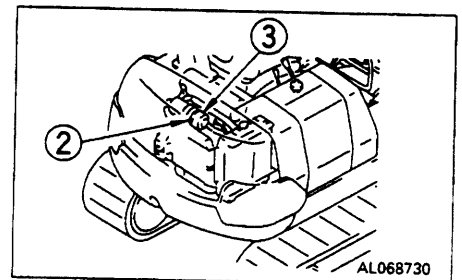

## 24. SERVICE PROCEDURE

5. Direct dry compressed air (less than 0.69 MPa (7 kg/cm<sup>2</sup>, 100 psi)) to the element from inside along its folds, then direct it from outside along its folds and again from inside.

- (1) Replace the element which has been cleaned 5 times repeatedly or used throughout a year.
- (2) Replace element when the dust indicator red piston appears soon after installing the cleaned element even though it has not been cleaned 5 times.

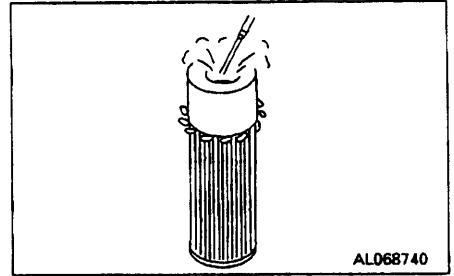

6. If small holes or thinner parts are found on the element when it is checked with an electric bulb after cleaning, replace the element.

### NOTICE

Do not use an element whose folds or gasket or seal are damaged.

When cleaning the element, do not hit it or beat it against something.

Wrap unused elements and store them in a dry place.

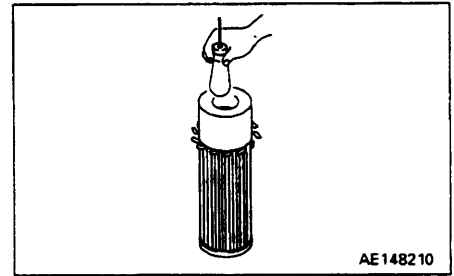

7. Remove the cloth or tape used as a cover in Step 3.

8. Set the cleaned element in position, and secure it with the wing nut.

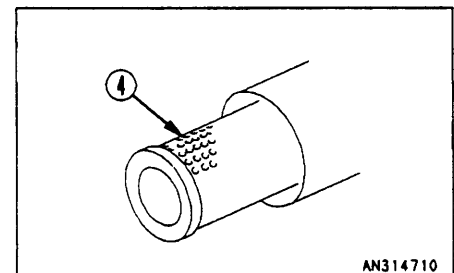

9. Set dust cap ③ with the arrow pointing up, then set it to the air cleaner body and secure it with clip ②.

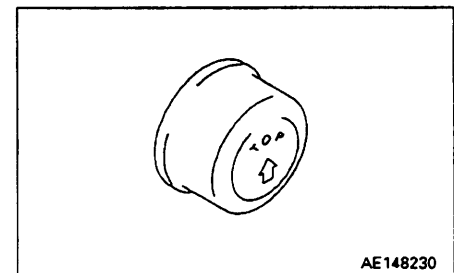

10. Press the button of dust indicator ① to return the red piston to its original position.

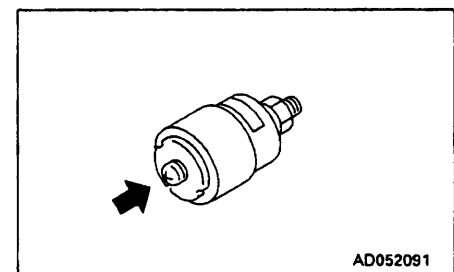

**Replacing element**

1. Open the engine hood at the rear of the machine, release clip ②, and remove dust cap ③. Remove wing nut ④, take out element ⑤, then use a clean cloth or tape to cover the air connector inside the air cleaner body to prevent dust from entering.
2. Clean the inside of the air cleaner body, then remove the cloth or tape used as a cover in Step 1.
3. Set the new element in position.
4. Install dust cup ③.
5. After replacing the element, return the red piston in the dust indicator to its original position.

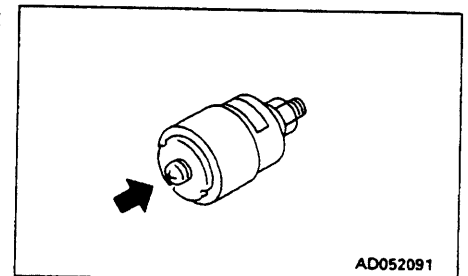
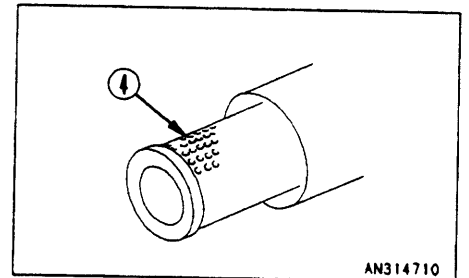
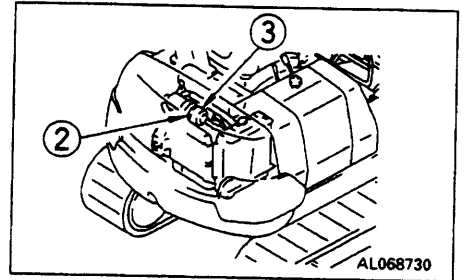

**24.2.2 CLEAN INSIDE OF COOLING SYSTEM**

**⚠ WARNING**

- **Soon after the engine has been stopped, the coolant is hot and can cause personal injury. Allow the engine to cool before draining water.**
- **Since cleaning is performed while the engine is running, it is very dangerous to enter the rear side of the machine as the machine may suddenly start moving. There is also danger of touching the fan when the engine hood is open. While the engine is running, never enter the rear side of the machine.**
- **Never remove the radiator cap when the engine is at operating temperature. At operating temperature, the coolant is under pressure. Steam blowing up from the radiator could cause personal injury. Allow the engine to cool until the radiator filler cap is cool enough to touch with your hand. Remove the filler cap slowly to allow pressure to be relieved.**

- **Clean the inside of the cooling system, change the coolant and replace the corrosion resistor according to the table below.**

Kind of coolant	Cleaning inside of cooling system and changing coolant	Adding corrosion resistor agent KI or replacing corrosion resistor cartridge
Permanent type antifreeze (All season type)	Every year (autumn) or every 2000 hours whichever comes first	Every 1000 hours and when cleaning the inside of the cooling system and when changing coolant.
Non permanent type antifreeze containing ethylene glycol (Winter, one season type)	Every 6 months (spring, autumn) (Drain antifreeze in spring, add antifreeze in autumn)	
When not using antifreeze	Every 6 months or every 1000 hours whichever comes first	

- **Stop the machine on level ground when cleaning or changing the coolant.**
- **Use a permanent type of antifreeze. If, for some reason, it is impossible to use permanent type antifreeze, use an antifreeze containing ethylene glycol.**

- When deciding the ratio of antifreeze to water, check the lowest temperature in the past, and decide from the mixing rate table given below.

It is actually better to estimate a temperature about 10°C lower when deciding the mixing rate.

### Mixing rate of water and antifreeze

#### PC35R

Min. atmospheric temperature	°C	-5	-10	-15	-20	-25	-30
	°F	23	14	5	-4	-13	-22
Amount of antifreeze	ℓ	1.6	2.1	2.5	2.8	3.2	3.4
	US gal	0.41	0.54	0.65	0.72	0.83	0.88
	UK gal	0.35	0.46	0.55	0.61	0.70	0.74
Amount of water	ℓ	5.2	4.7	4.3	4.0	3.6	3.4
	US gal	1.35	1.22	1.11	1.04	0.93	0.88
	UK gal	1.14	1.03	0.94	0.88	0.79	0.74

#### PC45R

Min. atmospheric temperature	°C	-5	-10	-15	-20	-25	-30
	°F	23	14	5	-4	-13	-22
Amount of antifreeze	ℓ	1.8	2.3	2.7	3.1	3.6	3.75
	US gal	0.46	0.59	0.70	0.80	0.93	0.97
	UK gal	0.39	0.50	0.59	0.68	0.79	0.82
Amount of water	ℓ	5.7	5.2	4.8	4.4	3.9	3.75
	US gal	1.48	1.35	1.24	1.14	1.01	0.97
	UK gal	1.25	1.14	1.05	0.96	0.85	0.82

### WARNING

**Antifreeze is flammable, so keep it away from any flame.**

- Use city water for the cooling water.  
If river water, well water or other such water supply must be used, contact your Komatsu distributor.
- We recommend use of an antifreeze density gauge to control the mixing proportions.

**⚠ WARNING**

**When removing drain plug, avoid pouring coolant on yourself.**

- Prepare a container to catch drained coolant  
PC35R : Min. 6.8 ℓ (1.76 US gal, 1.49 UK gal) capacity.  
PC45R : Min. 7.5 ℓ (1.95 US gal, 1.65 UK gal) capacity.
  - Prepare a water inlet hose.
1. Remove cover ① and open engine hood ②.
  2. Slowly turn radiator cap ③ to remove it.
  3. Set a container to receive the coolant mixture under drain valve ④ and drain plug ⑤.
  4. Open drain valve ④ on the underside of the radiator to drain the water. Remove drain plug ⑤ of the cylinder block to drain the water.
  5. After draining the water, close drain valve ④ and drain plug ⑤, then supply city water. After the radiator becomes full of water, start and run the engine idle at a low speed.
  6. Continue to run the engine idle at a low speed, and open drain valve ④ and drain plug ⑤ and supply water to clean the radiator for 10 minutes.
- While cleaning the radiator, keep it full of water by adjusting the water supply rate and draining rate.
- While cleaning the radiator, take care that the water hose are not removed from the water filler of the radiator.
7. After cleaning the radiator, stop the engine and turn off the water. Drain the water, then close drain valve ④ and drain plug ⑤.
  8. After draining the water, clean the radiator with detergent.
- For the cleaning method, see the instruction manual of the detergent.
9. After cleaning, open drain valve ④ and drain plug ⑤ to drain all water, then close them and supply city water up to the water filler.

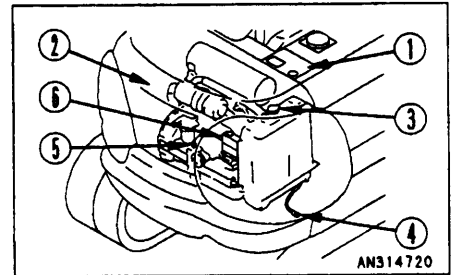

10. After the water level reaches the water filler, open drain valve ④ and drain plug ⑤. Run the engine idle at a low speed until clean water flows out.

While cleaning the radiator, keep it full of water by adjusting the water supply rate and draining rate.

11. After clean water flows out, stop the engine and close drain valve ④ and drain plug ⑤.
12. Supply city water through the water filler to the full level.
13. Run the engine idle at a low speed for five minutes, then at a high speed for five minutes to bleed air mixed in the cooling water. (At this time, keep the water filler cap removed.)

14. Drain the cooling water from sub-tank ⑥ and clean the inside of the sub-tank, then supply cooling water to the middle level between the FULL and LOW marks.

15. Stop the engine. About three minutes later, supply city water up to the water filler, then close radiator cap ③.

16. Close engine hood ② and install cover ①.

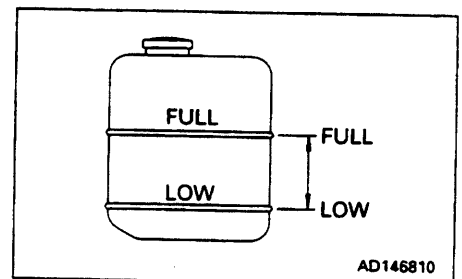

### 24.2.3 DRAIN WATER, SEDIMENT FROM FUEL TANK

1. Carry out this procedure before operating the machine.
2. Prepare a container to catch the fuel that is drained.
3. Open valve ① at the bottom of the tank and drain the sediment and water that has accumulated at the bottom together with fuel. When doing this, be careful not to get fuel on yourself.
4. When only clean fuel comes out, close drain valve ①.

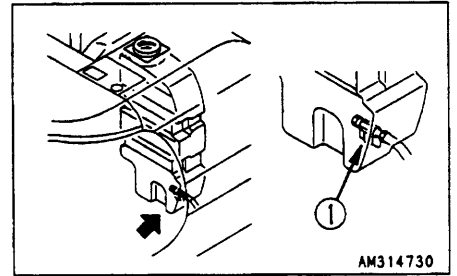

### 24.2.4 CHECK ELECTRIC WIRINGS

**⚠ WARNING**

**If fuses are frequently blown or if there are traces of short circuit on the electrical wiring, locate the cause and carry out repair.**

Check for damage of the fuse and any sign of disconnection or short circuit in the electric wiring. Check also for loose terminals and tighten any loose parts. Check the following points carefully.

- Battery
- Starting motor
- Alternator

Please contact your Komatsu distributor for investigation and correction of the cause.

**⚠ WARNING**

- **If dead leaves, twigs, grass, etc. accumulates around the battery, they may catch a fire. Be sure to remove them.**
- **Keep the top of the battery clean. Check the vents of the battery caps for clogging, and wash clogged battery caps in water.**

When carrying out walk-around checks or checks before starting, always check if there is any accumulation of flammable material around the battery, and remove such flammable material.



### 23.2.5 CHECK RUBBER SHOES, ROAD LINERS (MACHINE EQUIPPED WITH RUBBER SHOES, ROAD LINERS (PC45R))

If rubber shoes or road liners are worn to the following levels, it must be repaired or replaced. Ask your Komatsu distributor for repair or replacement.

#### Height of lug

- If lug height "a" is reduced by wear, the drawbar pull will drop. If "a" is less than 5 mm (0.2 in), replace with a new part.

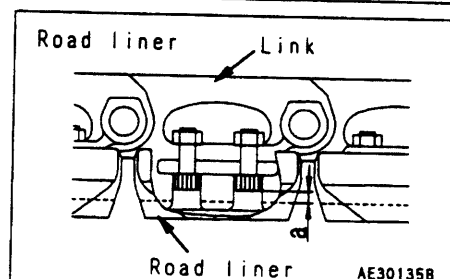
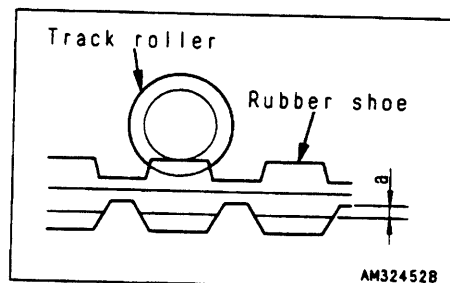

- If the lug wears and the steel cord inside the shoe is exposed for two links or more, replace with a new part.

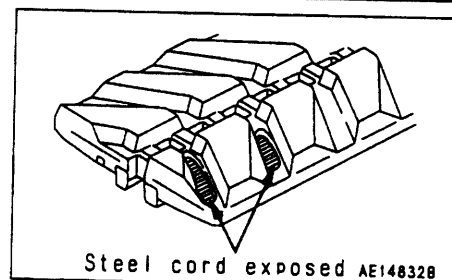

#### Cuts in rubber shoe steel cord

If more than half of the steel cord layer on one side is cut, replace with a new part.

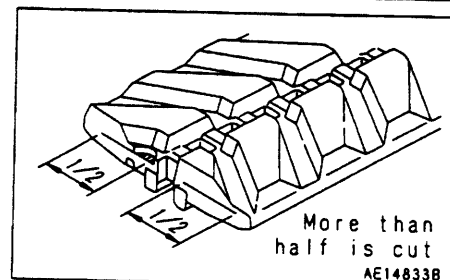

#### Separation of rubber shoe core

If the rubber core has separated at one place or more, replace with a new part.

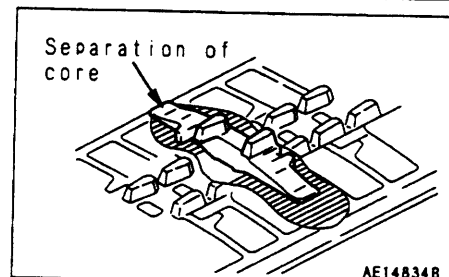

**Rubber shoe tension**

If the rubber shoe is still slack even when grease is pumped in, replace with a new part or replace the seal inside the cylinder.

If the track tension can only be increased to a level where the rubber shoe may come off, there may be not only elongation of the rubber shoe but also damage to the grease cylinder.

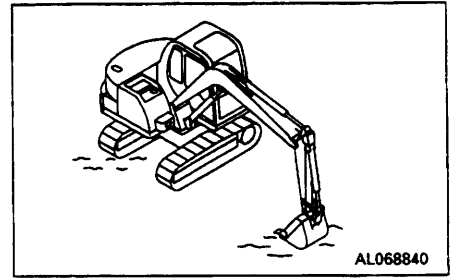

**Cracks in rubber shoe**

If the cracks between the rubber shoe lugs increase to a size of approx. 60 mm (2.36 in) the rubber shoe must be repaired. Even if the track is small and short, if the steel cord can be seen inside, carry out repairs immediately.

If the length is less than 30 mm (1.18 in) or the depth of the crack is less than 10 mm (0.39 in), there is no particular need to carry out repairs.

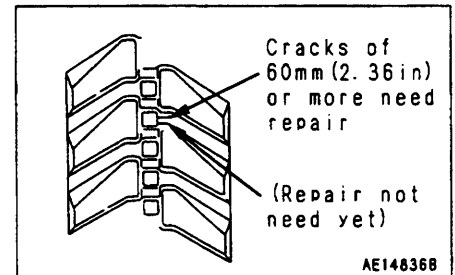

Ask your Komatsu distributor to judge if the rubber shoes or road liners need to be replaced or repaired or if they can be reused.

**When replacing road liner**

When replacing all road liners of a machine, ask your Komatsu distributor.

If only a part of the road liners needs to be replaced, replace them by using the road liner replacing tool (See "21.1 INTRODUCTION OF NECESSARY TOOLS"). Place an order for the tool from your Komatsu distributor.

## 24.2.6 CHECK AND ADJUST TRACK TENSION (MACHINE EQUIPPED WITH RUBBER SHOES)

### WARNING

Carry out this operation with two workers. The operator must move the machine in accordance with the signals from the other worker. The track tension is checked with the chassis raised, so it is extremely dangerous if the machine is lowered by mistake during the inspection. Never move the machine while anyone is carrying out measurements.

The wear of the rubber shoe will vary with the working conditions and type of soil. Therefore, it is necessary to inspect the wear and track tension frequently.

After new tracks are installed or on a new machine, the track tension lowers in the first 5 – 30 hours of machine operation. If the track tension is adjusted frequently until the initial loosening is completed, the shoes will not detach due to insufficient track tension.

### Inspection

1. Set the connection (M mark) of the rubber shoe at the top midway between the two axes.
2. Raise the chassis with the boom and arm. When doing this, operate the levers slowly.
3. If the track tension is normal, clearance A between the flange of the third track roller from the sprocket and the shoulder of the track shoe is set to the standard value.

Clearance A	Standard value	10 – 15 mm (0.4 – 0.6 in)
	Loosened track	Min. 20 mm (Min. 0.8 in)

If the rubber track is loose and the machine is operated, the track may come off, or there will be premature wear of the core.

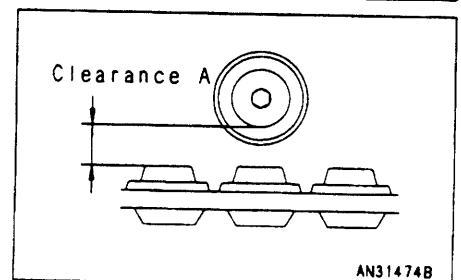
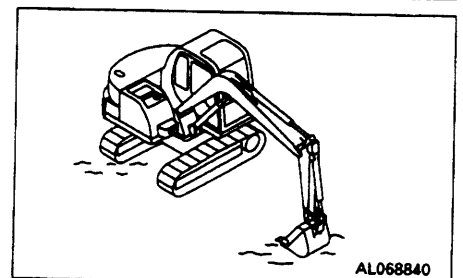
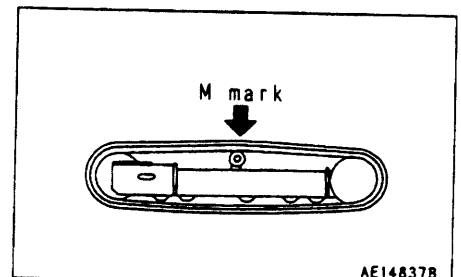

## 24. SERVICE PROCEDURE

If the track tension is not at the standard value, adjust it in the following manner.

### Adjustment

#### WARNING

Grease inside the adjusting mechanism is under high pressure. Grease coming from lubricator ① under pressure can penetrate the body causing injury or death. For this reason, do not loosen lubricator ① more than one turn. Do not loosen any part other than lubricator ①.

If the track tension is not relieved by this procedure, please contact your Komatsu distributor.

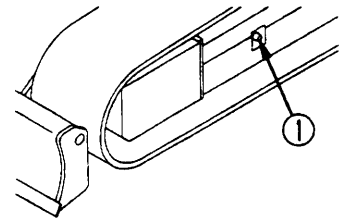

AM314750

- When increasing tension
- Prepare a grease gun

1. Pump in grease through lubricator ① with a grease gun.

#### REMARK

For PC40R and PC45R, replace the grease gun nozzle with the attached chuck-type nozzle (which will fit to the grease fitting).

2. To check that the correct tension has been achieved, move the machine backwards and forwards.
3. Check the track tension again, and if the tension is not correct, adjust it again.
4. Grease may be supplied until S changes to 0 mm. If the tension is still low, the rubber shoe needs to be replaced or the seal in the cylinder needs to be replaced. Ask your Komatsu distributor for replacement.

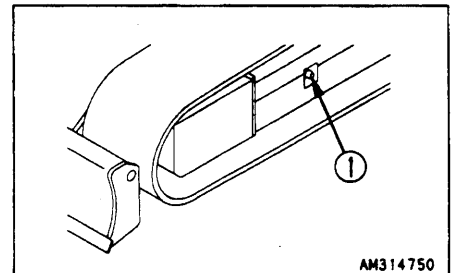

AM314750

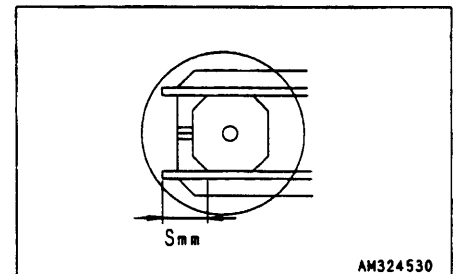

AM324530

● When loosening tension

**⚠ WARNING**

It is extremely dangerous to release the grease by any method except the procedure given below. If the track tension is not relieved by this procedure, please contact your Komatsu distributor.

1. Loosen lubricator ① gradually to release the grease.
2. Turn lubricator ① a maximum of one turn.
3. If the grease does not come out smoothly, move the machine backwards and forwards a short distance.
4. Tighten lubricator ①.
5. To check that the correct tension has been achieved, move the machine backwards and forwards.
6. Check the track tension again, and if the tension is not correct, adjust it again.

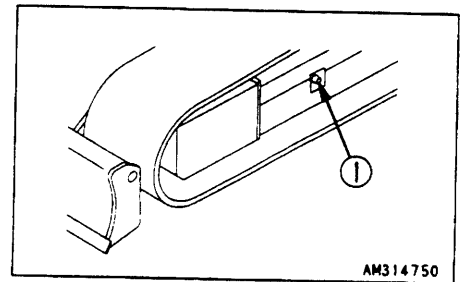

AM314750

### 24.2.7 REPLACE RUBBER SHOES (MACHINE EQUIPPED WITH RUBBER SHOES)

**⚠ WARNING**

Carry out this operation with two workers. The operator must move the machine in accordance with the signals from the other worker. The track is replaced with the chassis raised, so it is extremely dangerous if the machine is lowered by mistake while the track is being replaced. During the replacement operation, operate only the track that is being replaced. Do not operate any other part.

**⚠ WARNING**

Grease inside the adjusting mechanism is under high pressure. Grease coming from lubricator ① under pressure can penetrate the body causing injury or death. For this reason, do not loosen lubricator ① more than one turn. Do not loosen any part other than lubricator ①.  
If the track tension is not relieved by this procedure, please contact your Komatsu distributor.

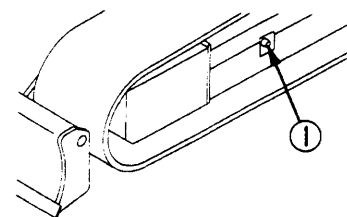

AM314750

## 24. SERVICE PROCEDURE

Prepare the following:

- Grease gun
- Steel pipe

### REMOVAL OF RUBBER SHOE

#### WARNING

- It is extremely dangerous to release the grease by any method except the procedure given below. If the track tension is not relieved by this procedure, please contact your Komatsu distributor.
- Check that all the grease has been released before rotating the sprocket to remove the rubber shoe.

1. Raise the chassis with the boom and arm.  
When doing this, operate the levers slowly.

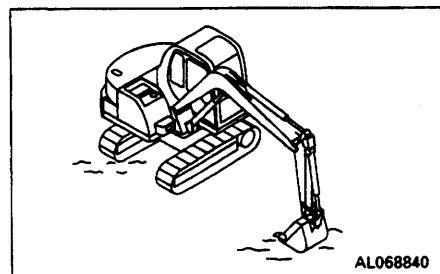

2. Loosen lubricator ① gradually to release the grease.
3. Turn lubricator ① a maximum of one turn.

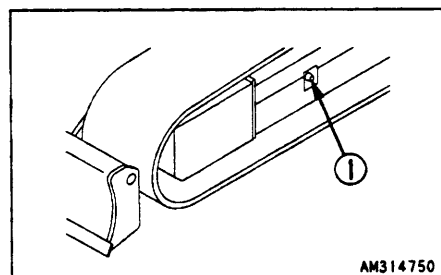

4. Fit the steel pipes inside the rubber shoe, rotate the sprocket in reverse, so that the steel pipes make the rubber shoe come up from the idler, then slide to the side to remove.

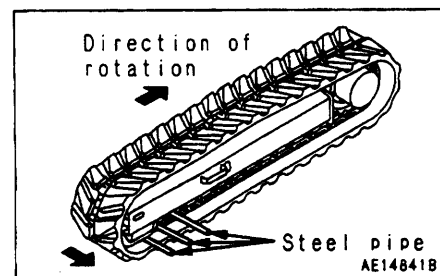

**INSTALLATION OF RUBBER SHOE**

1. Raise the chassis with the boom and arm.  
When doing this, operate the levers slowly.
2. Mesh the rubber shoe with the sprocket and fit it over the idler.
3. Rotate the sprocket in reverse, then push in the rubber shoe and stop the rotation.
4. Mesh a steel pipe with the rubber shoe, then rotate the sprocket again and fit the rubber shoe securely on the idler.
5. Stop the rotation, and check that the rubber shoe is securely fitted to the sprocket and idler.
6. Adjust the tension of the rubber shoe.  
For details, see "24.2.6 CHECK AND ADJUST TRACK TENSION".
7. Check that the track tension is correct and that the rubber shoe is correctly meshed on the sprocket and idler, then lower the machine to the ground.

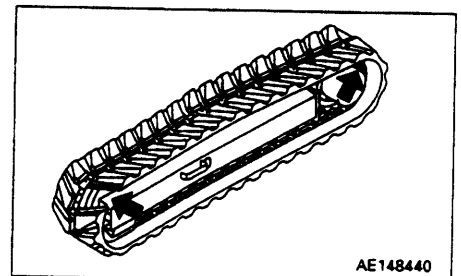
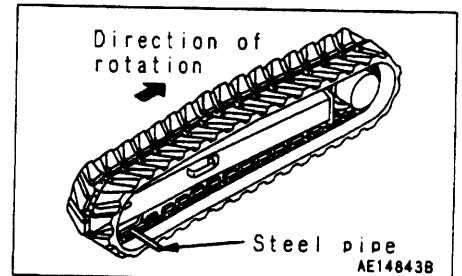
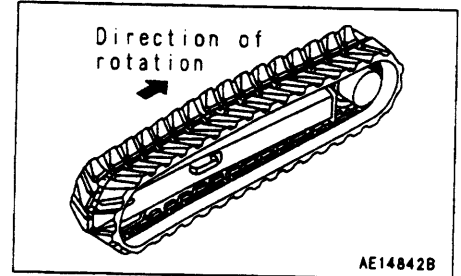
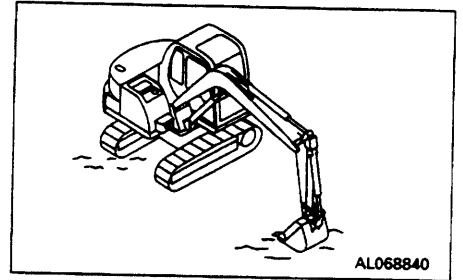

### 24.2.8 CHECK AND ADJUST TRACK TENSION (MACHINE EQUIPPED WITH STEEL SHOES, ROAD LINERS (PC45R))

**⚠ WARNING**

Carry out this operation with two workers. The operator must move the machine in accordance with the signals from the other worker. The track tension is checked with the chassis raised, so it is extremely dangerous if the machine is lowered by mistake during the inspection. Never move the machine while anyone is carrying out measurements.

The wear of pins and bushings on the undercarriage will vary with the working conditions and soil properties. It is thus necessary to continually inspect the track tension so as to maintain the standard tension.

Carry out the check and adjustment under the same conditions as when operating (on jobsites where the track becomes clogged with mud, measure with the track clogged with mud).

#### Inspection

1. Raise the chassis with the boom and arm.  
When doing this, operate the levers slowly.
2. The standard tension is a clearance of 30 – 50 mm (1.18 – 1.97 in) between the roller surface of the track shoe and the track roller tread at the 3rd track roller from the sprocket.

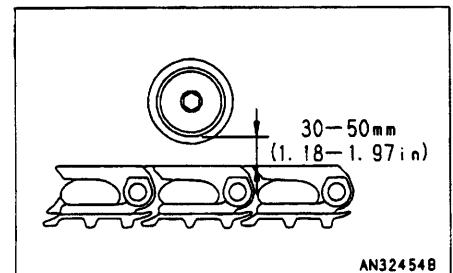
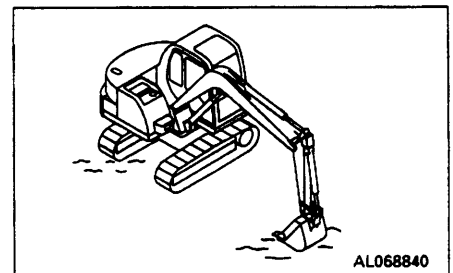



If the track tension is not at the standard value, adjust it in the following manner.

### Adjustment

#### WARNING

Grease inside the adjusting mechanism is under high pressure. Grease coming from lubricator ① under pressure can penetrate the body causing injury or death. For this reason, do not loosen lubricator ① more than one turn. Do not loosen any part other than lubricator ①.

If the track tension is not relieved by this procedure, please contact your Komatsu distributor.

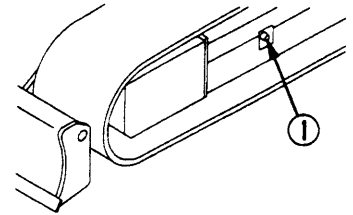

AM314750

- **When increasing tension**
  - Prepare a grease gun
1. Pump in grease through lubricator ① with a grease pump.
  2. To check that the correct tension has been achieved, move the machine backwards and forwards.
  3. Check the track tension again, and if the tension is not correct, adjust it again.
  4. Continue to pump in grease until S becomes 0 mm (0.0 in). If the tension is still loose, the pin and bushing are excessively worn, so they must be either turned or replaced. Please contact your Komatsu distributor.

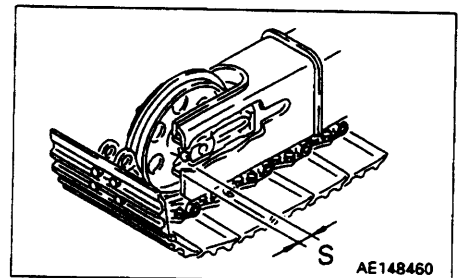

AE148460

## 24. SERVICE PROCEDURE

---

### ● When loosening tension

**⚠ WARNING**

It is extremely dangerous to release the grease by any method except the procedure given below. If the track tension is not relieved by this procedure, please contact your Komatsu distributor.

1. Loosen lubricator ① gradually to release the grease.
2. Turn lubricator ① a maximum of one turn.
3. If the grease does not come out smoothly, move the machine backwards and forwards a short distance.
4. Tighten lubricator ①.
5. To check that the correct tension has been achieved, move the machine backwards and forwards.
6. Check the track tension again, and if the tension is not correct, adjust it again.

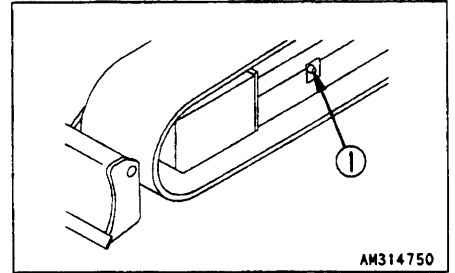

AM314750

### 24.2.9 REPLACE BUCKET TEETH (VERTICAL PIN TYPE)

Replace the bucket tooth before they have been worn to the end and the adapter starts to be worn.

#### ⚠ WARNING

If the work equipment starts moving while the tooth is replaced, it is dangerous. Set the work equipment in a stable position and stop the engine, then set the safety lock lever to the LOCK position securely.

Machine equipped with canopy

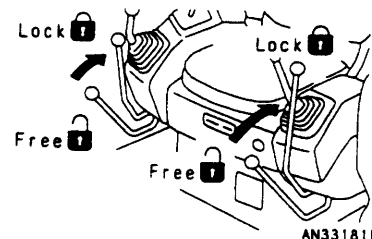

AN33181B

Machine equipped with cab



AE14595B

1. Place a block under the bucket so that the pin of tooth ① can be driven out. Stop the engine and operate the lever to the stroke end. Confirm that the work equipment is stabilized and lock the safety lock lever. Set the bucket bottom horizontally.

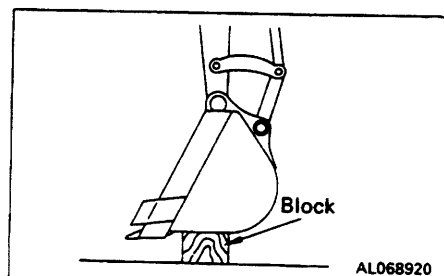

AL068920

2. Using a hammer and driving tool, drive out locking pin ② securing tooth ① to the bucket. (If the driving tool is set against rubber pin lock ③ when it is hit, the rubber pin lock may break. Set it against the back of the pin.)

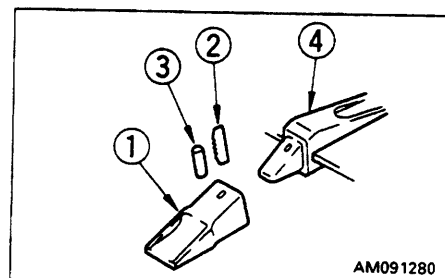

AM091280

3. After removing lock pin ② and rubber pin lock ③, check them.

If lock pins and rubber pin locks with the following defects are used, the point may come off the bucket. Replace them with new ones.

## 24. SERVICE PROCEDURE

- The rubber of the rubber pin lock is torn, and the steel balls may come out.

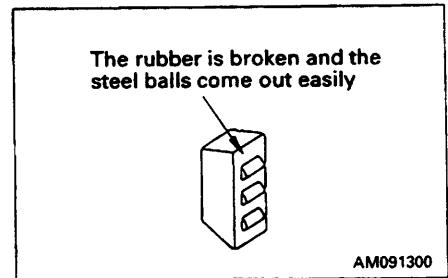

- The steel balls are buried when they are pressed by hand.

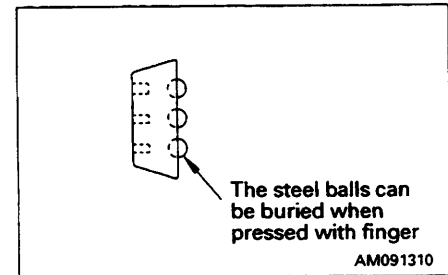

4. Clean the surface of adapter ④ and remove the soil from it with a knife.

5. Use your hand or a hammer to push rubber pin lock ③ into the hole of the adapter.  
When doing this, be careful that the rubber pin lock does not fly out from the adapter surface.

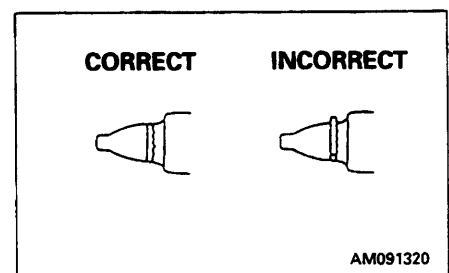

6. Clean the inside of tooth ①, then install it to adapter ④. If there is mud stuck to it or if there are protrusions, the tooth will not enter the adapter properly, and there will not be proper contact at the mating portion.
7. Fit tooth ① to adapter ④, and confirm that when the tooth is pressed strongly, the rear face of the hole for the pin of the tooth is at the same level as the rear face of the hole for the pin of the adapter.

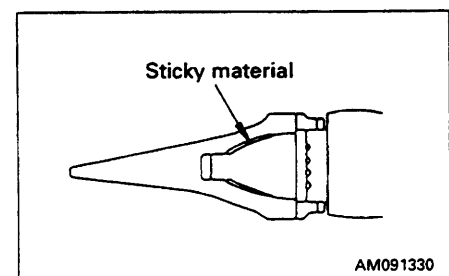

If the rear face of the hole for the pin of tooth ① is protruding to the front from the rear face of the pin hole for adapter ④, do not try to knock the pin in. There is something preventing tooth ① from entering adapter ④ fully, so remove the obstruction. When tooth ① enters adapter ④ fully, knock in lock pin ②.

8. Insert locking pin ② in the pin hole of the tooth and drive it in until its top is 2.5 mm (0.1 in) lower than the surface of tooth ① (The depths on the upper and lower sides are the same).
9. After replacing a bucket tooth, always check the following.
  - 1) After the lock pin has been knocked in completely, check that it is being secured by the tooth and surface.
  - 2) Lightly hit lock pin ② in the reverse direction from which it was hit in.
  - 3) Lightly hit the tip of the tooth from above and below, and hit its sides from right and left.

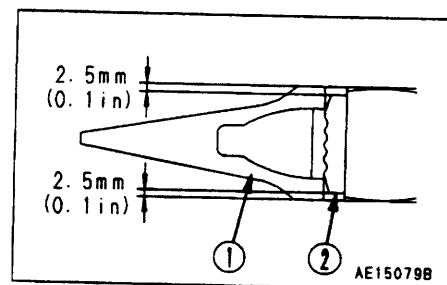

- 4) Confirm that rubber pin lock ③ and lock pin ② are set as shown in the figure.

The life of the tooth can be lengthened and the frequency of its replacement can be reduced by turning it upside down so that it will wear evenly.

Replace the rubber pin and locking pin with new pins at the same time as replacing the tooth to prevent the tooth from falling.

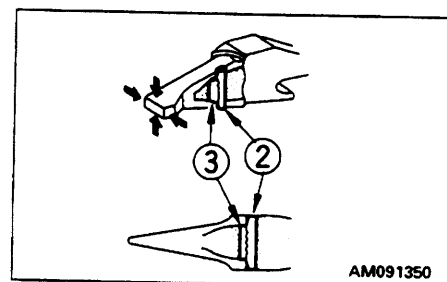

### 24.2.11 INSPECTION OF BUCKET PLAY ADJUSTMENT MECHANISM

**WARNING**

If the work equipment starts moving while the bucket is checked for play, it is dangerous. Set the work equipment in a stable position and stop the engine, then set the safety lock lever to the LOCK position securely.

Machine equipped with canopy

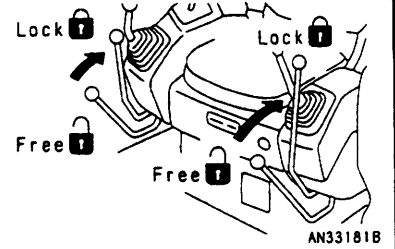

Machine equipped with cab

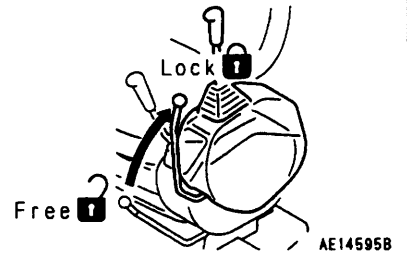

This machine is equipped with play preventive rings to prevent shaking and play of the bucket. If the bucket play increases, replace these rings.

1. Set the work equipment as shown at right and stop the engine, then turn the lock lever to the LOCK position.

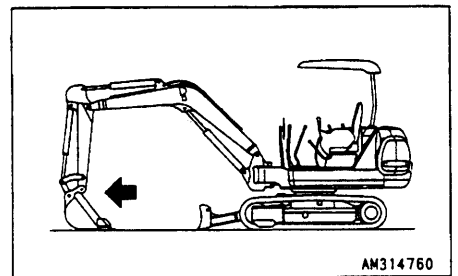

2. Measure outside diameter A of each play preventive ring. If it is 83.5 mm (3.29 in) or less, replace the ring.  
 Dimensions A of new ring: 85 mm (3.35 in)  
 Using limit of A: 83.5 mm (3.29 in)

Do not measure dimension A at the cut of the ring core.

For the replacement procedure of the play preventive rings, see "12.14 REPLACEMENT OF BUCKET".

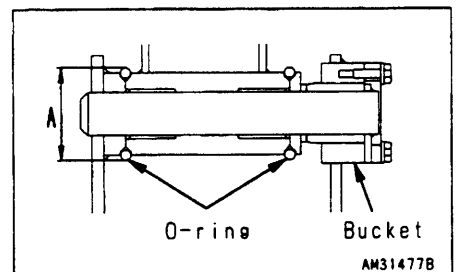

## 24.3 CHECK BEFORE STARTING

### 24.3.1 CHECK COOLANT LEVEL, ADD WATER

#### ⚠ WARNING

Do not open the radiator cap unless necessary. When checking the coolant, always check the radiator reserve tank when the engine is cold.

1. Open the engine hood and check that the cooling water level is between the FULL and LOW marks on radiator reserve tank ① (shown in the diagram on the right).  
If the water level is low, add water through the water filler of reserve tank ① to the FULL level.
2. After adding water, tighten the cap securely.
3. If the reserve becomes empty, first inspect for water leaks and then fill the radiator and the reserve tank with water.

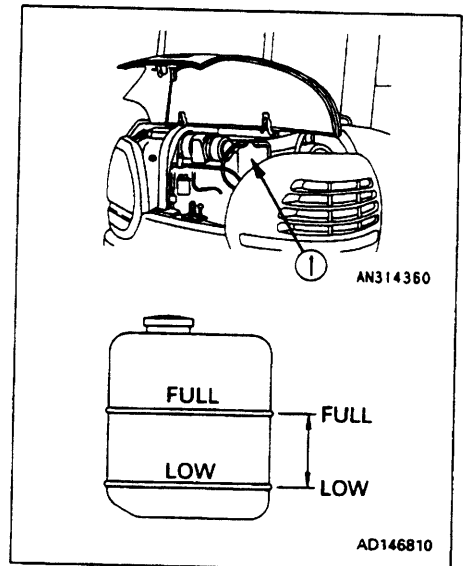

### 24.3.2 CHECK OIL LEVEL IN ENGINE OIL PAN, ADD OIL

1. Open the engine hood.
2. Remove dipstick ⑥ and wipe the oil off with a cloth.
3. Insert dipstick ⑥ fully in the oil filler pipe, then take it out again.
4. The oil level should be between the H and L marks on dipstick ⑥.  
If the oil level is below the L mark, add engine oil through oil filler ⑦.

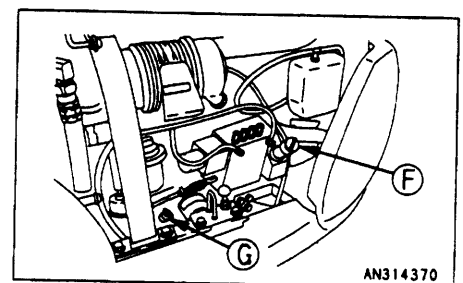

#### NOTICE

For details of the oil to use, see "20. USE OF FUEL, COOLANT AND LUBRICANTS ACCORDING TO AMBIENT TEMPERATURE".

5. If the oil is above the H mark, drain the excess engine oil from drain valve ⑧, and check the oil level again.
6. If the oil level is correct, tighten the oil filler cap securely and close the engine hood.

#### REMARK

When checking the oil level after the engine has been operated, for at least 15 minutes after stopping the engine before checking. If the machine is at an angle, make it horizontal before checking.

### 24.3.3 CHECK FUEL LEVEL, ADD FUEL

**⚠ WARNING**

When adding fuel, never let the fuel overflow. This may cause a fire. If spilling fuel, thoroughly clean up any spillage.

1. Insert the key in starting switch ①, and turn it to the ON position to light up the monitor.
2. Check the fuel level on fuel gauge ②. If the fuel level is low, add fuel through fuel filler port .

Fuel capacity: 50 ℓ (13.2 US gal, 11.0 UK gal)

**NOTICE**

For details of the fuel to use, see "20. USE OF FUEL, COOLANT AND LUBRICANTS ACCORDING TO AMBIENT TEMPERATURE".

3. After adding fuel, tighten the cap securely.

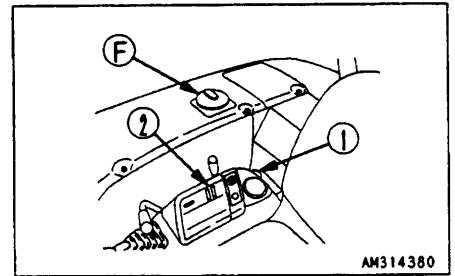

**REMARK**

If breather hole ③ on the cap is clogged, the pressure in the tank will drop and fuel will not flow. Clean the hole from time to time.

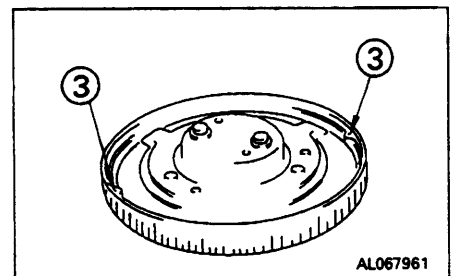



### 24.3.4 CHECK OIL LEVEL IN HYDRAULIC TANK, ADD OIL

#### **⚠ WARNING**

When removing the oil filler cap, oil may spurt out, so turn the cap slowly to release the internal pressure before removing the cap.

1. If the work equipment is not in the condition shown in the diagram on the right, start the engine run the engine at low speed, lower the blade, retract the arm and bucket cylinders, then lower the boom, set the bucket teeth in contact with the ground, and stop the engine.

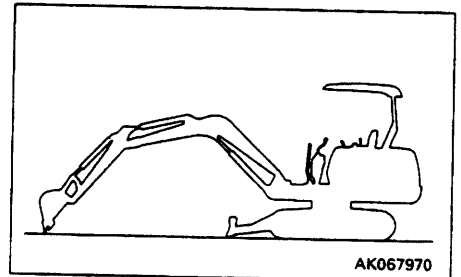

2. Open engine hood ① and check sight gauge ②. If the oil level is between the H and L lines, it is proper.

#### **NOTICE**

Do not add oil if the level is above the H line. This will damage the hydraulic equipment and cause the oil to spurt out.

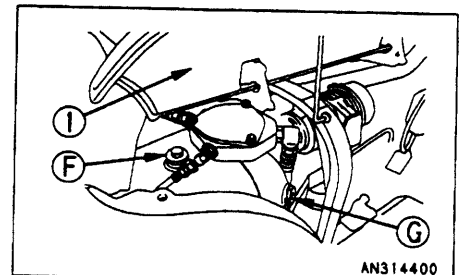

3. If the oil level is below the L line, remove the cover from the top of the hydraulic tank on the right side of the machine body, and add oil through oil filler ③.

#### **NOTICE**

For details of the oil to use, see "20. USE OF FUEL, COOLANT AND LUBRICANTS ACCORDING TO AMBIENT TEMPERATURE".

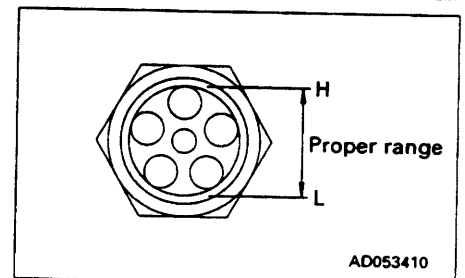

#### **⚠ WARNING**

If oil has been added to above the H mark, stop the engine and wait for the hydraulic oil to cool down, then drain the excess oil from drain plug.

#### **REMARK**

The oil level will vary depending upon the oil temperature. Accordingly, use the following as a guide:

- Before operation: around L level  
(Oil temperature 10 to 30°C (50 to 86°F))
- Normal operation: around H level  
(Oil temperature 50 to 80°C (122 to 176°F))

### 24.3.5 CHECK DUST INDICATOR

1. Open the engine hood and check that the red piston is not showing in dust indicator ①.
2. If the red piston has appeared, clean or replace the element immediately.  
For details of the method of cleaning the element, see "24.2.1 CHECK, CLEAN AND REPLACE AIR CLEANER ELEMENT".
3. After checking, cleaning, and replacing, press the knob of dust indicator ① to return the red piston to its original position.

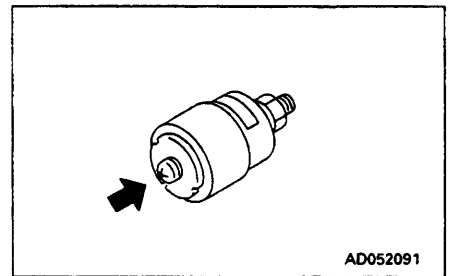
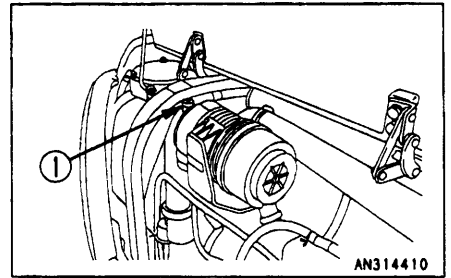

### 24.3.6 CHECK WATER SEPARATOR

If red ring ① of the water separator is at the bottom of case ②, there is no water.

If red ring ① is floating, there is water up to the bottom of the ring, so drain the water as follows.

- Use a water separator filter wrench.
1. Open the engine hood.
  2. Set handle ③ to the CLOSED position.
  3. Using the filter wrench, loosen ring ④, then remove case ② and throw out the water inside it.
  4. Set case ② in position, then tighten ring ④ to install it.
  5. Set handle ③ to the OPEN position.
  6. Drain any water or sediment from the fuel tank. For details, see "24.2.3 DRAIN WATER, SEDIMENT FROM FUEL TANK".

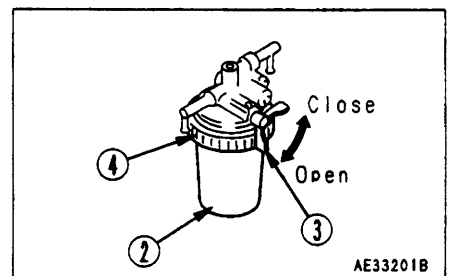
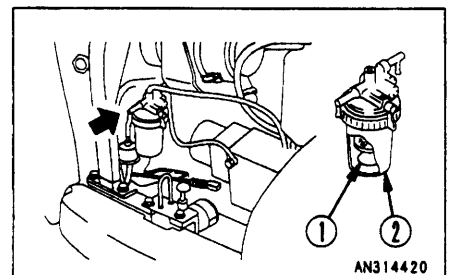

## 24.4 EVERY 100 HOURS SERVICE

### 24.4.1 LUBRICATING

**WARNING**

Never swing the upper structure while greasing the swing pinion.

- Prepare a grease gun.
- 1. Set the work equipment in the greasing posture, then lower the work equipment to the ground and stop the engine.
- 2. Using a grease gun, pump in grease through the grease fittings shown by arrows.
- 3. After greasing, wipe off any old grease that was pushed out.

1. Swing pinion (1 point)

When lubricating the swing pinion, turn the chassis little by little and apply grease through the grease fitting.

2. Swing circle (1 point)

3. Boom swing cylinder foot pin (1 point)

4. Bucket cylinder rod end (1 point)

5. Link coupling pin (1 point)

6. Bucket - Link coupling pin (1 point)

7. Arm - Bucket coupling pin (1 point)

8. Arm - Link coupling pin (1 point)

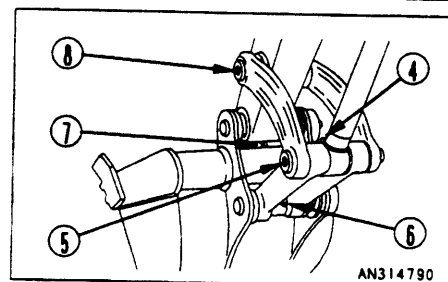
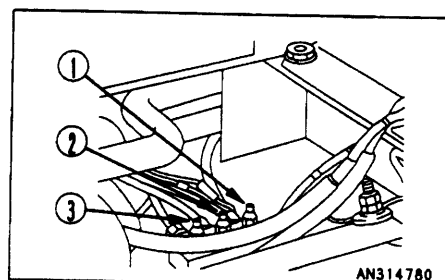

## 24.5 EVERY 250 HOURS SERVICE

### 24.5.1 CHANGE OIL IN ENGINE OIL PAN

**⚠ WARNING**

The oil is at high temperature after the engine has been operated, so never change the oil immediately after finishing operations. Wait for the oil to cool down before changing it.

Prepare the following.

- Container to catch drained oil: PC35R: Min. 6.9 ℓ capacity  
PC45R: Min. 8.0 ℓ capacity
  - Refill capacity: PC35R: 6.9 ℓ (1.79 US gal, 1.51 UK gal)  
PC45R: 8.0 ℓ (2.08 US gal, 1.76 UK gal)
  - Filter wrench for engine oil filter cartridge
1. Set a container to catch the oil immediately under the drain plug at the bottom of the machine.
  
  
  
  
  
  
  
  
  
  
  2. Remove drain plug **Ⓟ** slowly to avoid getting oil on yourself, and drain the oil.
  3. Check the drained oil, and if there are excessive metal particles or foreign material, please contact your Komatsu distributor.
  4. Install drain plug **Ⓟ**.
  5. Supply engine oil through oil filler **ⓕ** up to between the H and L lines.

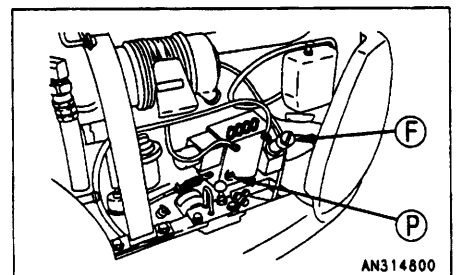

#### NOTICE

For details of the fuel to use, see "20. USE OF FUEL, COOLANT AND LUBRICANTS ACCORDING TO AMBIENT TEMPERATURE".

6. Run the engine idle for a while, then stop the engine and confirm that the oil level is between the H and L lines according to "24.3.2 CHECK OIL LEVEL IN ENGINE OIL PAN, ADD OIL".

If the operating time does not reach 250 hours in six months, replace the oil after six months.

If the operating time reaches 250 hours before six months, replace the oil at 250 hours.

### 24.5.2 CHECK FAN BELT TENSION, ADJUST

1. Remove inspection cover ①.
2. Open hood ② and secure it with hood support lever ③.

#### Checking

Press the intermediate point between the alternator pulley and fan pulley with the thumb (about 58.8 N (6 kgf, 13.2 lb)). If the tension is proper, the belt should be deflected about 5 – 6 mm (0.2 – 0.23 in).

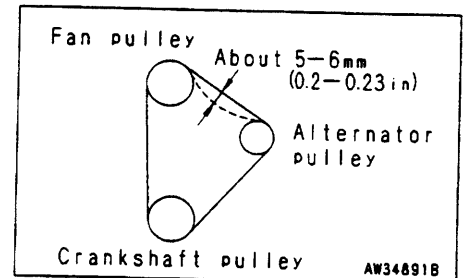
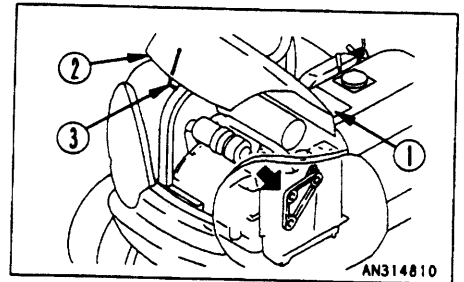

#### Adjusting

Prepare the following

- Bar
- Wooden block

1. Insert a bar between alternator ① and the cylinder block to fix alternator ① in position. When fixing alternator ① in position, insert a wooden block between the bar and alternator ① to prevent damage to the alternator.
2. Loosen bolts and nuts ② and ③.
3. Move alternator ① so that the belt will be deflected about 5 – 6 mm (0.2 – 0.23 in) when it is pressed with a force of about 58.8 N (6 kgf, 13.2 lb).
4. Tighten the bolts and nuts ② and ③ to fix alternator ① in position.
5. Check each pulley for damage, wear of the V-groove, and wear of the V-belt. In particular, be sure to check that the V-belt is not touching the bottom the V-groove.
6. If the belt is stretched, leaving no allowance for adjustment, or if it is cut or cracked, please contact your Komatsu distributor for replacement.

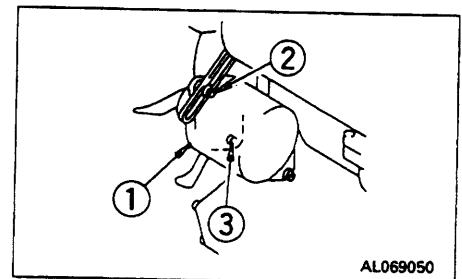

## 24.6 EVERY 500 HOURS SERVICE

Maintenance for every 100 and 250 hours should be carried out at the same time.

### 24.6.1 REPLACE ENGINE OIL FILTER CARTRIDGE

**⚠ WARNING**

The oil is at high temperature after the engine has been operated, so never change the oil immediately after finishing operations. Wait for the oil to cool down before changing it.

Prepare the following.

- Container to catch drained oil: PC35R: Min. 6.9 ℓ capacity  
PC45R: Min. 8.0 ℓ capacity
  - Refill capacity: PC35R: 6.9 ℓ (1.79 US gal, 1.51 UK gal)  
PC45R: 8.0 ℓ (2.08 US gal, 1.76 UK gal)
  - Filter wrench for engine oil filter cartridge
1. Set the container to catch the oil immediately under the drain plug at the bottom of the machine.
  
  2. Remove drain plug **Ⓟ** slowly to avoid getting oil on yourself, and drain the oil.
  
  3. Check the drained oil, and if there are excessive metal particles or foreign material, please contact your Komatsu distributor.
  
  4. Install drain plug **Ⓟ**.
  
  5. Using a filter wrench, turn filter cartridge **①** counterclockwise to remove it.  
In particular, if this operation is carried out immediately after stopping the engine, a large amount of oil will come out, so wait for 10 minutes before starting the operation.
  
  6. Clean the filter holder, coat the packing surface of a new filter cartridge with engine oil (or coat it thinly with grease), then install it to the filter holder.

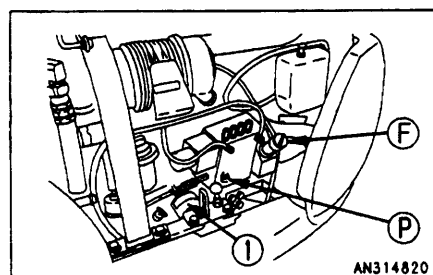

7. When installing; tighten until the packing surface contacts the seal surface of the filter holder, then tighten it up 1/2 to 3/4 of a turn.
8. After replacing the filter cartridge, add engine oil through oil filler  $\text{\textcircled{F}}$  until the oil level is between the H and L marks on the dipstick.

**NOTICE**

For details of the oil to use, see "20. USE OF FUEL, COOLANT AND LUBRICANTS ACCORDING TO AMBIENT TEMPERATURE".

9. Run the engine at idling for a short time, then stop the engine, and check that the oil level is between the H and L marks on the dipstick. For details, see "24.3.2 CHECK OIL LEVEL IN ENGINE OIL PAN, ADD OIL".

### 24.6.2 REPLACE FUEL FILTER CARTRIDGE (WITH WATER SEPARATOR)

**WARNING**

- Engine is at high temperature immediately after the machine has been operated. Wait for engine to cool down before replacing the filter.
- Do not bring fire or sparks near the fuel.

Prepare the following.

- Filter wrench for fuel filter element
- Container to catch drained fuel

1. Set the container to catch the fuel under the filter element.
2. Using the filter wrench, loosen ring ①, then remove element cup ② and take out element ③.
3. Wash element cup ② in light oil or in a cleaning oil and install a new element.

When replacing a fuel filter element, replace the filter O-ring at the same time.

4. Set the fuel control lever to the low idling position.
5. After replacing the fuel filter element bleed the air.

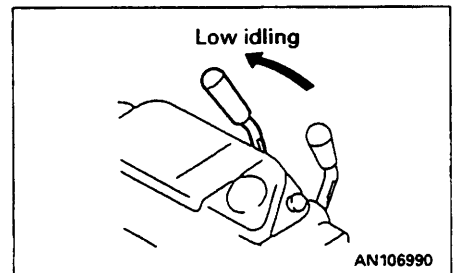
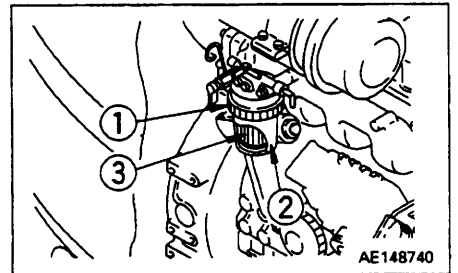



● **Air bleeding procedure**

1. Fill the fuel tank with fuel (until fuel gauge  $\odot$  indicates F).

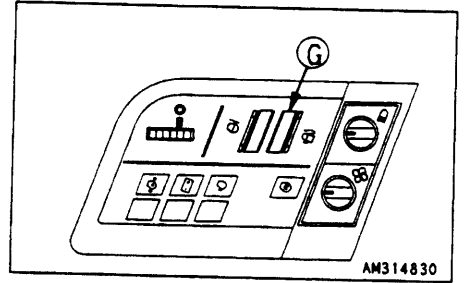

2. Turn and keep the starting key to the ON position for 15 – 20 seconds. Air is automatically bled by the automatic air bleeding device.

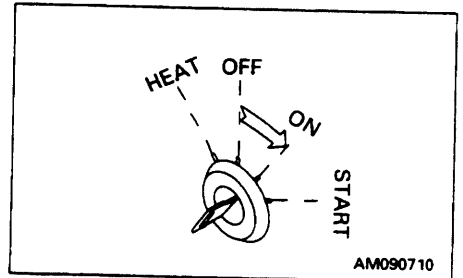

3. Turn the starting key to the START position, and the engine starts.

**REMARK**

The above air bleeding method can be applied when the fuel has run out.

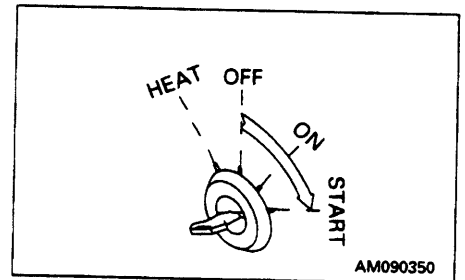

AM314830

AM090710

AM090350

### 24.6.3 REPLACE FEED PUMP PRE-FILTER

**WARNING**

- Do not replace the pre-filter just after stopping the engine, since each part is still hot. Wait until each part has cooled down.
- After replacing the pre-filter, connect the fuel hoses securely so that fuel will not leak.
- Do not bring an open flame source of fire near the pre-filter.

- Prepare a fuel receiving container.
1. Set a fuel receiving container under the pre-filter ①.
  2. Set the fuel control lever to the low idling position.
  3. Remove pre-filter ① from clamp ②.
  4. Loosen clamp ③ and remove fuel hose ④ from pre-filter ①.
  5. Loosen clamp ⑤ and remove fuel hose ⑥ from pre-filter ①.
  6. Connect fuel hoses ④ and ⑥ of new pre-filter ①, then secure them with clamps ③ and ⑤.
  7. Install pre-filter ① to clamp ②.
  8. After replacing the pre-filter, bleed air. For the air bleeding procedure, see "24.6.2 REPLACE FUEL FILTER (WITH WATER SEPARATOR)".

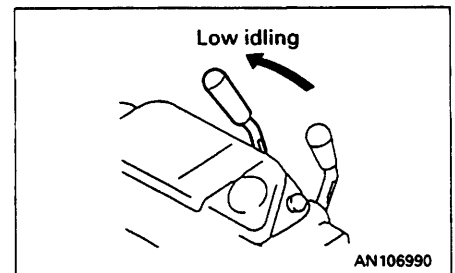
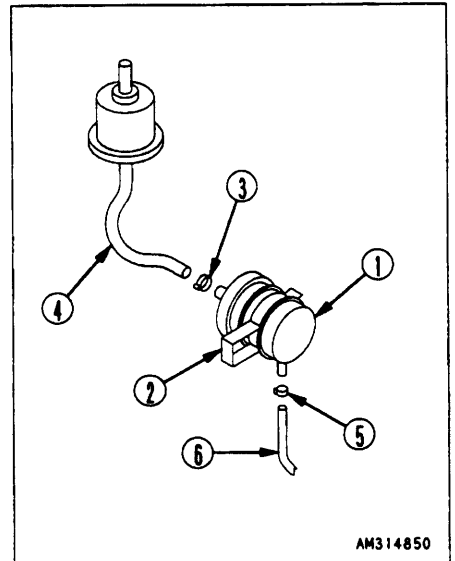

### 24.6.4 CHECK OIL LEVEL IN FINAL DRIVE CASE, ADD OIL

#### ⚠ WARNING

- The oil is at high temperature immediately after the machine has been operated. Wait for the oil to cool down before starting the operation.
- If there is still pressure remaining inside the case, the oil or plug may fly out.  
Loosen the plug slowly to release the pressure.

Prepare the following.

- Container to catch drained oil
- Hexagon wrench

#### In case of PC35R

1. Set the track so that the line connecting plug ⑥ and drain plug ⑦ will be at right angles at the ground, with plug ⑥ up.
2. Set an oil receiving container under level plug ⑧.
3. Remove level plug ⑧ with a hexagonal wrench (Width across flats: 4mm). Oil level should be near the bottom of the plug hole.
4. If the oil is insufficient, remove plug ⑥ with a hexagonal wrench (Width across flats: 8mm), then add oil through plug ⑥, until oil flows out of level plug hole ⑧.

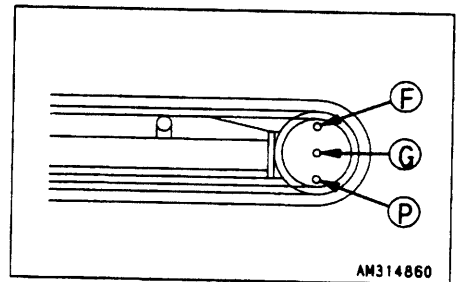

#### NOTICE

For details of the oil to use, see "20. USE OF FUEL, COOLANT AND LUBRICANTS ACCORDING TO AMBIENT TEMPERATURE".

5. After checking the oil level, install plugs ⑥ and ⑧.

**In case of PC45R**

1. Set the track so that the line connecting plug ③ and drain plug ④ will be at right angles at the ground, with plug ③ up.
2. Set an oil receiving container under plug ③.
3. Remove plug ③ with a hexagonal wrench (Width across flats: 8 mm). Oil level should be near the bottom of the plug hole.
4. If the oil is insufficient, remove plug ④ with a hexagon wrench (Width across flats: 8 mm), then add oil through plug ④, until oil flows out of level plug hole ③.

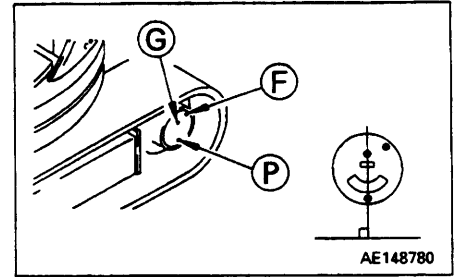

**NOTICE**

For details of the oil to use, see "20. USE OF FUEL, COOLANT AND LUBRICANTS ACCORDING TO AMBIENT TEMPERATURE".

5. After checking the oil level, install plugs ④ and ③.

## 24.6.5 REPLACE HYDRAULIC FILTER ELEMENT

**⚠ WARNING**

When removing the oil filler cap, turn it slowly to release the internal pressure before removing it.

1. Open engine hood ① and secure it with hood support lever.
2. Remove the cap from oil filler ⑥, and release the internal pressure.
3. Loosen 3 bolts, then remove cover ②. When doing this, the cover may fly out under the force of spring ③, so hold the cover down when removing the bolts.
4. After removing spring ③ and valve ④, take out element ⑤.
5. Clean the removed parts in diesel oil.
6. Install the new element in the place where old element ⑤ was installed.
7. Set valve ④ and spring ③ on top of the element.
8. Set cover ② in position, push it down by hand, and install the cover with the mounting bolts.
9. Pressurize hydraulic tank.  
Extend the boom, arm, and bucket cylinders fully as shown in the diagram on the right, remove the oil filler cap, then install the cap and pressurize the inside of the tank.

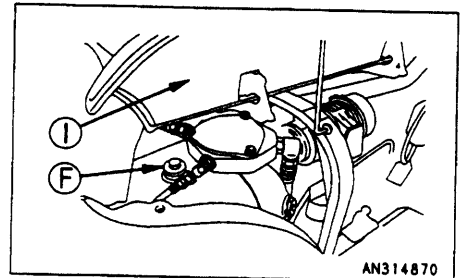

AN314870

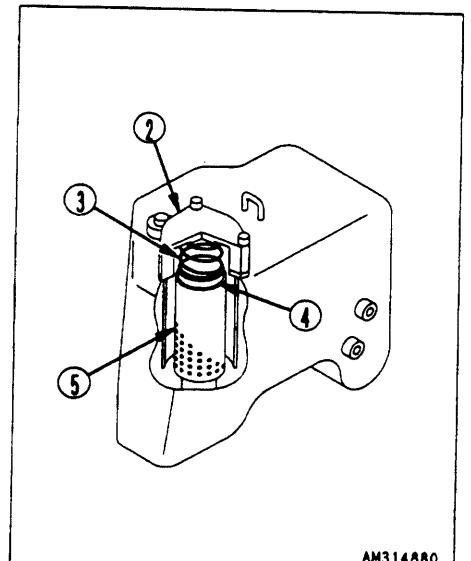

AM314880

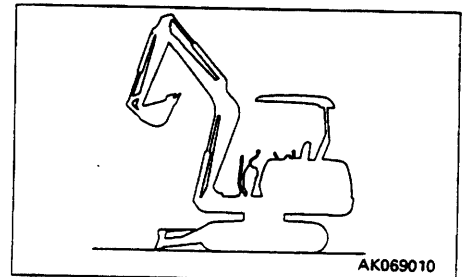

AK069010

**NOTICE**

If pressure is not applied to the hydraulic tank, the pump will suck air which will cause problems.

## 24. SERVICE PROCEDURE

10. Remove the hood support lever and secure it to the lever lock, then close hood ①.

If the hydraulic breaker is installed, the hydraulic oil will be more deteriorated than working with the normal bucket. Accordingly, replace the filter element after the first 100 – 150 hours, then replace it according to the table at right.

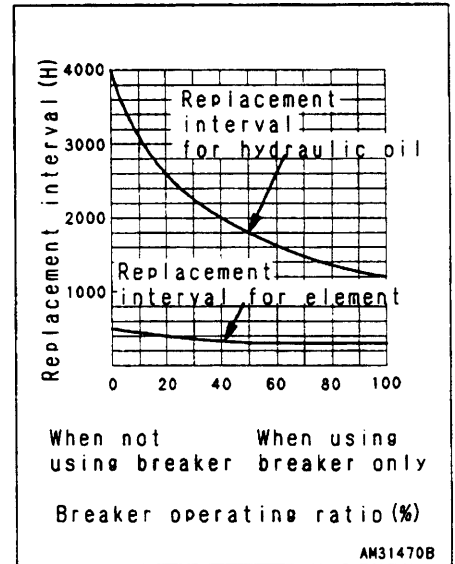

### 24.6.6 CLEAN, CHECK RADIATOR FINS

#### ⚠ WARNING

If compressed air, steam, or water hit your body directly, there is danger of injury. Always wear protective glasses, mask, and safety shoes.

1. Open the engine food.
2. If the radiator fins are clogged badly, remove the hydraulic oil cooler.
3. Use compressed air to blow off the mud, dirt, or leaves clogging radiator fins ①.

#### NOTICE

To prevent damage to the fins when using compressed air, do not bring the jet close to the radiator fins. If the fins are damaged, this will lead to water leakage or overheating.

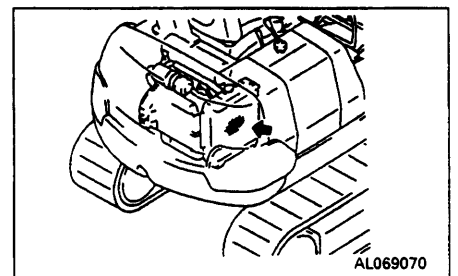

### 24.6.7 CHECK LEVEL OF BATTERY ELECTROLYTE

**⚠ WARNING**

- To avoid gas explosions, do not bring fire or sparks near the battery.
- Battery electrolyte is dangerous. If it gets in your eyes or on your skin, wash it off with large amounts of water, and consult a doctor.

Carry out this check before operating the machine.

1. Open battery cover ①.
2. Remove cap ②. If the electrolyte is below the UPPER LEVEL, add distilled water up to the UPPER LEVEL. Do not add the distilled water more than UPPER LEVEL. Excessive distilled water can cause leakage and a fire.

If the electrolyte has spilled, add dilute sulfuric acid.

3. Clean the vents of the battery caps, then close the caps securely. Keep the top of the battery clean and wipe it with a wet cloth.

If electrolyte level is low, add distilled water before starting work on the next day to prevent it from freezing.

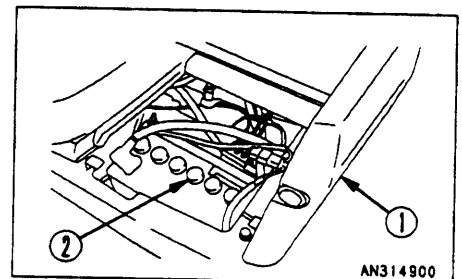

### 24.6.8 LUBRICATING

- Prepare a grease gun.
- 1. Set the work equipment in the greasing posture, then lower the work equipment to the ground and stop the engine.
- 2. Using a grease gun, pump in grease through the grease fittings shown by arrows.
- 3. After greasing, wipe off any old grease that was pushed out.

1. Boom swing cylinder rod end (1 point)
2. Boom cylinder foot pin (1 point)
3. Blade cylinder foot pin (1 point)
4. Blade foot pin (2 points)
5. Blade cylinder rod end (1 point)

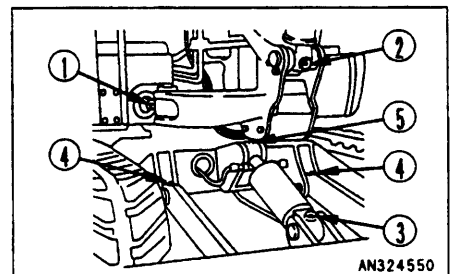

6. Boom foot pin (2 points)
7. Boom swing bracket pin (1 point)

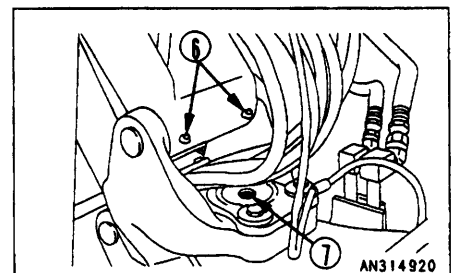

8. Arm cylinder foot pin (1 point)
9. Boom cylinder rod end (1 point)
10. Boom - Arm coupling pin (1 point)
11. Arm cylinder rod end pin (1 point)
12. Bucket cylinder foot pin (1 point)

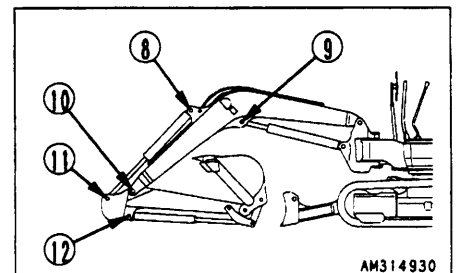



## 24.7 EVERY 1000 HOURS SERVICE

Maintenance for every 100, 250 and 500 hours should be carried out at the same time.

### 24.7.1 CHANGE OIL IN FINAL DRIVE CASE

#### **⚠ WARNING**

- The oil is at high temperature immediately after the machine has been operated. Wait for the oil to cool down before starting the operation.
- If there is still pressure remaining inside the case, the oil or plug may fly out.  
Loosen the plug slowly to release the pressure.

Prepare the following.

- Container to catch drained oil
  - PC35R : Min. 0.7 ℓ capacity
  - PC45R : Min. 1.1 ℓ capacity
- Refill capacity
  - PC35R : 0.7 ℓ (0.18 US gal, 0.15 UK gal)
  - PC45R : 1.1 ℓ (0.29 US gal, 0.24 UK gal)
- Prepare hexagon wrenches (Width across flats: 4 mm, 8 mm).

#### In case of PC35R

1. Set the track so that the line connecting plug ⑤ and drain plug ⑥ will be at right angles at the ground, with plug ⑤ up.
2. Set an oil receiving container under plug ⑥.
3. Remove plugs ⑥, ④ and ⑤ (Three places) with hexagonal wrenches (Width across flats: 4 mm, 8 mm) to drain the oil.
4. Tighten plug ⑥.
5. Supply oil through the hole of plug ⑤ up to the specified level.

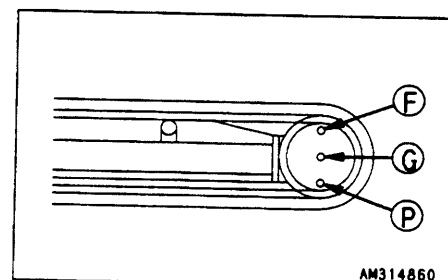

#### NOTICE

For details of the oil to use, see "20. USE OF FUEL, COOLANT AND LUBRICANTS ACCORDING TO AMBIENT TEMPERATURE".

6. After the oil flows out of the hole of plug ④, install plugs ⑤ and ⑥.

## 24. SERVICE PROCEDURE

---

### In case of PC45R

1. Set the track so that the line connecting plugs ③ and ④ will be right angles at the ground, with plug ③ up.
2. Set an oil receiving container under plug ③.
3. Remove plugs ④, ③ and ⑤ with hexagonal wrench (Width across flats: 8 mm) to drain the oil.
4. Tighten plug ④.
5. Supply oil through the hole of plug ⑤ up to the specified level.

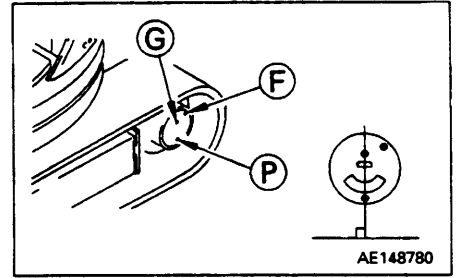

### NOTICE

For details of the oil to use, see "20. USE OF FUEL, COOLANT AND LUBRICANTS ACCORDING TO AMBIENT TEMPERATURE".

6. After the oil flows out of the hole of plug ③, install plugs ⑤ and ③.

## **24.8 EVERY 2000 HOURS SERVICE**

Maintenance for every 100, 250, 500 and 1000 hours should be carried out at the same time.

### **24.8.1 CHECK ALTERNATOR, STARTING MOTOR**

The brush may be worn, or the bearing may have run out of grease, so contact your Komatsu distributor for inspection or repair. If the engine is started frequently, carry out inspection every 1000 hours.

### **24.8.2 CHECK ENGINE VALVE CLEARANCE, ADJUST**

As special tool is required for removing and adjusting the parts, you shall request Komatsu distributor for service.

## 24.9 EVERY 4000 HOURS SERVICE

Maintenance for every 100, 250, 500 1000, and 2000 hours should be carried out at the same time.

### 24.9.1 CHANGE OIL IN HYDRAULIC TANK, CLEAN STRAINER

**⚠ WARNING**

The oil is at high temperature immediately after the machine has been operated. Wait for the oil to cool down before changing the oil. When removing the oil filler cap, turn it slowly to release the internal pressure, then remove it carefully.

Prepare the following.

- Container to catch drained oil: Min. 33 ℓ capacity
- Refill capacity: 33 ℓ (8.58 US gal, 7.26 UK gal)
- Handle

1. Swing the upper structure about 45° so that the drain plug under the hydraulic tank will be between both tracks.

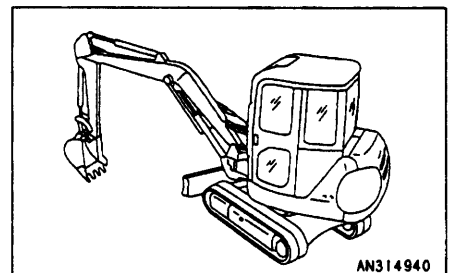

2. Retract the arm cylinder and bucket cylinder to the end, then lower the boom until the tooth touches the ground.

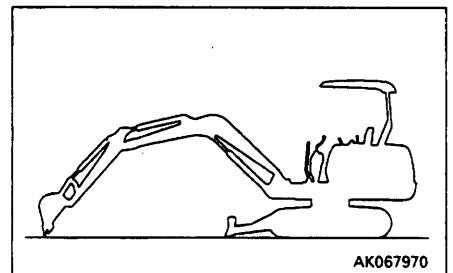

3. Lower the blade to the ground, then stop the engine.

4. Open engine hood ① and secure it with the hood support lever, then remove the cap of oil filler ②.

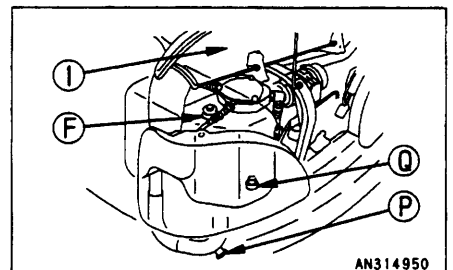

5. Set an oil receiving container under the drain plug on the underside of the machine body. Remove drain plugs (P) and (Q) with the handle to drain the oil. Check the O-rings fitted to plugs (P) and (Q). If they have any flaw, replace them. After draining the oil, tighten drain plugs (P) and (Q).

#### Tightening torque

Drain plug (P) (Fitted to pipe): 44.1 – 53.9 N·m ( $5 \pm 0.5$  kgf·m,  $36 \pm 3.6$  lbft)

Drain plug (Q) (Fitted to tank bottom): 58.8 – 78.4 N·m ( $7 \pm 1$  kgf·m,  $50.6 \pm 7.2$  lbft)

When removing drain plugs (P) and (Q), take care not to get soaked with oil.

6. Loosen hose band (2) and remove bolt (3). Remove flange (4) and strainer (5).
7. Remove all dust from strainer (5) and wash it in clean light oil. If strainer (5) is broken, replace it with new one.
8. Insert and fit strainer (5) in the projection of flange (4).
9. Secure hose (6) and pipe (7) with hose band (2).
10. Supply engine oil through oil filler (F) to a level between H and L lines of sight gauge (G).

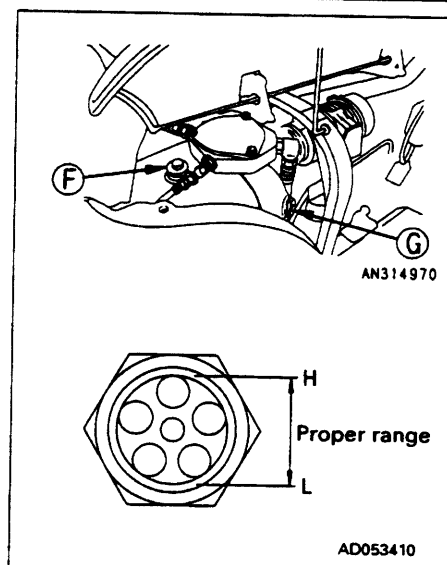
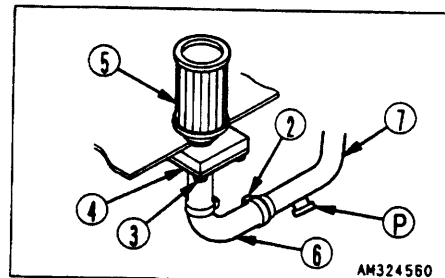

#### NOTICE

For details of the oil to use, see "20. USE OF FUEL, COOLANT AND LUBRICANTS ACCORDING TO AMBIENT TEMPERATURE".

11. Apply pressure to the hydraulic tank.  
Extract each cylinder of the boom, arm and bucket to the end as shown at right, and remove the oil filler cap, then install the cap again and apply pressure to the tank.

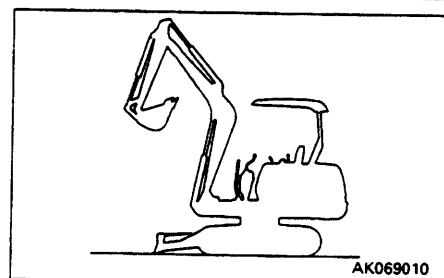

#### NOTICE

If pressure is not applied to the hydraulic tank, the pump will suck air which will cause problems.

## 24. SERVICE PROCEDURE

12. After replacing the oil, set each control lever to the neutral position and run the engine idle at a low speed for 2 – 3 minutes, then start the normal work.

### NOTICE

If the hydraulic breaker is installed, the hydraulic oil is more deteriorated than working with the normal bucket. Accordingly, replace the oil according to the table at right.

13. After replacing or cleaning the hydraulic oil, filter element and strainer, bleed air from the circuit according to the following procedure.

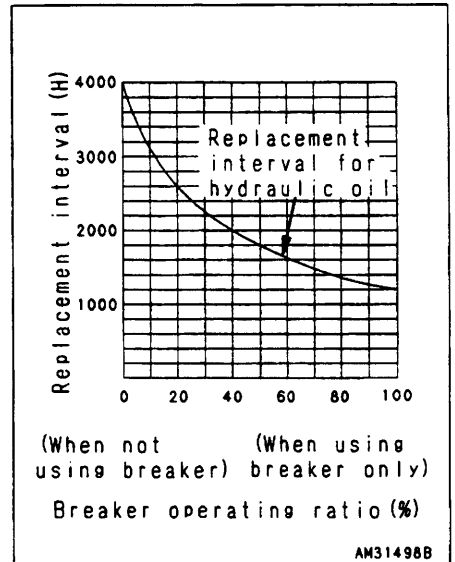

### ● Air bleeding procedure

#### 1. Bleeding air from piston pump

1. Remove the oil filler cap from the hydraulic oil.
2. Loosen air bleeder ① and confirm that oil oozes through it (the all air has been bled).
3. After bleeding air, tighten the air bleeder.
4. Tighten the oil filler cap of the hydraulic tank.

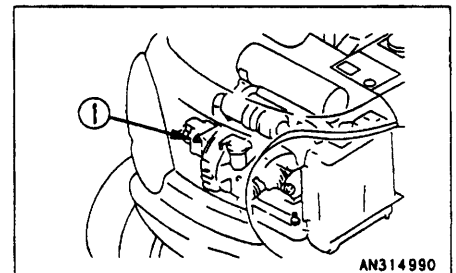

### NOTICE

If the pump is operated without filling the pump case with hydraulic oil, the pump will be heated abnormally and may be broken. Be sure to bleed all air.

## 2. Start engine

1. Referring to "12.2 STARTING ENGINE", start the engine.
2. Extract each cylinder of the boom, arm and bucket to the end, and remove the oil filler cap, then install the cap again and apply pressure to the tank.
3. Run the engine idle at a low speed for about five minutes, then start the following work.

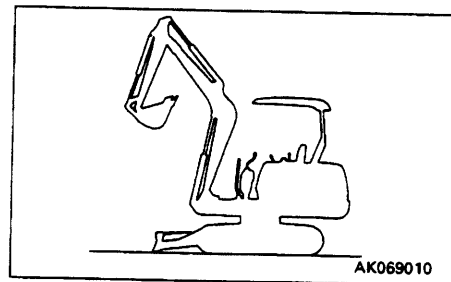

## 3. Bleed air from cylinder

1. Run the engine at a low speed and extract and retract each cylinder without bringing it to the stroke end (about 100 mm (4 in) before the stroke end) 4 – 5 times.
2. Operate each cylinder to the stroke end 3 – 4 times.
3. Further operate each cylinder to the stroke end 4 – 5 times to bleed all air.

### NOTICE

If the engine speed is raised to a high level or the cylinders are operated to the stroke end at first, the air in the cylinders may break the piston .

## 4. Bleed air from attachment (If installed)

If the breaker or another attachment is installed, operate the attachment pedal repeatedly (about 10 times) with the engine speed at a low level until all air is bled from the attachment and its circuit.

### NOTICE

If an air bleeding procedure is given for the attachment by the manufacturer, bleed air according to it.

## 5. Operation

1. After bleeding air, stop the engine and wait for at least five minutes. Then, start the engine. By this operation, the bubbles in the oil in the tank will be discharged.
2. Check each part for oil leakage and wipe off any spilt oil.

# **SPECIFICATIONS**



25. SPECIFICATIONS

**PC35R-8**

		Rubber shoes and canopy	Ruber shoes and cab	Steel shoes and canopy	Steel shoes and cab
<b>WEIGHT</b>					
● Operating weight (without operator)		3185 kg (7023 lb)	3340 kg (7365 lb)	3200 kg (7056 lb)	3355 kg (7398 lb)
<b>PERFORMANCE</b>					
Bucket capacity (standard bucket) SAE/CECE		0.11 m <sup>3</sup> (0.14 cu.yd) / 0.10m <sup>3</sup>			
● Width of opening (Standard bucket)	(Without side cutter)	525 mm (20.7 in)			
	(With side cutter)	600 mm (23.6 in)			
● Travel speed	High speed	4.55 km/h (2.7 MPH)		4.3 km/h (2.6 MPH)	
	Low speed	2.8 km/h (1.7 MPH)		2.7 km/h (1.6 MPH)	
● Swing speed		9.0 rpm			
● Track shoe		Rubber shoe 300 mm (11.8 in)		Double grouser shoe 300 mm (11.8 in)	
<b>ENGINE</b>					
● Model		Komatsu 3D84E-3FD diesel engine			
● Flywheel horsepower		20.59 kW (28 HP) / 2500 rpm			
● Starting motor		12 V 1.8 kW			
● Alternator		12 V 40 A			
● Battery		12 V 70 Ah x 1 piece			

PC35R-8

- Canopy (rubber shoe/steel shoe) specification

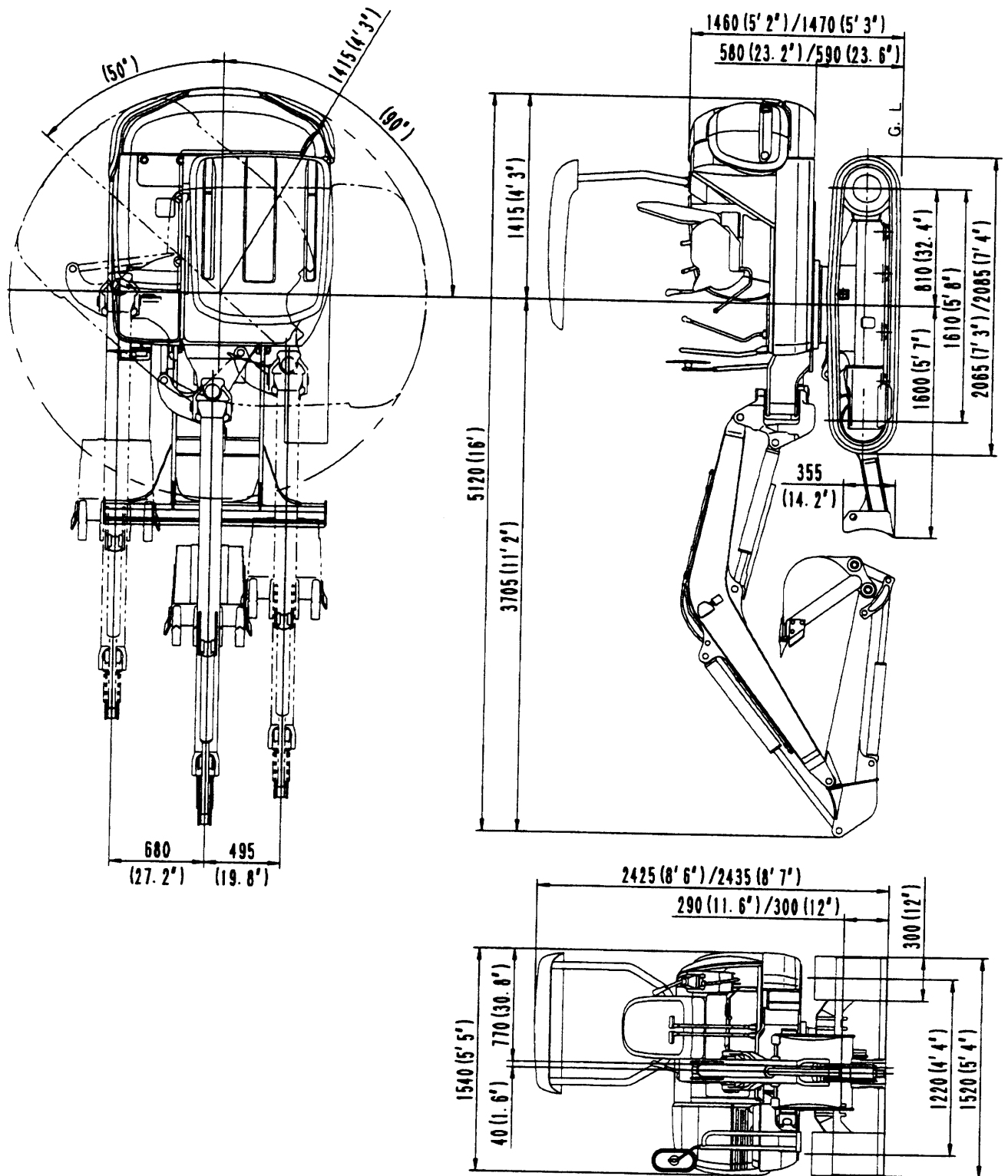

AM32457B

25. SPECIFICATIONS

PC35R-8

- Cab (rubber shoe/steel shoe) specification

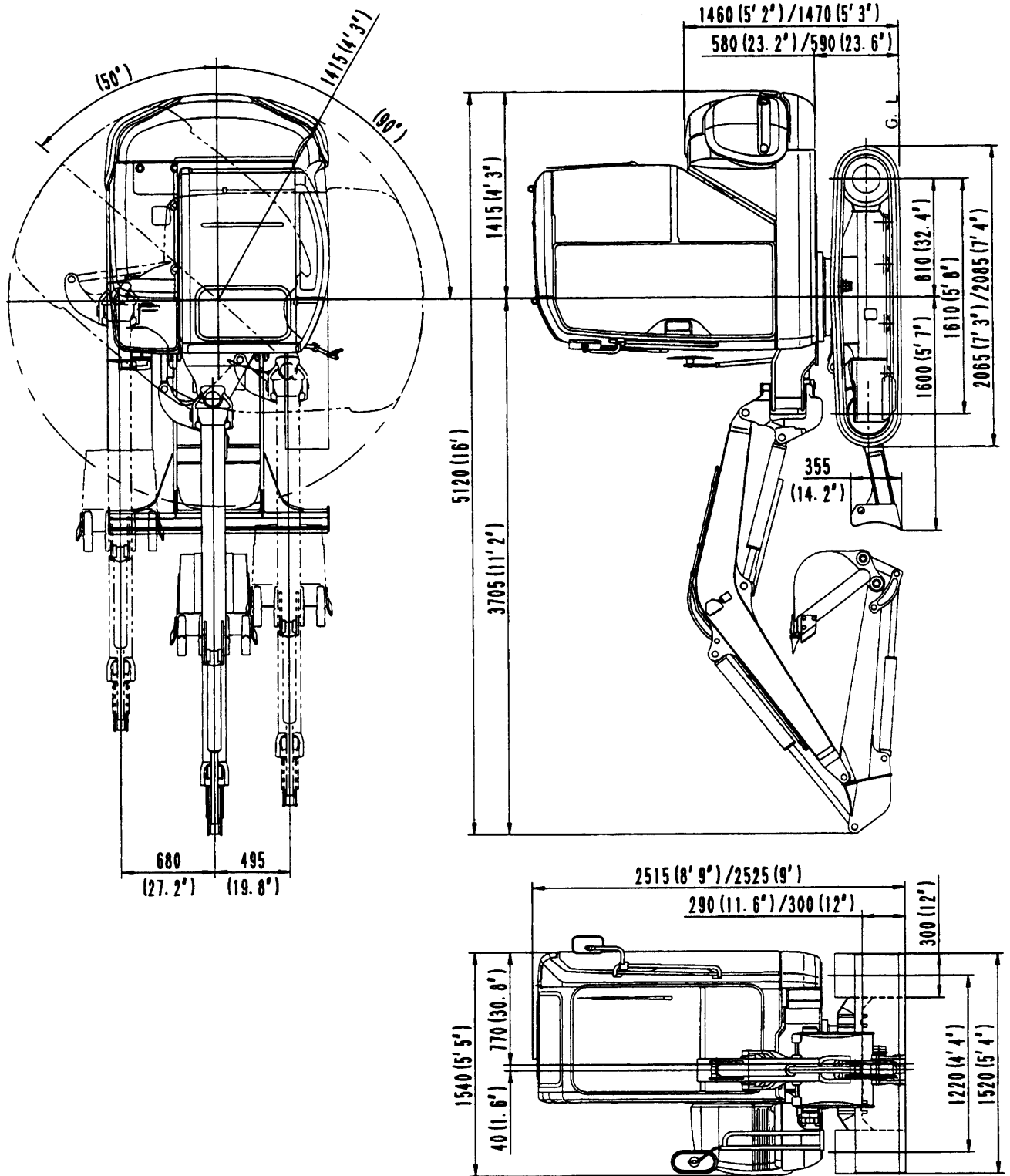

PC35R-8

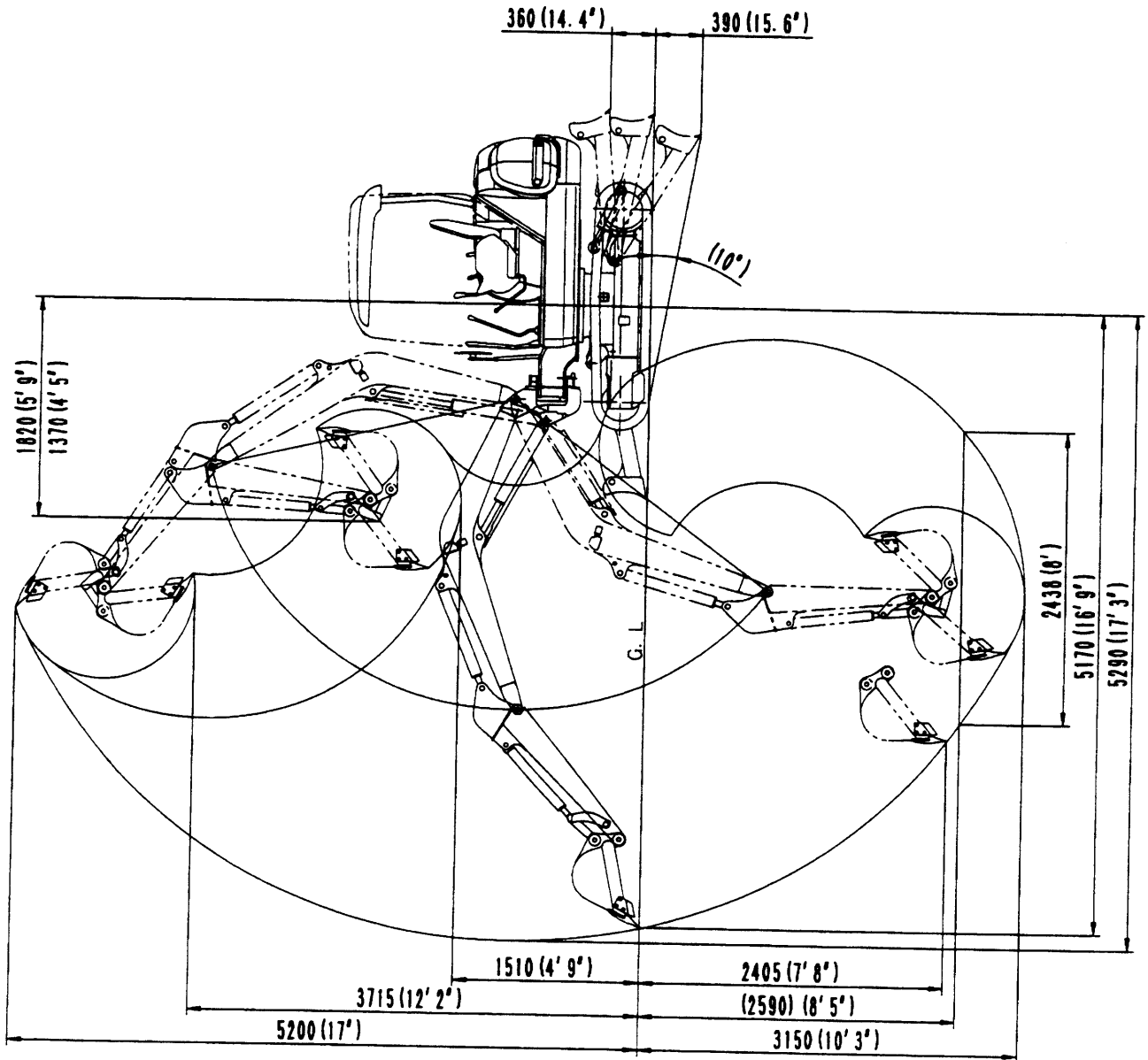

AM31854B

## 25. SPECIFICATIONS

### PC45R-8

	Rubber shoes and canopy	Ruber shoes and cab	Steel shoes and canopy	Steel shoes and cab
<b>WEIGHT</b>				
● Operating weight (without operator)	4230 kg (9327 lb)	4385 kg (9669 lb)	4300 kg (9482 lb)	4455 kg (9823 lb)
<b>PERFORMANCE</b>				
Bucket capacity (standard bucket) SAE/CECE	0.16 m <sup>3</sup> (0.21 cu.yd) / 0.14 m <sup>3</sup>			
● Width of opening (Standard bucket)	(Without side cutter)	585 mm (23.0 in)		
	(With side cutter)	650 mm (25.6 in)		
● Travel speed	High speed	4.55 km/h (2.7 MPH)	4.3 km/h (2.6 MPH)	
	Low speed	2.8 km/h (1.7 MPH)	2.7 km/h (1.6 MPH)	
● Swing speed	9.0 rpm			
● Track shoe	Rubber shoe 400 mm (13.6 in)	Triple grouser shoe 400 mm (15.8 in)		
<b>ENGINE</b>				
● Model	Komatsu 4D84E-3DD diesel engine			
● Flywheel horsepower	28.32 kW (38.5 HP) / 2500 rpm			
● Starting motor	12 V 2.0 kW			
● Alternator	12 V 40 A			
● Battery	12 V 70 Ah x 1 piece			

PC45R-8

- Canopy (rubber shoe/steel shoe) specification

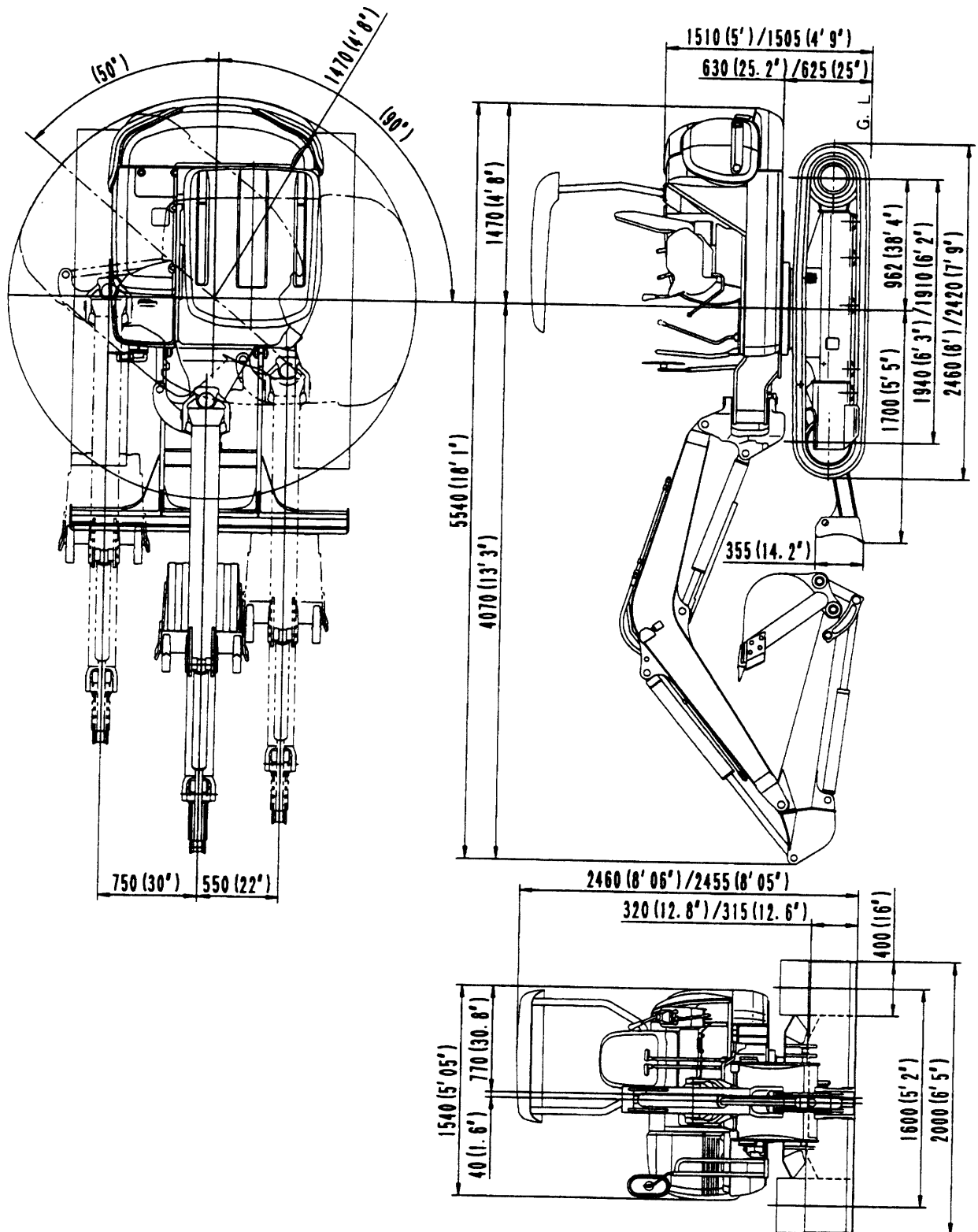

AM318588

25. SPECIFICATIONS

PC45R-8

- Cab (rubber shoe/steel shoe) specification

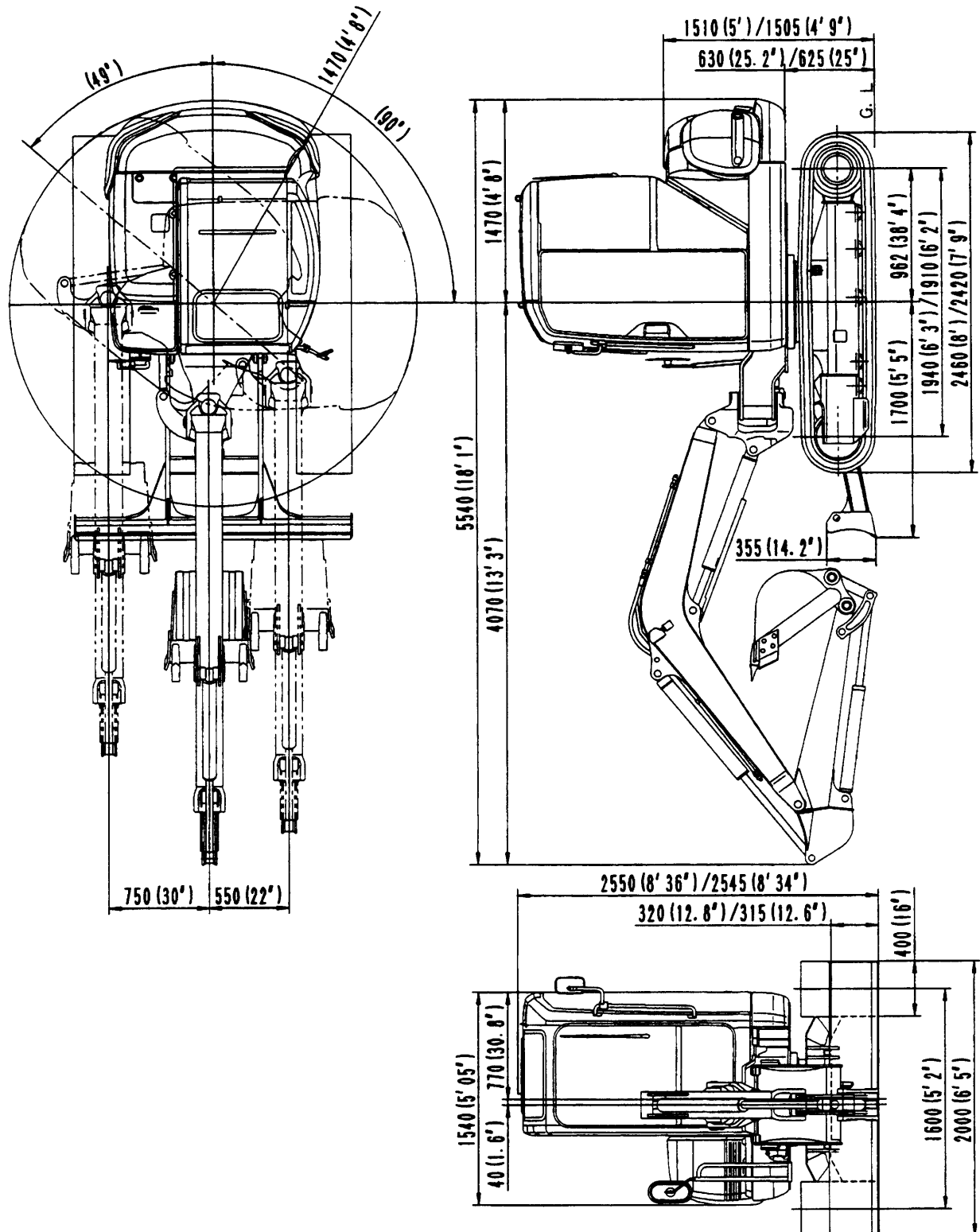

AM318598

PC45R-8

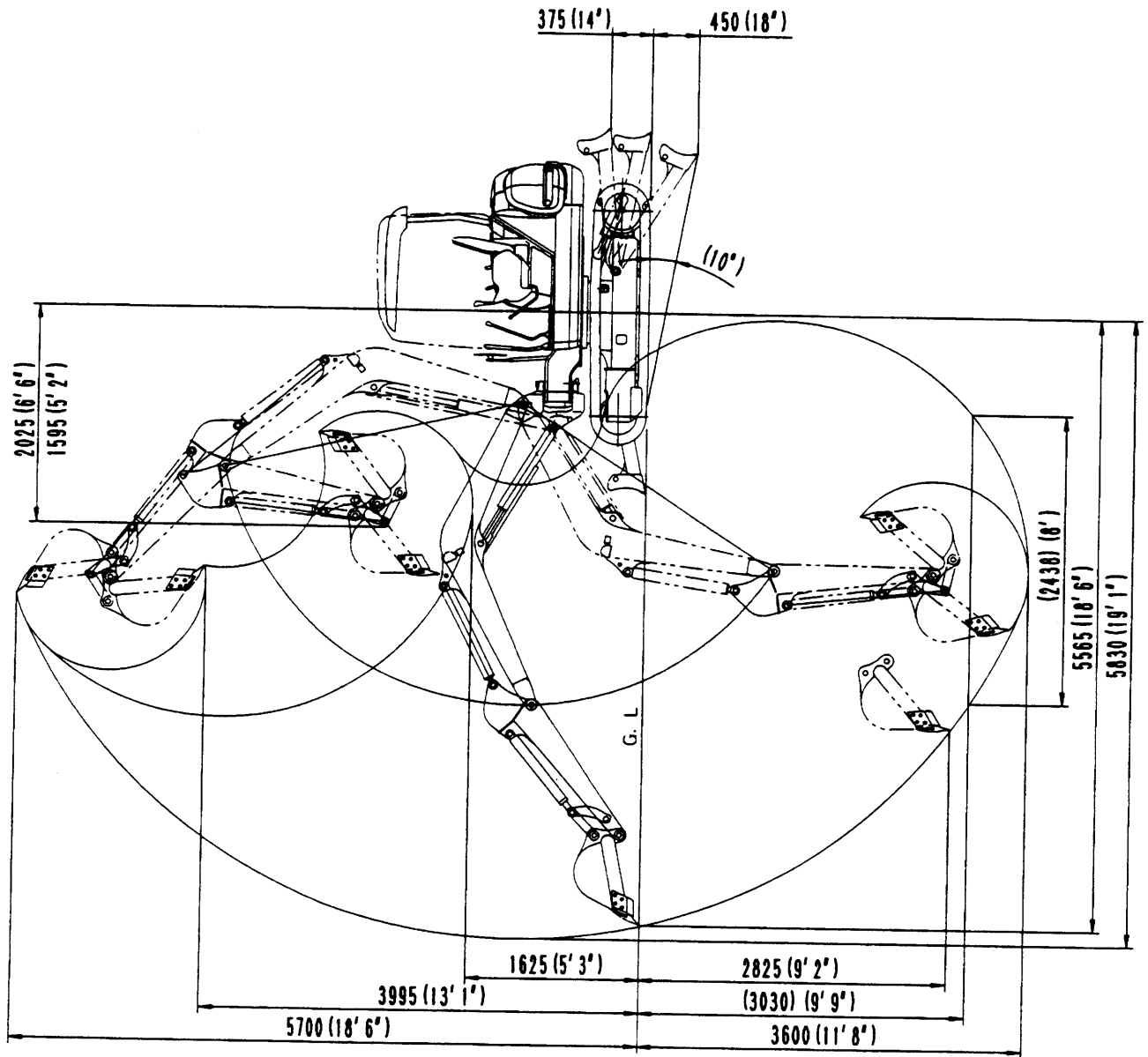

AM318608



# **OPTIONS, ATTACHMENTS**

## 26. GENERAL PRECAUTIONS

---

### 26.1 PRECAUTIONS RELATED TO SAFETY

If attachments or options other than those authorized by Komatsu are installed, this will not only affect the life of the machine, but will also cause problems with safety.

When installing attachments not listed in this Operation and Maintenance Manual, please contact your Komatsu distributor first.

If you do not contact Komatsu, we cannot accept any responsibility for any accident or failure.

#### WARNING

##### **Precautions for removal and installation operations**

**When removing or installing attachments, obey the following precautions and take care to ensure safety during the operation.**

- **Carry out the removal and installation operations on a flat, firm ground surface.**
- **When the operation is carried out by two or more workers, determine signals and follow these during the operation.**
- **When carrying heavy objects (more than 25 kg (55 lb)), use a crane.**
- **When removing heavy parts, always support the part before removing it.  
When lifting such heavy parts with a crane, always pay careful attention to the position of the center of gravity.**
- **It is dangerous to carry out operations with the load kept suspended. Always set the load on a stand, and check that it is safe.**
- **When removing or installing attachments, make sure that they are in a stable condition and will not fall over.**
- **Never go under a load suspended from a crane.  
Always stand in a position that is safe even if the load should fall.**

#### **NOTICE**

**Qualifications are required to operate a crane. Never allow the crane to be operated by an unqualified person.**

**For details of the removal and installation operations, please contact your Komatsu distributor.**

## 26.2 PRECAUTIONS WHEN INSTALLING ATTACHMENTS

### ⚠ WARNING

Long work equipment reduces the stability of the chassis, so if the swing is operated on a slope, or when going down a steep hill, the machine may lose its balance and overturn. The following operations are particularly dangerous, so never operate the machine in these ways.

- Going downhill with the work equipment raised

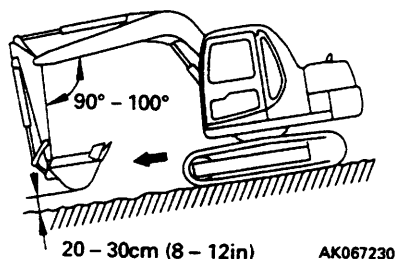

- Traveling across slopes

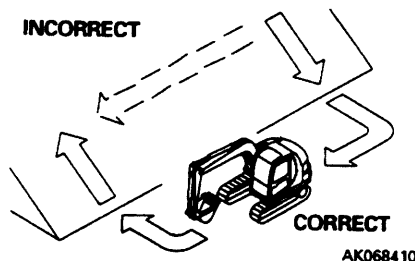

- Swinging the upper structure on slopes

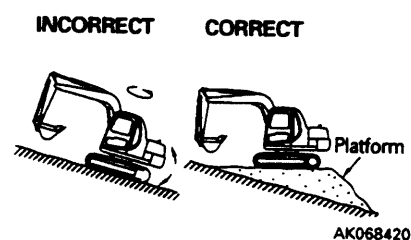

- If heavy work equipment is installed, the overrun of the swing becomes greater (the distance from the point where the operator operates the control levers to stop the swing to the point where the upper structure stops completely), so there is danger of mistaking the distance and hitting something.

Always operate so that there is an ample margin to the stopping point.

Furthermore, the hydraulic drift also becomes larger (when the work equipment is stopped in mid-air, it will gradually move down under its own weight).

- Always follow the correct procedure when installing the boom and arm. If the correct procedure is not followed, this may lead to serious damage or injury, so please consult your Komatsu distributor before carrying out installation.

If long work equipment is installed, the working range will suddenly become larger, so there is danger of mistaking the distance and hitting something.

Always operate the work equipment so that there is ample space from any obstacles in the area.

## 27. HANDLING BUCKET WITH HOOK

### 27.1 CHECKING FOR DAMAGE TO BUCKET WITH HOOK

Check that there is no damage to the hook, stopper, or hook mount. If any abnormality is found, please contact your Komatsu distributor.

### 27.2 PROHIBITED OPERATIONS

The standard work equipment must not be used for lifting loads. If this machine is to be used for lifting loads, it is necessary to install the special bucket with hook.

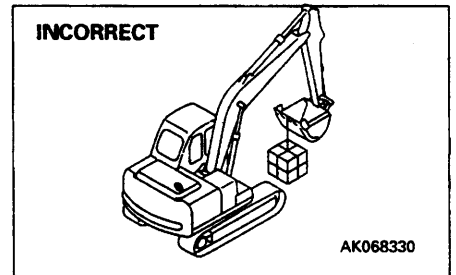

### 27.3 PRECAUTIONS DURING OPERATIONS

- When carrying out lifting operations, reduce the engine speed.
- Depending on the posture of the work equipment, there is danger that the wire or load may slip off the hook. Always be careful to maintain the correct hook angle to prevent this from happening.
- Never steer the machine while lifting a load.
- If the bucket with hook is turned and used for operations, it will hit the arm during dumping operations, so be careful when using it.
- Loads suspended must not exceed the limit indicated in the "LIFTING CAPACITY TABLE" stuck on the right-side lower portion of the driver's seat.
- If you wish to install a hook in the future, please contact your Komatsu distributor.

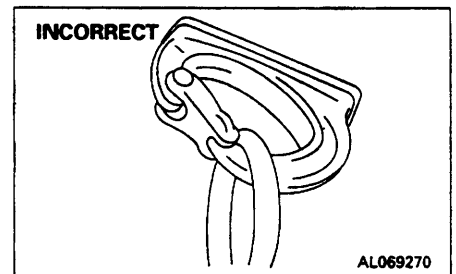
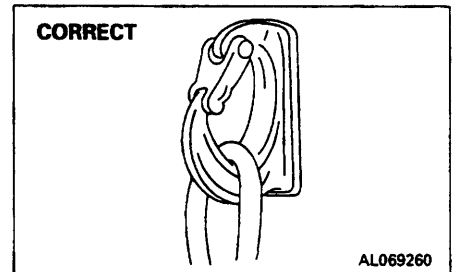

## 28. USING SEAT BELT

### 28.1 SEAT BELT

**⚠ WARNING**

- Before fastening the seat belt, inspect the securing brackets and belt for abnormal conditions. Replace any worn or damaged seat belt or the securing brackets.
- Adjust and fasten the seat belt before operating the machine.
- Always use seat belt when operating the machine.
- Do not use seat belt with either half of the belt kinked.

#### 28.1.1 FASTEN THE BELT AND REMOVE IT

1. Adjust the seat so that the operator still feels that there is sufficient knee room when fully depressing the pedal while seated, with the operator's back against the backrest.
2. After adjusting the seat position, sit in the seat. Grip buckle ① and tongue ② in each hand and insert tongue ② into buckle ①. Confirm by pulling the belt that the tongue is securely locked to the buckle.
3. When removing the belt, raise the tip of buckle ① lever to release it.

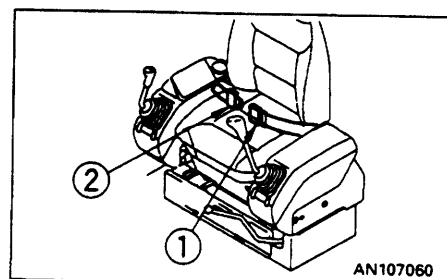

Fasten belt along your body without kinking it. Adjust the lengths of the belt on both the buckle and the tongue sides so that the buckle is located at the mid-point of your body front.

### 28.1.2 ADJUST BELT LENGTH

#### When shortening

Pull the free end on the buckle side or the plug side.

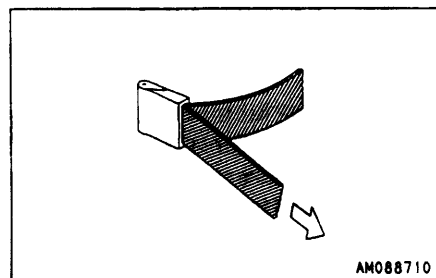

#### When lengthening

Pull the fixed end on the buckle side or the plug side, at right angles to the buckle or plug.

Check the mounting bolts of the belt fittings on the machine body for looseness, and re-tighten them if necessary.

The tightening torque for the mounting bolt is  $24.5 \pm 4.9$  N·m ( $2.5 \pm 0.5$  kgf·m,  $18.1 \pm 3.6$  lbft).

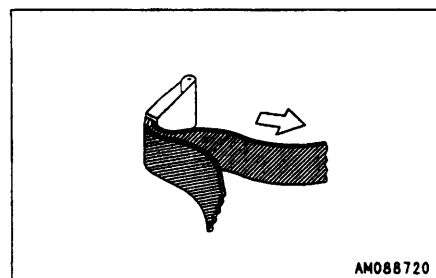

If the belt surface is scratched or frayed or if the fittings are broken or deformed, replace the seat belt unit.

# 29. OPERATION OF CAR RADIO (MACHINE EQUIPPED WITH CAB)

## 29.1 EXPLANATION OF CONTROLS

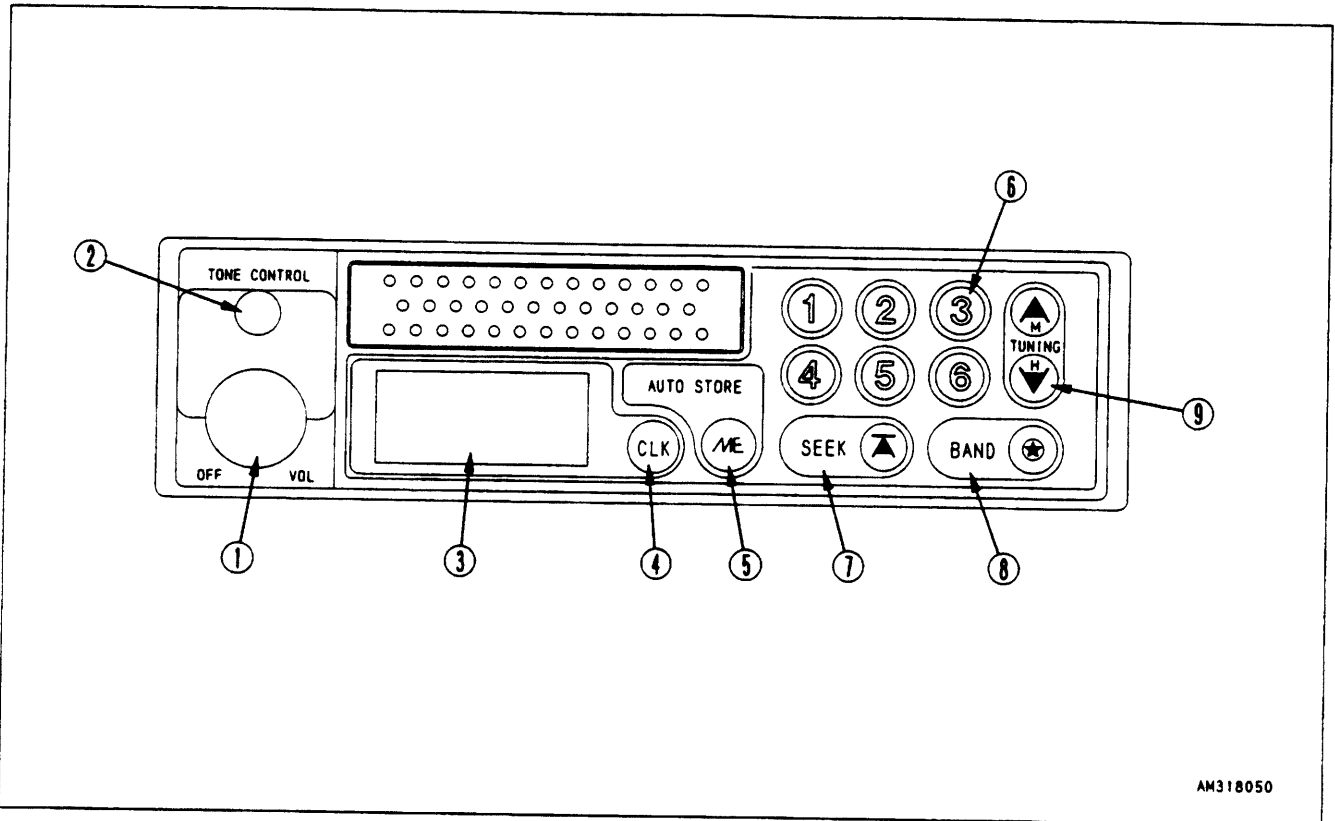

### 1. OFF-VOL KNOB

If this knob is turned to the right, it clicks and the radio is turned on and the frequency is indicated in display unit ③. If it is turned to the left until it clicks, the radio is turned off.

As the knob is turned to the right, the sound volume is increased, and vice versa.

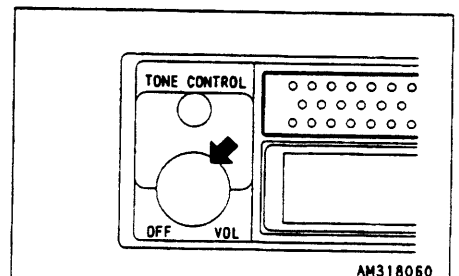

### 2. TONE CONTROL KNOB

If this knob is turned clockwise from the central position, the high tone is increased, and vice versa.

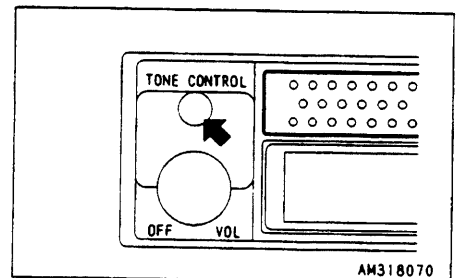

### 3. DISPLAY UNIT

This unit displays the receiving band, frequency, time, preset No. and operation mode.

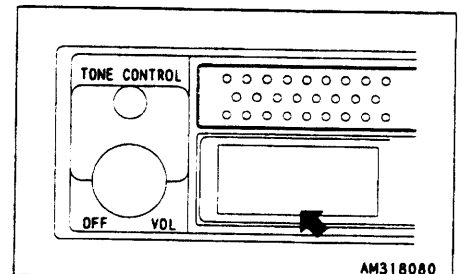

**4. CLK BUTTON**

If this button is pressed while the power is turned on, the display unit indicates the time. If it is pressed again, it indicates the frequency.

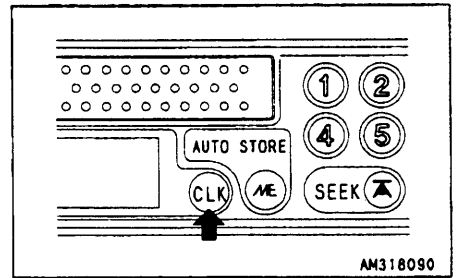

**5. ME BUTTON**

If this button is pressed once, the receiving band, frequency and preset No. are indicated (the present No. flashes), and the preset stations are called one by one. If a desired station is selected, press this button again, and the selecting operation stops.

If this button is pressed and held for two seconds, the auto memory function is set and the system is preset automatically.

For details, see "29.2.3 HOW TO USE AUTO MEMORY FUNCTION".

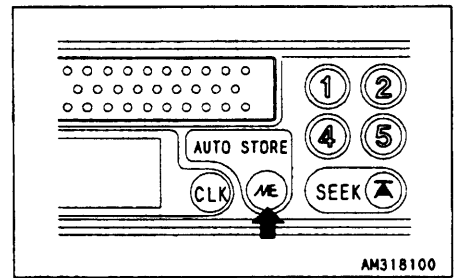

**6. PRESET (1, 2, 3, 4, 5, 6) BUTTONS**

If a desired station is preset to each of these buttons, it can be selected by touching that button.

One FM station and one MW (AM) station can be preset to each button.

For details, see "29.2.2 HOW TO SET PRESET BUTTONS".

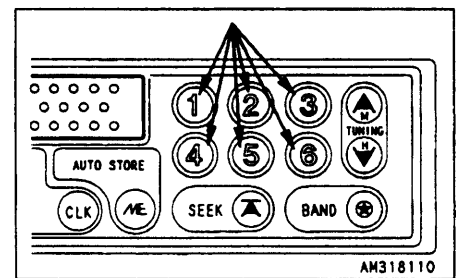

**7. SEEK BUTTON**

If this button is pressed, the radio system starts seeking a receivable station and stops at the first detected station.

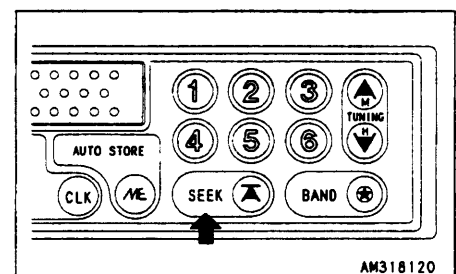



**8. BAND BUTTON**

If this button is pressed, the FM and MW (AM) bands are changed to each other. The display unit displays the receiving band and frequency.

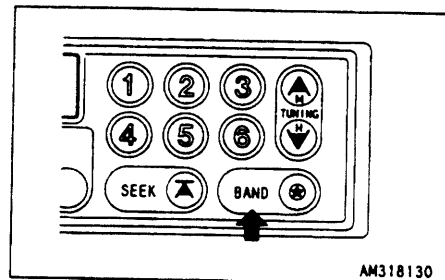

AM318130

**9. TUNING BUTTON**

Each time the TUNING UP (^) button is pressed, the frequency increases, and each time the TUNING DOWN (v) button is pressed, the frequency decreases. If either of these buttons is pressed and held, the frequency changes continuously.

In the clock adjustment mode, the DOWN button is used to change the hour and the UP button is used to change the minute.

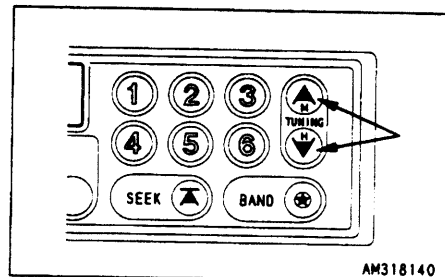

AM318140

**29.2 OPERATION METHOD**

**29.2.1 LISTENING TO THE RADIO**

1. Turn OFF-VOL knob ① to the right until it clicks, and display unit displays the receiving band and frequency.
2. Select a desired band with BAND button ⑧.
3. Select a desired frequency with PRESET button ⑥ or SEEK button ⑦.
4. Adjust the sound volume and tone with OFF.VOL knob ① and TONE CONTROL knob ②.
5. When turning off the radio, turn OFF-VOL knob ① to the left until it clicks.

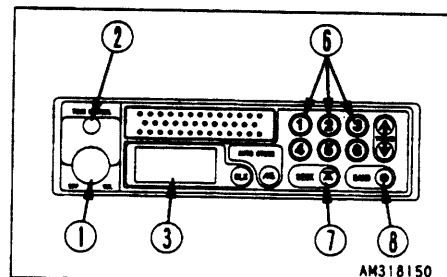

AM318150

**29.2.2 HOW TO SET PRESET BUTTONS**

1. Turn OFF-VOL knob ① to the right until it clicks.
2. Select a desired band with BAND button ⑧.
3. Select a desired frequency with SEEK button ⑦ or TUNING button ⑨.

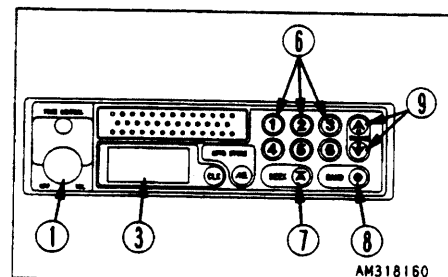

AM318160

## 29. OPERATION OF CAR RADIO (MACHINE EQUIPPED WITH CAB)

4. Press and hold PRESET button ⑥ of any number for about two seconds, and the number of that button is displayed by display unit ③.
- Preset the other stations by repeating procedures 2 through 4. above.
  - If the frequency reaches the upper or lower limit, it changes from the upper limit to the lower limit or from the lower limit to the upper limit automatically.
  - When setting a station to a button to which another station has been preset, repeat procedures 2 through 4 above, too.
  - One AM station and one FM station can be preset for each preset button.

### 29.2.3 HOW TO USE AUTO MEMORY FUNCTION

Press and hold ME button ⑤ for two seconds, the receivable stations in the current area are selected one by one and memorized in the preset buttons automatically.

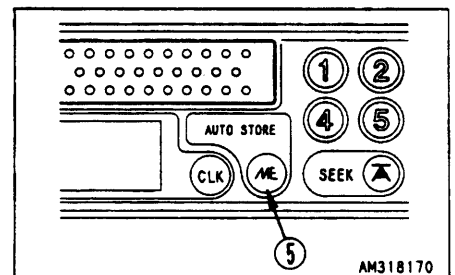

### 29.2.4 HOW TO USE AUTOMATIC TUNING

If SEEK button ⑥ is pressed, the radio system seeks a receivable station in the higher frequency direction, and stops if one is detected.

If this button is pressed again, the next station is detected.

If the radio wave is so weak that this function does not work, select each station manually.

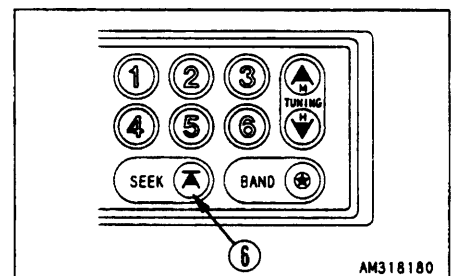

### 29.2.5 HOW TO SELECT STATIONS MANUALLY

Press TUNING button ⑨ to select a desired frequency. Each time this button is pressed, the frequency changes by 9 MHz in the MW (AM) mode and by 0.1 MHz in the FM mode.

^ button: Frequency rises.

∨ button: Frequency lowers.

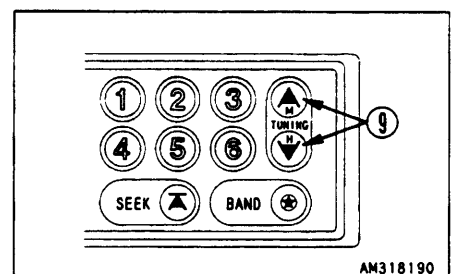

### 29.2.6 ADJUSTMENT OF TIME

1. Press CLK button ④ to display the clock in the display unit.
2. Pressing CLK button ④, press time adjustment button ⑨ ∨ (Used as TUNING button, too), and the indicated hour changes. If the correct hour is indicated, release the button.
3. Pressing CLK button ④, press time adjustment button ⑨ ∧ (Used as TUNING button, too), and the indicated minute changes. If the correct minute is indicated, release the button.

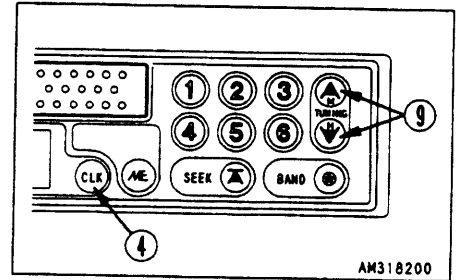

#### REMARK

The clock is a 12-hour system.

### 29.3 PRECAUTIONS FOR USE

- For safety reasons limit the sound volume to the degree that you can hear sounds outside of the machine.
- If water enters the speaker cases or the car radio (auto-tuning unit), this may cause trouble. Take care not splash water over them.
- Do not wipe the dials and buttons with benzine or thinner. Wipe them with a clean dry cloth (soaked in alcohol when they are very dirty).
- If the battery is replaced, all memories of the preset buttons will be lost. Set them again in this case.

## 29.4 SPECIFICATIONS

### Radio section

- **FM unit**  
Synchronization method : PLL synthesizer method  
Receiving frequency : 76.1 – 89.9 MHz  
Usable sensitivity : 18 dB max. (S/N: 30 dB)

- **AM unit**  
Synchronization method : PLL synthesizer method  
Receiving frequency : 522 – 1629 MHz  
Usable sensitivity : 20 dB max. (Max.)

### Other items

- Suitable load impedance : 4  $\Omega$
- Max. output : 7 W
- Rated output : 5 W
- Source voltage : DC 12 V or 24 V (Common)
- Current consumption : 3A max. (At max. output)
- Outside dimensions : 180 mm wide, 50 mm high,  
106mm deep

## 30. OPERATION OF WINDOW WASHER (MACHINE EQUIPPED WITH CAB)

If the window washer is installed, operate it according to the following procedure.

### 30.1 OPERATION OF WINDOW WASHER

#### WARNING

Use window washer fluid of ethyl alcohol type.  
The vapor of window washer fluid of methyl alcohol type may contain elements harmful to human bodies.  
Since the window washer fluid tank is installed inside the machine, use window washer fluid of ethyl alcohol type.

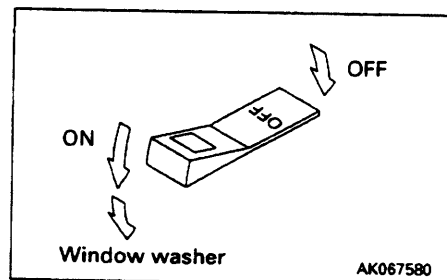

Further press the windshield wiper switch from the ON position, and the window washer fluid will spout.

#### NOTICE

If the window washer is operated continuously for more than 10 seconds or operated with the window washer fluid tank empty, the motor may be broken.

### 30.2 CHECK AND REFILLING OF WINDOW WASHER FLUID

If air is mixed in the window washer fluid, check the fluid level of window washer fluid tank ①. If it is too low, supply window washer fluid for automobile. At this time, take care that dust does not enter the tank.

- **Dilution ratio of window washer fluid**

Dilute the window washer fluid according to the following table.

District and season	Dilution ratio	Freezing temperature
Ordinary	1 part of solution to 2 mparts of water	-10°C
Winter in cold district	1 part of solution to 1 part of water	-20°C
Winter in very cold district	Undiluted solution	-30°C

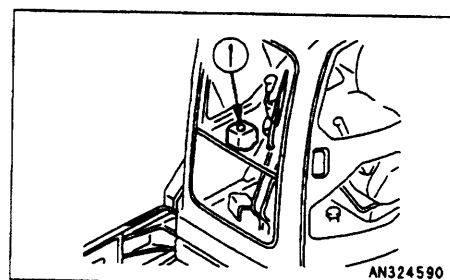

Select fluid having a freezing point of -10°C (for general districts) or one having the freezing point of -30°C (for cold districts) according to the district where the machine is used and the season.

## 31. INTRODUCTION OF ATTACHMENTS

### 31.1 SPECIFICATIONS AND USES

Name	Specifications and uses		
	Item	PC35R	PC45R
Narrow bucket	Capacity	0.04 m <sup>3</sup>	0.05 m <sup>3</sup>
	Opening width	350 mm	365 mm
Narrow bucket	Capacity	0.05 m <sup>3</sup>	0.10 m <sup>3</sup>
	Opening width	425 mm	500 mm
Narrow bucket	Capacity	0.08 m <sup>3</sup>	-
	Opening width	500 mm	-
Wide bucket	Capacity	0.12 m <sup>3</sup>	0.16 m <sup>3</sup>
	Opening width	700 mm	700 mm
Track	Standard width	300 mm width	400 mm width
	White rubber shoe	300 mm width	400 mm width
	Road liner	-	400 mm width

#### Other items

- Car radio (Machines equipped with cab)
- Window washer (Machines equipped with cab)
- Ashtray (Machines equipped with cab)
- Additional front lamp
- Battery for cold districts
- Canopy rain guard (Machines equipped with canopy)
- Car heater (Machines equipped with cab)
- Long arm
- Machines which can be equipped with attachments
- Power tilt, power angle blade

For the above attachments, ask your Komatsu distributor.

## 31.2 COMBINATIONS TABLE OF ATTACHMENTS

The long arm and standard arm can be combined with the buckets according to the following table.

If the long arm is installed and the bucket is fully pulled toward the machine, it interferes with the machine body. Avoid this operation.

When lowering the boom while digging diagonally, it interferes with the undercarriage. Take care.

### Classification of uses

For general digging: Digging and loading of ordinary soil such as sand, gravel, clay, etc.

For light digging: Digging and loading of dry and loose soil, sand, etc.

For loading: Loading of dry and crumbled soil and sand.

### Judgment

○: Usable

△: Usable for light work only

X: Unusable

### PC35R

	Capacity (m <sup>3</sup> )	Opening width (mm)	Application	Standard arm	Long arm
Standard bucket	0.10	600	For general digging	○	X
Narrow bucket	0.04	350	For narrow digging	○	○
Narrow bucket	0.05	425	For narrow digging	○	○
Narrow bucket	0.08	500	For narrow digging	○	○
Wide bucket	0.12	700	For loading	△	X

### PC45R

	Capacity (m <sup>3</sup> )	Opening width (mm)	Application	Standard arm	Long arm
Standard bucket	0.14	650	For general digging	○	X
Narrow bucket	0.05	365	For narrow digging	○	○
Narrow bucket	0.10	500	For narrow digging	○	○
Wide bucket	0.16	700	For loading	△	X

## 31. INTRODUCTION OF ATTACHMENTS

### 31.3 SELECTION OF TRACK SHOES (RUBBER SHOE, ROAD LINER)

Select track shoes proper to working conditions.

#### Selection method of shoe

Check the classification of the use according to the following table, then select shoes according to the table under that table.

Classification	Application	Precautions for use
A	Rocky ground, river, ordinary ground	<ul style="list-style-type: none"> <li>● Select Lo travel speed on rough ground where there are large boulders, fallen trees, etc.</li> </ul>
B	Very soft ground (Swamp)	<ul style="list-style-type: none"> <li>● Use these shoes only when A and B sink and cannot be used.</li> <li>● These shoes cannot be used on rough ground where there are large boulders, fallen trees, etc.</li> <li>● Select Hi travel speed for only flat ground. When you must ride over an obstacle, lower travel speed to about 1/2 of Lo.</li> </ul>
C	Paved road	<ul style="list-style-type: none"> <li>● See "12.20 HANDLING OF RUBBER SHOES AND ROAD LINER".</li> </ul>

	PC35R		PC45R	
	Specification	Classification	Specification	Classification
Option	300 double	A	400 triple	A
Option	400 swamp	B		
Option				
Option	-	-	400 rubber shoes	C
Option	300 rubber shoes	C	400 road liners	C
Standard	300 steel shoes	A	400 rubber shoes	A



**31.4 CONSUMABLE PARTS OF BUCKET**

Item	Part No.	Part name	Q'ty
Bucket	20T-70-72320	Tooth	4
	(20T-70-71950)	(Pin)	(4)
	(20T-70-71960)	(Lock)	(4)
	20S-70-71340	Side cutter (Right)	1
	20S-70-71330	Side cutter (Left)	1
	(20P-70-71351)	(Bolt)	(6)
Bucket (PC45R)	(20P-70-71360)	(Nut)	(6)
	20T-70-72320	Tooth	4
	(20T-70-71950)	(Pin)	(4)
	(20T-70-71960)	(Lock)	(4)
	20U-70-13251	Side cutter (Right)	1
	20U-70-13241	Side cutter (Left)	1
	(20U-70-28130)	(Bolt)	(8)
	(203-32-51220)	(Nut)	(8)

### 31.5 HANDLING OF POWER ANGLE/POWER TILT BLADE

This blade can be tilted, angled and lifted with the blade control lever.

#### 31.5.1 BLADE CONTROL LEVER

- LIFTING/TILTING OPERATION**

The blade is lifted and tilted by the following operation.

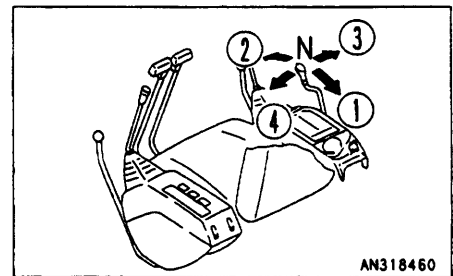

**Lifting operation**

- ① RAISE
- ② LOWER

N HOLD: The blade stops and does not move.

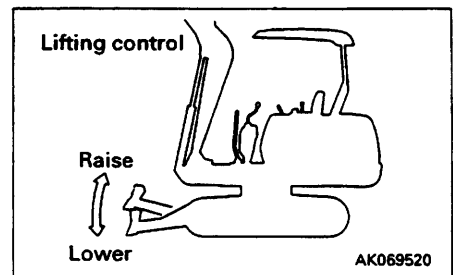

**Tilting operation**

- ① RIGHT TILT
- ② LEFT TILT

The tilting distance is as follows.

	PC35R	PC45R
RIGHT TILT	80 mm (3.2 in)	100 mm (4 in)
LEFT TILT	75 mm (3.0 in)	100 mm (4 in)

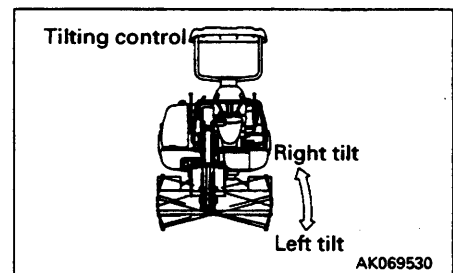

- ANGLING OPERATION**

Set the lever to the neutral (HOLD) position, and angle the blade, pushing the switch at the top of the knob.

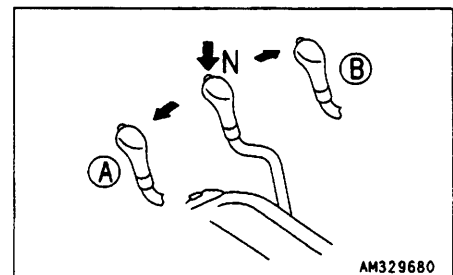

- Ⓐ LEFT ANGLE

N HOLD: The blade stops and does not move.

- Ⓑ RIGHT ANGLE

The blade can be angled to 20° on each side.

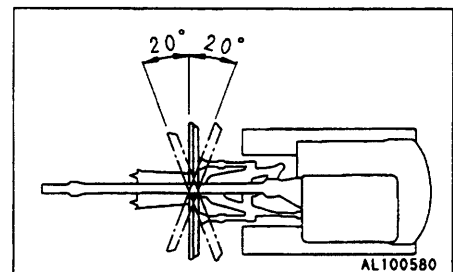

### 31.5.2 EVERY 100 HOURS SERVICE

#### GREASING

1. Supply grease to the grease fittings indicated by the arrow with a grease gun.
2. After supplying grease, wipe off the projected used grease.
1. Tilt cylinder foot pin (1 place)
2. Tilt cylinder rod end (1 place)
3. Angle cylinder foot pin (2 places)
4. Angle cylinder rod end pin (1 place)

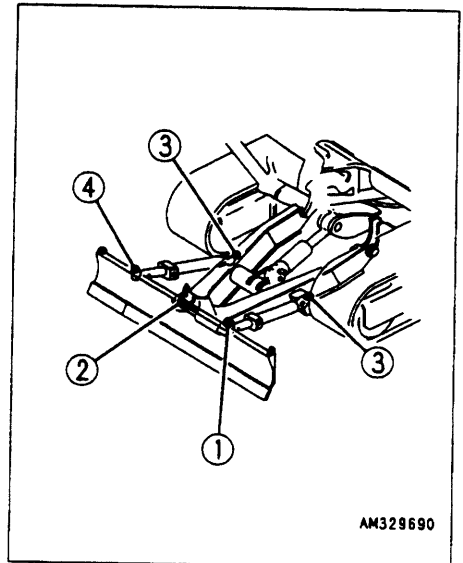

### 31.5.2 EVERY 500 HOURS SERVICE

#### GREASING

1. Lift cylinder foot pin (1 place)
2. Lift cylinder rod end pin (1 place)
3. Blade foot pin (2 places)

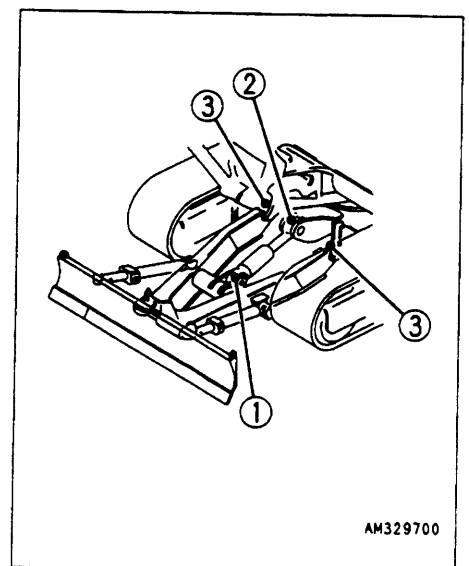

## 31. INTRODUCTION OF ATTACHMENTS

### 31.5.3 CONSUMABLE PARTS

#### PC35R

Part No.	Part name	Q'ty
20S-910-3131	Cutting edge	1
(02090-10840)	(Bolt)	(7)
(02090-10813)	(Nut)	(7)
20U-910-1980	End bit	2
(02090-10840)	(Bolt)	(6)
(02090-10813)	(Nut)	(6)

#### PC45R

Part No.	Part name	Q'ty
20T-71-22220	Cutting edge	1
(02090-10840)	(Bolt)	(8)
(02290-10813)	(Nut)	(8)
20U-910-1980	End bit	2
(02090-10840)	(Bolt)	(6)
(02290-10813)	(Nut)	(6)

### 31.5.4 SPECIFICATIONS

		PC35R	PC45R
● Blade	Width x Height	1770 mm x 400 mm	2000 mm x 400 mm
● Rising distance	Rubber shoe	400 mm	365 mm
	Steel shoe	390 mm	345 mm
● Lowering distance	Rubber shoe	490 mm	620 mm
	Steel shoe	510 mm	640 mm
● Angling degree		20° on each side	20° on each side
● Tilting distance		90 mm on each side	100 mm on each side

### 31.6 PRECAUTIONS FOR OPERATING WITH HYDRAULIC BREAKER

**WARNING**

When using the hydraulic breaker, put on. Put on a helmet, safety shoes, ear plugs, etc. For certain works, be sure to wear dust mask, protective goggles, gloves, etc.

Select the hydraulic breaker matched to the machine body.

- Use the hydraulic breaker we specify. For selection of the models, consult one of our distributors.

#### 34.6.1 MAIN APPLICABLE APPLICATIONS

- Crushing stones
- Demolition of buildings
- Road works

The hydraulic breaker can be used widely for demolishing buildings, breaking roads, tunnel construction, breaking slag, crushing stone, breaking rocks, etc.

Press the chisel at right angles at the point to be broken.

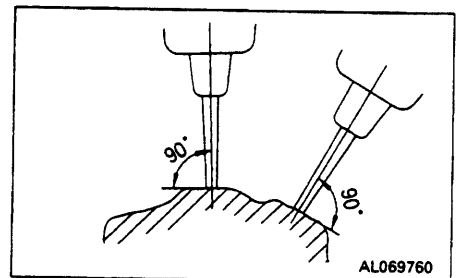

AL069760

When producing impact, press the chisel against the point to be broken and lift the machine body about 5 cm (2 in). Do not lift the machine body more than necessity.

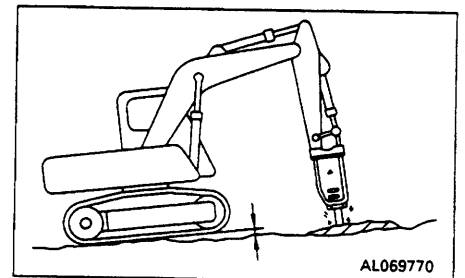

AL069770

If the chisel cannot break or go through the point to be broken after producing impact for one minute continuously, change the breaking point and break the end of the block.

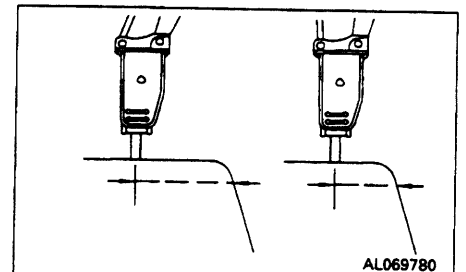

AL069780

## 31. INTRODUCTION OF ATTACHMENTS

As the chisel is driven, it deviates from the direction of the breaker. Correct it's direction with the bucket cylinder.

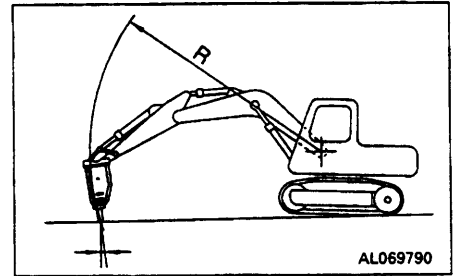

Press the chisel against the point to be broken correctly, so that it will not produce impact in the air.

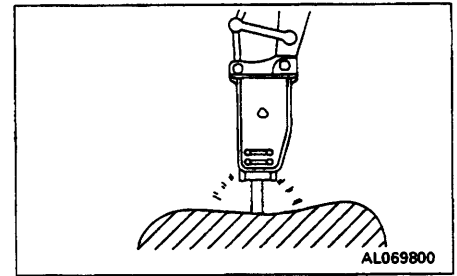

### 31.6.2 WRONG USES

Do not use the breaker as shown below for longer life of the machine and safer work.

Do not move the cylinder to the stroke end, but give a margin of about 5 cm (2 in) to it.

Collect rocks with the mounting section

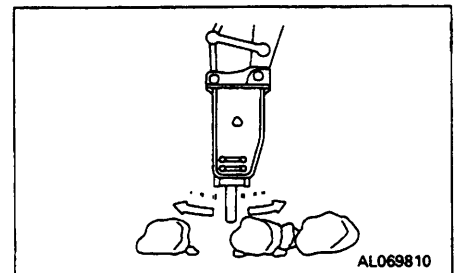

Work with swing force

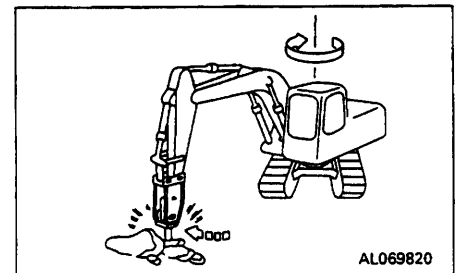

Move the chisel while it is producing impact

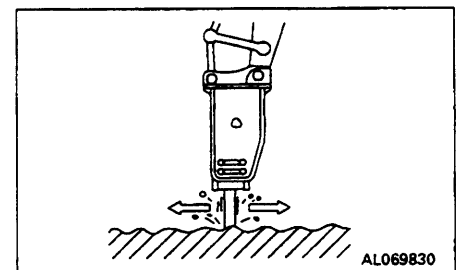

Produce impact horizontally or upward

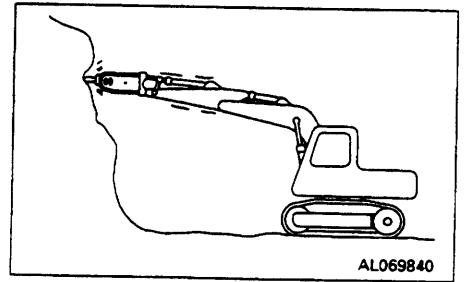

Incline the chisel after it goes through the ground

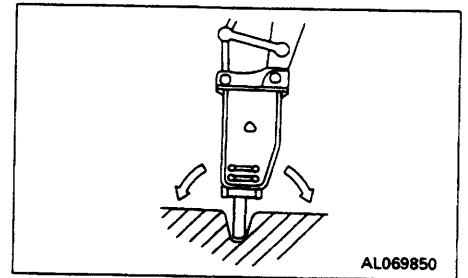

Pick the ground

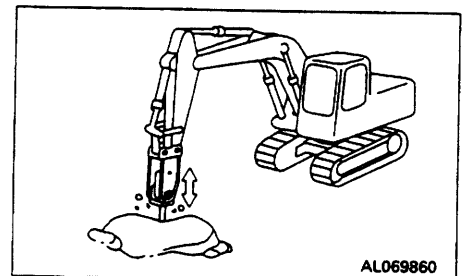

Lift the machine body with the bucket cylinder extracted to the end

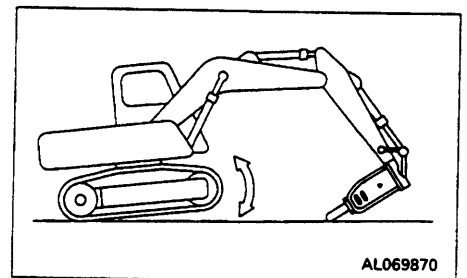

### 31.7 OPERATION OF MACHINE WHICH CAN BE EQUIPPED WITH ATTACHMENTS

#### 31.7.1 EXPLANATION OF EACH DEVICE

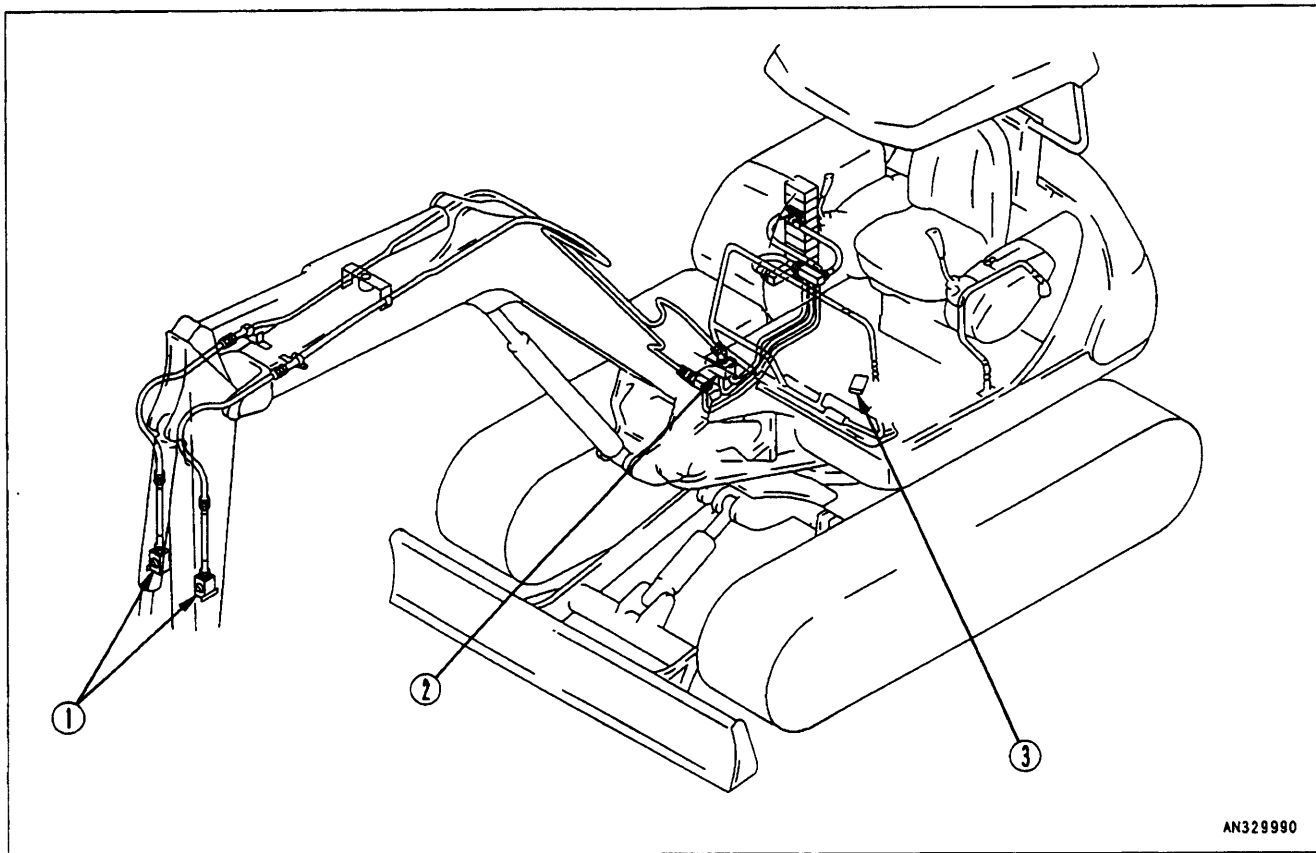

AN329980

#### 1. STOP VALVE

This valve is used to stop the flow of the hydraulic oil. The hexagon part turns by 90°.

- ① FREE: Hydraulic oil flows.
- ② LOCK: Hydraulic oil stops.

When installing or removing an attachment, set this valve to the LOCK position. Turn the hexagon part until it is stopped by the stopper.

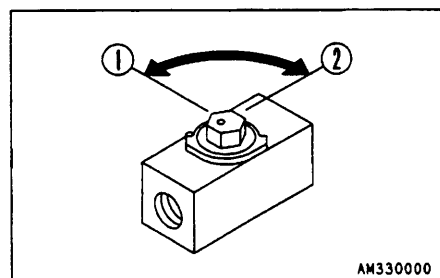

AN330000

#### 2. CHANGEOVER VALVE

This valve is used to switch the flow of the hydraulic oil.

- Position ①: For use of breaker
- Position ②: For use of general attachments (Tilt bucket, etc.)

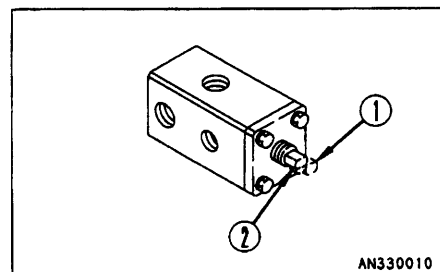

AN330010



**3. CONTROL PEDAL**

This pedal is used to control the attachments.

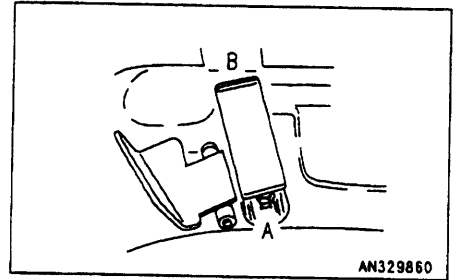

**4. PEDAL LOCK (FOR ATTACHMENT CONTROL PEDAL)**

**⚠ WARNING**

**When attachments are not used, lock them by locking the pedal. If the operator touches the operation pedal unnecessarily while it is not locked, and serious accident may result.**

This device is used to lock the attachment control pedal. If the plate is placed on this pedal, the pedal is locked.

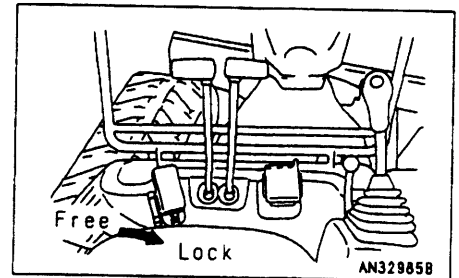

### 31.7.2 HYDRAULIC CIRCUIT

#### Connection of hydraulic circuit

When connecting an attachment, connect its circuit according to the following procedure.

1. Confirm that the stop valve is at the LOCK position, then remove the plug.  
Take care not to miss or damage the removed parts.
2. Connect the piping of the attachment supplied by the attachment manufacturer.

The nominal size of the mounting screw hole of the stop valve is PT 1/2.

Determine the dimensions on the attachment side by arranging with the attachment manufacturer.

3. After connecting the piping, bleed air from the circuit.
  - (1) Referring to "12.2 STARTING ENGINE", start the engine and run it idle at a low speed for 10 minutes, then start the following work.
  - (2) Keep the engine speed at a low level and press the attachment pedal repeatedly (about 10 times) to bleed all air from the attachment circuit.

#### NOTICE

If an air bleeding procedure is given to the attachment by the manufacturer, bleed air according to it.

- (3) After bleeding air, stop the engine and wait for at least five minutes. Then, start the engine. By this operation, the bubbles in the oil in the tank will be discharged.
- (4) Check each part for oil leakage and wipe off any spilt oil.

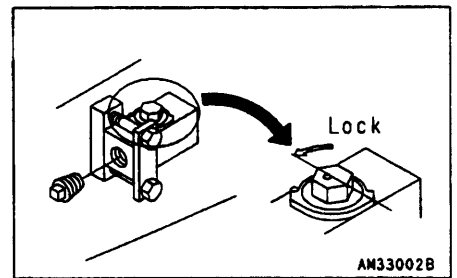

### 31.7.3 OPERATION

Operate the attachments according to the following procedure.

#### When breaker is used

Press the pedal toward (A) (toward this side), and the breaker works.

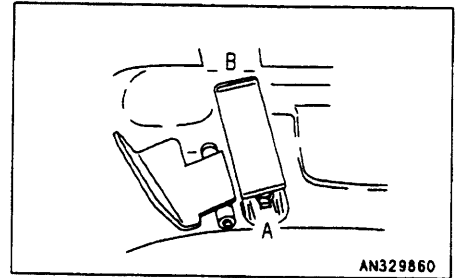

#### Precautions for use

- Confirm that the stop valve is at the FREE position.

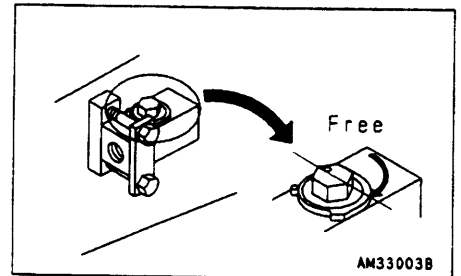

- Confirm that the changeover valve is at the position for the breaker.

For the route of the hydraulic oil, see "31.7.2 HYDRAULIC CIRCUIT".

- For the precautions for use of the breaker, see the operation manual supplied by the breaker manufacturer.

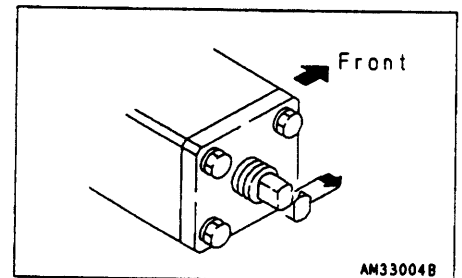

## 31. INTRODUCTION OF ATTACHMENTS

---

**When tilt bucket or another general attachment is used**  
Press the pedal, and the attachment works.

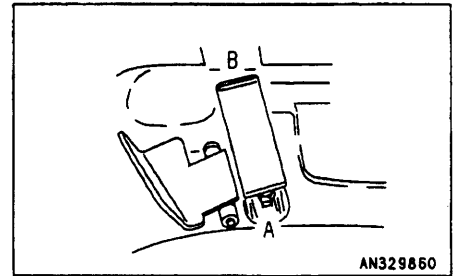

### Precautions for use

- Confirm that the stop valve is at the FREE position.
- Confirm that the changeover valve is at the position for the general attachments such as the tilt bucket.

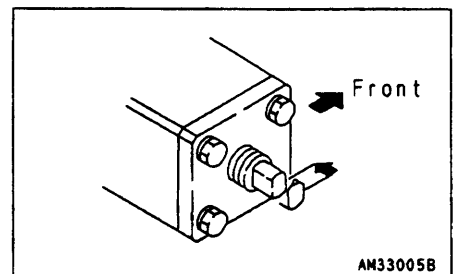
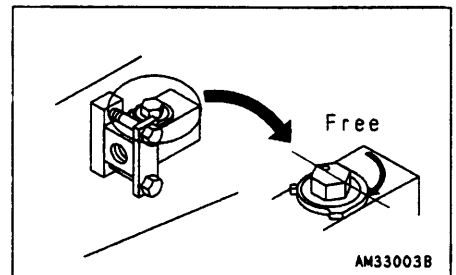

If the pedal is operated while the breaker or another attachment is not installed, the machine may overheat.

### 31.7.4 LONG-TERM STORAGE

When leaving the attachments unused for a long term, set the machine as follows.

- Set the stop valve to the LOCK position.
- Fit a plug to the stop valve.
- Set the changeover valve to the position for the general attachments such as the tilt bucket.
- Set the pedal lock plate to the LOCK position so that the pedal will not be pressed.

If the pedal is operated while the breaker or another attachment is not installed, the machine may overheat.

- Lock the pedal with adjustment bolt ①, then tighten lock nut ②.

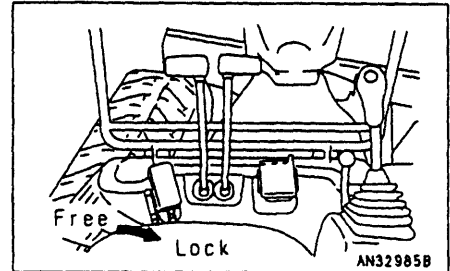

### 31.7.5 SPECIFICATIONS

#### Hydraulic specifications

● Flow rate	50 l / min.
● Relief pressure	24.5 MPa (250 kgf/cm <sup>2</sup> ) (Option: 17.2 MPa (175 kgf/cm <sup>2</sup> ))
● Cracking pressure of safety valve	27.9 MPa (285 kgf/cm <sup>2</sup> )

**PC35R-8,PC45R-8 HYDRAULIC EXCAVATOR**

---

Form No. SEAM015304T