

# Operation & Maintenance Manual

# PC200, 210, 220-3 PC240, 280-3 HYDRAULIC EXCAVATOR

SERIAL NUMBERS	PC200,200LC	- 33763
	PC210,210LC	- K10005
	PC220,220LC	- 23303
	PC240,240LC,240NLC	- 10093 AND UP
	PC240,240LC,240NLC	- K10093
	PC280,282NLC	- 10001
	PC280LC,280NLC	- K10001



## — WARNING —

Unsafe use of this machine may cause serious injury or death. Operators and maintenance personnel must read this manual before operating or maintaining this machine. This manual should be kept inside the cab for reference and periodically reviewed by all personnel who will come into contact with the machine.

# KOMATSU



## FOREWORD

This manual describes procedures for operation, handling, lubrication, maintenance, checking, and adjustment. It will help the operator or anyone realize peak performance through effective, economical and safe machine operation and maintenance.

- Please read this manual carefully BEFORE operating the machine.
- Please continue studying this manual until proper operation is completely reinforced into personal habit.
- This manual describes the basic techniques. Skill is performed as the operator or anyone get the correct knowledge and performance of the machine.
- Operation, inspection, and maintenance should be carefully carried out, and the safety must be given the first priority. Safety precautions are indicated with  marks and technical precautions with ★ marks in this manual. The safety information contained in this manual is intended only to supplement safety codes, insurance requirements, local laws, rules and regulations.
- Some photographs and illustration pictures are different from your machine as technical improvement is continuously reflected on it. Revision to up-to-date manual's content is performed in later editions.
- This operation & maintenance manual may contain attachments and optional equipment that are not available in your area. Please consult your local Komatsu distributor for those items you may require. Materials and specifications are subject to change without notice.

ww -02595

- 1 -

### BREAKING IN YOUR NEW MACHINE

## BREAKING IN YOUR NEW MACHINE

Each machine is carefully adjusted and tested before shipment. However, a new machine requires careful operation during the first 100 hours to break in the various parts.

If a machine is subjected to unreasonably hard use at the initial operation stage, the potential of performance will prematurely deteriorate and the service life will be reduced. A new machine must be operated with care, particularly with regard to the following items.

- After starting, let the engine idle for 5 minutes to allow proper engine warm-up prior to actual operation.
- Avoid operation with heavy loads or at high speeds.
- Sudden starting or acceleration, unnecessarily abrupt braking and sharp turning should be avoided.
- During the initial 100 hours, the work equipment fixing pins are to be greased before each operation. Greasing is to be repeated after operation of the boom, arm and bucket is conducted several times.
- At the first 250 hours of operation, the machine should be maintained in the following manner:
  - 1) Checking and adjustment of engine valve clearance
  - 2) Changing fuel filter cartridge  
See maintenance table in the maintenance section.
- ★ When replacing oil filter elements (cartridges), check their interiors for dirt and dust. If heavily collected, check for possible cause before starting operation.
- ★ Hours of operation are indicated by the service meter.

- 2 -

# CONTENTS

OPERATION	
GENERAL LOCATIONS AND SPECIFICATIONS . . . . .	4
INSTRUMENTS AND CONTROLS . . . . .	6
CHECK BEFORE STARTING . . . . .	39
OPERATING YOUR MACHINE . . . . .	44
INVERSION AND REPLACEMENT OF BUCKET . . . . .	57
HANDLING THE TRAPEZOIDAL BUCKET . . . . .	58
USING THE EXTENSION ARM . . . . .	59
HANDLING THE CLAMSHELL BUCKET . . . . .	59
COLD WEATHER OPERATION . . . . .	60

MAINTENANCE	
PERIODIC MAINTENANCE . . . . .	65
MAINTENANCE TABLE . . . . .	66
OIL FILLER AND LEVEL GAUGE POSITIONS . . . . .	69
EVERY 100 HOURS SERVICE . . . . .	70
INITIAL 250 HOURS SERVICE . . . . .	74
EVERY 250 HOURS SERVICE . . . . .	74
EVERY 500 HOURS SERVICE . . . . .	80
EVERY 1000 HOURS SERVICE . . . . .	83
EVERY 2000 HOURS SERVICE . . . . .	86
EVERY 4000 HOURS SERVICE . . . . .	91
WHEN REQUIRED . . . . .	92
ADJUSTMENT . . . . .	105
TROUBLE SHOOTING GUIDE . . . . .	106
SERVICE METER . . . . .	110
MACHINE AND ENGINE SERIAL NUMBERS . . . . .	111
FUEL, COOLANT AND LUBRICANTS . . . . .	112

P-02963

## GENERAL LOCATIONS AND SPECIFICATIONS

### GENERAL LOCATIONS AND SPECIFICATIONS

- |                    |                  |
|--------------------|------------------|
| 1. Bucket          | 6. Boom cylinder |
| 2. Bucket cylinder | 7. Sprocket      |
| 3. Arm             | 8. Track frame   |
| 4. Arm cylinder    | 9. Idler         |
| 5. Boom            | 10. Track shoe   |

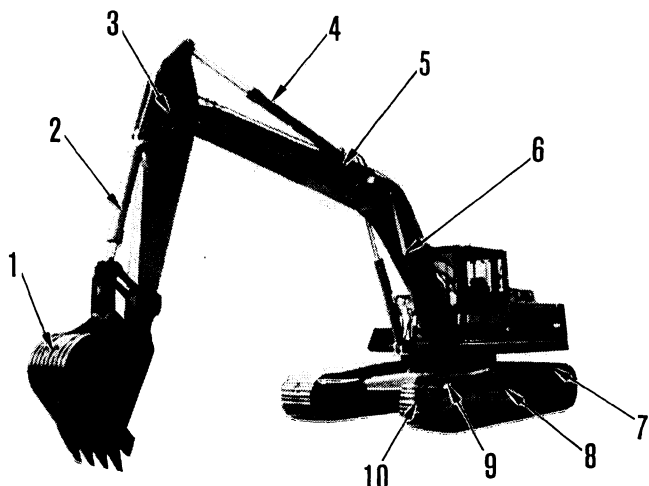

MACHINE MODEL		
PERFORMANCE	Bucket capacity (m <sup>3</sup> )	[SAE]
		[CECE]
	Travel speed (km/h)	
	Swing speed (rpm)	
OPERATING WEIGHT (kg)		
ENGINE	Model	
	Flywheel horsepower (HP) [Rated rpm]	

NOTE: Specifications are subject to change without notice.

PC200	PC200LC	PC210	PC210LC	PC220	PC220LC	PC240	PC240LC	PC240NLC	PC280LC	PC280NLC
0.8	0.8	1.0	1.0	1.0	1.0	1.2	1.2	1.2	1.2	1.2
0.7	0.7	0.9	0.9	0.9	0.9	1.1	1.1	1.1	1.1	1.1
3.8	3.3	3.8	3.3	3.4	3.4	3.4	3.4	3.4	2.5	2.5
13	13	13	13	13	13	13	13	13	13	13
18000	19140	18660	19800	22000	23130	22770	23900	23100	26800	26300
Komatsu S6D105-B-1 Diesel Engine				Komatsu S6D105-1 Diesel Engine					Komatsu S6D110-1 Diesel Engine	
118 [2100]	118 [2100]	123 [2100]	123 [2100]	148 [2100]	148 [2100]	148 [2100]	148 [2100]	148 [2100]	168 [2100]	168 [2100]

P-03872

- 5 -

INSTRUMENTS AND CONTROLS

## INSTRUMENTS AND CONTROLS

### MONITOR PANEL

This monitor system consists of monitor lamp groups (A)(B)(C), meter group (D) and switch group (E).

- To check the monitor system, turn the starting switch to ON before starting the engine. Then all the monitor lamps and the gauges light up and the alarm buzzer sounds for about 3 seconds. After that all lamps go off and the buzzer stops. If any monitor lamp does not light up, ask your Komatsu distributor to inspect that monitor lamp.

- ★ The monitor lamps cannot be checked for breakage until 30 seconds after the engine has been stopped.

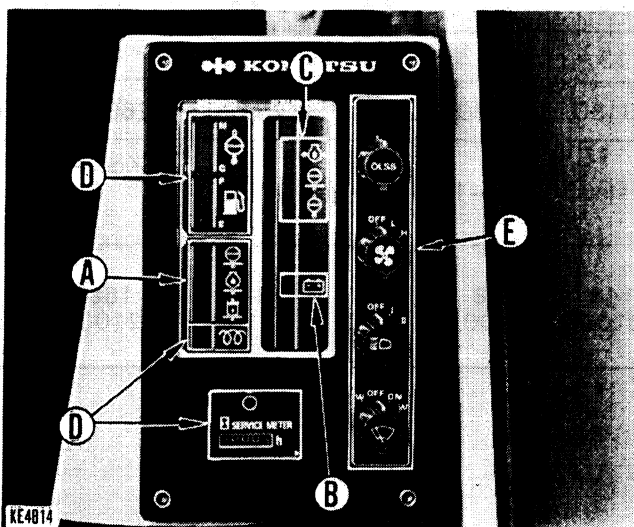

**Ⓐ CHECK MONITOR GROUP**  
(Check items before starting)

If there is any abnormality, the appropriate monitor lamp will flash.

- ★ When the engine is started, these monitor lamps will go off even if there are abnormalities.

**Ⓑ CAUTION MONITOR GROUP**  
(Caution items)

If any abnormality occurs while the engine is running, the appropriate monitor lamp will flash to indicate the abnormality.

- ★ Even if any monitor lamp flashes, the machine can operate, but it should be repaired as soon as possible.

**Ⓒ CAUTION MONITOR GROUP**  
(Emergency stop items)

If any abnormality occurs while the engine is running, the appropriate monitor lamp will flash and the alarm buzzer will sound intermittently at the same time.

- ★ If any monitor lamp flashes, stop the engine or run it at a low idling speed, and repair it immediately.

**Ⓓ METER GROUP**

This group consists of engine water temperature gauge, fuel gauge, engine pre-heating monitor lamp and service meter.

**Ⓔ SWITCH GROUP**

This group consists of lamp switch, cab heater switch, mode selector switch and wiper switch.

P-00022

- 7 -

INSTRUMENTS AND CONTROLS

**A: CHECK MONITOR GROUP**  
(Check items before starting)

- ★ Do not rely on the "CHECK MONITOR GROUP (Check before starting)" only for the check

before starting. Always make the check by referring to the section on CHECK BEFORE STARTING.

**1. RADIATOR COOLANT LEVEL MONITOR**



This monitor indicates a low radiator coolant level.

If the monitor lamp flashes, check the coolant level and add water as required.

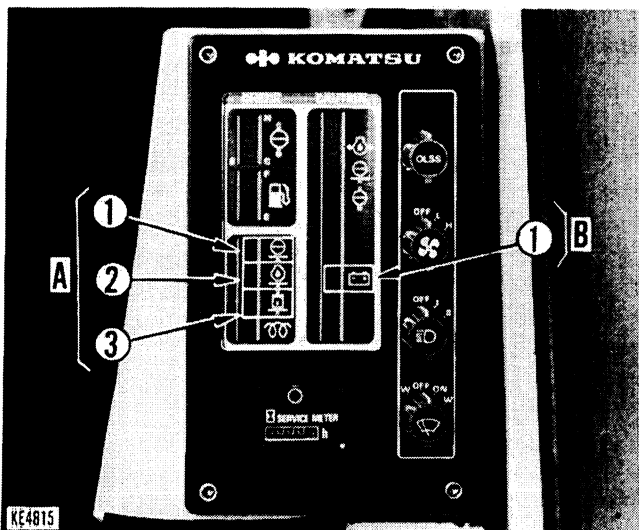

**2. ENGINE OIL LEVEL MONITOR**

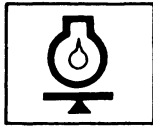

This monitor indicates a low oil level in the engine oil pan.  
If the monitor lamp flashes, check the oil level in the engine oil pan and add oil as required.

**3. HYDRAULIC OIL LEVEL MONITOR**

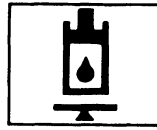

This monitor indicates a low oil level in the hydraulic tank. If the monitor lamp flashes, check the oil level in the hydraulic tank and add oil as required.

**B: CAUTION MONITOR GROUP (Caution items)**

If any abnormality occurs while the engine is running, the appropriate monitor lamp will flash to indicate the abnormality at the same time.

**1. CHARGE MONITOR**

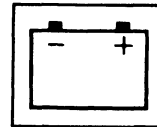

This monitor indicates an abnormality in the charging system while the engine is running.

If the monitor lamp flashes, check the charging circuit.

- ★ Park the machine on level ground and check the monitor lamps.
- ★ Confirm that these monitor lamps light for about 3 seconds after turning the starting switch to **ON**. If any monitor lamp does not light, ask your Komatsu distributor to inspect that monitor lamp.

P-00024

**C: CAUTION MONITOR GROUP (Emergency stop items)**

If any abnormality occurs while the engine is running, the appropriate monitor lamp will flash and the alarm buzzer will sound intermittently at the same time.

**1. ENGINE OIL PRESSURE MONITOR**

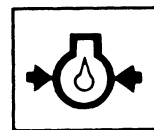

This monitor indicates a low engine oil pressure.

If the alarm buzzer sounds and this lamp flashes, the engine oil pressure is below the lower limit. Immediately stop the engine.

- ★ This monitor lamp lights and the alarm buzzer sounds, when the starting switch is turned to **ON** immediately after the engine is started. It does not indicate an abnormality.

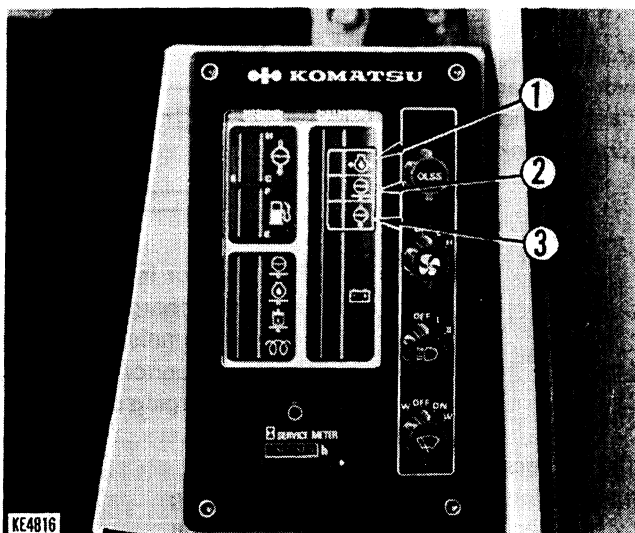

**2. RADIATOR COOLANT LEVEL MONITOR**

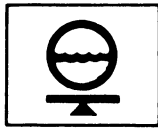

This monitor indicates a low radiator coolant level.

Check the coolant level when the alarm buzzer sounds and this monitor lamp flashes, stop engine and add water as required.

**3. ENGINE COOLING WATER TEMPERATURE MONITOR**

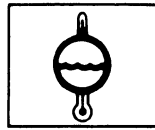

This monitor indicates a rise in the cooling water temperature.

When the alarm buzzer sounds and this monitor lamp flashes, run the engine at the low idling speed until the green range of the engine water temperature gauge lights.

- ★ Park the machine on level ground and check the monitor lamps.
- ★ Confirm that these monitor lamps light for about 3 seconds after the starting switch is turned to **ON**. If any monitor lamp does not light, ask your Komatsu distributor to inspect that monitor lamp.

P-00026

INSTRUMENTS AND CONTROLS

**D: METER GROUP**

**1. ENGINE COOLING WATER TEMPERATURE GAUGE**

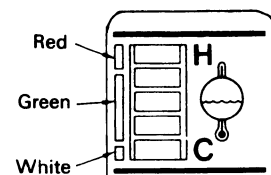

This gauge indicates the temperature of the cooling water. If the temperature is normal during operation, the green range will light. If the red range lights during operation, the alarm buzzer will sound and the engine water temperature monitor lamp will flash at the same time. If this occurs, stop the machine and run the engine at a low idling speed until the green range lights.

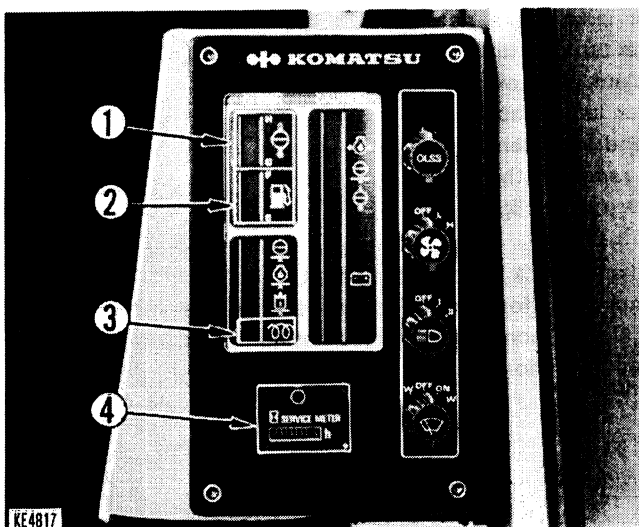



**2. FUEL GAUGE**

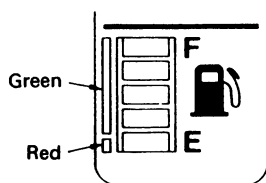

This gauge indicates the amount of fuel in the fuel tank. If there is enough fuel in the tank while the engine is running, the green range lights. If the red range lights, there is less than 40 liters of fuel in the tank.

When the red range lights, add fuel.

**3. ENGINE PRE-HEATING MONITOR LAMP**

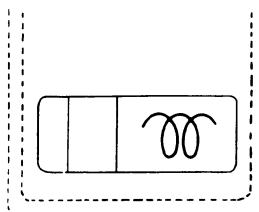

This monitor lamp indicates the pre-heating time required when starting the engine at an ambient temperature below 5°C.

The monitor lamp lights when the starting switch is turned to HEAT position and flashes after about 36 seconds to show that the pre-heating is completed. (The monitor lamp will go off after about 16 seconds.)

**4. SERVICE METER**

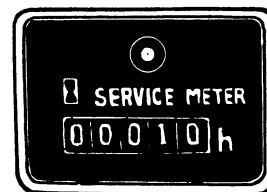

This meter shows the total operation hours of the machine. The service meter advances while the engine is running - even if the machine is not traveling.

Refer to the section "SERVICE METER".

★ While engine is running, green pilot lamp on the service meter flashes to show the service meter advances.

- ★ Confirm that gauges (1), (2) and monitor lamp (3) will light, when the starting switch is turned to **ON** before the engine is started. If any gauge or monitor lamp does not light, ask your Komatsu distributor to inspect that monitor lamp or gauge.

P-01984

INSTRUMENTS AND CONTROLS

**E: SWITCHES**

**1. MODE SELECTOR SWITCH**

(There are two types:  
2-stage and 3-stage)

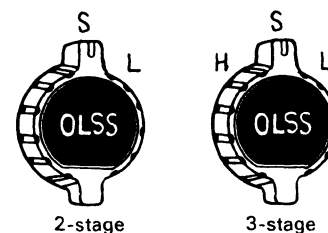

This switch is used to change the mode.

- H: (available only for 3-stage)  
For heavy duty work or traveling at high speed.
- S: For general work
- L: For light duty work.

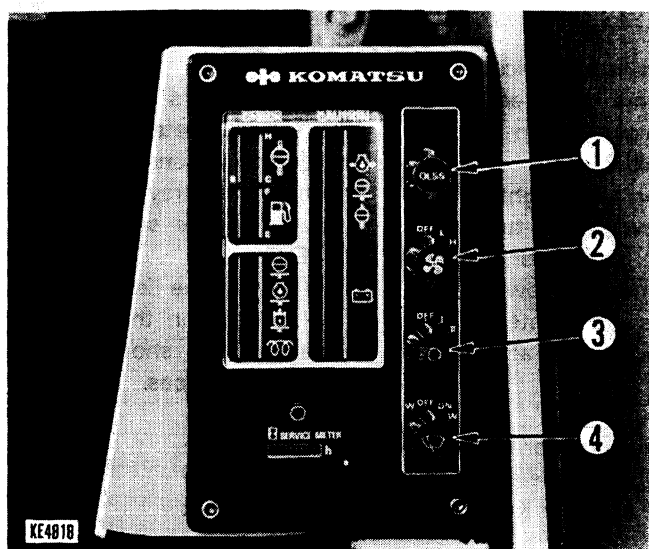

**2. CAB HEATER SWITCH**

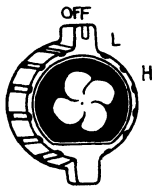

This switch is used to heat the operator's compartment. The flow rate of the hot air can be set to two levels.

L: Low

H: High

★ The cab is heated by means of warm water from the engine. Accordingly, heating can not take place while the engine cooling water is warming up.

**3. LAMP SWITCH**

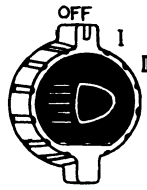

With lamp switch in position I, panel lamps will light.

With lamp switch in position II, head lamp and working lamp will also light.

**4. WIPER SWITCH**

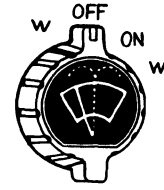

This switch is used to turn on the front windshield wiper.

ON: For operation

W: For splashing detergent over windshield glass (if equipped)

P-00030

INSTRUMENTS AND CONTROLS

**OPERATING MODE SELECTOR SWITCH**

The mode selector switch is used to change the mode to match the conditions and purpose of the work, and thereby achieve higher efficiency. Use the mode selector switch effectively according the following table.

**HOW TO READ THE TABLE AND STANDARD FOR SELECTION**

The most appropriate modes for various combinations of work and soil are shown below. Select the mode according to the jobsite and type of work.

● **Standards of use (2-stage type)**

I: For normal work

II: When speed is not necessary but the fuel should be saved.

**MODE SELECTOR SWITCH (OLSS)**



★ The letters S and L in the table refer to the positions of the switch in the above figure.

Description of work Standard of use	Digging		Loading		Leveling		Backfilling and leveling		Rock crushing	Carrying
	I	II	I	II	I	II	I	II		
Type of soil									S	S
Soft clay	S	L	S	L	L	L	S	L		
Crumbled sandy soil	S	L	S	L	L	L	S	L		
Compact sandy soil	S	L	S	L	L	L	-	-		
Gravel and ore	S	L	S	L	S	L	-	-		
Compact soil containing gravel	S	L	S	L	S	L	-	-		
Soft rock	S	S	S	S	S	S	-	-		

**MODE SELECTOR SWITCH (OLSS)**

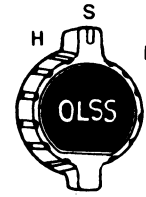

● **Standards of use (3-stage type)**

- I: For heavy duty work at high speed
- II: For normal work
- III: When speed is not necessary but the fuel should be saved.

- ★ The letters H, S and L in the table refer to the positions of the switch in the above figure.
- ★ Hp refers to use in H mode at partial throttle (80% of engine output).

Description of work Standard of use	Digging			Loading			Leveling			Backfilling and leveling			Rock crushing	Carrying
	I	II	III	I	II	III	I	II	III	I	II	III		
Type of soil														
Soft clay	H	S	L	H	S	L	L	L	L	H	S	L	H or Hp	<ul style="list-style-type: none"> <li>● Flat ground: S</li> <li>● Slopes and long distance travel: H</li> </ul>
Crumbled sandy soil	H	S	L	H	S	L	L	L	L	H	S	L		
Compact sandy soil	H	S	L	H	S	L	S	L	L	S	—	—		
Gravel and ore	H	Hp	L	H	Hp	L	S	S	L	S	—	—		
Compact soil containing gravel	H	Hp	L	H	Hp	L	H	Hp	L	L	—	—		
Soft rock	H	Hp	Hp	H	Hp	Hp	H	Hp	Hp	L	—	—		

P-01616

INSTRUMENTS AND CONTROLS

**CONTROL BOX**

(available only for machine with 3-stage mode selector)

The control box has a self-diagnostic function. Through the monitor window installed to the cover of the box, red and green LEDs (Light Emitting Diodes) which indicate abnormalities can be seen.

When there is no abnormality, red LED goes off and green LED lights.

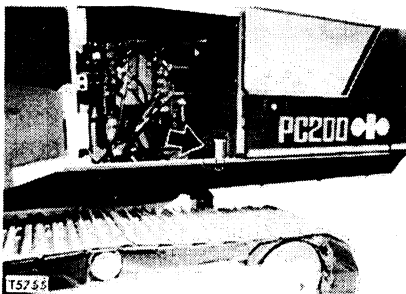

● **When normal**

Indication of LED		Condition of machine
Red	Green	
Goes off	Lights	Machine is normal in the mode "S"
Goes off	Flashes fast	Machine is normal in the mode "H" or "L".
Goes off	Flashes slowly	Machine is normal and auto-decelerator is applied.

- ★ For details of the LED display when an abnormality occurs, see TROUBLE SHOOTING GUIDE.

**SWITCHES AND LAMP**

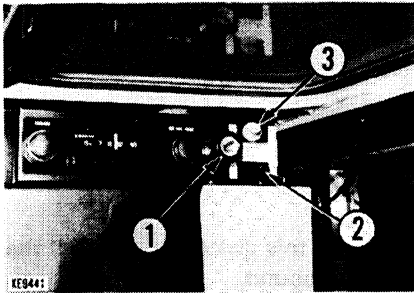

**1. CIGARETTE LIGHTER**



This is used to light cigarettes. To use, push the lighter in. After a few seconds it will spring back.

At that time, remove the lighter and light your cigarette.

P-01986

**2. AUTO-DECELERATOR SWITCH**

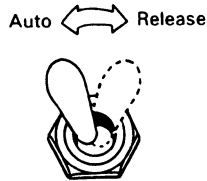

**Auto:**

Even if the fuel control lever is set in high idling position, the auto-deceleration device will reduce the engine speed to medium when the other control levers are put into neutral.

**Release:**

Use this position when you do not want the engine speed to slow down automatically.

**3. SWING BRAKE RELEASING SWITCH**

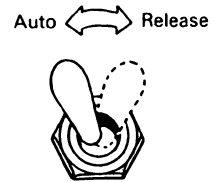

When the swing mechanical brake is left applied, this switch is used to cancel the swing mechanical brake function.

Auto: Actuated  
Release: Canceled

INSTRUMENTS AND CONTROLS

**4. HORN SWITCH**

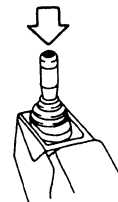

When this switch is pressed, the horn will sound.

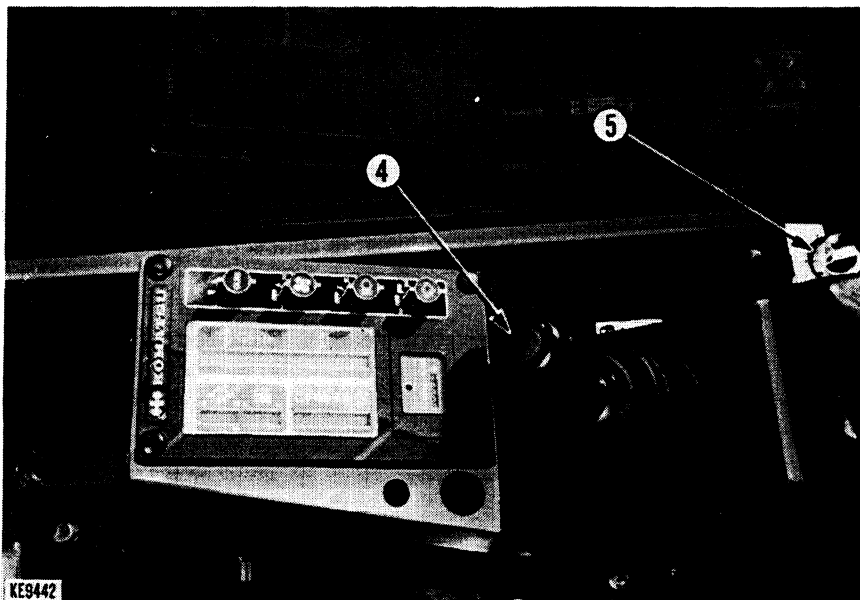

**5. STARTING SWITCH**

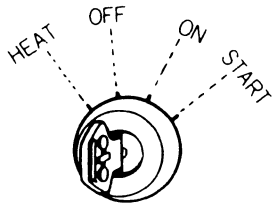

**OFF**

Key insertion-withdrawal position. None of electrical circuits activate.

**ON**

Charging and lamp circuits activate. Keep key at ON after starting.

**START**

At this key position, the starting motor will crank the engine. Release key immediately after starting.

**HEAT**

Use this position when starting in cold weather.

Release the key to allow it to return automatically to OFF and then, without delay, turn it to START.

★ When starting, be sure to use the starting key.

**6. ROOM LAMP SWITCH**

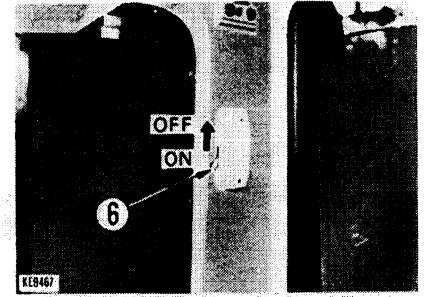

When this switch is moved to ON position, room lamp will light.

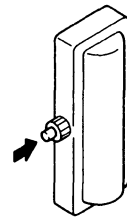

Press to switch on.  
Press to switch off.

P-02922

**7. EMERGENCY STOP SWITCH**

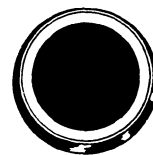

This switch is used to stop the engine when an abnormality occurs.

★ Use this switch only in an emergency.

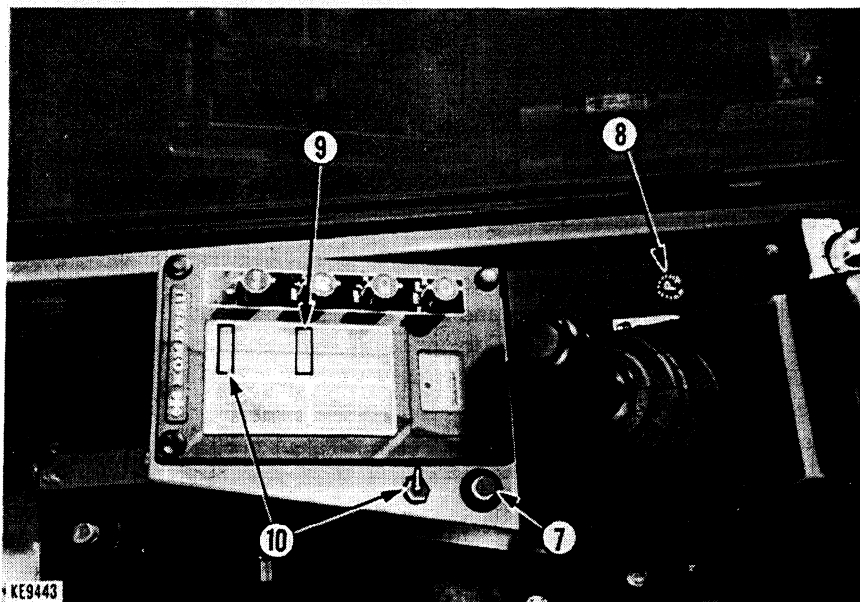

**8. SWING BRAKE PILOT LAMP**



The pilot lamp will light when the swing mechanical brake is applied.

- ★ The swing mechanical brake will start working about 5 seconds with swing brake releasing switch put in AUTO position after the swing control lever is shifted to neutral position.

**9. OVERLOAD WARNING MINITOR**

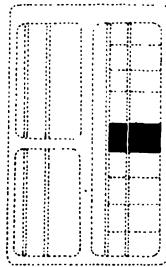

This lamp comes on when there is danger of a machine falling over because of a slung load.

If the lamp lights, immediately lower the load to the ground or bring the arm in towards the machine. At this time, make sure that the lamp goes out.

- ★ See PRECAUTIONS FOR HANDLING THE OVERLOAD WARNING DEVICE.

**10. PPC LOW PRESSURE LAMP AND SWITCH**

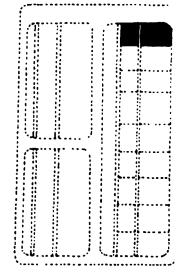

If the oil pressure goes down and the PPC valve can not operate, the lamp on the monitor will flash and the buzzer will sound. In this case, stop the engine and check the pump.

- ★ The buzzer will stop sounding if the switch is turned OFF.

PPC: Proportional Pressure Control

P-01990

INSTRUMENTS AND CONTROLS

**LEVERS**

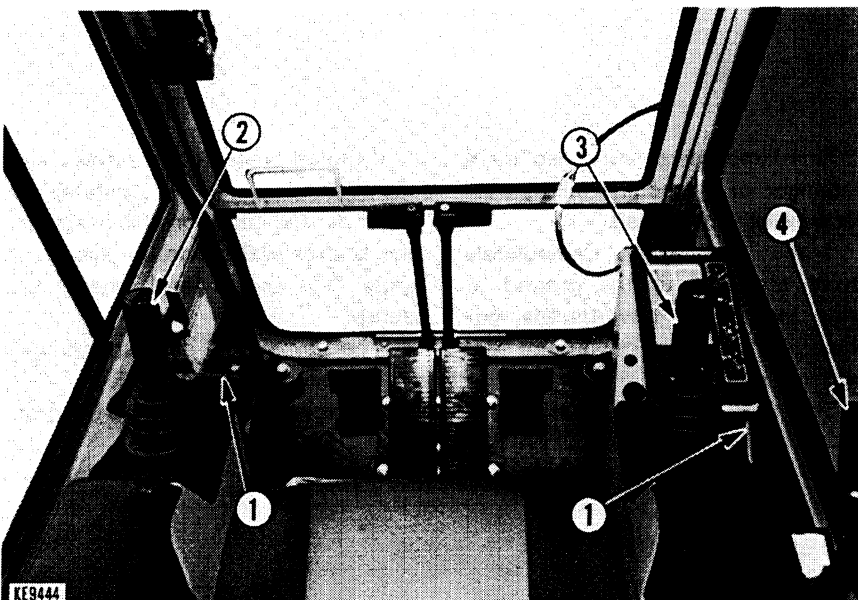

**1. SAFETY LEVERS**  
(for working equipment levers)

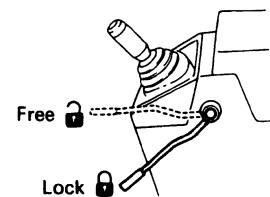

The safety levers are used to lock the working equipment levers.

- ⚠ When stopping the machine or leaving the machine, be sure to lower the bucket to the ground, then operate the levers to lock the left and right working equipment levers.

**2. LEFT WORK EQUIPMENT LEVER**  
(arm/swing control lever)  
(with auto-deceleration device)

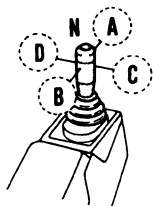

Ⓝ Neutral:  
When the lever in this position, the upper works and the arm will be retained in the position in which they stop.

**Arm operation**

- Ⓐ Arm moves out.
- Ⓑ Arm moves in.

**Swing operation**

- Ⓒ Upper works swings to the right.
- Ⓓ Upper works swings to the left.

**3. RIGHT WORK EQUIPMENT LEVER**  
(boom/bucket control lever)  
(with auto-deceleration device)

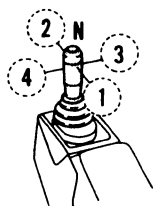

Ⓝ Neutral:  
When the lever in this position, the boom and the bucket will be retained in the position in which they stop.

**Boom operation**

- ① Boom raises.
- ② Boom lowers.

**Bucket operation**

- ③ Bucket dumps.
- ④ Bucket curls.

**4. FUEL CONTROL LEVER**  
(with auto-deceleration device)

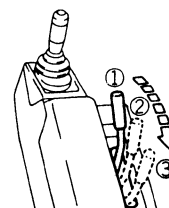

This lever is used to control the engine speed and output.

- ① Engine stop position:  
Push the lever fully.
- ② Low idling position:  
Pull the lever from engine stop position ① until you feel the operating force falls off.
- ③ High idling position:  
Pull the lever fully from low idling position ②.

P-03873

**5. TRAVELING AND STEERING LEVERS**  
(with auto-deceleration device)

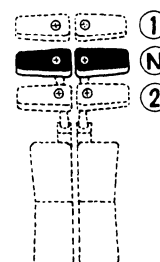

The traveling and steering levers are used to operate the left and right travel motors.

- ① Forward:  
Push the levers forward.
- ② Reverse:  
Pull the levers backward.
- Ⓝ Neutral:  
Parking brake is applied and the machine stops.

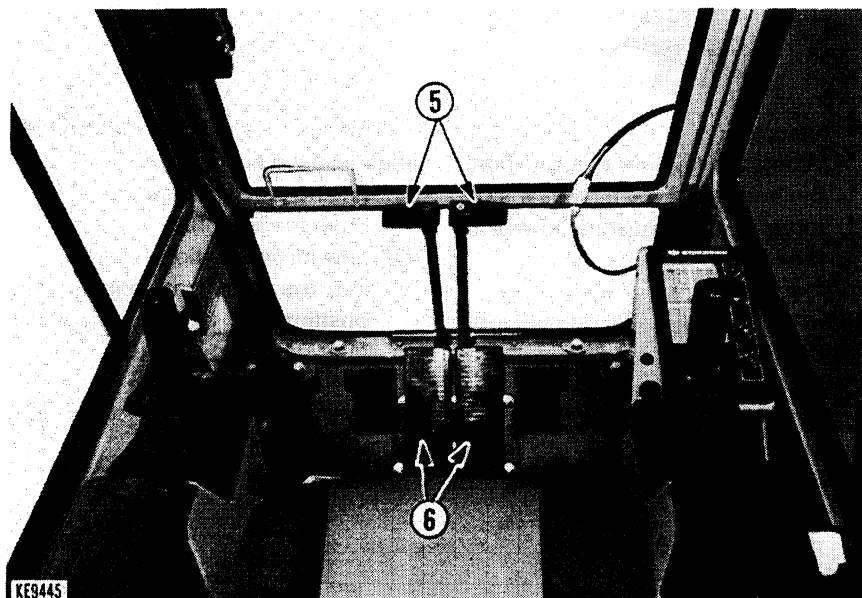

KE9445

## 6. TRAVELING AND STEERING PEDALS (with auto-deceleration device)

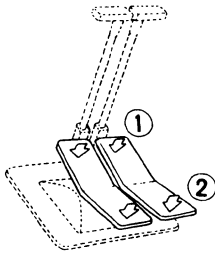

These pedals are used to operate the left and right travel motors as traveling and steering levers.

- ① Forward:  
Depress the front part of pedals.
- ② Reverse:  
Depress the rear part of pedals.

**⚠ Do not place your foot on pedals unnecessary.**

**⚠ If the track frame is facing backwards, operate the traveling and steering levers or pedals in the reverse manner to that when the track frame is facing forward.**

**⚠ Before operating the traveling and steering levers or pedals, check whether the track frame is facing forward or backwards. Assuming the machine is in a position to advance by means of being the sprocket at the rear.**

When operating the machine with only the traveling and steering pedals, that is, without using the traveling and steering levers, pull out the traveling and steering levers and keep them in the operator's compartment.

P-03875

- 27 -

## INSTRUMENTS AND CONTROLS

- ★ For machine with auto-deceleration device, the engine revolution changes as follows according to the positions of levers 2, 3, 5 and traveling and steering pedals 6 because of the function of the auto-deceleration device:  
When the traveling and steering levers, pedals and working equipment levers are all at the neutral position, the engine revolution speed does not rise beyond the medium speed range.  
If either of the levers or pedals is operated, the engine speed rises to the level set by the fuel control lever.

**⚠ Careful lever and pedal operation is necessary in the deceleration range because the engine speed rises quickly.**



## 7. SWING LOCK LEVER

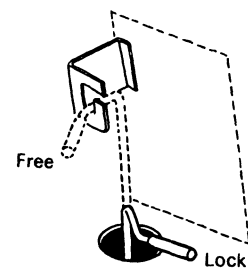

When this lever is placed to the lock position, the upper works is locked.

- ★ Swing lock lever must be in lock position during traveling of machine.
- ★ This lever must be in the lock position after the upper works is parallel with the track frame.

**⚠ Do not attempt to rotate the upper works, when the swing lock lever is in the lock position.**

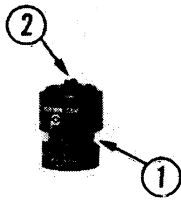

**DUST INDICATOR**

T8774

This device indicates clogging of the air cleaner element. When red piston (1) appears in the transparent part of this indicator, the element is clogged. Immediately clean element.

After cleaning, push indicator button (2) to return red piston to original position.

Dust indicator is on air cleaner bracket in engine hood.

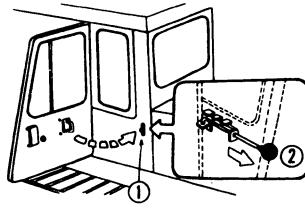
**DOOR LOCK**

Use the door lock to fix the door in position after opening it.

The door will become fixed in place when it is pressed against magnetic catch (1).

To release the door, pull knob (2) on the left side of the operator's seat so as to remove the lock.

★ When fixing the door, fix it firmly to the magnetic catch.

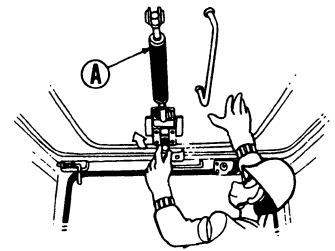
**CEILING WINDOW**

Ceiling window is opened by releasing the lock in the direction of the arrow and pushing the handle.

★ When opening or closing the ceiling window, grasp the handle. Do not push in grasping stay-dumper (A).

P-02965

- 29 -

## INSTRUMENTS AND CONTROLS

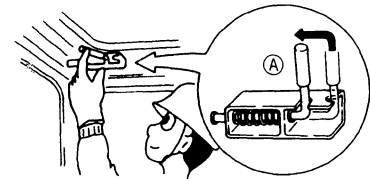
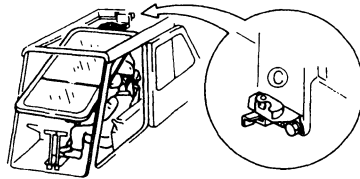
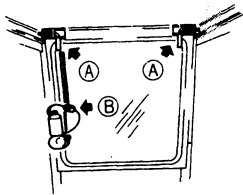
**FRONT WINDSHIELD**

It is possible to pull up the front windshield flush with the ceiling of the cab.

★ Before opening or closing the windshield, be sure to lower the working equipment with the machine on level ground, stop the engine and lock the left and right working equipment levers.

**OPENING SEQUENCE**

1. When lock pins (A) at the left and right of the top of the front windshield are pulled to the inside, the lock will be removed.
2. Disconnect the wiring of the wiper motor at socket (B).
3. Grip the lower handle with the left hand and the upper handle with the right hand from the inside of the operator's cab, then pull up the windshield and push it firmly against catch (C).

4. Then, after checking that the windshield is properly locked, be sure to retain it with left and right lock pins (A).

**OPERATOR'S SEAT**

The seat adjustment should be checked at the beginning of each shift and when operators change.

**Forward-backward adjustment**

Move lever (1) to the right, move the seat to the best position and release the lever. The seat can be moved forward or backward over 160 mm in eight stages.

- To release the lock from catch (C), move release lever (D) in the direction of the arrow. (When releasing the lock, grasp the handle at the lower part of the front windshield with the left hand and the upper part of the windshield with the right hand, then carefully lower the front windshield.)

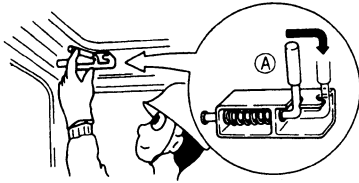
**CLOSING SEQUENCE**

- Free left and right lock pins (A).

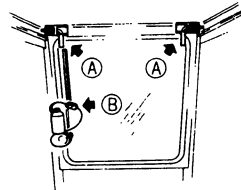
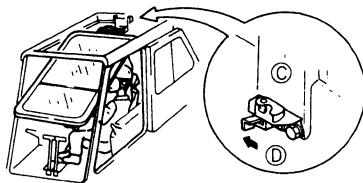

- Be sure to retain the windshield with left and right lock pins (A).
- Connect the wiring of the wiper motor at socket (B).

P-03146

- 31 -

## INSTRUMENTS AND CONTROLS

**Height adjustment**

Turn knob (2) clockwise to lower seat.

Turn counterclockwise to raise.

The adjustable amount is 190 mm.

**Backrest adjustment**

Pull lever (3) in the direction of arrow, move the back-rest to the desired position and release the lever.

A limiter is provided to enlarge the reclining angle at the seat forwards position. Return the back-rest to its original position when moving the seat backward.

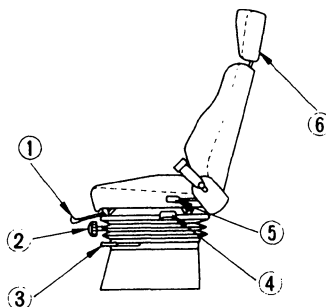
**OPERATOR'S SEAT  
SUSPENSION TYPE****1. Front height adjustment**

Pull lever (1) upwards to adjust seat height. Front of seat cushion moves up or down (tilts) to any of 5 different positions. (May be used in conjunction with lever (4)).

**2. Weight adjustment**

Adjust seat suspension for operator body weight. Turn handwheel (2) until figure corresponding to weight in kg appears between indicators. Turn clockwise to increase weight (viewed from front) i.e. "+" direction.

Adjustment range is 40 – 130 kg.

**3. Forward – backward adjustment**

Pivot lever (3) upward, move seat to best position and release lever. The seat can be moved forward or backward within a range of 150 mm.

**4. Rear height adjustment**

Pull lever (4) upwards to adjust rear of seat height. Rear of seat cushion moves up or down (tilt) to any of 5 different positions. (May be used in conjunction with lever (1)).

- 32 -

P-03147

**5. Backrest adjustment**

Pull lever (5) upward to adjust the angle of the backrest (squab) forwards or backwards. Squab is spring loaded to move forward on moving lever. Release lever to lock squab in the desired position. Squab may be adjusted to any of 19 different positions.

**6. Headrest adjustment**

Pivot headrest (6) forwards or backwards to best position. The angle is adjustable within a range of 33 degrees. Pull upwards to increase height of headrest to desired position. Vertical adjustment, 125 mm.

**OPERATOR'S SEAT  
BUCKET TYPE**

The seat adjustment should be checked at the beginning of each shift and when operators change.

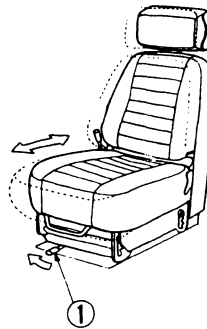

**Forward-backward adjustment**

Move lever (1) to the right, move the seat to the best position and release the lever. The seat can be moved forward or backward within a range of 150 mm.

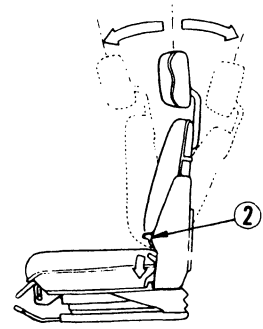

**Backrest adjustment**

Lower lever (2), and tilt the seat backward or pull it forward.

P-03148

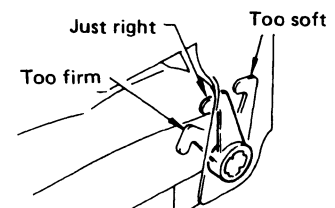
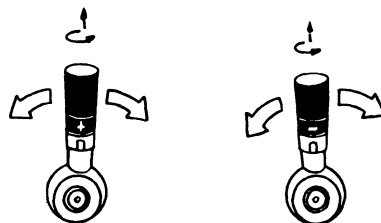
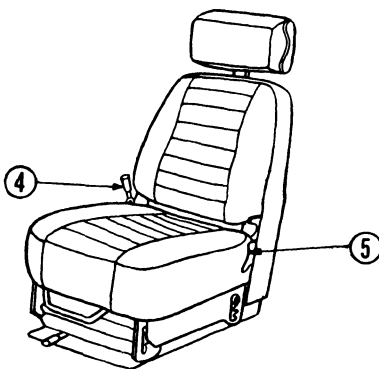

**Seat cushion adjustment**

The ride of the seat can be adjusted according to the weight of the operator (50 to 120 kg).

- 1) For a firmer ride:  
Turn the knob of adjustment handle (4) to the plug (+) side, and move the handle.
- 2) For a softer ride:  
Turn the knob of adjustment handle (4) to the minus (-) side, and move the handle.

When sitting on the seat, the ride of the seat is adjusted properly if indicator panel (5) is vertical. If it tilts forward, the ride is too firm; if it tilts backward, it is too soft.

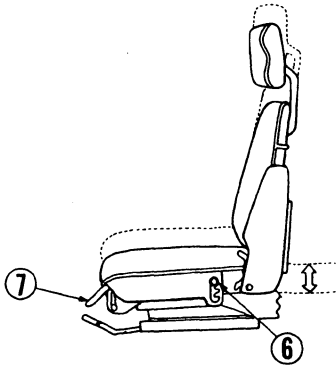

### Seat height and angle adjustment

Both the height and angle of the seat can be adjusted.

1. Adjusting the height of the seat  
Remove lock bolt (6), set the rear of the seat to the desired height, then tighten the bolt. Move lever (7) upward, and set the seat to the desired height. The seat can be set within 60 mm.

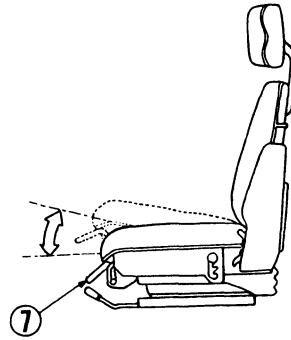

2. Adjusting the angle of the seat  
Move lever (7) upward and set the seat to the desired angle. It can be set to four steps within 60 mm.

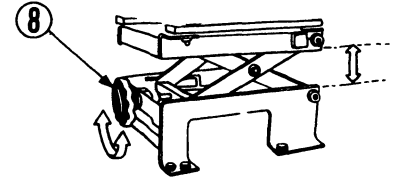

### Seat height adjustment

Turn knob (8) clockwise to lower the seat, and vice versa.

The seat can be adjusted within a range of 190 mm.

P-00050

- 35 -

## INSTRUMENTS AND CONTROLS

### SEAT BELT

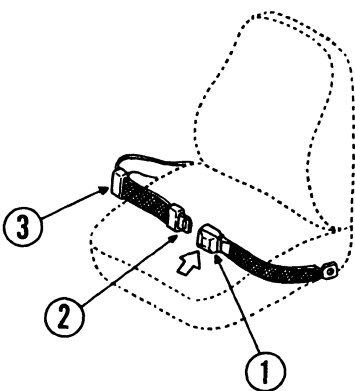

**⚠ Before fastening the seat belt, inspect the securing brackets and belt for abnormal conditions.**

Fasten the belt and remove it in the following manner.

1. Adjust the seat with the operator's back against the backrest.
2. Sit in the seat. Hold buckle (1) and insert (2) into buckle (1). Adjust the length with (3).
3. When removing the belt, push the portion indicated by an arrow.

★ If the seat belt is scratched or frayed or if any of the fittings are broken or deformed from long service, replace the seat belt immediately.

**FUSE BOX**

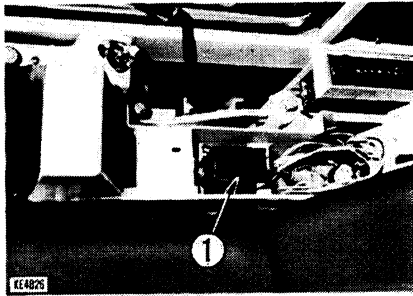

Remove cover (1).

★ Replace a fuse with another of the same capacity.

**⚠ Before replacing a fuse, be sure to turn off the starting switch.**

**Fuse arrangement and circuit**

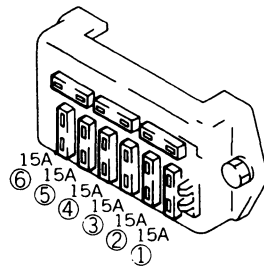

★ Spare fuses (two of 15A, one of 20A) are kept in the spare fuse box.

No.	Fuse capacity	Circuit	Remark
①	15 A	Monitor lamp, Head lamp Working lamp	—
②	15 A	Wiper, Horn, Room lamp	—
③	15 A	Swing brake pilot lamp	—
④	15 A	Monitor Engine sensor	—
⑤	15 A	Radio, Cigarette lighter	—
⑥	15 A	Cab heater	—

PP-01996

INSTRUMENTS AND CONTROLS

**PRECAUTIONS FOR HANDLING THE OVERLOAD WARNING DEVICE**

★ Excavators are provided with this device to prevent them from tipping over while lifting loads.

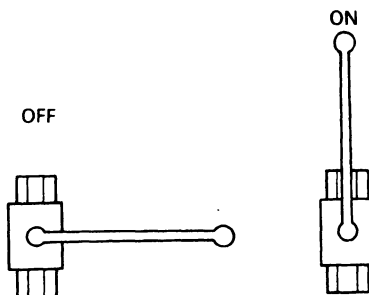
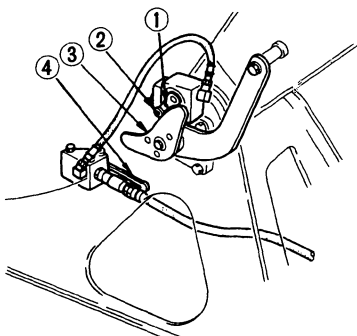

**1. When lifting loads**

- 1) Remove bolt (1) fastening the lever of the pressure switch and put roller (2) of the lever against cam (3).
- 2) Shift valve lever (4) to ON so that the hydraulic pressure of the bottom sides of the boom cylinders can be directed to the pressure switch.

**2. When not lifting loads**

When the machine is performing any kind of operation other than lifting loads, shift valve lever (4) to OFF and fasten the pressure switch lever with the bolt to prolong the life at the pressure switch.

- ★ Remove valve lever (4) and the bolt, and keep them in a safe place when they are not in use.
- ★ When an adjustment is required, contact your Komatsu distributor and have him make the adjustment.

## CHECK BEFORE STARTING

Pre-operation checks forestall machine trouble. Never neglect them.

### a. WALK-AROUND CHECK

Look around the machine and under the machine to check for loose nut or bolts, collection of dirt, or leakage of oil, fuel, or coolant, and check the condition of the work equipment and hydraulic system. Check also for loose wiring, play, and collection of dust at places which reach high temperatures.

1. Check for oil leak at high pressure hose, high pressure hose joints and hydraulic cylinder seal.
2. Check tightness of idler mounting bolt.
3. Check tightness of battery terminal.
4. Check radiator for water leak.

5. Check around the engine for water and oil leaks.
6. Check final drive case for oil leaks and check tightness of sprocket mounting bolt.
7. Check tightness of air cleaner mounting bolt.

### b. CHECK AND REFILL COOLANT

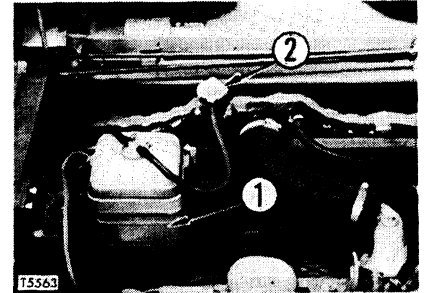

(For PC280 only)

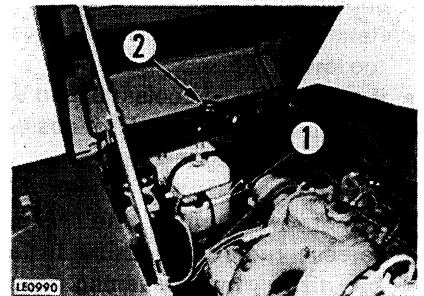

P-04094

— 39 —

## CHECK BEFORE STARTING

### c. CHECK OIL LEVEL IN ENGINE OIL PAN

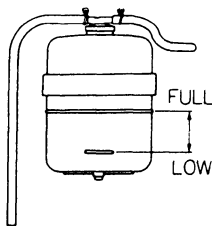

1. Open the engine hood and check if the cooling water level in sub-tank (1) is within the range shown above.
  2. Refill through filler (2) if level is too low.
- ★ If the volume of coolant added is more than usual, check for possible water leakage.

**⚠** When removing the cap, release radiator pressure little by little by loosening cap slowly, then remove cap.

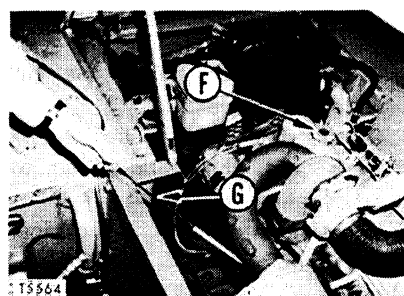

1. Use the dipstick (G) to check the oil level.
  2. The oil level should be between mark L and H, if necessary, add oil at the oil filler (F).
- ★ The type of lubricant used depends on the ambient temperature. Select according to the table "FUEL, COOLANT AND LUBRICANTS".
- ★ Stop the engine when checking the oil level.

(For PC280 only)

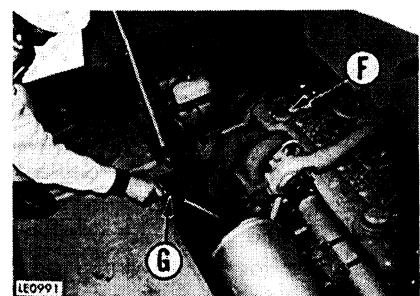

- ★ When checking the oil level, park the machine on a level surface, stop the engine and wait for 15 minutes before checking.

— 40 —

P-04095

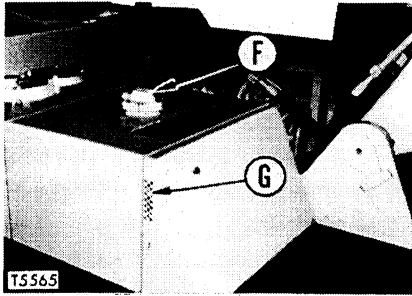
**d. CHECK FUEL LEVEL**

1. Check the fuel level using sight gauge (G) on the side face of the tank.
2. Upon completion of work, pour in additional fuel from filler (F) until the fuel tank is full.

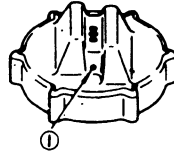

- ★ If breather hole (1) in the cap is blocked up, fuel flow to the engine may stop. Accordingly, clean it from time to time.
- ★ Fuel capacity: 280ℓ
- ★ When adding fuel, never let the fuel overflow. This may cause a fire.

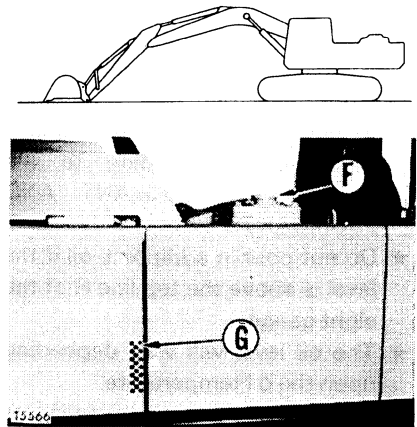
**e. CHECK OIL LEVEL IN HYDRAULIC TANK**

1. Run the engine at low speed, retract the arm and bucket cylinder to the stroke end, lower the boom until the tip of the arm touches the ground and then stop the engine.
2. Move each control lever (for working equipment and travel) to its full travel to release the internal pressure.

P-04096

- 41 -

## CHECK BEFORE STARTING

3. If the level of hydraulic oil is not between top H and bottom L lines of sight gauge (G), pour in additional engine oil from filler (F).
- ★ The type of lubricant used depends on the ambient temperature. Select according to the table "FUEL, COOLANT AND LUBRICANTS".
  - ★ Do not pour in additional oil if the level is above the top line H of the sight gauge.
  - ★ The oil level will vary depending upon the oil temperature. Accordingly, use the following as a guide:
    - i) When the oil temperature is close to the ambient temperature (10 to 30°C), the level will be close to bottom line L on the sight gauge.
    - ii) When the oil temperature is the normal operating temperature (50 to 80°C), the level will be close to top line H on the sight gauge.

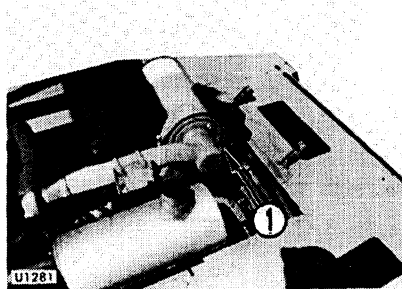
**f. CHECK DUST INDICATOR**

(For PC280 only)

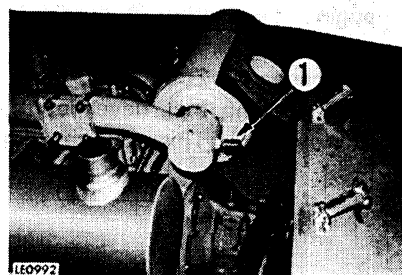

When the air cleaner element is clogged, the red piston of dust indicator (1) reaches the service level and gets locked.

In that case, clean the element, referring to the section "WHEN REQUIRED".

After cleaning the element, push the button to return the red piston.

**g. CHECK FOR SEDIMENT AND WATER IN THE WATER SEPARATOR**

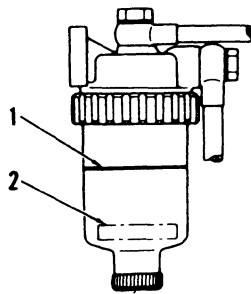

The water separator separates water mixed in the fuel. If float (2) is at or above red line (1), drain the water. For the draining procedure, see section "WHEN REQUIRED".

★ Even if a water separator is installed, be sure to check the fuel tank to remove water and sediment in the fuel.

**h. LUBRICATE CLAMSHELL BUCKET**

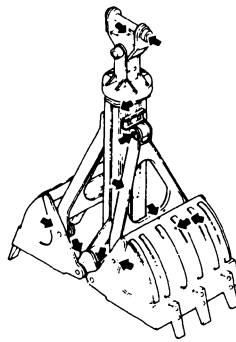

Apply grease to the grease fitting shown by the arrows. (12 points)

**i. CHECK ELECTRICAL WIRING**

Check for any sign of disconnection or short circuit in the electric wiring. Check also for loose terminals and tighten any loose parts.

Check the following points carefully.

- Battery
- Starting motor
- Alternator

OPERATING YOUR MACHINE

**OPERATING YOUR MACHINE**

**BEFORE STARTING THE ENGINE**

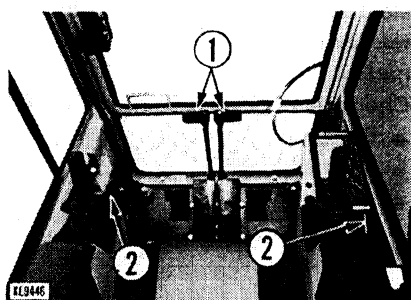

1. Carry out an initial inspection. (For details of the inspection, see CHECK BEFORE STARTING.)

2. Put the traveling and steering control levers (1) in the N (neutral) position.

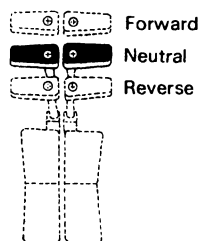

3. Put the left and right working equipment levers in neutral and check that safety levers (2) are locked.

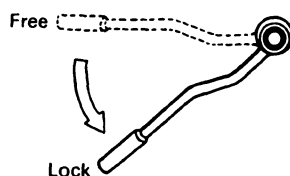

**TO START THE ENGINE**

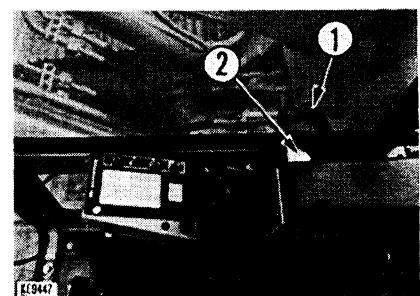

1. Pull fuel control lever (1) a little towards you from the low idling position.

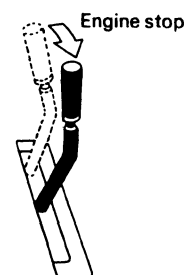



- Turn starting key (2) to the START position.

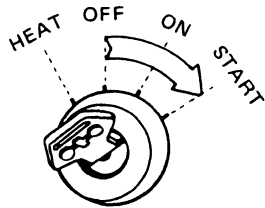

- When engine is started, release starting key (2) and the key will return automatically to ON.

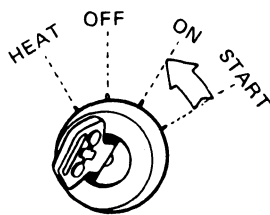

- ★ If engine will not start, repeat the starting procedure after about 2 minutes.
- ★ Do not leave the key in START for more than 20 seconds.
- ★ Do not put the key in OFF position while the engine is running.
- ★ To start engine in cold weather, refer to COLD WEATHER OPERATION.

**Special starting**

When starting after running out of fuel, fill with fuel, then fill the fuel filter cartridge with fuel and bleed the air from the fuel system before starting.

Refer to FUEL FILTER in EVERY 500 HOURS SERVICE.

**CHECKS AFTER STARTING**

After starting, make the following checks.

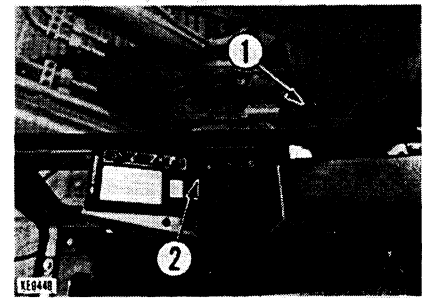

- Pull fuel control lever (1) and run the engine at medium speed. Then run the engine at no load for about 5 minutes.

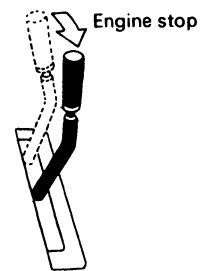

P-02005

OPERATING YOUR MACHINE

- Leaving bucket control lever (2) in either pushing or pulling side, run the engine for about 5 minutes to warm up the hydraulic oil.

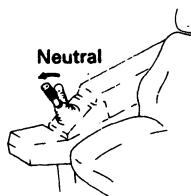

- ★ Avoid abruptly accelerating the engine until the completion of warm-up.
- ★ Do not run for more than 20 minutes at low idling or at high idling.
- ★ The hydraulic oil temperature should ideally lie within the range 50 to 80°C. If the machine is operated after raising the oil temperature to 20°C, the life of the machine will be extended.

**TO MOVE THE MACHINE OFF**

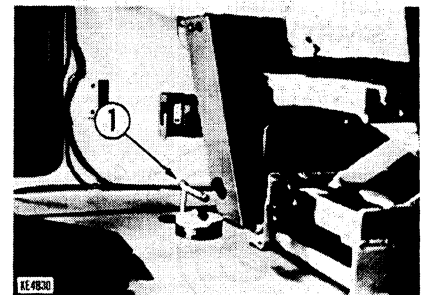

- Put swing lock lever (1) into the lock position by pushing the lever down.

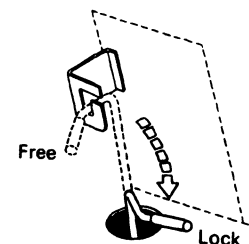

- After warm-up run is completed, check gauges, monitor lamps for proper operation.
- Continue to run the engine at light load until the green range of the engine water temperature gauge lights.
- Check if the exhaust color is normal or whether there is any abnormal noise or vibration.

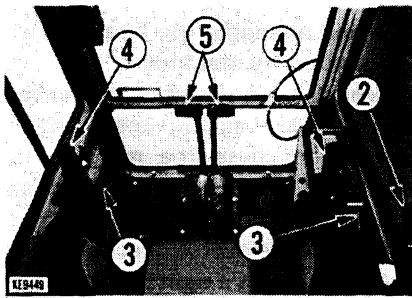

2. Pull fuel control lever (2) to increase engine speed.

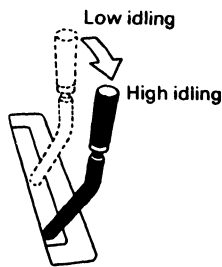

PP-02007

3. Free safety levers (3) of left and right working equipment levers (4), move the work equipment in and raise it to a height of about 40 to 50 cm.

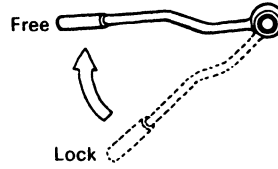

4. Slowly incline left and right traveling and steering levers (5) in the forward (forward moving off) or reverse (reverse moving off) direction, and move off.

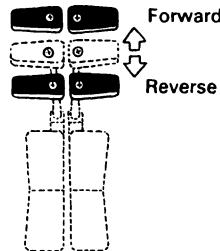

- 47 -

**⚠ Check whether the track frame is facing forward or backward before operating the traveling and steering levers.**

**⚠ Avoid abruptly operating the traveling and steering levers with the fuel control lever fully open, as this will cause the machine to move off suddenly.**

**⚠ For machine with auto-deceleration device, if the lever is operated inside the deceleration range, the engine speed will rise suddenly.**

**TURNING**

Operate the two traveling and steering levers in the following manner.

**Left pivot turn (forward)**

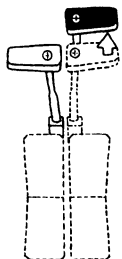

**Right pivot turn (forward)**

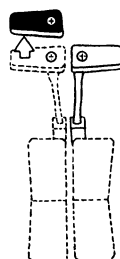

**Left pivot turn (reverse)**

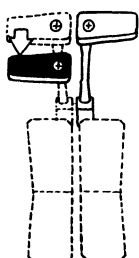

**Right pivot turn (reverse)**

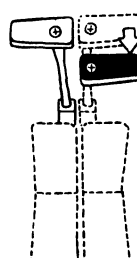

● **When changing the direction of a stationary machine**

When making a left turn, incline the right traveling and steering lever forward to cause the machine to turn left in the forward direction, or pull it back to make the machine turn left in the reverse direction.

In the case of a right turn, operate the left traveling and steering lever in a similar manner to the above.

● **When changing the direction of a running machine (when left and right traveling and steering levers are inclined in the same direction)**

When making a left turn, return the left traveling and steering lever to the neutral position. This will cause the machine to make a pivot turn to the left.

In the case of a right turn, operate the right traveling and steering lever in a similar manner to the above.

Counterrotation turn (left)

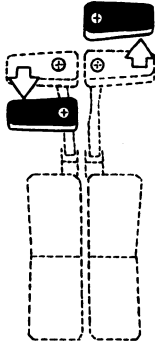

Counterrotation turn (right)

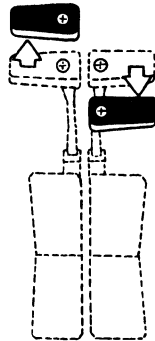

● **When performing counterrotation**

To counterrotate the machine to the left, pull back the left traveling and steering lever and push forward the right traveling and steering lever.

★ The above applies to the running operation of the lower mechanism. When the upper works is facing backward as opposed to the track frame, the various traveling and steering operation methods will be reversed. It is therefore necessary to always keep in mind the direction of the track frame when operating the machine.

★ Avoid abruptly changing the direction of the machine as far as possible. In particular, before counterrotating the machine, first bring it to a halt.

P-00072

OPERATING YOUR MACHINE

**OPERATION OF THE WORKING EQUIPMENT**

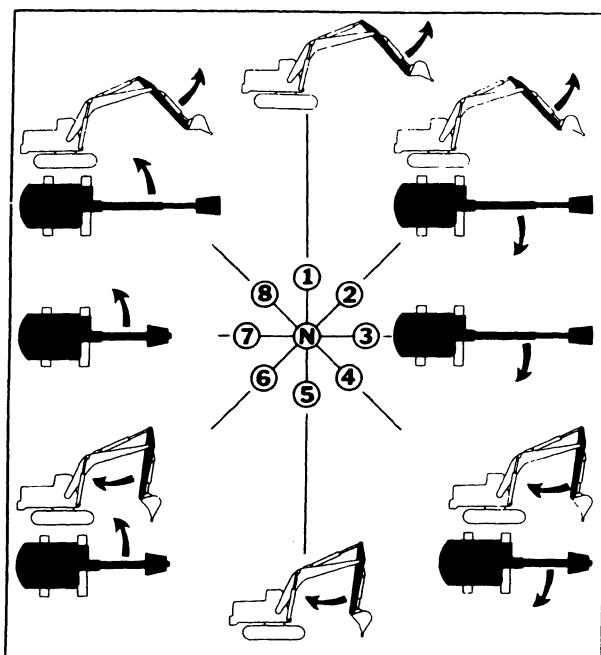

- N. Neutral
- 1. Arm out
- 2. Arm out and swing right
- 3. Swing right
- 4. Arm in and swing right
- 5. Arm in
- 6. Arm in and swing left
- 7. Swing left
- 8. Arm out and swing left

The working equipment is operated by means of the left and right working equipment levers. The left lever is used to operate the arm and swing the machine, and the right lever is used to operate the boom and the bucket.

The motion of the lever and working equipment is as shown in the diagrams.

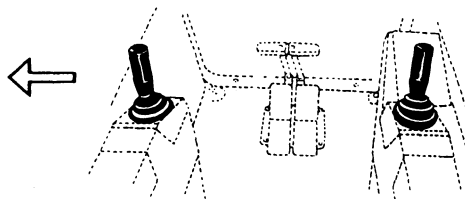

★ Before swinging the upper works, make sure that the swing lock lever has been in free.

- N. Neutral
- 1. Boom lower
- 2. Boom lower and bucket dump
- 3. Bucket dump
- 4. Boom raise and bucket dump
- 5. Boom raise
- 6. Boom raise and bucket curl
- 7. Bucket curl
- 8. Boom lower and bucket curl

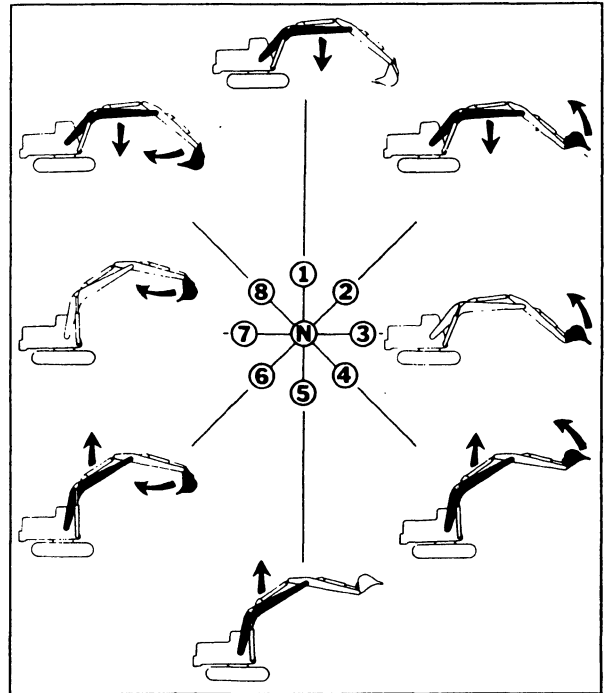
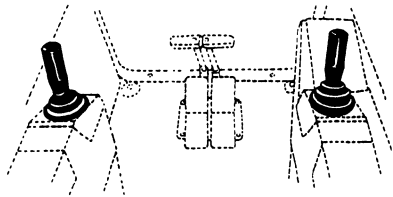

P-01656

OPERATING YOUR MACHINE

TO STOP THE MACHINE

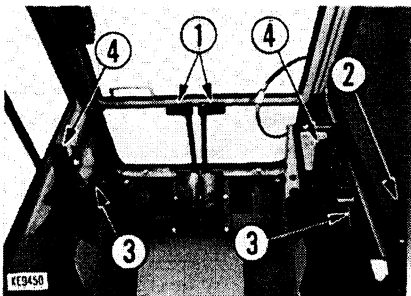

1. Put the left and right traveling and steering levers (1) in the neutral position.

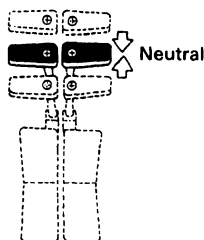

2. Lower the engine speed using fuel control lever (2).

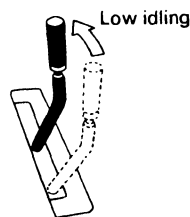

3. Lower the bucket horizontally until its underside touches the ground.
4. Lock safety levers (3) for work equipment levers (4).

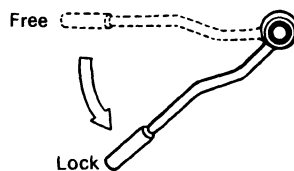

**!** When stopping the machine, select flat hard ground and avoid dangerous places. If it is unavoidably necessary to park the machine on a slope, insert blocks underneath the track shoes. As an additional safety measure, thrust the bucket into the ground.

## TO STOP THE ENGINE

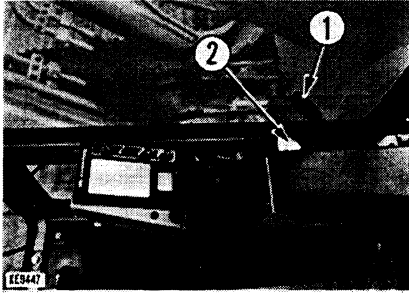

1. Run the engine at low idling speed for about 5 minutes to allow it to gradually cool down.
2. Put fuel control lever (1) in the engine stop position and stop the engine.

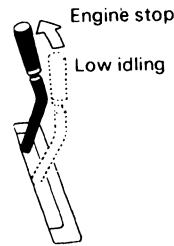

3. Return starting key (2) to the OFF position and remove key.

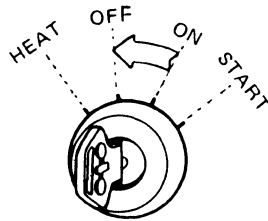

- ★ If the engine is abruptly stopped before it has cooled down, engine life may be greatly shortened. Consequently, do not abruptly stop the engine apart from an emergency.
- ★ In particular, if the engine has overheated, do not abruptly stop it but run it at medium speed to allow it to cool gradually, then stop it.

P-02010

- 53 -

## OPERATING YOUR MACHINE

### PRECAUTIONS FOR OPERATION

- Be careful not to compact the soil or damage earth mounds as a result of the swinging force.
- When swinging, do not dig the bucket teeth into the soil.
- Do not move off and excavate with the bucket leaving dug into the ground.
- When working with the machine, do not move the cylinder to the end of its stroke but leave a small safety margin.
- Do not use the dropping force of the bucket as a pickaxe, breaker, or pile driver.
- Do not use the dropping force of the machine for digging.
- It is better to excavate hard rocky ground after breaking it up by some other means. This will not only reduce damage to the machine but make for better economy.

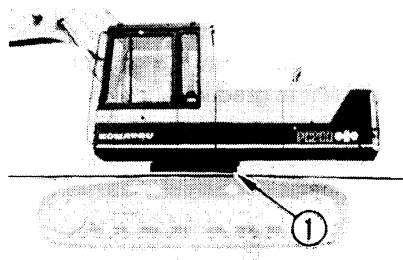

15763

- Do not immerse the machine in water by more than the permissible depth (under swing circle (1)). In addition, properly grease parts which have been immersed in water for a long time, until the old grease comes out from the bearings (vicinity of bucket pins, swing circle system, etc.).
- When removing the machine from water, if the machine is given a posture of climbing at a steep angle (less than 15 degrees, however), the rear part of the upper swing body may dip into the water, with its radiator

fan scooping up water. In that event, the fan may break. Be sufficiently careful when removing the machine from water for this reason.

- To brake the machine during downhill runs, put the traveling and steering lever in the neutral position. This will cause the brake to be automatically applied.
- When descending a steep slope, adjust the speed by means of the traveling and steering levers and the fuel control lever.
- When climbing a hill, if the shoes slip or the travel motor relieves, preventing the machine from climbing by means of the tracks alone, it is possible to use the force of the arm as an aid.

- 54 -

- When the engine stops on a slope, move the traveling and steering levers to neutral position and lower the bucket. Thereafter, turn starting key to START.
- Note that the following phenomena are not faults:
  - 1) When the arm is pulled back, it will sometimes stop when becomes more or less vertical.
  - 2) The arm may sometimes stop when the bucket teeth become more or less horizontal.
  - 3) At the beginning and end of a swinging, a noise may sometimes be emitted from the brake valve.
  - 4) When descending a steep slope at low speed, a noise may sometimes be emitted from the travel motor.

- The wide triple grouser shoe (700, 800, 900 mm) and swamp shoe (860 mm) are designed for use on soft, weak ground. Do not use them on rocky ground, gritty ground or unlevelled ground.

**⚠ For machine with auto-deceleration device, if the lever is operated inside the deceleration range, the engine speed will rise suddenly.**

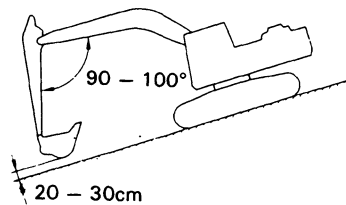

- When traveling down a hill, adjust the speed with the travel lever and fuel control lever. If the grade exceeds 15°, set the machine in the posture shown in the diagram above, and reduce the engine speed.

**⚠ Do not travel on slopes of over 30° as there is danger that the machine may overturn.**

- Matters for attention at special work sites
  - 1) If operation is executed in water, if the work equipment fixing pins come in contact with water, greasing is to be performed after every under-water operation.
  - 2) Greasing of the work equipment fixing pins is to be performed every time before heavy digging or deep digging.
- ★ After greasing is done, the boom, arm and bucket are to be operated several times. This should be followed by re-greasing.

P-03878

- 55 -

## OPERATING YOUR MACHINE

**HOW TO ESCAPE FROM MUD**

- Always operate carefully to avoid getting stuck in mud. If the machine does get stuck in mud, use the following procedures to get the machine out.
- **When one side is stuck.**  
When only one side is stuck in mud, use the bucket to raise the track, then lay boards or logs and drive the machine out. If necessary, put a board under the bucket also.
- ★ When using the boom or arm to raise the machine, always have the bottom of the bucket in contact with the ground. (Never push with the teeth.) The angle between the boom and arm should be 90° to 110°. The same applies when using the inverting bucket.
- **When both sides are stuck.**  
When the tracks on both sides are stuck in mud and the machine will not move, lay boards as explained on the left, and dig the bucket into the ground in front. Then pull in the arm as in normal digging operations and put the travel levers in the FORWARD position to pull the machine out.

# INVERSION AND REPLACEMENT OF BUCKET

Stop the machine on a firm, flat surface. When performing joint work, make clear signals to each other and work carefully for safety's sake.

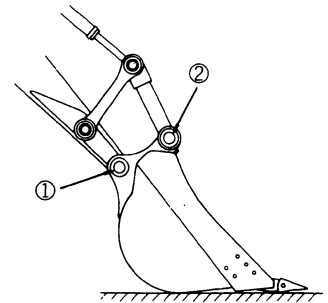
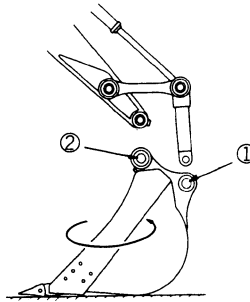
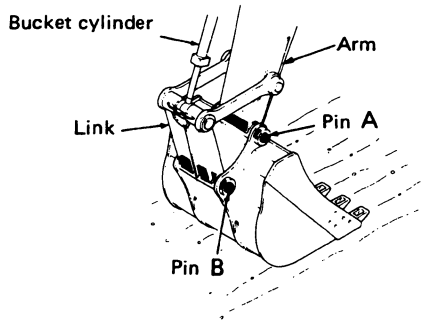

1. Select a flat surface and stabilize the bucket.
2. After removing the stop bolt and nut for each pin, extract pins A and B.
  - ★ After removing the pins, make sure that they do not become contaminated with sand or mud and that the seals of bushing on both sides do not become damaged..

3. Reverse the bucket.
  - ★ After reversing the bucket, correct the direction and inclination of mounting pin holes (1) and (2) then firmly stabilize the bucket so that it does not shake about.

4. Couple the arm to hole (1), then connect the link to hole (2).
5. After mounting the stop bolt and nut for each pin, apply grease to each pin.
  - ★ When replacing bucket, adjust bucket clearance.

P-02014

- 57 -

## HANDLING THE TRAPEZOIDAL BUCKET

# HANDLING THE TRAPEZOIDAL BUCKET

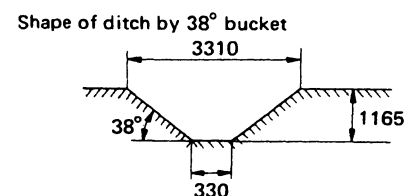
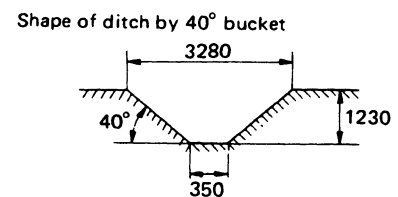
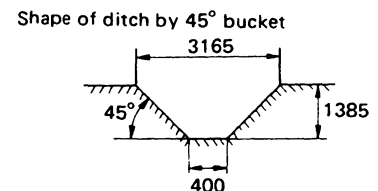
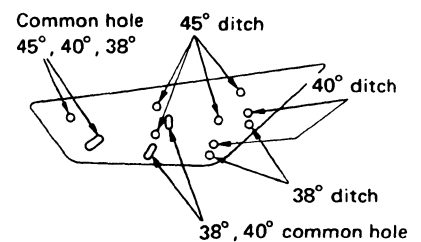
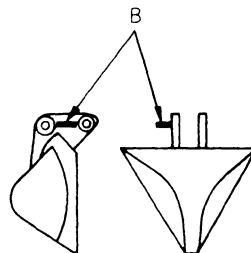
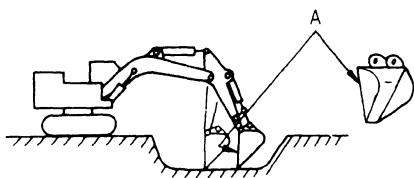

This bucket is used in sloped ditch digging work in the farm.

The three different ditch inclination can be obtained by changing the angle of the attached plate.

The angles available are 45°, 40° and 38°.

Install the bucket using the holes for 45°, 40° and 38° ditch.

### How to perform excavation

Operate the boom, the arm and the bucket to make the line A of the side-plate of the bucket vertical.

The guide plate B to check this position is installed beside the bucket pins. Accordingly, hold this plate horizontal when digging.

★ Hold the plate horizontal for every ditch angle.

- 58 -

P-02015

## USING THE EXTENSION ARM

When the extension arm is installed, be careful when retracting the arm because the bucket hits the foot of the boom cylinder or the lower frame of the swing circle.

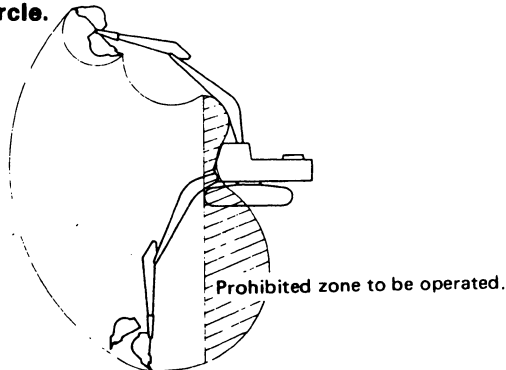

- Use the narrow bucket (width: 750 mm) without the side-cutter when installing the extension arm. When you use the standard width bucket, the machine stability is lost. Also the bucket will hit the cab when the arm is retracted.
- Work in hard soil or rocky terrain will shorten the life of the extension arm, the boom and the arm. It is better not to use the extension arm in such conditions.

## HANDLING THE CLAMSHELL BUCKET

This bucket is used for digging and loading in side-ditches or the confined spaces.

### How to perform excavation

Carry out digging work by lowering the boom keeping the clamshell opened.

Close the bucket while raising the boom gradually.

When you begin to dig and find the bucket rotating, do as follows.

Extend the bucket cylinder fully and hold, the bucket will soon stop rotating.

- ★ Make the teeth of the bucket vertical in digging.
- ★ For safety, always avoid abrupt traveling, swing and stopping.
- ★ Do not swing the bucket to crush the rock or to cut through soil.
- ★ Do not use the bucket for hammering or pulling out piles etc.
- ★ Before leaving the machine, open the bucket and lower it to the ground.
- ★ Remove the bucket from the arm when transporting the machine.

P-02016

— 59 —

## COLD WEATHER OPERATION

## COLD WEATHER OPERATION

### PREPARATION FOR LOW TEMPERATURE

If the temperature becomes low, it becomes difficult to start the engine, and the coolant may freeze, so do as follows.

### FUEL AND LUBRICANTS

Change to fuel and oil with low viscosity for all components. For details of the specified viscosity, see the TABLE OF FUEL, COOLANT AND LUBRICANTS.

### COOLANT

After cleaning inside of the cooling system, add antifreeze to the coolant to prevent the coolant from freezing when the machine is not being used.

- ★ For details of the antifreeze mixture when changing the coolant, see WHEN REQUIRED.

### Care in using Antifreeze

Use a Permanent Antifreeze (ethylene glycol mixed with corrosion inhibitor, antifoam agent, etc.) meeting the standard requirements as shown below. With permanent antifreeze, no change of coolant is required for a year. If it is doubtful that an available antifreeze meets the standard requirements, ask the supplier of that antifreeze for information.

Standard requirements for permanent antifreeze

- SAE ..... J1034
- FEDERAL STANDARD  
..... O-A-548D



- ★ Never use methanol, ethanol or propanol based antifreeze.
- ★ Where no permanent antifreeze is available, an ethylene glycol antifreeze without corrosion inhibitor may be used only for the cold season. In this case, clean the cooling system twice a year (in spring and autumn). When refilling the cooling system, add antifreeze in autumn, but do not add any in spring.
- ★ Absolutely avoid using any water leak preventing agent irrespective of whether it is used independently or mixed with an antifreeze.
- ★ Do not mix one antifreeze with a different brand.

**⚠ Antifreeze is flammable, so keep it away from any flame.**

**BATTERY**

As ambient temperature drops, battery capacity will drop, and electrolyte may sometimes freeze if battery charge is low. Maintain battery at a charge level of approx. 100% and insulate it against cold temperature so that machine can be readily started the next morning.

★ Measure specific gravity of fluid and obtain rate of charge from the following conversion table:

Temp. of fluid Rate of charge	20°C	0°C	-10°C	-20°C
100%	1.28	1.29	1.30	1.31
90%	1.26	1.27	1.28	1.29
80%	1.24	1.25	1.26	1.27
75%	1.23	1.24	1.25	1.26

- ★ When electrolyte level is low, add distilled water in the morning before work instead of after the day's work. This is to prevent fluid from freezing at night.

**⚠ To avoid gas explosions, do not bring fire or sparks near the battery.**

**⚠ If the electrolyte gets on your skin or clothes, immediately wash with plenty of clean water.**

COLD WEATHER OPERATION

**STARTING IN COLD WEATHER**

For the pre- and post-starting inspection, refer to the section OPERATING YOUR MACHINE.

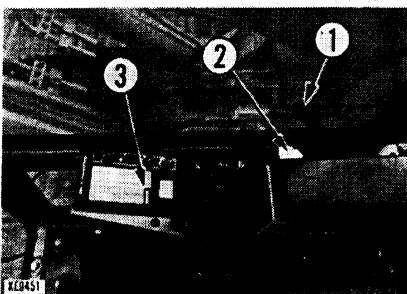

1. Pull fuel control lever (1) a little towards you from the low idling position.

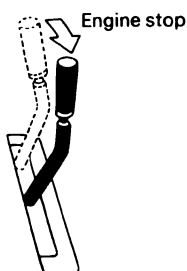

2. Turn starting key (2) to HEAT, and confirm that engine preheating monitor lamp (3) comes on. After about 36 seconds, preheating monitor lamp (3) will flash for about 16 seconds to indicate that preheating is finished.

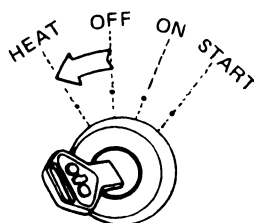

3. After preheating monitor lamp (3) starts to flash, turn the key (2) to START and start the engine.

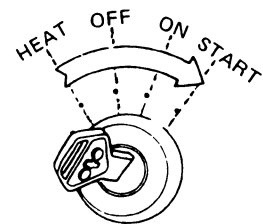

4. Release starting key (2), and the key will return automatically to ON.

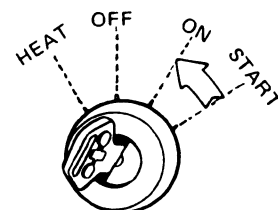

- ★ If the engine does not start up under the above procedure, repeat steps 2 and 3 after waiting for about 2 minutes.

**⚠ Never use starting aid fluids as they may cause explosions.**

### CAUTIONS AFTER COMPLETION OF WORK

1. Mud and water on the machine body should be completely removed.

Park the machine on concrete or hard ground. If this is impossible, park the machine on wooden boards. This will prevent the accessories from freezing or the track and undercarriage from freezing to the ground thereby preventing vehicle movement the next morning. Particular attention should be given to water drops collected on the surface of the hydraulic cylinder piston rods. Such droplets must be fully wiped off because if water is frozen to the rod when the cylinder is utilized, the cylinder oil seals may be damaged.

2. Drain water collected in fuel system so that such water may be frozen at night.
3. As battery capacity drops, at low ambient temperature, cover the battery or remove it from the machine to be kept warm at night.

P-03822

- 63 -

### COLD WEATHER OPERATION

#### AFTER COLD WEATHER

When weather becomes warm, perform the following without fail:

- Replace lubricating oils for various units with the ones specified for warm-weather use.
- If for any reason permanent antifreeze cannot be used, and an ethyl glycol base antifreeze (winter, one season type) is used instead, or if no antifreeze is used, drain the cooling system completely, then clean out the inside of the cooling system thoroughly, and fill with fresh water.

#### PREPARING THE CAB HEATER

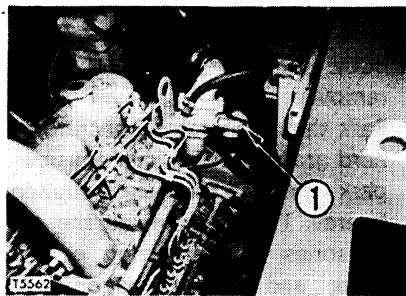

(For PC280 only)

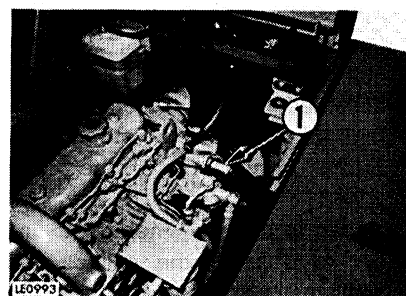

If the ambient temperature drops, use the cab heater.

1. When using the cab heater, turn valve (1) on the water manifold counterclockwise to open it.
2. When leaving the cab heater unused for a long time, turn valve (1) clockwise to close it.

# PERIODIC MAINTENANCE

Proper lubrication and maintenance assure trouble-free operation and long machine life. Time and money spent for scheduled periodic maintenance will be amply compensated by prolonged machine operation and reduced operating cost.

All hourly figures given in the following descriptions are based on service meter readings. In practice, however, it is recommended to rearrange all of them into units of days, weeks and months to make the maintenance schedule more convenient. Under rough job site or operating conditions, it is necessary to somewhat shorten the maintenance intervals stated in this manual.

P-01222

- 65 -

## MAINTENANCE TABLE

## MAINTENANCE TABLE

No.	ITEM	SERVICE	PAGE
<b>CHECK BEFORE STARTING</b>			
a	Walk-around check		39
b	Coolant	Check and supply	39
c	Engine oil pan	Check and supply	40
d	Fuel	Check and supply	41
e	Hydraulic tank	Check and supply	41
f	Dust indicator	Check	42
g	Water separator	Inspect float position	43
h	Clamshell bucket	Lubricate 12 points	43
i	Electric wirings	Check	43
<b>EVERY 100 HOURS SERVICE</b>			
a	Swing machinery case	Check and supply	70
b	Fuel tank	Drain water and sediment	70
c	Lubricating		71
-1	Boom cylinder foot pin	Lubricate 2 points	71

No.	ITEM	SERVICE	PAGE
-2	Boom foot pin	Lubricate 2 points	71
-3	Boom cylinder rod end pin	Lubricate 2 points	72
-4	Arm cylinder foot pin	Lubricate 1 point	72
-5	Boom-Arm coupling pin	Lubricate 1 point	72
-6	Arm cylinder rod end pin	Lubricate 1 point	72
-7	Bucket cylinder foot pin	Lubricate 1 point	72
-8	Arm-bucket coupling pin	Lubricate 1 point	73
-9	Arm-link coupling pin	Lubricate 1 point	73
-10	Link coupling pin	Lubricate 2 points	73
-11	Bucket-link coupling pin	Lubricate 2 points	73
-12	Bucket cylinder rod end pin	Lubricate 1 point	73
<b>INITIAL 250 HOURS SERVICE</b>			
a	Fuel filter	Replace cartridge	74
b	Engine valve clearance	Check and adjust	74



# OIL FILLER AND LEVEL GAUGE POSITIONS

1. Swing machinery case oil filler
2. Final drive case oil filler
3. Final drive case drain plug
4. Swing machinery case drain plug
5. Engine oil pan oil filler
6. Engine oil pan level gauge
7. Cooling water inlet
8. Hydraulic tank oil filler

9. Fuel tank oil filler
10. Fuel tank level gauge
11. Fuel tank drain valve
12. Hydraulic tank level gauge
13. Hydraulic tank drain plug
14. Cooling water drain valve
15. Engine oil pan drain plug

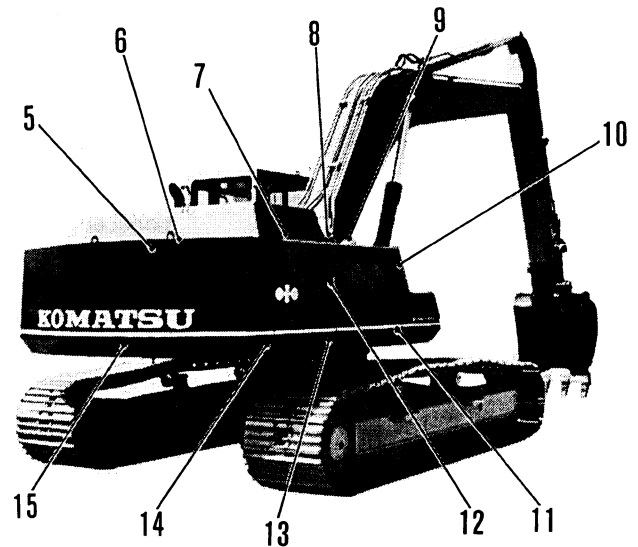
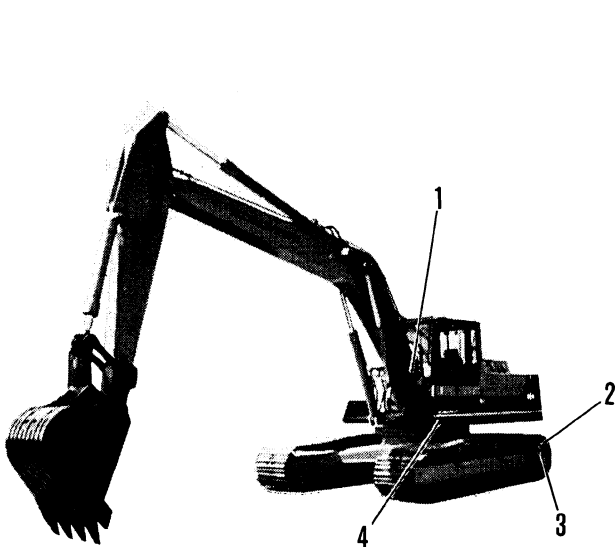

P-02024

- 69 -

CHECK BEFORE STARTING  
EVERY 100 HOURS SERVICE

## CHECK BEFORE STARTING

See the section on CHECK BEFORE STARTING mentioned.

## EVERY 100 HOURS SERVICE

### a. SWING MACHINERY CASE

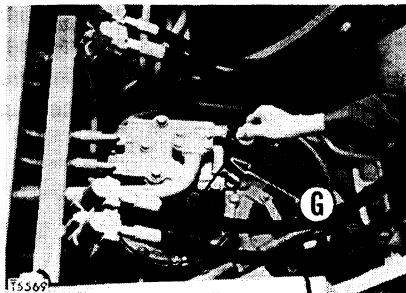

Inspect the oil level using dipstick (G), and if insufficient pour in additional engine oil from gauge hole.

★ The type of lubricant used depends on the ambient temperature. Select according to the table "FUEL, COOLANT AND LUBRICANTS".

★ Screw in dipstick (G) until O-ring on the dipstick contacts the guide, and check the oil level.

### b. FUEL TANK

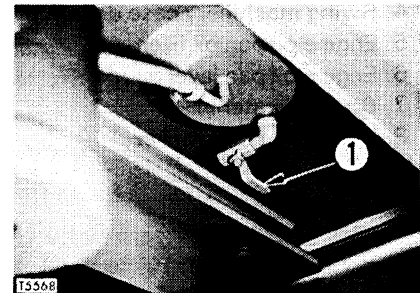

Loosen valve (1) on the bottom of the tank so that the precipitation and mixed water will be drained in accompaniment with fuel.

**c. LUBRICATING**

Apply grease to the grease fittings shown by arrows.

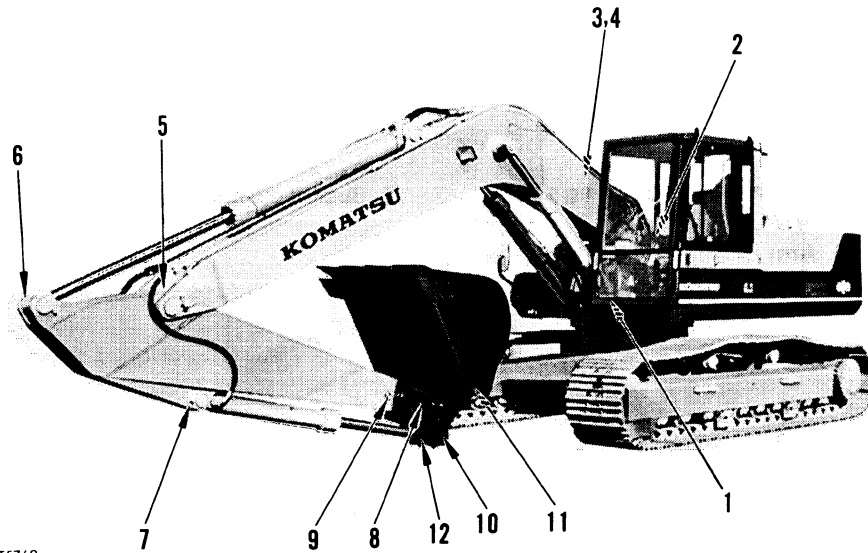

T5769

P-00105

1. Boom cylinder foot pin (2 points)

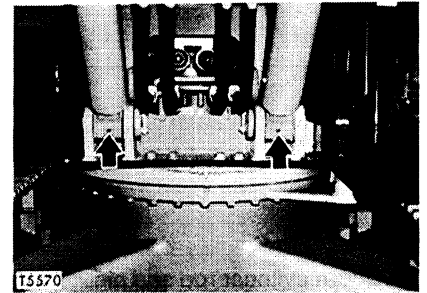

2. Boom foot pin (2 points)

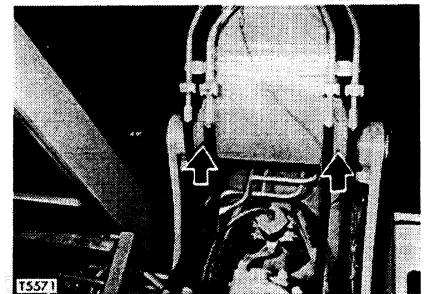

EVERY 100 HOURS SERVICE

- 3. Boom cylinder rod end pin (2 points)
- 4. Arm cylinder foot pin (1 point)

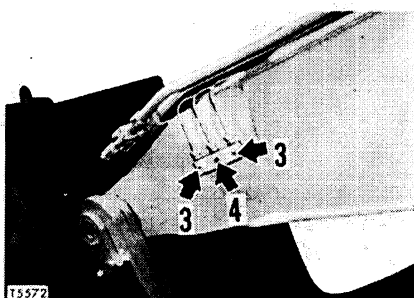

- 5. Boom — Arm coupling pin (1 point)
- 6. Arm cylinder rod end pin (1 point)

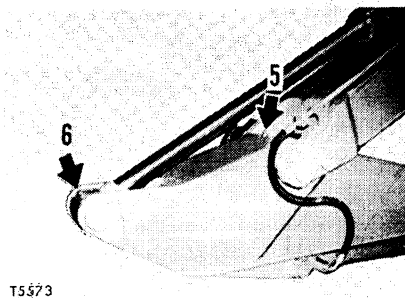

7. Bucket cylinder foot pin (1 point)

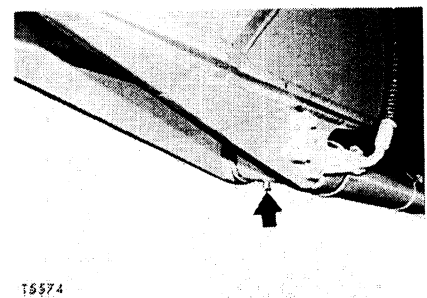

- 8. Arm — Bucket coupling pin (1 point)
- 9. Arm — Link coupling pin (1 point)

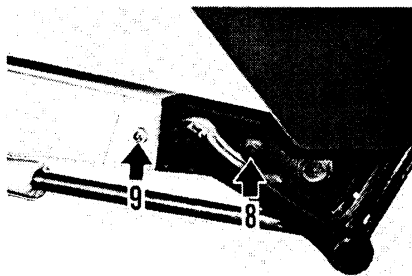

T5575

- 10. Link coupling pin (2 points)
- 11. Bucket — Link coupling pin (2 points)
- 12. Bucket cylinder rod end pin (1 point)

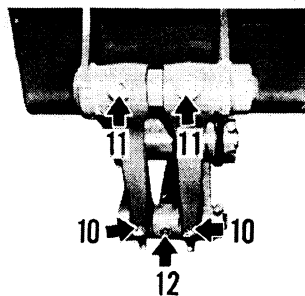

T5576

P-00107

INITIAL 250 HOURS SERVICE  
EVERY 250 HOURS SERVICE

### INITIAL 250 HOURS SERVICE

Perform the following maintenance after running the machine for the first 250 hours.

- a. FUEL FILTER
- b. ENGINE VALVE CLEARANCE

For details of the method of replacing or maintaining, see the section on EVERY 500 HOURS AND 2000 HOURS SERVICE.

### EVERY 250 HOURS SERVICE

#### a. FINAL DRIVE CASE

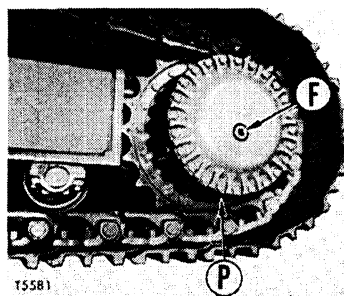

T5581

1. Set the machine with plug (F) and plug (P) perpendicular to the ground surface.
2. Remove plug (F), and check that oil level is within 10 mm below the bottom of the plug hole. If it is not within this range, add engine oil through the plug hole.

★ The type of lubricant used depends on the ambient temperature. Select according to the table "FUEL, COOLANT AND LUBRICANTS".

**b. ENGINE OIL PAN AND FILTER**

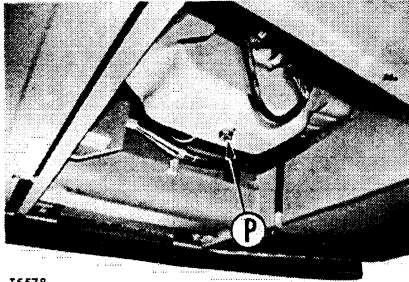

T5578

(For PC280 only)

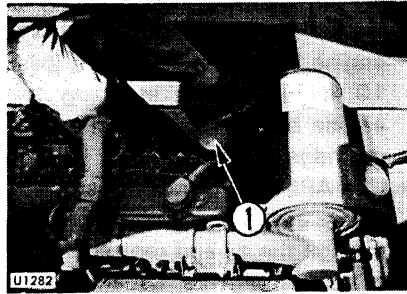

U1282

(For PC280 only)

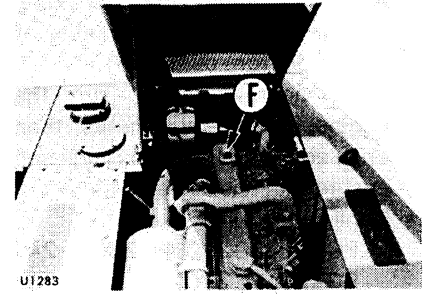

U1283

(For PC280 only)

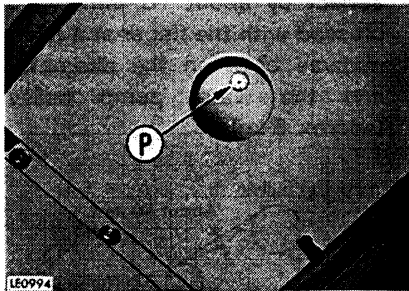

LE0994

1. Remove drain plug (P) to drain oil. After draining, tightening the drain plug.

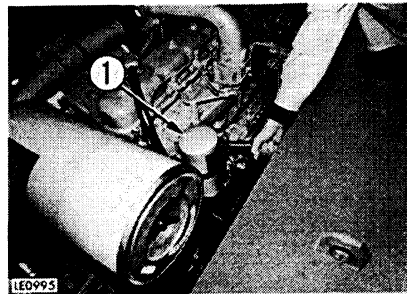

LE0995

2. Using a filter wrench, remove cartridge (1) of the engine oil filter by turning it counterclockwise.

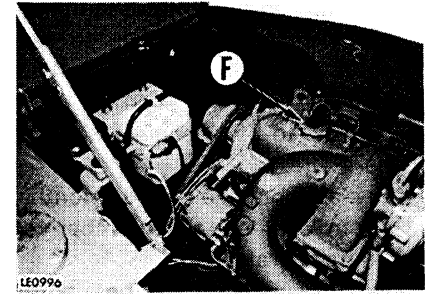

LE0996

3. Clean the filter base, apply a dab of oil to the gasket of the new cartridge, and after the gasket contacts the seal face, tighten it up by hand 1/2 to 3/4 of a turn.

P-02975

— 75 —

EVERY 250 HOURS SERVICE

4. After replacing the cartridge, pour in the specified quantity of engine oil from oil filler (F).

5. After pouring in oil, run the engine for several minutes, then once again check the oil level and ensure that it is correct.

★ Refill capacity:

PC200, PC210, PC280: 24 ℓ

PC220, PC240: 25 ℓ

★ The type of lubricant used depends on the ambient temperature. Select according to the table "FUEL, COOLANT AND LUBRICANTS".

★ Be sure to fit a genuine Komatsu cartridge.

★ Replace once every 6 months, regardless of the number of hours operated.

★ When supplying oil, be careful not to get oil on the alternator.

★ If filter cartridge (1) is removed immediately after stopping the engine, oil will spill. Wait at least 10 minutes after stopping the engine before replacing the filter cartridge.

★ Use API category CD class oil. If CC class oil must be used, change the oil and replace the oil filter at half the usual interval (125 hours).

**c. WATER PUMP BELT**

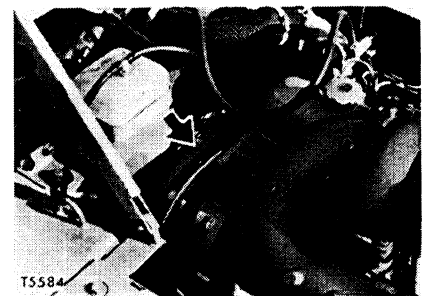

T5584

1. The belt tension should normally deflect by about 10 mm when pressed with the finger at a point midway between the alternator and the water pump pulley (approx. 6 kg).

Water pump pulley

About 10 mm

Alternator pulley

Crankshaft pulley



(For PC280 only)

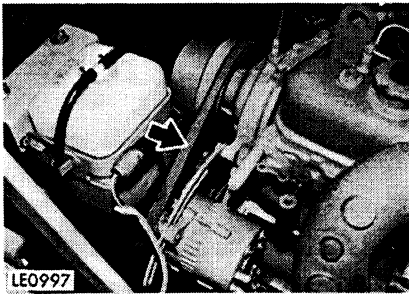

2. To adjust the belt tension, loosen bolt (1) and nut (2) and shift alternator (3) slightly.
3. After adjustment, tighten bolt (1) and nut (2) securely.

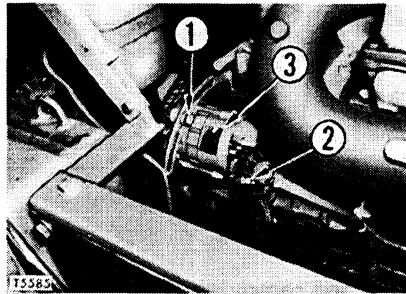

- ★ When adjusting the V-belt, do not attempt to push alternator (3) directly with a bar or the like, but use a wood pad to prevent damage to the core.
- ★ Check each pulley for damage, and V-grooves and V-belt for wear. Particularly, check whether V-belt is in contact with bottom of V-groove through wear.

(For PC280 only)

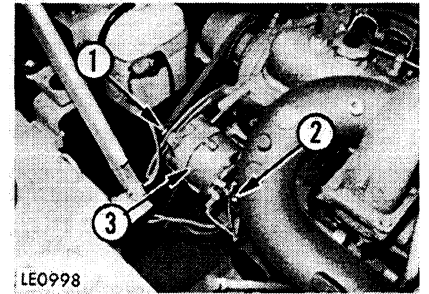

- ★ Replace belt if it has stretched, leaving no allowance for adjustment, or if there is a cut or crack on belt.

P-02977

EVERY 250 HOURS SERVICE

**d. HYDRAULIC FILTER**

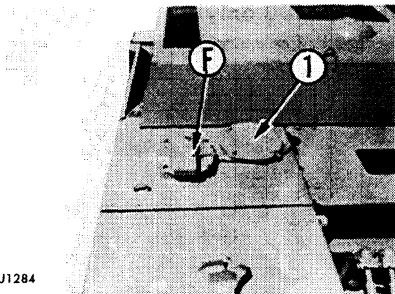

1. Open the cover and remove cap (F).
  2. Remove cover (1), spring (2) and valve (3) at the top of the hydraulic tank, then remove element (4).
  3. Clean removed parts and install a new element.
- ★ Be sure to use a genuine Komatsu element.

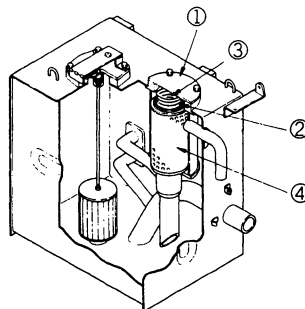

**⚠ When removing the cap, turn it slowly to relieve inner pressure.**

**⚠ When removing the cover (1), undo the bolts (4 bolts) gradually to prevent the cover flying off under the force of the spring (2).**

**e. SWING CIRCLE**

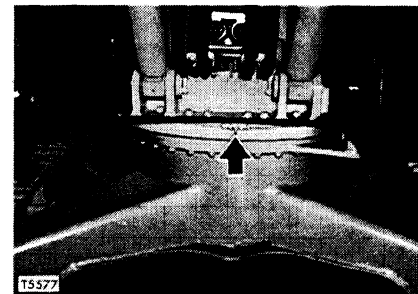

Lubricate to the 3 grease fittings shown by an arrow.

**f. BATTERY ELECTROLYTE**

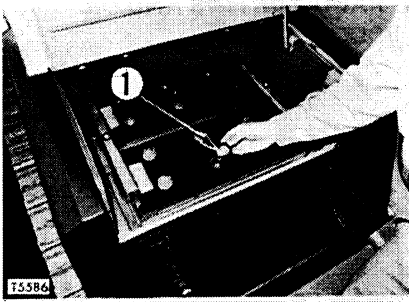

1. Open the front right side cover.
  2. If the electrolyte level is lower than the prescribed level (10 to 12 mm above the plate), supply distilled water.
- ★ Should any of the acid be spilt, have it replenished by the nearest battery shop with acid of the correct specific gravity.
  - ★ When inspecting electrolyte level, clean the air hole of the battery cap (1).

- ⚠ If the electrolyte gets on your skin or clothes, immediately wash with plenty of clean water.
- ⚠ To avoid gas explosions, do not bring fire or sparks near the battery.

PP-00439

— 79 —

EVERY 500 HOURS SERVICE

**EVERY 500 HOURS SERVICE**

- ★ Maintenance for every 100 and 250 hours should be carried out at the same time.

**a. SWING CIRCLE PINION**

(For PC280 only)

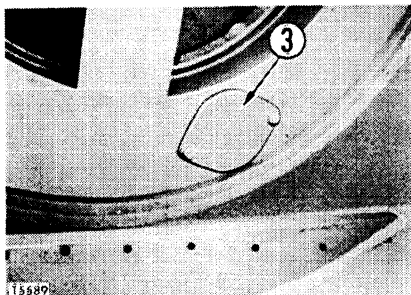
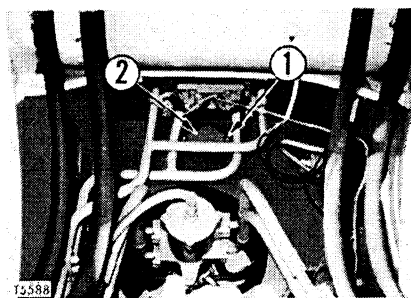

1. Remove bolts (1) (2 bolts) on the top of the revolving frame and remove cover (2).

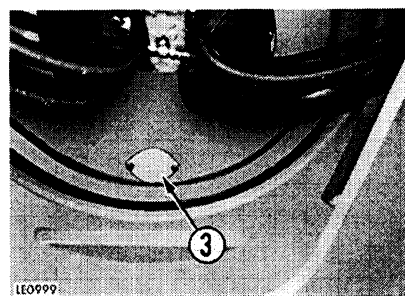

2. Check with scale that grease depth is about 44 mm. If there is insufficient grease, replenish it.
- ★ If the grease is particularly milky due to ingress of water, etc., then remove cover (3) from the bottom of the track frame and remove the grease. Replace all of the grease with new grease. The total amount of grease is 15.5 l [14 kg].

**b. RADIATOR FINS AND OIL COOLER FINS**

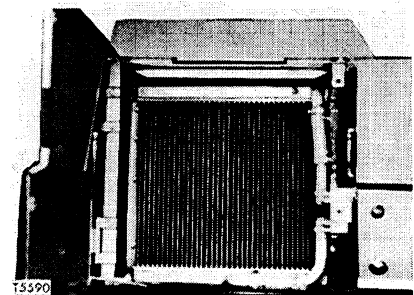

Clean the radiator fins and oil cooler fins clogged with mud, dust and leaves with compressed air. Steam or water may be used instead of compressed air.

- ★ The rubber hose should be checked at the same time. If the hose is found to have cracks or to be hardened by ageing, such hose should be replaced by new one. Further, loosened hose clamp should also be checked.

**c. FUEL FILTER**

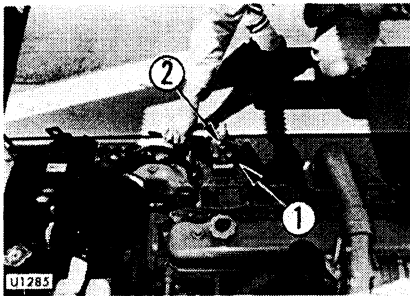

1. Using a filter wrench, remove cartridge (1) by turning it counterclockwise.
2. Fill the new cartridge with fuel and refit it after applying a dab of oil to the gasket face.

(For PC280 only)

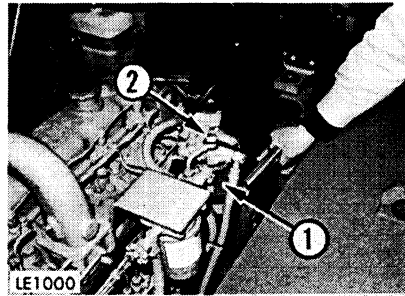

- ★ To refit the cartridge, place the gasket face in contact with the seal face of the filter stand, then screw up the cartridge by hand 1/2 to 3/4 of a turn (be careful not to tighten it up excessively).

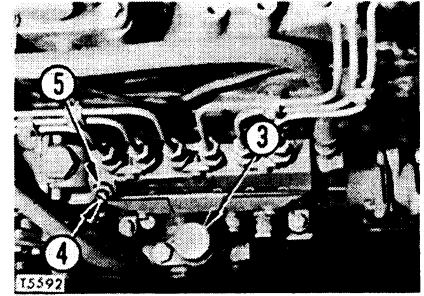

3. After replacing the cartridge, slacken off air vent plug (2).
4. Loosen the knob of feed pump (3) and move the pump up and down to draw off fuel until air ceases to come out of plug (2).
5. Tighten up air vent plug (2).
6. Hold the fuel injection pump sleeve (5) and loosen air vent plug (4). Bleed air from the fuel injection pump using the same procedure as described for the fuel filter.

P-02979

EVERY 500 HOURS SERVICE

(For PC280 only)

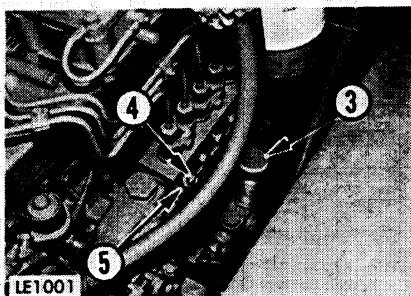

7. After air bleeding, tighten plug (4) with holding sleeve (5). Push in feed pump knob (3) and tighten it.
- ★ After replacing the cartridge, start up the engine and check the filter seal face for possible oil leakage.
  - ★ Be sure to use a genuine Komatsu cartridge.

**EVERY 1000 HOURS SERVICE**

- ★ Maintenance for every 100, 250 and 500 hours should be carried out at the same time.

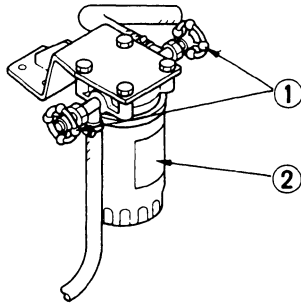
**a. CORROSION RESISTOR**

1. Close valves (1) (2 points).
2. Using the filter wrench provided, remove cartridge (2) by turning it counterclockwise. Fit a new cartridge after applying a dab of engine oil to the seal face. To fit the cartridge, put the seal face in contact with head, then screw it up by hand about 2/3 of a turn. (Be careful not to apply excessive torque.)

3. After replacement, open valves (1).
- ★ Be sure to use a genuine Komatsu cartridge.

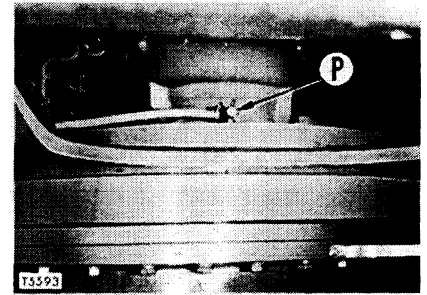
**b. SWING MACHINERY CASE**

1. Drain off oil from drain valve (P) at the bottom of the machine. After draining, tighten the drain valve (P).

P-03884

- 83 -

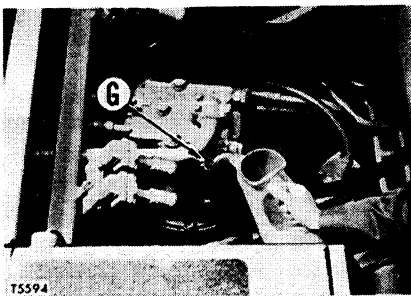
**EVERY 1000 HOURS SERVICE**

2. Pour in the specified amount of engine oil from gauge hole (G). (Refer to EVERY 100 HOURS SERVICE.)
- ★ The type of lubricant used depends on the ambient temperature. Select according to the table "FUEL, COOLANT AND LUBRICANTS".
- ★ Refill capacity: 7 ℓ

**c. TURBOCHARGER CLAMPING JOINT**

Contact your Komatsu distributor for checking, or proceed as follows: Periodically inspect all joints for looseness. Tighten when necessary.

- Tightening torque for bolts on turbine housing side:
  - 1.84 to 2.19 kgm
- Tightening torque for clamp bolts on blower housing side:
  - 1.15 to 1.50 kgm
- Tightening torque for exhaust manifold and turbine housing mounting bolts: 6.0 to 7.5 kgm
- Tightening torque for turbocharger oil pipe (inlet): 2.8 to 3.5 kgm
- Tightening torque for turbocharger oil pipe (outlet):
  - 6.0 to 7.5 kgm

**d. TURBOCHARGER ROTOR PLAY**

Contact your Komatsu distributor for checking, or proceed as follows:

Remove air intake and exhaust pipes from turbocharger.

**1. Axial play**

Check axial play by moving rotor in axial direction.

Play:

Standard 0.025 to 0.100 mm

**2. Radial play**

Measure radial play by moving rotor holding both ends by hands in radial direction in parallel.

Play:

Standard 0.075 to 0.180 mm

★ If the play is over the limit, consult your Komatsu distributor.

★ If the rotor is excessively soiled with dust or carbon or if any oil leakage caused by turbocharger trouble is noted, have the turbocharger repaired by your Komatsu distributor.

P-02033

EVERY 2000 HOURS SERVICE

**EVERY 2000 HOURS SERVICE**

★ Maintenance for every 100, 250, 500 and 1000 hours should be carried out at the same time.

**a. HYDRAULIC TANK**

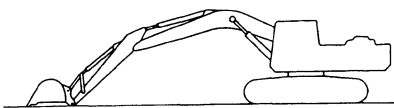

U1286

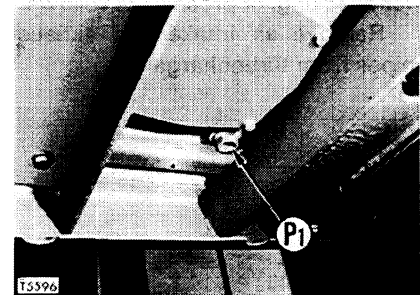
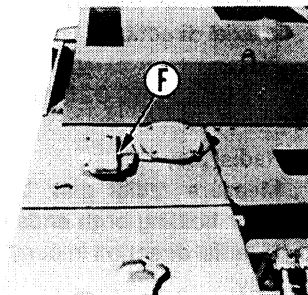

T5396

1. Retract the arm and bucket cylinder to the stroke end, then lower the boom and put the tip of the arm in contact with the ground.
2. Remove cover and cap (F).

3. Remove drain plugs (P<sub>1</sub>) and (P<sub>2</sub>) to drain off the oil. After draining off the oil, tighten up drain plugs (P<sub>1</sub>) and (P<sub>2</sub>).

4. Pour in the specified amount of engine oil from oil filler (F). (Refer to CHECK BEFORE STARTING.)

★ The type of lubricant used depends on the ambient temperature. Select according to the table "FUEL, COOLANT AND LUBRICANTS".

**⚠ When removing the cap, turn it slowly to relieve inner pressure.**

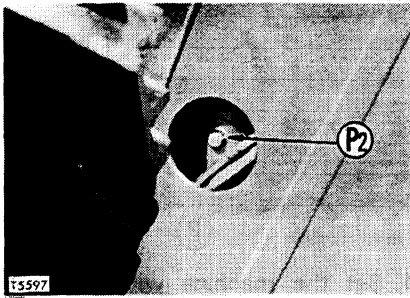

- ★ After changing oil, put the control levers in N (neutral) position and run the engine at low idling speed for a few minutes before operation of working equipment.
- ★ Refill capacity: 150 ℓ

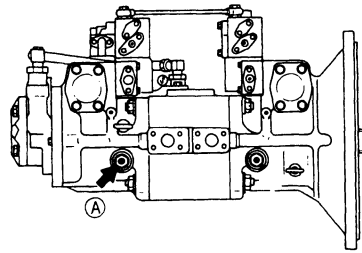

When the hydraulic oil or the main pump is replaced, or when the suction pipe of the pump or gear pump is removed, bleed the air according to the following procedure.

- ★ Remove the hose connected to portion A, add oil to the hydraulic tank to the specified level, then leave for approx. 10 minutes. Remove the elbow at portion A, and if oil overflows from portion A, the bleeding of air is completed.
- ★ If the pump is not filled with oil and is driven, abnormal heat will occur and the pump will soon break down.

P-02035

EVERY 2000 HOURS SERVICE

**b. HYDRAULIC TANK STRAINER**

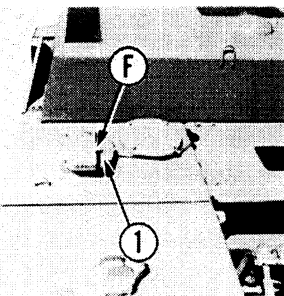

1. Open the cover and remove cap (F).
2. Remove cover (1) and lift up the top of rod (3) from above to take out spring (2) and strainer (4).
3. Wash the strainer with fuel oil. If strainer (4) is damaged, replace it with a new one.
4. Refit strainer (4) by inserting it into tank projecting part (5).

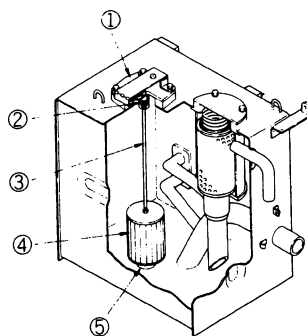

- ⚠ When removing the cap, turn it slowly to relieve inner pressure.
- ⚠ When removing cover (1), undo the bolts (4 bolts) gradually to prevent the cover flying off under the force of spring (2).

**c. FINAL DRIVE CASE**

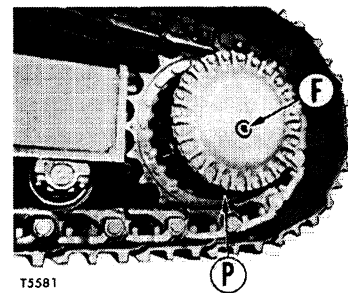

1. Set the machine with plug (F) and plug (P) perpendicular to the ground surface.
2. Drain the oil from drain plugs (P) on both sides of the machine. After draining, tighten the drain plugs.
3. Then, supply new engine oil through oil filler (F) respectively to the specified level. (Refer to EVERY 250 HOURS SERVICE.)

**d. TURBOCHARGER**

Excessive carbon or oil sludge adhering to the turbocharger blower impeller may deteriorate normal performance of the turbocharger and may sometimes damage it.

Contact your Komatsu distributor.

1. Remove the turbocharger oil supply tube and the drain tube. Then, remove the connection area of the intake manifold and the blower housing so that the blower impeller can be seen.
2. Using light oil, wash the impeller to eliminate carbon adhered on the surface. Do not use wire brushes or the like to prevent damage to the impeller surface.

3. Pour light oil through the turbocharger oil filler. Turn the blower impeller several turns so that foreign materials such as sludge can be washed away.

4. Using your fingers, turn the impeller vigorously for one revolution or more. If there is no sign of interference or catching, the impeller is normal.

If the impeller seems to turn heavily, contact your Komatsu distributor to ask for repair or replacement.

5. If the impeller is found normal after this check, supply engine oil to the turbocharger.

★ The type of lubricant used depends on the ambient temperature. Select according to the table "FUEL, COOLANT AND LUBRICANTS".

★ Refill capacity  
 PC200, PC210  
 PC220, PC240: 4.0 ℓ (each side)  
 PC280: 10.5 ℓ (each side)

P-02981

- 89 -

## EVERY 2000 HOURS SERVICE

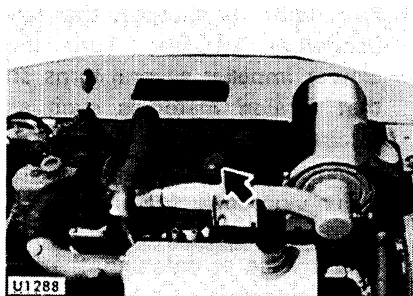
**e. ENGINE BREATHER**

1. Remove the breather from the cylinder head cover.
2. Put the whole breather in diesel oil and rinse. Then dry with compressed air and install again.
3. Check the breather hose or pipe, and if there is any sediment for deteriorated oil (sludge) inside, replace with a new hose or pipe.

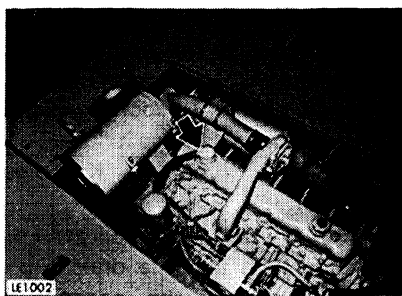
**(For PC280 only)**

- ★ Before removing the breather, wipe off all the dirt around the breather.
- ★ Check the O-ring, and if necessary replace it with a new part.

**f. ALTERNATOR AND STARTING MOTOR**

As the hours of engine employment indicate that the brushes are already worn out, you should request repair from a Komatsu distributor.

★ They should be repaired every 1000 hours, if the machine is frequently operated at night.

**g. ENGINE VIBRATION DAMPER**

Check the vibration damper for cracks or separation on rubber surface.

If there are cracks or separation, contact your Komatsu distributor for replacement.

**h. ENGINE VALVE CLEARANCE**

Ask Komatsu distributor to check engine valve clearance because special tools should be used.

## EVERY 4000 HOURS SERVICE

★ Maintenance for every 100, 250, 500, 1000 and 2000 hours should be carried out at the same time.

### a. WATER PUMP

Inspect the water pump for play in the pulley, grease leakage and water leakage.

If any fault is detected, ask Komatsu distributor to disassemble and repair or replace.

P-02039

— 91 —

WHEN REQUIRED

## WHEN REQUIRED

### a. CLEAN INSIDE OF COOLING SYSTEM

Clean the inside of the cooling system, change the coolant, and replace the corrosion resistor, according to the table.

★ Stop the machine on level ground when cleaning or changing the coolant.

★ Use a permanent type of antifreeze.

If, for some reason, it is impossible to use permanent type antifreeze, use an antifreeze containing ethylene glycol.

★ Be sure to replace the corrosion resistor cartridge.

★ Use city water for the cooling water.

If river water, well water or other such water supply must be used, contact your Komatsu distributor.

 **Antifreeze is flammable, so keep it away from any flame.**

● Add antifreeze in the cooling water

When deciding the ratio of antifreeze to water, check the lowest temperature in the past, and decide from the mixing rate table given below.

It is actually better to estimate a temperature about 10°C lower when deciding the mixing rate.

### Mixing rate of water and antifreeze

( ): PC220, PC240, PC280

Min. atmospheric temperature (°C)	-5	-10	-15	-20
Amount of antifreeze (ℓ)	5 (5)	6 (6.5)	7.5 (8)	8.5 (9)
Amount of water (ℓ)	15 (16)	14 (14.5)	12.5 (13)	11.5 (12)

★ We recommend use of an antifreeze density gauge to control the mixing proportions.

Type of antifreeze solution	Cleaning inside of cooling system and changing coolant	Replacing corrosion resistor
Permanent type antifreeze (All season type)	Every year (autumn) or every 2000 hours whichever comes first	Every 1000 hours and when cleaning the inside of the cooling system and when changing coolant
Non permanent type antifreeze containing ethylene glycol (Winter, one season type)	Every 6 months (spring, autumn) (Drain antifreeze in spring, add antifreeze in autumn)	
When not using antifreeze	Every 6 months or every 1000 hours whichever comes first	



**Corrosion resistor**

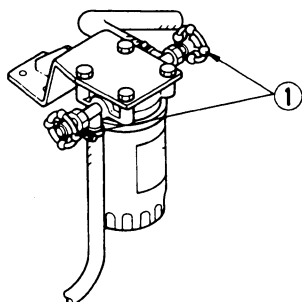

1. Stop the engine, close corrosion resistor valves (1).
2. Turn radiator cap (2) slowly until it comes off.

**⚠ If the water temperature is high, do not remove the cap. This is because of the possibility of scalding water spurting out. When removing the cap, turn the cap slowly to allow pressure to be relieved.**

**Water filler**



3. Loosen drain valve (3) at the bottom of the radiator and drain valve (4) at the cylinder block side and drain the cooling water.
4. Close drain valves (3) and (4) and pour in clean water (ex., city water) up to the vicinity of the water filler.

**(For PC280 only)**

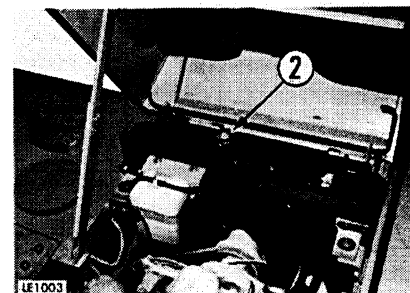

5. When the water reaches the vicinity of the water filler, put the engine at low idling, open the drain valves (3) and (4), then pass water through the cooling system until clean water comes out from the drain valves for 10 minutes.
- ★ When flushing, adjust the flow so that water is added at the same rate as the water is drained to keep the radiator always full.

P-04102

WHEN REQUIRED

**Drain valve (bottom of radiator)**

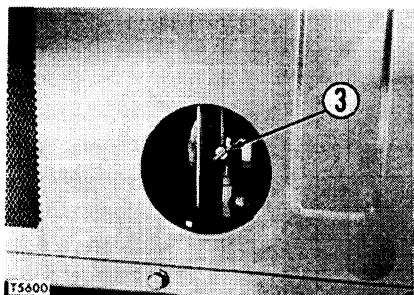

6. After washing the cooling system, stop the engine. Open drain valves (3) and (4) to drain water and close drain valves (3) and (4).
7. After draining off the cooling water, wash out the cooling system using commercially available detergent. Follow the instructions on the detergent container.

**Drain valve (cylinder block)**

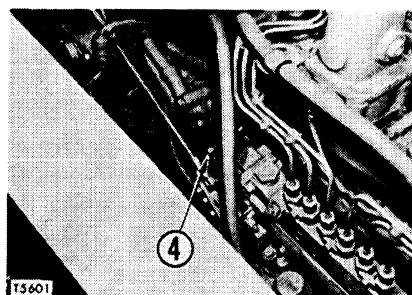

8. After washing the cooling system, drain all the water, then close the drain valves and pour in clean water (ex. city water) slowly up to the vicinity of the water filler.
9. When the water reaches the vicinity of the water filler, put the engine at low idling, open the drain valves, then pass water through the cooling system until clean water comes out of the drain valves.

**(For PC280 only)**

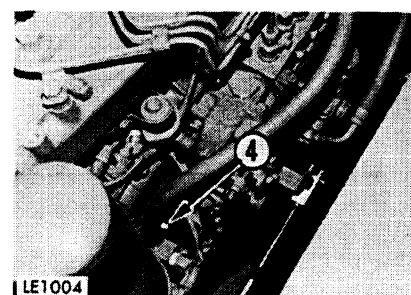

- ★ When flushing, adjust the flow so that water is added at the same rate as the water is drained to keep the radiator always full.
10. When the water becomes completely clean, stop the engine and close all drain valves.

**Sub-tank**

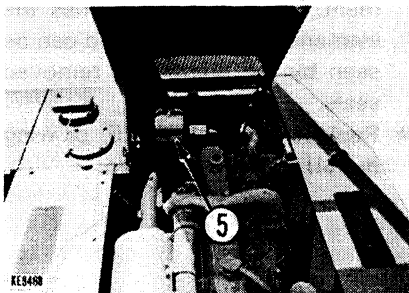

11. Replace the corrosion resistor cartridge and open valves (1).
- ★ For details of replacement of the corrosion resistor, see EVERY 1000 HOURS SERVICE.
12. Supply water until it overflows from the water filler.

**(For PC280 only)**

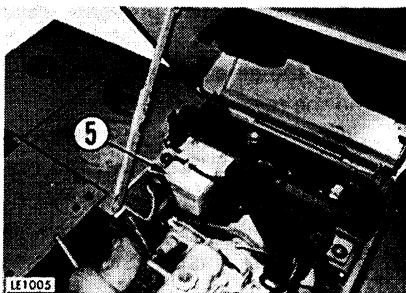

13. Run the engine 5 minutes at low idling and then for another 5 minutes at high idling to eliminate air trapped in the cooling system (leave the radiator cap off during the operation).
14. Stop the engine and wait for about 3 minutes. Supply cooling water up to the specified level. Tighten the cap.
15. Drain off the cooling water in sub-tank (5), clean the sub-tank interior, and add the water up to the FULL level.

**b. CHECK, CLEAN AND REPLACE AIR CLEANER ELEMENT**  
**Checking**

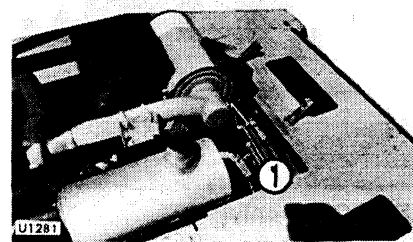

**(For PC280 only)**

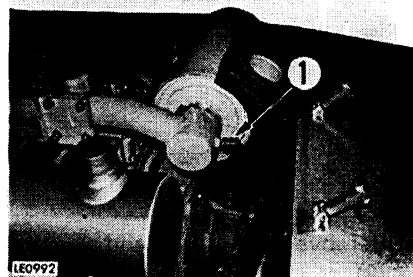

Whenever the red piston in dust indicator (1) appears, clean the air cleaner outer element. Stop the engine when cleaning the element.

WHEN REQUIRED

**Cleaning or replacing the element**

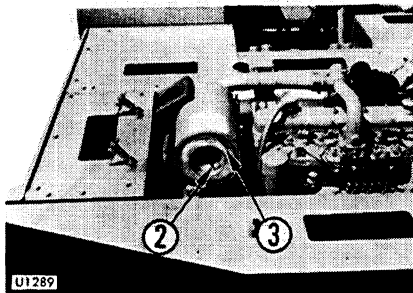

**(For PC280 only)**

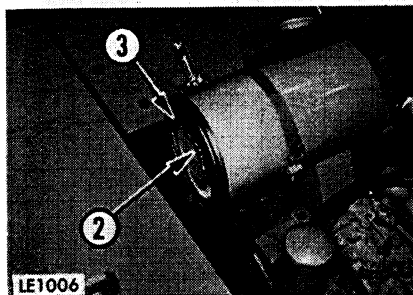

1. Remove wing nut (2) and element (3).

2. Place the cover over the air intake part to prevent dust entering.
  3. Clean the air cleaner body interior and the removed cover.
  4. Clean and inspect the element. (See the item "Cleaning the element" for cleaning procedure.)
  5. Remove the cover from the air intake port. Install the cleaned element.
  6. Push the dust indicator reset button to return the red piston to the original position.
- ★ Replace the element which has been cleaned 6 times repeatedly or used throughout a year.
  - ★ Replace the element when the dust indicator red piston appears soon after installing the cleaned element even though it has not been cleaned 6 times.

- ★ Remove one seal from the element. The number of times the element has been cleaned can be seen by the number of removed seals.
- ★ Replace seal washer (5) or wing nut (4) if they are broken.

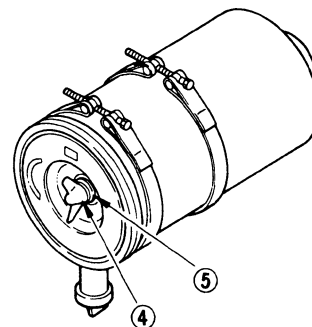

**⚠ Do not clean or replace the element with the engine running.**

## Cleaning the element

### With compressed air



Direct dry compressed air (less than 7 kg/cm<sup>2</sup>) to the element from inside along its folds, then direct it from outside along its folds and again from inside, and check the element.

**⚠ When using compressed air, wear safety glasses and other things required to maintain safety.**

The following methods require spare parts.

### With water

Dash city water (less than 3 kg/cm<sup>2</sup>) on the element from inside along folds, then from outside and again from inside. Dry and check it.

### With cleaning agent

For removing oils and fats as well as carbon, etc., attached on the element, the element may be cleaned in lukewarm solution of mild detergent, then rinsed in clean water and left to drip dry.

- ★ Drying can be speeded up by blowing dried compressed air (less than 7 kg/cm<sup>2</sup>) from the inside to the outside of the element.
- Never attempt to heat the element.
- ★ Using warm water (about 40°C) instead of soapy water may also be effective.

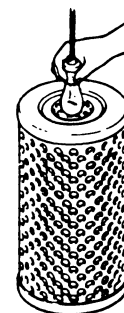

- ★ If small holes or thinner parts are found on the element when it is checked with an electric bulb after cleaning and drying, replace the element.
- ★ If the element is usable, wrap it and store it in dry place.
- ★ Do not use an element whose folds or gasket or seal are damaged.
- ★ When cleaning the element, do not hit it or beat it against something.

P-03890

WHEN REQUIRED

## c. CHECK TRACK TENSION

The wear of pins and bushings on the undercarriage will vary with the working conditions and soil properties. It is thus necessary to continually inspect the track tension so as to maintain the standard tension on it.

If the track tension is not at the standard value, adjust it in the following manner:

### Inspection

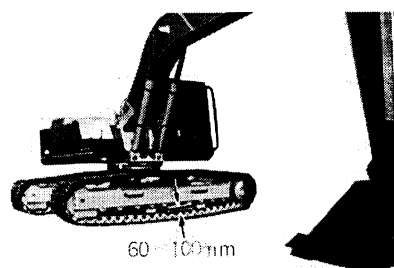

T5767

Raise the machine by means of the boom and arm, and measure the clearance between the tread of the fourth (the fifth) track roller from the sprocket and the roller contact face of the track link. If the clearance is between 60 and 100 mm, the track tension is normal.

( ): LC type

### Adjustment

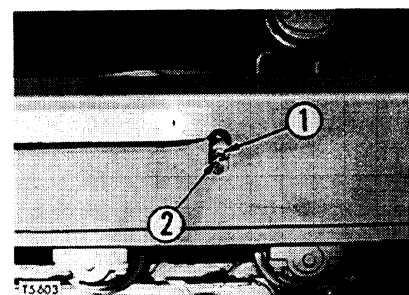

To increase the track tension, insert grease from grease fitting (1) of lubricator (2), and conversely to reduce tension, gradually return lubricator (2) to expel grease.

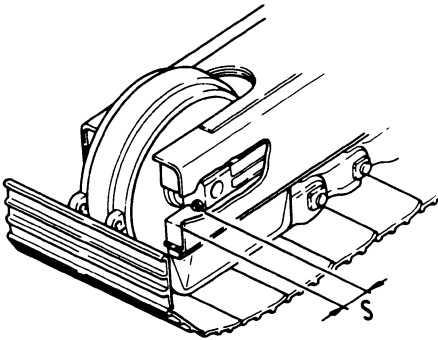

It is permissible to insert grease until S becomes 0 mm. If, despite doing this, the track tension is still too loose, the pin and bushing have become excessively worn and must either be inverted or replaced.

Have this work done by Komatsu distributor.

**⚠ When loosening lubricator (2), do not slacken it by more than one turn. Also, during this operation, do not loosen any part other than the lubricator. (This is because of the danger of grease spurting out under high pressure.) If the grease comes out sluggishly, move the machine slightly backward and forward.**

P-03892

WHEN REQUIRED

**d. CHECK ELECTRICAL INTAKE AIR HEATER**

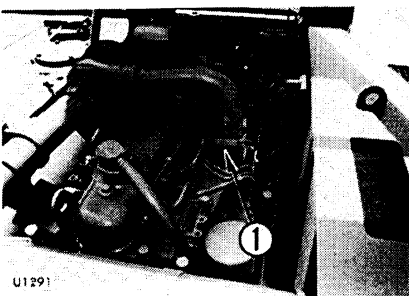

U1291

(For PC280 only)

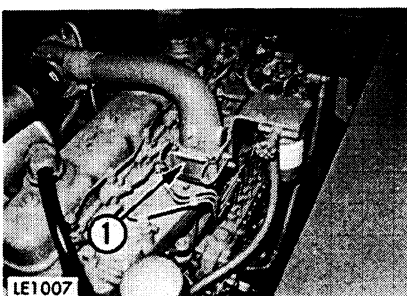

LE1007

Check electrical intake air heater (1) once a year before commencing work in the cold season.

Remove electrical intake air heater (1) from the engine intake connection, and check it for possible open-circuits and dirt.

When inspecting and replacing electrical intake air heater (1), replace the gasket with new one.

**e. TRACK SHOE BOLTS**

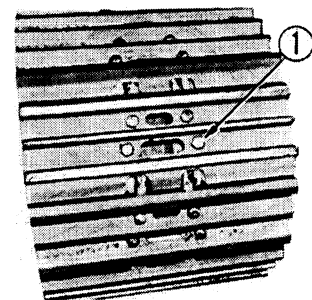

T5587

Shoe bolts (1) which secure track shoes to links will break if used in a loosened state.

Tighten all loosened bolts.

★ Track shoe bolts tightening torque: First,  $40 \pm 4$  ( $40 \pm 5$ ) kgm, tighten a further  $120^\circ \pm 10^\circ$  ( ): PC280  
PC280 - 3K:  $85 \pm 5$ kgm

**f. REPLACE BUCKET TEETH**

Replace the point before the adapter starts to wear.

★ Set the bucket so that its bottom is horizontal.

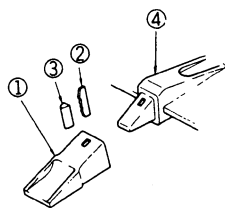

1. Use a hammer and drift to drive out lock pin (2), which is fixing point (1) to the bucket. (If the drift is struck while facing rubber pin lock (3), the rubber pin lock may break. Direct the drift to the back of the pin.)

2. Check lock pin (2) and rubber pin lock (3) which were removed.

★ If the lock pins and rubber pin locks with the following defects are used, the point may come off the bucket. Replace them with new ones.

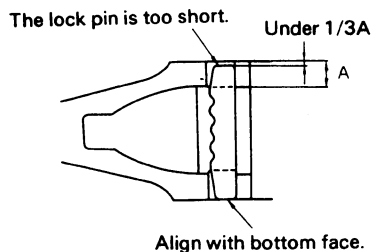

● A lock pin which is too short.

The rubber is broken and the steel balls come out easily.

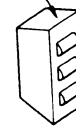

● A rubber pin lock, the rubber of which is broken and whose steel balls come out easily.

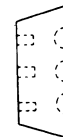

The steel balls can be buried when pressed with finger.

● A rubber pin lock, the steel balls of which can be buried by being pressed with a finger.

3. Clean the surface of adapter (4) and remove the soil from it with a knife.

P-02988

WHEN REQUIRED

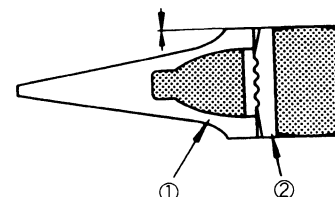
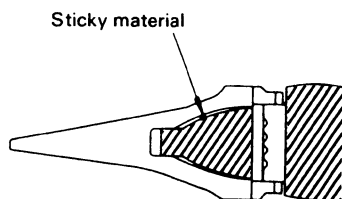
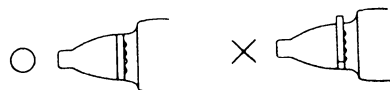

4. Use your hand or a hammer to drive rubber pin lock (3) into the hole of the adapter. Take care that the rubber pin lock does not project out of the adapter.

5. Clean the inside of point (1) and install it to adapter (4). If it is stained with soil or has projections, it will not fit to the adapter.

6. Fit point (1) to adapter (4), and confirm that when the pointer is pressed strongly, the rear face of the hole for the pin of the point is at the same level as the rear face of the hole for the pin of the adapter.

★ If the rear face of the hole for the pin of point (1) is projecting from that of adapter (4), do not drive in the pin. Instead, find out what substance is preventing point (1) from fitting to adapter (4), and remove it. Then fit point (1) to adapter (4) and drive in lock pin (2).

7. Insert lock pin (2) in the hole of the point and hit it until its top is the same level as the surface of point (1).

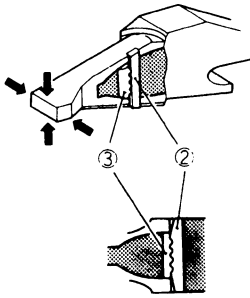

8. After replacing a bucket tooth, confirm that it is installed securely by doing the following:

- 1) Confirm that the surface of the lock pin is secured against the point.
- 2) Lightly hit lock pin (2) in the reverse direction from which it was hit in.
- 3) Lightly hit the tip of the point from above and below, and hit its sides from right and left.
- 4) Confirm that rubber pin lock (3) and lock pin (2) are set as shown in the above figure.

★ The life of the point can be lengthened and the frequency of its replacement can be reduced by turning it upside down so that it will wear evenly.

★ When replacing the point, replace the rubber pin and lock pin with new ones. This will prevent the point from falling.

P-00133

- 103 -

WHEN REQUIRED

### g. WATER SEPARATOR

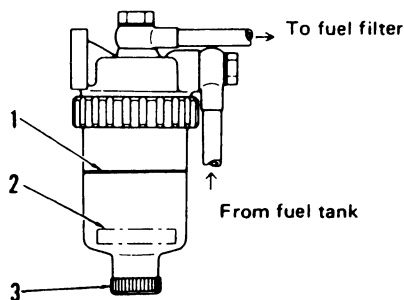

When float (2) is at or above red line (1), drain the water according to the following procedure:

1. Loosen drain plug (3) and drain the accumulated water until the float reaches the bottom.
2. Tighten drain plug (3).

3. If the air is sucked into the fuel line when draining the water, be sure to bleed the air in the same manner as for the fuel filter. (See Fuel Filter Cartridge in EVERY 500 HOURS SERVICE section.)

## ADJUSTMENT

### ADJUSTMENT OF BUCKET CLEARANCE

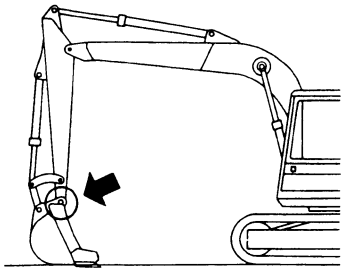

If there is excessive free play on the coupling section of the bucket and arm, adjust the bucket clearance in the following manner.

- ★ Set the work equipment in the posture as above.

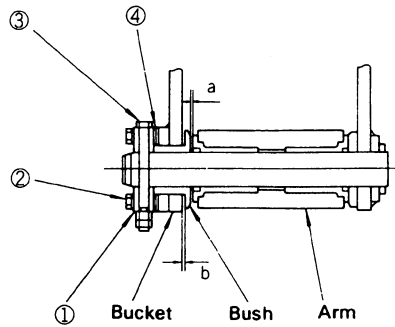

1. Loosen 4 bolts (2), bolt (3) and plate (1).
2. Take out shims (4) equivalent in size to free play "a".
  - ★ Thickness of shim (4) is 0.5 mm.
  - ★ When free play "a" is less than 0.5 mm, do not compress the shims by tightening bolt (2).

3. Tighten 4 bolts (2) and bolt (3).
  - ★ Tightening torque for bolt (2) is  $56 \pm 6$  kgm.
  - Then, clearance "b" becomes larger and free play "a" is removed.

P-02480

- 105 -

### TROUBLE SHOOTING GUIDE

## TROUBLE SHOOTING GUIDE

This guide is not intended to cover every conditions, however many of the more common possibilities are listed.

### ELECTRICAL SYSTEM

**Lamp does not glow brightly even when engine runs at high speed.**

**Lamp flickers while engine runs.**

- Check for loose terminals and open-circuit wiring.
- Adjust belt tension.

**Charge monitor does not go out even when engine runs at high speed.**

- Replace the alternator.
- Inspect and repair wiring.

**Unusual noise is emitted from the alternator.**

- Replace the alternator.

**Starting motor does not turn when starting switch is turned on.**

- Inspect and repair the wiring.
- Charge the battery.

**The pinion of the starting motor keeps going in and out.**

- Charge the battery.

**Starting motor turns the engine sluggishly.**

- Charge the battery.
- Replace the starting motor.

**The starting motor disengages before the engine starts up.**

- Check and repair the wiring.
- Charge the battery.

**The engine pre-heating monitor does not flash.**

- Check and repair wiring.
- Replace the heater relay.
- Replace the monitor.

**The engine oil pressure monitor does not light up when engine is stationary (when the starting switch is in ON position.)**

- Replace the monitor.
- Replace the monitor switch.

**Charge monitor does not light up when the engine is stationary. (When the starting switch is in ON position.)**

- Replace the monitor.
- Inspect and repair the wiring.

**Outside the electrical intake air heater is not warm when touched with the hand.**

- Check and repair wiring.
- Replace the electrical intake air heater.
- Check and repair the heater switch.

## ENGINE

**The engine oil pressure monitor flashes when engine speed is raised after completion of warm-up.**

- Add the oil to the specified level.
- Replace the oil element.
- Check oil leakage from the pipe or the joint.
- Replace the monitor.

**Steam is emitted from the top part of the radiator (the pressure valve).**

**The radiator cooling water level monitor flashes.**

- Supply the cooling water and check leakage.
- Adjust fan belt tension.
- Wash out inside of cooling system.
- Clean or repair the radiator fin.
- Replace the thermostat.
- Tighten the radiator cap firmly or replace the gasket of it.
- Replace the monitor.

**The engine does not start when the starting motor is turned over.**

- Add fuel.
- Repair where air is leaking into fuel system.
- Replace the injection pump or the nozzle.
- Check the valve clearance.
- Check engine compression pressure.
- Refer to the section of electrical system.

**Exhaust gas is white or blue.**

- Adjust to specified oil quantity.
- Replace with specified fuel.

**Exhaust gas occasionally turns black.**

- Clean or replace the air cleaner element.
- Replace the nozzle.
- Check engine compression pressure.
- Clean or replace the turbocharger.

**Combustion noise occasionally changes to breathing sound.**

- Replace the nozzle.

**Unusual combustion noise or mechanical noise.**

- Replace with specified fuel.
- Check over-heating.
- Replace the muffler.
- Adjust valve clearance.

P-02481

— 107 —

## TROUBLE SHOOTING GUIDE

### CHASSIS

**Slow speed of travel, swing, boom, arm and bucket**

- Add oil to specified level.

**Unusual noise emitted from pump**

- Clean the hydraulic tank strainer.

**No swinging**

- Check the left lock pin in place.

**Excessive oil temperature rise of hydraulic oil**

- Clean the oil cooler.
- Add oil to specified level.

**Track slip out of place**

**Excessive wear of the sprocket**

- Adjust tension of track.

**Bucket either rises slowly or not at all**

- Add oil to specified level.



**MECHATRONICS RELATED PARTS (If the machine equipped with 3 stage mode selector)**

## ● When normal

Indication of LED		Condition of machine	Abnormal section (system)
Red	Green		
Goes off	Lights	Machine is normal in the mode "S".	—
	Flashes fast	Machine is normal in the mode "H" or "L".	—
	Flashes slowly	Machine is normal and auto-decelerator is applied	—

- If the abnormalities given on the left appear, lower the work equipment to the ground, and check the LED display of the controller. Contact your Komatsu distributor for repairs.

- If there is any abnormality or cause not listed on the left, contact your Komatsu distributor for repairs.

## ● When abnormal

Goes off	Goes off	The engine stalls or slow down extremely while the machine is working (traveling).	Electric power source
Lights	Lights	The engine stalls or slow down extremely while the machine is working (traveling). The auto-decelerator is always applied or not applied at all.	Control box
Flashes slowly	Goes off	The engine stalls or slow down extremely while the machine is working (traveling).	T.V.C. valve solenoid
	Flashes	The work (travel) speed is extremely low.	Rotation sensor ※
Lights	Goes off	The mode selector does not change. speed and power.	Throttle sensor
	Flashes fast	The auto-decelerator is not applied at all or is always applied.	Auto decelerator solenoid B
	Flashes slowly		Auto decelerator solenoid A

※ While the engine is stopped, red and green LEDs indicate this abnormality of rotation sensor system.

P-02054

— 109 —

## SERVICE METER

**SERVICE METER**

This meter indicates the integrated work hours. So, use it according to the following instructions.

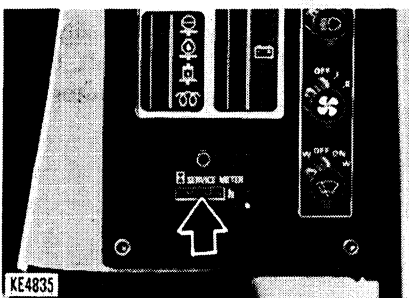

- Record the readings at the start and the end of work, this is the work record of the machine.
- This record will indicate, when periodical maintenance is due.
- It also indicates the integrated working hours when machine problems are encountered.

## ★ How the meter progresses

The service meter progresses by 1 when the engine is operated for one hour, regardless of the engine speed.

Consequently, if the engine is running, the service meter will advance even if the machine does not move.

- While engine is running, green pilot lamp on the service meter flashes to show the service meter advances.

# MACHINE AND ENGINE SERIAL NUMBERS

When calling for a service of mechanic or when making replacement-parts order, be sure to give Komatsu distributor the machine and engine serial numbers as well as the service meter reading before mentioned. These numbers are found on the plates shown in the photos below.

- Location of the engine serial number mark.

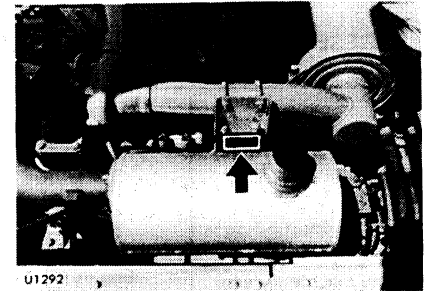

(For PC280 only)

- Location of the machine serial number mark.

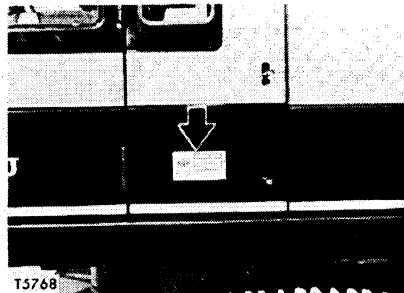

This is seen on the bottom left of the cab.

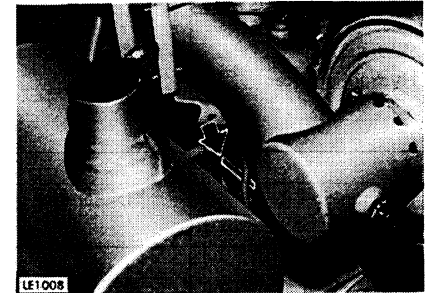

This is seen on the upper right of the cylinder block, when seen from the fan side.

P-02989

## FUEL, COOLANT AND LUBRICANTS

# FUEL, COOLANT AND LUBRICANTS

## PROPER SELECTION OF FUEL, COOLANT AND LUBRICANTS

RESERVOIR	KIND OF FLUID	AMBIENT TEMPERATURE					CAPACITY (ℓ)		
		14 -10	32 0	50 10	68 20	86° F 30° C	Specified	Refill	
Engine oil pan	Engine oil	SAE 30					PC200,PC210, PC280: 24 PC220,PC240: 25	24 25	
		SAE 10W							
		SAE 10W-30							
		SAE 15W-40							
Swing machinery case Final drive case (each)	Engine oil	SAE 30					8 PC200,PC210, PC220,PC240: 4 PC280: 10.5	7 4 10.5	
Hydraulic system		SAE 10W					250	150	
		SAE 10W-30							
		SAE 15W-40							
Fuel tank	Diesel fuel	※	ASTM D975 No. 2					280	-
Cooling system	Water	Add antifreeze					PC200,PC210: 20 PC220,PC240, PC280: 21	-	

※ ASTM D975 No. 1

**NOTE:**

(1)When fuel sulphur content is less than 0.5%, change oil in the oil pan every periodic maintenance hours described in this manual.

Change oil according to the following table if fuel sulphur content is above 0.5%.

Fuel sulphur content	Change interval of oil in engine oil pan
0.5 to 1.0%	1/2 of regular interval
Above 1.0%	1/4 of regular interval

ASTM: American Society of Testing and Material

SAE: Society of Automotive Engineers

API: American Petroleum Institute

Specified capacity: Total amount of oil including oil for components and oil in piping.

Refill capacity: Amount of oil needed to refill system during normal inspection and maintenance.

(2)When starting the engine in an atmospheric temperature of lower than 0°C, be sure to use engine oil of SAE10W, SAE10W-30 and SAE15W-40, even though an atmospheric temperature goes up to 10°C more or less in the day time.

(3)Use API classification CD as engine oil and if API classification CC, reduce the engine oil change interval to half.

# **SAFETY AND OPERATION**



P-02443

# CONTENTS

SAFETY HINTS . . . 	2
RADIO	15
LOCKING CAP	17
OPERATING THE CAR COOLER	18
OPERATING THE AIR CONDITIONER	20
EXCAVATOR'S WORK	26
HANDLING OF BATTERY	27
TRANSPORTATION	30
PRECAUTIONS FOR MAINTENANCE	32
STORAGE	38
COOLANT AND LUBRICANTS	40

P-04105

- 1 -

## SAFETY HINTS . . .

### OPERATION GENERAL



- Wear well-fitting helmet, safety shoes and working clothes. If the nature of the work requires safety, wear protective goggles or mask, thick gloves, ear plugs or other protection.

- Accidents or injuries are liable to occur when the operator is careless or slack. It is most important to bear safe operation in mind at all times.
- Take care of your health. Do not operate when tired, or after drinking.
- Learn the prohibitions, cautions and rules about work procedures in the work site.  
When there is a leader, fix standard signals and always follow these signals when operating.



- If there should be an accident or fire or any other such unexpected mishap, deal with it quickly, using the nearest apparatus. Learn beforehand the locations of the first aid boxes and fire extinguishers and how to use them. It is also important to know the emergency contact system.
- Learn about the safety devices on your own machine and about how to use them. Confirm that they are correctly attached in the prescribed position. Such safety devices include:
  - ★ Protective-Devices
  - ★ Seat Belts

- 2 -

P-04069

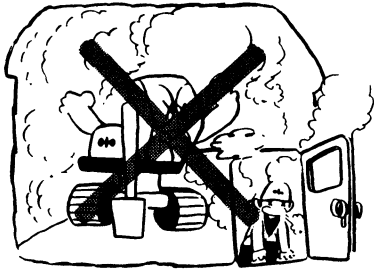

- Exhaust gas is dangerous. When running the engine for long periods in a poorly ventilated area, there is a danger of gas poisoning, so open the windows or doors to ensure a good supply of fresh air.
- Read the Operation and Maintenance Manual carefully. Learn how to use the control devices, gauges and warning devices. Be sure you understand the meaning of the caution plates. Remember the check points and checking method for engine oil, fuel, cooling water and hydraulic oil levels.

- When operating inside a building always be sure of the clearance of the ceiling, entrances, aisles, etc. and the load limit of the floor.
- Never allow other person than the operator to ride on the machine during operation.

## BEFORE STARTING OPERATION



- Examine the lay of the land and the kind of soil at the work site to determine the dangerous points and the best method of operation. Proceed with the work only after making safety arrangements about the dangerous points.
- Inspect leakages from the fuel, lubricating and hydraulic systems. Check that the shoe bolts are not loose, and that no other parts are damaged or missing. Machines having such failures should not be operated.

P-04070

- 3 -



- When getting on or off the machine, use the handrail provided. Do not jump up or down from the machine.



- Do not leave parts or tools lying around in the vicinity of or on the floor of the operator's cab. Keep everything in its proper place.
- Wipe off thoroughly any grease, oil or mud on the handrail, floor or control levers. Failure to do this may cause you to slip.
- Check the level of the fuel, lubricants and cooling water. Extinguish cigarettes before checking or replenishing. Check that the radiator cap and each oil filler caps or plugs are firmly tightened.

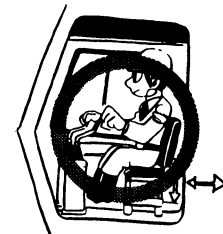

- Adjust the operator's seat until it is in the most comfortable position for operating. Always sit in the seat while operating. Do not operate the machine from any other position.

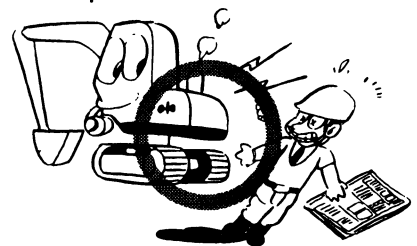

- To ensure the safety of workers near the machine, always sound the horn to warn them before starting the engine and moving the machine. Be particularly careful to check that the rear is clear before backing the machine.

- 4 -

P-04071



- Inspect the inside of the engine room and remove any dead leaves or papers. Dead leaves or papers are highly inflammable and can cause fires.

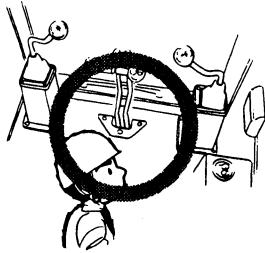

- Before starting the engine, confirm that all control levers are in NEUTRAL.

#### AFTER STARTING THE ENGINE

- Confirm that all gauges and warning devices are functioning correctly, and that the gauge readings are within the prescribed range.
- Check the play and travel of each lever.
- Operate the working equipment to confirm that they are functioning normally.



- Before operating the traveling and steering levers, check whether the track frame is forward or backwards. If the track frame is facing backwards, operate the traveling and steering levers in the reverse manner to that when the track frame is facing forward.

- Move the machine slowly and listen carefully to the engine or gears to confirm that they are not making any unusual noises.

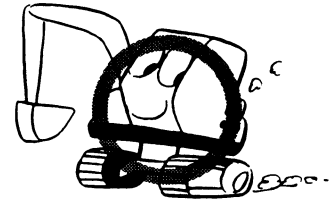

- Choosing a safe place, turn the machine to the left and right to confirm that the traveling and steering levers are functioning normally.
- If these tests reveal anything wrong, however slight it may be, contact the man in charge of the machine and operate the machine only after obtaining his permission.

P-04072

- 5 -

#### DURING OPERATION

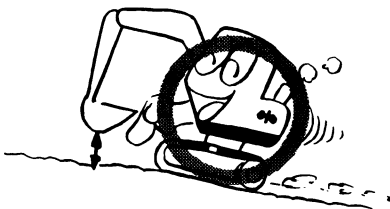

- Maintain the bucket at a height of 40 to 50 cm above the ground so that it can be quickly lowered to the ground and the machine stopped in an emergency.
- As far as possible, operate the machine so that it does not tilt. (Do not tilt it by more than 35° in either the forward, rear, left or right directions, even under static conditions.)

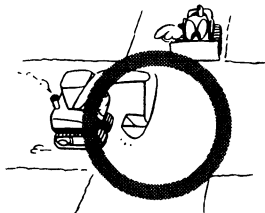

- Always operate slowly in crowded places. On haul roads or in narrow places, give way to loaded vehicles.
- Do not allow unauthorized persons into the work area.
- Before reversing or turning, ensure that there is nobody in the vicinity. Also, be careful of obstacles.

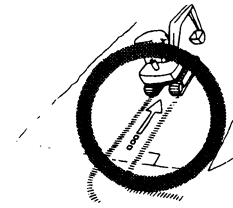

- When operating on slopes, as far as possible, avoid turning the machine on a slope. It may cause the machine to roll over or slip sideways.

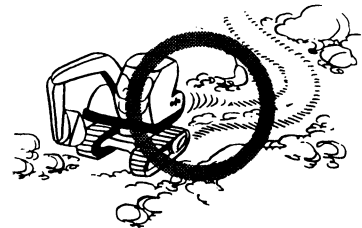

- When operating the machine along a road, retract the working equipment to improve machine stability. As far as possible proceed along a flat road.

- 6 -

P-04073

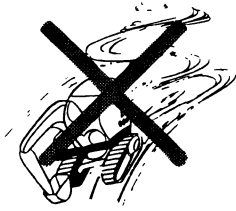

- The machine should always be operated at a speed where it can be correctly controlled. Never do the following:
  - 1) Speeding
  - 2) Sudden starting, sudden braking, sudden turning.
  - 3) Snaking
  - 4) Coasting
- When operating on uneven ground or in places where there are obstacles, remember the following points:
  - ★ Operate at as low a speed as possible and avoid sudden changes in direction.

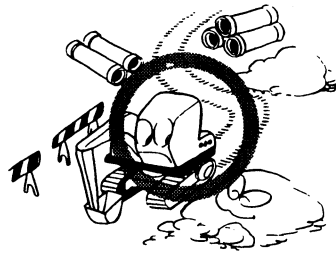

- ★ Wherever possible, avoid traveling over large rocks, fallen trees, tree stumps and other such obstacles. Either use the working equipment to remove them, or travel round them. When it is impossible to avoid traveling over them, reduce speed and mount over the obstacle. Just before the front of the machine tips down, reduce speed even more to make the shock of hitting ground as small as possible.
- ★ Never mount over an obstacle at an angle; never disengage one traveling and steering lever to travel over an obstacle.

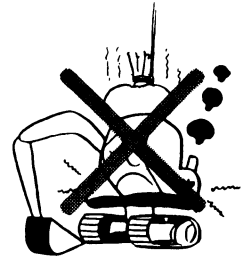

- The machine condition can be judged from many factors. Changes in the gauges, sound, vibration, exhaust gas color or response of the control levers can indicate the occurrence of some disorder. If any disorder occurs, park the machine immediately in a safe place and take appropriate action. Be especially careful in the case of a fuel leak as there is danger of fire.

P-04074

- 7 -

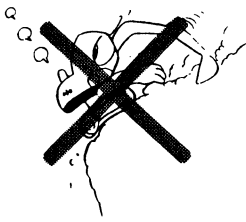

- The work area should be made as flat as possible. If the work area is flat, operation is made much easier and this reduces operator fatigue.
- Always concentrate. It is extremely dangerous to allow yourself to be distracted or to think of other things when operating a machine. In dangerous places, or where there is restricted visibility, it is important to get down from the machine and confirm whether it is safe before continuing work.



- Be careful of those around you, and always confirm that there is no person or obstacle in the way before moving or turning the machine.

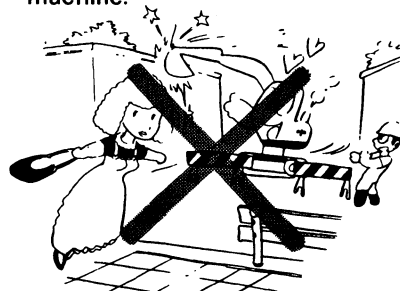

- When using the working equipment, be sure to keep your eyes on it all the time. Failure to do this may result in an accident.



- When passing through a narrow space, be careful of the side and overhead clearances. Take special care not to touch any obstacles on either side or overhead. If necessary, have someone outside the machine call out instructions.
- Be careful not to operate the machine into a bog. In the event that the machine goes into a bog, extract it in the following manner;
  - 1) If only one track of the machine is in the bog, push the bucket down against the ground on the side of the machine which is stuck so as to float the track. Then place logs or timber underneath the track and free the machine.

- 8 -

P-04075





★ When raising the undercarriage by means of the boom or arm, push the bottom of the bucket against the ground (on no account use the teeth) until the angle between the boom and the arm is 90° to 110°.

2) If both tracks of the machine are in the bog and slip, preventing the machine from getting in, place logs or timber under the tracks in the manner described in 1), then thrust the bucket into the soil in front of the machine and drag it out by bending the arm in the same manner as when excavating and putting the traveling and steering lever into the forward position.

● After earthquakes, confirm that the ground is still firm; after blasting, confirm that there are no unexploded charges remaining.



● When continuing operations after rain, remember that conditions will have changed from those before the rain started, so proceed with caution. Be particularly careful when approaching the shoulder of the road of cliffs, as they may have been loosened by the rain.



● When working on river embankments or other places made of piled soil, there is the danger that the weight of vibration of the machine may cause the machine to sink into the piled soil, so be extremely careful when operating in such places.

P-04076

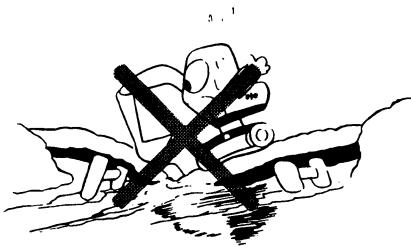

● Check the load limits of bridges before crossing.

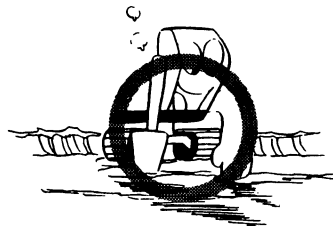

● When operating in water or when crossing shallows, first check the bed soil condition and the depth and flow speed of water, then proceed, taking care not to go beyond the permitted depth.



● When operating in fog, mist or smoke, where visibility is bad, be especially careful to confirm first whether operation is safe. When visibility drops below safety level, stop work and wait for the visibility to improve.



● When working in water or marshy ground, be careful of the following:

★ When working on soft ground, place thick boards on the ground to prevent the machine sinking. Place the boards horizontally and arrange them as neatly as possible.

★ First check the water depth, the firmness of the ground and the strength of the current. Do not enter if the water exceeds the permissible depth (up to the bottom of the swing circle).



- When operating at night, remember the following points:
  - ★ Be sure to arrange an adequate lighting system.
  - ★ At night it is very easy to make mistakes in assuming the distance and height of objects and land.

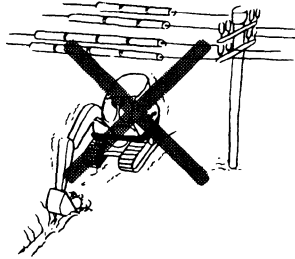

- Be very careful not to touch electric wires, always bearing in mind that there is a possibility of receiving an electric shock.
- ★ Wear rubber or leather soled shoes.
- ★ Position a full-time watcher at the site to ensure that operator is not exposed to the risk of electric shock.

- ★ Depending upon the supply voltage it is conceivable that an electric shock may be received by merely coming into the vicinity of an electric feeder wire. Accordingly, observe the minimum distances given in the table below, taking into account the inertia of the boom when in motion.

Supply voltage (number of insulators)	Minimum safe separation
6.6 kv (distribution line)	3 m
33.0 (1 to 3 insulators)	4 m
66.0 (5 to 8 insulators)	5 m
154.0 (10 to 18 insulators)	8 m
275.0 (16 to 30 insulators)	10 m

- ★ Become familiar with the necessary measures to be taken in the event that an operator receives an electric shock.

P-04078

— 11 —



- Do not perform excavation at the bottom of a precipice as it is dangerous practice.
- If it is unavoidably necessary to operate the working equipment lever when traveling the machine in the vicinity of a precipice, road shoulders, on sloping ground or through a confined space, stop the machine momentarily before operating the working equipment lever in order to minimize danger.

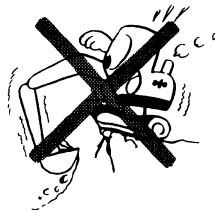

- When working on loose, crumbly soil, do not dig deeply and back the machine off smartly. If the ground crumbles, preventing the machine from getting away in time, do not panic and raise the working equipment. It is often better in the interests of stability to leave it down.
- Do not undercut the machine, unless absolutely necessary. If necessary, always take care to prevent the machine falling.

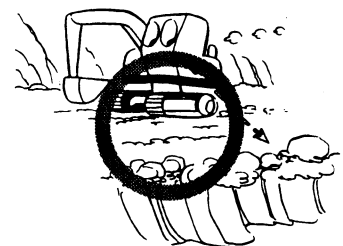

- When operating at the edge of a cliff or on the shoulder of a road, remember the following points:
  - ★ When operating in a place where there is danger of the machine falling over the side, be doubly careful. Do not approach the edge of the cliff or road shoulder by mistake.

— 12 —

P-04079



- If you suspect that there are buried facilities (water or gas pipes, etc.) at the work site, check with the companies responsible for looking after such facilities and also try a different method of excavation. Then, after confirming the existence and location of such facilities, carefully carry out excavation work.

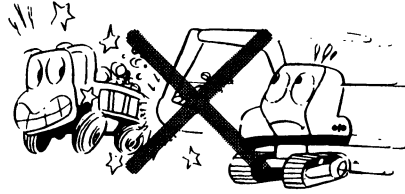

- Take care not to swing the bucket against the sides of trenches or dump trucks. Load the truck from the rear.

P-04080

- 13 -

## PARKING

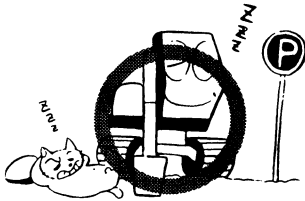

- When parking the machine, park it in a safe place outside the working area, or in the specified place. The following factors should be considered when choosing a parking place: it should be on flat, firm ground where there is no danger of rock-falls, landslides or floods. If the machine has to be parked on a slope, it should be parked facing directly up or down the slope, and chocks should be placed under the tracks. When the machine is facing downhill, lower the bucket so that it cuts slightly into the ground to further increase the safety.



- When parking the machine, return the working equipment levers to neutral, apply the brake lock, lower the bucket to the ground, and put all safety levers in the lock position. Switch off the engine and remove the key.
- Before leaving the machine, carry out the following:
  - ★ Apply the swing lock.
  - ★ Lower the bucket to the ground.
  - ★ Put the working equipment lever in neutral and lock it.
  - ★ Stop the engine and remove the key to prevent other people using the machine.
  - ★ Lock the cab.

- 14 -

P-04081

# RADIO

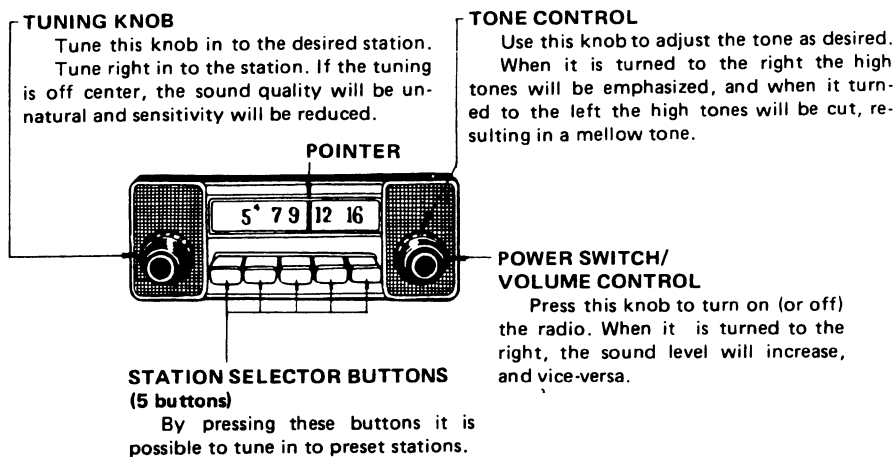

## How to set station selector buttons

Set the station selector buttons to the desired stations as shown in the following figure.



1. Pull back the button corresponding to the station to be preselected.



2. Turn the station selector knob until the pointer is in front of the desired station. (Carefully tune in so that noise disappears and the broadcast is heard plainly.)

W-03827

- 15 -

## RADIO

### Precautions when using radio

- To prevent possible breakdown, keep water well away from the speaker case and interior of the radio. In particular, close the window during rain or when washing the machine.
- Do not wipe the dial plate or knobs with benzine or paint thinners, etc. Always use a dry, soft cloth (if the radio is particularly dirty, soak the cloth in alcohol).
- Do not disassemble the radio.



3. Carefully push back the button with the fingertip until it clicks into place.

★ When setting the turning selector to a strong station, shorten the antenna to reduce the input as far as possible before carrying out alignment.

### Trouble shooting guide

#### No sound

- Turn the SW/VOL knob to the right and press it two or three times.

#### Sound quality is poor.

#### Reception is noisy.

- Return using the station selector knob. If the problem disappears, reset the tuning button.
- Try lengthening the antenna to its fullest extent.

## LOCKING CAP

A locking cap is available as an optional radiator cap, fuel tank cap or hydraulic tank cap. Open and close locking caps as follows:

### 1. To open the cap

1) Insert the key into the cap.

★ Insert the key as far as it will go. If the key is turned before it is inserted all the way, it may break.

2) Turn the key counterclockwise and bring the rotor groove in line with the aligning mark on the cap. Turn the cap slowly until a "clicking" sound is made. This releases the lock and allows the cap to be opened.

### 2. To lock the cap

1) Turn the cap into place.

2) Turn the key clockwise and take the key out.

★ When the cap is locked (against vandalism), it rotates freely.

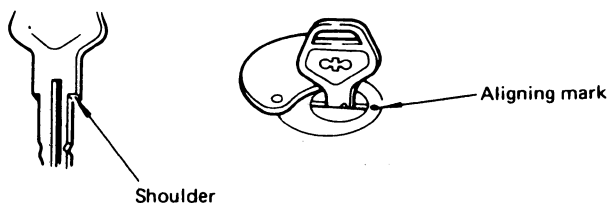
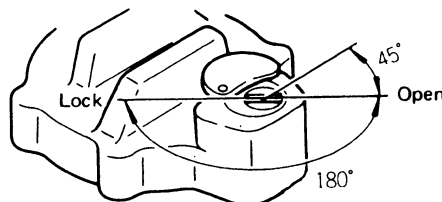

W-03826

- 17 -

## OPERATING THE CAR COOLER

## OPERATING THE CAR COOLER

### CONTROL PANEL

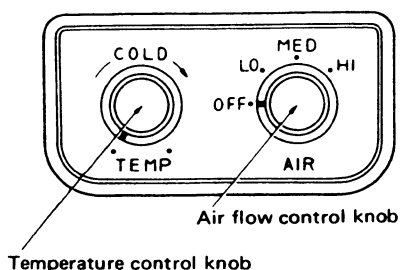

- Air flow control knob  
Turn from LO to MED or HI to increase the air flow.
- Temperature control knob  
Turn the knob clockwise to give a lower room temperature.

#### For efficient use

- ★ If the inside of the operator's cab is hot after the machine has been parked for a long time in the sun, open the windows and doors fully to cool the operator's cab before switching on the cooler.
- ★ When using the cooler, make sure that the windows and doors are properly shut.
- ★ If there is dirt or mud on the condenser, the cooler will not cool properly. When washing or checking the machine, always remove all dirt and mud from the condenser, to ensure a good flow of air.
- ★ For reasons of health, the temperature inside the cab should not be adjusted too low. As a general rule, the temperature should be kept at a maximum of 5 to 6°C below the outside temperature, enough to feel cool when entering the cab.

## CHECKING AND MAINTAINING CAR COOLER

### a. Checking coolant level

If the cooling effect is poor, check the side glass (liquid eye) of the receiver drier. If there are many bubbles, the coolant level is too low. Check whether there is any coolant, and have the cooler serviced.

### b. Clogging of condenser

If there is any dirt or mud stuck to the condenser, there will be a big reduction in the cooling efficiency of the condenser. That will mean a reduction in the cooling capacity, so clean the dirt and mud off and correct any bent fins with a screw-driver.

### c. Checking and adjusting V-belt tension

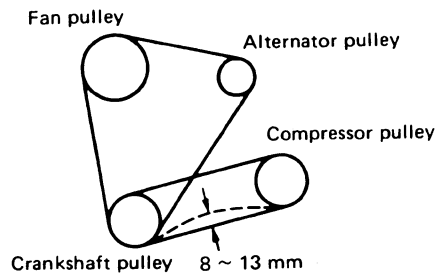

The slack should be 8 to 13 mm when pushed with a finger force of about 6 kg midway between the compressor pulley and the crankshaft pulley.

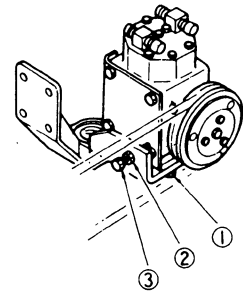

To adjust, loosen three bolts (1), then loosen lock nut (2) and move the compressor with adjustment bolt (3).

P-00055

- 19 -



## OPERATING THE AIR CONDITIONER

# OPERATING THE AIR CONDITIONER

### CONTROL PANEL

#### ① Outlet change-over knob

- Switches over air outlets

Knob position	Air outlet	Purpose
FOOT 	Floor	Heating Dehumidity
FACE 	Rear	Cooling

#### ② Heater temperature knob

- Controls heating temperature
- The nearer to WARM MAX. the knob goes, the higher heater outlet air temperature will be.
- At OFF position, water valve will be closed and heating function will stop.

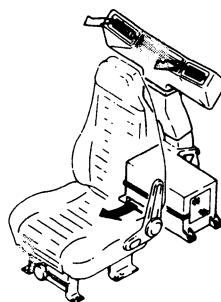
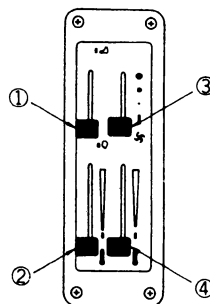

#### ③ Blower switch

- Used for both controlling the air flow in cooling and heating and as the main switch.
- Changeable at three steps; low, medium and high.
- Placing knob in OFF cuts off the power supply and stops the air conditioner.

#### ④ Cooler temperature knob

- The temperature is controlled with this knob for cooling. It is also the cooler switch.
- Move the knob towards LOW to decrease the output air temperature.
- When the knob is moved to OFF, the cooler switch is turned off and the cooling stops.

## OPERATION

### Cooling

Set the knobs to the following positions and a cool breeze will be flowed in from the rear vents.

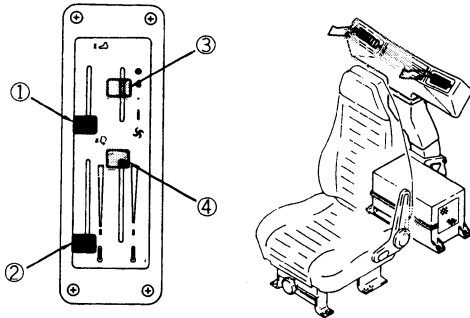

- Outlet change-over knob (1): FACE
- Heater temperature knob (2): OFF
- Blower switch (3): See table below.
- Cooler temperature knob (4): See table below.

Control knob	Blower switch (3)	Cooler temp. knob (4)
Purpose		
Quick cooling	HIGH	HIGH
Normal cooling	MEDIUM-LOW	MEDIUM
Gradual cooling	LOW	LOW

P-00057

### Heating

Set the knobs to the following positions, then warm breeze will be flowed in to the feet.

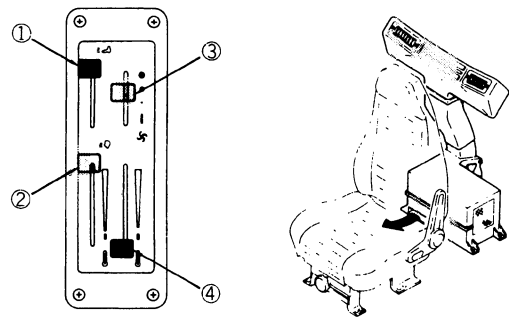

- Outlet change-over knob (1): FOOT
- Heater temperature knob (2): See table below.
- Blower switch (3): See table below.
- Cooler temperature knob (4): OFF

Control knob	Heater temp. knob (2)	Blower switch (3)
Purpose		
Quick heating	HIGH	HIGH
Normal heating	MEDIUM	MEDIUM or LOW
Mild heating	LOW	LOW

- 21 -

## OPERATING THE AIR CONDITIONER

### Dehumidity and heating

Set the knobs to the following positions and a dry, fresh, warm breeze will be flowed from the vents at operator's feet.

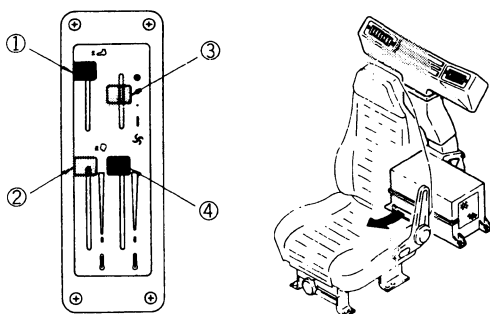

- Outlet change-over knob (1): FOOT
- Heater temperature knob (2): See table below.
- Blower switch (3): See table below.
- Cooler temperature knob (4): HIGH

Control knob	Heater temp. knob (2)	Blower switch (3)
Purpose		
Dehumidifying and heating	Winter	HIGH
	Spring and Autumn	MEDIUM or LOW
		HIGH

★ If very damp air is used for heating, only hot, humid air will be sent to the cab, producing an unpleasant atmosphere. This air conditioner first cools the air to dehumidify it, and then reheats it to produce the optimum heating conditions. In addition, there is no problem with the windows misting up. This setting is particularly useful in spring, autumn or on rainy days when the air is very damp.

- When the outside temperature is from 2°C to 6.5°C, a low pressure cut switch functions to automatically and switch the compressor off. In this situation it is impossible to use the combination of dehumidifying and heating.

- 22 -

P-00058

**Precautions for using air conditioner**

- When cooling, change the air occasionally.
- Smoking in the air-conditioned cab will cause your eyes to get sore. While smoking, open the window to let the smoke out of the cab.
- While using the air conditioner, open the window once every hour.

- When using the cooler, make sure the hot water circuit is completely stopped.
- If hot water is circulating in the heater, it is like having a hot water bottle in the cab. Always make sure the heater temperature knob is at the OFF position.
- When not using the heater for a long period, fully close the hot water outlet and inlet valves under the engine water manifold and radiator.
- Be careful not to overcool the cab.  
The cab should feel cool when entering there from outside (5°C or 6°C lower than the outside temperature). It is unhealthy to have the temperature in the cab too low. Always give careful consideration to temperature regulation.

**INSPECTION AND MAINTENANCE**

**Clean air filter**

If the air filter inlets is clogged, the heating or cooling capacity will drop.

Clean the air filter with compressed air once a week.

**OPERATING THE AIR CONDITIONER**

**Check tension of compressor belt.**

If the belt is loose, it will slip and the air conditioner will not be able to cool properly.

Periodically press the mid-point of the belt with the finger and check that the deflection is 15 to 18 mm.

When the belt is new, it is particularly liable to stretch, so always adjust it after 2 to 3 days.

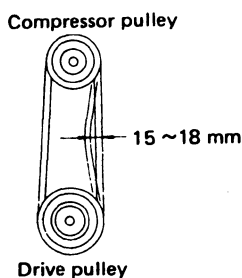

**Check volume of refrigerant (gas)**

If there is a lack of refrigerant, the cooling performance will be poor.

When operating the cooler at high speed, there should be no bubbles in the sight glass (inspection window) mounted on the condenser unit receiver.

If there are any bubbles, there is a lack of gas, so have to add refrigerant at a shop.

**⚠ The refrigerant used in the cooler is colorless and odorless, and is harmless when released into the atmosphere. However if it gets in the eyes or on the hands, it will be cause of burn or loss of sight, so never loosen any part of the refrigerant circuit.**

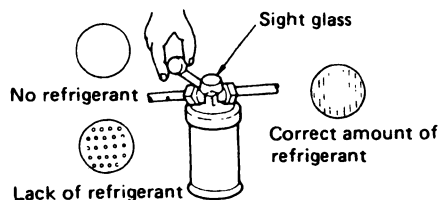



**Check during off-season**

When the air conditioner is not being used, run the compressor at low speed for a few minutes every week to avoid loss of oil. (Run the engine at low speed with the cooler temperature regulator knob at LOW COOL.)

- ★ In cold weather, do not run the compressor suddenly at high speed. This may cause failure in the compressor. When the temperature is below 2 to 6.5°C, the low pressure cut-off switch functions to stop the compressor from running even when the air conditioner switch is pressed.

P-01870

- 25 -

## EXCAVATOR'S WORK

**EXCAVATOR'S WORK**

In addition to the following, it is possible to further increase the range of applications by using various attachments.

**BACK HOE WORK**

A back hoe is suitable for excavation at a position lower than the machine. It is possible to effectively move the arm through 30° in the direction towards the machine and 45° in the direction away from the machine, making for efficient work.

**SHOVEL WORK**

A shovel is suitable for excavation at a position higher than the machine. Shovel work is performed by attaching the bucket in the reverse direction.

**LOADING WORK**

About half of the time spent during excavating and loading work is taken up swinging. Maximum work efficiency can be attained by carrying out work in such a way that the swinging angle is kept as small as possible in accordance with the terrain.

When loading, it is better to fit the machine in the longitudinal direction of the dump truck and to load from the front of the dump truck body. This both facilitates loading and also enables a greater amount of material to be loaded as compared with loading from the side of the truck.

**DITCH DIGGING WORK**

Ditch digging work can be performed efficiently by attaching a bucket to match the width of the ditch and then setting the tracks parallel to the line of the ditch to be excavated.

To excavate a wide ditch, first dig out both sides and then finally remove the center portion.

## HANDLING OF BATTERY

### PRECAUTIONS FOR CHARGING BATTERY

1. Before charging, disconnect the cable from the negative (–) terminal of the battery. Otherwise, an unusually high voltage will damage the alternator.
2. While charging the battery, remove all battery plugs for satisfactory ventilation. To avoid gas explosions, do not bring fire or sparks near the battery.
3. If the electrolyte temperature exceeds 45°C, stop charging for a while.
4. Turn off the charger as soon as the battery is charged. Overcharging the battery may cause followings:
  - 1) Overheating the battery
  - 2) Decreasing the quantity of electrolyte.
  - 3) Damaging the electrode plate.
5. If the electrolyte gets on your skin or clothes, immediately wash with plenty of clean water.
6. Do not mix up cables (positive (+) to negative (–) or negative (–) to positive (+)), as it will damage the alternator.
7. When inspecting or servicing a battery, be sure to stop the engine and turn the starting switch key to "OFF" position.
8. When performing any service to battery besides checking the electrolyte level or measuring the specific gravity, disconnect cables from the battery.

P-01401

– 27 –

### HANDLING OF BATTERY

#### REMOVAL AND INSTALLATION OF BATTERY

- When removing the battery, first disconnect the cable from the ground (normally, from the negative (–) terminal). If a tool touches a cable connecting the positive terminal and the chassis, there is danger of sparks being emitted.
- When installing the battery, the ground cable should be connected to the ground terminal as the last step.

#### STARTING ENGINE WITH A BOOSTER CABLE

When starting the engine with a booster cable, do as follows:

1. Before connecting the booster cable
  - 1) Size of booster cable and clip should be suitable for the battery size.
  - 2) Check cables and clips for breaks, corroded surfaces, etc.
  - 3) Make sure cables and clips are firmly secured.
  - 4) Keep the starting switch in the "OFF" position.
  - 5) The battery of the running engine must be the same capacity as that of the engine to be started.

2. Connect the booster cables in the following manner.

- 1) Connect one clip of booster cable A to the positive (+) terminal of the engine to be started.
  - 2) Connect the other clip to the positive (+) terminal of the engine which is running.
  - 3) Connect one clip of booster cable B to the negative (–) terminal of the engine which is running.
  - 4) Connect the other clip to the engine block to be started.
- ★ Make sure the clips are firmly connected to battery terminals. Then, start the engine.

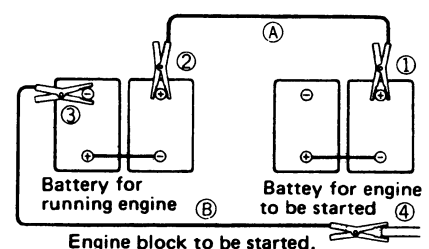

**⚠** When connecting the cables, never contact the positive (+) and negative (–) terminals.

**⚠** Make sure that the booster cable connections are correct. Connect the booster cable to the engine block as far as possible from the battery.

### 3. Starting engine

- 1) Turn the starting switch to START position and start up the engine.
- 2) If the engine doesn't start at first, try again after 2 minutes or so.

After the engine has started, the booster cables should be disconnected in the reverse order in which they were connected.

1. Disconnecting the booster cables
  - 1) Disconnect the clip of booster cable B from the engine block which was started.
  - 2) Disconnect the other clip from the negative (–) terminal of the running engine.

- 3) Disconnect the clip of booster cable A from the positive (+) terminal of the running engine.
- 4) Disconnect the other clip from the positive (+) terminal of the engine which was started.

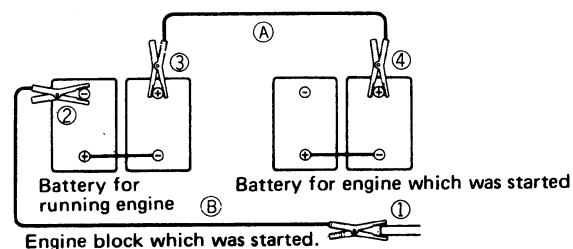

PP-01403

– 29 –

## TRANSPORTATION

### TRANSPORTATION

When transporting the machine, observe the various road rules, road transportation vehicle laws and vehicle limit ordinances, etc. It is a good idea to obtain a special platform for loading and unloading the machine. When it is unavoidably necessary to use a gangplank, however, at the very least observe the following for the sake of safety.

1. Properly apply the brakes on the trailer and insert blocks beneath the tires to ensure that it does not move. Then fix the gangplank in line with the centers of the trailer and the machine.
  - ★ Make sure the gangplank has sufficient width, length and thickness to enable the machine to be safely loaded and unloaded.
  - If the gangplank sags appreciably, reinforce it with blocks, etc.
  - ★ Lock the upper works using the swing lock lever.
2. Determine the direction of the gangplank, then slowly load or unload the machine.
  - ⚠ Remove the mud from the undercarriage to prevent the machine from slipping to the side on slopes.**
  - ★ Move the machine backward to get on the trailer.
  - ★ Do not on any account change the direction of the machine while it is on the gangplank. To change the direction of the machine, first take it down from the gangplank.
3. Correctly load the machine onto the specified part of the trailer. After loading the machine, fully extend the bucket and arm cylinders, then slowly lower the boom.
  - ★ When transporting the machine, place rectangular timber under one end of the bucket cylinder to prevent it touching the ground, thereby saving it from possible damage.

4. When transporting the machine, place rectangular timber underneath the front and rear track shoes to prevent the machine from moving about. Also, hold it down with chains or rope. Be particularly careful to ensure that the machine does not slip sideways.
  5. Lock the swing lock lever and apply the lock to the working equipment lever.
- ★ Determine the route for transporting the machine by taking into account the width, height and weight of the machine.

P-02018

- 31 -

## PRECAUTION FOR MAINTENANCE

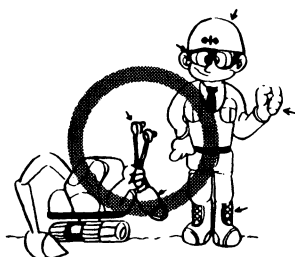
**PRECAUTION FOR MAINTENANCE****SAFETY . . . . . ⚠**

- Wear well-fitting helmet, safety shoes and working clothes. When drilling, grinding or hammering, always wear protective goggles.



- Fuel or oil are dangerous substances. Never handle fuel, oil, grease or oily clothes in places where there is any fire or flame. As preparation in case of fire, always know the location and directions for use of fire extinguishers and other fire-fighting equipment.

- Do not handle electrical equipment while wearing wet gloves, or in wet places, as this can cause electric shock.
- During maintenance do not allow any unauthorized person to stand near the machine.

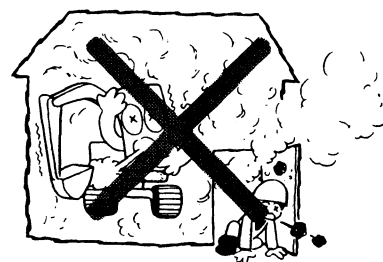

- Exhaust gas is dangerous. When working inside, be particularly careful to have good ventilation.

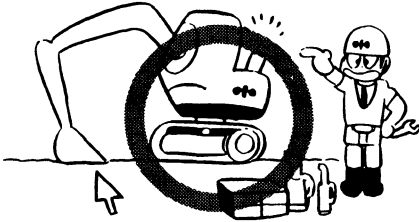

- Unless you have special instructions to the contrary, maintenance should always be carried out with the engine stopped. Lock the swing lock lever and also all of the safety levers. If maintenance is carried out with the engine running, there must be two men present: one sitting in the operator's seat and the other one performing the maintenance. In such a case, never touch any moving part.



- When working underneath the machine, place a sign to that effect on the operator's seat and, if necessary, put a similar signs in the vicinity as well.
- Do not go underneath the machine after raising it up using the boom and the arm.

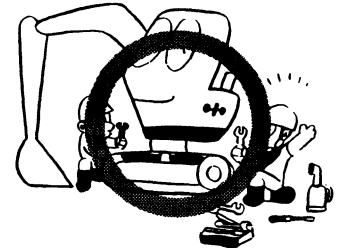

- When working with others, choose a group leader and work according to his instructions. Do not perform any maintenance beyond the agreed work.
- When maintenance has to be carried out with the working equipment raised, they must be securely supported by blocks.

P-04083

PRECAUTION FOR MAINTENANCE



- Always remember that the hydraulic oil circuit is under pressure. When feeding or draining the oil or carrying out inspection and maintenance, release the pressure first.

Method of relieving pressure

- 1) Lower the working equipment to the ground and stop the engine after idling it for two or three minutes. Then operate the various operation levers. (working equipment, traveling and steering lever through their full stroke in each direction)

When removing air instruments or pipings, open the drain valve under the air reservoir to relieve air pressure.

- 2) Gradually unscrew the cap of the hydraulic tank and leave it for a few minutes.



- Flames should never be used instead of lamps. Never use a naked flame to check leaks or the level of oil, fuel, antifreeze or electrolyte.
- Immediately remove any oil or grease on the floor of the operator's compartment, or on the handrail. It is very dangerous if someone slips while on the machine.
- Be particularly careful when removing the radiator cap. If this is done immediately after using the machine, there is a danger that boiling water may spurt out.

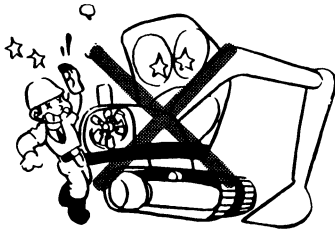

- Do not check the fan belt tension while the engine is running. Be sure to turn off the engine before inspecting other rotating parts and the vicinity thereof.

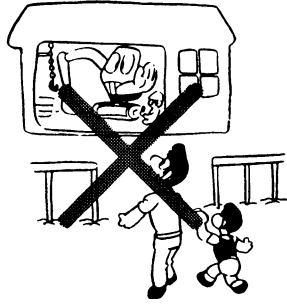

- Do not allow anybody other than the necessary workers to go near the machine while it is being inspected or maintained. Also, be careful of people in the vicinity. It is necessary to exercise particular care when performing grinding or welding, or when swinging a large hammer.

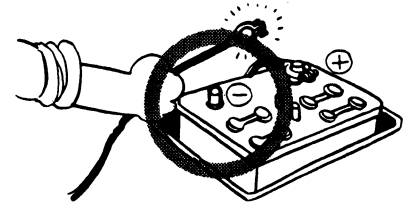

- Remove the minus terminal from the battery in maintaining the electrical system.
- When the tracks are removed, never put your fingers between the shoes.
- When carrying out other difficult maintenance works, carrying them out carelessly can cause unexpected accidents. If you consider the maintenance is too difficult, always request Komatsu distributor to carry out it.



- Use the tool which is suitable for the maintenance work.

P-04085

— 35 —

PRECAUTIONS FOR MAINTENANCE

MISCELLANEOUS

- Thoroughly wash the machine, particularly the oiling and greasing parts and the vicinity, thereof, in order to prevent the ingress of dust.
- Use genuine Komatsu replacement parts specified in the parts list.
- Use Komatsu specified oil and grease. Use oil and grease having the recommended viscosity for the particular ambient temperature.
- Use clean oil and grease and keep them in clean containers to avoid the ingress of dust.
- Inspect or replace oil in a dust-free location to prevent the ingress of dirt.
- Drain off used oil after heating it to a suitable temperature (about 20 to 40°C).

- After replacing oil, filter element or strainer, bleed the air from the circuit.
- When the strainer is located in the oil filler, the strainer must not be removed while adding oil.
- When adding oil or checking the oil level, check that the oil is at the correct level.
- After greasing up, always wipe off the old grease that was forced out.
- When changing the oil or filter, check the drained oil and filter for any signs of excessive metal particles or other foreign materials.
- When removing parts containing O-rings, gaskets or seals, clean the mounting surface and replace with new sealing parts.

- When washing the machine, ensure that water does not get onto the alternator.
- Special measuring apparatus is needed for testing hydraulic pressure.
- Thoroughly wash the machine. In particular, be careful to clean the filler caps, grease fittings and the area around the dipsticks. Be careful not to let any dirt or dust into the system.
- When check an open cover there is a risk of dropping things in. Before removing the covers to inspect cover, empty everything from your pockets. Be particularly careful to remove wrenches and nuts.

- When working on the sea shore, check that the various plugs and valves, etc., are tightened up properly. After the completion of work, thoroughly wash the machine and carefully clean all electrical equipment to ensure that it does not corrode.
- Before working in muddy water, rain or snow, check that the various plugs, valves, are properly screwed up. Upon completion of work, wash the machine, then check the various parts of the machine for cracking, scratching, loose or missing nuts and bolts. Also, oil and grease the various parts of the machine.
- When working on rocky ground, be careful of damage to the undercarriage, loose nuts and bolts, cracks, wear and other damage. Also, adjust the track tension so that it is a little slacker than usual.
- When working in a dusty location, be careful of the following:
  - 1) Inspect the dust indicator to see whether the air cleaner is blocked up. Clean the air cleaner as soon as it becomes dirty.
  - 2) Clean the radiator core so that it does not become blocked up.
  - 3) Clean or replace the fuel filter as soon as it becomes dirty.
  - 4) Clean the electrical equipment, particularly the starting motor and alternator, to prevent accumulation of dust.
- When installing car radio and a walkie-talkie or citizen band, contact your Komatsu distributor.
- When washing the machine, take care not to splash water over the electrical equipment. If it is soaked with water, it may not operate normally.
- After disconnecting the connector, cover it with a vinyl bag to prevent oil or dust from sticking to its contact section.
- When welding, be careful of the following:
  - 1) Turn OFF the power (starting switch).
  - 2) Do not continuously apply more than 200 V.
  - 3) Install the ground cable at least 1 m from the range to be welded.
  - 4) Take care not to install the seals between the grounded point and the range to be welded.

P-00098

- 37 -

## STORAGE

**STORAGE****BEFORE STORAGE**

To place the machine in storage for an extended period of time, the following measures must be taken to insure that it can be returned to operation with minimum of service.

- After every part is washed and dried, the machine should be housed in a dry building. Never leave it outdoors.
- In case it is unavoidable to leave it outdoors, lay wood plates on the ground, and park the machine on the wood plates and cover it with canvas, etc.
- Completely fill the fuel tank, lubricate and change the oil before storage.
- Apply a thin coat of grease to metal surfaces (hydraulic piston rods and front idler adjusting rods).
- As for the batteries, remove the terminals and cover them, or remove them from the machine and store separately.
- When the ambient temperature is anticipated to drop below 0°C, always add antifreeze in the cooling water.
- The fuel control lever should be set to STOP position.

**DURING STORAGE**

- Operate the engine and move the machine for a short distance once a month so that a new film of oil will be coated over movable parts and component surfaces.
- Before operating the working equipment, wipe off the grease on the hydraulic piston rod.

**⚠** If it is unavoidably necessary to carry out the rust-preventive operation while the machine is indoors, open the doors and windows to improve ventilation and prevent gas poisoning.

**AFTER STORAGE**

After storage (when it is kept without cover or the rust-preventive operation once a month is not made), you shall apply the following treatment before operation.

- Loosen the drain plugs on oil pan and other cases and drain mixed water.
- Remove the cylinder head cover and lubricate sufficiently valves and rocker arms. And inspect the valve operation.
- After the engine is started, operate it until it is warmed up completely.

**Engine with turbocharger only**

Remove the oil pipe flange on the turbocharger oil inlet, fill with 0.5 to 1 l engine oil, and leave the flange lightly loosened. Then, rotate the engine by the starting motor without fuel injection and decompression so that the discharge of oil is confirmed. Then, tighten the flange and start the engine.

## COOLANT AND LUBRICANTS

**COOLANT AND LUBRICANTS**

No.	Supplier Name	Engine Oil [CD] SAE10W, SAE30, SAE10W/30, SAE15W/40	Grease [Lithium-Base] NLGI-2	Anti-Freeze Coolant [Ethylene Glycol Base] [Permanent Type]
1	AGIP	Diesel Sigma S Superdiesel Multigrade	GR M	—
2	AMOCO	Amoco 300	Super Permalube Grease	—
3	ARCO	Arco Fleet S-3 Plus	Litholine H-EP	—
4	BP	Vanellus C-3	Energrease L2 Energrease LS2	Antifreeze
5	CALTEX	RPM Delo 300 RPM Delo 400	Marfak Multipurpose Marfak All Purpose	AF Engine Coolant
6	CASTROL	RX Super CRD	LM Grease	Antifreeze
7	CHEVRON	Delo 300 Delo 400	Multi-Motive Grease Ultra-Duty Grease 2	—
8	ELF	Multiperformance 3C Performance 3C	Multi EPEXA 2	Glacelf
9	EXXON (ESSO)	Essolube D-3 Essolube XD-3 Essolube XD-3 Extra	Multi Purpose Grease Beacon EP2	—



No.	Supplier Name	Engine Oil [CD] SAE10W, SAE30, SAE10W/30, SAE15W/40	Grease [Lithium-Base] NLGI-2	Anti-Freeze Coolant [Ethylene Glycol Base] [Permanent Type]
10	GULF	Super Duty	Gulfcrown Grease No. 2 Gulfcrown EP Special Grease No. 2	Cruisemaster Antifreeze and Summer Coolant
11	MOBIL	Delvac 1300 Delvac 1400 Delvac 1400 Super	Mobilgrease MP Mobilgrease 77 Mobilgrease 532 Mobilux EP2	Permazone
12	PENNZOIL	Supreme Duty Fleet Multi-Duty	Multi-Purpose No. 705 Wheel Bearing No.707L	Anti Freeze & Summer Coolant
13	SHELL	Rimula Rimula X	Alvania Grease EP	—
14	SUN	Sunfleet Dieselube XL Sunfleet Super C	Sunfleet HP Sun Prestige 742 EP	Sunoco Multi-Season Anti-Freeze
15	TEXACO	Ursa Super Plus Ursa Oil LA Ursa Super LA	Marfak All Purpose Marfak Multi Purpose 2	Startex AF & Summer Coolant
16	TOTAL	Rubia S Rubia x	Multis EP2	Antifreeze
17	UNION	Guardol	Unoba EP	—