

# Operation & Maintenance Manual

## D31E-20

## D31P-20

## D31PL-20

## D31PLL-20

## D31P-20A

## D37E-5

## D37P-5A

### BULLDOZER

<b>SERIAL NUMBERS</b>	<b>D31E-20</b>	<b>42723 and up</b>
	<b>D31P, PL-20</b>	<b>47617 and up</b>
	<b>D31PLL-20</b>	<b>47653 and up</b>
	<b>D31P-20A</b>	<b>47617 and up</b>
	<b>D37E-5</b>	<b>3731 and up</b>
	<b>D37P-5A</b>	<b>3661 and up</b>

This material is proprietary to Komatsu America Corp. and is not to be reproduced, used, or disclosed except in accordance with written authorization from Komatsu America Corp..

It is our policy to improve our products whenever it is possible and practical to do so. We reserve the right to make changes or improvements at any time without incurring any obligation to install such changes on products sold previously.

Due to this continuous program of research and development, revisions may be made to this publication. It is recommended that customers contact their distributor for information on the latest revision.

Copyright 2003 Komatsu  
Printed in U.S.A.  
Komatsu America Corp.

# 1. FOREWORD

---

This manual provides rules and guidelines which will help you use this machine safely and effectively. Keep this manual handy and have all personnel read it periodically. If this manual has been lost or has become dirty and can not be read, request a replacement manual from Komatsu or your Komatsu distributor.

If you sell the machine, be sure to give this manual to the new owners.

Continuing improvements in the design of this machine can lead to changes in detail which may not be reflected in this manual. Consult Komatsu or your Komatsu distributor for the latest available information of your machine or for questions regarding information in this manual.

This manual may contain attachments and optional equipment that are not available in your area. Consult Komatsu or your Komatsu distributor for those items you may require.

## WARNING

- **Improper operation and maintenance of this machine can be hazardous and could result in serious injury or death.**
- **Operators and maintenance personnel should read this manual thoroughly before beginning operation or maintenance.**  
**Keep this manual in a readily available place near the machine (on machines with cab, there is a door pocket to hold the manual), and have all personnel involved in working on the machine read the manual periodically.**  
**Where to keep this manual. → See "11.7 MANUAL POCKET".**
- **Some actions involved in operation and maintenance of the machine can cause a serious accident, if they are not done in a manner described in this manual.**
- **The procedures and precautions given in this manual apply only to intended uses of the machine. If you use your machine for any unintended uses that are not specifically prohibited, you must be sure that it is safe for you and others. In no event should you or others engage in prohibited uses or actions as described in this manual.**
- **Komatsu delivers machines that comply with all applicable regulations and standards of the country to which it has been shipped. If this machine has been purchased in another country or purchased from someone in another country, it may lack certain safety devices and specifications that are necessary for use in your country. If there is any question about whether your product complies with the applicable standards and regulations of your country, consult Komatsu or your Komatsu distributor before operating the machine.**
- **The description of safety is given in SAFETY INFORMATION on page 0-2 and in SAFETY from page 1-1.**

### **CALIFORNIA**

#### **Proposition 65 Warning**

**Diesel engine exhaust and some of its constituents are known to the State of California to cause cancer, birth defects, and other reproductive harm.**

## 2. SAFETY INFORMATION

---

Most accidents are caused by the failure to follow fundamental safety rules for the operation and maintenance of machines. To avoid accidents, read, understand and follow all precautions and warnings in this manual and on the machine before performing operation and maintenance.

To identify safety messages in this manual and on machine labels, the following signal words are used.

 **DANGER** – This word is used on safety messages and safety labels where there is a high probability of serious injury or death if the hazard is not avoided. These safety messages or labels usually describe precautions that must be taken to avoid the hazard. Failure to avoid this hazard may also result in serious damage to the machine.

 **WARNING** – This word is used on safety messages and safety labels where there is a potentially dangerous situation which could result in serious injury or death if the hazard is not avoided. These safety messages or labels usually describe precautions that must be taken to avoid the hazard. Failure to avoid this hazard may also result in serious damage to the machine.

 **CAUTION** – This word is used on safety messages and safety labels for hazards which could result in minor or moderate injury if the hazard is not avoided. This word might also be word for hazards where the only result could be damage to the machine.

**NOTICE** – This word is used for precautions that must be taken to avoid actions which could shorten the life of the machine.

Safety precautions are described in SAFETY from page 1-1.

Komatsu cannot predict every circumstance that might involve a potential hazard in operation and maintenance. Therefore the safety messages in this manual and on the machine may not include all possible safety precautions. If any procedures or actions not specifically recommended or allowed in this manual are used, you must be sure that you and others can do such procedures and actions safely and without damaging the machine. If you are unsure about the safety of some procedures, contact your Komatsu distributor.

## **3. INTRODUCTION**

---

### **3.1 INTENDED USE**

This Komatsu BULLDOZER is designed to be used mainly for the following work:

- Dozing
- Smoothing
- Cutting into hard or frozen ground or ditching.

See the section "12.10 WORK POSSIBLE USING BULLDOZER" for further details.

### **3.2 FEATURES**

- The first complete mono lever system in its class for easier operation
- Maintenance as easy as a mini hydraulic excavator
- Newly installed warning lamps for fuel level, coolant level in the sub radiator tank, and air cleaner.

### **3.3 BREAKING IN THE MACHINE**

Your Komatsu machine has been thoroughly adjusted and tested before shipment.

However, operating the machine under severe conditions at the beginning can adversely affect the performance and shorten the machine life.

Be sure to break in the machine for the initial 100 hours (as indicated by the service meter.)

During breaking in:

- Idle the engine for 5 minutes after starting it up.
- Avoid operation with heavy loads or at high speeds.
- Avoid sudden starts, sudden acceleration, sudden steering and sudden stops except in cases of emergency.

The precautions given in this manual for operating, maintenance, and safety procedures are only those that apply when this product is used for the specified purpose. If the machine is used for a purpose that is not listed in this manual, Komatsu cannot bear any responsibility for safety. All consideration of safety in such operations is the responsibility of the user.

Operations that are prohibited in this manual must never be carried out under any circumstances.



## 4. LOCATION OF PLATES, TABLE TO ENTER SERIAL NO. AND DISTRIBUTOR

### 4.1 MACHINE SERIAL NO. PLATE POSITION

On the inside of the L.H. armrest

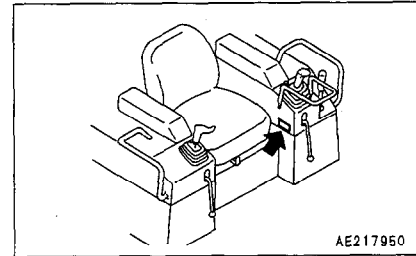

### 4.2 ENGINE SERIAL NO. PLATE POSITION

On the upper side of the engine cylinder head cover

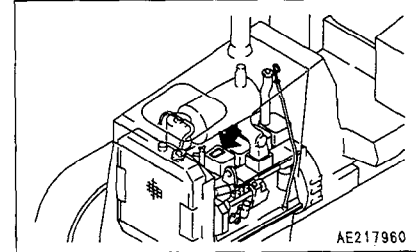

### 4.3 TABLE TO ENTER SERIAL NO. AND DISTRIBUTOR

Machine serial No.:	
Engine serial No.:	
Distributor name:	
Address:	Phone:
Service personnel for your machine:	

### REMARKS

## 5. CONTENTS

---

1. Foreword .....	0- 1
2. Safety information .....	0- 2
3. Introduction .....	0- 3
4. Location of plates, table to enter serial No. and distributor .....	0- 4

### SAFETY

6. General precautions .....	1- 2
7. Precautions during operation .....	1- 7
7.1 Before starting engine .....	1- 7
7.2 After starting engine .....	1- 9
7.3 Transportation .....	1-15
7.4 Battery .....	1-16
7.5 Towing .....	1-18
8. Precautions for maintenance .....	1-19
8.1 Before carrying out maintenance .....	1-19
8.2 During maintenance .....	1-24
9. Position for attaching safety labels .....	1-29

### OPERATION

10. General view .....	2- 2
10.1 General view of machine .....	2- 2
10.2 General view of controls and gauges .....	2- 3
11. Explanation of components .....	2- 4
11.1 Meters and lamps .....	2- 4
11.2 Switches .....	2- 6
11.3 Control levers, pedals .....	2- 8
11.4 Fuse box .....	2-13
11.5 Location of fire extinguisher .....	2-13
11.6 Electric power take-out adapter .....	2-14
11.7 Manual pocket .....	2-14
12. Operation .....	2-15
12.1 Checks before starting engine .....	2-15
12.2 Starting engine .....	2-26
12.3 Operations and checks after starting engine .....	2-29
12.4 Moving machine .....	2-30
12.5 Shifting gear .....	2-31
12.6 Shifting between forward and reverse .....	2-32
12.7 Steering machine .....	2-33
12.8 Stopping machine .....	2-36
12.9 Precautions for operation .....	2-37
12.10 Work possible using bulldozer .....	2-38
12.11 Parking machine .....	2-39
12.12 Check after finishing work .....	2-40
12.13 Stopping engine .....	2-41
12.14 Check after stopping engine .....	2-42

12.15 Locking .....	2-42
12.16 Tips for longer undercarriage life .....	2-43
<b>13. Transportation .....</b>	<b>2-46</b>
13.1 Loading, unloading work .....	2-46
13.2 Precautions for loading .....	2-47
13.3 Lifting machine .....	2-48
13.4 Precautions for transportation .....	2-50
<b>14. Cold weather operation .....</b>	<b>2-51</b>
14.1 Precautions for low temperature .....	2-51
14.2 After completion of work .....	2-53
14.3 After cold weather .....	2-53
<b>15. Long-term storage (More than one month) .....</b>	<b>2-54</b>
15.1 Before storage .....	2-54
15.2 During storage .....	2-54
15.3 After storage .....	2-54
<b>16. Troubleshooting .....</b>	<b>2-55</b>
16.1 After running out of fuel .....	2-55
16.2 If battery is discharged .....	2-55
16.3 Other trouble .....	2-59

## MAINTENANCE

<b>17. Guides to maintenance .....</b>	<b>3- 2</b>
<b>18. Outlines of service .....</b>	<b>3- 4</b>
18.1 Outline of oil, fuel, coolant .....	3- 4
18.2 Relating to electric system .....	3- 6
<b>19. Wear parts list .....</b>	<b>3- 7</b>
<b>20. Use of fuel, coolant and lubricants according to ambient temperature .....</b>	<b>3- 8</b>
<b>21. Standard tightening torques for bolts and nuts .....</b>	<b>3-12</b>
21.1 Introduction of necessary tools .....	3-12
21.2 Torque list .....	3-13
<b>22. Periodic replacement of safety critical parts .....</b>	<b>3-14</b>
<b>23. Maintenance schedule chart .....</b>	<b>3-16</b>
<b>24. Service Procedure .....</b>	<b>3-19</b>
24.1 Initial 250 hours service .....	3-19
24.2 When required .....	3-20
24.3 Check before starting .....	3-34
24.4 Every 50 hours service .....	3-40
24.5 Every 250 hours service .....	3-41
24.6 Every 500 hours service .....	3-47
24.7 Every 1000 hours service .....	3-51
24.8 Every 2000 hours service .....	3-58
24.9 Every 4000 hours service .....	3-59

---

## SPECIFICATIONS

25. Specifications .....	4- 2
--------------------------	------

## OPTIONS, ATTACHMENTS

26. General precautions .....	5- 2
26.1 Precautions related to safety .....	5- 2
27. Using seat belt .....	5- 3
27.1 Seat belt (for fixed type) .....	5- 3
27.2 Seat belt (for suspension type) .....	5- 4
28. Handling suspension seat .....	5- 5
29. Handling decelerator pedal .....	5- 6

**MEMO**

# SAFETY

 **WARNING**

**Read and follow all safety precautions. Failure to do so may result in serious injury or death.**

This safety section also contains precautions for optional equipment and attachments.

## 6. GENERAL PRECAUTIONS

**▲ WARNING:** For reasons of safety, always follow these safety precautions.

### SAFETY RULES

- Only trained and authorized personnel can operate and maintain the machine.
- Follow all safety rules, precautions and instructions when operating or performing maintenance on the machine.
- Do not operate the machine if you are not feeling well, or if you are taking medicine which will make you sleepy, or if you have been drinking. Operating in such a condition will adversely affect your judgement and may lead to an accident.
- When working with another operator or with a person on worksite traffic duty, be sure that all personnel understand all hand signals that are to be used.
- Always follow all rules related to safety.

### SAFETY FEATURES

- Be sure that all guards and covers are in their proper position. Have guards and covers repaired if damaged.
- Use safety features such as safety lock levers ① and the seat belt properly.
- Never remove any safety features. Always keep them in good operating condition.  
**Safety lock lever** → See "12.11 PARKING MACHINE".  
**Seat belt** → See "27. USING SEAT BELT".
- Improper use of safety features could result in serious bodily injury or death.

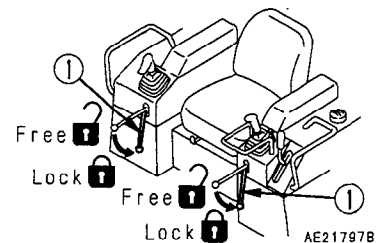

### CLOTHING AND PERSONAL PROTECTIVE ITEMS

- Avoid loose clothing, jewelry, and loose long hair. They can catch on controls or in moving parts and cause serious injury or death.
- Also, do not wear oily clothes, because they are flammable.
- Wear a hard hat, safety glasses, safety shoes, mask or gloves when operating or maintaining the machine. Always wear safety goggles, hard hat and heavy gloves if your job involves scattering metal chips or minute materials particularly when driving pins with a hammer and when cleaning the air cleaner element with compressed air. Check also that there is no one near the machine.
- Check that all protective equipment functions properly before using.

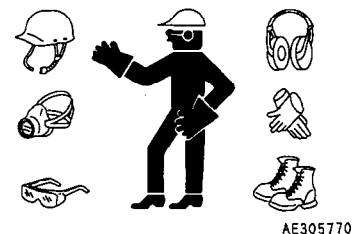

### UNAUTHORIZED MODIFICATION

Any modification made without authorization from Komatsu can create hazards. Before making a modification, consult your Komatsu distributor. Komatsu will not be responsible for any injury or damage caused by any unauthorized modification.

**ALWAYS APPLY LOCK WHEN LEAVING OPERATOR'S SEAT**

- When standing up from the operator's seat, always place the safety lock levers and parking brake lever securely in the LOCK position. If you accidentally touch the levers when they are not locked, the work equipment may suddenly move and cause serious injury or damage.
- When leaving the machine, lower the blade and ripper completely to the ground, set the safety lock levers and parking brake lever to the LOCK position, then stop the engine. Use the key to lock all the equipment. Always remove the key and take it with you.

**Work equipment posture → See "12.11 PARKING MACHINE".**

**Locking → See "12.15 LOCKING"**

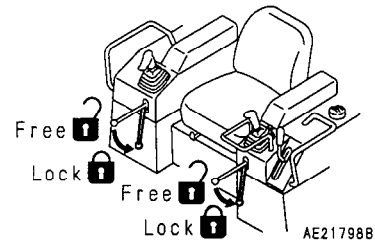

**MOUNTING AND DISMOUNTING**

- Never jump on or off the machine. Never get on or off a moving machine.
- When getting on or off the machine, always face the machine and use the handrails and steps.
- Never hold any control levers or lock levers when getting on or off the machine.
- Maintain three-point contact to be sure that you do not fall from the machine.
- Repair any damaged handhold, and tighten any loose bolts. Handholds, track frame and track shoes must be free of oil, grease and excessive dirt.

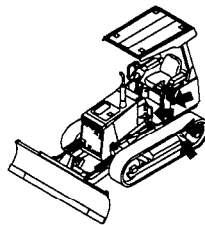
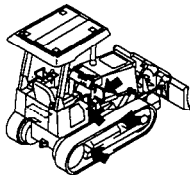



### FIRE PREVENTION FOR FUEL AND OIL

Fuel, oil, and antifreeze can be ignited by a flame. Fuel is particularly flammable and can be hazardous.

Always observe the following:

- Keep any flame or lighted cigarette away from flammable fluids.
- Stop the engine and do not smoke when refueling.
- Tighten all fuel and oil caps securely.
- Use well-ventilated areas for adding or storing oil and fuel.
- Keep oil and fuel in the determined place and do not allow unauthorized persons to enter.



A0055020

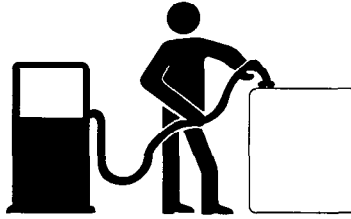

A0055030



A0055040

### PRECAUTIONS WHEN HANDLING AT HIGH TEMPERATURE

- Immediately after operations are stopped, the engine oil and hydraulic oil are at high temperature and are still under pressure. Attempting to remove the cap, drain the oil or water, or replace the filters may lead to serious burns. Always wait for the temperature to go down, and follow the specified procedures when carrying out these operations.
- To prevent hot water from spurting out, stop the engine, wait for the water to cool, then loosen the cap slowly to relieve the pressure before removing the cap.  
(When checking if the water temperature has gone down, put your hand near the front face of the radiator and check the air temperature. Be careful not to touch the radiator.)
- To prevent hot oil from spurting out, stop the engine, wait for the oil to cool, then loosen the cap slowly to relieve the pressure before removing the cap.  
(When checking if the oil temperature has gone down, put your hand near the front face of the hydraulic tank and check the air temperature. Be careful not to touch the hydraulic tank.)

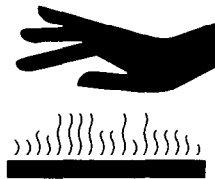

A0055050

### ASBESTOS DUST HAZARD PREVENTION

Asbestos dust can be hazardous to your health if it is inhaled.

Komatsu does not use asbestos in its products, but if you handle materials containing asbestos fibers, follow the guidelines given below:

- Never use compressed air for cleaning.
- Use water to keep down the dust when cleaning.
- If there is danger that there may be asbestos dust in the air, operate the machine from an upwind position whenever possible.
- Use an approved respirator if necessary.

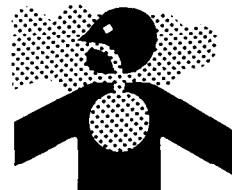

A0055060

### CRUSHING OR CUTTING PREVENTION

Do not enter, or put your hand or arm or any other part of your body between movable parts such as the work equipment and cylinders, or between the machine and work equipment.

If the work equipment is operated, the clearance will change and this may lead to serious damage or personal injury.

If it is necessary to go between movable parts, always lock the levers and be sure that the work equipment cannot move. For details, see "8. PRECAUTIONS FOR MAINTENANCE".



A0066090

### FIRE EXTINGUISHER AND FIRST AID KIT

Always follow the precautions below to prepare for action if any injury or fire should occur.

- Be sure that fire extinguishers have been provided and read the labels to ensure that you know how to use them.
- Provide a first aid kit at the storage point. Carry out periodic checks and add to the contents if necessary.
- Know what to do in the event of a fire or injury.
- Decide the phone numbers of persons (doctor, ambulance, fire station, etc.) to contact in case of an emergency. Post these contact numbers in specified places and make sure that all personnel know the numbers and correct contact procedures.

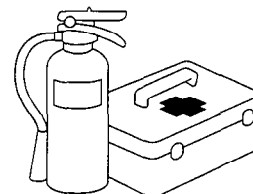

A0055070

### ROPS

If ROPS is installed, do not operate the machine with the ROPS removed. ROPS is installed to protect the operator if the machine should roll over. It supports the load when the machine rolls over and also absorbs impact energy. The Komatsu ROPS fulfills all worldwide regulations and standards, but it is damaged by falling objects or by rolling over, its strength will be reduced and it will not be able to provide its original capacity. In such a case, please contact your Komatsu distributor for advice on the method of repair. Even if ROPS is installed, it can only protect you properly if you wear the seat belt. Always fasten the seat belt when operating the machine.

**Seat belt → See "27. USING SEAT BELT".**

### PRECAUTIONS FOR ATTACHMENTS

- When installing and using an optional attachment, read the instruction manual for the attachment and the information related to attachments in this manual.
- Do not use optional parts or attachments that are not authorized by Komatsu or your Komatsu distributor. Use of unauthorized attachments could create a safety problem and adversely affect the proper operation and useful life of the machine.
- Any injury, accidents, product failures resulting from the use of unauthorized attachments will not be the responsibility of Komatsu.

### PRECAUTIONS WITH SEAT BELT

- To ensure safety during operations, always wear the seat belt.
- Before fastening the seat belt, check that there is no abnormality in the belt or belt mount bracket. If these are worn or damaged, replace the seat belt.
- Be sure that the seat belt is not twisted when fastening it.

**Seat belt → See "27. USING SEAT BELT".**

### VENTILATION FOR ENCLOSED AREAS

Exhaust fumes from the engine can kill.

- If it is necessary to start the engine within an enclosed area, or you handle fuel, flushing oil, or paint, open the doors and windows to ensure that you provide adequate ventilation to prevent gas poisoning.
- If opening the doors and windows still does not provide adequate ventilation, set up fans.



A0055060

## 7. PRECAUTIONS DURING OPERATION

**⚠ WARNING:** Failure to follow these safety precautions may lead to a serious accident.

### 7.1 BEFORE STARTING ENGINE

#### SAFETY AT WORKSITE

- Before starting operations, thoroughly check the area for any unusual conditions that could be dangerous.
- Check the terrain and condition of the ground at the worksite, and determine the best and safest method of operation.
- Make the ground surface as hard and horizontal as possible before carrying out operations. If the jobsite is dusty, spray water before starting operations.
- If you need to operate on a road, protect pedestrians and cars by designating a person for worksite traffic duty or by installing fences and putting up No Entry signs around the worksite.
- If water lines, gas lines, or high-voltage electrical lines may be buried under the worksite, contact each utility and identify their locations. Be careful not to sever or damage any of these lines.
- Check the ground condition and the depth and flow of water before operating in water or crossing a river. NEVER be in water which is in excess of the permissible water depth.  
**Permissible water depth → See "12.9 PRECAUTIONS FOR OPERATION".**

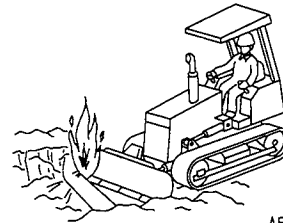

AE212070

#### CHECKS BEFORE STARTING ENGINE

Carry out the following checks before starting the engine at the beginning of the days work. Failure to carry out these checks may lead to serious injury or damage.

- Completely remove all flammable materials accumulated around the engine and battery, return all fuel containers to their proper place, remove all parts and tools from the operator's compartment, and remove any dirt from the mirrors, handrails, and steps.

**Walk-around checks → See "12.1.1 WALK-AROUND CHECK".**

- Check the coolant level, fuel level, and oil level in the hydraulic tank, check for clogging of the air cleaner, and check the electric wiring.

**Checks before starting → See "12.1.2 CHECK BEFORE STARTING".**

- Adjust the operator's seat to a position where it is easy to carry out operations, and check for wear or damage to the seat belt and seat belt mounting equipment.

**Adjusting operator's seat → See "12.1.3 ADJUST OPERATOR'S SEAT".**

- Check that the gauges work properly, and check that the control levers are all at the NEUTRAL position.

**Method of checking operation of gauges →**

**See "12.1.4 OPERATIONS AND CHECKS BEFORE STARTING ENGINE".**

If the above inspections show any abnormality, carry out repairs immediately.



A0055020

**WHEN STARTING ENGINE**

- Walk around your machine again just before mounting it, and check for people and objects that might be in the way.
- Never start the engine if a warning tag has been attached to the blade control lever.
- When starting the engine, sound the horn as an alert.
- Start and operate the machine only while seated.
- An additional worker may ride in the machine only when sitting in the passenger seat. Do not allow anyone to ride on the machine body.
- Do not short circuit the starting motor circuit to start the engine. It is not only dangerous, but will also cause damage to the equipment.



## 7.2 AFTER STARTING ENGINE

### CHECKS AFTER STARTING ENGINE

Failure to carry out the checks properly after starting the engine will lead to delays in discovery of abnormalities, and this may lead to serious injury or damage to the machine.

When carrying out the checks, use a wide area where there are no obstructions. Do not allow anyone near the machine.

- Check the operation of the gauges and equipment, and check the operation of the blade, ripper, brakes, travel system, and steering system.
- Checks for any abnormality in the sound of the machine, vibration, heat, smell, or gauges; check also that there is no leakage of air, oil, or fuel.
- If any abnormality is found, carry out repairs immediately.  
If the machine is used when it is not in proper condition, it may lead to serious injury or damage to the machine.

### PRECAUTIONS WHEN STARTING OFF

- Before starting off, check again that there is no one in the surrounding area and that there are no obstacles.
- When starting off, sound the horn as an alert.  
Always operate the machine only when seated.
- An additional worker may ride in the machine only when sitting in the passenger seat. Do not allow anyone to ride on the machine body.
- Fasten your seat belt securely equipped with seat belt.
- Check that the backup alarm works properly.
- Always close the door of the operator's compartment and check that the door is securely locked.

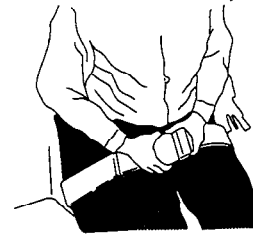

AE305800

### CHECK WHEN CHANGING DIRECTION

To prevent serious injury or death, always do the following before moving the machine or doing the leveling work.

- Before changing between forward and reverse, reduce speed and stop the machine.
- Before operating the machine, sound the horn to warn people in the area.
- Check that there is no one near the machine. Be particularly careful to check behind the machine.
- When operating in areas that may be hazardous or have poor visibility, designate a person to direct worksite traffic.
- Ensure that no unauthorized person can come within the direction of turning or direction of travel.  
Always be sure to carry out the above precautions even when the machine is equipped with a backup alarm and mirrors.

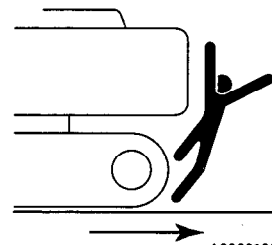

A0066100

**PRECAUTIONS WHEN TRAVELING**

- Never turn the key in the starting switch to the OFF position when traveling. It is dangerous if the engine stops when the machine is traveling, because it becomes impossible to operate the steering. (for machines stopped by starting switch)
- It is dangerous to look around you when operating. Always concentrate on your work.
- It is dangerous to drive too fast, or to start suddenly, stop suddenly, turn sharply, or zigzag.
- If you find any abnormality in the machine during operation (noise, vibration, smell, incorrect gauges, air leakage, oil leakage, etc.), move the machine immediately to a safe place and look for the cause.
- Set the work equipment to a height of 40 – 50 cm (16 – 20 in) from the ground level and travel on level ground.
- When traveling, do not operate the work equipment control levers. If the work equipment control levers have to be operated, never operate them suddenly.
- Do not operate the steering suddenly. The work equipment may hit the ground surface and cause the machine to lose its balance, or may damage the machine or structures in the area.
- When traveling on rough ground, travel at low speed, and avoid sudden changes in direction.
- Avoid traveling over obstacles as far as possible. If the machine has to travel over an obstacle, keep the work equipment as close to the ground as possible and travel at low speed. Never travel over obstacles which make the machine tilt strongly (10° or more).
- When traveling or carrying out operations, always keep your distance from other machines or structures to avoid coming into contact with them.
- NEVER be in water which is in excess of the permissible water depth.  
**Permissible water depth → See "12.9 PRECAUTIONS FOR OPERATION".**
- When passing over bridges or structures on private land, check first that the structure is strong enough to support the mass of the machine. When traveling on public roads, check first with the relevant authorities and follow their instructions.

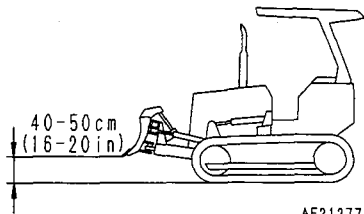

AE21277B

### TRAVELING ON SLOPES

- Traveling on slopes could result in the machine tipping over or slipping to the side.
- When traveling on slopes, keep the blade approximately 20 to 30 cm (8 to 12 in) above the ground. In case of emergency, quickly lower the blade to the ground to help the machine to stop.
- Do not turn on slopes or travel across slopes. Always go down to a flat place to perform these operations.
- Do not travel on grass, fallen leaves, or wet steel plates. Even slight slopes may cause the machine to slip to the side, so travel at low speed and make sure that the machine is always traveling directly up or down the slope.
- When traveling downhill, use the braking force of the engine and travel slowly.
- Be careful when allowing the machine to travel downhill under its own weight. It may steer in the opposite direction.

**Reverse steering when traveling downhill →**

**See "12.7.2 TURNING WHILE DESCENDING A SLOPE".**

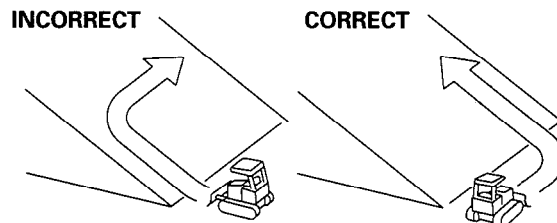

AD051690

### PROHIBITED OPERATIONS

To prevent the machine from turning over or the work equipment from being damaged because of overload, always keep within the safe angle and maximum load specified for the machine. Never use the machine in excess of its capacity.

### PRECAUTIONS WHEN OPERATING

- Be careful not to approach too close to the edge of cliffs. When making embankments or landfills, or when dropping soil over a cliff, dump one pile, then use the next pile of soil to push the first pile.
- The load suddenly becomes lighter when the soil is pushed over a cliff or when the machine reaches the top of a slope. When this happens, there is danger that the travel speed will suddenly increase, so be sure to reduce the speed.
- If the load is applied to only one side of the blade, the rear of the machine may swing.
- Carry out only work that is specified as the purpose of the machine. Carrying out other operations will cause breakdowns.  
**Specified operations → See "12.10 WORK POSSIBLE USING BULLDOZER".**
- Do the following to ensure good visibility.
  - When operating in dark places, turn on the working lamps and front lamps, and install lighting at the jobsite if necessary.
  - Do not carry out operations in fog, mist, snow, or heavy rain, or other conditions where the visibility is poor. Wait for the weather to clear so that visibility is sufficient to carry out work.
- Always do the following to prevent the work equipment from hitting other objects.
  - When operating in tunnels, under bridges, under electric wires, or other places where the height is limited, be extremely careful not to let the blade hit anything.
  - To prevent accidents caused by hitting other objects, always operate the machine at a speed which is safe for operation, particularly in confined spaces, indoors, and in places where there are other machines.



### DO NOT GO CLOSE TO HIGH-VOLTAGE CABLES

- Do not let the machine touch overhead electric cables. Even going close to high-voltage cables can cause electric shock. Always maintain the safe distance given below between the machine and the electric cable.
- To prevent accidents, always do as follows.
  - On jobsites where there is danger that the machine may touch the electric cables, consult the electricity company before starting operations to check that the actions determined by the relevant laws and regulations have been taken.
  - Wear rubber shoes and gloves. Lay a rubber sheet on top of the operator's seat, and be careful not to touch the chassis with any exposed part of your body.
  - Use a signalman to give warning if the machine approaches too close to the electric cables.
  - If the work equipment should touch the electric cable, the operator should not leave the operator's compartment.
  - When carrying out operations near high voltage cables, do not let anyone come close to the machine.
  - Check with the electricity company about the voltage of the cables before starting operations.

	Voltage	Min. safety distance
Low voltage	100 - 200 V	2 m
	6,600 V	2 m
Very high voltage	22,000 V	3 m
	66,000 V	4 m
	154,000 V	5 m
	187,000 V	6 m
	275,000 V	7 m
	500,000 V	11 m

### USING BRAKES

- When the machine is traveling, do not rest your foot on the brake pedal. Put your foot on the pedal only when using the brakes.  
If you travel with your foot resting on the pedal, the brake will always be applied, and this will cause the brakes to overheat and fail.
- Do not depress the brake pedal lightly to apply partial braking to control the travel speed. This will cause the brake to overheat and it will be impossible to use the brakes effectively when they are needed.
- When traveling downhill, use the braking force of the engine, and always use the brake pedal.

### OPERATE CAREFULLY ON SNOW

- When working on snow or icy roads, even a slight slope may cause the machine to slip to the side, so always travel at low speed and avoid sudden starting, stopping, or turning. There is danger of slipping particularly on uphill or downhill slopes.
- With frozen road surfaces, the ground becomes soft when the temperature rises, so the travel conditions become unstable. In such cases be extremely careful when traveling.
- When there has been heavy snow, the road shoulder and objects placed beside the road are buried in the snow and cannot be seen, so always carry out operations carefully.  
When traveling on snow-covered slopes, never apply the brakes suddenly. Reduce the speed and use the engine as a brake while applying the foot brake intermittently (depress the brake intermittently several times). If necessary, lower the blade to the ground to stop the machine.
- The load varies greatly according to the characteristics of the snow, so adjust the load accordingly and be careful not to let the machine slip.

### WORKING ON LOOSE GROUND

- Do not operate the machine on soft ground. It is difficult to get the machine out again.
- Avoid operating your machine too close to the edge of cliffs, overhangs, and deep ditches. If these areas collapse under the mass or vibration of your machine, it could fall or tip over and this could result in serious injury or death. Remember that the soil after heavy rain, blasting, or earthquakes is weakened in these areas.
- Earth laid on the ground and the soil near ditches is loose. It can collapse under the mass or vibration of your machine and cause your machine to tip over.
- Install the head guard (FOPS) when working in areas where there is danger of falling stones.
- Install the ROPS and wear the seat belt when working in areas where there is danger of falling rocks or of the machine turning over.

### PARKING MACHINE

- Park the machine on level ground where there is no danger of falling rocks or landslides, or of flooding if the land is low, and lower the work equipment to the ground.
- If it is necessary to park the machine on a slope, set blocks under the tracks to prevent the machine from moving, then dig the work equipment into the ground.
- After stopping the engine, operate the blade control lever several times to the RAISE and LOWER positions to release the remaining pressure in the hydraulic circuit.
- When parking on public roads, provide fences, signs, flags, or lights, and put up any other necessary signs to ensure that passing traffic can see the machine clearly, and park the machine so that the machine, flags, and fences do not obstruct traffic.

**Parking procedure → See "12.11 PARKING MACHINE".**

- When leaving the machine, lower the work equipment completely to the ground, place the joystick to the neutral position, and the blade control levers to the HOLD position. Then set the safety lock lever and parking brake lever to the LOCK position, stop the engine, and use the key to lock all the equipment. Always remove the key and take it with you.

**Work equipment posture → See "12.11 PARKING MACHINE".**

**Locks → See "12.15 LOCKING".**

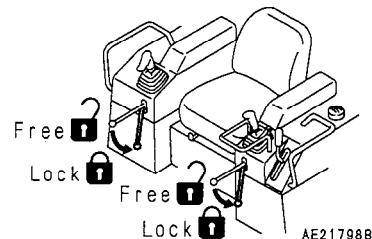
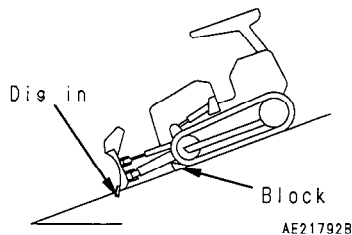

**PRECAUTIONS IN COLD AREAS**

- After completing operations, remove all water, snow, or mud stuck to the wiring harness, connector ①, switches, or sensors, and cover these parts.  
If the water freezes, it will cause malfunctions of the machine when it is next used, which may lead to unexpected accidents.
- Carry out the warming-up operation thoroughly. If the machine is not thoroughly warmed up before the control levers are operated, the reaction of the machine will be slow, and this may lead to unexpected accidents.
- Operate the control levers to relieve the hydraulic pressure (raise to above the set pressure for the hydraulic circuit and release the oil to the hydraulic tank) to warm up the oil in the hydraulic circuit. This ensures good response from the machine and prevents malfunctions.
- If the battery electrolyte is frozen, do not charge the battery or start the engine with a different power source. There is danger that this will ignite the battery.  
When charging or starting the engine with a different power source, melt the battery electrolyte and check for leakage of battery electrolyte before starting.

**Battery charge rate → See "14. COLD WEATHER OPERATION".**

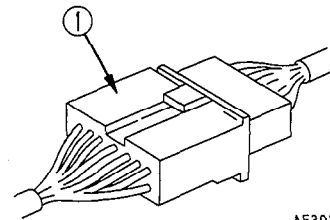

AE305820

### 7.3 TRANSPORTATION

#### LOADING AND UNLOADING

- Loading and unloading the machine always involves potential hazards. **EXTREME CAUTION SHOULD BE USED.**
- When loading or unloading the machine, run the engine at low idling and travel at low speed.
- Perform loading and unloading on firm, level ground only. Maintain a safe distance from the edge of a road.
- **ALWAYS** use ramps of adequate strength. Be sure that the ramps are wide, long, and thick enough to provide a safe loading slope. Place blocks under both ramps to support them before loading and unloading.
- When unloading on to an embankment or temporary structure, make sure that it has ample width, strength, and grade.
- To prevent the machine from slipping, be sure that the ramp surface is clean and free of grease, oil, ice and loose materials. Remove mud from the machine tracks.
- **NEVER** correct your steering on the ramps. If necessary, drive away from the ramps and climb again.
- After loading, block the machine tracks and secure the machine with tie-downs.

**Loading and unloading → See "13. TRANSPORTATION".**

**Tie-downs → See "13. TRANSPORTATION".**

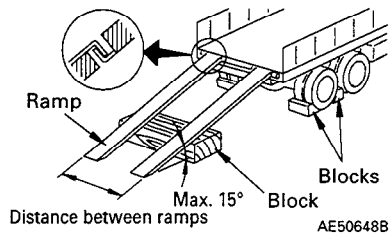

#### SHIPPING

- When shipping the machine on a hauling vehicle, obey all state and local laws governing the weight, width, and length of a load. Also obey all applicable traffic regulations.
- Take into account the width, height and weight of the load when determining the shipping route.  
**Height, width, load of machine → See "13.4 PRECAUTIONS FOR TRANSPORTATION".**
- When passing over bridges or structures on private land, check first that the structure is strong enough to support the mass of the machine. When traveling on public roads, check first with the relevant authorities and follow their instructions.

## 7.4 BATTERY

### BATTERY HAZARD PREVENTION

Battery electrolyte contains sulphuric acid, and batteries generate hydrogen gas, so mistaken handling can lead to serious injury or fire. For this reason, always observe the following precautions.

- Never bring any lighted cigarette or flame near the battery.
- When working with batteries, ALWAYS wear safety glasses and rubber gloves.
- If you spill acid on your clothes or skin, immediately flush the area with large amounts of water.
- Battery acid could cause blindness if splashed into the eyes. If acid gets into your eyes, flush them immediately with large quantities of water and see a doctor at once.
- If you accidentally drink electrolyte, drink a large quantity of water or milk, beaten egg or vegetable oil. Call a doctor or poison prevention center immediately.
- Before working with batteries, stop the engine and turn the starting switch to the OFF position.
- Avoid short-circuiting the battery terminals (between the positive ⊕ terminal and negative ⊖ terminal) through accidental contact with metal objects, such as tools.
- When installing the battery, connect the positive ⊕ terminal first, and when removing the battery, disconnect the negative ⊖ terminal (ground side) first.
- When removing or installing, check which is the positive ⊕ terminal and negative ⊖ terminal, and tighten the nuts securely.  
If the battery electrolyte is near the LOWER LEVEL, add distilled water. Do not add distilled water above the UPPER LEVEL.
- When cleaning the top surface of the battery, wipe it with a damp cloth. Never use gasoline, thinner, or any other organic solvent or cleaning agent.
- Tighten the battery caps securely.
- If the battery electrolyte is frozen, do not charge the battery or start the engine with a different power source. There is danger that this will ignite the battery.  
When charging or starting the engine with a different power source, melt the battery electrolyte and check for leakage of battery electrolyte before starting.
- Always remove the battery from the chassis before charging it.

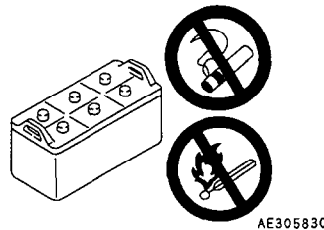
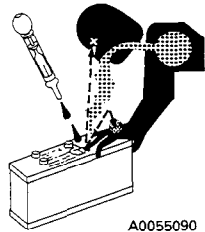

### STARTING WITH BOOSTER CABLES

If any mistake is made in the method of connecting the booster cables, it may cause a fire, so always do as follows.

- Carry out the starting operation with two workers (with one worker sitting in the operator's seat).
- When starting from another machine, do not allow the two machines to touch.
- When connecting the booster cables, turn the starting switch OFF for both the normal machine and problem machine.
- Be sure to connect the positive  $\oplus$  cable first when installing the booster cables. Disconnect the ground or negative  $\ominus$  cable first when removing them.
- The final ground connection is the connection of the ground to the engine block of the problem machine. However, this will cause sparks, so be sure to connect it as far as possible from the battery.

**Starting procedure when using booster cables → See "16.2 IF BATTERY IS DISCHARGED".**

- When removing the booster cables, be careful not to let the booster cable clips touch each other or to let the clips touch the machine.

**INCORRECT**

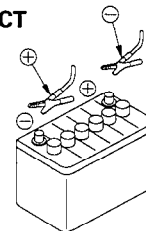

A0067320

### CHARGING BATTERY

If the battery is handled incorrectly when it is being charged, there is danger that the battery may explode, so follow the instructions in HANDLING BATTERY and in the instruction manual for the charger, and always observe the following precautions.

- Carry out the charging in a well-ventilated place, and remove the battery caps. This disperses the hydrogen gas and prevents explosion.
- Set the voltage on the charger to match the voltage on the battery to be charged. If the voltage setting is wrong, it will cause the charger to overheat and catch fire, and this may lead to an explosion.

Connect the positive  $\oplus$  charging clip of the charger to the positive  $\oplus$  terminal of the battery, then connect the negative  $\ominus$  charging clip to the negative  $\ominus$  terminal of the battery. Be sure to tighten both terminals securely.

- If the battery charge is less than 1/10 of the rated charge, and high speed charging is carried out, set to a value below the rated capacity of the battery.

If there is an excessive flow of charging current, it may cause leakage or evaporation of the electrolyte, which may catch fire and explode.

**INCORRECT**

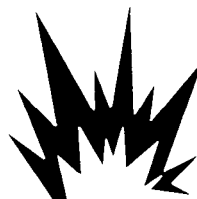

A0055110

## 7.5 TOWING

### WHEN TOWING

- Injury or death could result if a disabled machine is towed incorrectly or if there is a mistake in the selection of the wire rope, so always do as follows.
- Do not tow in a different way from the method given in the section METHOD OF TOWING.
- Always wear leather gloves when handling wire rope.
- When carrying out the preparation for towing with another worker, agree on signals before starting the operation.
- If the engine on the problem machine will not start or there is a failure in the brake system, please contact your Komatsu distributor for repairs.
- It is dangerous to tow a machine on a slope, so choose a place where there is a gradual slope. If there is no place with a gradual slope, carry out work to make the slope as small as possible.
- If a problem machine is towed by another machine, ALWAYS use a wire rope with a sufficient towing capacity for the weight of the problem machine.
- Do not use a wire rope which has cut strands (A), kinks (B), or reduced diameter (C).

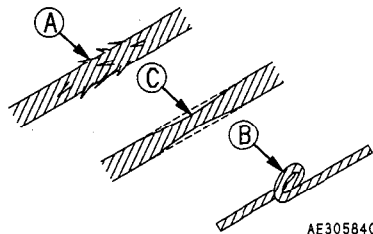

AE305840

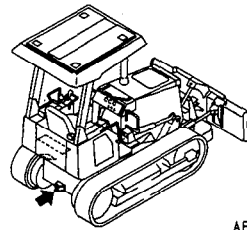

AE212080

## 8. PRECAUTIONS FOR MAINTENANCE

**⚠ WARNING:** Failure to follow these safety precautions may lead to a serious accident.

### 8.1 BEFORE CARRYING OUT MAINTENANCE

#### NOTIFICATION OF FAILURE

Carrying out maintenance not described in the Komatsu operation and maintenance manual may lead to unexpected failures.  
Please contact your Komatsu distributor for repairs.

#### WARNING TAG

- ALWAYS attach the "DO NOT OPERATE" warning tag to the blade control lever in the operator's cab to alert others that you are working on the machine. Attach additional warning tags around the machine if necessary.
- If others start the engine, or touch or operate the blade control lever while you are performing service or maintenance, you could suffer serious injury or death.

Warning tag Part No. 09963-03000

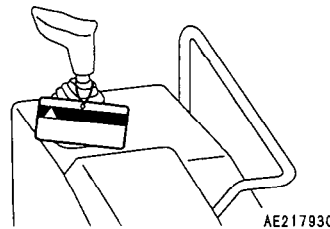
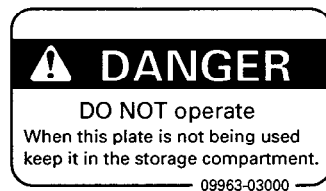

#### CLEAN BEFORE INSPECTION AND MAINTENANCE

- Clean the machine before carrying out inspection and maintenance. This will ensure that dirt does not get into the machine and will also ensure that maintenance can be carried out safely.
- If inspection and maintenance are carried out with the machine still dirty, it will be difficult to find the location of problems, and there is also the danger that you will get dirty or mud in your eyes, and that you will slip and injure yourself.
- When washing the machine, always do as follows.
  - Wear non-slip shoes to prevent yourself from slipping on the wet surface.
  - When using high-pressure steam to wash the machine, always wear protective clothing. This will protect you from being hit by high-pressure water, and cutting your skin or getting mud or dust into your eyes.
  - Do not spray water directly on to the electrical system (sensors, connectors) ①. If water gets into the electrical system, there is danger that it will cause defective operation and malfunction.

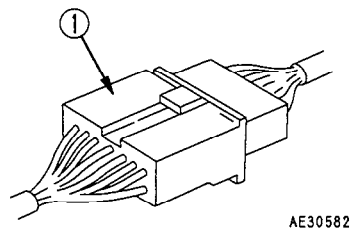
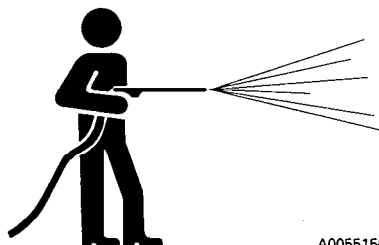



**KEEP WORK PLACE CLEAN AND TIDY**

Do not leave hammers or other tools lying around in the work place. Wipe up all grease, oil, or other substances that will cause you to slip. Always keep the work place clean and tidy to enable you to carry out operations safely.

If the work place is not kept clean and tidy, there is danger that you will trip, slip, or fall over and injure yourself.

**APPOINT LEADER WHEN WORKING WITH OTHERS**

When repairing the machine or when removing and installing the work equipment, appoint a leader and follow his instructions during the operation.

When working with others, misunderstandings between workers can lead to serious accidents.

**RADIATOR WATER LEVEL**

- When inspecting the radiator water level, stop the engine, and wait for the engine and radiator to cool down. Check the water level in the sub-tank. Under normal conditions, do not open the radiator cap.
- If there is no sub-tank, or the radiator cap must be removed, always do as follows.
- Wait for the radiator water temperature to go down before checking the water level. (When checking if the water temperature has gone down, put your hand near the engine or radiator and check the air temperature. Be careful not to touch the radiator or engine.)
- Release the internal pressure before removing the radiator cap, and remove the radiator cap slowly.



A0055050

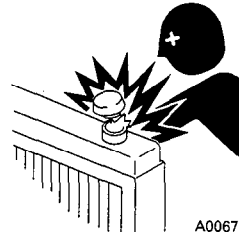

A0067380

**STOP ENGINE BEFORE CARRYING OUT INSPECTION AND MAINTENANCE**

- When carrying out inspection and maintenance, park the machine on level ground where there is no danger of falling rocks or land slides, or of flooding if the land is low, then lower the work equipment to the ground and stop the engine.
- Operate blade control lever ① several times to the RAISE and LOWER positions to release the remaining pressure in the hydraulic circuit, then set safety lock lever ② to the LOCK position.
- Put blocks under the track to prevent the machine from moving.
- The worker carrying out the maintenance should be extremely careful not to touch or get caught in the moving parts.

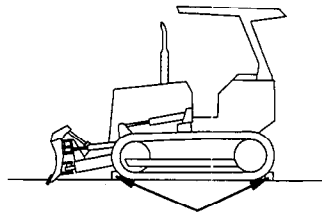

Block AE21279B

Machines stopped by fuel control lever

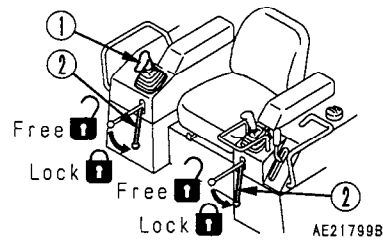

Machines stopped by starting switch

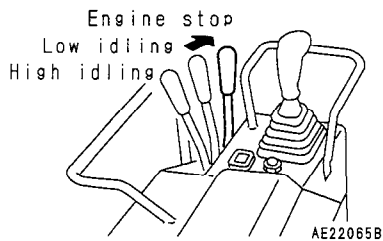

AE22065B

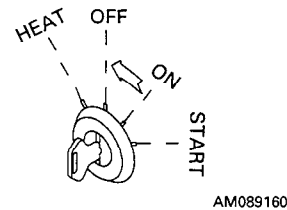

AM089160

**SAFETY DEVICES FOR WORK EQUIPMENT**

When carrying out inspection and maintenance with the blade raised, fit a stand securely under the blade to prevent the blade from coming down. Place the work equipment control levers at HOLD, and set the safety lever and parking brake lever to the LOCK position.



A0055140

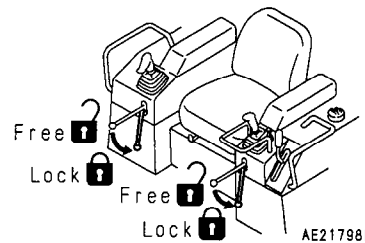

AE21798B

**PROPER TOOLS**

Use only tools suited to the task. Using damaged, low quality, faulty, or makeshift tools could cause personal injury.

Broken pieces of chisels or hammers could fly into your eyes and blind you.

**Tools → See "21.1 INTRODUCTION OF NECESSARY TOOLS".**



A0055120

**PERIODIC REPLACEMENT OF SAFETY CRITICAL PARTS**

Hoses and other parts of the fuel, hydraulic, and brake system are critical parts for ensuring safety, so they must be replaced periodically.

Replacement of safety critical parts requires skill, so please ask your Komatsu distributor to carry out replacement.

- Replace these components periodically with new ones, regardless of whether or not they appear to be defective.

These components deteriorate over time, and can cause fire because of oil leakage or failure in the work equipment system.

- Replace or repair any such components if any defect is found, even though they have not reached the time specified.

**Replacement of safety critical parts →**

**See "22. PERIODIC REPLACEMENT OF SAFETY CRITICAL PARTS".**

**USE OF LIGHTING**

- When checking fuel, oil, or battery electrolyte, always use lighting with anti-explosion specifications.

If such lighting equipment is not used, there is danger of explosion.

- If work is carried out in dark places without installing lighting, there is danger of injury, so always install proper lighting.

- Even if it is dark, do not use a lighter or flame instead of lighting. There is danger of starting a fire, and if the battery gas ignites, it may cause an explosion.

- When using the machine as the power supply for the lighting, follow the instructions in this Operation and Maintenance Manual.



A0055160

### PREVENTION OF FIRE

There is danger of the fuel and battery gas catching fire during maintenance, so always follow the precautions below when carrying out maintenance.

- Store fuel, oil, grease, and other flammable materials away from flame.
- Use non-flammable materials as the flushing oil for cleaning parts. Do not use diesel oil or gasoline. There is danger that they will catch fire.
- Never smoke when carrying out inspection or maintenance. Always smoke in the prescribed place.
- When checking fuel, oil, or battery electrolyte, always use lighting with anti-explosion specifications. Never use lighters or matches as lighting.
- When carrying out grinding or welding operations on the chassis, remove any flammable materials to a safe place.
- Be sure that a fire extinguisher is present at the inspection and maintenance point.



A0055020

## 8.2 DURING MAINTENANCE

### PERSONNEL

Only authorized personnel can service and repair the machine. Do not allow unauthorized personnel into the area. If necessary, employ an observer. Extra precaution should be used when grinding, welding, and using a sledge-hammer.

### ATTACHMENTS

- Appoint a leader before starting removal or installation operations for attachments.
- Do not allow anyone other than the workers close to the machine or attachment.
- Place attachments that have been removed from the machine in a safe place so that they do not fall. Put a fence around the attachments, and set up No Entry signs to prevent unauthorized persons from coming close.



A0055130

### WORK UNDER THE MACHINE

- Stop the machine on firm, level ground, and always lower all work equipment to the ground before performing service or repairs under the machine.
- Always block the track shoes securely.
- It is extremely dangerous to work under the machine if the track shoes are off the ground and the machine is supported only by the work equipment. Never work under the machine if the machine is poorly supported.



A0055140

### WORK ON TOP OF MACHINE

- When carrying out maintenance on top of the machine, make sure that the footholds are clean and free of obstructions, and follow the precautions below to prevent yourself from falling.
  - Do not spill oil or grease.
  - Do not leave tools lying around.
  - Mind your step when you are walking.
- Never jump down from the machine. When getting on or off the machine, always use the steps and handrails, and maintain three-point contact (both feet and one hand or both hands and one foot) at all times.
- Use protective equipment if necessary.



A0305870

### LOCKING INSPECTION COVERS

When carrying out maintenance with the inspection cover open, lock it securely with a lock bar. If maintenance is carried out with the inspection cover open and not locked in position, it may close suddenly if knocked or blown by the wind, and may cause injury to the operator.

### MAINTENANCE WITH ENGINE RUNNING

To prevent injury, do not carry out maintenance with the engine running. If maintenance must be carried out with the engine running, carry out the operation with at least two workers and do as follows.

- One worker must always sit in the operator's seat and be ready to stop the engine at any time. All workers must maintain contact with the other workers.
- When carrying out operations near rotating parts, there is danger of being caught in the parts, so be extremely careful.
- When cleaning inside the radiator, set safety lock lever ① to the LOCK position to prevent the work equipment from moving.
- Do not touch any control levers. If any control lever must be operated, always give a signal to the other workers to warn them to move to a safe place.
- Never touch the fan blade or fan belt with any tool or any part of your body. There is danger of serious injury.



A0055210

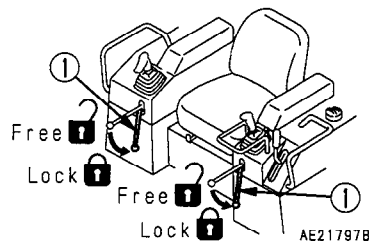

AE21797B

### DO NOT DROP TOOLS OR PARTS INSIDE MACHINE

- When opening the inspection window or tank oil filler to carry out inspection, be careful not to drop any nuts, bolts, or tools inside the machine. If such parts are dropped into the machine, it will cause breakage of the machine, mistaken operation, and other failures. If you drop any part into the machine, always be sure to remove it from the machine.
- When carrying out inspection, do not carry any unnecessary tools or parts in your pocket.

### PRECAUTIONS WHEN USING HAMMER

When using a hammer, always wear safety glasses, safety helmet, and other protective clothing, and put a brass bar between the hammer and the part being hammered. If hard metal parts such as pins, edges, teeth, or bearings are hit with a hammer, there is danger that broken pieces might fly into your eyes and cause injury.

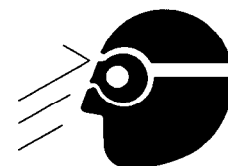

AE305880

**REPAIR WELDING**

Welding operations must always be carried out by a qualified welder and in a place equipped with a proper equipment. Gas is generated, and there is danger of fire or electrocution when carrying out welding, so never allow any unqualified personnel to carry out welding.

The qualified welder must follow the precautions given below.

- Disconnect the battery terminals to prevent explosion of the battery.
- Remove the paint from the place being welded to prevent gas from being generated.
- If hydraulic equipment or piping, or places close to these are heated, flammable vapor or spray will be generated, and there is danger of this catching fire, so avoid applying heat to such places.
- If heat is applied directly to rubber hoses or piping under pressure, they may suddenly burst, so cover them with fireproof sheeting.
- Always wear protective clothing.
- Ensure that there is good ventilation.
- Clear up any flammable materials, and make sure that there is a fire extinguisher at the workplace.

**PRECAUTIONS WITH BATTERY**

When repairing the electrical system or when carrying out electrical welding, remove the negative (-) terminal of the battery to stop the flow of current.

**Handling battery → See "16.2 IF BATTERY IS DISCHARGED".**

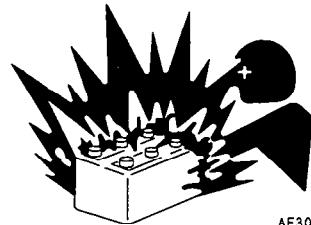

**WHEN ABNORMALITY IS LOCATED**

- If any abnormality is found during inspection, always carry out repairs. In particular, if the machine is used when there is any abnormality in the brakes or work equipment systems, it may lead to serious accident.
- Depending on the type of failure, please contact your Komatsu distributor for repairs.

**RULES TO FOLLOW WHEN ADDING FUEL OR OIL**

If any flame is brought close to fuel or oil, there is danger that it will catch fire, so always follow the precautions below.

- Stop the engine when adding fuel or oil.
- Do not smoke.
- Spilled fuel and oil may cause you to slip, so always wipe it up immediately.
- Always tighten the cap of the fuel and oil fillers securely.
- Always add fuel and oil in a well-ventilated place.



**PRECAUTIONS WHEN USING HIGH-PRESSURE GREASE TO ADJUST TRACK TENSION**

- Grease is pumped into the track tension adjustment system under high pressure. If the specified procedure for maintenance is not followed when making adjustment, valve ① may fly out and cause damage or personal injury.
- When loosening grease drain valve ①, never loosen it more than one turn.
- Never put your face, hands, feet, or any other part of your body directly in front of any grease drain valve.

Adjusting track tension → See "24.2 WHEN REQUIRED".

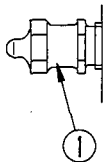
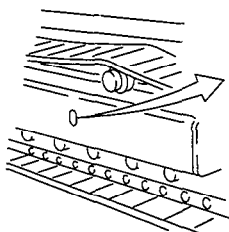

AB307180

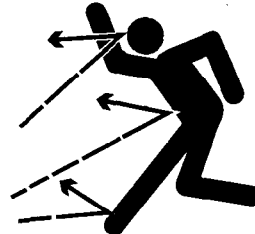

A0055200

**HANDLING HIGH-PRESSURE HOSES**

- If oil or fuel leaks from high-pressure hoses, it may cause fire or defective operation, which may lead to personal injury or damage. If any damaged hoses or loose bolts are found, stop work and contact your Komatsu distributor for repairs.
- Replacing high-pressure hoses requires a high level of skill, and the torque is determined according to the type of hose and size, so please do not carry out replacement yourself. Ask your Komatsu distributor to carry out replacement.

**PRECAUTIONS WITH HIGH-PRESSURE OIL**

When inspecting or replacing high-pressure piping or hoses, always check that the pressure in the hydraulic circuit has been released. If the circuit is still under pressure, it will lead to serious injury or damage, so always do as follows.

- For details of the method of releasing the pressure, see 8.1 BEFORE MAINTENANCE, STOP ENGINE BEFORE CARRYING OUT INSPECTION AND MAINTENANCE. Never carry out inspection or replacement before releasing the pressure completely.
- Wear safety glasses and leather gloves.
- If there is any leakage from the piping or hoses, the piping, hoses, and the surrounding area will be wet, so check for cracks in the piping and hoses and for swelling in the hoses. If it is difficult to locate the leakage, always please contact your Komatsu distributor for repairs.
- If you are hit by a jet of high-pressure oil, consult a doctor immediately for medical attention.

INCORRECT



A0055180

CORRECT

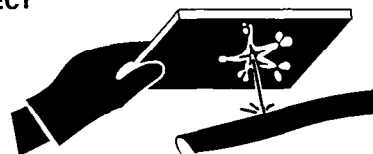

A0055190



### PRECAUTIONS WHEN CARRYING OUT MAINTENANCE AT HIGH TEMPERATURE

Immediately after stopping operations, the engine coolant, oil at all parts, the exhaust manifold, and the muffler are at high temperature.

In this condition, if the cap is removed, or the oil is drained, or the filters are replaced, this may result in burns or other injury. Wait for the temperature to go down, then carry out the inspection and maintenance in accordance with the procedures given in this manual.

**Cleaning inside of cooling system → See "24.2 WHEN REQUIRED".**

**Checking coolant level → see "24.3 CHECK BEFORE STARTING".**

**Checking oil level in hydraulic tank → see "24.5 PERIODIC MAINTENANCE".**

**Checking lubricating oil level, adding oil → see "24.3 CHECK BEFORE STARTING".**  
see "24.5 PERIODIC MAINTENANCE".

**Changing oil, replacing filters → see "24.5 - 7 PERIODIC MAINTENANCE".**



A0055050

### CHECKS AFTER INSPECTION AND MAINTENANCE

Failure to carry out inspection and maintenance fully, or failure to check the function of various maintenance locations may cause unexpected problems and may even lead to personal injury or damage, so always do as follows.

- Checks when engine is stopped
  - Have all the inspection and maintenance locations been checked?
  - Have all the inspection and maintenance items been carried out correctly?
  - Have any tools or parts dropped inside the machine? It is particularly dangerous if they get caught in the lever linkage.
  - Has water and oil leakage been repaired? Have bolts been tightened?
- Checks when engine is running
 

For details of checks when the engine is running, see "8.2 DURING MAINTENANCE, MAINTENANCE WITH ENGINE RUNNING", and be extremely careful to ensure safety.
- Do the inspection and maintenance locations work normally?
- Is there any oil leakage when the engine speed is raised and load is applied to the hydraulic system?

### WASTE MATERIALS

To prevent pollution, particularly in places where people or animals are living, always follow the procedures given below.

- Never dump waste oil in a sewer system, rivers, etc.
- Always put oil drained from your machine in containers. Never drain oil directly onto the ground.
- Obey appropriate laws and regulations when disposing of harmful objects such as oil, fuel, coolant, solvent, filters, and batteries.

**INCORRECT**

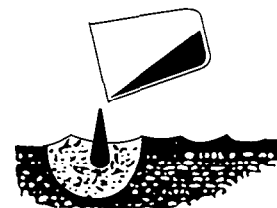

A0055220

## 9. POSITION FOR ATTACHING SAFETY LABELS

Always keep these labels clean. If they are lost or damaged, attaching them again or replace them with a new label.

There are other labels in addition to the safety labels listed as follows, so handle them in the same way.

Safety labels may be available in languages other than English.

To find out what labels are available, contact your Komatsu distributor.

### 9.1 POSITION FOR ATTACHING SAFETY LABELS

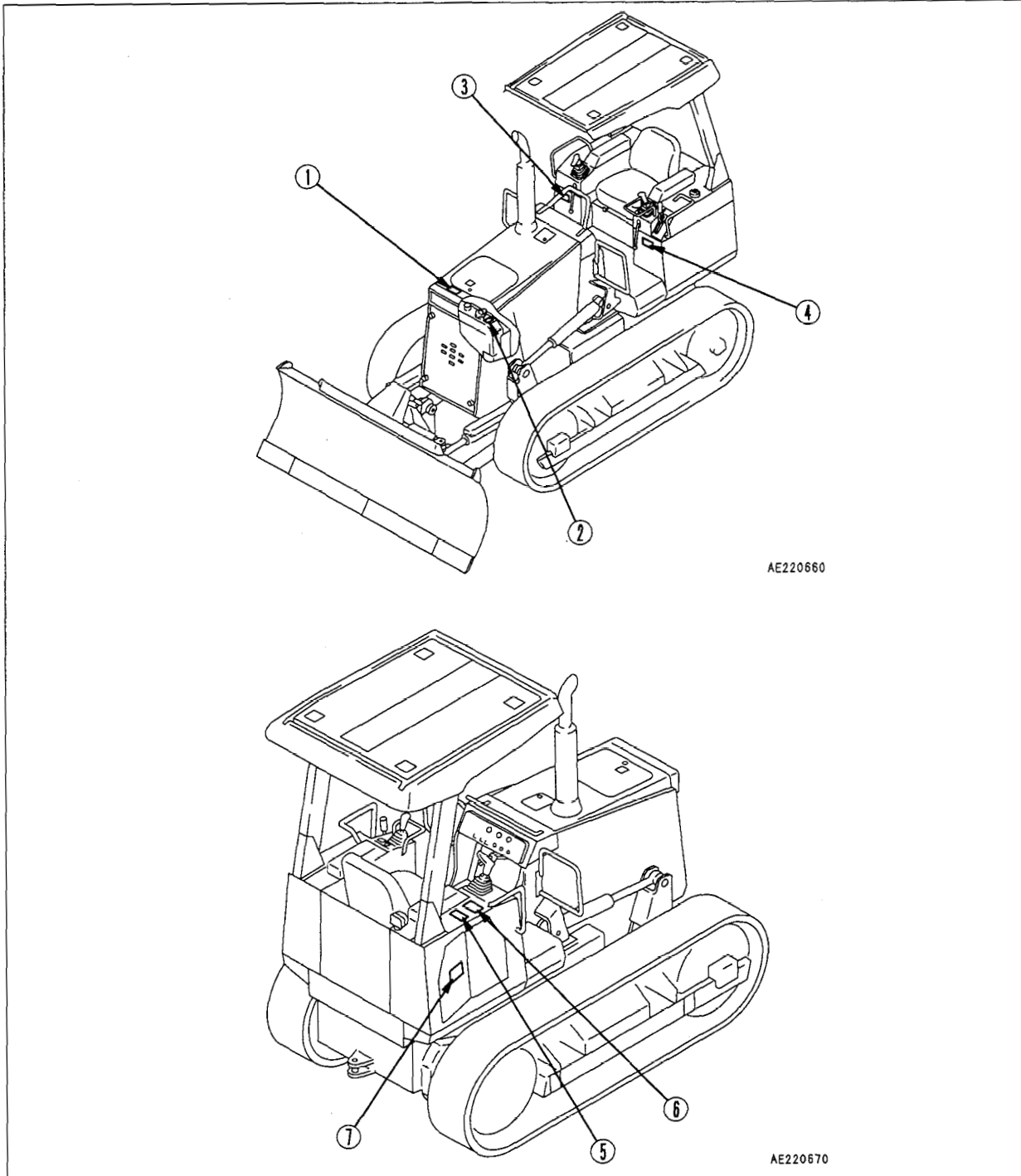

## 9. POSITION FOR ATTACHING SAFETY LABELS

1. Cautions for checking engine room  
(09667-03000)



2. Warnings for opening radiator cap  
(09668-03000)

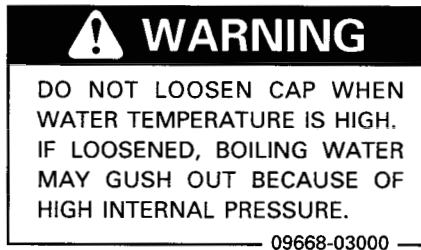

3. Cautions for inspection and maintenance  
(09173-03000)

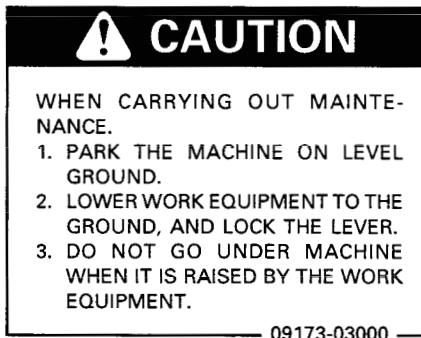

4. Warnings for adjusting track tension  
(09657-03010)

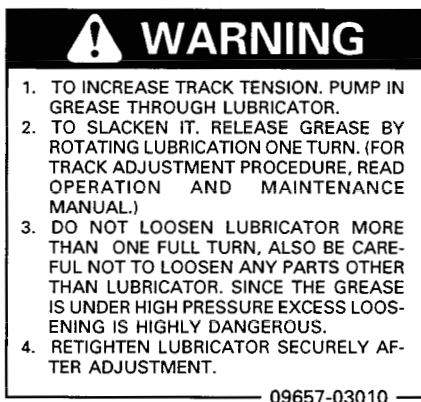

5. Warnings for leaving operator's seat  
(114-98-44510)

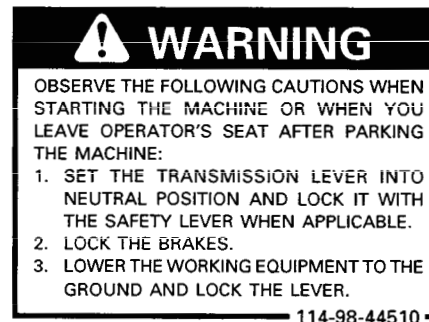

6. Cautions before operating machine  
(09651-03000)

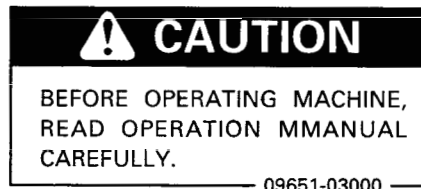

7. Cautions for opening hydraulic tank cap  
(09653-03000)



# OPERATION

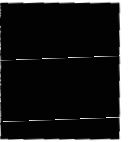

## 10. GENERAL VIEW

### 10.1 GENERAL VIEW OF MACHINE

If directions are indicated in this section, they refer to the directions shown by the arrows in the diagram below.

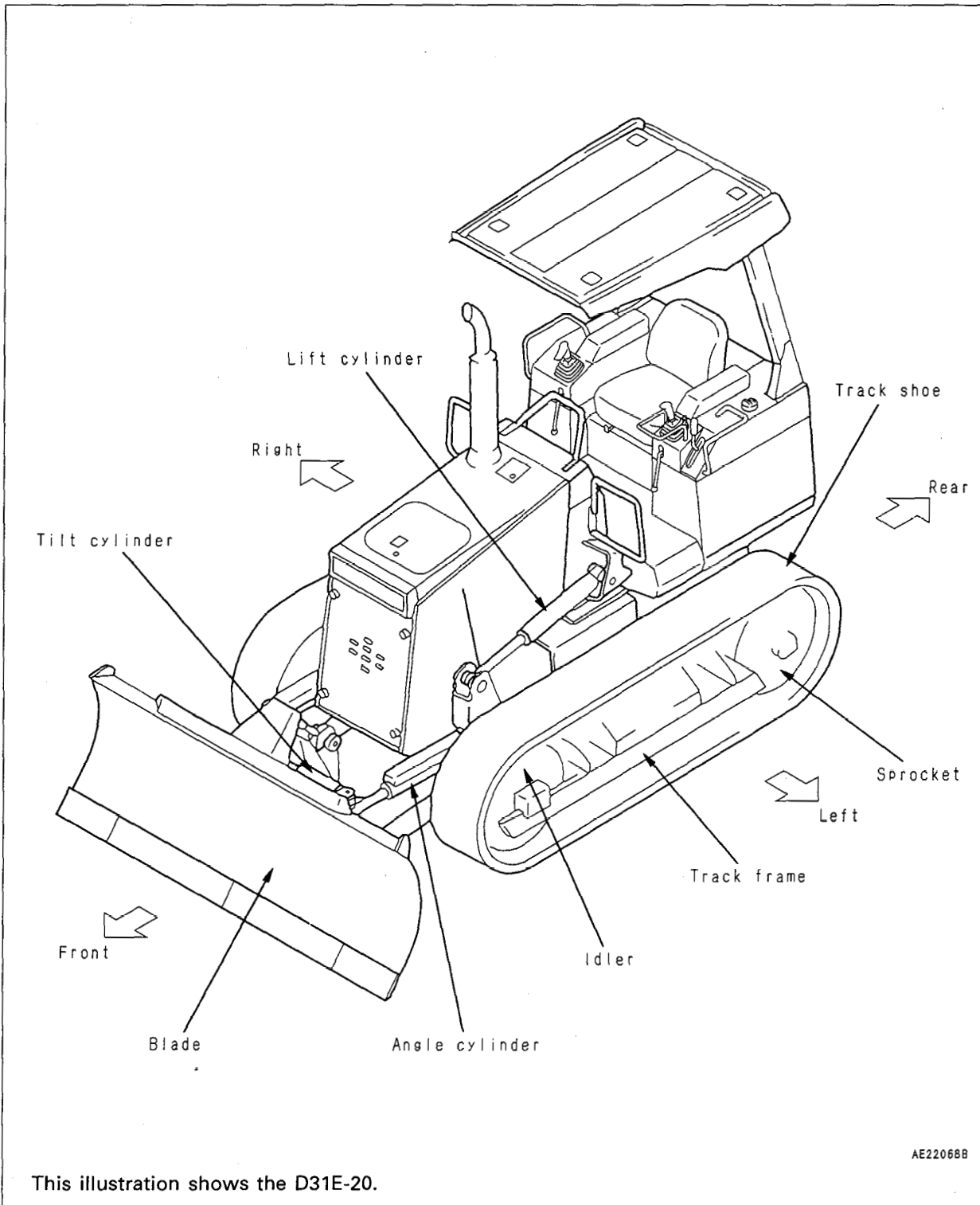

10.2 GENERAL VIEW OF CONTROLS AND GAUGES

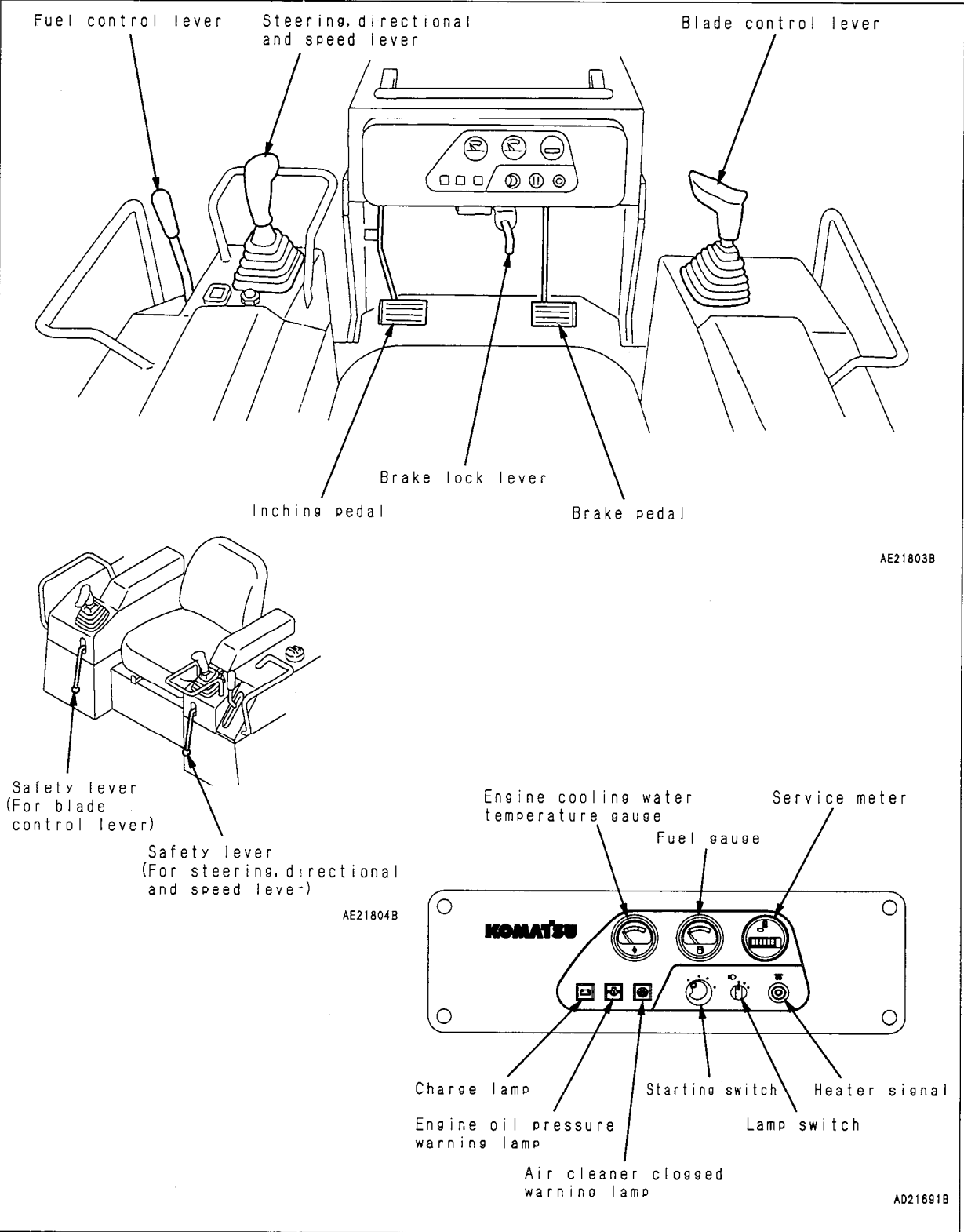

# 11. EXPLANATION OF COMPONENTS

The following is an explanation of the devices needed for operating the machine.

To carry out suitable operations correctly and safely, it is important to understand fully the methods of operating the equipment and the meanings of the displays.

## REMARK

The following explanation covers two types of machine: machines where the engine stops when the fuel control lever is set to the engine STOP position (machines stopped by the fuel control lever), and machines where the engine stops when the starting switch is turned to the OFF position (machines stopped by the starting switch).

## 11.1 METERS AND LAMPS

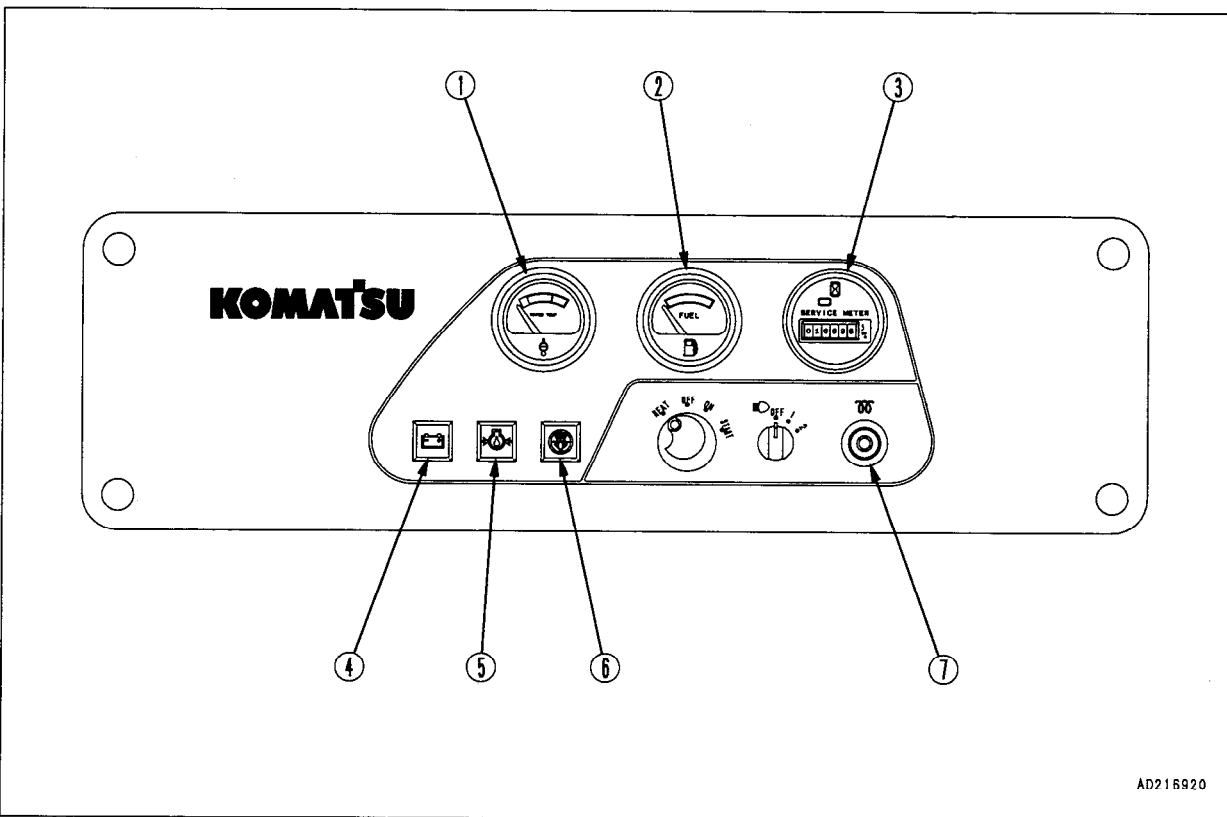

AD216920

### 1. ENGINE WATER TEMPERATURE GAUGE

This gauge indicates the cooling water temperature.

When the indicator is in the green range during operation, the water temperature is normal.

If the indicator moves from the green range into the red range during operation, stop the machine and run the engine with no load at medium speed until the water temperature goes down.

After starting the engine, warm up it until the indicator moves into the green range.

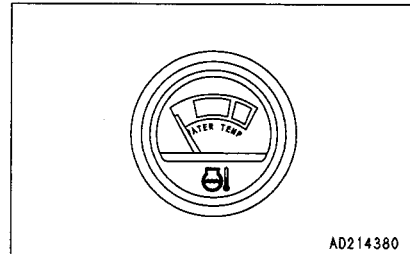

AD214380

**2. FUEL GAUGE**

This gauge indicates the amount of fuel in the fuel tank.  
 F indicates that the tank is full  
 E indicates that there is less than 14 liters of fuel remaining in the tank, so add fuel.  
 After each operation, be sure to fill up the fuel tank.

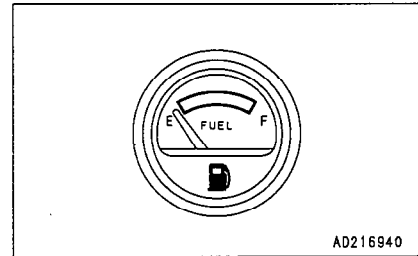
**3. SERVICE METER**

This meter shows the total operation hours of the machine.  
 The service meter advances while the engine is running – even if the machine is not traveling.  
 Set the periodic maintenance intervals using this display.  
 While the engine is running, operation display ① at the top inside of the meter will rotate to show that the meter is advancing.  
 Meter ② will advance by 1 for each hour of operation regardless of the engine speed.

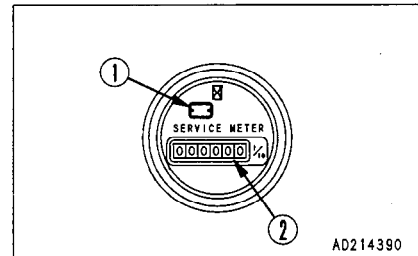
**4. CHARGE LAMP**

This lamp indicates malfunction of the alternator.  
 When the starting switch is turned ON, it will light up, but it should go out when the engine speed rises.

If the lamp lights up during operation, stop the engine and check the V-belt tension. If any abnormality is found, see "16. TROUBLESHOOTING."

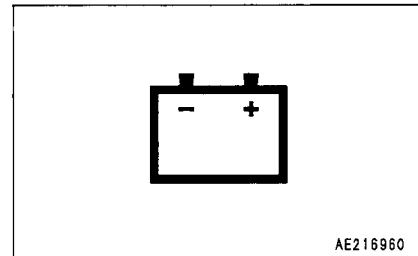
**5. ENGINE OIL PRESSURE WARNING LAMP**

This lamp warns that the engine lubricating oil pressure has dropped. When the starting switch is turned ON, it will light up. When the lamp goes off after the engine is started, the oil pressure is normal.

When the lamp lights up during operation, the oil pressure is lower. Immediately stop the engine and look for the cause. For details, see "16. TROUBLESHOOTING".

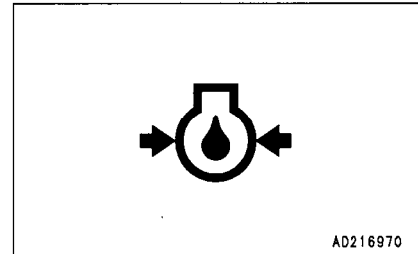
**6. AIR CLEANER CLOGGED WARNING LAMP**

This lamp warns that the air cleaner element is clogged.  
 When the lamp is off during operation, the air cleaner is normal.  
 When the lamp lights up, immediately clean the element.  
 After cleaning it, confirm that the lamp is off.

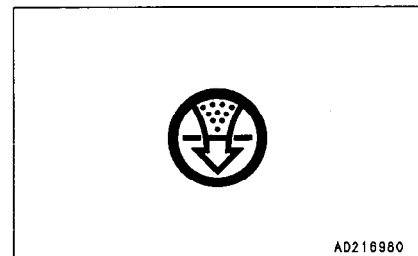
**7. HEATER SIGNAL**

This indicates the electrical intake air heater is red-heated.  
 When holding the starting switch key at the HEAT position, this signal glows red after 20 – 30 seconds.  
 When releasing the key, the key will return to the OFF position and the signal will go off.

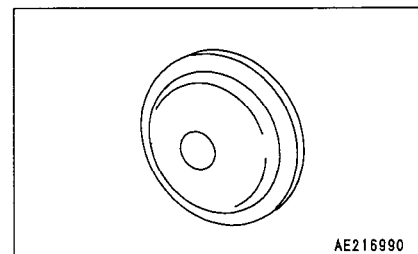



## 11.2 SWITCHES

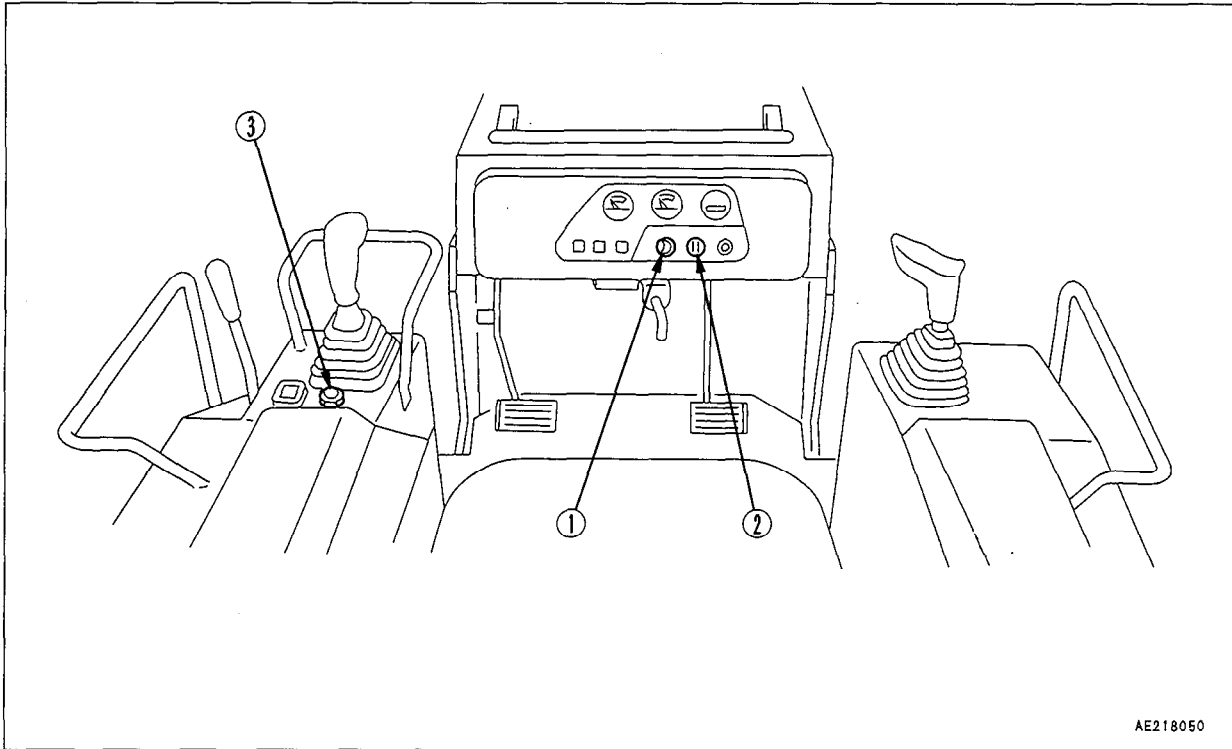

AE218050

### 1. STARTING SWITCH

(For machines stopped by fuel control lever)

This switch is used to start the engine.

OFF position:

At this position, the starting switch key can be inserted or removed. When the switch is turned to this position, the electrical circuits are switched off.

ON position:

In this position, electric current flows in the charging and lamp circuits.

Keep the starting switch key at the ON position while the engine is running.

Once the engine starts, do not turn the starting switch key to the OFF position.

START position:

This is the position to start the engine. Hold the key at this position while cranking. Release the key immediately after the engine has been started. The key will return to ON position when released.

HEAT position:

Turn the starting switch key to the HEAT position when starting in cold weather.

The electrical intake air heater is operated while the key is held in the HEAT position.

When the heater signal is red hot, release the key.

When the key is released, it will return to OFF, so turn it immediately to the START position to start the engine.

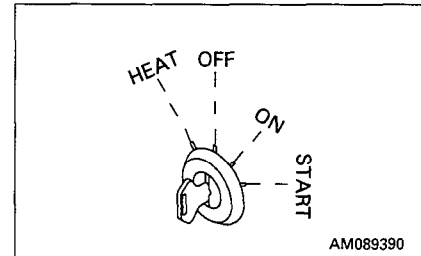

AM089390

**1. STARTING SWITCH**

**(For machines stopped by starting switch)**

This switch is used to start or stop the engine.

**OFF position:**

At this position, the starting switch key can be inserted or removed. When the switch is turned to this position, the electrical circuits are switched off and the engine stops.

**ON position:**

In this position, electric current flows in the charging and lamp circuits.

Keep the starting switch key at the ON position while the engine is running.

**START position:**

This is the position to start the engine. Hold the key at this position while cranking. Release the key immediately after the engine has been started. The key will return to ON position when released.

**HEAT position:**

Turn the starting switch key to the HEAT position when starting in cold weather.

The electrical intake air heater is operated while the key is held in the HEAT position.

When the heater signal is red hot, release the key.

When the key is released, it will return to OFF, so turn it immediately to the START position to start the engine.

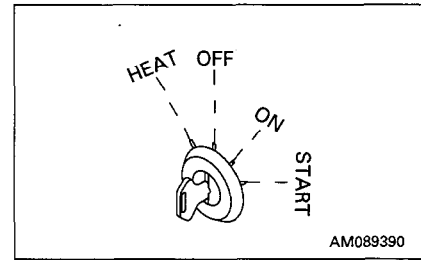

**2. LAMP SWITCH**

This lights up the head lamps, the rear working lamp and the panel lamp.

**Position OFF:** Lamps go off.

**Position 1:** Head lamps and panel lamp light up.

**Position 2:** Rear working lamp lights up in addition to the lamps in position 1.

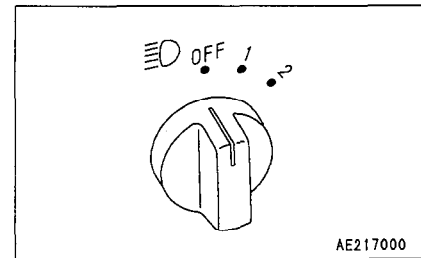

**3. HORN BUTTON**

To sound the horn, push the button located in front of the L.H. armrest.

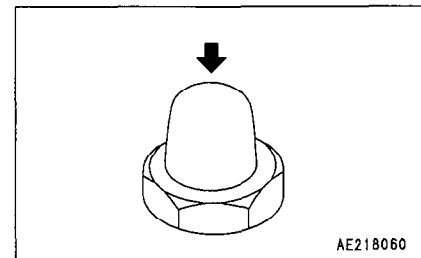

### 11.3 CONTROL LEVERS AND PEDALS

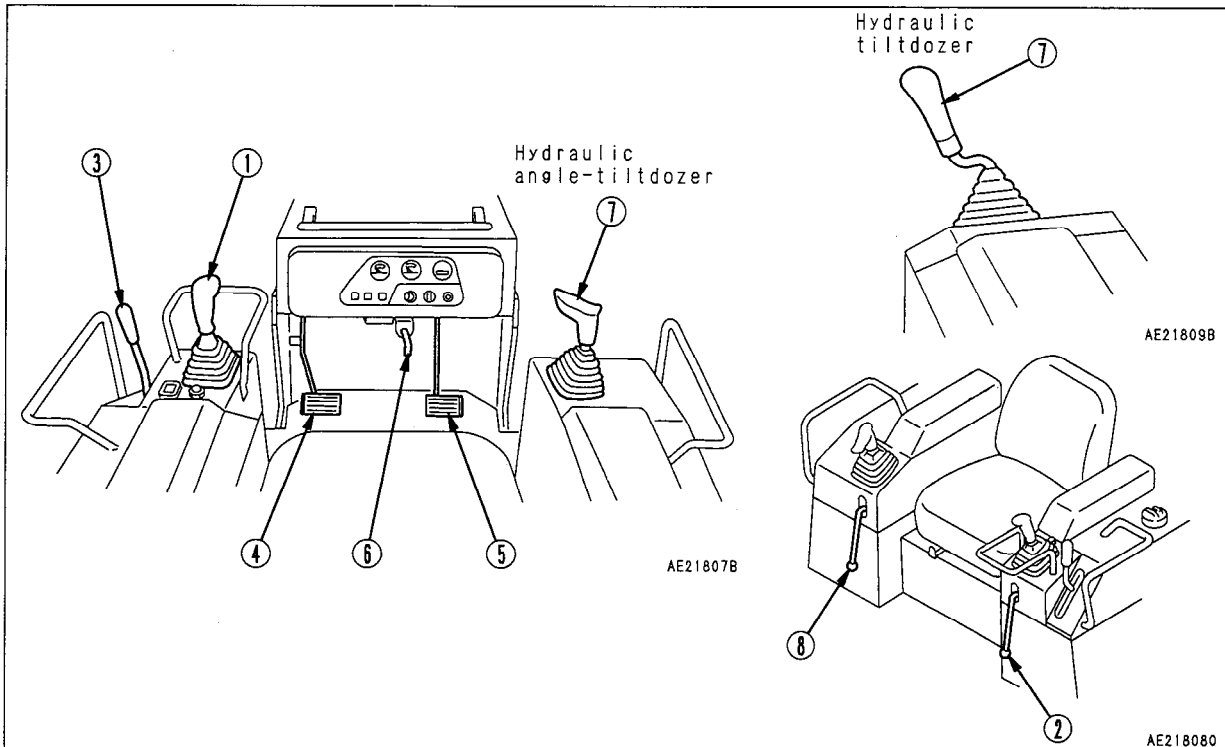

#### 1. STEERING, DIRECTIONAL AND SPEED LEVER

This lever is used to switch between forward and reverse, to shift the transmission gear, speed to steer the machine, and to perform spin turns.

##### Forward-reverse shifting

- ①: FORWARD
- ②: REVERSE
- Ⓝ: NEUTRAL

Push the lever forward, the machine will move off forward.

Pull the lever backward, the machine will move off in reverse.

##### Steering

- Ⓛ: LEFT TURN
- Ⓡ: RIGHT TURN

If the lever is moved partially in the direction to turn the machine, the steering clutch is disengaged and the machine will turn gradually. If the lever is moved more, the steering brake is applied and the machine will turn on the spot.

If the lever is released when steering the machine, the lever will return to the ① position or the ② position and the machine will be returned to straight movement.

##### REMARK

When starting the engine, check that the levers are at the N position and that the safety lever is at the LOCK position. If they are not at these positions the engine will not start.

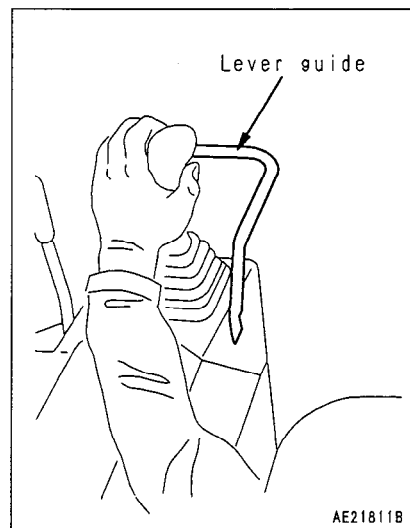
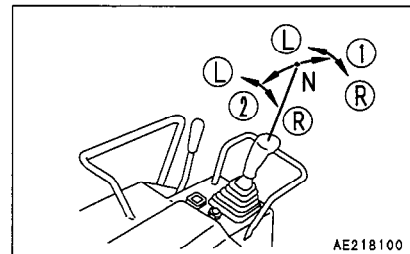

**Gear shifting**

Shift the gear by turning the steering, directional and speed lever in the range of 30°.

- Ⓐ: First speed
- Ⓑ: Second speed
- Ⓒ: Third speed

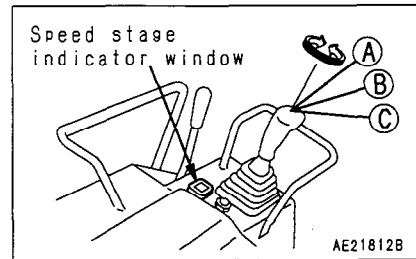

**REMARK**

If the gear is shifted, the speed is indicated in the indicator window at the rear of the lever.

- First speed: ① is indicated in the indicator window.
- Second speed: ② is indicated in the indicator window.
- Third speed: ③ is indicated in the indicator window.

**2. SAFETY LEVER (For steering, directional speed lever)**

**⚠ WARNING**

- When leaving the operator's compartment, set the safety lever securely to the LOCK position. If the control lever is not locked, and it is touched by mistake, this may lead to a serious accident.
- If the safety lever is not placed securely in the LOCK position, the control lever may not be properly locked.

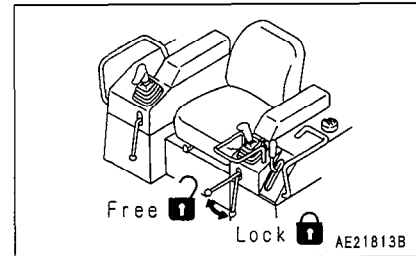

This locks the steering and directional lever. Move the steering and directional lever to the N (neutral) position and lower the lever to apply the lock.

**REMARK**

If the safety lever is not in the LOCK position, the engine cannot be started.

**3. FUEL CONTROL LEVER**

**(For machines stopped by fuel control lever)**

This lever is used to control the engine speed and output.

- ① Engine stop position: Push the lever fully.
- ② Low idling position: Pull the lever from engine stop position ① until you feel the operating force falls off.
- ③ High idling position: Pull the lever fully.

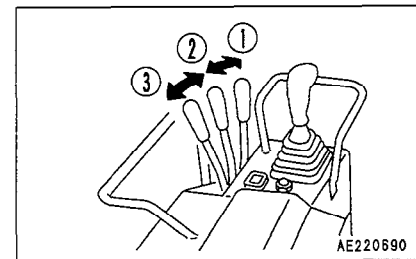

**3. FUEL CONTROL LEVER**

**(For machines stopped by starting switch)**

This lever is used to control the engine speed and output.

- ① Low idling position: Push the lever fully.
- ② High idling position: Pull the lever fully.

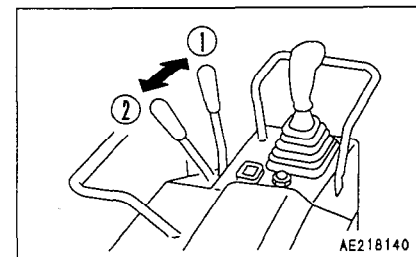

## 11. EXPLANATION OF COMPONENTS

### 4. INCHING PEDAL

**⚠ WARNING**

**Do not place your foot on this pedal unnecessarily.**

This pedal engages and cuts the transmission of motive force from the engine and is used to carry out fine travel operations.

If the pedal is depressed half way, the motive force is cut; if the pedal is depressed fully, the brake is applied and the machine will stop.

This operation is used when approaching the target.

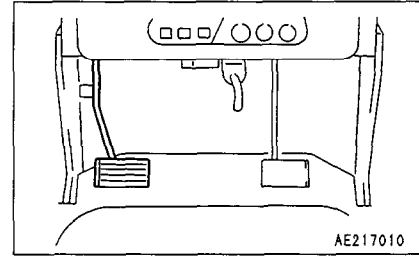

### 5. BRAKE PEDAL

**⚠ WARNING**

**Do not place your foot on this pedal unnecessarily.**

Depress the pedal to apply the right and left brakes.

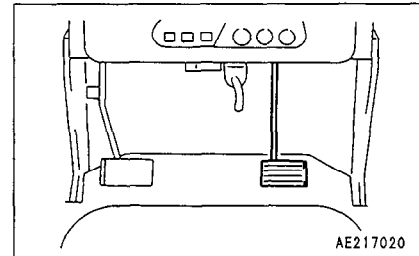

### 6. BRAKE LOCK LEVER

**⚠ WARNING**

**Whenever machine is parked, lock brake pedal without fail.**

This is the locking device of the brake pedal when parking. When locking the brakes, pull the lock lever towards you (place in the LOCK position), then depress the brake pedal strongly to apply the lock securely.

When releasing the brake, keep the brake pedal depressed, and push the lock lever.

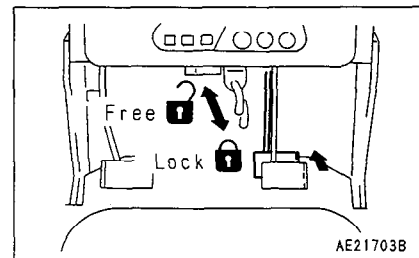

**7. BLADE CONTROL LEVER**

**Lifting and tilting control**

This lever is used to raise or tilt the blade.

① RAISE : 

② HOLD : 

Blade is stopped and held in this position.

③ LOWER : 

④ FLOAT : 

Blade will move freely according to external force.

When released from FLOAT position, this lever will not return to HOLD position, so it must be moved back by hand.

Ⓐ LEFT TILT : 

Ⓑ RIGHT TILT : 

**REMARK**

To change from ANGLE to TILT, keep the switch at the front of the lever pressed down and return the lever to the HOLD position. Then release the switch and carry out the standard tilt operations. (Hydraulic angle-tilt dozer only)

(Hydraulic angle-tilt dozer)

Blade condition	Tilt (mm)	
	D31E-20, D37E-5	D31P-20A, D37P-5A
No angling	350	420
Right angle, right tilt	370	305
Right angle, left tilt	315	500
Left angle, right tilt	350	475
Left angle, left tilt	350	345

(Hydraulic tilt dozer)

Machine model	Tilt (mm)
D31P-20	355
D31PL-20	415
D31PLL-20	450

**Angling control**

(For hydraulic angle-tilt dozer only)

Place the lever in the neutral (HOLD) position. Keep the switch at the front of the lever pressed and operate the lever to the left or right to angle the blade.

Ⓐ LEFT ANGLE (  )

② HOLD:

Blade is stopped and held in this position.

Ⓑ RIGHT ANGLE (  )

Blade can be angled at 25° on both right and left sides.

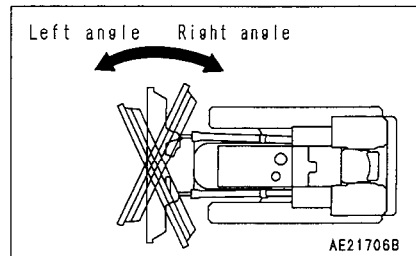
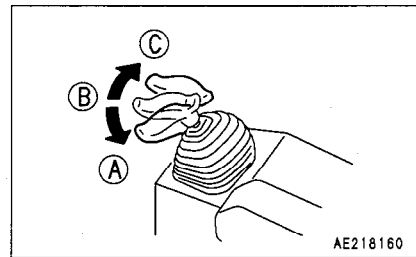
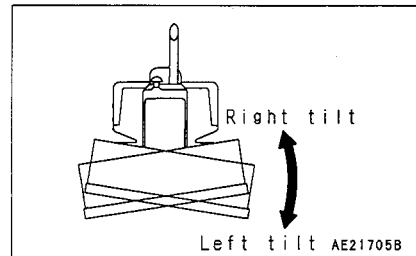
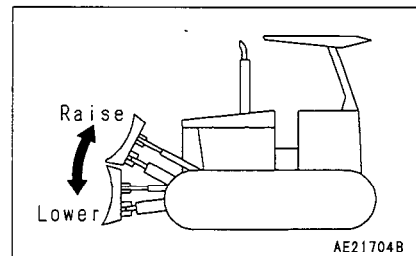
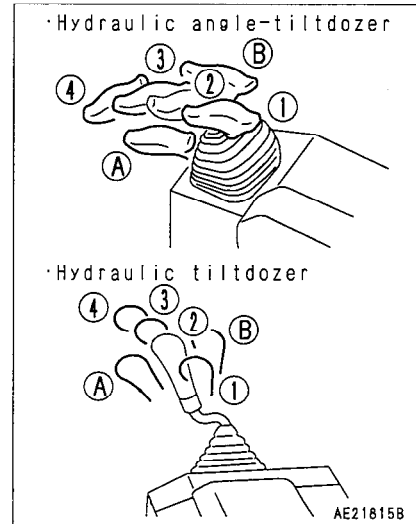

8. SAFETY LEVER (For blade control lever)

**⚠ WARNING**

- When leaving the operator's compartment, set the safety lever securely to the LOCK position. If the control lever is not locked, and it is touched by mistake, this may lead to a serious accident.
- If the safety lever is not placed securely in the LOCK position, the control lever may not be properly locked. Check that the situation is as shown in the diagram.
- When parking or servicing the machine, be sure to lower the blade and set the safety lock in the LOCK position.

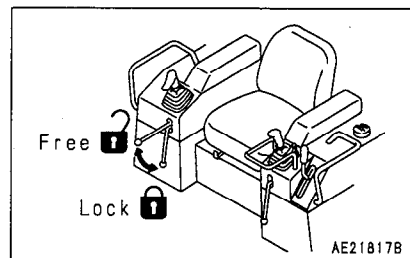

This is the locking device of blade control lever. Lower the lever to apply the lock.

### 11.4 FUSE BOX

**NOTICE**

- Before replacing a fuse, be sure to turn off the starting switch.
- If the fuse blows again immediately after it is replaced, please contact your Komatsu distributor to have the system inspected.

The fuses protect the electrical equipment and wiring from burning out.

If the fuse becomes corroded, or white powder can be seen, or the fuse is loose in the fuse holder, replace the fuse.

Replace a fuse with another of the same capacity.

**Fuse capacity and circuit name**

No.	FUSE CAPACITY	CIRCUIT NAME
①	20 A (yellow)	Head lamp, Rear working lamp
②	10 A (red)	Horn
③	10 A (red)	Water temperature gauge, Fuel gauge, Angle select switch for hydraulic angle-tilt dozer (Back-up alarm)
④	20 A (red)	
⑤	30 A (green)	Engine stop motor (for machines stopped by starting switch) Power source for inspection and maintenance

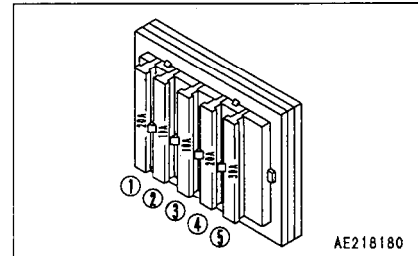
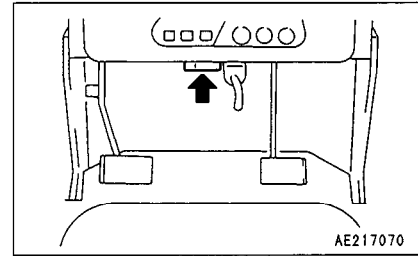

### 11.5 LOCATION OF FIRE EXTINGUISHER

When providing a fire extinguisher, install it in the position shown below.

Position for installing fire extinguisher.

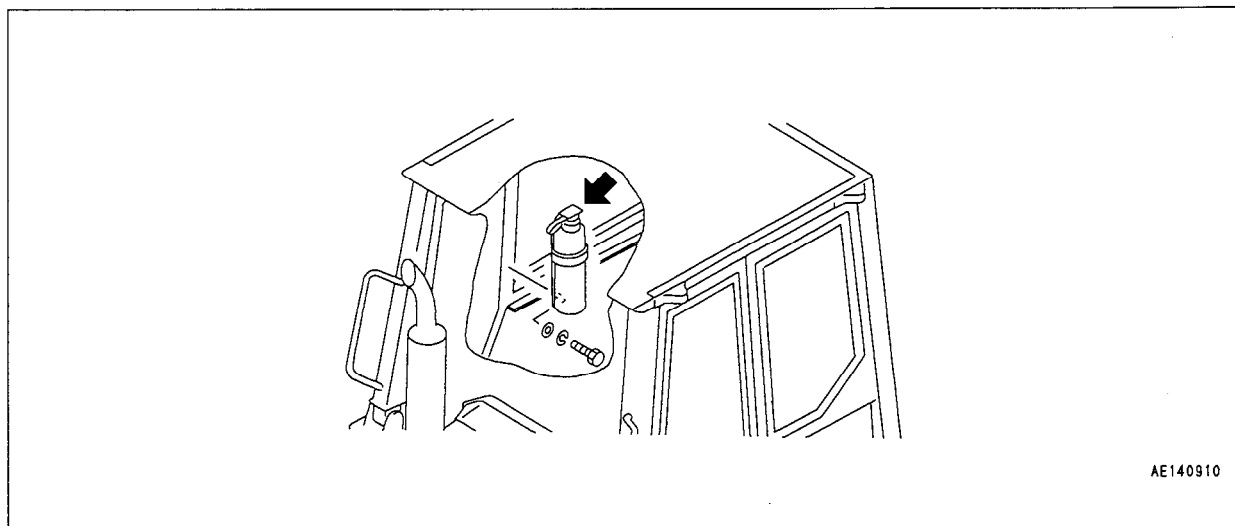



## 11.6 ELECTRIC POWER TAKE-OUT ADAPTER

1. Remove the side cover from the left side of the machine body.

2. Pull out the connector plug for taking out electric power from the rear side of the panel.

⊕: wire-yellow

⊖: wire-black for grounding (2 poles)

	⊕ wire	⊖ wire
Fitting connector	08021-04000	08022-04001
Capacity of fuse	5 A	
Maximum usable electric power	120W	

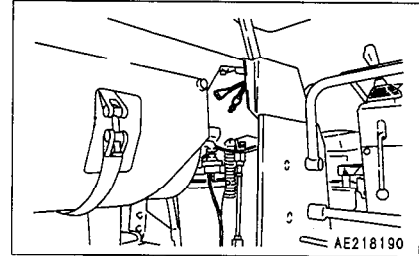

### REMARK

There is a fuse (5A) just after the ⊕ connector.

## 11.7 MANUAL POCKET

The operator's seat has a manual pocket in the back of backrest.

This manual should be kept in it for reference and periodical reviewing.

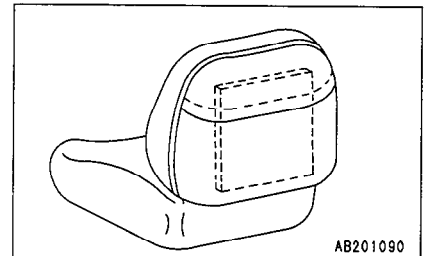

## 12. OPERATION

### 12.1 CHECK BEFORE STARTING ENGINE

#### 12.1.1 WALK-AROUND CHECK

**⚠ WARNING**

Leakage of oil or fuel, or accumulation of flammable material around high temperature parts, such as the engine muffler may cause fire.

Check carefully, and if any abnormality is found, repair it or contact your Komatsu distributor.

Before starting the engine, look around the machine and under the machine to check for loose nut or bolts, or leakage of oil, fuel, or coolant, and check the condition of the work equipment and hydraulic system. Check also for loose wiring, play, and collection of dust at places which reach high temperatures.

Perform the contents of this section only once before starting the engine every day.

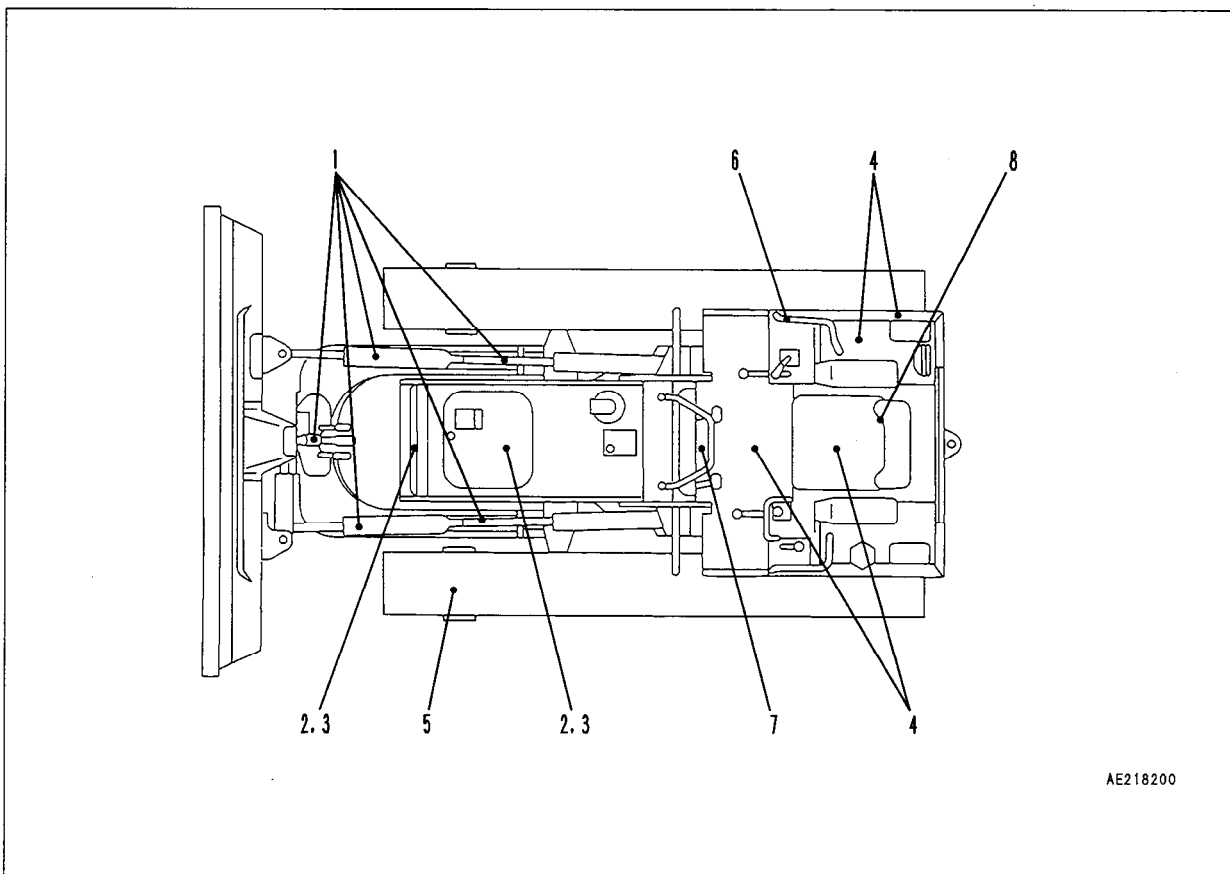

AE218200

- 1. Check for damage, wear, play in work equipment, cylinders, linkage, hoses**  
Check that there are no cracks, excessive wear, or play in the work equipment, cylinders, linkage, or hoses. If any abnormality is found, repair it.
- 2. Remove dirt and dust from around engine, battery radiator**  
Check if there is any dirt or dust accumulated around the engine or radiator. Check also if there is any flammable material (dead leaves, twigs, grass, etc.) accumulated around the battery or high temperature engine parts, such as the engine muffler. Remove all such dirt or flammable material.
- 3. Check for leakage of water or oil around engine**  
Check that there is no leakage of oil from the engine or leakage of water from the cooling system. If any abnormality is found, repair it.
- 4. Check for oil leakage from transmission case, transfer case (incl. bevel gear case), steering clutch case, final drive case, hydraulic tank, hoses, joints**  
Check that there is no oil leakage. If any abnormality is found, repair the place where the oil is leaking.  
Check for oil leakage by checking the undercover and ground for oil drips.
- 5. Check the undercarriage (track, sprocket, idler, guard) for damage, wear, loose bolts, or leakage of oil from rollers**  
If any damage, wear, or oil leakage is detected, repair it, and retighten the bolts.
- 6. Check for damage to handrail, loose bolts**  
Repair any damage and tighten any loose.
- 7. Check for damage to gauges, lamps on instrument panel, loose bolts**  
Check that there is no damage to the panel, gauges and lamps. If any abnormality is found, replace the parts. Clean off any dirt on the surface.
- 8. Check for damage to seat belt and mounting clamps (option)**  
Check that there is no abnormality in the seat belt or mounting clamps. If there is any damage, replace with new parts.

### 12.1.2 CHECK BEFORE STARTING

#### CHECK COOLANT LEVEL, ADD WATER

**⚠ WARNING**

**Do not open the radiator cap normally. Check the coolant level at the sub tank while the engine is cold.**

1. Open the top cover at the front of the machine body and confirm that the coolant level is between the FULL and LOW lines of sub tank ① (Shown at right). If it is lower than the LOW line, supply coolant to the FULL line through the coolant filler of sub tank ①.

**REMARK**

In summer, the coolant may flow out through the drain hose of the sub tank. This is caused by supply of too much coolant, and is not a problem.

2. After supplying coolant, close the cap securely.
3. If the sub tank is empty, check for water leakage and confirm that the radiator main tank is full, then supply coolant to the radiator sub tank.
4. After supplying coolant, close the top cover.

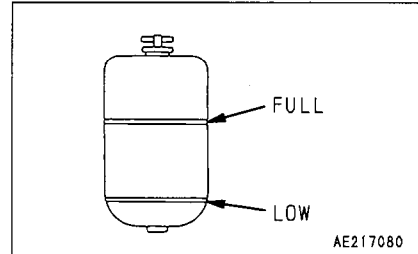
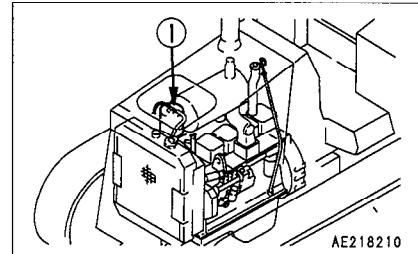

#### CHECK FUEL LEVEL, ADD FUEL

**⚠ WARNING**

**When adding fuel, never let the fuel overflow. This may cause a fire. If spilling fuel, thoroughly clean up any spillage.**

1. Turn on the engine starting switch and check the fuel level with fuel gauge ⑥. After checking the fuel level, turn off the switch.
2. After completing work, fill the fuel tank through oil filler port ⑦.

**NOTICE**

For details of the oil to use, see "20. USE OF FUEL, COOLANT AND LUBRICANTS ACCORDING TO AMBIENT TEMPERATURE".

3. After adding fuel, tighten the cap securely.  
Fuel capacity: 118 ℓ (3.12 US gal, 26.0 UK gal)

**NOTICE**

A clogged cap breather hole ① may stop the fuel flow to the engine. Check it from time to time and clean.

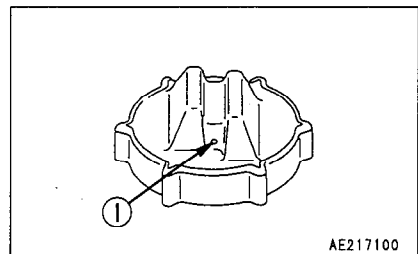
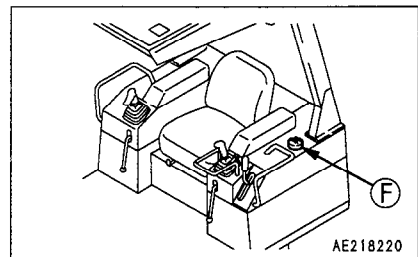
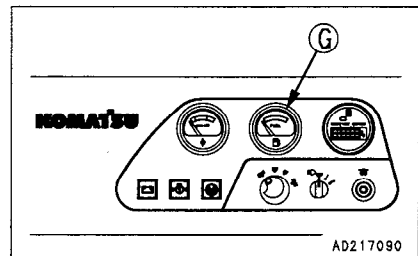

**CHECK OIL LEVEL IN ENGINE OIL PAN, ADD OIL**

1. Open the upper cover at the rear of the engine hood.
2. Remove dipstick ③ and wipe the oil off with a cloth.
3. Insert dipstick ③ fully in the oil filler pipe, then take it out again.
4. The oil level should be between the H and L marks on dipstick ③.  
④.  
If the oil level is below the L mark, add engine oil through oil filler ⑤.

**NOTICE**

For details of the oil to use, see "20. USE OF FUEL, COOLANT AND LUBRICANTS ACCORDING TO AMBIENT TEMPERATURE".

5. If the oil is above the H mark, drain the excess engine oil from drain plug ⑥, and check the oil level again.
6. If the oil level is correct, tighten the oil filler cap securely and close the engine side cover.

**REMARK**

- When checking the oil level after the engine has been operated, wait for at least 15 minutes after stopping the engine before checking.
- If the machine is at an angle, make it horizontal before checking.

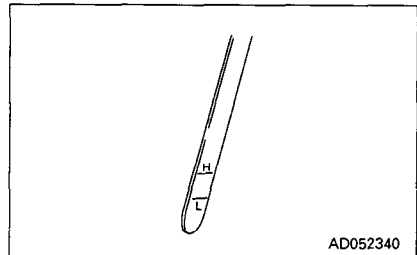
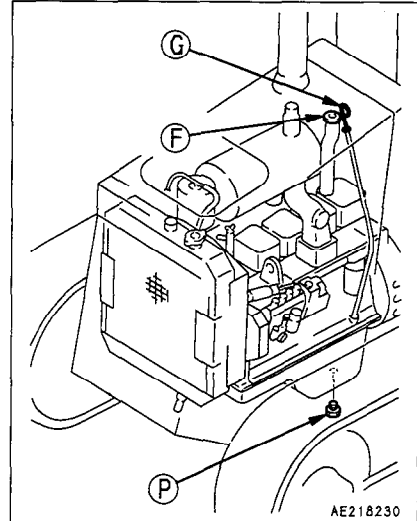

**CHECK OIL LEVEL IN TRANSMISSION CASE, ADD OIL**

1. Open the cover, remove dipstick ③, and wipe the oil off with a cloth.
2. Insert dipstick ③ fully in the oil filler pipe, then take it out again.
3. The oil level should be between the H and L marks on dipstick ③.  
④.  
If the oil level is below the L mark, add engine oil through oil filler ⑤.

**NOTICE**

For details of the oil to use, see "20. USE OF FUEL, COOLANT AND LUBRICANTS ACCORDING TO AMBIENT TEMPERATURE".

4. If the oil is above the H mark, drain the excess engine oil from drain plug ⑥, and check the oil level again.
5. If the oil level is correct, tighten the oil filler cap securely and close the cover.

**REMARK**

- When checking the oil level after the engine has been operated, wait for at least 15 minutes after stopping the engine before checking.
- If the machine is at an angle, make it horizontal before checking.

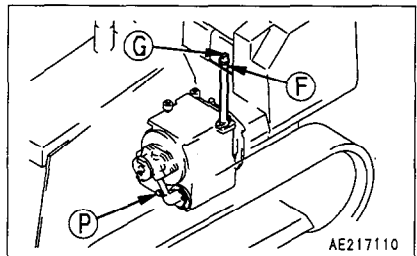

**CHECK OIL LEVEL IN TRANSFER CASE (INCL. BEVEL GEAR CASE),  
ADD OIL**

1. Open the cover, remove dipstick **Ⓒ**, and wipe the oil off with a cloth.
2. Insert dipstick **Ⓒ** fully in the oil filler pipe, then take it out again.
3. The oil level should be between the H and L marks on dipstick **Ⓒ**.  
If the oil level is below the L mark, add engine oil through oil filler **Ⓕ**.

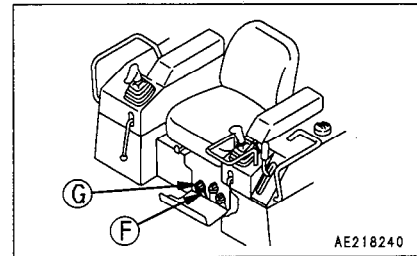

**NOTICE**

For details of the oil to use, see "20. USE OF FUEL, COOLANT AND LUBRICANTS ACCORDING TO AMBIENT TEMPERATURE".

4. If the oil is above the H mark, drain the excess engine oil from drain plug **⒫**, and check the oil level again.
5. If the oil level is correct, tighten the oil filler cap securely and close the cover.

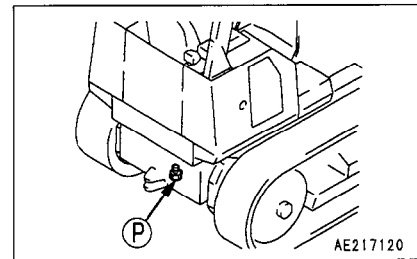

**REMARK**

- When checking the oil level after the engine has been operated, wait for at least 15 minutes after stopping the engine before checking.
- If the machine is at an angle, make it horizontal before checking.

**CHECK OIL LEVEL IN STEERING CLUTCH CASE, ADD OIL**

1. Open the cover, remove dipstick ③, and wipe the oil off with a cloth.
2. Insert dipstick ③ fully in the oil filler pipe, then take it out again.
3. The oil level should be between the H and L marks on dipstick ③.  
 If the oil level is below the L mark, add engine oil through oil filler ④.

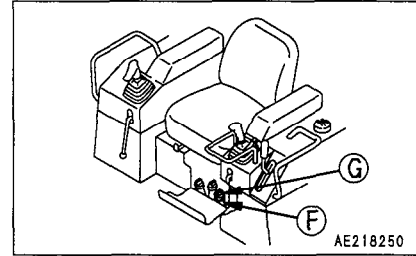

**NOTICE**

For details of the oil to use, see "20. USE OF FUEL, COOLANT AND LUBRICANTS ACCORDING TO AMBIENT TEMPERATURE".

4. If the oil is above the H mark, drain the excess engine oil from drain plug ⑤, and check the oil level again.
5. If the oil level is correct, tighten the oil filler cap securely and close the cover.

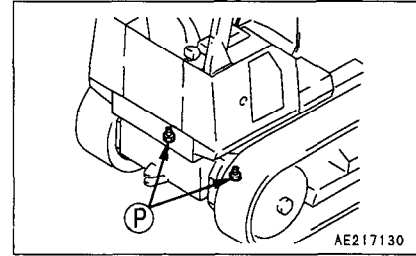

**REMARK**

- When checking the oil level after the engine has been operated, wait for at least 15 minutes after stopping the engine before checking.
- If the machine is at an angle, make it horizontal before checking.

**CHECK BRAKE PEDAL TRAVEL**

**WARNING**

If the travel of the brake pedal is not within a range of 110 – 162 mm (4.33 – 6.38 in), the brakes and steering will be too strong or they will not work properly. If the travel of the brake pedal is 163 mm (6.42 in) or more, carry out adjustment.

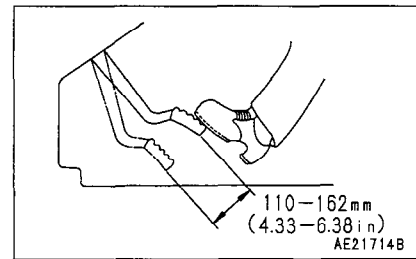

1. Depress the brake pedal all the way until it stops.
2. Measure the pedal travel for being from 110 mm (4.33 in) to 162 mm (6.38 in) at the bottom end of the pedal.
3. When this value exceeds 163 mm (6.42 in), or the brake fails to work adjust the pedal referring to "24.2 WHEN REQUIRED".

**DOES THE HORN SOUND NORMALLY?**

If the horn does not sound, or its volume is extremely low, there may be trouble with the horn or its wires may be broken. In such cases, ask your Komatsu distributor for repairs.

1. Turn on the starting switch.
2. Press the horn switch in front of the left-hand armrest to see if the horn sounds.

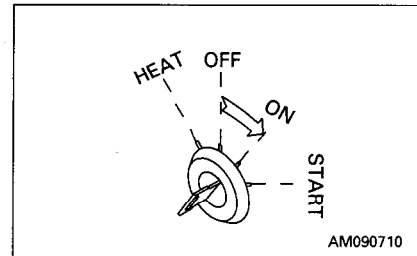

AM090710

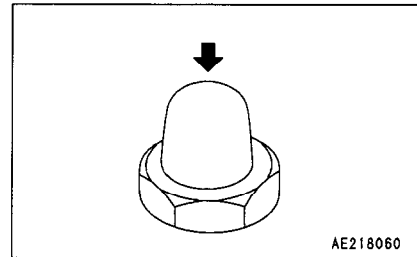

AE218060

**DO LAMPS LIGHT UP NORMALLY?  
ARE THEY FREE FROM DIRT AND DAMAGE?**

Confirm that the head lamps, rear lamps, and lamps in the instruments light up normally, and check them for dirt and damage.

If any lamp does not light up, its bulb or wire may be broken. In such case, ask your Komatsu distributor for repair.

1. Turn on the starting switch.
2. Turn each lamp switch to positions of OFF, 1 and 2, and confirm that the lamps lights up and goes off normally.

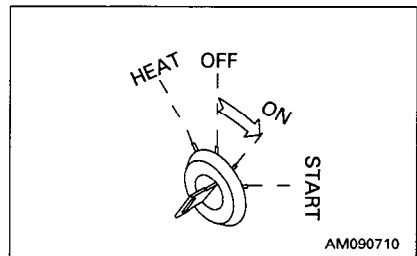

AM090710

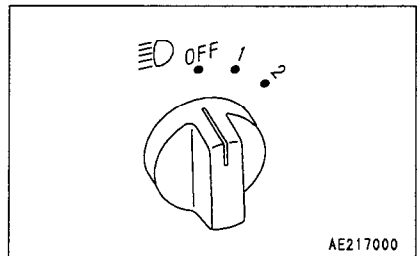

AE217000



**CHECK OF OPERATION OF BACKUP ALARM (OPTION)**

Confirm that the backup alarm operates normally. If it does not operate, it may be broken or a wire may be loose or broken. In such cases ask your Komatsu distributor for repairs.

1. Turn on the starting switch.

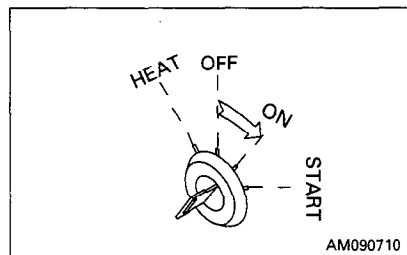

2. Set the steering, directional and speed lever to the reverse position, and confirm that the alarm operates.

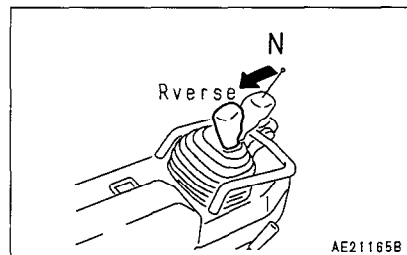

**WEAR AND DAMAGE OF SEAT BELT (OPTION)**

Check the seat belt and its fitting. If they are worn or damaged, replace them.

**CHECK OF EXHAUST GAS COLOR AND SOUND OF ENGINE**

**CHECK OF OPERATION OF INSTRUMENTS**

**CHECK FOR WATER AND SEDIMENT IN WATER SEPARATOR, DRAIN WATER (ONLY FOR MACHINES EQUIPPED WITH WATER SEPARATOR)**

Open the inspection cover of the left-hand engine side cover.

The water separator separates water mixed in the fuel. If float ② is at or above red line ①, drain the water according to the following procedure:

1. Loosen drain plug ③ and drain the accumulated water until the float reaches the bottom.
2. Tighten drain plug ③.
3. If the air is sucked into fuel line when draining and water, be sure to bleed air in the same manner as for the fuel filter. See "24.6 EVERY 500 HOURS SERVICE".

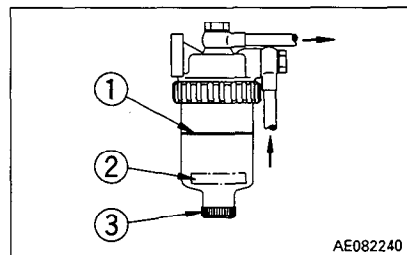

### 12.1.3 ADJUST OPERATOR'S SEAT

**⚠ WARNING**

- Adjust the seat position at the beginning of each shift or when operators change.
- Adjust the seat so that the brake pedal can be depressed all the way with the operator's back against the backrest.

#### Fore-aft adjustment of seat

Set the seat in the desired position by moving lever ① to right; then release the lever.

Fore-aft adjustment: 160 mm (6.3 in) in 9 steps.

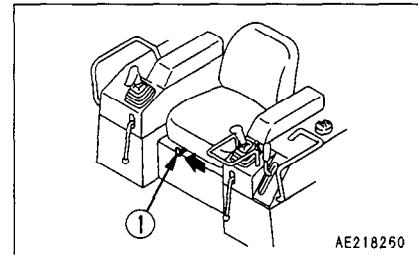

### 12.1.4 OPERATIONS AND CHECKS BEFORE STARTING ENGINE

**⚠ WARNING**

If the control levers are touched by accident, the work equipment or the machine may move suddenly. When leaving the operator's compartment, always set the safety lever securely to the LOCK position.

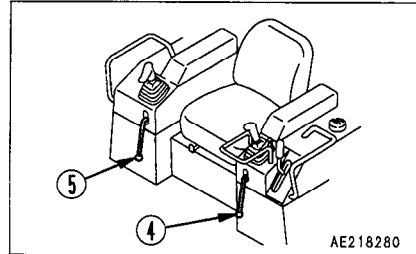
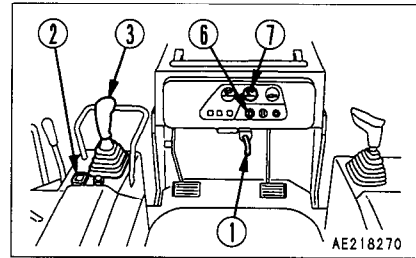

1. Check that the brake pedal is locked with brake lock lever ①.

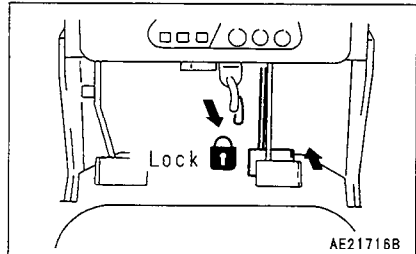

2. Confirm that speed stage indicator window ② indicates the first speed.

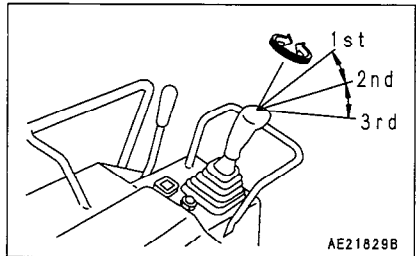

3. Check that steering, directional and speed lever ③ is the N (neutral) position and is locked with safety lever ④. When starting the engine, check that the levers are at the N position and that the safety lever is at the LOCK position. If they are not at these positions the engine will not start.

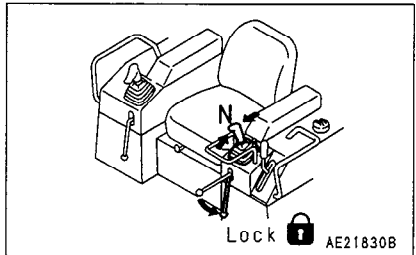

4. Check that the blade is lowered on the ground and the blade control lever is locked with safety lever ⑤.

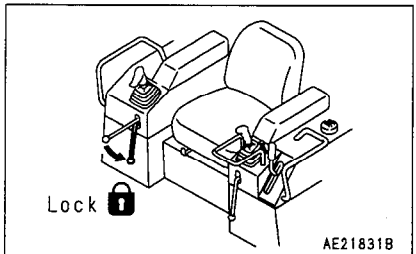

5. Insert the key in starting switch ⑥, turn the key to the ON position, then check the fuel level using fuel gauge ⑦.

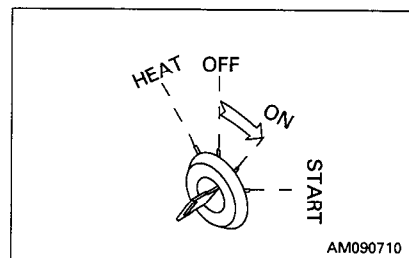

## 12.2 STARTING ENGINE

### 12.2.1 NORMAL STARTING

**WARNING**

Check that there are no persons or obstacles in the surrounding area, then sound the horn and start the engine.

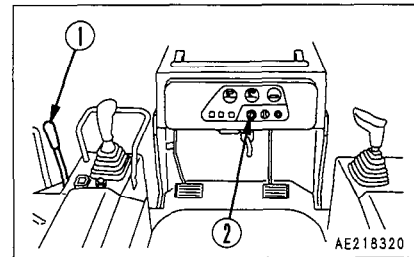

**NOTICE**

Do not keep the starting motor rotating continuously for more than 20 seconds.

If the engine will not start, wait for at least 2 minutes before trying to start the engine again.

1. Pull the fuel control lever ① to the middle point between the low idling position and full speed position.

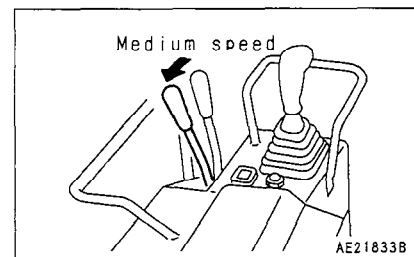

2. Insert the key in the starting switch ② and turn it to the START position, and the engine will start.

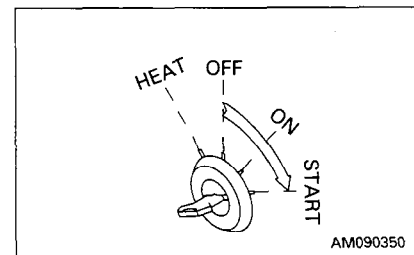

3. When the engine starts, release the key in starting switch ②. The key will return automatically to the ON position.

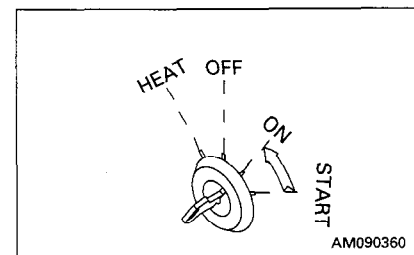

**12.2.2 STARTING IN COLD WEATHER**

When starting in low temperatures, do as follows.

**⚠ WARNING**  
**Never use starting aid fluids as they may cause explosions.**

**NOTICE**

Do not keep the starting motor rotating continuously for more than 20 seconds.

If the engine fails to start, repeat steps 2 and 3 after waiting for about 2 minutes.

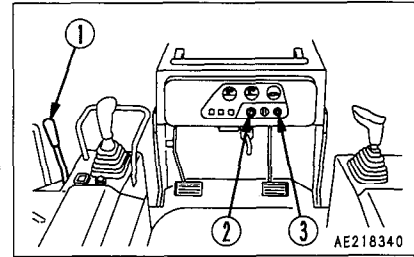

1. Pull the fuel control lever ① to the middle point between the low idling position and full speed position.

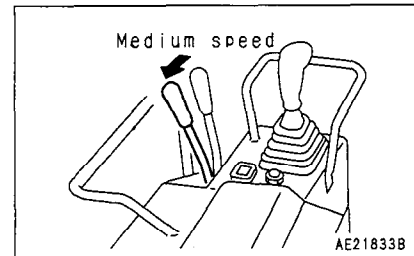

2. Insert the key in starting switch ② and turn it to the HEAT position, and keep it in this position until the heater signal ③ becomes red.

The preheating times are as shown below.

Ambient temperature	Preheat time
Above 0°C	-
0°C to -10°C	20 seconds
-10°C to -20°C	30 seconds

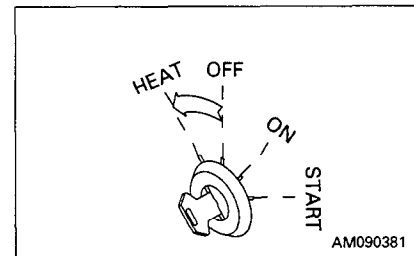

If the preheating time is too long or too short, the engine will not start easily. Observe the correct preheating time.

3. When heater signal ③ becomes red, turn the key of starting switch ② to the START position and start the engine.

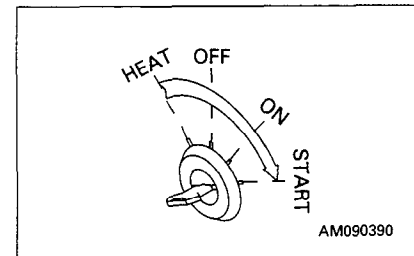

## 12. OPERATION

---

4. When the engine starts, release the key in starting switch ②.  
The key will return automatically to the ON position.

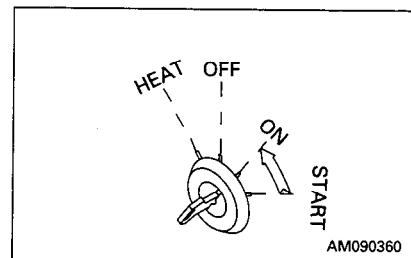

### 12.3 OPERATIONS AND CHECKS AFTER STARTING ENGINE

After starting the engine, do not immediately start operations. First, carry out the following operations and checks.

#### NOTICE

**Avoid abrupt acceleration until warm-up run is completed.**

**Do not run the engine at low idling or high idling for more than 20 minutes.**

**If it is necessary to run the engine at idling, apply a load or run at a medium speed from time to time.**

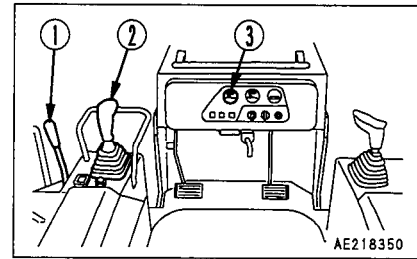

1. Pull fuel control lever ① to the center position between LOW IDLING and HIGH IDLING and run the engine at medium speed for about 5 minutes with no load.

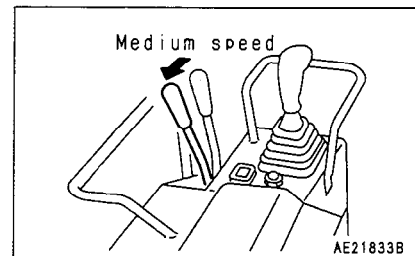

2. When starting in cold weather, operate the steering, directional and speed lever ② as follows. Move steering, directional and speed lever ② to the N position, move the lever fully in left direction ① and hold it for 5 seconds, then move the lever fully in right direction ② and hold it for 5 seconds. Repeat this operation in each direction in turn for 5 minutes with engine running under no load.

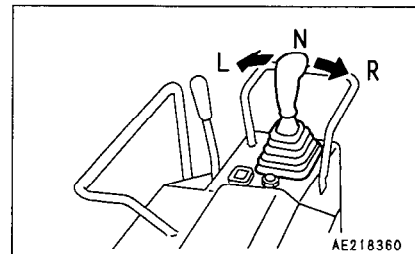

3. After warm-up run is completed, check gauges, warning lamps and charge lamp for proper operation. If any abnormality is found, repair it.

Continue to run the engine at light load until engine water temperature gauge indicator ③ falls within the green range.

4. Check that there is no abnormal exhaust gas color, noise, or vibration. If any abnormality is found, repair it.

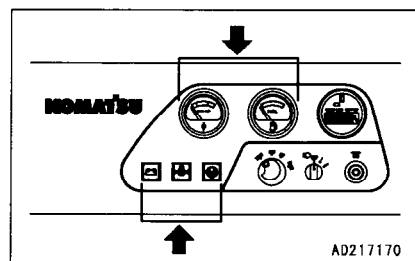



## 12.4 MOVING MACHINE

### WARNING

- When moving off, check that the area around the machine is safe, and sound the horn before moving. Clear all personnel from the machine and the area. Clear all obstacles from the path of the machine. Use extreme care when reversing the machine. Note there is an blind spot behind the machine.
- When starting on slopes, always keep brake pedal ② depressed even after releasing brake lock lever ①.
- When starting on a sharp slope, raise the engine speed to the maximum and set the steering, directional and speed lever ③ to the first speed of F (Forward) or R (Reverse) with brake pedal ② depressed. If the machine starts slowly (or the shoe slips), release brake pedal ② gradually to start the machine.
- If the machine is equipped with the backup alarm, set the steering, directional and speed lever ③ to the reverse position and confirm that the alarm operates normally.

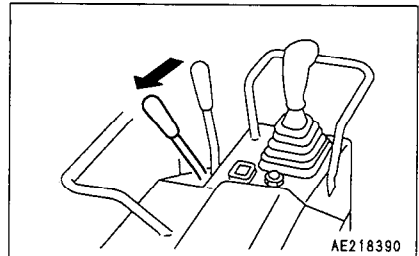
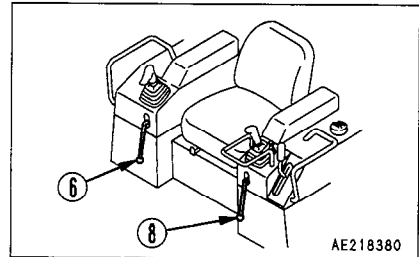
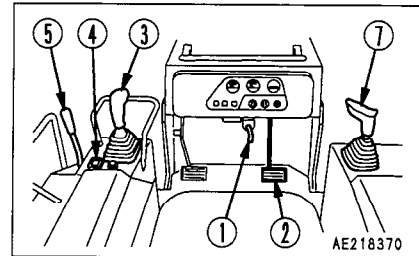

1. Pull fuel control lever ⑤ to increase the engine speed.

2. Operate steering, directional and speed lever ③ and confirm that the desired speed is selected by speed stage indicator window ④.

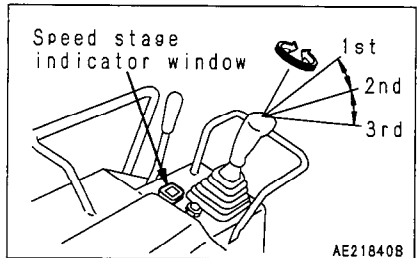

3. Set safety lever ⑥ for blade control lever ⑦ to the FREE position.

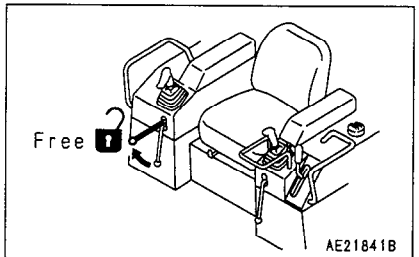

4. Put blade control lever ⑦ in the RAISE position to raise the blade 400 to 500 mm (16 to 20 in) off the ground.

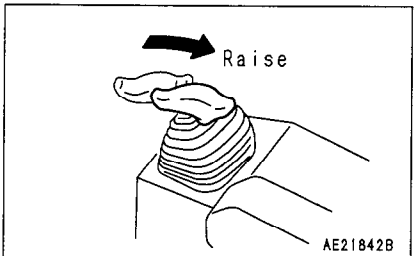

- Depress brake pedal ② and push brake lock lever ① to the FREE position. Keep brake pedal ② depressed.

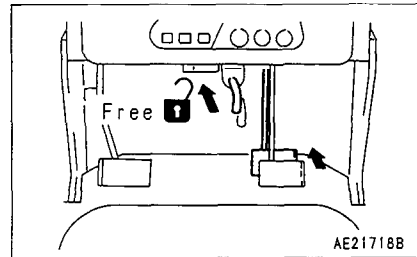

- Set safety lever ⑧ for the steering, directional and speed lever to the FREE position.

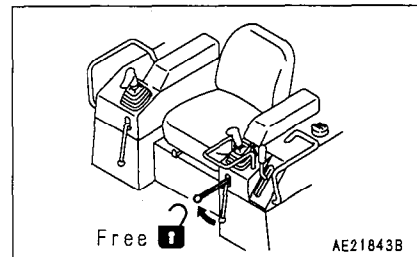

- Set the steering, directional and speed lever ③ to the position F (Forward) or R (Reverse).

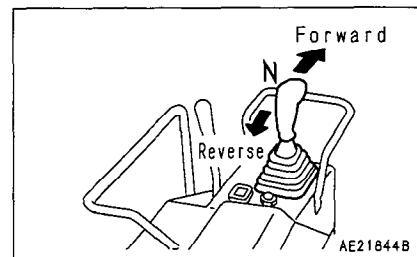

- Release brake pedal ② and the machine will start.

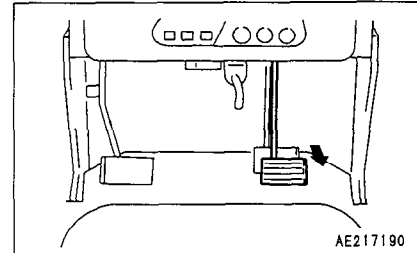

### 12.5 SHIFTING GEAR

There is no need to stop machine to shift gears.  
Set the steering, directional and speed lever ① in the desired position to shift gear.

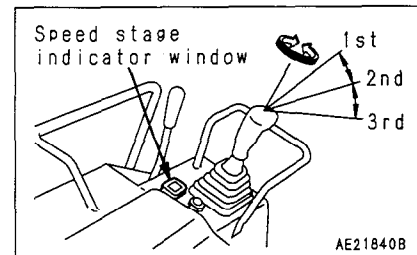
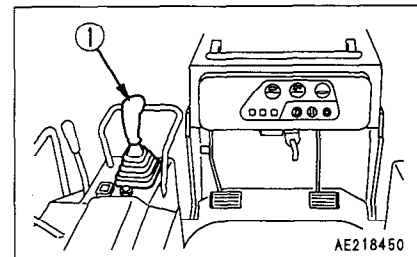

## 12.6 SHIFTING BETWEEN FORWARD AND REVERSE

**CAUTION**

Forward - reverse shifting should be made after reduction of machine speed for safety purpose and preventing shock to machine.

1. Lower engine speed by fuel control lever ①.
2. Place steering, directional and speed lever ② in the desired position.
3. Increase engine speed by fuel control lever ①.
4. If the machine is equipped with the backup alarm, set the steering, directional and speed lever ② to the reverse position and confirm that the alarm sounds. If the alarm does not sound, ask your Komatsu distributor for repair.

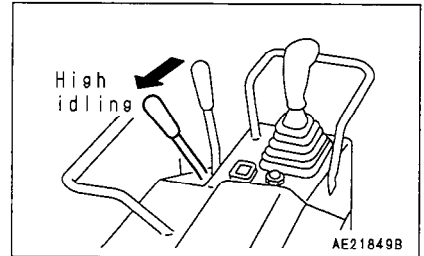
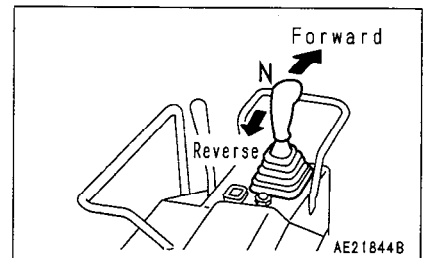
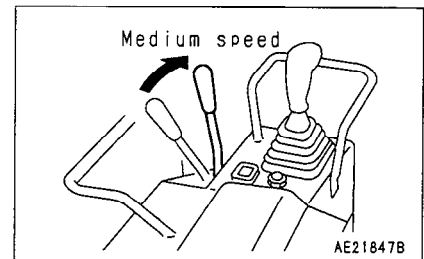
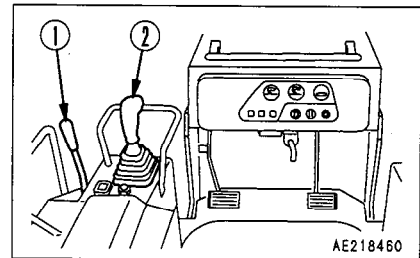

## 12.7 STEERING MACHINE

### ⚠ WARNING

- Avoid as much as possible turning the machine on a slope. The machine will tend to slip sideways. Particular care should be taken on soft or clay land.
- Never make a pivot turn at high speed.

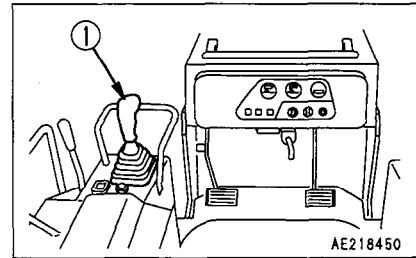

### 12.7.1 NORMAL TURNING

To turn the machine while traveling, incline steering, directional and speed lever ① in the direction to turn.

- **When turning to the left gradually while traveling forward**  
Incline the steering, directional and speed lever forward, then incline it to the left (L) halfway, and the steering clutch is disengaged and the machine turns to the left gradually.

#### REMARK

When turning to the right gradually while traveling forward, incline the steering, directional and speed lever forward, then incline it to the right halfway.

The turning method during the reverse travel is the same.

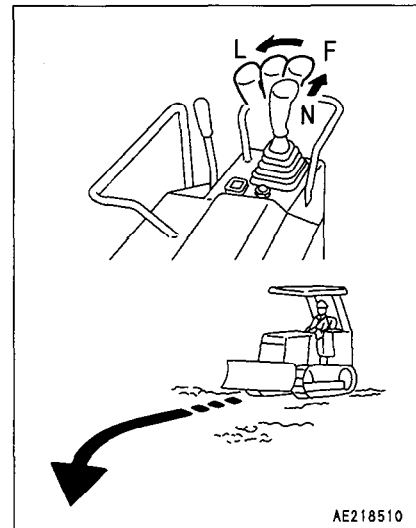

Using the lever guide for fine control

If you use the lever guide, it is easier to make fine adjustments in the steering direction.

There are the following two methods of using the lever guide.

- A: Hook your fingers or thumb over the left or right guides, and operate the steering with a light touch.
- B: Keep your wrist fixed and run all your fingers along the front of the guide to operate the steering.

Select the method which you find best matches the frequency and ease of use.

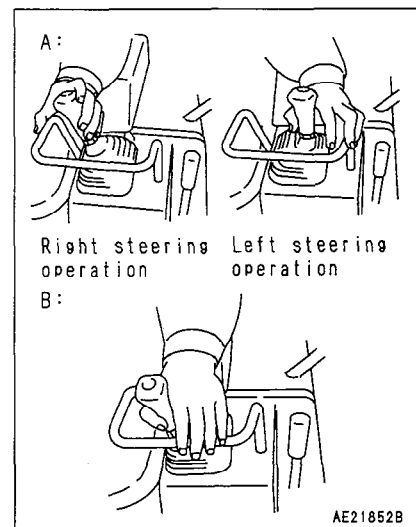

## 12. OPERATION

---

- **When making a pivot turn to the left while traveling**

Incline the steering, directional and speed lever forward, then incline it to the left (L) until it stops, and the steering clutch is disengaged and the steering brake is applied, and the machine makes a pivot turn to the left.

**REMARK**

When making a pivot turn to the right while traveling, incline the steering, directional and speed lever forward, then incline it to the right until it stops.

The pivot turn method during the reverse travel is the same.

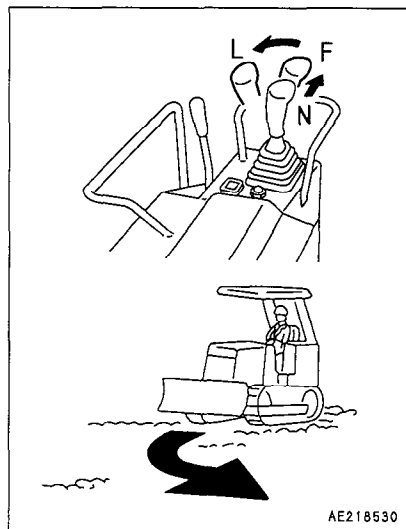

### 12.7.2 TURNING WHILE DESCENDING A SLOPE

**⚠ WARNING**

When descending such a sharp slope that the machine will go down of its own weight or when going down a slope with a scraper or the like, you should exercise great care. The machine will turn to the opposite side to the direction of the moved lever.

- **When turning to the left gradually while traveling forward**  
Incline the steering, directional and speed lever forward, then incline it to the right (R) halfway, and the machine turns to the left gradually (Cross steering).

**REMARK**

When turning to the right gradually while traveling forward, incline the steering, directional and speed lever forward, then incline it to the left halfway (Cross steering).

The turning method during the reverse travel is the same.

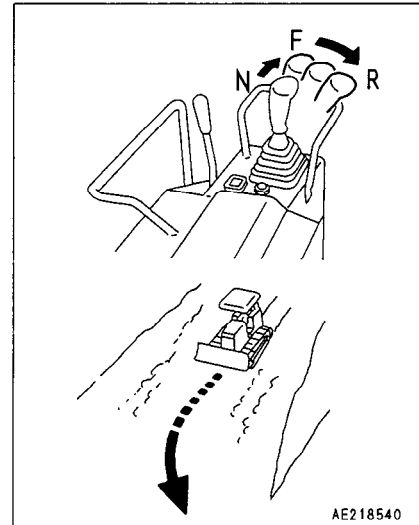

- **When making a pivot turn to the left while traveling**  
Incline the steering, directional and speed lever forward, then incline it to the left (L) until it stops, and the machine makes a pivot turn to the left (Normal steering).

**REMARK**

When making a pivot turn to the right while traveling, incline the steering, directional and speed lever forward, then incline it to the right until it stops (Normal steering).

The pivot turn method during the reverse travel is the same.

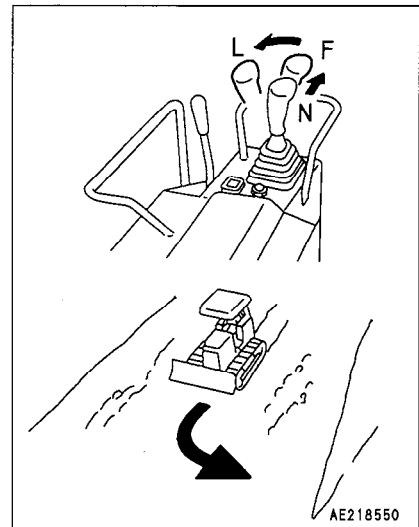

## 12.8 STOPPING MACHINE

**⚠ WARNING**

- Avoid stopping suddenly. Give yourself ample room when stopping.
- Avoid parking the machine on a slope. If it is obliged to park on a slope, apply the brake and lock it with the brake lock lever, then place chocks and lower the work equipment into the ground.
- If you touch a control lever by mistake, the work equipment or the machine will move suddenly, and that can cause a serious accident. When leaving the operator's seat, be sure to incline the safety lock lever to lock the machine.

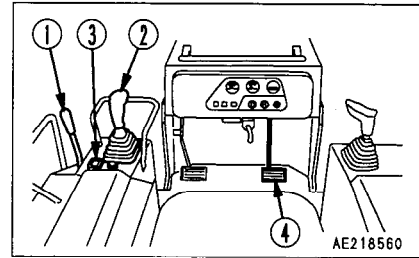

1. Lower engine speed by operating fuel control lever ①.

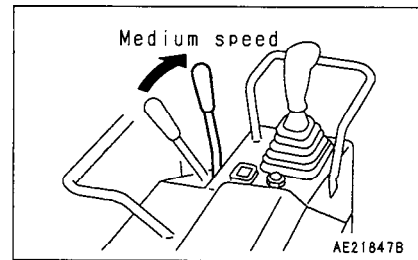

2. Place steering, directional and speed lever ② in the N (neutral) position.

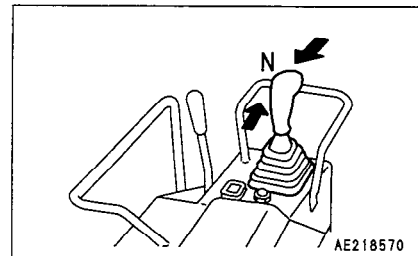

3. Set steering, directional and speed lever ② to the first speed position. Check speed stage indicator window ③.

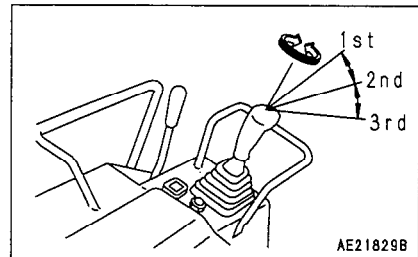

4. Depress brake pedal ④ to stop the machine.

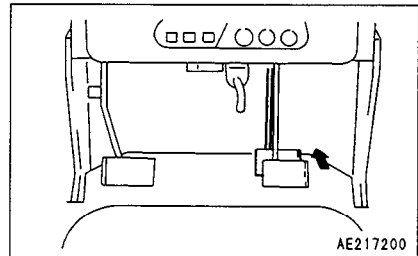

## 12.9 PRECAUTIONS FOR OPERATION

### 12.9.1 METHOD OF USING STEERING CLUTCH

If the steering clutch one side is used frequently or if many gradual turns are made with steering clutch half-engaged, the steering clutch will wear out in a short time. Design the travel road well and steer the machine properly.

### 12.9.2 PERMISSIBLE WATER DEPTH

When operating in water, always keep the bottom of the carrier roller above the surface of the water.

Also, be careful that the engine cooling fan will not come in contact with water. The fan can be damaged.

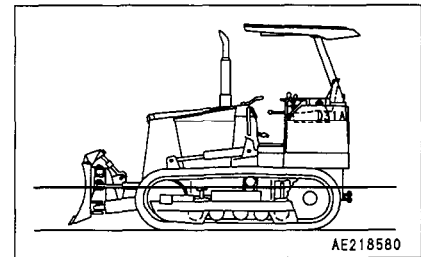

### 12.9.3 PRECAUTIONS WHEN TRAVELING UP OR DOWN HILLS

#### Use engine as brake

When going downhill, shift gear shift lever into low speed to run engine at slow speed and travel down slope using the engine as a brake.

Do not set the steering, directional and speed lever to the N (Neutral) position.

#### REMARK

If the inching pedal is depressed halfway during deceleration, the engine does not work as a brake.

When going downhill or uphill, do not keep the inching pedal depressed.

#### Braking when traveling downhill

While descending a slope using the engine as a brake, also apply the brakes.

Failure to brake may result in overrunning, causing engine trouble.

### 12.9.4 PRECAUTIONS ON SLOPES

#### Be careful of fuel level

If the fuel level in the fuel tank becomes low when working on slopes, the engine may suck in air because of the angle of the machine or the swaying of the machine. If this makes the engine stop, so be careful not to let the fuel level in the fuel tank become too low.

#### Precautions when engine stops on slopes

If the engine stops while working or traveling on a hill, immediately depress the brake pedal, lower the blade to the ground to stop the machine, then lock the brake pedal with the brake lock lever.

Thereafter, move the steering, directional and speed lever to the N (neutral) position, lock the lever, then prestart the engine.



## 12.10 WORK POSSIBLE USING BULLDOZER

In addition to the following, it is possible to further increase the range of applications by using various attachments.

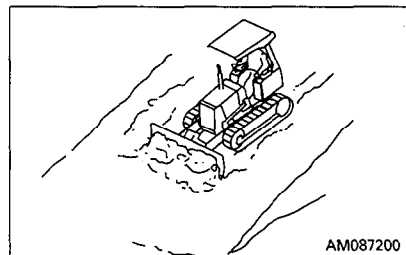

### 12.10.1 DOZING

A bulldozer digs and transports dirt in a forward direction.

Slope excavation can always be most effectively carried out by proceeding from the top downward.

When dozing toward one side only, operate with angled blade (angledozer only).

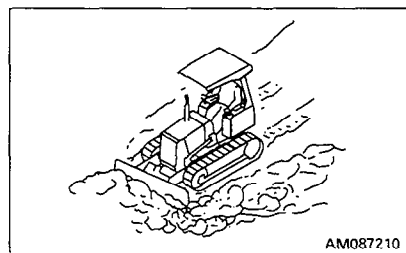

### 12.10.2 SMOOTHING

#### NOTICE

**Avoid smoothing on rocky or stony ground. It can damage the blade.**

Uneven ground surfaces remaining after digging can be levelled off by fine operation of blade. The basic method is to operate the machine at low speeds with the blade fully loaded with soil and sand. A flat finished surface is also possible by slowly backing the machine with the blade "floating" so it is dragged across the surface. However, avoid this on rocky or stony ground, as it may damage the blade.

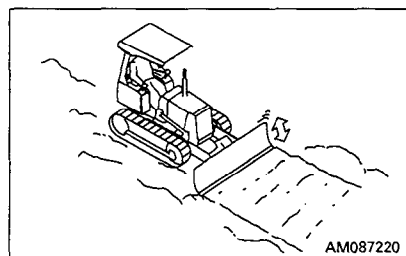

The D31PL, PLL can be used for leveling of fields where there are no rocks when the ground is too soft for standard swamp bulldozers to operate.

### 12.10.3 CUTTING INTO HARD OR FROZEN GROUND OR DITCHING

#### NOTICE

**Do not perform severe operations such as uprooting by angling or tilting the blade.**

For digging and ditch excavation of hard or frozen ground, tilt the blade. Even hard ground can be dug effectively by a tilted or angled blade.

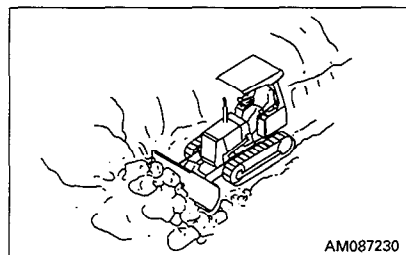

## 12.11 PARKING MACHINE

 **WARNING**

- Avoid stopping suddenly. Give yourself ample room when stopping.
- Avoid parking the machine on a slope. If it is obliged to park on a slope, apply the brake and lock it with the brake lock lever, then place chocks and lower the work equipment into the ground.
- If you touch a control lever by mistake, the work equipment or the machine will move suddenly, and that can cause a serious accident. When leaving the operator's seat, be sure to incline the safety lock lever to lock the machine.

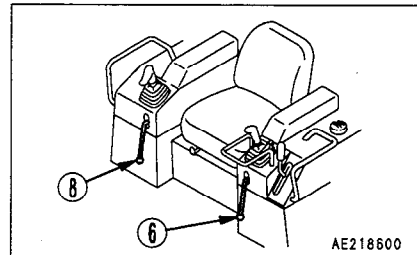
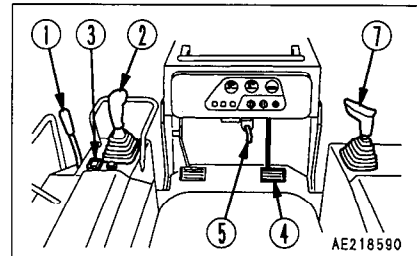

1. Lower engine speed by operating fuel control lever ①.

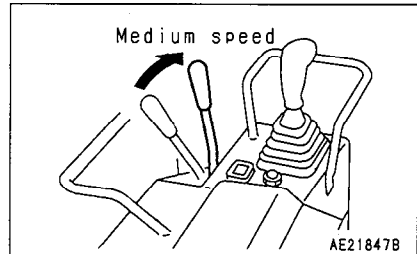

2. Place steering, directional and speed lever ② in NEUTRAL position.

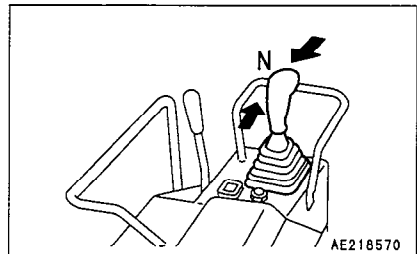

3. Set steering, directional and speed lever ② to the first speed position. Check speed stage indicator window ③.

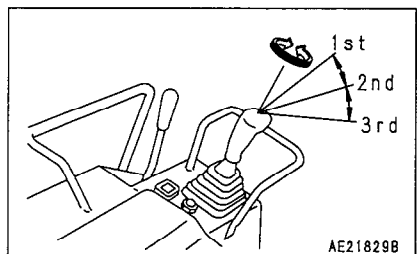

4. Depress brake pedal ④ to stop the machine.

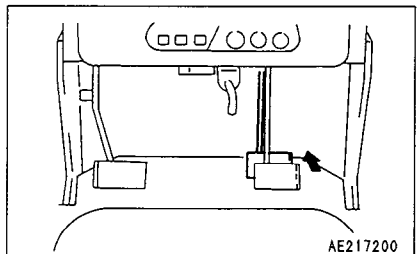

## 12. OPERATION

5. Pull brake lock lever ⑤ and depress brake pedal ④ strongly to apply the lock securely.

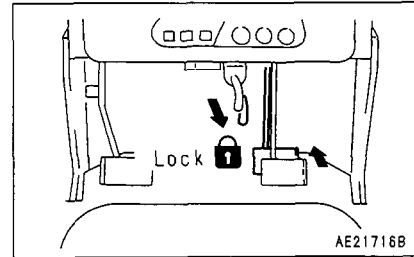

6. Lock steering, directional and speed lever ② with safety lever ⑥.

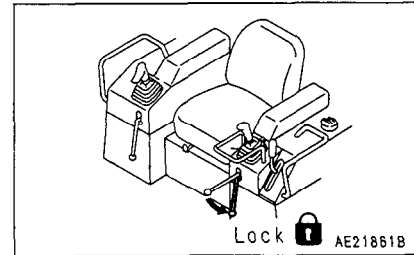

7. Put blade control lever ⑦ in the LOWER positions to lower the blade to the ground while keeping it horizontal.

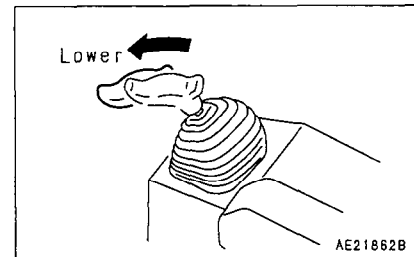

8. Lock blade control lever ⑦ with safety lever ⑧.

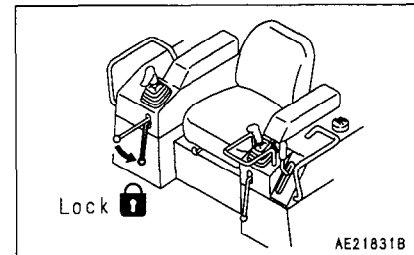

### 12.12 CHECK AFTER FINISHING WORK

1. Check the gauges and lamps for engine water temperature, engine oil pressure, fuel level and air cleaner clogged.

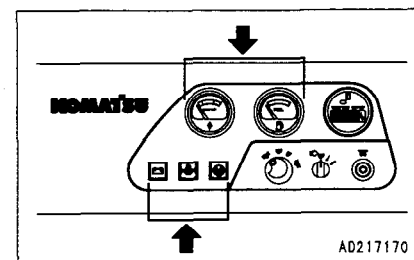

## 12.13 STOPPING ENGINE

### NOTICE

If the engine is abruptly stopped before it has cooled down, engine life may be greatly shortened. Consequently, do not abruptly stop the engine apart from an emergency.

In particular, if the engine has overheated, do not abruptly stop it but run it at medium speed to allow it to cool gradually, then stop it.

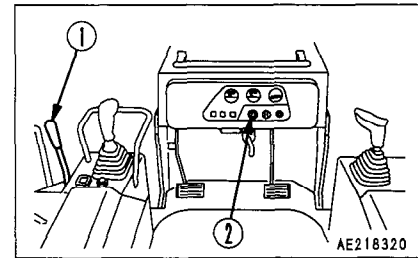

1. Run the engine at low idling speed for about 5 minutes to allow it to gradually cool down.

- **For machines stopped by fuel control lever**

2. Place fuel control lever ① in the engine stop position and stop the engine.

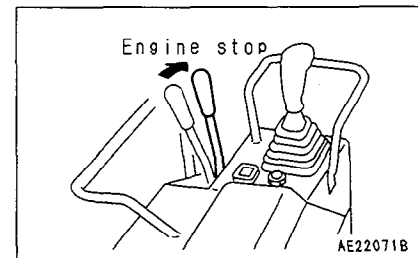

3. Turn the key in starting switch ② to the OFF position and remove the key from starting switch ②.

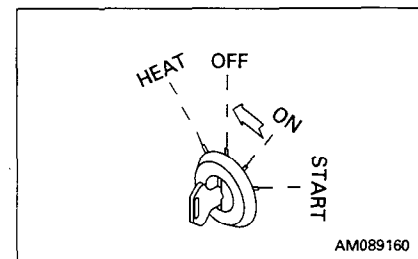

- **For machines stopped by starting switch**

2. Turn the key in starting switch ② to the OFF position and stop the engine.

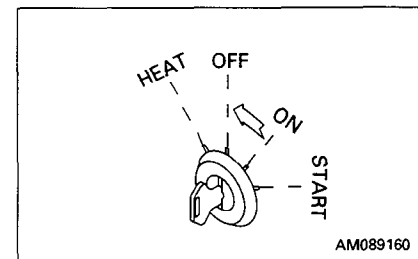

3. Remove the key from starting switch ②.

### 12.14 CHECK AFTER STOPPING ENGINE

1. Walk around the machine and check the work equipment, paintwork, and undercarriage, and check also for leakage of oil or water. If any abnormalities are found, repair them.
2. Fill the fuel tank.
3. Check the engine compartment for paper and debris. Clean out any paper and debris to avoid a fire hazard.
4. Remove any mud stuck to the undercarriage.

### 12.15 LOCKING

The following parts can be locked for protection from vandalism.

- ① Top cover on the engine hood (2 pieces)
- ② Side cover on the hydraulic tank

#### REMARK

Use the starting switch key to open and close cover ① and ②.

Commercially available locks can be fitted to the following places.

- ③ Battery inspection cover

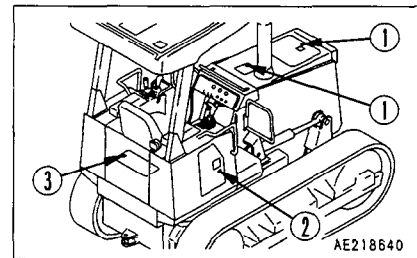

## 12.16 TIPS FOR LONGER UNDERCARRIAGE LIFE

Undercarriage life greatly varies depending on operation method, inspection and maintenance. For most efficient operation, keep the following point in mind.

### 12.16.1 OPERATION METHOD

- Select the track shoe that best suits the type of soil to be encountered in service.  
Please consult your Komatsu distributor when selecting track shoes.
- Do not allow shoe slipping to occur during operation. If shoe slipping occurs, reduce load to the blade until slipping stops.
- Avoid sudden starts, acceleration or stops, unnecessarily high speeds and sharp turns.
- Always operate machine in a straight line whenever possible. When making turns, be careful not to allow the machine to stay to one side, so operation in both turning directions can be done properly. Make turns with the largest possible radius.
- Prior to operation, clear boulders and obstacles to prevent machine from riding over them while operating.
- On a slope, operate the machine parallel to the inclination of the slope. Do not operate across the slope. Also when stopping the machine on a slope, the machine should face toward the top of the slope.
- When ground inclines to left or right during digging operation, do not continue to dig with machine inclined. Move machine back to level ground and start to dig again.
- When idlers or sprockets are lifted due to obstacles during dozing, do not attempt to force the machine to perform. Because work at this time exceeds machine working capability.

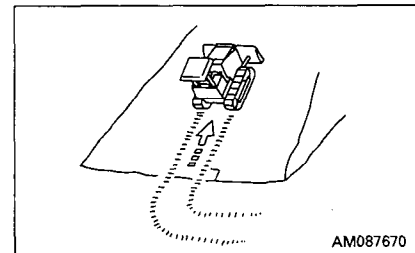

**12.16.2 INSPECTION AND ADJUSTMENT**

- Properly adjust track tension.  
Tension should be measured at clearance ① shown in the diagram – usually 20 to 30 mm (0.79 to 11.8 in) at this point. For rocky terrain, tighten tracks slightly. In clay or sandy areas, slightly loosen them. (For inspection and adjustment procedures, refer to “24.2 WHEN REQUIRED”).
- Check idler rollers for oil leakage as well as for loose bolts and nuts. If any trouble is detected, repair immediately.

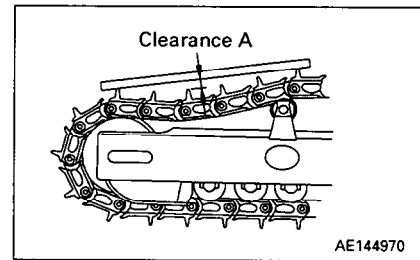

- Check the clearance between the idler guide plate and the track frame. If clearance ② increases, idler may develop side motion and tracks may come off. (For inspection and adjustment procedures, refer to “24.2 WHEN REQUIRED”).

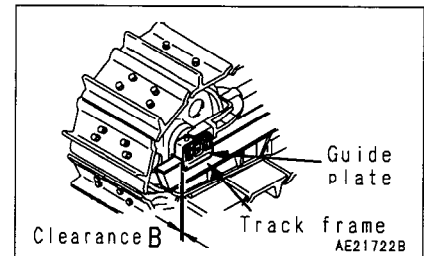

**12.16.3 INSPECTION AND REPAIR**

Frequent inspection and prompt repair will reduce repair costs. The following items for inspection will serve as a guide to maintenance service of each undercarriage part. Perform periodical inspection and contact the Komatsu distributor in your area when machine has approached repairable limits and reversing limits.

**Measuring link pitch**

1. Insert a wooden block between track shoe and sprocket to take up the slack in track shoes.

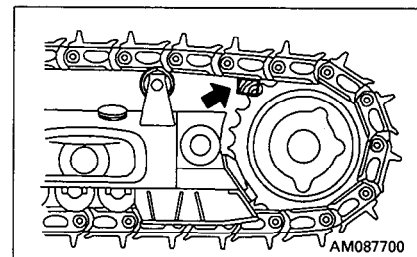

2. Measure pitch length of 4 links in stretched portion at more than 2 links away from master pin. Of length obtained, 1/4 is the link pitch.  
Standard link pitch: 154.25 mm (6.07 in)  
Reversing limit link pitch: 157 mm (6.18 in)  
A center hole is provided on both ends of master pin.

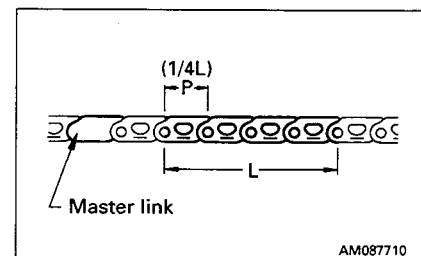

**Measuring height of grouser**

After taking up slack in track shoes, measure height at center of shoe as shown below.

Standard height (h): 47 mm (1.85 in)

Repair limits: 20 mm (0.79 in)

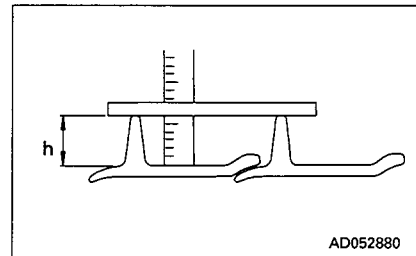
**Measuring outside diameter of track roller**

1. Measure height (size C) of link tread as shown.
2. Stop machine at position where link tread, whose size C has been measured completely, contacts roller tread. Then measure size B.
3. Calculate outside diameter of tread (size A):  

$$A = (B - C) \times 2$$

Standard size (A): 170 mm (6.69 in)  
 Repair limits: 160 mm (6.30 in)

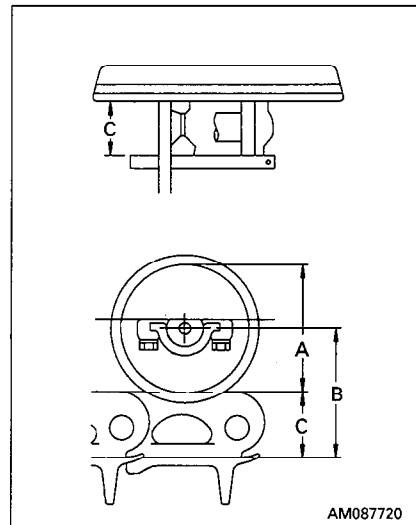



## 13. TRANSPORTATION

When transporting the machine, observe all related laws and regulations, and be careful to assure safety.

### 13.1 LOADING, UNLOADING WORK

#### **⚠ WARNING**

- When loading and unloading the machine, be very careful since it is dangerous work.
- When loading and unloading the machine, run the engine at a low speed and operate slowly.
- Make sure the ramp has sufficient width, length and thickness to enable the machine to be safely loaded and unloaded. If the ramp sags appreciably, reinforce it with blocks, etc.
- When loading and unloading the machine, park the trailer on a flat firm roadbed. Keep a fairly long distance between the road shoulder and the machine.
- Remove the mud from the undercarriage to prevent the machine from slipping to the side on slopes. Be sure the ramp surface is clean and free of grease, oil, ice and loose materials.
- Never change the direction of travel when on the ramps. If it is necessary to change direction, drive off the ramps and correct the direction, then drive on to the ramps again.

When loading or unloading, always use ramps or a platform and carry out the operations as follows.

1. Properly apply the brakes on the trailer and insert blocks beneath the tires to ensure that it does not move. Then fix the ramps in line with the centers of the trailer and the machine. Be sure that the two sides are at the same level as one another.
2. Determine the direction of the ramps, then slowly load or unload the machine at 1st travel speed.
3. Load the machine correctly in the specified position on the trailer.
4. Use the first speed and run the engine at the low idling speed. When moving only a short distance, use the inching pedal. Although the brake can be applied with the inching pedal even on the ramps, be sure to depress the brake pedal with the right foot so that the machine will not fall over.

#### **NOTICE**

**Limit the angle of the ramps to 15°.**

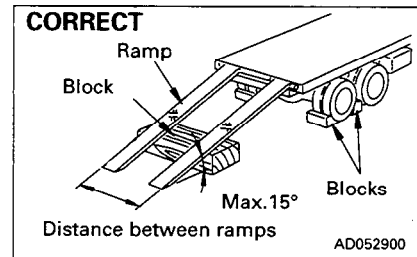

## 13.2 PRECAUTIONS FOR LOADING



### WARNING

**When the edge of the blade protrudes beyond the trailer, angle the blade.**

After loading to the specified position, secure the machine as follows.

1. Lower the blade slowly.
2. Lock all the control levers securely with the safety lever.
3. Set the parking lever to the LOCK position.
4. Set the fuel control lever to the ENGINE STOP position, then turn the starting switch to the OFF position to stop the engine, and remove the key.
5. When transporting the machine, place rectangular timber underneath the front and rear track shoes to prevent the machine from moving about. Also, hold it down with chains or rope. Be particularly careful to ensure that the machine does not slip sideways.

### 13.3 LIFTING MACHINE

**⚠ DANGER**

- When lifting the machine, if the wire rope is not fitted correctly the machine may fall and cause serious injury or even death. Raise the machine 100 – 200 mm (4 – 8 in) from the ground, check that the machine is horizontal and that there is no slack in the wire rope, then continue to lift the machine.
- Before lifting the machine, always stop the engine and lock the brakes.

#### 13.3.1 POSITION FOR STICKING LIFTING POSITION MARKS

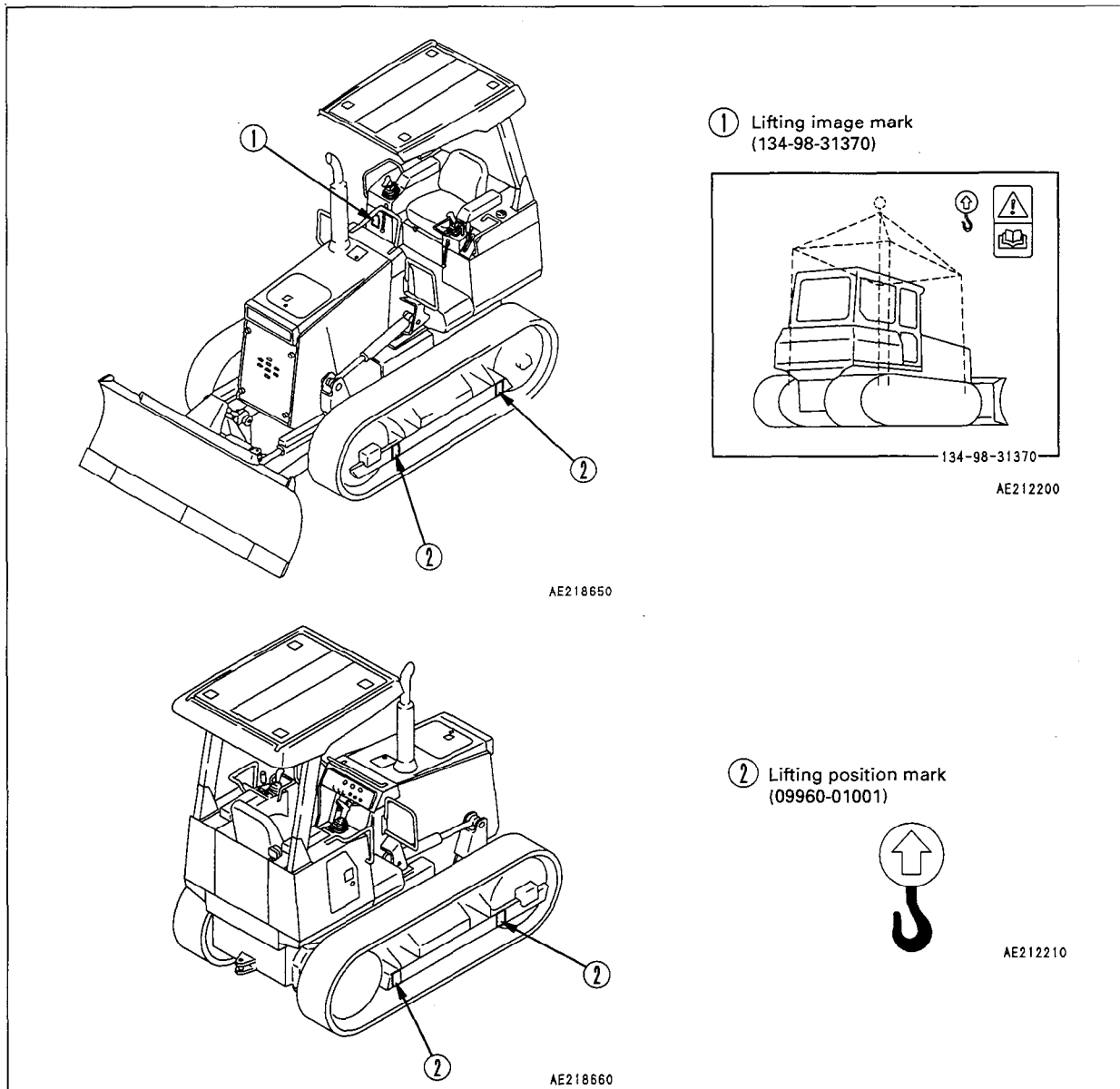

For the weight, see "25. SPECIFICATIONS".

### 13.3.2 METHOD OF FITTING WIRE ROPE

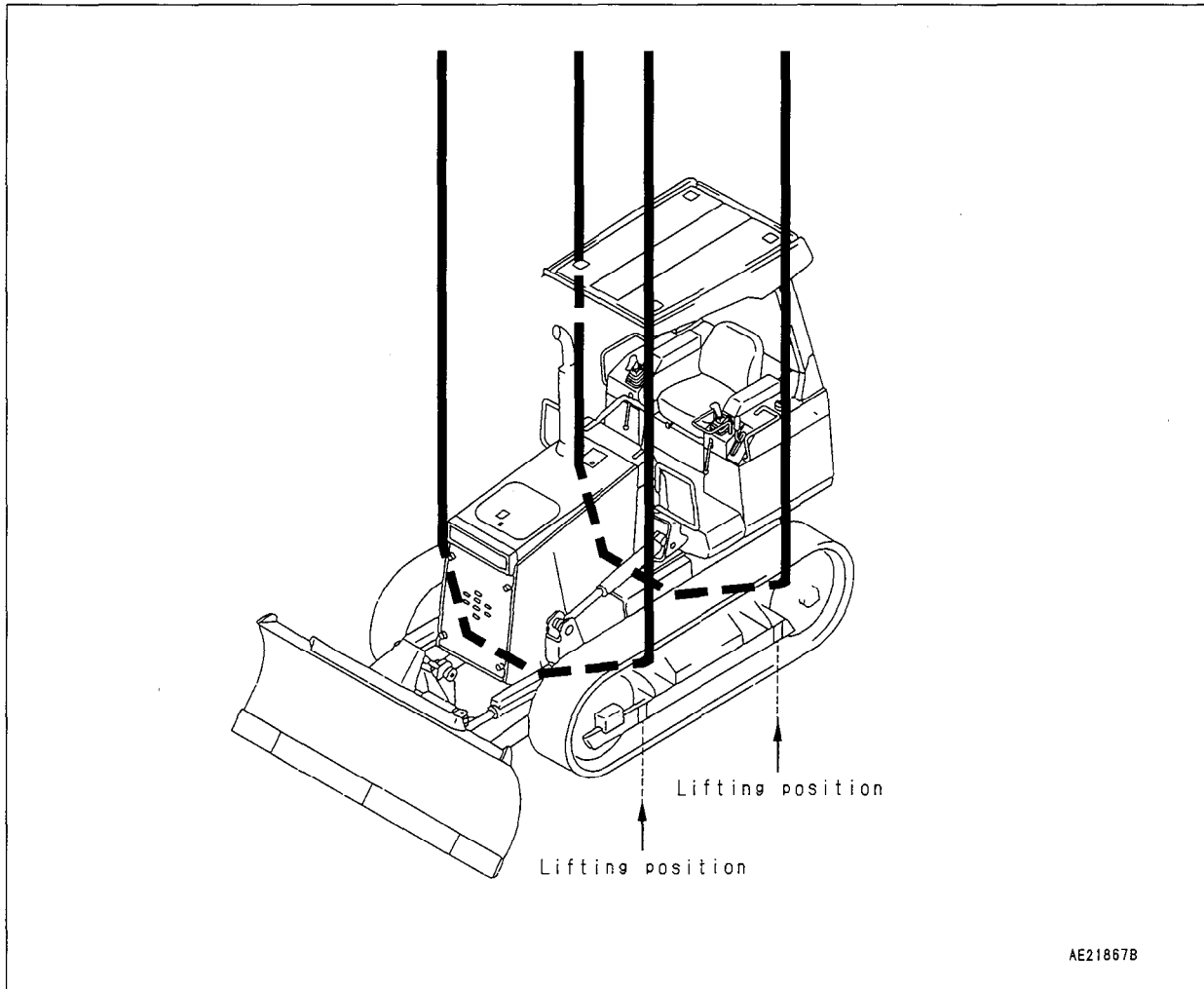

Park the machine on level place, then hang it according to the following procedure.

1. Stop the engine and depress the brake pedal to the end, then pull the brake lock lever to lock the brake.
2. Fit wire ropes and slings matched to the machine weight as shown in the above figure.

#### NOTICE

- Fit protectors, etc. to sharp corners and narrow places where the wire ropes will be applied to protect the wire ropes from being cut.
  - Use the sled and bar sufficient large so that they will not touch the machine.
3. Hang the machine in the set position about 100 – 200 mm (4 – 8 in) above the ground just before lifting it up. Confirm that the wire ropes are not loosened and the machine is kept level, then lift up the machine slowly.

## 13.4 PRECAUTIONS FOR TRANSPORTATION



### WARNING

**Determine the route for transporting the machine by taking into account the width, height and weight of the machine.**

Obey all state and local laws governing the weight, width and length of a load. Observe all regulations governing wide loads.

## 14. COLD WEATHER OPERATION

---

### 14.1 PRECAUTIONS FOR LOW TEMPERATURE

If the temperature becomes low, it becomes difficult to start the engine, and the coolant may freeze, so do as follows.

#### 14.1.1 FUEL AND LUBRICANTS

Change to fuel and oil with low viscosity for all components.

For details of the specified viscosity, see "20. USE OF FUEL, COOLANT AND LUBRICANTS ACCORDING TO AMBIENT TEMPERATURE".

#### 14.1.2 COOLANT

 **WARNING**

**Keep antifreeze fluid away from an open flame. Never smoke when using antifreeze.**

#### NOTICE

**Never use methanol, ethanol or propanol based antifreeze.**

Where no permanent antifreeze is available, an ethylene glycol antifreeze without corrosion inhibitor may be used only for the cold season. In this case, clean the cooling system twice a year (in spring and autumn). When refilling the cooling system, add antifreeze in autumn, but do not add any in spring.

Absolutely avoid using any water leak preventing agent irrespective of whether it is used independently or mixed with an antifreeze.

Do not mix one antifreeze with a different brand.

For details of the antifreeze mixture when changing the coolant, see "24.2 WHEN REQUIRED".

Use a Permanent Antifreeze (ethylene glycol mixed with corrosion inhibitor, antifoam agent, etc.) meeting the standard requirements as shown below. With permanent antifreeze, no change of coolant is required for a year. If it is doubtful that an available antifreeze meets the standard requirements, ask the supplier of that antifreeze for information.

Standard requirements for permanent antifreeze.

- SAE ..... J1034
- FEDERAL STANDARD ..... O-A-548D

### 14.1.3 BATTERY

**⚠ WARNING**

- To avoid gas explosions, do not bring fire or sparks near the battery.
- Battery electrolyte is dangerous. If it gets in your eyes or on your skin, wash it off with large amounts of water, and consult a doctor.

When the ambient temperature drops, the capacity of the battery will also drop. If the battery charge ratio is low, the battery electrolyte may freeze. Maintain the battery charge as close as possible to 100%, and insulate it against cold temperature so that the machine can be started easily the next morning.

Measure the specific gravity and calculate the rate of charge from the following conversion table.

Temp. of fluid Rate of charge	20°C	0°C	-10°C	-20°C
100%	1.28	1.29	1.30	1.31
90%	1.26	1.27	1.28	1.29
80%	1.24	1.25	1.26	1.27
75%	1.23	1.24	1.25	1.26

## 14.2 AFTER COMPLETION OF WORK

To prevent mud, water, or the undercarriage from freezing and making it impossible for the machine to move on the following morning, always observe the following precautions.

- Mud and water on the machine body should be completely removed. This is to prevent damage to the seal caused by mud or dirt getting inside the seal with frozen drops of water.
- Park the machine on concrete or hard ground. If this is impossible, park the machine on wooden boards. The boards help protect the tracks from being freezed in soil and the machine can start next morning.
- Open the drain valve and drain any water collected in the fuel system to prevent it from freezing.
- As the battery capacity drops markedly in low temperatures, cover the battery or remove it from the machine, keep it in a warm place, and install it again the next morning.

## 14.3 AFTER COLD WEATHER

When season changes and the weather becomes warmer, do as follows.

- Replace the fuel and oil for all parts with oil of the viscosity specified.  
For details, see "20. USE OF FUEL, COOLANT AND LUBRICANTS ACCORDING TO AMBIENT TEMPERATURE".
- If for any reason permanent antifreeze cannot be used, and an ethyl glycol base antifreeze (winter, one season type) is used instead, or if no antifreeze is used, drain the cooling system completely, then clean out the inside of the cooling system thoroughly, and fill with fresh water.
- If electrolyte level is found low, add distilled water in the morning before beginning work. Do not add the water after the day's work so as to prevent fluid in the battery from freezing in the night.



## **15. LONG-TERM STORAGE (MORE THAN ONE MONTH)**

### **15.1 BEFORE STORAGE**

** WARNING**

**If possible, prepare the machine for long-term storage outdoors. If this must be done indoors, open doors and windows for ventilation to prevent carbon monoxide poisoning.**

When putting the machine in storage for a long time, do as follows.

- After every part is washed and dried, the machine shall be housed in a dry building. Never leave it outdoors. In case it is indispensable to leave it outdoors, park the machine on the flat ground and cover it with canvas etc.
- Completely fill the fuel tank, lubricate and change the oil before storage.
- Apply a thin coat of grease to metal surface of the hydraulic piston rods and the idler adjusting rods.
- Disconnect the negative terminals of the battery and cover it, or remove it from the machine and store it separately.
- If the ambient temperature is expected to drop below 0°, always add antifreeze to the cooling water.
- Lock each control lever with the safety lock and place the fuel control lever in the low idling position. Do not lock the brake pedal; use blocks to stop the machine from moving.

### **15.2 DURING STORAGE**

- Operate the engine and move the machine for a short distance once a month so that a new film of oil will be coated over movable parts and component surfaces. At the same time, also charge the battery.
- Before operating the work equipment, wipe off the grease on the hydraulic piston rod.

### **15.3 AFTER STORAGE**

#### **NOTICE**

**If the machine is stored without carrying out the monthly rust prevention operation, request your Komatsu distributor for service.**

Carry out the following procedure when taking the machine out of long-term storage.

- Wipe off the grease from the hydraulic cylinder rods.
- Add oil and grease to all places.

## 16. TROUBLESHOOTING

### 16.1 AFTER RUNNING OUT OF FUEL

When starting after running out of fuel, fill with fuel, then fill the fuel filter cartridge with clean fuel and bleed the air from the fuel system before starting.

For details of bleeding the air, see "24.6 EVERY 500 HOURS SERVICE".

### 16.2 IF BATTERY IS DISCHARGED

#### WARNING

- When checking or handling the battery, stop the engine and turn the starting key to the OFF position before starting.
- Wipe the dust off the battery top with a wet cloth before starting the engine.
- The battery generates hydrogen gas, so there is danger of explosion. Do not bring lighted cigarettes near the battery, or do anything that will cause sparks.
- Battery electrolyte is dilute sulphuric acid, and it will attack your clothes and skin. If it gets on your clothes or on your skin, wash it immediately off with large amounts of water. If it gets in your eyes, wash it out with fresh water, and consult a doctor.
- When handling battery, always wear protective goggles.
- When removing the battery, first disconnect the cable from the ground (normally, from the negative  $\ominus$  terminal). When installing, install the positive  $\oplus$  terminal first. If a tool touches the cable connecting the positive terminal and the chassis, there is danger that it will cause sparks.
- If the terminals are loose, there is danger that the defective contact may generate sparks that will cause an explosion. When installing the terminals, install them tightly.
- When removing and installing the battery, confirm the  $\oplus$  and  $\ominus$  terminals.
- After a new battery is installed, secure it. If it is loosened, the terminals will be loosened and they make sparks, which is dangerous.

When removing, disconnect the cable from the ground terminal first.

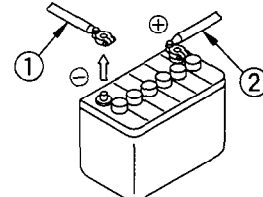

When installing, connect the cable to the positive  $\oplus$  terminal first.

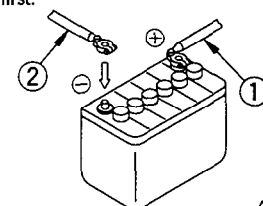

AM087770

**16.2.1 REMOVE AND INSTALL BATTERY**

- When removing the battery, disconnect the grounding cable (⊖ terminal side, normally) first. If a tool, etc. touch the terminal and the machine body, sparks are made, which is dangerous.
- When installing the battery, connect the grounding cable at last.
- When replacing the battery, secure it with battery fitting ①.

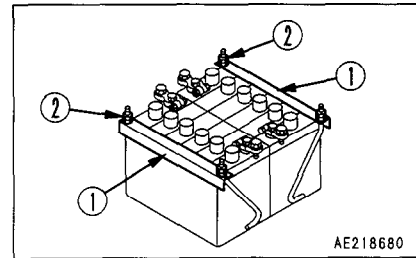

Tightening torque of mounting nut ②

Nut and fitting	Double nut
3.92 – 5.88 N·m {0.4 – 0.6 kgf·m}	34 – 74 N·m {3.5 – 7.5 kgf·m}

**NOTICE**

Secure the battery and confirm that it does not move. If there is any movement, secure it again.

**16.2.2 PRECAUTIONS FOR CHARGING BATTERY**

When charging the battery without removing it from the machine

- Before charging, disconnect the wiring of the battery terminals, since abnormal voltage may be applied to the alternator to break it.
- Keep all battery caps removed to release the produced gas while charging.
- If the battery is overheated (the battery fluid temperature exceeds 45°C), stop charging for a while.
- After the battery is charged fully, stop charging immediately. Overcharging can cause the following problems.
  - 1) Overheating of battery
  - 2) Reduction of battery fluid
  - 3) Battery trouble
- Do not connect the cables to the battery inversely (connect the ⊕ cable to the ⊖ terminal, and the ⊖ cable to the ⊕ terminal). If they are connected so, the alternator, etc. may be broken.
- When handling the battery for a purpose other than check of the battery fluid level or measurement of specific gravity of the battery fluid, disconnect the cables from it.

### 16.2.3 STARTING ENGINE WITH BOOSTER CABLE

When starting the engine with a booster cable, do as follows:

#### Precautions when connecting and disconnecting booster cable

#### WARNING

- When starting the engine from another machine, connect the batteries in parallel.
- When connecting the cables, never contact the positive  $\oplus$  and negative  $\ominus$  terminals.
- When starting the engine with a booster cable, always wear safety glasses.
- Be careful not to let the normal machine and problem machine contact each other. This prevents sparks from generating near the battery which could ignite the hydrogen gas given off by the battery. If hydrogen gas explodes. It could cause serious injury.
- Make sure that there is no mistake in the booster cable connections. The final connection is to the engine block of the problem machine, but sparks will be generated when this is done, so connect to a place as far as possible from the battery.
- Use care when removing the cables from the machine that has been started. Do not allow the cable ends to contact each other or the machine, to avoid hydrogen explosion.

#### NOTICE

- The size of the booster cable and clip should be suitable for the battery size.
- The battery of the normal machine must be the same capacity as that of the engine to be started.
- Check the cables and clips for damage or corrosion.
- Make sure that the cables and clips are firmly connected.

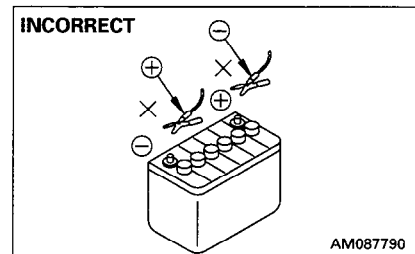

**CONNECTING THE BOOSTER CABLES**

Keep the starting switch at the OFF position.

Connect the booster cable as follows, in the order of the numbers marked in the diagram.

1. Make sure that the starting switches of the normal machine and problem machine are both at the OFF position.
2. Connect one clip of booster cable (A) to the positive  $\oplus$  terminal of the problem machine.
3. Connect the other clip of booster cable (A) to the positive  $\oplus$  terminal of the normal machine.
4. Connect one clip of booster cable (B) to the negative  $\ominus$  terminal of the normal machine.
5. Connect the other clip of booster cable (B) to the engine block of the problem machine.

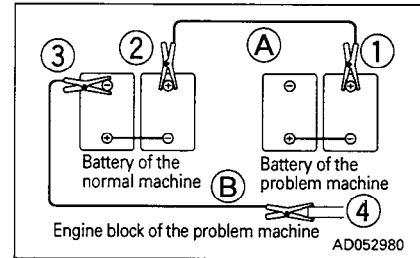
**STARTING THE ENGINE**

1. Make sure the clips are firmly connected to the battery terminals.
2. Start the engine of the normal machine and keep it to run at high idling speed.
3. Turn the starting switch of the problem machine to the START position and start the engine. Refer to "12.2 STARTING ENGINE".

**DISCONNECTING THE BOOSTER CABLES**

After the engine has started, disconnect the booster cables in the reverse of the order in which they were connected.

1. Remove one clip of booster cable (B) from the engine block of the problem machine.
2. Remove the other clip of booster cable (B) from the negative  $\ominus$  terminal of the normal machine.
3. Remove one clip of booster cable (A) from the positive  $\oplus$  terminal of the normal machine.
4. Remove the other clip of booster cable (A) from the positive  $\oplus$  terminal of the problem machine.

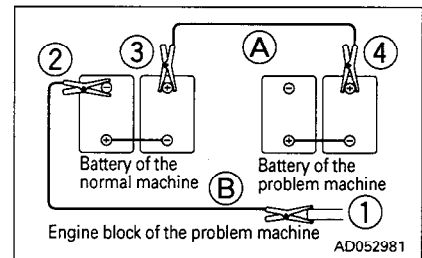

## 16.3 OTHER TROUBLE

- ( ): Always contact your Komatsu distributor when dealing with these items.
- In cases of abnormalities or causes which are not listed below, please contact your Komatsu distributor for repairs.

### 16.3.1 ELECTRICAL SYSTEM

Problem	Main causes	Remedy
Lamp does not glow brightly even when the engine runs at high speed	<ul style="list-style-type: none"> <li>● Defective wiring</li> <li>● Defective adjustment of fan belt tension</li> </ul>	<ul style="list-style-type: none"> <li>(● Check, repair loose terminals, disconnections)</li> <li>● Adjust fan belt tension For details, see EVERY 1000 HOURS SERVICE</li> </ul>
Lamp flickers while engine is running		
Charge lamp does not go out even when engine is running	<ul style="list-style-type: none"> <li>● Defective alternator</li> <li>● Defective wiring</li> </ul>	<ul style="list-style-type: none"> <li>(● Replace)</li> <li>(● Check, repair)</li> </ul>
Abnormal noise is generated from alternator	<ul style="list-style-type: none"> <li>● Defective alternator</li> </ul>	<ul style="list-style-type: none"> <li>(● Replace)</li> </ul>
Starting motor does not turn when starting switch is turned to ON	<ul style="list-style-type: none"> <li>● Defective wiring</li> <li>● Insufficient battery charge</li> </ul>	<ul style="list-style-type: none"> <li>(● Check, repair)</li> <li>● Charge</li> </ul>
Pinion of starting motor keeps going in and out	<ul style="list-style-type: none"> <li>● Insufficient battery charge</li> </ul>	<ul style="list-style-type: none"> <li>● Charge</li> </ul>
Starting motor turns engine sluggishly	<ul style="list-style-type: none"> <li>● Insufficient battery charge</li> <li>● Defective starting motor</li> </ul>	<ul style="list-style-type: none"> <li>● Charge</li> <li>(● Replace)</li> </ul>
Starting motor disengages before engine starts	<ul style="list-style-type: none"> <li>● Defective wiring</li> <li>● Insufficient battery charge</li> </ul>	<ul style="list-style-type: none"> <li>(● Check, repair)</li> <li>● Charge</li> </ul>
Heater signal does not glow red	<ul style="list-style-type: none"> <li>● Defective wiring</li> <li>● Defective heater relay</li> <li>● Defective heater signal</li> </ul>	<ul style="list-style-type: none"> <li>(● Check, repair)</li> <li>(● Replace)</li> <li>(● Replace)</li> </ul>
Oil pressure warning lamp does not light up when engine is stopped (starting switch at ON position)	<ul style="list-style-type: none"> <li>● Defective warning lamp</li> <li>● Defective warning lamp switch</li> </ul>	<ul style="list-style-type: none"> <li>(● Replace)</li> <li>(● Replace)</li> </ul>
Charge lamp does not light up when engine is stopped (starting switch at ON position)	<ul style="list-style-type: none"> <li>● Defective charge lamp</li> <li>● Defective wiring</li> </ul>	<ul style="list-style-type: none"> <li>(● Replace)</li> <li>(● Check, repair)</li> </ul>
Outside of electrical intake air heater is not warm when touched by hand	<ul style="list-style-type: none"> <li>● Defective wiring</li> <li>● Disconnection in electrical intake air heater</li> <li>● Defective operation of heater relay switch</li> </ul>	<ul style="list-style-type: none"> <li>(● Check, repair)</li> <li>(● Replace)</li> <li>(● Check, repair heater relay switch)</li> </ul>

16. TROUBLESHOOTING

16.3.2 CHASSIS

Problem	Main causes	Remedy
When steering, directional and speed lever is moved to desired position, machine does not start, or traveling speed is slow	<ul style="list-style-type: none"> <li>● Oil pressure of transmission is not raised.                             <ol style="list-style-type: none"> <li>1. Insufficient oil in transmission case</li> <li>2. Clogged strainer in transmission case</li> </ol> </li> </ul>	<ul style="list-style-type: none"> <li>● Add oil to specified level, see CHECK BEFORE STARTING</li> <li>● Clean strainer</li> </ul>
When steering, directional and speed lever is moved in direction to turn machine, machine does not turn and goes straight	<ul style="list-style-type: none"> <li>● Steering clutch of moved side is not disengaged                             <ul style="list-style-type: none"> <li>○ Steering oil pressure does not reach the specified pressure (air is leaking into oil pump)</li> </ul> </li> <li>● Brake of moved side is not actuated</li> </ul>	<ul style="list-style-type: none"> <li>(● Check, adjust steering clutch)</li> <li>● Adjust brake, see WHEN REQUIRED</li> </ul>
When brake pedal is depressed, machine does not stop	<ul style="list-style-type: none"> <li>● Brakes out of adjust</li> </ul>	<ul style="list-style-type: none"> <li>● Adjust brake, see WHEN REQUIRED</li> </ul>
Track comes off	<ul style="list-style-type: none"> <li>● Track too loose</li> </ul>	<ul style="list-style-type: none"> <li>● Adjust track tension, see WHEN REQUIRED</li> </ul>
Abnormal wear of sprocket	<ul style="list-style-type: none"> <li>● Track too loose or too tightened</li> </ul>	
Blade rises slowly, does not rise	<ul style="list-style-type: none"> <li>● Lack of hydraulic oil level</li> </ul>	<ul style="list-style-type: none"> <li>● Add oil to specified level, see EVERY 250 HOURS SERVICE</li> </ul>

## 16.3.3 ENGINE

Problem	Main causes	Remedy
Engine oil pressure warning lamp remains alight when engine speed is raised after completion of warm-up	<ul style="list-style-type: none"> <li>● Engine oil pan oil level is low (sucking in air)</li> <li>● Clogged oil filter cartridge</li> <li>● Defective tightening of oil pipe joint, oil leakage from damaged part</li> <li>● Defective caution lamp</li> </ul>	<ul style="list-style-type: none"> <li>● Add oil to specified level, see CHECK BEFORE STARTING</li> <li>● Replace cartridge, see EVERY 250 HOURS SERVICE</li> <li>(● Check, repair)</li> <li>(● Replace lamp)</li> </ul>
Steam is emitted from top part of radiator (pressure valve)	<ul style="list-style-type: none"> <li>● Cooling water level low, water leakage</li> <li>● Loose fan belt</li> <li>● Dirt or scale accumulated in cooling system</li> <li>● Clogged radiator fin or damaged fin</li> <li>● Defective thermostat</li> <li>● Loose radiator filler cap (high altitude operation)</li> <li>● Defective water temperature gauge</li> </ul>	<ul style="list-style-type: none"> <li>● Add cooling water, repair, see CHECK BEFORE STARTING</li> <li>● Adjust fan belt tension, see EVERY 1000 HOURS SERVICE</li> <li>● Change cooling water, clean inside of cooling system, see WHEN REQUIRED</li> <li>● Clean or repair, see EVERY 500 HOURS SERVICE</li> <li>(● Replace thermostat)</li> <li>● Tighten cap or replace packing</li> <li>(● Replace water temperature gauge)</li> </ul>
Indicator of water temperature gauge is in red range on right side of gauge	<ul style="list-style-type: none"> <li>● Defective thermostat</li> <li>● Defective water temperature gauge</li> </ul>	<ul style="list-style-type: none"> <li>(● Replace thermostat)</li> <li>(● Replace water temperature gauge)</li> </ul>
Indicator of water temperature gauge is in white range on left side of gauge	<ul style="list-style-type: none"> <li>● Defective thermostat</li> <li>● Defective water temperature gauge</li> </ul>	<ul style="list-style-type: none"> <li>(● Replace thermostat)</li> <li>(● Replace water temperature gauge)</li> </ul>
Engine does not start when starting motor is turned	<ul style="list-style-type: none"> <li>● Lack of fuel</li> <li>● Air in fuel system</li> <li>● Defective fuel injection pump or nozzle</li> <li>● Starting motor cranks engine sluggishly</li> <li>● Heater signal does not glow red</li> <li>● Defective compression <ul style="list-style-type: none"> <li>○ Defective valve clearance</li> </ul> </li> </ul>	<ul style="list-style-type: none"> <li>● Add fuel, see CHECK BEFORE STARTING</li> <li>● Repair place where air is sucked in</li> <li>(● Replace pump or nozzle)</li> <li>— See ELECTRICAL SYSTEM</li> <li>(○ Adjust valve clearance)</li> </ul>
Exhaust gas is white or blue	<ul style="list-style-type: none"> <li>● Too much oil in oil pan</li> <li>● Improper fuel</li> </ul>	<ul style="list-style-type: none"> <li>● Add oil to specified level, see CHECK BEFORE STARTING</li> <li>● Change to specified fuel</li> </ul>
Exhaust gas occasionally turns black	<ul style="list-style-type: none"> <li>● Clogged air cleaner element</li> <li>● Defective nozzle</li> <li>● Defective compression</li> </ul>	<ul style="list-style-type: none"> <li>● Clean or replace, see WHEN REQUIRED</li> <li>(● Replace nozzle)</li> <li>(● Adjust valve clearance)</li> </ul>
Combustion noise occasionally makes breathing sound	<ul style="list-style-type: none"> <li>● Defective nozzle</li> </ul>	<ul style="list-style-type: none"> <li>(● Replace nozzle)</li> </ul>
Abnormal noise generated (combustion or mechanical)	<ul style="list-style-type: none"> <li>● Low grade fuel being used</li> <li>● Overheating</li> <li>● Damage inside muffler</li> <li>● Excessive valve clearance</li> </ul>	<ul style="list-style-type: none"> <li>● Change to specified fuel</li> <li>● See item "Indicator of water temperature gauge is in red range on right side of gauge".</li> <li>(● Replace muffler)</li> <li>(● Adjust valve clearance)</li> </ul>



**MEMO**

# **MAINTENANCE**

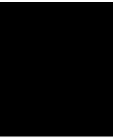

## **17. GUIDES TO MAINTENANCE**

---

Do not carry out any inspection and maintenance operation that is not given in this manual.

Perform maintenance work on hard, flat ground.

### **Check service meter**

Check the service meter reading every day to see if the time has come for any necessary maintenance to be carried out.

### **Komatsu genuine replacement parts:**

Use Komatsu genuine parts specified in the parts list as replacement parts.

### **Komatsu genuine oils:**

Use Komatsu genuine oils and grease. Choose oils and grease with proper viscosities specified for ambient temperature.

### **Always use clean washer fluid:**

Use automobile window washer fluid and be careful not to let any dirt get into it.

### **Clean oil and grease:**

Use clean oil and grease. Also, keep containers of the oil and grease clean. Keep foreign materials away from oil and grease.

### **Keeping the machine clean:**

Always keep the machine clean. This makes it easier to find parts causing problems. Keep in particular grease fittings, breathers and oil level gauges clean and avoid foreign matters from getting in them.

### **Be careful of hot water and oil:**

Draining hot oils and coolants and removing their filters immediately after the engine stops are hazardous. Allow the engine to cool.

If the oil has to be drained when it is cold, warm up the oil to a suitable temperature (approx. 20 – 40°C) before draining it.

### **Checking foreign materials in drained oil:**

After oil is changed or filters are replaced, check the oil and filters for metallic particles and foreign materials. If large quantities of metallic particles or foreign materials are found, consult your Komatsu distributor.

### **Fuel strainer:**

If your machine is equipped with a fuel strainer, do not remove it while fueling.

### **Oil change:**

Check or change oils in the places where dust is scarce to keep foreign materials away from oils.

**Warning tag:**

Attach the warning tag to the starting switch or other appropriate control lever to avoid someone who is not aware of the circumstances from starting the engine.

**Obey precautions:**

During the operation, always obey the precautions on the safety label stuck to the machine.

**Welding instructions:**

- Turn off the engine starting switch.
- Do not apply more than 200 V continuously.
- Connect grounding the cable within 1 m from the area to be welded.
- Avoid seals or bearings from being between the area to be welded and the position of grounding point.

**Fire prevention:**

Use nonflammable cleaner or light oil for cleaning parts. Keep flame or cigarette light away from light oil.

**Clamp faces:**

When O-rings or gaskets are removed, clean the clamp faces and replace the O-rings and gaskets with new ones. Be sure to fit O-rings and gaskets when assembling.

**Objects in your pockets:**

Keep your pockets free of loose objects which can fall out and drop into the machinery; especially when you work on the machinery while bending over it.

**Checking undercarriage:**

When working in rocky areas, check for damage to the undercarriage and for looseness, flaws, wear and damage in bolts and nuts. Loosen the track tension a little when working in such areas.

**Cleaning machine:**

- Do not direct a high-pressure jet directly at the radiator.
- Do not splash water over the electrical equipment.

**Pre- and post-work checks:**

Before starting work in mud, rain, snow or at seashore, check plugs and valves for tightness. Wash the machine immediately after the work to protect components from rusting.

Lubricate components more frequently than usual. Be sure to lubricate work equipment pins daily if they are submerged in water.

**Dusty worksites:**

When working at dusty worksites, do as follows:

- Check the air cleaner for clogging more frequently. Clean the air cleaner at shorter intervals than specified.
- Clean the radiator core frequently to avoid clogging.
- Clean and replace the fuel filter frequently.
- Clean electrical components, especially the starting motor and alternator, to avoid accumulation of dust.

**Avoid mixing oils:**

Never mix oils of different brands. If you have only oil which is a different brand from the one that is used in the machine, do not add it but replace all the oil.

## 18. OUTLINES OF SERVICE

---

- Use Komatsu genuine parts for replacement.
- When changing or adding oil, do not use a different type of oil.
- Unless otherwise specified, the oil and coolant used at the time of shipment from the factory are as shown in the table below.

Item	Kind of fluid
Engine oil pan	SAE 15W-40 API classification CD
Transmission case Transfer case (Incl. bevel gear case) Steering clutch case Final drive case	SAE 30 API classification CD
Hydraulic tank	SAE 10W API classification CD
Fuel tank	ASTM D975 No. 2 (However, ASTM D975 No. 1 is used for the winter season (October to March))
Radiator	Komatsu Super Coolant (AF-ACL) 41% added to water

### 18.1 OUTLINE OF OIL, FUEL, COOLANT

#### 18.1.1 OIL

- Oil is used in the engine and work equipment under extremely severe conditions (high temperature, high pressure), and it deteriorates with use.  
Always use oil that matches the grade and temperature for use given in the Operation and Maintenance Manual. Even if the oil is not dirty, always replace the oil after the specified interval.
- Oil corresponds to blood in the human body, so always be careful when handling it to prevent any impurities (water, metal particles, dirt, etc.) from getting in.  
The majority of problems with machine are caused by the entry of such impurities.  
Take particular care not to let any impurities get in when storing or adding oil.
- Never mix oils of different grades or brands.
- Always add the specified amount of oil.  
Having too much oil or too little oil are both causes of problems.
- If the oil in the work equipment is not clear, there is probably water or air getting into the circuit.  
In such cases, please contact your Komatsu distributor.
- When changing the oil, always replace the related filters at the same time.
- We recommend you to have an analysis made of the oil periodically to check the condition of the machine. For those who wish to use this service, please contact your Komatsu distributor.

### 18.1.2 FUEL

- The fuel pump is a precision instrument, and if fuel containing water or dirt is used, it cannot work properly.
- Be extremely careful not to let impurities get in when storing or adding fuel.
- Always use the fuel specified in the Operation and Maintenance Manual.  
Fuel may congeal depending on the temperature when it is used (particularly in low temperature below  $-15^{\circ}\text{C}$ ), so it is necessary to change to a fuel that matches the temperature.
- To prevent the moisture in the air from condensing and forming water inside the fuel tank, always fill the fuel tank after completing the day's work.
- Before starting the engine, or when 10 minutes have passed after adding fuel, drain the sediment and water from the fuel tank.
- If the engine runs out of fuel, or if the filters have been replaced, it is necessary to bleed the air from the circuit.

### 18.1.3 COOLANT

- River water contains large amounts of calcium and other impurities, so if it is used, scale will stick to the engine and radiator, and this will cause defective heat exchange and overheating.  
Do not use water that is not suitable for drinking.
- When using anti-freeze, always observe the precautions given in the Operation and Maintenance Manual.
- Komatsu machines are supplied with Komatsu original anti-freeze in the coolant when the machine is shipped.  
This anti-freeze is effective in preventing corrosion of the cooling system.  
The anti-freeze can be used continuously for two years or 4000 hours. Therefore, it can be used as it is even in hot areas.
- Anti-freeze is inflammable, so be extremely careful not to expose it to flame or fire.
- The proportion of anti-freeze to water differs according to the ambient temperature.  
For details of the mixing proportions, see "24.2.1 CLEAN INSIDE OF COOLING SYSTEM".
- If the engine overheats, wait for the engine to cool before adding coolant.
- If the coolant level is low, it will cause overheating and will also cause problems with corrosion from the air in the coolant.

### 18.1.4 GREASE

- Grease is used to prevent twisting and noise at the joints.
- The nipples not included in the maintenance section are nipples for overhaul, so they do not need grease.  
If any part becomes stiff after being used for a long time, add grease.
- Always wipe off all of the old grease that is pushed out when greasing. Be particularly careful to wipe off the old grease in places where sand or dirt sticking in the grease would cause wear of the rotating parts.

### **18.1.5 STORING OIL AND FUEL**

- Keep indoors to prevent any water, dirt, or other impurities from getting in.
- When keeping drum cans for a long period, put the drum on its side so that the filler port of the drum can is at the side. (To prevent moisture from being sucked in)  
If drum cans have to be stored outside, cover them with a waterproof sheet or take other measures to protect them.
- To prevent any change in quality during long-term storage, be sure to use in the order of first in – first out (use the oldest oil or fuel first).

### **18.1.6 FILTERS**

- Filters are extremely important safety parts. They prevent impurities in the fuel and air circuits from entering important equipment and causing problems.  
Replace all filters periodically. For details, see the Operation and Maintenance Manual.  
However, when working in severe conditions, it is necessary to consider replacing the filters at shorter intervals according to the oil and fuel (sulfur content) being used.
- Never try to clean the filters (cartridge type) and use them again. Always replace with new filters.
- When replacing oil filters, check if any metal particles are stuck to the old filter. If any metal particles are found, please contact your Komatsu distributor.
- Do not open packs of spare filters until just before they are to be used.
- Always use Komatsu genuine filters.

## **18.2 RELATING TO ELECTRIC SYSTEM**

- If the wiring gets wet or the insulation is damaged, the electric system leaks and this could result in hazardous malfunction of the machine.
- Services relating to the electric system are (1) check of fan belt tension, (2) check of damage or wear in the fan belt and (3) check of battery fluid level.
- Never remove or disassemble any electric components installed in the machine.
- Never install any electric components other than these specified by Komatsu.
- Be careful to keep the electric system free of water when washing the machine or when it rains.
- When working on the seashore, carefully clean the electric system to prevent corrosion.
- Never connect any optional power source to the fuse, starting switch, battery relay, etc.

## 19. WEAR PARTS LIST

Wear parts such as the filter element, cutting edge, etc. are to be replaced at the time of periodic maintenance or before their abrasion limits.

The wear parts should be changed correctly in order to use the machine economically.  
For part change, Komatsu genuine parts of excellent quality should be used.

The parts in parentheses are to be replaced at the same time.

Item	Part No.	Part Name	Q'ty	Replacement frequency
Engine oil filter	6732-51-5140	Cartridge	1	Every 250 hours service
Fuel filter	6732-71-6110	Cartridge	1	Every 500 hours service
Additional fuel filter (option)	600-311-9121	Cartridge	1	Every 500 hours service
Hydraulic oil filter	113-60-43321	Cartridge	1	Every 1000 hours service
Air cleaner	600-181-6050	Element ass'y	1	-
Blade (D31E-20) (D37E-5)	12F-70-31251	Edge	1	
	12F-70-31261	Edge	1	
	112-946-1510	End bit	2	
	(02090-11050)	(bolt)	(19)	
	(02290-11016)	(Nut)	(19)	
Blade (D31P-20)	12F-70-31251	Edge	1	-
	12F-70-31261	Edge	1	
	11G-71-31170	End bit	2	
	(02090-11050)	(Bolt)	(19)	
	(02290-11016)	(Nut)	(19)	
Blade (D31P-20A) (D37P-5A)	12F-70-31281	Edge	1	-
	12F-70-31261	Edge	1	
	112-946-1510	End bit	2	
	(02090-11050)	(Bolt)	(22)	
	(02290-11016)	(Nut)	(22)	
Blade (D31PL, PLL-20)	12F-B74-3171	Edge	3	-
	12F-929-2170	End bit	2	
	(02090-10840)	(Bolt)	(26)	
	(02290-10813)	(Nut)	(26)	
Electrical intake air heater	6732-11-4810	Gasket	2	-
Corrosion resistor (option)	600-411-1151	Cartridge (400 g)	1	When changed the coolant
Corrosion resistor (option)	600-411-1191	Cartridge (200 g)	1	Every 1000 hours service



# 20. USE OF FUEL, COOLANT AND LUBRICANTS ACCORDING TO AMBIENT TEMPERATURE

## PROPER SELECTION OF FUEL, COOLANT AND LUBRICANTS

RESERVOIR	KIND OF FLUID	AMBIENT TEMPERATURE											CAPACITY								
		-40	-22	-4	14	32	50	68	86	104	122°F	-40	-30	-20	-10	0	10	20	30	40	50°C
Engine oil pan	Engine oil	SAE 15W-40											15.2 ℓ 4.02 US gal 3.34 UK gal	14 ℓ 3.70 US gal 3.08 UK gal							
		SAE 10W-30																			
		SAE 30W																			
		SAE 10W																			
		Synthetic SAE 5W-30																			
Transmission case															16 ℓ 4.22 US gal 3.52 UK gal	13 ℓ 3.43 US gal 2.86 UK gal					
Transfer case (incl. bevel gear case)															17.5 ℓ 4.62 US gal 3.85 UK gal	17 ℓ 4.49 US gal 3.74 UK gal					
Steering clutch case	SAE 30											30 ℓ 7.92 US gal 6.60 UK gal	30 ℓ 7.92 US gal 6.60 UK gal								
Final drive case (each)	SAE 10W											9.5 ℓ (each) 2.51 US gal 2.09 UK gal (D31E, P-20, D37E-5)	9.5 ℓ 2.51 US gal 2.09 UK gal								
												12 ℓ (each) 3.17 US gal 2.64 UK gal (D31P-20A, D37P-5A)	12 ℓ 3.17 US gal 2.64 UK gal								
												15 ℓ (each) 3.96 US gal 3.30 UK gal (D31PL, PLL-20)	15 ℓ 3.96 US gal 3.30 UK gal								
Hydraulic system	SAE 10W											49 ℓ 12.94 US gal 10.78 UK gal (D31E-20, D31P-20A, D37E-5, D37P-5A)	33 ℓ 8.71 US gal 7.26 UK gal								
	SAE 10W-30																				
	SAE 15W-40																				
Fuel tank	Diesel fuel	ASTM D975 No.2											118 ℓ 31.15 US gal 25.96 UK gal	-							
Cooling system	Water	Add antifreeze											22 ℓ 5.81 US gal 4.84 UK gal	-							

※ ASTM D975 No. 1

**REMARK**

- When fuel sulphur content is less than 0.5%, change oil in the oil pan every periodic maintenance hours described in this manual.

Change oil according to the following table if fuel sulphur content is above 0.5%.

Fuel sulphur content	Change interval of oil in engine oil pan
0.5 to 1.0%	1/2 of regular interval
Above 1.0%	1/4 of regular interval

- When starting the engine in an atmospheric temperature of lower than 0°C, be sure to use engine oil of SAE10W, SAE10W-30 and SAE15W-40, even though an atmospheric temperature goes up to 10°C more or less in the day time.
- Use API classification CD, CE or CF-4 as engine oil and if API classification CC, reduce the engine oil change interval to half.
- There is no problem if single grade oil is mixed with multigrade oil (SAE10W-30, 15W-40), but be sure to add single grade oil that matches the temperature in the table.
- We recommend Komatsu genuine oil which has been specifically formulated and approved for use in engine and hydraulic work equipment applications.

Specified capacity: Total amount of oil including oil for components and oil in piping.

Refill capacity: Amount of oil needed to refill system during normal inspection and maintenance.

ASTM: American Society of Testing and Material

SAE: Society of Automotive Engineers

API: American Petroleum Institute

20. USE OF FUEL, COOLANT AND LUBRICANTS ACCORDING TO AMBIENT TEMPERATURE

No.	Supplier	Engine Oil [CD, CE or CF-4] SAE10W, 30, 40 10W30, 15W40 (The 15W40 oil marked * is CE.)	Gear Oil [GL-4 or GL-5] SAE80, 90, 140	Grease [Lithium-Base] NLGI No. 2	Anti-freeze Coolant [Ethylene Glycol Base] Permanent Type
1	KOMATSU	EO10-CD EO30-CD EO10-30CD EO15-40CD	GO90 GO140	G2-LI G2-LI-S	AF-ACL AF-PTL AF-PT (Winter, one season type)
2	AGIP	Diesel sigma S Super dieselmulti- grade *Sigma turbo	Rotra MP	GR MU/EP	-
3	AMOCO	*Amoco 300	Multi-purpose gear oil	RYKON premium grease	-
4	ARCO	*Arcofleet S3 plus	Arco HD gear oil	Litholine HEP 2 Arco EP moly D	-
5	BP	Vanellus C3	Gear oil EP Hypogear EP	Energrease LS-EP2	Antifreeze
6	CALTEX	*RPM delo 400 RPM delo 450	Universal thuban Universal thuban EP	Marfak all purpose 2 Ultra-duty grease 2	AF engine coolant
7	CASTROL	*Turbomax *RX super CRD	EP EPX Hypoy Hypoy B Hypoy C	MS3 Spheerol EPL2	Anti-freeze
8	CHEVRON	*Delo 400	Universal gear	Ultra-duty grease 2	-
9	CONOCO	*Fleet motor oil	Universal gear lubricant	Super-sta grease	-
10	ELF	Multiperformance 3C Performance 3C	-	Tranself EP Tranself EP type 2	Glacelf
11	EXXON (ESSO)	Essolube D3 *Essolube XD-3 *Essolube XD-3 Extra *Esso heavy duty Exxon heavy duty	Gear oil GP Gear oil GX	Beacon EP2	All season coolant
12	GULF	Super duty motor oil *Super duty plus	Multi-purpose gear lubricant	Gulfcrown EP2 Gulfcrown EP special	Antifreeze and coolant
13	MOBIL	Delvac 1300 *Delvac super 10W-30, 15W-40	Mobilube GX Mobilube HD	Mobilux EP2 Mobilgrease 77 Mobilgrease special	-

20. USE OF FUEL, COOLANT AND LUBRICANTS ACCORDING TO AMBIENT TEMPERATURE

No.	Supplier	Engine Oil [CD, CE or CF-4] SAE 10W, 30, 40 10W30, 15W40 (The 15W40 oil marked * is CE.)	Gear Oil [GL-4 or GL-5] SAE 80, 90, 140	Grease [Lithium-Base] NLGI No. 2	Anti-freeze Coolant [Ethylene Glycol Base] Permanent Type
14	PENNZOIL	*Supreme duty fleet motor oil	Multi-purpose 4092 Multi-purpose 4140	Multi-purpose white grease 705 707L White – bearing grease	Anti-freeze and summer coolant
15	PETROFINA	FINA kappa TD	FINA potonic N FINA potonic NE	FINA marson EPL2	FINA tamidor
16	SHELL	Rimula X	Spirax EP Spirax heavy duty	Alvania EP grease	-
17	SUN	-	Sunoco GL5 gear oil	Sunoco ultra prestige 2EP Sun prestige 742	Sunoco antifreeze and summer coolant
18	TEXACO	*Ursa super plus Ursa premium	Multigear	Multifak EP2 Starplex 2	Code 2055 startex antifreeze coolant
19	TOTAL	Rubia S *Rubia X	Total EP Total transmission TM	Multis EP2	Antigel/antifreeze
20	UNION	*Guardol	MP gear lube LS	Unoba EP	-
21	VEEDOL	*Turbostar *Diesel star MDC	Multigear Multigear B Multigear C	-	Antifreeze

# 21. STANDARD TIGHTENING TORQUES FOR BOLTS AND NUTS

## 21.1 INTRODUCTION OF NECESSARY TOOLS

The following tools are needed when carrying out maintenance.

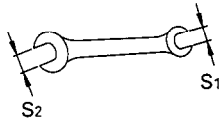
No.	Name of tool	Part No.	Remarks
1	Wrench set	09000-30006	Applicable width across flats (S <sub>1</sub> - S <sub>2</sub> ) 8 mm - 10 mm, 12 mm - 14 mm 13 mm - 17 mm, 19 mm - 22 mm 24 mm - 27 mm, 30 mm - 32 mm
			 AD053370
2	Socket	09021-01725	Applicable width across flats 17 mm
3	Socket	09021-01928	Applicable width across flats 19 mm
4	Socket	09021-02233	Applicable width across flats 22 mm
5	Socket	09021-02436	Applicable width across flats 24 mm
6	Extension	09022-00150	
7	Handle	09023-00300	
8	Screwdriver	09033-00190	Interchangeable flat-head and cross-head type
9	Filter wrench	09019-08035	For filter cartridges
10	Grease pump	07952-80002	For greasing work
11	Grease cartridge	07950-90403	(Lithium base grease, 400 g)

If any of the above tools are broken, please order them from your Komatsu distributor.

## 21.2 TORQUE LIST

Unless otherwise specified, tighten the metric bolts and nuts to the torque shown in the table.

The tightening torque is determined by the width across the flats  $\textcircled{b}$  of the nut and bolt.

If it is necessary to replace any nut or bolt, always use a Komatsu genuine part of the same size as the part that was replaced.

Nm (newton meter):  $1\text{Nm} \approx 0.1 \text{kgf}\cdot\text{m}$   
 $\approx 0.74 \text{lbft}$

Thread diameter of bolt (mm) (a)	Width across flat (mm) (b)	AD054300		
		N·m	kgf·m	lbft
6	10	$13.2 \pm 1.4$	$1.35 \pm 0.15$	$9.73 \pm 1.03$
8	13	$31.4 \pm 2.9$	$3.2 \pm 0.3$	$23.2 \pm 2.1$
10	17	$65.7 \pm 6.8$	$6.7 \pm 0.7$	$48.5 \pm 5.0$
12	19	$112 \pm 9.8$	$11.5 \pm 1.0$	$82.6 \pm 7.2$
14	22	$177 \pm 19$	$18.0 \pm 2.0$	$131 \pm 14$
16	24	$279 \pm 29$	$28.5 \pm 3$	$206 \pm 21$
18	27	$383 \pm 39$	$39 \pm 3$	$282 \pm 29$
20	30	$549 \pm 58$	$56 \pm 6$	$405 \pm 43$
22	32	$745 \pm 78$	$76 \pm 8$	$549 \pm 58$
24	36	$927 \pm 98$	$94.5 \pm 10$	$684 \pm 72$
27	41	$1320 \pm 140$	$135 \pm 15$	$973 \pm 100$
30	46	$1720 \pm 190$	$175 \pm 20$	$1270 \pm 140$
33	50	$2210 \pm 240$	$225 \pm 25$	$1630 \pm 180$
36	55	$2750 \pm 290$	$280 \pm 30$	$2030 \pm 210$
39	60	$3280 \pm 340$	$335 \pm 35$	$2420 \pm 250$

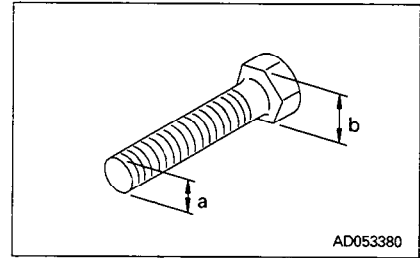

### NOTICE

When tightening panels or other parts having tightening fixtures made of plastic, be careful not to use excessive tightening torque: doing so will damage the plastic parts.

## **22. PERIODIC REPLACEMENT OF SAFETY CRITICAL PARTS**

To ensure safety at all times when operating or driving the machine, the user of the machine must always carry out periodic maintenance. In addition, to further improve safety, the user should also carry out periodic replacement of the parts given in the table. These parts are particularly closely connected to safety and fire prevention.

With these parts, the material changes as time passed, or they easily wear or deteriorate. However, it is difficult to judge the condition of the parts simply by periodic maintenance, so they should always be replaced after a fixed time has passed, regardless of their condition. This is necessary to ensure that they always maintain their function completely.

However, if these parts show any abnormality before the replacement interval has passed, they should be repaired or replaced immediately.

If the hose clamps show any deterioration, such as deformation or cracking, replace the clamps at the same as the hoses.

When replacing the hoses, always replace the O-rings, gaskets, and other such parts at the same time.

Ask your Komatsu distributor to replace the critical parts.

**SAFETY CRITICAL PARTS**

No.	Safety critical parts for periodic replacement	Q'ty	Replacement interval
1	Fuel hose (Between fuel tank and fuel injection pump)	1	Every 2 years or 4000 hours, whichever comes sooner
2	Spill hose (Between fuel tank and air bleed motor pump)	2	
3	Fuel hose (Between air bleed motor pump and priming pump)	1	
4	Spill hose (Between fuel injection pump and priming pump)	1	
5	Spill hose (Between nozzle and fuel tank)	1	
6	Turbocharger lubricating hose	1	
7	Hose between transmission cooler and transmission	2	
8	Hose between transmission valve and PPC valve	2	
9	Hose between PPC valve and steering cylinder	2	
10	Hose between PPC valve and brake cylinder	2	
11	Brake cylinder hose (Between brake cylinders)	2	
12	Case, O-ring, and plug of water separator (Option)	1	
13	Seat belt (Option)	1	Replace every 3 years

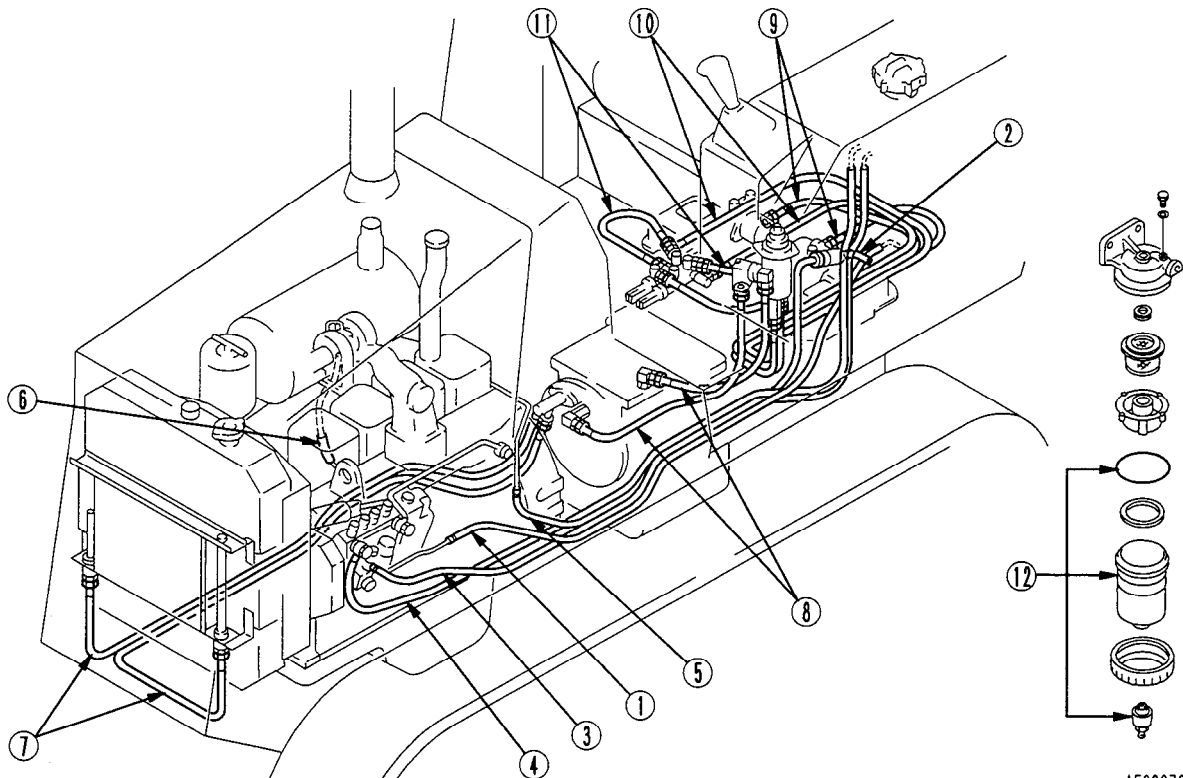

AE220720



## 23. MAINTENANCE SCHEDULE CHART

---

### 23.1 MAINTENANCE SCHEDULE CHART

SERVICE ITEM	PAGE
<b>INITIAL 250 HOURS SERVICE (only after the first 250 hours)</b>	
Replace fuel filter cartridge and additional fuel filter cartridge (option)	3-47
Change oil in transmission case, clean strainer	3-51
Change oil in transfer case (incl. bevel gear case)	3-52
Change oil in steering clutch case	3-53
Change oil in final drive case	3-54
Change oil in hydraulic tank, replace hydraulic oil filter cartridge	3-55
Check engine valve clearance, adjust	3-58
<b>WHEN REQUIRED</b>	
Clean inside of cooling system	3-20
Check, clean and replace air cleaner element	3-25
Check track tension	3-27
Check and tighten track shoe bolts	3-28
Check electrical intake air heater	3-29
Reverse and replace the end bits and cutting edges	3-29
Bleed air from head end of angle circuit	3-30
Adjust brake pedal (test, adjust steering brake)	3-31
Adjust idler clearance	3-32
Adjust angle of blade edge	3-32
<b>CHECK BEFORE STARTING</b>	
Check coolant level, add water	3-34
Check fuel level, add fuel	3-34
Check oil level in engine oil pan, add oil	3-35
Check oil level in transmission case, add oil	3-35
Check oil level in transfer case (incl. bevel gear case), add oil	3-36
Check oil level in steering clutch case, add oil	3-37
Check brake pedal travel	3-37
Does horn sound normally?	3-38
Do lamps light up normally? Are the free from dirt and damage?	3-38

SERVICE ITEM	PAGE
Check of operation of backup alarm (Option)	3-39
Wear and damage of seat belt	3-39
Check of exhaust gas color and sound of engine	3-39
Check of operation of instruments	3-39
Check for water and sediment in water separator, drain water (only for machines equipped with water separator)	3-39
<b>EVERY 50 HOURS SERVICE</b>	
Drain water, sediment from fuel tank	3-40
<b>EVERY 250 HOURS SERVICE</b>	
Lubricating	3-41
(For hydraulic angle – tilt dozer)	
● Angle – tilt frame center pin (1 point)	3-41
● Brace pin (2 points)	3-41
● Lift cylinder bottom pin (2 points)	3-41
● Lift cylinder head pin (2 points)	3-41
● Angle – tilt frame support pin (2 points)	3-42
● Angle cylinder head pin (2 points)	3-42
● Tilt cylinder head pin (1 point)	3-42
● Tilt cylinder bottom pin (1 point)	3-42
● Angle cylinder bottom pin (2 points)	3-42
(For hydraulic tilt dozer)	
● Lift cylinder yolk (8 points)	3-42
● Lift cylinder head pin (2 points)	3-42
● Tilt cylinder head pin (1 point)	3-42
● Tilt brace pin (2 points)	3-42
● Center brace pin (4 points)	3-42
Check oil level in final drive case, add oil	3-43
Check oil level in hydraulic tank, add oil	3-43
Check level of battery electrolyte	3-44
Change oil in engine oil pan, replace oil filter cartridge	3-45
Check electric wirings	3-46

23. MAINTENANCE SCHEDULE CHART

SERVICE ITEM	PAGE
<b>EVERY 500 HOURS SERVICE</b>	
Replace fuel filter cartridge and additional fuel filter cartridge (option)	3-47
Clean, check radiator fins	3-50
Clean transmission case breather (1 point)	3-50
Clean transfer case breather (1 point)	3-50
Clean steering clutch case breather (1 point)	3-50
<b>EVERY 1000 HOURS SERVICE</b>	
Change oil in transmission case, clean strainer	3-51
Change oil in transfer case (incl. bevel gear case)	3-52
Change oil in steering clutch case	3-53
Change oil in final drive case	3-54
Change oil in hydraulic tank, replace hydraulic oil filter cartridge	3-55
Check oil in undercarriage components	3-56
Check fan belt tension and replace	3-56
Check all tightening parts of turbocharger	3-56
Check play of turbocharger rotor	3-56
Replace corrosion resistor cartridge (only for machines equipped with corrosion resistor)	3-57
<b>EVERY 2000 HOURS SERVICE</b>	
Check alternator, starting motor	3-58
Check engine valve clearance, adjust	3-58
Clean, check turbocharger	3-58
<b>EVERY 4000 HOURS SERVICE</b>	
Check water pump	3-59

## **24. SERVICE PROCEDURE**

---

### **24.1 INITIAL 250 HOURS SERVICE**

Carry out the following maintenance only after the first 250 hours.

- REPLACE FUEL FILTER CARTRIDGE AND ADDITIONAL FUEL FILTER CARTRIDGE (OPTION)
- CHANGE OIL IN TRANSMISSION CASE, CLEAN STRAINER
- CHANGE OIL IN TRANSFER CASE (INCL. BEVEL GEAR CASE)
- CHANGE OIL IN STEERING CLUTCH CASE
- CHANGE OIL IN FINAL DRIVE CASE
- CHANGE OIL IN HYDRAULIC TANK, REPLACE HYDRAULIC OIL FILTER CARTRIDGE
- CHECK ENGINE VALVE CLEARANCE, ADJUST

For details of the method of replacing or maintaining, see the section on EVERY 500 HOURS, 1000 HOURS AND 2000 HOURS SERVICE.

## 24.2 WHEN REQUIRED

### 24.2.1 CLEAN INSIDE OF COOLING SYSTEM

**⚠ WARNING**

- **Soon after the engine has been stopped, the coolant is hot and can cause personal injury. Allow the engine to cool before draining water.**
- **Since cleaning is performed while the engine is running, it is very dangerous to enter the rear side of the machine as the machine may suddenly start moving. If the under cover is left removed, it may interfere with the fan. While the engine is running, never enter the rear side of the machine.**
- **Never remove the radiator cap when the engine is at operating temperature. At operating temperature, the coolant is under pressure. Steam blowing up from the radiator could cause personal injury. Allow the engine to cool until the radiator filler cap is cool enough to touch with your hand. Remove the filler cap slowly to allow pressure to be relieved.**
- **When removing drain plug, avoid pouring coolant on yourself.**
- **Antifreeze is flammable, so keep it away from any flame.**

- Clean the inside of the cooling system, change the coolant and replace the corrosion resistor (option) according to the table below.

Kind of coolant	Cleaning inside of cooling system and changing coolant	Replacing corrosion resistor
Permanent type antifreeze (All season type)	Every year (autumn) or every 2000 hours whichever comes first	Every 1000 hours and when cleaning the inside of the cooling system and when changing coolant
Non permanent type antifreeze containing ethylene glycol (Winter, one season type)	Every 6 months (spring, autumn) (Drain antifreeze in spring, add antifreeze in autumn)	
When not using antifreeze	Every 6 months or every 1000 hours whichever comes first	

- Stop the machine on level ground when cleaning or changing the coolant.
- Use a permanent type of antifreeze.  
If, for some reason, it is impossible to use permanent type antifreeze, use an antifreeze containing ethylene glycol.

- When deciding the ratio of antifreeze to water, check the lowest temperature in the past, and decide from the mixing rate table given below.

It is actually better to estimate a temperature about 10°C (50°F) lower when deciding the mixing rate.

#### Mixing rate of water and antifreeze

Min. atmospheric temperature	°C	-5	-10	-15	-20	-25	-30
	°F	23	14	5	-4	-13	-22
Amount of antifreeze	ℓ	5.1	6.6	7.9	9.0	10.1	11.0
	US gal	1.35	1.74	2.09	2.38	2.67	2.905
	UK gal	1.12	1.45	1.74	1.98	2.22	2.42
Amount of water	ℓ	16.9	15.4	14.1	13.0	11.9	11.0
	US gal	4.46	4.07	3.72	3.43	3.14	2.905
	UK gal	3.72	3.39	3.10	2.86	2.62	2.42

#### WARNING

**Antifreeze is flammable, so keep it away from any flame.**

- Use city water for the cooling water.  
If river water, well water or other such water supply must be used, contact your Komatsu distributor.
- We recommend use of an antifreeze density gauge to control the mixing proportions.

#### WARNING

**When removing drain plug, avoid pouring coolant on yourself.**

## 24. SERVICE PROCEDURE

1. Stop the engine and close valve ① of the corrosion resistor (Option).
2. Turn radiator cap ② slowly until it is stopped at the 1st stop.
3. Push and turn radiator cap ② until it is stopped at the 2nd stop, then remove it.
4. Prepare a container to receive the coolant. Open drain valve ③ on the underside of the radiator and drain plug ④ on the underside of the coolant inlet block to drain the water.
5. After draining the water, close drain valve ③ and drain plug ④, and fill with city water.
6. Open drain valve ③ and drain plug ④, run the engine at low idling, and flush water through the system for 10 minutes. When doing this, adjust the speed of filling and draining the water so that the radiator is always full.  
While flushing water through the system, watch carefully that the water inlet hose does not come out of the radiator water filler.
7. After flushing, stop the engine, open drain valve ③ and drain plug ④, then close it again after all the water has drained out.
8. After draining the water, clean with a flushing agent.

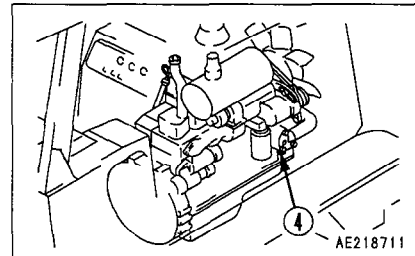
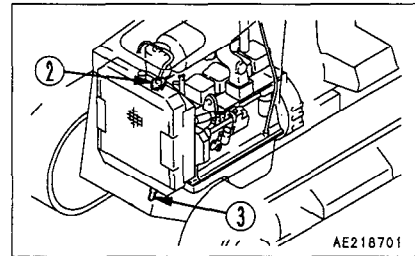
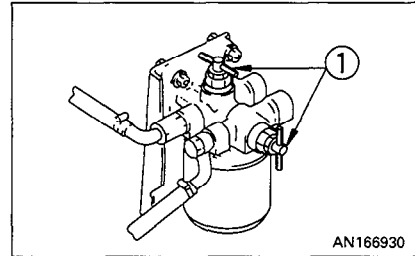

We recommend you to use Komatsu genuine flushing agent KC.

### **CAUTION**

**Flushing agent KC is a strong acid, so after flushing, add neutralizing agent KN to the container to neutralize the water, then drain the water.**

**Do not put neutralizing agent KN inside the engine cooling water system. The rust is ionized by flushing agent KC, but if neutralizing agent KN is added, sediment will be formed again, and this may accumulate inside the cooling system.**

- (1) Use a clean polyethylene container, and dissolve one packet of flushing agent KC in 6 liters of water.  
If the container is large enough, it is possible to dissolve all the necessary flushing agent at the same time.
- (2) Add the KC solution to the radiator.
- (3) Add water to the radiator to the specified water level.
- (4) Tighten the radiator cap, and run the engine at idling at a midrange speed for one or two hours. Every 20 minutes, apply load to the engine.
- (5) Stop the engine, then drain and add water in accordance with Steps 1 – 3.
- (6) Add water and open drain plug ③ at the same time, and run water to flush the system for about 30 minutes with the engine at a midrange speed.  
When doing this, be careful to adjust the amount of water supplied and drained to ensure that the radiator is always filled.

- (7) After flushing for 30 minutes, take a sample and check the condition of the water in the cooling system. If the water is orange, continue flushing until the water becomes colorless and transparent.
- (8) When the drained water becomes colorless and transparent, collect 100 cc of the drained water in a container, add 5 cc of neutralizing agent KN (white powder), mix it well, and check that no blue-green or orange sediment is formed. If any blue-green or orange sediment is formed, continue the flushing operation until this problem disappears.

**REMARK**

Flushing agent KC comes in packets of 500 g and neutralizing agent KN in packets of 250 g.

(The specified density for the flushing agent KC is 35 g/l, and for the neutralizing agent KN is 17.5 g/l.)

There is no problem in using commercially available flushing agents or neutralizing agent (when draining the water). In this case, use the flushing agent or neutralizing agent in the way specified on the instruction sheet supplied with the agent.

9. After washing, open drain valve ③ and drain plug ④ to drain all water. Close them and supply city water up to near the water filler.
10. When the water level reaches near the water filler, open drain valve ③ and drain plug ④. Start the engine and run it at the low idling speed. Keep water supplied until clear water flows out. Adjust the water supply rate and draining rate so that the radiator will be filled with water during washing.
11. If clear water flows out, stop the engine, then close drain valve ③ and drain plug ④.
12. Drain the coolant from sub tank ⑤ and wash the inside of the sub tank. Supply coolant to the middle between FULL and LOW marks of the sub tank.
13. Replace the corrosion resistor (Option) and open valve ①. For the replacing procedure of the corrosion resistor, see "24.7 EVERY 1000 HOURS SERVICE".
14. Supply antifreeze through the water filler. For the quantity of the antifreeze, see "Mixing ratio of water and antifreeze".
15. Supply city water up to near the water filler.

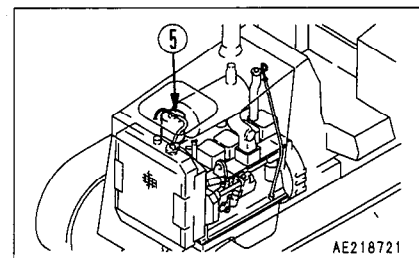



#### 24. SERVICE PROCEDURE

---

16. Run the engine at the low idling speed for 5 minutes, then at the high idling speed to bleed air contained in the cooling water. (At this time, keep the water filler cap removed.)
17. Stop the engine and wait for 3 about minutes. Then, supply city water up to near the water filler, then close the cap.

## 24.2.2 CHECK, CLEAN AND REPLACE AIR CLEANER ELEMENT

### WARNING

- Do not clean or replace the air cleaner while the engine is running.
- When cleaning the element with compressed air, wear protective goggles to protect your eyes from dust.

#### Checking

If air cleaner caution lamp ① lights up, clean the outer element of the air cleaner.

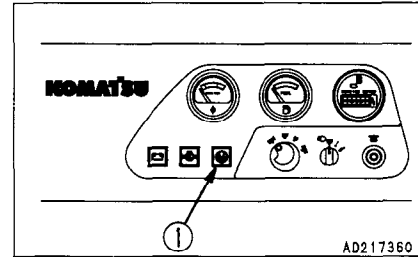

#### Cleaning or replacing outer element

1. Remove hood catcher ② on the left side.
2. Remove wing nut ③, then remove the outer element.

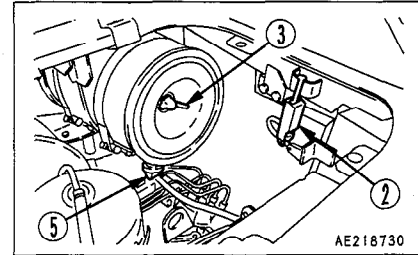

3. Clean the inside of the body.
4. Blow dry compressed air (0.69 MPa {7kg/cm<sup>2</sup>} maximum) against the inside of the element along the pleats. Then, blow against the outside along the pleats, then against the inside again.
  - (1) Remove one seal each time the element is cleaned.
  - (2) After cleaning the outer element six times or using it for one year, replace it. At this time, replace the inner element, too.
  - (3) Even if the number of cleaning times of the outer element is less than six, if the air cleaner clogging caution lamp lights up soon after it is cleaned, replace both outer and inner elements.
  - (4) Check the clamping nut of the inner element for looseness, and tighten it if necessary.
  - (5) If seal washer ④ is damaged or the threads of wing nut ③ are broken, replace them with new ones.
  - (6) Remove evacuator valve ⑤ and clean it with compressed air, etc., then install it again.

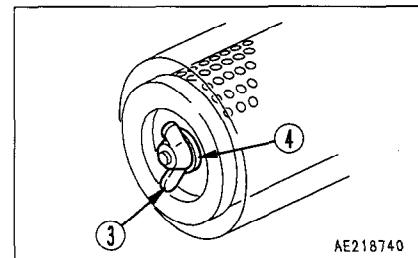
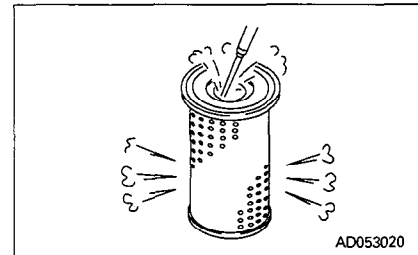

**NOTICE**

**Light up the inside of the cleaned element with a lamp. If any hole or a thin part is found, replace the element.**

**When cleaning the element, do not strike it or hit it against something.**

**Do not use the element, if its pleats, gasket, or seal are damaged.**

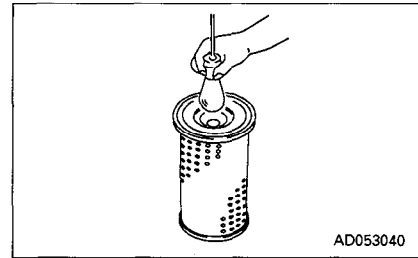

5. Install the cleaned element.
6. Apply hood catcher ② to the hood to secure the latter.

**Replacing inner element**

1. Remove the outer element, then remove the inner element.
2. Cover the air connector (outlet side) with a clean cloth or cloth tape to prevent dust from entering it.
3. Clean the inside of the body, then remove the cover fitted in 2. above.
4. Install a new inner element to the connector and tighten the nut. Do not reuse the inner element after cleaning it.
5. Install the outer element.
6. Apply hood catcher ② to the hood to secure the latter.

### 24.2.3 CHECK TRACK TENSION

The wear of pins and bushings on the undercarriage will vary with the working conditions and soil properties. It is thus necessary to continually inspect the track tension so as to maintain the standard tension.

Carry out the check and adjustment under the same conditions as when operating (on jobsites where the track becomes clogged with mud, measure with the track clogged with mud).

#### INSPECTION

Stop the machine on level ground (stop with the transmission in FORWARD without applying the brake). Then place a straight bar on the track shoes between the carrier roller and the idler as shown in the figure, and measure the clearance between the bar and the grouser at the midpoint. If the clearance is 20 – 30 mm (0.79 – 1.18 in), the tension is standard.

If the track tension is not at the standard value, adjust it in the following manner.

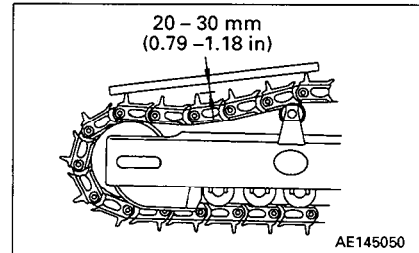

#### ADJUSTMENT

##### **⚠ WARNING**

**Grease inside the adjusting mechanism is under high pressure. Grease coming from lubricator ② under pressure can penetrate the body causing injury or death. For this reason, do not loosen lubricator ② more than one turn. Do not loosen any part other than lubricator ②. Furthermore, do not bring your face in front of the grease fitting ①.**  
**If the track tension is not relieved by this procedure, please contact your Komatsu distributor.**

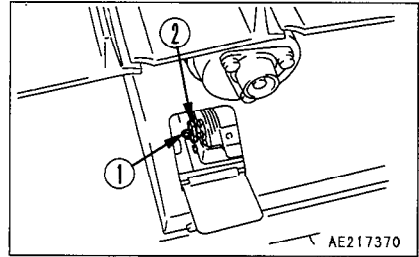

#### ● When increasing tension

1. Pump in grease through the grease fitting ① with a grease pump.
2. To check that the correct tension has been achieved, move the machine backwards and forwards.
3. Check the track tension again, and if the tension is not correct, adjust it again.
4. Continue to pump in grease until S becomes 39 mm (1.54 in). If the tension is still loose, the pin and bushing are excessively worn, so they must be either turned or replaced. Please contact your Komatsu distributor.

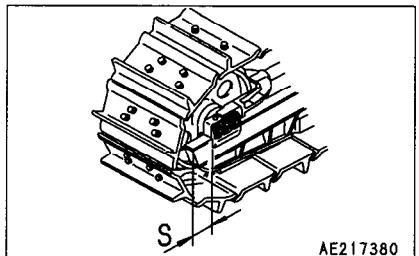

● When loosening tension

**⚠ WARNING**

It is extremely dangerous to release the grease by any method except the procedure given below. If the track tension is not relieved by this procedure, please contact your Komatsu distributor.

1. Loosen lubricator ① gradually to release the grease.
2. Turn lubricator ① a maximum of one turn.
3. If the grease does not come out smoothly, move the machine backwards and forwards a short distance.
4. Tighten lubricator ①.
5. To check that the correct tension has been achieved, move the machine backwards and forwards.
6. Check the track tension again, and if the tension is not correct, adjust it again.

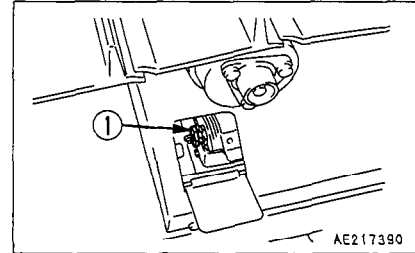

**24.2.4 CHECK AND TIGHTEN TRACK SHOE BOLTS**

If the machine is used with track shoe bolts ① loose, they will break, so tighten any loose bolts immediately.

● **Method for tightening (shoe bolt)**

1. First tighten to a tightening torque of  $117.7 \pm 19.6$  N·m ( $12 \pm 2$  kgf·m) then check that the nut and shoe are in close contact with the link contact surface.
2. After checking, tighten a further  $90^\circ \pm 10^\circ$ .

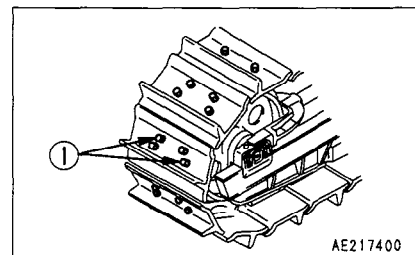

● **Method for tightening (master link connecting bolt)**

1. First tighten to a tightening torque of  $147 \pm 19.6$  N·m ( $15 \pm 2$  kgf·m), then check that the link contact surfaces are in close contact.
2. After checking, tighten a further  $180^\circ \pm 10^\circ$ .

**Order for tightening**

Tighten the bolts in the order shown in the diagram on the right.

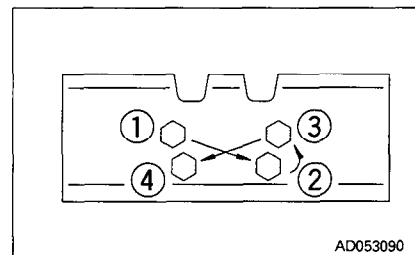

### 24.2.5 CHECK ELECTRICAL INTAKE AIR HEATER

Before starting the engine in the cold season (once a year), ask your Komatsu distributor for check of the electrical heater for breakage, dust, etc., and ask for repairs if necessary.

### 24.2.6 REVERSE AND REPLACE THE END BITS AND CUTTING EDGES

#### WARNING

**It is dangerous if the work equipment moves by mistake when the cutting edges and end bits are being reversed or replaced. Set the work equipment in a stable condition, then stop the engine and apply the locks securely to the levers.**

Reverse or replace the end bits and cutting edges before it is worn out to the blade end.

1. Raise the blade to a proper height and apply a block to the frame so as to prevent fall of the blade.
2. Remove the cutting edge and the end bit and clean the mounting surface.

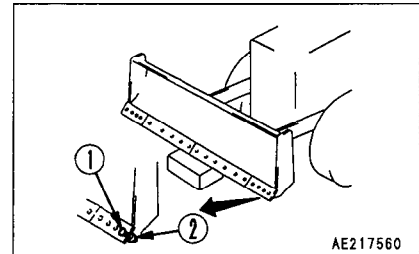

If the cutting edge and the end bit on both sides are worn out, replace with new one.

If it has been worn out up to the fitting surface, repair the fitting surface and then reverse or replace.

3. Reverse or replace the cutting edge and the end bit when worn out.

Nut tightening torque:  $260 \pm 34\text{N}\cdot\text{m}$   $\{26.5 \pm 3.5 \text{ kgf}\cdot\text{m}\}$

If bolt ① and nut ② are damaged, replace them with new ones at the same time.

4. After several hours of running, retighten the nuts.

### 24.2.7 BLEED AIR FROM HEAD END OF ANGLE CIRCUIT

- Hydraulic angle-tilt dozer

**⚠ WARNING**

When loosening the oil filler cap, oil may spurt out, so turn the cap slowly to release the internal pressure before loosening the cap.

**Bleed the air if the work equipment has been removed or repaired.**

1. Loosen the cap of the hydraulic tank.
2. Start the engine, raise the blade approx. 300 mm (12 in) from the ground (level with or higher than the frame), then run the engine at low idling.
3. With the engine at low idling, operate between left tilt and right tilt about ten times repeatedly to the end of the cylinder stroke to fill the tilt circuit with oil.
4. Operate the blade to the maximum left angle, loosen plug ① three turns, then loosen valve ③ two turns.
5. Run the engine at low idling and operate the right tilt until no more bubbles come out with the oil from plug ①. After checking that there are no more bubbles in the oil, tighten plug ①. Operate the tilt slowly with the engine running at low idling.
6. Operate the blade to the maximum right angle, and loosen plug ② three turns.
7. Run the engine at low idling and operate the right tilt until no more bubbles come out with the oil from plug ②. After checking that there are no more bubbles in the oil, tighten plug ②. Operate the tilt slowly with the engine running at low idling.
8. Tighten valve ③.

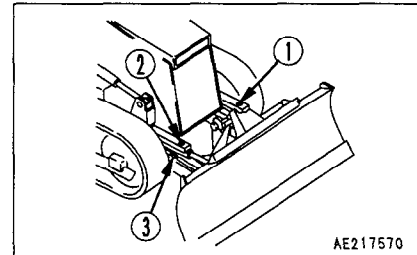

AE217570

Tightening torque of valve ③:  $24.5 \pm 4.9 \text{ N}\cdot\text{m}$  { $12.5 \pm 0.5 \text{ kgf}\cdot\text{m}$ }

9. After bleeding the air, check the hydraulic oil level and add oil if necessary. Then close the hydraulic tank cap and wipe off all oil from around the cylinder.

### 24.2.8 ADJUST BRAKE PEDAL (TEST, ADJUST STEERING BRAKE)

If the travel of the brake pedal increases, the brake lining may be worn out. Adjust brakes as follows.

#### ADJUSTMENT

Adjust both left and right brakes.

1. Remove the rear cover and inspection cover ① in this order.

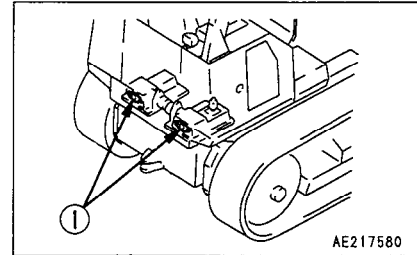

2. Tighten adjustment nuts ②, ③ to torque of 39 N·m {4 kgf·m} until the lining contacts the drum. Then, turn adjustment nuts ②, ③ in reverse directions for 2.5 rotations.
3. Check the travel of the brake pedal, referring to "24.3 CHECK BEFORE STARTING".

The standard clearance between the brake lining and the drum should be 0.3 mm (0.012 in).

Basically speaking, this completes the adjustment of the brake band clearance, but to ensure that the clearance between the lining and drum is the same on both the left and right side, check as follows.

If there is a difference between the clearance of the left and right brakes, the brakes will pull to one side.

#### ● Test, adjust left steering brake

1. Open inspection cover ④ under the operator's seat. Lever ⑤ can be seen behind the oil level gauge tube. Hook the end of a steel tape measure on the end of lever ⑤ at a position as close as possible to yoke ⑥.
2. Read the movement of the steel tape (lever ⑤) while the brake pedal is depressed fully.

It is easy to read the movement of the lever if you watch edge ⑦ of the inspection cover.

If the movement is 30 mm (1.18 in), it is normal.

If the movement is not 30 mm (1.18 in), carry out fine adjustment with left adjustment nut ② as follows.

If it is LESS than 30 mm (1.18 in), LOOSEN nut ②.

If it is MORE than 30 mm (1.18 in), TIGHTEN nut ②.

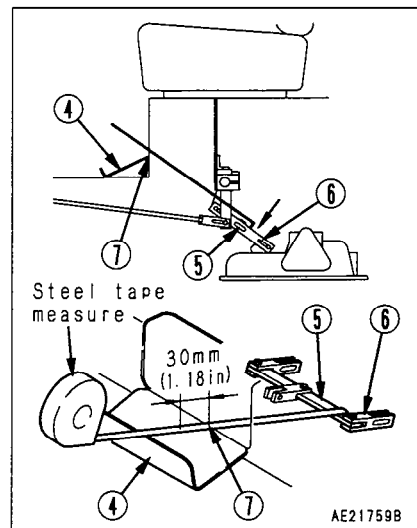
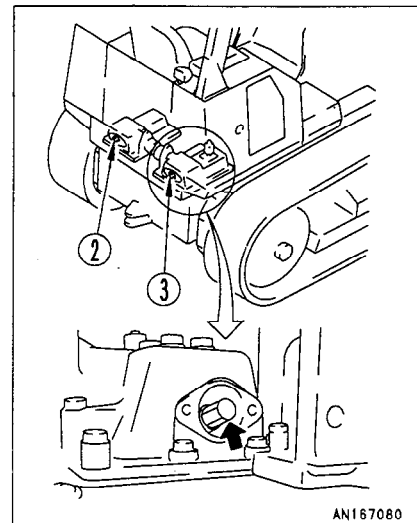



● **Test, adjust right steering brake**

1. The travel at the tip of the pedal should be 110 mm (4.33 in) when the brake pedal is depressed fully.  
If the movement is not 110 mm (4.33 in), adjust again with adjustment nut ③ on the right side.  
When left and right adjustment nuts ② and ③ are turned 1/2 turns, the travel of lever ⑤ and the brake pedal will change as shown below.  
Change of lever ⑤ travel: 6 mm (0.24 in)  
Change of brake pedal travel: 11 mm (0.43 in)

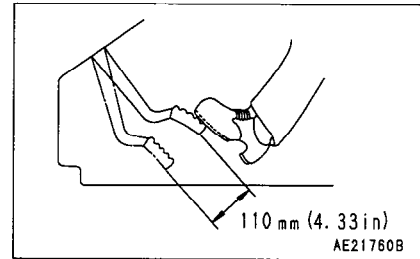

If the brake effect is poor after adjustment, ask your Komatsu distributor to repair it.

**24.2.9 ADJUST IDLER CLEARANCE**

Since the idlers are forced to move forward and backward by an external force guide plates will be worn out.

Wear of these plates will cause the vibration of idlers from side to side or inclination of the idlers, and running off of track links from the idlers or unevenly worn idler and links may result.

Therefore, adjust the idlers according to the following procedure.

**ADJUSTMENT**

1. Drive the machine about 1 or 2 meters (3.28 or 6.56 ft) on a flat ground and measure the clearance A (4 locations: left, right, inside and outside) between the track frame and the guide plate.
2. If the clearance A exceeds 3.0 mm (0.12 in), loosen bolt ①, and pull out the shim to adjust the clearance at one end to 0.5 mm (0.020 in).

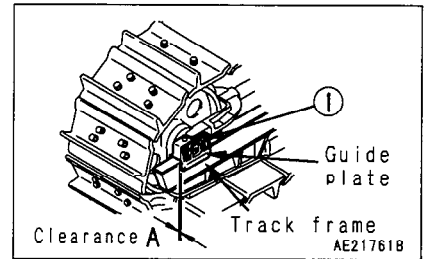

Thickness of one shim is 1.0 mm (0.039 in).

**24.2.10 ADJUST ANGLE OF BLADE EDGE**

**⚠ WARNING**

It is dangerous if the work equipment moves by mistake when adjusting angle of the blade edge. Set the work equipment in a stable condition, then stop the engine and apply the locks securely to the levers.

- **Hydraulic tildozer**  
Adjust the angle of the blade edge to match the type of soil.

**ADJUSTMENT**

Turn the brace with bar handle ① and adjust the length ( $\ell$ ) between the joints to change the angle ( $\theta$ ) of the edge of the blade as follows.

INCREASE length to INCREASE angle  
 DECREASE length to DECREASE angle

Standard blade angle: 55°

- When adjusting the blade angle ( $\theta$ ), keep within a range of the standard length between joints  $\pm 15$  mm (0.59 in).

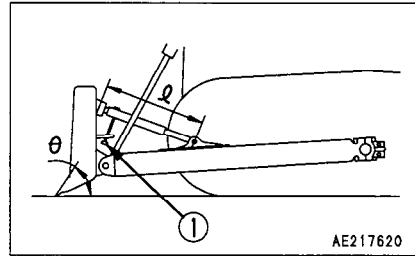

Model	Standard length ( $\ell$ ) between joints
D31P-20	731 mm (28.78 in)
D31PL-20	733 mm (28.86 in)
D31PLL-20	735 mm (28.93 in)

## 24.3 CHECK BEFORE STARTING

### 24.3.1 CHECK COOLANT LEVEL, ADD WATER

**⚠ WARNING**

Normally, do not open the radiator cap. When checking the cooling water level, check the sub-tank when the engine is cold.

1. Open the top cover at the front of the machine body and confirm that the coolant level is between the FULL and LOW lines of sub tank ① (Shown at right). If it is lower than the LOW line, supply coolant to the FULL line through the coolant filler of sub tank ①.

**REMARK**

In summer, the coolant may flow out through the drain hose of the sub tank. This is caused by supply of too much coolant, and is not a problem.

2. After supplying coolant, close the cap securely.
3. If the sub tank is empty, check for water leakage and confirm that the radiator main tank is full, then supply coolant to the radiator sub tank.
4. After supply coolant, close the top cover.

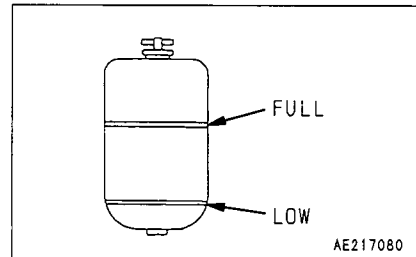
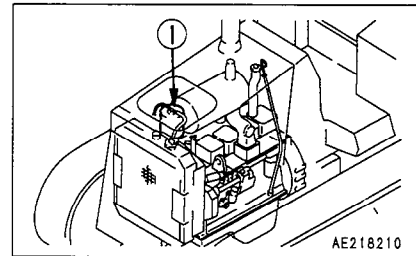

### 24.3.2 CHECK FUEL LEVEL, ADD FUEL

**⚠ WARNING**

When adding fuel, never let the fuel overflow. This may cause a fire. If spilling fuel, thoroughly clean up any spillage.

1. Turn on the engine starting switch and check the fuel level with fuel gauge ⑥. After checking the fuel level, turn off the switch.
2. After completing work, fill the fuel tank through oil filler port ⑦.

**NOTICE**

For details of the oil to use, see "20. USE OF FUEL, COOLANT AND LUBRICANTS ACCORDING TO AMBIENT TEMPERATURE".

3. After adding fuel, tighten the cap securely.  
Fuel capacity: 118 l (3.12 US gal, 26.0 UK gal)

**NOTICE**

A clogged cap breather hole ① may stop the fuel flow to the engine. Check it from time to time and clean.

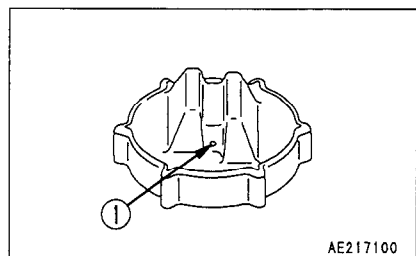
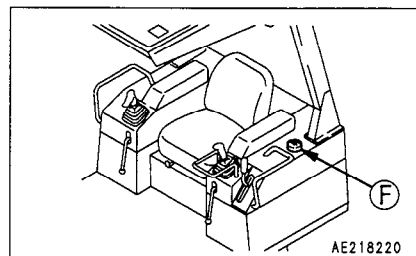
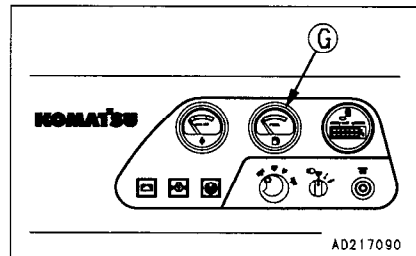

**24.3.3 CHECK OIL LEVEL IN ENGINE OIL PAN, ADD OIL**

1. Open the upper cover at the rear of the engine hood.
2. Remove dipstick ⑥ and wipe the oil off with a cloth.
3. Insert dipstick ⑥ fully in the oil filler pipe, then take it out again.
4. The oil level should be between the H and L marks on dipstick ⑥.  
If the oil level is below the L mark, add engine oil through oil filler ⑦.

**NOTICE**

For details of the oil to use, see "20. USE OF FUEL, COOLANT AND LUBRICANTS ACCORDING TO AMBIENT TEMPERATURE".

5. If the oil is above the H mark, drain the excess engine oil from drain plug ⑧, and check the oil level again.
6. If the oil level is correct, tighten the oil filler cap securely and close the engine side cover.

**REMARK**

- When checking the oil level after the engine has been operated, wait for at least 15 minutes after stopping the engine before checking.
- If the machine is at an angle, make it horizontal before checking.

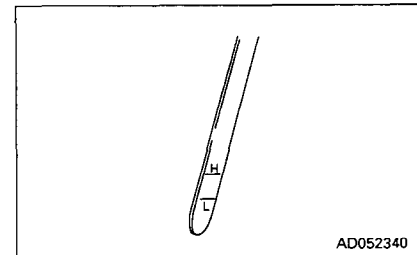
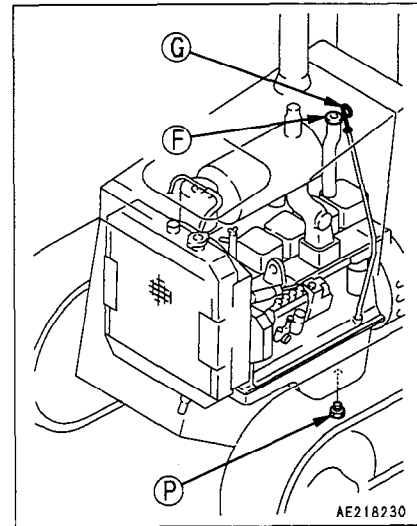
**24.3.4 CHECK OIL LEVEL IN TRANSMISSION CASE, ADD OIL**

1. Open the cover, remove dipstick ⑥, and wipe the oil off with a cloth.
2. Insert dipstick ⑥ fully in the oil filler pipe, then take it out again.
3. The oil level should be between the H and L marks on dipstick ⑥.  
If the oil level is below the L mark, add engine oil through oil filler ⑦.

**NOTICE**

For details of the oil to use, see "20. USE OF FUEL, COOLANT AND LUBRICANTS ACCORDING TO AMBIENT TEMPERATURE".

4. If the oil is above the H mark, drain the excess engine oil from drain plug ⑧, and check the oil level again.
5. If the oil level is correct, tighten the oil filler cap securely and close the cover.

**REMARK**

- When checking the oil level after the engine has been operated, wait for at least 15 minutes after stopping the engine before checking.
- If the machine is at an angle, make it horizontal before checking.

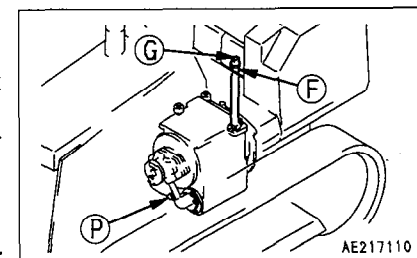

**24.3.5 CHECK OIL LEVEL IN TRANSFER CASE (INCL. BEVEL GEAR CASE), ADD OIL**

1. Open the cover, remove dipstick (G), and wipe the oil off with a cloth.
2. Insert dipstick (G) fully in the oil filler pipe, then take it out again.
3. The oil level should be between the H and L marks on dipstick (G).  
If the oil level is below the L mark, add engine oil through oil filler (F).

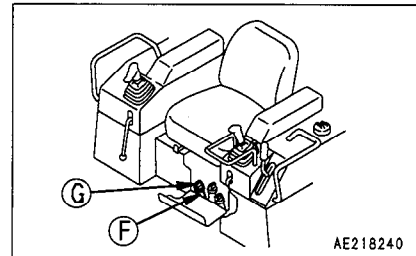

**NOTICE**

For details of the oil to use, see "20. USE OF FUEL, COOLANT AND LUBRICANTS ACCORDING TO AMBIENT TEMPERATURE".

4. If the oil is above the H mark, drain the excess engine oil from drain plug (P), and check the oil level again.
5. If the oil level is correct, tighten the oil filler cap securely and close the cover.

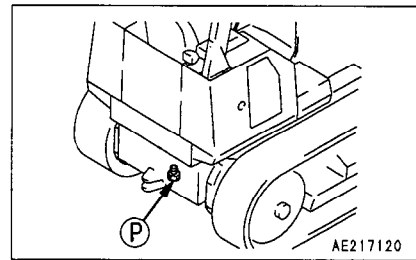

**REMARK**

- When checking the oil level after the engine has been operated, wait for at least 15 minutes after stopping the engine before checking.
- If the machine is at an angle, make it horizontal before checking.

### 24.3.6 CHECK OIL LEVEL IN STEERING CLUTCH CASE, ADD OIL

1. Open the cover, remove dipstick **Ⓒ**, and wipe the oil off with a cloth.
2. Insert dipstick **Ⓒ** fully in the oil filler pipe, then take it out again.
3. The oil level should be between the H and L marks on dipstick **Ⓒ**.  
If the oil level is below the L mark, add engine oil through oil filler **Ⓕ**.

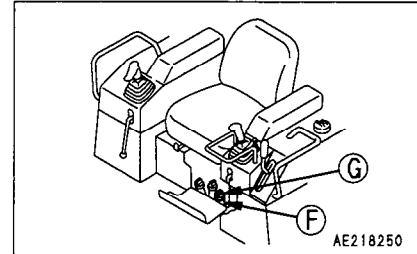

#### NOTICE

For details of the oil to use, see "20. USE OF FUEL, COOLANT AND LUBRICANTS ACCORDING TO AMBIENT TEMPERATURE".

4. If the oil is above the H mark, drain the excess engine oil from drain plug **Ⓓ**, and check the oil level again.
5. If the oil level is correct, tighten the oil filler cap securely and close the cover.

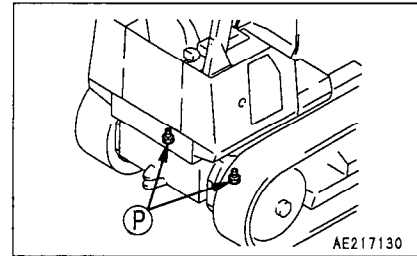

#### REMARK

- When checking the oil level after the engine has been operated, wait for at least 15 minutes after stopping the engine before checking.
- If the machine is at an angle, make it horizontal before checking.

### 24.3.7 CHECK BRAKE PEDAL TRAVEL

#### **⚠** WARNING

If the travel of the brake pedal is not within a range of 110 – 162 mm (4.33 – 6.38 in), the brakes and steering will be too strong or they will not work properly. If the travel of the brake pedal is 163 mm (6.42 in) or more, carry out adjustment.

1. Depress the brake pedal all the way until it stops.
2. Measure the pedal travel for being from 110 mm (4.33 in) to 162 mm (6.38 in) at the bottom end of the pedal.
3. When this value exceeds 163 mm (6.42 in), or the brake fails to work adjust the pedal referring to "24.2 WHEN REQUIRED".

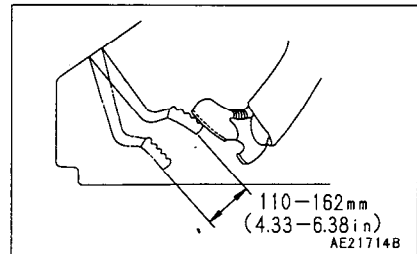

### 24.3.8 DOES THE HORN SOUND NORMALLY?

If the horn does not sound, or its volume is extremely low, there may be trouble with the horn or its wires may be broken. In such cases, ask your Komatsu distributor for repairs.

1. Turn on the starting switch.

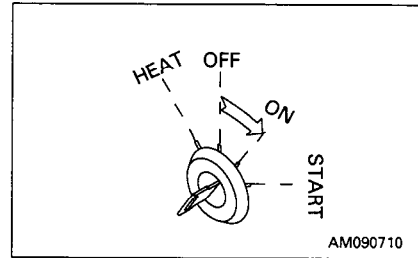

2. Press the horn switch in front of the left-hand armrest to see if the horn sounds.

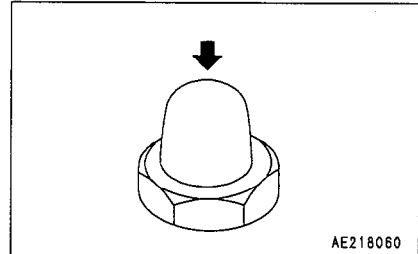

### 24.3.9 DO LAMPS LIGHT UP NORMALLY? ARE THEY FREE FROM DIRT AND DAMAGE?

Confirm that the head lamps, rear lamps, and lamps in the instruments light up normally, and check them for dirt and damage.

If any lamp does not light up, its bulb or wire may be broken. In such case, ask your Komatsu distributor for repair.

1. Turn on the starting switch.

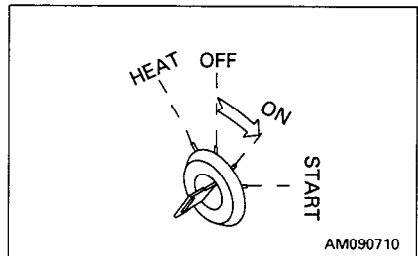

2. Turn each lamp switch to positions of OFF, 1 and 2, and confirm that the lamps lights up and goes off normally.

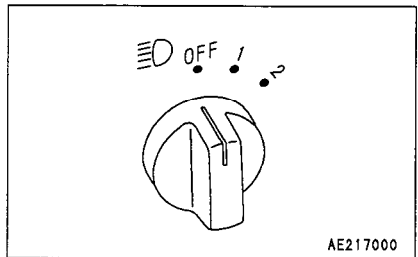

### 24.3.10 CHECK OF OPERATION OF BACKUP ALARM (OPTION)

Confirm that the backup alarm operates normally. If it does not operate, it may be broken or a wire may be loose or broken. In such cases ask your Komatsu distributor for repairs.

1. Turn on the starting switch.
2. Set the steering, directional and speed lever to the reverse position, and confirm that the alarm operates.

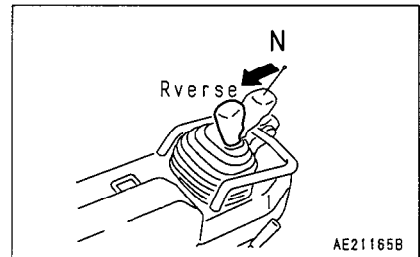
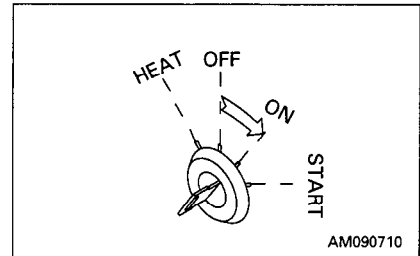

### 24.3.11 WEAR AND DAMAGE OF SEAT BELT (OPTION)

Check the seat belt and its fitting. If they are worn or damaged, replace them.

### 24.3.12 CHECK OF EXHAUST GAS COLOR AND SOUND OF ENGINE

### 24.3.13 CHECK OF OPERATION OF INSTRUMENTS

### 24.3.14 CHECK FOR WATER AND SEDIMENT IN WATER SEPARATOR, DRAIN WATER (ONLY FOR MACHINES EQUIPPED WITH WATER SEPARATOR)

Open the inspection cover of the left-hand engine side cover.

The water separator separates water mixed in the fuel. If float ② is at or above red line ①, drain the water according to the following procedure:

1. Loosen drain plug ③ and drain the accumulated water until the float reaches the bottom.
2. Tighten drain plug ③.
3. If the air is sucked into fuel line when draining and water, be sure to bleed air in the same manner as for the fuel filter. See "24.6 EVERY 500 HOURS SERVICE".

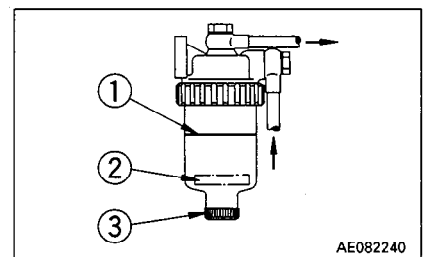



## 24.4 EVERY 50 HOURS SERVICE

### 24.4.1 DRAIN WATER, SEDIMENT FROM FUEL TANK

1. Carry out this procedure before operating the machine.
2. Prepare a container to catch the fuel that is drained.
3. Open drain valve ① at the bottom of the tank and drain the sediment and water that has accumulated at the bottom together with fuel. When doing this, be careful not to get fuel on yourself.
4. When only clean fuel comes out, close drain valve ①.

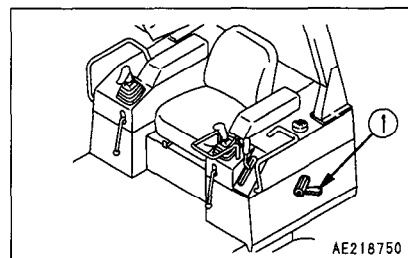

#### REMARK

Even if a water separator is installed, be sure to check the fuel tank to remove water and sediment in the fuel.

## 24.5 EVERY 250 HOURS SERVICE

Maintenance for every 50 hours service should be carried out at the same time.

### 24.5.1 LUBRICATING

1. Lower the blade to the ground, then stop the engine.
2. Using a grease pump, pump in grease through the grease fittings shown by arrows.
3. After greasing, wipe off any old grease that was pushed out.

- Hydraulic angle-tilt dozer

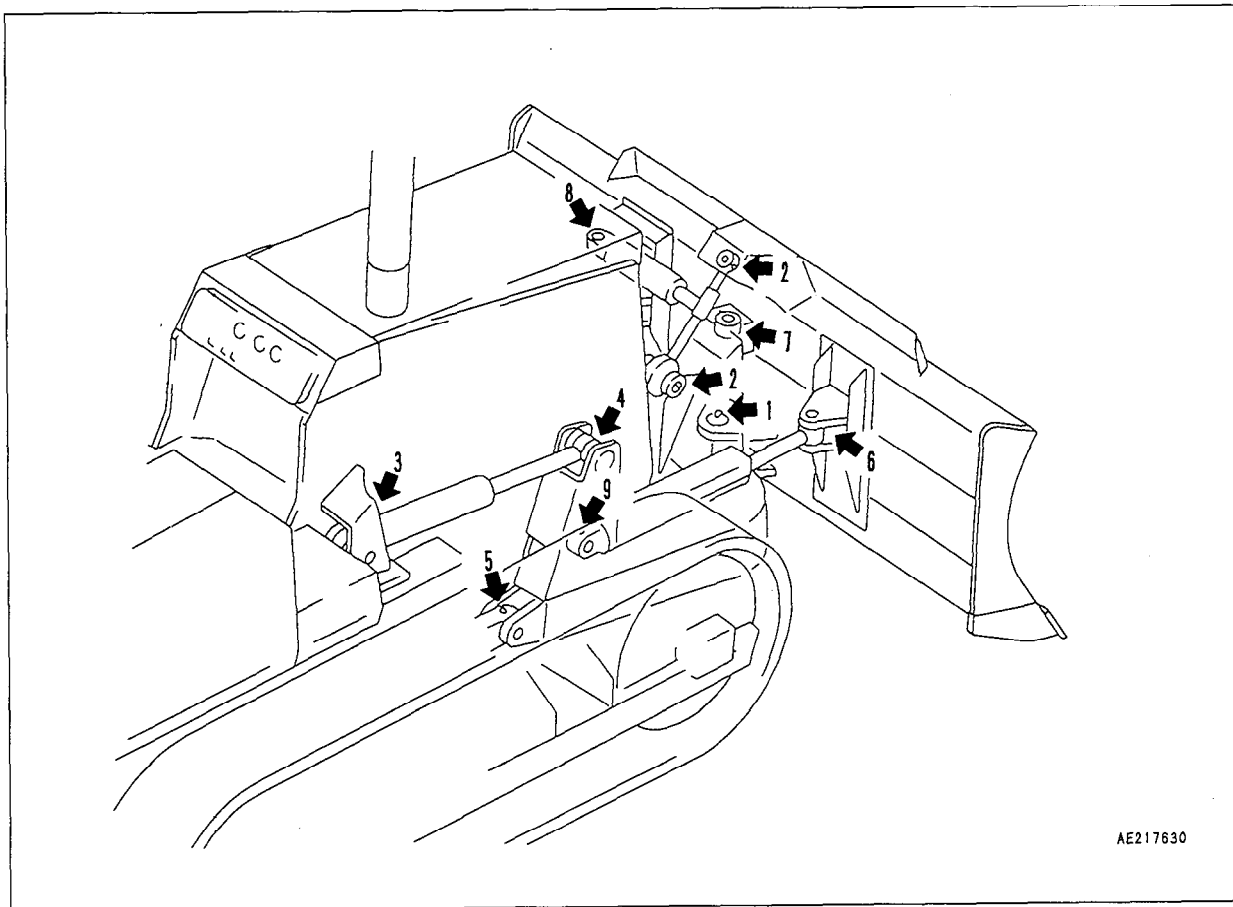

1. Angle-tilt frame center pin (1 point)
2. Brace pin (2 points)
3. Lift cylinder bottom pin (2 points)
4. Lift cylinder head pin (2 points)

## 24. SERVICE PROCEDURE

5. Angle-tilt frame support pin (2 points)
6. Angle cylinder head pin (2 points)
7. Tilt cylinder head pin (1 point)
8. Tilt cylinder bottom pin (1 point)
9. Angle cylinder bottom pin (2 points)

### ● Hydraulic tiltdozer

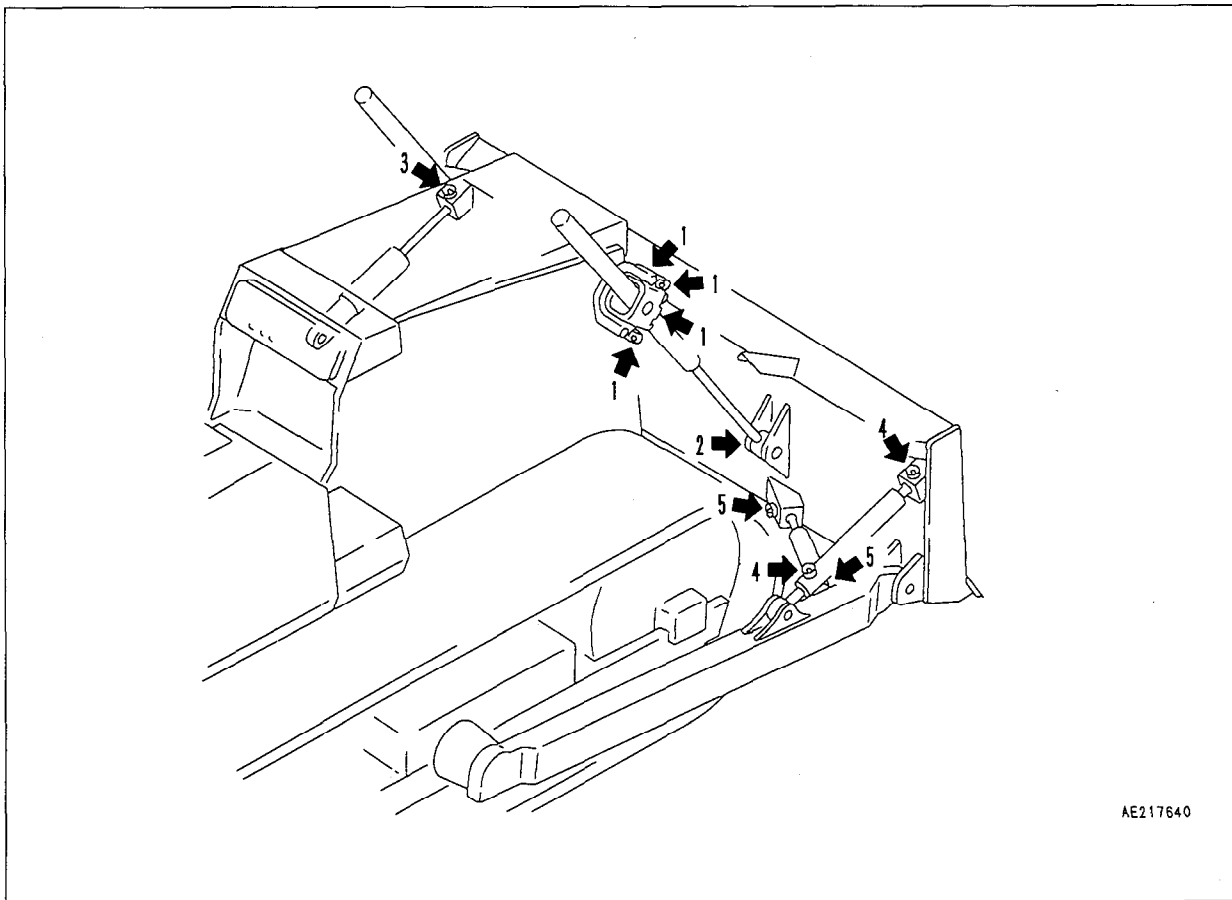

1. Lift cylinder yolk (8 points)
2. Lift cylinder head pin (2 points)
3. Tilt cylinder head pin (1 point)
4. Tilt brace pin (2 points)
5. Center brace pin (4 points)

## 24.5.2 CHECK OIL LEVEL IN FINAL DRIVE CASE, ADD OIL

**⚠ WARNING**

The oil is at high temperature immediately after the machine has been operated. Wait for the oil to cool down before starting the operation.

1. Remove plugs ⑤ on both sides and check whether the final drive case is filled with oil to lower edge of the plug hole.
2. If the oil level is still too low, add engine oil through the plug hole until the oil overflows.

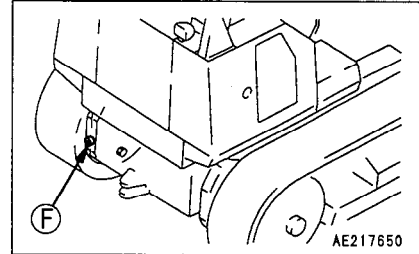
**NOTICE**

For details of the oil to use, see "20. USE OF FUEL, COOLANT AND LUBRICANTS ACCORDING TO AMBIENT TEMPERATURE".

## 24.5.3 CHECK OIL LEVEL IN HYDRAULIC TANK, ADD OIL

**⚠ WARNING**

- When removing the oil filler cap, oil may spurt out, so turn the cap slowly to release the internal pressure before removing the cap.
- If oil has been added to above the H mark, stop the engine and wait for the hydraulic oil to cool down, then drain the excess oil from drain plug ⑥.

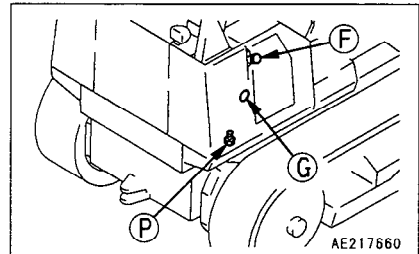
**NOTICE**

Do not add oil if the level is above the H line. This will damage the hydraulic equipment and cause the oil to spurt out.

1. Lower the blade to the ground, stop the engine and wait for about 5 minutes before checking oil level. If oil level is between H and L in sight gauge ③.
2. If the level is below the L mark, add engine oil through oil filler ⑤.

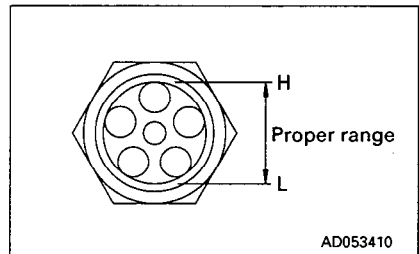
**NOTICE**

For details of the oil to use, see "20. USE OF FUEL, COOLANT AND LUBRICANTS ACCORDING TO AMBIENT TEMPERATURE".

### 24.5.4 CHECK LEVEL OF BATTERY ELECTROLYTE

Carry out this check before operating the machine.

**⚠ WARNING**

- To avoid gas explosions, do not bring fire or sparks near the battery.
- Battery electrolyte is dangerous. If it gets in your eyes or on your skin, wash it off with large amounts of water, and consult a doctor.

1. Open the cover behind the operator's seat.
2. Remove cap ①, and check that the electrolyte is at the specified level (10 to 12 mm (0.39 to 0.47 in) above the plate). If the electrolyte level is low, add distilled water to the specified level. If the battery electrolyte is spilled, have dilute sulphuric acid added.
3. Clean the air hole in the battery cap, then tighten the cap securely.

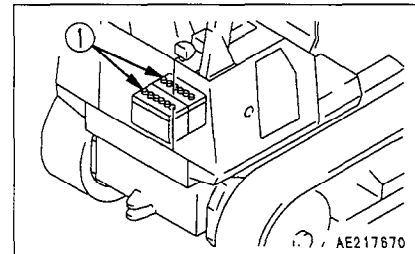

**REMARK**

When adding distilled water in cold weather, add it before starting operations in the morning to prevent the electrolyte from freezing.

### 24.5.5 CHANGE OIL IN ENGINE OIL PAN, REPLACE ENGINE OIL FILTER CARTRIDGE

**⚠ WARNING**

The oil is at high temperature after the engine has been operated, so never change the oil immediately after finishing operations. Wait for the oil to cool down before changing it.

Prepare the followings.

- Container to catch drained oil: Min. 14 ℓ capacity
  - Refill capacity: 14 ℓ (3.70 US gal, 3.08 UK gal)
  - Socket wrench, filter wrench.
1. Remove the cover at the bottom of the machine and set a container to catch the oil under the drain plug.
  2. Remove drain plug **Ⓟ** slowly to avoid getting oil on yourself, and drain the oil.
  3. Check the drained oil, and if there are excessive metal particles or foreign material, please contact your Komatsu distributor.
  4. Install drain plug **Ⓟ**.
  5. Using a filter wrench, turn filter cartridge **①** counterclockwise to remove it.  
When doing this, to prevent getting oil on yourself, do not carry out this operation from immediately under the cartridge.  
In particular, if this operation is carried out immediately after stopping the engine, a large amount of oil will come out, so wait for 10 minutes before starting the operation.
  6. Clean the filter holder, coat the packing surface of a new filter cartridge with engine oil (or coat it thinly with grease), then install it to the filter holder.
  7. When installing, tighten until the packing surface contacts the seal surface of the filter holder, then tighten it 3/4 of a turn.

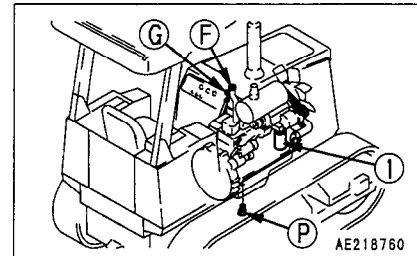

8. After replacing the filter cartridge, add engine oil through oil filler (P) until the oil level is between the H and L marks on the dipstick.

**NOTICE**

For details of the oil to use, see "20. USE OF FUEL, COOLANT, AND LUBRICANTS ACCORDING TO AMBIENT TEMPERATURE".

9. Run the engine at idling for a short time, then stop the engine, and check that the oil level is between the H and L marks on the dipstick. For details, see "24.3 CHECKS BEFORE STARTING".

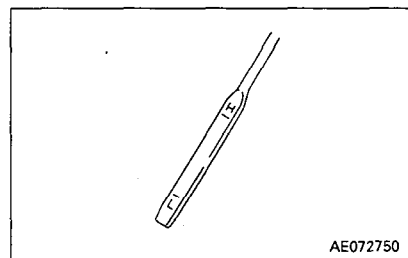

**NOTICE**

Even if the machine has not been operated for 250 hours, the oil and filter cartridge must be replaced when the machine has been operated for 6 months.

In the same way, even if the machine has not been operated for 6 months, the oil and filter cartridge must be replaced when the machine has been operated for 250 hours.

### 24.5.6 CHECK ELECTRIC WIRINGS

**⚠ WARNING**

**If the fuse blows frequently, or there are traces of shortcircuiting in the electric wiring, always locate and repair the cause.**

Check for damage of the fuse and any sign of disconnection or short circuit in the electric wiring. Check also for loose terminals and tighten any loose parts. Check the following points carefully.

- Battery
- Starting motor
- Alternator

Please contact your Komatsu distributor for investigation and correction of the cause.

**⚠ WARNING**

- **Accumulation of flammable material (dead leaves, twigs, grass, etc.) around the battery may cause fire, so always check and remove such material.**
- **Keep the battery top clean. Check the vents of the battery caps. If they are clogged with mud, etc. clean them in water.**

When carrying out walk-around checks or checks before starting, always check if there is any accumulation of flammable material around the battery, and remove such flammable material.

## 24.6 EVERY 500 HOURS SERVICE

Maintenance for every 50 and 250 hours service should be carried out at the same time.

### 24.6.1 REPLACE FUEL FILTER CARTRIDGE AND ADDITIONAL FUEL FILTER CARTRIDGE (OPTION)

**⚠ WARNING**

- Engine is at high temperature immediately after the machine has been operated. Wait for engine to cool down before replacing the filter.
- Do not bring fire or sparks near the fuel.

Prepare a filter wrench and a container to catch the fuel.

1. Set the container to catch the fuel under the filter cartridge.
2. Using a filter wrench, turn filter cartridge ① and ④ counterclockwise to remove it.
3. Clean the filter holder, fill a new filter cartridge ① with clean fuel, coat the packing surface with engine oil, then install it to the filter holder.
4. When installing, tighten until the packing surface contacts the seal surface of the filter holder, then tighten it up 1/2 a turn.
5. Clean the additional filter holder, fill a new additional filter cartridge ④ with clean fuel, coat the packing surface with engine oil, then install it to the filter holder.
6. When installing, tighten until the packing surface contacts the seal surface of the additional filter holder, then tighten it up 2/3 of a turn.

If the filter cartridge is tightened too far, the packing will be damaged and this will lead to leakage of fuel. If the filter cartridge is too loose, fuel will also leak from the packing, so always tighten to the correct amount.

7. After replacing the fuel filter cartridge, bleed the air. Bleed the air according to the following procedures.

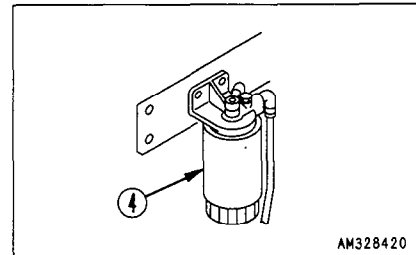
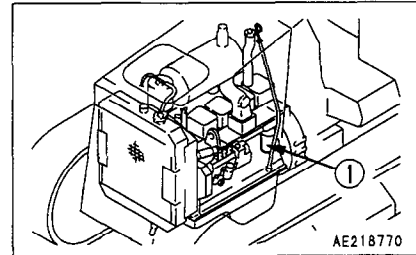



● **Manual air bleeding procedure**

1. After replacing filter cartridge ①, loosen air bleed plug ②.
2. Loosen the knob ③ of feed pump and move it up and down (several tens of strokes) until bubbles in the fuel flowing out of the air bleed plug are eliminated.
3. Tighten air bleed plug ②.  
Use Komatsu's genuine filter cartridge.  
After replacing the filter cartridge, start the engine and check the filter seal for oil leakage.

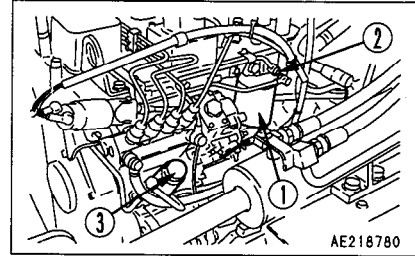

**REMARK**

When the fuel tank is filled after fuel has run out, bleed air by operating the feed pump as explained above.

● **Use of automatic air bleeder (Option)**

**⚠ WARNING**  
 Since the engine starts for bleeding air, confirm safety around the engine thoroughly before cranking the engine.

Air in the fuel circuit can be bled by simply turning on the starting motor with the starting switch according to the following procedure.

1. After replacing the filter cartridge, set the fuel control lever to the medium speed position.
2. Set the safety lock lever of the steering, directional and speed lever to the lock position.
3. Turn the starting switch key to the START position and hold it for 20 seconds. At this time, the starting motor operates about 2 seconds, then stops, but the air bleeding motor pump keeps operating to bleed air. Hold the key at the START position for 20 seconds, even if the engine starts or not.
4. Return the starting switch key to the ON position, and wait for about 30 seconds.
5. Turn the starting key switch to the START position again, and hold it for 20 seconds. At this time, the starting motor operates about 2 seconds, then stops again. Hold the key at the START position for 20 seconds, even if the engine starts. If it is held at the START position, the motor pump operates to bleed air.

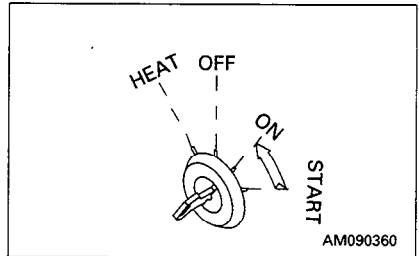
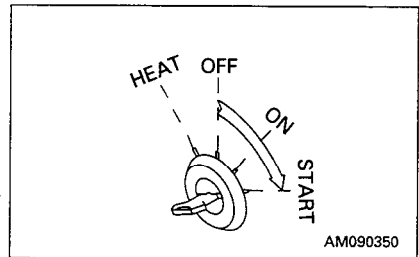
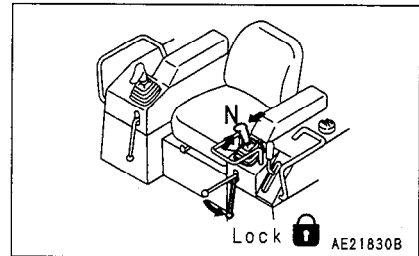
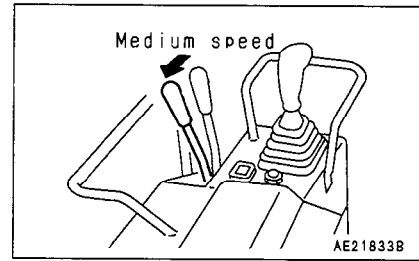

**NOTICE**

Even if the engine starts, hold the starting switch key to the START position for 20 seconds. While it is held, air is bled. If the key is returned to the ON position when the engine starts, air bleeding cannot be completed.

6. Return the starting switch key to the ON position. If the engine fails to start, repeat step 5.

**NOTICE**

**When the fuel tank is filled after fuel has run out, air can be bled by repeating the above 20 seconds operation of the starting switch two - three times. If the fuel tank is filled, air can be bled more quickly.**

### 24.6.2 CLEAN, CHECK RADIATOR FINS

**⚠ WARNING**  
If compressed air, steam, or water hit your body directly, there is danger of injury. Always wear protective glasses, mask, and safety shoes.

1. Remove bolts ① and radiator grill ②.
2. Clean the radiator fins clogged with mud, dust and leaves with compressed air. Steam or water may be used instead of compressed air.
3. Check the rubber hose. If the hose is found to have cracks to be hardened by ageing, replace such hose with new one. Further, loosen hose clamp should also be checked.

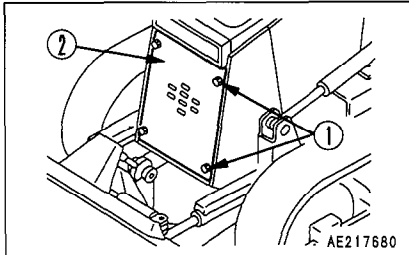

### 24.6.3 CLEAN BREATHER

Remove the breather and wash out dust remaining inside with diesel oil and flushing oil.

1. Transmission case breather (1 point)
2. Transfer case breather (1 point)
3. Steering clutch case breather (1 point)

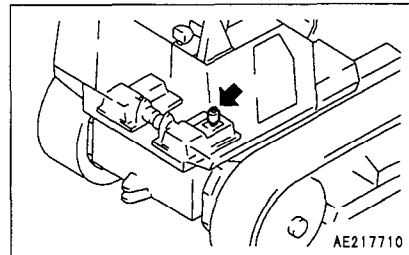
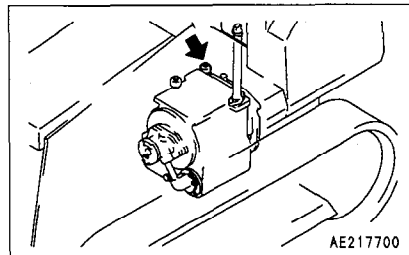
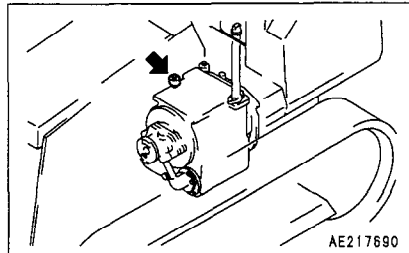

## 24.7 EVERY 1000 HOURS SERVICE

Maintenance for every 50, 250 and 500 hours service should be carried out at the same time.

### 24.7.1 CHANGE OIL IN TRANSMISSION CASE, CLEAN STRAINER

#### **⚠ WARNING**

The oil is at high temperature immediately after the machine has operated. Wait for the oil to cool down before starting the operation.

Prepare the followings.

- Container to catch drained oil: Min. 13 ℓ capacity
- Refill capacity: 13 ℓ (3.43 US gal, 2.86 UK gal)
- Socket wrench

1. Remove the cover at the bottom of the machine, and set a container to catch the oil under drain plug **(P)**.
2. Remove drain plug **(P)** slowly to avoid getting oil on yourself, and drain the oil.  
After draining the oil, tighten the drain plug **(P)**.
3. Remove mounting bolts **(1)** on tube **(4)**, remove lowest mounting bolt **(3)** on strainer case **(2)** then take out tube **(4)**.
4. Take out strainer **(5)**. If strainer **(5)** is damaged, replace it with new one.
5. Remove all dirt from the strainer, then wash in clean diesel oil or flushing oil.  
Clean the case interior and the removed parts.
6. After installing the strainer, refill the specified quantity of engine oil through oil filler **(F)**.

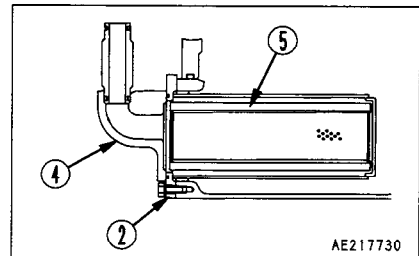
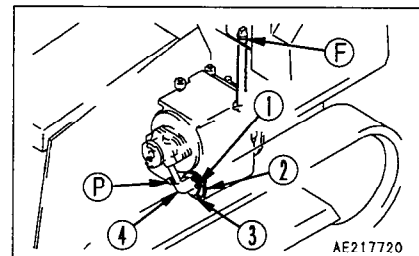

#### **NOTICE**

For details of the oil to use, see "20. USE OF FUEL, COOLANT AND LUBRICANTS ACCORDING TO AMBIENT TEMPERATURE".

## 24. SERVICE PROCEDURE

7. Check that the oil is at the specified level.  
For details, see "24.3 CHECK BEFORE STARTING".
8. Keep the steering, directional and speed lever at the N (neutral) position, and move the lever fully in the left direction. Next, move the lever fully in the right direction. Repeat this operation 10 times and fill the steering and brake circuits with oil.
9. Travel the machine at first speed and check that the machine can make a left turn and a right turn certainly.

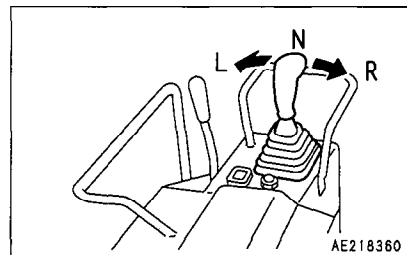





### 24.7.2 CHANGE OIL IN TRANSFER CASE (INCL. BEVEL GEAR CASE)

#### WARNING

The oil is at high temperature immediately after the machine has been operated. Wait for the oil to cool down before starting the operation.

Prepare the followings.

- Container to catch drained oil: Min. 17 ℓ capacity
- Refill capacity: 17 ℓ (4.49 US gal, 3.74 UK gal)
- Socket wrench

1. Set a container to catch the oil under drain plug  at the bottom of the machine.
2. Remove drain plug  slowly to avoid getting oil on yourself, and drain the oil.  
After draining the oil, tighten drain plug .
3. Refill the specified quantity of engine oil through oil filler .

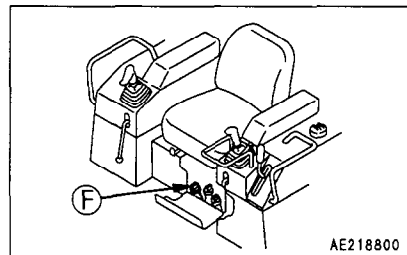
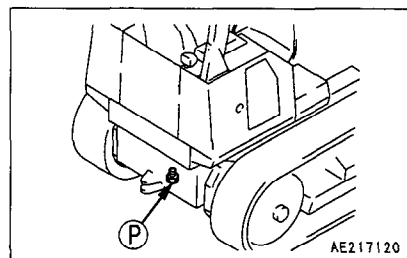

#### NOTICE

For details of the oil to use, see "20. USE OF FUEL, COOLANT AND LUBRICANTS ACCORDING TO AMBIENT TEMPERATURE".

4. Check that the oil is at the specified level.  
For details, see "24.3 CHECK BEFORE STARTING"

### 24.7.3 CHANGE OIL IN STEERING CLUTCH CASE

**⚠ WARNING**

The oil is at high temperature immediately after the machine has been operated. Wait for the oil to cool down before starting the operation.

Prepare the followings.

- Container to catch drained oil: Min. 30 l capacity
  - Refill capacity: 30 l (7.92 US gal, 6.60 UK gal)
  - Socket wrench
1. Set a container to catch the oil under drain plug **(P)** at the bottom of the machine.
  2. Remove drain plug **(P)** slowly to avoid getting oil on yourself, and drain the oil.  
After draining the oil, tighten drain plug **(P)**.
  3. Refill the specified quantity of engine oil through oil filler **(F)**.

**NOTICE**

For details of the oil to use, see "20. USE OF FUEL, COOLANT AND LUBRICANTS ACCORDING TO AMBIENT TEMPERATURE".

4. Check that the oil is at the specified level.  
For details, see "24.3 CHECK BEFORE STARTING"

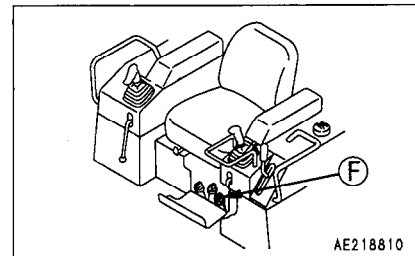
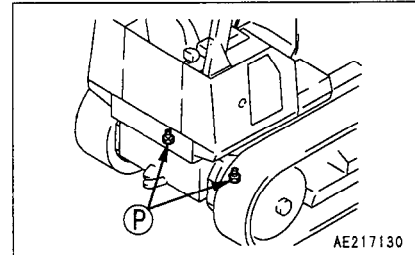

### 24.7.4 CHANGE OIL IN FINAL DRIVE CASE

**⚠ WARNING**

The oil is at high temperature immediately after the machine has been operated. Wait for the oil to cool down before starting the operation.

Prepare the followings.

- Container to catch drained oil: Min. 15 ℓ capacity
- Refill capacity:
  - D31E, P-20, D37E-5: each 9.5 ℓ (2.51 US gal, 2.09 UK gal)
  - D31P-20A, D37E-5A: each 12 ℓ (3.17 US gal, 2.64 UK gal)
  - D31PL, PLL-20: each 15 ℓ (3.96 US gal, 3.30 UK gal)
- Socket wrench
- Replace the oil in both final drive cases.

1. Set a container to catch the oil under drain plug (P).
2. Remove drain plug (P) and oil filler plug (F) to drain the oil, then tighten drain plug (P).
3. Refill the specified quantity of engine oil through oil filler (F).

**NOTICE**

For details of the oil to use, see "20. USE OF FUEL, COOLANT AND LUBRICANTS ACCORDING TO AMBIENT TEMPERATURE".

4. Check that the oil is at the specified level.  
For details, see "24.5 EVERY 250 HOURS SERVICE"

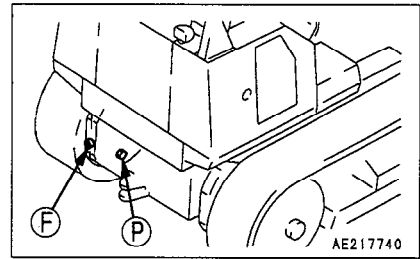

### 24.7.5 CHANGE OIL IN HYDRAULIC TANK, REPLACE HYDRAULIC OIL FILTER CARTRIDGE

**⚠ WARNING**

The oil is at high temperature immediately after the machine has been operated. Wait for the oil to cool down before changing the oil. When removing the oil filler cap, turn it slowly to release the internal pressure, then remove it carefully.

Prepare the followings.

- Container to catch drained oil: Min. 33 ℓ capacity
- Refill capacity: 33 ℓ (8.71 US gal, 7.26 UK gal)
- Socket wrench, filter wrench

1. Lower the blade to the ground. With the engine stopped, move the blade control lever forward and backward (or to the right and left), and slowly turn the cap of oil filler (F) until it is stopped at the 1st stop to release the internal pressure.
2. Pressing the cap, turn it until it is stopped at the 2nd stop.
3. Set a container to catch the oil under drain plug (P).
4. Remove drain plug (P) to drain the oil.  
After draining the oil, tighten plug (P).  
When removing drain plug (P), be careful to avoid getting oil on yourself.
5. Using a filter wrench, turn filter cartridge (I) counterclockwise to remove it.
6. Clean the filter holder, coat the packing surface of a new filter cartridge with engine oil (or coat it thinly with grease), then install it to the filter holder.
7. When installing, tighten until the packing surface contacts the seal surface of the filter holder, then tighten it up about 2/3 of a turn.
8. Add the specified amount of engine oil through the oil filler (F).

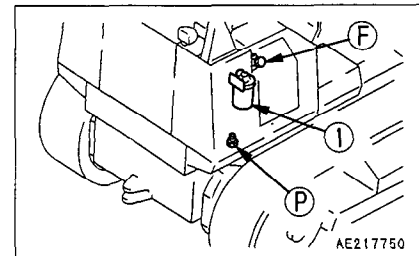

**NOTICE**

For details of the oil to use, see "20. USE OF FUEL, COOLANT AND LUBRICANTS ACCORDING TO AMBIENT TEMPERATURE".

9. Check that the oil is at the specified level.  
For details, see "24.5 EVERY 250 HOURS SERVICE"



#### **24.7.6 CHECK OIL IN UNDERCARRIAGE COMPONENTS**

Check consumption of oil in track roller, carrier roller and idler as follows.

1. Stop the machine on the level ground.
2. Slowly loosen seal bolt and see if oil oozes out of screw. If oil oozes out, oil is still sufficient. Tighten bolt immediately.
3. If oil does not flow even after seal bolt has been removed, oil amount is insufficient. Request Komatsu distributor to perform necessary repairs.

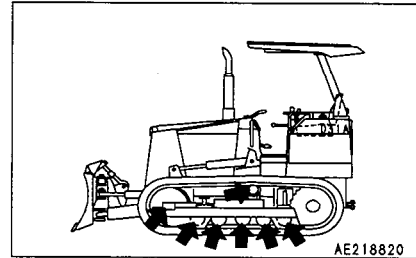

#### **24.7.7 CHECK FAN BELT TENSION AND REPLACE**

Special tools are required for inspection and replacement of the alternator belt. Contact your Komatsu distributor for inspection and replacement.

#### **REMARK**

Since the auto-tensioner alternator belt is installed, its tension does not need to be adjusted.

#### **24.7.8 CHECK ALL TIGHTENING PARTS OF TURBOCHARGER**

Contact your Komatsu distributor to have the tightening portions checked.

#### **24.7.9 CHECK PLAY OF TURBOCHARGER ROTOR**

Contact your Komatsu distributor to have the play checked.

### 24.7.10 REPLACE CORROSION RESISTOR CARTRIDGE (ONLY FOR MACHINES EQUIPPED WITH CORROSION RESISTOR)

**⚠ WARNING**

If the engine has been operated, all parts will be at a high temperature, so never try to replace the cartridge immediately after stopping the engine.  
Always wait for the engine and other parts to cool down.

Prepare the followings.

- Container to catch drained coolant
- Filter wrench

1. Close valves ①.
2. Set a container to catch the coolant under the cartridge.
3. Using a filter wrench remove cartridge ②.
4. Clean the filter holder, coat the packing surface and thread of the new cartridge with engine oil, then install it to the filter holder.
5. When installing, tighten until the packing surface contacts the seal surface of the filter holder, then tighten it up 2/3 of a turn. If the filter cartridge is tightened too far, the packing will be damaged and this will lead to leakage of coolant. If the filter cartridge is too loose, coolant will also leak from the packing, so always tighten to the correct amount.
6. Open valves ①.
7. After replacing the cartridge, start the engine and check for any leakage of water from the filter seal surface. If there is any water leakage, check if the cartridge is tightened properly.

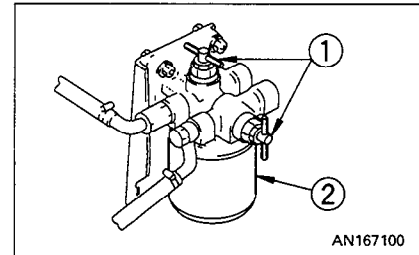

### **24.8 EVERY 2000 HOURS SERVICE**

Maintenance for every 50, 250, 500 and 1000 hours service should be carried out at the same time.

#### **24.8.1 CHECK ALTERNATOR, STARTING MOTOR**

The brush may be worn, or the bearing may have run out of grease, so contact your Komatsu distributor for inspection or repair.

If the engine is started frequently, carry out inspection every 1000 hours.

#### **24.8.2 CHECK ENGINE VALVE CLEARANCE, ADJUST**

Contact your Komatsu distributor for inspection or adjustment.

#### **24.8.3 CLEAN, CHECK TURBOCHARGER**

Contact your Komatsu distributor for cleaning inspection.

## **24.9 EVERY 4000 HOURS SERVICE**

Maintenance for every 50, 250, 500, 1000 and 2000 hours service should be carried out at the same time.

### **24.9.1 CHECK WATER PUMP**

The pulley may have play, or grease or water may be leaking, or the drain hole may be clogged. Ask your Komatsu distributor for inspection.

**MEMO**

# **SPECIFICATIONS**



## 25. SPECIFICATIONS

D31E, P, PL, PLL-20  
D31P-20A

	D31E-20	D31P-20	D31PL-20	D31PLL-20	D31P-20A
<b>WEIGHT</b>					
● Operating weight (without operator) kg	6200 (13670 lb)	6840 (15080 lb)	7190 (15850 lb)	7700 (16980 lb)	6930 (15280 lb)
<b>BLADE</b>					
● Equipment weight (incl. cylinder) kg	850 (1870 lb)	820 (1810 lb)	780 (1720 lb)	800 (1760 lb)	900 (1980 lb)
<b>PERFORMANCE</b>					
● Travel speed	Forward	1st km/h	2.2 (1.4 MPH)		
		2nd km/h	3.9 (2.4 MPH)		
		3rd km/h	6.5 (4.0 MPH)		
	Reverse	1st km/h	2.4 (1.5 MPH)		
		2nd km/h	4.3 (2.7 MPH)		
		3rd km/h	7.1 (4.4 MPH)		
● Maximum drawbar pull kg	9030 (19910 lb)	8960 (19760 lb)	8930 (19690 lb)	8890 (19600 lb)	8960 (19760 lb)
● Ground pressure kg/cm <sup>2</sup>	0.50	0.26	0.16	0.14	0.26
<b>ENGINE</b>					
● Model	Komatsu S4D102E-1 diesel engine				
● Flywheel horsepower	52.2 kW (70 HP)/2350 rpm				
● Maximum torque	265 N·m (27 kgf·m)/1400 rpm				
● Starting motor	24 V 5.5 kW				
● Alternator	24 V 25 A				
● Battery	12 V 70 Ah x 2 pieces				

**D37E-5  
D37P-5A**

		D37E-5	D37P-5A
<b>WEIGHT</b>			
● Operating weight (without operator) kg		6420 (14160 lb)	7020 (15480 lb)
<b>BLADE</b>			
● Equipment weight (incl. cylinder) kg		860 (1900 lb)	900 (1980 lb)
<b>PERFORMANCE</b>			
● Travel speed	Forward	1st km/h	2.3 (1.4 MPH)
		2nd km/h	4.1 (2.5 MPH)
		3rd km/h	6.9 (4.3 MPH)
	Reverse	1st km/h	2.5 (1.6 MPH)
		2nd km/h	4.5 (2.8 MPH)
		3rd km/h	7.5 (4.7 MPH)
● Maximum drawbar pull kg		9500 (20950 lb)	9450 (20840 lb)
● Ground pressure kg/cm <sup>2</sup>		0.52	0.27
<b>ENGINE</b>			
● Model		Komatsu S4D102E-1 diesel engine	
● Flywheel horsepower		59.6 kW (80 HP)/2500 rpm	
● Maximum torque		270 N-m (27.5 kgf-m)/1400 rpm	
● Starting motor		24 V 5.5 kW	
● Alternator		24 V 25 A	
● Battery		12 V 70 Ah x 2 pieces	



D31E-20

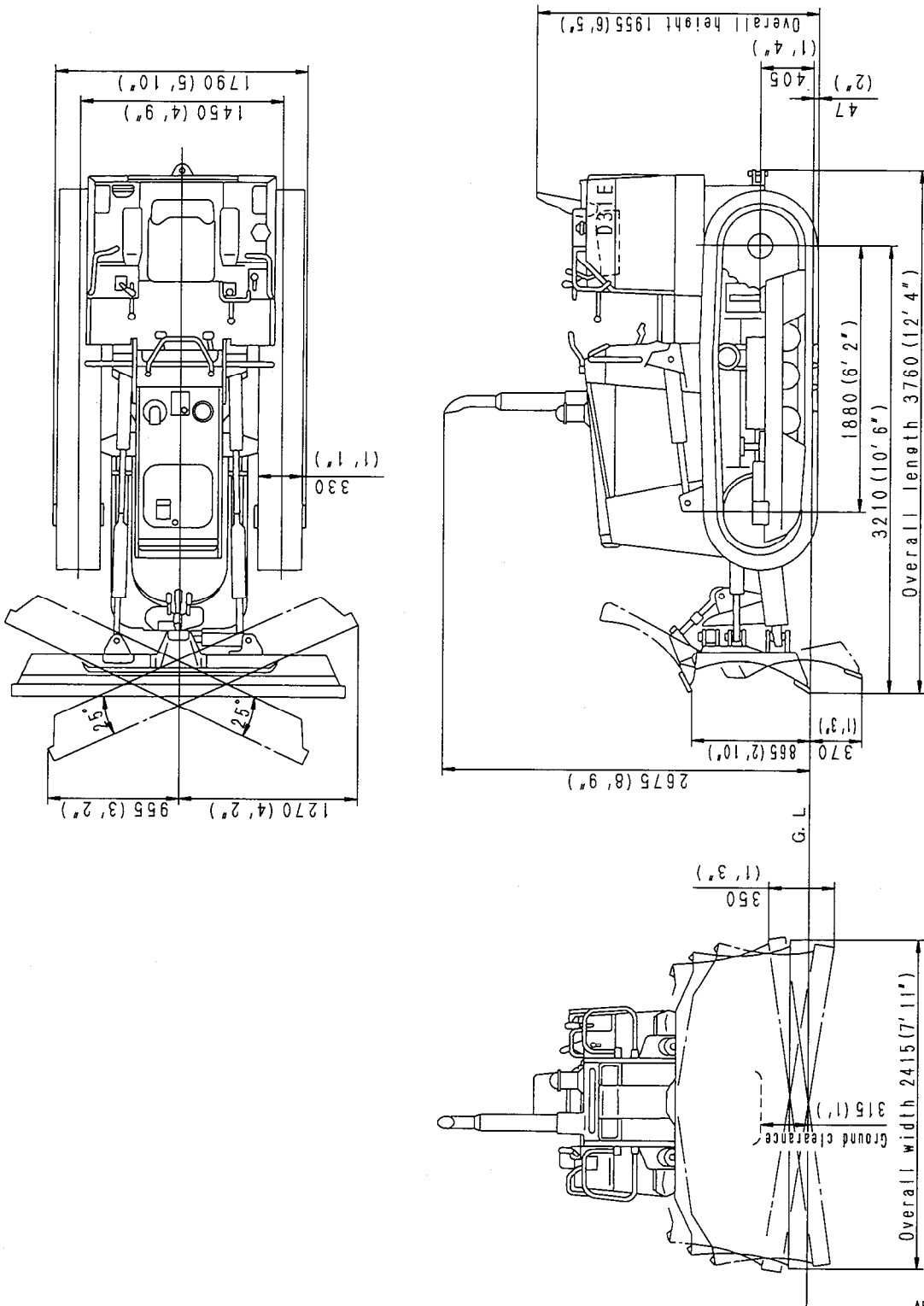

AE22073B

**D31P, PL, PLL-20**

Note: The values given are the values for D31P-20.

( ): Values for D31PL-20

[ ]: Values for D31PLL-20

In cases where there are no values given in ( ) or [ ], the values are the same as for D31P-20.

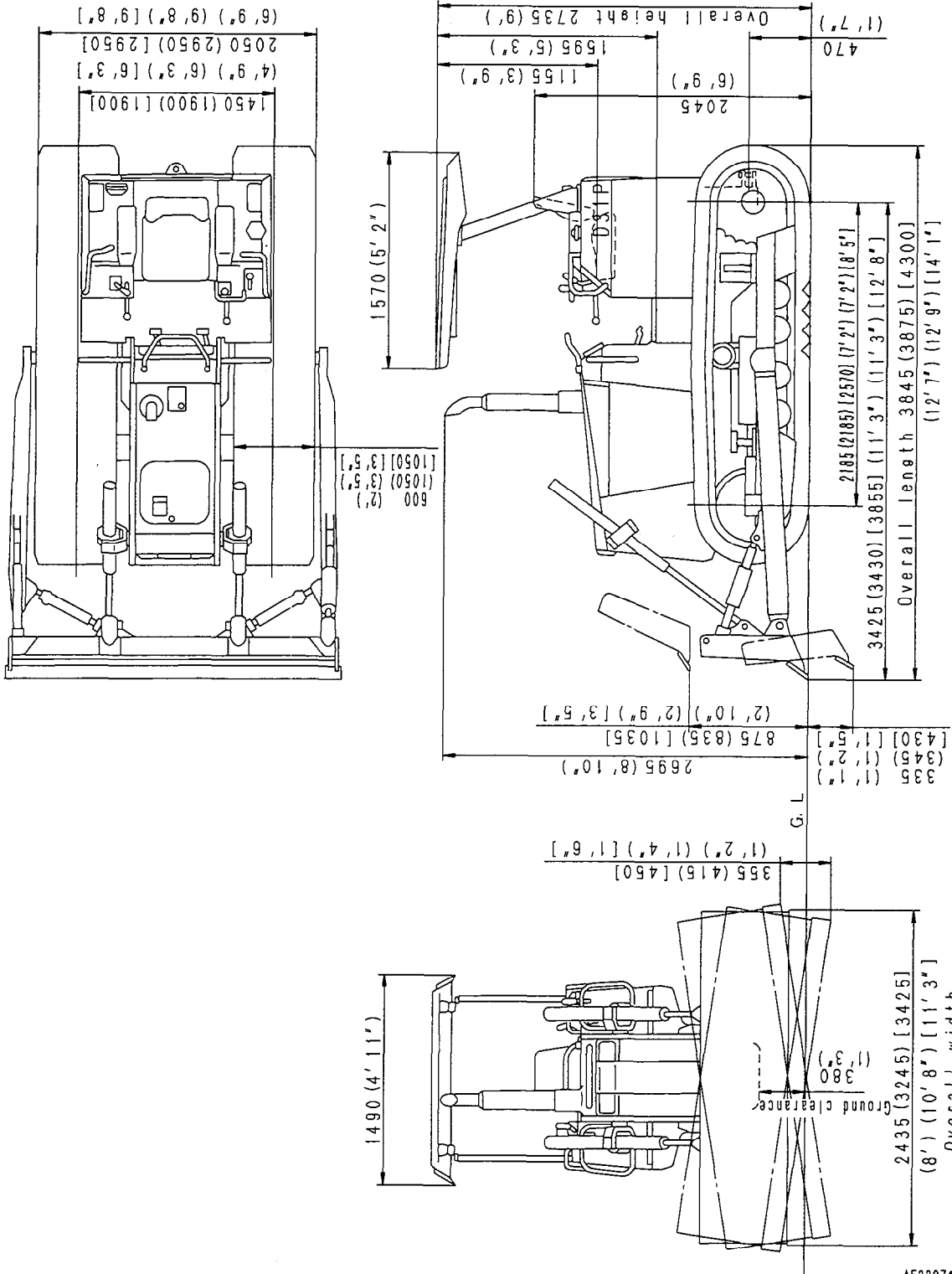

AE22074B

D31P-20A

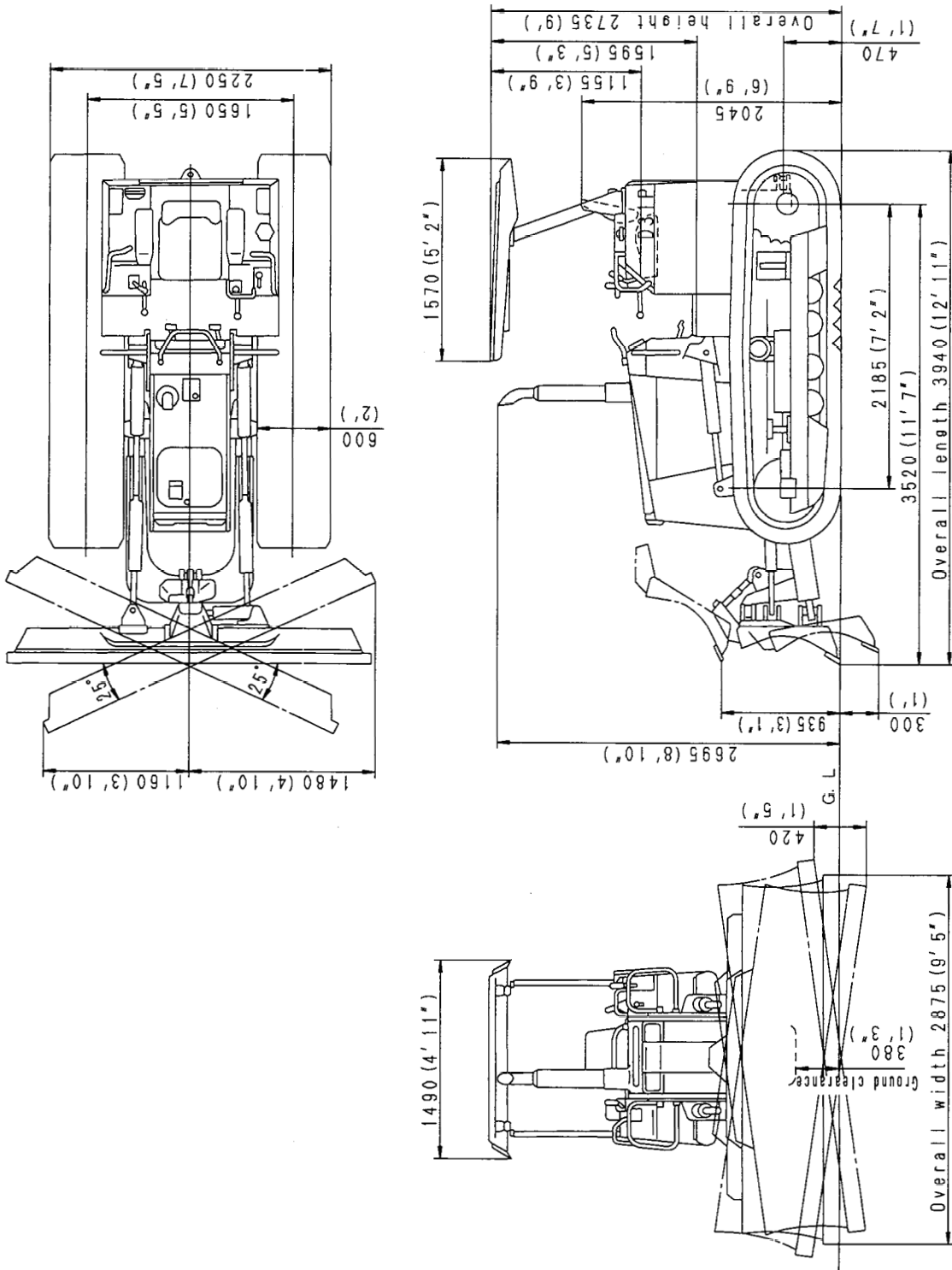

AE22075B

D37E-5

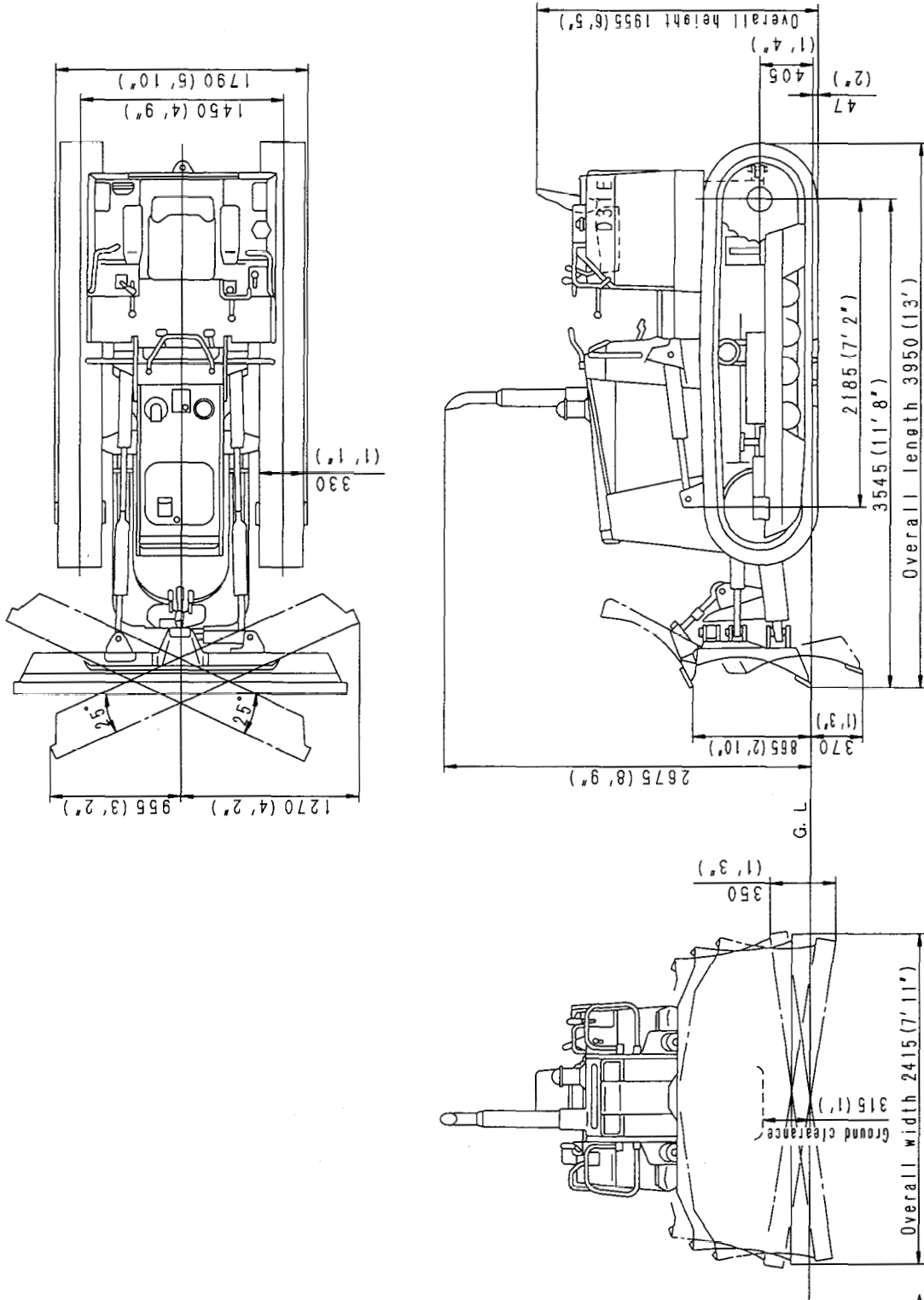

AE22076B

D37P-5A

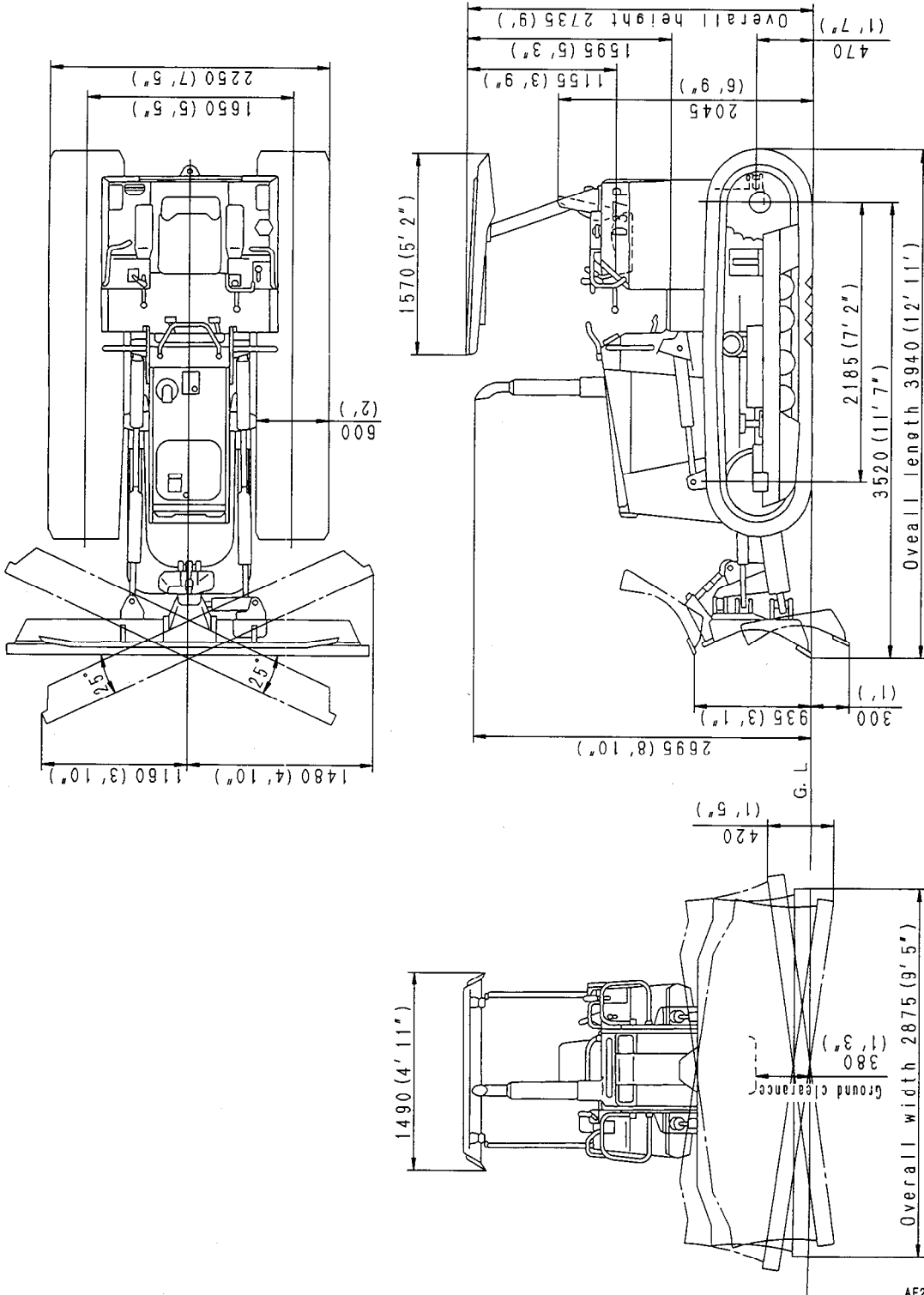

AE220778

# **OPTIONS, ATTACHMENTS**



## 26. GENERAL PRECAUTIONS

---

### 26.1 PRECAUTIONS RELATED TO SAFETY

If attachments or options other than those authorized by Komatsu are installed, this will not only affect the life of the machine, but will also cause problems with safety.

When installing attachments not listed in this Operation and Maintenance Manual, please contact your Komatsu distributor first.

If you do not contact Komatsu, we cannot accept any responsibility for any accident or failure.

#### WARNING

##### Precautions for removal and installation operations

- When removing or installing attachments, obey the following precautions and take care to ensure safety during the operation.
- Carry out the removal and installation operations on a flat, firm ground surface.
- When the operation is carried out by two or more workers, determine signals and follow these during the operation.
- When carrying heavy objects (more than 25 kg (55 lb)), use a crane.
- When removing heavy parts, always support the part before removing it.  
When lifting such heavy parts with a crane, always pay careful attention to the position of the center of gravity.
- It is dangerous to carry out operations with the load kept suspended. Always set the load on a stand, and check that it is safe.
- When removing or installing attachments, make sure that they are in a stable condition and will not fall over.
- Never go under a load suspended from a crane.  
Always stand in a position that is safe even if the load should fall.

#### NOTICE

Qualifications are required to operate a crane. Never allow the crane to be operated by an unqualified person.

For details of the removal and installation operations, please contact your Komatsu distributor.

## 27. USING SEAT BELT

### 27.1 SEAT BELT (For fixed type)

When operating a machine equipped with ROPS, be sure to use the seat belt.

**⚠ WARNING**

- Before fastening the seat belt, inspect the securing brackets and belt for abnormal conditions. Replace any worn or damaged seat belt or the securing brackets.
- Adjust and fasten the seat belt before operating the machine.
- Always use seat belt when operating the machine.
- Do not use seat belt with either half of the belt kinked.

#### 27.1.1 FASTEN THE BELT AND REMOVE IT IN THE FOLLOWING MANNER

1. Adjust the seat so that the brake pedal can be depressed all the way with the operator's back against the backrest.
2. After positioning the seat, sit in the seat. Hold buckle ① with your left hand and tongue ② with our right hand, put the tongue into buckle ①. Check that the belt has locked by pulling it.
4. When removing the belt, raise the tip of the buckle lever to release it.  
Fasten belt along your body without kinking it. Adjust the lengths of the belt on both the buckle and the tongue sides so that the buckle is located at the mid-point of your body front.

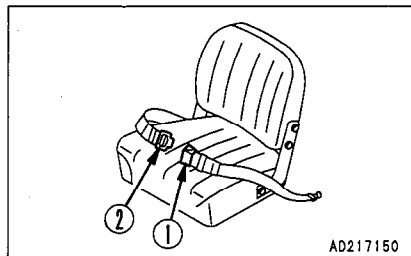

#### 27.1.2 ADJUST THE BELT LENGTH

##### To shorten the belt

Pull the free end of the belt on either the buckle body or tongue side.

##### To lengthen the belt

Pull the belt while holding it at a right angle to buckle or tongue.

Inspect bolts and fittings on the chassis for tightness. Retighten any loose bolts to 20 to 29 N·m (2 to 3 kgf·m, 15 to 20 lbft) torque.

If the seat is scratched or frayed or if any of the fittings are broken or deformed from long service, replace the seat belt immediately.

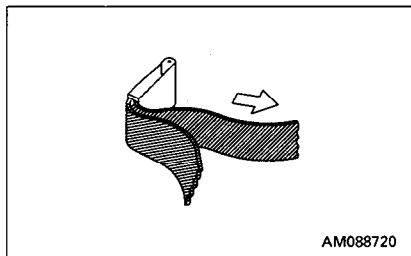
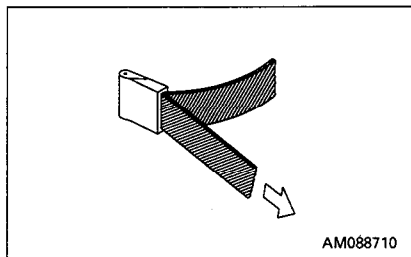



## 27.2 SEAT BELT (For suspension type)

When operating a machine equipped with ROPS, be sure to use the seat belt.

### WARNING

- Before fastening the seat belt, inspect the securing brackets and belt for abnormal conditions. Replace any worn or damaged seat belt or the securing brackets.
- Adjust and fasten the seat belt before operating the machine.
- Always use seat belt when operating the machine.
- Do not use seat belt with either half of the belt kinked.
- Check that there are no kinks in the tether belt.

### 27.2.1 FASTEN THE BELT AND REMOVE IT IN THE FOLLOWING MANNER

1. Adjust the seat so that the brake pedal can be depressed all the way with the operator's back against the backrest.
2. After positioning the seat, adjust the tether belt ①. With the seat unoccupied, tense the belt slightly across the seat and install.
3. Sit in the seat. Hold buckle ② with your left hand and tongue ③ with your right hand, put the tongue into the buckle. Check that the belt has locked by pulling it.
4. When removing the belt, raise the tip of the buckle lever to release it.  
Fasten belt along your body without kinking it. Adjust the lengths of the belt on both the buckle and the tongue sides so that the buckle is located at the mid-point of your body front.

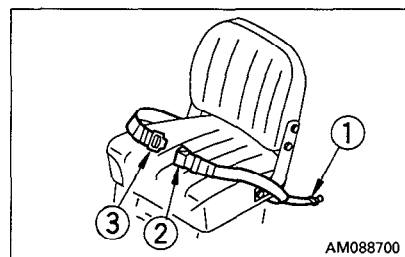

### 27.2.2 ADJUST THE BELT LENGTH

#### To shorten the belt

Pull the free end of the belt on either the buckle body or tongue side.

#### To lengthen the belt

Pull the belt while holding it at a right angle to buckle or tongue.

Inspect bolts and fittings on the chassis for tightness. Retighten any loose bolts to 20 to 29 N·m (2 to 3 kgf·m, 15 to 20 lbft) torque.

If the seat is scratched or frayed or if any of the fittings are broken or deformed from long service, replace the seat belt immediately.

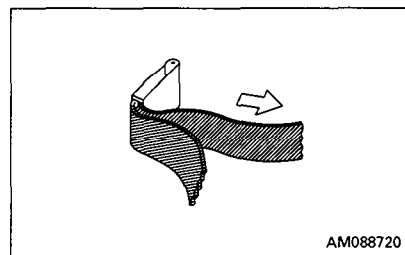
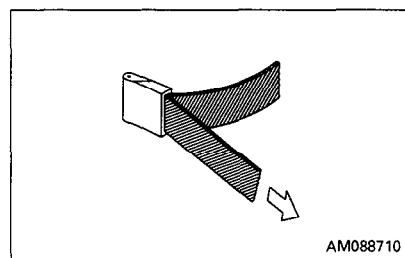

## 28. HANDLING SUSPENSION SEAT

**⚠ WARNING**

- Adjust the seat position at the beginning of each shift or when operators change.
- Adjust the seat so that the brake pedal can be depressed all the way with the operator's back against the backrest.

- **Fore-aft adjustment of seat**

Move lever ① to the left set the seat to a position where it is easy to operate, then release the lever.

Fore-aft adjustment: 160 mm (6.3 in) in 9 steps.

- **Adjusting seat cushion**

Turn knob ② to the desired direction to adjust the riding condition.

- **Adjusting reclining angle**

Pull lever ③, set the seatback to a position where it is easy to operate, then release the lever.

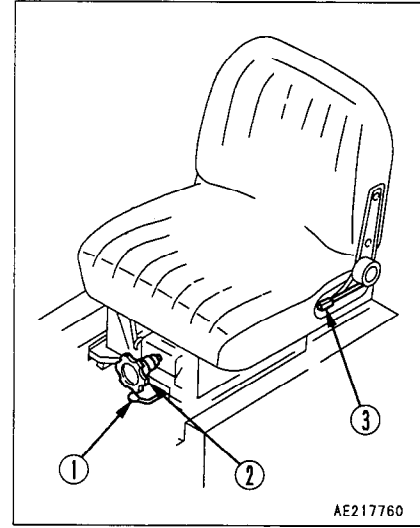

AE217760

## 29. HANDLING DECELERATOR PEDAL

### 29.1 OPERATION OF DECELERATOR PEDAL

**⚠ WARNING**

When arriving at the top of a slope, or when dumping earth from a cliff, the machine will increase its speed with the sudden loss of load. Slow the machine by depressing the decelerator pedal.

This pedal is used to decelerate engine speed.

When switching between forward and reverse, or when stopping the machine, depress this pedal to reduce the travel speed.

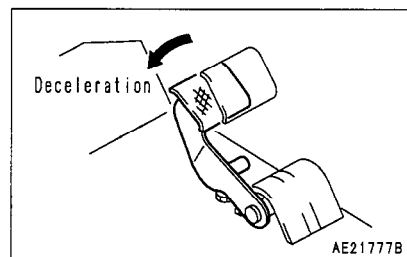

### 29.2 LUBRICATION OF DECELERATOR PEDAL

If the pedal is heavy or does not move smoothly, apply grease to the grease fitting (1 point) shown by an arrow.

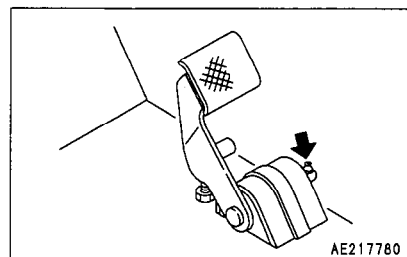

Komatsu America International Company  
 440 North Fairway Drive  
 Vernon Hills, IL 60061-8112 U.S.A.  
 Attn: Technical Publications  
 Fax No. (847) 970-4186

**PROPOSAL FOR MANUAL REVISION**

FOR INTERNAL USE ONLY -- No. PMR

<b>P R O P O S E R</b>	NAME OF COMPANY:		LOCATION:	
			PHONE NO:	
	DEPARTMENT:		DATE:	
	NAME:			
MANUAL NAME:				
MANUAL NO:				
MACHINE MODEL: S/N IF APPLICABLE:				

PAGE NO:

PROBLEM:

Attach photo or sketch.  
 If more space is needed, use another sheet.

FOR INTERNAL USE ONLY		
CORRECTIVE ACTION:		
