

Operation & Maintenance Manual

PC25-1

PC30-7

PC40-7

PC45-1

HYDRAULIC EXCAVATOR

SERIAL NUMBERS **PC25-1 6471** and up
PC30-7 26423 and up
PC40-7 24522 - 24994
PC45-1 3506 and up

This material is proprietary to Komatsu America International Company and is not to be reproduced, used, or disclosed except in accordance with written authorization from Komatsu America International Company.

It is our policy to improve our products whenever it is possible and practical to do so. We reserve the right to make changes or improvements at any time without incurring any obligation to install such changes on products sold previously.

Due to this continuous program of research and development, revisions may be made to this publication. It is recommended that customers contact their distributor for information on the latest revision.

Copyright 2003 Komatsu
DataKom Publications and Training Division

February 2003

1. FOREWORD

This manual provides rules and guidelines which will help you use this machine safely and effectively. Keep this manual handy and have all personnel read it periodically. If this manual has been lost or has become dirty and can not be read, request a replacement manual from Komatsu or your Komatsu distributor.

If you sell the machine, be sure to give this manual to the new owners.

Continuing improvements in the design of this machine can lead to changes in detail which may not be reflected in this manual. Consult Komatsu or your Komatsu distributor for the latest available information of your machine or for questions regarding information in this manual.

This manual may contain attachments and optional equipment that are not available in your area. Consult Komatsu or your Komatsu distributor for those items you may require.

WARNING

- **Improper operation and maintenance of this machine can be hazardous and could result in serious injury or death.**
- **Operators and maintenance personnel should read this manual thoroughly before beginning operation or maintenance.**
- **Some actions involved in operation and maintenance of the machine can cause a serious accident, if they are not done in a manner described in this manual.**
- **The procedures and precautions given in this manual apply only to intended uses of the machine. If you use your machine for any unintended uses that are not specifically prohibited, you must be sure that it is safe for you and others. In no event should you or others engage in prohibited uses or actions as described in this manual.**
- **Komatsu delivers machines that comply with all applicable regulations and standards of the country to which it has been shipped. If this machine has been purchased in another country or purchased from someone in another country, it may lack certain safety devices and specifications that are necessary for use in your country. If there is any question about whether your product complies with the applicable standards and regulations of your country, consult Komatsu or your Komatsu distributor before operating the machine.**
- **The description of safety is given in SAFETY INFORMATION on page 0-2 and in SAFETY from page 1-1.**

2. SAFETY INFORMATION

Most accidents are caused by the failure to follow fundamental safety rules for the operation and maintenance of machines. To avoid accidents, read, understand and follow all precautions and warnings in this manual and on the machine before performing operation and maintenance.

To identify safety messages in this manual and on machine labels, the following signal words are used.

-  **DANGER** – This word is used on safety messages and safety labels where there is a high probability of serious injury or death if the hazard is not avoided. These safety messages or labels usually describe precautions that must be taken to avoid the hazard. Failure to avoid this hazard may also result in serious damage to the machine.

-  **WARNING** – This word is used on safety messages and safety labels where there is a potentially dangerous situation which could result in serious injury or death if the hazard is not avoided. These safety messages or labels usually describe precautions that must be taken to avoid the hazard. Failure to avoid this hazard may also result in serious damage to the machine.

-  **CAUTION** – This word is used on safety messages and safety labels for hazards which could result in minor or moderate injury if the hazard is not avoided. This word might also be word for hazards where the only result could be damage to the machine.

- NOTICE** – This word is used for precautions that must be taken to avoid actions which could shorten the life of the machine.

Safety precautions are described in SAFETY from page 1-1.

Komatsu cannot predict every circumstance that might involve a potential hazard in operation and maintenance. Therefore the safety messages in this manual and on the machine may not include all possible safety precautions. If any procedures or actions not specifically recommended or allowed in this manual are used, you must be sure that you and others can do such procedures and actions safely and without damaging the machine. If you are unsure about the safety of some procedures, contact Komatsu distributor.

3. INTRODUCTION

3.1 INTENDED USE

This Komatsu HYDRAULIC EXCAVATOR is designed to be used mainly for the following work:

- Digging work
- Smoothing work
- Ditching work
- Loading work

See the section "12.13 WORK POSSIBLE USING HYDRAULIC EXCAVATOR" for further details.

3.2 FEATURES

- Employment of LCD monitor
- Employment of short-pitch rubber shoe for higher operator comfort
- Use of common undercarriage parts for easy exchange of rubber and steel shoes
- Employment of bucket tooth of vertical pin type
- Employment of semi-wrist control lever for easier operation
- Low noise and stylish form and coloring facilitate operations without problem even in residential areas.
- Work equipment which operates faster and generates less shocks
- Wide range of attachments for superb versatility

3.3 BREAKING IN THE MACHINE

Your Komatsu machine has been thoroughly adjusted and tested before shipment. However, operating the machine under severe conditions at the beginning can adversely affect the performance and shorten the machine life.

Be sure to break in the machine for the initial 100 hours (as indicated by the service meter.)

During breaking in:

- Idle the engine for 5 minutes after starting it up.
- Avoid operation with heavy loads or at high speeds.
- Avoid sudden starts, sudden acceleration, sudden steering and sudden stops except in cases of emergency.

The precautions given in this manual for operating, maintenance, and safety procedures are only those that apply when this product is used for the specified purpose. If the machine is used for a purpose that is not listed in this manual, Komatsu cannot bear any responsibility for safety. All consideration of safety in such operations is the responsibility of the user.

Operations that are prohibited in this manual must never be carried out under any circumstances.

4. LOCATION OF PLATES, TABLE TO ENTER SERIAL NO. AND DISTRIBUTOR

4.1 MACHINE SERIAL NO. PLATE POSITION

On the left front of the frame

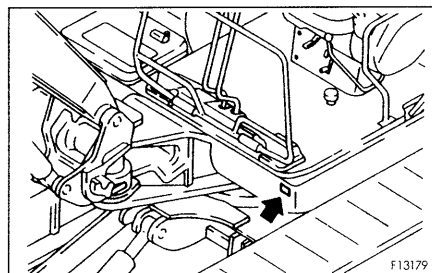

4.2 ENGINE SERIAL NO. PLATE POSITION

On the upper side of the engine cylinder head cover

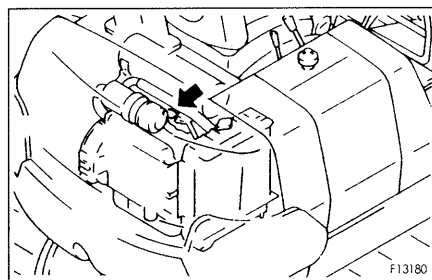

4.3 TABLE TO ENTER SERIAL NO. AND DISTRIBUTOR

Machine serial No.:	
Engine serial No.:	
Distributor name:	
Address:	Phone:
Service personnel for your machine:	

REMARKS

5. CONTENTS

1. Foreword	0- 1
2. Safety information	0- 2
3. Introduction	0- 3
4. Location of plates, table to enter serial No. and distributor	0- 4

SAFETY

6. General precautions	1- 2
7. Precautions during operation	1- 7
7.1 Before starting engine	1- 7
7.2 Operating machine	1- 9
7.3 Transportation	1-14
7.4 Battery	1-15
7.5 Towing	1-16
7.6 Bucket with hook	1-17
8. Precautions for maintenance	1-20
8.1 Before carrying out maintenance	1-20
8.2 During maintenance	1-23
9. Position for attaching safety labels	1-27

OPERATION

10. General view	2- 2
10.1 General view of machine	2- 2
10.2 General view of controls and gauges	2- 3
11. Explanation of components	2- 4
11.1 Machine monitor	2- 4
11.2 Switches	2- 9
11.3 Control levers and pedals	2-12
11.4 Engine food	2-16
11.5 Front window (Machines equipped with cab)	2-17
11.6 Door lock	2-19
11.7 Fuse	2-20
11.8 Fusible link	2-20
11.9 Cap, cover with lock	2-21
11.10 Canopy (Machines equipped with canopy)	2-22

12. Operation	2-23
12.1 Check before starting engine	2-23
12.2 Starting engine	2-31
12.3 Operations and checks after starting engine	2-33
12.4 Moving machine off	2-35
12.5 Steering machine	2-38
12.6 Stopping machine	2-40
12.7 Swinging	2-41
12.8 Operation of work equipment	2-42
12.9 Prohibitions for operation	2-43
12.10 Precautions for operation	2-46
12.11 Precautions when traveling up or down hills	2-47
12.12 How to escape from mud	2-49
12.13 Work possible using hydraulic excavator	2-50
12.14 Replacement of bucket	2-52
12.15 Parking machine	2-55
12.16 Check after finishing work	2-56
12.17 Stopping engine	2-56
12.18 Check after stopping engine	2-57
12.19 Locking	2-57
12.20 Handling rubber shoes (Rubber shoes only)	2-58
13. Transportation	2-63
13.1 Loading, unloading work	2-63
13.2 Method of lifting machine	2-65
13.3 Precautions for loading	2-67
13.4 Precautions for transportation	2-68
14. Cold weather operation	2-69
14.1 Precautions for low temperature	2-69
14.2 Precautions after completion of work	2-71
14.3 Preparing the cab heater (Machines equipped with cab)	2-71
14.4 After cold weather	2-71
15. Long-term storage	2-72
15.1 Before storage	2-72
15.2 During storage	2-73
15.3 After storage	2-73
16. Troubleshooting	2-74
16.1 Phenomena that are not failures	2-74
16.2 Method of towing machine	2-74
16.3 Precautions on particular jobsites	2-74
16.4 If battery is discharged	2-75
16.5 Other trouble	2-80

MAINTENANCE

17. Guides to maintenance	3- 2
18. Outlines of service	3- 4
18.1 Outline of oil, fuel, coolant	3- 4
18.2 Outline of electric system	3- 7
18.3 Outline of hydraulic system	3- 8
19. Wear parts list	3- 9
20. Use of fuel, coolant and lubricants according to ambient temperature	3-10
21. Standard tightening torques for bolts and nuts	3-14
21.1 Introduction of necessary tools	3-14
21.2 Torque list	3-15
22. Periodic replacement of safety critical parts	3-16
23. Maintenance schedule chart	3-18
23.1 Maintenance schedule chart	3-18
23.2 Maintenance interval when using hydraulic breaker	3-20
24. Service Procedure	3-21
24.1 Initial 250 hours service	3-21
24.2 When required	3-22
24.3 Check before starting	3-45
24.4 Every 100 hours service	3-49
24.5 Every 250 hours service	3-51
24.6 Every 500 hours service	3-58
24.7 Every 1000 hours service	3-61
24.8 Every 2000 hours service	3-64

SPECIFICATIONS

25. Specifications	4- 2
---------------------------------	------

OPTIONS, ATTACHMENTS

26. General precautions	5- 2
26.1 Precautions related to safety	5- 2
26.2 Precautions when installing attachments	5- 3
27. Handling bucket with hook	5- 4
27.1 Checking for damage to bucket with hook	5- 4
27.2 Prohibited operations	5- 4
27.3 Precautions during operations	5- 4

MEMO

SAFETY

 **WARNING**

Read and follow all safety precautions. Failure to do so may result in serious injury or death.

This safety section also contains precautions for optional equipment and attachments.

6. GENERAL PRECAUTIONS

⚠ WARNING: For reasons of safety, always follow these safety precautions.

SAFETY RULES

- ONLY trained and authorized personnel can operate and maintain the machine.
- Follow all safety rules, precautions and instructions when operating or performing maintenance on the machine.
- When working with another operator or a person on worksite traffic duty, be sure all personnel understand all hand signals that are to be used.

SAFETY FEATURES

- Be sure all guards and covers are in their proper position. Have guards and covers repaired if damaged.
- Use safety features such as safety lock and seat belts properly.
- NEVER remove any safety features. ALWAYS keep them in good operating condition.
Safety lever → See "12.15 PARKING MACHINE".
- Improper use of safety features could result in serious bodily injury or death.

CLOTHING AND PERSONAL PROTECTIVE ITEMS

- Avoid loose clothing, jewelry, and loose long hair. They can catch on controls or in moving parts and cause serious injury or death. Also, do not wear oily clothes because they are flammable.
- Wear a hard hat, safety glasses, safety shoes, mask or gloves when operating or maintaining the machine. Always wear safety goggles, hard hat and heavy gloves if your job involves scattering metal chips or minute materials - this is so particularly when driving pins with a hammer and when cleaning the air cleaner element with compressed air.
Check also that there is no one near the machine.
Driving in pins → See "12.14 REPLACEMENT AND INVERSION OF BUCKET".
Cleaning of air cleaner element → See "24.2 WHEN REQUIRED" in service procedure.

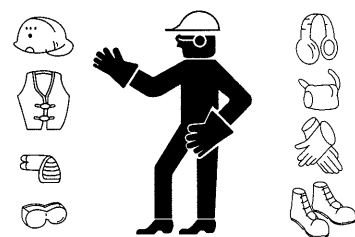

A0055010

UNAUTHORIZED MODIFICATION

- Any modification made without authorization from Komatsu can create hazards.
- Before making a modification, consult your Komatsu distributor. Komatsu will not be responsible for any injury or damage caused by any unauthorized modification.

ALWAYS APPLY LOCK WHEN LEAVING OPERATOR'S SEAT

- When standing up from the operator's seat, always place the safety lock lever securely in the LOCK position. If you accidentally touch the travel or swing lever when they are not locked, the work equipment may suddenly move and cause serious injury or damage.
- When leaving the machine, lower the work equipment completely to the ground, set the safety lock lever to the LOCK position, then stop the engine and use the key to lock all the equipment. Always take the key with you.

Work equipment posture → See "12.15 PARKING MACHINE."

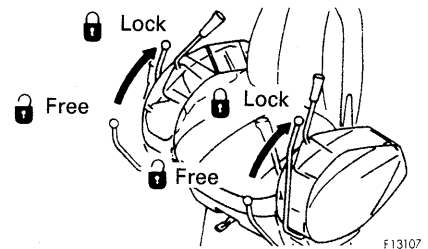

MOUNTING AND DISMOUNTING

- NEVER jump on or off the machine. NEVER get on or off a moving machine.
- When mounting or dismounting, always face the machine and use the handrails, machine or track frame steps, and track shoes.
- Do not hold any control levers when getting on or off the machine.
- Ensure safety by always maintaining at least three-point contact of hands and feet with the handrails, steps or track shoes.
- Always remove any oil or mud from the handrails, steps and track shoes. If they are damaged, repair them and tighten any loose bolts.
- Never climb on to the engine hood. There is danger that you will slip and fall.

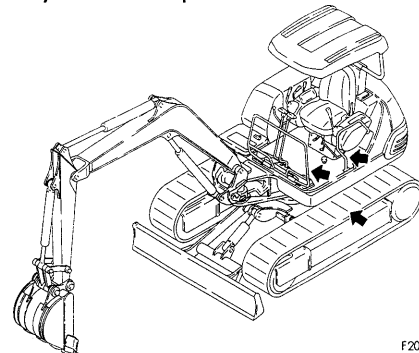

FIRE PREVENTION FOR FUEL AND OIL

Fuel, oil, and antifreeze can be ignited by a flame. Fuel is particularly **FLAMMABLE** and can be **HAZARDOUS**.

- Keep a flame away from flammable fluids.
- Stop the engine and do not smoke when refueling.
- Tighten all fuel and oil caps securely.
- Refueling and oiling should be made in well ventilated areas.
- Keep oil and fuel in the determined place and do not allow unauthorized persons to enter.



A0055020

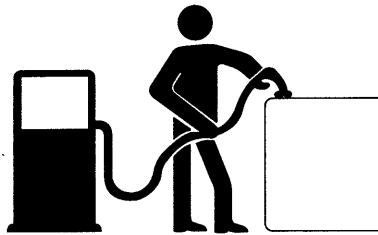

A0055030



A0055040

PRECAUTIONS WHEN HANDLING AT HIGH TEMPERATURES

- Immediately after operations are stopped, the engine coolant, engine oil, and hydraulic oil are at high temperatures, and are still under pressure. Attempting to remove the cap, drain the oil or water, or replace the filters may lead to serious burns. Always wait for the temperature to go down, and follow the specified procedures when carrying out these operations.
- To prevent hot water from spurting out:
 - 1) Turn engine off.
 - 2) Allow water to cool.
 - 3) Slowly loosen cap to relieve pressure before removing.
- To prevent hot oil from spurting out:
 - 1) Turn engine off.
 - 2) Allow oil to cool.
 - 3) Slowly loosen cap to relieve pressure before removing.

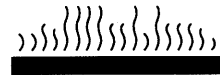

A0055050

ASBESTOS DUST HAZARD PREVENTION

Asbestos dust can be HAZARDOUS to your health if it is inhaled.

If you handle materials containing asbestos fibers, follow these guidelines as given below:

- NEVER use compressed air for cleaning.
- Use water for cleaning to keep down the dust.
- Operate the machine with the wind to your back, whenever possible.
- Use an approved respirator if necessary.



A0055060

CRUSHING OR CUTTING PREVENTION

- Do not enter, or put your hand or arm or any other part of your body between movable parts such as between the work equipment and cylinders, or between the machine and work equipment. If the work equipment is operated, the clearance will change and this may lead to serious damage or personal injury.



A0066090

FIRE EXTINGUISHER AND FIRST AID KIT

- Be sure fire extinguishers have been provided and know how to use them.
- Provide a first aid kit at the storage point.
- Know what to do in the event of a fire.
- Be sure you know the phone numbers of persons you should contact in case of an emergency.

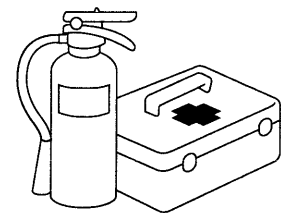

A0055070

PRECAUTIONS FOR ATTACHMENTS

- When installing and using an optional attachment, read the instruction manual for the attachment and the information related to attachments in this manual.
- Do not use attachments that are not authorized by Komatsu or your Komatsu distributor. Use of unauthorized attachments could create a safety problem and adversely affect the proper operation and useful life of the machine.
- Any injuries, accidents, product failures resulting from the use of unauthorized attachments will not be the responsibility of Komatsu.

BE CAREFUL NOT TO BREAK CAB GLASS

If the cab glass should be cracked or broken, it is extremely dangerous to use the machine as it is. Always replace the glass immediately.

7. PRECAUTIONS DURING OPERATION

⚠ WARNING: Failure to follow these safety precautions may lead to a serious accident.

7.1 BEFORE STARTING ENGINE

SAFETY AT WORKSITE

- Before starting the engine, thoroughly check the area for any unusual conditions that could be dangerous.
- Before starting the engine, examine the terrain and soil conditions of the worksite. Determine the best and safest method of operation.
- Make the slope as horizontal as possible before continuing operations.
- If you need to operate on a street, protect pedestrians and cars by designating a person for worksite traffic duty or by installing fences around the worksite.
- If water lines, gas lines, and high-voltage electrical lines may be buried under the worksite, contact each utility and identify their locations. Be careful not to sever or cut any of these lines.
- Check the depth and flow of water before operating in water or crossing a river. NEVER be in water which is in excess of the permissible water depth.

Permissible water depth → See "12.10 PRECAUTIONS FOR OPERATION".

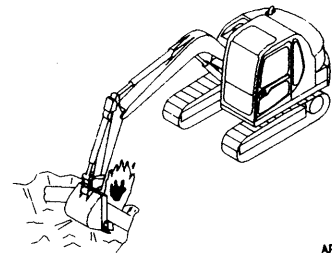

APA00050

FIRE PREVENTION

- Thoroughly remove wood chips, leaves, paper and other flammable things accumulated on the engine compartment. They could cause a fire.
- Check fuel, lubrication, and hydraulic systems for leaks. Have any leaks repaired. Wipe up any excess oil, fuel or other flammable fluids.
Check point → See "12.1.1 WALK-AROUND CHECK".
- Be sure a fire extinguisher is present and working.



A0055020

IN OPERATOR'S CAB

- Do not leave tools or spare parts lying around in the operator's compartment. They may damage or break the control levers or switches. Always put them in the tool box under the operator's seat.
- Keep the cab floor, controls, steps and handrails free of oil, grease, snow, and excess dirt.

VENTILATION FOR ENCLOSED AREAS

- If it is necessary to start the engine within an enclosed area, provide adequate ventilation. Exhaust fumes from the engine can KILL.



A0055060

PRECAUTIONS FOR WINDOWS AND LIGHT

- Remove all dirt from the surface of the windows and lights to ensure that you can see well.
- Check that the head lamps and working lamps are installed to match the operating conditions. Check also that they light up properly.

⚠ WARNING: Failure to follow these safety precautions may lead to a serious accident.

7.2 OPERATING MACHINE

WHEN STARTING ENGINE

- Walk around your machine again just before mounting it, checking for people and objects that might be in the way.
- NEVER start the engine if a warning tag has been attached to the control.
- When starting the engine, sound the horn as an alert.
- Start and operate the machine only while seated.
- Do not allow anyone other than the operator to ride in the cab or on the machine body.

CHECK DIRECTION BEFORE STARTING MACHINE

Before operating the travel lever, check the direction of the track frame. If the sprocket is at the front, the travel lever must be operated in the opposite direction.
Travel operations → See "12.4 MOVING MACHINE OFF".

Travel in reverse direction

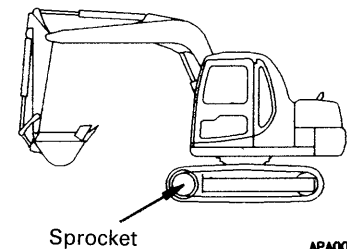

CHECK THAT NO ONE IS IN AREA BEFORE SWINGING OR TRAVELING IN REVERSE

- Always position a signalman in places in dangerous places or places where the view is not clear.
- Make sure that no one comes inside the swing radius or direction of travel.
- Before starting to move, sound the horn or give a signal to warn people not to come close to the machine.
- There are blind spots behind the machine, so if necessary, swing the upper structure to check that there is no one behind the machine before traveling in reverse.

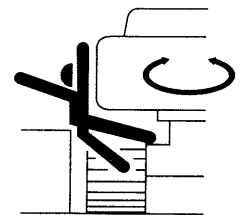
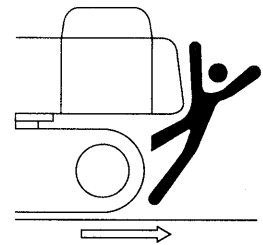

PRECAUTIONS WHEN TRAVELING

- Fold in the work equipment as shown in the diagram below, and keep it at a height of 40 - 50 cm (16 to 20 in) from the ground level before starting to travel.
- When traveling, do not operate the work equipment control levers. If the work equipment control levers have to be operated, never operate them suddenly.
- When traveling on rough ground, travel at low speed, and avoid sudden changes in direction.
- Avoid traveling over obstacles as far as possible. If the machine has to travel over an obstacle, keep the work equipment as close to the ground as possible and travel at low speed. Never travel over obstacles which make the machine tilt strongly (10° or more).

Travel posture

INCORRECT

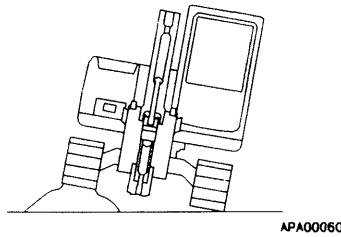
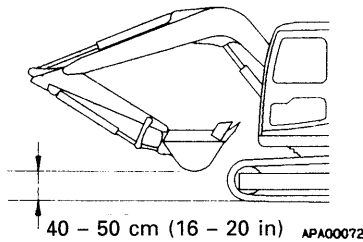

TRAVELING ON SLOPES

- Traveling on hills, banks or slopes that are steep could result in the machine tipping over or slipping.
- On hills, banks or slopes, carry the bucket closer to the ground, approximately 20 to 30 cm (8 to 12 in) above the ground. In case of emergency, quickly lower the bucket to the ground to help the machine stop and prevent it from tipping over.
- Do not turn on slopes or travel across slopes. Always go down to a flat place to perform these operations.

Method of traveling on slopes → See "12.11 PRECAUTIONS WHEN TRAVELING UP OR DOWN HILLS".

- Do not travel up and down on grass, fallen leaves, and wet steel plates. These materials may allow the machine to slip, if it is traveling sideways. Keep travel speed very low.

Downhill

Uphill

INCORRECT

CORRECT

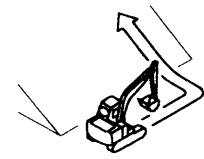
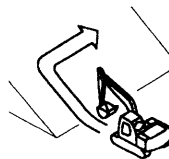
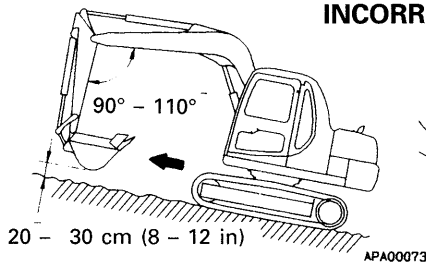
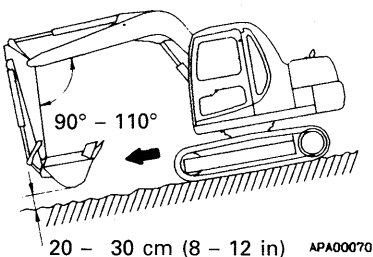

AZ125400

⚠ WARNING: Failure to follow these safety precautions may lead to a serious accident.

7. PRECAUTIONS DURING OPERATION

PROHIBITED OPERATIONS

- Do not dig the work face under an overhang. This may cause the overhang to collapse and fall on top of the machine.
- Do not carry out deep digging under the front of the machine. The ground under the machine may collapse and cause the machine to fall.

INCORRECT

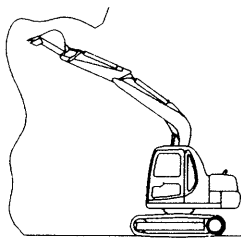

APA00074

INCORRECT

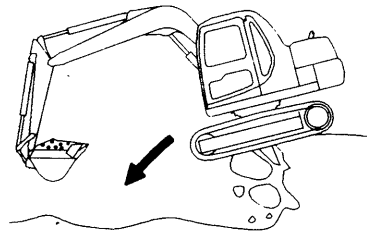

APA00075

IT IS PROHIBITED TO LIFT LOADS

- It is prohibited to use this machine for lifting loads.
 - It is permitted to use this machine only for pulling out steel plates, but this work requires the use of a special device.
- Lifting loads → See "12.9 PROHIBITIONS FOR OPERATION".**

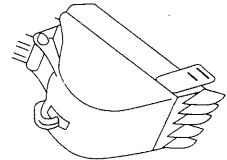

A0066240

DO NOT GO CLOSE TO HIGH-VOLTAGE CABLES

- Going close to high-voltage cables can cause electric shock. Always maintain the safe distance given below between the machine and the electric cable.
- The following actions are effective in preventing accidents.
 - 1) Wear shoes with rubber or leather soles.
 - 2) Use a signalman to give warning if the machine approaches too close to the electric cable.
- If the work equipment should touch the electric cable, the operator should not leave the operator's compartment.
- When carrying out operations near high voltage cables, do not let anyone come close to the machine.
- Check with the electricity company about the voltage of the cables before starting operations.

Voltage	Min. safety distance	
	m	ft
6.6 kV	3 m	10ft
33.0 kV	4 m	14ft
66.0 kV	5 m	17ft
154.0 kV	8 m	27ft
275.0 kV	10 m	33ft

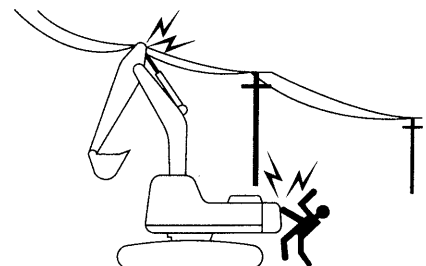

A0066190

DO NOT HIT WORK EQUIPMENT

- When working in places where there are height limits, such as in tunnels, under bridges, under electric cables, or in garages, be extremely careful not to hit the boom or arm.

ENSURE GOOD VISIBILITY

- When working in dark places, install working lamps and head lamps, and set up lighting in the work area if necessary.
- Stop operations if the visibility is poor, such as in mist, snow, or rain, and wait for the weather to improve to a condition that allows the operation to be carried out safely.

OPERATE CAREFULLY ON SNOW

- When working on snow or icy roads, even a slight slope may cause the machine to slip to the side, so always travel at low speed and avoid sudden starting, stopping, or turning.
- When there has been heavy snow, the road shoulder and objects placed beside the road are buried in the snow and cannot be seen, so always carry out snow-clearing operations carefully.

WORKING ON LOOSE GROUND

- Avoid operating your machine too close to the edge of cliffs, overhangs, and deep ditches. If these areas collapse, your machine could fall or tip over and result in serious injury or death. Remember that the soil after heavy rain or blasting is weakened in these areas.
- Earth laid on the ground and the soil near ditches are loose. They can collapse under the weight or vibration of your machine.
- Install the HEAD GUARD if working in areas where there is danger of falling rocks and dirt.

OPERATIONS ON SLOPES

- When working on slopes, there is danger that the machine may lose its balance and turn over when the swing or work equipment are operated. Always carry out these operations carefully.
- Do not swing the work equipment from the uphill side to the downhill side when the bucket is loaded. This operation is dangerous.
(See the upper diagram on the right.)
- If the machine has to be used on a slope, pile the soil to make a platform that will keep the machine as horizontal as possible.
(See the lower diagram on the right.)

Piled soil on slope → See "12.11 PRECAUTIONS WHEN TRAVELING UP OR DOWN HILLS."

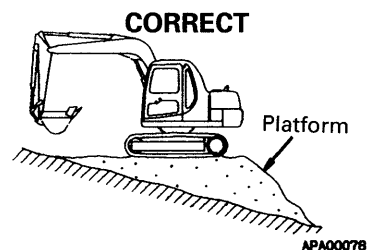
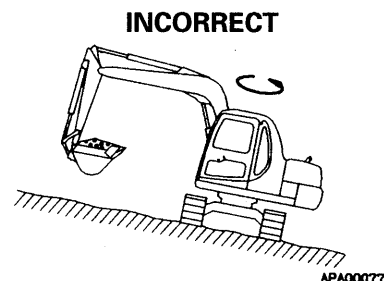

PARKING THE MACHINE

- Park on level ground whenever possible. If not possible, block the tracks, lower the bucket to the ground and thrust the bucket in the ground.

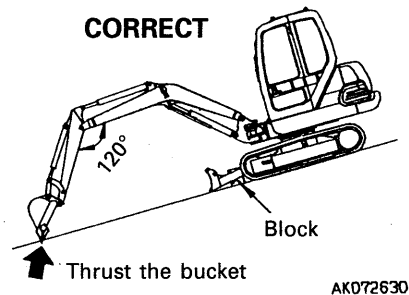

- When parking on public roads, provide fences and signs, such as flags or lights, on the machine to warn passersby to be careful. Be sure that the machine, flags or lights do not obstruct traffic.
Parking procedure → See "12.15 PARKING MACHINE".

- When leaving the machine, lower the work equipment completely to the ground, set the safety lock lever to the LOCK position, then stop the engine and use the key to lock all the equipment. Always take the key with you.

Work equipment posture → See "12.15 PARKING MACHINE".

Places to lock → See "12.19 LOCKING".

Method of locking

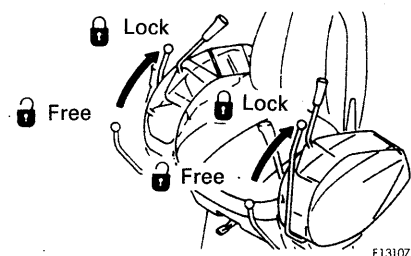

7.3 TRANSPORTATION

LOADING AND UNLOADING

- Loading and unloading the machine always involves potential hazards. **EXTREME CAUTION SHOULD BE USED.**
- When loading or unloading the machine, run the engine at low idling and operate the travel levers slowly.
- Perform loading and unloading on firm, level ground only. Maintain a safe distance from the edge of a road.
- **ALWAYS** block the wheels of the hauling vehicle and place blocks under both ramps before loading and unloading.
- **ALWAYS** use ramps of adequate strength. Be sure the ramps are wide and long enough to provide a safe loading slope.
- Be sure that the ramps are securely positioned and fastened, and that the two sides are at the same level as one another.
- Be sure the ramp surface is clean and free of grease, oil, ice and loose materials. Remove dirt from the machine tracks.
- **NEVER** correct your steering on the ramps. If necessary, drive away from the ramps and climb again.
- Swing the upper structure with extreme care on the trailer to avoid a possible accident caused by body instability.
- After loading, block the machine tracks and secure the machine with tie-downs.

Loading and unloading → See "13. TRANSPORTATION".

Tie-downs → See "13. TRANSPORTATION".

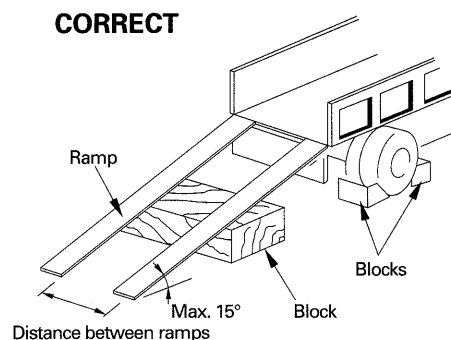

A0067310

SHIPPING

- When shipping the machine on a hauling vehicle, obey all state and local laws governing the weight, width, and length of a load. Also obey all applicable traffic regulations.
- Determine the shipping route while taking into account the width, height and weight of the load.

7.4 BATTERY

BATTERY HAZARD PREVENTION

- Battery electrolyte contains sulfuric acid and can quickly burn the skin and eat holes in clothing. If you spill acid on yourself, immediately flush the area with water.
- Battery acid could cause blindness if splashed into the eyes. If acid gets into the eyes, flush them immediately with large quantities of water and see a doctor at once.
- If you accidentally drink acid, drink a large quantity of water or milk, beaten egg or vegetable oil. Call a doctor or poison prevention center immediately.
- When working with batteries. ALWAYS wear safety glasses or goggles.
- Batteries generate hydrogen gas. Hydrogen gas is very EXPLOSIVE, and is easily ignited with a small spark or flame.
- Before working with batteries, stop the engine and turn the starting switch to the OFF position.
- Avoid short-circuiting the battery terminals through accidental contact with metallic objects, such as tools, across the terminals.
- Tighten the battery terminals securely. Loosened terminals can generate sparks and lead to an explosion.
- When removing or installing, check which is the positive (+) terminal and negative (-) terminal.
- Tighten the battery caps securely.

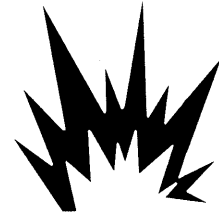
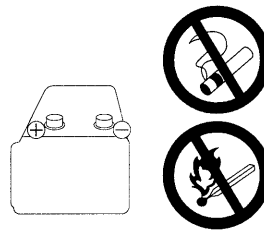
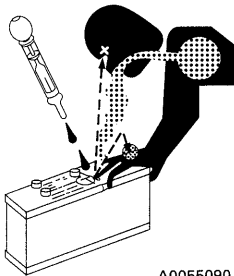

STARTING WITH BOOSTER CABLES

- ALWAYS wear safety glasses or goggles when starting the machine with booster cables.
- When starting from another machine, do not allow the two machines to touch.
- Be sure to connect the positive (+) cable first when installing the booster cables. Disconnect the ground or negative (-) cable first when removing them.
- If any tool touches between the positive (+) terminal and the chassis, it will cause sparks. This is dangerous, so be sure to work carefully.
- Connect the batteries in parallel: positive to positive and negative to negative.
- When connecting the ground cable to the frame of the machine to be started, be sure to connect it as far as possible from the battery.

Starting with booster cables → See "16.4 IF BATTERY IS DISCHARGED".

INCORRECT

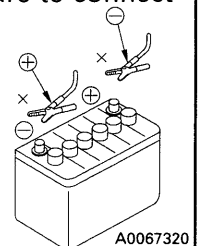

7.5 TOWING

WHEN TOWING, ATTACH WIRE TO FRAME

- Injury or death could result if a disabled machine is towed incorrectly.
- If your machine is towed by another machine, ALWAYS use a wire rope with a sufficient towing capacity.
- NEVER allow a disabled machine to be towed on a slope.
- Do not use a kinked or frayed wire rope.
- Do not straddle the towing cable or wire rope.
- When connecting up a towing machine, do not let anyone enter the area between the towing machine and the equipment being towed.
- Set the towing machine and the towing connection of the equipment being towed in a straight line when connecting it.
- Place pieces of wood between the wire ropes and body to protect them from wear or damage.

Towing method → See "16.2 METHOD OF TOWING MACHINE."

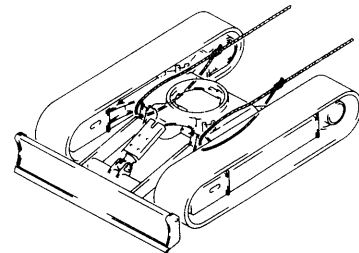

F17122

7.6 BUCKET WITH HOOK

7.6.1 GENERAL PRECAUTIONS

SPECIAL HOOK

- When carrying out lifting work, the special lifting hook is necessary.
- The following operations are prohibited.
 - Lifting loads with a wire rope fitted around the bucket teeth.
 - Lifting loads with the wire rope wrapped directly around the boom or arm.

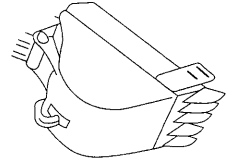

A0066240

CHECKING HOOK

- When lifting a load, carry out the following checks to confirm that there is no abnormality before starting operations.
 - Check that there are no cracks or deformation in the lifting equipment.
 - Check that there is no abnormality in the stopper device.

HOOKING WIRE ROPE SECURELY TO HOOK

- When performing lifting operation, securely hook the wire rope onto the special lifting hook.

PRECAUTIONS FOR MACHINE INSTALLATION

- After carrying out a preliminary inspection of ground conditions, select a flat, solid location. Confirm that the machine can be safely operated without toppling or rolling.

PROHIBITED OPERATIONS OTHER THAN MAIN APPLICATIONS

- When performing lifting operation, never raise or lower a person.

NO PERSONS SHALL BE PERMITTED TO ENTER THE WORKING AREA

- Due to the possible danger of the load falling or of collision with the load, no persons shall access the working area.

⚠ WARNING: For reasons of safety, always follow these safety precautions.

7. PRECAUTIONS DURING OPERATION

OPERATION SUPERVISOR

- Before performing lifting operation, designate an operation supervisor.
Always execute operation according to his instructions.
 - Execute operating methods and procedures under his direction.
 - Select a person responsible for signaling. Operate only on signals given by such person.

HANDING OF WIRE ROPES ETC.

- Wear leather gloves when handling wire ropes.

7.6.2 PRECAUTIONS FOR LIFTING OPERATION

GRADUAL LIFTING OPERATION

- Reduce the engine speed and carry out lifting operations slowly.
- Avoid sudden lever shifting and acceleration.
- Swing speed is three to four times that of movable cranes. Therefore, be especially careful when performing swing operation.

NEVER LEAVE THE OPERATOR'S SEAT

- Never leave the operator's seat while lifting a load.

NEVER CARRY OUT EXCESSIVE OPERATIONS

- Operation exceeding machine performance may result in accident or failure.
- Carry out lifting operation within specified load limit.
- Never carry out operations which may damage the machine such as overload or over-impact-load.
- Never drag a load laterally or longitudinally, nor retract the arm, otherwise, a dangerous situation may result.

INCORRECT

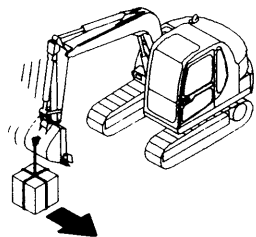

APA00090

INCORRECT

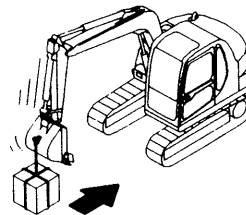

APA00091

NEVER TRAVELLING WHILE LIFTING A LOAD

- Never travel while carrying a load.

OPERATING POSTURE

- If the machine posture is not correct, the wire ropes or ring may detach from the hook. Confirm that the hook angle is correct to avoid this.

8. PRECAUTIONS FOR MAINTENANCE

⚠ WARNING: For reasons of safety, always follow these safety precautions.

8.1 BEFORE CARRYING OUT MAINTENANCE

WARNING TAG

- If others start the engine or operate the controls while you are performing service or lubrication, you could suffer serious injury or death.
- ALWAYS attach the WARNING TAG to the control lever in the operator's cab to alert others that you are working on the machine. Attach additional warning tags around the machine, if necessary.
- These tags are available from your Komatsu distributor. (Part No. 09963-03000)

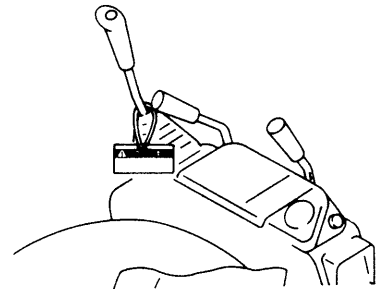
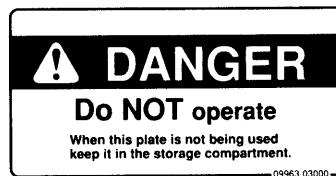

PROPER TOOLS

- Use only tools suited to the task. Using damaged, low quality, faulty, or makeshift tools could cause personal injury.
Tools → See "21.1 INTRODUCTION OF NECESSARY TOOLS".



A0055120

PERIODIC REPLACEMENT OF SAFETY CRITICAL PARTS

- Replace the following fire-related components periodically:
 - Fuel system: Fuel hose, spilling hose, and fuel tube cap
 - Hydraulic system: Pump outlet hose, and front and rear pump branch hoses
- Replace these components periodically with new ones, regardless of whether or not they appear to be defective. These components deteriorate over time.
- Replace or repair any such components if any defect is found, even though they have not reached the time specified.
Replacement of safety critical components → See "22. PERIODIC REPLACEMENT OF SAFETY CRITICAL PARTS".

⚠ WARNING: Failure to follow these safety precautions may lead to a serious accident. follow these safety precautions.

8. PRECAUTIONS FOR MAINTENANCE

STOP THE ENGINE BEFORE CARRYING OUT INSPECTION AND MAINTENANCE

- Always stop the machine on firm flat ground and stop the engine before carrying out inspection and maintenance.
- If it is necessary to run the engine when carrying out maintenance, such as when cleaning the inside of the radiator, place the safety lock lever at the LOCK position and carry out the operation with two workers.
- One worker should sit in the operator's seat so that he can stop the engine immediately if necessary. He should also be extremely careful not to touch any lever by mistake. Touch the levers only when they have to be operated.
- The worker carrying out the maintenance should be extremely careful not to touch or get caught in the moving parts.

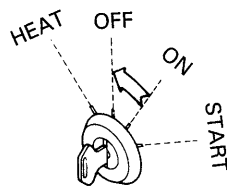

F05247

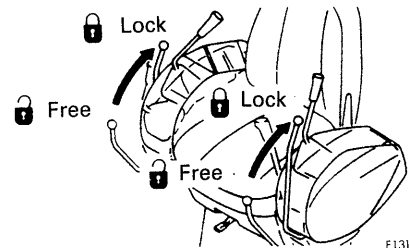

F13107

RULES TO FOLLOW WHEN ADDING FUEL OR OIL

- Keep away from flame when filling with fuel or oil.
- Spilled fuel and oil may cause you to slip, so always wipe it up immediately.
- Always tighten the cap of the fuel and oil fillers securely.
- Never use fuel for washing any parts.
- Always add fuel and oil in a well-ventilated place.



A0055020



A0055030



A0055040

RADIATOR WATER LEVEL

- If it is necessary to add water to the radiator, stop the engine and allow the engine and radiator to cool down before adding the water.
- Slowly loosen the caps to relieve pressure before removing the caps.

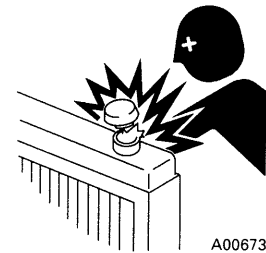

A0067380

USE OF LIGHTING

- When checking fuel, oil, coolant, or battery electrolyte, always use lighting with anti-explosion specifications. If such lighting equipment is not used, there is danger of explosion.



A0055160

DO NOT STAND ON ENGINE HOOD

Never climb on to the engine hood. There is danger that you will slip and fall.

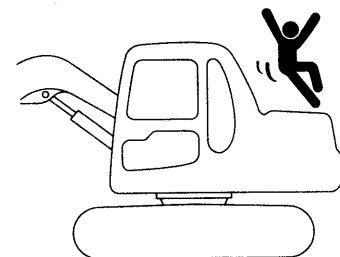

A0067390

8.2 DURING MAINTENANCE

PERSONNEL

- Only authorized personnel can service and repair the machine. Extra precaution should be used when grinding, welding, and using a sledge-hammer.

ATTACHMENTS

- Place attachments that have been removed from the machine in a safe place so that they do not fall. If they fall on you or others, serious injury could result.



A0055130

WORK UNDER THE MACHINE

- Always lower all movable work equipment to the ground or to their lowest position before performing service or repairs under the machine.
- Always block the track shoes of the machine securely.
- Never work under the machine if the machine is poorly supported.



A0055140

KEEP THE MACHINE CLEAN

- Spilled oil or grease, or scattered tools or broken pieces are dangerous because they may cause you to slip or trip. Always keep your machine clean and tidy.
- If water gets into the electrical system, there is danger that the machine may not move or may move unexpectedly. Do not use water or steam to clean the sensors, connectors, or the inside of the operator's compartment.

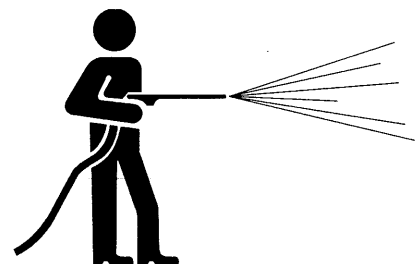

A0055150

PRECAUTIONS WITH BATTERY

- When repairing the electrical system or when carrying out electrical welding, remove the negative (-) terminal of the battery to stop the flow of current.



A0055170

HANDLING HIGH-PRESSURE HOSES

- Do not bend high-pressure hoses or hit them with hard objects. Do not use any bent or cracked piping, tubes or hoses. They may burst during use.
- Always repair any loose or broken fuel hoses or oil hoses. If fuel or oil leaks, it may cause a fire.

PRECAUTIONS WITH HIGH PRESSURE OIL

- Do not forget that the work equipment circuits are always under pressure.
- Do not add oil, drain oil, or carry out maintenance or inspection before completely releasing the internal pressure.
- If oil is leaking under high pressure from small holes, it is dangerous if the jet of high-pressure oil hits your skin or enters your eyes. Always wear safety glasses and thick gloves, and use a piece of cardboard or a sheet of wood to check for oil leakage.
- If you are hit by a jet of high-pressure oil, consult a doctor immediately for medical attention.

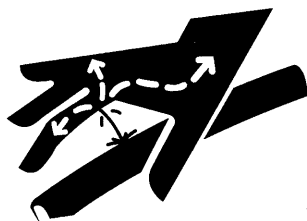

A0055180

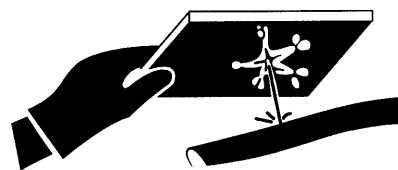

A0055190

PRECAUTIONS WHEN CARRYING OUT MAINTENANCE AT HIGH TEMPERATURE OR HIGH PRESSURE

- Immediately after stopping operations, the engine cooling water and oil at all parts is at high temperature and under high pressure. In this condition, if the cap is removed, or the oil or water are drained, or the filters are replaced, this may result in burns or other injury. Wait for the temperature to go down, then carry out the inspection and maintenance in accordance with the procedures given in this manual.

Cleaning inside or cooling system → see “24.2 WHEN REQUIRED”.

Checking cooling water level, hydraulic oil level → see “24.3 CHECK BEFORE STARTING”.

Checking lubricating oil level, adding oil → see “24.3 – 8 PERIODIC MAINTENANCE”.

Changing oil, replacing filters → see “24.5 – 8 PERIODIC MAINTENANCE”.

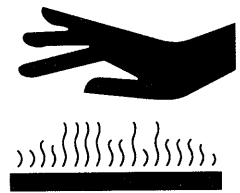

A0055050

PRECAUTIONS WHEN USING HIGH PRESSURE GREASE TO ADJUST TRACK TENSION

Grease is pumped into the track tension adjustment system under high pressure. If the specified procedure for maintenance is not followed when making adjustments, the plug or grease fitting may fly out and cause damage or personal injury.

- When loosening the grease drain plug, never loosen it more than one turn.
- Never put your face, hands, feet, or any other part of your body directly in front of any grease drain plug or valve.

Adjusting track tension → see “24.2 WHEN REQUIRED”.

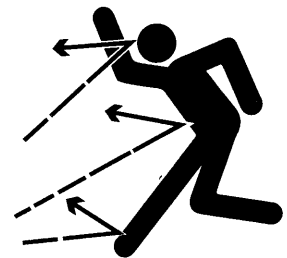

A0055200

ROTATING FAN AND BELT

- Keep away from rotating parts and be careful not to let anything get caught in them.
- If your body or tools touch the fan blades or fan belt, they may be cut off or sent flying, so never touch any rotating parts.

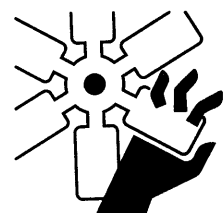

A0055210

WASTE MATERIALS

- Never dump waste oil in a sewer system, rivers, etc.
- Always put oil drained from your machine in containers. Never drain oil directly on the ground.
- Obey appropriate laws and regulations when disposing of harmful objects such as oil, fuel, coolant, solvent, filters, batteries, and others.

INCORRECT

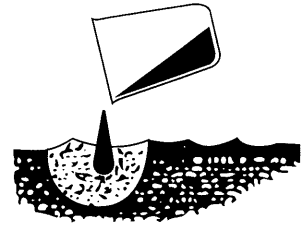

A0055220

9. POSITION FOR ATTACHING SAFETY LABELS

Always keep these labels clean. If they are lost or damaged, attach them again or replace them with a new label.

There are other labels in addition to the safety labels listed as follows, so handle them in the same way.

Safety labels may be available in languages other than English. To find out what labels are available, contact your Komatsu distributor.

9.1 POSITION FOR ATTACHING SAFETY LABELS

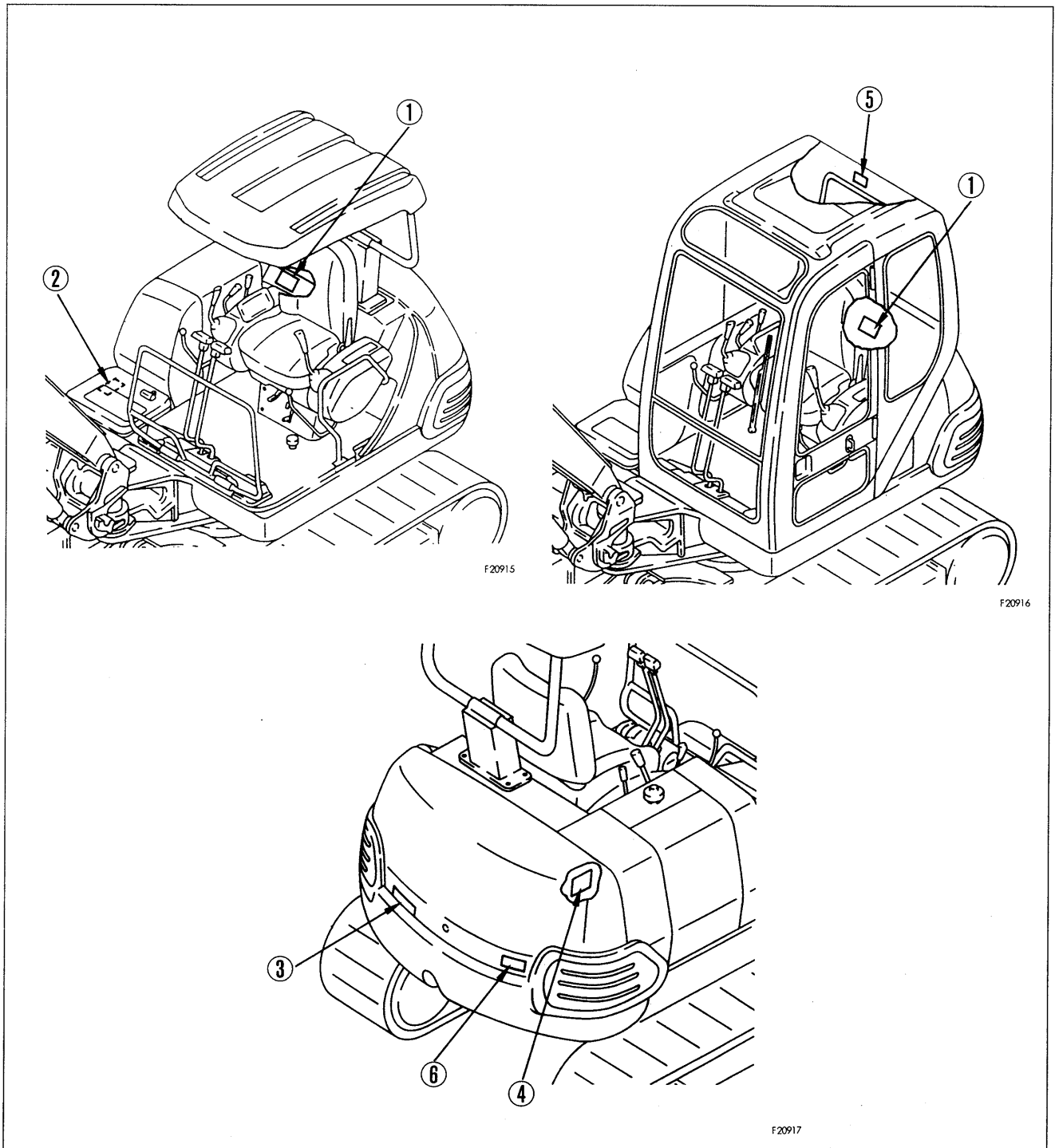

1. Warnings for leaving operator's seat (20T-98-72310)

⚠ WARNING

1. WHEN STARTING OR LEAVING MACHINE, OBSERVE THE FOLLOWING:
 - (1) LOWER WORK EQUIPMENT TO GROUND.
 - (2) RAISE CONSOLE BOX TO LOCK WORK EQUIPMENT.
2. ALWAYS CHOCK TRACKS WHEN PARKING ON A SLOPE.
3. WHEN ADJUSTING TRACKS, DO NOT LOOSEN VALVE MORE THAN ONE TURN. IF IT IS LOOSENED MORE, GREASE MAY BE SPOUTED BY HIGH PRESSURE. (FOR ADJUSTMENT OF TRACKS, SEE OPERATION MANUAL).

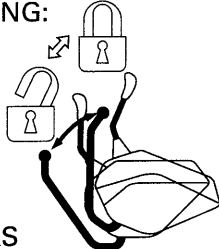

⚠ CAUTION

1. BEFORE OPERATING MACHINE, READ OPERATION MANUAL CAREFULLY
2. WHEN CARRYING, BE SURE TO FIX SWING LOCK PIN.
3. WHEN INSPECTING OR MAINTANING, OBSERVE THE FOLLOWING:
 - (1) PARK MACHINE ON LEVEL PART.
 - (2) LOWER WORK EQUIPMENT TO GROUND AND RAISE CONSOLE BOX TO LOCK WORK EQUIPMENT.
 - (3) DO NOT ENTER UNDER MACHINE BODY WITH IT LIFTED WITH WORK EQUIPMENT.

20T-98-72310

2. Warnings for high temperature hydraulic oil (20T-98-72390)

HYDRAULIC OIL



⚠ CAUTION

1. ALWAYS STOP ENGINE WHEN REMOVING CAP.
2. DO NOT LOOSEN CAP WHEN OIL TEMPERATURE IS HIGH. IF LOOSENED, OIL MAY GUSH OUT.
3. SLOWLY OPEN HYDRAULIC OIL TANK CAP AND RELEASE INTERNAL PRESSURE COMPLETELY.
4. DO NOT OPEN DRAIN PLUG WHEN OIL TEMPERATURE IS HIGH.
5. REPLACE HYDRAULIC OIL FILTER ELEMENT EVERY 250 OPERATING HOURS. (SEE YOUR OPERATION AND MAINTENANCE MANUAL FOR DETAILS) WHEN REPLACING THE ELEMENT: REST THE WORK ATTACHMENT ON THE GROUND AND STOP THE ENGINE.

20T-98-72390

3. Keeping out of turning area (20T-98-72350)

⚠ DANGER

KEEP OUT OF TURNING AREA

4. Warnings when opening or closing radiator cap
(09668-03000)

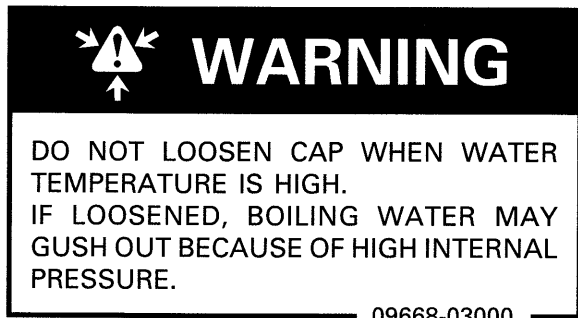

5. Warnings when opening front window
(205-00-63350)

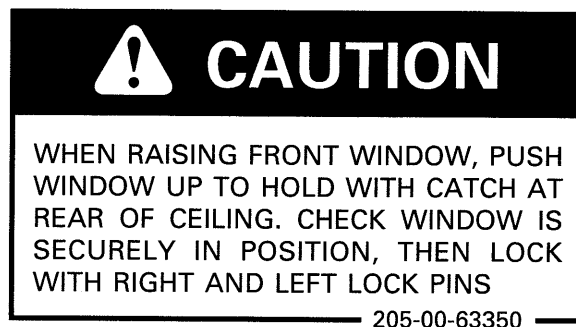

6. Warnings when opening or closing engine hood
(21W-98-21480)

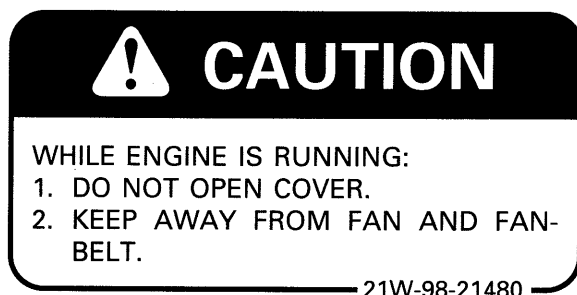

MEMO

OPERATION

10. GENERAL VIEW

10.1 GENERAL VIEW OF MACHINE

If directions are indicated in this section, they refer to the directions shown by the arrows in the diagram below.

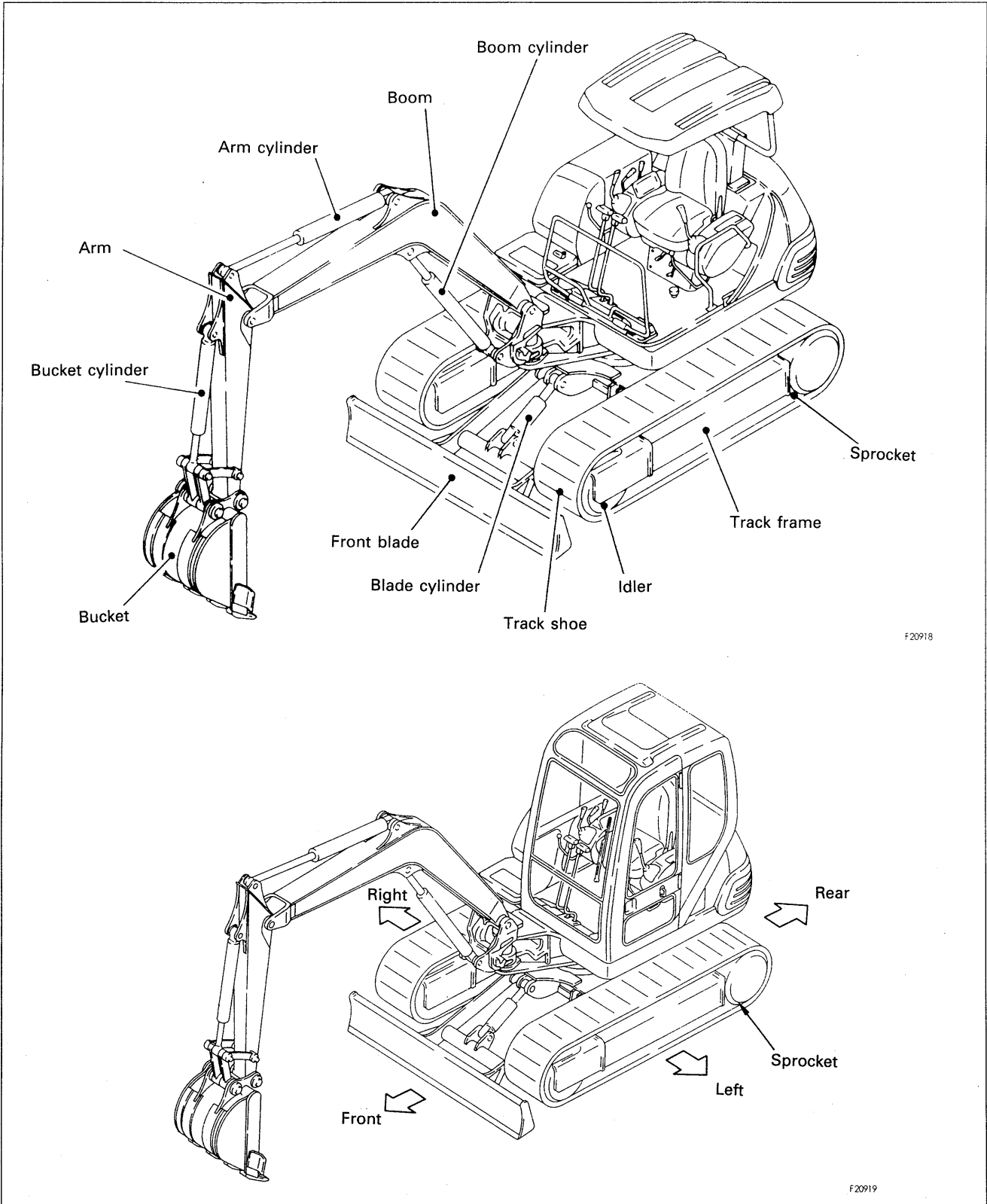

10.2 GENERAL VIEW OF CONTROLS AND GAUGES

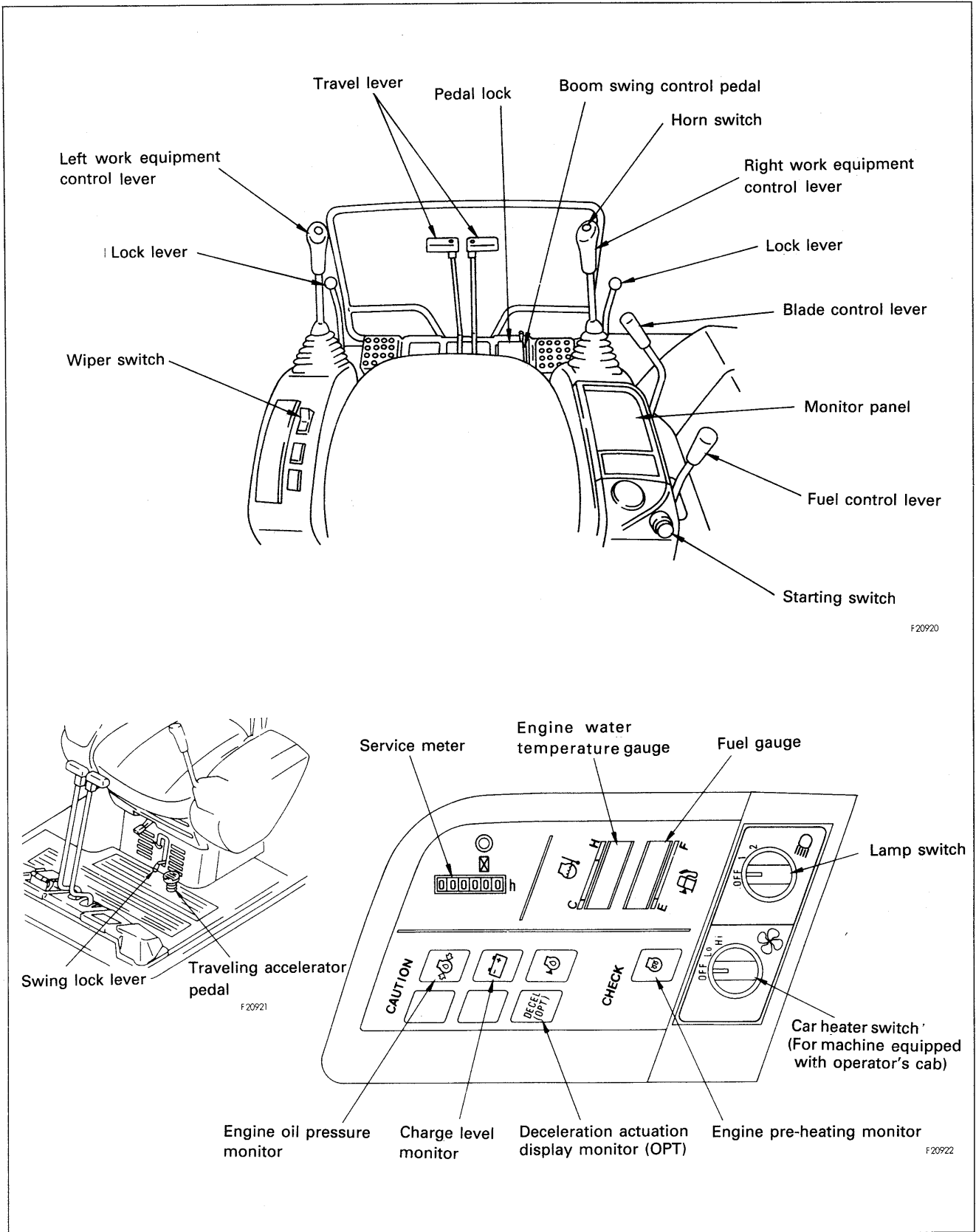

11. EXPLANATION OF COMPONENTS

The following is an explanation of the devices needed for operating the machine.

To carry out suitable operations correctly and safely, it is important to understand fully the methods of operating the equipment and the meanings of the displays.

11.1 MACHINE MONITOR

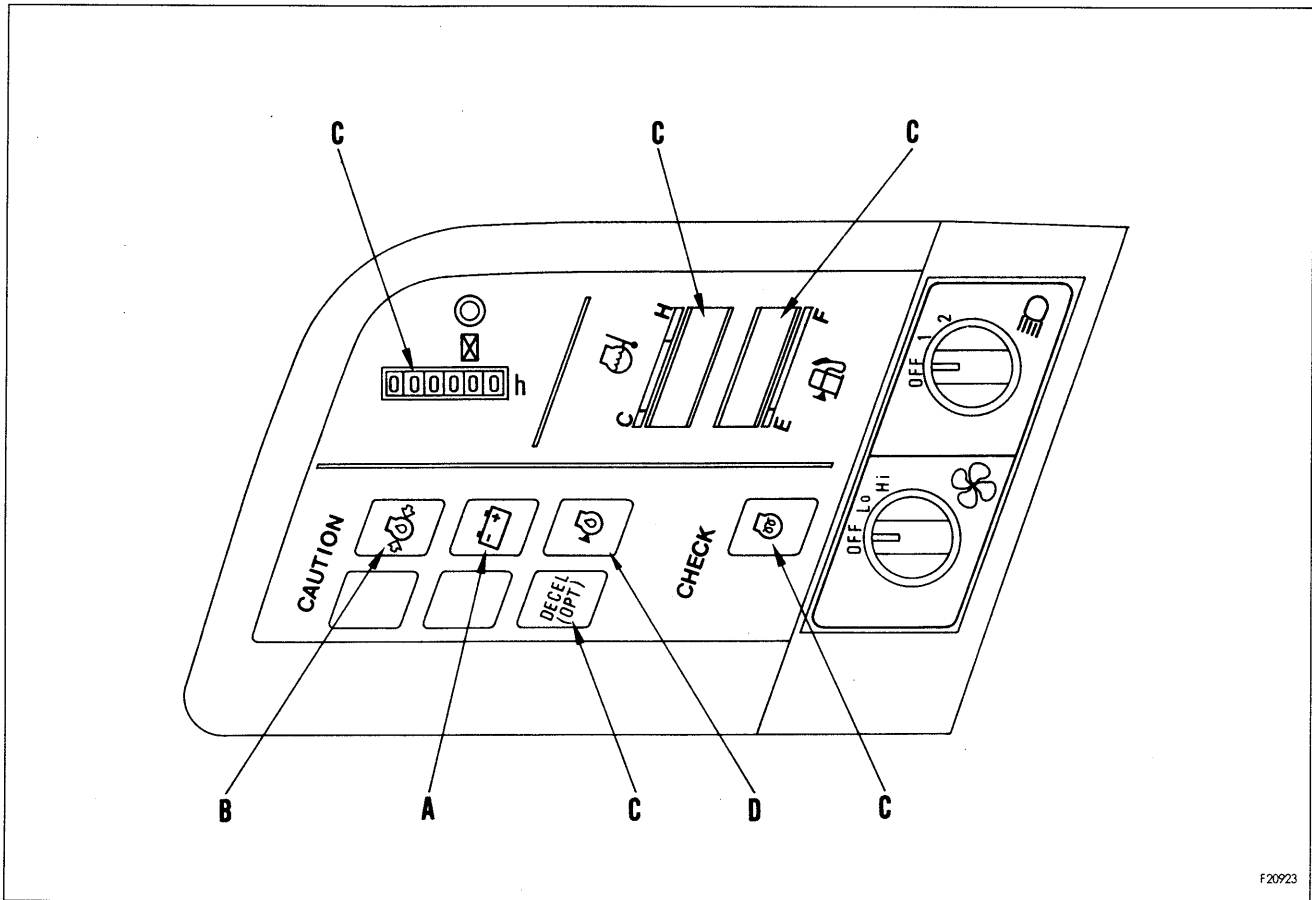

F20923

NOTICE

When carrying out checks before starting, do not simply rely on the monitor. Always refer to the periodic maintenance items or "12. OPERATION" to carry out the checks.

A. CAUTION ITEMS (11.1.1)**⚠ CAUTION**

If these monitor items light up, check and repair the appropriate location as soon as possible.

These are items which need to be observed while the engine is running. If any abnormality occurs, items which need to be repaired as soon as possible are displayed.

If there is any abnormality, the appropriate monitor lamp will flash to indicate the location of the abnormality and the buzzer will sound.

B. EMERGENCY STOP ITEMS (11.1.2)**⚠ CAUTION**

If these monitor items light up, stop operations immediately, then check and repair the appropriate location.

These are items which need to be observed while the engine is running. If any abnormality occurs, items which need to be repaired immediately are displayed.

If there is any abnormality, the appropriate monitor lamp will flash to indicate the location of the abnormality and the buzzer will sound.

C. METER DISPLAY PORTION (11.1.3)

This portion consists of pre-heating monitor, service meter, engine water temperature gauge and fuel gauge.

D. NO MONITOR FUNCTION PORTION

Although engine oil level monitor illustration is shown on the monitor panel, the machine does not have this function.

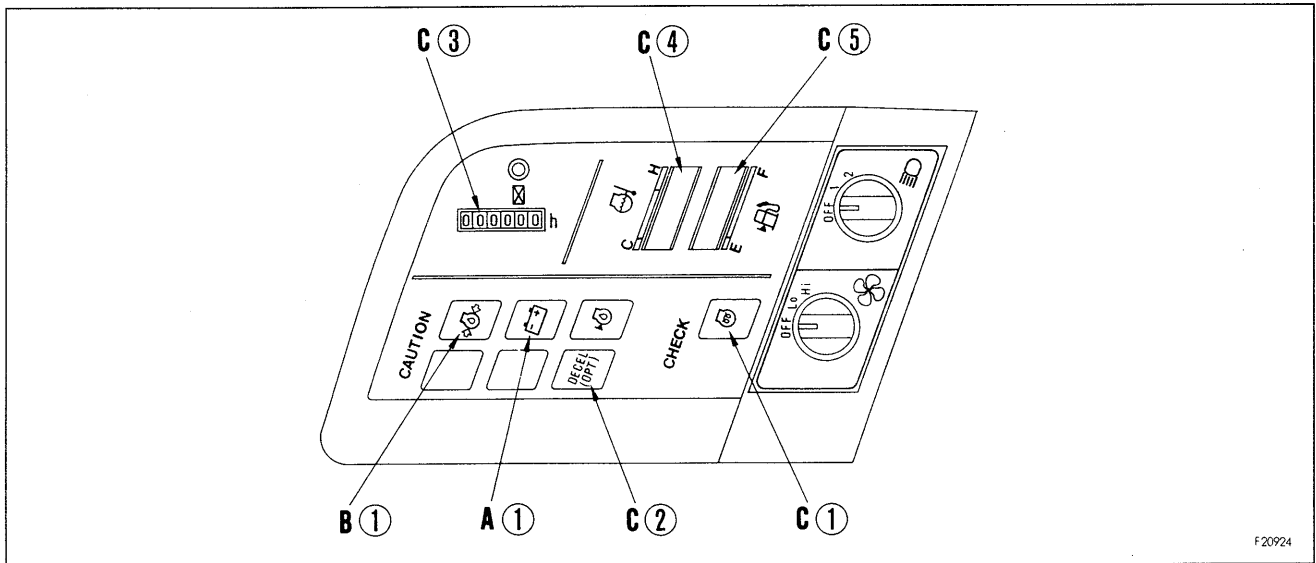

F20924

12.1.1 A: CAUTION ITEMS

CAUTION

If the caution monitor lamp lights up, repair the problem as soon as possible.

1. CHARGE LEVEL

This monitor indicates an abnormality in the charging system while the engine is running.

If the monitor lamp lights up, check the V-belt tension. If any abnormality is found, see "16.5 OTHER TROUBLE".

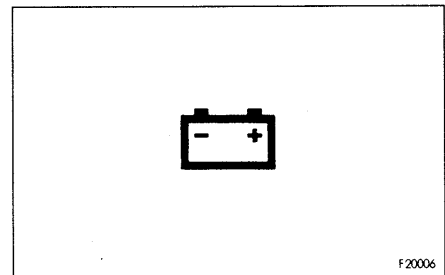

F20006

REMARK

- While the starting switch is ON, the lamp will remain lit and will go off once the engine is started.
- When the engine is started or stopped with the starting switch at the ON position, the lamp may light up and the buzzer may sound momentarily, but this does not indicate any abnormality.

11.1.2 B: EMERGENCY STOP ITEMS

⚠ CAUTION

If any monitor lamp lights up, stop the engine or run it at low idling, and take the following action.

1. ENGINE OIL PRESSURE

If the engine oil pressure drops below the normal pressure, the monitor lamp lights up. At this item, stop the engine and inspect it according to "16.5 OTHER TROUBLE."

REMARK

This lamp lights up when the start switch is turned on, and goes off when the engine starts. When the engine is started, this lamp may go off and the buzzer may sound momentarily, however, this does not indicate a problem.

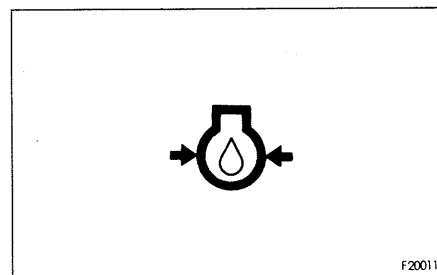

11.1.3 C: METER DISPLAY PORTION

1. ENGINE PRE-HEATING MONITOR

This monitor lamp indicates the pre-heating time required when starting the engine at an ambient temperature below 0°C.

The monitor lamp lights when the starting switch is turned to HEAT position and flashes after about 18 seconds to show that the pre-heating is completed.

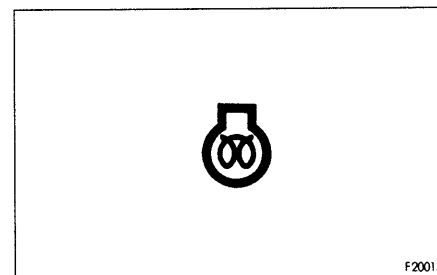

2. AUTO-DECELERATION MONITOR (Optional)

This monitor indicates that the auto-deceleration is working and lights up while it is in operation.

Actuated: Lights up

This monitor lights up when the control levers and pedals are at the neutral positions.

REMARK

The auto-deceleration system lowers the engine speed while the machine is not working or traveling.

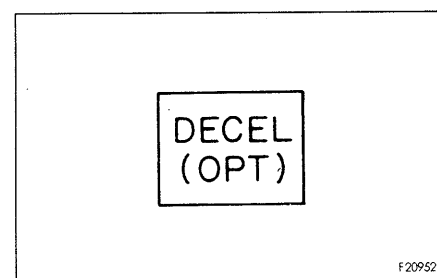

3. SERVICE METER

This meter shows the total operation hours of the machine. Set the periodic maintenance intervals using this display. The service meter advances while the engine is running - even if the machine is not traveling.

While the engine is running, operation display ① at the top inside of the meter will light to show that the meter is advancing.

The meter will advance by 1 for each hour of operation regardless of the engine speed.

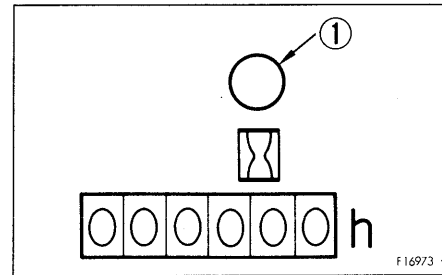

4. ENGINE WATER TEMPERATURE GAUGE

This displays the engine cooling water temperature. During normal operation, the lamp should light up in the green range.

If the lamp in the red range lights up during operation, run the engine at low idling and wait for the temperature to go down to the green range.

After starting the engine, warm up it until the green range lights up.

If the red range lights up, the alarm buzzer sounds.

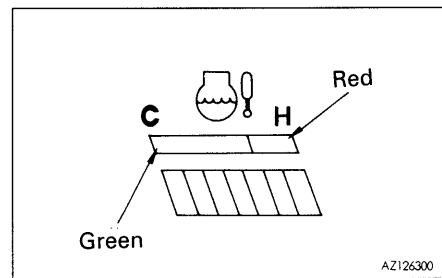

5. FUEL GAUGE

This shows the fuel level in the fuel tank. During normal operation, the lamp should light up in the green range.

If the lamp in the red range lights up during operation, there is less than 8.3 liters (2.12 US gal, 1.83 UK gal) of fuel remaining, so check and add fuel.

The correct level may not be displayed for a short time after the starting switch is turned to the ON position, but this is not an abnormality.

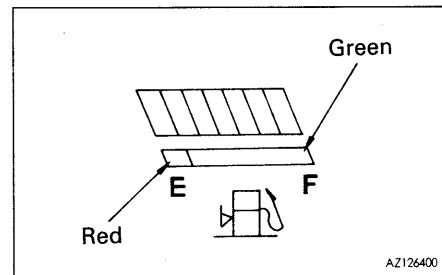

11.2 SWITCHES

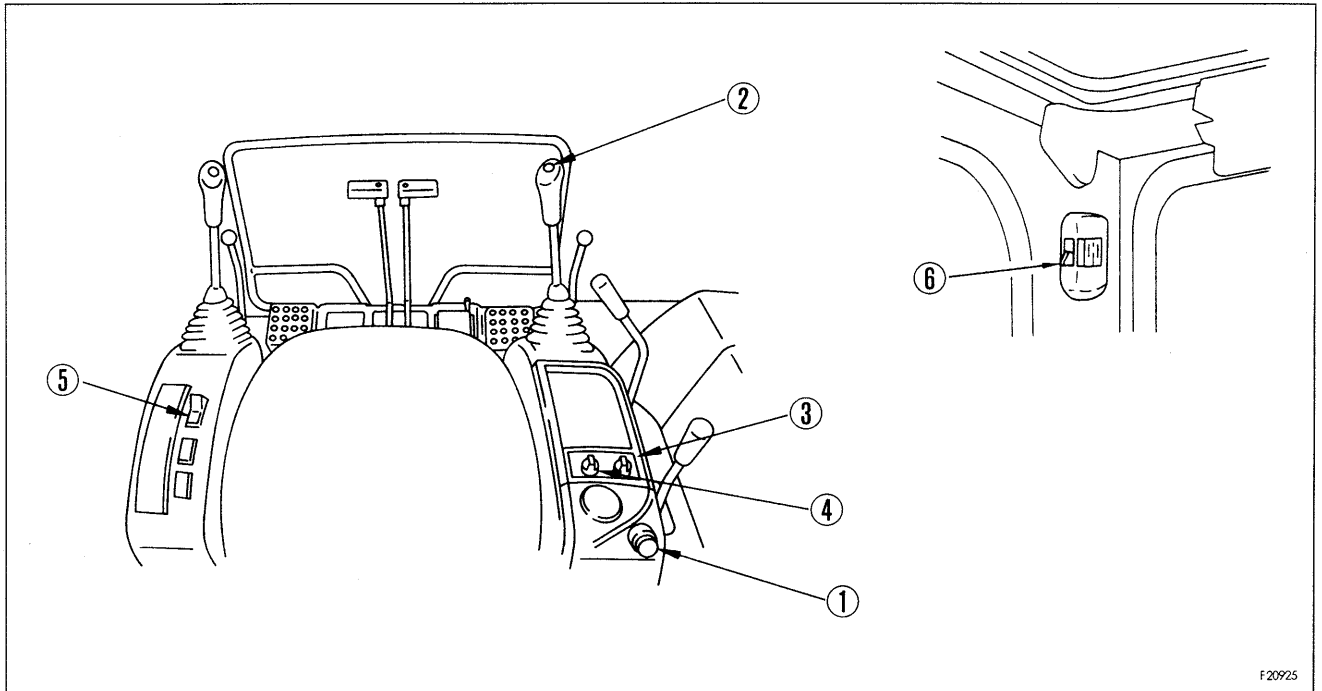

1. STARTING SWITCH

This switch is used to start or stop the engine.

OFF position

The key can be inserted or withdrawn. Except for the cab lamp, the switches for the electric system are all turned off and the engine is stopped.

ON position

Electric current flows in the charging and lamp circuits. Keep the starting switch key at the ON position while the engine is running.

START position

This is the engine-start position. Keep the key at this position during cranking. Immediately after starting the engine, release the key which will automatically return to the ON position.

HEAT (preheat) position

When starting the engine in winter, set the key to this position. When the key is set to the HEAT position, the pre-heating monitor lights up. Keep the key at this position until the monitor lamp flashes. Immediately after the pre-heating monitor flashes, release the key. The key automatically returns to the OFF position. Then, start the engine by turning the key to the START position.

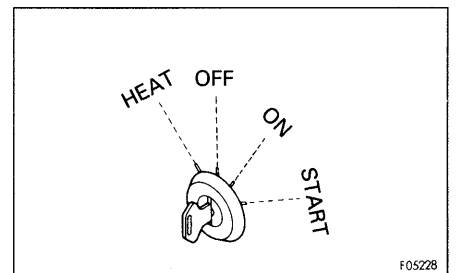

F05228

11. EXPLANATION OF COMPONENTS

2. HORN SWITCH

If the center of the right work equipment control lever knob is pressed, the horn sounds.

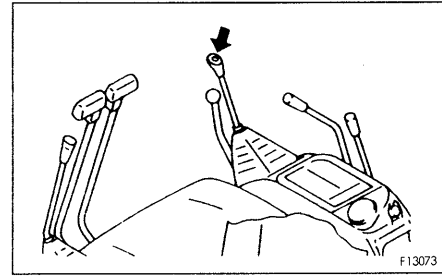

3. LAMP SWITCH

This lights up the head lamps and the panel lamp.

Position 1: Panel lamp lights up.

Position 2: Head lamps and panel lamp light up.

Position OFF: Lamps go off.

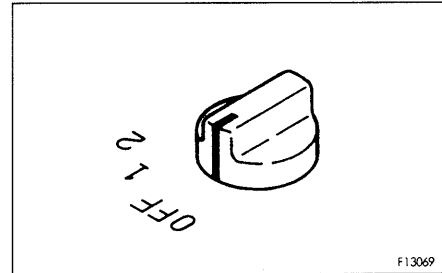

4. CAB HEATER SWITCH (MACHINES EQUIPPED WITH CAB)

This switch is used to heat the operator's compartment. The flow rate of the hot air can be set to two levels.

Hi position: Strong

Lo position: Weak

OFF position: Cab heater is stopped.

The cab is heated by hot water from the engine, so if the engine cooling water temperature is low, the cab will not heat up.

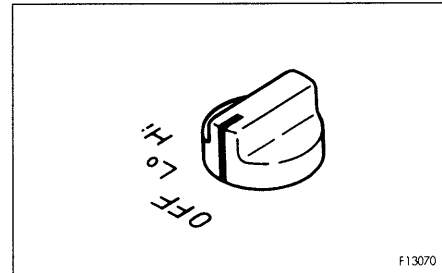

5. WIPER SWITCH (MACHINES EQUIPPED WITH CAB)

This switch actuates the front window wiper.

① OFF: The wiper stops.

② ON: The wiper moves continuously.

REMARK

If the window washer system is installed, the washer fluid is sprayed out when the wiper switch is pushed in further from the ON position.

Be careful of the following when operating this system.

- Do not keep the switch pressed at the washer spray position for more than ten seconds continuously.
- Do not press the switch to the washer spray position if the washer fluid container is empty.

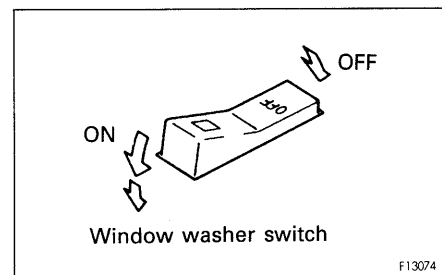

6. CAB LAMP SWITCH

This lights up the cab lamp.
ON position: Lights up

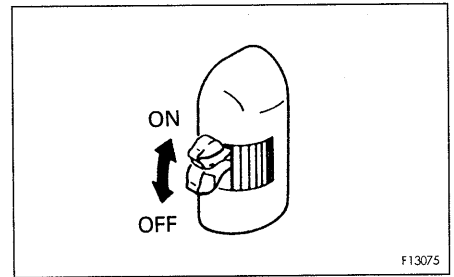

11.3 CONTROL LEVERS AND PEDALS

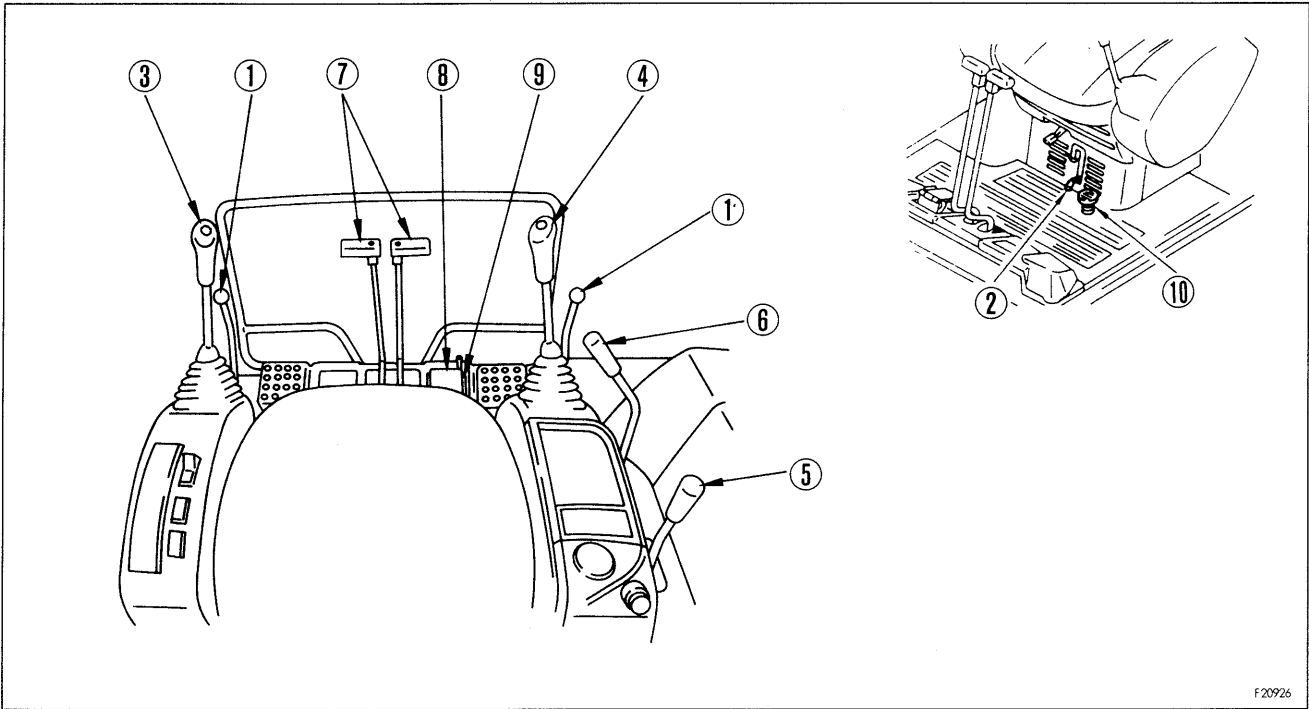

1. LOCK LEVER (FOR LEFT AND RIGHT WORK EQUIPMENT LEVERS)

WARNING

- When leaving the operator's compartment, set the safety lever securely to the LOCK position. If the gear shift lever is not locked, and it is touched by mistake, this may lead to a serious accident.
- If the safety lever is not placed securely in the LOCK position, the control lever may not be properly locked. Check that the situation is as shown in the diagram.

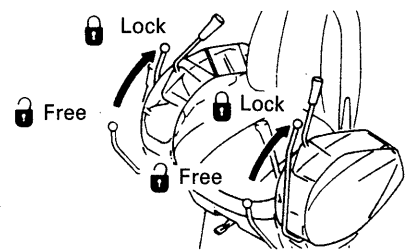

F13107

WARNING

- Even when the lock lever is in the lock position, it does not lock the blade.
- When pulling the lock lever up, be careful not to touch the work equipment control lever. If the lock lever is not pulled up fully, there is danger that the work equipment or swing may move.

WARNING

When the safety lock lever is lowered, take care not to touch the work equipment control lever.

This lever locks the work equipment control and swing systems. When the lever is pulled up, the lever stand springs up and is locked.

Since left and right lock levers are coupled with each other, the operator can use either one.

This lock lever is a hydraulic lock type, so it is possible to move the work equipment control levers even when it is in the lock position, but the work equipment and swing motors will not move.

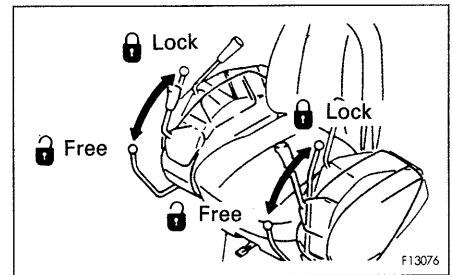
**2. SWING LOCK LEVER****WARNING**

When the machine is traveling under its own power, or when the swing is not being operated, always set the swing lock lever to the LOCK position.

NOTICE

Do not attempt to rotate the upper works, when the swing lock lever is in the lock position.

This lever is used to lock the upper structure so that it cannot swing.

When the lever is pulled up, the lock is released.

When setting the lever to the LOCK position, always set the upper structure and track frame parallel and push the lever down fully.

If the upper structure and track frame are not parallel, the lock is not applied even if the lever is set to the LOCK position.

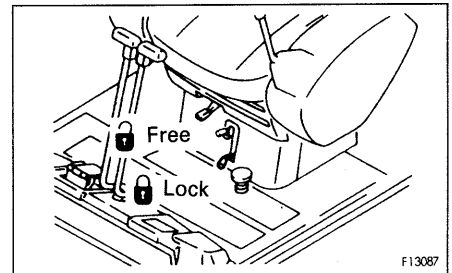

11. EXPLANATION OF COMPONENTS

3. LEFT WORK EQUIPMENT CONTROL LEVER

This lever is used to operate the arm and upper structure.

Swing operation Arm operation

- Ⓐ Swing to right Ⓒ Arm IN
- Ⓑ Swing to left Ⓓ Arm OUT

N (Neutral)

When the lever in this position, the upper structure and the arm will be retained in the position in which they stop.

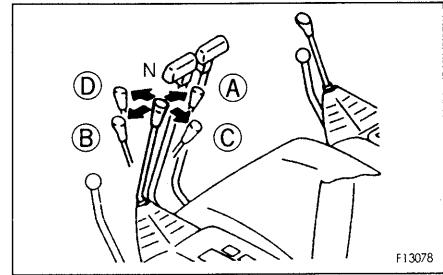

4. RIGHT WORK EQUIPMENT CONTROL LEVER

This lever is used to operate the boom and bucket.

Boom operation Bucket operation

- ① RAISE ③ DUMP
- ② LOWER ④ CURL

N (Neutral)

When the lever in this position, the boom and the bucket will be retained in the position in which they stop.

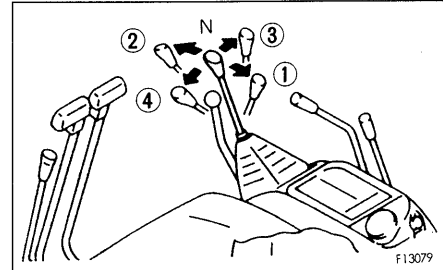

5. FUEL CONTROL LEVER

This lever is used to control the engine speed and output.

- ① Low idling position: Push the lever fully.
- ② High idling position: Pull the lever fully.

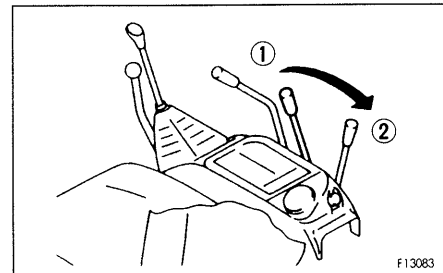

6. BLADE CONTROL LEVER

NOTICE

This lever is not locked even when the lock lever is at the LOCK position, so when not operating the blade, be careful not to touch this lever.

This lever is used to control the blade.

- ① LOWER
- ② RAISE

N (Neutral): Blade is stopped and held in this position.

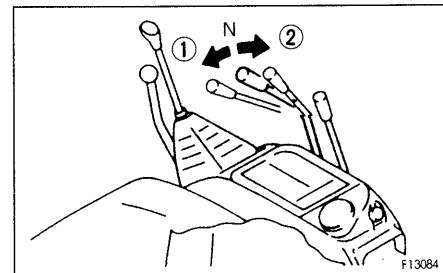

7. TRAVEL LEVERS

WARNING

When the track frame is facing the rear, the direction of the travel operation is reversed.
 Before operating the travel lever, check if the track frame is facing the front or the rear.
 (The track frame is facing the front if the sprocket is at the rear.)

- ① FORWARD:
The lever is pushed forward
- ② REVERSE:
The lever is pulled back
- N (Neutral): The machine stops

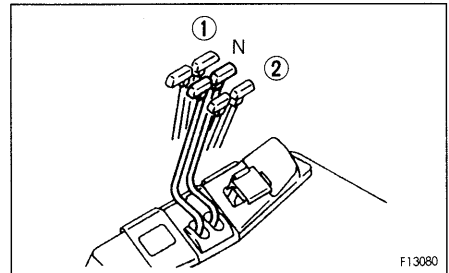
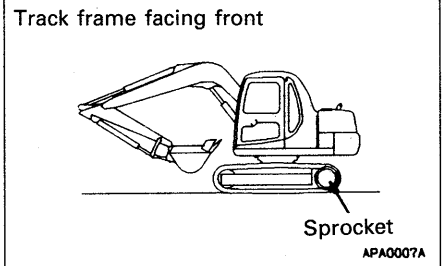

8. PEDAL LOCK (For boom swing pedal)

WARNING

When boom swing operation is not required, lock the boom with the pedal lock.
 If the operation pedal is accidentally pressed while it is not locked, a serious accident may occur.

This device is used to lock the boom swing pedal. If the plate is laid over the pedal, the pedal is locked.

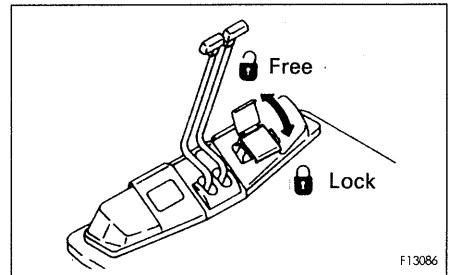

9. BOOM SWING CONTROL PEDAL

This pedal is used to swing the boom.

- ①: Boom swings to the right.
- ②: Boom swings to the left.
- N (Neutral): Boom is stopped and held in this position.

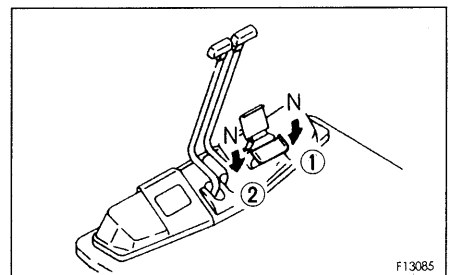

10. TRAVELING ACCELERATOR PEDAL

If the pedal is depressed, the machine speed will increase.

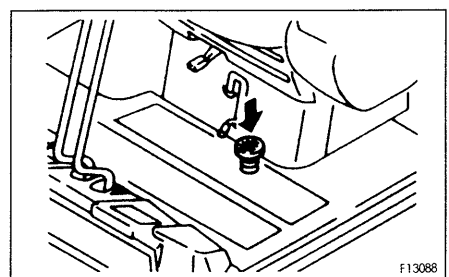

11.4 ENGINE HOOD

CAUTION

When carrying out inspection or maintenance inside the engine hood, always use the hood support lever to keep the engine hood open.

1. Pull engine hood knob ① to release the lock.

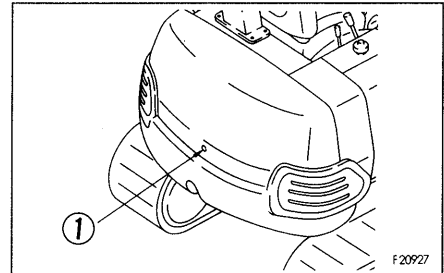

2. Push hood ② up, then fix the hood in position with hood support lever ③.

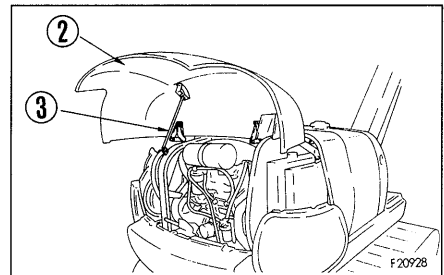

3. To close hood ②, remove hood support lever ③, secure it firmly in the lever lock, then lower the hood slowly and push the hood down to apply the lock.

NOTICE

For vandalism protection, be sure to keep the hood locked, except for when it needs to be opened for a particular reason.

It is possible to check if the lock is applied by looking at the direction of the key groove in the open knob.

REMARK

When the hood is locked, the hood knob will not move.

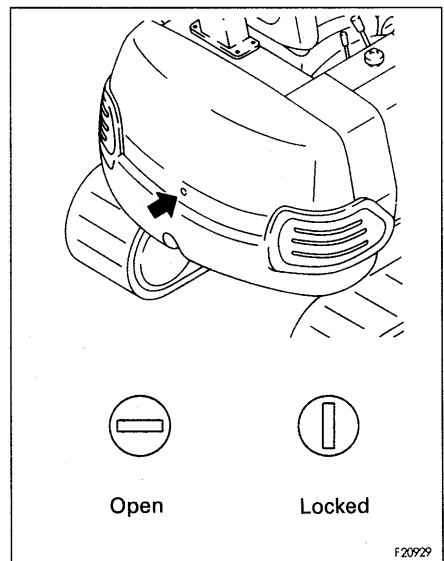

11.5 FRONT WINDOW (MACHINES EQUIPPED WITH CAB)

⚠ WARNING

When opening the front window, always hold the grip firmly with both hands and pull up. If you use only one hand, your hand may slip and get caught.

It is possible to store (pull up) the front window (top) in the roof of the operator's compartment.

When opening

⚠ WARNING

When the front window is open, there is danger that it will fall, so always lock it with left and right lock pins (A).

1. Stop the machine on flat ground, lower the work equipment to the ground, and stop the engine.
2. Set the lock lever for the work equipment control levers securely to the LOCK position.
3. Disconnect the wiring for the wiper motor from socket (B).

NOTICE

If it is attempted to open the front window without disconnecting the wiring, the wiring will be torn off.

4. Pull lock pins (A) at the top left and right sides of the front window to the inside to release the lock.

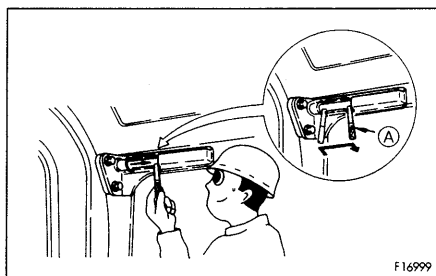
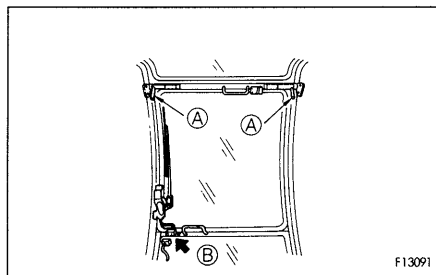
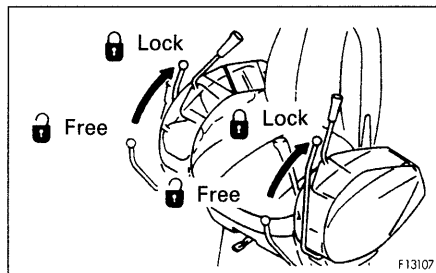
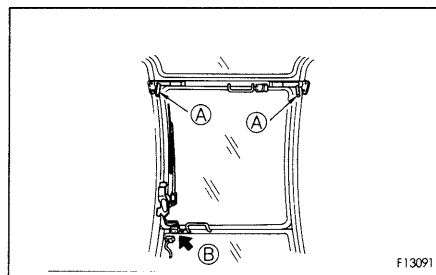

11. EXPLANATION OF COMPONENTS

5. From the inside of the operator's cab, hold the bottom grip with the left hand and the top grip with the right hand, pull up the window, and push it in fully until it is locked by catch ③.

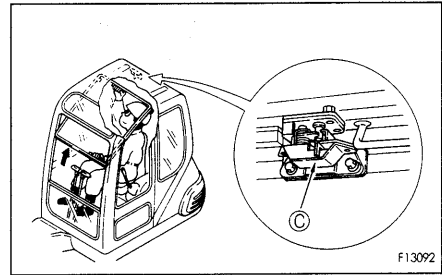

6. Lock with lock pins ① on the left and right sides.

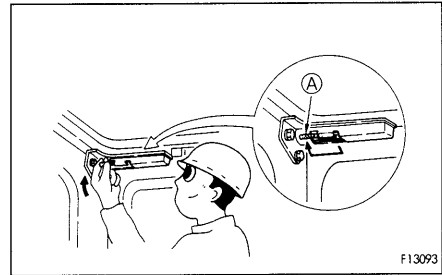

When closing

WARNING

When closing the window, lower it slowly and be careful not to get your hand caught.

1. Place the work equipment on a flat ground and stop the engine.
2. Securely lock the safety lock lever.

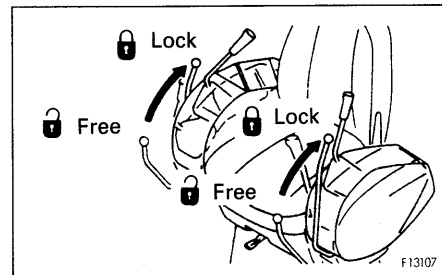

3. Release the lock pin ①.

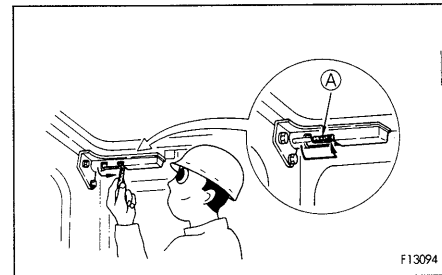

4. Hold the grip at the bottom of the front window with your left hand and the grip at the top with your right hand, release the lock of catch ③ with your right thumb, then pull the top grip slowly and lower the front window. When releasing the lock of catch ③, push release lever ④ in the direction of the arrow to release the lock.

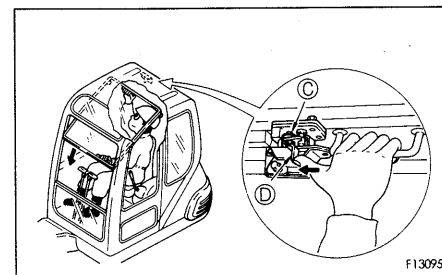

5. Lock securely with lock pins ① at the left and right sides.
6. Connect the wiper motor wiring to socket ②.

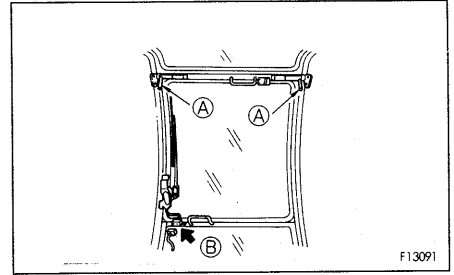

Removing front window (bottom)

With the front window open, remove lock pins ③, and the bottom part of the front window can be removed.

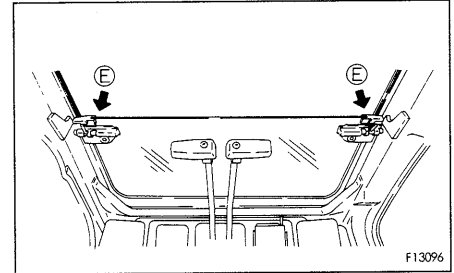

Store the removed bottom part of the front window at the rear of the operator's cab.

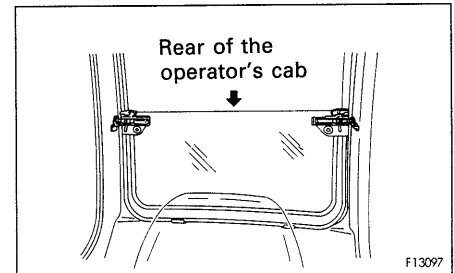

11.6 DOOR LOCK

Use the door lock to fix the door in position after opening it.

1. The door will become fixed in place when it is pressed against catch ①.
2. When unlocking the door, pull lever ② on the left side of the operator's seat to release the catch. When fixing the door, fix it firmly to the catch.

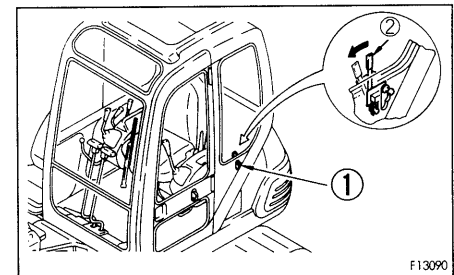

11.7 FUSE

NOTICE

Before replacing a fuse, be sure to turn off the starting switch.

The fuses protect the electrical equipment and wiring from burning out.

If the fuse becomes corroded, or white powder can be seen, or the fuse is loose in the fuse holder, replace the fuse.

Replace a fuse with another of the same capacity.

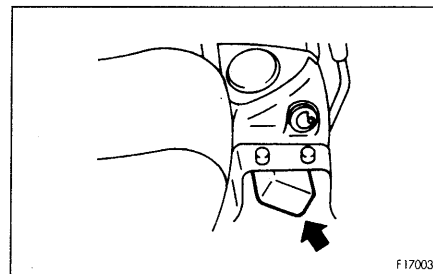

Fuse capacity and name of circuit

No.	Fuse capacity	Name of circuit
①	10 A	Spare fuse
②	10 A	Engine control system, valve for work equipment lever lock
③	20 A	Monitor panel, *wiper, *heater, *room lamp, *radio (opt)
④	20 A	Head lamp, travel selector valve
⑤	30 A	Engine control system

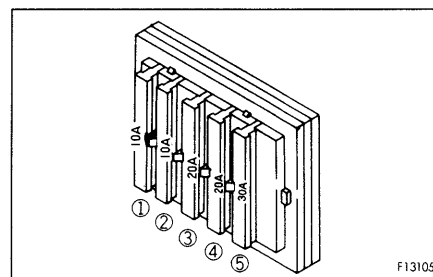

* These items are only for the cab specification machine.

11.8 FUSIBLE LINK

If the power does not come on when the starting switch is turned to the ON position, the wire-shaped fusible link ① may be cut, so remove the cover on the right side of the chassis, and check or replace.

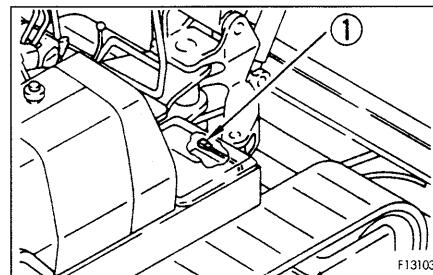

REMARK

A fusible link is a large fuse wire installed in a circuit where there is a large current flowing.

It acts in the same way as a normal fuse to prevent electrical components and wiring from burning out if there is an abnormal current.

11.9 CAP, COVER WITH LOCK

The fuel filler, operator's cab, engine hood and battery cover are fitted with locks.

Use the starting switch key to lock or unlock these places.

11.9.1 METHOD OF OPENING AND CLOSING CAP WITH LOCK (For the fuel tank filler port)

To open the cap

1. Insert the key into the cap.
2. Turn the key counterclockwise, align the match mark on the cap with the rotor groove, then remove the cap.

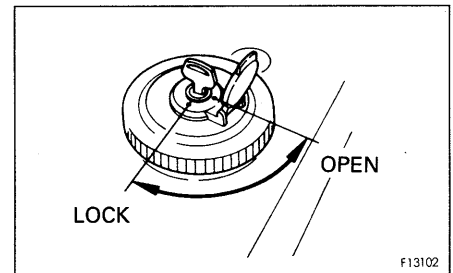

To lock the cap

1. Turn the cap into place.
2. Turn the key clockwise and take the key out.

Insert the key as far as it will go. If the key is turned before it is inserted all the way, it may break.

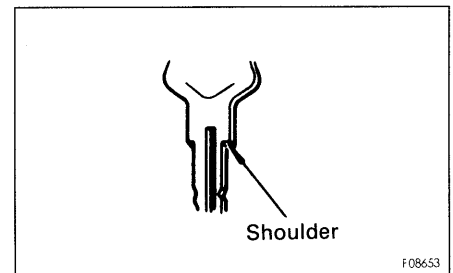

11.10 CANOPY (MACHINES EQUIPPED WITH CANOPY)

WARNING

When transporting the canopy retracted, be sure to secure it with ropes.
When installing the canopy to the machine, tighten the canopy mounting bolts securely. If these are loose, there is danger that the canopy may come off.

Tightening torque of canopy mounting bolts:
279.5 Nm (28.5 kgm, 206 lbft)

The canopy can be retracted for transportation and the overall height reduced by about 320 mm (12.6 in).

Retraction method

1. Tilt back sheet ① forward.
2. Remove mounting bolts ③ (four bolts) of canopy ② and tilt canopy forward.
3. Secure the canopy with ropes so that it will not be dislodged by wind.

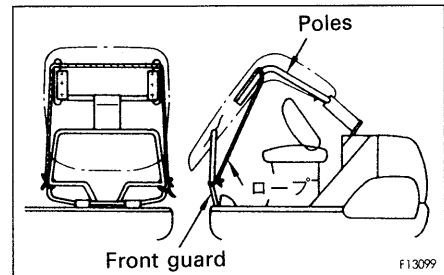
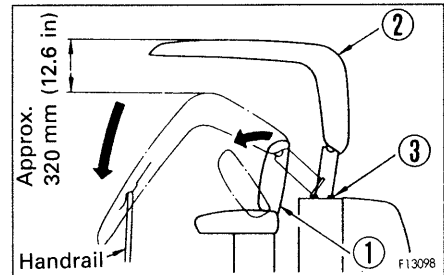

12. OPERATION

12.1 CHECK BEFORE STARTING ENGINE

12.1.1 WALK-AROUND CHECK

⚠ WARNING

If you open the engine hood, always lock the hood in position securely with hood support lever ①.

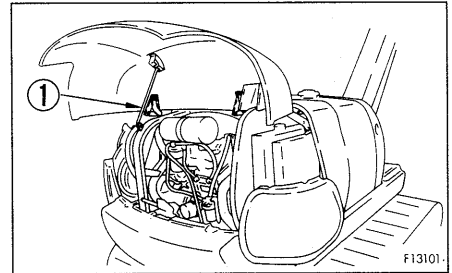

⚠ WARNING

Leakage of oil or fuel, or accumulation of flammable material around high temperature parts, such as the engine muffler may cause fire.
Check carefully, and if any abnormality is found, repair it or contact your Komatsu distributor.

Before starting the engine, look around the machine and under the machine to check for loose nut or bolts, or leakage of oil, fuel, or coolant, and check the condition of the work equipment and hydraulic system. Check also for loose wiring, play, and collection of dust at places which reach high temperatures.

Always carry out the items in this section before starting the engine each day.

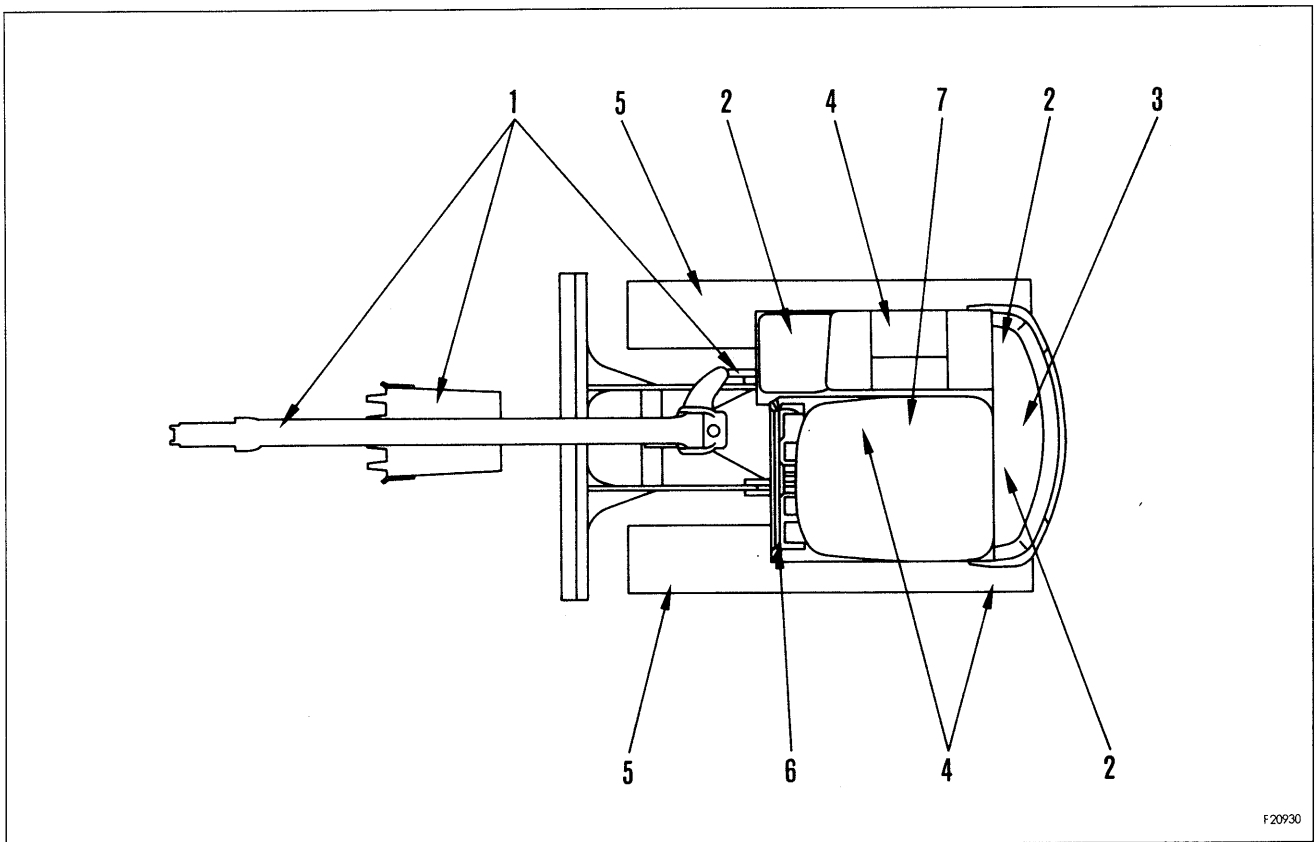

- 1. Check for damage, wear, play in work equipment, cylinders, linkage, hoses**
Check that there are no cracks, excessive wear, or play in the work equipment, cylinders, linkage, or hoses. If any abnormality is found, repair it.
- 2. Remove dirt and dust from around engine, battery, radiator**
Check if there is any dirt or dust accumulated around the engine or radiator. Check also if there is any flammable material (dead leaves, twigs, grass, etc.) accumulated around the battery or high temperature engine parts, such as the engine muffler or turbocharger. Remove all such dirt or flammable material.
- 3. Check for leakage of water or oil around engine**
Check that there is no leakage of oil from the engine or leakage of water from the cooling system. If any abnormality is found, repair it.
- 4. Check for oil leakage from hydraulic equipment, hydraulic tank, hoses, joints**
Check that there is no oil leakage. If any abnormality is found, repair the place where the oil is leaking.
- 5. Check the undercarriage (track, sprocket, idler, guard) for damage, wear, loose bolts, or leakage of oil from rollers**
- 6. Check for damage to handrail, loose bolts**
Repair any damage and tighten any loose.
- 7. Check for damage to gauges, monitor, loose bolts**
Check that there is no damage to the gauges and monitor in the operator's cab. If any abnormality is found, replace the parts. Clean off any dirt on the surface.

12.1.2 CHECK BEFORE STARTING

Always carry out the items in this section before starting the engine each day.

CHECK COOLANT LEVEL, ADD WATER

WARNING

Do not open the radiator cap unless necessary. When checking the coolant, always check the radiator reserve tank when the engine is cold.

1. Open the engine hood and check that the cooling water level is between the FULL and LOW marks on radiator reserve tank ① (shown in the diagram on the right). If the water level is low, add water through the water filler of reserve tank ① to the FULL level.
2. After adding water, tighten the cap securely.
3. If the reserve tank becomes empty, first inspect for water leaks and then fill the radiator and the reserve tank with water.

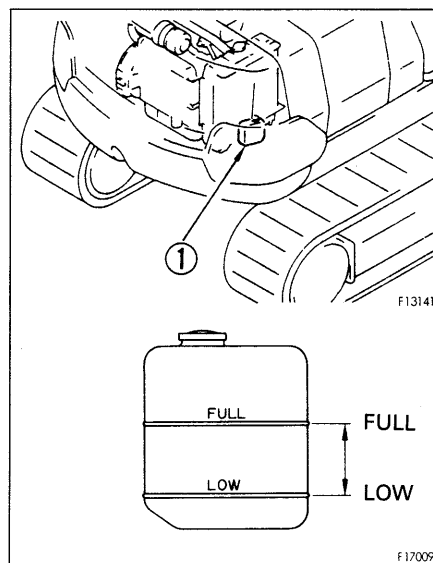

CHECK OIL LEVEL IN ENGINE OIL PAN, ADD OIL

1. Open the engine hood.
2. Remove dipstick ⑥ and wipe the oil off with a cloth.
3. Insert dipstick ⑥ fully in the oil filler pipe, then take it out again.
4. The oil level should be between the H and L marks on dipstick ⑥.
If the oil level is below the L mark, add engine oil through oil filler ⑦.

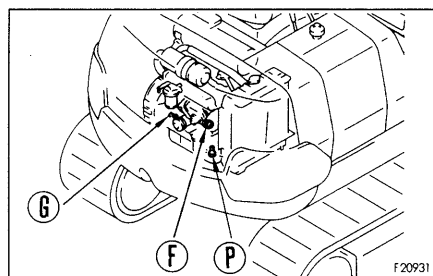

For details of the oil to use, see "20. USE OF FUEL, COOLANT AND LUBRICANTS ACCORDING TO AMBIENT TEMPERATURE".

5. If the oil is above the H mark, drain the excess engine oil from drain plug ⑧, and check the oil level again.
6. If the oil level is correct, tighten the oil filler cap securely and close the engine hood.

REMARK

When checking the oil level after the engine has been operated, wait for at least 15 minutes after stopping the engine before checking.

If the machine is at an angle, make it horizontal before checking.

CHECK FUEL LEVEL, ADD FUEL

⚠ WARNING

When adding fuel, never let the fuel overflow. This may cause a fire. If spilling fuel, thoroughly clean up any spillage.

1. Insert the key in starting switch ①, and turn it to the ON position to light up the monitor.
2. Check the fuel level on fuel gauge ②. If the fuel level is low, add fuel through filler port ④.

Fuel capacity: 50 ℓ (13.2 US gal, 11.0 UK gal)

For details of the fuel to use, see "20. USE OF FUEL, COOLANT AND LUBRICANTS ACCORDING TO AMBIENT TEMPERATURE".

3. After adding fuel, tighten the cap securely.

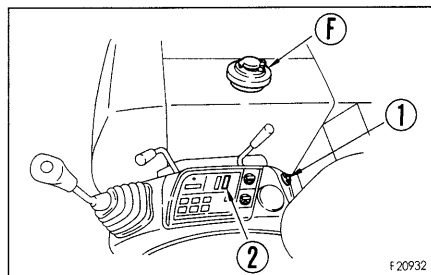

REMARK

If breather hole ③ on the cap is clogged, the pressure in the tank will drop and fuel will not flow. Clean the hole from time to time.

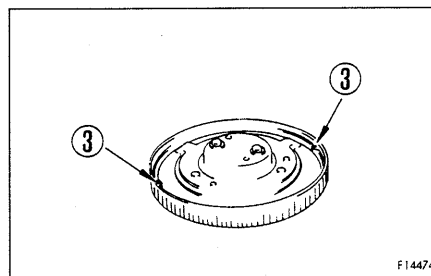

CHECK OIL LEVEL IN HYDRAULIC TANK, ADD OIL

⚠ WARNING

- When removing the oil filler cap, oil may spurt out, so turn the cap slowly to release the internal pressure before removing the cap.
- If oil has been added to above the H mark, stop the engine and wait for the hydraulic oil to cool down, then drain the excess oil from the drain plug.

1. If the work equipment is not in the condition shown in the diagram on the right, start the engine, run the engine at low speed, lower the blade, retract the arm and bucket cylinders, then lower the boom, set the bucket teeth in contact with the ground, and stop the engine.

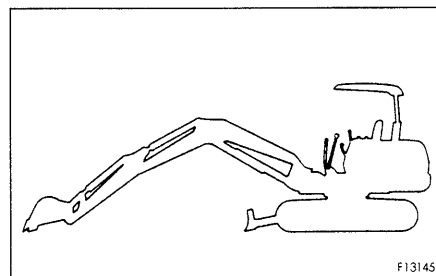

2. Remove cover ① and check sight gauge ②. The oil level is normal if between the H and L marks.

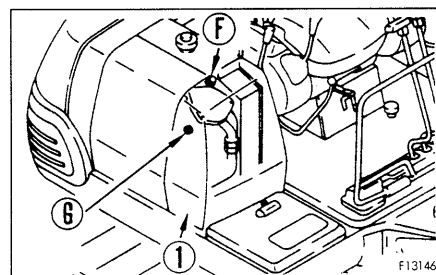
**NOTICE**

Do not add oil if the level is above the H line. This will damage the hydraulic equipment and cause the oil to spurt out.

3. If the level is below the L mark, remove the upper cover of the hydraulic tank on the right side of the machine and add oil through oil filler ③.

For details of the oil to use, see "20. USE OF FUEL, COOLANT AND LUBRICANTS ACCORDING TO AMBIENT TEMPERATURE".

REMARK

The oil level will vary depending upon the oil temperature. Accordingly, use the following as a guide:

- Before operation: around L level (Oil temperature 10 to 30°C (50 to 86°F))
- Normal operation: around H level (Oil temperature 50 to 80°C (122 to 176°F))

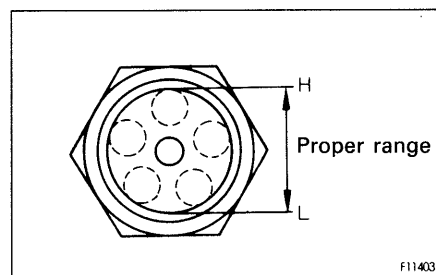

CHECK DUST INDICATOR

1. Open the engine hood and check that the red piston is not showing in dust indicator ①.
2. If the red piston has appeared, clean or replace the element immediately.
For details of the method of cleaning the element, see "24.2.1 CHECK, CLEAN AND REPLACE AIR CLEANER ELEMENT".
3. After checking, cleaning, and replacing, press the knob of dust indicator ① to return the red piston to its original position.

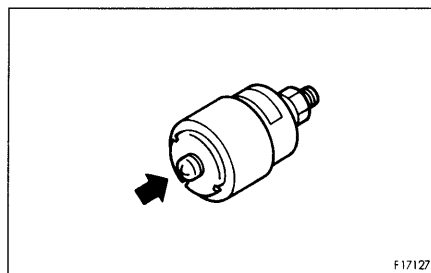
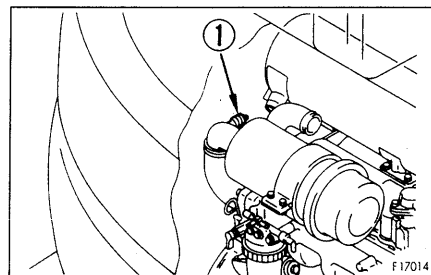

CHECK WATER SEPARATOR

If red ring ① of the water separator is at the bottom of case ②, there is no water.

If red ring ① is floating, there is water up to the bottom of the ring, so drain the water as follows.

- Use a water separator filter wrench.
1. Open the engine hood.
 2. Set handle ③ to the CLOSED position.
 3. Using the filter wrench, loosen ring ④, then remove case ② and throw out the water inside it.
 4. Set case ② in position, then tighten ring ④ to install it.
 5. Set handle ③ to the OPEN position.
 6. Drain any water or sediment from the fuel tank. For details, see "24.2.3 DRAIN WATER, SEDIMENT FROM FUEL TANK".

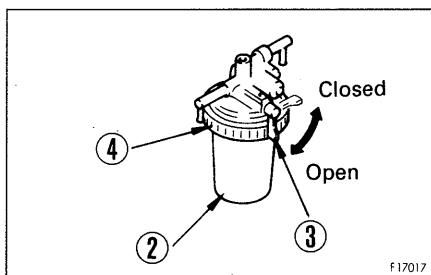
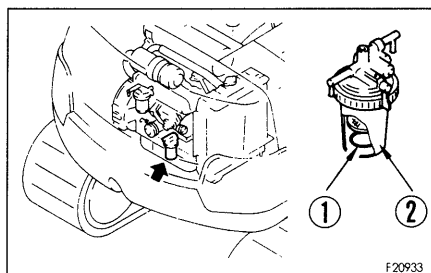

12.1.3 ADJUSTING BEFORE STARTING OPERATION

CAUTION

Adjust the seat position at the beginning of each shift or when operators change.

ADJUSTING OPERATOR'S SEAT

Ⓐ Fore-and-aft adjustment of operator's seat

The seat and the left and right console boxes slide to the front and rear.

Move lever ① to the right, set the operator's seat at the desired position, then release the lever.

Fore-and-aft adjustment: 80 mm (3.2 in) (5 stages)

Adjust the position of the operator's seat to match the operation. For example, when carrying out deep digging operations, slide the seat to the front to improve the view below the front of the machine.

Ⓑ Adjusting reclining angle of seat

Pull lever ② in the direction of the arrow, set the seat- back to the desired position, then release the lever.

REMARK

The position of the operator's seat cannot be adjusted in the forward and backward directions. It can also be reinstalled 40 mm (1.6 in) behind the standard position.

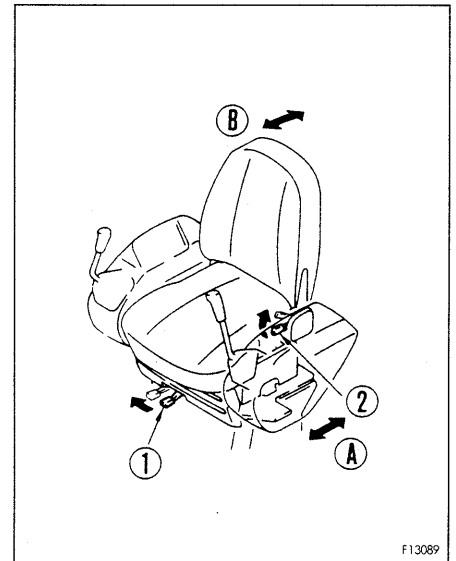

F13089

12.1.4 OPERATIONS AND CHECKS BEFORE STARTING ENGINE

WARNING

If the control lever is touched by accident, the work equipment or the machine may move suddenly. When leaving the operator's compartment, always set the safety lock lever securely to the LOCK position.

1. Check that safety lock lever ① is at the LOCK position.

2. Check the position of each lever.

3. Insert the key in starting switch ②, turn the key to the ON position, then carry out the following checks.

(1) The buzzer will sound for approx. 1 sec, and the following monitors and gauges will light up for approx. 3 sec.

- Engine oil pressure monitor ③
- Charge level monitor ④
- Engine water temperature monitor ⑤
- Fuel level monitor ⑥

If the monitors or gauges do not light up or the buzzer does not sound, there is probably a broken bulb or disconnection in the monitor wiring, so contact your Komatsu distributor for repairs.

After approx. 3 sec, the following gauges will remain on and the other monitors will go out.

- Engine water temperature gauge ⑤
- Fuel gauge ⑥

(2) Turn lamp switch ⑦ to turn on the head lamps.

If the lamps do not light up, there is probably a broken bulb or disconnection in the wiring, so contact your Komatsu distributor for repairs.

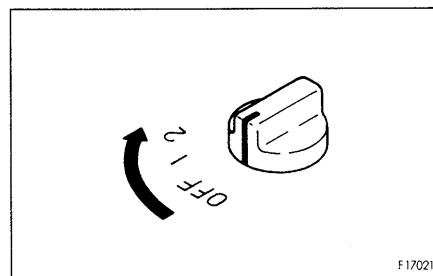
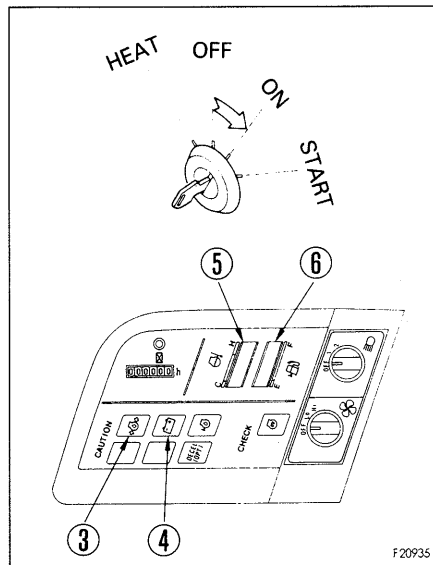
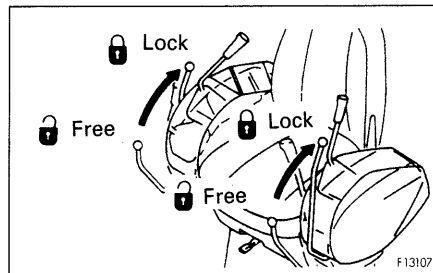
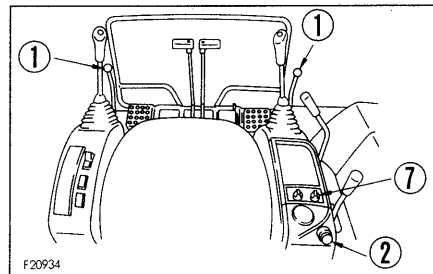

12.2 STARTING ENGINE

12.2.1 NORMAL STARTING

WARNING

Check that there are no persons or obstacles in the surrounding area, then sound the horn and start the engine.

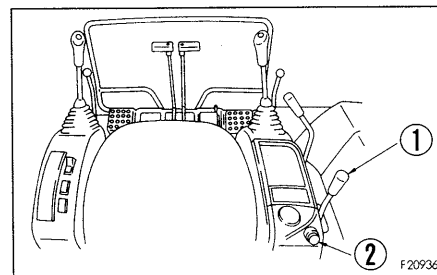

NOTICE

Do not keep the starting motor rotating continuously for more than 20 seconds.

If the engine will not start, wait for at least 2 minutes before trying to start the engine again.

1. Pull fuel control lever ① to the center position between LOW IDLING and HIGH IDLING.

REMARK

While the engine is warm, it can start with the fuel control lever at the LOW IDLING position.

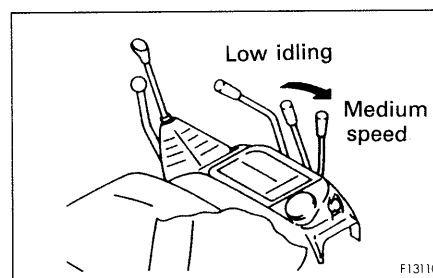

2. Turn the key in starting switch ② to the START position. The engine will start.

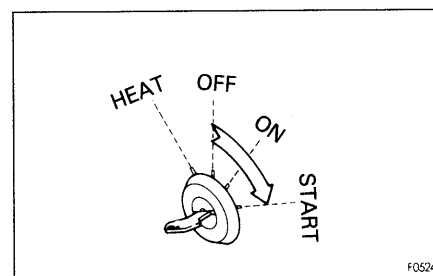

3. When the engine starts, release the key in starting switch ②. The key will return automatically to the ON position.

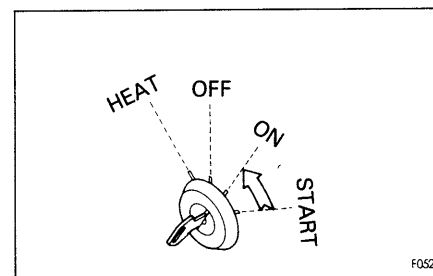

12.2.2 STARTING IN COLD WEATHER

⚠ WARNING

Check that there are no persons or obstacles in the surrounding area, then sound the horn and start the engine.

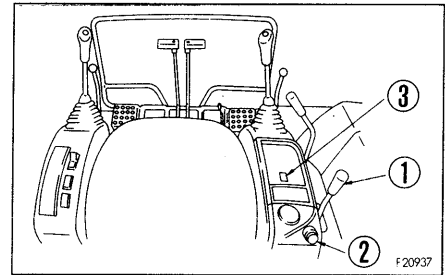

NOTICE

Do not keep the starting motor rotating continuously for more than 20 seconds.

If the engine fails to start, repeat steps from 2 and after waiting for about 2 minutes.

When starting in low temperatures, do as follows.

1. Pull fuel control lever ① to the HIGH IDLING position.

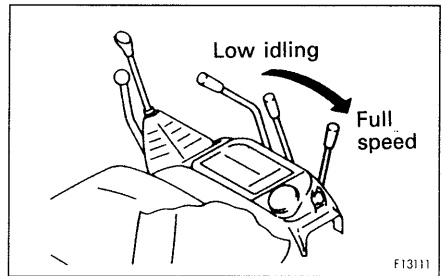

2. Hold the key in starting switch ② at the HEAT position, and check that preheating monitor ③ lights up. After approx. 18 seconds, preheating monitor ③ goes out to inform that the preheating is completed.

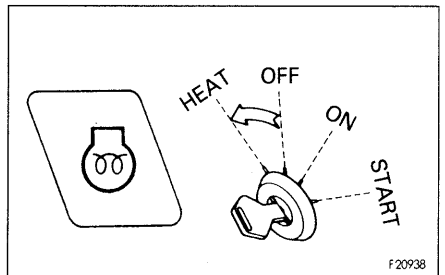

REMARK

The monitor and gauge also light up when the key is at the HEAT position, but this does not indicate any abnormality.

3. When preheating monitor ③ goes out, turn the key in starting switch ② to the START position to start the engine.

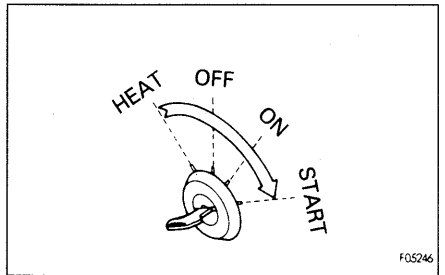

4. When the engine starts, release the key in starting switch ②. The key will return automatically to the ON position.

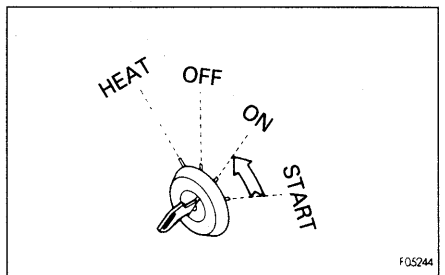

12.3 OPERATIONS AND CHECKS AFTER STARTING ENGINE

⚠ WARNING

- **Emergency stop**
If there has been any abnormal actuation or trouble, turn the starting switch key to the OFF position. The electrical system and engine will stop. Then contact your Komatsu distributor for inspection.
- If the work equipment is operated without warming the machine up sufficiently, the response of the work equipment to the movement of the control lever will be slow, and the work equipment may not move as the operator desires, so always carry out the warming-up operation. Particularly in cold areas, be sure to carry out the warming-up operation fully.

NOTICE

The most suitable temperature for the hydraulic oil is 50 – 80°C, but in order to extend the life of the machine, the temperature must be raised to at least 20°C before starting work.

NOTICE

Do not suddenly operate the levers when the hydraulic oil temperature is below 20°C.

NOTICE

Do not suddenly accelerate the engine before the warming-up operation is completed.

Do not run the engine at low idling or high idling continuously for more than 20 minutes.

If it is necessary to run the engine at idling, apply a load from time to time or run the engine at a mid-range speed.

After starting the engine, do not immediately start operations. First, carry out the following operations and checks.

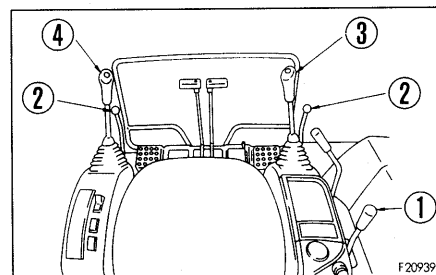

1. Pull fuel control lever ① to the center position between LOW IDLING and HIGH IDLING and run the engine at medium speed for about 5 minutes with no load.

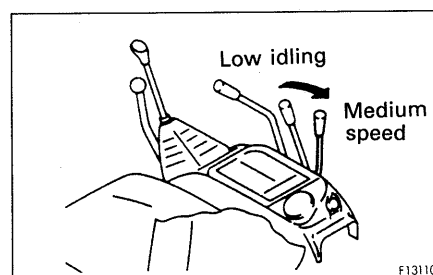

F13110

12. OPERATION

- Set lock lever ② to the FREE position, and raise the bucket from the ground.

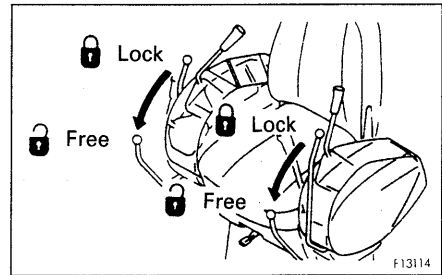

- Operate bucket control lever ③ and arm control lever ④ slowly to move the bucket cylinder and arm cylinder to the end of the stroke.

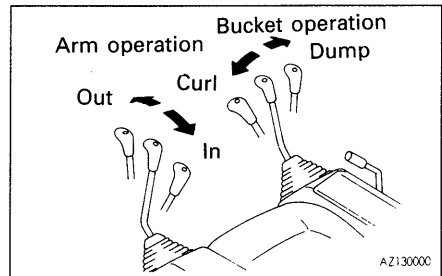

- Carry out bucket and arm operation for 5 minutes at full stroke, alternating between bucket operation and arm operation at 30 second intervals.

NOTICE

When the work equipment is retracted, take care that it does not interfere with the machine body or ground.

- After carrying out the warming-up operation, check that each gauge and monitor lamp is in the following condition.

- Engine water temperature gauge ⑤. Inside green range
- Fuel gauge ⑥. Inside green range
- Engine oil pressure monitor ⑦. OUT
- Charge level monitor ⑧. OUT

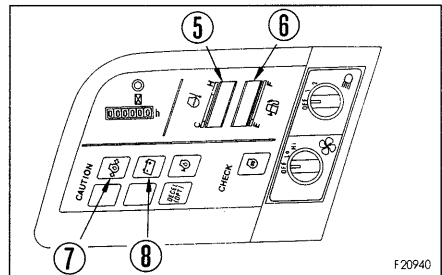

- Check that there is no abnormal exhaust gas color, noise, or vibration. If any abnormality is found, repair it.

- Set lock lever ② to the LOCK position and check that it is impossible to operate the swing and work equipment with the left and right work equipment control levers.

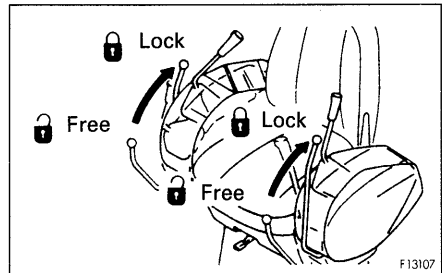

12.4 MOVING MACHINE OFF

12.4.1 MOVING MACHINE FORWARD

WARNING

- Before operating the travel levers, check the direction of the track frame. If the sprocket is at the front, the operation of the travel levers is reversed.
- When moving off, check that the area around the machine is safe, and sound the horn before moving.
- Clear all personnel from the machine and the area.
- Clear all obstacles from the path of the machine.

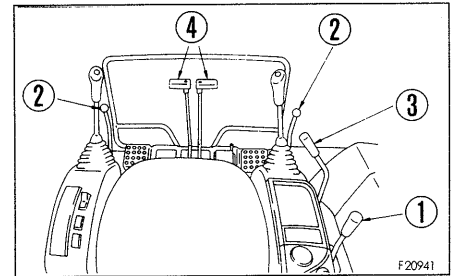

1. Pull fuel control lever ① towards the high idling position to increase the engine speed.

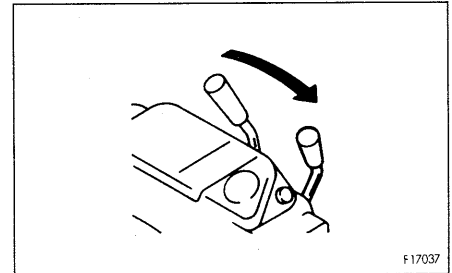

2. Set lock lever ② in the FREE position, fold the work equipment, and raise it 40 – 50 cm (16 to 20 in) from the ground.

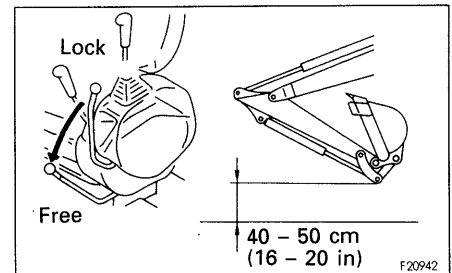

3. Pull blade control lever ③ to raise the blade.

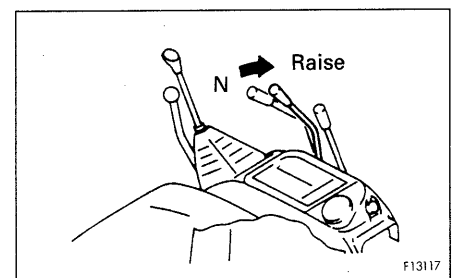

4. Operate right and left travel levers ④ as follows.

- **When the sprocket is at the rear of the machine**
Push levers ④ forward slowly to move the machine off.
- **When the sprocket is at the front of the machine**
Pull levers ④ backward slowly to move the machine off.

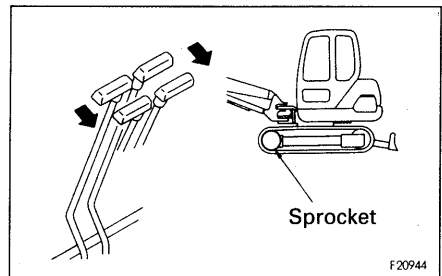
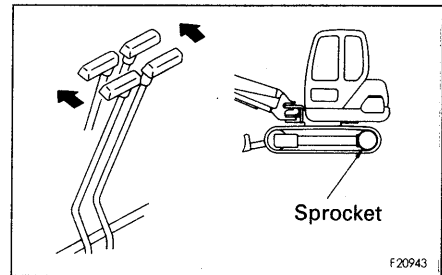

12.4.2 MOVING MACHINE BACKWARD

⚠ WARNING

- Before operating the travel levers, check the direction of the track frame. If the sprocket is at the front, the operation of the travel levers is reversed.
- When moving off, check that the area around the machine is safe, and sound the horn before moving.
- Clear all personnel from the machine and the area.
- Clear all obstacles from the path of the machine.
- Use extreme care when reversing the machine. Note there is an blind spot behind the machine.

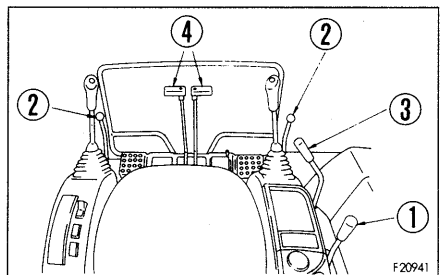

1. Pull fuel control lever ① towards the high idling position to increase the engine speed.

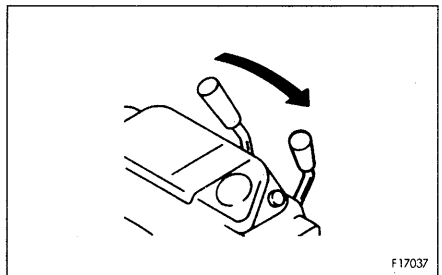

2. Set lock lever ② in the FREE position, fold the work equipment, and raise it 40 – 50 cm (16 to 20 in) from the ground.

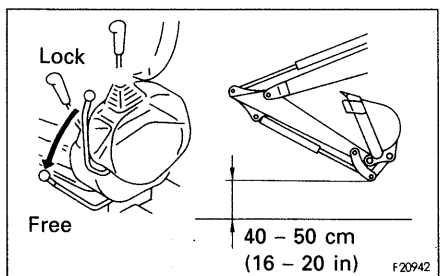

3. Pull blade control lever ③ to raise the blade.

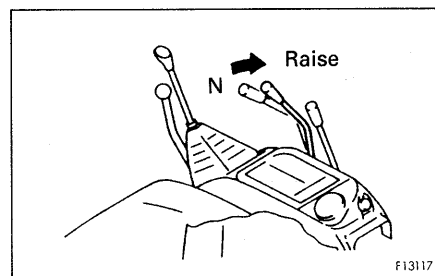

4. Operate right and left travel levers ④ as follows.

- **When the sprocket is at the rear of the machine**
Pull levers ④ backward slowly to move the machine off.

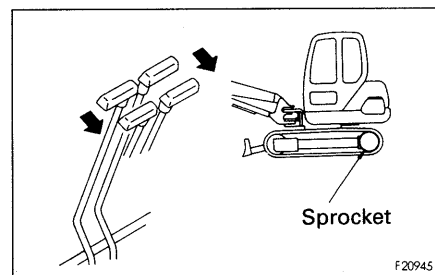

- **When the sprocket is at the front of the machine**
Push levers ④ forward slowly to move the machine off.

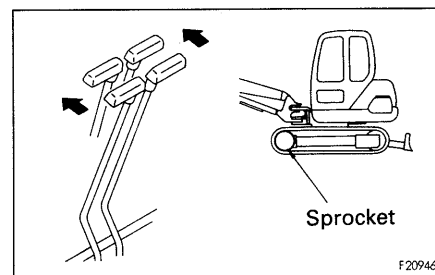

12.5 STEERING MACHINE

12.5.1 STEERING (CHANGING DIRECTION)

⚠ WARNING

Before operating the travel levers, check the position of the sprocket. If the sprocket is at the front, the operation of the travel levers is reversed.

Use the travel levers to change direction.

Avoid sudden changes of direction as far as possible. In particular, when carrying out counter-rotation (spin turn), stop the machine first before turning.

Operate two travel levers ① as follows.

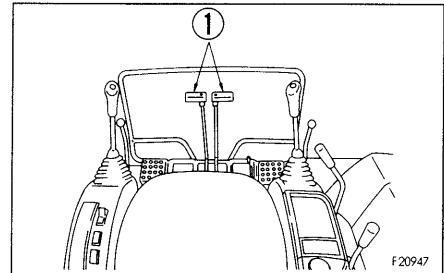

Changing direction of machine when stopped

When turning to the left:

Push the right travel lever forward to travel left when traveling forward; and pull it back to turn left when traveling in reverse.

REMARK

When turning to the right, operate the left travel lever in the same way.

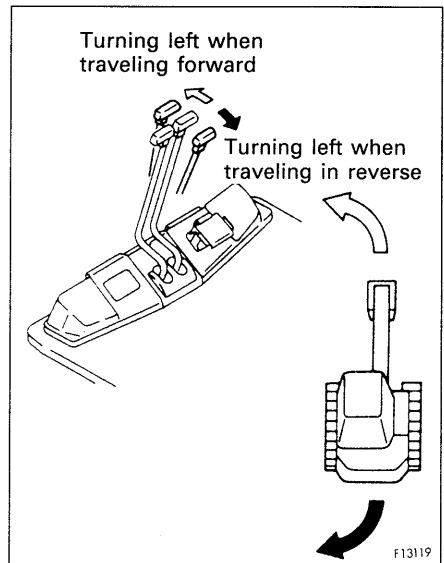

Steering when traveling (left and right travel levers both operated in same direction)

When turning to the left:

If the left travel lever is returned to the neutral position, the machine will turn to the left.

REMARK

When turning to the right, operate the right travel lever in the same way.

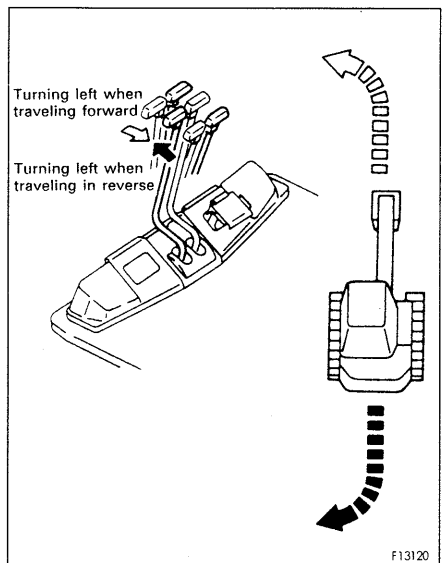

When making counter-rotation turn (spin turn)

When turning left using counter-rotation, pull the left travel lever back and push the right travel lever forward.

REMARK

When turning right using counter-rotation, pull the right travel lever back and push the left travel lever forward.

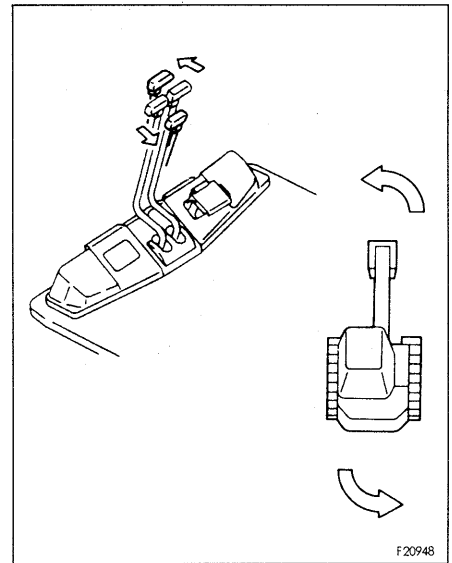

12.6 STOPPING MACHINE

⚠ CAUTION

- Avoid stopping suddenly. Give yourself ample room when stopping.

⚠ WARNING

- When stopping the machine, select flat hard ground and avoid dangerous places. If it is unavoidably necessary to park the machine on a slope, insert blocks underneath the track shoes. As an additional safety measure, thrust the bucket into the ground.

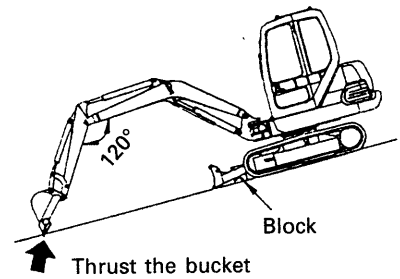

⚠ WARNING

- If the control lever is touched by accident, the work equipment or the machine may move suddenly, and this may lead to a serious accident. Before leaving the operator's compartment, always set the safety lock lever securely to the LOCK position.

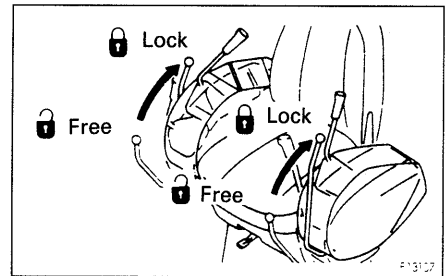

1. Put the left and right travel levers ① in the neutral position, then stop the machine.

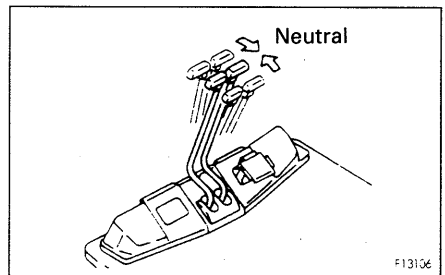
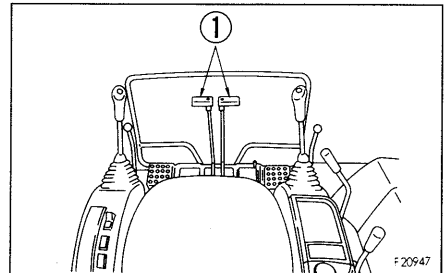

12.7 SWINGING

⚠ WARNING

When operating the swing, check that the area around the machine is safe.

1. Before operating the swing, set swing lock lever ① to the FREE position.

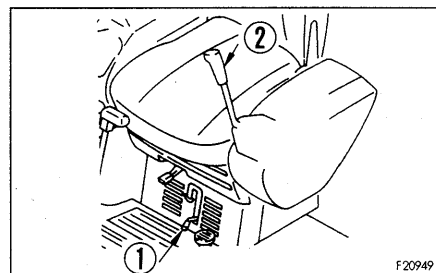

2. Operate left work equipment control lever ③ to swing the upper structure.

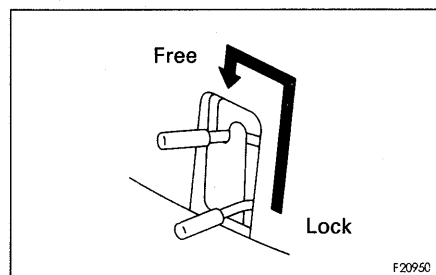

3. When not using the swing, set the upper structure and track frame parallel, then move lock lever ① to the LOCK position. When setting the lever to the LOCK position, always set the upper structure and track frame parallel and push lever ① down fully.

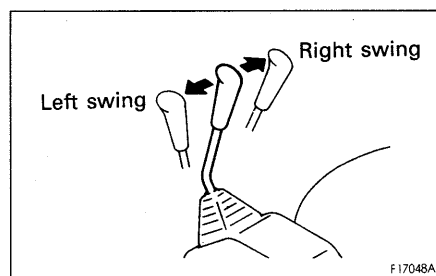

If the upper structure and track frame are not parallel, the lock is not applied even if the lever is set to the LOCK position.

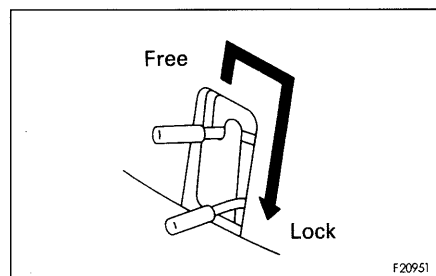

12.8 OPERATION OF WORK EQUIPMENT

The work equipment is operated with the left and right work equipment levers, boom swing control pedal and blade control lever.

The left work equipment lever is used for arm operation and swinging, the right work equipment lever for boom and bucket operation, the boom swing control pedal for swinging the boom, and the blade control lever for operating the blade.

The movements of the lever and work equipment are as shown in the drawings on the right. When the levers are released, they automatically return to the neutral position and the work equipemnt is held in place.

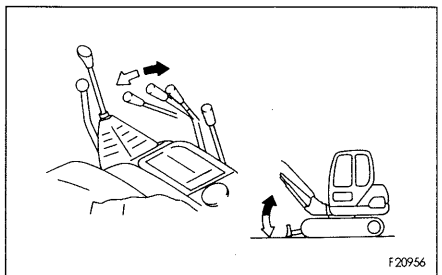
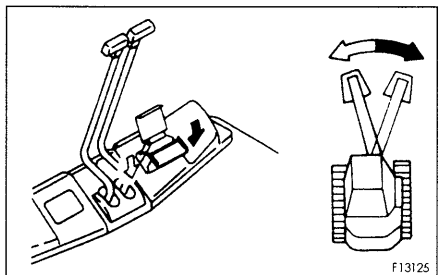
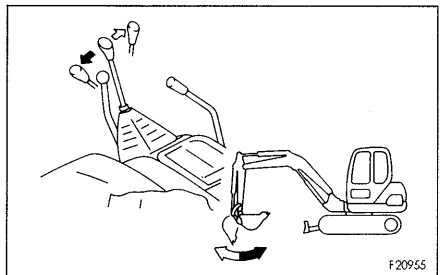
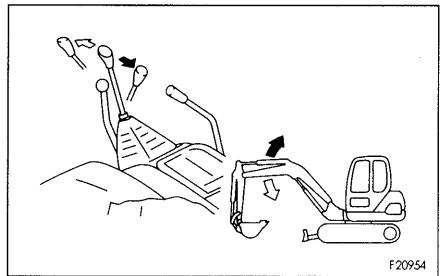
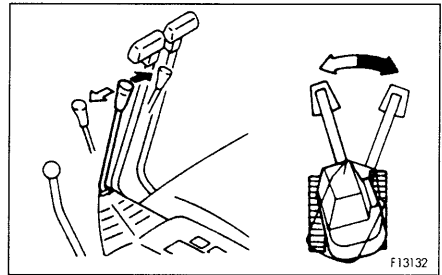
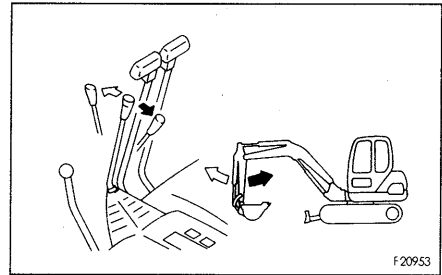

12.9 PROHIBITIONS FOR OPERATION

⚠ WARNING

- If it is necessary to operate the work equipment control lever when the machine is traveling, stop the machine before operating the work equipment control lever.
- Never operate the machine on a rock bed (hard or soft rock).

Prohibited operations using swing force

Do not use the swing force to compact soil or break earth mounds or walls.

When swinging, do not dig the bucket teeth into the soil. These operations will damage the work equipment.

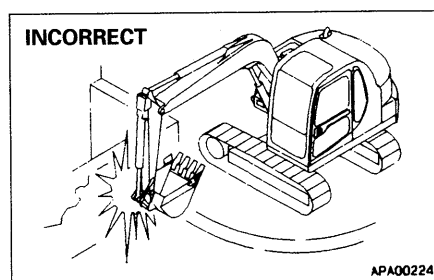

Prohibited operations using travel force

Do not leave the bucket dug into the ground and use the travel force to excavate. This will bring excessive force to bear on the rear of the machine.

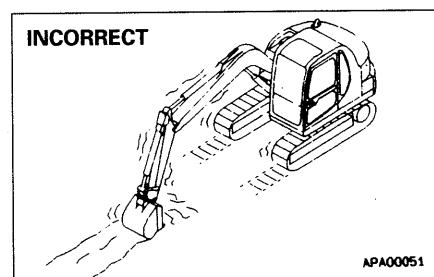

Precautions when operating hydraulic cylinders to end of stroke

If the cylinder is operated to the end of its stroke during operations, force will be brought to bear on the stopper inside the cylinder, and this will reduce the life of the machine. To prevent this, always leave a small safety margin when operating the cylinders.

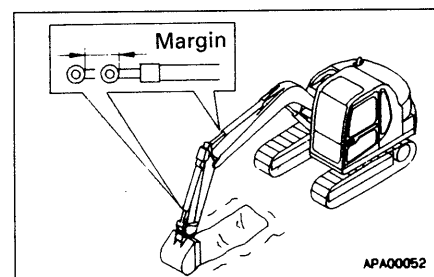

Prohibited operations using dropping force of bucket

Do not use the dropping force of the bucket as a pickaxe, breaker, or pile driver. This will bring excessive force to bear on the rear of the machine, and will not only damage the machine, but is also dangerous.

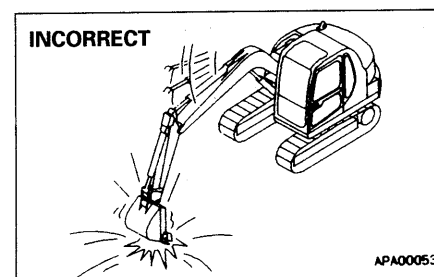

Prohibited operations using dropping force of machine

Do not use the dropping force of the machine for digging.

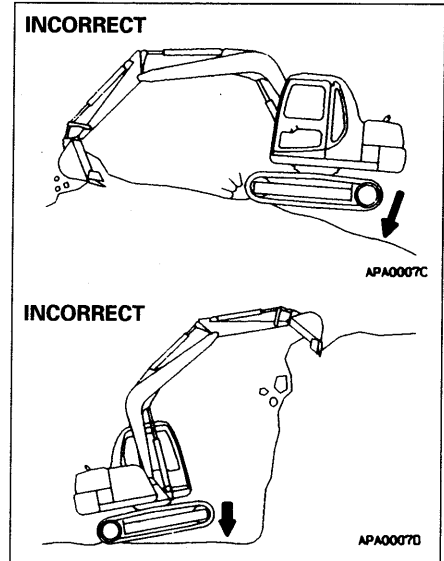

Digging rocky ground

It is better to excavate hard rocky ground after breaking it up by some other means. This will not only reduce damage to the machine but make for better economy.

Avoid hitting blade

Be careful not to hit the blade against rocks or boulders. This will cause premature damage to the blade or cylinders.

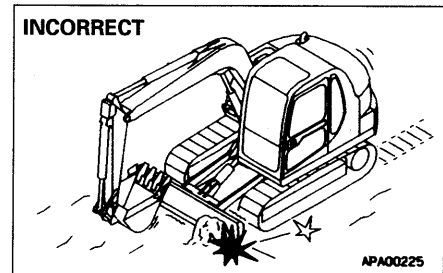

Be careful when folding in work equipment

When folding in the work equipment to the travel or transportation posture, be careful not to let the bucket hit the blade.

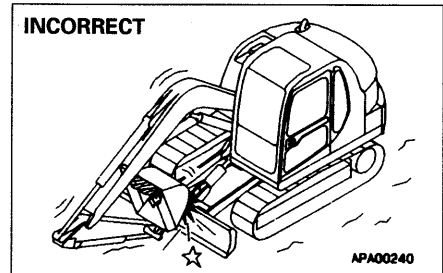

Support blade on both sides

When using the blade as an outrigger, never support the machine with only one end of the blade.

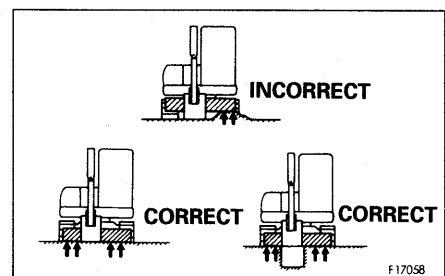

Be careful of blade during backhoe operations

When carrying out deep digging operations with the blade at the front, be careful not to let the boom cylinder hit the blade. Always position the blade at the back unless it is needed at the front.

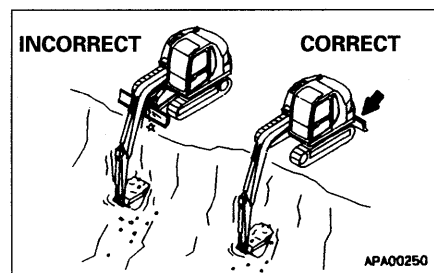

12.10 PRECAUTIONS FOR OPERATION

PRECAUTIONS WHEN TRAVELING

When traveling over obstacles such as boulders or tree stumps, the machine (in particular, the undercarriage) is subjected to a large shock, so reduce the travel speed and travel over the obstacle at the center of the tracks. As far as possible, remove such obstacles or avoid traveling over them.

PERMISSIBLE WATER DEPTH NOTICE

When driving the machine out of water, if the angle of the machine exceeds 15°, the rear of the upper structure will go under water, and water will be thrown up by the radiator fan. This may cause the fan to break.

Be extremely careful when driving the machine out of water.

Do not immerse the machine in water by more than the permissible depth (under center of carrier roller ①).

In addition, for parts that have been immersed in water for a long time, pump in grease until the old grease comes out from the bearings. (Around the bucket pins)

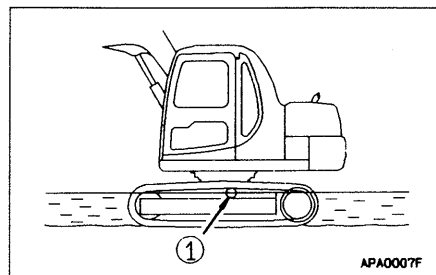
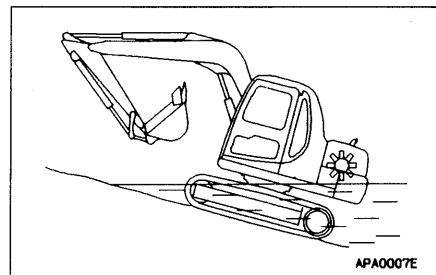
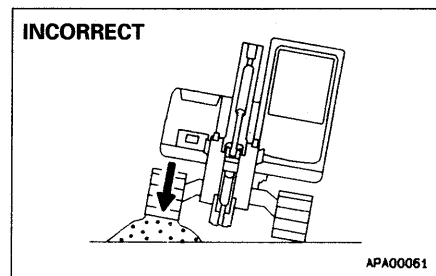

12.11 PRECAUTIONS WHEN TRAVELING UP OR DOWN HILLS

⚠ WARNING

- When traveling, raise the bucket approx. 20 – 30 cm (8 – 12 in) from the ground.
Do not travel downhill in reverse.
- When traveling over ridges or other obstacles, keep the work equipment close to the ground and travel slowly.
- It is dangerous to turn on slopes or to travel across slopes. Always go down to a flat place to perform these operations. It may be longer, but it will ensure safety.
- If the machine starts to slide or loses stability, lower the bucket immediately and brake the machine.
- Turning or operating the work equipment when working on slopes may cause the machine to lose its balance and turn over, so avoid such operations. It is particularly dangerous to swing downhill when the bucket is loaded. If such operations have to be carried out, pile soil to make platform on the slope so that the machine can be kept horizontal when operating.
- Do not travel on slopes of over 30° as there is danger that the machine may overturn.

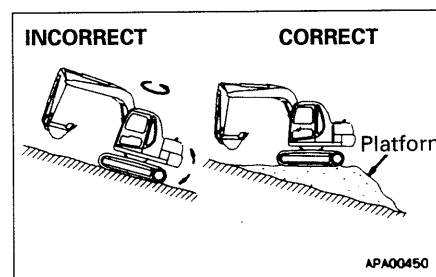
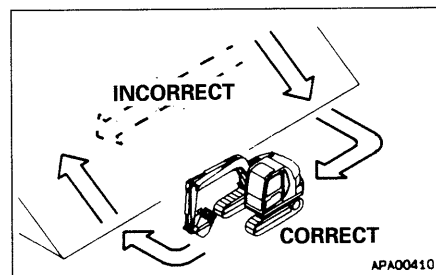

- 1) When traveling down steep hills, use the travel lever and fuel control lever to keep the travel speed low. When traveling down slopes of more than 15°, set the work equipment in the posture shown in the figure on the right, and lower the engine speed.

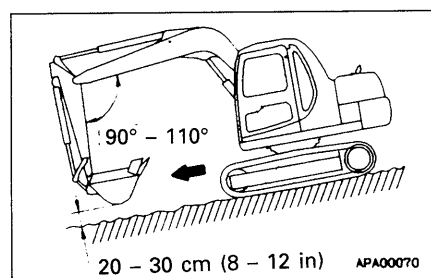

- 2) When traveling up a steep hill of more than 15°, set the work equipment in the posture shown in the diagram on the right.

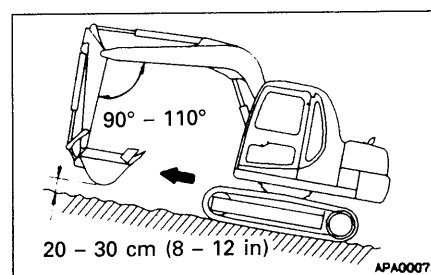

Braking when traveling downhill

To brake the machine during downhill runs, put the travel lever in the neutral position. This will cause the brake to be automatically applied.

If shoes slip

When traveling uphill, if the shoes slip or it is impossible to travel uphill using the force of the track only, it is possible to use the pulling force of the arm to help the machine travel uphill.

If engine stops

If the engine stops when traveling uphill, move the travel levers to the neutral position, lower the bucket to the ground, stop the machine, then start the engine again.

Precautions on slopes

If the engine stops when the machine is on a slope, never use the left work equipment control lever to carry out swing operations. The upper structure will swing under its own weight.

12.12 HOW TO ESCAPE FROM MUD

Always operate carefully to avoid getting stuck in mud. If the machine does get stuck in mud, use the following procedures to get the machine out.

12.12.1 WHEN ONE SIDE IS STUCK

When only one side is stuck in mud, use the bucket to raise the track, then lay boards or logs and drive the machine out. If necessary, put a board under the bucket also.

NOTICE

When using the boom or arm to raise the machine, always have the bottom of the bucket in contact with the ground. (Never push with the teeth). The angle between the boom and arm should be 90° to 110°.

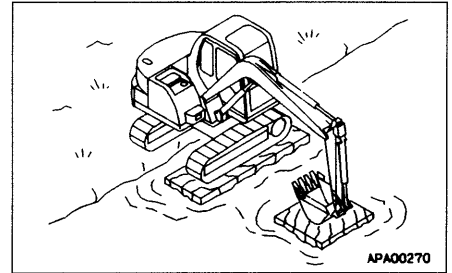

12.12.2 WHEN BOTH SIDES ARE STUCK

When the tracks on both sides are stuck in mud and the machine will not move, lay boards as explained above, and dig the bucket into the ground in front. Then pull in the arm as in normal digging operations and put the travel levers in the FORWARD position to pull the machine out.

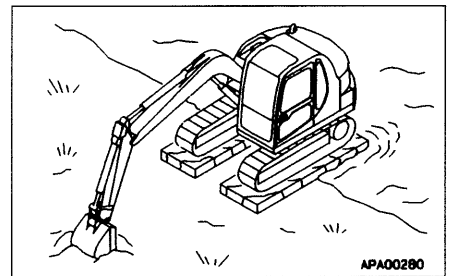

12.13 WORK POSSIBLE USING HYDRAULIC EXCAVATOR

In addition to the following, it is possible to further increase the range of applications by using various attachments.

12.13.1 BACKHOE WORK

When condition of the machine is as shown in the diagram at right, each cylinders maximum pushing excavation force is obtained when the bucket cylinder and link, arm cylinder and arm are at 90°.

When excavating, use this angle effectively to optimize your work efficiency.

The range for excavating with the arm is from a 45° angle away from the machine to a 30° toward the machine.

There may be some differences depending on the excavation depth, but try to use within the above range rather than going all the way to the extreme end of the cylinder stroke.

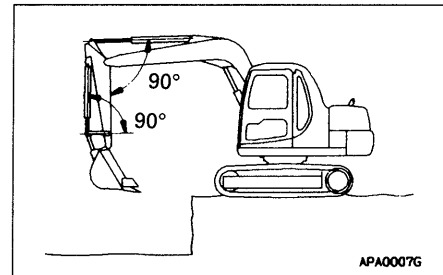

APA0007G

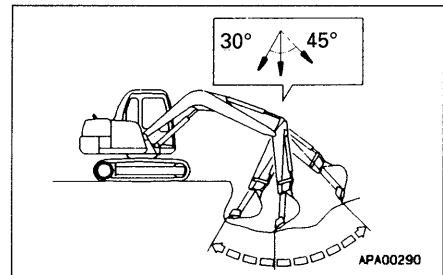

APA00290

12.13.2 DITCHING WORK

Ditching work can be performed efficiently by attaching a bucket to match the width of the ditch and then setting the tracks parallel to the line of the ditch to be excavated.

To excavate a wide ditch, first dig out both sides and then finally remove the center portion.

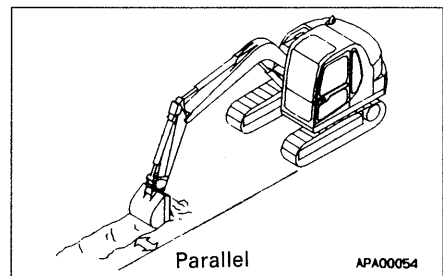

Parallel

APA00054

12.13.3 LOADING WORK

In places where the swing angle is small, work efficiency can be enhanced by locating the dump truck in a place easily visible to the operator.

Loading is easier and capacity greater if you begin from the front of the dump truck body than if loading is done from the side.

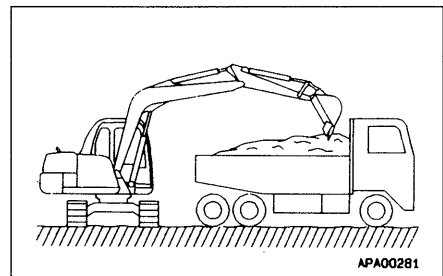

APA00281

12.13.4 SMOOTHING WORK

When refilling after excavation and when smoothing the ground surface, use the blade.

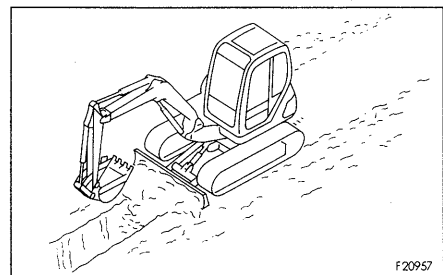

F20957

12.13.5 SIDE DITCHING

The machine can be used for side ditching in a confined worksite by combining the swing and boom swing operations.

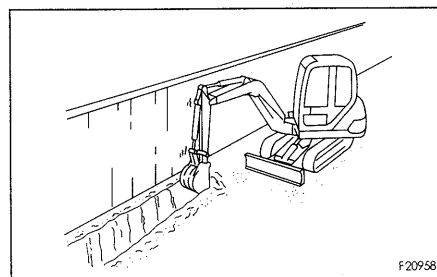

12.14 REPLACEMENT OF BUCKET

WARNING

- When knocking the pin in with a hammer, metal particles may fly and cause serious injury, particularly if they get into your eyes. When carrying out this operation, always wear goggles, helmet, gloves, and other protective equipment.
- When the bucket is removed, place it in a stable condition.

Stop the machine on a firm, flat surface. When performing joint work, make clear signals to each other and work carefully for safety's sake.

12.14.1 REMOVAL OF BUCKET

1. Lower the work equipment to the ground with the bucket back down.

REMARK

When removing the pins, place the bucket so that it is in light contact with the ground.

If the bucket is lowered strongly to the ground, the resistance will be increased and it will be difficult to remove the pins.

NOTICE

After removing the pins, make sure that they do not become contaminated with sand or mud and that the seals of bushing on both sides do not become damaged.

2. Remove mounting bolts ② of link pin retainer ①, and remove retainer ①.
3. Remove link pin ③.
4. Remove arm top pin ④ according to steps 2 – 3.
5. Lower the work equipment slowly to remove the bucket.

REMARK

At this time, make sure that spacer ⑤ and play preventive ring ⑥ do not drop out and become damaged.

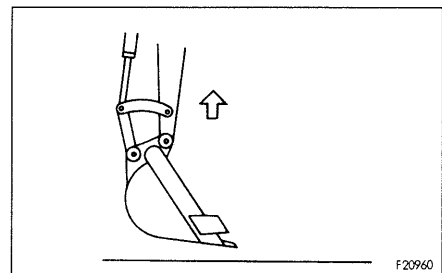
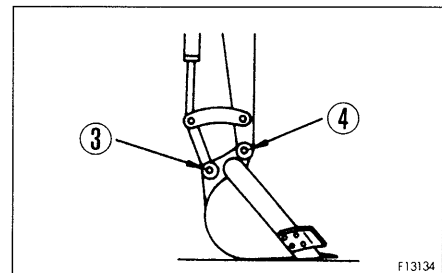
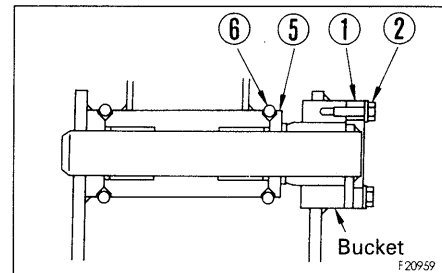

12.14.2 INSTALLATION OF BUCKET

When installing the bucket, apply molybdenum disulfide lubricant (NLGI No. 1 or equivalent) to the sliding surfaces of the pin and ring.

1. Wipe off any mud from the ring boss and sliding surfaces.
2. Lower the bucket to the ground with the bucket back down. Align the holes for arm pin ④.

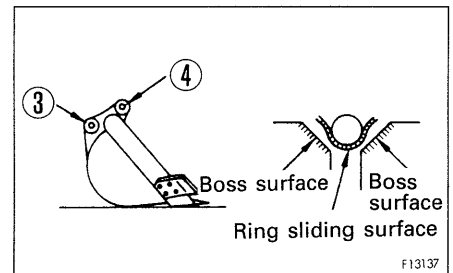

3. Insert pin ④ in bucket boss ⑦, spacer ⑤, play preventive ring ⑥, arm boss ⑧ and play preventive ring ⑨ in order in the arrow direction.
4. When inserting pin ④, align the dent of pin ④ with the projection of spacer ⑤, the groove of retainer ① with the lock plate of pin ④, and the bolt of retainer ① with the tap hole of the bucket. Tighten bolts ② temporarily.

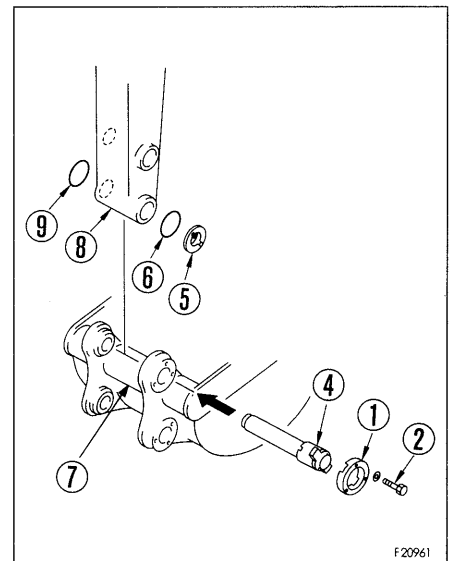

NOTICE

Set the lock plates of pins ③ and ④ as shown at right.

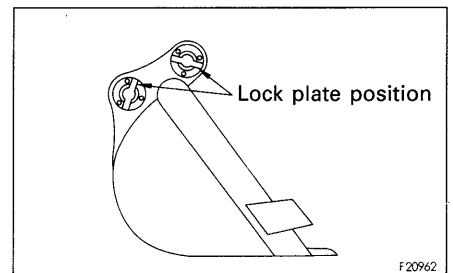

5. Lift the work equipment to free the bucket.
6. Extract the bucket cylinder and align link mounting pin ③. (Do not fit play preventive rings ⑥ and ⑨ at this time.)

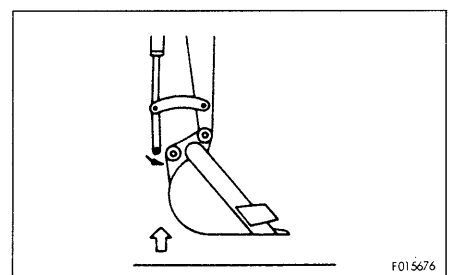

12. OPERATION

7. Insert pin ③ in bucket boss ⑦, spacer ⑤, play preventive ring ⑥, and bucket link ⑪ in order in the arrow direction. Finally, fit pin ③ together with bucket link ⑪ and play preventive ring ⑨. At this time, align the lock bolt hole.

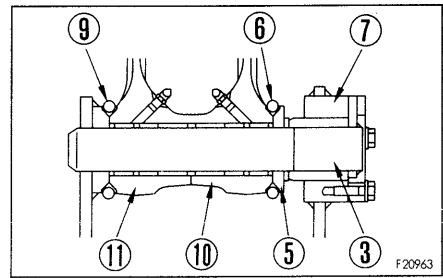

8. Install retainer ① according to step 4.

9. Tighten bolts ② (six pieces in total) of arm top pin ④ and link mounting pin ③.

Tightening torque: 58.8 – 73.5 Nm (6.0 – 7.5 kgm, 43.4 – 54.2 lbft)

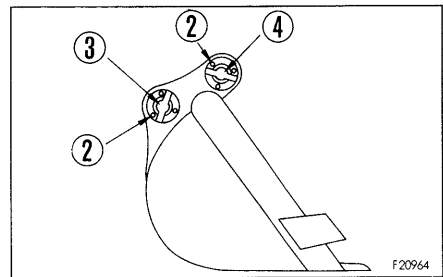

12.15 PARKING MACHINE

CAUTION

Avoid stopping suddenly. Give yourself ample room when stopping.

WARNING

When stopping the machine, select flat hard ground and avoid dangerous places. If it is unavoidably necessary to park the machine on a slope, insert blocks underneath the track shoes. As an additional safety measure, thrust the bucket into the ground.

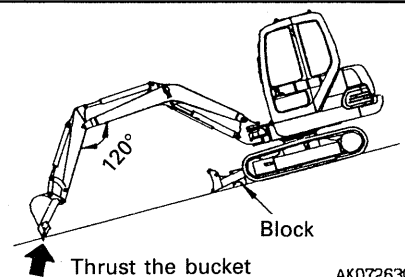
**WARNING**

If the control lever is touched by accident, the work equipment or the machine may move suddenly, and this may lead to a serious accident. Before leaving the operator's compartment, always set the safety lock lever securely to LOCK position.

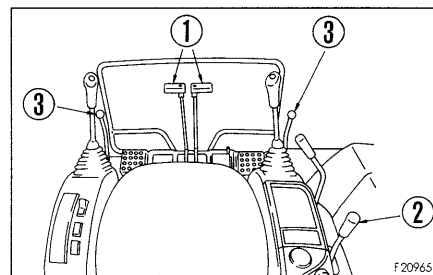

1. Put left and right travel levers ① in the neutral position.

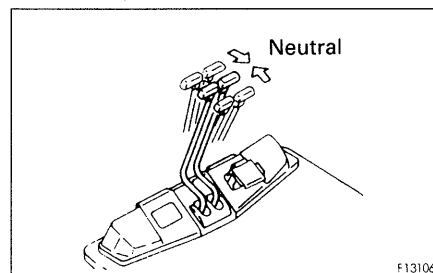

2. Lower the engine speed to low idling by fuel control lever ②.

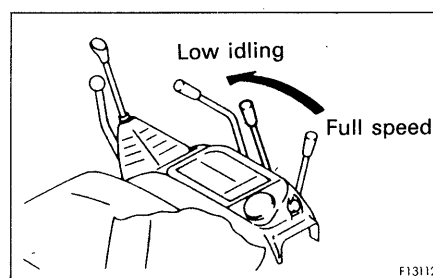

3. Lower the bucket horizontally until the bottom touches the ground.

4. Lower the blade to the ground.

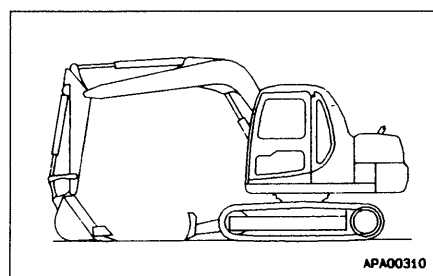

- Set lock lever ③ in the LOCK position.

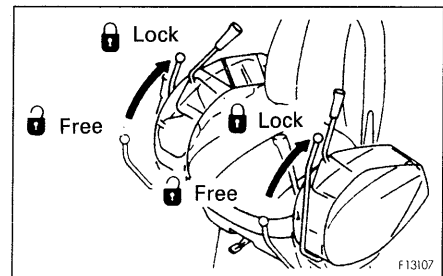

12.16 CHECK AFTER FINISHING WORK

Check the engine water temperature, engine oil pressure and fuel level on the monitor.

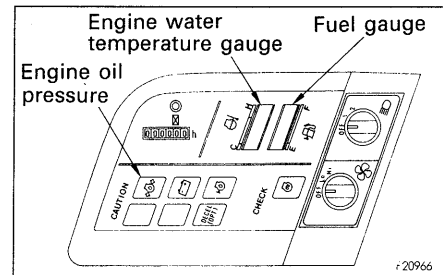

12.17 STOPPING ENGINE

NOTICE

If the engine is abruptly stopped before it has cooled down, engine life may be greatly shortened. Consequently, do not abruptly stop the engine apart from an emergency.

In particular, if the engine has overheated, do not abruptly stop it but run it at medium speed to allow it to cool gradually, then stop it.

- Run the engine at low idling speed for about 5 minutes to allow it to gradually cool down.

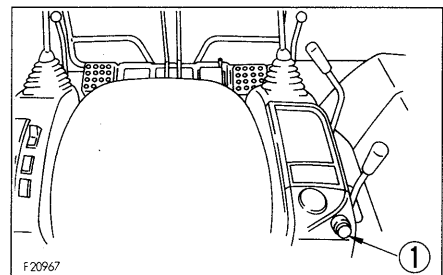

- Turn the key in starting switch ① to the OFF position and stop the engine.
- Remove the key from starting switch ①.

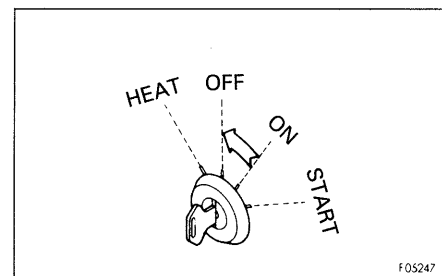

12.18 CHECK AFTER STOPPING ENGINE

1. Walk around the machine and check the work equipment, paint-work, and undercarriage, and check also for leakage of oil or water. If any abnormalities are found, repair them.
2. Fill the fuel tank.
3. Check the engine compartment for paper and debris. Clean out any paper and debris to avoid a fire hazard.
4. Remove any mud stuck to the undercarriage.

12.19 LOCKING

Always lock the following places.

- ① Door of operator's cab (machines equipped with cab)
Always remember to close the window.
- ② Fuel tank filler port
- ③ Engine hood
- ④ Battery cover

REMARK

Use the starting switch key to open and close all these places.

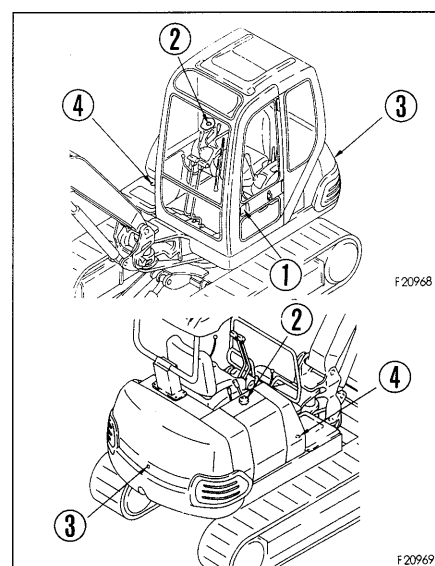

12.20 HANDLING RUBBER SHOES (RUBBER SHOES ONLY)

12.20.1 SKILLFUL USE OF RUBBER SHOES

Rubber shoes have excellent properties that are not found in metal shoes. However, if they are used in the same way as metal shoes, full use cannot be made of their advantages. Be sure to operate with rubber shoes in a way that matches the condition of the jobsite and the nature of the work.

Comparison of rubber shoes and metal shoes

	Rubber shoes	Metal shoes
Little vibration	Excellent	Average
Smooth travel	Excellent	Good
Little noise	Excellent	Average
No damage to paved surface	Excellent	Average
Easy to handle	Excellent	Average
Easily damaged	Average	Excellent
Strong drawbar pull	Excellent	Excellent

Considering the properties of the material used, rubber shoes offer various advantages. However, their weak point is lack of strength. Therefore, it is important to understand the advantages of rubber shoes, and to follow the precautions regarding handling and prohibited work. This will extend the life of the rubber shoes and will enable the machine to display the advantages of rubber shoes to the maximum. Before using rubber shoes, always read "12.20.3 PRECAUTIONS WHEN USING RUBBER SHOES".

12.20.2 WARRANTY FOR RUBBER SHOES

It is important to inspect and maintain the tracks at the correct tension. Furthermore, these shoes must not be used near objects where they are likely to suffer damage, such as the corners of steel plates, U-shaped grooves, and blocks, on crushed rock or the sharp edges of rocks, iron beams or scrap iron.

If the customer carries out prohibited work or does not follow the precautions for operation, the damage resulting from the customer's mistaken use of the machine shall not be included in the scope of the warranty.

12.20.3 PRECAUTIONS WHEN USING RUBBER SHOES

Prohibited work

Do not carry out the following types of work.

- Carrying out operations and steering on crushed rock, extremely rough hard rock, steel beams, scrap iron, or near the edges of steel plates will cause damage to the rubber shoes.
- In places such as riverbeds where there are large numbers of large and small boulders, the stones may get caught and damage the rubber shoes or make the shoes come off. If dozing operations are carried out when the shoes slip, this will also reduce the life of the rubber shoes.
- Be careful not to get oil, fuel, or chemical solvent on the rubber shoes. If such a substance should get on the shoes, remove it immediately. Furthermore, do not travel on road surfaces where oil has collected.
- When putting the machine into long-term storage (3 months or more), store the machine indoors where it is protected from direct sunlight or rain.
- Do not use the machine in high temperature areas, such as areas where there is burning wood, steel plate that have been left under the hot sun, or places where asphalt is being laid.
- Do not move the machine with the crawler on one side raised using the work equipment. This will cause damage to the rubber shoes and may cause the shoes to come off.

12.20.4 PRECAUTIONS WHEN USING

Be careful of the following points when carrying out work.

- Avoid carrying out counterrotation turns on concrete surfaces.
- Avoid making sudden changes in direction. This may cause premature wear or damage to the rubber shoes.
- Avoid operating the steering when traveling over places where there is a big difference in height. When traveling over obstacles or places where there is a difference in height, drive the machine at right angles to the obstacles to prevent the shoes from coming off.
- If the machine has been raised using the bucket, lower it slowly.
- Avoid doing work with materials that produce oil when crushed (soya beans, corn, or vegetables squeezed for oil), or wash the machine after using it.
- Avoid handling materials that will attach the adhesion of the steel core such as salt, ammonium sulphate, potassium chloride, potassium sulphate, calcium superphosphate; or wash the machine after use.
- The adhesion of the core will be attacked by salt, so avoid using the machine in coastal areas.
- When handling salt, sugar, wheat, or soya beans, if there is any deep cut in the rubber shoes, these substances may get into the lugs or cut portion of the rubber, so always repair the rubber before use.
- Do not carry out work that involves scraping against walls or concrete embankments.
- Rubber shoes slip extremely easily on snow or frozen roads. Be careful not to slip when traveling or working on slopes.
- The properties of rubber shoes change when working in extremely cold places, and this will reduce the life of the rubber shoe.
- Because of the properties of rubber, use the rubber shoes within a range of -25°C – $+55^{\circ}\text{C}$ (-13°F – 131°F).

- When working, be careful not to damage the rubber shoes with the bucket.
- To prevent the shoes from coming off, always maintain the correct tension. If the tracks are slack, the shoes will come off under the following conditions. Even when the tension is correct, be extremely careful when carrying out these operations.

1. When traveling over curbs, rocks, or places where there is a big difference in level (approx. 20 cm (8 in)), do not turn the machine. When traveling over such objects, always travel at right angles to the object.

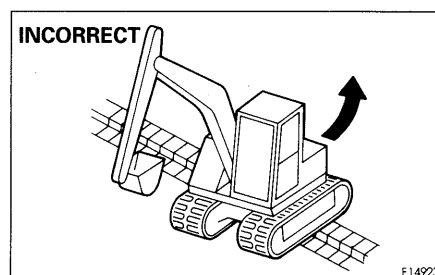

2. When traveling in reverse up a slope, do not turn when moving from flat ground onto the slope. If it is necessary to turn on slopes, be sure to turn gradually.

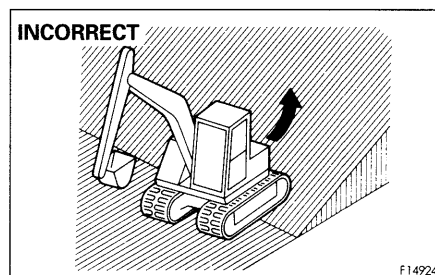

3. Avoid traveling along the edge of a slope or on rough ground with the track on one side raised (with the machine tilting at angle of more than approx. 10°), and one side on the flat ground. To avoid damage to the rubber shoes, travel with both tracks on flat ground.

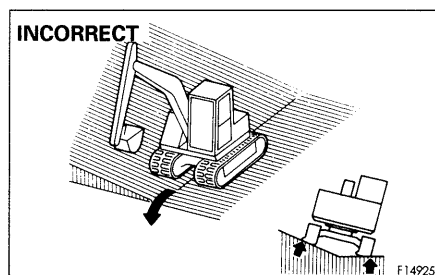

4. In Items 1 – 3, if the rubber track is loose, avoid turning in the posture in the diagram.

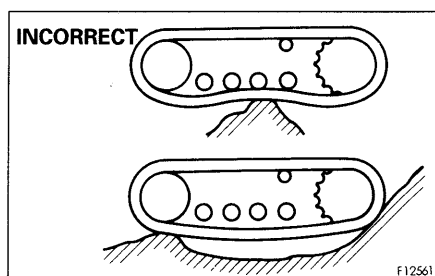

12. OPERATION

(Mechanism of rubber shoe coming off track)

- 1) When traveling over an obstacle, a gap is formed between the track roller and the rubber shoe. In this condition, the rubber shoe may come off.

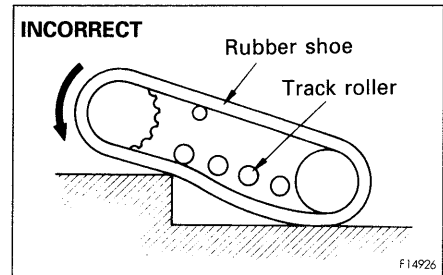

- 2) If the machine travels further in reverse, a gap is formed among the track roller, idler and the rubber shoe.

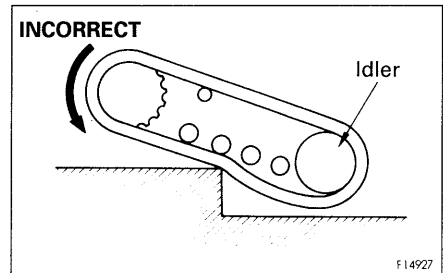

- When turning in a condition where the rubber shoe cannot move to the side because of the object it is passing over, or because of some other object.
- When the idler or track roller are out of alignment with the core because of movement of the rubber shoe out of alignment.

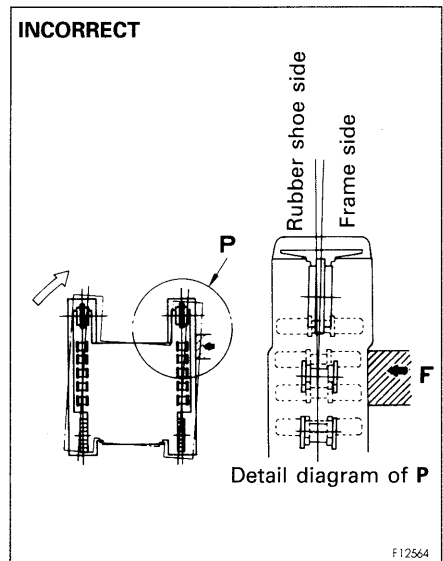

- If the machine travels in reverse in this condition, the rubber shoe will come off.

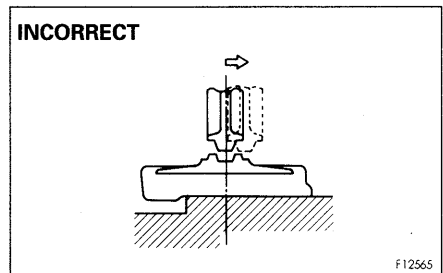

- If the machine is turned in this condition, the rubber shoe will come off.

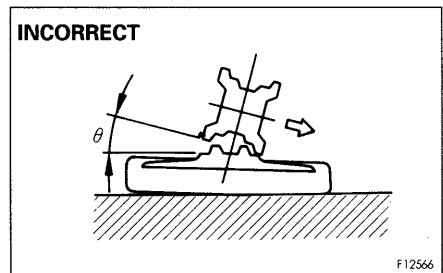

13. TRANSPORTATION

When transporting the machine, observe all related laws and regulations, and be careful to assure safety.

13.1 LOADING, UNLOADING WORK

WARNING

- Loading or unloading the machine can be a dangerous operation, so be particularly careful. When loading or unloading the machine, run the engine at low idling and travel at low speed.
- Make sure the ramp has sufficient width, length and thickness to enable the machine to be safely loaded and unloaded. If the ramp sags appreciably, reinforce it with blocks, etc.
- When loading and unloading the machine, park the trailer on a flat firm roadbed. Keep a fairly long distance between the road shoulder and the machine.
- Remove the mud from the undercarriage to prevent the machine from slipping to the side on slopes. Be sure the ramp surface is clean and free of grease, oil, ice and loose materials.
- Never change the direction of travel when on the ramps. If it is necessary to change direction, drive off the ramps and correct the direction, then drive on to the ramps again.
- When turning the machine on the trailer, the machine's footing is unstable, so carry out the operation slowly.

CAUTION

Always check that the sliding door on the cab specification machine is locked, regardless of whether it is open or closed. Do not open or close the door on ramps or on a platform. This may cause a sudden change in the operating force.

When loading or unloading, always use ramps or a platform and carry out the operations as follows.

1. Properly apply the brakes on the trailer and insert blocks beneath the tires to ensure that it does not move. Then fix the ramps in line with the centers of the trailer and the machine. Be sure that the two sides are at the same level as one another.

Make the angle of the ramps a maximum of 15°.

Set the distance between the ramps to match the center of the tracks.

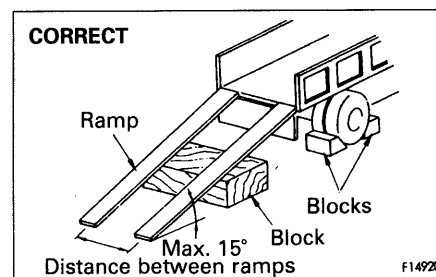

13. TRANSPORTATION

2. Lower the engine speed using the fuel control lever.
3. Set the swing lock lever to the LOCK position.
4. Set in the direction of the ramps, lower the work equipment as far as possible without letting it hit the trailer, then travel slowly to load or unload the machine.

If the work equipment is installed to the machine, load from the front; if the work equipment is not installed, load from the rear.

When on the ramps, do not operate any lever other than the travel lever.

5. Load the machine correctly in the specified position on the trailer.

13.2 METHOD OF LIFTING MACHINE

WARNING

- Never raise the machine with any worker on it.
- Always make sure that the wire rope used for lifting the machine is of ample strength for the weight of the machine.
- Never try to lift the machine in any posture other than the posture given in the procedure below.
There is danger that the machine may lose its balance.
- The machine must never be raised with the undercarriage turned.
- When lifting the machine, be careful of the position of the center of gravity and always maintain the balance.

When lifting the machine, carry out the operation as follows on flat ground.

1. Start the engine, swing the upper structure so that the blade is at the rear of the machine, then place the swing lock lever at the LOCK position.
2. Raise the blade to the maximum height.
3. Fully extend the bucket cylinder, arm cylinder and boom cylinder, then turn the lock lever to the LOCK position.
4. Set the boom swing pedal to the neutral position without swinging the boom, then turn the pedal lock to the LOCK position.
5. Stop the engine, check that there is nothing around the operator's compartment, then get down from the machine.
For machines with cab specification, be sure to close the cab door and front glass securely.

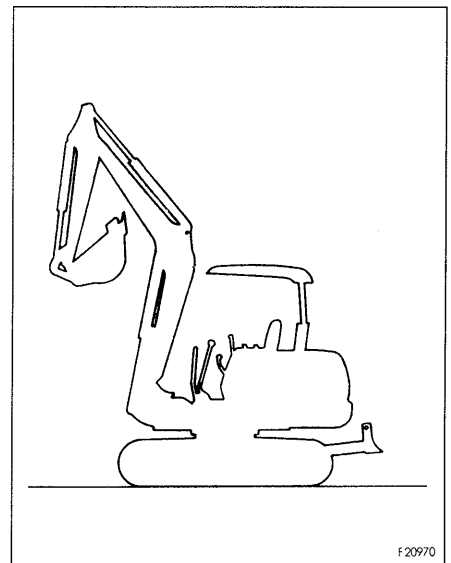

13. TRANSPORTATION

6. Install shackles to the slinging holes (two) at both ends of the blade and the slinging holes (two) of the boom, then connect wire ropes to them.

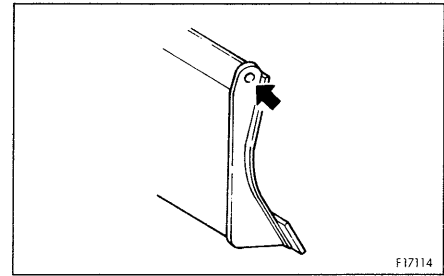

Be sure to use the four brackets.
Do not sling the machine with the boom or upper structure swung.

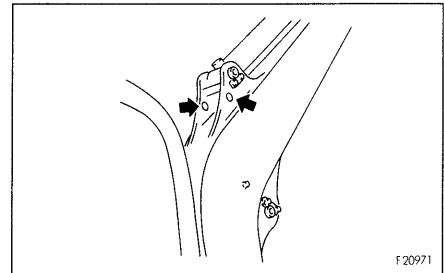

7. Make the slinging angle of the wire rope $30^{\circ} - 40^{\circ}$ and carry out the lifting operation.
8. When the machine leaves the ground, stop for a moment and wait for the machine to stabilize, then continue the slinging operation slowly.

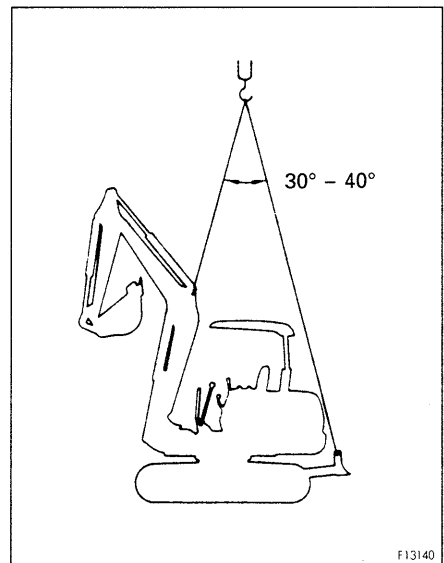

13.3 PRECAUTIONS FOR LOADING

WARNING

When loading the machine, park the trailer on a flat firm roadbed. Keep a fairly long distance between the road shoulder and the machine.

After loading to the specified position, secure the machine as follows.

1. Lower the brade.
2. Fully extend the bucket and arm cylinders, then slowly lower the boom.
3. Stop the engine and remove the key from the starting switch.
4. Lock all the control levers securely with the safety lock lever.
5. When transporting the machine, place rectangular timber underneath the front and rear track shoes to prevent the machine from moving about. Also, hold it down with chains or rope. Be particularly careful to ensure that the machine does not slip sideways.

NOTICE

When transporting the machine, place rectangular timber under one end of the bucket cylinder to prevent it touching the ground, thereby saving it from possible damage.

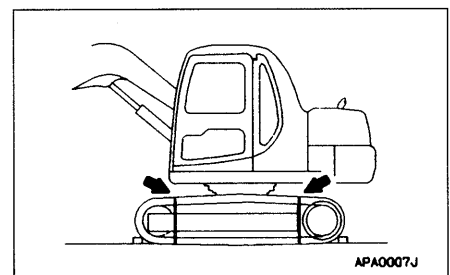
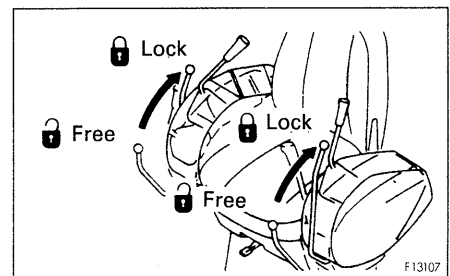
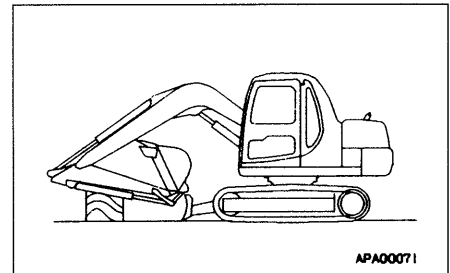

13.4 PRECAUTIONS FOR TRANSPORTATION



WARNING

- Determine the route for transporting the machine by taking into account the width, height and weight of the machine.
- Always check that the door on the cab is closed and locked before transporting the machine.

NOTICE

Be sure to retract the antenna of the radio (optional for cab-spec. machine).

Obey all state and local laws governing the weight, width and length of a load. Observe all regulations governing wide loads.

If the canopy is retracted, its height is reduced by about 320 mm (12.6 in).

14. COLD WEATHER OPERATION

14.1 PRECAUTIONS FOR LOW TEMPERATURE

If the temperature becomes low, it becomes difficult to start the engine, and the coolant may freeze, so do as follows.

14.1.1 FUEL AND LUBRICANTS

Change to fuel and oil with low viscosity for all components. For details of the specified viscosity, see "20. USE OF FUEL, COOLANT AND LUBRICANTS ACCORDING TO AMBIENT TEMPERATURE".

14.1.2 COOLANT

 **WARNING**

Keep antifreeze fluid away from an open flame. Never smoke when using antifreeze.

NOTICE

- Never use methanol, ethanol or propanol based antifreeze.
- Absolutely avoid using any water leak preventing agent irrespective of whether it is used independently or mixed with an antifreeze.
- Do not mix one antifreeze with a different brand.

For details of the antifreeze mixture when changing the coolant, see "24.2 WHEN REQUIRED".

Use a Permanent Antifreeze (ethylene glycol mixed with corrosion inhibitor, antifoam agent, etc.) meeting the standard requirements as shown below. With permanent antifreeze, no change of coolant is required for a year. If it is doubtful that an available antifreeze meets the standard requirements, ask the supplier of that antifreeze for information.

Standard requirements for permanent antifreeze

- SAE J1034
- FEDERAL STANDARD O-A-548D

REMARK

Where no permanent antifreeze is available, an ethylene glycol antifreeze without corrosion inhibitor may be used only for the cold season. In this case, clean the cooling system twice a year (in spring and autumn). When refilling the cooling system, add antifreeze in autumn, but do not add any in spring.

14.1.3 BATTERY

⚠ WARNING

- To avoid gas explosions, do not bring fire or sparks near the battery.
- Battery electrolyte is dangerous. If it gets in your eyes or on your skin, wash it off with large amounts of water, and consult a doctor.

When the ambient temperature drops, the capacity of the battery will also drop. If the battery charge ratio is low, the battery electrolyte may freeze. Maintain the battery charge as close as possible to 100%, and insulate it against cold temperature so that the machine can be started easily the next morning.

REMARK

Measure the specific gravity and calculate the rate of charge from the following conversion table.

Temp. of fluid	20°C (68°F)	0°C (32°F)	-10°C (14°F)	-20°C (-4°F)
Rate of charge				
100%	1.28	1.29	1.30	1.31
90%	1.26	1.27	1.28	1.29
80%	1.24	1.25	1.26	1.27
75%	1.23	1.24	1.25	1.26

14.2 PRECAUTIONS AFTER COMPLETION OF WORK

To prevent mud, water, or the undercarriage from freezing and making it impossible for the machine to move on the following morning, always observe the following precautions.

- Mud and water on the machine body should be completely removed. This is to prevent damage to the seal caused by mud or dirt getting inside the seal with frozen drops of water.
- Park the machine on hard, dry ground. If this is impossible, park the machine on wooden boards. The boards help protect the tracks from being freezed in soil and the machine can start next morning.
- Open the drain valve and drain any water collected in the fuel system to prevent it from freezing.
- As the battery capacity drops markedly in low temperatures, cover the battery or remove it from the machine, keep it in a warm place, and install it again the next morning.
- If electrolyte level is found low, add distilled water in the morning before beginning work. Do not add the water after the day's work so as to prevent fluid in the battery from freezing in the night.

14.3 PREPARING THE CAB HEATER (MACHINES EQUIPPED WITH CAB)

If the ambient temperature drops, use the cab heater.

- When using the cab heater, turn valve ① on the water manifold counterclockwise to open it.
- When leaving the cab heater unused for a long time, turn valve ① clockwise to close it.

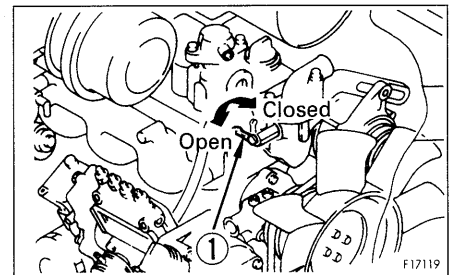

14.4 AFTER COLD WEATHER

When season changes and the weather becomes warmer, do as follows.

- Replace the fuel and oil for all parts with oil of the viscosity specified.
For details, see "20. USE OF FUEL, COOLANT AND LUBRICANTS ACCORDING TO AMBIENT TEMPERATURE".
- If for any reason permanent antifreeze cannot be used, and an ethyl glycol base antifreeze (winter, one season type) is used instead, or if no antifreeze is used, drain the cooling system completely, then clean out the inside of the cooling system thoroughly, and fill with fresh water.

15. LONG-TERM STORAGE

15.1 BEFORE STORAGE

NOTICE

To protect the cylinder rod when the machine is not being used, set the work equipment in the posture shown in the diagram. (This prevents rusting of the cylinder rod)

When putting the machine in storage for a long time, do as follows.

- After every part is washed and dried, the machine shall be housed in a dry building. Never leave it outdoors. In case it is indispensable to leave it outdoors, park the machine on the well-drained concrete and cover it with canvas etc.
- Completely fill the fuel tank, lubricate and change the oil before storage.
- Apply a thin coat of grease to metal surface of the hydraulic piston rods.
- Disconnect the negative terminals of the battery and cover it, or remove it from the machine and store it separately.
- If the ambient temperature is expected to drop below 0°C, always add antifreeze to the cooling water.
- Lock each control lever and pedal with the lock lever and pedal lock.

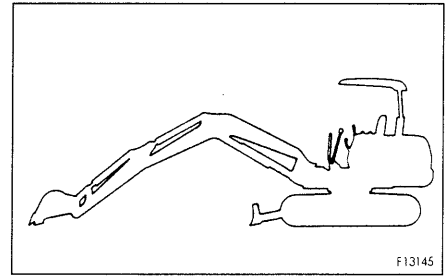

15.2 DURING STORAGE

⚠ WARNING

If it is unavoidably necessary to carry out the rustpreventive operation while the machine is indoors, open the doors and windows to improve ventilation and prevent gas poisoning.

Operate the engine and move the machine for a short distance once a month so that a new film of oil will be coated over movable parts and component surfaces. At the same time, also charge the battery.

When operating the work equipment, wipe off the grease applied to the hydraulic cylinder rod.

After operating the work equipment, apply grease again.

15.3 AFTER STORAGE

NOTICE

If the machine is stored without carrying out the monthly rust prevention operation, request your Komatsu distributor for service.

Carry out the following procedure when taking the machine out of long-term storage.

- Wipe off the grease from the hydraulic cylinder rods.
- Add oil and grease to all places.

16. TROUBLESHOOTING

16.1 PHENOMENA THAT ARE NOT FAILURES

Note that the following phenomena are not failures:

1. When the arm is pulled in, the speed of movement will drop momentarily when the arm is more or less vertical.
2. The arm speed will drop momentarily when the bucket teeth are more or less horizontal.
3. When starting or stopping the swing, noise will be emitted from the brake valve.
4. When going down a steep slope at low speed, a noise will be emitted from the travel motor.

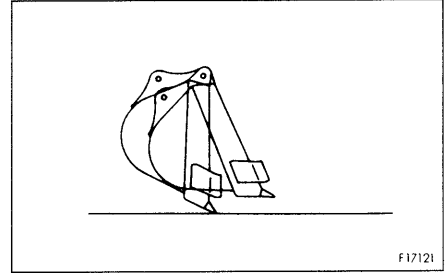
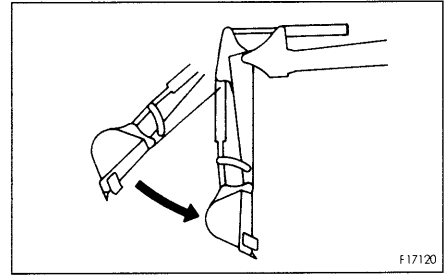

16.2 METHOD OF TOWING MACHINE

WARNING

When towing the machine, use a wire rope that has ample strength for the weight of the machine that is being towed.

If the machine sinks in mud and cannot get out under its own power, or if the drawbar pull of the excavator is being used to tow a heavy object, use a wire rope as shown in the diagram on the right. Place pieces of wood between wire ropes and body to prevent damage to ropes and body.

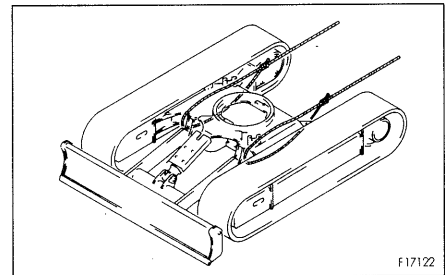

16.3 PRECAUTIONS ON PARTICULAR JOBSITES

- When digging in water, if the water gets on to the work equipment mounting pins, add grease to bucket links (A), (B), and (C) for each operation.
- When carrying out heavy duty digging and deep digging operations, add grease to bucket links (A), (B), and (C) (total: 4 points) before each operation.
After greasing, operate the bucket several times, then add grease again.

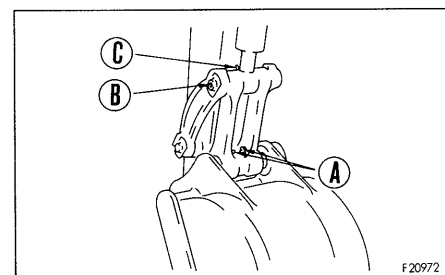

16.4 IF BATTERY IS DISCHARGED

⚠ WARNING

- When checking or handling the battery, stop the engine and turn the starting switch key to the OFF position before starting.
- The battery generates hydrogen gas, so there is danger of explosion. Do not bring lighted cigarettes near the battery, or do anything that will cause sparks.
- Battery electrolyte is dilute sulphuric acid, and it will attack your clothes and skin. If it gets on your clothes or on your skin, wash it immediately off with large amounts of water. If it gets in your eyes, wash it out with fresh water, and consult a doctor.
- When handling battery, always wear protective goggles.
- When removing the battery, first disconnect the cable from the ground (normally, from the negative \ominus terminal). When installing, install the positive \oplus terminal first. If a tool touches the cable connecting the positive terminal and the chassis, there is danger that it will cause sparks.
- If the terminals are loose, there is danger that the defective contact may generate sparks that will cause an explosion. When installing the terminals, install them tightly.
- When removing or installing, check which is the positive \oplus terminal and negative \ominus terminal.

When removing, disconnect the cable from the ground terminal first.

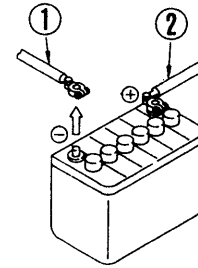

When installing, connect the cable to the positive \oplus terminal first.

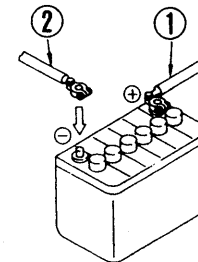

F16801

16.4.1 STARTING ENGINE WITH BOOSTER CABLE

When starting the engine with a booster cable, do as follows:

Precautions when connecting and disconnecting booster cable

⚠ WARNING

- When connecting the cables, never contact the positive \oplus and negative \ominus terminals.
- When starting the engine with a booster cable, always wear safety glasses.
- Be careful not to let the normal machine and problem machine contact each other. This prevents sparks from generating near the battery which could ignite the hydrogen gas given off by the battery. If hydrogen gas explodes, it could cause serious injury.
- Make sure that there is no mistake in the booster cable connections. The final connection is to the revolving frame, but sparks will be generated when this is done, so connect to a place as far as possible from the battery. (However, avoid connecting the cable to the work equipment, as conduction is poor.)
- Use care when removing the cables from the machine that has been started. Do not allow the cable ends to contact each other or the machine, to avoid hydrogen explosion.

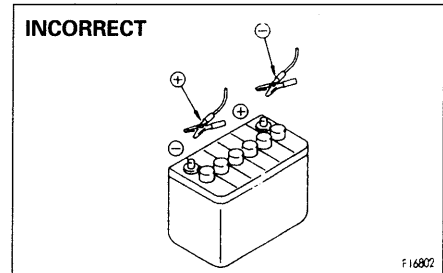

NOTICE

- The size of the booster cable and clip should be suitable for the battery size.
- The battery of the normal machine must be the same capacity as that of the engine to be started.
- Check the cables and clips for damage or corrosion.
- Make sure that the cables and clips are firmly connected.

Charging battery while still mounted on machine

- There is danger that an abnormal voltage may be applied to the alternator and damage it, so remove the wires from the battery terminals when charging.
- Remove all the battery filler caps when charging to release the gas that is generated.
- If the battery overheats (the electrolyte exceeds 45°C), stop the charging temporarily.
- After completing charging, stop the charging immediately. If charging is continued after the charging is completed, the following problems will occur.
 - 1) Overheating of battery
 - 2) Reduction in battery electrolyte level
 - 3) Problems with battery
- When connecting the battery, be sure to connect the wires properly. Never connect (⊕ to ⊖ or ⊖ to ⊕). Connecting the wires wrongly will cause damage to the alternator and other parts.
- Except when checking the battery electrolyte level or measuring the specific gravity, always remove the cables connected to the battery before handling the battery.

Connecting the booster cables

Keep the starting switch at the OFF position.

Connect the booster cable as follows, in the order of the numbers marked in the diagram.

1. Make sure that the starting switches of the normal machine and problem machine are both at the OFF position.
2. Connect one clip of booster cable (A) to the positive (+) terminal of the problem machine.
3. Connect the other clip of booster cable (A) to the positive (+) terminal of the normal machine.
4. Connect one clip of booster cable (B) to the negative (-) terminal of the normal machine.
5. Connect the other clip of booster cable (B) to the engine block of the problem machine.

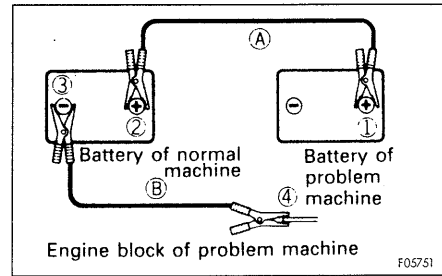

Starting the engine

1. Make sure the clips are firmly connected to the battery terminals.
2. Start the engine of the normal machine and keep it to run at high idling speed.
3. Turn the starting switch of the problem machine to the START position and start the engine. If the engine doesn't start at first, try again after 2 minutes or so. Refer to "12.2 STARTING ENGINE".

Disconnecting the booster cables

After the engine has started, disconnect the booster cables in the reverse of the order in which they were connected.

1. Remove one clip of booster cable (B) from the engine block of the problem machine.
2. Remove the other clip of booster cable (B) from the negative \ominus terminal of the normal machine.
3. Remove one clip of booster cable (A) from the positive \oplus terminal of the normal machine.
4. Remove the other clip of booster cable (A) from the positive \oplus terminal of the problem machine.

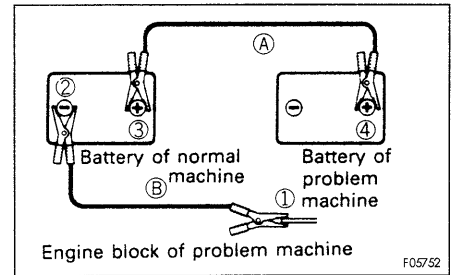

16.5 OTHER TROUBLE**16.5.1 ELECTRICAL SYSTEM**

- (): Always contact your Komatsu distributor when dealing with these items.
- In cases of abnormalities or causes which are not listed below, please contact your Komatsu distributor for repairs.

Problem	Main causes	Remedy
Lamp does not glow brightly even when the engine runs at high speed	<ul style="list-style-type: none"> ● Defective wiring ● Defective adjustment of fan belt tension 	<ul style="list-style-type: none"> (● Check, repair loose terminals, disconnections) ● Adjust fan belt tension For details, see EVERY 250 HOURS SERVICE
Lamp flickers while engine is running		
Charge lamp does not go out even when engine is running	<ul style="list-style-type: none"> ● Defective alternator ● Defective wiring 	<ul style="list-style-type: none"> (● Replace) (● Check, repair)
Abnormal noise is generated from alternator	<ul style="list-style-type: none"> ● Defective alternator 	<ul style="list-style-type: none"> (● Replace)
Starting motor does not turn when starting switch is turned to ON	<ul style="list-style-type: none"> ● Defective wiring ● Insufficient battery charge 	<ul style="list-style-type: none"> (● Check, repair) ● Charge
Pinion of starting motor keeps going in and out	<ul style="list-style-type: none"> ● Insufficient battery charge 	<ul style="list-style-type: none"> ● Charge
Starting motor turns engine sluggishly	<ul style="list-style-type: none"> ● Insufficient battery charge ● Defective starting motor 	<ul style="list-style-type: none"> ● Charge (● Replace)
Starting motor disengages before engine starts	<ul style="list-style-type: none"> ● Defective wiring ● Insufficient battery charge 	<ul style="list-style-type: none"> (● Check, repair) ● Charge
Pre-heating monitor does not light	<ul style="list-style-type: none"> ● Defective wiring ● Defective monitor 	<ul style="list-style-type: none"> (● Check, repair) (● Replace)
Oil pressure monitor does not light up when engine is stopped (starting switch at ON position)	<ul style="list-style-type: none"> ● Defective monitor ● Defective oil pressure switch 	<ul style="list-style-type: none"> (● Replace) (● Replace)

16.5.2 CHASSIS

- (): Always contact your Komatsu distributor when dealing with these items.
- In cases of abnormalities or causes which are not listed below, please contact your Komatsu distributor for repairs.

Problem	Main causes	Remedy
Speed of travel, swing, boom, arm, bucket is slow	<ul style="list-style-type: none"> ● Lack of hydraulic oil 	<ul style="list-style-type: none"> ● Add oil to specified level, see CHECK BEFORE STARTING
Pump generates abnormal noise	<ul style="list-style-type: none"> ● Clogged element in hydraulic tank strainer 	<ul style="list-style-type: none"> ● Clean, see EVERY 2000 HOURS SERVICE
Does not swing	<ul style="list-style-type: none"> ● Swing lock pin not removed 	<ul style="list-style-type: none"> ● Remove pin
Excessive rise in hydraulic oil temperature	<ul style="list-style-type: none"> ● Loose fan belt ● Lack of hydraulic oil 	<ul style="list-style-type: none"> ● Adjust fan belt tension, see EVERY 250 HOURS SERVICE ● Add oil to specified level see CHECK BEFORE STARTING
Track comes off	<ul style="list-style-type: none"> ● Track too loose 	<ul style="list-style-type: none"> ● Adjust track tension, see WHEN REQUIRED
Abnormal wear of sprocket		
Bucket rises slowly, does not rise	<ul style="list-style-type: none"> ● Lack of hydraulic oil 	<ul style="list-style-type: none"> ● Add oil to specified level, see CHECK BEFORE STARTING

16.5.3 ENGINE

- (): Always contact your Komatsu distributor when dealing with these items.
- In cases of abnormalities or causes which are not listed below, please contact your Komatsu distributor for repairs.

Problem	Main causes	Remedy
Engine oil pressure monitor lights up	<ul style="list-style-type: none"> ● Engine oil pan oil level is low (sucking in air) ● Clogged oil filter element ● Defective tightening of oil pipe joint, oil leakage from damaged part ● Defective monitor lamp 	<ul style="list-style-type: none"> ● Add oil to specified level, see CHECK BEFORE STARTING ● Replace cartridge, see EVERY 250 HOURS SERVICE (● Check, repair) (● Replace lamp)
Steam is emitted from top part of radiator (pressure valve)	<ul style="list-style-type: none"> ● Cooling water level low, water leakage ● Loosen fan belt ● Dirt or scale accumulated in cooling system ● Clogged radiator fin or damaged fin ● Defective thermostat ● Loose radiator filler cap (high altitude operation) 	<ul style="list-style-type: none"> ● Add cooling water, repair, see CHECK BEFORE STARTING ● Adjust fan belt tension, see EVERY 250 HOURS SERVICE ● Change cooling water, clean inside of cooling system, see WHEN REQUIRED ● Clean or repair, see EVERY 500 HOURS SERVICE (● Replace thermostat) ● Tighten cap or replace packing
Red range on engine water temperature gauge lights up		
White range on engine water temperature gauge lights up	<ul style="list-style-type: none"> ● Defective thermostat 	<ul style="list-style-type: none"> (● Replace thermostat)
Engine does not start when starting motor is turned	<ul style="list-style-type: none"> ● Lack of fuel ● Air in fuel system ● Defective fuel injection pump or nozzle ● Starting motor cranks engine sluggishly ● Preheating monitor does not light up ● Defective compression <ul style="list-style-type: none"> ○ Defective valve clearance 	<ul style="list-style-type: none"> ● Add fuel, see CHECK BEFORE STARTING ● Repair place where air is sucked in, see EVERY 500 HOURS SERVICE (● Replace pump or nozzle) — See ELECTRICAL SYSTEM (○ Adjust valve clearance)

ENGINE (cont'd) (16. 5. 3)

Problem	Main causes	Remedy
Exhaust gas is white or blue	<ul style="list-style-type: none"> ● Too much oil in oil pan ● Improper fuel 	<ul style="list-style-type: none"> ● Add oil to specified level, see CHECK BEFORE STARTING ● Change to specified fuel
Exhaust gas occasionally turns black	<ul style="list-style-type: none"> ● Clogged air cleaner element ● Defective nozzle ● Defective compression 	<ul style="list-style-type: none"> ● Clean or replace, see WHEN REQUIRED (● Replace nozzle) (● See defective compression above)
Combustion noise occasionally makes breathing sound	<ul style="list-style-type: none"> ● Defective nozzle 	<ul style="list-style-type: none"> (● Replace nozzle)
Abnormal noise generated (combustion or mechanical)	<ul style="list-style-type: none"> ● Low grade fuel being used ● Overheating ● Damage inside muffler ● Excessive valve clearance 	<ul style="list-style-type: none"> ● Change to specified fuel ● Red range of engine water temperature gauge lights up as above (● Replace muffler) (● Adjust valve clearance)

MEMO

MAINTENANCE



17. GUIDES TO MAINTENANCE

Do not carry out any inspection and maintenance operation that is not given in this manual.

Perform maintenance work on hard, flat ground.

Check service meter:

Check the service meter reading every day to see if the time has come for any necessary maintenance to be carried out.

Komatsu genuine replacement parts:

Use Komatsu genuine parts specified in the Parts Book as replacement parts.

Komatsu genuine oils:

Use Komatsu genuine oils and grease. Choose oils and grease with proper viscosities specified for ambient temperature.

Always use clean washer fluid:

Use automobile window washer fluid and be careful not to let any dirt get into it.

Always use clean oil and grease:

Use clean oil and grease. Also, keep containers of the oil and grease clean. Keep foreign materials away from oil and grease.

Keeping the machine clean:

Always keep the machine clean. This makes it easier to find parts causing problems. Keep in particular grease fittings, breathers and oil level gauges clean and avoid foreign matters from getting in them.

Be careful of hot water and oil:

Draining hot oils and coolants and removing their filters immediately after the engine stops are hazardous. Allow the engine to cool.

If the oil has to be drained when it is cold, warm up the oil to a suitable temperature (approx. 20 – 40°C) before draining it.

Checking foreign materials in drained oil and on filter:

After oil is changed or filters are replaced, check the oil and filters for metallic particles and foreign materials. If large quantities of metallic particles or foreign materials are found, consult your Komatsu distributor.

Fuel strainer:

If your machine is equipped with a fuel strainer, do not remove it while fueling.

Oil change:

Check or change oils in the places where dust is scarce to keep foreign materials away from oils.

Warning tag:

Attach the warning tag to the starting switch or other appropriate control lever to avoid someone who is not aware of the circumstances from starting the engine.

Obey precautions:

During the operation, always obey the precautions on the safety label attached to the machine.

Welding instructions:

- Turn off the engine starting switch.
- Do not apply more than 200 V continuously.
- Connect grounding the cable within 1 m from the area to be welded.
- Avoid seals or bearings from being between the area to be welded and the position of grounding point.
- Do not use the area around the work equipment pins or the hydraulic cylinders as the grounding point.

Fire prevention:

Use nonflammable cleaner or light oil for cleaning parts. Keep flame or cigarette light away from light oil.

Clamp faces:

When O-rings or gaskets are removed, clean the clamp faces and replace the O-rings and gaskets with new ones. Be sure to fit O-rings and gaskets when assembling.

Objects in your pockets:

Keep your pockets free of loose objects which can fall out and drop into the machinery; especially when you work on the machinery while bending over it.

Checking undercarriage:

When working in rocky areas, check for damage to the undercarriage and for looseness, flaws, wear and damage in bolts and nuts. Loosen the track tension a little when working in such areas.

Precautions when washing machine:

- Never spray steam or water directly on the connectors and mechatronics parts.
- Do not allow water to get on the monitors and controllers inside the operator's cab.
- Never spray steam or water directly at the radiator or oil cooler portions.
- Acryl is used for the rear face, roof, and left face of the cab specification machine, so do not wipe it with any dirty cloth or chemical (thinner, gasoline, etc.). If any of these parts is scratched, polish it with a compound. When cleaning it, use water and a clean cloth to remove all the mud and dirt.

Pre-and post-work checks:

Before starting work in mud, rain, snow or at seashore, check plugs and valves for tightness.

Wash the machine immediately after the work to protect components from rusting.

Lubricate components more frequently than usual. Be sure to lubricate work equipment pins daily if they are submerged in water.

Dusty worksites:

When working at dusty worksites, do as follows:

- Inspect the dust indicator to see whether the air cleaner is blocked up. Clean the air cleaner at shorter intervals than specified.
- Clean the radiator core frequently to avoid clogging.
- Clean and replace the fuel filter frequently.
- Clean electrical components, especially the starting motor and alternator, to avoid accumulation of dust.

Avoid mixing oils:

Never mix oils of different brands. If you have only oil which is a different brand from the one that is used in the machine, do not add it but replace all the oil.

18. OUTLINES OF SERVICE

- Use Komatsu genuine parts for replacement.
- When changing or adding oil, do not use a different type of oil.
- Unless otherwise specified, the oil and coolant used at the time of shipment from the factory are as shown in the table below.

Item	Kind of fluid
Engine oil pan	SAE 15W-40 API classification CD
Swing machinery case Final drive case PTO gear case	SAE 30 API classification CD
Hydraulic tank	SAE 10W API classification CD
Fuel tank	ASTM D975 No. 2 (However, ASTM D975 No. 1 is used for the winter season (October to March))
Radiator	Komatsu Super Coolant (AF-ACL) 30% added to water
Grease for automatic greasing	NLGI No. 2

18.1 OUTLINE OF OIL, FUEL, COOLANT

18.1.1 OIL

- Oil is used in the engine and work equipment under extremely severe conditions (high temperature, high pressure), and it deteriorates with use.
Always use oil that matches the grade and temperature for use given in the Operation and Maintenance Manual. Even if the oil is not dirty, always replace the oil after the specified interval.
- Oil corresponds to blood in the human body, so always be careful when handling it to prevent any impurities (water, metal particles, dirt, etc.) from getting in.
The majority of problems with machine are caused by the entry of such impurities.
Take particular care not to let any impurities get in when storing or adding oil.
- Never mix oils of different grades or brands.
- Always add the specified amount of oil.
Having too much oil or too little oil are both causes of problems.
- If the oil in the work equipment is not clear, there is probably water or air getting into the circuit.
In such cases, please contact your Komatsu distributor.
- When changing the oil, always replace the related filters at the same time.
- We recommend you to have an analysis made of the oil periodically to check the condition of the machine. For those who wish to use this service, please contact your Komatsu distributor.

18.1.2 FUEL

- The fuel pump is a precision instrument, and if fuel containing water or dirt is used, it cannot work properly.
- Be extremely careful not to let impurities get in when storing or adding fuel.
- Always use the fuel specified in the Operation and Maintenance Manual.
Fuel may congeal depending on the temperature when it is used (particularly in low temperature below-15°C), so it is necessary to change to a fuel that matches the temperature.
- To prevent the moisture in the air from condensing and forming water inside the fuel tank, always fill the fuel tank after completing the day's work.
- Before starting the engine, or when 10 minutes have passed after adding fuel, drain the sediment and water from the fuel tank.
- If the engine runs out of fuel, or if the filters have been replaced, it is necessary to bleed the air from the circuit.

18.1.3 COOLANT

- River water contains large amounts of calcium and other impurities, so if it is used, scale will stick to the engine and radiator, and this will cause defective heat exchange and overheating.
Do not use water that is not suitable for drinking.
- When using anti-freeze, always observe the precautions given in the Operation and Maintenance Manual.
- Komatsu machines are supplied with Komatsu original anti-freeze in the coolant when the machine is shipped.
This anti-freeze is effective in preventing corrosion of the cooling system.
The anti-freeze can be used continuously for two years or 4000 hours. Therefore, it can be used as it is even in hot areas.
- Anti-freeze is inflammable, so be extremely careful not to expose it to flame or fire.
- The proportion of anti-freeze to water differs according to the ambient temperature.
For details of the mixing proportions, see "24.2.2 CLEAN INSIDE OF COOLING SYSTEM."
- If the engine overheats, wait for the engine to cool before adding coolant.
- If the coolant level is low, it will cause overheating and will also cause problems with corrosion from the air in the coolant.

18.1.4 GREASE

- Grease is used to prevent twisting and noise at the joints.
- The nipples not included in the maintenance section are nipples for overhaul, so they do not need grease.
If any part becomes stiff after being used for long time, add grease.
- Always wipe off all of the old grease that is pushed out when greasing. Be particularly careful to wipe off the old grease in places. Where sand or dirt sticking in the grease would cause wear of the rotating parts.

18.1.5 STORING OIL AND FUEL

- Keep indoors to prevent any water, dirt, or other impurities from getting in.
- When keeping drum cans for a long period, put the drum on its side so that the filler port of the drum can is at the side. (To prevent moisture from being sucked in)
If drum cans have to be stored outside, cover them with a waterproof sheet or take other measures to protect them.
- To prevent any change in quality during long-term storage, be sure to use in the order of first in - first out (use the oldest oil or fuel first).

18.1.6 FILTERS

- Filters are extremely important safety parts. They prevent impurities in the fuel and air circuits from entering important equipment and causing problems.
Replace all filters periodically. For details, see the Operation and Maintenance Manual.
However, when working in severe conditions, it is necessary to consider replacing the filters at shorter intervals according to the oil and fuel (sulfur content) being used.
- Never try to clean the filters (cartridge type) and use them again. Always replace with new filters.
- When replacing oil filters, check if any metal particles are stuck to the old filter. If any metal particles are found, please contact your Komatsu distributor.
- Do not open packs of spare filters until just before they are to be used.
- Always use Komatsu genuine filters.

18.2 OUTLINE OF ELECTRIC SYSTEM

- If the wiring gets wet or the insulation is damaged, the electric system leaks and this could result in hazardous malfunction of the machine.
- Services relating to the electric system are (1) check of fan belt tension, (2) check of damage or wear in the fan belt and (3) check of battery fluid level.
- Never remove or disassemble any electric components installed in the machine.
- Never install any electric components other than these specified by Komatsu.
- Be careful to keep the electric system free of water when washing the machine or when it rains.
- Since the controller for the control system may cause malfunction due to external wave interference, before installing a radio receiver and a walkie-talkie or citizen band, consult your Komatsu distributor.
- When working on the seashore, carefully clean the electric system to prevent corrosion.
- When installing a car cooler or any other electrical equipment, connect it to an independent power source connector. The optional power source must never be connected to the fuse, starting switch, or battery relay.

18.3 OUTLINE OF HYDRAULIC SYSTEM

- During operation and immediately after operation is ended, the temperature of the hydraulic system still remains high.
In addition, high hydraulic pressure is applied to the system. Take care when inspecting and maintaining the hydraulic system.
 - Stop the machine on level ground, lower the bucket to the ground, then set so that there is no pressure applied to the cylinder circuit.
 - Always stop the engine.
 - Immediately after operations, the hydraulic oil and lubricating oil are at high temperature and high pressure, so wait for the oil temperature to go down before starting maintenance.
Even when the temperature goes down, the circuit may still be under internal pressure, so when loosening the plug or screw, or the hose joint, do not stand in front of the part. Loosen it slowly to release the internal pressure before removing it.
 - When carrying out inspection or maintenance of the hydraulic circuit, always bleed the air from the hydraulic tank to remove the internal pressure.
- Periodic maintenance includes the inspection of the hydraulic oil level, replacement of the filter and refilling of hydraulic oil.
- When the high pressure hose, etc. is removed, check the O-ring for damage. If necessary, replace it.
- After the hydraulic filter element and strainer are cleaned or replaced, or after the hydraulic system is repaired or replaced or the hydraulic piping is removed, bleed air from the hydraulic circuit.

19. WEAR PARTS LIST

Wear parts such as the filter element, bucket tooth, etc. are to be replaced at the time of periodic maintenance or before their abrasion limits.

The wear parts should be changed correctly in order to use the machine economically.

For part change, Komatsu genuine parts of excellent quality should be used.

When ordering parts, please check the part number in the parts book.

The parts in parentheses are to be replaced at the same time.

Item	Part No.	Part Name	Q'ty	Replacement frequency	
Hydraulic oil filter	07063-01054 (07000-02135)	Element (O-ring)	1 (1)	Every 250 hours service	
Engine oil filter	YM129150-35151	Oil filter assembly	1	Every 250 hours service	
Fuel filter	YM129100-55650	Element	1	Every 500 hours service	
Air cleaner	YM121120-12901	Element	1	—	
Standard bucket (Vertical pin) (PC25, 30)	20T-70-72320 (20T-70-71950) (20T-70-71960)	Tooth (Pin) (Lock)	4 (4) (4)	—	
	(20S-70-71330) (20S-70-71340) (20P-70-71350) (20P-70-71360)	Side cutter (left) Side cutter (right) (Bolt) (Nut)	1 1 (6) (6)	—	
	20T-70-72320 (20T-70-71950) (20T-70-71960)	Tooth (Pin) (Lock)	4 (4) (4)	—	
	20U-70-13241 20U-70-13251 (20U-70-13270) (203-32-51220)	Side cutter (left) Side cutter (right) (Bolt) (Nut)	1 1 (8) (8)	—	
	20S-71-21120	Edge (welded)	1	—	
Blade (PC25,30)	Steel shoes specification	20S-71-31520	Edge (welded)	1	—
Blade (PC40,45)	Rubber shoes specification	20T-71-41120	Edge (welded)	1	—
	Steel shoes specification	20T-71-42120	Edge (welded)	1	—

20. USE OF FUEL, COOLANT AND LUBRICANTS ACCORDING TO AMBIENT TEMPERATURE

PROPER SELECTION OF FUEL, COOLANT AND LUBRICANTS

RESERVOIR	KIND OF FLUID	AMBIENT TEMPERATURE								CAPACITY			
		-22 -30	-4 -20	14 -10	32 0	50 10	68 20	86 30	104°F 40°C	Specified	Refill		
Engine oil pan	Engine oil									SAE 30		PC25, 30 7.8 l	PC25, 30 7.3 l
										SAE 10W		2.06 US gal 1.72 UK gal	1.93 US gal 1.61 UK gal
										SAE 10W-30		PC40, 45 9.1 l	PC40, 45 8.5 l
										SAE 15W-40		2.40 US gal 2.00 UK gal	2.24 US gal 1.87 UK gal
Swing machinery case	Engine oil									PC25, 30 0.9 l	PC25, 30 0.9 l		
									0.24 US gal 0.20 UK gal	0.24 US gal 0.20 UK gal			
Final drive case (each)	Engine oil									PC40, 45 1.0 l	PC40, 45 1.0 l		
										0.26 US gal 0.22 UK gal	0.26 US gal 0.22 UK gal		
	Engine oil									SAE 30		PC25, 30 1.2 l	PC25, 30 1.2 l
										0.32 US gal 0.26 UK gal	0.32 US gal 0.26 UK gal		
	Engine oil									PC40 1.4 l	PC40 1.4 l		
										0.37 US gal 0.31 UK gal	0.37 US gal 0.31 UK gal		
	Engine oil									PC45 1.1 l	PC45 1.1 l		
										0.29 US gal 0.24 UK gal	0.29 US gal 0.24 UK gal		
Hydraulic system	Engine oil									SAE 10W		78 l	45 l
										SAE 10W-30		20.6 US gal	11.9 US gal
										SAE 15W-40		17.2 UK gal	9.9 UK gal
Fuel tank	Diesel fuel									ASTM D975 No.2		50 l	—
			※1							13.2 US gal 11.0 UK gal	—		
Cooling system	Water	Add antifreeze								PC25 4.8 l	—		
										1.27 US gal 1.06 UK gal			
										PC30 5.1 l			
										1.35 US gal 1.12 UK gal			
										PC40, 45 8.0 l			
										2.11 US gal 1.76 UK gal			

※1: ASTM D975 No. 1

REMARK

- When fuel sulphur content is less than 0.5%, change oil in the oil pan every periodic maintenance hours described in this manual.
Change oil according to the following table if fuel sulphur content is above 0.5%.

Fuel sulphur content	Change interval of oil in engine oil pan
0.5 to 1.0%	1/2 of regular interval
Above 1.0%	1/4 of regular interval

- When starting the engine in an atmospheric temperature of lower than 0°C, be sure to use engine oil of SAE10W, SAE10W-30 and SAE15W-40, even though an atmospheric temperature goes up to 10°C more or less in the day time.
- Use API classification CD as engine oil and if API classification CC, reduce the engine oil change interval to half.
- There is no problem if single grade oil is mixed with multigrade oil (SAE10W-30, 15W-40), but be sure to add single grade oil that matches the temperature in the table.
- We recommend Komatsu genuine oil which has been specifically formulated and approved for use in engine and hydraulic work equipment applications.

Specified capacity: Total amount of oil including oil for components and oil in piping.

Refill capacity: Amount of oil needed to refill system during normal inspection and maintenance.

ASTM: American Society of Testing and Material

SAE: Society of Automotive Engineers

API: American Petroleum Institute

20. USE OF FUEL, COOLANT AND LUBRICANTS ACCORDING TO AMBIENT TEMPERATURE

No.	Supplier	Engine Oil [CD or CE] SAE10W, 30, 40 10W30, 15W40 (The 15W40 oil marked * is CE.)	Gear Oil [GL-4 or GL-5] SAE80, 90, 140	Grease [Lithium-Base] NLGI No. 2	Anti-freeze Coolant [Ethylene Glycol Base] Permanent Type
1	KOMATSU	EO10-CD EO30-CD EO10-30CD EO15-40CD	GO90 GO140	G2-LI G2-LI-S	AF-ACL AF-PTL AF-PT (Winter, one season type)
2	AGIP	Diesel sigma S Super dieselmulti- grade *Sigma turbo	Rotra MP	GR MU/EP	-
3	AMOCO	*Amoco 300	Multi-purpose gear oil	RYKON premium grease	-
4	ARCO	*Arcofleet S3 plus	Arco HD gear oil	Litholine HEP 2 Arco EP moly D	-
5	BP	Vanellus C3	Gear oil EP Hypogear EP	Energrease LS-EP2	Antifreeze
6	CALTEX	*RPM delo 400 RPM delo 450	Universal thuban Universal thuban EP	Marfak all purpose 2 Ultra-duty grease 2	AF engine coolant
7	CASTROL	*Turbomax *RX super CRD	EP EPX Hypoy Hypoy B Hypoy C	MS3 Spheerol EPL2	Anti-freeze
8	CHEVRON	*Delo 400	Universal gear	Ultra-duty grease 2	-
9	CONOCO	*Fleet motor oil	Universal gear lubricant	Super-sta grease	-
10	ELF	Multiperformance 3C Performance 3C	-	Tranself EP Tranself EP type 2	Glacelf
11	EXXON (ESSO)	Essolube D3 *Essolube XD-3 *Essolube XD-3 Extra *Esso heavy duty Exxon heavy duty	Gear oil GP Gear oil GX	Beacon EP2	All season coolant
12	GULF	Super duty motor oil *Super duty plus	Multi-purpose gear lubricant	Gulfcrown EP2 Gulfcrown EP special	Antifreeze and coolant
13	MOBIL	Delvac 1300 *Delvac super 10W-30, 15W-40	Mobilube GX Mobilube HD	Mobilux EP2 Mobilgrease 77 Mobilgrease special	-

20. USE OF FUEL, COOLANT AND LUBRICANTS ACCORDING TO AMBIENT TEMPERATURE

No.	Supplier	Engine Oil [CD or CE] SAE10W, 30, 40 10W30, 15W40 (The 15W40 oil marked * is CE.)	Gear Oil [GL-4 or GL-5] SAE80, 90, 140	Grease [Lithium-Base] NLGI No. 2	Anti-freeze Coolant [Ethylene Glycol Base] Permanent Type
14	PENNZOIL	*Supreme duty fleet motor oil	Multi-purpose 4092 Multi-purpose 4140	Multi-purpose white grease 705 707L White – bearing grease	Anti-freeze and summer coolant
15	PETROFINA	FINA kappa TD	FINA potonic N FINA potonic NE	FINA marson EPL2	FINA tamidor
16	SHELL	Rimula X	Spirax EP Spirax heavy duty	Alvania EP grease	–
17	SUN	–	Sunoco GL5 gear oil	Sunoco ultra prestige 2EP Sun prestige 742	Sunoco antifreeze and summer coolant
18	TEXACO	*Ursa super plus Ursa premium	Multigear	Multifak EP2 Starplex 2	Code 2055 startex antifreeze coolant
19	TOTAL	Rubia S *Rubia X	Total EP Total transmission TM	Multis EP2	Antigel/antifreeze
20	UNION	*Guardol	MP gear lube LS	Unoba EP	–
21	VEEDOL	*Turbostar *Diesel star MDC	Multigear Multigear B Multigear C	–	Antifreeze

21. STANDARD TIGHTENING TORQUES FOR BOLTS AND NUTS

21.1 INTRODUCTION OF NECESSARY TOOLS

The following tools are needed when carrying out maintenance.

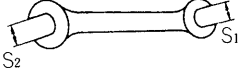
No.	Name of tool	Part No.	Remarks
1	Wrench set	09000-30006	Applicable width across flats ($S_1 - S_2$) 8 mm - 10 mm, 12 mm - 14 mm 13 mm - 17 mm, 19 mm - 22 mm 24 mm - 27 mm, 30 mm - 32 mm
			
2	Screw driver	09033-00190	Interchangeable flat-head and cross-head type
3	Hexagon wrench	09007-00836	Applicable width across flats 8 mm
4	Socket	09021-01725	Applicable width across flats 17 mm
5	Filter wrench	YM119640-92750	For engine oil filter
6	Filter wrench	YM171340-92760	For fuel filter
7	Filter wrench	YM171051-92760	For water separator
8	Grease pump	07952-80002	For greasing work
9	Nozzle	07951-11400	PC40, 45 For rubber shoe (For the machine equipped with rubber shoes)
10	Grease cartridge	07950-90403	(Lithium base grease, 400 g)

If any of the above tools are broken, please order them from your Komatsu distributor.

21.2 TORQUE LIST



Unless otherwise specified, tighten the metric bolts and nuts to the torque shown in the table.

The tightening torque is determined by the width across the flats (b) of the nut and bolt.

If it is necessary to replace any nut or bolt, always use a Komatsu genuine part of the same size as the part that was replaced.

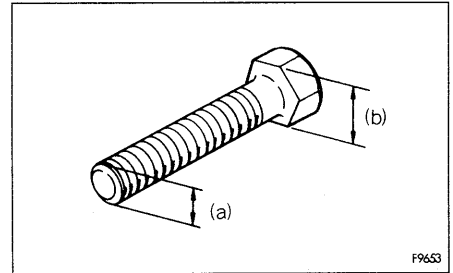
Nm (newton meter): 1Nm \approx 0.1 kgm
 \approx 0.74 lbft



Thread diameter of bolt (mm) (a)	Width across flat (mm) (b)	  AD054300		
		Nm	kgm	lbft
6	10	13.2 ± 1.4	1.35 ± 0.15	9.73 ± 1.03
8	13	31.4 ± 2.9	3.2 ± 0.3	23.2 ± 2.1
10	17	65.7 ± 6.8	6.7 ± 0.7	48.5 ± 5.0
12	19	112 ± 9.8	11.5 ± 1.0	82.6 ± 7.2
14	22	177 ± 19	18.0 ± 2.0	131 ± 14
16	24	279 ± 29	28.5 ± 3	206 ± 21
18	27	383 ± 39	39 ± 3	282 ± 29
20	30	549 ± 58	56 ± 6	405 ± 43
22	32	745 ± 78	76 ± 8	549 ± 58
24	36	927 ± 98	94.5 ± 10	684 ± 72
27	41	1320 ± 140	135 ± 15	973 ± 100
30	46	1720 ± 190	175 ± 20	1270 ± 140
33	50	2210 ± 240	225 ± 25	1630 ± 180
36	55	2750 ± 290	280 ± 30	2030 ± 210
39	60	3280 ± 340	335 ± 35	2420 ± 250

NOTICE

When tightening panels or other parts having tightening fixtures made of plastic, be careful not to use excessive tightening torque: doing so will damage the plastic parts.

22. PERIODIC REPLACEMENT OF SAFETY CRITICAL PARTS

To ensure safety at all times when operating or driving the machine, the user of the machine must always carry out periodic maintenance. In addition, to further improve safety, the user should also carry out periodic replacement of the parts given in the table. These parts are particularly closely connected to safety and fire prevention.

With these parts, the material changes as time passed, or they easily wear or deteriorate. However, it is difficult to judge the condition of the parts simply by periodic maintenance, so they should always be replaced after a fixed time has passed, regardless of their condition. This is necessary to ensure that they always maintain their function completely.

However, if these parts show any abnormality before the replacement interval has passed, they should be repaired or replaced immediately.

If the hose clamps show any deterioration, such as deformation or cracking, replace the clamps at the same as the hoses.

When replacing the hoses, always replace the O-rings, gaskets, and other such parts at the same time.

Ask your Komatsu distributor to replace the safety critical parts.

SAFETY CRITICAL PARTS

No.	Safety critical parts for periodic replacement	Q'ty	Replacement interval	
1	Fuel hose (fuel tank – water separator)	1	Every 2 years or 4000 hours, whichever comes sooner	
2	Fuel hose (water separator – feed pump)	1		
3	Fuel hose (feed pump – fuel filter)	1		
4	Fuel hose (fuel filter – injection pump)	2		
5	Fuel hose (fuel filter – fuel tank)	1		
6	Spill hose (between nozzles)	PC25, 30		2
		PC40, 45		3
7	Spill hose (nozzle – injection pump)	1		
8	Spill hose cap	1		

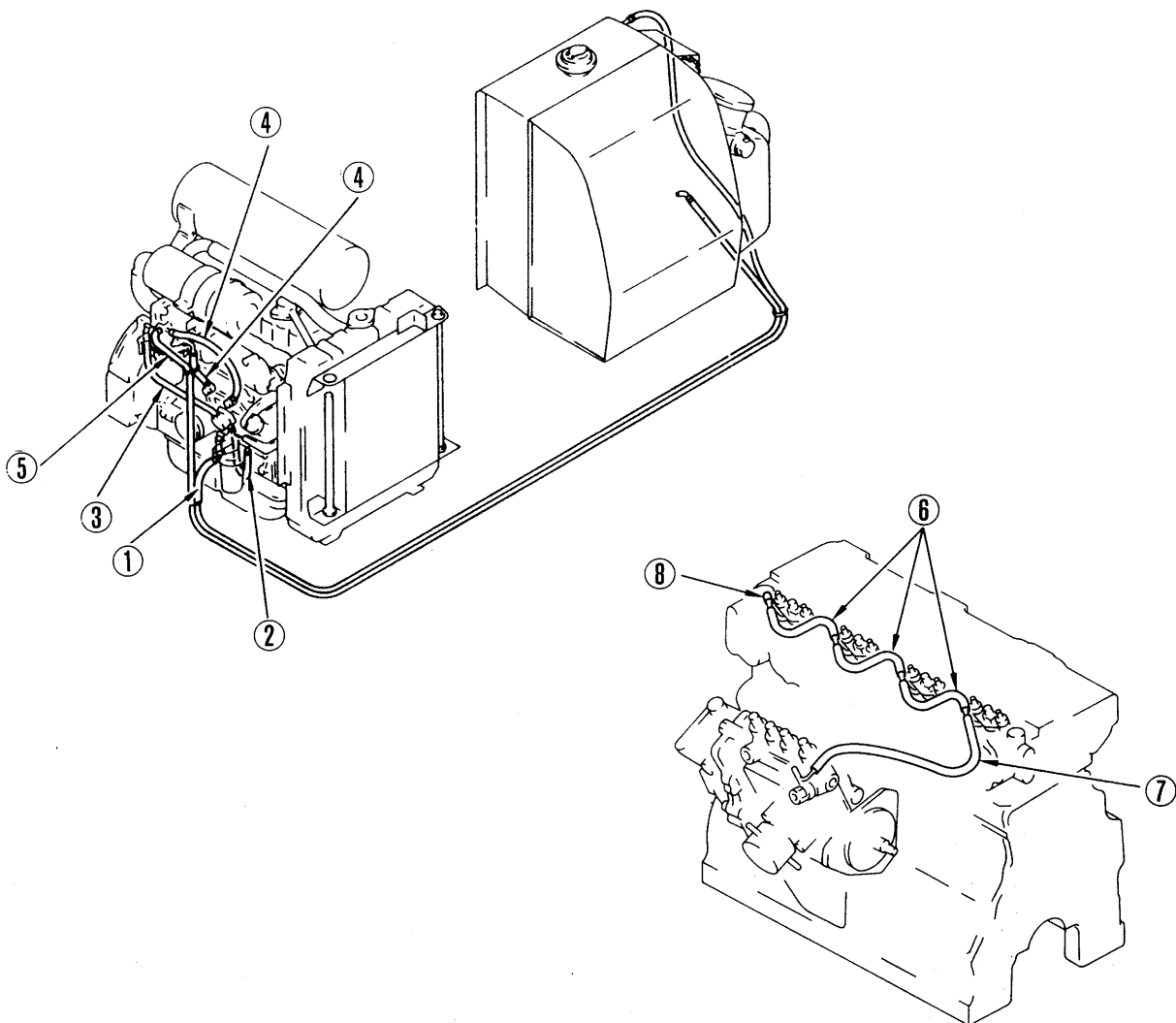

23. MAINTENANCE SCHEDULE CHART

23.1 MAINTENANCE SCHEDULE CHART

SERVICE ITEM	PAGE
INITIAL 250 HOURS SERVICE (only after the first 250 hours)	
Check engine valve clearance, adjust	3-68
WHEN REQUIRED	
Check, clean and replace air cleaner element	3-22
Clean inside of cooling system	3-25
Drain water, sediment form fuel tank	3-29
Clean water separator element	3-29
Check electric wirings	3-30
Check rubber shoes (Machine equipped with rubber shoes)	3-31
Check and adjust track tension (Machine equipped with rubber shoes)	3-33
Replace rubber shoes (Machine equipped with rubber shoes)	3-35
Check and adjust track tension (Machine equipped with steel shoes)	3-38
Replace bucket teeth (vertical pin type)	3-41
Inspection of bucket play adjustment mechanism	3-44
CHECK BEFORE STARTING	
Check coolant level, add water	3-45
Check oil level in engine oil pan, add oil	3-45
Check fuel level, add fuel	3-46
Check oil level in hydraulic tank, add oil	3-47
Check dust indicator	3-48
Check water separator	3-48
EVERY 100 HOURS SERVICE	
Lubricating	3-49
● Swing pinion (1 point)	3-49
● Swing circle (1 point)	3-49
● Boom swing cylinder foot pin (1 point)	3-49
● Boom swing cylinder rod end (1 point)	3-49
● Boom cylinder foot pin (1 point)	3-49
● Blade cylinder foot pin (1 point)	3-49
● Blade foot pin (2 points)	3-49
● Blade cylinder rod end (1 point)	3-49
● Boom foot pin (2 points)	3-49

SERVICE ITEM	PAGE
● Boom swing bracket pin (2 points)	3-49
● Arm cylinder foot pin (1 point)	3-50
● Boom cylinder rod end (1 point)	3-50
● Boom – Arm coupling pin (1 point)	3-50
● Arm cylinder rod end (1 point)	3-50
● Bucket cylinder foot pin (1 point)	3-50
● Bucket cylinder rod end (1 point)	3-50
● Link coupling pin (1 point)	3-50
● Bucket – Link coupling pin (2 points)	3-50
● Arm – Bucket coupling pin (1 point)	3-50
● Arm – Link coupling pin (1 point)	3-50
EVERY 250 HOURS SERVICE	
Change oil in engine oil pan, replace engine oil filter cartridge	3-51
Check oil level in final drive case, add oil	3-53
Check level of battery electrolyte	3-55
Replace hydraulic filter element	3-56
Check fan belt tension, adjust	3-57
EVERY 500 HOURS SERVICE	
Replace fuel filter cartridge	3-58
Clean, check radiator fins	3-60
EVERY 1000 HOURS SERVICE	
Change oil in swing machinery case	3-61
Change oil in final drive case	3-62
EVERY 2000 HOURS SERVICE	
Check oil in hydraulic tank, clean strainer	3-64
Check alternator, starting motor	3-68
Check engine valve clearance, adjust	3-68

23.2 MAINTENANCE INTERVAL WHEN USING HYDRAULIC BREAKER

For machines equipped with a hydraulic breaker, the hydraulic oil deteriorates faster than for normal bucket digging operations, so set the maintenance intervals as follows.

- Replacing hydraulic filter element**
 On new machines, replace the element after the first 100 to 150 hours, then carry out further replacement of the element according to the table on the right.
- Changing oil in hydraulic tank**
 Change the oil according to the table on the right.

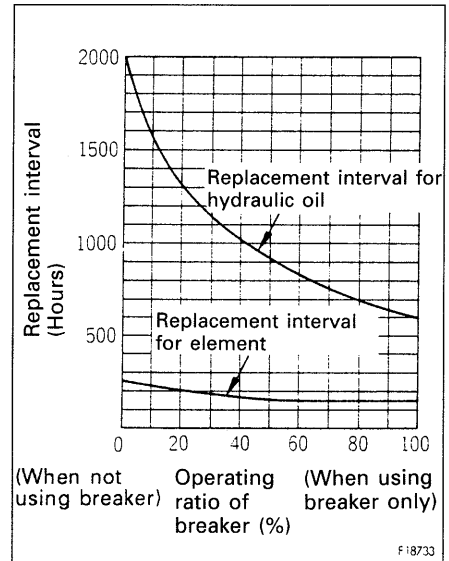

24. SERVICE PROCEDURE

24.1 INITIAL 250 HOURS SERVICE

Carry out the following maintenance only after the first 250 hours.

- **CHECK ENGINE VALVE CLEARANCE, ADJUST**

For details of the method of replacing or maintaining, see the section on EVERY 2000 HOURS SERVICE.

24.2 WHEN REQUIRED

24.2.1 CHECK, CLEAN AND REPLACE AIR CLEANER ELEMENT

⚠ WARNING

- Never clean or replace the air cleaner element with the engine running.
- When using pressure air to clean the element wear safety glasses or goggles to protect the eyes.

Checking

Whenever the red piston in dust indicator ① appears, clean the air cleaner element.

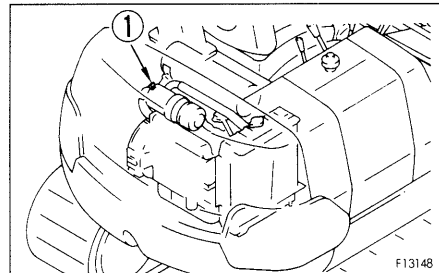

Cleaning or replacing outer element

1. Open the engine hood at the rear of the machine, loosen clip ②, remove dust cup ③.
2. Throw away the dust inside dust cup ③ and clean the inside of the cup.
3. Remove wing nut ④, take out element ⑤, then use a clean cloth or tape to cover the air connector inside the air cleaner body to prevent dust from entering.
4. Clean the inside of the air cleaner body.
5. Direct dry compressed air (less than 700 kPa (7 kg/cm², 100 psi)) to the element from inside along its folds, then direct it from outside along its folds and again from inside.
 - (1) Replace the element which has been cleaned 5 times repeatedly or used throughout a year.
 - (2) Replace element when the dust indicator red piston appears soon after installing the cleaned element even though it has not been cleaned 5 times.

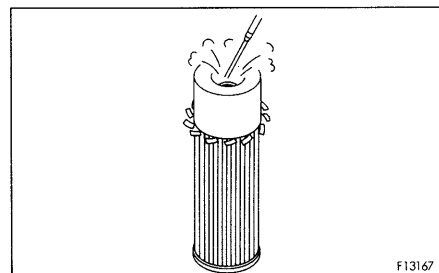
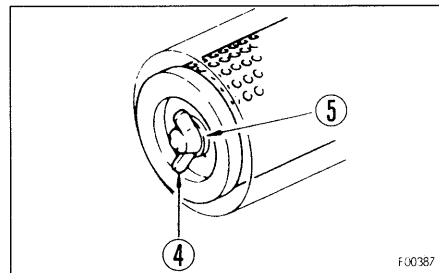
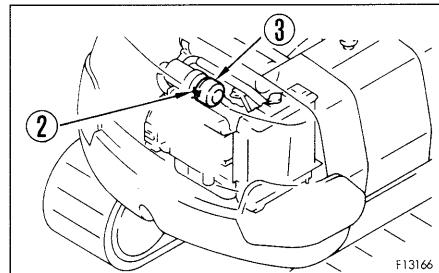

6. If small holes or thinner parts are found on the element when it is checked with an electric bulb after cleaning, replace the element.

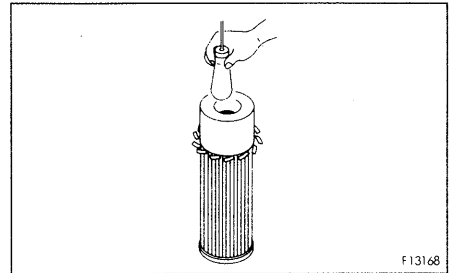

NOTICE

Do not use an element whose folds or gasket or seal are damaged.

When cleaning the element, do not hit it or beat it against something.

Wrap unused elements and store them in a dry place.

7. Remove the cloth or tape used as a cover in Step 3.

8. Set the cleaned element in position, and secure it with the wing nut.

9. Replace seal washer ⑥ or wing nut ④ with new parts if they are broken.

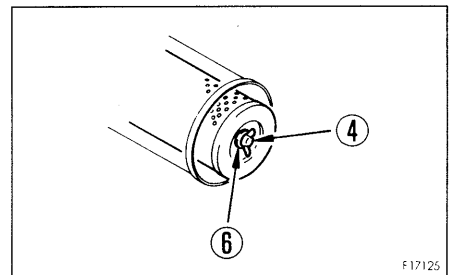

10. Set dust cap ③ with the arrow pointing up, then set it to the air cleaner body and secure it with clip ②.

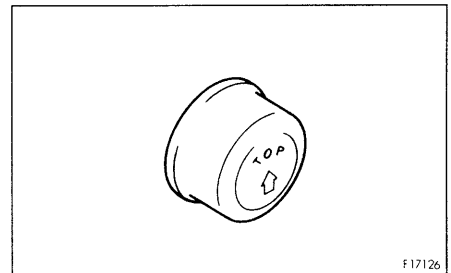

11. Press the button of dust indicator ① to return the red piston to its original position.

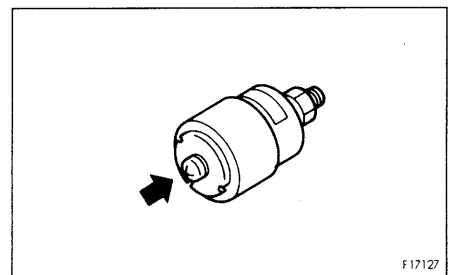

Replacing element

1. Open the engine hood at the rear of the machine, release clip ②, and remove dust cap ③. Remove wing nut ④, take out element ⑤, then use a clean cloth or tape to cover the air connector inside the air cleaner body to prevent dust from entering.
2. Clean the inside of the air cleaner body, then remove the cloth or tape used as a cover in Step 1.
3. Set the new element in position, and secure it with wing nut ④.
4. Install dust cup ③.
5. After replacing the element, return the red piston in the dust indicator to its original position.

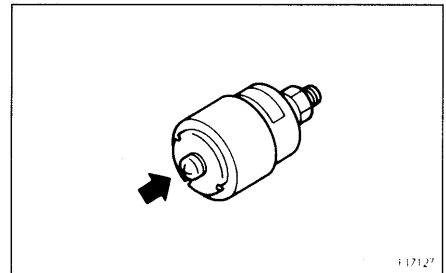
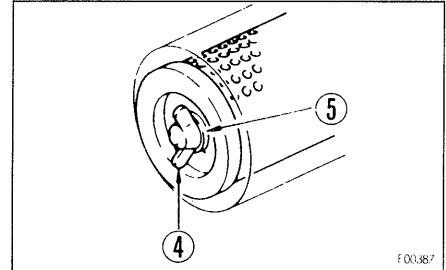
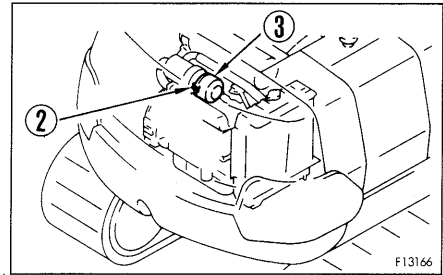

24.2.2 CLEAN INSIDE OF COOLING SYSTEM

WARNING

- **Soon after the engine has been stopped, the coolant is hot and can cause personal injury. Allow the engine to cool before draining water.**
 - **Since cleaning is performed while the engine is running, it is very dangerous to enter the rear side of the machine as the machine may suddenly start moving. There is also danger of touching the fan when the engine hood is open. While the engine is running, never enter the rear side of the machine.**
 - **Never remove the radiator cap when the engine is at operating temperature. At operating temperature, the coolant is under pressure. Steam blowing up from the radiator could cause personal injury. Allow the engine to cool until the radiator filler cap is cool enough to touch with your hand. Remove the filler cap slowly to allow pressure to be relieved.**
- Clean the inside of the cooling system, change the coolant and replace the corrosion resistor according to the table below.

Kind of coolant	Cleaning inside of cooling system and changing coolant	Adding corrosion resistor agent KI or replacing corrosion resistor cartridge
Permanent type antifreeze (All season type)	Every year (autumn) or every 2000 hours whichever comes first	Every 1000 hours and when cleaning the inside of the cooling system and when changing coolant.
Non permanent type antifreeze containing ethylene glycol (Winter, one season type)	Every 6 months (spring, autumn) (Drain antifreeze in spring, add antifreeze in autumn)	
When not using antifreeze	Every 6 months or every 1000 hours whichever comes first	

- Stop the machine on level ground when cleaning or changing the coolant.
- Use a permanent type of antifreeze.
If, for some reason, it is impossible to use permanent type antifreeze, use an antifreeze containing ethylene glycol.

24. SERVICE PROCEDURE

- When deciding the ratio of antifreeze to water, check the lowest temperature in the past, and decide from the mixing rate table given below.

It is actually better to estimate a temperature about 10°C lower when deciding the mixing rate.

Mixing rate of water and antifreeze

PC25

Min. atmospheric temperature	°C	-5	-10	-15	-20	-25	-30
	°F	23	14	5	-4	-13	-22
Amount of antifreeze	ℓ	1.2	1.5	1.8	2.0	2.3	2.4
	US gal	0.32	0.40	0.48	0.53	0.61	0.64
	UK gal	0.27	0.33	0.40	0.44	0.51	0.53
Amount of water	ℓ	3.6	3.3	3.0	2.8	2.5	2.4
	US gal	0.95	0.87	0.79	0.74	0.66	0.63
	UK gal	0.79	0.73	0.66	0.62	0.55	0.53

PC30

Min. atmospheric temperature	°C	-5	-10	-15	-20	-25	-30
	°F	23	14	5	-4	-13	-22
Amount of antifreeze	ℓ	1.2	1.6	1.9	2.1	2.4	2.6
	US gal	0.32	0.42	0.50	0.56	0.64	0.69
	UK gal	0.26	0.35	0.42	0.46	0.53	0.57
Amount of water	ℓ	3.9	3.5	3.2	3.0	2.7	2.5
	US gal	1.03	0.93	0.85	0.79	0.71	0.66
	UK gal	0.86	0.77	0.70	0.66	0.59	0.55

PC40, 45

Min. atmospheric temperature	°C	-5	-10	-15	-20	-25	-30
	°F	23	14	5	-4	-13	-22
Amount of antifreeze	ℓ	1.9	2.4	2.9	3.3	3.8	4.0
	US gal	0.50	0.63	0.77	0.87	1.00	1.06
	UK gal	0.42	0.53	0.64	0.73	0.84	0.88
Amount of water	ℓ	6.1	5.6	5.1	4.7	4.2	4.0
	US gal	1.61	1.48	1.34	1.24	1.11	1.05
	UK gal	1.34	1.23	1.12	1.03	0.92	0.88

⚠ WARNING

Antifreeze is flammable, so keep it away from any flame.

- Use city water for the cooling water.
If river water, well water or other such water supply must be used, contact your Komatsu distributor.
- We recommend use of an antifreeze density gauge to control the mixing proportions.

⚠ WARNING

When removing drain plug, avoid pouring coolant on yourself.

- Prepare a container to catch drained coolant
PC25 : Min. 4.8 ℓ (1.27 US gal, 1.06 UK gal) capacity.
PC30 : Min. 5.1 ℓ (1.35 US gal, 1.12 UK gal) capacity.
PC40, 45 : Min. 8.0 ℓ (2.11 US gal, 1.76 UK gal) capacity.
 - Prepare a water inlet hose.
1. Turn radiator cap ① slowly to remove it.
 2. Set a container to catch the coolant under drain valve ② and drain plug ③.
 3. Open the engine food and open drain valve ② at the bottom of the radiator to drain the water.
Remove drain plug ③ on the side face of cylinder block to drain the water.
 4. After draining the coolant, close drain valve ② and drain plug ③, then fill the radiator with city water. Run the engine at low idling speed.
 5. Running the engine at the low idling speed, open drain valve ② and drain plug ③ and keep supplying water for 10 minutes to clean the radiator.

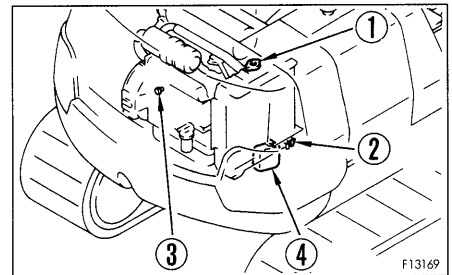

When doing this, adjust the speed of filling and draining the water so that the radiator is always full.
While flushing water through the system, watch carefully that the water inlet hose does not come out of the radiator water filler.

6. After flushing, stop the engine, open drain valve ③ and drain plug ④, then close it again after all the water has drained out.

24. SERVICE PROCEDURE

7. After draining the water, clean with a flushing agent.
We recommend use of a Komatsu genuine cleaning agent. For details of the cleaning method, see the instructions given with the cleaning agent.
8. After cleaning, open drain valve ③ and drain plug ④ to drain all the cooling water, then close them and fill slowly with clean water.
9. When the water comes up to near the water filler port, open drain valve ③ and drain plug ④, run the engine at low idling, and continue to run water through the system until clean colorless water comes out.

When doing this, adjust the speed of filling and draining the water so that the radiator is always full.

10. When the water is completely clean, stop the engine, close drain valve ② and drain plug ③.
11. Add cooling water until it overflows from the water filler.
12. To remove the air in the cooling water, run for five minutes at low idling, then for another five minutes at high idling.
When doing this, leave radiator cap ① off.
13. After draining off the cooling water of sub-tank ④, clean the inside of the sub-tank and refill the water between FULL and LOW level.
14. Stop the engine, wait for about three minutes, add cooling water up to near the radiator water filler port, then tighten cap ①.

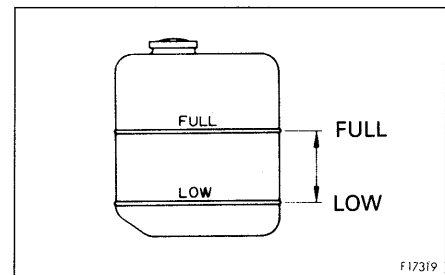

24.2.3 DRAIN WATER, SEDIMENT FROM FUEL TANK

1. Carry out this procedure before operating the machine.
2. Prepare a container to catch the fuel that is drained.
3. Open valve ① at the bottom of the tank and drain the sediment and water that has accumulated at the bottom together with fuel. When doing this, be careful not to get fuel on yourself.
4. When only clean fuel comes out, close drain valve ①.

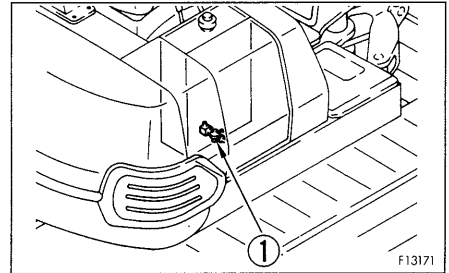

24.2.4 CLEAN WATER SEPARATOR ELEMENT

Prepare the following.

- Filter wrench to water separator
- Container to catch drained oil

1. Open the engine hood.
2. Set handle ① to the CLOSED position.
3. Using a filter wrench, loosen ring ②, then remove case ③ and throw out the water inside it.

Be careful not to lose red ring ④ inside the case.

4. Clean the inside of the case and element ⑤ with diesel oil.
5. Set case ③ in position, then tighten ring ② to install it.
6. Set handle ① to the OPEN position.

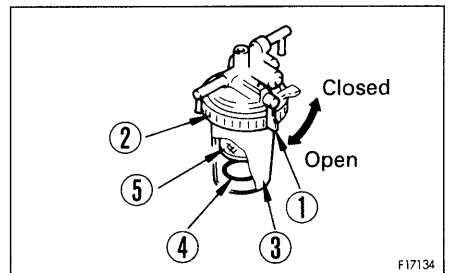
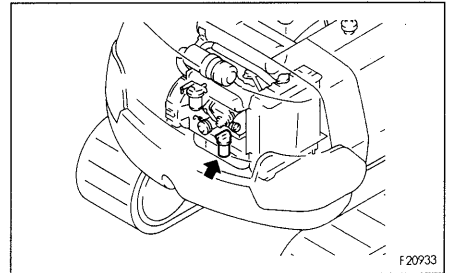

24.2.5 CHECK ELECTRIC WIRINGS

 **WARNING**

If fuses are frequently blown or if there are traces of short circuit on the electrical wiring, locate the cause and carry out repair.

Check for damage of the fuse and any sign of disconnection or short circuit in the electric wiring. Check also for loose terminals and tighten any loose parts. Check the following points carefully.

- Battery
- Starting motor
- Alternator

Please contact your Komatsu distributor for investigation and correction of the cause.

 **WARNING**

Accumulation of flammable material (dead leaves, twigs, grass, etc.) around the battery may cause fire, so always check and remove such material.

When carrying out walk-around checks or checks before starting, always check if there is any accumulation of flammable material around the battery, and remove such flammable material.

24.2.6 CHECK RUBBER SHOES (MACHINE EQUIPPED WITH RUBBER SHOES)

If the rubber shoes are in the following condition, they must be repaired or replaced, so please contact your Komatsu distributor for repair or replacement.

Height of lug

- If lug height "a" is reduced by wear, the drawbar pull will drop. If "a" is less than 5 mm (0.2 in), replace with a new part.

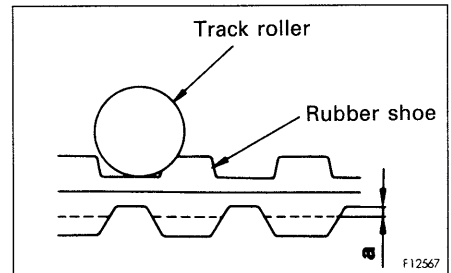

- If the lug wears and the steel cord inside the shoe is exposed for two links or more, replace with a new part.

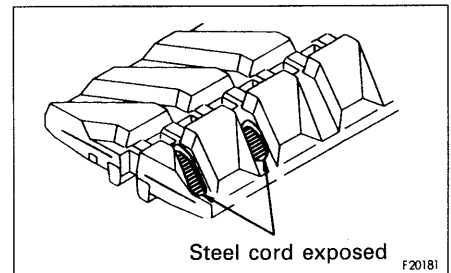

Cuts in rubber shoe steel cord

If more than half of the steel cord layer on one side is cut, replace with a new part.

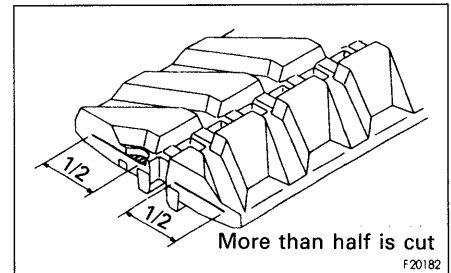

Separation of rubber shoe core

If the rubber core has separated at one place or more, replace with a new part.

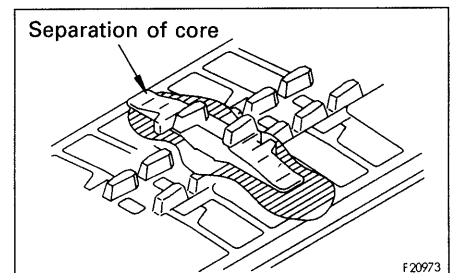

Rubber shoe tension

If the rubber shoe is still slack even when grease is pumped in, replace with a new part or replace the seal inside the cylinder.

If the track tension can only be increased to a level where the rubber shoe may come off, there may be not only elongation of the rubber shoe but also damage to the grease cylinder.

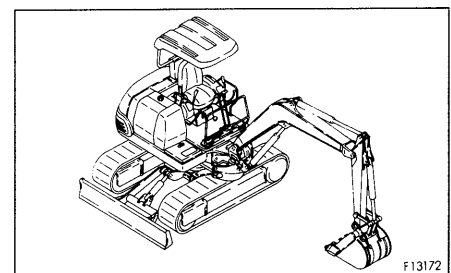

Cracks in rubber shoe

If the cracks between the rubber shoe lugs increase to a size of approx. 60 mm (2.36 in) the rubber shoe must be repaired. Even if the track is small and short, if the steel cord can be seen inside, carry out repairs immediately.

If the length is less than 30 mm (1.18 in) or the depth of the crack is less than 10 mm (0.39 in), there is no particular need to carry out repairs.

When making judgement whether to replace, repair, or continue using rubber shoes, please contact your Komatsu distributor.

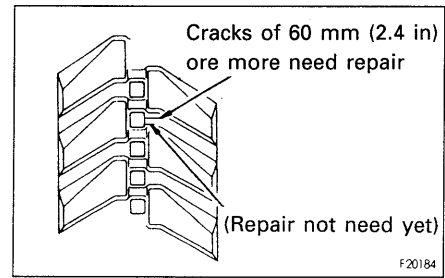

24.2.7 CHECK AND ADJUST TRACK TENSION (MACHINE EQUIPPED WITH RUBBER SHOES)

⚠ WARNING

Carry out this operation with two workers. The operator must move the machine in accordance with the signals from the other worker. The track tension is checked with the chassis raised, so it is extremely dangerous if the machine is lowered by mistake during the inspection. Never move the machine while anyone is carrying out measurements.

The wear of the rubber shoe will vary with the working conditions and type of soil. Therefore, it is necessary to inspect the wear and track tension frequently.

After new tracks are installed or on a new machine, the track tension lowers in the first 5 – 30 hours of machine operation. If the track tension is adjusted frequently until the initial loosening is completed, the shoes will not detach due to insufficient track tension.

Inspection

1. Set the connection (M mark) of the rubber shoe at the top midway between the two axles.
2. Raise the chassis with the boom and arm. When doing this, operate the levers slowly.
3. If the track tension is normal, clearance A between the flange of the third track roller from the sprocket and the shoulder of the track shoe is set to the standard value.

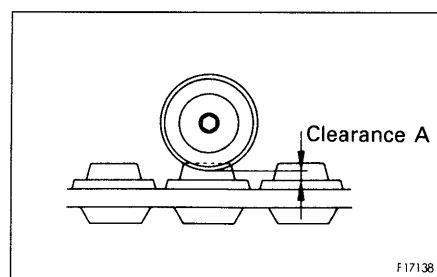
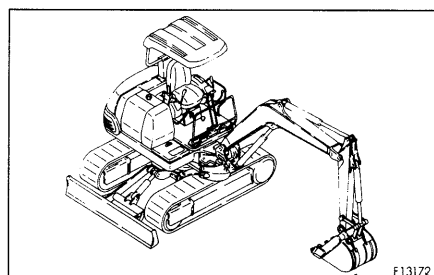
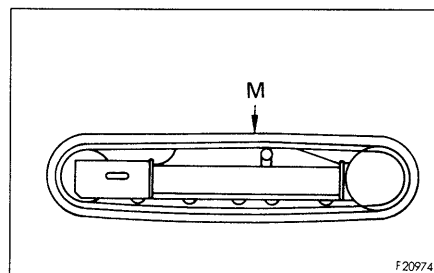

		PC25, 30	PC40, 45
Clearance A	Standard value	14 – 19 mm (0.6 – 0.7 in)	20 – 25 mm (0.8 – 1 in)
	Loosened track	Min. 25 mm (Min. 1 in)	Min. 30 mm (Min. 1.2 in)

If the rubber track is loose and the machine is operated, the track may come off, or there will be premature wear of the core.

If the track tension is not at the standard value, adjust it in the following manner.

Adjustment

⚠ WARNING

Grease inside the adjusting mechanism is under high pressure. Grease coming from lubricator ① under pressure can penetrate the body causing injury or death. For this reason, do not loosen lubricator ① more than one turn. Do not loosen any part other than lubricator ①.
If the track tension is not relieved by this procedure, please contact your Komatsu distributor.

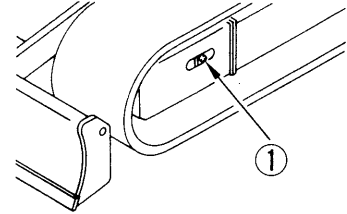

F17139

- **When increasing tension**
- Prepare a grease gun

1. Pump in grease through lubricator ① with a grease gun.

REMARK

For PC40 and PC45, replace the grease gun nozzle with the attached chuck-type nozzle (which will fit to the grease fitting).

2. To check that the correct tension has been achieved, move the machine backwards and forwards.
3. Check the track tension again, and if the tension is not correct, adjust it again.
4. If the tension is yet loose after applying pressurized injection of grease, it is necessary to replace the rubber shoes or seal inside of cylinder. Consult your Komatsu distributor for repair.

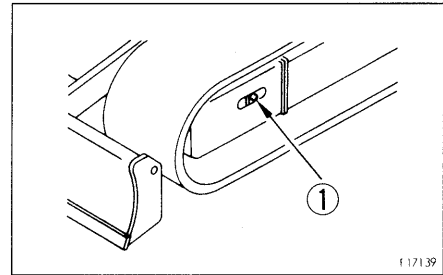

F17139

- When loosening tension

⚠ WARNING

It is extremely dangerous to release the grease by any method except the procedure given below. If the track tension is not relieved by this procedure, please contact your Komatsu distributor.

- Loosen lubricator ① gradually to release the grease.
- Turn lubricator ① a maximum of one turn.
- If the grease does not come out smoothly, move the machine backwards and forwards a short distance.
- Tighten lubricator ①.
- To check that the correct tension has been achieved, move the machine backwards and forwards.
- Check the track tension again, and if the tension is not correct, adjust it again.

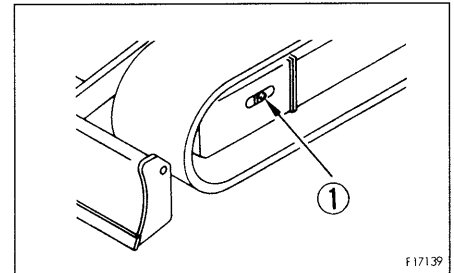

24.2.8 REPLACE RUBBER SHOES (MACHINE EQUIPPED WITH RUBBER SHOES)

⚠ WARNING

Carry out this operation with two workers. The operator must move the machine in accordance with the signals from the other worker. The track is replaced with the chassis raised, so it is extremely dangerous if the machine is lowered by mistake while the track is being replaced. During the replacement operation, operate only the track that is being replaced. Do not operate any other part.

⚠ WARNING

Grease inside the adjusting mechanism is under high pressure. Grease coming from lubricator ① under pressure can penetrate the body causing injury or death. For this reason, do not loosen lubricator ① more than one turn. Do not loosen any part other than lubricator ①.

If the track tension is not relieved by this procedure, please contact your Komatsu distributor.

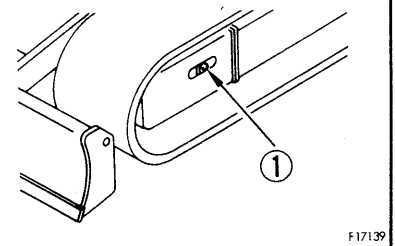

F17139

Prepare the following:

- Grease gun
- Steel pipe

REMOVAL OF RUBBER SHOE

⚠ WARNING

- It is extremely dangerous to release the grease by any method except the procedure given below. If the track tension is not relieved by this procedure, please contact your Komatsu distributor.
- Check that all the grease has been released before rotating the sprocket to remove the rubber shoe.

1. Raise the chassis with the boom and arm.
When doing this, operate the levers slowly.

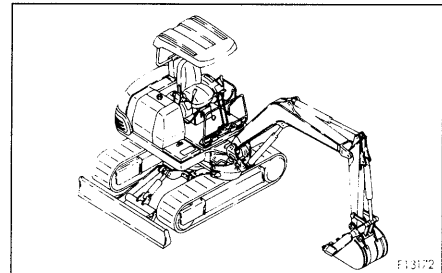

2. Loosen lubricator ① gradually to release the grease.
3. Turn lubricator ① a maximum of one turn.

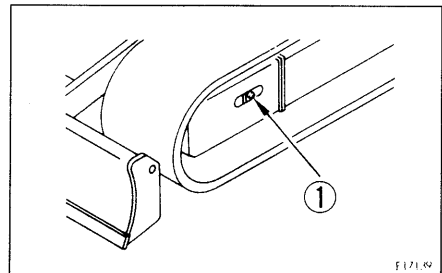

4. Fit the steel pipes inside the rubber shoe, rotate the sprocket in reverse, so that the steel pipes make the rubber shoe come up from the idler, then slide to the side to remove.

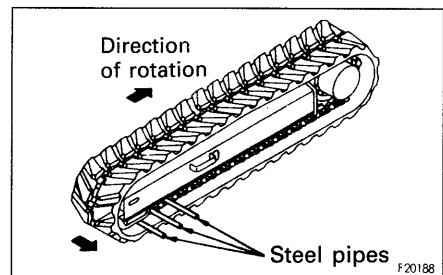

INSTALLATION OF RUBBER SHOE

1. Raise the chassis with the boom and arm.
When doing this, operate the levers slowly.
2. Mesh the rubber shoe with the sprocket and fit it over the idler.
3. Rotate the sprocket in reverse, then push in the rubber shoe and stop the rotation.
4. Mesh a steel pipe with the rubber shoe, then rotate the sprocket again and fit the rubber shoe securely on the idler.
5. Stop the rotation, and check that the rubber shoe is securely fitted to the sprocket and idler.
6. Adjust the tension of the rubber shoe.
For details, see "24.2.6 CHECK AND ADJUST TRACK TENSION".
7. Check that the track tension is correct and that the rubber shoe is correctly meshed on the sprocket and idler, then lower the machine to the ground.

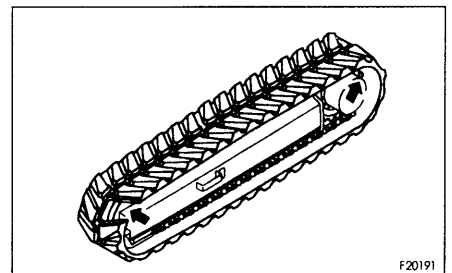
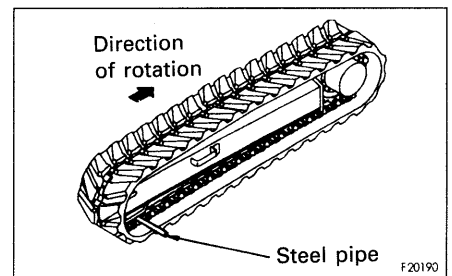
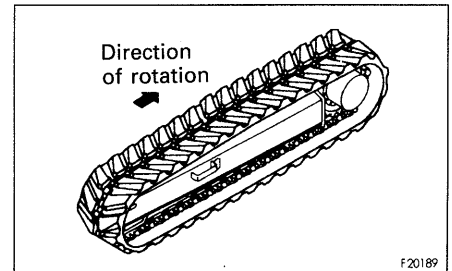
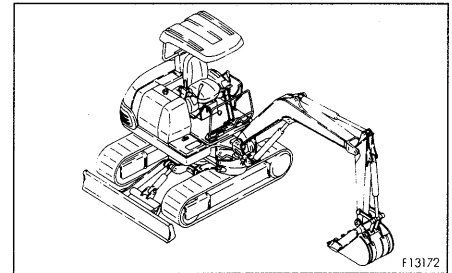

24.2.9 CHECK AND ADJUST TRACK TENSION (MACHINE EQUIPPED WITH STEEL SHOES)

⚠ WARNING

Carry out this operation with two workers. The operator must move the machine in accordance with the signals from the other worker. The track tension is checked with the chassis raised, so it is extremely dangerous if the machine is lowered by mistake during the inspection. Never move the machine while anyone is carrying out measurements.

The wear of pins and bushings on the undercarriage will vary with the working conditions and soil properties. It is thus necessary to continually inspect the track tension so as to maintain the standard tension.

Carry out the check and adjustment under the same conditions as when operating (on jobsites where the track becomes clogged with mud, measure with the track clogged with mud).

Inspection

1. Raise the chassis with the boom and arm.
When doing this, operate the levers slowly.
2. The standard tension is a clearance of 30 – 50 mm (1.18 – 1.97 in) between the roller surface of the track shoe and the track roller tread at the 3rd track roller from the sprocket.

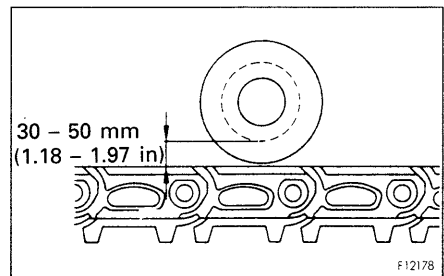
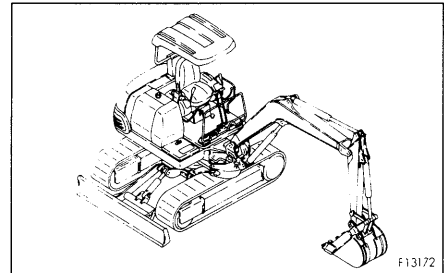

If the track tension is not at the standard value, adjust it in the following manner.

Adjustment

WARNING

Grease inside the adjusting mechanism is under high pressure. Grease coming from lubricator ① under pressure can penetrate the body causing injury or death. For this reason, do not loosen lubricator ① more than one turn. Do not loosen any part other than lubricator ①.
If the track tension is not relieved by this procedure, please contact your Komatsu distributor.

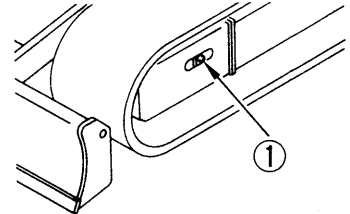

F17139

- When increasing tension
 - Prepare a grease gun
1. Pump in grease through lubricator ① with a grease pump.
 2. To check that the correct tension has been achieved, move the machine backwards and forwards.
 3. Check the track tension again, and if the tension is not correct, adjust it again.
 4. Continue to pump in grease until S becomes 0 mm (0.0 in). If the tension is still loose, the pin and bushing are excessively worn, so they must be either turned or replaced. Please contact your Komatsu distributor.

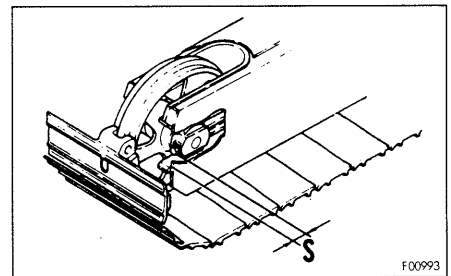

F00993

● When loosening tension

⚠ WARNING

It is extremely dangerous to release the grease by any method except the procedure given below. If the track tension is not relieved by this procedure, please contact your Komatsu distributor.

1. Loosen lubricator ① gradually to release the grease.
2. Turn lubricator ① a maximum of one turn.
3. If the grease does not come out smoothly, move the machine backwards and forwards a short distance.
4. Tighten lubricator ①.
5. To check that the correct tension has been achieved, move the machine backwards and forwards.
6. Check the track tension again, and if the tension is not correct, adjust it again.

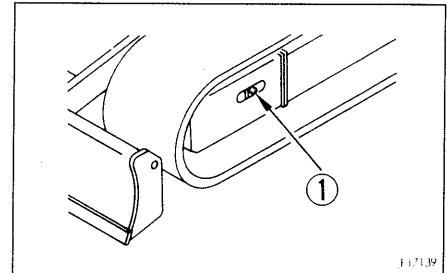

24.2.10 REPLACE BUCKET TEETH (VERTICAL PIN TYPE)

Replace the teeth before the adapter starts to wear.

⚠ WARNING

It is dangerous if the work equipment moves by mistake when the teeth are being replaced. Set the work equipment in a stable condition, then stop the engine and apply the locks securely to the levers.

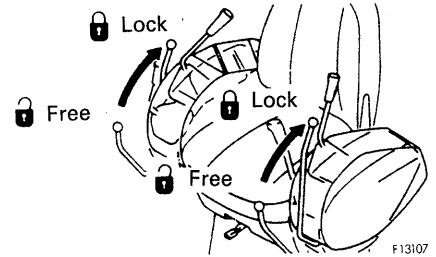

1. Place a block under the bucket so that the pin of tooth ① can be driven out. Stop the engine and operate the lever to the stroke end. Confirm that the work equipment is stabilized and lock the safety lock lever. Set the bucket bottom horizontally.

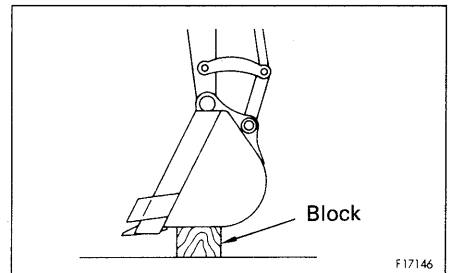

2. Using a hammer and driving tool, drive out locking pin ② securing tooth ① to the bucket. (If the driving tool is set against rubber pin lock ③ when it is hit, the rubber pin lock may break. Set it against the back of the pin.)

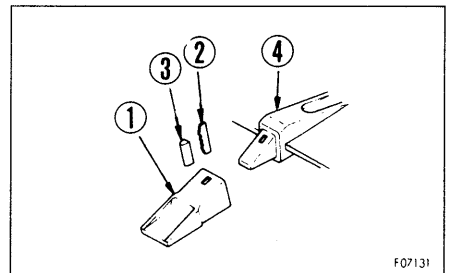

3. After removing lock pin ② and rubber pin lock ③, check them.

If lock pins and rubber pin locks with the following defects are used, the point may come off the bucket. Replace them with new ones.

- The rubber of the rubber pin lock is torn, and the steel balls may come out.

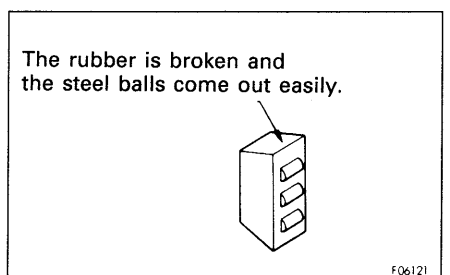

24. SERVICE PROCEDURE

- The steel balls are buried when they are pressed by hand.

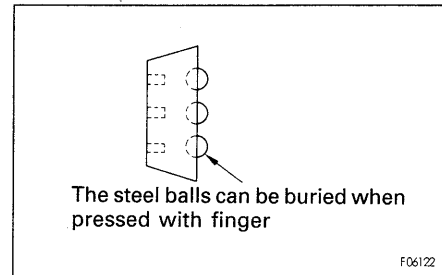

4. Clean the surface of adapter ④ and remove the soil from it with a knife.

5. Use your hand or a hammer to push rubber pin lock ③ into the hole of the adapter.
When doing this, be careful that the rubber pin lock does not fly out from the adapter surface.

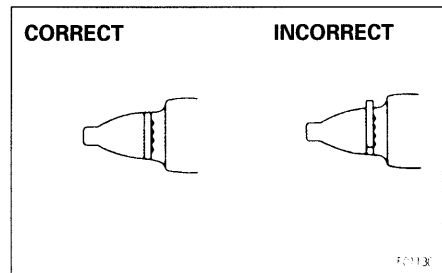

6. Clean the inside of tooth ①, then install it to adapter ④. If there is mud stuck to it or if there are protrusions, the tooth will not enter the adapter properly, and there will not be proper contact at the mating portion.
7. Fit tooth ① to adapter ④, and confirm that when the tooth is pressed strongly, the rear face of the hole for the pin of the tooth is at the same level as the rear face of the hole for the pin of the adapter.

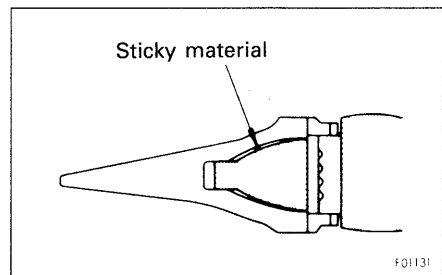

If the rear face of the hole for the pin of tooth ① is protruding to the front from the rear face of the pin hole for adapter ④, do not try to knock the pin in. There is something preventing tooth ① from entering adapter ④ fully, so remove the obstruction. When tooth ① enters adapter ④ fully, knock in lock pin ②.

8. Insert locking pin ② in the pin hole of the tooth and drive it in until its top is 2.5 mm (0.1 in) lower than the surface of tooth ① (The depths on the upper and lower sides are the same).
9. After replacing a bucket tooth, always check the following.
 - 1) After the lock pin has been knocked in completely, check that it is being secured by the tooth and surface.
 - 2) Lightly hit lock pin ② in the reverse direction from which it was hit in.
 - 3) Lightly hit the tip of the tooth from above and below, and hit its sides from right and left.

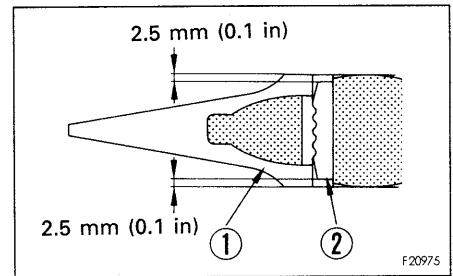

- 4) Confirm that rubber pin lock ③ and lock pin ② are set as shown in the figure.

The life of the tooth can be lengthened and the frequency of its replacement can be reduced by turning it upside down so that it will wear evenly.

Replace the rubber pin and locking pin with new pins at the same time as replacing the tooth to prevent the tooth from falling.

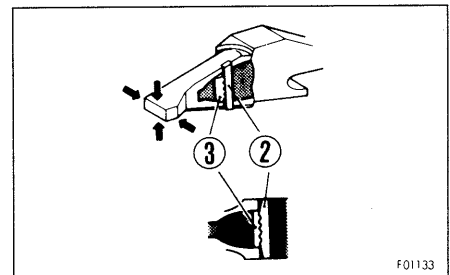

24.2.11 INSPECTION OF BUCKET PLAY ADJUSTMENT MECHANISM

⚠ WARNING

It is potentially highly dangerous if the work equipment accidentally moves during inspection and adjustment of play. Accordingly, set the work equipment on a stable place and stop the engine, then lock the lever securely.

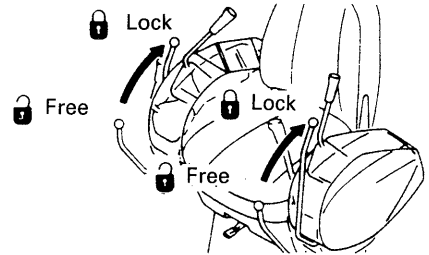

This machine is equipped with play preventive rings to prevent shaking and play of the bucket. If the bucket play increases, replace these rings.

1. Set the work equipment as shown at right and stop the engine, then turn the lock lever to the LOCK position.

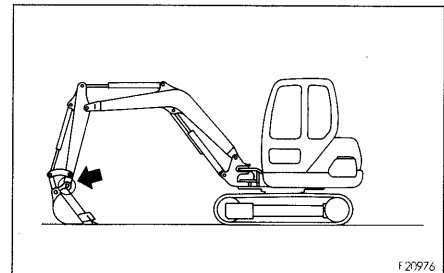

2. Measure outside diameter A of each play preventive ring. If it is 83.5 mm (3.29 in) or less, replace the ring.
 Dimensions A of new ring: 85 mm (3.35 in)
 Using limit of A: 83.5 mm (3.29 in)

Do not measure dimension A at the cut of the ring core.

For the replacement procedure of the play preventive rings, see "12.14 REPLACEMENT OF BUCKET".

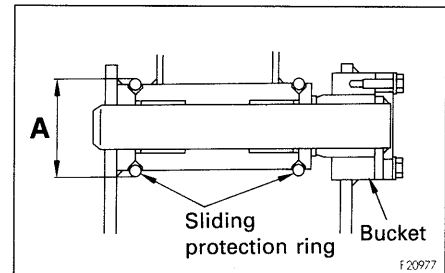

24.3 CHECK BEFORE STARTING

24.3.1 CHECK COOLANT LEVEL, ADD WATER

⚠ WARNING

Do not open the radiator cap unless necessary. When checking the coolant, always check the radiator reserve tank when the engine is cold.

1. Open the engine hood and check that the cooling water level is between the FULL and LOW marks on radiator reserve tank ① (shown in the diagram on the right).
If the water level is low, add water through the water filler of reserve tank ① to the FULL level.
2. After adding water, tighten the cap securely.
3. If the reserve becomes empty, first inspect for water leaks and then fill the radiator and the reserve tank with water.

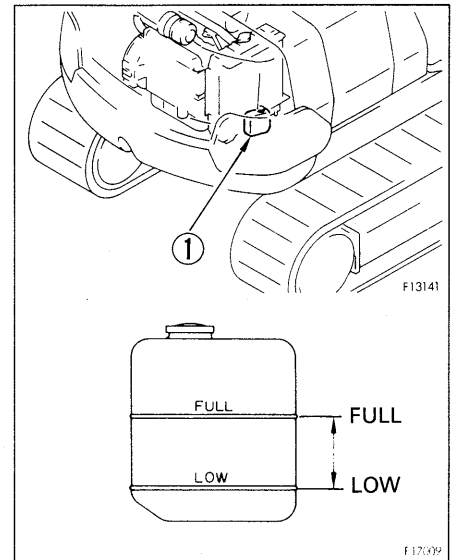

24.3.2 CHECK OIL LEVEL IN ENGINE OIL PAN, ADD OIL

1. Open the engine hood.
2. Remove dipstick ⑥ and wipe the oil off with a cloth.
3. Insert dipstick ⑥ fully in the oil filler pipe, then take it out again.
4. The oil level should be between the H and L marks on dipstick ⑥.
If the oil level is below the L mark, add engine oil through oil filler ⑦.

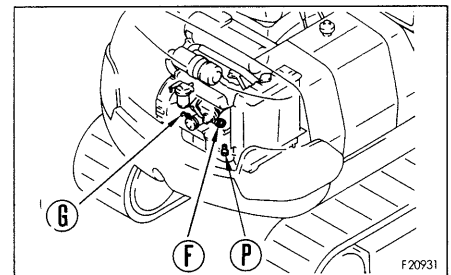

For details of the oil to use, see "20. USE OF FUEL, COOLANT AND LUBRICANTS ACCORDING TO AMBIENT TEMPERATURE".

5. If the oil is above the H mark, drain the excess engine oil from drain valve ⑧, and check the oil level again.
6. If the oil level is correct, tighten the oil filler cap securely and close the engine hood.

REMARK

When checking the oil level after the engine has been operated, for at least 15 minutes after stopping the engine before checking. If the machine is at an angle, make it horizontal before checking.

24.3.3 CHECK FUEL LEVEL, ADD FUEL

⚠ WARNING

When adding fuel, never let the fuel overflow. This may cause a fire. If spilling fuel, thoroughly clean up any spillage.

1. Insert the key in starting switch ①, and turn it to the ON position to light up the monitor.
2. Check the fuel level on fuel gauge ②. If the fuel level is low, add fuel through fuel filler port ③.

Fuel capacity: 50 l (13.2 US gal, 11.0 UK gal)

For details of the fuel to use, see "20. USE OF FUEL, COOLANT AND LUBRICANTS ACCORDING TO AMBIENT TEMPERATURE".

3. After adding fuel, tighten the cap securely.

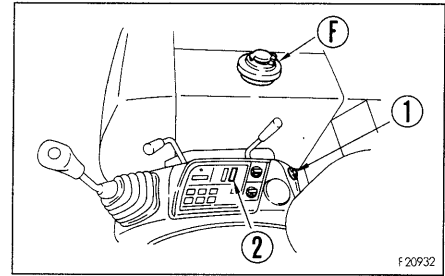

REMARK

If breather hole ③ on the cap is clogged, the pressure in the tank will drop and fuel will not flow. Clean the hole from time to time.

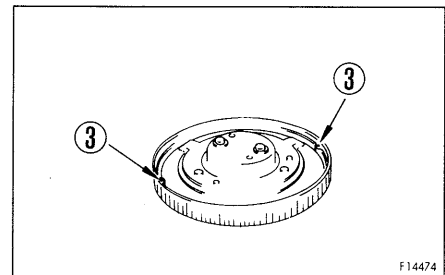

24.3.4 CHECK OIL LEVEL IN HYDRAULIC TANK, ADD OIL

⚠ WARNING

- When removing the oil filler cap, oil may spurt out, so turn the cap slowly to release the internal pressure before removing the cap.
- If oil has been added to above the H mark, stop the engine and wait for the hydraulic oil to cool down, then drain the excess oil from drain plug.

1. If the work equipment is not in the condition shown in the diagram on the right, start the engine run the engine at low speed, lower the blade, retract the arm and bucket cylinders, then lower the boom, set the bucket teeth in contact with the ground, and stop the engine.
2. Remove cover ① and check sight gauge ②. The oil level is normal if between the H and L marks.

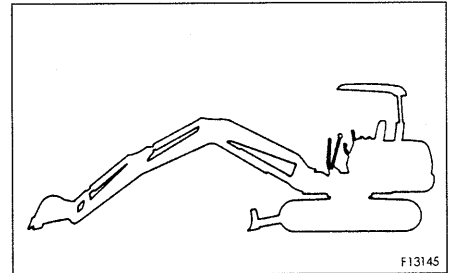
**NOTICE**

Do not add oil if the level is above the H line. This will damage the hydraulic equipment and cause the oil to spurt out.

3. If the level is below the L mark, remove the upper cover of the hydraulic tank on the right side of the machine and add oil through oil filler ③.

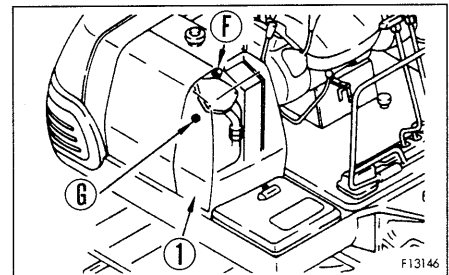

For details of the oil to use, see "20. USE OF FUEL, COOLANT AND LUBRICANTS ACCORDING TO AMBIENT TEMPERATURE".

REMARK

The oil level will vary depending upon the oil temperature. Accordingly, use the following as a guide:

- Before operation: around L level
(Oil temperature 10 to 30°C (50 to 86°F))
- Normal operation: around H level
(Oil temperature 50 to 80°C (122 to 176°F))

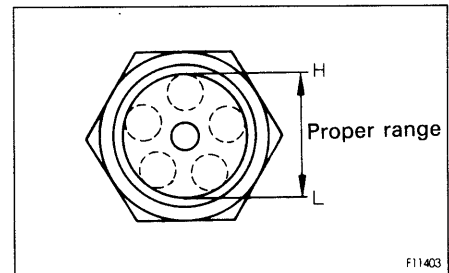

24.3.5 CHECK DUST INDICATOR

1. Open the engine hood and check that the red piston is not showing in dust indicator ①.
2. If the red piston has appeared, clean or replace the element immediately.
For details of the method of cleaning the element, see "24.2.1 CHECK, CLEAN AND REPLACE AIR CLEANER ELEMENT".
3. After checking, cleaning, and replacing, press the knob of dust indicator ① to return the red piston to its original position.

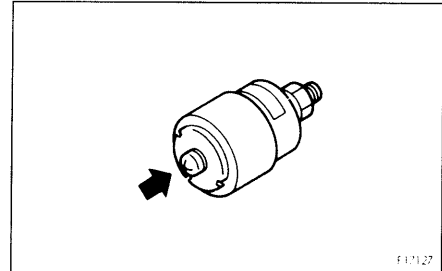
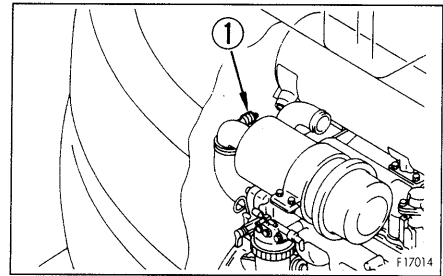

24.3.6 CHECK WATER SEPARATOR

If red ring ① of the water separator is at the bottom of case ②, there is no water.

If red ring ① is floating, there is water up to the bottom of the ring, so drain the water as follows.

- Use a water separator filter wrench.
1. Open the engine hood.
 2. Set handle ③ to the CLOSED position.
 3. Using the filter wrench, loosen ring ④, then remove case ② and throw out the water inside it.
 4. Set case ② in position, then tighten ring ④ to install it.
 5. Set handle ③ to the OPEN position.
 6. Drain any water or sediment from the fuel tank. For details, see "24.2.3 DRAIN WATER, SEDIMENT FROM FUEL TANK".

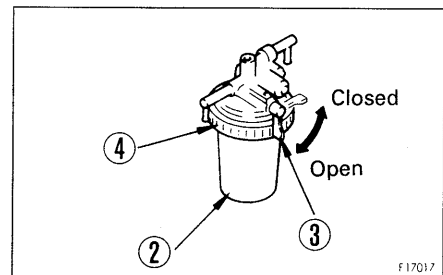
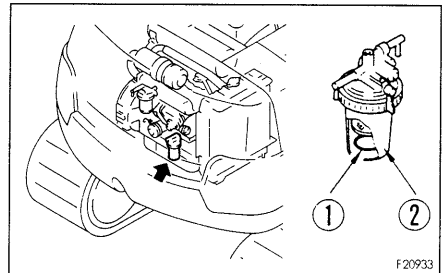

24.4 EVERY 100 HOURS SERVICE

24.4.1 LUBRICATING

WARNING

Never swing the upper structure while greasing the swing pinion.

- Prepare a grease gun.
- 1. Set the work equipment in the greasing posture on the right, then lower the work equipment to the ground and stop the engine.
- 2. Using a grease gun, pump in grease through the grease fittings shown by arrows.
- 3. After greasing, wipe off any old grease that was pushed out.

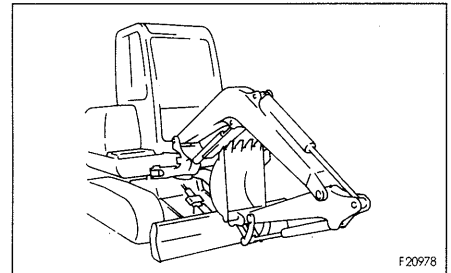

1. Swing pinion (1 point)
When lubricating the swing pinion, turn the chassis little by little and apply grease through the grease fitting.
2. Swing circle (1 point)
3. Boom swing cylinder foot pin (1 point)
4. Boom swing cylinder rod end (1 point)
5. Boom cylinder foot pin (1 point)
6. Blade cylinder foot pin (1 point)
7. Blade foot pin (2 points)
8. Blade cylinder rod end (1 point)

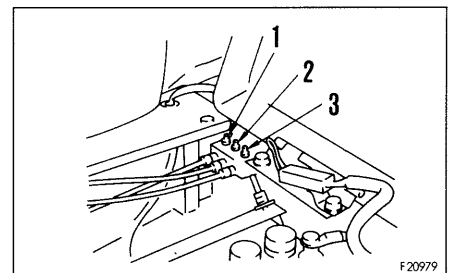

9. Boom foot pin (2 points)
10. Boom swing bracket pin (2 points)

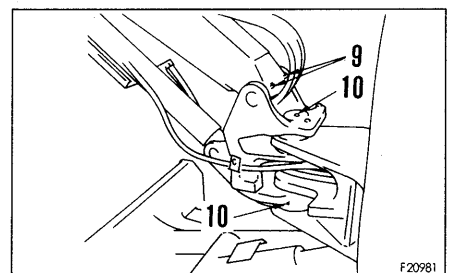
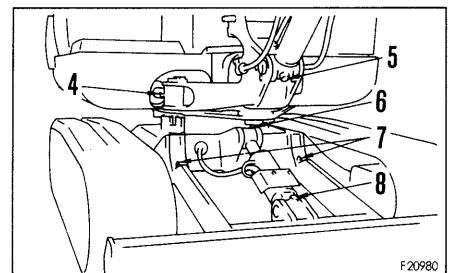

24. SERVICE PROCEDURE

- 11. Arm cylinder foot pin (1 point)
- 12. Boom cylinder rod end (1 point)
- 13. Boom – Arm coupling pin (1 point)
- 14. Arm cylinder rod end pin (1 point)
- 15. Bucket cylinder foot pin (1 point)

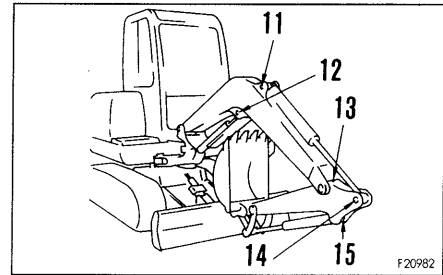

- 16. Bucket cylinder rod end pin (1 point)
- 17. Link coupling pin (1 point)
- 18. Bucket – Link coupling pin (2 points)
- 19. Arm – Bucket coupling pin (1 point)
- 20. Arm – Link coupling pin (1 point)

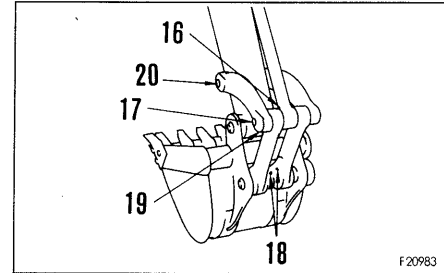

24.5 EVERY 250 HOURS SERVICE

24.5.1 CHANGE OIL IN ENGINE OIL PAN, REPLACE ENGINE OIL FILTER CARTRIDGE

⚠ WARNING

The oil is at high temperature after the engine has been operated, so never change the oil immediately after finishing operations. Wait for the oil to cool down before changing it.

Prepare the following.

- Container to catch drained oil: PC25, 30: Min. 7.3 ℓ capacity
PC40, 45: Min. 8.5 ℓ capacity
 - Refill capacity: PC25, 30: 7.3 ℓ (1.93 US gal, 1.61 UK gal)
PC40, 45: 8.5 ℓ (2.24 US gal, 1.87 UK gal)
 - Filter wrench for engine oil filter cartridge
1. Set a container to catch the oil immediately under the drain plug at the bottom of the machine.

 2. Remove drain plug **Ⓟ** slowly to avoid getting oil on yourself, and drain the oil.
 3. Check the drained oil, and if there are excessive metal particles or foreign material, please contact your Komatsu distributor.
 4. Install drain plug **Ⓟ**.
 5. Using a filter wrench, turn filter cartridge **①** counterclockwise to remove it.
In particular, if this operation is carried out immediately after stopping the engine, a large amount of oil will come out, so wait for 10 minutes before starting the operation.
 6. Clean the filter holder, coat the packing surface of a new filter cartridge with engine oil (or coat it thinly with grease), then install it to the filter holder.

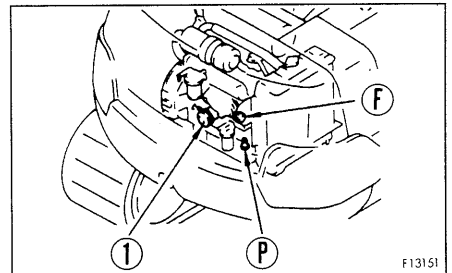

24. SERVICE PROCEDURE

7. When installing; tighten until the packing surface contacts the seal surface of the filter holder, then tighten it up 1/2 to 3/4 of a turn.
8. After replacing the filter cartridge, add engine oil through oil filler (F) until the oil level is between the H and L marks on the dipstick.
For details of the oil to use, see "20. USE OF FUEL, COOLANT AND LUBRICANTS ACCORDING TO AMBIENT TEMPERATURE".
9. Run the engine at idling for a short time, then stop the engine, and check that the oil level is between the H and L marks on the dipstick. For details, see "24.3.2 CHECK OIL LEVEL IN ENGINE OIL PAN, ADD OIL".

NOTICE

Even if the machine has not been operated for 250 hours, the oil and filter cartridge must be replaced when the machine has been operated for 6 months.

In the same way, even if the machine has not been operated for 6 months, the oil and filter cartridge must be replaced when the machine has been operated for 250 hours.

24.5.2 CHECK OIL LEVEL IN FINAL DRIVE CASE, ADD OIL

⚠ WARNING

- The oil is at high temperature immediately after the machine has been operated. Wait for the oil to cool down before starting the operation.
- If there is still pressure remaining inside the case, the oil or plug may fly out.
Loosen the plug slowly to release the pressure.

Prepare the following.

- Container to catch drained oil
- Hexagon wrench

PC25, 30, 40

1. Park the machine so that level plugs Ⓞ (2 places) are horizontal and drain plug Ⓟ is at the lowest position.
2. Set a container under level plug Ⓞ to catch the oil.
3. Using the hexagon wrench, remove level plug Ⓞ, and check that the oil level is near the bottom of the plug hole.
4. If there is insufficient oil, remove the other level plug Ⓞ with the hexagonal wrench and supply new oil.
Add engine oil until the oil flows out from level plug hole Ⓞ.

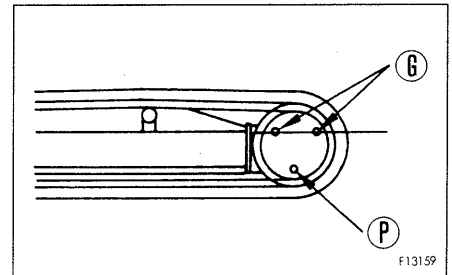

For details of the oil to use, see "20. USE OF FUEL, COOLANT AND LUBRICANTS ACCORDING TO AMBIENT TEMPERATURE".

5. After inspection, install plugs Ⓞ (2 places).

PC45

1. Set plug ③ at the top, with plug ③ and plug ④ perpendicular to the ground surface.
2. Set a container under plug ④ to catch the oil.
3. Using the hexagon wrench, remove plug ③, and check that the oil level is near the bottom of the plug hole.
4. If the oil level is low, use the hexagon wrench to remove plug ⑤, then add oil through the hole of plug ⑤. Add engine oil until the oil flows out from plug hole ③.

For details of the oil to use, see "20. USE OF FUEL, COOLANT AND LUBRICANTS ACCORDING TO AMBIENT TEMPERATURE".

5. After checking, install plug ⑤ and plug ③.

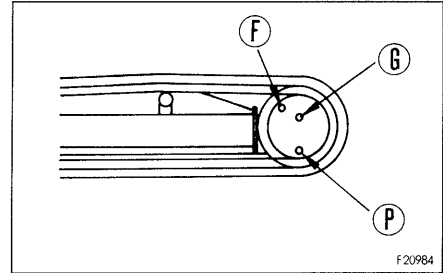

24.5.3 CHECK LEVEL OF BATTERY ELECTROLYTE

⚠ WARNING

- To avoid gas explosions, do not bring fire or sparks near the battery.
- Battery electrolyte is dangerous. If it gets in your eyes or on your skin, wash it off with large amounts of water, and consult a doctor.

Carry out this check before operating the machine.

1. Open the battery cover.
2. Remove cap ①, and check that the electrolyte is at the specified level (10 to 12 mm (0.40 to 0.47 in) above the plate). If the electrolyte level is low, add distilled water to the specified level.

If the battery electrolyte is spilled, have dilute sulphuric acid added.

3. Clean the air hole in the battery cap, then tighten the cap securely.

When adding distilled water in cold weather, add it before starting operations in the morning to prevent the electrolyte from freezing.

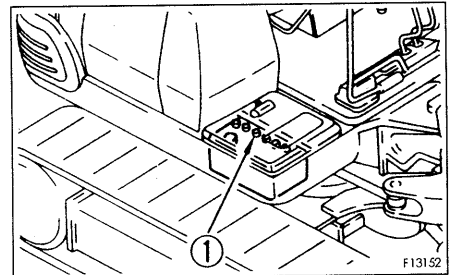

24.5.4 REPLACE HYDRAULIC FILTER ELEMENT

⚠ WARNING

When removing the oil filler cap, turn it slowly to release the internal pressure before removing it.

1. Remove cover ① at the right side of the machine.
2. Remove the cap from oil filler ⑥, and release the internal pressure.
3. Loosen 3 bolts, then remove cover ②. When doing this, the cover may fly out under the force of spring ③, so hold the cover down when removing the bolts.
4. After removing spring ③ and valve ④, take out element ⑤.
5. Clean the removed parts in diesel oil.
6. Install the new element in the place where old element ⑤ was installed.
7. Set valve ④ and spring ③ on top of the element.
8. Set cover ② in position, push it down by hand, and install the cover with the mounting bolts.
9. Pressurize hydraulic tank
Extend the boom, arm, and bucket cylinders fully as shown in the diagram on the right, remove the oil filler cap, then install the cap and pressurize the inside of the tank.
10. Install cover ①.

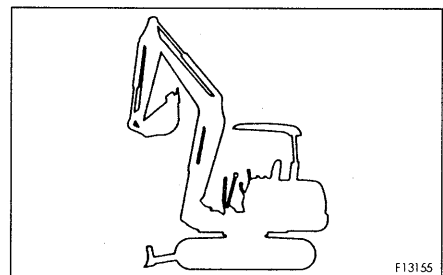
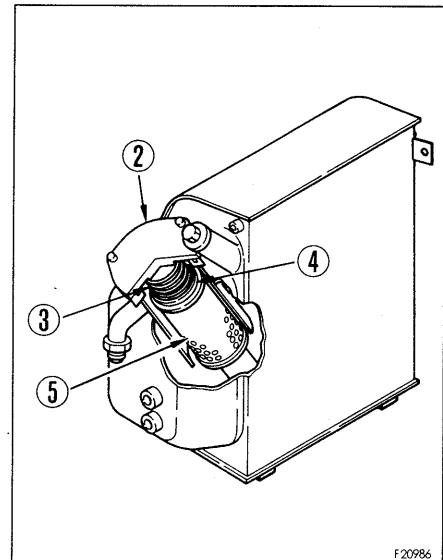
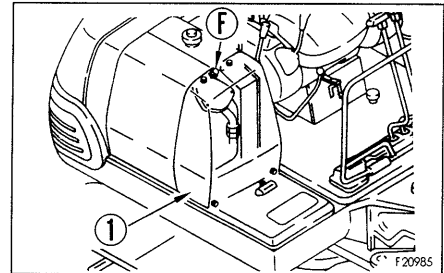

If a hydraulic breaker is installed, the hydraulic oil deteriorates far more rapidly than when carrying out normal bucket operations, so set the maintenance interval as follows. On new machines, replace after the first 100 – 150 hours, and after that, replace the element at the interval shown in the graph on the right.

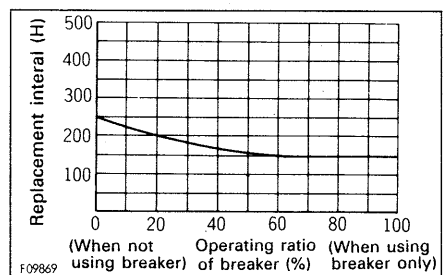

24.5.5 CHECK FAN BELT TENSION, ADJUST

Checking

The belt should normally deflect by 10 – 15 mm (0.39 – 0.59 in) when pressed with the finger (with a force of approx. 6 kg (13 lb)) at a point midway between the alternator pulley and fan pulley.

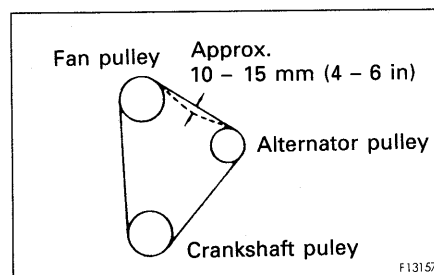
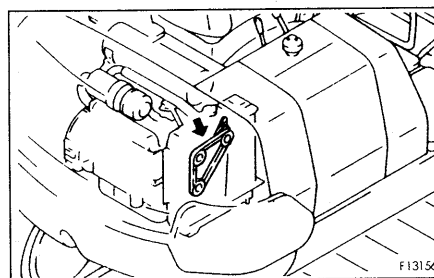

Adjusting

Prepare the following

- Bar
- Wooden block

1. Insert a bar between alternator ③ and the cylinder block to fix alternator ③ in position. When fixing alternator ③ in position, insert a wooden block between the bar and alternator ③ to prevent damage to the alternator.
2. Loosen bolts and nuts ① and ②.
3. Move alternator ③ with a bar so that the deflection of the belt is 10 – 15 mm (0.39 – 0.59 in) (approx. 6 kg (13 lb)).
4. Tighten the bolts and nuts ① and ② to fix alternator ③ in position.
5. Check each pulley for damage, wear of the V-groove, and wear of the V-belt. In particular, be sure to check that the V-belt is not touching the bottom the V-groove.
6. If the belt is stretched, leaving no allowance for adjustment, or if it is cut or cracked, please contact your Komatsu distributor for replacement.

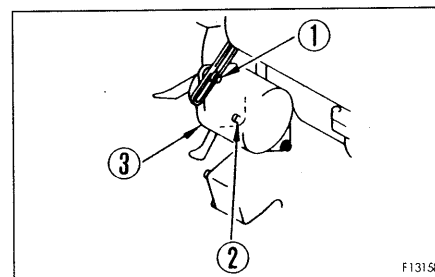

24.6 EVERY 500 HOURS SERVICE

Maintenance for every 100 and 250 hours should be carried out at the same time.

24.6.1 REPLACE FUEL FILTER CARTRIDGE

⚠ WARNING

- Engine is at high temperature immediately after the machine has been operated. Wait for engine to cool down before replacing the filter.
- Do not bring fire or sparks near the fuel.

Prepare the following.

- Filter wrench for fuel filter element
- Container to catch drained fuel

1. Set the container to catch the fuel under the filter element.
2. Using the filter wrench, loosen ring ①, then remove element cup ② and take out element ③.
3. Wash element cup ② in light oil or in a cleaning oil and install a new element.

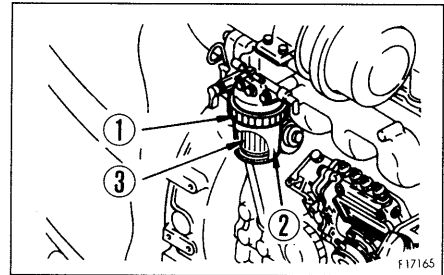

REMARK

When replacing a fuel filter element, replace the filter O-ring at the same time.

4. Set the fuel control lever to the low idling position.

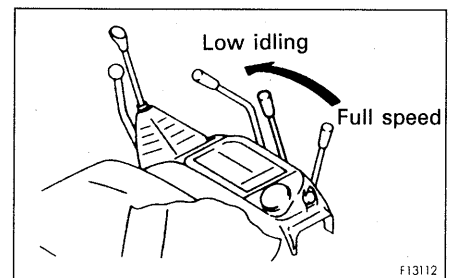

5. After replacing the fuel filter element bleed the air.

Procedure for bleeding air

1) Fill the fuel tank with fuel (to the FULL position on fuel gauge ⑥).

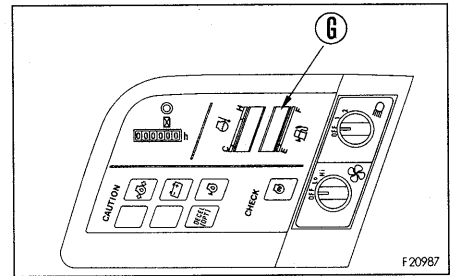

2) Turn the starting switch key to the START position, and turn the starting motor for 15 – 20 seconds to crank the engine. The automatic air bleed device will automatically bleed the air, and the engine will start.

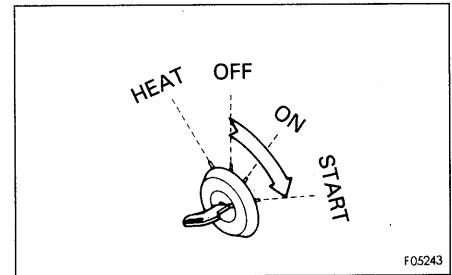
**NOTICE**

After running the starting motor once, wait for at least 2 minutes before running it again.

After replacing the filter element, start the engine to check for oil leakage from the filter seal.

REMARK

When the engine has run out of fuel, carry out the same procedure and crank the engine for 15 – 20 seconds. Repeat this operation 2 – 3 times to bleed the air.

Procedure for bleeding air with manual pump

Air can be bled from fuel by using manual pump ①.

Press lever ② of the fuel pump about 30 times to fill the fuel filter with fuel, then crank the engine for 15 – 20 seconds one or two times. Air is bled and the engine can start.

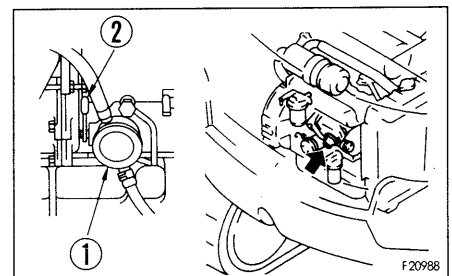

24.6.2 CLEAN, CHECK RADIATOR FINS

⚠ WARNING

If compressed air, steam, or water hit your body directly, there is danger of injury. Always wear protective glasses, mask, and safety shoes.

1. Open the engine food.
2. Use compressed air to blow off the mud, dirt, or leaves clogging radiator fins ①.

NOTICE

To prevent damage to the fins when using compressed air, do not bring the jet close to the radiator fins. If the fins are damaged, this will lead to water leakage or overheating.

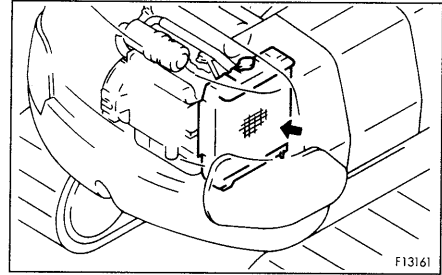

24.7 EVERY 1000 HOURS SERVICE

Maintenance for every 100, 250 and 500 hours should be carried out at the same time.

24.7.1 CHANGE OIL IN SWING MACHINERY CASE

⚠ WARNING

The oil is at high temperature immediately after the machine has been operated. Wait for the oil to cool down before starting the operation.

Prepare the following.

- Container to catch drained oil: PC25, 30: Min. 0.9 ℓ capacity
PC40, 45: Min. 1.0 ℓ capacity
- Refill capacity: PC25, 30: 0.9 ℓ (0.24 US gal, 0.20 UK gal)
PC40, 45: 1.0 ℓ (0.26 US gal, 0.22 UK gal)

1. Set a container to catch the oil under drain plug **(P)** at the bottom of the machine.
2. Remove drain plug **(P)** under the chassis, drain the oil, then tighten the plug again.

Tightening torque of drain plug **(P)**: 29.4 ± 9.8 Nm (3 ± 1 kgm, 21.7 ± 7.2 lbft)

3. Remove the cover under the right console box, then remove the cap of oil filler port **(F)** and level plug **(1)**. Add engine oil through oil filler port **(F)** to the specified level.

For details of the oil to use, see "20. USE OF FUEL, COOLANT AND LUBRICANTS ACCORDING TO AMBIENT TEMPERATURE".

4. Add oil until the oil flows out from the hole for level plug **(1)**, then install level plug **(1)**.

Tightening torque of level plug **(1)**: 14.7 ± 4.9 Nm (1.5 ± 0.5 kgm, 10.9 ± 3.6 lbft)

5. Install cap of oil filler **(F)**.

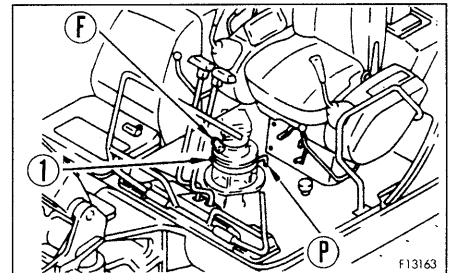

F13163

24.7.2 CHANGE OIL IN FINAL DRIVE CASE

⚠ WARNING

- The oil is at high temperature immediately after the machine has been operated. Wait for the oil to cool down before starting the operation.
- If there is still pressure remaining inside the case, the oil or plug may fly out.
Loosen the plug slowly to release the pressure.

Prepare the following.

- Container to catch drained oil
 - PC25, 30 : Min. 1.2 ℓ capacity
 - PC40 : Min. 1.4 ℓ capacity
 - PC45 : Min. 1.1 ℓ capacity
- Refill capacity
 - PC25, 30 : 1.2 ℓ (0.32 US gal, 0.27 UK gal)
 - PC40 : 1.4 ℓ (0.37 US gal, 0.31 UK gal)
 - PC45 : 1.1 ℓ (0.29 US gal, 0.24 UK gal)
- Hexagon wrench

PC25, 30, 40

1. Park the machine so that level plugs Ⓒ (2 places) are horizontal and drain plug Ⓓ is at the lowest position.
2. Set a container under level plug Ⓒ to catch the oil.
3. Using the hexagon wrench, remove plug Ⓓ and plugs Ⓒ (2 points), and drain the oil.
4. Tighten plug Ⓓ.
5. Refill the specified quantity of engine oil through oil filler Ⓒ. For details of the oil to use, see "20. USE OF FUEL, COOLANT AND LUBRICANTS ACCORDING TO AMBIENT TEMPERATURE".
6. When oil comes out from the hole of plug Ⓒ, install plugs Ⓒ (2 points).

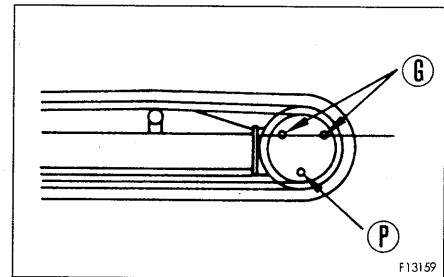

PC45

1. Set plug ③ at the top, with plug ③ and plug ④ perpendicular to the ground surface.
2. Set a container under plug ④ to catch the oil.
3. Using the hexagon wrench, remove plugs ④, ③, and ⑤, and drain the oil.
4. Tighten plug ④.
5. Refill the specified quantity of engine oil through oil filler ⑤. For details of the oil to use, see "20. USE OF FUEL, COOLANT AND LUBRICANTS ACCORDING TO AMBIENT TEMPERAUTRE".
6. When oil comes out from the hole of plug ③, install plug ③ and ⑤.

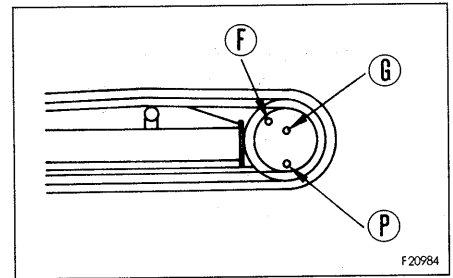

24.8 EVERY 2000 HOURS SERVICE

Maintenance for every 100, 250, 500 and 1000 hours should be carried out at the same time.

24.8.1 CHANGE OIL IN HYDRAULIC TANK CLEAN STRAINER

⚠ WARNING

The oil is at high temperature immediately after the machine has been operated. Wait for the oil to cool down before changing the oil. When removing the oil filler cap, turn it slowly to release the internal pressure, then remove it carefully.

Prepare the following.

- Container to catch drained oil: Min. 45 l capacity
- Refill capacity: 45 l (11.9 US gal, 9.9 UK gal)
- Handle

1. Swing the upper structure so that the drain plug under the hydraulic tank is between the left and right tracks.

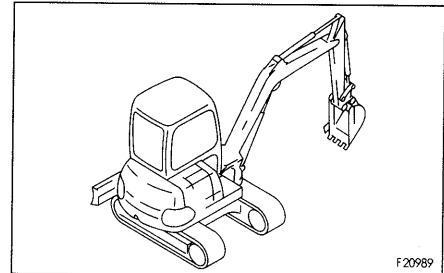

2. Retract the arm and bucket cylinder to the stroke end, then lower the boom and put the bucket teeth in contact with the ground.

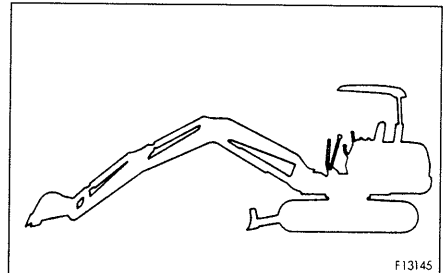

3. Lower the blade to the ground and stop the engine.

4. Remove cover ① on the right side of the machine, then remove the cap of oil filler port ⑥.

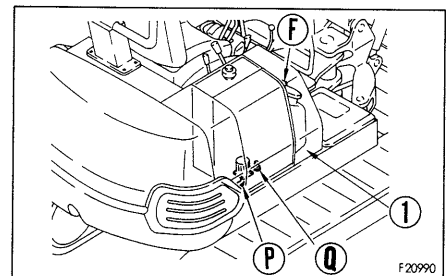

- Set the oil container under the drain plug under the machine. Using the handle, remove drain plug ⑤ and ⑥, and drain the oil. Check the O-ring installed to plug ⑤ and ⑥, and if it is damaged, replace the O-ring. After draining the oil, tighten drain plug ⑤ and ⑥.

Tightening torque

Plug ⑤ (pipe mounted):

$49.0 \pm 4.9 \text{ Nm}$ ($5 \pm 0.5 \text{ kgm}$, $36.2 \pm 3.6 \text{ lbft}$)

Plug ⑥ (tank bottom mounted):

$68.6 \pm 9.8 \text{ Nm}$ ($7 \pm 1 \text{ kgm}$, $50.6 \pm 7.2 \text{ lbft}$)

When removing drain plug ⑤ and ⑥, be careful not to get oil on yourself.

- Loosen hose band ② and bolt ③, remove flange, then remove strainer ⑤.
- Remove the dirt stuck to strainer ⑤, then wash it in clean diesel oil or flushing oil. If strainer ⑤ is damaged, replace it with a new one.
- When installing, insert strainer ⑤ into the protruding part of flange ④, and assemble.
- Add engine oil to the specified level through oil filler port ⑦. Check that the oil level is between the H and L marks on sight gauge ⑧.

For details of the oil to use, see "20. USE OF FUEL, COOLANT AND LUBRICANTS ACCORDING TO AMBIENT TEMPERATURE".

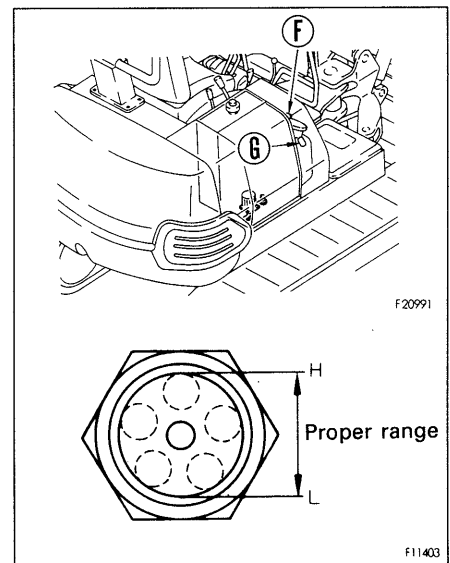
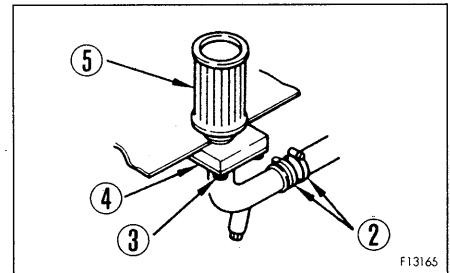

- Pressurize hydraulic tank

Extend the boom, arm and bucket cylinders fully as shown in the diagram on the right, remove the oil filler cap, then install the cap and pressurize the inside of the tank.

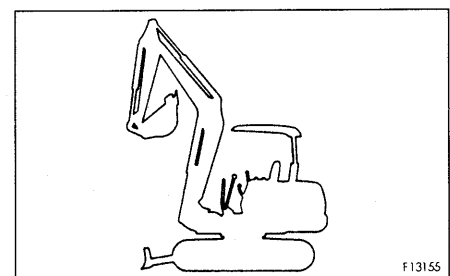

11. After changing the oil, place all the control levers at neutral, and run the engine at low idling for approx. 2 – 3 minutes before starting work.

NOTICE

When the hydraulic breaker is installed, the hydraulic oil deteriorates earlier than in normal bucket digging work. Therefore, replace the hydraulic oil according to the table at the right.

12. After replacing hydraulic oil and cleaning or replacing filter element and strainer, bleed air from the circuit according to the following procedure.

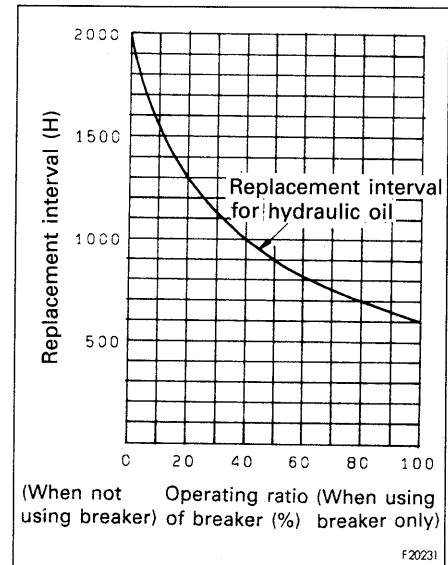

Procedure for bleeding air

1. Bleeding air from piston pump (Only PC30 and PC45)

1. Remove the oil filler cap from the hydraulic tank.
2. Loosen air bleeder ① and confirm that oil oozes out of the bleeder (all air has been bled).
3. After completing the air bleeding operation, tighten the air bleeder.
4. Tighten the oil filler cap of the hydraulic tank.

NOTICE

If the pump is operated without filling the pump case with hydraulic oil, abnormal heat will be generated and this may lead to premature damage of the pump.

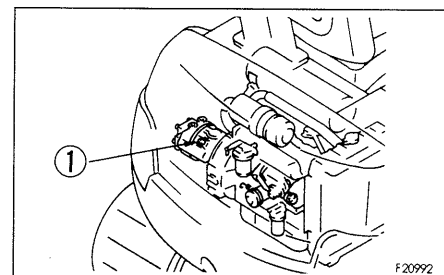

2. Starting engine

1. Start the engine according to "12.2 STARTING ENGINE".
2. Fully extend the boom cylinder, arm cylinder and bucket cylinder, then remove the oil filler cap. Install the cap again and pressurize the tank.
3. Run the engine at the low idling speed for about 5 minutes, then perform the following work.

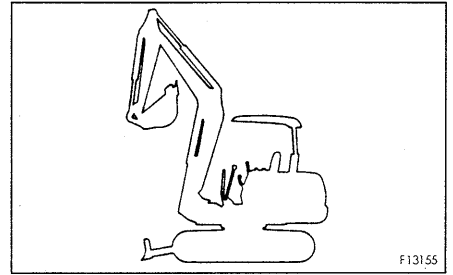

3. Bleeding air from cylinders

1. Run the engine at low idling, and extend and retract each cylinder 4 – 5 times without operating it to the end of its stroke. (Stop approx. 100 mm (4 in) before the end of the stroke)
2. Next, operate each cylinder to the end of its stroke 3 – 4 times.
3. After this, operate each cylinder 4 – 5 times to the end of its stroke to completely bleed the air.

NOTICE

If, at first, the engine is run at high speed or the cylinder is operated to the end of its stroke, the air inside the cylinder may cause damage to the piston packing or other parts.

4. Bleeding air from attachment (if installed)

For machines equipped with attachments such as the breaker, actuate the attachment pedal about 10 times to bleed the air completely from the attachment circuit while running the engine at low idling.

NOTE

If the attachment bleeding procedure is specified by the manufacturer, bleed the attachment according to such procedure.

5. Operation

1. After completion of bleeding the air, stop the engine, and wait for at least 5 minutes before starting operations. In this way, the air bubbles are removed from the oil inside the hydraulic tank.
2. Check for any leakage of oil, and wipe off any oil that has been spilled.

24.8.2 CHECK ALTERNATOR, STARTING MOTOR

The brush may be worn, or the bearing may have run out of grease, so contact your Komatsu distributor for inspection or repair. If the engine is started frequently, carry out inspection every 1000 hours.

24.8.3 CHECK ENGINE VALVE CLEARANCE, ADJUST

As special tool is required for removing and adjusting the parts, you shall request Komatsu distributor for service.

SPECIFICATIONS

25. SPECIFICATIONS

PC25-1

	Rubber shoes and canopy	Ruber shoes and cab	Steel shoes and canopy	Steel shoes and cab
--	-------------------------	---------------------	------------------------	---------------------

WEIGHT

● Operating weight (without operator)	2935 kg (6472 lb)	3090 kg (6813 lb)	2950 kg (6505 lb)	3105 kg (6847 lb)
---------------------------------------	----------------------	----------------------	----------------------	----------------------

PERFORMANCE

Bucket capacity (standard bucket) SAE/CECE		0.09 m ³ (0.12 cu.yd) / 0.08m ³		
● Width of opening (Standard bucket)	(Without side cutter)	425 mm (16.7 in)		
	(With side cutter)	500 mm (19.7 in)		
● Travel speed	High speed	3.8 km/h (2.4 MPH)	3.6 km/h (2.2 MPH)	
	Low speed	2.4 km/h (1.5 MPH)	2.3 km/h (1.4 MPH)	
● Swing speed		9.5 rpm		
● Track shoe		Rubber shoe 300 mm (11.8 in)	Double grouser shoe 300 mm (11.8 in)	

ENGINE

● Model	Komatsu 3D84E – 3B diesel engine			
● Flywheel horsepower	21 kw (28 HP) / 2700 rpm			
● Starting motor	12 V 1.8 kw			
● Alternator	12 V 20 A			
● Battery	12 V 70 Ah x 1 piece			

PC25-1

- Canopy, rubber shoe specification machine
- Canopy, steel shoe specification machine

The values without parentheses are the values for the rubber shoe specification machine.
 The values inside parentheses are the values for steel shoe specification machine.

If only one value is given, the value is the same for both the rubber shoe specification and steel shoe specification machines.

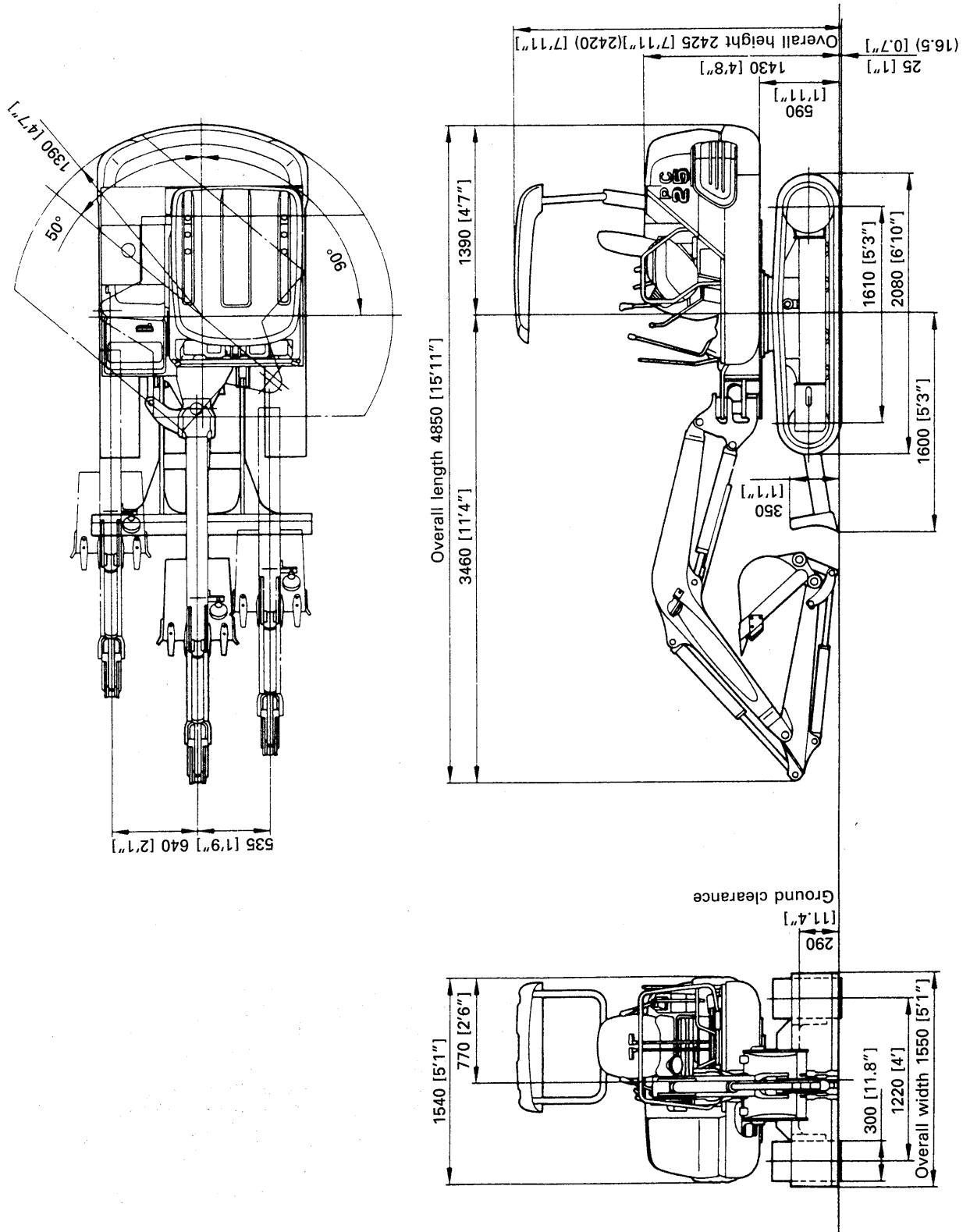

25. SPECIFICATIONS

PC25-1

- Cab, rubber shoe specification machine
- Cab, steel shoe specification machine

The values without parentheses are the values for the rubber shoe specification machine.
 The values inside parentheses are the values for steel shoe specification machine.

If only one value is given, the value is the same for both the rubber shoe specification and steel shoe specification machines.

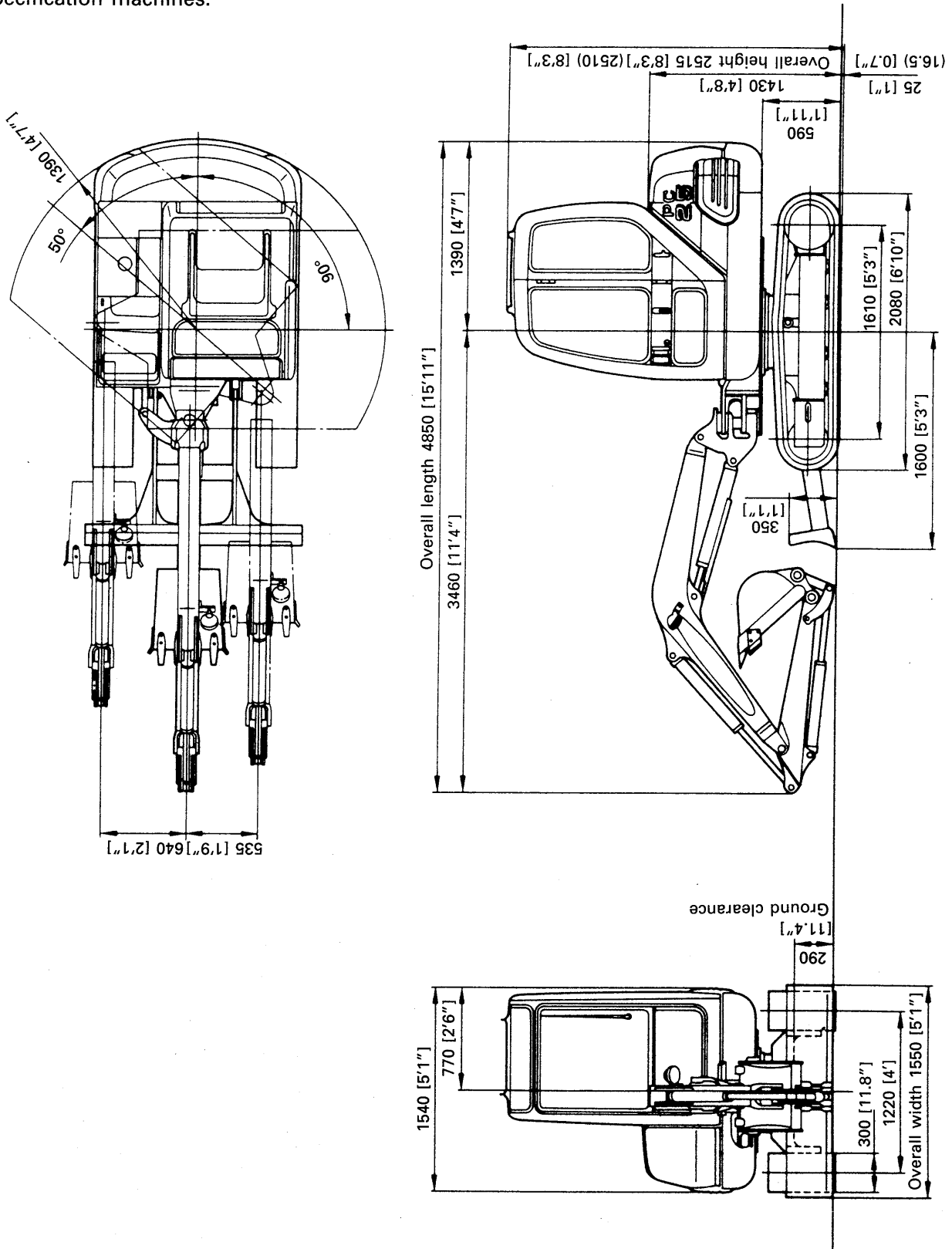

PC25-1

- Canopy, rubber shoe specification machine
- Canopy, steel shoe specification machine
- Cab, rubber shoe specification machine
- Cab, steel shoe specification machine

Never allow other person than the operator to enter the swing range (Max. swing range, Max. digging radius).

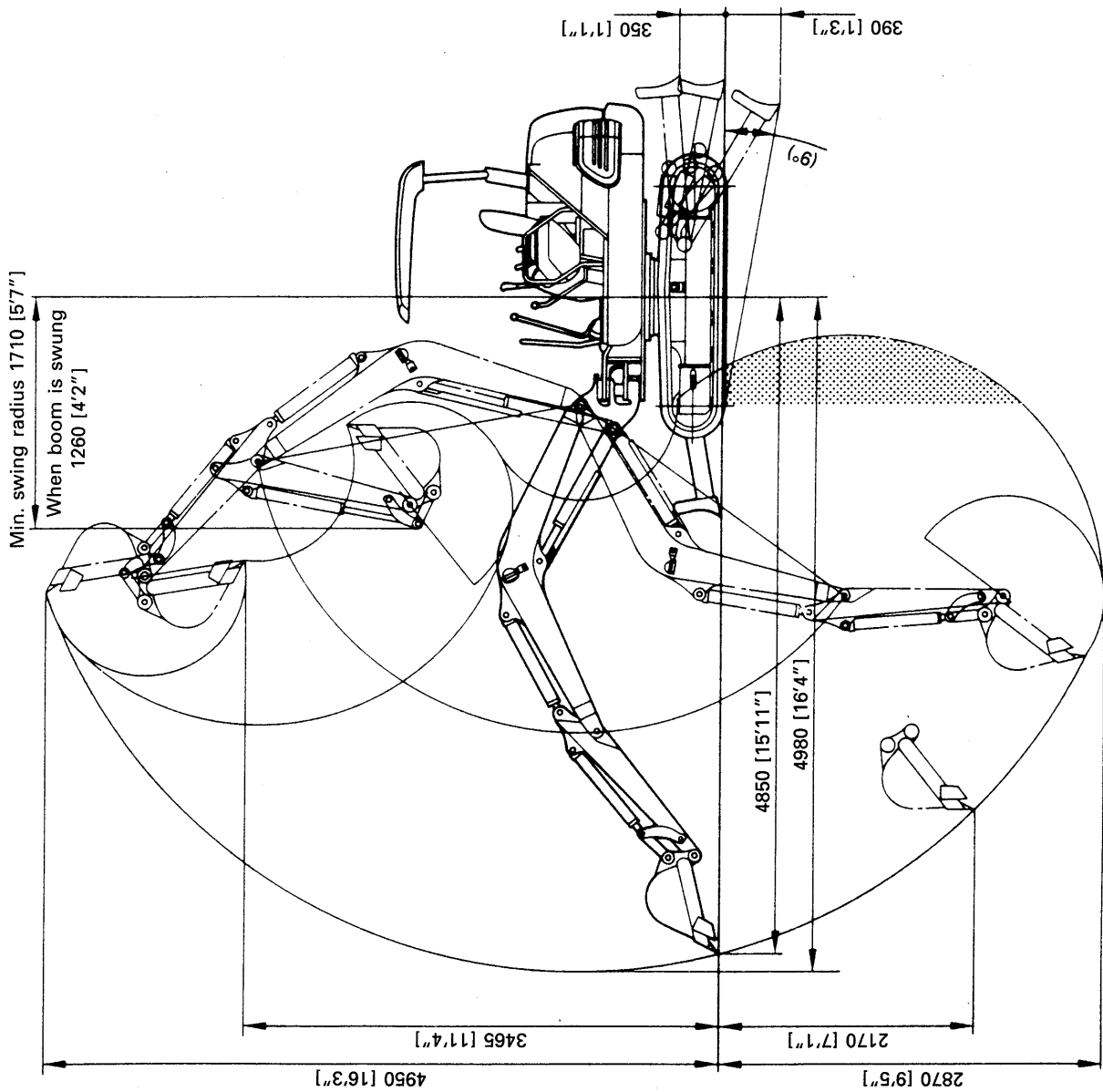

25. SPECIFICATIONS

PC30-7

	Rubber shoes and canopy	Ruber shoes and cab	Steel shoes and canopy	Steel shoes and cab
--	-------------------------	---------------------	------------------------	---------------------

WEIGHT

● Operating weight (without operator)	3185 kg (7023 lb)	3340 kg (7365 lb)	3200 kg (7056 lb)	3355 kg (7398 lb)
---------------------------------------	-------------------	-------------------	-------------------	-------------------

PERFORMANCE

Bucket capacity (standard bucket) SAE/CECE	0.11 m ³ (0.14 cu.yd) / 0.10m ³			
● Width of opening (Standard bucket)	(Without side cutter)	525 mm (20.7 in)		
	(With side cutter)	600 mm (23.6 in)		
● Travel speed	High speed	4.0 km/h (2.5 MPH)	3.8 km/h (2.4 MPH)	
	Low speed	2.7 km/h (1.7 MPH)	2.5 km/h (1.6 MPH)	
● Swing speed	11 rpm			
● Track shoe	Rubber shoe 300 mm (11.8 in)	Double grouser shoe 300 mm (11.8 in)		

ENGINE

● Model	Komatsu 3D84E – 3A diesel engine			
● Flywheel horsepower	21 kw (28 HP) / 2550 rpm			
● Starting motor	12 V 1.8 kw			
● Alternator	12 V 40 A			
● Battery	12 V 70 Ah x 1 piece			

PC30-7

- Canopy, rubber shoe specification machine
- Canopy, steel shoe specification machine

The values without parenthese are the values for the rubber shoe specification machine.

The values inside parenthese are the values for steel shoe specification machine.

If only one value is given, the value is the same for both the rubber shoe specification and steel shoe specification machines.

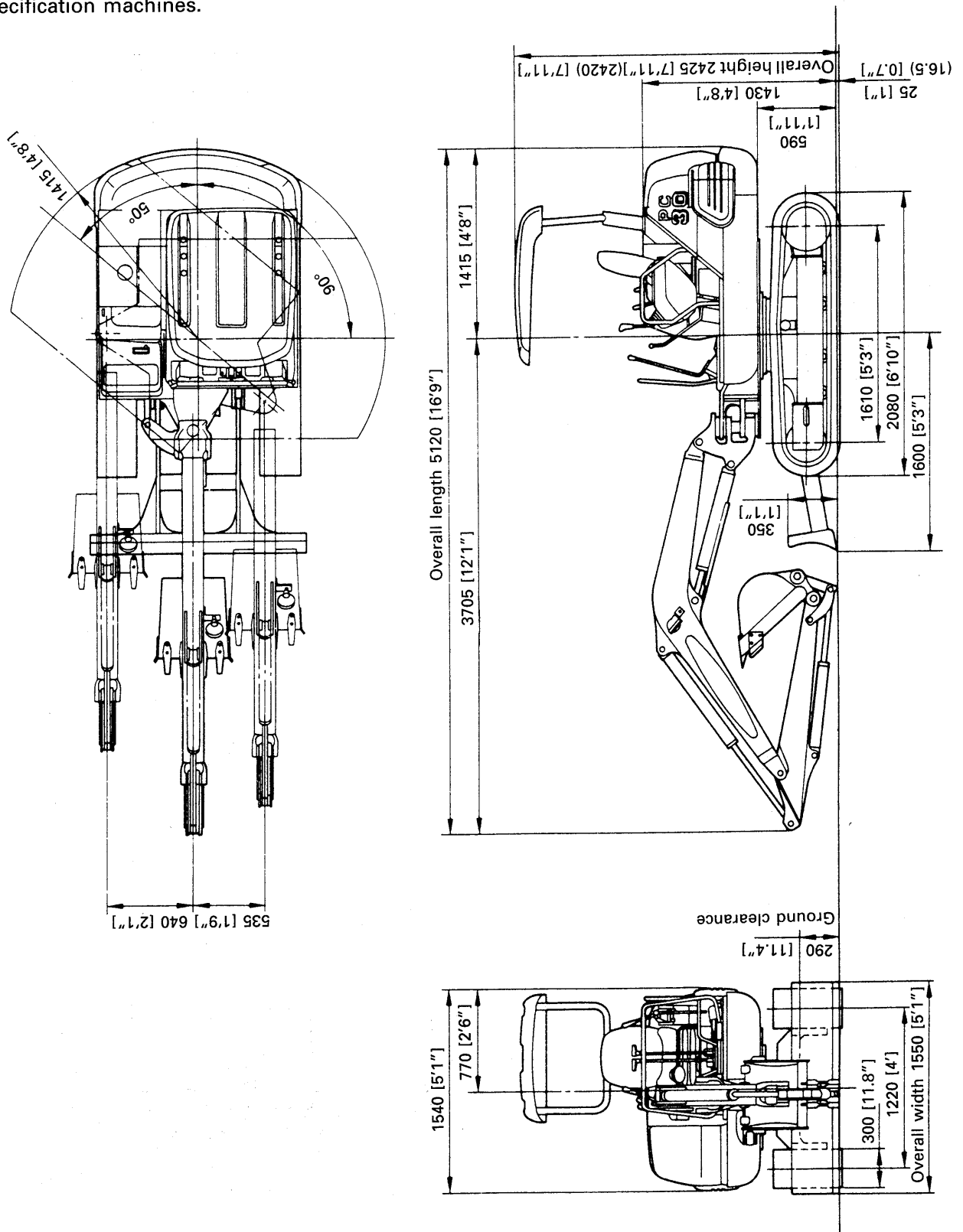

25. SPECIFICATIONS

PC30-7

- Cab, rubber shoe specification machine
- Cab, steel shoe specification machine

The values without parentheses are the values for the rubber shoe specification machine.
 The values inside parentheses are the values for steel shoe specification machine.

If only one value is given, the value is the same for both the rubber shoe specification and steel shoe specification machines.

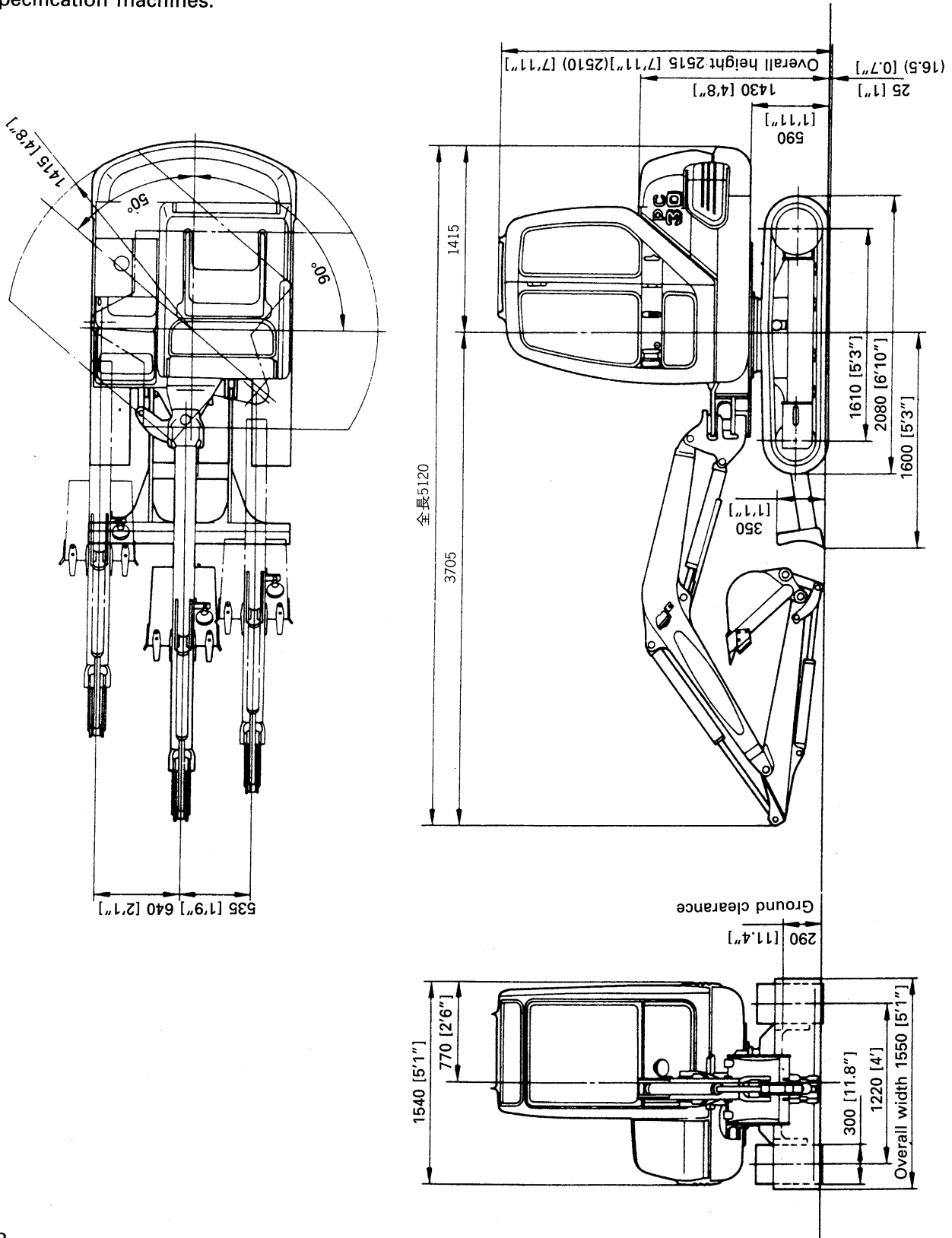

PC30-7

- Canopy, rubber shoe specification machine
- Canopy, steel shoe specification machine
- Cab, rubber shoe specification machine
- Cab, steel shoe specification machine

Never allow other person than the operator to enter the swing range (Max. swing range, Max. digging radius).

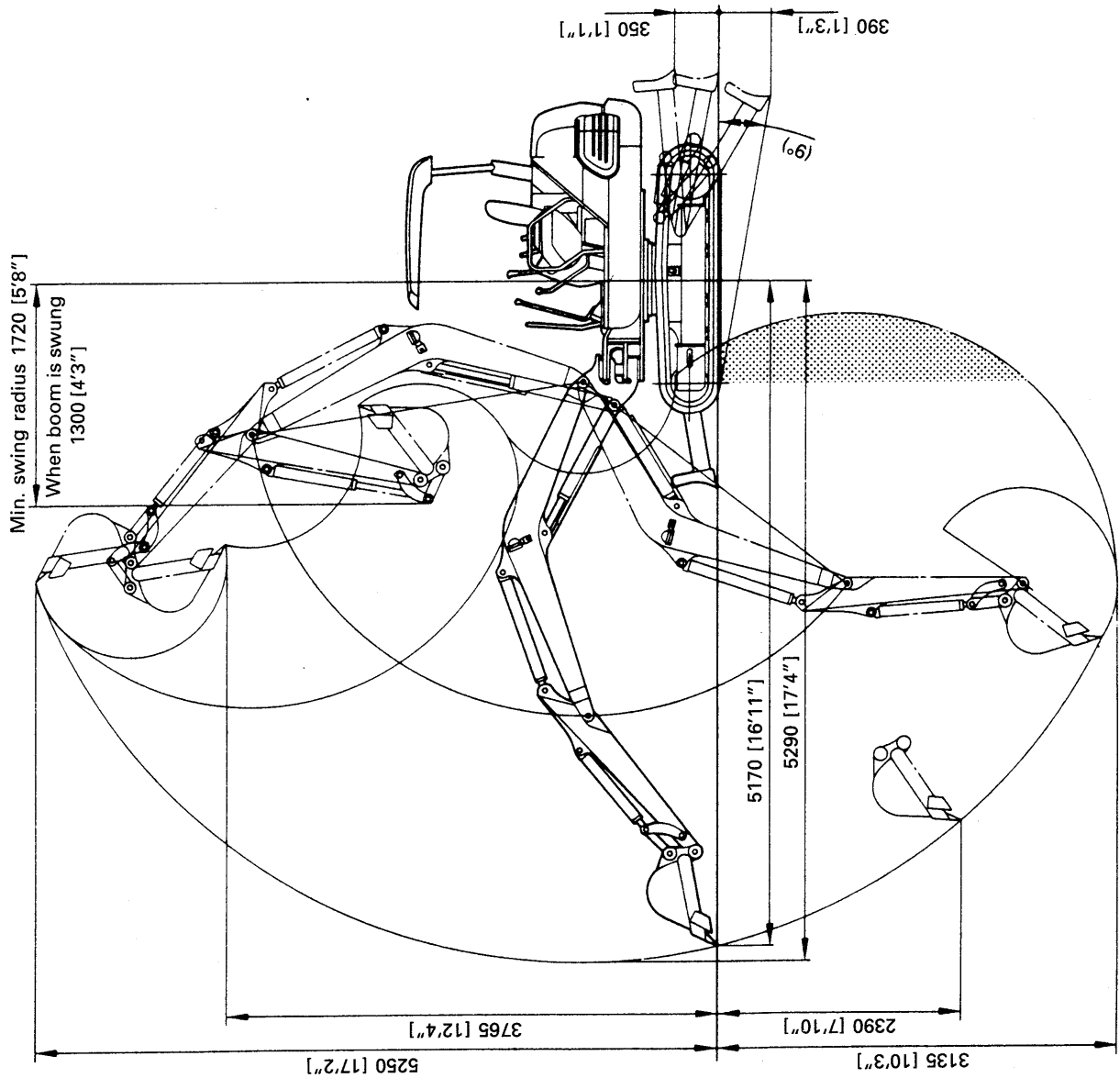

25. SPECIFICATIONS

PC40-7

	Rubber shoes and canopy	Ruber shoes and cab	Steel shoes and canopy	Steel shoes and cab
--	-------------------------	---------------------	------------------------	---------------------

WEIGHT

● Operating weight (without operator)	4005 kg (8831 lb)	4160 kg (9173 lb)	4000 kg (8820 lb)	4155 kg (9162 lb)
---------------------------------------	-------------------	-------------------	-------------------	-------------------

PERFORMANCE

Bucket capacity (standard bucket) SAE/CECE	0.14 m ³ (0.18 cu.yd) / 0.13 m ³			
● Width of opening (Standard bucket)	(Without side cutter)	535 mm (21.1 in)		
	(With side cutter)	600 mm (23.6 in)		
● Travel speed	High speed	3.9 km/h (2.4 MPH)	3.7 km/h (2.3 MPH)	
	Low speed	2.5 km/h (1.6 MPH)	2.4 km/h (1.5 MPH)	
● Swing speed	9.5 rpm			
● Track shoe	Rubber shoe 400 mm (13.6 in)	Triple grouser shoe 400 mm (13.6 in)		

ENGINE

● Model	Komatsu 4D84E – 3C diesel engine			
● Flywheel horsepower	27 kw (36 HP) / 2700 rpm			
● Starting motor	12 V 2.0 kw			
● Alternator	12 V 40 A			
● Battery	12 V 70 Ah x 1 piece			

PC40-7

- Canopy, rubber shoe specification machine
- Canopy, steel shoe specification machine

The values without parentheses are the values for the rubber shoe specification machine.

The values inside parentheses are the values for steel shoe specification machine.

If only one value is given, the value is the same for both the rubber shoe specification and steel shoe specification machines.

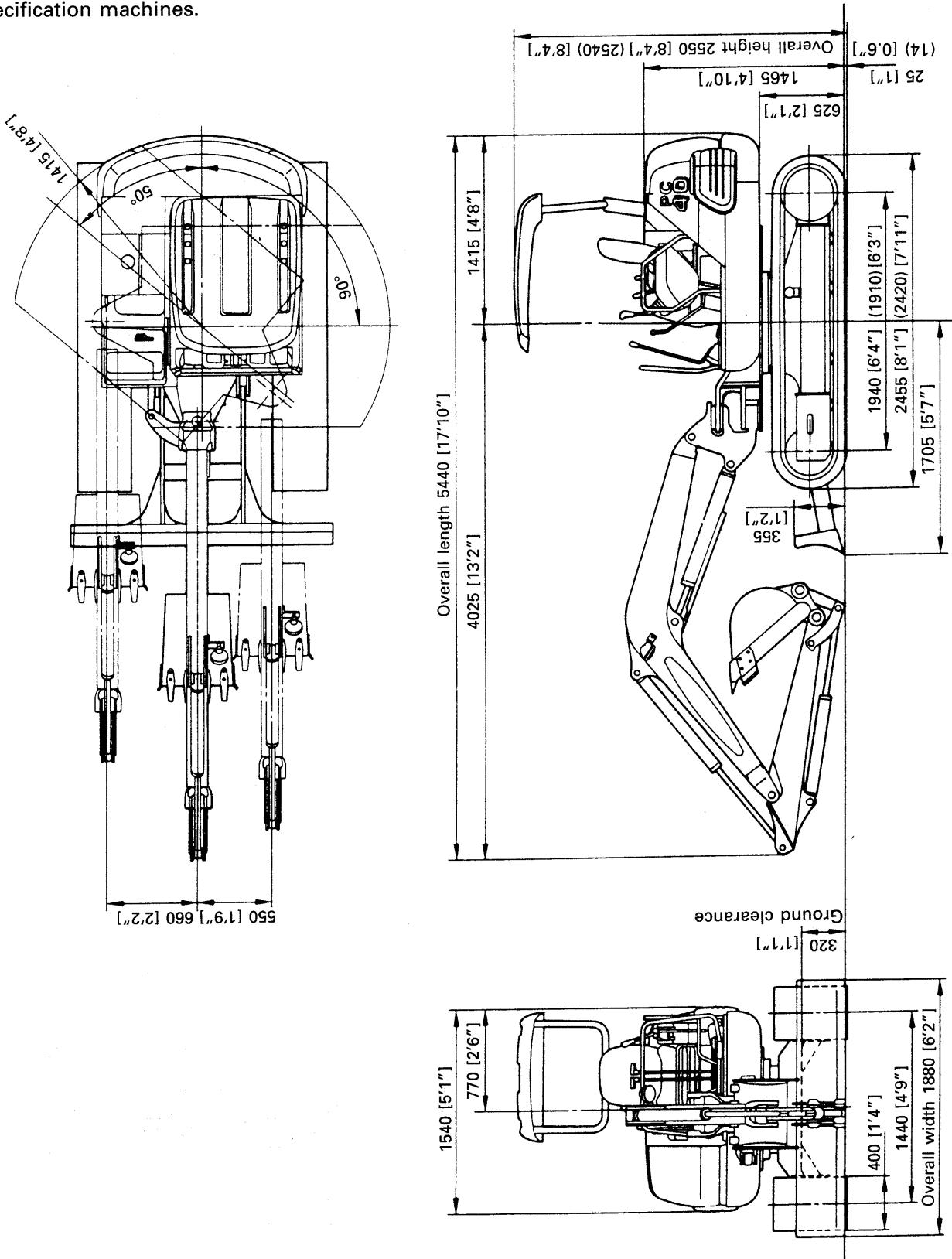

25. SPECIFICATIONS

PC40-7

- Cab, rubber shoe specification machine
- Cab, steel shoe specification machine

The values without parentheses are the values for the rubber shoe specification machine.
 The values inside parentheses are the values for steel shoe specification machine.

If only one value is given, the value is the same for both the rubber shoe specification and steel shoe specification machines.

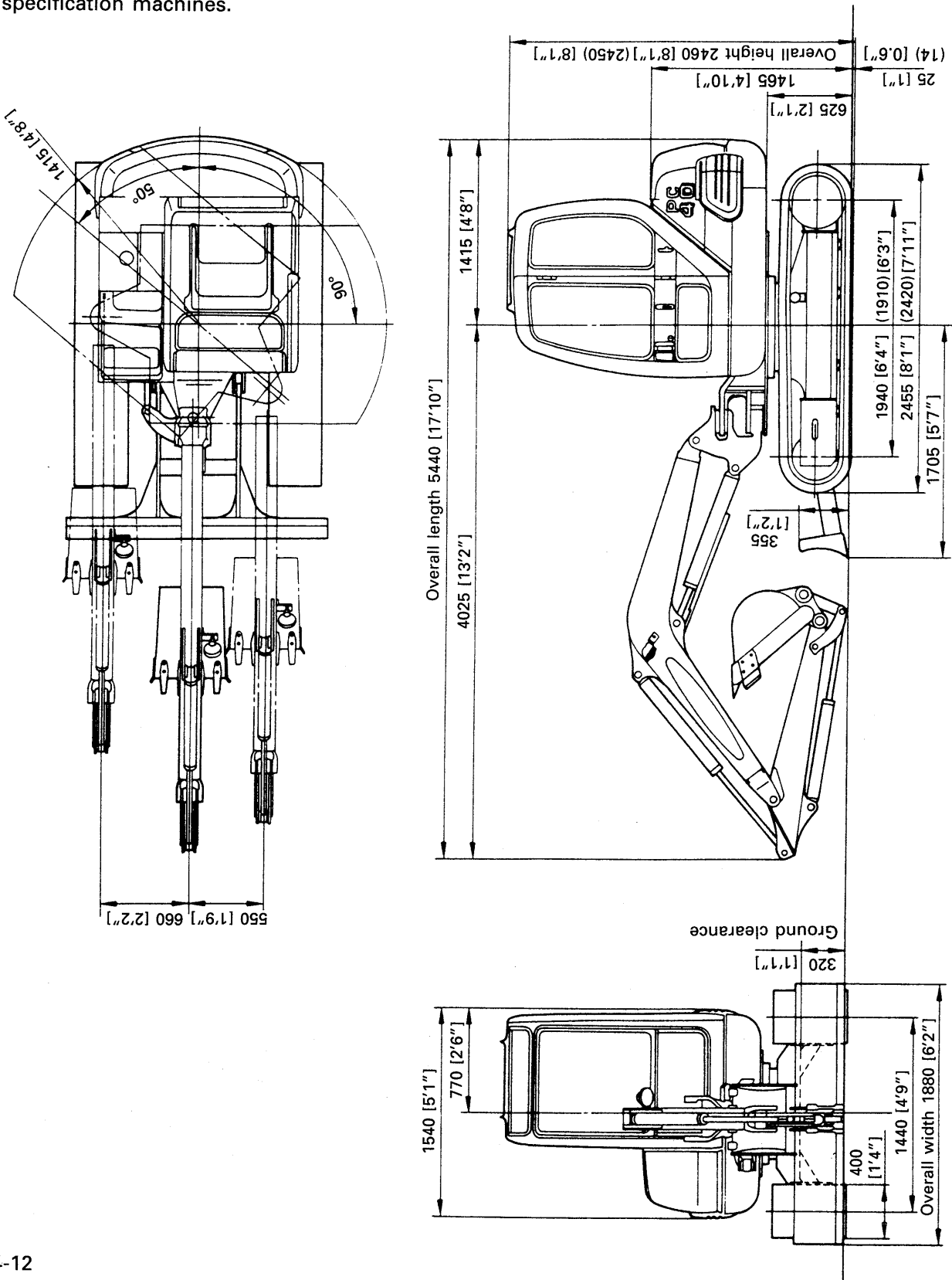

PC40-7

- Canopy, rubber shoe specification machine
- Canopy, steel shoe specification machine
- Cab, rubber shoe specification machine
- Cab, steel shoe specification machine

Never allow other person than the operator to enter the swing range (Max. swing range, Max. digging radius).

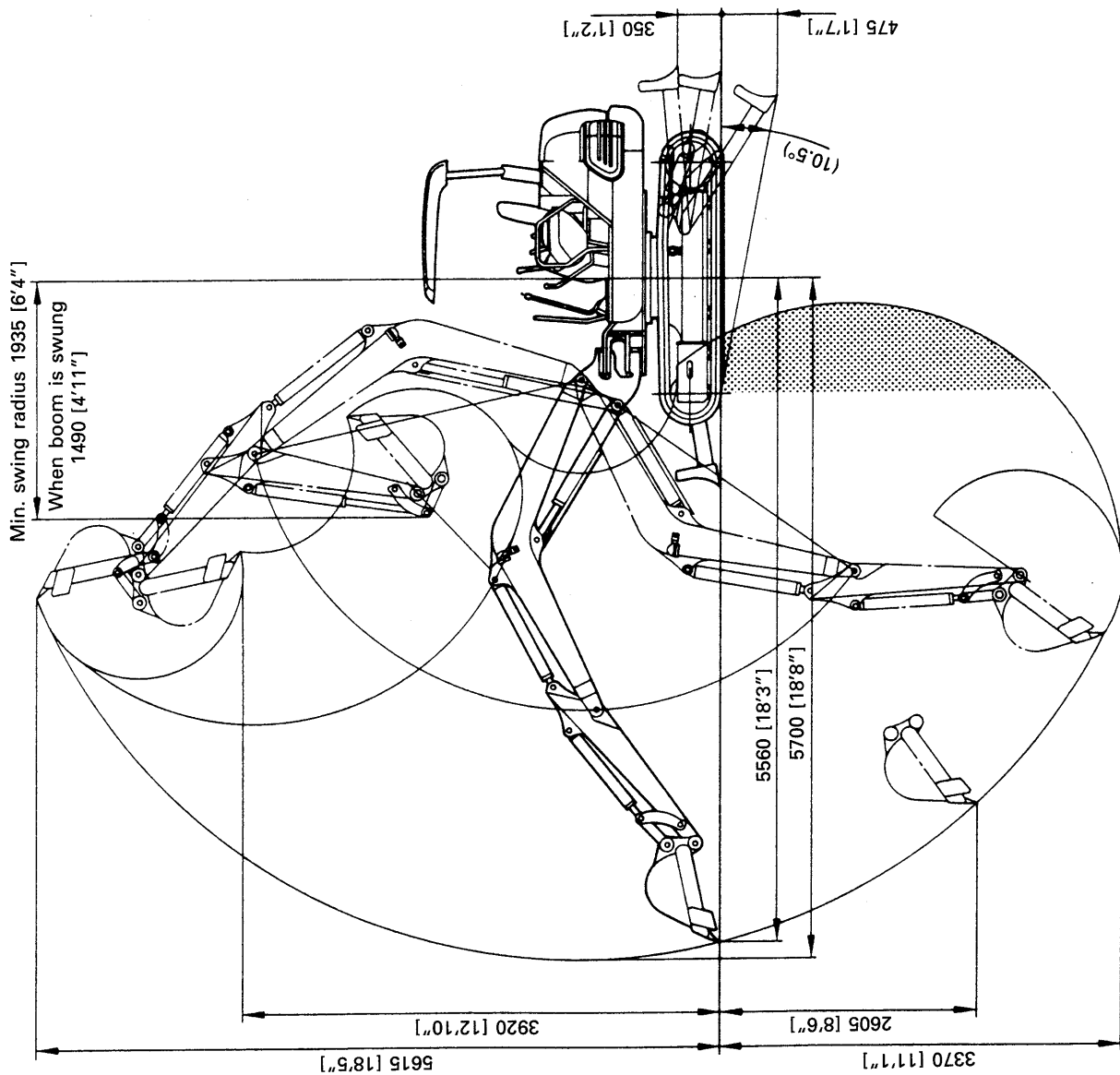

25. SPECIFICATIONS

PC45-1

	Rubber shoes and canopy	Ruber shoes and cab	Steel shoes and canopy	Steel shoes and cab
--	-------------------------	---------------------	------------------------	---------------------

WEIGHT

● Operating weight (without operator)	4230 kg (9327 lb)	4385 kg (9669 lb)	4300 kg (9482 lb)	4455 kg (9823 lb)
---------------------------------------	-------------------	-------------------	-------------------	-------------------

PERFORMANCE

Bucket capacity (standard bucket) SAE/CECE		0.16 m ³ (0.21 cu.yd) / 0.14 m ³		
● Width of opening (Standard bucket)	(Without side cutter)	585 mm (23.0 in)		
	(With side cutter)	650 mm (25.6 in)		
● Travel speed	High speed	4.0 km/h (2.5 MPH)	3.8 km/h (2.4 MPH)	
	Low speed	2.8 km/h (1.7 MPH)	2.6 km/h (1.6 MPH)	
● Swing speed		10 rpm		
● Track shoe		Rubber shoe 400 mm (15.8 in)	Triple grouser shoe 400 mm (15.8 in)	

ENGINE

● Model	Komatsu 4D84E – 3B diesel engine			
● Flywheel horsepower	27 kw (36 HP) / 2450 rpm			
● Starting motor	12 V 2.0 kw			
● Alternator	12 V 40 A			
● Battery	12 V 70 Ah x 1 piece			

PC45-1

- Canopy, rubber shoe specification machine
- Canopy, steel shoe specification machine

The values without parentheses are the values for the rubber shoe specification machine.

The values inside parentheses are the values for steel shoe specification machine.

If only one value is given, the value is the same for both the rubber shoe specification and steel shoe specification machines.

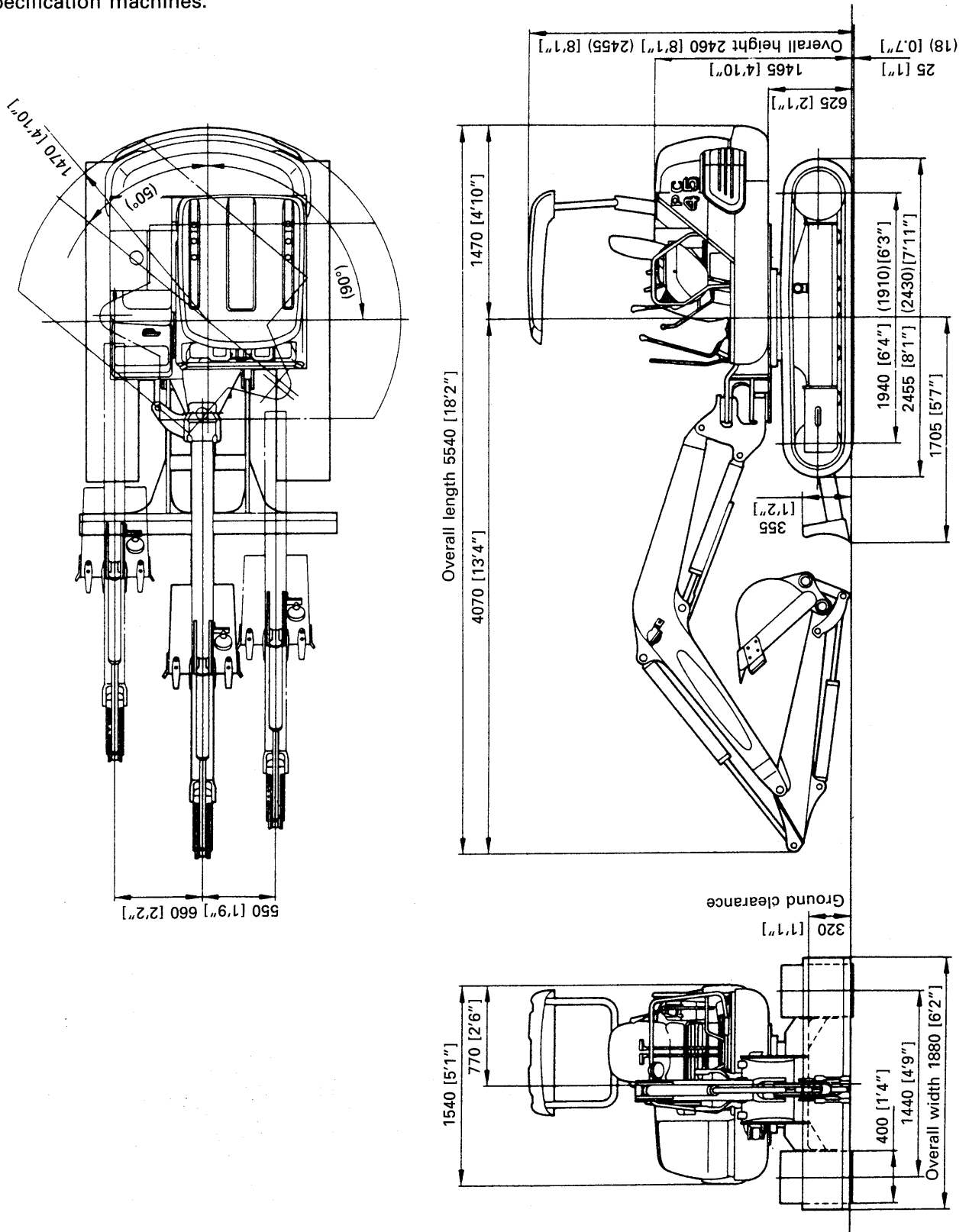

25. SPECIFICATIONS

PC45-1

- Cab, rubber shoe specification machine
- Cab, steel shoe specification machine

The values without parentheses are the values for the rubber shoe specification machine.

The values inside parentheses are the values for steel shoe specification machine.

If only one value is given, the value is the same for both the rubber shoe specification and steel shoe specification machines.

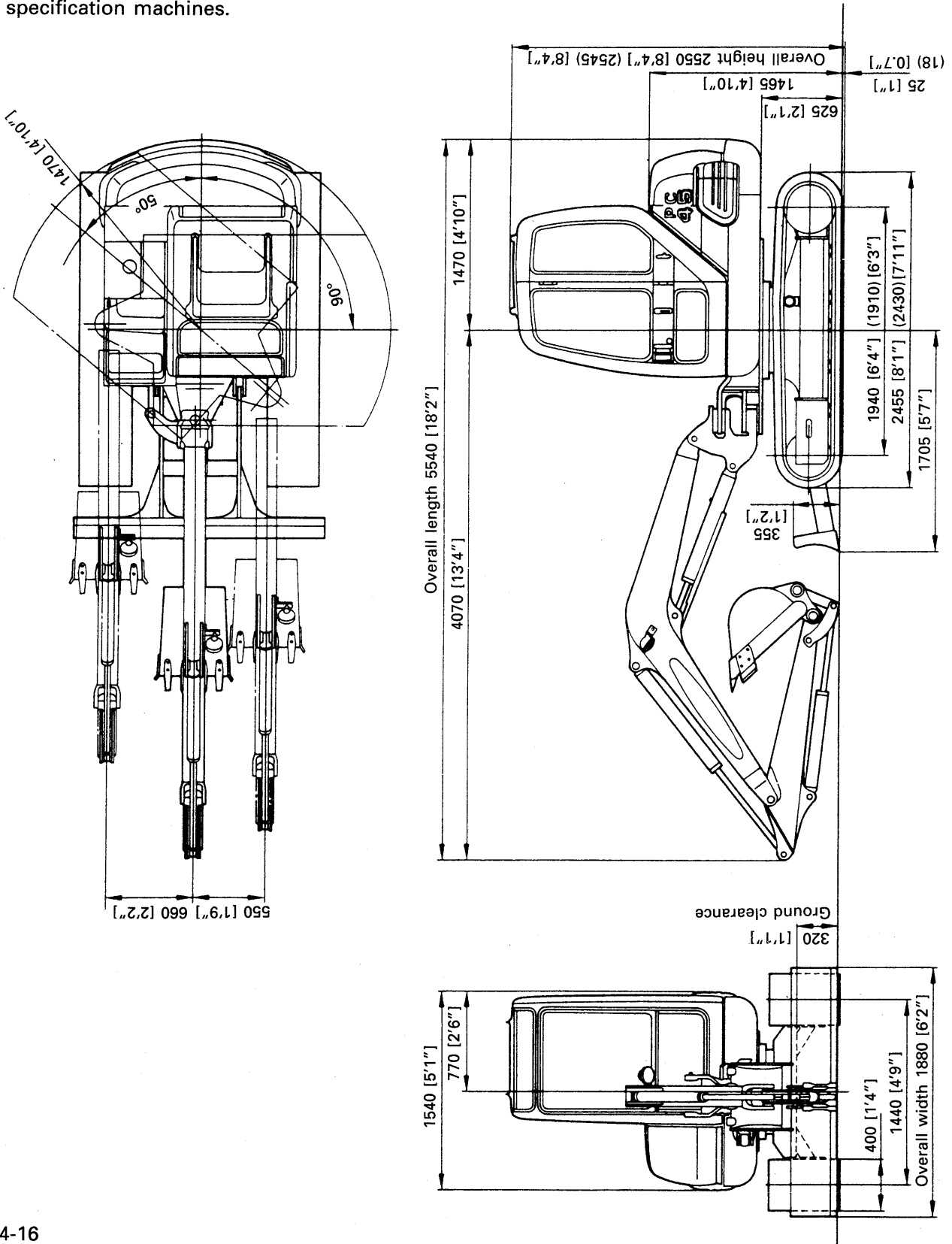

PC45-1

- Canopy, rubber shoe specification machine
- Canopy, steel shoe specification machine
- Cab, rubber shoe specification machine
- Cab, steel shoe specification machine

Never allow other person than the operator to enter the swing range (Max. swing range, Max. digging radius).

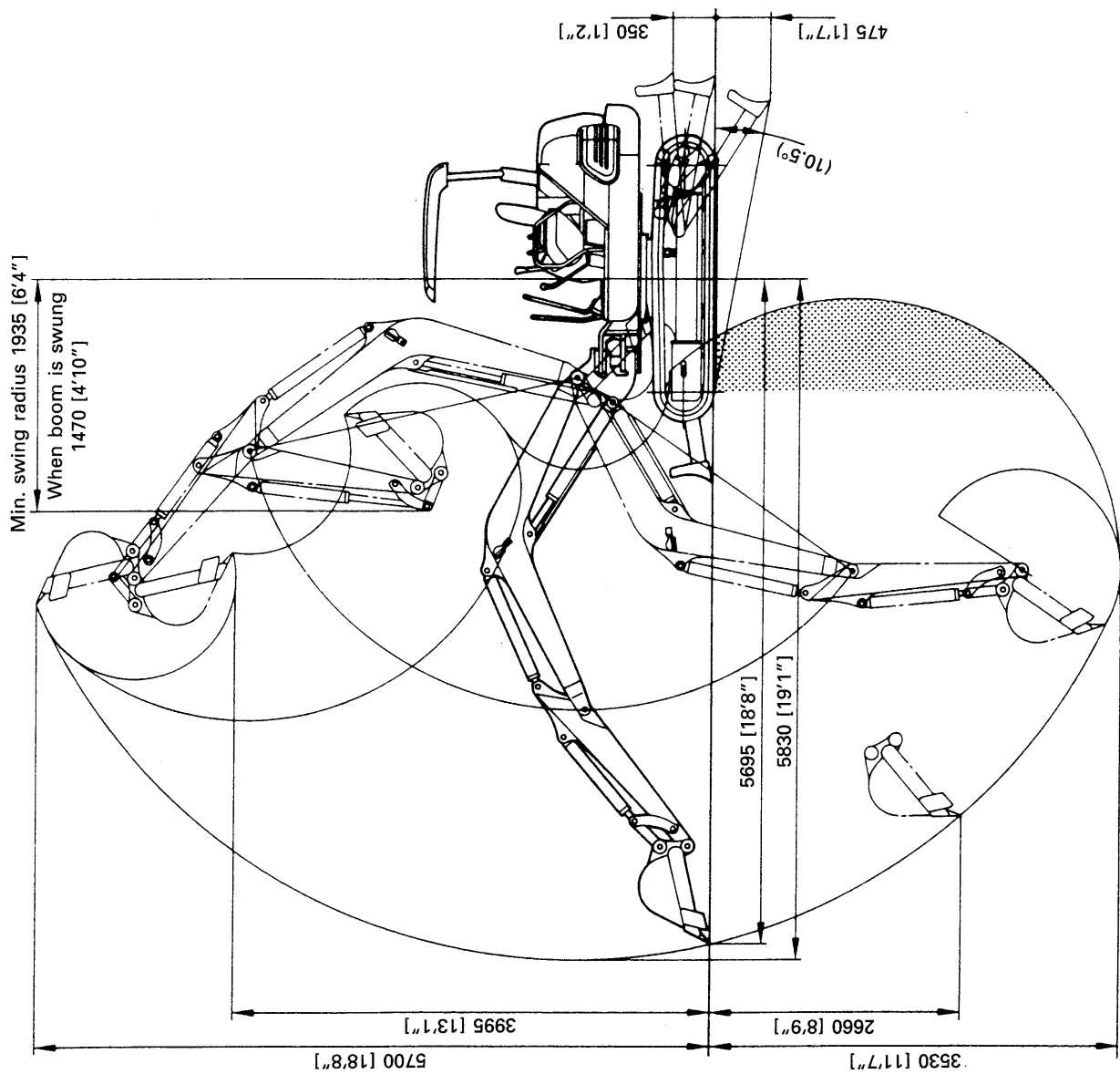

MEMO

OPTIONS, ATTACHMENTS

26. GENERAL PRECAUTIONS

26.1 PRECAUTIONS RELATED TO SAFETY

If attachments or options other than those authorized by Komatsu are installed, this will not only affect the life of the machine, but will also cause problems with safety.

When installing attachments not listed in this Operation and Maintenance Manual, please contact your Komatsu distributor first.

If you do not contact Komatsu, we cannot accept any responsibility for any accident or failure.

WARNING

Precautions for removal and installation operations

When removing or installing attachments, obey the following precautions and take care to ensure safety during the operation.

- Carry out the removal and installation operations on a flat, firm ground surface.
- When the operation is carried out by two or more workers, determine signals and follow these during the operation.
- When carrying heavy objects (more than 25 kg (55 lb)), use a crane.
- When removing heavy parts, always support the part before removing it.
When lifting such heavy parts with a crane, always pay careful attention to the position of the center of gravity.
- It is dangerous to carry out operations with the load kept suspended. Always set the load on a stand, and check that it is safe.
- When removing or installing attachments, make sure that they are in a stable condition and will not fall over.
- Never go under a load suspended from a crane.
Always stand in a position that is safe even if the load should fall.

NOTICE

Qualifications are required to operate a crane. Never allow the crane to be operated by an unqualified person.

For details of the removal and installation operations, please contact your Komatsu distributor.

26.2 PRECAUTIONS WHEN INSTALLING ATTACHMENTS

⚠ WARNING

Long work equipment reduces the stability of the chassis, so if the swing is operated on a slope, or when going down a steep hill, the machine may lose its balance and overturn. The following operations are particularly dangerous, so never operate the machine in these ways.

- Going downhill with the work equipment raised

CORRECT

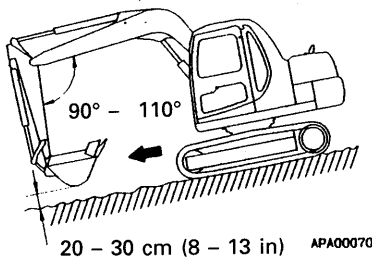

- Traveling across slopes

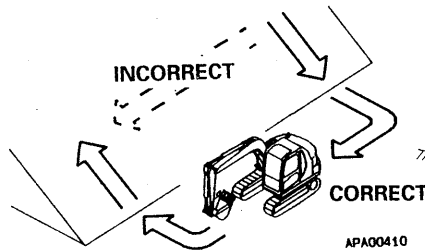

- Swinging the upper structure on slopes

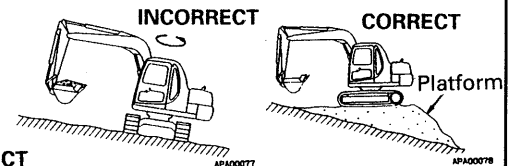

- If heavy work equipment is installed, the overrun of the swing becomes greater (the distance from the point where the operator operates the control levers to stop the swing to the point where the upper structure stops completely), so there is danger of mistaking the distance and hitting something.
Always operate so that there is an ample margin to the stopping point.
Furthermore, the hydraulic drift also becomes larger (when the work equipment is stopped in mid-air, it will gradually move down under its own weight).
- Always follow the correct procedure when installing the boom and arm. If the correct procedure is not followed, this may lead to serious damage or injury, so please consult your Komatsu distributor before carrying out installation.

If long work equipment is installed, the working range will suddenly become larger, so there is danger of mistaking the distance and hitting something.

Always operate the work equipment so that there is ample space from any obstacles in the area.

27. HANDLING BUCKET WITH HOOK

27.1 CHECKING FOR DAMAGE TO BUCKET WITH HOOK

Check that there is no damage to the hook, stopper, or hook mount. If any abnormality is found, please contact your Komatsu distributor.

27.2 PROHIBITED OPERATIONS

The standard work equipment must not be used for lifting loads. If this machine is to be used for lifting loads, it is necessary to install the special bucket with hook.

27.3 PRECAUTIONS DURING OPERATIONS

- When carrying out lifting operations, reduce the engine speed.
- Depending on the posture of the work equipment, there is danger that the wire or load may slip off the hook. Always be careful to maintain the correct hook angle to prevent this from happening.
- Never steer the machine while lifting a load.
- If the bucket with hook is turned and used for operations, it will hit the arm during dumping operations, so be careful when using it.
- Loads suspended must not exceed the limit indicated in the "LIFTING CAPACITY TABLE" stuck on the right-side lower portion of the driver's seat.
- If you wish to install a hook in the future, please contact your Komatsu distributor.

