

Operation & Maintenance Manual

SEAM000902

D20AG, PL, PLL-7 D21A, AG-7 D20P, PG-7A/D21PG-7A BULLDOZER

	D20AG-7	-76441	
	D21A, AG-7	-76441	
SERIAL NUMBERS	D20PL, PLL-7	-62001	and up
	D20P, PG-7A	-76441	
	D21PG-7A	-76441	

WARNING

Unsafe use of this machine may cause serious injury or death. Operators and maintenance personnel must read this manual before operating or maintaining this machine. This manual should be kept near the machine for reference and periodically reviewed by all personnel who will come into contact with it.

NOTICE

Komatsu has Operation & Maintenance Manuals written in some other languages. If a foreign language manual is necessary, contact your local distributor for availability.

KOMATSU

This manual provides rules and guidelines which will help you use this machine safely and effectively. Keep this manual handy and have all personnel read it periodically. If this manual has been lost or has become dirty and can not be read, request a replacement manual from Komatsu or your Komatsu distributor.

If you sell the machine, be sure to give this manual to the new owners.

Continuing improvements in the design of this machine can lead to changes in detail which may not be reflected in this manual. Consult Komatsu or your Komatsu distributor for the latest available information of your machine or for questions regarding information in this manual.

This manual may contain attachments and optional equipment that are not available in your area. Consult Komatsu or your Komatsu distributor for those items you may require.

 **WARNING**

- **Improper operation and maintenance of this machine can be hazardous and could result in serious injury or death.**
- **Operators and maintenance personnel should read this manual thoroughly before beginning operation or maintenance.**
- **Some actions involved in operation and maintenance of the machine can cause a serious accident, if they are not done in a manner described in this manual.**
- **The procedures and precautions given in this manual apply only to intended uses of the machine. If you use your machine for any unintended uses that are not specifically prohibited, you must be sure that it is safe for you and others. In no event should you or others engage in prohibited uses or actions as described in this manual.**
- **Komatsu delivers machines that comply with all applicable regulations and standards of the country to which it has been shipped. If this machine has been purchased in another country or purchased from someone in another country, it may lack certain safety devices and specifications that are necessary for use in your country. If there is any question about whether your product complies with the applicable standards and regulations of your country, consult Komatsu or your Komatsu distributor before operating the machine.**
- **The description of safety is given in SAFETY INFORMATION on page 0-2 and in SAFETY from page 1-1.**

2. SAFETY INFORMATION

Most accidents are caused by the failure to follow fundamental safety rules for the operation and maintenance of machines. To avoid accidents, read, understand and follow all precautions and warnings in this manual and on the machine before performing operation and maintenance.

To identify safety messages in this manual and on machine labels, the following signal words are used.

- ⚠ DANGER** — This word is used on safety messages and safety labels where there is a high probability of serious injury or death if the hazard is not avoided. These safety messages or labels usually describe precautions that must be taken to avoid the hazard. Failure to avoid this hazard may also result in serious damage to the machine.

- ⚠ WARNING** — This word is used on safety messages and safety labels where there is a potentially dangerous situation which could result in serious injury or death if the hazard is not avoided. These safety messages or labels usually describe precautions that must be taken to avoid the hazard. Failure to avoid this hazard may also result in serious damage to the machine.

- ⚠ CAUTION** — This word is used on safety messages and safety labels for hazards which could result in minor or moderate injury if the hazard is not avoided. This word might also be word for hazards where the only result could be damage to the machine.

- NOTICE** — This word is used for precautions that must be taken to avoid actions which could shorten the life of the machine.

Safety precautions are described in SAFETY from page 1-1.

Komatsu cannot predict every circumstance that might involve a potential hazard in operation and maintenance. Therefore the safety message in this manual and on the machine may not include all possible safety precautions. If any procedures or actions not specifically recommended or allowed in this manual are used, you must be sure that you and others can do such procedures and actions safely and without damaging the machine. If you are unsure about the safety of some procedures, contact Komatsu or a Komatsu distributor.

3. INTRODUCTION

3.1 INTENDED USE

This Komatsu BULLDOZER is designed to be used mainly for the following work:

- Dozing
- Smoothing
- Cutting into hard or frozen ground or ditching.

See the section "WORK POSSIBLE USING BULLDOZER" for further details.

3.2 FEATURES

- Simple, easy operation
One lever with hydraulic control is used for the steering and directional lever (D21).
One lever with hydraulic control is used for the steering lever (D20).
One lever with a solenoid selector system is used for the blade control lever (hydraulic angle-tiltdozer).
- Simple, easy maintenance
- Fuel gauge and air cleaner clogged warning lamp installed on instrument panel

3.3 BREAKING IN THE MACHINE

Your Komatsu machine has been thoroughly adjusted and tested before shipment. However, operating the machine under severe conditions at the beginning can adversely affect the performance and shorten the machine life.

Be sure to break in the machine for the initial 100 hours (as indicated by the service meter.)

During breaking in:

- Idle the engine for 5 minutes after starting it up.
- Avoid operation with heavy loads or at high speeds.
- Avoid sudden starts, sudden acceleration, sudden steering and sudden stops except in cases of emergency.

The precautions given in this manual for operating, maintenance, and safety procedures are only those that apply when this product is used for the specified purpose. If the machine is used for a purpose that is not listed in this manual, Komatsu cannot bear any responsibility for safety. All consideration of safety in such operations is the responsibility of the user.

Operations that are prohibited in this manual must never be carried out under any circumstances.

4. LOCATION OF PLATES, TABLE TO ENTER SERIAL NO. AND DISTRIBUTOR

4.1 MACHINE SERIAL NO. PLATE POSITION

On the inside of the L.H. armrest

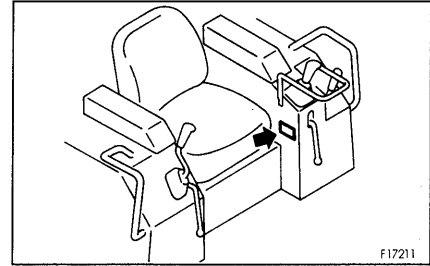

4.2 ENGINE SERIAL NO. PLATE POSITION

On the upper side of the engine cylinder head cover

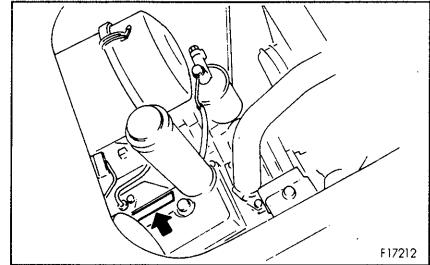

4.3 TABLE TO ENTER SERIAL NO. AND DISTRIBUTOR

Machine serial No.:	
Engine serial No.:	
Distributor name:	
Adress:	Phone:
Service personnel for your machine:	

REMARKS

5. CONTENTS

1. Foreword	0-1
2. Safety information	0-2
3. Introduction	0-3
4. Location of plates, table to enter serial No. and distributor	0-4

SAFETY

6. General precautions	1-2
7. Precautions during operation	1-7
7.1. Before starting engine	1-7
7.2. Operating machine	1-9
7.3. Transportation	1-12
7.4. Battery	1-13
7.5. Towing	1-15
8. Precautions for maintenance	1-16
8.1 Before carrying out maintenance	1-16
8.2 During maintenance	1-18
9. Position for sticking safety labels	1-23

OPERATION

10. General view	2-2
10.1. General view of machine	2-2
10.2. General view of controls and gauges	2-3
11. Explanation of components	2-5
11.1. Meters and lamps	2-5
11.2. Switches	2-7
11.3. Control levers and pedals	2-9
11.4. Fuse box	2-15
12. Operation	2-16
12.1. Check before starting engine	2-16
[Only those using D20AG, PL, PLL-7, D20P, PG-7A need read this section in 12A. Operation.]	
12A. Operation	2-25
12A.1.4 Operations and checks before starting engine	2-26
12A.2. Starting engine	2-28
12A.3. Operations and checks after starting engine	2-32
12A.4. Moving machine off	2-33
12A.5. Steering machine	2-35
12A.6. Stopping machine	2-37
12A.7. Shifting gear, shifting between forward and reverse	2-38
12A.8. Precautions for operation	2-40
12A.9. Work possible using bulldozer	2-41
12A.10. Parking machine	2-42
12A.11. Check after finishing work	2-43
12A.12. Stopping engine	2-44
12A.13. Check after stopping engine	2-45
12A.14. Locking	2-45

[Only those using D21A, AG-7, D21PG-7A need read this section in 12B. Operation.]

12B. Operation	2-46
12B.1.4 Operations and checks before starting engine	2-47
12B.2. Starting engine	2-49
12B.3. Operations and checks after starting engine	2-52
12B.4. Moving machine off	2-53
12B.5. Shifting gear	2-54
12B.6. Shifting between forward and reverse	2-55
12B.7. Steering machine	2-56
12B.8. Stopping machine	2-58
12B.9. Precautions for operation	2-59
12B.10. Work possible using bulldozer	2-60
12B.11. Parking machine	2-61
12B.12. Check after finishing work	2-62
12B.13. Stopping engine	2-63
12B.14. Check after stopping engine	2-64
12B.15. Locking	2-64

[Only those using the machines given in () need read the following items.]

12.16. Tips for longer undercarriage life (D20PL, PLL-7, D20P-7A, D21A-7)	2-65
12.17. Handling rubber shoes (D20AG-7, D20PG-7A, D21AG-7, D21PG-7A)	2-68
13. Transportation	2-74
13.1. Loading, unloading work	2-74
13.2. Precautions for loading	2-75
13.3. Precautions for transportation	2-76
14. Cold weather operation	2-77
14.1. Precautions for low temperature	2-77
14.2. Precautions after completion of work	2-79
14.3. After cold weather	2-79
15. Long-term storage	2-80
15.1. Before storage	2-80
15.2. During storage	2-80
15.3. After storage	2-81
16. Troubleshooting	2-82
16.1. After running out of fuel	2-82
16.2. If battery is discharged	2-83
16.3. Other trouble	2-87

MAINTENANCE

17. Guides to maintenance	3-2
18. Outlines of service	3-5
18.1. Outline of oil, fuel, coolant	3-5
18.2. Relating to electric system	3-8
19. Wear parts list	3-9
20. Use of fuel, coolant and lubricants according to ambient temperature	3-10
21. Standard tightening torques for bolts and nuts	3-14
21.1. Introduction of necessary tools	3-14
21.2. Torque list	3-15
22. Periodic replacement of safety critical parts	3-16
23. Maintenance schedule chart	3-18
24. Service procedure	3-21
24.1. Initial 250 hours service	3-21
24.2. When required	3-22
24.3. Check before starting	3-44
24.4. Every 50 hours service	3-50
24.5. Every 250 hours service	3-51
24.6. Every 500 hours service	3-56
24.7. Every 1000 hours service	3-61
24.8. Every 2000 hours service	3-69
24.9. Every 4000 hours service	3-70

SPECIFICATIONS

25. Specifications	4-2
---------------------------------	-----

OPTIONS, ATTACHMENTS

26. General precautions	5-2
26.1. Precautions related to safety	5-2
27. Using seat belt	5-3
27.1. Seat belt (for fixed type)	5-3
27.2. Seat belt (for suspension type)	5-5
28. Handling suspension seat	5-7

SAFETY



WARNING

Read and follow all safety precautions. Failure to do so may result in serious injury or death.

This safety section also contains precautions for optional equipment and attachments.

6. GENERAL PRECAUTIONS

⚠ WARNING: For reasons of safety, always follow these safety precautions.

SAFETY RULES

- ONLY trained and authorized personnel can operate and maintain the machine.
- Follow all safety rules, precautions and instructions when operating or performing maintenance on the machine.
- When working with another operator or a person on worksite traffic duty, be sure all personnel understand all hand signals that are to be used.

SAFETY FEATURES

- Be sure all guards and covers are in their proper position. Have guards and covers repaired if damaged.
Proper position → See "12.1.1 WALK-AROUND CHECK".
- Use safety features such as safety lock and seat belts properly.
- NEVER remove any safety features. ALWAYS keep them in good operating condition.
Safety lever → See "12A.10, 12B.11 PARKING MACHINE".
Seat belts → See "27. USING SEAT BELT".
- Improper use of safety features could result in serious bodily injury or death.

CLOTHING AND PERSONAL PROTECTIVE ITEMS

- Avoid loose clothing, jewelry, and loose long hair. They can catch on controls or in moving parts and cause serious injury or death. Also, do not wear oily clothes because they are flammable.
- Wear a hard hat, safety glasses, safety shoes, mask or gloves when operating or maintaining the machine. Always wear safety goggles, hard hat and heavy gloves if your job involves scattering metal chips or minute materials — this is so particularly when driving pins with a hammer and when cleaning the air cleaner element with compressed air. Check also that there is no one near the machine.
Cleaning of air cleaner element → See "24.2 WHEN REQUIRED" in service procedure.



UNAUTHORIZED MODIFICATION

- Any modification made without authorization from Komatsu can create hazards.
- Before making a modification, consult your Komatsu distributor. Komatsu will not be responsible for any injury or damage caused by any unauthorized modification.

STANDING UP FROM THE SEAT

- ALWAYS move the SAFETY LEVER to the LOCK position before standing up from the operator's seat. If you don't, you could unintentionally hit the control levers, resulting in sudden machine movement and the possibility of damage, injury or death.
- Before leaving your machine, lower the blade to the ground, move the SAFETY LEVER to LOCK, and stop the engine.

Machine posture → See "12A.10, 12B.11 PARKING MACHINE". Locking

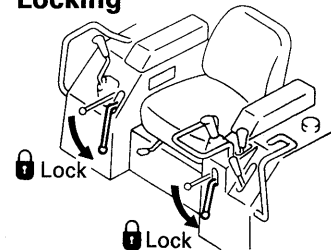

MOUNTING AND DISMOUNTING

- NEVER jump on or off the machine. NEVER get on or off a moving machine.
- When mounting and dismounting, face the machine and use the handholds, track frame and track shoes.
- Do not hold any control levers when getting on or off the machine.
- Maintain three-point contact to be sure that you do not fall from the machine.
- Repair any damaged handhold, and tighten any loose bolts. Handholds, track frame and track shoes must be free of oil, grease and excessive dirt.

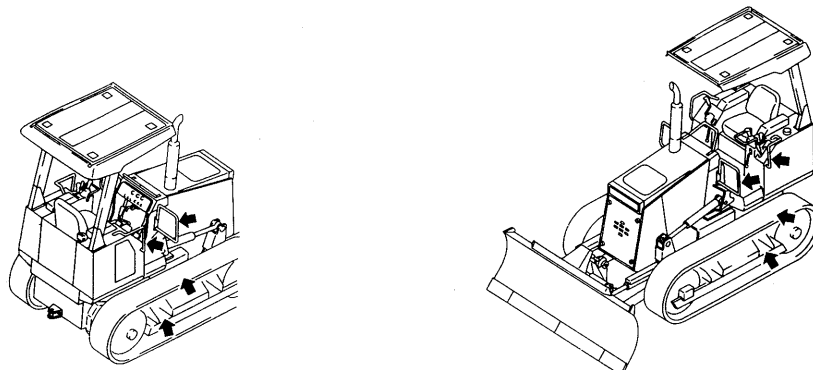

FIRE PREVENTION FOR FUEL AND OIL

Fuel, oil, and antifreeze can be ignited by a flame. Fuel is particularly **FLAMMABLE** and can be **HAZARDOUS**.

- Keep a flame away from flammable fluids.
- Stop the engine and do not smoke when refueling.
- Tighten all fuel and oil caps securely.
- Refueling and oiling should be made in well ventilated areas.
- Keep oil and fuel in the determined place and do not allow unauthorized persons to enter.

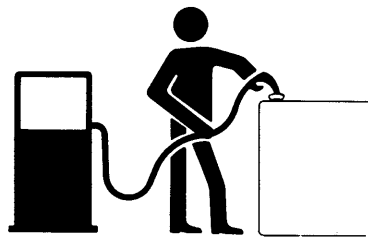
**BURN HAZARD PREVENTION**

- If the coolant, engine oil or hydraulic oil is hot, use a heavy cloth, gloves, heavy clothing and safety glasses or goggles before checking or touching.
- Before checking the coolant level, stop the engine and let the radiator cool. If it is necessary to check an overheated engine, slightly loosen the cap to relieve pressure inside the radiator before removing the cap. Hot coolant spurting from the radiator can seriously scald or burn you.
- Before checking the engine or hydraulic oil level, stop the engine and let the oil cool. Hot oil spurting from the oil tank can seriously scald or burn you.



ASBESTOS DUST HAZARD PREVENTION

- Asbestos dust can be HAZARDOUS to your health if it is inhaled.
- If you handle materials containing asbestos fibers, follow these guidelines as given below:
 - 1) NEVER use compressed air for cleaning.
 - 2) Use water for cleaning to minimize dust cloud.
 - 3) Operate the machine with the wind to your back, whenever possible.
 - 4) Use an approved respirator if necessary.

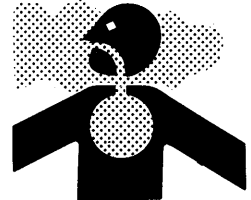

CRUSHING OR CUTTING PREVENTION

- Do not enter, or put your hand or arm or any other part of your body between movable parts such as between the work equipment and cylinders, or between the machine and the blade or ripper or any other attachment. If the work equipment is operated, the clearance will change and this may lead to serious damage or personal injury.



FIRE EXTINGUISHER AND FIRST AID KIT

- Be sure fire extinguishers have been provided and know how to use them.
- Know where a first aid kit is located.
- Know what to do in the event of a fire.
- Be sure you know the phone numbers of persons you should contact in case of an emergency.

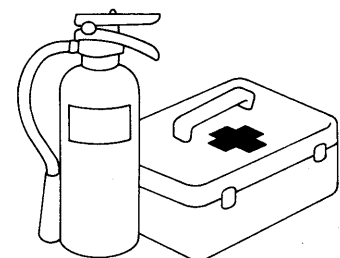

PRECAUTIONS FOR ROPS

- Do not operate machine with ROPS removed if equipped.
- The ROPS is installed to protect the operator if the machine should overturn. It is designed not only to take the load when the machine overturns, but also to absorb the impact energy.
- The Komatsu ROPS fulfills all worldwide regulations and standards, but if any unauthorized modification is carried out on it, or if it is damaged when the machine overturns, its strength will be reduced and it will not be able to provide its original capacity. It will be able to provide this capacity only if modifications and repairs are carried out in the specified way.
- When carrying out modification or repairs, always consult your Komatsu distributor first.
- Even when the ROPS is installed, if you do not fasten your seat belt securely, it cannot protect you properly. Always fasten your seat belt when operating the machine.
Seat belts → See "27. USING SEAT BELT."

PRECAUTIONS FOR ATTACHMENTS

- When installing and using an optional attachment, read the instruction manual for the attachment and the information related to attachments in this manual.
- Do not use attachments that are not authorized by Komatsu or your Komatsu distributor. Use of unauthorized attachments could create a safety problem and adversely affect the proper operation and useful life of the machine.
- Any injuries, accidents, product failures resulting from the use of unauthorized attachments will not be the responsibility of Komatsu.

7. PRECAUTIONS DURING OPERATION

⚠ WARNING: Failure to follow these safety precautions may lead to a serious accident.

7.1 BEFORE STARTING ENGINE

SAFETY AT WORKSITE

- Before starting the engine, thoroughly check the area for any unusual conditions that could be dangerous.
- Before starting the engine, examine the terrain and soil conditions of the worksite. Determine the best and safest method of operation.
- Make rough terrain areas as level as possible before operation.
- If you need to operate on a street, protect pedestrians and cars by designating a person for worksite traffic duty or by installing fences around the worksite.
- If water lines, gas lines, and high-voltage electrical lines may be buried under the worksite, contact each utility and identify their locations. Be careful not to sever or cut any of these lines.
- Check the depth and flow of water before operating in water or crossing a river. **NEVER** be in water which is in excess of the permissible water depth.
Permissible water depth → See "12A.8.2, 12B.9.2 PERMISSIBLE WATER DEPTH".

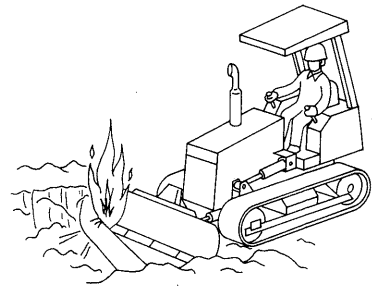

FIRE PREVENTION

- Thoroughly remove wood chips, leaves, paper and other flammable things accumulated on the engine compartment. They could cause a fire.
- Check fuel, lubrication, and hydraulic systems for leaks. Have any leaks repaired. Wipe up any excess oil, fuel or other flammable fluids.
Check points → See "12.1 CHECKS BEFORE STARTING ENGINE".
- Be sure a fire extinguisher is present and working.



IN OPERATOR'S CAB

- Stow or tie down all loose items, such as components and tools. They could accidentally hit or jam a control lever or other switch.
- Keep the cab floor, controls, steps and handholds free of oil, grease, snow, and excess dirt.
- Check the seat belt, buckle and hardware for damage or wear. Replace any worn or damaged parts. Always use seat belts when operating your machine.
Seat belts → See "27. USING SEAT BELT".

VENTILATION FOR ENCLOSED AREAS

- If it is necessary to start the engine within an enclosed area, provide adequate ventilation. Exhaust fumes from the engine can KILL.

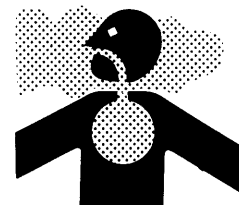

PRECAUTIONS FOR MIRRORS, WINDOWS AND LIGHTS

- Remove all dirt from the surface of the windows and lights to ensure that you can see well.
- Adjust the side mirror so that you can see clearly from the operator's seat, and always keep the surface of the mirror clean. If any glass is broken, replace it with a new part.
- Check that the head lamps and working lamps are installed to match the operating conditions. Check also that they light up properly.

7.2 OPERATING MACHINE

WHEN STARTING ENGINE

- Walk around your machine again just before mounting it, checking for people and objects that might be in the way.
- NEVER start the engine if a warning tag has been attached to the control.
- When starting the engine, sound the horn as an alert.
- Start and operate the machine only while seated.
- Do not allow anyone other than the operator to ride in the cab or on the machine body.

PRECAUTIONS WHEN MOVING FORWARD OR BACKWARD

- When operating in areas that may be hazardous or have poor visibility, designate a person to direct worksite traffic.
- Be sure no one is around machine, particularly behind machine.
- Before starting machine motion, sound the horn to alert people.
- There is a blind spot behind the machine. Make sure that nobody is present behind it before driving the machine backward.

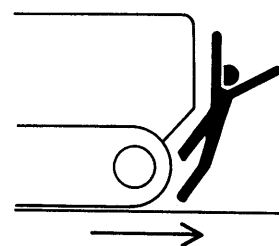

TRAVELING

- If any control lever must be operated during travel, avoid rapid operation.
- When traveling on uneven ground, slow down the machine and avoid quick movement of the steering lever.
- Avoid riding over obstacles as much as possible. If you must ride over obstacles, keep the work equipment close to the ground surface, and travel at a very slow speed. Riding over large obstacles could cause the machine to tip over on its side.

TRAVELING ON SLOPES

- Traveling on hills, banks or slopes that are steep could result in the machine tipping over or slipping.
- On hills, banks or slopes, carry the work equipment closer to the ground, approximately 20 to 30 cm (8 to 12 in.) above the ground. In case of emergency, quickly lower the work equipment to the ground to help the machine stop and prevent it from tipping over.
- Do not change direction on slopes. Avoid sideways travel whenever possible: rather travel up and down the slopes.
- Do not travel up and down on grass, fallen leaves, and wet steel plates. These materials may allow the machine to slip, if it is traveling sideways. Keep travel speed very low.
- When traveling downhill, drive slowly and use the engine as a brake.
- When traveling downhill with the machine being pushed by its own weight, the machine may steer in the opposite direction, so be careful when steering.
Reverse steering when traveling downhill → See "12A.5.2, 12B.7.2 TURNING WHILE DESCENDING A SLOPE".

INCORRECT

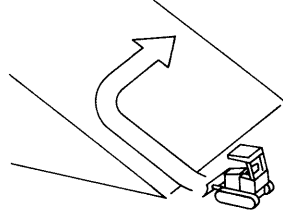

CORRECT

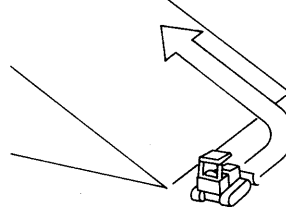

VISIBILITY

- Turn ON the head lamps and working lamp, when working at night or at dark sites. Provide additional lights for the worksite if necessary.
- If visibility is diminished by fog, snow or rain, stop operation. Wait until there is adequate visibility for safe operation.

WORKING ON SNOWY SITE

- Snow-covered and frozen ground may allow the machine to slip sideways, even if the grade is not steep. Slow down the machine when traveling on such ground. Avoid rapid starts, stops, and steering.
- In snow removal work, pay special attention to the edge of the road and to objects under the snow.

WORKING ON LOOSE GROUND

- Avoid operating your machine too close to the edge of cliffs, overhangs, and deep ditches. If these areas collapse, your machine could fall or tip over and result in serious injury or death. Remember that the soil after heavy rain or blasting is weakened in these areas.
- Earth laid on the ground and the soil near ditches are loose. They can collapse under the weight or vibration of your machine.
- Install the HEAD GUARD if working in areas where there is danger of falling rocks and dirt.
- When working in places where there is danger of falling rocks or danger of the machine turning over, install ROPS and a seat belt.

PARKING THE MACHINE

- Park on level ground whenever possible. If not possible, block the tracks, lower the blade to the ground and thrust the edge of the blade in the ground.

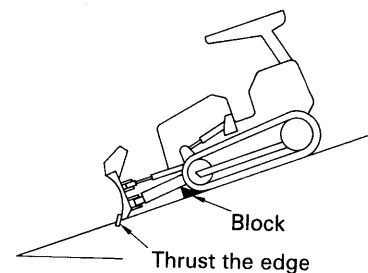

- When parking on public roads, provide fences and signs, such as flags or lights, on the machine to warn passersby to be careful. Be sure that the machine, flags or lights do not obstruct traffic.

Parking procedure → See "12A.10, 12B.11 PARKING MACHINE".

- Before leaving the machine, lower the work equipment to the ground, move the SAFETY LEVER to LOCK position, stop the engine, and lock all the doors, windows, and covers and remove the key(s).

Work equipment posture → See "12A.10, 12B.11 PARKING MACHINE".

Locks → See "12A.14, 12B.15 LOCKING".

Locking

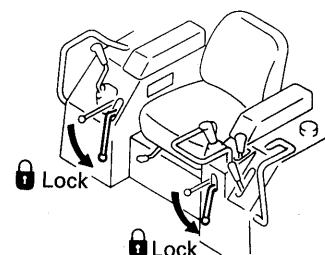

7.3 TRANSPORTATION

LOADING AND UNLOADING

- Loading and unloading the machine always involves potential hazards. **EXTREME CAUTION SHOULD BE USED.**
- Perform loading and unloading on firm, level ground only. Maintain a safe distance from the edge of a road.
- **ALWAYS** block the wheels of the hauling vehicle and place blocks under both ramps before loading and unloading.
- **ALWAYS** use ramps of adequate strength. Be sure the ramps are wide and long enough to provide a safe loading slope.
- Be sure that the ramps are securely positioned and fastened, and that the two sides are at the same level as one another.
- Be sure the ramp surface is clean and free of grease, oil, ice and loose materials. Remove dirt from the machine tracks.
- **NEVER** correct your steering on the ramps. If necessary, drive away from the ramps and climb again.
- After loading, block the machine tracks and secure the machine with tie-downs.

Loading and unloading → See "13. TRANSPORTATION."

Tie-downs → See "13. TRANSPORTATION."

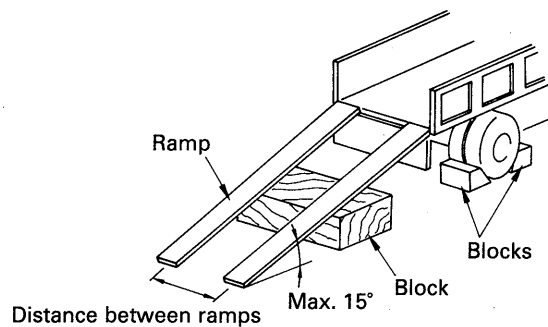

SHIPPING

- When shipping the machine on a hauling vehicle, obey all state and local laws governing the weight, width, and length of a load. Also obey all applicable traffic regulations.
- Determine the shipping route while taking into account the width, height and weight of the load.

7.4 BATTERY

BATTERY HAZARD PREVENTION

- Battery electrolyte contains sulfuric acid and can quickly burn the skin and eat holes in clothing. If you spill acid on yourself, immediately flush the area with water.
- Battery acid could cause blindness if splashed into the eyes. If acid gets into the eyes, flush them immediately with large quantities of water and see a doctor at once.
- If you accidentally drink acid, drink a large quantity of water or milk, beaten egg or vegetable oil. Call a doctor or poison prevention center immediately.
- When working with batteries. **ALWAYS** wear safety glasses or goggles.
- Batteries generate hydrogen gas. Hydrogen gas is very **EXPLOSIVE**, and is easily ignited with a small spark or flame.
- Before working with batteries, stop the engine and turn the starting switch to the **OFF** position.
- Avoid short-circuiting the battery terminals through accidental contact with metallic objects, such as tools, across the terminals.
- Tighten the battery terminals securely. Loosened terminals can generate sparks and lead to an explosion.

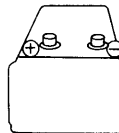
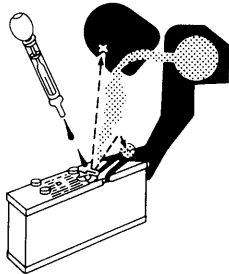

STARTING WITH BOOSTER CABLES

- ALWAYS wear safety glasses or goggles when starting the machine with booster cables.
- When starting from another machine, do not allow the two machines to touch.
- Be sure to connect the positive (+) cable first when installing the booster cables. Disconnect the ground or negative (-) cable first when removing them.
- Connect the batteries in parallel: positive to positive and negative to negative.
- When connecting the ground cable to the frame of the machine to be started, be sure to connect it as far as possible from the battery.

Starting with booster cables → See "16.2 IF BATTERY IS DISCHARGED".

WRONG

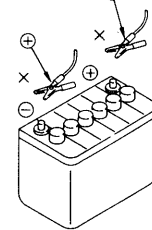

7.5 TOWING

WHEN TOWING THE MACHINE

- Injury or death could result if a disabled machine is towed incorrectly.
- If your machine is towed by another machine, **ALWAYS** use a wire rope with a sufficient towing capacity.
- When the machine is towed, always set the steering and directional lever to the N (neutral) position.
- **NEVER** allow a disabled machine to be towed on a slope.
- Do not use a kinked or frayed wire rope.
- Do not straddle the towing cable or wire rope.
- When connecting up a towing machine, do not let anyone enter the area between the towing machine and the equipment being towed.
- Set the towing machine and the towing connection of the equipment being towed in a straight line when connecting it.
- Take up the slack in the wire rope and tow the machine.

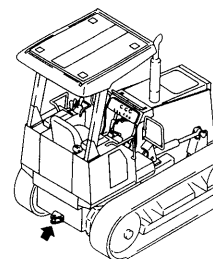

8. PRECAUTIONS FOR MAINTENANCE

⚠ WARNING: For reason of safety, always follow these safety precautions.

8.1 BEFORE CARRYING OUT MAINTENANCE

WARNING TAG

- If others start the engine or operate the controls while you are performing service or lubrication, you could suffer serious injury or death.
- ALWAYS attach the WARNING TAG to the control lever in the operator's cab to alert others that you are working on the machine. Attach additional warning tags around the machine, if necessary.
- These tags are available from your Komatsu distributor. (Part No. 09963-03000)

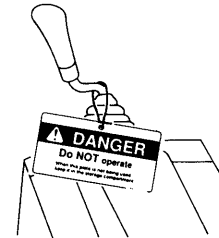

PROPER TOOLS

- Use only tools suited to the task. Using damaged, low quality, faulty, or makeshift tools could cause personal injury.

Tools → See "21.1 INTRODUCTION OF NECESSARY TOOLS".



PERIODIC REPLACEMENT OF SAFETY CRITICAL PARTS

- Replace the following fire-related components periodically:
 - Fuel system: Fuel hose, spilling hose, and fuel tube cap
 - Hydraulic system: Pump outlet hose, and front and rear pump branch hoses
- Replace these components periodically with new ones, regardless of whether or not they appear to be defective. These components deteriorate over time.
- Replace or repair any such components if any defect is found, even though they have not reached the time specified.

Replacement of safety critical components → See "22. PERIODIC REPLACEMENT OF SAFETY CRITICAL PARTS"

STOP THE ENGINE BEFORE CARRYING OUT INSPECTION AND MAINTENANCE

- Always stop the machine on firm flat ground and stop the engine before carrying out inspection and maintenance.
- If it is necessary to run the engine when carrying out maintenance, such as when cleaning the inside of the radiator, place the safety lock lever at the LOCK position and carry out the operation with two workers.
- One worker should sit in the operator's seat so that he can stop the engine immediately if necessary. He should also be extremely careful not to touch any lever by mistake. Touch the levers only when they have to be operated.
- The worker carrying out the maintenance should be extremely careful not to touch or get caught in the moving parts.
- If maintenance is carried out with the work equipment raised, always support it securely with blocks.

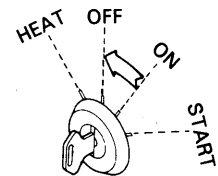

8.2 DURING MAINTENANCE

PERSONNEL

- Only authorized personnel can service and repair the machine. Extra precaution should be used when grinding, welding, and using a sledge-hammer.

ATTACHMENTS

- Place attachments that have been removed from the machine in a safe place so that they do not fall. If they fall on you or others, serious injury could result.



WORK UNDER THE MACHINE

- Always lower all movable work equipment to the ground or to their lowest position before performing service or repairs under the machine.
- Always block the tracks of the machine securely.
- Never work under the machine if the machine is poorly supported.



KEEP THE MACHINE CLEAN

- Spilled oil or grease, or scattered tools or broken pieces are dangerous because they may cause you to slip or trip. Always keep your machine clean and tidy.
- If water gets into the electrical system, there is danger that the machine may not move or may move unexpectedly. Do not use water or steam to clean the sensors, connectors, or the inside of the operator's compartment.

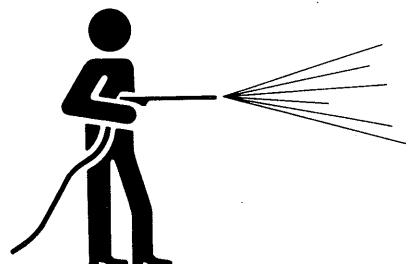

RULES TO FOLLOW WHEN ADDING FUEL OR OIL

- Spilled fuel and oil may cause you to slip, so always wipe it up immediately.
- Always tighten the cap of the fuel and oil fillers securely.
- Never use fuel for washing any parts.
- Always add fuel and oil in a well-ventilated place.

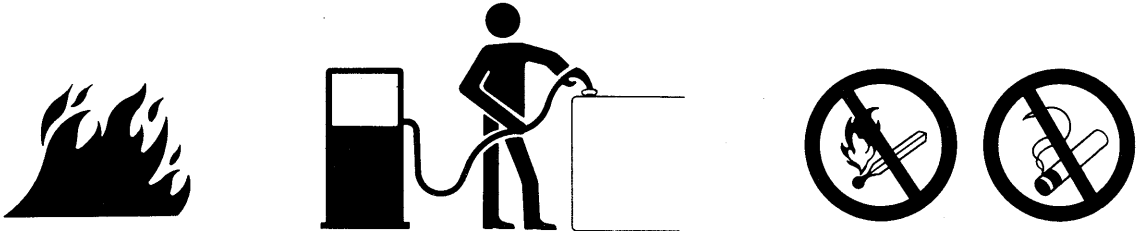

RADIATOR WATER LEVEL

- When checking the water level, stop the engine and wait for the engine and radiator to cool down first.
- Slowly loosen the caps to relieve pressure before removing the caps.

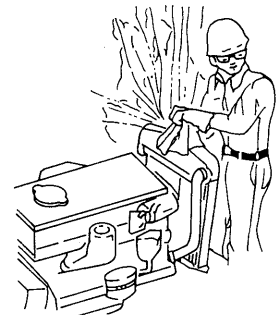

USE OF LIGHTING

- When checking fuel, oil, coolant, or battery electrolyte, always use lighting with anti-explosion specifications.
If such lighting equipment is not used, there is danger of explosion.

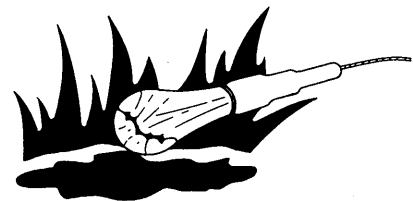

PRECAUTIONS WITH BATTERY

- When repairing the electrical system or when carrying out electrical welding, remove the negative (–) terminal of the battery to stop the flow of current.

**HANDLING HIGH-PRESSURE HOSES**

- Do not bend high-pressure hoses or hit them with hard objects. Do not use any bent or cracked piping, tubes or hoses. They may burst during use.
- Always repair any loose or broken fuel hoses or oil hoses. If fuel or oil leaks, it may cause a fire.
- Avoid torching, soldering, or welding on pipes, tubes and equipment that contain fuel or oils. If heated, they can generate flammable fumes or mist and could cause a fire or explosion.

PRECAUTIONS WITH HIGH PRESSURE OIL

- Do not forget that the work equipment circuits are always under pressure.
- Do not add oil, drain oil, or carry out maintenance or inspection before completely releasing the internal pressure.
- If oil is leaking under high pressure from small holes, it is dangerous if the jet of high-pressure oil hits your skin or enters your eyes. Always wear safety glasses and thick gloves, and use a piece of cardboard or a sheet of wood to check for oil leakage.
- If you are hit by a jet of high-pressure oil, consult a doctor immediately for medical attention.

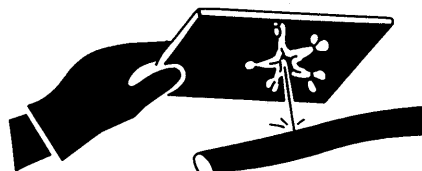

PRECAUTIONS WHEN CARRYING OUT MAINTENANCE AT HIGH TEMPERATURE OR HIGH PRESSURE

- Immediately after stopping operations, the engine cooling water and oil at all parts is at high temperature and under high pressure. In this condition, if the cap is removed, or the oil or water are drained, or the filters are replaced, this may result in burns or other injury. Wait for the temperature to go down, then carry out the inspection and maintenance in accordance with the procedures given in this manual.

Cleaning inside or cooling system → See "24.2 WHEN REQUIRED".

Checking cooling water level, lubricating oil level → See "24.3 CHECK BEFORE STARTING".

Checking oil level in hydraulic tank, final drive case → See "24.5 PERIODIC MAINTENANCE".

Changing oil, replacing filters → See "24.6 - 7 PERIODIC MAINTENANCE".



PRECAUTIONS WHEN USING HIGH PRESSURE GREASE TO ADJUST TRACK TENSION

Grease is pumped into the track tension adjustment system under high pressure. If the specified procedure for maintenance is not followed when making adjustments, the plug or grease fitting may fly out and cause damage or personal injury.

- When loosening the grease drain plug, never loosen it more than one turn.
- Never put your face, hands, feet, or any other part of your body directly in front of any grease drain plug or valve.

Adjusting track tension → See "24.2 WHEN REQUIRED".



ROTATING FAN AND BELT

- Keep away from rotating parts and be careful not to let anything get caught in them.
- If your body or tools touch the fan blades or fan belt, they may be cut off or sent flying, so never touch any rotating parts.



WASTE MATERIALS

- NEVER dump waste oil in a sewer system, rivers, etc.
- ALWAYS put oil drained from your machine in containers. Never drain oil directly on the ground.
- Obey appropriate laws and regulations when disposing of harmful objects such as oil, fuel, coolant, solvent, filters, batteries, and others.

INCORRECT

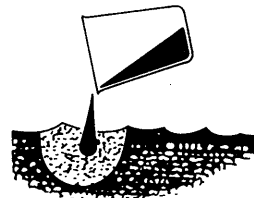

9. POSITION FOR STICKING SAFETY LABELS

Always keep these labels clean. If they are lost or damaged, stick them back again or replace them with a new label.

There are other labels in addition to the safety labels listed as follows, so handle them in the same way.

Safety labels may be available in languages other than English. To find out what labels are available, contact your Komatsu distributor.

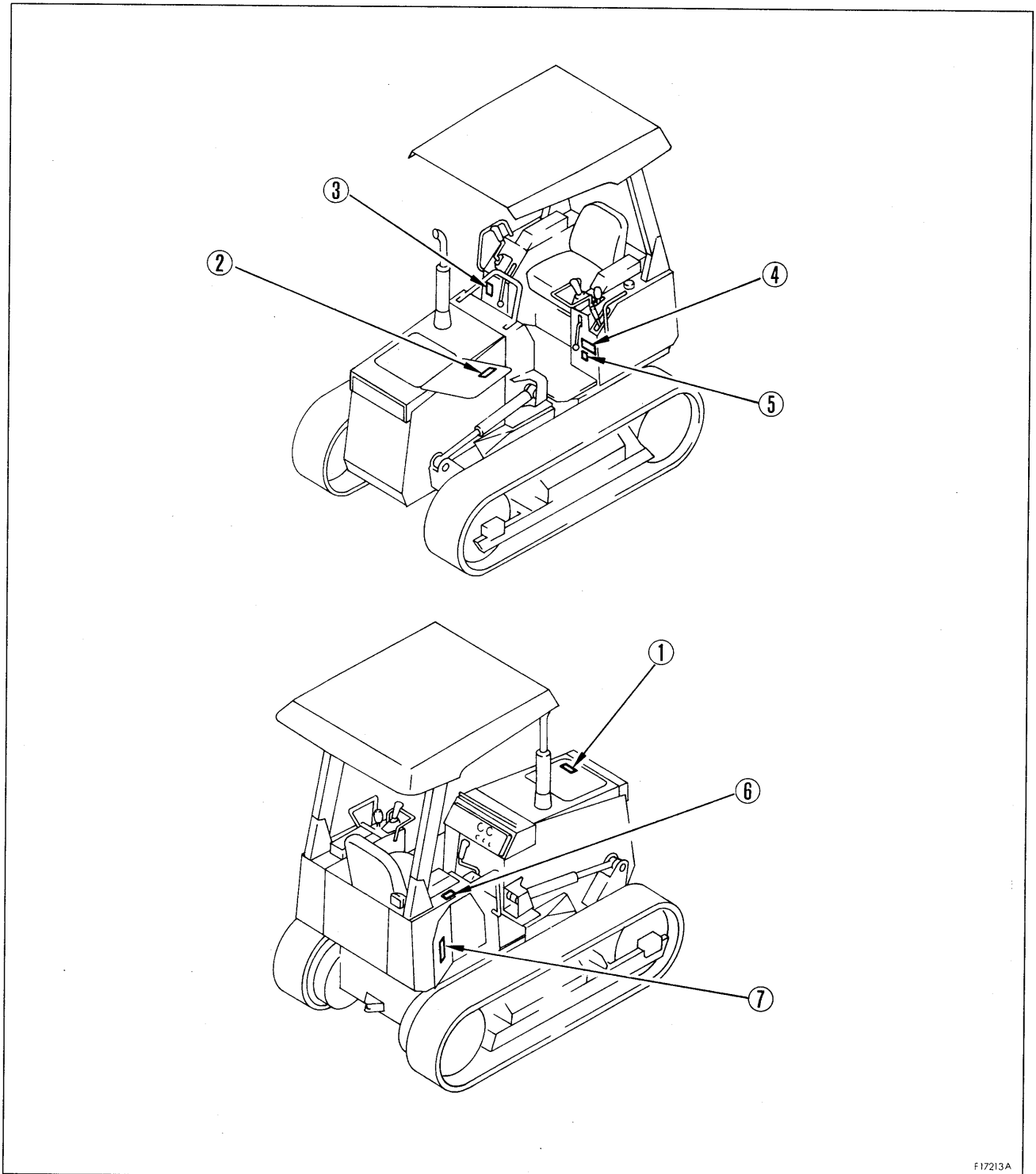

F17213A

9. POSITION FOR ATTACHING SAFETY LABELS

1. Cautions for checking engine room
(09667-03000)

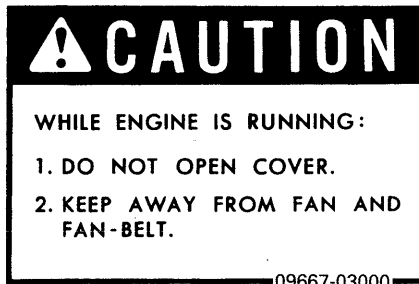

5. Warnings for leaving operator's seat
(114-98-44510)



2. Warnings for opening radiator cap
(09668-03000)

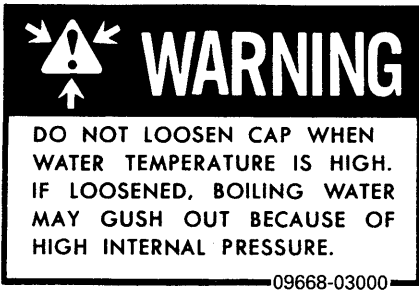

6. Cautions before operating machine
(09651-03000)

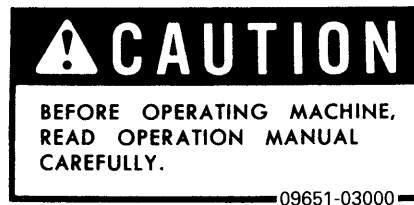

3. Cautions for inspection and maintenance
(09173-03000)



7. Cautions for opening hydraulic tank cap
(09653-03000)

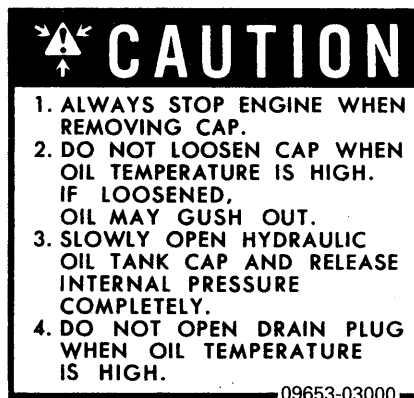

4. Warnings for adjusting track tension
(09657-03010)

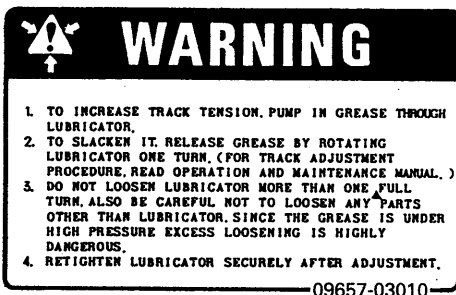

OPERATION

10. GENERAL VIEW

10.1 GENERAL VIEW OF MACHINE

If directions are indicated in this section, they refer to the directions shown by the arrows in the diagram below.

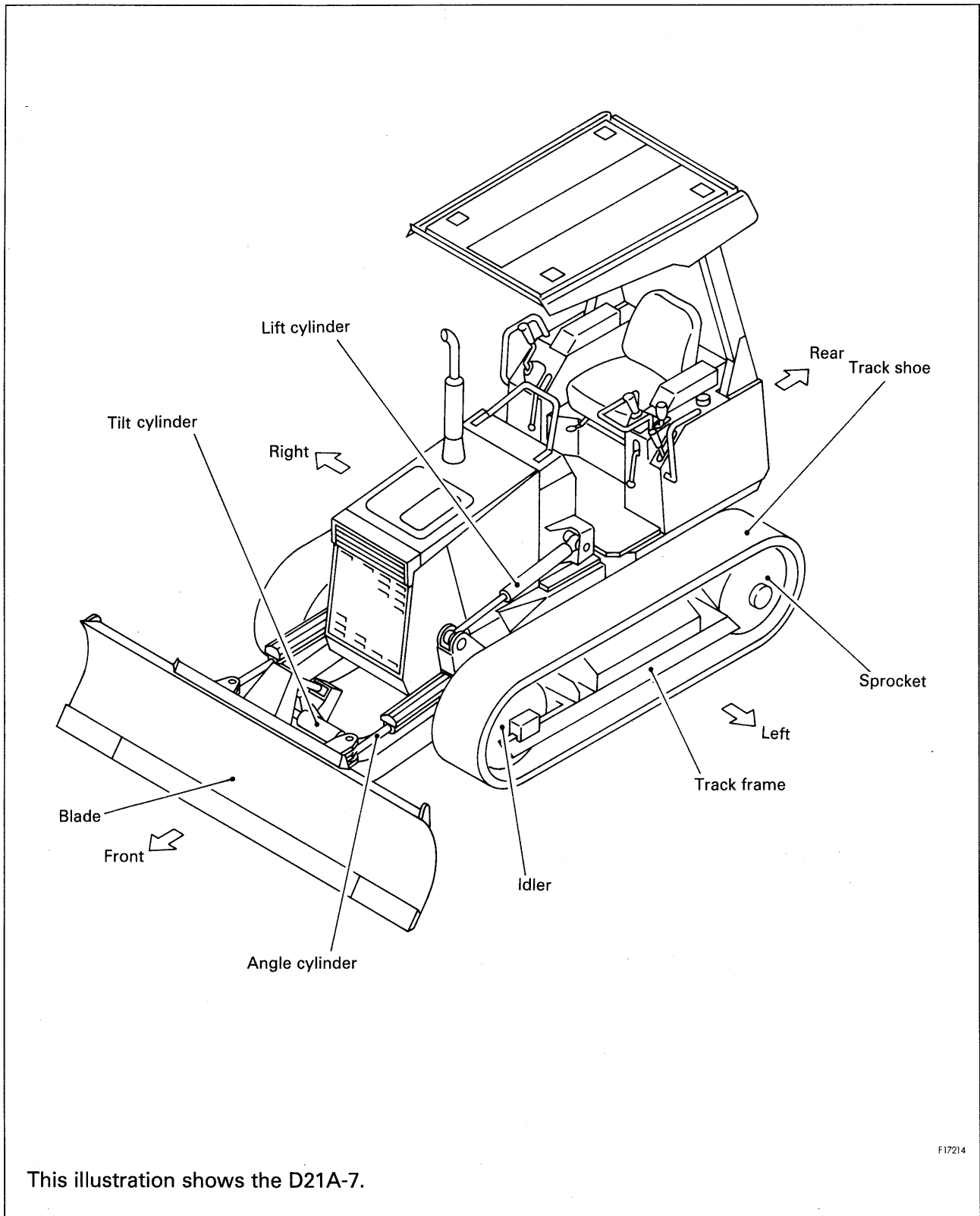

This illustration shows the D21A-7.

F17214

10.2 GENERAL VIEW OF CONTROLS AND GAUGES

10.2.1 GENERAL VIEW OF CONTROLS AND GAUGES (D20)

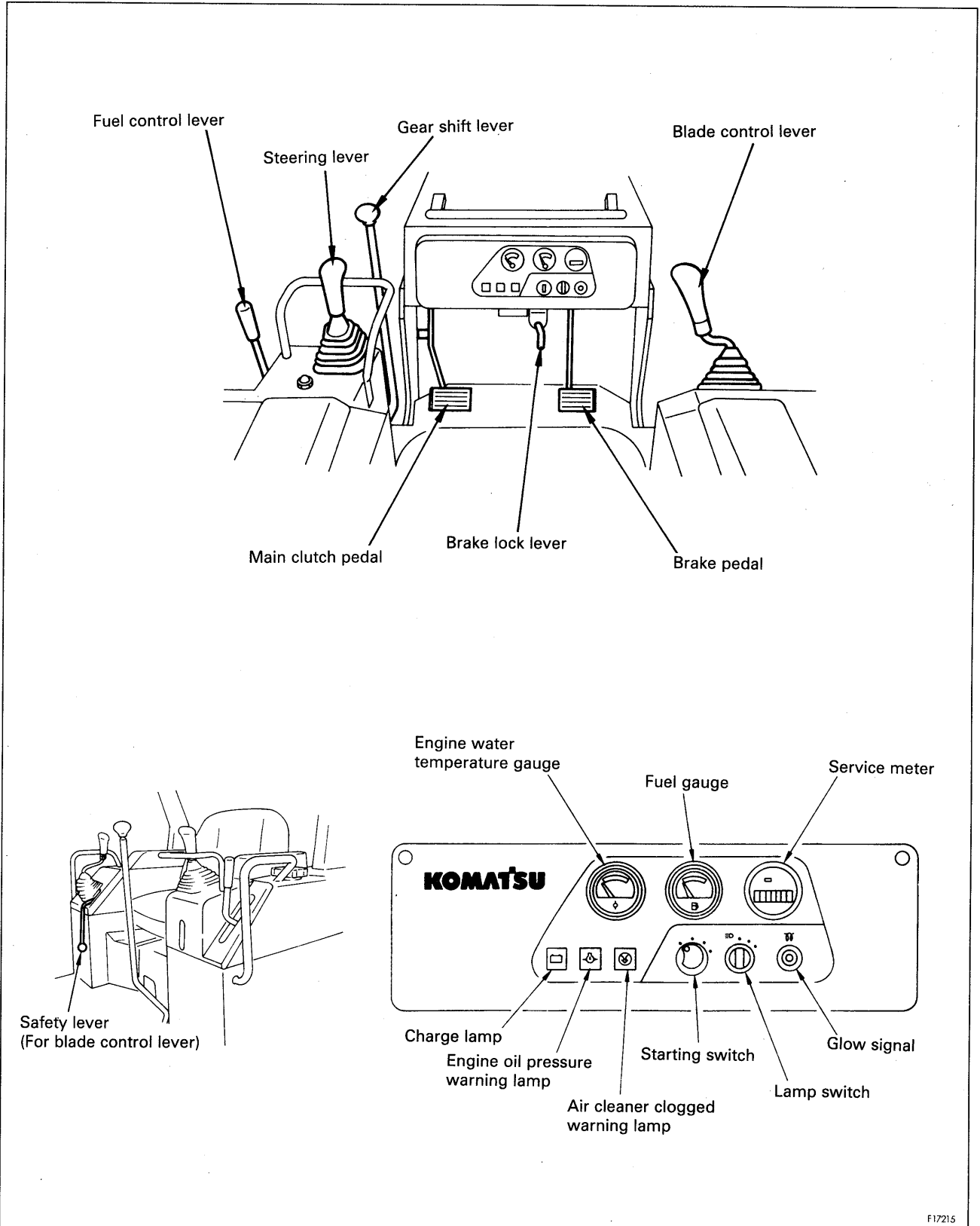

10.2.2 GENERAL VIEW OF CONTROLS AND GAUGES (D21)

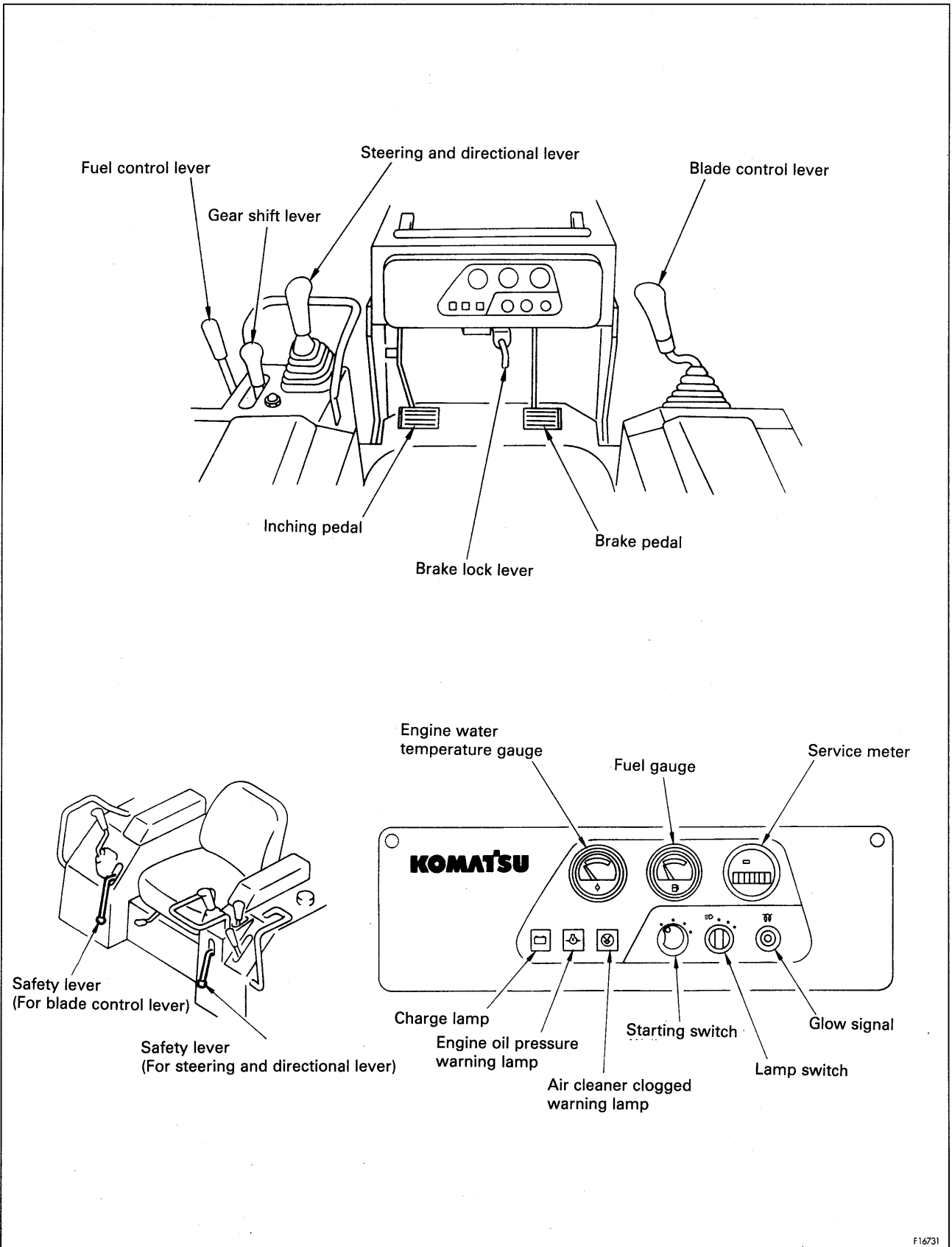

11. EXPLANATION OF COMPONENTS

The following is an explanation of the devices needed for operating the machine.

To carry out suitable operations correctly and safely, it is important to understand fully the methods of operating the equipment and the meanings of the displays.

REMARK

The following explanation covers two types of machine: machines where the engine stops when the fuel control lever is set to the engine STOP position (machines stopped by the fuel control lever), and machines where the engine stops when the starting switch is turned to the OFF position (machines stopped by the starting switch).

11.1 METERS AND LAMPS

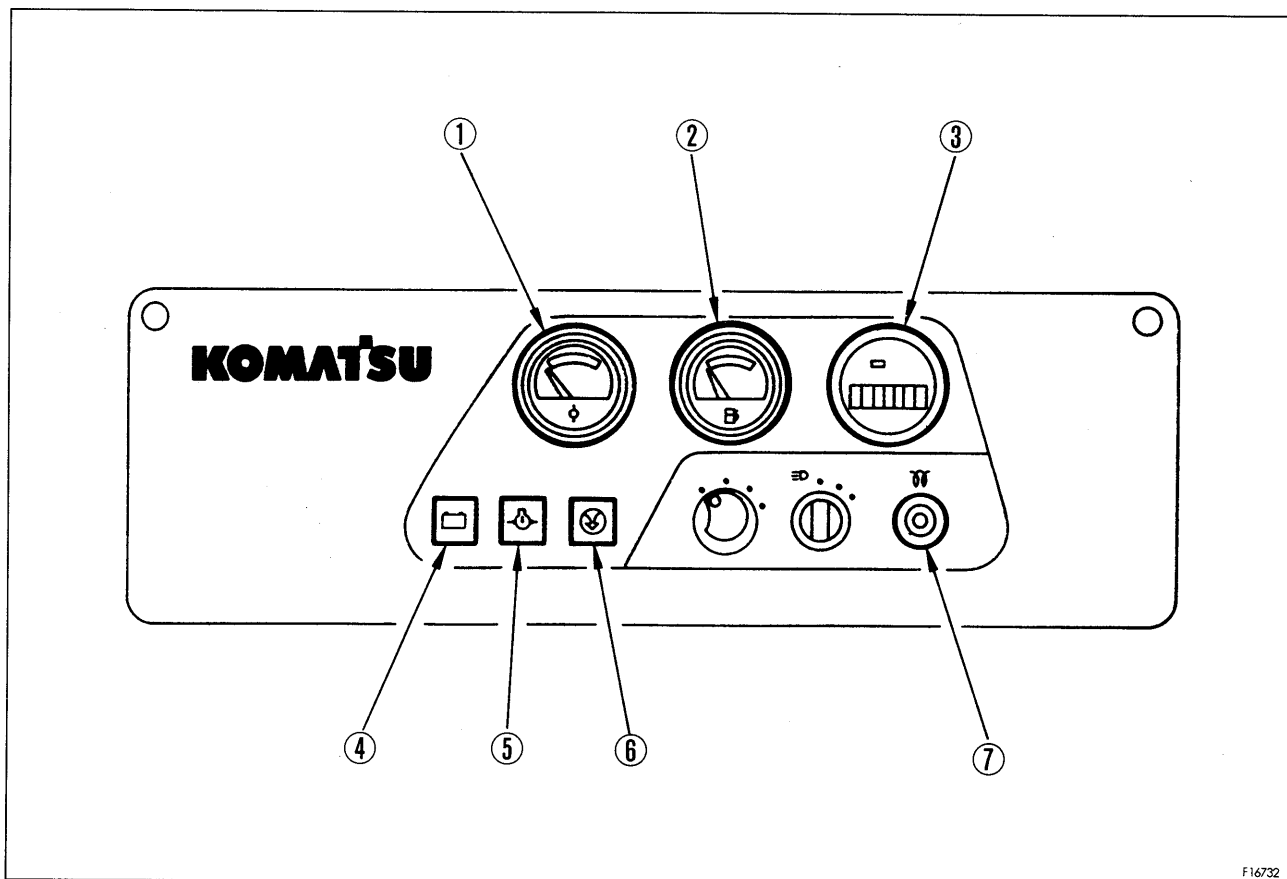

1. ENGINE WATER TEMPERATURE GAUGE

This gauge indicates the cooling water temperature.

When the indicator is in the green range during operation, the water temperature is normal.

If the indicator moves from the green range into the red range during operation, stop the machine and run the engine with no load at medium speed until the water temperature goes down.

After starting the engine, warm up it until the indicator moves into the green range.

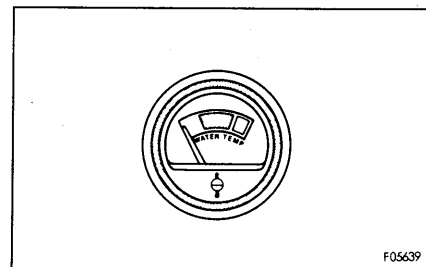

F05639

11. EXPLANATION OF COMPONENTS

2. FUEL GAUGE

This gauge indicates the amount of fuel in the fuel tank. F indicates that the tank is full. E indicates that there is less than 14 liters of fuel remaining in the tank, so add fuel. After each operation, be sure to fill up the fuel tank.

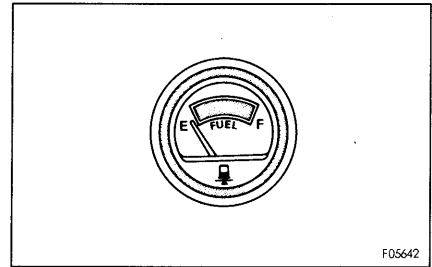

3. SERVICE METER

This meter shows the total operation hours of the machine. The service meter advances while the engine is running — even if the machine is not traveling. Set the periodic maintenance intervals using this display. While the engine is running, operation display ① at the top inside of the meter will rotate to show that the meter is advancing. Meter ② will advance by 1 for each hour of operation regardless of the engine speed.

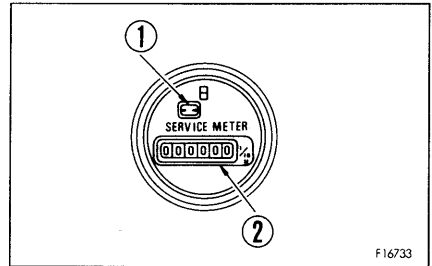

4. CHARGE LAMP

This lamp indicates malfunction of the alternator. When the starting switch is turned ON, it will light up, but it should go out when the engine speed rises. If the lamp lights up during operation, stop the engine and check the V-belt tension. If any abnormality is found, see "16. TROUBLESHOOTING".

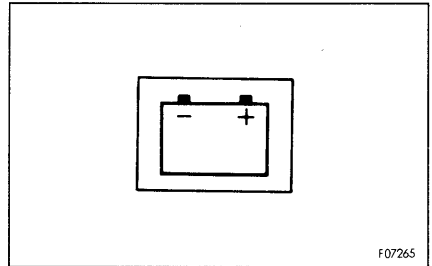

5. ENGINE OIL PRESSURE WARNING LAMP

This lamp warns that the engine lubricating oil pressure has dropped. When the starting switch is turned ON, it will light up. When the lamp goes off after the engine is started, the oil pressure is normal. When the lamp lights up during operation, the oil pressure is lower. Immediately, stop the engine and look for the cause. For details, see "16. TROUBLESHOOTING".

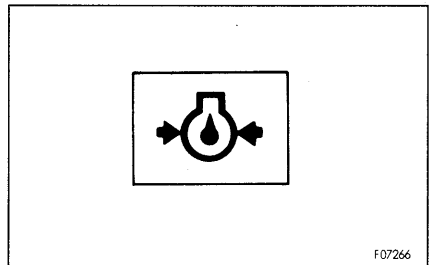

6. AIR CLEANER CLOGGED WARNING LAMP

This lamp warns that the air cleaner element is clogged. When the lamp is off during operation, the air cleaner is normal. When the lamp lights up, immediately clean the element. After cleaning it, confirm that the lamp is off.

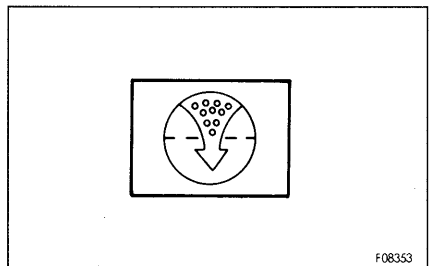

7. GLOW SIGNAL

This indicates the glow plug is red-heated. When holding the starting switch key at the HEAT position, this signal glows red after 20 — 30 seconds. When releasing the key, the key will return to the OFF position and the signal will go off.

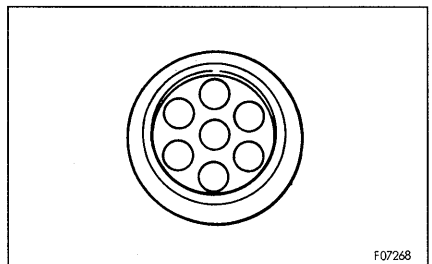

11.2 SWITCHES

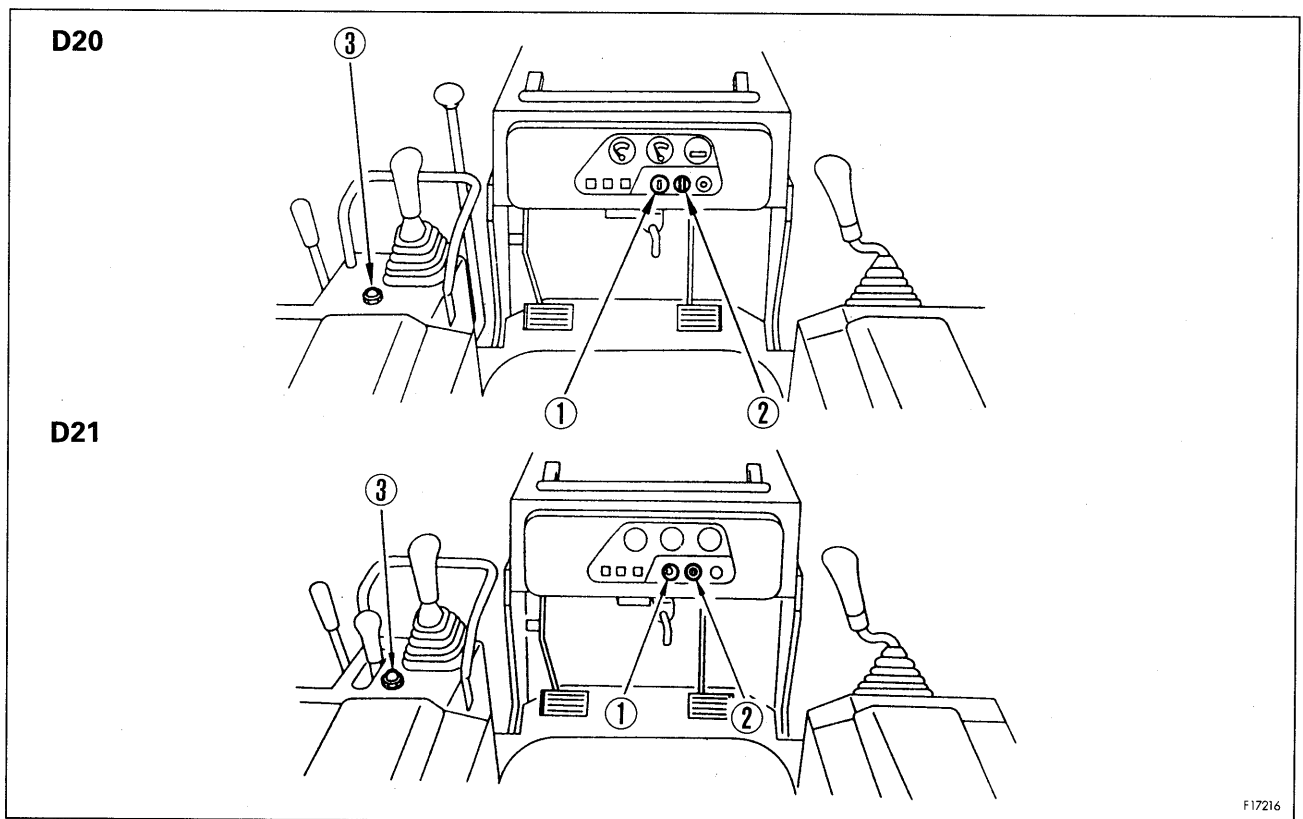

1. STARTING SWITCH

(For machines stopped by the fuel control lever)

This switch is used to start the engine.

OFF position:

At this position, the starting switch key can be inserted or removed. When the switch is turned to this position, the electrical circuits are switched off.

ON position:

In this position, electric current flows in the charging and lamp circuits.

Keep the starting switch key at the ON position while the engine is running.

START position:

This is the position to start the engine. Hold the key at this position while cranking. Release the key immediately after the engine has been started. The key will return to ON position when released.

HEAT position:

Turn the starting switch key to the HEAT position when starting in cold weather.

The glow plug is operated while the key is held in the HEAT position.

When the glow signal is red hot, release the key.

When the key is released, it will return to OFF, so turn it immediately to the START position to start the engine.

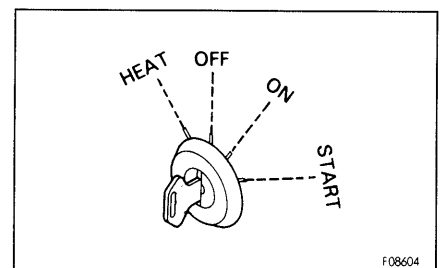

F08604

11. EXPLANATION OF COMPONENTS

1. STARTING SWITCH

(For machines stopped by the starting switch)

This switch is used to start or stop the engine.

OFF position:

At this position, the starting switch key can be inserted or removed. When the switch is turned to this position, the electrical circuits are switched off and the engine stops.

ON position:

In this position, electric current flows in the charging and lamp circuits.

Keep the starting switch key at the ON position while the engine is running.

START position:

This is the position to start the engine. Hold the key at this position while cranking. Release the key immediately after the engine has been started. The key will return to ON position when released.

HEAT position:

Turn the starting switch key to the HEAT position when starting in cold weather.

The glow plug is operated while the key is held in the HEAT position.

When the glow signal is red hot, release the key.

When the key is released, it will return to OFF, so turn it immediately to the START position to start the engine.

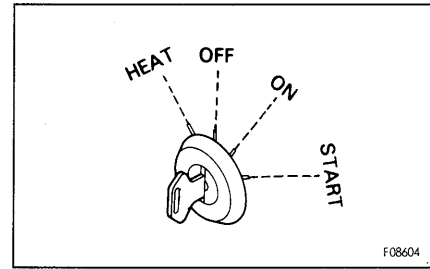

2. LAMP SWITCH

This lights up the head lamps, the rear working lamp and the panel lamp.

Position OFF: Lamps go off.

Position 1: Head lamps and panel lamp light up.

Position 2: Rear working lamp lights up in addition to the lamps in position 1.

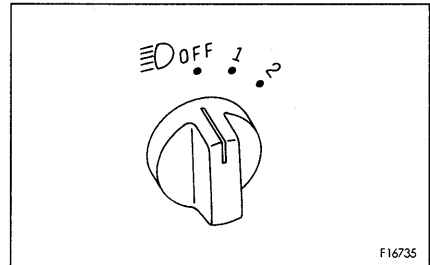

3. HORN BUTTON

To sound the horn, push the button located in front of the L.H. arm rest.

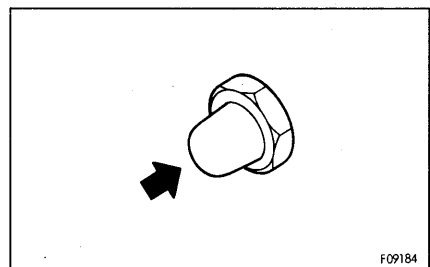

11.3 CONTROL LEVERS AND PEDALS

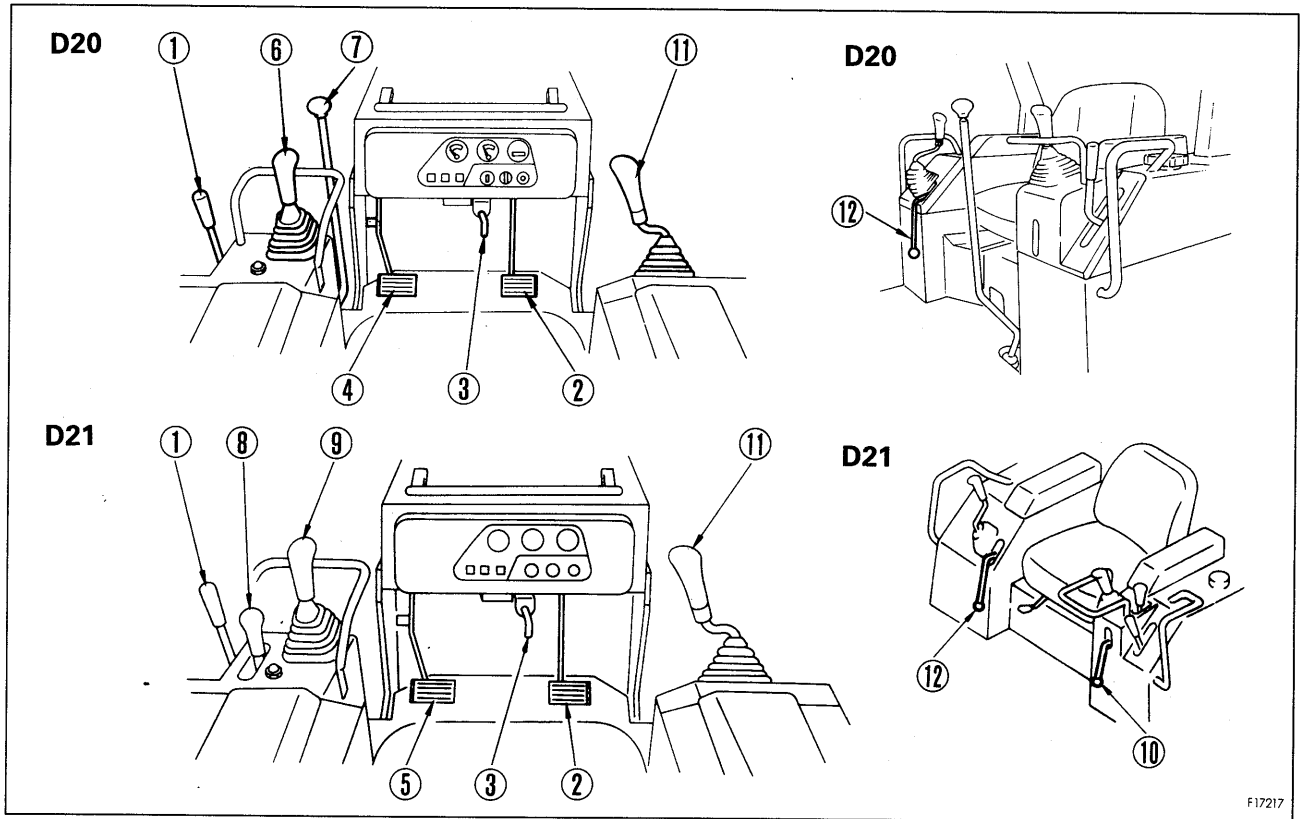

F17217

1. FUEL CONTROL LEVER

(For machines stopped by the fuel control lever)

This lever is used to control the engine speed and output.

- ① Engine stop position: Push the lever fully.
- ② Low idling position: Pull the lever from engine stop position ① until you feel the operating force falls off.
- ③ High idling position: Pull the lever fully.

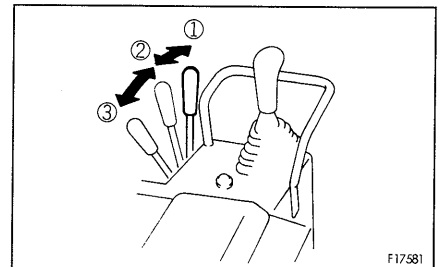

F17581

1. FUEL CONTROL LEVER

(For machines stopped by the starting switch)

This lever is used to control the engine speed and output.

- ① Low idling position: Push the lever fully.
- ② High idling position: Pull the lever fully.

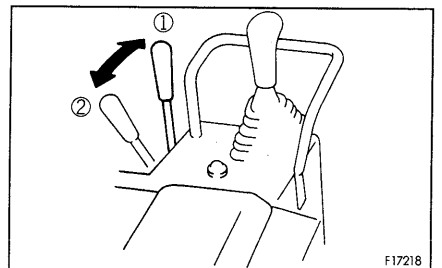

F17218

2. BRAKE PEDAL



WARNING

Do not place your foot on this pedal unnecessarily.

Depress the pedal to apply the right and left brakes.

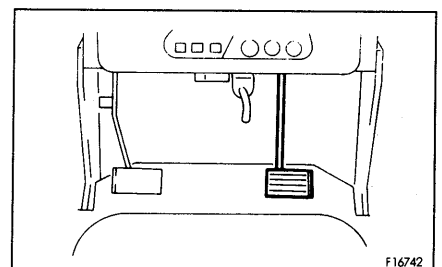

F16742

3. BRAKE LOCK LEVER

⚠ WARNING

Whenever machine is parked, lock brake pedal without fail.

This is the locking device of the brake pedal when parking. When locking the brakes, pull the lock lever towards you (place in the LOCK position), then depress the brake pedal strongly to apply the lock securely. When releasing the brake, keep the brake pedal depressed, and push the lock lever.

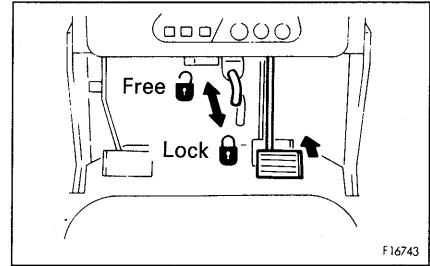

4. MAIN CLUTCH PEDAL (D20 only)

⚠ WARNING

Do not put your foot on the pedal unless you are using it.

Operate the main clutch to engage or disengage the engine and transmission. When the pedal is depressed, the main clutch is disengaged. Use this pedal when starting, shifting gear, or stopping the machine.

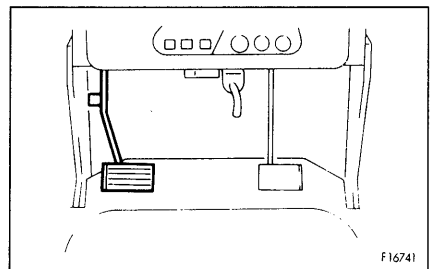

NOTICE

The engine cannot be started unless the main clutch pedal is depressed.

5. INCHING PEDAL (D21 only)

⚠ WARNING

Do not place your foot on this pedal unnecessarily.

This pedal engages and cuts the transmission of motive force from the engine and is used to carry out fine travel operations.

If the pedal is depressed, the motive force is cut. This operation is used when approaching the target.

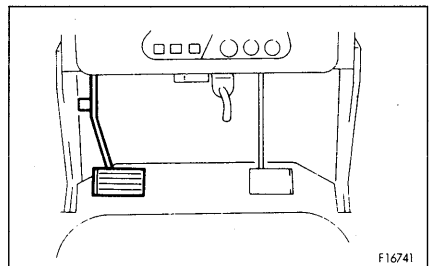

6. STEERING LEVER (D20 only)

This lever is used to steer the machine.

L position: Machine turns to left

R position: Machine turns to right

N position: Neutral

When the lever on the side to which the machine is to be turned is moved partially, the steering clutch is disengaged, and the machine turns gradually. If the lever is moved further, the steering brake is applied and the machine turns on the spot. When the steering lever is being operated, if it is released, it will return to the N position and the machine will travel in a straight line.

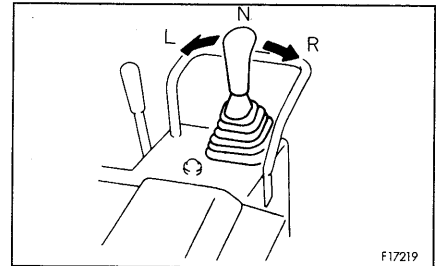
**7. GEAR SHIFT LEVER (D20 only)**

Depress the main clutch pedal and shift the lever to the desired position.

F1, F2, F3: Forward 1st, 2nd, 3rd

R1, R2: Reverse 1st, 2nd

N: Neutral

If it is difficult to engage the gear, do not try to force the gear in. Move the gear shift lever back to neutral, engage the clutch slightly, then depress the main clutch pedal again and shift the gear lever.

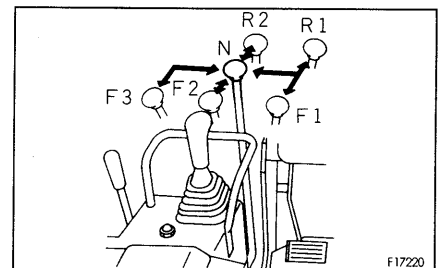
**NOTICE**

Stop the machine before shifting gear.

8. GEAR SHIFT LEVER (D21 only)

This lever is used to shift the transmission speed. There are two speeds: to shift gear simply shift the lever to the desired position.

A 3-speed machine is available as an option.

- ① First speed
- ② Second speed
- ③ Third speed (option)

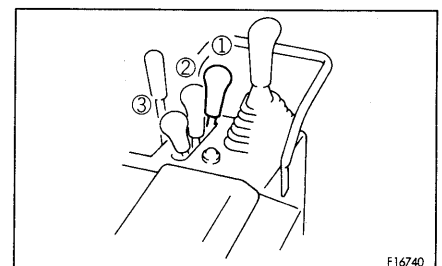
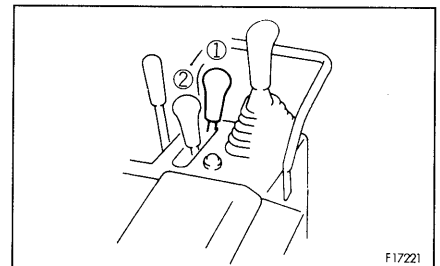

9. STEERING AND DIRECTIONAL LEVER (D21 only)

This lever is used to switch between forward and reverse and to steer the machine.

Forward-reverse shifting

- ①: FORWARD
- ②: REVERSE
- Ⓝ: NEUTRAL

Steering

- Ⓛ: LEFT TURN
- Ⓡ: RIGHT TURN

If the lever is moved partially in the direction to turn the machine, the steering clutch is disengaged and the machine will turn gradually. If the lever is moved more, the steering brake is applied and the machine will turn on the spot.

If the lever is released when steering the machine, the lever will return to the ① position or the ② position and the machine will be returned to straight movement.

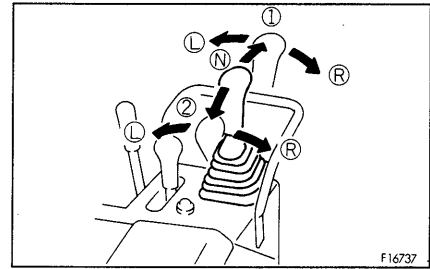

F16737

REMARK

When starting the engine, check that the levers are at the N position and that the safety lever is at the LOCK position. If they are not at these positions the engine will not start.

10. SAFETY LEVER (For steering and directional lever) (D21 only)

⚠ WARNING

- When leaving the operator's compartment, set the safety lever securely to the LOCK position. If the control lever is not locked, and it is touched by mistake, this may lead to a serious accident.
- If the safety lever is not placed securely in the LOCK position, the control lever may not be properly locked.

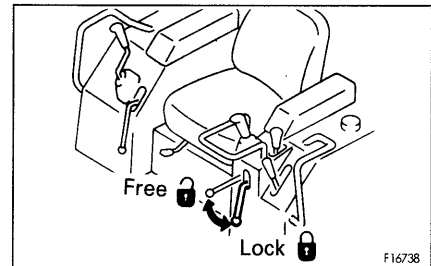

F16738

This locks the steering and directional lever. Move the steering and directional lever to the N (neutral) position and lower the lever to apply the lock.

REMARK

If the safety lever is not in the LOCK position, the engine cannot be started.

11. BLADE CONTROL LEVER

Lifting and tilting control

This lever is used to raise or tilt the blade.

① RAISE ()

② HOLD ()

Blade is stopped and held in this position.

③ LOWER ()

④ FLOAT ()

Blade will move freely according to external force.

When released from FLOAT position, this lever will not return to HOLD position, so it must be moved back by hand.

Ⓐ LEFT TILT ()

Ⓑ RIGHT TILT ()

The amount of tilt for each model is as shown below.

Machine model	Tilt (mm)
D20AG, D21A, AG-7	250
D20P, PG, D21PG-7A	280
D20PL, PLL-7	320

Angling control

(For hydraulic angle-tilt dozer only)

Place the lever in the neutral (HOLD) position. Keep the switch at the front of the lever pressed and operate the lever to the left or right to angle the blade.

Ⓐ LEFT ANGLE ()

② HOLD:

Blade is stopped and held in this position.

Ⓑ RIGHT ANGLE ()

Blade can be angled at 25° on both right and left sides.

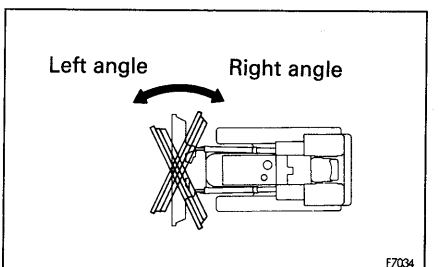
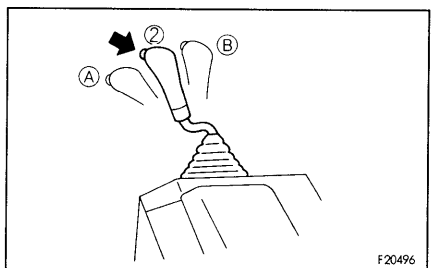
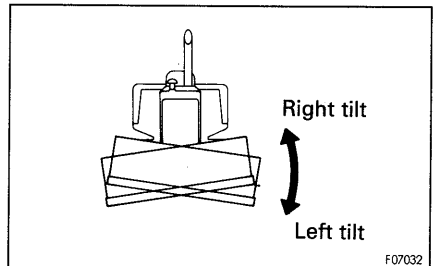
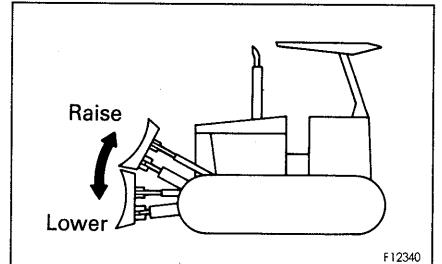
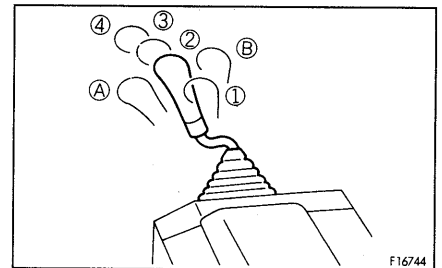

12. SAFETY LEVER (For blade control lever)

⚠ WARNING

- When leaving the operator's compartment, set the safety lever securely to the LOCK position. If the control lever is not locked, and it is touched by mistake, this may lead to a serious accident.
- If the safety lever is not placed securely in the LOCK position, the control lever may not be properly locked.
- When parking or servicing the machine, be sure to lower the blade and set the safety lock in the LOCK position.

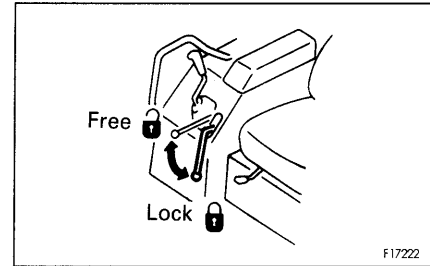

This is the locking device of blade control lever. Lower the lever to apply the lock.

11.4 FUSE BOX

NOTICE

Before replacing a fuse, be sure to turn off the starting switch.

The fuses protect the electrical equipment and wiring from burning out.

If the fuse becomes corroded, or white powder can be seen, or the fuse is loose in the fuse holder, replace the fuse.

Replace a fuse with another of the same capacity.

Fuse capacity and circuit name

No.	FUSE CAPACITY	CIRCUIT NAME
①	20A (yellow)	Head lamp. Rear working lamp
②	10A (red)	Horn
③	10A (red)	Water temperature gauge, Fuel gauge, Angle select switch for hydraulic angle-tiltdozer, (Back-up alarm)
④	10A (red)	Service meter, Warning lamps (3 pieces)
⑤	30A (green)	Engine stop motor (for machines stopped by starting switch)

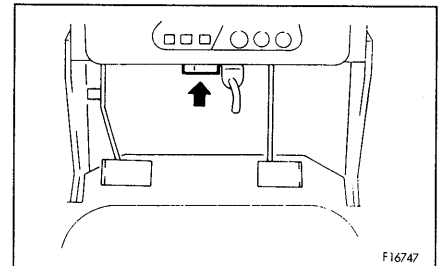

F16747

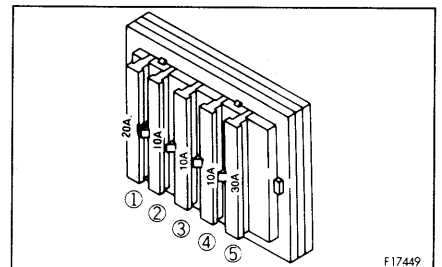

F17449

12. OPERATION

12.1 CHECK BEFORE STARTING ENGINE

12.1.1 WALK-AROUND CHECK



WARNING

Leakage of oil or fuel, or accumulation of flammable material around high temperature parts, such as the engine muffler may cause fire.

Check carefully, and if any abnormality is found, repair it or contact your Komatsu distributor.

Before starting the engine, look around the machine and under the machine to check for loose nut or bolts, or leakage of oil, fuel, or coolant, and check the condition of the work equipment and hydraulic system. Check also for loose wiring, play, and collection of dust at places which reach high temperatures.

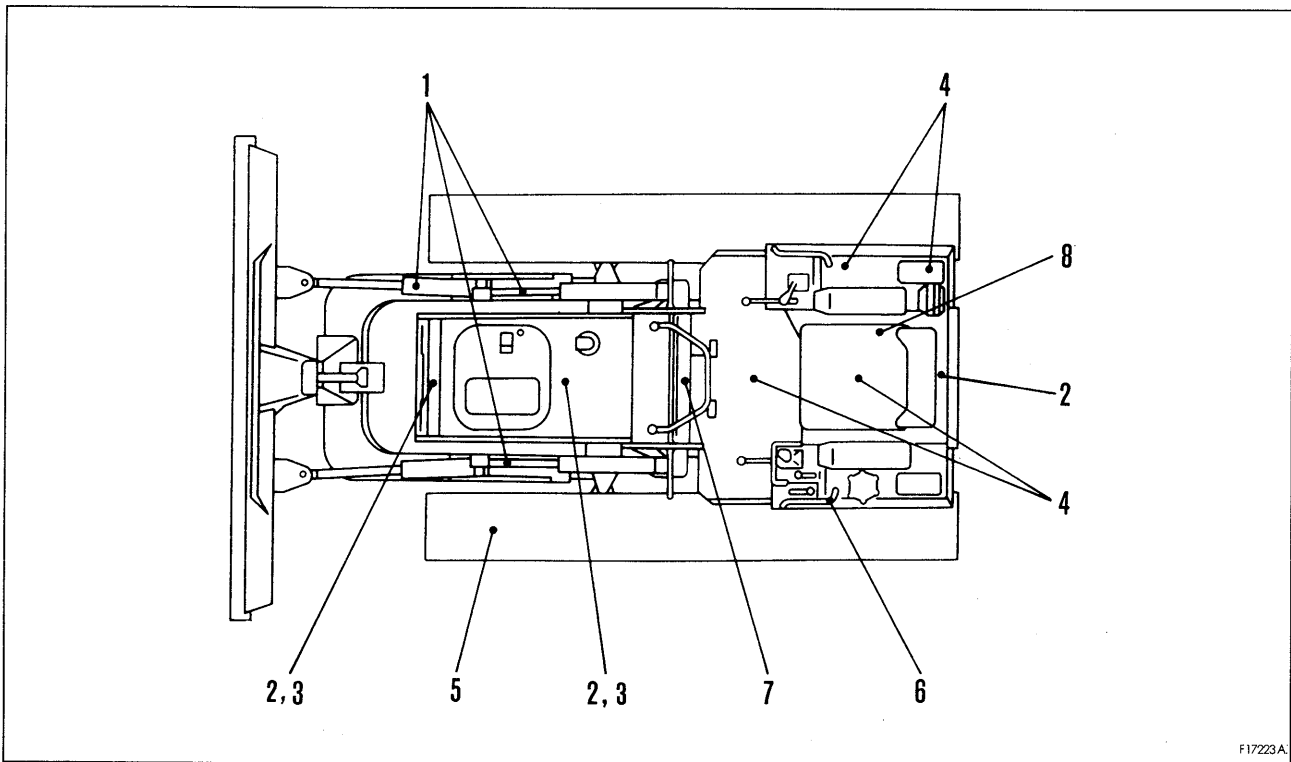

F17223A

1. Check for damage, wear, play in work equipment, cylinders, linkage, hoses

Check that there are no cracks, excessive wear, or play in the work equipment, cylinders, linkage, or hoses. If any abnormality is found, repair it.

2. Remove dirt and dust from around engine, battery, radiator

Check if there is any dirt or dust accumulated around the engine or radiator. Check also if there is any flammable material (dead leaves, twigs, grass, etc.) accumulated around the battery or high temperature engine parts, such as the engine muffler. Remove all such dirt or flammable material.

3. Check for leakage of water or oil around engine

Check that there is no leakage of oil from the engine or leakage of water from the cooling system. If any abnormality is found, repair it.

4. Check for oil leakage from transmission case, main clutch case (D20), transfer case (D21), bevel gear case, final drive case, hydraulic tank, hoses, joints

Check that there is no oil leakage. If any abnormality is found, repair the place where the oil is leaking.

5. Check the undercarriage (track, sprocket, idler, guard) for damage, wear, loose bolts, or leakage of oil from rollers.**6. Check for damage to handrail, loose bolts**

Repair any damage and tighten any loose.

7. Check for damage to gauges, lamps on instrument panel, loose bolts

Check that there is no damage to the panel, gauges and lamps. If any abnormality is found, replace the parts. Clean off any dirt on the surface.

8. Check for damage to seat belt and mounting clamps

Check that there is no abnormality in the seat belt or mounting clamps. If there is any damage, replace with new parts.

12.1.2 CHECK BEFORE STARTING

CHECK AND REFILL COOLANT

⚠ WARNING

Do not remove cap ① while cooling water is hot. Hot water may spout out.

When removing cap ①, wait until the water temperature goes down and release radiator pressure little by little by loosening caps slowly, then remove the cap.

1. Open the upper cover at the front of the machine, remove radiator cap ① and check that the coolant level is in the shaded area. If level is low, add water.
2. After adding water, tighten the cap securely.

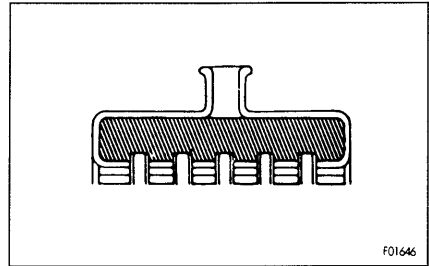
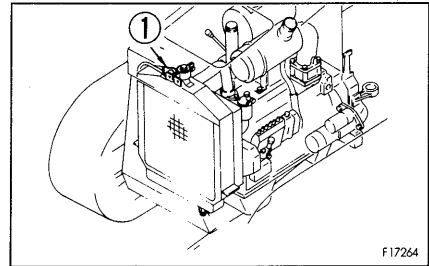

CHECK FUEL LEVEL

⚠ WARNING

When adding fuel, never let the fuel overflow. This may cause a fire. If spilling fuel, thoroughly clean up any spillage.

1. Check the fuel level using fuel gauge ㉔.
2. After completing work, fill the fuel tank through oil filler port ㉕.
For details of the oil to use, see "20. USE OF FUEL, COOLANT AND LUBRICANTS ACCORDING TO AMBIENT TEMPERATURE".
3. After adding fuel, tighten the cap securely.
Fuel capacity: 60 ℓ

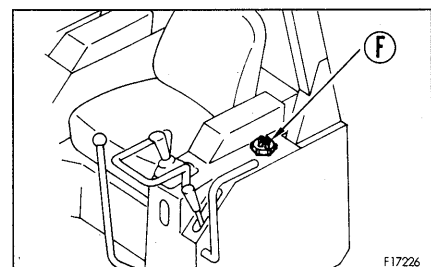
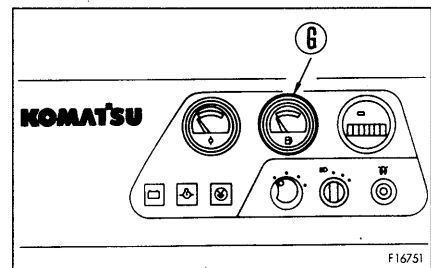

NOTICE

A clogged cap breather hole ① may stop the fuel flow to the engine. Check it from time to time and clean.

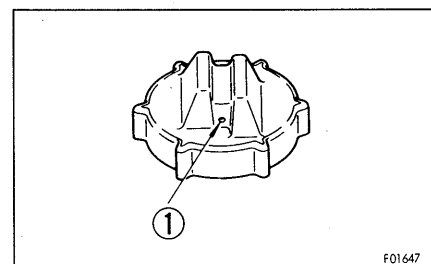

CHECK OIL LEVEL IN ENGINE OIL PAN, ADD OIL

1. Open the upper cover at the front of the machine.
2. Remove dipstick ⑥ and wipe the oil off with a cloth.
3. Insert dipstick ⑥ fully in the oil filler pipe, then take it out again.
4. The oil level should be between the H and L marks on dipstick ⑥.
If the oil level is below the L mark, add engine oil through oil filler ⑤.
For details of the oil to use, see "20. USE OF FUEL, COOLANT AND LUBRICANTS ACCORDING TO AMBIENT TEMPERATURE".
5. If the oil is above the H mark, drain the excess engine oil from drain plug ④, and check the oil level again.
6. If the oil level is correct, tighten the oil filler cap securely and close the upper cover.

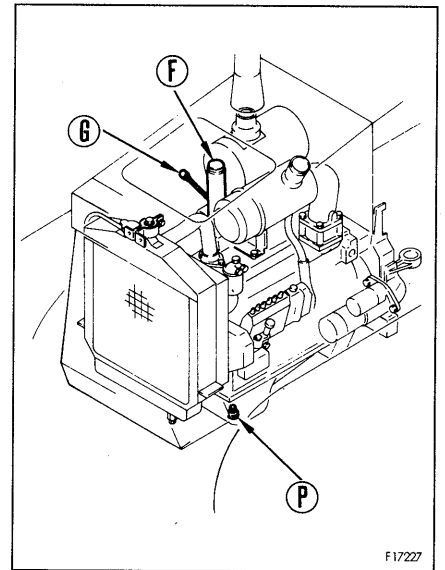
**REMARK**

When checking the oil level after the engine has been operated, wait for at least 15 minutes after stopping the engine before checking.

If the machine is at an angle, make it horizontal before checking.

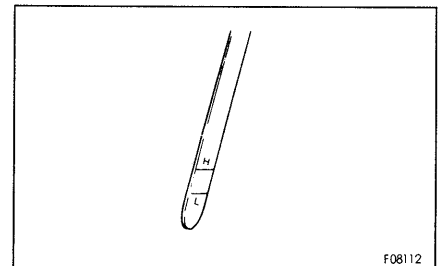

CHECK OIL LEVEL IN BEVEL GEAR CASE, TRANSMISSION CASE, ADD OIL (D20 only)

CHECK OIL LEVEL IN BEVEL GEAR CASE, TRANSFER CASE, ADD OIL (D21 only)

1. Remove dipstick ⑥ and wipe the oil off with a cloth.
2. Insert dipstick ⑥ fully in the oil filler pipe, then take it out again.
3. The oil level should be between the H and L marks on dipstick ⑥.

If the oil level is below the L mark, add engine oil through oil filler ⑦.

For details of the oil to use, see "20. USE OF FUEL, COOLANT AND LUBRICANTS ACCORDING TO AMBIENT TEMPERATURE".

4. If the oil is above the H mark, drain the excess engine oil from drain plug ⑨, and check the oil level again.
5. If the oil level is correct, tighten the oil filler cap securely.

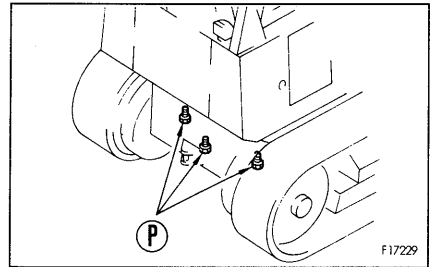
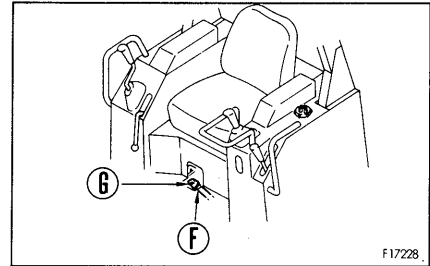

REMARK

When checking the oil level after the engine has been operated, wait for at least 15 minutes after stopping the engine before checking.

If the machine is at an angle, make it horizontal before checking.

CHECK OIL LEVEL IN MAIN CLUTCH CASE, ADD OIL (D20 only)

1. Remove dipstick ⑥ and wipe the oil off with a cloth.
2. Insert dipstick ⑥ fully in the oil filler pipe, then take it out again.
3. The oil level should be between the H and L marks on dipstick ⑥.

If the oil level is below the L mark, add engine oil through oil filler ⑤.

For details of the oil to use, see "20. USE OF FUEL, COOLANT AND LUBRICANTS ACCORDING TO AMBIENT TEMPERATURE".

4. If the oil is above the H mark, drain the excess engine oil from drain plug ④, and check the oil level again.
5. If the oil level is correct, tighten the oil filler cap securely.

REMARK

When checking the oil level after the engine has been operated, wait for at least 5 minutes after stopping the engine before checking.

When checking the oil level with the engine idling, use a point 15 mm below the line on the level gauge as a guideline when inspecting.

If the machine is at an angle, make it horizontal before checking.

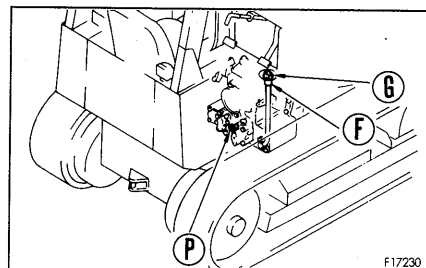

CHECK OIL LEVEL IN TRANSMISSION CASE, ADD OIL (D21 only)

1. Remove dipstick ⑥ and wipe the oil off with a cloth.
2. Insert dipstick ⑥ fully in the oil filler pipe, then take it out again.
3. The oil level should be between the H and L marks on dipstick ⑥.

If the oil level is below the L mark, add engine oil through oil filler ⑦.

For details of the oil to use, see "20. USE OF FUEL, COOLANT AND LUBRICANTS ACCORDING TO AMBIENT TEMPERATURE".

4. If the oil is above the H mark, drain the excess engine oil from drain plug ⑨, and check the oil level again.
5. If the oil level is correct, tighten the oil filler cap securely.

REMARK

When checking the oil level after the engine has been operated, wait for at least 15 minutes after stopping the engine before checking.

If the machine is at an angle, make it horizontal before checking.

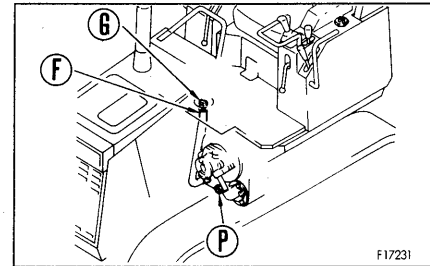

CHECK BRAKE PEDAL TRAVEL

1. Depress the brake pedal all the way until it stops.
2. Measure the pedal travel for being from 98 mm to 134 mm at the bottom end of the pedal.
3. When this value exceeds 134 mm, or the brake fails to work, adjust the pedal referring to "24.2 WHEN REQUIRED".

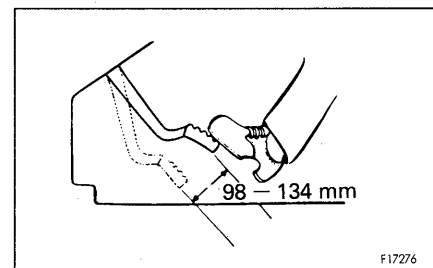

CHECK PLAY OF MAIN CLUTCH PEDAL (D20 only)

1. Depress the main clutch pedal.
2. Check that the play at the bottom tip of the pedal is 10 – 33 mm.
3. If it is more than 33 mm, or the effect is poor, carry out adjustments.

For details, see "24.2 WHEN REQUIRED".

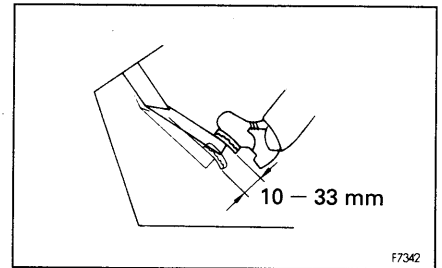
**REMARK**

If the temperature of the oil in the main clutch case rises, the pedal play tends to increase.

CHECK MAIN CLUTCH INERTIA BRAKE (D20 only)

1. Run the engine at full speed.
2. Depress the main clutch pedal fully and check that the clutch shaft stops within 2.5 – 3.5 seconds.
3. If it does not stop within the above range, carry out adjustments.

For details, see "24.2 WHEN REQUIRED".

CHECK FOR WATER AND SEDIMENT IN WATER SEPARATOR, DRAIN WATER

The water separator separates water mixed in the fuel. If float ② is at or above red line ①, drain the water according to the following procedure:

1. Loosen drain plug ③ and drain the accumulated water until the float reaches the bottom.
2. Tighten drain plug ③.
3. If the air is sucked into fuel line when draining the water, be sure to bleed air in the same manner as for the fuel filter. See "24.6 EVERY 500 HOURS SERVICE".

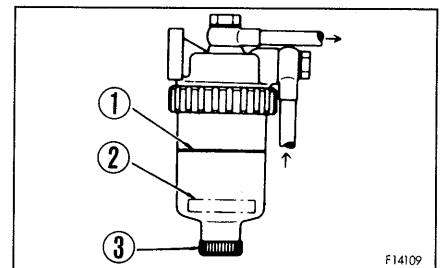

F14109

12.1.3 ADJUST OPERATOR'S SEAT

⚠ WARNING

- Adjust the seat position at the beginning of each shift or when operators change.
- Adjust the seat so that the brake pedal can be depressed all the way with the operator's back against the backrest.

Fore-aft adjustment of seat

Set the seat in the desired position by moving lever ① to right, then release the lever.

Fore-aft adjustment: 160 mm (9 stages)

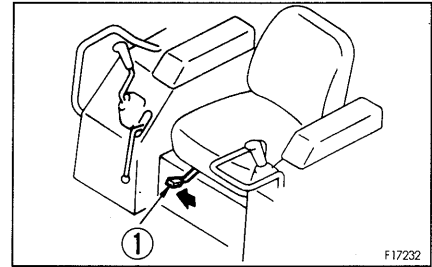

D20AG, PL, PLL-7/D20P, PG-7A

For customers using the above models, please see Section 12A.1.4 OPERATIONS AND CHECKS BEFORE STARTING ENGINE to 12A.14 LOCKING.

For customers using other models, please see Section 12B.1.4 OPERATIONS AND CHECKS BEFORE STARTING ENGINE to 12B.15 LOCKING.

12A.1.4 OPERATIONS AND CHECKS BEFORE STARTING ENGINE

⚠ WARNING

If the blade control lever is touched by accident, the work equipment may move suddenly. When leaving the operator's compartment, always set the safety lever securely to the LOCK position.

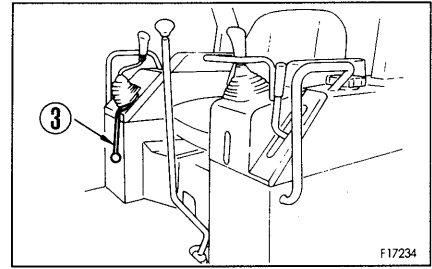
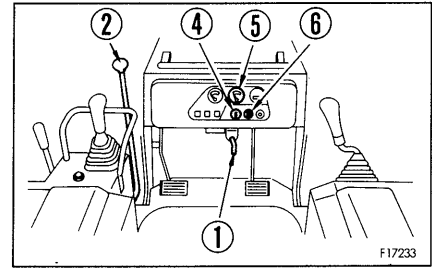

1. Check that the brake pedal is locked with brake lock lever ①.

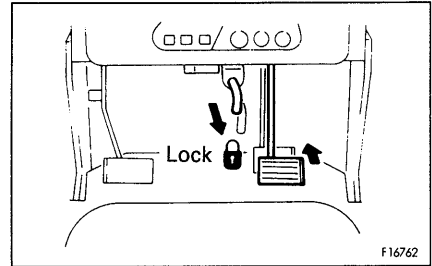

2. Check that gear shift lever ② is the N (neutral) position.

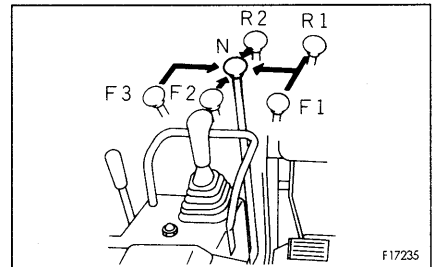

3. Check that the blade is lowered on the ground and the blade control lever is locked with safety lever ③.

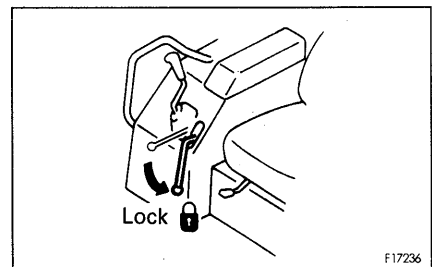

4. Insert the key in starting switch ④, turn the key to the ON position, then check the fuel level using fuel gauge ⑤.

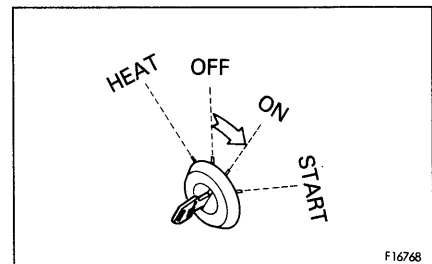

5. Turn lamp switch ⑥ to turn on the head lamps.
If the lamps do not light up, there is probably a broken bulb or disconnection in the wiring, so contact your Komatsu distributor for repairs.

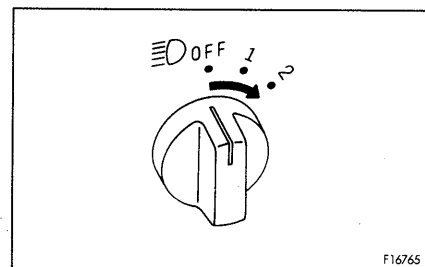

12A.2 STARTING ENGINE

12A.2.1 NORMAL STARTING

⚠ WARNING

Check that there are no persons or obstacles in the surrounding area, then sound the horn and start the engine.

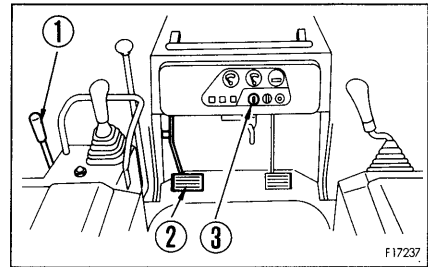

NOTICE

Do not keep the starting motor rotating continuously for more than 20 seconds.

If the engine will not start, wait for at least 2 minutes before trying to start the engine again.

1. Pull fuel control lever ① to a position a little past the LOW IDLING position toward the HIGH IDLING position.

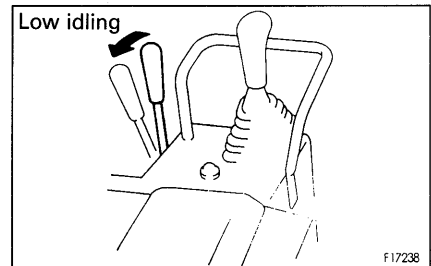

2. Depress main clutch pedal ②.
The engine cannot be started unless the main clutch pedal is depressed.

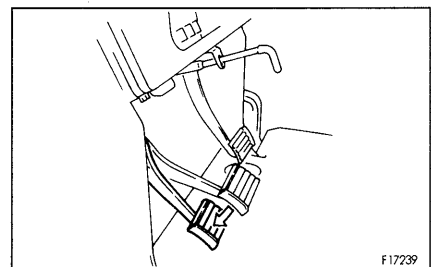

3. Turn the key of starting switch ③ to the START position.
The engine will start.

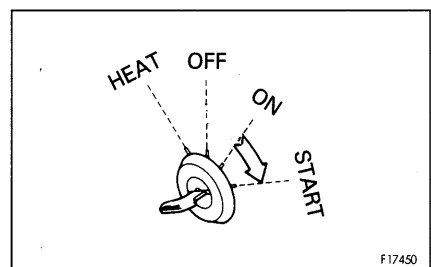

4. When the engine starts, release the key in starting switch ③. The key will return automatically to the ON position.

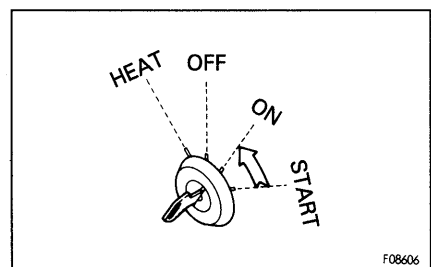

5. Gradually release your foot from main clutch pedal ②.

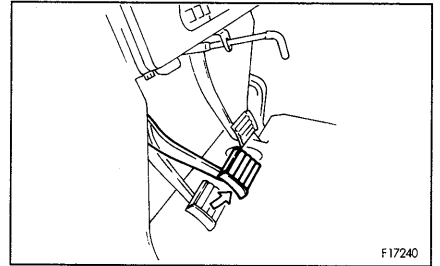

12A.2.2 STARTING IN COLD WEATHER

When starting in low temperatures, do as follows.

WARNING
 Never use starting aid fluids as they may cause explosions.

NOTICE

Do not keep the starting motor rotating continuously for more than 20 seconds.

If the engine fails to start, repeat Steps 2 and 3 after about 2 minutes.

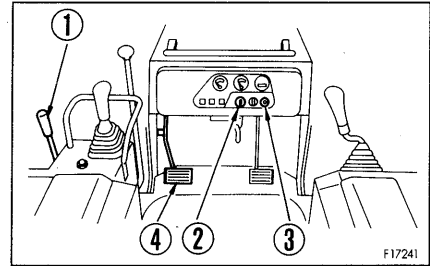

1. Pull fuel control lever ① to a position a little past the LOW IDLING position toward the HIGH IDLING position.

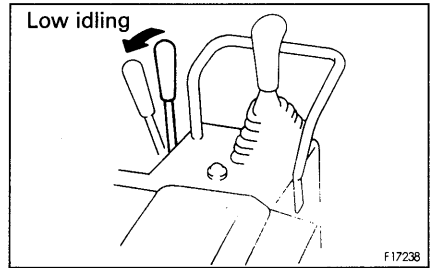

2. Turn the key of starting switch ② to the HEAT position and hold it until glow signal ③ glows red.

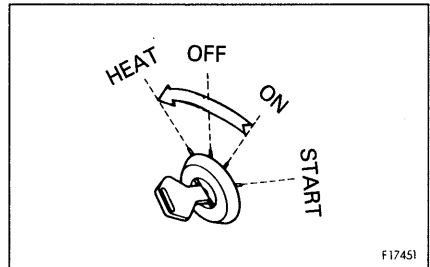

The preheating times are as shown below.

Ambient temperature	Preheat time
Above 0°C	—
0°C to -10°C	20 seconds
-10°C to -20°C	30 seconds

If the preheating time is too long or too short, the engine will not start easily. Observe the correct preheating time.

3. Depress main clutch pedal ④.
 The engine cannot be started unless the main clutch pedal is depressed.

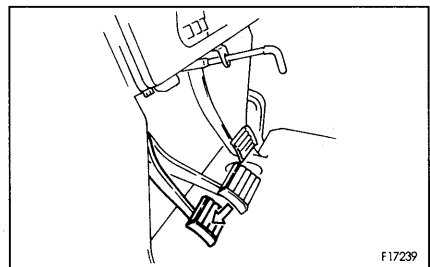

4. When glow signal ③ becomes red, turn the key of starting switch ② to the START position and start the engine.

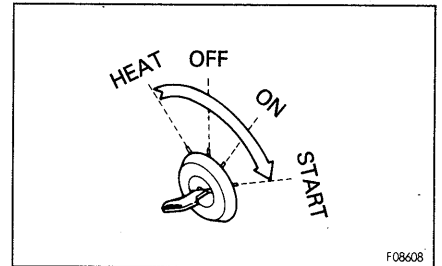

5. When the engine starts, release the key in starting switch ②. The key will return automatically to the ON position.

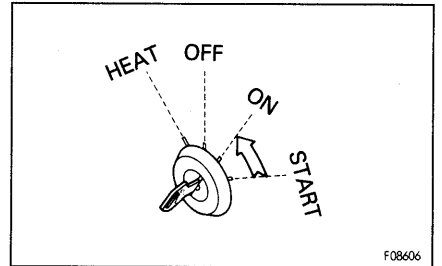

6. Gradually release your foot from main clutch pedal ④.

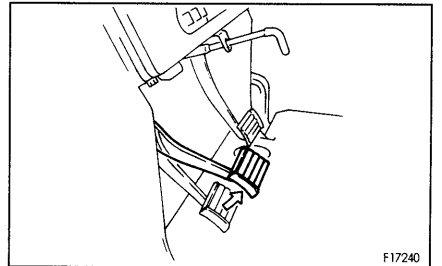

12A.3 OPERATIONS AND CHECKS AFTER STARTING ENGINE

After starting the engine, do not immediately start operations. First, carry out the following operations and checks.

NOTICE

Avoid abrupt acceleration until warm-up run is completed.

Do not run the engine at low idling or high idling for more than 20 minutes. If it is necessary to run the engine at idling, apply a load or run at a medium speed from time to time.

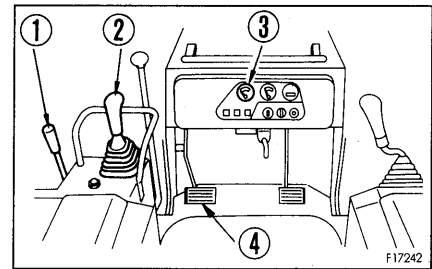

1. Pull fuel control lever ① to the center position between LOW IDLING and HIGH IDLING and run the engine at medium speed for about 5 minutes with no load.

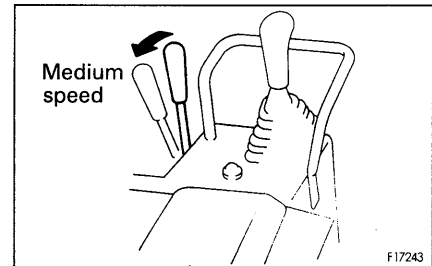

2. When starting in cold weather, operate the steering lever ② as follows. Move steering lever ② to the N position, move the lever fully in left (L) direction and hold it for 5 seconds, then move the lever fully in right (R) direction and hold it for 5 seconds. Repeat this operation in each direction in turn for 5 minutes with engine running under no load.

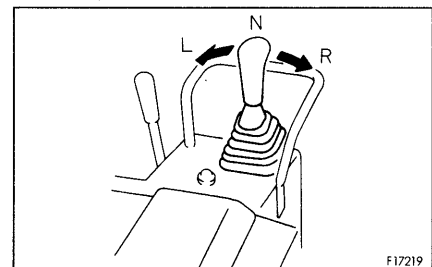

3. After warm-up run is completed, check gauges, warning lamps and charge lamp for proper operation. If any abnormality is found, repair it.
Continue to run the engine at light load until engine water temperature gauge indicator ③ falls within the green range.
4. Check that there is no abnormal exhaust gas color, noise, or vibration. If any abnormality is found, repair it.

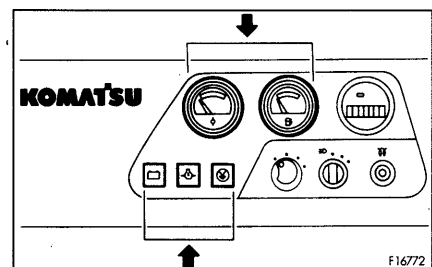

12A.4 MOVING MACHINE OFF

⚠ WARNING

- When moving off, check that the area around the machine is safe, and sound the horn before moving. Clear all personnel from the machine and the area. Clear all obstacles from the path of the machine. Use extreme care when reversing the machine. Note there is an blind spot behind the machine.
- When starting on slopes, always keep brake pedal ② depressed even after releasing brake lock lever ①.
- When starting on steep uphill slopes, place gear shift lever ③ in 1st, run the engine at full speed, then release main clutch pedal ④ slowly while keeping brake pedal ② depressed. When the machine starts to move (or the shoes start to slip), release the brake pedal and main clutch pedal completely to start the machine.

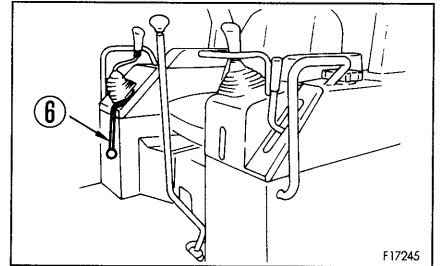
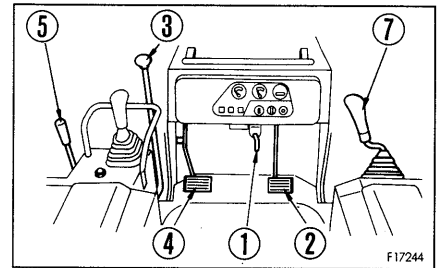

1. Depress main clutch pedal ④.

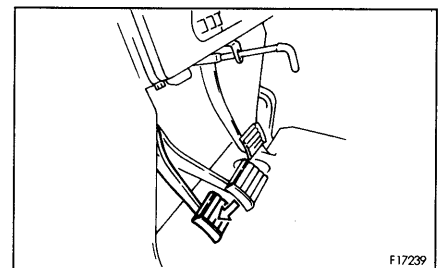

2. Place gear shift lever ③ in the desired position.

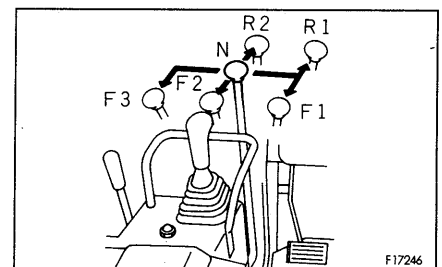

3. Pull fuel control lever ⑤ to increase engine speed.

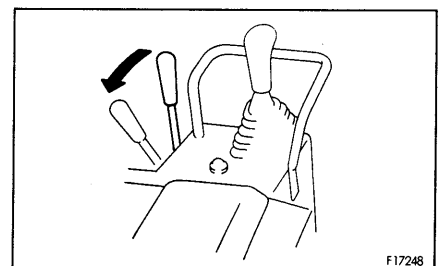

4. Set safety lever ⑥ for blade control lever ⑦ to the FREE position.

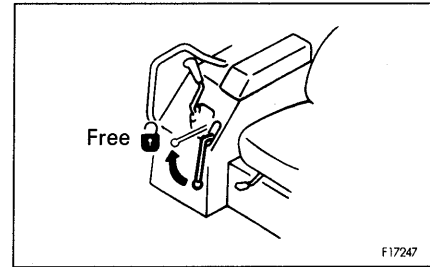

5. Put blade control lever ⑦ in the RAISE position to raise the blade 400 to 500 mm off the ground.

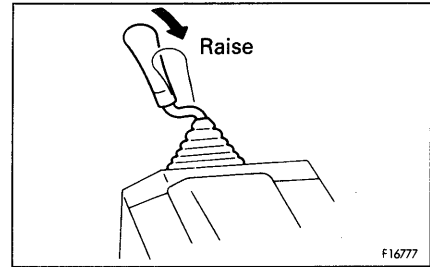

6. Depress brake pedal ②, set brake lock lever ① in the FREE position, then release the pedal.

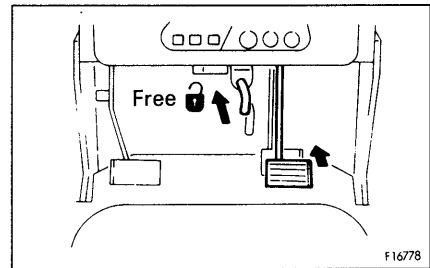

7. Gradually release main clutch pedal ④ and the machine will start.

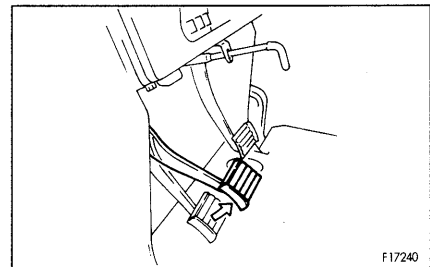

12A.5 STEERING MACHINE

WARNING

- Avoid as much as possible turning the machine on a slope. The machine will tend to slip sideways. Particular care should be taken on soft or clay land.
- Never make a pivot turn at high speed.

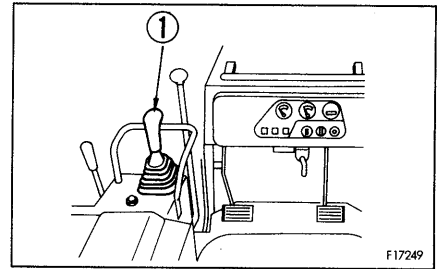

12A.5.1 NORMAL TURNING

To turn the machine while traveling, incline steering lever ① in the direction to turn.

- **To make a gradual left turn**

If the steering lever is moved partially to the left (L), the steering clutch is disengaged and the machine turns gradually to the left.

REMARK

To make a gradual right turn, move the steering lever partially to the right.

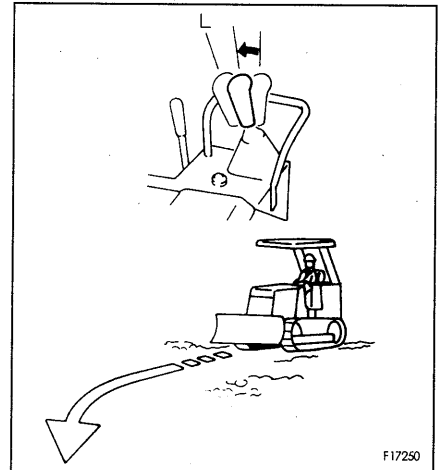

Using the lever guide for fine control

If you use the lever guide, it is easier to make fine adjustments in the steering direction.

There are the following two methods of using the lever guide.

A: Hook your fingers or thumb over the left or right guides, and operate the steering with a light touch.

B: Keep your wrist fixed and run all your fingers along the front of the guide to operate the steering.

Select the method which you find best matches the frequency and ease of use.

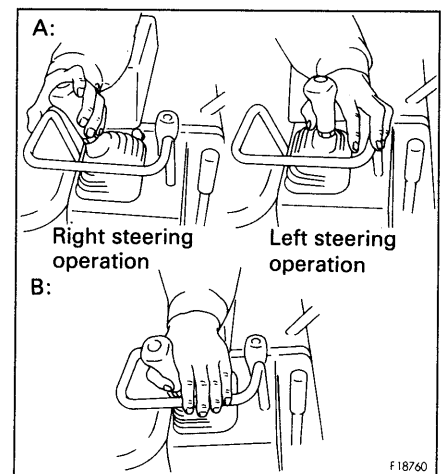

- **To make a pivot left turn**

If the steering lever is moved fully to the left (L), the steering clutch is disengaged and the steering brake is applied, so the machine will carry out a pivot turn to the left.

REMARK

To make a pivot right turn, move the steering lever fully to the right.

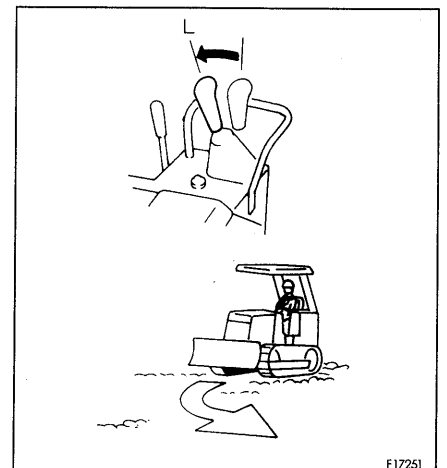

12A.5.2 TURNING WHILE DESCENDING A SLOPE

⚠ WARNING

When descending such a sharp slope that the machine will go down of its own weight or when going down a slope with a scraper or the like, you should exercise great care. The machine will turn to the opposite side to the direction of the moved lever.

- **To make a gradual left turn**

If the steering lever is moved partially to the right (R), the steering clutch is disengaged and the machine turns gradually to the left (compensation steering).

REMARK

To make a gradual right turn, move the steering lever partially to the left (compensation steering).

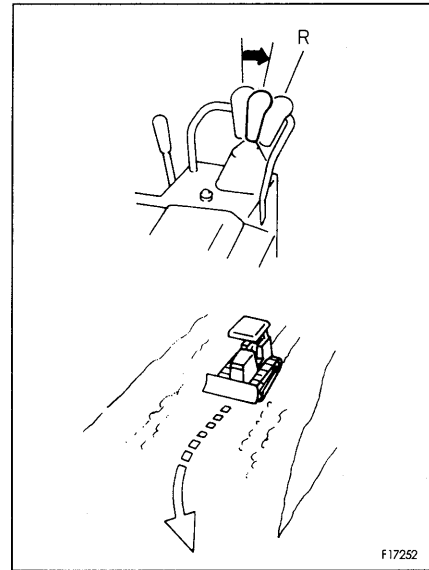

- **To make a pivot left turn**

If the steering lever is moved fully to the left (L), the steering clutch is disengaged and the steering brake is applied, so the machine will carry out a pivot turn to the left (no compensation steering).

REMARK

To make a pivot right turn, move the steering lever fully to the right (no compensation steering).

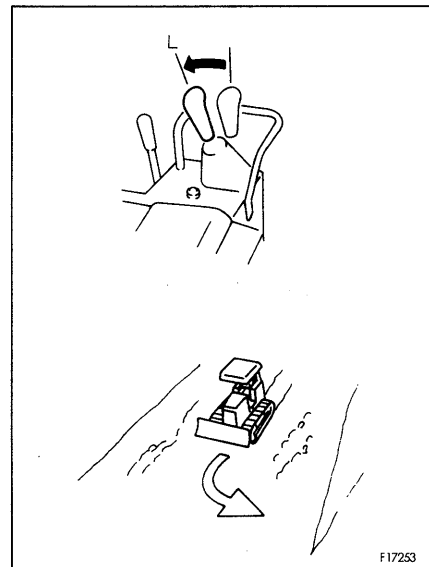

12A.6 STOPPING MACHINE

WARNING

- Avoid stopping suddenly. Give yourself ample room when stopping.
- When stopping the machine, select flat hard ground and avoid dangerous places. If it is unavoidably necessary to park the machine on a slope, insert blocks underneath the track shoes. As an additional safety measure, thrust the blade into the ground.
- If the blade control lever is touched by accident, the work equipment may move suddenly, and this may lead to a serious accident. Before leaving the operator's compartment, always apply the lock securely.

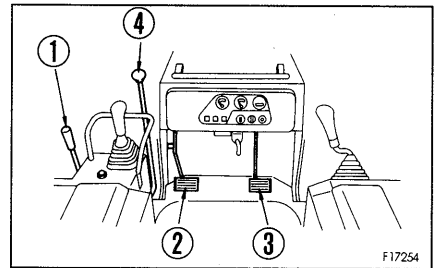

1. Lower engine speed by operating fuel control lever ①.

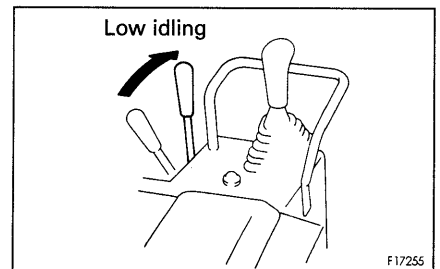

2. Depress main clutch pedal ②.

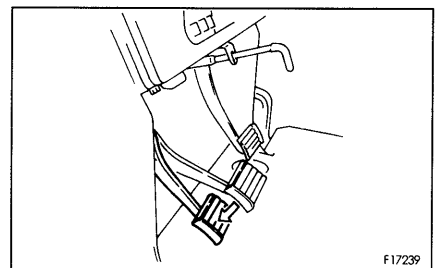

3. Depress brake pedal ③ to apply the brake.
The machine will stop.

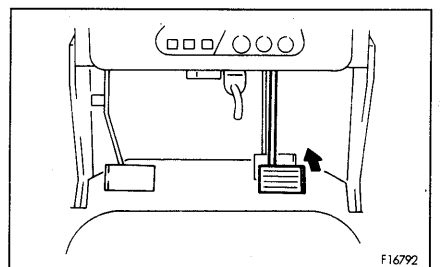

4. Place gear shift lever ④ in the N (neutral) position.

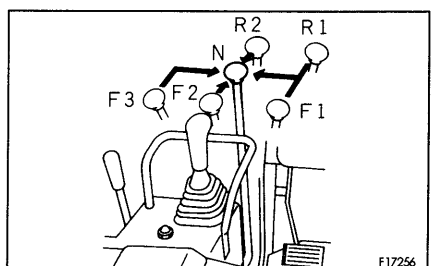

12A.7 SHIFTING GEAR, SHIFTING BETWEEN FORWARD AND REVERSE

Depress the clutch pedal and brake pedal, stop the machine, then move the gear shift lever to the desired position.

1. Lower engine speed by fuel control lever ①.

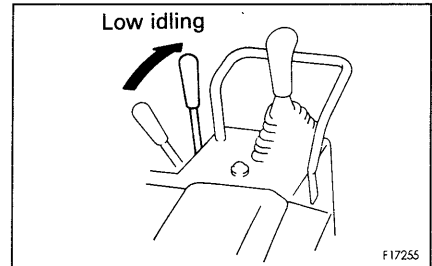
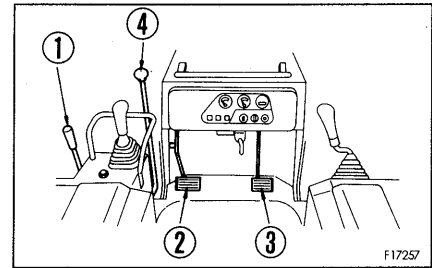

2. Depress main clutch pedal ②.

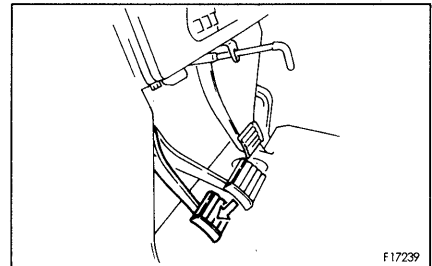

3. Depress brake pedal ③ to apply the brake.

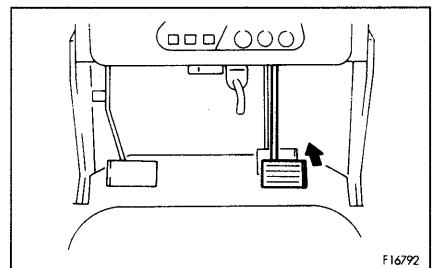

4. Place gear shift lever ④ in the desired position.

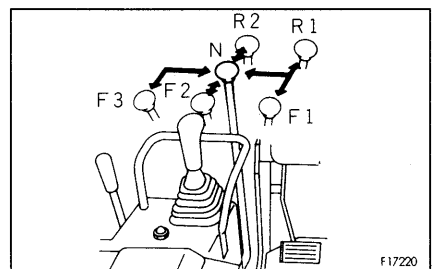

5. Release brake pedal ③.

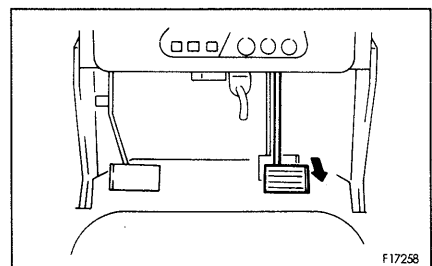

6. Gradually release main clutch pedal ② and the machine will start.

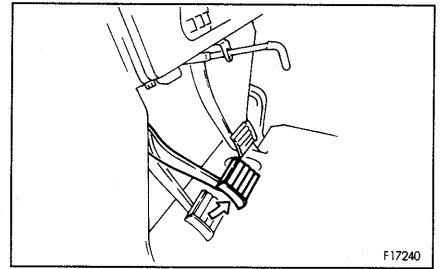

7. Increase engine speed by fuel control lever ①.

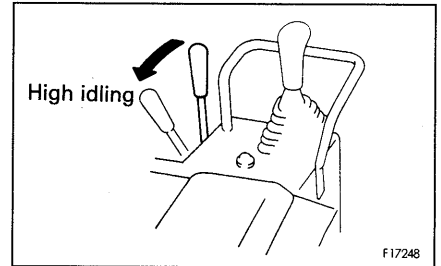

12A.8 PRECAUTIONS FOR OPERATION

12A.8.1 METHOD OF USING STEERING CLUTCH

If the steering clutch one side is used frequently or if many gradual turns are made with steering clutch half-engaged, the steering clutch will wear out in a short time. Design the travel road well and steer the machine properly.

12A.8.2 PERMISSIBLE WATER DEPTH

When operating in water, always keep the bottom of the carrier roller above the surface of the water.

Also, be careful that the engine cooling fan will not come in contact with water. The fan can be damaged.

12A.8.3 PRECAUTIONS WHEN TRAVELING UP OR DOWN HILLS

Use engine as a brake

When going downhill, shift gear shift lever into low speed to run engine at slow speed and travel down slope using the engine as a brake.

Never coast down slope with the gear shift lever in the N (neutral) position.

Braking when traveling downhill

While descending a slope using the engine as a brake, also apply the brakes.

Failure to brake may result in overrunning, causing engine trouble.

12A.8.4 PRECAUTIONS ON SLOPES

Be careful of fuel level

If the fuel level in the fuel tank becomes low when working on slopes, the engine may suck in air because of the angle of the machine or the swaying of the machine. If this makes the engine stop, so be careful not to let the fuel level in the fuel tank become too low.

Precautions when engine stops on slopes

If the engine stops while working or traveling on a hill, immediately depress the brake pedal, lower the blade to the ground to stop the machine, then lock the brake pedal with the brake lock lever.

Thereafter, keep the main clutch pedal depressed and move the gear shift lever to the N (neutral) position, then restart the engine.

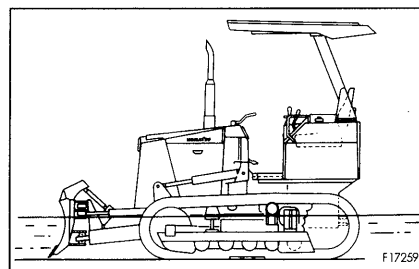

12A.9 WORK POSSIBLE USING BULLDOZER

In addition to the following, it is possible to further increase the range of applications by using various attachments.

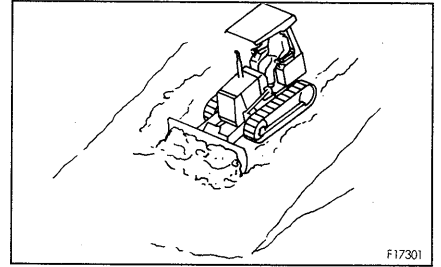

12A.9.1 DOZING

A bulldozer digs and transports dirt in a forward direction. Slope excavation can always be most effectively carried out by proceeding from the top downward.

When dozing toward one side only, operate with angled blade (angledozer only).

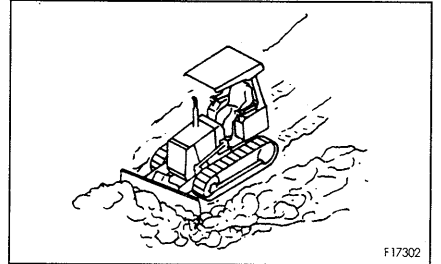

12A.9.2 SMOOTHING

NOTICE

Avoid smoothing on rocky or stony ground. It can damage the blade.

Uneven ground surfaces remaining after digging can be levelled off by fine operation of blade. The basic method is to operate the machine at low speeds with the blade fully loaded with soil and sand. A flat finished surface is also possible by slowly backing the machine with the blade "floating" so it is dragged across the surface. However, avoid this on rocky or stony ground, as it may damage the blade.

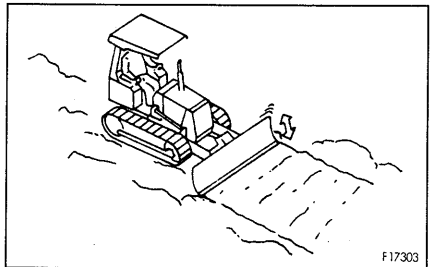

The D20PL, PLL can be used for leveling of fields where there are no rocks when the ground is too soft for standard swamp bulldozers to operate.

12A.9.3 CUTTING INTO HARD OR FROZEN GROUND OR DITCHING

NOTICE

Do not perform severe operations such as uprooting by angling or tilting the blade.

For digging and ditch excavation of hard or frozen ground, tilt the blade. Even hard ground can be dug effectively by a tilted or angled blade.

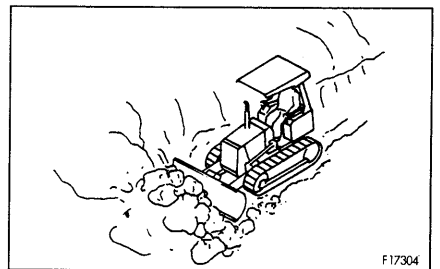

12A.10 PARKING MACHINE

⚠ WARNING

- Avoid stopping suddenly. Give yourself ample room when stopping.
- When stopping the machine, select flat hard ground and avoid dangerous places. If it is unavoidably necessary to park the machine on a slope, insert blocks underneath the track shoes. As an additional safety measure, thrust the blade into the ground.
- If the control lever is touched by accident, the work equipment or the machine may move suddenly, and this may lead to a serious accident. Before leaving the operator's compartment, always apply the lock securely.

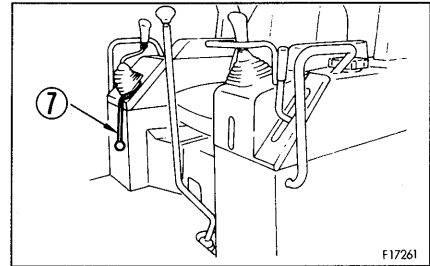
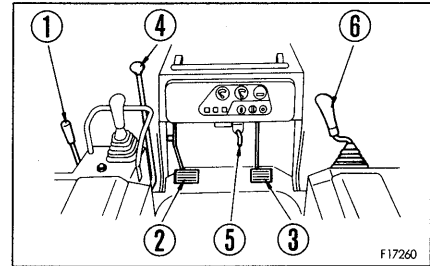

1. Lower engine speed by operating fuel control lever ①.

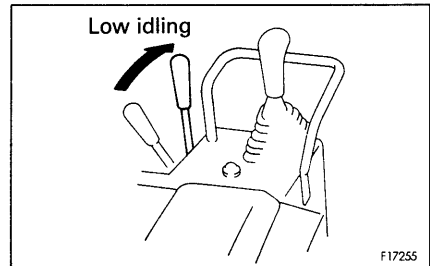

2. Depress main clutch pedal ②.

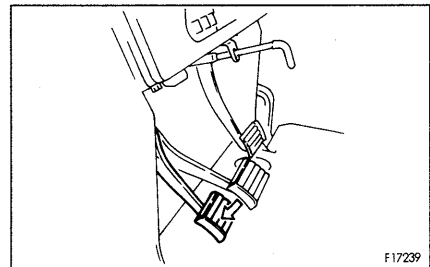

3. Depress brake pedal ③ to stop the machine.

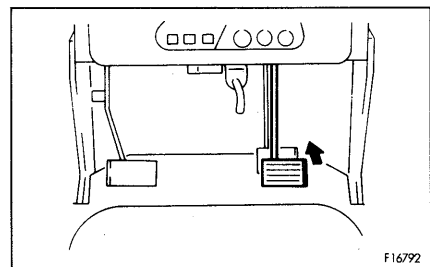

4. Place gear shift lever ④ in NEUTRAL position.

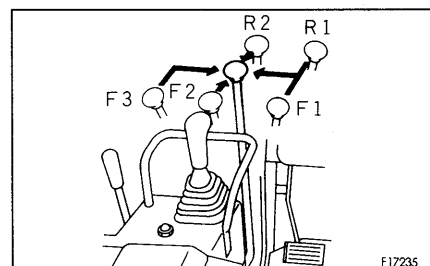

5. Pull brake lock lever ⑤ and depress brake pedal ③ strongly to apply the lock securely.

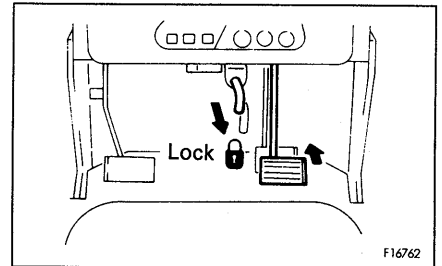

6. Release main clutch pedal ②.

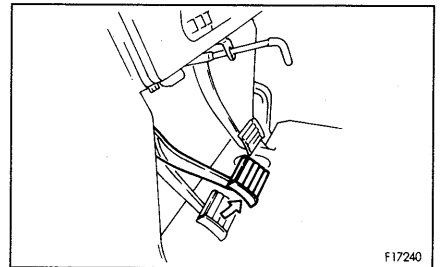

7. Put blade control lever ⑥ in the LOWER position to lower the blade to the ground while keeping it horizontal.

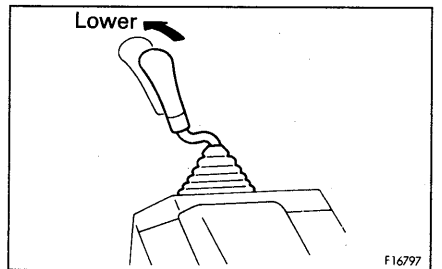

8. Lock blade control lever ⑥ with safety lever ⑦.

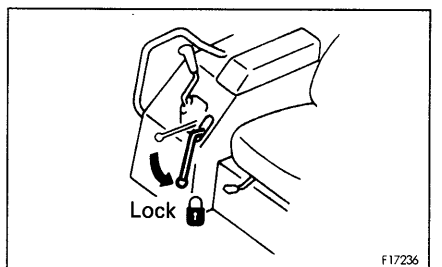

12A.11 CHECK AFTER FINISHING WORK

1. Check the gauges and lamps for engine water temperature, engine oil pressure, fuel level and air cleaner clogged.

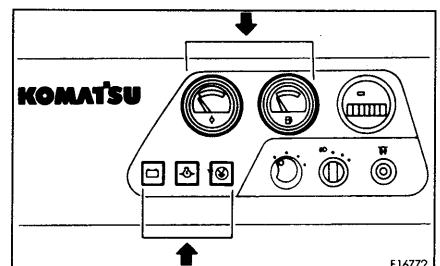

12A.12 STOPPING ENGINE

NOTICE

If the engine is abruptly stopped before it has cooled down, engine life may be greatly shortened. Consequently, do not abruptly stop the engine apart from an emergency.

In particular, if the engine has overheated, do not abruptly stop it but run it at medium speed to allow it to cool gradually, then stop it.

1. Run the engine at low idling speed for about 5 minutes to allow it to gradually cool down.

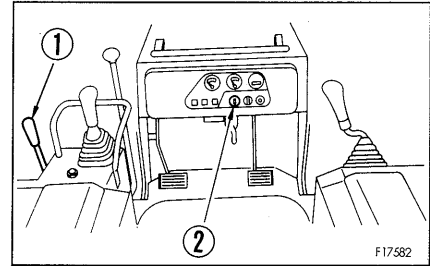

- **For machine stopped by fuel control lever.**
2. Place fuel control lever ① in the engine stop position and stop the engine.

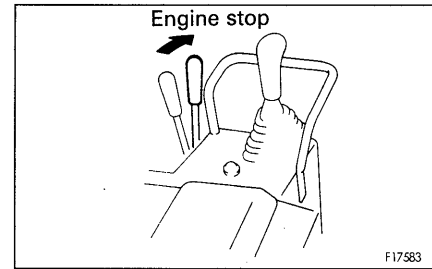

3. Turn the key in starting switch ② to the OFF position and remove the key from starting switch ②.

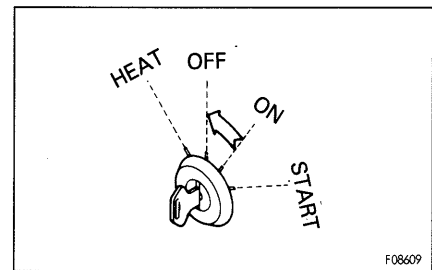

- **For machines stopped by starting switch**
2. Turn the key in starting switch ② to the OFF position and stop the engine.

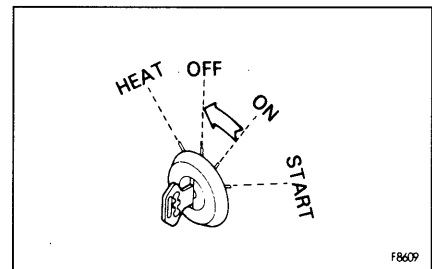

3. Remove the key from starting switch ②.

12A.13 CHECK AFTER STOPPING ENGINE

1. Walk around the machine and check the work equipment, paintwork, and undercarriage, and check also for leakage of oil or water. If any abnormalities are found, repair them.
2. Fill the fuel tank.
3. Check the engine compartment for paper and debris. Clean out any paper and debris to avoid a fire hazard.
4. Remove any mud stuck to the undercarriage.

12A.14 LOCKING

Always lock the following places.

- ① Top cover on the engine hood
- ② Side cover on the hydraulic tank

REMARK

Use the starting switch key to open and close covers ① and ②.

Commercially available locks can be fitted to the following places.

- ③ Battery inspection cover
- ④ Inspection cover for fuel tank drain valve

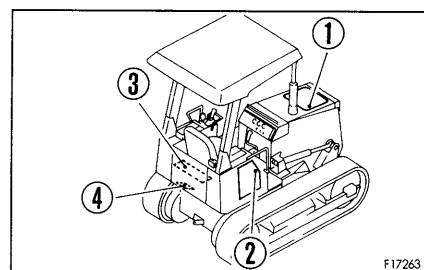

D21A, AG-7/D21PG-7A

For customers using the above models, please see Section 12B.1.4 OPERATIONS AND CHECKS BEFORE STARTING ENGINE to 12B.15 LOCKING.

For customers using other models, please see Section 12A.1.4 OPERATIONS AND CHECKS BEFORE STARTING ENGINE to 12A.14 LOCKING.

12B.1.4 OPERATIONS AND CHECKS BEFORE STARTING ENGINE

⚠ WARNING

If the control levers are touched by accident, the work equipment or the machine may move suddenly. When leaving the operator's compartment, always set the safety lever securely to the LOCK position.

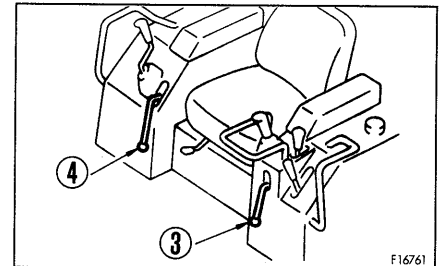
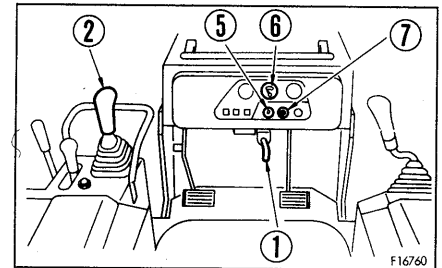

1. Check that the brake pedal is locked with brake lock lever ①.

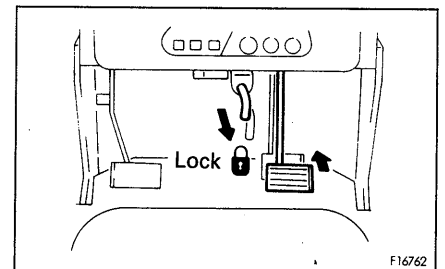

2. Check that steering and directional lever ② is the N (neutral) position and is locked with safety lever ③. When starting the engine, check that the levers are at the N position and that the safety lever is at the LOCK position. If they are not at these positions the engine will not start.

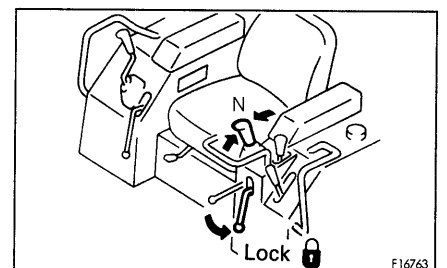

3. Check that the blade is lowered on the ground and the blade control lever is locked with safety lever ④.

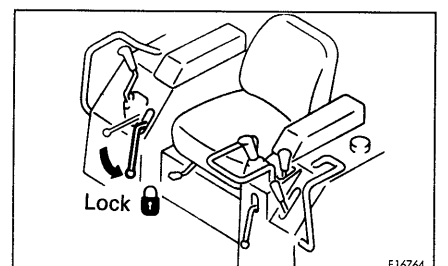

4. Insert the key in starting switch ⑤, turn the key to the ON position, then check the fuel level using fuel gauge ⑥.

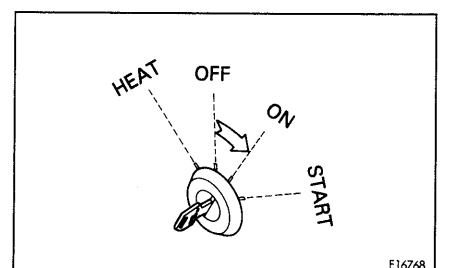

5. Turn lamp switch ⑦ to turn on the head lamps.
If the lamps do not light up, there is probably a broken bulb or disconnection in the wiring, so contact your Komatsu distributor for repairs.

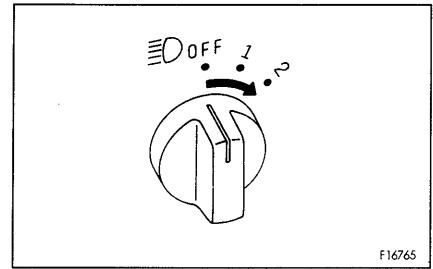

12B.2 STARTING ENGINE

12B.2.1 NORMAL STARTING

WARNING

Check that there are no persons or obstacles in the surrounding area, then sound the horn and start the engine.

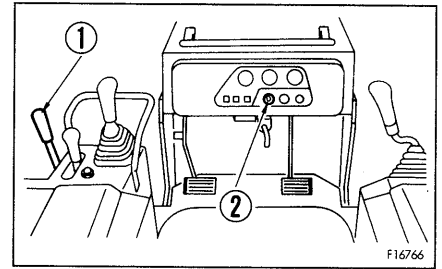

NOTICE

Do not keep the starting motor rotating continuously for more than 20 seconds.

If the engine will not start, wait for at least 2 minutes before trying to start the engine again.

1. Pull fuel control lever ① to a position a little past the LOW IDLING position toward the HIGH IDLING position.

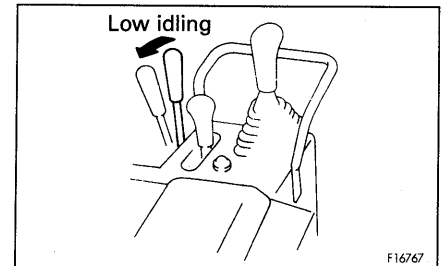

2. Turn the key of starting switch ② to the START position. The engine will start.

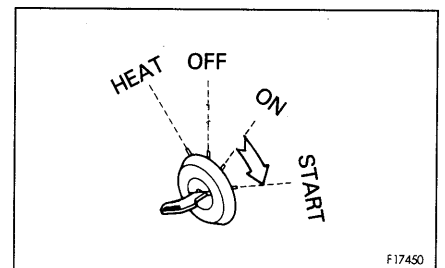

3. When the engine starts, release the key in starting switch ②. The key will return automatically to the ON position.

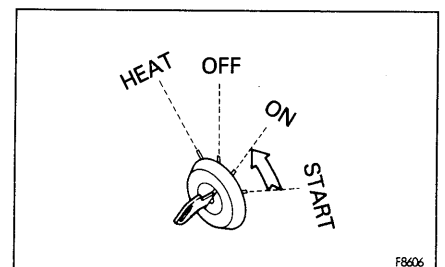

12B.2.2 STARTING IN COLD WEATHER

When starting in low temperatures, do as follows.

WARNING
 Never use starting aid fluids as they may cause explosions.

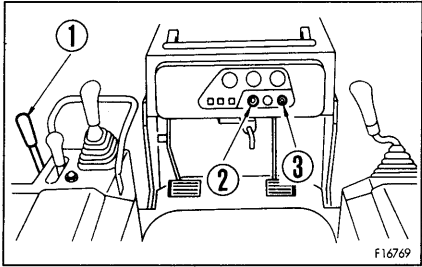

NOTICE

Do not keep the starting motor rotating continuously for more than 20 seconds.

If the engine fails to start, repeat Steps 2 and 3 after waiting for about 2 minutes.

1. Pull fuel control lever ① to a position a little past the LOW IDLING position toward the HIGH IDLING position.

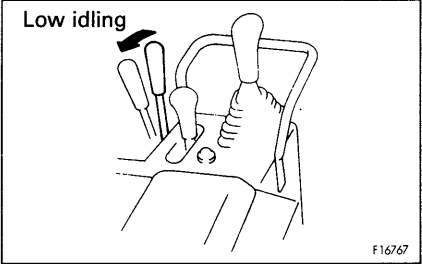

2. Turn the key of starting switch ② to the HEAT position and hold it until glow signal ③ glows red.

The preheating times are as shown below.

Ambient temperature	Preheat time
Above 0°C	—
0°C to -10°C	20 seconds
-10°C to -20°C	30 seconds

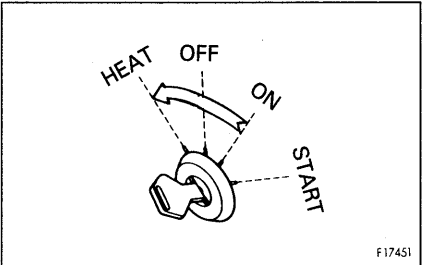

If the preheating time is too long or too short, the engine will not start easily. Observe the correct preheating time.

3. When glow signal ③ becomes red, turn the key of starting switch ② to the START position and start the engine.

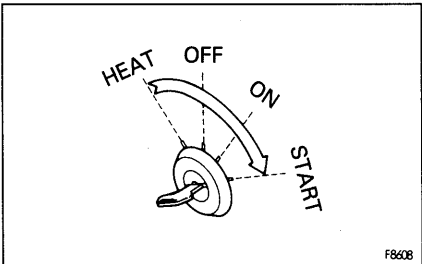

4. When the engine starts, release the key in starting switch
②. The key will return automatically to the ON position.

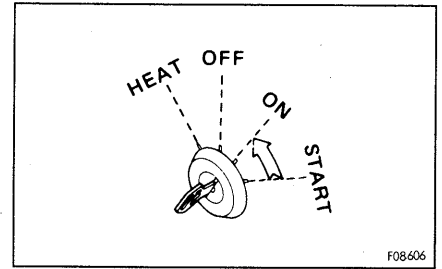

12B.3 OPERATIONS AND CHECKS AFTER STARTING ENGINE

After starting the engine, do not immediately start operations. First, carry out the following operations and checks.

NOTICE

Avoid abrupt acceleration until warm-up run is completed.

Do not run the engine at low idling or high idling for more than 20 minutes. If it is necessary to run the engine at idling, apply a load or run at a medium speed from time to time.

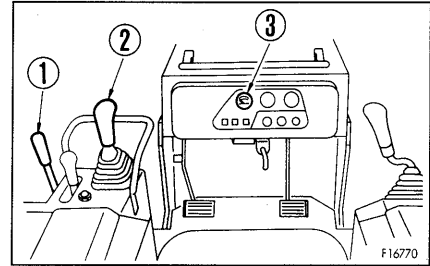

1. Pull fuel control lever ① to the center position between LOW IDLING and HIGH IDLING and run the engine at medium speed for about 5 minutes with no load.

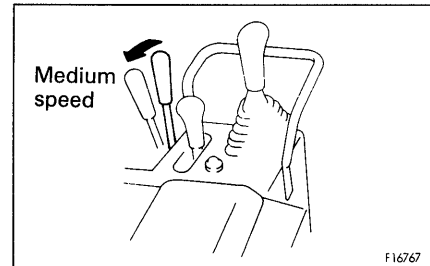

2. When starting in cold weather, operate the steering and directional lever ② as follows. Move steering and directional lever ② to the N position, move the lever fully in left (L) direction, and hold it for 5 seconds, then move the lever fully in right (R) direction, and hold it for 5 seconds. Repeat this operation in each direction in turn for 5 minutes with engine running under no load.

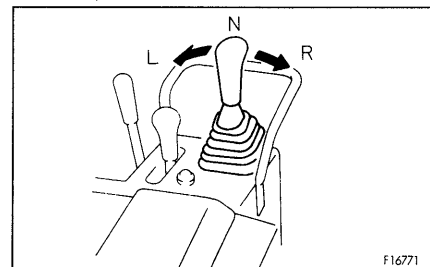

3. After warm-up run is completed, check gauges, warning lamps and charge lamp for proper operation. If any abnormality is found, repair it.
Continue to run the engine at light load until engine water temperature gauge indicator ③ falls within the green range.

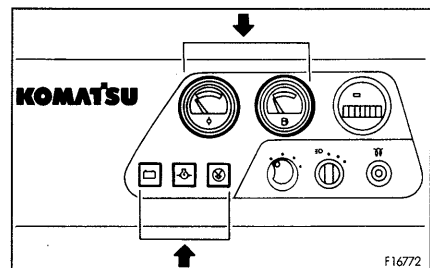

4. Check that there is no abnormal exhaust gas color, noise, or vibration. If any abnormality is found, repair it.

12B.4 MOVING MACHINE OFF

⚠ WARNING

- When moving off, check that the area around the machine is safe, and sound the horn before moving. Clear all personnel from the machine and the area. Clear all obstacles from the path of the machine. Use extreme care when reversing the machine. Note there is an blind spot behind the machine.
- When starting on slopes, always keep brake pedal ② depressed even after releasing brake lock lever ①.
- When starting the machine on a steep uphill grade, run the engine at full-throttle and shift gear shift lever ③ into 1st and move steering and directional lever ④ to the F (forward) or R (reverse) position with brake pedal ② depressed. When the machine has started slowly (or track shoes are slipping), propel the machine by slowly releasing brake pedal ②.

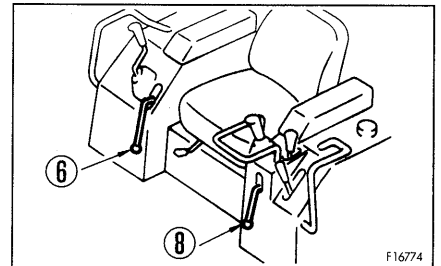
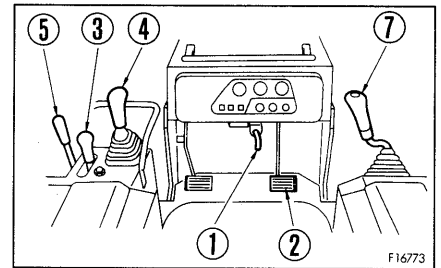

1. Pull fuel control lever ⑤ to increase engine speed.

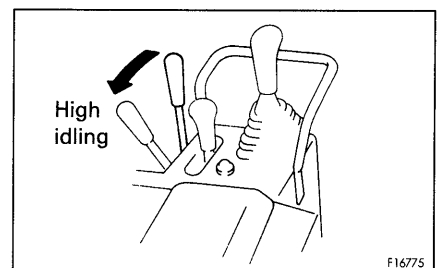

2. Set safety lever ⑥ for blade control lever ⑦ to the FREE position.

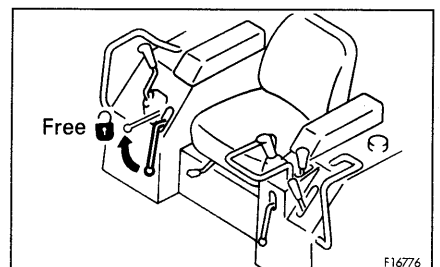

3. Put blade control lever ⑦ in the RAISE position to raise the blade 400 to 500 mm off the ground.

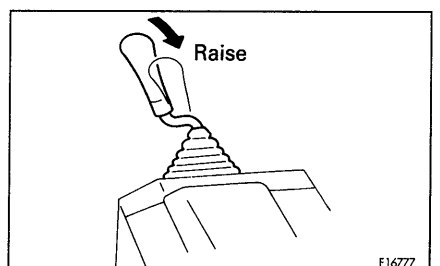

4. Depress brake pedal ② and push brake lock lever ① to the FREE position. Keep brake pedal ② depressed.

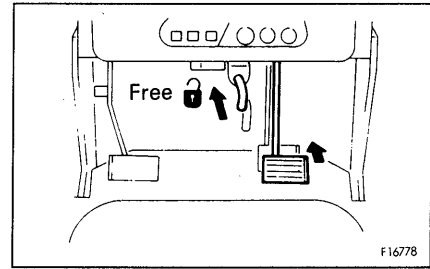

5. Set safety lever ⑧ for the steering and directional lever to the FREE position.

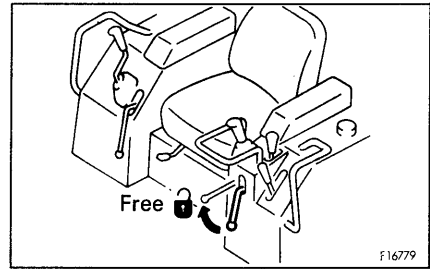

6. Set gear shift lever ③ to position 1 or 2, set steering and directional lever ④ to the forward or reverse position.

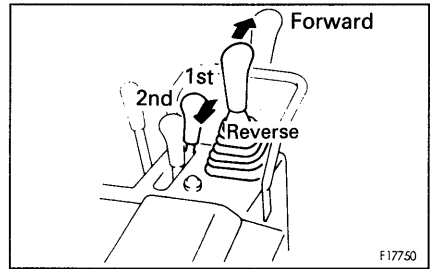

7. Release brake pedal ② and the machine will start.

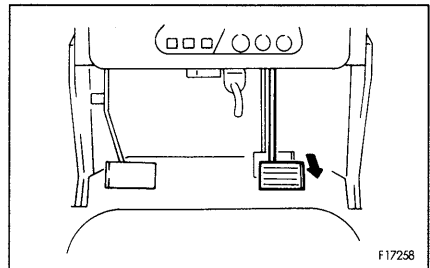

12B.5 SHIFTING GEAR

There is no need to stop machine to shift gears.
Set gear shift lever ① in the desired position to shift gear.

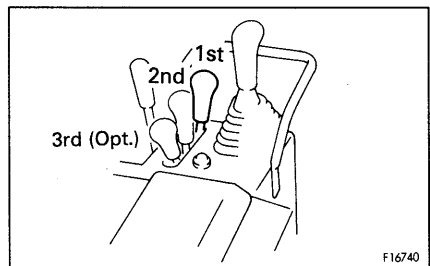
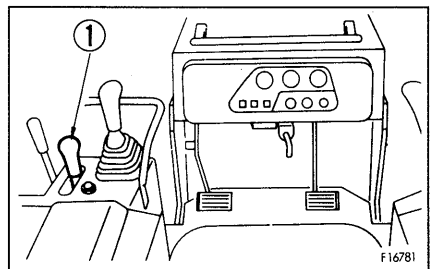

12B.6 SHIFTING BETWEEN FORWARD AND REVERSE

⚠ CAUTION

Forward-reverse shifting should be made after reduction of machine speed for safety purpose and preventing shock to machine.

1. Lower engine speed by fuel control lever ①.
2. Place steering and directional lever ② in the desired position.
3. Increase engine speed by fuel control lever ①.

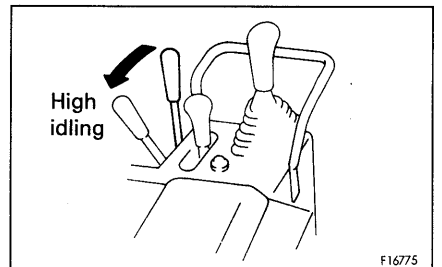
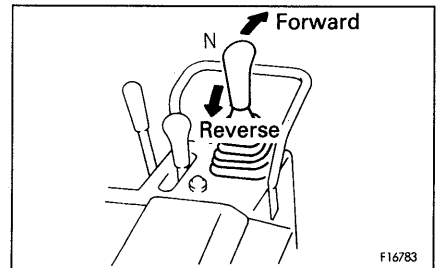
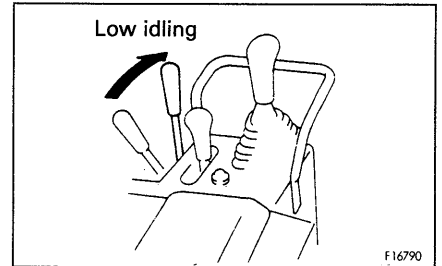
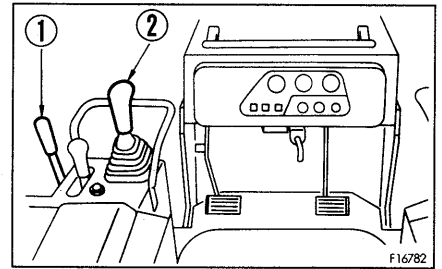

12B.7 STEERING MACHINE

⚠ WARNING

- Avoid as much as possible turning the machine on a slope. The machine will tend to slip sideways. Particular care should be taken on soft or clay land.
- Never make a pivot turn at high speed.

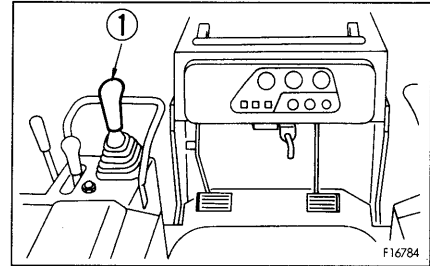

12B.7.1 NORMAL TURNING

To turn the machine while traveling, incline steering and directional lever ① in the direction to turn.

- **To make a gradual left turn**

If the steering and directional lever is moved partially to the left \curvearrowleft , the steering clutch is disengaged and the machine turns gradually to the left.

REMARK

To make a gradual right turn, move the steering and directional lever partially to the right.

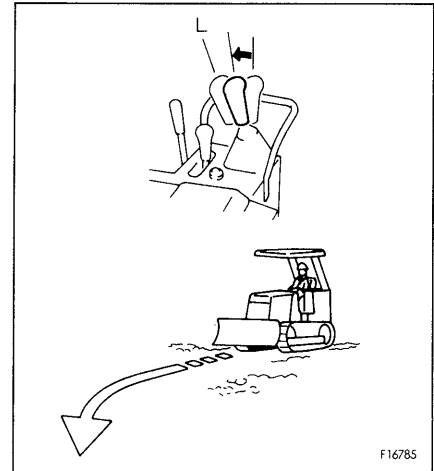

Using the lever guide for fine control

If you use the lever guide, it is easier to make fine adjustments in the steering direction.

There are the following two methods of using the lever guide.

A: Hook your fingers or thumb over the left or right guides, and operate the steering with a light touch.

B: Keep your wrist fixed and run all your fingers along the front of the guide to operate the steering.

Select the method which you find best matches the frequency and ease of use.

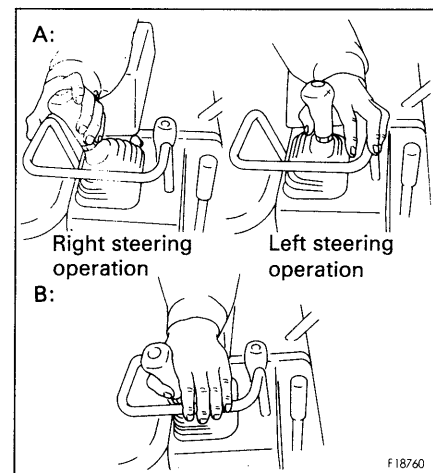

- **To make a pivot left turn**

If the steering and directional lever is moved fully to the left \curvearrowleft , the steering clutch is disengaged and the steering brake is applied, so the machine will carry out a pivot turn to the left.

REMARK

To make a pivot right turn, move the steering and directional lever fully to the right.

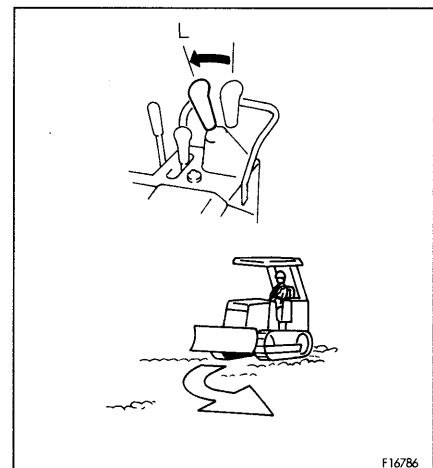

12B.7.2 TURNING WHILE DESCENDING A SLOPE

⚠ WARNING

When descending such a sharp slope that the machine will go down of its own weight or when going down a slope with a scraper or the like, you should exercise great care. The machine will turn to the opposite side to the direction of the moved lever.

- **To make a gradual left turn**

If the steering and directional lever is moved partially to the right (R), the steering clutch is disengaged and the machine turns gradually to the left (compensation steering).

REMARK

To make a gradual right turn, move the steering and directional lever partially to the left (compensation steering).

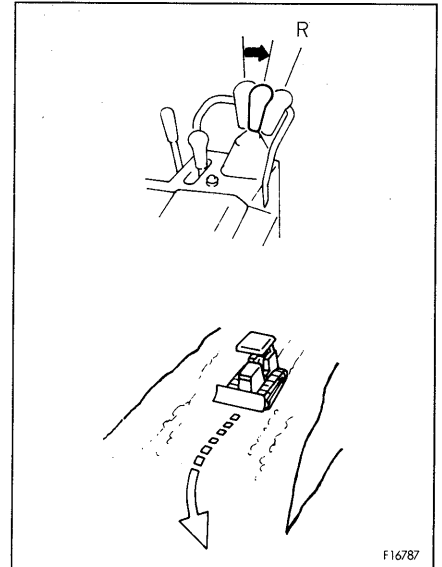

F16787

- **To make a pivot left turn**

If the steering and directional lever is moved fully to the left (L), the steering clutch is disengaged and the steering brake is applied, so the machine will carry out a pivot turn to the left (no compensation steering).

REMARK

To make a pivot right turn, move the steering and directional lever fully to the right (no compensation steering).

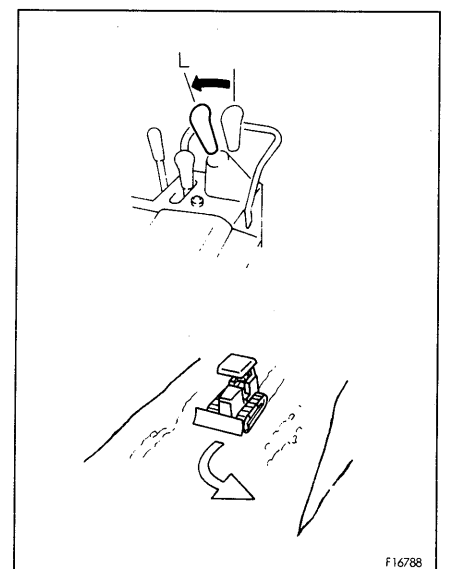

F16788

12B.8 STOPPING MACHINE

⚠ WARNING

- Avoid stopping suddenly. Give yourself ample room when stopping.
- When stopping the machine, select flat hard ground and avoid dangerous places. If it is unavoidably necessary to park the machine on a slope, insert blocks underneath the track shoes. As an additional safety measure, thrust the blade into the ground.
- If the control lever is touched by accident, the work equipment or the machine may move suddenly, and this may lead to a serious accident. Before leaving the operator's compartment, always apply the lock securely.

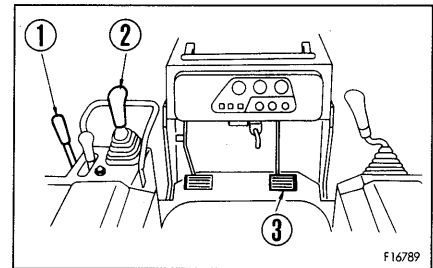

1. Lower engine speed by operating fuel control lever ①.

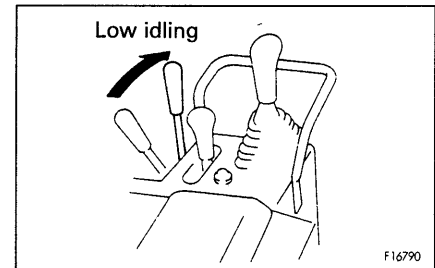

2. Place steering and directional lever ② in the N (neutral) position.

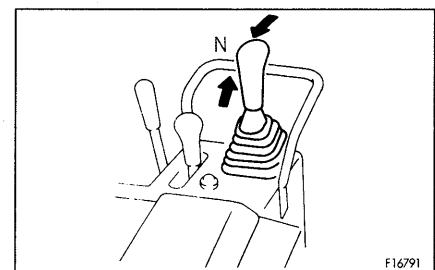

3. Depress brake pedal ③ to stop the machine.

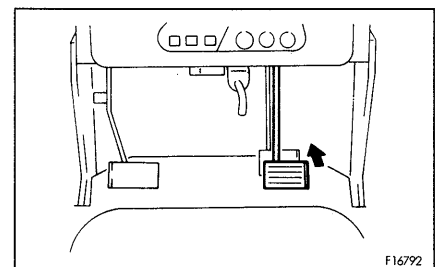

12B.9 PRECAUTIONS FOR OPERATION

12B.9.1 METHOD OF USING STEERING CLUTCH

If the steering clutch one side is used frequently or if many gradual turns are made with steering clutch half-engaged, the steering clutch will wear out in a short time. Design the travel road well and steer the machine properly.

12B.9.2 PERMISSIBLE WATER DEPTH

When operating in water, always keep the bottom of the carrier roller above the surface of the water.

Also, be careful that the engine cooling fan will not come in contact with water. The fan can be damaged.

12B.9.3 PRECAUTIONS WHEN TRAVELING UP OR DOWN HILLS

Use engine as a brake

When going downhill, shift gear shift lever into low speed to run engine at slow speed and travel down slope using the engine as a brake.

Never coast down slope with the steering and directional lever in the N (neutral) position or with the inching pedal depressed.

Braking when traveling downhill

While descending a slope using the engine as a brake, also apply the brakes.

Failure to brake may result in overrunning, causing engine trouble.

12B.9.4 PRECAUTIONS ON SLOPES

Be careful of fuel level

If the fuel level in the fuel tank becomes low when working on slopes, the engine may suck in air because of the angle of the machine or the swaying of the machine. If this makes the engine stop, so be careful not to let the fuel level in the fuel tank become too low.

Precautions when engine stops on slopes

If the engine stops while working or traveling on a hill, immediately depress the brake pedal, lower the blade to the ground to stop the machine, then lock the brake pedal with the brake lock lever.

Thereafter, move the steering and directional lever to the N (neutral) position, lock the lever, then restart the engine.

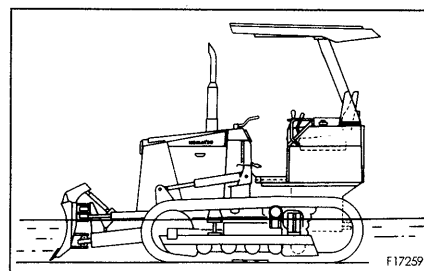

12B.10 WORK POSSIBLE USING BULLDOZER

In addition to the following, it is possible to further increase the range of applications by using various attachments.

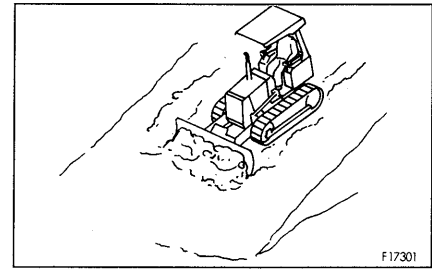

12B.10.1 DOZING

A bulldozer digs and transports dirt in a forward direction. Slope excavation can always be most effectively carried out by proceeding from the top downward.

When dozing toward one side only, operate with angled blade (angledozer only).

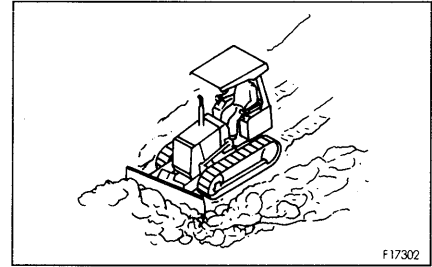

12B.10.2 SMOOTHING

NOTICE

Avoid smoothing on rocky or stony ground. It can damage the blade.

Uneven ground surfaces remaining after digging can be levelled off by fine operation of blade. The basic method is to operate the machine at low speeds with the blade fully loaded with soil and sand. A flat finished surface is also possible by slowly backing the machine with the blade "floating" so it is dragged across the surface. However, avoid this on rocky or stony ground, as it may damage the blade.

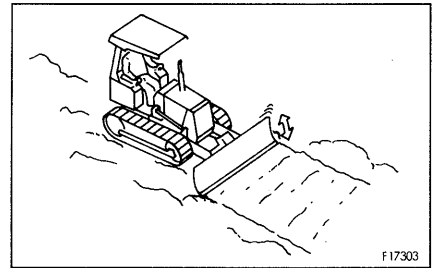

12B.10.3 CUTTING INTO HARD OR FROZEN GROUND OR DITCHING

NOTICE

Do not perform severe operations such as uprooting by angling or tilting the blade.

For digging and ditch excavation of hard or frozen ground, tilt the blade. Even hard ground can be dug effectively by a tilted or angled blade.

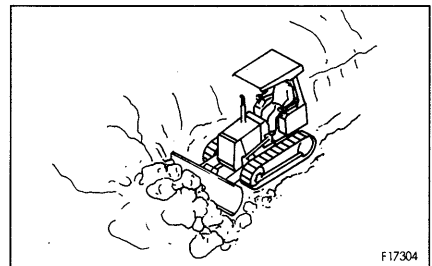

12B.11 PARKING MACHINE

WARNING

- Avoid stopping suddenly. Give yourself ample room when stopping.
- When stopping the machine, select flat hard ground and avoid dangerous places. If it is unavoidably necessary to park the machine on a slope, insert blocks underneath the track shoes. As an additional safety measure, thrust the blade into the ground.
- If the control lever is touched by accident, the work equipment or the machine may move suddenly, and this may lead to a serious accident. Before leaving the operator's compartment, always apply the lock securely.

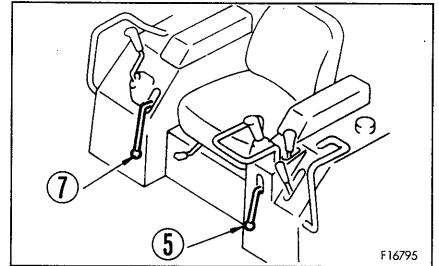
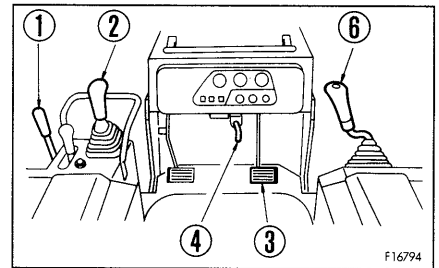

1. Lower engine speed by operating fuel control lever ①.

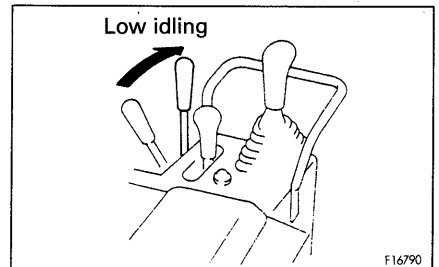

2. Place steering and directional lever ② in NEUTRAL position.

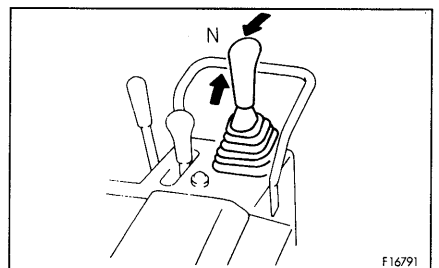

3. Depress brake pedal ③ to stop the machine.

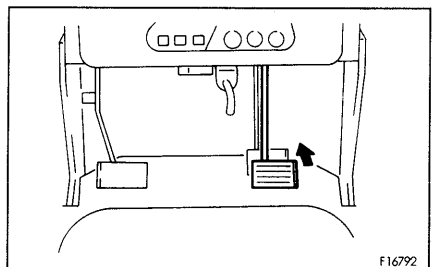

4. Pull brake lock lever ④ and depress brake pedal ③ strongly to apply the lock securely.

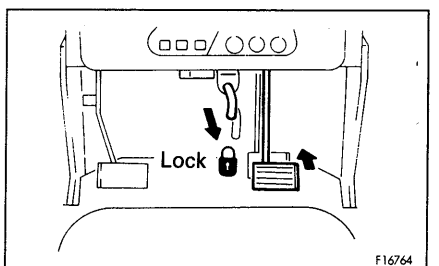

5. Lock steering and directional lever ② with safety lever ⑤.

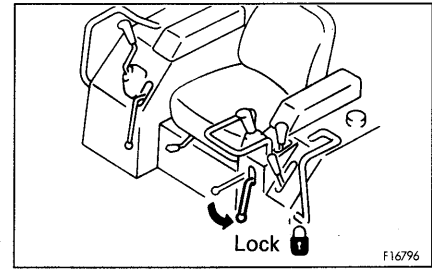

6. Put blade control lever ⑥ in the LOWER position to lower the blade to the ground while keeping it horizontal.

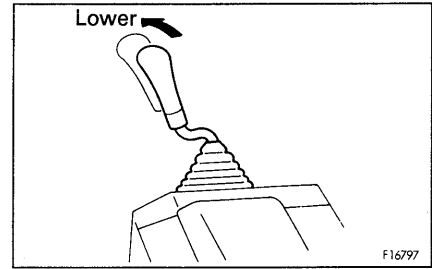

7. Lock blade control lever ⑥ with safety lever ⑦.

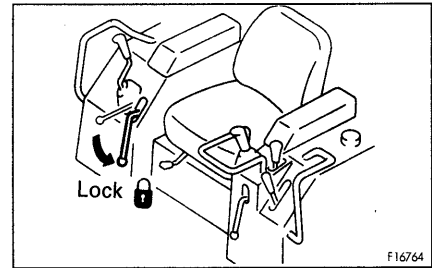

12B.12 CHECK AFTER FINISHING WORK

1. Check the gauges and lamps for engine water temperature, engine oil pressure, fuel level and air cleaner clogged.

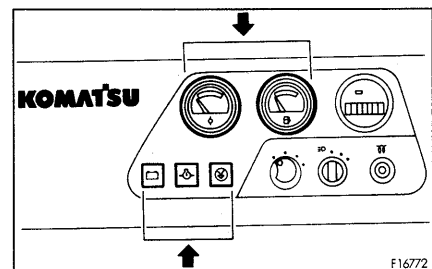

12B.13 STOPPING ENGINE

NOTICE

If the engine is abruptly stopped before it has cooled down, engine life may be greatly shortened. Consequently, do not abruptly stop the engine apart from an emergency.

In particular, if the engine has overheated, do not abruptly stop it but run it at medium speed to allow it to cool gradually, then stop it.

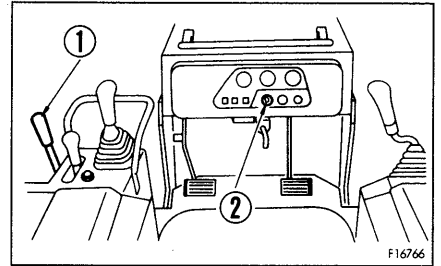

1. Run the engine at low idling speed for about 5 minutes to allow it to gradually cool down.

- **For machines stopped by fuel control lever**

2. Place fuel control lever ① in the engine stop position and stop the engine.

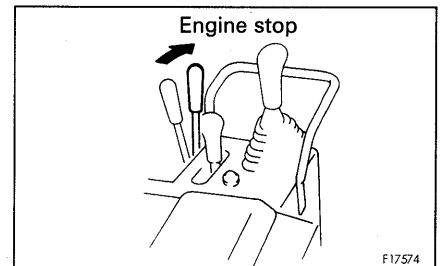

3. Turn the key in starting switch ② to the OFF position and remove the key from starting switch ②.

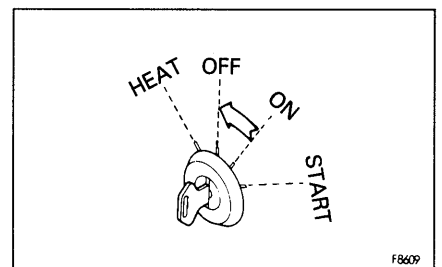

- **For machines stopped by starting switch**

2. Turn the key in starting switch ② to the OFF position and stop the engine.

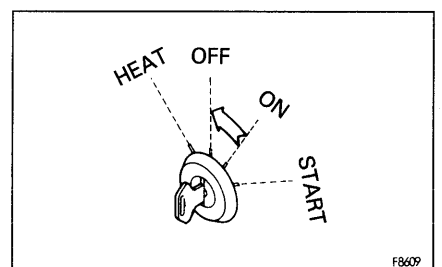

3. Remove the key from starting switch ②.

12B.14 CHECK AFTER STOPPING ENGINE

1. Walk around the machine and check the work equipment, paintwork, and undercarriage, and check also for leakage of oil or water. If any abnormalities are found, repair them.
2. Fill the fuel tank.
3. Check the engine compartment for paper and debris. Clean out any paper and debris to avoid a fire hazard.
4. Remove any mud stuck to the undercarriage.

12B.15 LOCKING

Always lock the following places.

- ① Top cover on the engine hood
- ② Side cover on the hydraulic tank

REMARK

Use the starting switch key to open and close covers ① and ②.

Commercially available locks can be fitted to the following places.

- ③ Battery inspection cover
- ④ Inspection cover for fuel tank drain valve

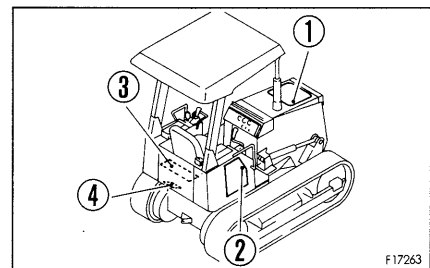

F17263

12.16 TIPS FOR LONGER UNDERCARRIAGE LIFE (STEEL SHOES ONLY)

Undercarriage life greatly varies depending on operation method, inspection and maintenance. For most efficient operation, keep the following point in mind.

12.16.1 OPERATION METHOD

- Select the track shoe that best suits the type of soil to be encountered in service.
Please consult your Komatsu distributor when selecting track shoes.
- Do not allow shoe slipping to occur during operation. If shoe slipping occurs, reduce load to the blade until slipping stops.
- Avoid sudden starts, acceleration or stops, unnecessarily high speeds and sharp turns.
- Always operate machine in a straight line whenever possible. When making turns, be careful not to allow the machine to stay to one side, so operation in both turning directions can be done properly. Make turns with the largest possible radius.
- Prior to operation, clear boulders and obstacles to prevent machine from riding over them while operating.
- On a slope, operate the machine parallel to the inclination of the slope. Do not operate across the slope. Also when stopping the machine on a slope, the machine should face toward the top of the slope.
- When ground inclines to left or right during digging operation, do not continue to dig with machine inclined. Move machine back to level ground and start to dig again.
- When idlers or sprockets are lifted due to obstacles during dozing, do not attempt to force the machine to perform. Because work at this time exceeds machine working capability.

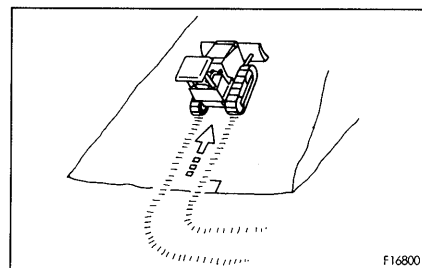

12.16.2 INSPECTION AND ADJUSTMENT

- Properly adjust track tension.
Tension should be measured at clearance ① shown in the diagram — usually 20 to 30 mm at this point. For rocky terrain, tighten tracks slightly. In clay or sandy areas, slightly loosen them. (For inspection and adjustment procedures, refer to “24.2 WHEN REQUIRED”).

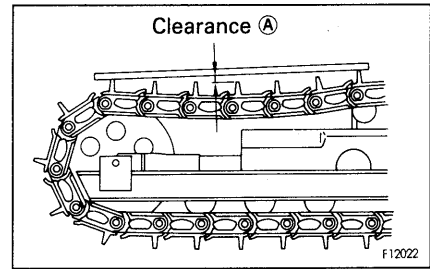

- Check idler rollers for oil leakage as well as for loose bolts and nuts. If any trouble is detected, repair immediately.

- Check the clearance between the idler guide plate and track frame. If clearance ② increases, idler may develop side motion and tracks may come off. (For inspection and adjustment procedures, refer to “24.2 WHEN REQUIRED”).

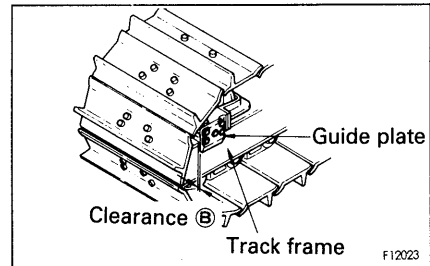

12.16.3 INSPECTION AND REPAIR

Frequent inspection and prompt repair will reduce repair costs. The following items for inspection will serve as a guide to maintenance service of each undercarriage part. Perform periodical inspection and contact the Komatsu distributor in your area when machine has approached repairable limits and reversing limits.

Measuring link pitch

1. Insert a wooden block between track shoe and sprocket to take up the slack in track shoes.

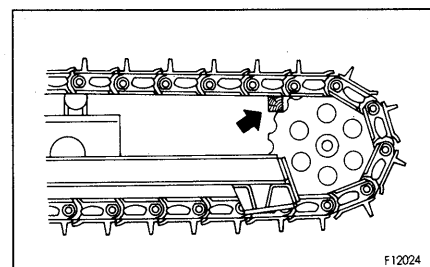

2. Measure pitch length of 4 links in stretched portion at more than 2 links away from master pin. Of length obtained, 1/4 is the link pitch.

Standard link pitch: 135 mm

Reversing limit link pitch: 138 mm

A center hole is provided on both ends of master pin.

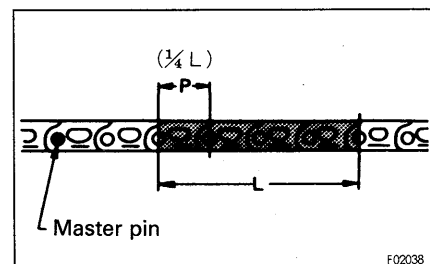

Measuring height of grouser

After taking up slack in track shoes, measure height at center of shoe as shown below.

Standard height (h): 38.5 mm

Repair limits: 15.0 mm

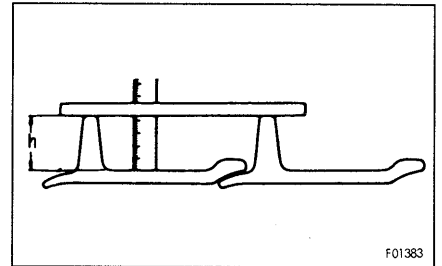
**Measuring outside diameter of track roller**

1. Measure height (size C) of link tread as shown.
2. Stop machine at position where link tread, whose size C has been measured completely, contacts roller tread. Then measure size B.
3. Calculate outside diameter of tread (size A):

$$A = (B - C) \times 2$$

Standard size (A): 135 mm

Repair limits: 127 mm

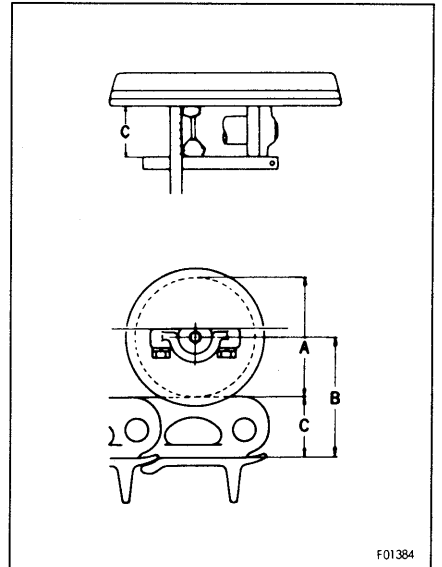

F01384

12.17 HANDLING RUBBER SHOES (RUBBER SHOES ONLY)

12.17.1 SKILLFUL USE OF RUBBER SHOES

Rubber shoes have excellent properties that are not found in metal shoes. However, if they are used in the same way as metal shoes, full use cannot be made of their advantages. Be sure to operate with rubber shoes in a way that matches the condition of the jobsite and the nature of the work.

Comparison of rubber shoes and metal shoes

	Rubber shoes	Metal shoes
Little vibration	Excellent	Average
Smooth travel	Excellent	Good
Little noise	Excellent	Average
No damage to paved surface	Excellent	Average
Easy to handle	Excellent	Average
Easily damaged	Average	Excellent
Strong drawbar pull	Excellent	Excellent

- ★ Considering the properties of the material used, rubber shoes offer various advantages. However, their weak point is lack of strength. Therefore, it is important to understand the advantages of rubber shoes, and to follow the precautions regarding handling and prohibited work. This will extend the life of the rubber shoes and will enable the machine to display the advantages of rubber shoes to the maximum. Before using rubber shoes, always read PRECAUTIONS WHEN USING RUBBER SHOES.

12.17.2 WARRANTY FOR RUBBER SHOES

It is important to inspect and maintain the tracks at the correct tension. Furthermore, these shoes must not be used near objects where they are likely to suffer damage, such as the corners of steel plates, U-shaped grooves, and blocks, on crushed rock or the sharp edges of rocks, iron beams or scrap iron.

If the customer carries out prohibited work or does not follow the precautions for operation, the damage resulting from the customer's mistaken use of the machine shall not be included in the scope of the warranty.

12.17.3 PRECAUTIONS WHEN USING RUBBER SHOES

Prohibited work

Do not carry out the following types of work.

- Carrying out operations and steering on crushed rock, extremely rough hard rock, steel beams, scrap iron, or near the edges of steel plates will cause damage to the rubber shoes.
 - In places such as riverbeds where there are large numbers of large and small boulders, the stones may get caught and damage the rubber shoes or make the shoes come off. If dozing operations are carried out when the shoes slip, this will also reduce the life of the rubber shoes.
 - Be careful not to get oil, fuel, or chemical solvent on the rubber shoes. If such a substance should get on the shoes, remove it immediately. Furthermore, do not travel on road surfaces where oil has collected.
 - When putting the machine into long-term storage (3 months or more), store the machine indoors where it is protected from direct sunlight or rain.
-
- Do not use the machine in high temperature areas, such as areas where there is burning wood, steel plate that have been left under the hot sun, or places where asphalt is being laid.

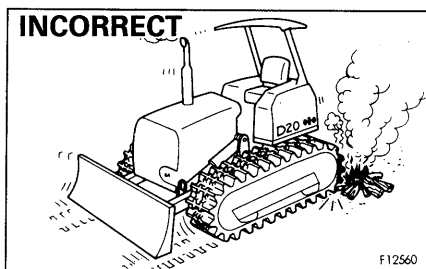
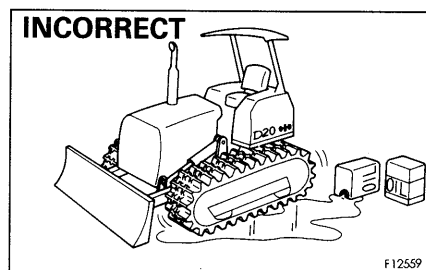
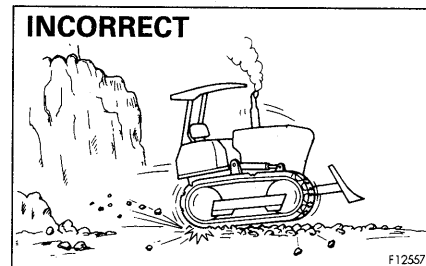

Precautions when using

Be careful of the following points when carrying out work.

- Avoid carrying out counterrotation turns on concrete surfaces.
- Avoid making sudden changes in direction. This may cause premature wear or damage to the rubber shoes.
- Avoid operating the steering when traveling over places where there is a big difference in height. When traveling over obstacles or places where there is a difference in height, drive the machine at right angles to the obstacles to prevent the shoes from coming off.
- If the machine has been raised using the blade, lower it slowly.
- Avoid doing work with materials that produce oil when crushed (soya beans, corn, or vegetables squeezed for oil), or wash the machine after using it.
- Avoid handling materials that will attach the adhesion of the steel core such as salt, ammonium sulphate, potassium chloride, potassium sulphate, calcium superphosphate; or wash the machine after use.
- The adhesion of the core will be attacked by salt, so avoid using the machine in coastal areas.
- When handling salt, sugar, wheat, or soya beans, if there is any deep cut in the rubber shoes, these substances may get into the lugs or cut portion of the rubber, so always repair the rubber before use.
- Do not carry out work that involves scraping against walls or concrete embankments.
- Rubber shoes slip extremely easily on snow or frozen roads. Be careful not to slip when traveling or working on slopes.
- The properties of rubber shoes change when working in extremely cold places, and this will reduce the life of the rubber shoe.

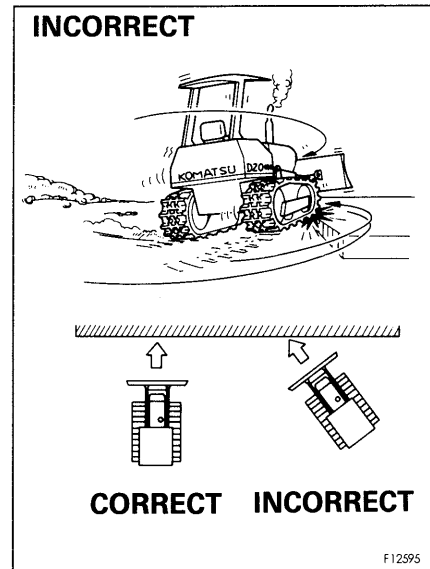

- Because of the properties of rubber, use the rubber shoes within a range of $-25^{\circ}\text{C} - +55^{\circ}\text{C}$.
- To prevent the shoes from coming off, always maintain the correct tension. If the tracks are slack, the shoes will come off under the following conditions. Even when the tension is correct, be extremely careful when carrying out these operations.

1. When traveling over curbs, rocks, or places where there is a big difference in level (approx. 20 cm), do not turn the machine. When traveling over such objects, always travel at right angles to the object.

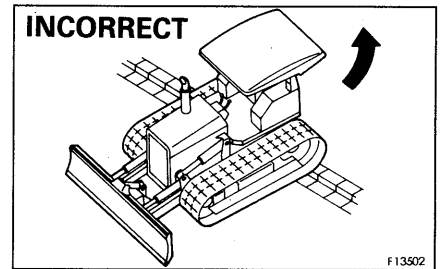

2. When traveling in reverse up a slope, do not turn when moving from flat ground onto the slope. If it is necessary to turn on slopes, be sure to turn gradually.

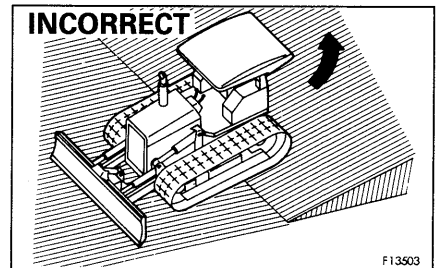

3. Avoid traveling along the edge of a slope or on rough ground with the track on one side raised (with the machine tilting at angle of more than approx. 10°), and one side on the flat ground. To avoid damage to the rubber shoes, travel with both tracks on flat ground.

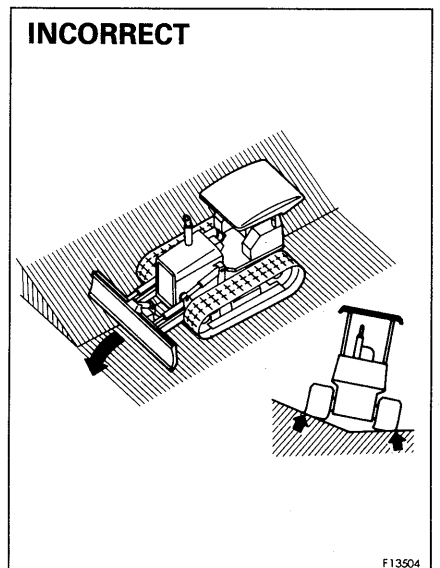

4. In Items 1 – 3, if the rubber track is loose, avoid turning in the posture in the diagram.

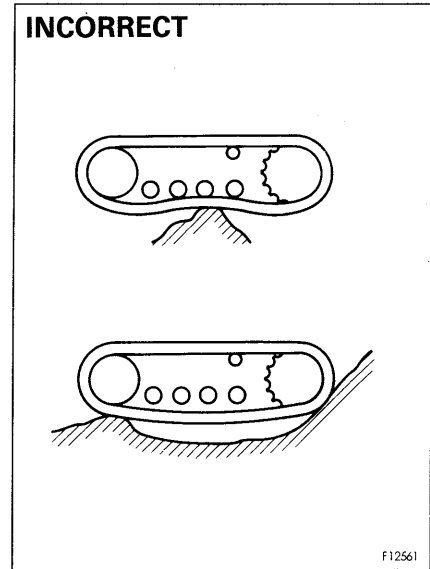

(Mechanism of rubber shoe coming off track)

- 1) When traveling over an obstacle, a gap is formed between the track roller and the rubber shoe.
In this condition, the rubber shoe may come off.

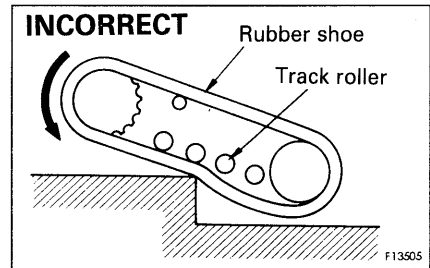

- 2) If the machine travels further in reverse, a gap is formed among the track roller, idler and the rubber shoe.

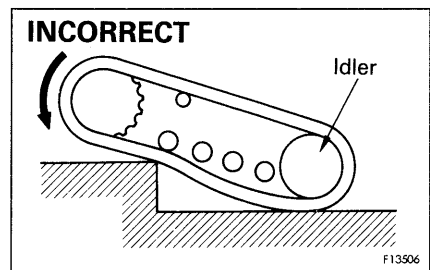

- When turning in a condition where the rubber shoe cannot move to the side because of the object it is passing over, or because of some other object.

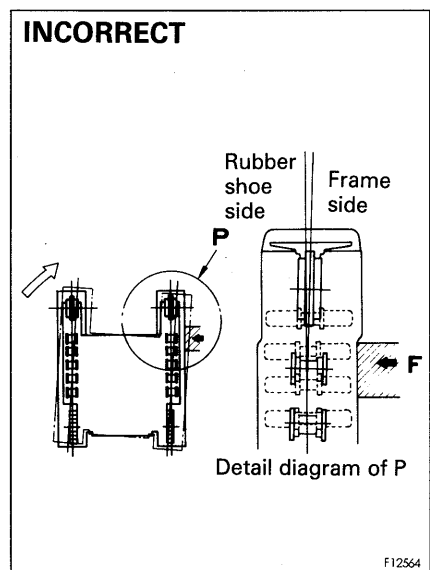

- When the idler or track roller are out of alignment with the core because of movement of the rubber shoe out of alignment.
- If the machine travels in reverse in this condition, the rubber shoe will come off.
- If the machine is turned in this condition, the rubber shoe will come off.

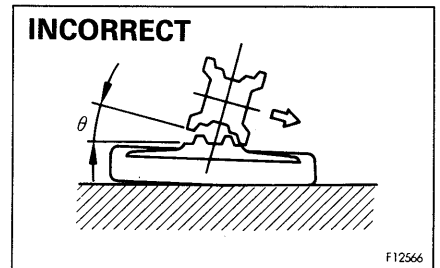
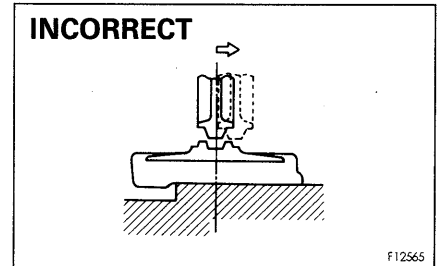

13. TRANSPORTATION

When transporting the machine, observe all related laws and regulations, and be careful to assure safety.

13.1 LOADING, UNLOADING WORK

⚠ WARNING

- **Make sure the ramp has sufficient width, length and thickness to enable the machine to be safely loaded and unloaded. If the ramps sag appreciably, reinforce it with blocks, etc.**
- **When loading and unloading the machine, park the trailer on a flat firm roadbed. Keep a fairly long distance between the road shoulder and the machine.**
- **Remove the mud from the undercarriage to prevent the machine from slipping to the side on slopes. Be sure the ramp surface is clean and free of grease, oil, ice and loose materials.**
- **Never change the direction of travel when on the ramps. If it is necessary to change direction, drive off the ramps and correct the direction, then drive on to the ramps again.**

When loading or unloading, always use ramps or a platform, and carry out the operations as follows.

1. Properly apply the brakes on the trailer and insert blocks beneath the tires to ensure that it does not move. Then fix the ramps in line with the centers of the trailer and the machine. Be sure that the two sides are at the same level as one another.
2. Determine the direction of the ramps, then slowly load or unload the machine.
3. Load the machine correctly in the specified position on the trailer.

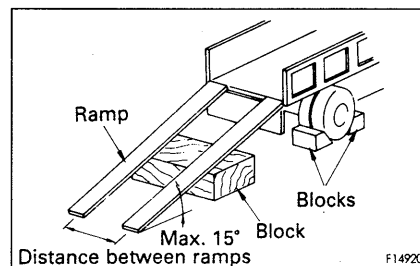

13.2 PRECAUTIONS FOR LOADING



WARNING

When the edge of the blade protrudes beyond the track, angle the blade. (Angledozer)

After loading to the specified position, secure the machine as follows.

1. Lower the blade slowly.
2. Lock all the control levers securely with the safety lever.
3. Depress the brake pedal and pull the brake lock lever to apply the brakes.
4. Move the fuel control lever to the low idling position and turn the starting switch key to the OFF position to stop the engine. Remove the key.
5. When transporting the machine, place rectangular timber underneath the front and rear track shoes to prevent the machine from moving about. Also, hold it down with chains or rope. Be particularly careful to ensure that the machine does not slip sideways.

13.3 PRECAUTIONS FOR TRANSPORTATION

 **WARNING**

Determine the route for transporting the machine by taking into account the width, height and weight of the machine.

Obey all state and local laws governing the weight, width and length of a load. Observe all regulations governing wide loads.

14. COLD WEATHER OPERATION

14.1 PRECAUTIONS FOR LOW TEMPERATURE

If the temperature becomes low, it becomes difficult to start the engine, and the coolant may freeze, so do as follows.

14.1.1 FUEL AND LUBRICANTS

Change to fuel and oil with low viscosity for all components. For details of the specified viscosity, see "20. USE OF FUEL, COOLANT AND LUBRICANTS ACCORDING TO AMBIENT TEMPERATURE".

14.1.2 COOLANT



WARNING

Keep antifreeze fluid away from an open flame. Never smoke when using antifreeze.

NOTICE

Never use methanol, ethanol or propanol based antifreeze.

Where no permanent antifreeze is available, an ethylene glycol antifreeze without corrosion inhibitor may be used only for the cold season. In this case, clean the cooling system twice a year (in spring and autumn). When refilling the cooling system, add antifreeze in autumn, but do not add any in spring.

Absolutely avoid using any water leak preventing agent irrespective of whether it is used independently or mixed with an antifreeze.

Do not mix one antifreeze with a different brand.

For details of the antifreeze mixture when changing the coolant, see "24.2 WHEN REQUIRED".

Use a Permanent Antifreeze (ethylene glycol mixed with corrosion inhibitor, antifoam agent, etc.) meeting the standard requirements as shown below. With permanent antifreeze, no change of coolant is required for a year. If it is doubtful that an available antifreeze meets the standard requirements, ask the supplier of that antifreeze for information.

Standard requirements for permanent antifreeze.

- SAE J1034
- FEDERAL STANDARD O-A-548D

14.1.3 BATTERY

⚠ WARNING

- To avoid gas explosions, do not bring fire or sparks near the battery.
- Battery electrolyte is dangerous. If it gets in your eyes or on your skin, wash it off with large amounts of water, and consult a doctor.

When the ambient temperature drops, the capacity of the battery will also drop. If the battery charge ratio is low, the battery electrolyte may freeze. Maintain the battery charge as close as possible to 100%, and insulate it against cold temperature so that the machine can be started easily the next morning.

Measure the specific gravity and calculate the rate of charge from the following conversion table.

Temp. of fluid Rate of charge	20°C	0°C	-10°C	-20°C
100%	1.28	1.29	1.30	1.31
90%	1.26	1.27	1.28	1.29
80%	1.24	1.25	1.26	1.27
75%	1.23	1.24	1.25	1.26

14.2 PRECAUTIONS AFTER COMPLETION OF WORK

To prevent mud, water, or the undercarriage from freezing and making it impossible for the machine to move on the following morning, always observe the following precautions.

- Mud and water on the machine body should be completely removed. This is to prevent damage to the seal caused by mud or dirt getting inside the seal with frozen drops of water.
- Park the machine on concrete or hard ground. If this is impossible, park the machine on wooden boards. The boards help protect the tracks from being frozen in soil and the machine can start next morning.
- Open the drain valve and drain any water collected in the fuel system to prevent it from freezing.
- As the battery capacity drops markedly in low temperatures, cover the battery or remove it from the machine, keep it in a warm place, and install it again the next morning.
- If electrolyte level is found low, add distilled water in the morning before beginning work. Do not add the water after the day's work so as to prevent fluid in the battery from freezing in the night.

14.3 AFTER COLD WEATHER

When season changes and the weather becomes warmer, do as follows.

- Replace the fuel and oil for all parts with oil of the viscosity specified.
For details, see "20. USE OF FUEL, COOLANT AND LUBRICANT ACCORDING TO AMBIENT TEMPERATURE".
- If for any reason permanent antifreeze cannot be used, and an ethyl glycol base antifreeze (winter, one season type) is used instead, or if no antifreeze is used, drain the cooling system completely, then clean out the inside of the cooling system thoroughly, and fill with fresh water.

15. LONG-TERM STORAGE

15.1 BEFORE STORAGE

When putting the machine in storage for a long time, do as follows.

- After every part is washed and dried, the machine shall be housed in a dry building. Never leave it outdoors.
In case it is indispensable to leave it outdoors, park the machine on the flat ground and cover it with canvas etc.
- Completely fill the fuel tank, lubricate and change the oil before storage.
- Apply a thin coat of grease to metal surface of the hydraulic piston rods and the idler adjusting rods.
- Disconnect the negative terminals of the battery and cover it, or remove it from the machine and store it separately.
- If the ambient temperature is expected to drop below 0°, always add antifreeze to the cooling water.
- Lock each control lever with the safety lock and place the fuel control lever in the low idling position. Do not lock the brake pedal; use blocks to stop the machine from moving.

15.2 DURING STORAGE

 **WARNING**

If it is unavoidably necessary to carry out the rust-preventive operation while the machine is indoors, open the doors and windows to improve ventilation and prevent gas poisoning.

- Operate the engine and move the machine for a short distance once a month so that a new film of oil will be coated over movable parts and component surfaces. At the same time, also charge the battery.
- Before operating the work equipment, wipe off the grease on the hydraulic piston rod.

15.3 AFTER STORAGE

NOTICE

If the machine is stored without carrying out the monthly rust prevention operation, request your Komatsu distributor for service.

Carry out the following procedure when taking the machine out of long-term storage.

- Wipe off the grease from the hydraulic cylinder rods.
- Add oil and grease to all places.

16. TROUBLESHOOTING

16.1 AFTER RUNNING OUT OF FUEL

When starting after running out of fuel, fill with fuel, then fill the fuel filter cartridge with clean fuel and bleed the air from the fuel system before starting.

For details of bleeding the air, see "24.6 EVERY 500 HOURS SERVICE".

16.2 IF BATTERY IS DISCHARGED

⚠ WARNING

- When checking or handling the battery, stop the engine and turn the starting key to the OFF position before starting.
- The battery generates hydrogen gas, so there is danger of explosion. Do not bring lighted cigarettes near the battery, or do anything that will cause sparks.
- Battery electrolyte is dilute sulphuric acid, and it will attack your clothes and skin. If it gets on your clothes or on your skin, wash it immediately off with large amounts of water. If it gets in your eyes, wash it out with fresh water, and consult a doctor.
- When handling battery, always wear protective goggles.
- When removing the battery, first disconnect the cable from the ground (normally, from the negative \ominus terminal). When installing, install the positive \oplus terminal first. If a tool touches the cable connecting the positive terminal and the chassis, there is danger that it will cause sparks.
- If the terminals are loose, there is danger that the defective contact may generate sparks that will cause an explosion. When installing the terminals, install them tightly.

When removing, disconnect the cable from the ground terminal first.

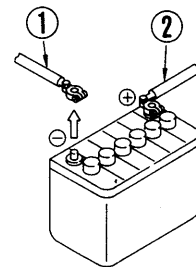

When installing, connect the cable to the positive \oplus terminal first.

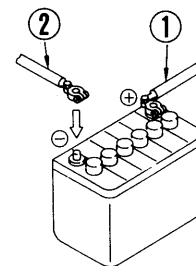

F16801

16.2.1 STARTING ENGINE WITH BOOSTER CABLE

When starting the engine with a booster cable, do as follows:

Precautions when connecting and disconnecting booster cable

WARNING

- When starting the engine from another machine, connect the batteries in parallel.
- When connecting the cables, never contact the positive \oplus and negative \ominus terminals.
- When starting the engine with a booster cable, always wear safety glasses.
- Be careful not to let the normal machine and problem machine contact each other. This prevents sparks from generating near the battery which could ignite the hydrogen gas given off by the battery. If hydrogen gas explodes. It could cause serious injury.
- Use care when removing the cables from the machine that has been started. Do not allow the cable ends to contact each other or the machine, to avoid hydrogen explosion.
- Make sure that there is no mistake in the booster cable connections. The final connection is to the engine block of problem machine, but sparks will be generated when this is done, so connect to a place as far as possible from the battery.
- Use care when removing the cables from the machine that has been started. Do not allow the cable ends to contact each other or the machine, to avoid hydrogen explosion.

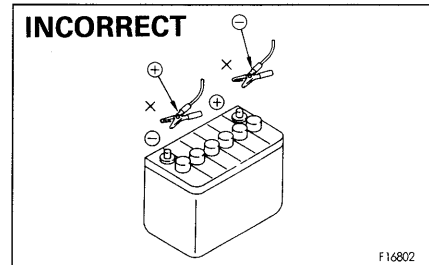

NOTICE

- The size of the booster cable and clip should be suitable for the battery size.
- The battery of the normal machine must be the same capacity as that of the engine to be started.
- Check the cables and clips for damage or corrosion.
- Make sure that the cables and clips are firmly connected.

Connecting the booster cables

Keep the starting switch at the OFF position.

Connect the booster cable as follows, in the order of the numbers marked in the diagram.

1. Make sure that the starting switches of the normal machine and problem machine are both at the OFF position.
2. Connect one clip of booster cable (A) to the positive \oplus terminal of the problem machine.
3. Connect the other clip of booster cable (A) to the positive \oplus terminal of the normal machine.
4. Connect one clip of booster cable (B) to the negative \ominus terminal of the normal machine.
5. Connect the other clip of booster cable (B) to the engine block of the problem machine.

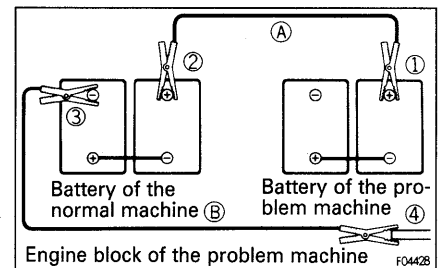
**Starting the engine**

1. Make sure the clips are firmly connected to the battery terminals.
2. Start the engine of the normal machine and keep it to run at high idling speed.
3. Turn the starting switch of the problem machine to the START position and start the engine. Refer to "12.2 STARTING ENGINE".

Disconnecting the booster cables

After the engine has started, disconnect the booster cables in the reverse of the order in which they were connected.

1. Remove one clip of booster cable **Ⓑ** from the engine block of the problem machine.
2. Remove the other clip of booster cable **Ⓑ** from the negative **⊖** terminal of the normal machine.
3. Remove one clip of booster cable **Ⓐ** from the positive **⊕** terminal of the normal machine.
4. Remove the other clip of booster cable **Ⓐ** from the positive **⊕** terminal of the problem machine.

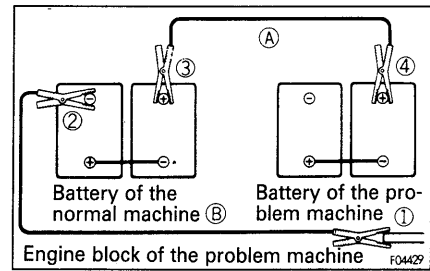

16.3 OTHER TROUBLE

(): Always contact your Komatsu distributor when dealing with these items.

- In cases of abnormalities or causes which are not listed below, please contact your Komatsu distributor for repairs.

16.3.1 ELECTRICAL SYSTEM

Problem	Main causes	Remedy
Lamp does not glow brightly even when the engine runs at high speed	<ul style="list-style-type: none"> • Defective wiring • Defective adjustment of fan belt tension 	<ul style="list-style-type: none"> (• Check, repair loose terminals, disconnections) • Adjust fan belt tension For details, see EVERY 250 HOURS SERVICE
Lamp flickers while engine is running		
Charge lamp does not go out even when engine is running	<ul style="list-style-type: none"> • Defective alternator • Defective wiring 	<ul style="list-style-type: none"> (• Replace) (• Check, repair)
Abnormal noise is generated from alternator	<ul style="list-style-type: none"> • Defective alternator 	<ul style="list-style-type: none"> (• Replace)
Starting motor does not turn when starting switch is turned to ON	<ul style="list-style-type: none"> • Defective wiring • Insufficient battery charge 	<ul style="list-style-type: none"> (• Check, repair) • Charge
Pinion of starting motor keeps going in and out	<ul style="list-style-type: none"> • Insufficient battery charge 	<ul style="list-style-type: none"> • Charge
Starting motor turns engine sluggishly	<ul style="list-style-type: none"> • Insufficient battery charge • Defective starting motor 	<ul style="list-style-type: none"> • Charge (• Replace)
Starting motor disengages before engine starts	<ul style="list-style-type: none"> • Defective wiring • Insufficient battery charge 	<ul style="list-style-type: none"> (• Check, repair) • Charge
Glow signal does not glow red	<ul style="list-style-type: none"> • Defective wiring • Defective glow plug • Defective glow signal 	<ul style="list-style-type: none"> (• Check, repair) (• Replace) (• Replace)
Oil pressure warning lamp does not light up when engine is stopped (starting switch at ON position)	<ul style="list-style-type: none"> • Defective warning lamp • Defective warning lamp switch 	<ul style="list-style-type: none"> (• Replace) (• Replace)
Charge lamp does not light up when engine is stopped (starting switch at ON position)	<ul style="list-style-type: none"> • Defective charge lamp • Defective wiring 	<ul style="list-style-type: none"> (• Replace) (• Check, repair)

16.3.2 CHASSIS

Problem	Main causes	Remedy
When steering and directional lever (D21) is moved to desired position, machine does not start, or traveling speed is slow	<ul style="list-style-type: none"> • Oil pressure of transmission is not raised. <ol style="list-style-type: none"> 1. Insufficient oil in transmission case 2. Clogged strainer in transmission case 	<ul style="list-style-type: none"> • Add oil to specified level, see CHECK BEFORE STARTING • Clean strainer
When steering lever (D20) or steering and directional lever (D21) is moved in direction to turn machine, machine does not turn and goes straight	<ul style="list-style-type: none"> • Steering clutch of moved side is not disengaged <ul style="list-style-type: none"> ◦ Steering oil pressure does not reach the specified pressure (air is leaking into oil pump) • Brake of moved side is not actuated 	<ul style="list-style-type: none"> (• Check, adjust steering clutch) • Adjust brake
When brake pedal is depressed, machine does not stop	<ul style="list-style-type: none"> • Brakes out of adjust 	<ul style="list-style-type: none"> • Adjust brake, see WHEN REQUIRED
Track comes off	<ul style="list-style-type: none"> • Track too loose 	<ul style="list-style-type: none"> • Adjust track tension, see WHEN REQUIRED
Abnormal wear of sprocket	<ul style="list-style-type: none"> • Track too loose or too tightened 	
Blade rises slowly, does not rise	<ul style="list-style-type: none"> • Lack of hydraulic oil 	<ul style="list-style-type: none"> • Add oil to specified level, see EVERY 250 HOURS SERVICE

16.3.3 ENGINE

Problem	Main causes	Remedy
Engine oil pressure warning lamp remains alight when engine speed is raised after completion of warm-up	<ul style="list-style-type: none"> • Engine oil pan oil level is low (sucking in air) • Clogged oil filter cartridge • Defective tightening of oil pipe and pipe joint, oil leakage from damaged part • Defective warning lamp 	<ul style="list-style-type: none"> • Add oil to specified level, see CHECK BEFORE STARTING • Replace cartridge, see EVERY 250 HOURS SERVICE (• Check, repair) (• Replace lamp)
Steam is emitted from top part of radiator (pressure valve)	<ul style="list-style-type: none"> • Cooling water level low, water leakage • Loose fan belt • Dirt or scale accumulated in cooling system • Clogged radiator fin or damaged fin • Defective thermostat • Loose radiator filler cap (high altitude operation) • Defective water temperature gauge 	<ul style="list-style-type: none"> • Add cooling water, repair, see CHECK BEFORE STARTING • Adjust fan belt tension, see EVERY 250 HOURS SERVICE • Change cooling water, clean inside of cooling system, see WHEN REQUIRED • Clean or repair, see EVERY 500 HOURS SERVICE (• Replace thermostat) • Tighten cap or replace packing (• Replace water temperature gauge)
Indicator of water temperature gauge is in red range on right side of gauge	<ul style="list-style-type: none"> • Defective thermostat • Defective water temperature gauge 	<ul style="list-style-type: none"> • Replace thermostat • Replace water temperature gauge
Indicator of water temperature gauge is in white range on left side of gauge	<ul style="list-style-type: none"> • Defective thermostat • Defective water temperature gauge 	<ul style="list-style-type: none"> • Replace thermostat • Replace water temperature gauge
Engine does not start when starting motor is turned	<ul style="list-style-type: none"> • Lack of fuel • Air in fuel system • Defective fuel injection pump or nozzle • Starting motor cranks engine sluggishly • Heater signal does not glow red • Defective compression <ul style="list-style-type: none"> ◦ Defective valve clearance 	<ul style="list-style-type: none"> • Add fuel, see CHECK BEFORE STARTING • Repair place where air is sucked in (• Replace pump or nozzle) } See ELECTRICAL SYSTEM (◦ Adjust valve clearance)
Exhaust gas is white or blue	<ul style="list-style-type: none"> • Too much oil in oil pan • Improper fuel 	<ul style="list-style-type: none"> • Add oil to specified level, see CHECK BEFORE STARTING • Change to specified fuel
Exhaust gas occasionally turns black	<ul style="list-style-type: none"> • Clogged air cleaner element • Defective nozzle • Defective compression 	<ul style="list-style-type: none"> • Clean or replace, see WHEN REQUIRED (• Replace nozzle) (• Adjust valve clearance)
Combustion noise occasionally makes breathing sound	<ul style="list-style-type: none"> • Defective nozzle 	<ul style="list-style-type: none"> (• Replace nozzle)
Abnormal noise generated (combustion or mechanical)	<ul style="list-style-type: none"> • Low grade fuel being used • Overheating • Damage inside muffler • Excessive valve clearance 	<ul style="list-style-type: none"> • Change to specified fuel • See item "Indicator of water temperature gauge is in red range on right side of gauge". (• Replace muffler) (• Adjust valve clearance)

MAINTENANCE

17. GUIDES TO MAINTENANCE

Obey all safety precautions in this manual and on the machine when performing maintenance.

Do not carry out any inspection and maintenance operation that is not given in this manual.

Perform maintenance work on hard, flat ground.

Check service meter

Check the service meter reading every day to see if the time has come for any necessary maintenance to be carried out.

Komatsu genuine replacement parts:

Use Komatsu genuine parts specified in the parts list as replacement parts.

Komatsu genuine oils:

Use Komatsu genuine oils and grease. Choose oils and grease with proper viscosities specified for ambient temperature.

Clean oil and grease:

Use clean oil and grease. Also, keep containers of the oil and grease clean. Keep foreign materials away from oil and grease.

Keeping the machine clean:

Always keep the machine clean. This makes it easier to find parts causing problems. Keep in particular grease fittings, breathers and oil level gauges clean and avoid foreign matters from getting in them.

Be careful of hot water and oil:

Draining hot oils and coolants and removing their filters immediately after the engine stops are hazardous. Allow the engine to cool.

If the oil has to be drained when it is cold, warm up the oil to a suitable temperature (approx. 20 – 40°C) before draining it.

Checking foreign materials in drained oil:

After oil is changed or filters are replaced, check the oil and filters for metallic particles and foreign materials. If large quantities of metallic particles or foreign materials are found, consult your Komatsu distributor.

Fuel strainer:

If your machine is equipped with a fuel strainer, do not remove it while fueling.

Oil change:

Check or change oils in the places where dust is scarce to keep foreign materials away from oils.

Warning tag:

Attach the warning tag to the starting switch or other appropriate control lever to avoid someone who is not aware of the circumstances from starting the engine.

Welding instructions:

- Turn off the engine starting switch.
- Do not apply more than 200 V continuously.
- Connect grounding the cable within 1 m from the area to be welded.
- Avoid seals or bearings from being between the area to be welded and the position of grounding point.

Fire prevention:

Use nonflammable cleaner or light oil for cleaning parts. Keep flame or cigarette light away from light oil.

Clamp faces:

When O-rings or gaskets are removed, clean the clamp faces and replace the O-rings and gaskets with new ones. Be sure to fit O-rings and gaskets when assembling.

Objects in your pockets:

Keep your pockets free of loose objects which can fall out and drop into the machinery; especially when you work on the machinery while bending over it.

Checking undercarriage:

When working in rocky areas, check for damage to the undercarriage and for looseness, flaws, wear and damage in bolts and nuts. Loosen the track tension a little when working in such areas.

Cleaning machine:

Do not direct a high-pressure jet directly at the radiator.
Do not splash water over the electrical equipment.

Pre- and post-work checks:

Before starting work in mud, rain, snow or at seashore, check plugs and valves for tightness. Wash the machine immediately after the work to protect components from rusting. Lubricate components more frequently than usual. Be sure to lubricate work equipment pins daily if they are submerged in water.

Dusty worksites:

When working at dusty worksites, do as follows:

- Check the air cleaner for clogging more frequently. Clean the air cleaner at shorter intervals than specified.
- Clean the radiator core frequently to avoid clogging.
- Clean and replace the fuel filter frequently.
- Clean electrical components, especially the starting motor and alternator, to avoid accumulation of dust.

Avoid mixing oils:

Never mix oils of different brands. If you have only oil which is a different brand from the one that is used in the machine, do not add it but replace all the oil.

18. OUTLINES OF SERVICE

- Use Komatsu genuine parts for replacement.
- When changing or adding oil, do not use a different type of oil.
- Unless otherwise specified, the oil and coolant used at the time of shipment from the factory are as shown in the table below.

Item	Kind of fluid
Engine oil pan	SAE 15W-40 API classification CD
Transmission case (Incl. bevel gear case) (D20) Transfer case (Incl. bevel gear case) (D21) Transmission case (D21) Final drive case	SAE 30 API classification CD
Hydraulic tank Main clutch case (D20)	SAE 10W API classification CD
Fuel tank	ASTM D975 No. 2 (However, ASTM D975 No. 1 is used for the winter season (October to March))
Radiator	Komatsu Supper Coolant (AF-ACL) 41% added to water

18.1 OUTLINE OF OIL, FUEL, COOLANT

18.1.1 OIL

- Oil is used in the engine and work equipment under extremely severe conditions (high temperature, high pressure), and it deteriorates with use.
Always use oil that matches the grade and temperature for use given in the Operation and Maintenance Manual. Even if the oil is not dirty, always replace the oil after the specified interval.
- Oil corresponds to blood in the human body, so always be careful when handling it to prevent any impurities (water, metal particles, dirt, etc.) from getting in.
The majority of problems with machine are caused by the entry of such impurities.
Take particular care not to let any impurities get in when storing or adding oil.
- Never mix oils of different grades or brands.
- Always add the specified amount of oil.
Having too much oil or too little oil are both causes of problems.
- If the oil in the work equipment is not clear, there is probably water or air getting into the circuit. In such cases, please contact your Komatsu distributor.
- When changing the oil, always replace the related filters at the same time.
- We recommend you to have an analysis made of the oil periodically to check the condition of the machine. For those who wish to use this service, please contact your Komatsu distributor.

18.1.2 FUEL

- The fuel pump is a precision instrument, and if fuel containing water or dirt is used, it cannot work properly.
- Be extremely careful not to let impurities get in when storing or adding fuel.
- Always use the fuel specified in the Operation and Maintenance Manual.
Fuel may congeal depending on the temperature when it is used (particularly in low temperature below -15°C), so it is necessary to change to a fuel that matches the temperature.
- To prevent the moisture in the air from condensing and forming water inside the fuel tank, always fill the fuel tank after completing the day's work.
- Before starting the engine, or when 10 minutes have passed after adding fuel, drain the sediment and water from the fuel tank.
- If the engine runs out of fuel, or if the filters have been replaced, it is necessary to bleed the air from the circuit.

18.1.3 COOLANT

- River water contains large amounts of calcium and other impurities, so if it is used, scale will stick to the engine and radiator, and this will cause defective heat exchange and overheating.
Do not use water that is not suitable for drinking.
- When using anti-freeze, always observe the precautions given in the Operation and Maintenance Manual.
- Komatsu machines are supplied with Komatsu original anti-freeze in the coolant when the machine is shipped.
This anti-freeze is effective in preventing corrosion of the cooling system.
The anti-freeze can be used continuously for two years or 4000 hours. Therefore, it can be used as it is even in hot areas.
- Anti-freeze is inflammable, so be extremely careful not to expose it to flame or fire.
- The proportion of anti-freeze to water differs according to the ambient temperature.
For details of the mixing proportions, see "24.2 WHEN REQUIRED".
- If the engine overheats, wait for the engine to cool before adding coolant.
- If the coolant level is low, it will cause overheating and will also cause problems with corrosion from the air in the coolant.

18.1.4 GREASE

- Grease is used to prevent twisting and noise at the joints.
- The nipples not included in the maintenance section are nipples for overhaul, so they do not need grease.
If any part becomes stiff after being used for a long time, add grease.
- Always wipe off all of the old grease that is pushed out when greasing. Be particularly careful to wipe off the old grease in places where sand or dirt sticking in the grease would cause wear of the rotating parts.

18.1.5 STORING OIL AND FUEL

- Keep indoors to prevent any water, dirt, or other impurities from getting in.
- When keeping drum cans for a long period, put the drum on its side so that the filler port of the drum can is at the side. (To prevent moisture from being sucked in)
If drum cans have to be stored outside, cover them with a waterproof sheet or take other measures to protect them.
- To prevent any change in quality during long-term storage, be sure to use in the order of first in — first out (use the oldest oil or fuel first).

18.1.6 FILTERS

- Filters are extremely important safety parts. They prevent impurities in the fuel and air circuits from entering important equipment and causing problems.
Replace all filters periodically. For details, see the Operation and Maintenance Manual.
However, when working in severe conditions, it is necessary to consider replacing the filters at shorter intervals according to the oil and fuel (sulfur content) being used.
- Never try to clean the filters (cartridge type) and use them again. Always replace with new filters.
- When replacing oil filters, check if any metal particles are stuck to the old filter. If any metal particles are found, please contact your Komatsu distributor.
- Do not open packs of spare filters until just before they are to be used.
- Always use Komatsu genuine filters.

18.2 RELATING TO ELECTRIC SYSTEM

- If the wiring gets wet or the insulation is damaged, the electric system leaks and this could result in hazardous malfunction of the machine.
- Services relating to the electric system are (1) check of fan belt tension, (2) check of damage or wear in the fan belt and (3) check of battery fluid level.
- Never remove or disassemble any electric components installed in the machine.
- Never install any electric components other than these specified by Komatsu.
- Be careful to keep the electric system free of water when washing the machine or when it rains.
- When working on the seashore, carefully clean the electric system to prevent corrosion.
- Never connect any optional power source to the fuse, starting switch, battery relay, etc.

19. WEAR PARTS LIST

Wear parts such as the filter element, cutting edge, etc. are to be replaced at the time of periodic maintenance or before their abrasion limits.

The wear parts should be changed correctly in order to use the machine economically.

For part change, Komatsu genuine parts of excellent quality should be used.

The parts in parentheses are to be replaced at the same time.

Item	Part No.	Part Name	Q'ty	Replacement frequency
Engine oil filter	600-211-6241	Cartridge	1	Every 500 hours service
Fuel filter	600-311-7440	Cartridge	1	Every 500 hours service
Hydraulic oil filter	113-60-43321	Cartridge	1	Every 1000 hours service
Air cleaner	600-181-7400	Element ass'y	1	—
	600-181-7300	Outer element ass'y	1	
Blade (D20AG, D21A, AG-7)	104-72-21140	Edge	1	—
	12F-929-2170	End bit	2	
	(02090-10840)	(Bolt)	(18)	
	(02290-10813)	(Nut)	(18)	
Blade (D20PL-7)	12F-B74-3171	Edge	2	—
	12F-929-2170	End bit	2	
	(02090-10840)	(Bolt)	(20)	
	(02290-10813)	(Nut)	(20)	
Blade (D20PLL-7)	10F-A74-8170	Edge	3	—
	12F-929-2170	End bit	2	
	(02090-10840)	(Bolt)	(26)	
	(02290-10813)	(Nut)	(26)	
Blade (D20P, PG, D21PG-7A)	10G-Z46-1120	Edge	1	—
	12F-929-2170	End bit	2	
	(02090-10840)	(Bolt)	(21)	
	(02290-10813)	(Nut)	(21)	

20. USE OF FUEL, COOLANT AND LUBRICANTS ACCORDING TO AMBIENT TEMPERATURE

PROPER SELECTION OF FUEL, COOLANT AND LUBRICANTS

RESERVOIR	KIND OF FLUID	AMBIENT TEMPERATURE									CAPACITY				
		-22 -30	-4 -20	14 -10	32 0	50 10	68 20	86 30	104 40	122°F 50°C	Specified	Refill			
Engine oil pan	Engine oil					SAE 30						8.0 ℓ 2.11 US gal 1.76 UK gal	7.0 ℓ 1.85 US gal 1.54 UK gal		
				SAE 10W											
				SAE 10W-30											
				SAE 15W-40											
Transmission case (incl. bevel gear case) (D20)												16.5 ℓ 4.36 US gal 3.63 UK gal	16.5 ℓ 4.36 US gal 3.63 UK gal		
Transfer case (incl. bevel gear case) (D21)												13.0 ℓ 3.43 US gal 2.86 UK gal	13.0 ℓ 3.43 US gal 2.86 UK gal		
Transmission case (D21)						SAE 30						13.0 ℓ 3.43 US gal 2.86 UK gal	11.0 ℓ 2.90 US gal 2.42 UK gal		
Final drive case (each)												6 ℓ (each) 1.58 US gal 1.32 UK gal (D20AG, D21A, AG-7)	6 ℓ 1.58 US gal 1.32 UK gal		
				SAE 10W								8 ℓ (each) 2.11 US gal 1.76 UK gal (D20PL-7 D20P-7A D20, 21PG-7A)	8 ℓ 2.11 US gal 1.76 UK gal		
												12 ℓ (each) 3.17 US gal 2.64 UK gal (D20PLL-7)	12 ℓ 3.17 US gal 2.64 UK gal		
Main clutch case (D20)			SAE 10W									6 ℓ 1.58 US gal 1.32 UK gal	6 ℓ 1.58 US gal 1.32 UK gal		
Hydraulic system											33 ℓ 8.71 US gal 7.26 UK gal (D20AG, D21A, AG-7 D20P, PG, D21PG-7A)	21 ℓ 5.54 US gal 4.62 UK gal			
				SAE 10W											
				SAE 10W-30											
					SAE 15W-40							31 ℓ 8.18 US gal 6.82 UK gal (D20PL-7 D20PLL-7)	21 ℓ 5.54 US gal 4.62 UK gal		
Fuel tank	Diesel fuel			ASTM D975 No. 2								60 ℓ 15.84 US gal 13.20 UK gal	—		
		※													
Cooling system	Water	Add antifreeze									10 ℓ 2.64 US gal 2.20 UK gal	—			

※ ASTM D975 No. 1

REMARK:

- When fuel sulphur content is less than 0.5%, change oil in the oil pan every periodic maintenance hours described in this manual.
Change oil according to the following table if fuel sulphur content is above 0.5%.

Fuel sulphur content	Change interval of oil in engine oil pan
0.5 to 1.0%	1/2 of regular interval
Above 1.0%	1/4 of regular interval

- When starting the engine in an atmospheric temperature of lower than 0°C, be sure to use engine oil of SAE10W, SAE10W-30 and SAE15W-40, even though an atmospheric temperature goes up to 10°C more or less in the day time.
- Use API classification CD as engine oil and if API classification CC, reduce the engine oil change interval to half.
- There is no problem if single grade oil is mixed with multigrade oil (SAE10W-30, 15W-40), but be sure to add single grade oil that matches the temperature in the table.
- We recommend Komatsu genuine oil which has been specifically formulated and approved for use in engine and hydraulic work equipment applications.

Specified capacity: Total amount of oil including oil for components and oil in piping.

Refill capacity: Amount of oil needed to refill system during normal inspection and maintenance.

ASTM: American Society of Testing and Material

SAE: Society of Automotive Engineers

API: American Petroleum Institute

20. USE OF FUEL, COOLANT AND LUBRICANTS ACCORDING TO AMBIENT TEMPERATURE

No.	Supplier	Engine Oil [CD or CE] SAE10W, 30, 40 10W30, 15W40 (The 15W40 oil marked * is CE.)	Gear Oil [GL-4 or GL-5] SAE80, 90, 140	Grease [Lithium-Base] NLGI No. 2	Anti-freeze Coolant [Ethylene Glycol Base] Permanent Type
1	KOMATSU	EO10-CD EO30-CD EO10-30CD EO15-40CD	GO90 GO140	G2-LI G2-LI-S	AF-ACL AF-PTL AF-PT (Winter, one season type)
2	AGIP	Diesel sigma S Super dieselmulti- grade *Sigma turbo	Rotra MP	GR MU/EP	—
3	AMOCO	*Amoco 300	Multi-purpose gear oil	RYKON premium grease	—
4	ARCO	*Arcofleet S3 plus	Arco HD gear oil	Litholine HEP 2 Arco EP moly D	—
5	BP	Vanellus C3	Gear oil EP Hypogear EP	Energrease LS-EP2	Antifreeze
6	CALTEX	*RPM delo 400 RPM delo 450	Universal thuban Universal thuban EP	Marfak all purpose 2 Ultra-duty grease 2	AF engine coolant
7	CASTROL	*Turbomax *RX super CRD	EP EPX Hypoy Hypoy B Hypoy C	MS3 Spheerol EPL2	Anti-freeze
8	CHEVRON	*Delo 400	Universal gear	Ultra-duty grease 2	—
9	CONOCO	*Fleet motor oil	Universal gear lubricant	Super-sta grease	—
10	ELF	Multiperformance 3C Performance 3C	—	Tranself EP Tranself EP type 2	Glacelf
11	EXXON (ESSO)	Essolube D3 *Essolube XD-3 *Essolube XD-3 Extra *Esso heavy duty Exxon heavy duty	Gear oil GP Gear oil GX	Beacon EP2	All season coolant
12	GULF	Super duty motor oil *Super duty plus	Multi-purpose gear lubricant	Gulfcrown EP2 Gulfcrown EP special	Antifreeze and coolant
13	MOBIL	Delvac 1300 *Delvac super 10W-30, 15W-40	Mobilube GX Mobilube HD	Mobilux EP2 Mobilgrease 77 Mobilgrease special	—

20. USE OF FUEL, COOLANT AND LUBRICANTS ACCORDING TO AMBIENT TEMPERATURE

No.	Supplier	Engine Oil [CD or CE] SAE10W, 30, 40 10W30, 15W40 (The 15W40 oil marked * is CE.)	Gear Oil [GL-4 or GL-5] SAE80, 90, 140	Grease [Lithium-Base] NLGI No. 2	Anti-freeze Coolant [Ethylene Glycol Base] Permanent Type
14	PENNZOIL	*Supreme duty fleet motor oil	Multi-purpose 4092 Multi-purpose 4140	Multi-purpose white grease 705 707L White – bearing grease	Anti-freeze and summer coolant
15	PETROFINA	FINA kappa TD	FINA potonic N FINA potonic NE	FINA marson EPL2	FINA tamidor
16	SHELL	Rimula X	Spirax EP Spirax heavy duty	Alvania EP grease	—
17	SUN	—	Sunoco GL5 gear oil	Sunoco ultra prestige 2EP Sun prestige 742	Sunoco antifreeze and summer coolant
18	TEXACO	*Ursa super plus Ursa premium	Multigear	Multifak EP2 Starplex 2	Code 2055 startex antifreeze coolant
19	TOTAL	Rubia S *Rubia X	Total EP Total transmission TM	Multis EP2	Antigel/antifreeze
20	UNION	*Guardol	MP gear lube LS	Unoba EP	—
21	VEEDOL	*Turbostar *Diesel star MDC	Multigear Multigear B Multigear C	—	Antifreeze

21. STANDARD TIGHTENING TORQUES FOR BOLTS AND NUTS

21.1 INTRODUCTION OF NECESSARY TOOLS

The following tools are needed when carrying out maintenance.

No.	Name of tool	Part No.	Remarks
1	Wrench set	09000-30006	Applicable width across flats ($S_1 - S_2$) 8 mm – 10 mm, 12 mm – 14 mm 13 mm – 17 mm, 19 mm – 22 mm 24 mm – 27 mm, 30 mm – 32 mm
			
2	Socket	09021-01725	Applicable width across flats 17 mm
3	Socket	09021-01928	Applicable width across flats 19 mm
4	Socket	09021-02233	Applicable width across flats 22 mm
5	Extension	09022-00150	
6	Handle	09023-00300	
7	Screwdriver	09033-00190	Interchangeable flat-head and cross-head type
8	Filter wrench	09019-08035	For filter cartridges
9	Grease pump	07952-80002	For greasing work
10	Grease cartridge	07950-90403	(Lithium base grease, 400 g)

If any of the above tools are broken, please order them from your Komatsu distributor.



21.2 TORQUE LIST

Unless otherwise specified, tighten the metric bolts and nuts to the torque shown in the table.

The tightening torque is determined by the width across the flats $\text{\textcircled{D}}$ of the nut and bolt.

If it is necessary to replace any nut or bolt, always use a Komatsu genuine part of the same size as the part that was replaced.

Nm (newton meter): $1\text{Nm} \doteq 0.1 \text{kgm}$

Thread diameter of bolt (mm) (a)	Width across flat (mm) (b)		
		kgm	Nm
6	10	1.35 ± 0.15	13.2 ± 1.4
8	13	3.2 ± 0.3	31.4 ± 2.9
10	17	6.7 ± 0.7	65.7 ± 6.8
12	19	11.5 ± 1.0	112 ± 9.8
14	22	18.0 ± 2.0	177 ± 19
16	24	28.5 ± 3	279 ± 29
18	27	39 ± 3	383 ± 39
20	30	56 ± 6	549 ± 58
22	32	76 ± 8	745 ± 78
24	36	94.5 ± 10	927 ± 98
27	41	135 ± 15	1320 ± 140
30	46	175 ± 20	1720 ± 190
33	50	225 ± 25	2210 ± 240
36	55	280 ± 30	2750 ± 290
39	60	335 ± 35	3280 ± 340

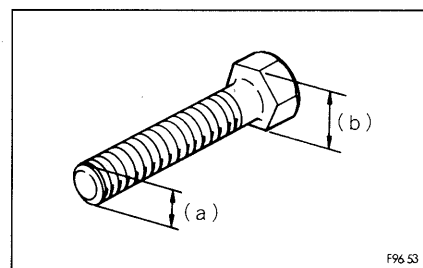

NOTICE

When tightening panels or other parts having tightening fixtures made of plastic, be careful not to use excessive tightening torque: doing so will damage the plastic parts.

22. PERIODIC REPLACEMENT OF SAFETY CRITICAL PARTS

To ensure safety at all times when operating or driving the machine, the user of the machine must always carry out periodic maintenance. In addition, to further improve safety, the user should also carry out periodic replacement of the parts given in the table on the next page. These parts are particularly closely connected to safety and fire prevention.

With these parts, the material changes as time passed, or they easily wear or deteriorate. However, it is difficult to judge the condition of the parts simply by periodic maintenance, so they should always be replaced after a fixed time has passed, regardless of their condition. This is necessary to ensure that they always maintain their function completely.

However, if these parts show any abnormality before the replacement interval has passed, they should be repaired or replaced immediately.

If the hose clamps show any deterioration, such as deformation or cracking, replace the clamps at the same as the hoses.

When replacing the hoses, always replace the O-rings, gaskets, and other such parts at the same time.

Ask your Komatsu distributor to replace the safety critical parts.

SAFETY CRITICAL PARTS

No.	Critical parts for periodical replacement	Q'ty	Replacement interval
①	Fuel hose (fuel filter – injection pump)	2	Every 2 years or 4000 hours, whichever comes sooner
②	Fuel hose (fuel tank – injection pump)	1	
③	Spill hose (fuel filter – nozzle)	1	
④	Spill hose (between nozzles)	3	
⑤	Spill hose (nozzle – fuel tank)	1	
⑥	Hose (main clutch cooler – main clutch) (D20)	2	
⑦	Hose (main clutch relief valve – PPC valve) (D20)	2	
⑧	Hose (main clutch case – PPC valve) (D20)	1	
⑨	Hose (transmission cooler – transmission) (D21)	2	
⑩	Hose (transmission valve – PPC valve) (D21)	2	
⑪	Hose (transmission case – PPC valve) (D21)	1	
⑫	Hose (PPC valve – steering cylinder)	2	
⑬	Hose (PPC valve – brake cylinder)	2	
⑭	Brake cylinder hose (between brake cylinder)	2	

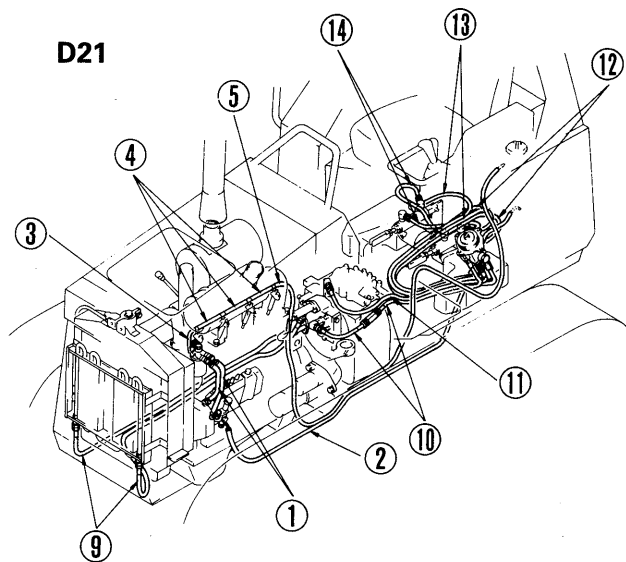
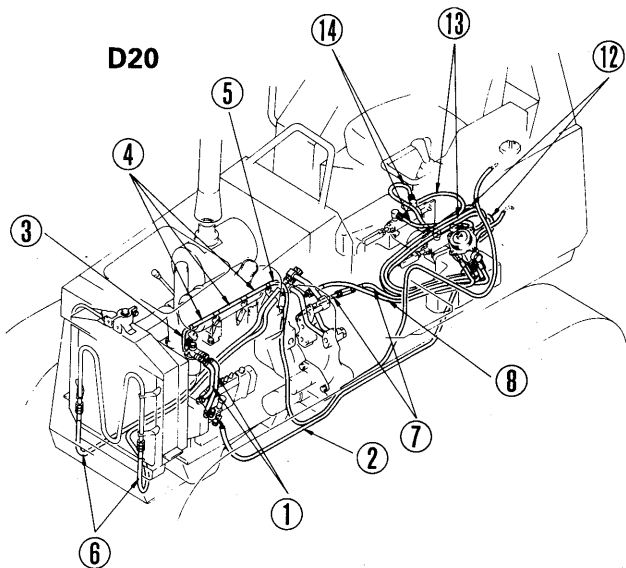

23. MAINTENANCE SCHEDULE CHART

23.1 MAINTENANCE SCHEDULE CHART

SERVICE ITEM	PAGE
INITIAL 250 HOURS SERVICE (only after the first 250 hours)	
Replace fuel filter cartridge	3-56
Change oil in engine oil pan, replace engine oil filter cartridge	3-58
Change oil in bevel gear case, transmission case (D20 only)	3-61
Change oil in bevel gear case, transfer case (D21 only)	3-61
Change oil in main clutch case, clean strainer (D20 only)	3-62
Change oil in transmission case, clean strainer (D21 only)	3-63
Change oil in final drive case	3-64
Change oil in hydraulic tank, replace hydraulic oil filter cartridge	3-65
Check engine valve clearance, adjust	3-69
WHEN REQUIRED	
Clean inside of cooling system	3-22
Check, clean and replace air cleaner element	3-27
Check track tension (Steel shoes only)	3-29
Check and tighten track shoe bolt (Steel shoes only)	3-30
Check and replace rubber shoes (Rubber shoes only)	3-31
Replace rubber shoes (Rubber shoes only)	3-32
Check and adjust track tension (Rubber shoes only)	3-35
Reverse and replace the end bits and cutting edges	3-37
Bleed air from head end of angle circuit	3-38
Adjust inertia brake (D20 only)	3-39
Adjust main clutch (D20 only)	3-40
Adjust brake pedal	3-41
Adjust idler clearance	3-42
Adjust angle of blade edge	3-42
CHECK BEFORE STARTING	
Check coolant level, add water	3-44
Check fuel level, add fuel	3-44
Check oil level in engine oil pan, add oil	3-45

SERVICE ITEM	PAGE
Check oil level in bevel gear case, transmission case, add oil (D20 only)	3-46
Check oil level in bevel gear case, transfer case, add oil (D21 only)	3-46
Check oil level in main clutch case, add oil (D20 only)	3-47
Check oil level in transmission case, add oil (D21 only)	3-48
Check brake pedal travel	3-49
Check play of main clutch pedal (D20 only)	3-49
Check main clutch inertia brake (D20 only)	3-49
Check for water and sediment in water separator, drain water	3-49
EVERY 50 HOURS SERVICE	
Drain water, sediment from fuel tank	3-50
EVERY 250 HOURS SERVICE	
Lubricating	3-51
(For hydraulic angle – tilt dozer)	
• Angle – tilt frame center pin (1 point)	3-51
• Rod pin (2 points)	3-51
• Lift cylinder bottom pin (2 points)	3-51
• Lift cylinder head pin (2 points)	3-51
• Angle – tilt frame support pin (2 points)	3-52
• Angle cylinder head pin (2 points)	3-52
• Tilt cylinder head pin (1 point)	3-52
• Tilt cylinder bottom pin (1 point)	3-52
• Angle cylinder bottom pin (2 points)	3-52
(For hydraulic tilt dozer)	
• Lift cylinder yolk (8 points)	3-52
• Lift cylinder head pin (2 points)	3-52
• Tilt cylinder head pin (1 point)	3-52
• Tilt brace pin (2 points)	3-52
• Center brace pin (4 points)	3-52
Check oil level in final drive case, add oil	3-53

23. MAINTENANCE SCHEDULE CHART

SERVICE ITEM	PAGE
(EVERY 250 HOURS SERVICE)	
Check oil level in hydraulic tank, add oil	3-53
Check level of battery electrolyte	3-54
Check fan belt tension, adjust	3-54
Check electric wirings	3-55
EVERY 500 HOURS SERVICE	
Replace fuel filter cartridge	3-56
Change oil in engine oil pan, replace engine oil filter cartridge	3-58
Clean, check radiator fins	3-59
Clean breather	3-60
• Transmission case breather (1 point)	3-60
• Main clutch case breather (D20 only) (1 point)	3-60
• Bevel gear case, transfer case breather (D21 only) (1 point)	3-60
EVERY 1000 HOURS SERVICE	
Change oil in bevel gear case, transmission case (D20 only)	3-61
Change oil in bevel gear case, transfer case (D21 only)	3-61
Change oil in main clutch case, clean strainer (D20 only)	3-62
Change oil in transmission case, clean strainer (D21 only)	3-63
Change oil in final drive case	3-64
Change oil in hydraulic tank, replace hydraulic oil filter cartridge	3-65
Check oil in undercarriage components	3-66
Add anti-corrosive agent to cooling system (Applicable only in hard water areas)	3-67
EVERY 2000 HOURS SERVICE	
Check alternator, starting motor	3-69
Check engine valve clearance, adjust	3-69
EVERY 4000 HOURS SERVICE	
Check water pump	3-70

24. SERVICE PROCEDURE

24.1 INITIAL 250 HOURS SERVICE

Carry out the following maintenance only after the first 250 hours.

- **REPLACE FUEL FILTER CARTRIDGE**
- **CHANGE OIL IN ENGINE OIL PAN, REPLACE ENGINE OIL FILTER CARTRIDGE**
- **CHANGE OIL IN BEVEL GEAR CASE, TRANSMISSION CASE (D20 only)**
- **CHANGE OIL IN BEVEL GEAR CASE, TRANSFER CASE (D21 only)**
- **CHANGE OIL IN MAIN CLUTCH CASE, CLEAN STRAINER (D20 only)**
- **CHANGE OIL IN TRANSMISSION CASE, CLEAN STRAINER (D21 only)**
- **CHANGE OIL IN FINAL DRIVE CASE**
- **CHANGE OIL IN HYDRAULIC TANK, REPLACE HYDRAULIC OIL FILTER CARTRIDGE**
- **CHECK ENGINE VALVE CLEARANCE, ADJUST**

For details of the method of replacing or maintaining, see the section on EVERY 500 HOURS, 1000 HOURS AND 2000 HOURS SERVICE.

24.2 WHEN REQUIRED

24.2.1 CLEAN INSIDE OF COOLING SYSTEM

⚠ WARNING

- **Soon after the engine has been stopped, the coolant is hot and can cause personal injury. Allow the engine to cool before draining water.**
- **Never remove the radiator cap when the engine is at operating temperature. At operating temperature, the coolant is under pressure. Steam blowing up from the radiator could cause personal injury. Allow the engine to cool until the radiator filler cap is cool enough to touch with your hand. Remove the filler cap slowly to relieve pressure.**
- **Never be under the machine with the engine running. To avoid serious injury, always stop the engine before being under the machine to open the drain valve.**
- **When removing drain plug, avoid pouring coolant on yourself.**
- **Antifreeze is flammable, so keep it away from any flame.**
- **Flushing agents, neutralizing agents, and anti-corrosive agents are strong acids or alkalize, so be careful not to get them on your skin. If you should get any of these on your skin, wash off immediately with ample water.**
- **After using the agent, do not use the empty packet for keeping food, etc.**

- Clean the inside of the cooling system, change the coolant and add corrosion resistant KI-2 (powder) according to the table below.

Kind of coolant	Cleaning inside of cooling system and changing coolant	Adding corrosion resistant KI-2 (in hard water areas)
Permanent type antifreeze (All season type)	Every year (autumn) or every 2000 hours whichever comes first	Every 1000 hours and when cleaning the inside of the cooling system and when changing coolant
Non permanent type antifreeze containing ethylene glycol (Winter, one season type)	Every 6 months (spring, autumn) (Drain antifreeze in spring, add antifreeze in autumn)	
When not using antifreeze	Every 6 months or every 1000 hours whichever comes first	

- Use a permanent type of antifreeze.
If, for some reason, it is impossible to use permanent type antifreeze, use an antifreeze containing ethylene glycol.
- Stop the machine on level ground when cleaning or changing the coolant.
- To restrict the formation of rust and scale in hard water areas, add Komatsu genuine corrosion resistant KI-2 (powder) to the cooling water.
Never use commercial available anti-corrosive agents (made by Fleetguard, etc.).
- When deciding the ratio of antifreeze to water, check the lowest temperature in the past, and decide from the mixing rate table given below.
It is actually better to estimate a temperature about 10°C lower when deciding the mixing rate.

Mixing rate of water and antifreeze

Min. atmospheric temperature (°C)	-5	-10	-15	-20	-25	-30
Amount of antifreeze (ℓ)	2.3	3.0	3.6	4.1	4.6	5.0
Amount of water (ℓ)	7.7	7.0	6.4	5.9	5.4	5.0

- We recommend use of an antifreeze density gauge to control the mixing proportions.
- Use city water for the cooling water.
If river water, well water or other such water supply must be used, contact your Komatsu distributor.

24. SERVICE PROCEDURE

1. Turn radiator cap ① slowly to remove it.
2. Set a container to catch the coolant under drain valve ② and drain plug ③. Open drain valve ② at the bottom of the radiator and drain plug ③ on the side face of the cylinder block to drain the water.
3. After draining the water, close drain valve ② and drain plug ③, and fill with city water.
4. Open drain plug ③, run the engine at low idling, and flush water through the system for 10 minutes. When doing this, adjust the speed of filling and draining the water so that the radiator is always full.
While flushing water through the system, watch carefully that the water inlet hose does not come out of the radiator water filler.
5. After flushing, stop the engine, open drain plug ③, then close it again after all the water has drained out.
6. After draining the water, clean with a flushing agent.

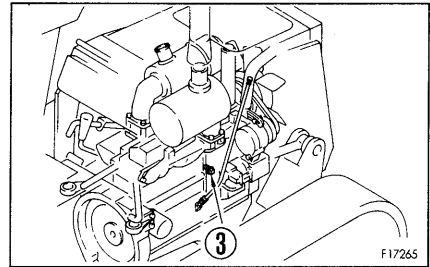
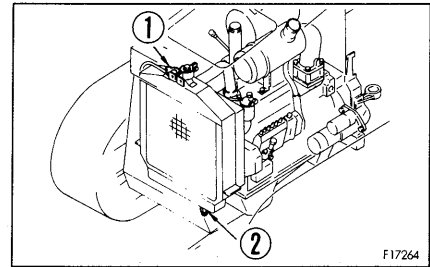

We recommend you to use Komatsu genuine flushing agent KC.

CAUTION

Flushing agent KC is a strong acid, so after flushing, add neutralizing agent KN to the container to neutralize the water, then drain the water.

Do not put neutralizing agent KN inside the engine cooling water system. The rust is ionized by flushing agent KC, but if neutralizing agent KN is added, sediment will be formed again, and this may accumulate inside the cooling system.

- (1) Use a clean polyethylene container, and dissolve one packet of flushing agent KC in 6 liters of water.
If the container is large enough, it is possible to dissolve all the necessary flushing agent at the same time.
- (2) Add the KC solution to the radiator.
- (3) Add water to the radiator to the specified water level.
- (4) Tighten the radiator cap, and run the engine at idling at a midrange speed for one or two hours. Every 20 minutes, apply load to the engine.
- (5) Stop the engine, then drain and add water in accordance with Steps 1 – 3.

- (6) Add water and open drain plug ③ at the same time, and run water to flush the system for about 30 minutes with the engine at a midrange speed.
When doing this, be careful to adjust the amount of water supplied and drained to ensure that the radiator is always filled.
- (7) After flushing for 30 minutes, take a sample and check the condition of the water in the cooling system. If the water is orange, continue flushing until the water becomes colorless and transparent.
- (8) When the drained water becomes colorless and transparent, collect 100 cc of the drained water in a container, add 5 cc of neutralizing agent KN (white powder), mix it well, and check that no blue-green or orange sediment is formed.
If any blue-green or orange sediment is formed, continue the flushing operation until this problem disappears.

REMARK

Flushing agent KC comes in packets of 500 g and neutralizing agent KN in packets of 250 g.

(The specified density for the flushing agent KC is 35 g/ℓ, and for the neutralizing agent KN is 17.5 g/ℓ.)

There is no problem in using commercially available flushing agents or neutralizing agent (when draining the water). In this case, use the flushing agent or neutralizing agent in the way specified on the instruction sheet supplied with the agent.

24. SERVICE PROCEDURE

7. Stop running water through the system, then stop the engine.
8. Open drain valve ② at the bottom of the radiator and drain plug ③ on the side face of the cylinder block to drain the water.
9. After draining the water, tighten drain valve ② and drain plug ③, and fill the radiator with water.
10. In areas where the water is hard, pour the anti-corrosive agent KI-2 solution to the radiator.
For details, see "24.7.8 ADD ANTI-CORROSIVE AGENT TO COOLING SYSTEM".
11. Add antifreeze solution to the specified density.
For details, see "Table of mixing rate of water and anti-freeze".
12. To remove the air in the cooling water, run for five minutes at low idling, then for another five minutes at high idling.
(When doing this, leave the radiator cap off.)
13. Stop the engine, wait for 3 minutes, add city water until the water level reaches near the water filler port, then tighten the cap.

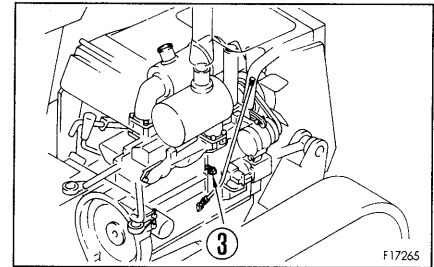
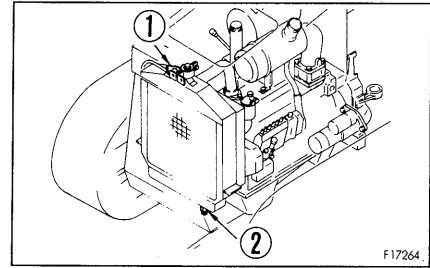

24.2.2 CHECK, CLEAN AND REPLACE AIR CLEANER ELEMENT

WARNING

- Never clean or replace the air cleaner element with the engine running.
- When using pressure air to clean the element wear safety glasses or goggles to protect the eyes.

Checking

Whenever air cleaner clogged warning lamp ① lights up, clean the air cleaner outer element.

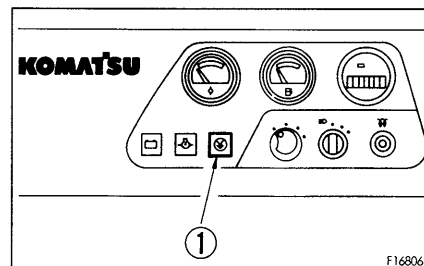

Cleaning or replacing outer element

1. Loosen clip ②, remove dust cup ③ and the outer element.
2. Clean the air cleaner body interior and the dust cup.

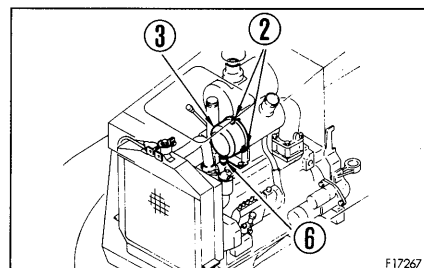

3. Direct dry compressed air (less than 7 kg/cm²) to the element from inside along its folds, then direct it from outside along its folds and again from inside.

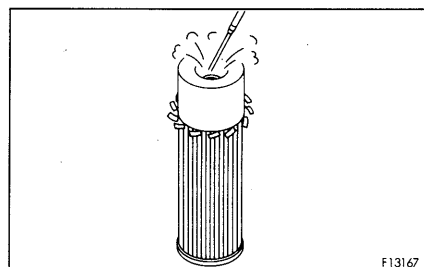

- 1) Remove one seal from the outer element. The number of times the outer element has been cleaned can be seen by the number of removed seals.
- 2) Replace the outer element which has been cleaned 6 times repeatedly or used throughout a year. Replace the inner element at the same time.
- 3) Replace the element when the air cleaner clogged warning lamp lights up soon after installing the cleaned element even though it has not been cleaned 6 times.
- 4) Check inner element mounting nuts for looseness and, if necessary, retighten.
- 5) Replace seal washer ⑤ or wing nut ④ with new parts if they are broken.
- 6) Remove evacuator valve ⑥ and clean with compressed air. After cleaning, install it.

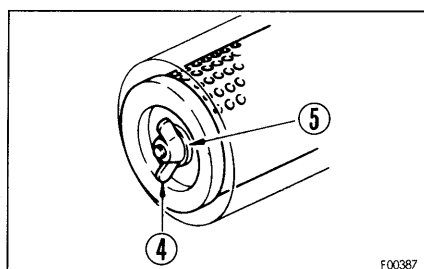

NOTICE

If small holes or thinner parts are found on the element when it is checked with an electric bulb after cleaning and drying, replace the element.

Do not use an element whose folds or gasket or seal are damaged.

When cleaning the element, do not hit it or beat it against something.

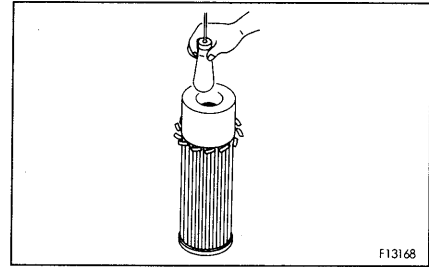

4. Set the cleaned element and dust cup.

Replacing inner element

1. First remove the dust cup and the outer element, and then remove the inner element.
2. To prevent dust from getting in, use a clean cloth or tape to cover the air connector (outlet side).
3. Clean the air cleaner body interior, then remove the cover installed in Step 2.
4. Fit a new inner element to the connector and tighten it with nuts. Do not clean and reinstall a inner element.
5. Install the outer element and the dust cup.

24.2.3 CHECK TRACK TENSION (STEEL SHOES ONLY)

The wear of pins and bushings on the undercarriage will vary with the working conditions and soil properties. It is thus necessary to continually inspect the track tension so as to maintain the standard tension.

Carry out the check and adjustment under the same conditions as when operating (on jobsites where the track becomes clogged with mud, measure with the track clogged with mud).

Inspection

Stop the machine on level ground (stop with the transmission in FORWARD without applying the brake.) Then place a straight bar on the track shoes between the carrier roller and the idler as shown in the figure, and measure the clearance between the bar and the grouser at the midpoint. If the clearance is 20 – 30 mm, the tension is standard.

If the track tension is not at the standard value, adjust it in the following manner.

Adjustment

⚠ WARNING

Grease inside the adjusting mechanism is under high pressure. Grease coming from lubricator ② under pressure can penetrate the body causing injury or death. For this reason, do not loosen lubricator ② more than one turn. Do not loosen any part other than lubricator ②. Furthermore, do not bring your face in front of grease fitting ①.

If the track tension is not relieved by this procedure, please contact your Komatsu distributor.

- When increasing tension
 1. Pump in grease through grease fitting ① with a grease pump.
 2. To check that the correct tension has been achieved, move the machine backwards and forwards.
 3. Check the track tension again, and if the tension is not correct, adjust it again.
 4. Continue to pump in grease until S becomes 0 mm. If the tension is still loose, the pin and bushing are excessively worn, so they must be either turned or replaced. Please contact your Komatsu distributor.

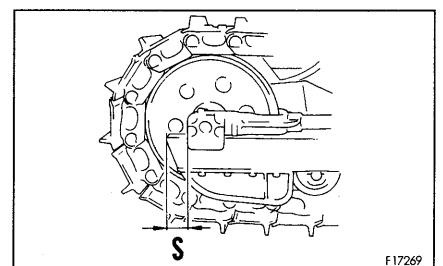
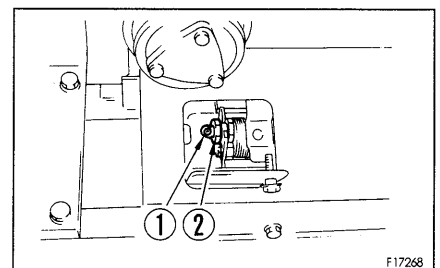
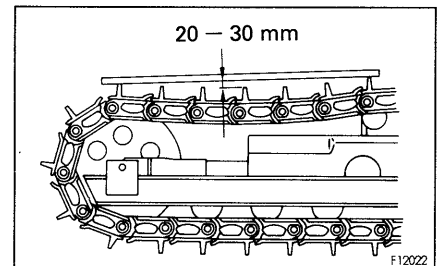

- When loosening tension

⚠ WARNING

It is extremely dangerous to release the grease by any method except the procedure given below. If the track tension is not relieved by this procedure, please contact your Komatsu distributor.

1. Loosen lubricator ① gradually to release the grease.
2. Turn lubricator ① a maximum of one turn.
3. If the grease does not come out smoothly, move the machine backwards and forwards a short distance.
4. Tighten lubricator ①.
5. To check that the correct tension has been achieved, move the machine backwards and forwards.
6. Check the track tension again, and if the tension is not correct, adjust it again.

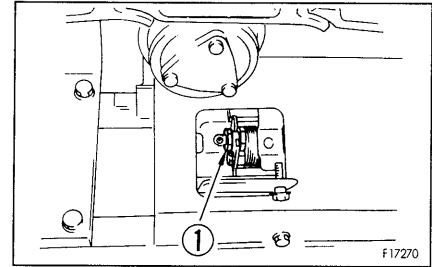

24.2.4 CHECK AND TIGHTEN TRACK SHOE BOLTS (STEEL SHOES ONLY)

If the machine is used with track shoe bolts ① loose, they will break, so tighten any loose bolts immediately.

• **Method for tightening (shoe bolt)**

1. First tighten to a tightening torque of 7 ± 1 kgm, then check that the nut and shoe are in close contact with the link contact surface.
2. After checking, tighten a further $60^\circ \pm 10^\circ$.

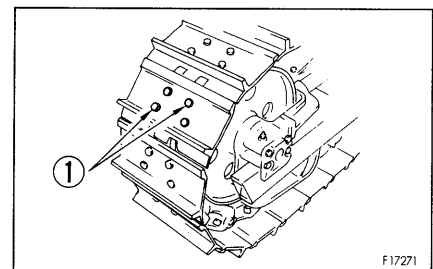

• **Method for tightening (master link connecting bolt)**

1. First tighten to a tightening torque of 7 ± 1 kgm, then check that the link contact surfaces are in close contact.
2. After checking, tighten a further $180^\circ \pm 10^\circ$.

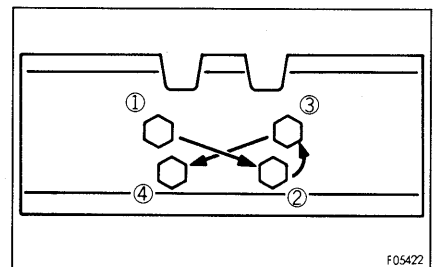

Order for tightening

Tighten the bolts in the order shown in the diagram on the right.

24.2.5 CHECK AND REPLACE RUBBER SHOES (RUBBER SHOES ONLY)

If the rubber shoes are in the following condition, repair or replace the rubber shoes.

CHECK RUBBER SHOES

- **Height of lug**
- If lug height "a" is reduced by wear, the drawbar pull will drop. If "a" is less than 33.5 mm, replace with a new part.

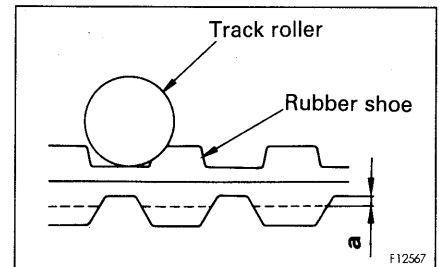

- When working in conditions where there is no drop in drawbar pull caused by shoe slippage, it is possible to use shoes until they are worn down to a lug height "a" of 5 mm. When the height becomes less than 5 mm, replace with a new part.
- If the lug wears and the steel cord inside the shoe is exposed for two links or more, replace with a new part.

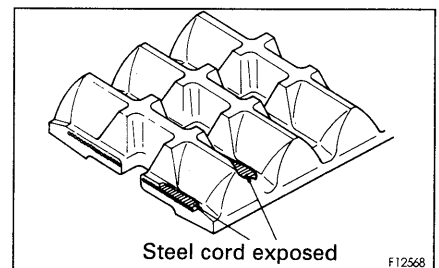

- **Cuts in rubber shoe steel cord**

If more than half of the steel cord layer on one side is cut, replace with a new part.

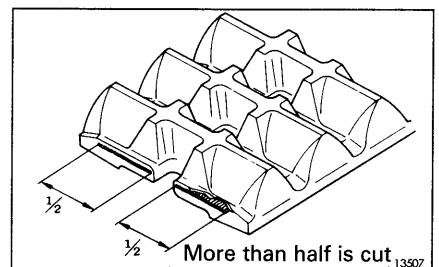

- **Separation of rubber shoe core**

If the rubber core has separated at one place or more, replace with a new part.

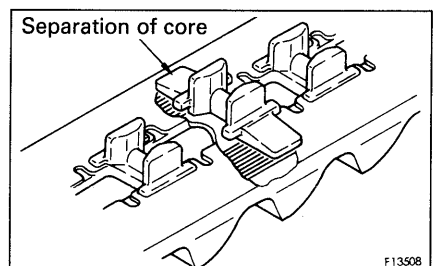

• **Rubber shoe tension**

If the rubber shoe is still slack even when grease is pumped in, replace with a new part or replace the seal inside the cylinder.

If the track tension can only be increased to a level where the rubber shoe may come off, there may be not only elongation of the rubber shoe but also damage to the grease cylinder.

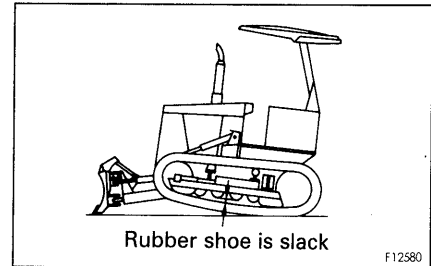

• **Cracks in rubber shoe**

If the cracks between the rubber shoe lugs increase to a size of approx. 60 mm the rubber shoe must be repaired. Even if the track is small and short, if the steel cord can be seen inside, carry out repairs immediately.

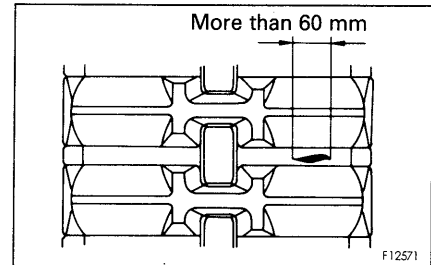

REMARK

If the length is less than 30 mm or the depth of the crack is less than 10 mm, there is no particular need to carry out repairs.

When making judgement whether to replace, repair, or continue using rubber shoes, please contact your Komatsu distributor.

24.2.6 REPLACE RUBBER SHOES (RUBBER SHOES ONLY)

REMOVAL OF RUBBER SHOE

⚠ WARNING

The grease is under high pressure, so there is danger that it will spurt out. For this reason, do not loosen lubricator ① more than one turn. Do not loosen any part other than lubricator ①. Furthermore, do not bring your face in front of lubricator ①. If the track tension is not relieved by this procedure, please contact your Komatsu distributor.

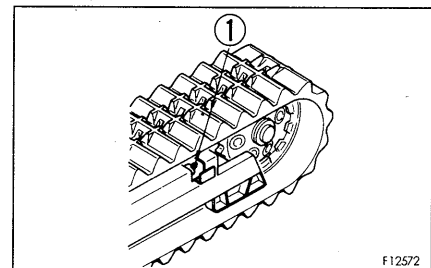

⚠ WARNING

When carrying out operations in Step 3, check that the internal grease has been completely released before rotating the sprocket.

1. Jack up the undercarriage.
For details, see "Method of raising undercarriage".
2. Loosen lubricator ① and drain the grease inside.

3. Fit steel pipes inside the rubber shoe, rotate the sprocket in reverse so that the steel pipes make the rubber shoe come up from the idler, then slide to the side to remove.

INSTALLATION OF RUBBER SHOE

WARNING

The grease is under high pressure, so there is danger that it will spurt out. For this reason, do not loosen lubricator ① more than one turn. Do not loosen any part other than lubricator ①. Furthermore, do not bring your face in front of lubricator ①. If the track tension is not relieved by this procedure, please contact your Komatsu distributor.

1. Jack up the undercarriage.
For details, see "Method of raising undercarriage".
2. Loosen lubricator ① and drain the grease inside.
3. Mesh the rubber shoe with the sprocket and fit it over the idler.
4. Rotate the sprocket in reverse and push in the rubber shoe.
5. Using a steel pipe, fit the rubber shoe and rotate the sprocket again.
6. Check that the rubber shoe is fitted securely on the sprocket and idler.
7. Adjust the track tension.
(For details, see "24.2.7 CHECK AND ADJUST TRACK TENSION (RUBBER SHOES ONLY)".)
8. Check that the track tension is correct and that the rubber shoe is correctly meshed on the sprocket and idler, then lower the machine to the ground.

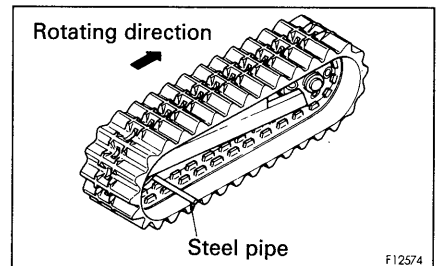
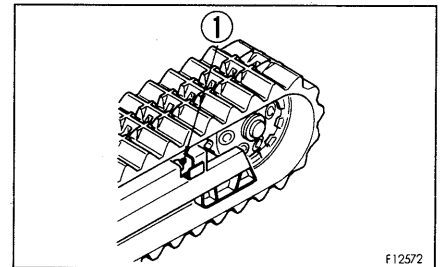
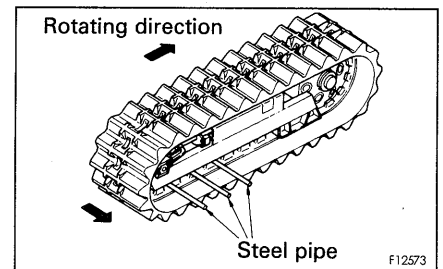

METHOD OF RAISING UNDERCARRIAGE

• **Method of lifting with wire cable**

⚠ WARNING

Always carry out this operation on a horizontal, hard ground surface.

The person operating the crane during the lifting operation must be a qualified crane operator.

1. Insert the wire cable in the drawbar, fit a wooden block between the cable and chassis to prevent the cable from rubbing against the chassis, then raise the machine.
2. Fit wooden blocks under the bottom of the steering case to keep the machine stable.
Prepare wooden blocks of height approx. 450 mm.
3. Lower the blade to jack up the chassis until the track is horizontal to the ground.

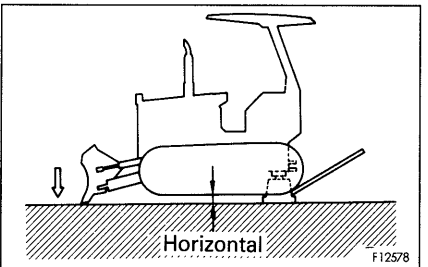
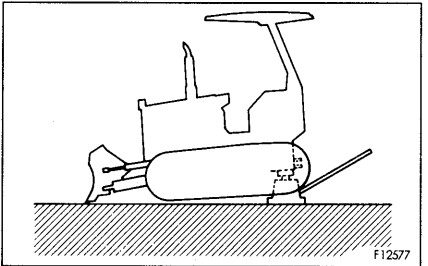
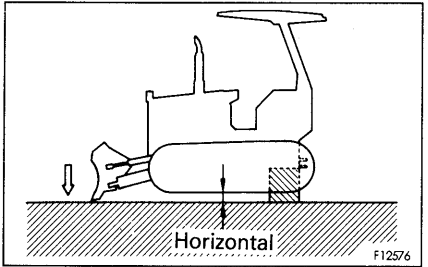
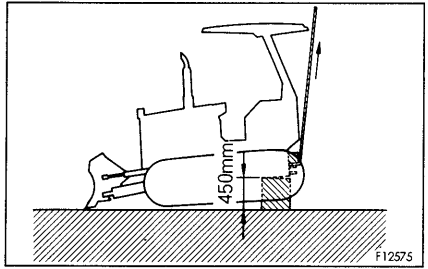

• **Method of jacking up**

⚠ WARNING

Always carry out this operation on a horizontal, hard ground surface.

1. Fit 2 jacks (capacity: min. 10 ton) under the bottom of the steering case and jack up the chassis until the track comes off the ground.
2. Lower the blade to jack up the chassis until the track is horizontal to the ground.

24.2.7 CHECK AND ADJUST TRACK TENSION (RUBBER SHOES ONLY)

The wear of the rubber shoe will vary with the working conditions and type of soil. Therefore, it is necessary to inspect the wear and track tension frequently.

After fitting new parts, be sure to carry out the first inspection after 30 hours of use.

Inspection

⚠ WARNING

Two people are needed to carry out this operation. The operator must move the machine in accordance with the signals given by the worker. Never move the machine when taking measurements. The track tension is inspected with the chassis raised, so it is extremely dangerous if the machine is lowered by mistake during the inspection.

Set the connection (M mark) of the rubber shoe at the top midway between the two axles. Then use the blade to raise the machine, and check the clearance between the rolling surface of the track shoe roller and the tread of the 3rd track roller from the sprocket.

The standard clearance is 15 to 20 mm. If the clearance is more than 25 mm, the tension must be adjusted.

NOTICE

If the machine is used with the rubber shoes loose, the tracks will come off, or there will be premature wear of the metal core.

Adjustment

⚠ WARNING

The grease is under high pressure, so there is danger that it will spurt out. For this reason, do not loosen lubricator ① more than one turn. Do not loosen any part other than lubricator ①. Furthermore, do not bring your face in front of lubricator ①. If the track tension is not relieved by this procedure, please contact your Komatsu distributor.

• When increasing tension

1. Pump in grease through lubricator ①.

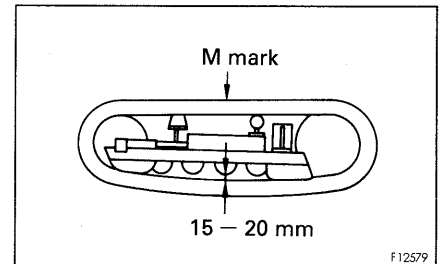

F12579

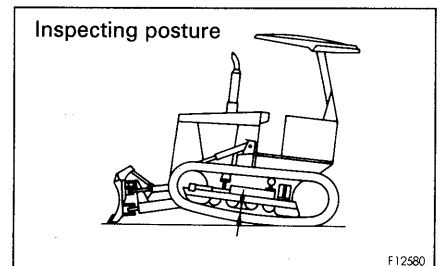

F12580

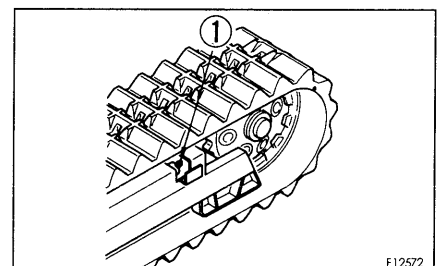

F12572

2. To check that the correct tension has been achieved, move the machine backwards and forwards.
3. Check the track tension again, and if the tension is not correct, adjust it again.
4. If the tension is yet loose after applying pressurized injection of grease, it is necessary to replace the rubber shoes or seal inside of cylinder. Consult your Komatsu distributor for repair.

• **When loosening tension**

⚠ WARNING

It is extremely dangerous to release the grease by any method except the procedure given below. If the track tension is not relieved by this procedure, please contact your Komatsu distributor.

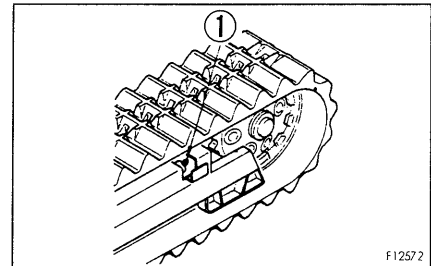

1. Loosen lubricator ① gradually to release the grease.
2. When loosening, turn lubricator ① a maximum of one turn.
3. If the grease does not come out smoothly, move the machine backwards and forwards a short distance.
4. Tighten lubricator ①.
5. To check that the correct tension has been achieved, move the machine backwards and forwards.
6. Check the track tension again, and if the tension is not correct, adjust it again.

24.2.8 REVERSE AND REPLACE THE END BITS AND CUTTING EDGES

WARNING

It is dangerous if the work equipment moves by mistake when the cutting edges and end bits are being reversed or replaced. Set the work equipment in a stable condition, then stop the engine and apply the locks securely to the levers.

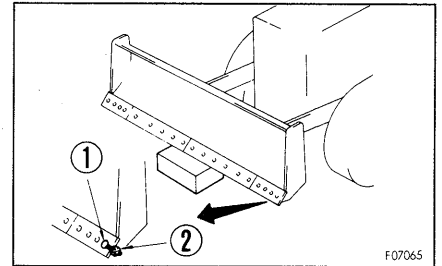

Reverse or replace the end bits and cutting edges before it is worn out to the blade end.

1. Raise the blade to a proper height and apply a block to the frame so as to prevent fall of the blade.
2. Remove the cutting edge and the end bit and clean the mounting surface.

If the cutting edge and the end bit on both sides are worn out, replace with new one.

If it has been worn out up to the fitting surface, repair the fitting surface and then reverse or replace.

3. Reverse or replace the cutting edge and the end bit when worn out.

Nut tightening torque: 13 ± 2 kgm

If bolt ① and nut ② are damaged, replace them with new ones at the same time.

4. After several hours of running, retighten the nuts.

24.2.9 BLEED AIR FROM HEAD END OF ANGLE CIRCUIT

- Hydraulic angle-tilt dozer

⚠ WARNING

When loosening the oil filler cap, oil may spurt out, so turn the cap slowly to release the internal pressure before loosening the cap.

Bleed the air if the work equipment has been removed or repaired.

1. Loosen the cap of the hydraulic tank.
2. Start the engine, raise the blade approx. 300 mm from the ground (level with or higher than the frame), then run the engine at low idling.
3. With the engine at low idling, operate between left tilt and right tilt about ten times repeatedly to the end of the cylinder stroke to fill the tilt circuit with oil.
4. Operate the blade to the maximum left angle, loosen plug ① three turns, then loosen valve ③ two turns.
5. Run the engine at low idling and operate the right tilt until no more bubbles come out with the oil from plug ①. After checking that there are no more bubbles in the oil, tighten plug ①.
Operate the tilt slowly with the engine running at low idling.
6. Operate the blade to the maximum right angle, and loosen plug ② three turns.
7. Run the engine at low idling and operate the right tilt until no more bubbles come out with the oil from plug ②. After checking that there are no more bubbles in the oil, tighten plug ②.
Operate the tilt slowly with the engine running at low idling.

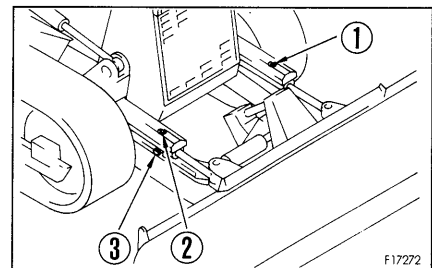

8. Tighten valve ③.

Tightening torque of valve ③: 2.5 ± 0.5 kgm

9. After bleeding the air, check the hydraulic oil level and add oil if necessary. Then close the hydraulic tank cap and wipe off all oil from around the cylinder.

24.2.10 ADJUST INERTIA BRAKE (D20 only)

Inspection

If it takes 2.5 to 3.5 seconds for inertia brake to stop clutch shaft with running engine fully and depressing clutch pedal fully, the inertia brake works well.

NOTICE

Be sure to adjust inertia brake properly.

If not, transmission gears and gear shift lever will be damaged.

Adjustment

1. Confirm that dimension **A** is 45 mm.
2. Loosen adjustment lock nut ①. If the brake works excessively, turn adjustment bolt ② and lengthen dimensions **B**. If the brake does not work well, shorten **B**.
3. Retighten nut ① tightly.

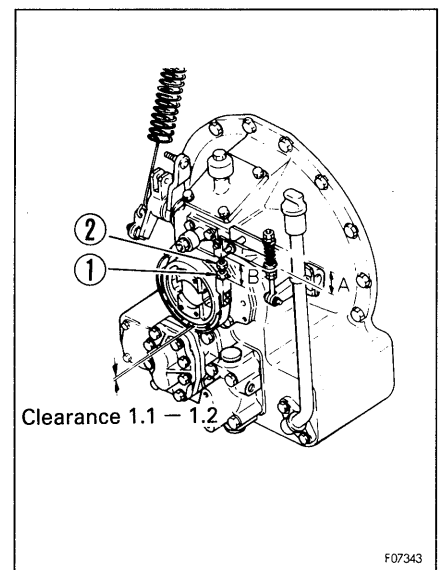

24.2.11 ADJUST MAIN CLUTCH (D20 only)

Inspection

Standard clutch pedal play is 10 to 33 mm at tip of pedal. If less or slippery, adjust as follows:

NOTICE

The pedal play tends to increase with rise of the main clutch case oil temperature. Wait for lowering of oil temperature when an adjustment is to be made during or after operation of the machine.

Be sure to adjust clutch properly. If you leave the less play or slippery clutch unadjusted, clutch lining will be worn out soon and the machine will be damaged due to heat generation.

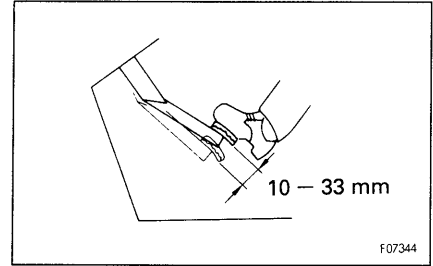

Adjustment

Remove the floor board. Loosen the lock nut of rod ①, turn rod ① to make the clutch pedal play between 20 and 25 mm at tip of pedal.

NOTICE

When measuring the play at the tip of the pedal, it is difficult to feel the play if the pedal is depressed with your foot, so push the pedal by hand.

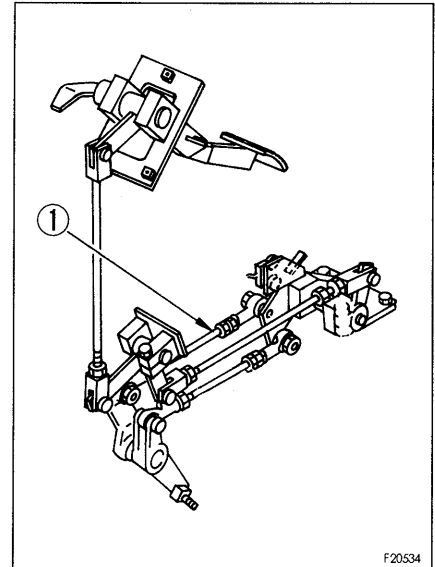

24.2.12 ADJUST BRAKE PEDAL

If the stroke of the brake pedal increases, the brake lining may be worn out. Adjust brakes as follows.

Adjustment

Adjust both left and right brakes.

1. Remove the rear cover and inspection cover ① in this order.

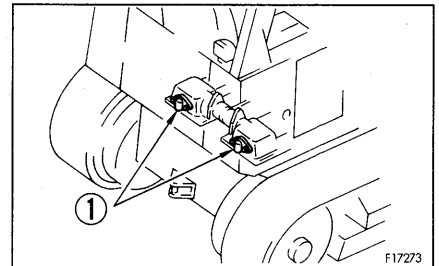

2. Tighten adjustment nuts ②, ③ to torque of 4 kgm until the lining contacts the drum. Then, turn adjustment nuts ②, ③ in reverse directions for 4 rotations.

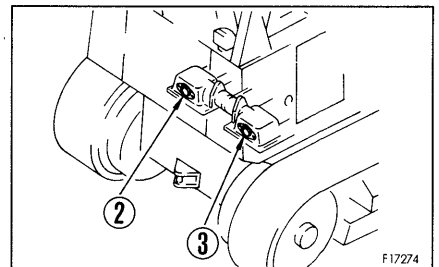

3. Check the travel of the brake pedal, referring to "24.3 CHECK BEFORE STARTING".

The standard clearance between the brake lining and the drum should be 1.0 mm.

Basically speaking, this completes the adjustment of the brake band clearance, but to ensure that the clearance between the lining and drum is the same on both the left and right side, check as follows.

If there is a difference between the clearance of the left and right brakes, the brakes will pull to one side.

4. Pin ⑤ on the long hole of the yoke can be seen behind the oil level gauge tube through inspection window ④ under the operator's seat. Hook the end of a steel tape measure on the end of the projecting part of pin ⑤.

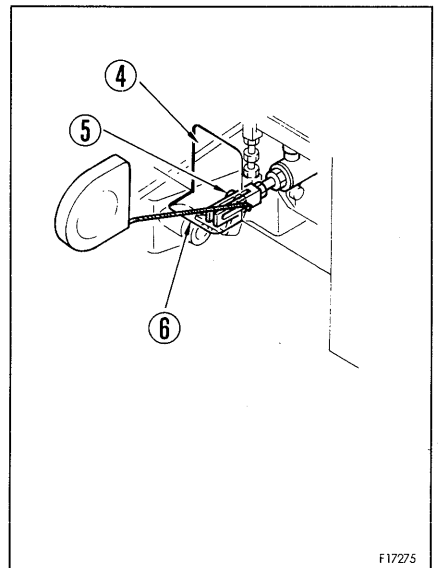

5. Read the movement of the steel tape measure (pin ⑤) while the brake pedal is depressed fully.

It is easy to read the movement of the steel tape measure if you watch edge ⑥ of the inspection window.

If the movement is 14.5 mm, it is normal.

If the movement is not 14.5 mm, adjust again with adjustment nut ③ on the right side.

6. The travel at the tip of the pedal should be 98 mm when the brake pedal is depressed fully.
 If the movement is not 98 mm, adjust again with adjustment nut ② on the left side.
 When left and right adjustment nuts ② and ③ are turned 1/2 turns, the travel of pin ⑤ and the brake pedal will change as shown below.
 Change of pin ⑤ travel: 1.6 mm
 Change of brake pedal travel: 11 mm

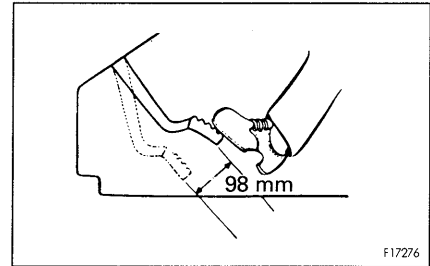

If the brake effect is poor after adjustment, ask your Komatsu distributor to repair it.

24.2.13 ADJUST IDLER CLEARANCE

Since the idlers are forced to move forward and backward by an external force the guide plates will be worn out.

Wear of these plates will cause the vibration of idlers from side to side or inclination of the idlers, and running off of track links from the idlers or unevenly worn idler and links may result.

Therefore, adjust the idlers according to the following procedure.

Adjustment

1. Move machine about 1- or 2 meters on a flat ground and measure the clearance **A** (4 locations: left, right, inside and outside) between the track frame and the guide plate.
2. If the clearance **A** exceeds 1.5 mm, loosen bolt ①, and pull out the shim to adjust the clearance at one end to 0.5 mm.

Thickness of one shim is 1.0 mm.

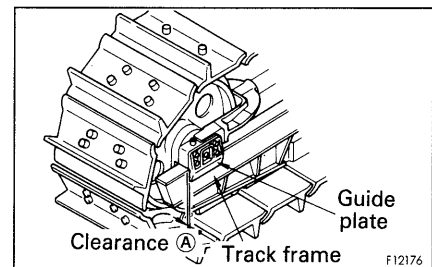

24.2.14 ADJUST ANGLE OF BLADE EDGE

⚠ WARNING

It is dangerous if the work equipment moves by mistake when adjusting angle of the blade edge. Set the work equipment in a stable condition, then stop the engine and apply the locks securely to the levers.

• HYDRAULIC TILTDOZER

Adjust the angle of the blade edge to match the type of soil.

Method of adjustment

Turn the brace with bar handle ① and adjust the length (ℓ) between the joints to change the angle (θ) of the edge of the blade as follows.

INCREASE length to INCREASE angle.

DECREASE length to DECREASE angle.

Standard blade angle: 55°

- When adjusting the blade angle (θ), keep within a range of the standard length between joints ± 15 mm.

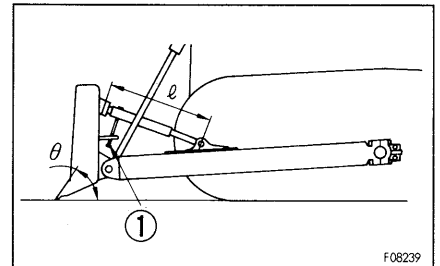

Model	Standard length (ℓ) between joints
D20PL-7	551.4 mm
D20PLL-7	550.6 mm

24.3 CHECK BEFORE STARTING

24.3.1 CHECK COOLANT LEVEL, ADD WATER

⚠ WARNING

Do not remove cap ① while cooling water is hot. Hot water may spout out.

When removing cap ①, wait until the water temperature goes down and release radiator pressure little by little by loosening caps slowly, then remove the cap.

1. Open the upper cover at the front of the machine, remove radiator cap ① and check that the coolant level is in the shaded area. If level is low, add water.
2. After adding water, tighten the cap securely.

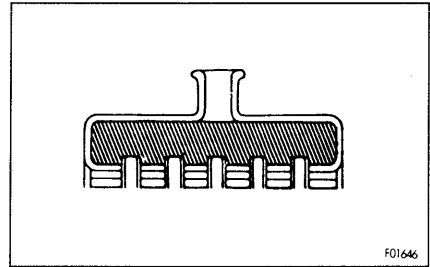
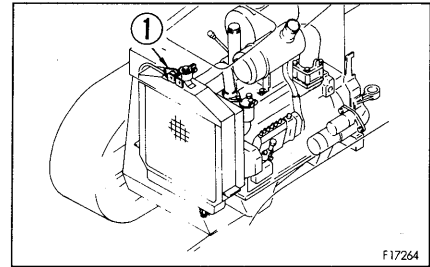

24.3.2 CHECK FUEL LEVEL, ADD FUEL

⚠ WARNING

When adding fuel, never let the fuel overflow. This may cause a fire. If spilling fuel, thoroughly clean up any spillage.

1. Check the fuel level using fuel gauge ⑥.
2. After completing work, fill the fuel tank through oil filler port ⑦. For details of the oil to use, see "20. USE OF FUEL, COOLANT AND LUBRICANTS ACCORDING TO AMBIENT TEMPERATURE".
3. After adding fuel, tighten the cap securely.

Fuel capacity: 60 ℓ

NOTICE

A clogged cap breather hole ① may stop the fuel flow to the engine. Check it from time to time and clean.

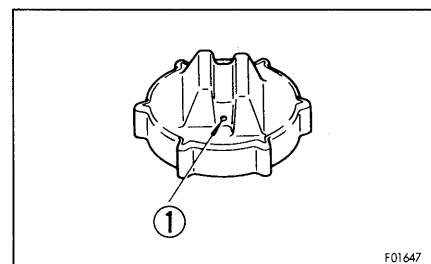
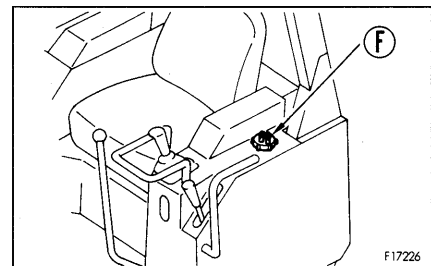
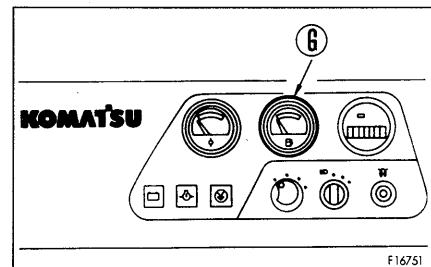

24.3.3 CHECK OIL LEVEL IN ENGINE OIL PAN, ADD OIL

1. Open the upper cover at the front of the machine.
2. Remove dipstick Ⓒ and wipe the oil off with a cloth.
3. Insert dipstick Ⓒ fully in the oil filler pipe, then take it out again.
4. The oil level should be between the H and L marks on dipstick Ⓒ .
If the oil level is below the L mark, add engine oil through oil filler Ⓕ .
For details of the oil to use, see "20. USE OF FUEL, COOLANT AND LUBRICANTS ACCORDING TO AMBIENT TEMPERATURE".
5. If the oil is above the H mark, drain the excess engine oil from drain plug Ⓓ , and check the oil level again.
6. If the oil level is correct, tighten the oil filler cap securely and close the upper cover.

REMARK

When checking the oil level after the engine has been operated, wait for at least 15 minutes after stopping the engine before checking.

If the machine is at an angle, make it horizontal before checking.

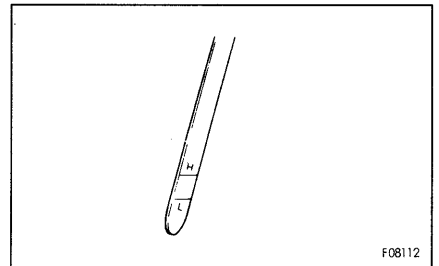
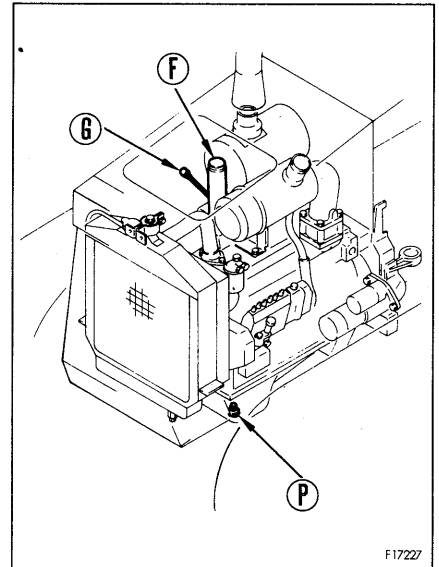

24.3.4 CHECK OIL LEVEL IN BEVEL GEAR CASE, TRANSMISSION CASE, ADD OIL (D20 only)

24.3.5 CHECK OIL LEVEL IN BEVEL GEAR CASE, TRANSFER CASE, ADD OIL (D21 only)

1. Remove dipstick ③ and wipe the oil off with a cloth.
2. Insert dipstick ③ fully in the oil filler pipe, then take it out again.
3. The oil level should be between the H and L marks on dipstick ③.
If the oil level is below the L mark, add engine oil through oil filler ④.
For details of the oil to use, see "20. USE OF FUEL, COOLANT AND LUBRICANTS ACCORDING TO AMBIENT TEMPERATURE".
4. If the oil is above the H mark, drain the excess engine oil from drain plug ⑤, and check the oil level again.
5. If the oil level is correct, tighten the oil filler cap securely.

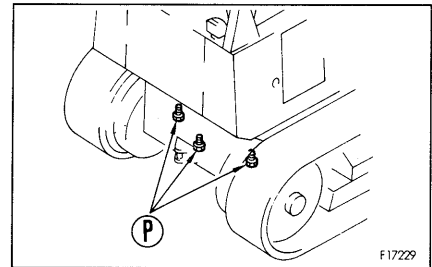
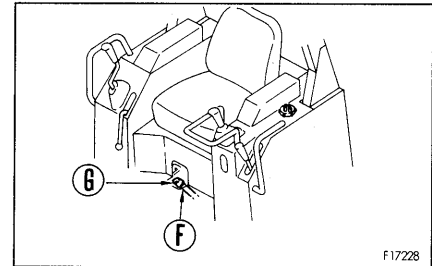

REMARK

When checking the oil level after the engine has been operated, wait for at least 15 minutes after stopping the engine before checking.

If the machine is at an angle, make it horizontal before checking.

24.3.6 CHECK OIL LEVEL IN MAIN CLUTCH CASE, ADD OIL (D20 only)

1. Remove dipstick ⑥ and wipe the oil off with a cloth.
2. Insert dipstick ⑥ fully in the oil filler pipe, then take it out again.
3. The oil level should be between the H and L marks on dipstick ⑥.
If the oil level is below the L mark, add engine oil through oil filler ⑤.
For details of the oil to use, see "20. USE OF FUEL, COOLANT AND LUBRICANTS ACCORDING TO AMBIENT TEMPERATURE".
4. If the oil is above the H mark, drain the excess engine oil from drain plug ④, and check the oil level again.
5. If the oil level is correct, tighten the oil filler cap securely.

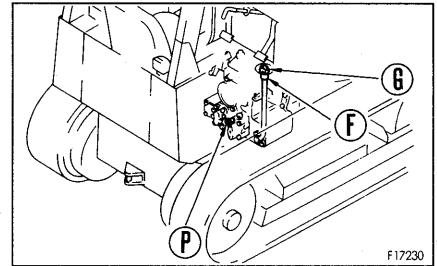

REMARK

When checking the oil level after the engine has been operated, wait for at least 5 minutes after stopping the engine before checking.

When checking the oil level with the engine idling, use a point 15 mm below the line on the level gauge as a guideline when inspecting.

If the machine is at an angle, make it horizontal before checking.

24.3.7 CHECK OIL LEVEL IN TRANSMISSION CASE, ADD OIL (D21 only)

1. Remove dipstick ③ and wipe the oil off with a cloth.
2. Insert dipstick ③ fully in the oil filler pipe, then take it out again.
3. The oil level should be between the H and L marks on dipstick ③.

If the oil level is below the L mark, add engine oil through oil filler ④.

For details of the oil to use, see "20. USE OF FUEL, COOLANT AND LUBRICANTS ACCORDING TO AMBIENT TEMPERATURE".

4. If the oil is above the H mark, drain the excess engine oil from drain plug ⑤, and check the oil level again.
5. If the oil level is correct, tighten the oil filler cap securely.

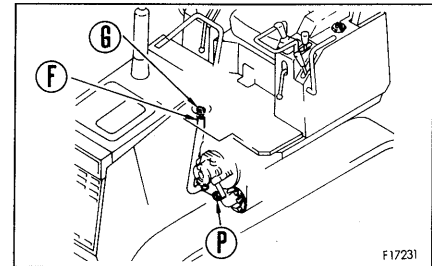

REMARK

When checking the oil level after the engine has been operated, wait for at least 15 minutes after stopping the engine before checking.

If the machine is at an angle, make it horizontal before checking.

24.3.8 CHECK BRAKE PEDAL TRAVEL

1. Depress the brake pedal all the way until it stops.
2. Measure the pedal travel for being from 98 mm to 134 mm at the bottom end of the pedal.
3. When this value exceeds 134 mm, or the brake fails to work, adjust the pedal referring to "24. WHEN REQUIRED".

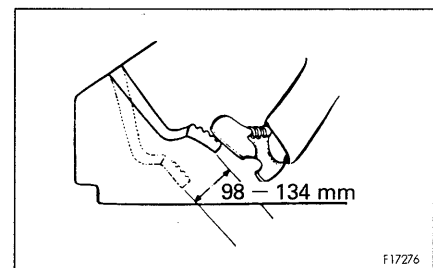

24.3.9 CHECK PLAY OF MAIN CLUTCH PEDAL (D20 only)

1. Depress the main clutch pedal.
2. Check that the play at the bottom tip of the pedal is 10 – 33 mm.
3. If it is more than 33 mm, or the braking effect is poor, carry out adjustments.
For details, see "24.2 WHEN REQUIRED".

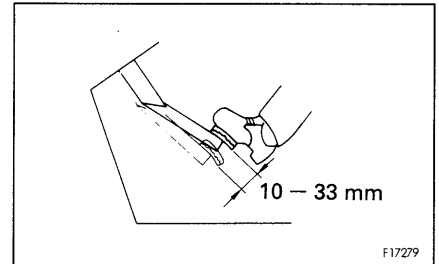

REMARK

If the temperature of the oil in the main clutch case rises, the pedal play tends to increase.

24.3.10 CHECK MAIN CLUTCH INERTIA BRAKE (D20 only)

1. Run the engine at full speed.
2. Depress the main clutch pedal fully and check that the clutch shaft stops within 2.5 – 3.5 seconds.
3. If it does not stop within the above range, carry out adjustments.
For details, see "24.2 WHEN REQUIRED".

24.3.11 CHECK FOR WATER AND SEDIMENT IN WATER SEPARATOR, DRAIN WATER

The water separator separates water mixed in the fuel. If float ② is at or above red line ①, drain the water according to the following procedure:

1. Loosen drain plug ③ and drain the accumulated water until the float reaches the bottom.
2. Tighten drain plug ③.
3. If the air is sucked into fuel line when draining the water, be sure to bleed air in the same manner as for the fuel filter. See "24.6 EVERY 500 HOURS SERVICE".

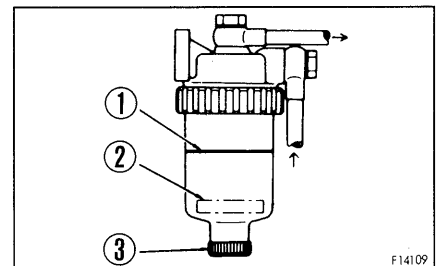

24.4 EVERY 50 HOURS SERVICE

24.4.1 DRAIN WATER, SEDIMENT FROM FUEL TANK

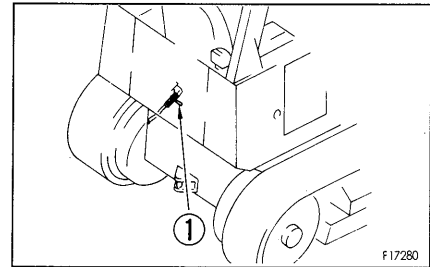

1. Carry out this procedure before operating the machine.
2. Prepare a container to catch the fuel that is drained.
3. Open valve ① at the bottom of the tank and drain the sediment and water that has accumulated at the bottom together with fuel. When doing this, be careful not to get fuel on yourself.
4. When only clean fuel comes out, close drain valve ①.

REMARK

Even if a water separator is installed, be sure to check the fuel tank to remove water and sediment in the fuel.

24.5 EVERY 250 HOURS SERVICE

Maintenance for the 50 hours service should be carried out at the same time.

24.5.1 LUBRICATING

1. Lower the blade to the ground, then stop the engine.
2. Using a grease pump, pump in grease through the grease fittings shown by arrows.
3. After greasing, wipe off any old grease that was pushed out.

- **Hydraulic angle-tilt dozer**

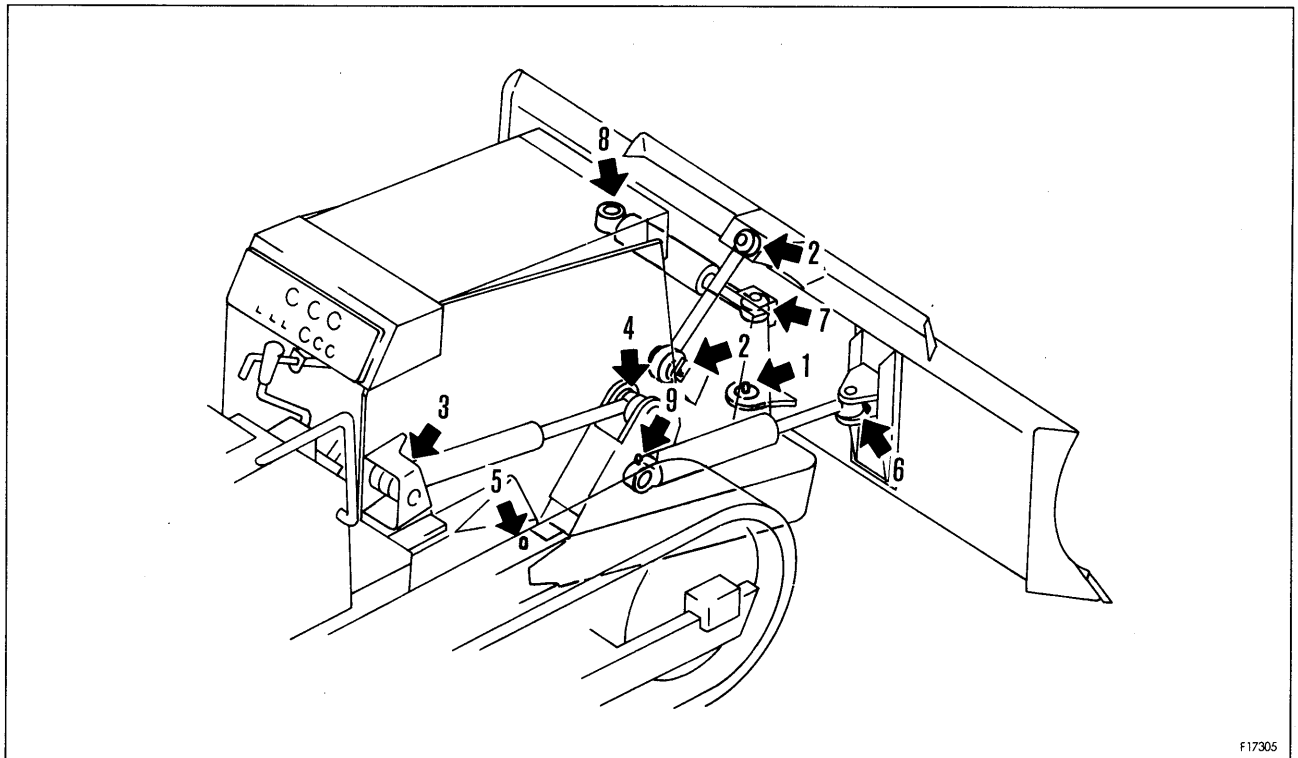

- | | |
|--------------------------------|------------|
| 1. Angle-tilt frame center pin | (1 point) |
| 2. Rod pin | (2 points) |
| 3. Lift cylinder bottom pin | (2 points) |
| 4. Lift cylinder head pin | (2 points) |

F17305

24. SERVICE PROCEDURE

- 5. Angle-tilt frame support pin (2 points)
- 6. Angle cylinder head pin (2 points)
- 7. Tilt cylinder head pin (1 point)
- 8. Tilt cylinder bottom pin (1 point)
- 9. Angle cylinder bottom pin (2 points)

• **Hydraulic tiltdozer**

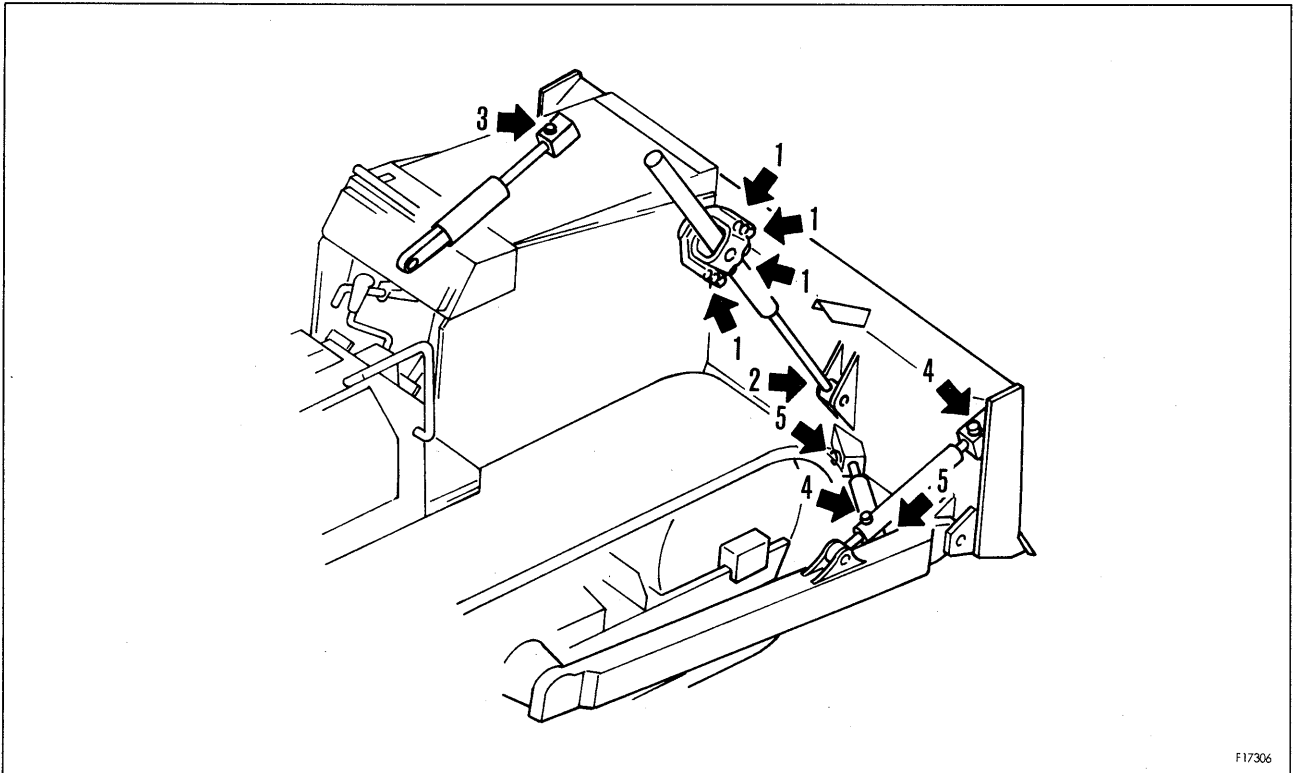

F17306

- 1. Lift cylinder yolk (8 points)
- 2. Lift cylinder head pin (2 points)
- 3. Tilt cylinder head pin (1 point)
- 4. Tilt brace pin (2 points)
- 5. Center brace pin (4 points)

24.5.2 CHECK OIL LEVEL IN FINAL DRIVE CASE, ADD OIL

WARNING

The oil is at high temperature immediately after the machine has been operated. Wait for the oil to cool down before starting the operation.

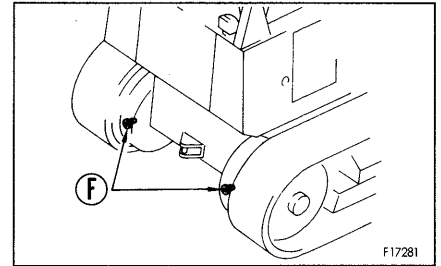

1. Remove plugs (F) on both sides and check whether the final drive case is filled with oil to lower edge of the plug hole. If oil level is below this point, refill with the engine oil through the plug hole.
2. If the oil level is still too low, add engine oil through the plug hole until the oil overflows.
For details of the oil to use, see "20. USE OF FUEL, COOLANT AND LUBRICANTS ACCORDING TO AMBIENT TEMPERATURE".

24.5.3 CHECK OIL LEVEL IN HYDRAULIC TANK, ADD OIL

WARNING

- When removing the oil filler cap, oil may spurt out, so turn the cap slowly to release the internal pressure before removing the cap.
- If oil has been added to above the H mark, stop the engine and wait for the hydraulic oil to cool down, then drain the excess oil from drain plug (P).

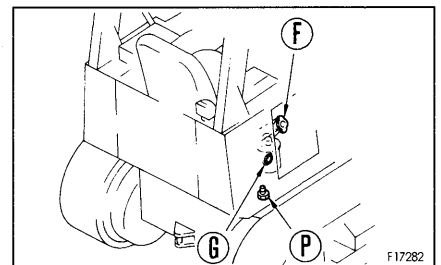

NOTICE

Do not add oil if the level is above the H line. This will damage the hydraulic equipment and cause the oil to spurt out.

1. Lower the blade to the ground, stop the engine and wait for about 5 minutes before checking oil level. If oil level is between H and L in sight gauge (G).
2. If the level is below the L mark, add engine oil through oil filler (F). For details of the oil to use, see "20. USE OF FUEL, COOLANT AND LUBRICANTS ACCORDING TO AMBIENT TEMPERATURE".

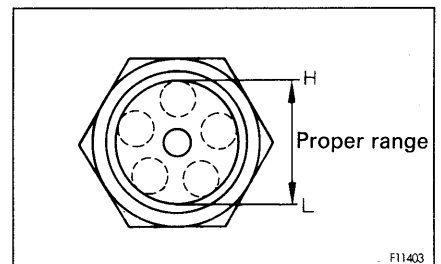

24.5.4 CHECK LEVEL OF BATTERY ELECTROLYTE

Carry out this check before operating the machine.

⚠ WARNING

To avoid gas explosions, do not bring fire or sparks near the battery.

Battery electrolyte is dangerous. If it gets in your eyes or on your skin, wash it off with large amounts of water, and consult a doctor.

1. Open the cover behind the operator's seat.
2. Remove cap ①, and check that the electrolyte is at the specified level (10 to 12 mm above the plate). If the electrolyte level is low, add distilled water to the specified level. If the battery electrolyte is spilled, have dilute sulphuric acid added.
3. Clean the air hole in the battery cap, then tighten the cap securely.

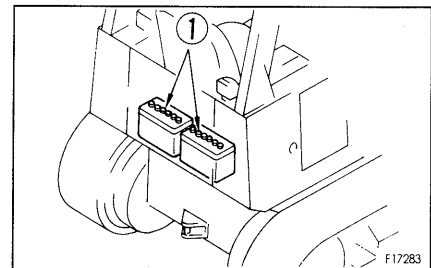

REMARK

When adding distilled water in cold weather, add it before starting operations in the morning to prevent the electrolyte from freezing.

24.5.5 CHECK FAN BELT TENSION, ADJUST

Checking

The belt should normally deflect by about 6 – 10 mm when pressed with the finger (with a force of approx. 6 kg) at a point midway between the alternator pulley and fan pulley.

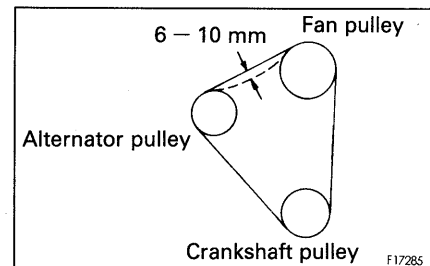
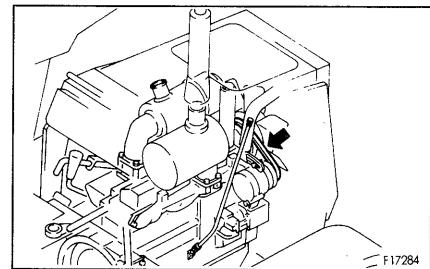

Adjusting

1. Insert a bar between alternator ① and the cylinder block to fix alternator ① in position. When fixing alternator ① in position, insert a wooden block between the bar and alternator ① to prevent damage to the alternator.
2. Loosen bolts and nuts ② and ③.
3. Move alternator ① with a bar so that the deflection of the belt is about 6 – 10 mm (approx. 6 kg).
4. Tighten the bolts and nuts ② and ③ to fix alternator ① in position.
5. Check each pulley for damage, wear of the V-groove, and wear of the V-belt. In particular, be sure to check that the V-belt is not touching the bottom of the V-groove.
6. Replace belt if it has stretched, leaving no allowance for adjustment, or if there is a cut or crack on belt.
7. When the new belt is set, readjust it after operation for an hour.

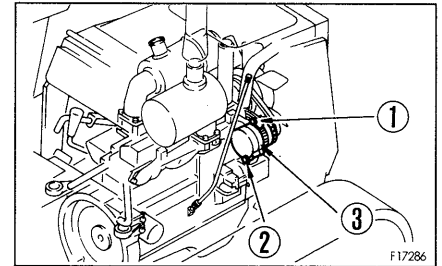
**24.5.6 CHECK ELECTRIC WIRINGS****⚠ WARNING**

If the fuse blows frequently, or there are traces of shortcircuiting in the electric wiring, always locate and repair the cause.

Check for damage of the fuse and any sign of disconnection or short circuit in the electric wiring. Check also for loose terminals and tighten any loose parts. Check the following points carefully.

- Battery
- Starting motor
- Alternator

Please contact your Komatsu distributor for investigation and correction of the cause.

⚠ WARNING

Accumulation of flammable material (dead leaves, twigs, grass, etc.) around the battery may cause fire, so always check and remove such material.

When carrying out walk-around checks or checks before starting, always check if there is any accumulation of flammable material around the battery, and remove such flammable material.

24.6 EVERY 500 HOURS SERVICE

Maintenance for every 50 and 250 hours should be carried out at the same time.

24.6.1 REPLACE FUEL FILTER CARTRIDGE

⚠ WARNING

- Engine is at high temperature immediately after the machine has been operated. Wait for engine to cool down before replacing the filter.
- Do not bring fire or sparks near the fuel.

Prepare a filter wrench and a container to catch the fuel.

1. Set the container to catch the fuel under the filter cartridge.
2. Using a filter wrench, turn filter cartridge ① counterclockwise to remove it.
3. Clean the filter holder, fill a new filter cartridge with clean fuel, coat the packing surface with engine oil, then install it to the filter holder.
4. When installing, tighten until the packing surface contacts the seal surface of the filter holder, then tighten about 2/3 turns.
If the filter cartridge is tightened too far, the packing will be damaged and this will lead to leakage of fuel. If the filter cartridge is too loose, fuel will also leak from the packing, so always tighten to the correct amount.
5. After replacing filter cartridge ①, loosen air bleeding plug ②.
6. Loosen feed pump knob ③ and move the pump up and down to draw off fuel until air ceases to come out of air bleeding plug ②.

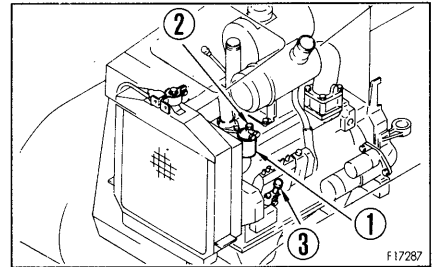

7. Tighten up air bleeding plug ②. Push in the knob of feed pump ③ and tighten it.
8. After replacing the filter cartridge, start the engine and check that there is no leakage of fuel from the filter seal surface. If there is any leakage of fuel, check the tightening of the filter cartridge. Whenever there is leakage of fuel, follow Steps 1 and 2 to remove the filter cartridge, then check the packing surface for damage or foreign material. If any damage or foreign material is found in the packing, replace the packing with a new part, then repeat Steps 3 – 8 to install the filter cartridge.

- **Method of using automatic air bleed mechanism**

 **WARNING**

When cranking the engine, confirm the safety around the engine, as the engine may start.

It is possible to bleed the air from the fuel circuit simply by rotating the starting motor with the starting switch. Bleed the air as follows.

1. After replacing the filter cartridge, check that the fuel control lever is at the low idling position.
2. (For D20 only) Depress the main clutch pedal.
(For D21 only) Place the safety lever for the steering and directional lever to the lock position.
3. Turn the starting switch key to the START position and rotate the starting motor for 15 – 20 seconds to crank the engine and bleed the air.

NOTICE

When the engine has run out of fuel, carry out the same procedure and crank the engine for 15 – 20 seconds.

Repeat this operation 2 – 3 times to bleed the air.

Do not rotate the starting motor continuously for more than 20 seconds. Wait for 1 – 2 minutes before rotating again.

The time taken to bleed the air is shorter when the fuel tank is full.

24.6.2 CHANGE OIL IN ENGINE OIL PAN, REPLACE ENGINE OIL FILTER CARTRIDGE

⚠ WARNING

The oil is at high temperature after the engine has been operated, so never change the oil immediately after finishing operations. Wait for the oil to cool down before changing it.

Prepare the followings.

- Container to catch drained oil: Min 7 ℓ capacity
- Refill capacity: 7 ℓ
- Socket wrench, filter wrench.

1. Remove the cover at the bottom of the machine and set a container to catch the oil under the drain plug.
2. Remove drain plug **Ⓟ** slowly to avoid getting oil on yourself, and drain the oil.
3. Check the drained oil, and if there are excessive metal particles or foreign material, please contact your Komatsu distributor.
4. Install drain plug **Ⓟ**.
5. Using a filter wrench, turn filter cartridge **Ⓛ** counterclockwise to remove it. When doing this, to prevent getting oil on yourself, do not carry out this operation from immediately under the cartridge.
In particular, if this operation is carried out immediately after stopping the engine, a large amount of oil will come out, so wait for 10 minutes before starting the operation.
6. Clean the filter holder, coat the packing surface of a new filter cartridge with engine oil (or coat it thinly with grease), then install it to the filter holder.
7. When installing, tighten until the packing surface contacts the seal surface of the filter holder, then tighten a further 1/2 turn.

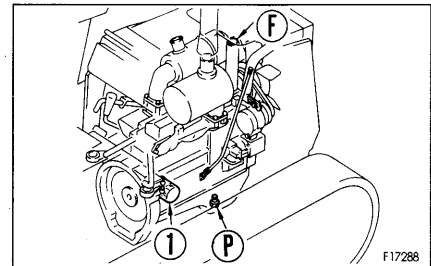

8. After replacing the filter cartridge, add engine oil through oil filler Ⓔ until the oil level is between the H and L marks on the dipstick.
For details of the oil to use, see "20. USE OF FUEL, COOLANT AND LUBRICANTS ACCORDING TO AMBIENT TEMPERATURE".
When supplying oil, be careful not to get oil on the alternator.
9. Run the engine at idling for a short time, then stop the engine, and check that the oil level is between the H and L marks on the dipstick. For details, see "24.3 CHECK BEFORE STARTING".

NOTICE

Even if the machine has not been operated for 500 hours, the oil and filter cartridge must be replaced when the machine has been operated for 6 months.

In the same way, even if the machine has not been operated for 6 months, the oil and filter cartridge must be replaced when the machine has been operated for 500 hours.

24.6.3 CLEAN, CHECK RADIATOR FINS



WARNING

If compressed air, steam, or water hit your body directly, there is danger of injury. Always wear protective glasses, mask, and safety shoes.

1. Remove bolts Ⓐ and radiator grille Ⓑ .
2. Clean the radiator fins clogged with mud, dust and leaves with compressed air. Steam or water may be used instead of compressed air.
3. Check the rubber hose. If the hose is found to have cracks to be hardened by ageing, replace such hose with new one. Further, loose hose clamp should also be checked.

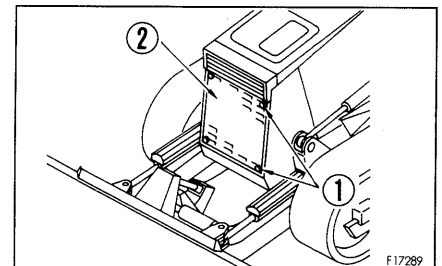

24.6.4 CLEAN BREATHER

Remove the breather and wash out dust remaining inside with diesel oil and flushing oil.

1. Transmission case breather

(1 point)

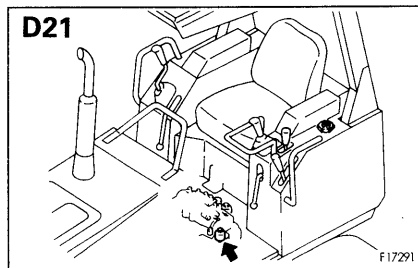
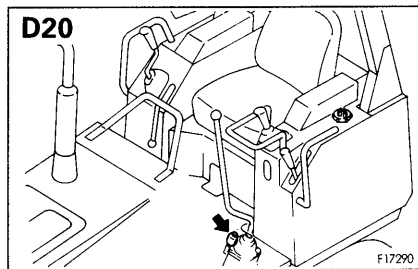

2. Main clutch case breather (D20 only)

(1 point)

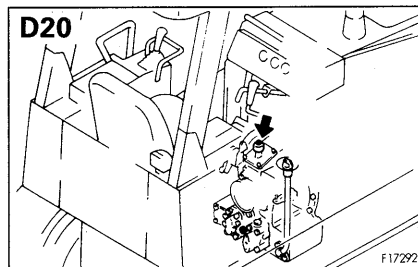

3. Bevel gear case, transfer case breather (D21 only)

(1 point)

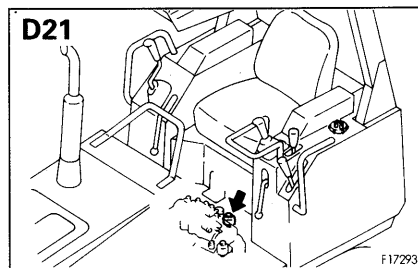

24.7 EVERY 1000 HOURS SERVICE

Maintenance for every 50, 250 and 500 hours should be carried out at the same time.

24.7.1 CHANGE OIL IN BEVEL GEAR CASE, TRANSMISSION CASE (D20 only)





24.7.2 CHANGE OIL IN BEVEL GEAR CASE, TRANSFER CASE (D21 only)

WARNING

The oil is at high temperature immediately after the machine has been operated. Wait for the oil to cool down before starting the operation.

Prepare the followings.

- Container to catch drained oil: Min. 17 ℓ capacity
- Refill capacity: D20 16.5 ℓ
D21 13.0 ℓ
- Socket wrench

1. Set a container to catch the oil under drain plug  at the bottom of the machine.
 2. Remove drain plug  slowly to avoid getting oil on yourself, and drain the oil.
After draining the oil, tighten drain plug .
 3. Refill the specified quantity of engine oil through oil filler .
- For details of the oil to use, see "20. USE OF FUEL, COOLANT AND LUBRICANTS ACCORDING TO AMBIENT TEMPERATURE".
4. Check that the oil is at the specified level.
For details, see "24.3 CHECK BEFORE STARTING".

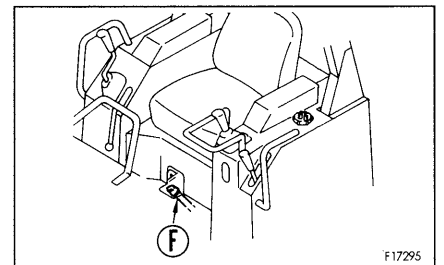
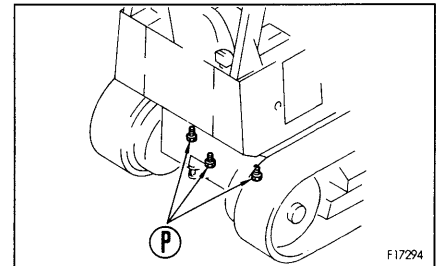

24.7.3 CHANGE OIL IN MAIN CLUTCH CASE, CLEAN STRAINER (D20 only)

⚠ WARNING

The oil is at high temperature immediately after the machine has been operated. Wait for the oil to cool down before starting the operation.

Prepare the followings.

- Container to catch drained oil: Min. 6 l capacity
- Refill capacity: 6 l
- Socket wrench

1. Set a container to catch the oil under drain plug **Ⓟ** at the bottom of the machine.
2. Remove drain plug **Ⓟ** slowly to avoid getting oil on yourself, and drain the oil.
After draining the oil, tighten drain plug **Ⓟ**.
3. Remove bolts **①** and cover **②**, then take out the strainer.
4. Remove all dirt from the strainer, then wash in clean diesel oil or flushing oil.
If the strainer is damaged, replace it with new one.
5. Refill the specified quantity of engine oil through oil filler **Ⓧ**.
For details of the oil to use, see "20. USE OF FUEL, COOLANT AND LUBRICANTS ACCORDING TO AMBIENT TEMPERATURE".
6. Check that the oil is at the specified level.
For details, see "24.3 CHECK BEFORE STARTING".

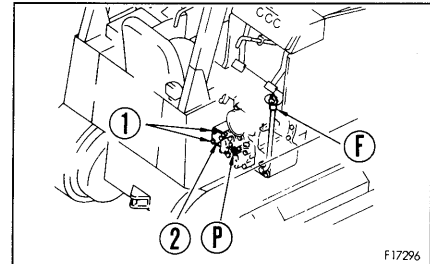

24.7.4 CHANGE OIL IN TRANSMISSION CASE, CLEAN STRAINER (D21 only)

WARNING

The oil is at high temperature immediately after the machine has been operated. Wait for the oil to cool down before starting the operation.

Prepare the followings.

- Container to catch drained oil: Min 11 ℓ capacity
- Refill capacity: 11 ℓ
- Socket wrench

1. Remove the cover at the bottom of the machine and set a container to catch the oil under drain plug P .
2. Remove drain plug P slowly to avoid getting oil on yourself, and drain the oil.
After draining the oil, tighten drain plug P .
3. Remove mounting bolts ① on tube ④ , remove lowest mounting bolt ③ on strainer case ② then take out tube ④ .
4. Take out strainer ⑤ . If strainer ⑤ is damaged, replace it with new one.
5. Remove all dirt from the strainer, then wash in clean diesel oil or flushing oil.
Clean the case interior and the removed parts.
6. After installing the strainer, refill the specified quantity of engine oil through oil filler F .
For details of the oil to use, see "20. USE OF FUEL, COOLANT AND LUBRICANTS ACCORDING TO AMBIENT TEMPERATURE".
7. Check that the oil is at the specified level.
For details, see "24.3 CHECK BEFORE STARTING".
8. Keep the steering and directional lever at the N (neutral) position, and move the lever fully in the left direction. Next, move the lever fully in the right direction. Repeat this operation 10 times and fill the steering and brake circuits with oil.
9. Travel the machine at first speed and check that the machine can make a left turn and a right turn certainly.

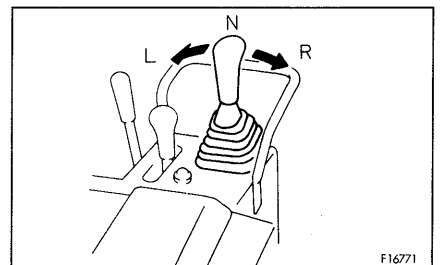
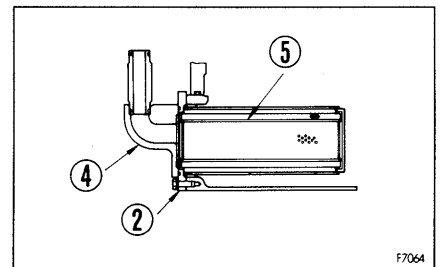
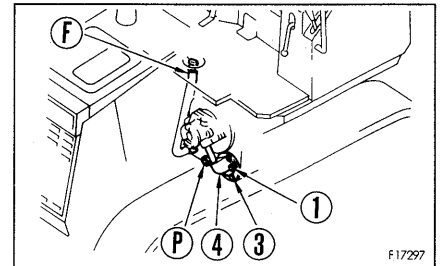

24.7.5 CHANGE OIL IN FINAL DRIVE CASE



WARNING

The oil is at high temperature immediately after the machine has been operated. Wait for the oil to cool down before starting the operation.

Prepare the followings.

- Container to catch drained oil: Min. 12 ℓ capacity
- Refill capacity
 - D20AG, D21A, AG-7: each 6 ℓ
 - D20PL-7: each 8 ℓ
 - D20P, PG, D21PG-7A: each 8 ℓ
 - D20PLL-7: each 12 ℓ
- Socket wrench

1. Set a container to catch the oil under drain plug ②.
2. Remove drain plug ② and drain the oil.
After draining the oil, tighten drain plug ②.
3. Refill the specified quantity of engine oil through oil filler ①.
For details of the oil to use, see "20 USE OF FUEL, COOLANT AND LUBRICANTS ACCORDING TO AMBIENT TEMPERATURE".
4. Check that the oil is at the specified level.
For details, see "24.5 EVERY 250 HOURS SERVICE".

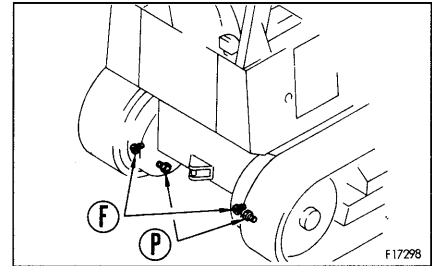

24.7.6 CHANGE OIL IN HYDRAULIC TANK, REPLACE HYDRAULIC OIL FILTER CARTRIDGE

⚠ WARNING

The oil is at high temperature immediately after the machine has been operated. Wait for the oil to cool down before changing the oil. When removing the oil filler cap, turn it slowly to release the internal pressure, then remove it carefully.

Prepare the followings.

- Container to catch drained oil: Min. 21 ℓ capacity
- Refill capacity: 21 ℓ
- Socket wrench, filter wrench

1. Lower the blade on the ground. With the engine stopped, move the blade control lever forward and backward or right and left and slowly turn the cap of oil filler ⑥ to release the internal pressure. Then, remove the cap.
2. Set a container to catch the oil under drain plug ⑤.
3. Remove drain plug ⑤ to drain the oil.
After draining the oil, tighten plug ⑤.
When removing drain plug ⑤, be careful to avoid getting oil on yourself.
4. Using a filter wrench, turn filter cartridge ① counterclockwise to remove it.
5. Clean the filter holder, coat the packing surface of a new filter cartridge with engine oil (or coat it thinly with grease), then install it to the filter holder.
6. When installing, tighten until the packing surface contacts the seal surface of the filter holder, then tighten about 1/2 – 3/4 turn.

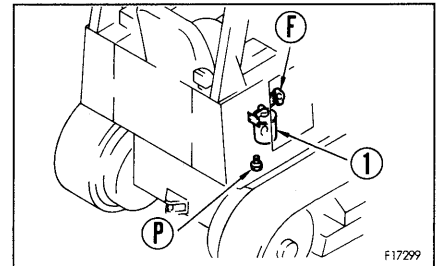

7. Add the specified amount of engine oil through the oil filler $\text{\textcircled{E}}$.
For details of the oil to use, see "20. USE OF FUEL, COOLANT AND LUBRICANTS ACCORDING TO AMBIENT TEMPERATURE".
8. Check that the oil is at the specified level. For details, see "24.5 EVERY 250 HOURS SERVICE".

24.7.7 CHECK OIL IN UNDERCARRIAGE COMPONENTS

Check consumption of oil in track roller and idler as follows.

1. Stop the machine on the level ground.
2. Slowly loosen seal bolt and see if oil oozes out of screw. If oil oozes out, oil is still sufficient. Tighten bolt immediately.
3. If oil does not flow even after seal bolt has been removed, oil amount is insufficient. Request Komatsu distributor to perform necessary repairs.

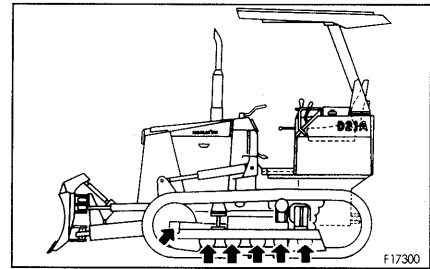

24.7.8 ADD ANTI-CORROSIVE AGENT TO COOLING SYSTEM

(Applicable only in hard water areas)

⚠ WARNING

- Do not remove the radiator cap when the water is hot. Boiling water may spurt out. Wait for the temperature to go down, then turn the cap slowly to release the pressure before removing the cap.
- The anti-corrosive agent KI-2 is a strong alkali, so be careful not to get it on your skin. If it gets on your skin, wash it off with ample water.
- Do not use the empty anti-corrosive KI-2 packet for keeping food.

NOTICE

To restrict the formation of rust and scale in hard water areas, add Komatsu genuine anti-corrosive agent KI-2 (powder) to the cooling system. Never use commercially available anti-corrosive agents (made by Fleetguard, etc.).

Select the amount of anti-corrosive agent KI-2 to match the quality of cooling water.

Quality of cooling water	Amount of anti-corrosive agent
Class 1	1 packet
Class 2	2 packets

If it is unclear what the quality of the water is, please contact your Komatsu distributor.

Method of adding

1. Stop the engine.
2. Slowly remove radiator water filler cap ①.

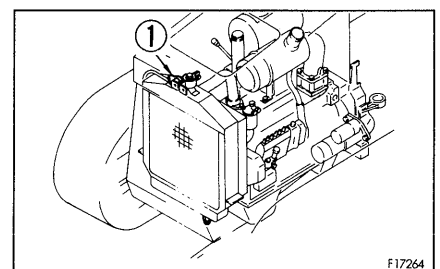

F17264

24. SERVICE PROCEDURE

3. Using a clean container, dissolve the specified number of packets of anti-corrosive agent KI-2 in fresh water.
(At room temperature, one packet will dissolve in approx. 3 liters of water.)
4. Pour the solution made in Step 3 into the radiator through the radiator water filler.
To prevent the radiator water from overflowing when doing this, first drain enough water from the radiator to leave room for the added solution. After adding the anti-corrosive agent solution, add fresh water to the specified level.
5. If anti-corrosive agent KI-2 is added directly through the radiator water filler, run the engine for 30 — 60 minutes to make sure that the solution is thoroughly mixed.

REMARK

Anti-corrosive agent KI-2 can be used together with almost any brand of antifreeze, but do not use it together with DOW-THERM 209.

When using anti-corrosive agent KI-2 for the first time in the engine of a machine that is in operation, first flush the cooling system.

24.8 EVERY 2000 HOURS SERVICE

Maintenance for every 50, 250, 500 and 1000 hours should be carried out at the same time.

24.8.1 CHECK ALTERNATOR, STARTING MOTOR

The brush may be worn, or the bearing may have run out of grease, so contact your Komatsu distributor for inspection or repair.

If the engine is started frequently, carry out inspection every 1000 hours.

24.8.2 CHECK ENGINE VALVE CLEARANCE, ADJUST

Contact your Komatsu distributor for inspection or adjustment.

24.9 EVERY 4000 HOURS SERVICE

Maintenance for every 50, 250, 500, 1000 and 2000 hours should be carried out at the same time.

24.9.1 CHECK WATER PUMP

Check that there is no play in the pulley, water leakage, or clogging of the drain hole. If any abnormality is found, contact your Komatsu distributor for disassembly and repair or replacement.

SPECIFICATIONS

25. SPECIFICATIONS

D20AG, PL, PLL-7 D20P, PG-7A

	D20AG-7	D20PL-7	D20PLL-7	D20P-7A	D20PG-7A
WEIGHT					
• Operating weight (without operator)(kg)	3590	4030	4670	3940	3980
BLADE					
• Equipment weight (incl. cylinder) (kg)	480	450	520	510	510
PERFORMANCE					
• Travel speed Forward	1st (km/h)	3.0	2.8		3.0
	2nd (km/h)	4.3	4.0		4.3
	3rd (km/h)	8.1	7.5		8.1
Reverse	1st (km/h)	4.9	4.5		4.9
	2nd (km/h)	7.0	6.5		7.0
• Maximum drawbar pull (kg)	4130	4380	4320	4390	4110
• Ground pressure (kg/cm ²)	0.35	0.16	0.11	0.23	0.24
ENGINE					
• Model	Komatsu 4D95S-1 diesel engine				
• Flywheel horsepower	39 HP/2450 rpm				
• Maximum torque	15.5 kgm/1300 rpm				
• Starting motor	24 V 2.8 kW				
• Alternator	24 V 15A				
• Battery	12 V 45 Ah x 2 pieces				

**D21A, AG-7
D21PG-7A**

	D21A-7	D21AG-7	D21PG-7A
WEIGHT			
• Operating weight (without operator)(kg)	3600	3640	4030
BLADE			
• Equipment weight (incl. cylinder) (kg)	480	480	510
PERFORMANCE			
• Travel speed Forward	1st (km/h)	2.6	2.8
	2nd (km/h)	4.4	4.8
Reverse	1st (km/h)	3.3	3.6
	2nd (km/h)	5.6	6.1
• Maximum drawbar pull (kg)	4520	4200	4180
• Ground pressure (kg/cm ²)	0.36	0.36	0.24
ENGINE			
• Model	Komatsu 4D95S-1 diesel engine		
• Flywheel horsepower	39 HP/2450 rpm		
• Maximum torque	15.5 kgm/1300 rpm		
• Starting motor	24 V 2.8 kW		
• Alternator	24 V 15A		
• Battery	12 V 45 Ah x 2 pieces		

D20AG-7

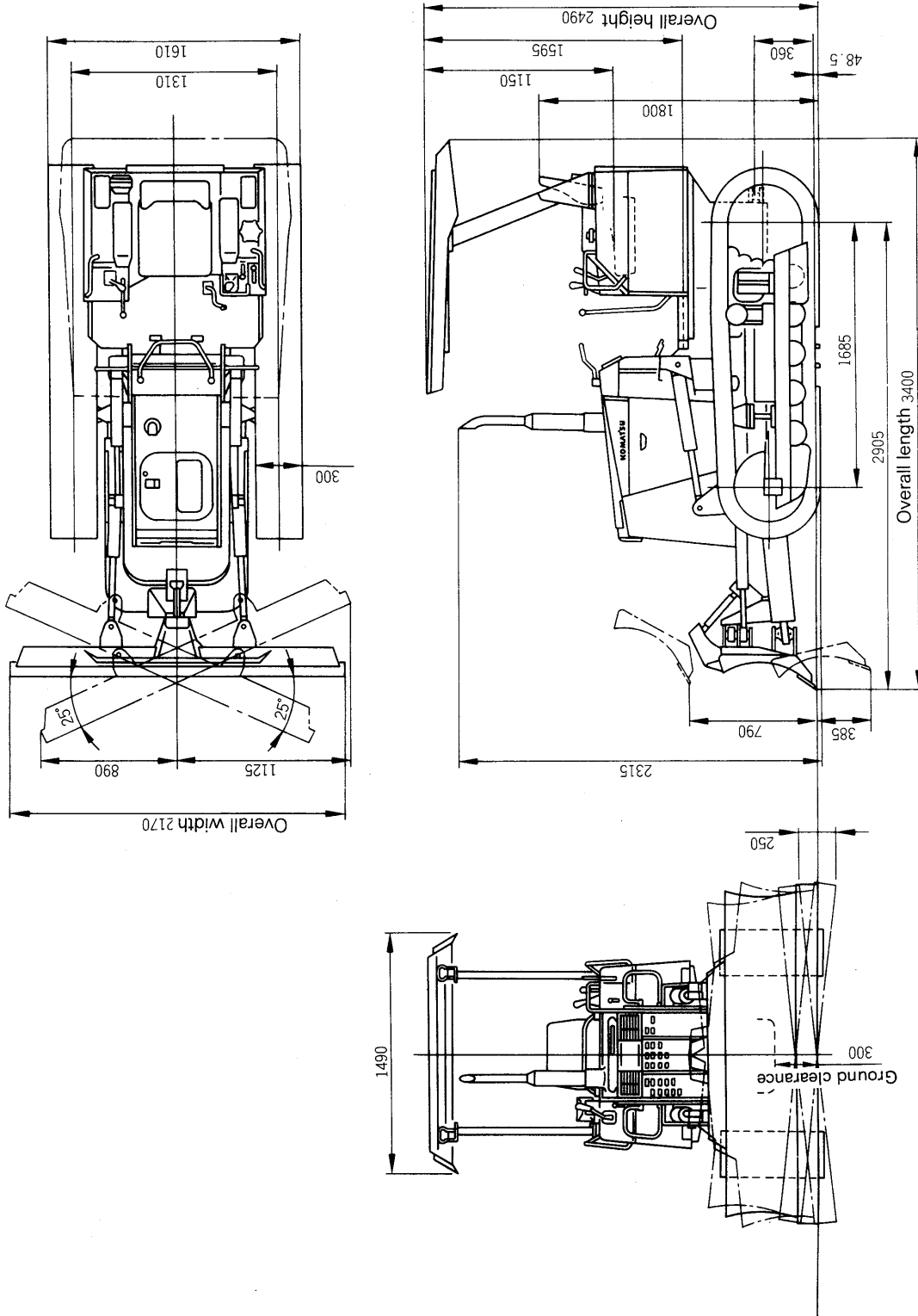

D20PL, PLL-7

Note: The values given are the values for D20PL-7.

(): Values for D20PLL-7

In cases where there are no values given in (), the values are the same as for D20PL-7.

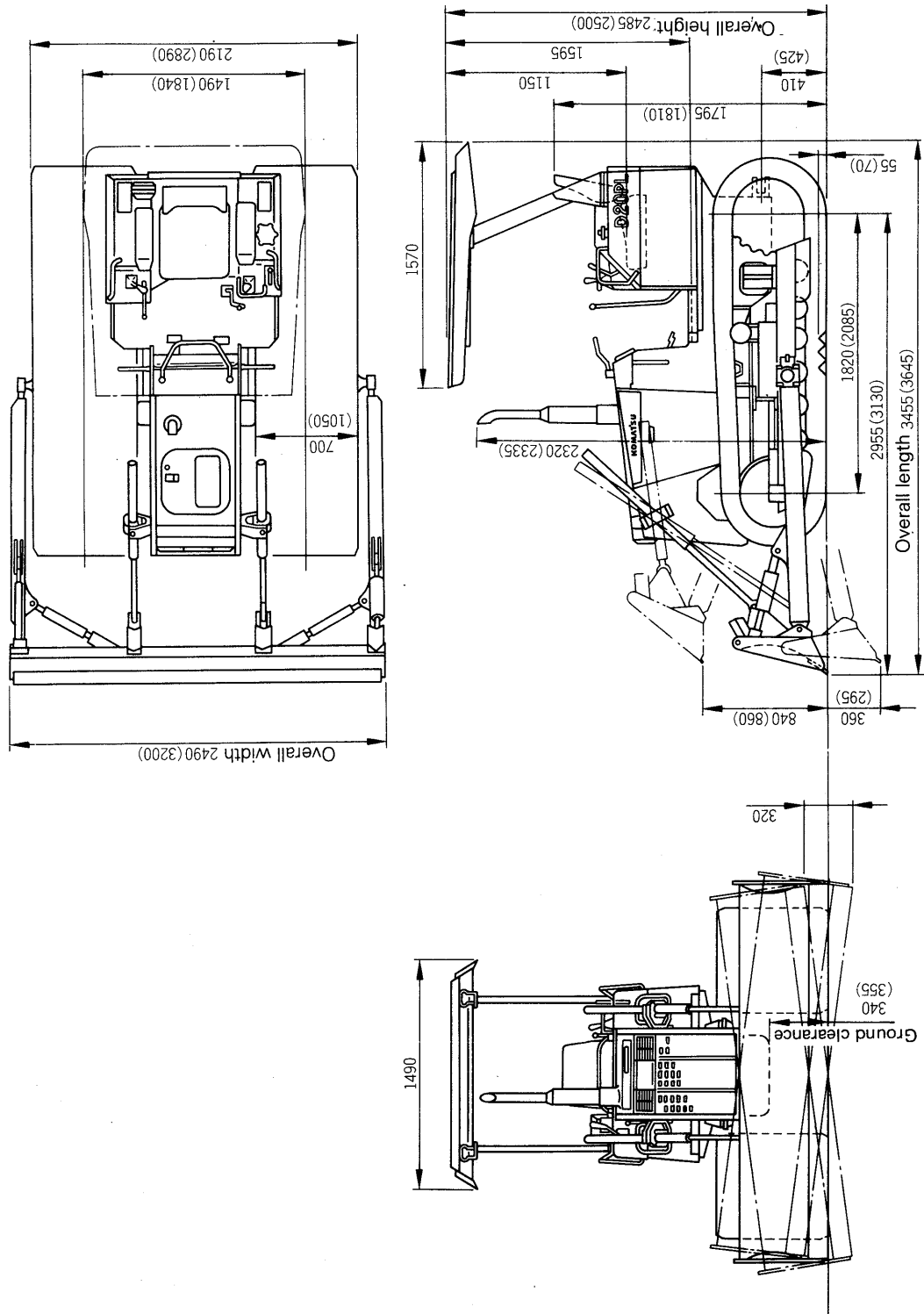

D20P, PG-7A

Note: The values given are the values for D20P-7A.

(): Values for D20PG-7A

In cases where there are no values given in (), the values are the same as for D20P-7A.

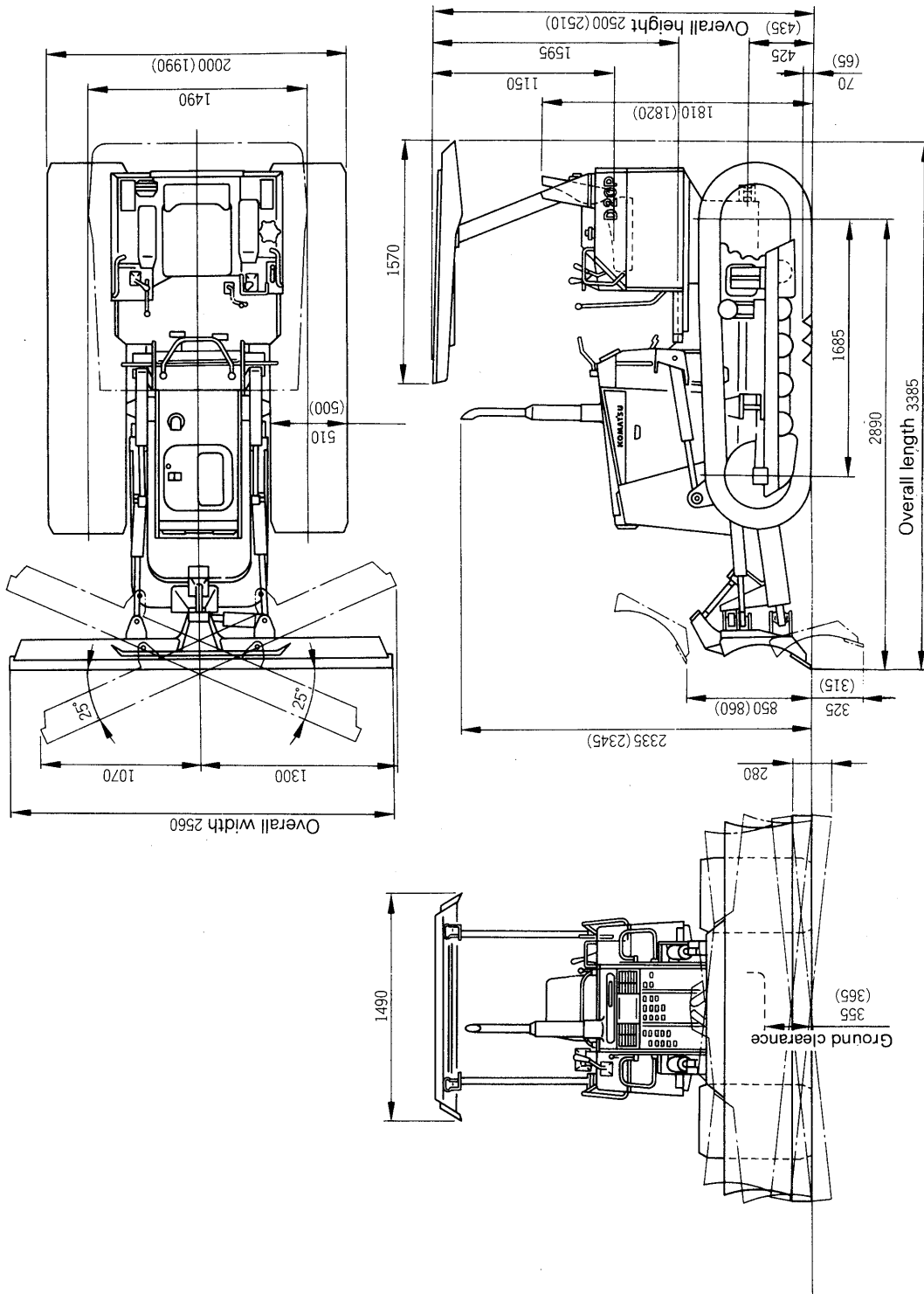

D21A, AG-7

Note: The values given are the values for D21A-7.

(): Values for D21AG-7

In cases where there are no values given in (), the values are the same as for D21A-7.

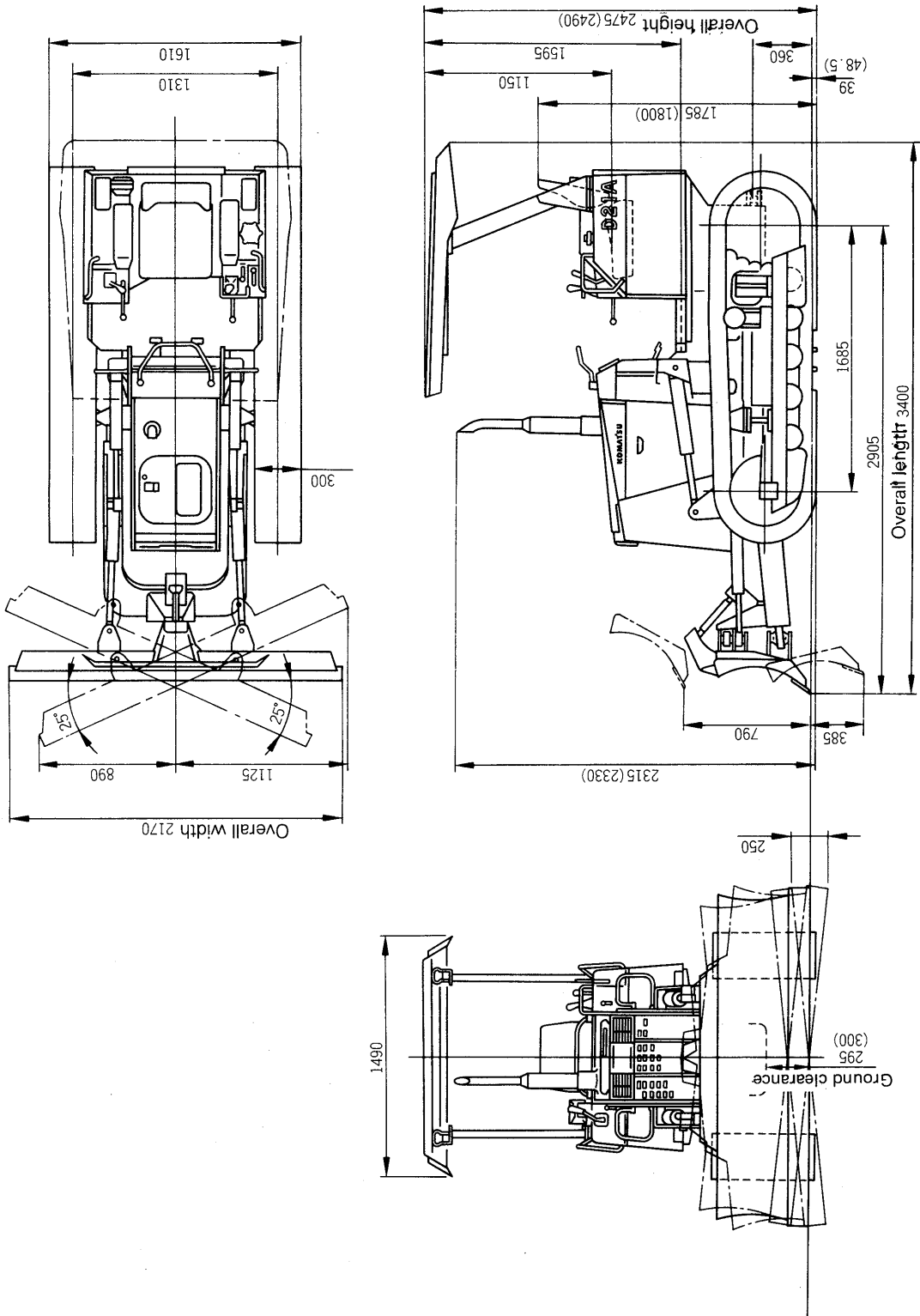

D21PG-7A

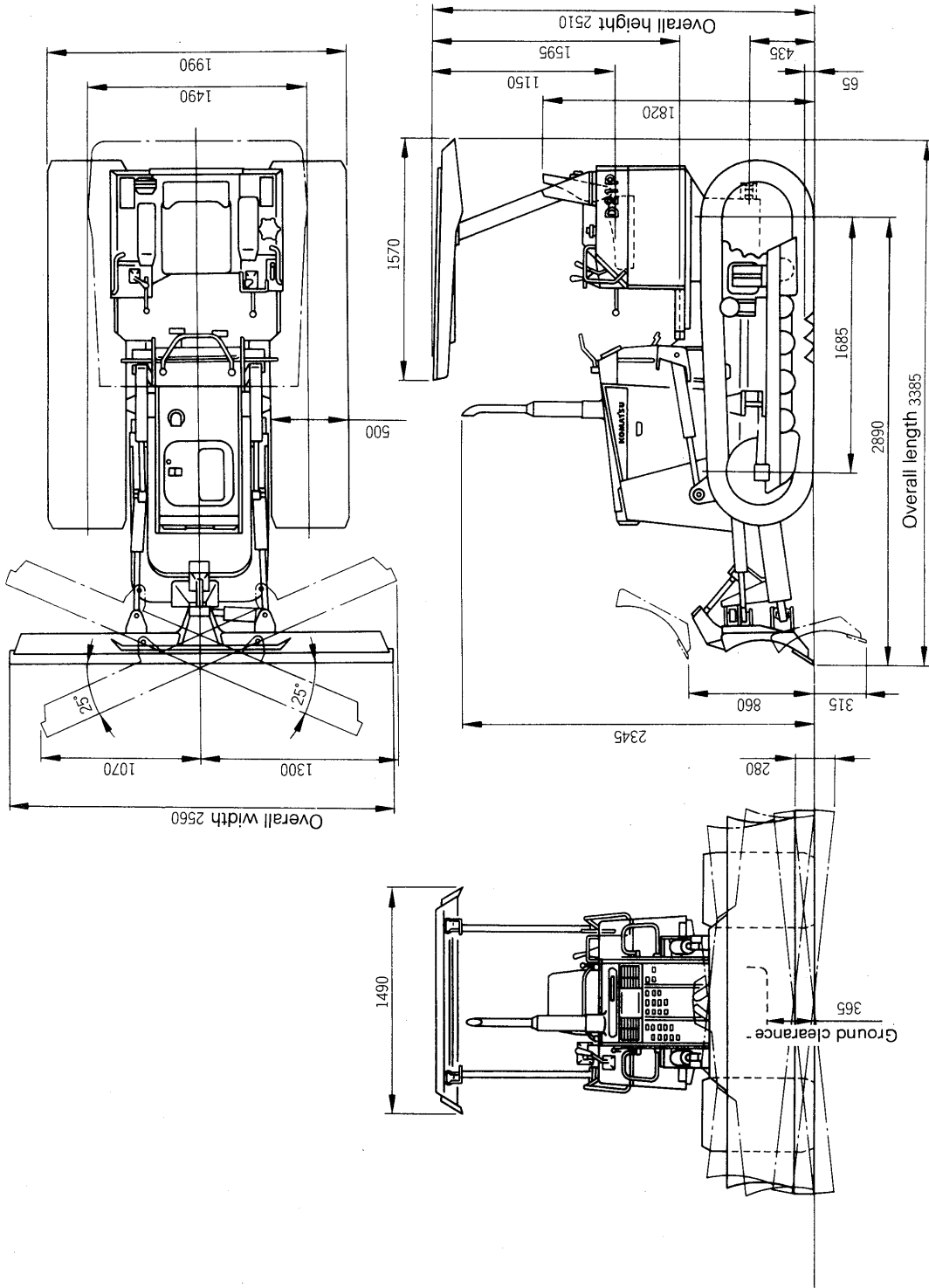

OPTIONS, ATTACHMENTS

26. GENERAL PRECAUTIONS

26.1 PRECAUTIONS RELATED TO SAFETY

If attachments or options other than those authorized by Komatsu are installed, this will not only affect the life of the machine, but will also cause problems with safety.

When installing attachments not listed in this Operation and Maintenance Manual, please contact your Komatsu distributor first.

If you do not contact Komatsu, we cannot accept any responsibility for any accident or failure.



WARNING

Precautions for removal and installation operations

- **When removing or installing attachments, obey the following precautions and take care to ensure safety during the operation.**
- **Carry out the removal and installation operations on a flat, firm ground surface.**
- **When the operation is carried out by two or more workers, determine signals and follow these during the operation.**
- **When carrying heavy objects (more than 25 kg), use a crane.**
- **When removing heavy parts, always support the part before removing it.
When lifting such heavy parts with a crane, always pay careful attention to the position of the center of gravity.**
- **It is dangerous to carry out operations with the load kept suspended. Always set the load on a stand, and check that it is safe.**
- **When removing or installing attachments, make sure that they are in a stable condition and will not fall over.**
- **Never go under a load suspended from a crane.
Always stand in a position that is safe even if the load should fall.**

NOTICE

Qualifications are required to operate a crane. Never allow the crane to be operated by an unqualified person.

For details of the removal and installation operations, please contact your Komatsu distributor.

27. USING SEAT BELT

27.1 SEAT BELT (For fixed type)

When operating a machine equipped with ROPS, be sure to use the seat belt.

⚠ WARNING

- Before fastening the seat belt, inspect the securing brackets and belt for abnormal conditions. Replace any worn or damaged seat belt or the securing brackets.
- Adjust and fasten the seat belt before operating the machine.
- Always use seat belt when operating the machine.
- Do not use seat belt with either half of the belt kinked.

27.1.1 FASTEN THE BELT AND REMOVE IT IN THE FOLLOWING MANNER

1. Adjust the seat so that the brake pedal can be depressed all the way with the operator's back against the backrest.
2. After positioning the seat, sit in the seat. Hold buckle ① with your left hand and tongue ② with our right hand, put the tongue into buckle ①. Check that the belt has locked by pulling it.
3. When removing the belt, raise the tip of the buckle lever to release it.
Fasten belt along your body without kinking it. Adjust the lengths of the belt on both the buckle and the tongue sides so that the buckle is located at the mid-point of your body front.

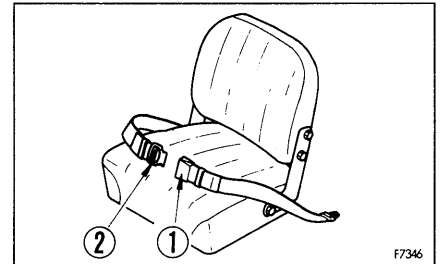

27.1.2 ADJUST THE BELT LENGTH IN THE FOLLOWING MANNER

To shorten the belt

Pull the free end of the belt on either the buckle body or tongue side.

To lengthen the belt

Pull the belt while holding it at a right angle to buckle or tongue.

Inspect bolts and fittings on the chassis for tightness. Retighten any loose bolts to 2 to 3 kgm torque.

If the seat is scratched or frayed or if any of the fittings are broken or deformed from long service, replace the seat belt immediately.

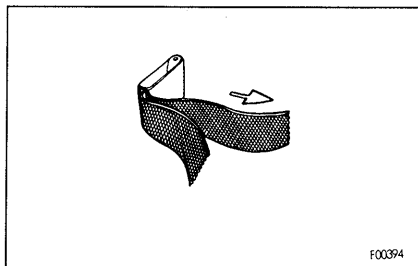
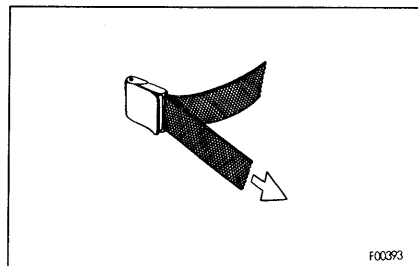

27.2 SEAT BELT (For suspension type)

When operating a machine equipped with ROPS, be sure to use the seat belt.

WARNING

- Before fastening the seat belt, inspect the securing brackets and belt for abnormal conditions. Replace any worn or damaged seat belt or the securing brackets.
- Adjust and fasten the seat belt before operating the machine.
- Always use seat belt when operating the machine.
- Do not use seat belt with either half of the belt kinked.
- Check that there are no kinks in the tether belt.

27.2.1 FASTEN THE BELT AND REMOVE IT IN THE FOLLOWING MANNER

1. Adjust the seat so that the brake pedal can be depressed all the way with the operator's back against the backrest.
2. After positioning the seat, adjust the tether belt ①. With the seat unoccupied, tense the belt slightly across the seat and install.
3. Sit in the seat. Hold buckle ② with your left hand and tongue ③ with your right hand, put the tongue into the buckle. Check that the belt has locked by pulling it.
4. When removing the belt, raise the tip of the buckle lever to release it.
Fasten belt along your body without kinking it. Adjust the lengths of the belt on both the buckle and the tongue sides so that the buckle is located at the mid-point of your body front.

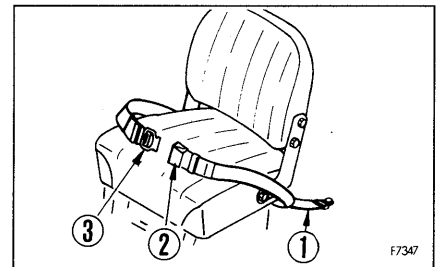

27.2.2 ADJUST THE BELT LENGTH IN THE FOLLOWING MANNER

To shorten the belt

Pull the free end of the belt on either the buckle body or tongue side.

To lengthen the belt

Pull the belt while holding it at a right angle to buckle or tongue.

Inspect bolts and fittings on the chassis for tightness. Retighten any loose bolts to 2 to 3 kgm torque.

If the seat is scratched or frayed or if any of the fittings are broken or deformed from long service, replace the seat belt immediately.

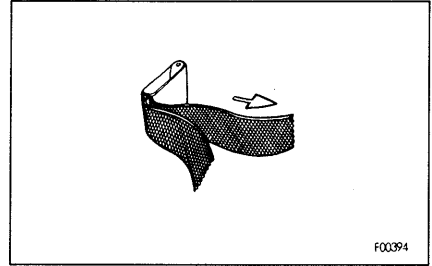
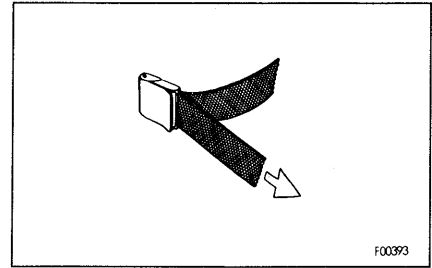

28. HANDLING SUSPENSION SEAT

WARNING

- Adjust the seat position at the beginning of each shift or when operators change.
- Adjust the seat so that the brake pedal can be depressed all the way with the operator's back against the backrest.

- Fore-aft adjustment of seat
Move lever ① to the left set the seat to a position where it is easy to operate, then release the lever.
Fore-aft adjustment: 160 mm (9 stages)
- Adjusting seat cushion
Turn knob ② to the desired direction to adjust the riding condition.
- Adjusting reclining angle
Pull lever ③, set the seatback to a position where it is easy to operate, then release the lever.

