

# Operation & Maintenance Manual

SEAM007603T

# D475A-2

## BULLDOZER

SERIAL NUMBERS D475A-10365 and up

### WARNING

Unsafe use of this machine may cause serious injury or death. Operators and maintenance personnel must read this manual before operating or maintaining this machine. This manual should be kept near the machine for reference and periodically reviewed by all personnel who will come into contact with it.

### NOTICE

Komatsu has Operation & Maintenance Manuals written in some other languages. If a foreign language manual is necessary, contact your local distributor for availability.

# KOMATSU

# 1. FOREWORD

---

This manual provides rules and guidelines which will help you use this machine safely and effectively. Keep this manual handy and have all personnel read it periodically. If this manual has been lost or has become dirty and can not be read, request a replacement manual from Komatsu or your Komatsu distributor.

If you sell the machine, be sure to give this manual to the new owners.

Continuing improvements in the design of this machine can lead to changes in detail which may not be reflected in this manual. Consult Komatsu or your Komatsu distributor for the latest available information of your machine or for questions regarding information in this manual.

This manual may contain attachments and optional equipment that are not available in your area. Consult Komatsu or your Komatsu distributor for those items you may require.

## WARNING

- **Improper operation and maintenance of this machine can be hazardous and could result in serious injury or death.**
- **Operators and maintenance personnel should read this manual thoroughly before beginning operation or maintenance.**  
**Keep this manual in a readily available place near the machine (on machines with cab, there is a door pocket to hold the manual), and have all personnel involved in working on the machine read the manual periodically.**
- **Some actions involved in operation and maintenance of the machine can cause a serious accident, if they are not done in a manner described in this manual.**
- **The procedures and precautions given in this manual apply only to intended uses of the machine. If you use your machine for any unintended uses that are not specifically prohibited, you must be sure that it is safe for you and others. In no event should you or others engage in prohibited uses or actions as described in this manual.**
- **Komatsu delivers machines that comply with all applicable regulations and standards of the country to which it has been shipped. If this machine has been purchased in another country or purchased from someone in another country, it may lack certain safety devices and specifications that are necessary for use in your country. If there is any question about whether your product complies with the applicable standards and regulations of your country, consult Komatsu or your Komatsu distributor before operating the machine.**
- **The description of safety is given in SAFETY INFORMATION on page 0-4 and in SAFETY from page 1-1.**

### **CALIFORNIA**

#### **Proposition 65 Warning**

**Diesel engine exhaust and some of its constituents are known to the State of California to cause cancer, birth defects, and other reproductive harm.**

### **CALIFORNIA**

#### **Proposition 65 Warning**

**Battery posts, terminals and related accessories contain lead and lead compounds, chemicals known to the State of California to cause cancer and birth defects or other reproductive harm.**

**Wash hands after handling.**

## EMISSION CONTROL WARRANTY

### EMISSION CONTROL WARRANTY STATEMENT (APPLIES TO CANADA ONLY)

#### 1. Products Warranted

Komatsu America International Company, Komatsu Mining Systems Inc. and Komatsu Utility Corporation (collectively "Komatsu") produce and/or market products under brand names of Komatsu, Dresser, Dresssta, Haulpak and Galion. This emissions warranty applies to new engines bearing the Komatsu name installed in these products and used in Canada in machines designed for industrial off-highway use. This warranty applies only to these engines produced on or after January 1, 2000. This warranty will be administered by Komatsu distribution in Canada.

#### 2. Coverage

Komatsu warrants to the ultimate purchaser and each subsequent purchaser that the engine is designed, built and equipped so as to conform, at the time of sale by Komatsu, with all U.S. Federal emission regulations applicable at the time of manufacture and that it is free from defects in workmanship or material which would cause it not to meet these regulations within five years or 3,000 hours of operation, whichever occurs first, as measured from the date of delivery of the engine to the ultimate purchaser.

#### 3. Limitations

Failures, other than those resulting from defects in materials or workmanship, are not covered by this warranty. Komatsu is not responsible for failures or damage resulting from what Komatsu determines to be abuse or neglect, including, but not limited to: operation without adequate coolant or lubricants; over fueling; over speeding; lack of maintenance of lubricating, cooling or intake systems; improper storage, starting, warm-up, run-in or shutdown practices; unauthorized modifications of the engine. Komatsu is also not responsible for failures caused by incorrect fuel or by water, dirt or other contaminants in the fuel. Komatsu is not responsible for non-engine repairs, "downtime" expense, related damage, fines, all business costs or other losses resulting from a warrantable failure.

### KOMATSU IS NOT RESPONSIBLE FOR INCIDENTAL OR CONSEQUENTIAL DAMAGES.

This warranty, together with the express commercial warranties, are the sole warranties of Komatsu. **THERE ARE NO OTHER WARRANTIES, EXPRESS OR IMPLIED, OR OF MERCHANTABILITY OR FITNESS FOR A PARTICULAR PURPOSE.**

## GARANTIE SUR LE CONTRÔLE DES ÉMISSIONS

### ÉNONCÉ DE GARANTIE SUR LE CONTRÔLE DES ÉMISSIONS (APPLICABLE AU CANADA SEULEMENT):

#### 1. Produits garantis:

Komatsu America International Company, Komatsu Mining Systems Inc. et Komatsu Utility Corporation (collectivement Komatsu) produisent et/ou font la mise en marché de produits portant les noms de marque Komatsu, Dresser, Dresssta, Haulpak et Galion. Cette garantie sur les émissions s'applique à tous les nouveaux moteurs portant le nom Komatsu, installés dans ces produits et utilisés au Canada dans des machines conçues pour utilisation industrielle non-routière. Cette garantie s'applique seulement sur les moteurs produits à partir du 1er Janvier 2000. Cette garantie sera administrée par la distribution de Komatsu au Canada.

#### 2. Couverture:

Komatsu garantit à l'acheteur ultime et chaque acheteur subséquent que le moteur est conçu, construit et équipé en toute conformité, au moment de la vente par Komatsu, avec toutes les Réglementations fédérales américaines sur les émissions applicables au moment de la fabrication et qu'il est exempt de défauts de construction ou de matériaux qui auraient pour effet de contrevenir à ces réglementations en dedans de 5 ans ou 3000 heures d'opération, mesuré à partir de la date de livraison du moteur au client ultime.

#### 3. Limitations:

Les bris, autres que ceux résultant de défauts de matériaux ou de construction, ne sont pas couverts par cette Garantie. Komatsu n'est pas responsable pour bris ou dommages résultant de ce que Komatsu détermine comme étant de l'abus ou négligence, incluant mais ne se limitant pas à: l'opération sans lubrifiants ou agent refroidissants adéquats; la suralimentation d'essence; la survitesse; le manque d'entretien des systèmes de lubrification, de refroidissement ou d'entrée; de pratiques non-propices d'entreposage, de mise en marche, de réchauffement, de conditionnement ou d'arrêt; les modifications non-autorisées du moteur. De plus, Komatsu n'est pas responsable de bris causés par de l'essence inadéquate ou de l'eau, des saletés ou autres contaminants dans l'essence. Komatsu n'est pas responsable des réparations non-relées au moteur, des dépenses encourues suite aux temps d'arrêts, des dommages relatifs, amendes, et de tout autre coût d'affaires ou autres pertes résultant d'un bris couvert par la garantie.

### KOMATSU N'EST PAS RESPONSABLE DES INCIDENTS OU DOMMAGES CONSÉQUENTS.

Cette garantie, ainsi que les garanties expresses commerciales, sont les seules garanties de Komatsu. **IL N'Y A AUCUNE AUTRE GARANTIE, EXPRESSE OU SOUS-ENTENDUE, MARCHANDABLE OU PROPICE A UNE UTILISATION PARTICULIÈRE.**

**INFORMATION IMPORTANTE SUR LE MOTEUR**  
 CE MOTEUR EST CONFORME AUX NORMES AMÉRICAINES DE L'EPA (ANNÉE DU MODÈLE) ET DE LA CALIFORNIE POUR LES MOTEURS LARGES NON-ROUTIERS À IGNITION PAR COMPRESSION. CE MOTEUR EST CERTIFIÉ POUR OPERATION À ESSENCE DIÉSEL.

**AVERTISSEMENT**  
 DES BLESSURES PEUVENT RÉSULTER ET LA GARANTIE S'ANNULER SI LES RPM DU TAUX D'ESSENCE OU L'ALTITUDE EXCÈDENT LES VALEURS MAXIMALES PUBLIÉES POUR CE MODÈLE ET SON APPLICATION.

**IMPORTANT ENGINE INFORMATION**

THIS ENGINE CONFORMS TO YYYY MODEL YEAR U.S. EPA REGULATION AND THE CALIFORNIA REGULATIONS LARGE NON ROAD COMPRESSION IGNITION ENGINES. THIS ENGINE IS CERTIFIED TO OPERATE ON DIESEL FUEL.

<b>WARNING</b>	
INJURY MAY RESULT AND WARRANTY IS VOIDED IF FUEL RATE RPM OR ALTITUDES EXCEED PUBLISHED MAXIMUM VALUES FOR THIS MODEL AND APPLICATION.	
ENGINE MODEL	SERIAL NO.
ENGINE FAMILY	DISPLACEMENT
EXHAUST EMISSION CONTROL SYSTEM	LITERS
ADV. LOAD OUTPUT	FIRING ORDER
	1 - 5 - 3 - 6 - 2 - 4
	RPM
VALVE LASH COLD (mm)	EX. FUEL RATE AT ADV.
	mm <sup>3</sup> /STROKE
IDLE SPEED	FAMILY EMISSION LIMIT
INITIAL INJECTION TIMING	DATE OF MANUFACTURE
	DEG. BTDC
	Kw ( HP)
	SEQUENCE DE MISE À FEU
	mm <sup>3</sup> /BATTEMENT
	TAUX D'ESSENCE À ADV.
	LIMITE D'ÉMISSION DE LA FAMILLE
	DATE DE FABRICATION
	KOMATSU LTD. MADE IN JAPAN

- MODÈLE DU MOTEUR
- FAMILLE DU MOTEUR
- SYSTÈME DE CONTRÔLE DES ÉMISSIONS D'ÉCHAPPEMENT
- CHARGE DE SORTIE ADV.
- PORTÉE DE VALVE À FROID (mm)
- VITESSE STATIQUE
- RÉGLAGE DE L'ALLUMAGE - INJECTION INITIALE
- DEG. BTDC

KOMATSU LTD.  
 FABRIQUE AU JAPON

ENGINE DATAPLATE - ENGLISH / FRENCH





## 2. SAFETY INFORMATION

---

Most accidents are caused by the failure to follow fundamental safety rules for the operation and maintenance of machines. To avoid accidents, read, understand and follow all precautions and warnings in this manual and on the machine before performing operation and maintenance.

To identify safety messages in this manual and on machine labels, the following signal words are used.

-  **DANGER** – This word is used on safety messages and safety labels where there is a high probability of serious injury or death if the hazard is not avoided. These safety messages or labels usually describe precautions that must be taken to avoid the hazard. Failure to avoid this hazard may also result in serious damage to the machine.
  
-  **WARNING** – This word is used on safety messages and safety labels where there is a potentially dangerous situation which could result in serious injury or death if the hazard is not avoided. These safety messages or labels usually describe precautions that must be taken to avoid the hazard. Failure to avoid this hazard may also result in serious damage to the machine.
  
-  **CAUTION** – This word is used on safety messages and safety labels for hazards which could result in minor or moderate injury if the hazard is not avoided. This word might also be word for hazards where the only result could be damage to the machine.
  
- NOTICE** – This word is used for precautions that must be taken to avoid actions which could shorten the life of the machine.

Safety precautions are described in SAFETY from page 1-1.

Komatsu cannot predict every circumstance that might involve a potential hazard in operation and maintenance. Therefore the safety messages in this manual and on the machine may not include all possible safety precautions. If any procedures or actions not specifically recommended or allowed in this manual are used, you must be sure that you and others can do such procedures and actions safely and without damaging the machine. If you are unsure about the safety of some procedures, contact your Komatsu distributor.

## 3. INTRODUCTION

---

### 3.1 INTENDED USE

This Komatsu BULLDOZER is designed to be used mainly for the following work.

- Dozing
- Cutting into hard or frozen ground or ditching
- Felling trees, removing stumps
- Pushing
- Ripping

See the section "12.16 WORK POSSIBLE USING BULL DOZER" for further details.

### 3.2 FEATURES

- Increase in production through use of lock-up torque converter
- Big increase in durability of undercarriage
- Simplification of inspection and maintenance through use of monitoring system and centralization of maintenance on one side
- Improvement in operator comfort through use of large cab

### 3.3 BREAKING IN THE MACHINE

#### NOTICE

**Before operating the machine for the first time, check that there is coolant in the radiator. If the machine is delivered with no coolant in the radiator, flush the inside of the radiator thoroughly with tap water, then fill the radiator with coolant.**

Your Komatsu machine has been thoroughly adjusted and tested before shipment.

However, operating the machine under severe conditions at the beginning can adversely affect the performance and shorten the machine life.

Be sure to break in the machine for the initial 100 hours (as indicated by the service meter.)

During breaking in:

- Idle the engine for 5 minutes after starting it up.
- Avoid operation with heavy loads or at high speeds.
- Avoid sudden starts, sudden acceleration, sudden steering and sudden stops except in cases of emergency.

The precautions given in this manual for operating, maintenance, and safety procedures are only those that apply when this product is used for the specified purpose. If the machine is used for a purpose that is not listed in this manual, Komatsu cannot bear any responsibility for safety. All consideration of safety in such operations is the responsibility of the user.

Operations that are prohibited in this manual must never be carried out under any circumstances.

## 4. LOCATION OF PLATES, TABLE TO ENTER SERIAL NO. AND DISTRIBUTOR

### 4.1 MACHINE SERIAL NO. PLATE POSITION

Under the front of the console box on the right side of the operator's seat.

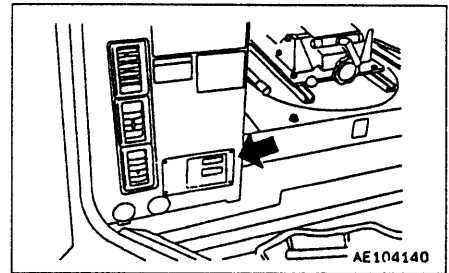

### 4.2 ENGINE SERIAL NO. PLATE POSITION

On the air intake manifold at the right side of the engine, when seen from the fan.

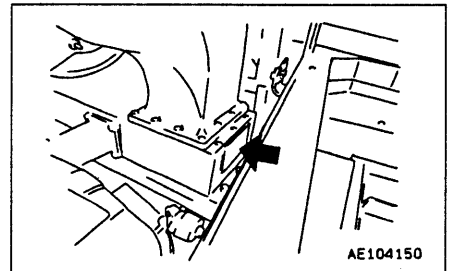

### 4.3 BLADE SERIAL NO. PLATE POSITION

This is located at the right side of blade back surface.

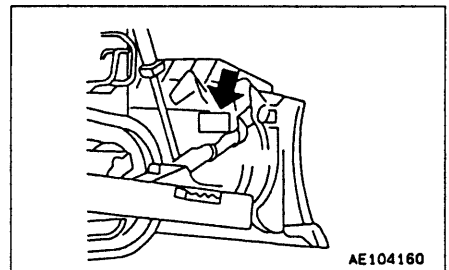

### 4.4 RIPPER SERIAL NO. PLATE POSITION

This is located at the left side surface of ripper beam.

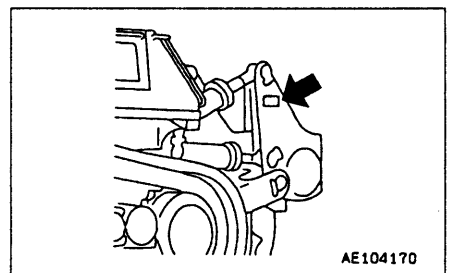

### 4.5 TABLE TO ENTER SERIAL NO. AND DISTRIBUTOR

Machine serial No.:	
Engine serial No.:	
Distributor name:	
Address:	Phone:
Service personnel for your machine:	

### REMARKS

# 5. CONTENTS

---

1. Foreword .....	0- 1
2. Safety information .....	0- 4
3. Introduction .....	0- 5
4. Location of plates, table to enter serial No. and distributor .....	0- 6

## SAFETY

6. General precautions .....	1- 2
7. Precautions during operation .....	1- 8
7.1 Before starting engine .....	1- 8
7.2 Operating machine .....	1-10
7.3 Transportation .....	1-13
7.4 Battery .....	1-14
7.5 Towing .....	1-15
8. Precautions for maintenance .....	1-16
8.1 Before carrying out maintenance .....	1-16
8.2 During maintenance .....	1-18
9. Position for attaching safety labels .....	1-23
9.1 Position for attaching safety labels .....	1-23
9.2 Content and use of warning plates .....	1-26

## OPERATION

10. General view .....	2- 2
10.1 General view of machine .....	2- 2
10.2 General view of controls and gauges .....	2- 3
11. Explanation of components .....	2- 4
11.1 Monitor panel .....	2- 4
11.2 Lamps .....	2-14
11.3 Switches .....	2-15
11.4 Control levers and pedals .....	2-17
11.5 Dust indicator .....	2-22
11.6 Fuse box .....	2-22
11.7 Door lock .....	2-23
11.8 Car stereo .....	2-24
11.9 Operating the air conditioner .....	2-30

<b>12. Operation</b> .....	2-36
12.1 Check before starting engine .....	2-36
12.2 Starting engine .....	2-49
12.3 Operations and checks after starting engine .....	2-52
12.4 Moving machine .....	2-53
12.5 Shifting gear .....	2-54
12.6 Shifting between forward and reverse .....	2-55
12.7 Steering machine .....	2-56
12.8 Stopping machine .....	2-58
12.9 Precautions for operation .....	2-59
12.10 Work possible using bulldozer .....	2-61
12.11 Ripper operation .....	2-62
12.12 Adjustment of work equipment .....	2-64
12.13 Parking machine .....	2-67
12.14 Check after finishing work .....	2-68
12.15 Stopping engine .....	2-69
12.16 Check after stopping engine .....	2-70
12.17 Locking .....	2-70
12.18 Tips longer undercarriage life .....	2-71
<b>13. Transportation</b> .....	2-73
13.1 Loading, unloading work .....	2-73
13.2 Precautions for loading .....	2-74
13.3 Lifting position .....	2-74
13.4 Precautions for transportation .....	2-75
13.5 Removal of cab .....	2-75
<b>14. Cold weather operation</b> .....	2-78
14.1 Precautions for low temperature .....	2-78
14.2 After completion of work .....	2-80
14.3 After cold weather .....	2-80
<b>15. Long-term storage</b> .....	2-81
15.1 Before storage .....	2-81
15.2 During storage .....	2-81
15.3 After storage .....	2-82
<b>16. Troubleshooting</b> .....	2-83
16.1 After running out of fuel .....	2-83
16.2 Method of towing machine .....	2-83
16.3 If battery is discharged .....	2-83
16.4 Other trouble .....	2-86

## MAINTENANCE

<b>17. Guides to maintenance</b> .....	3- 2
<b>18. Outlines of service</b> .....	3- 5
18.1 Outline of oil, fuel, coolant .....	3- 5
18.2 Relating to electric system .....	3- 7
<b>19. Wear parts list</b> .....	3- 8
<b>20. Use of fuel, coolant and lubricants according to ambient temperature</b> .....	3- 9
<b>21. Standard tightening torques for bolts and nuts</b> .....	3-13
21.1 Introduction of necessary tools .....	3-13
21.2 Torque list .....	3-14
<b>22. Periodic replacement of safety critical parts</b> .....	3-15
<b>23. Maintenance schedule chart</b> .....	3-19
<b>24. Service Procedure</b> .....	3-22
24.1 Initial 250 hours service .....	3-22
24.2 When required .....	3-23
24.3 Check before starting .....	3-40
24.4 Every 250 hours service .....	3-47
24.5 Every 500 hours service .....	3-55
24.6 Every 1000 hours service .....	3-57
24.7 Every 2000 hours service .....	3-61
24.8 Every 4000 hours service .....	3-65

## SPECIFICATIONS

<b>25. Specifications</b> .....	4- 2
---------------------------------	------

## OPTIONS, ATTACHMENTS

<b>26. General precautions</b> .....	5- 2
26.1 Precautions related to safety .....	5- 2
<b>27. Using seat belt</b> .....	5- 3
27.1 Fasten the belt and remove it in the following manner .....	5- 3
<b>28. Procedure for selecting ripper point</b> .....	5- 4
28.1 Procedure for selecting ripper point .....	5- 4
<b>29. Handling cap with lock</b> .....	5- 5
29.1 Opening and closing lockable cap .....	5- 5

# SAFETY

 **WARNING**

**Read and follow all safety precautions. Failure to do so may result in serious injury or death.**

This safety section also contains precautions for optional equipment and attachments.

## 6. GENERAL PRECAUTIONS

**⚠ WARNING:** For reasons of safety, always follow these safety precautions.

### SAFETY RULES

- ONLY trained and authorized personnel can operate and maintain the machine.
- Follow all safety rules, precautions and instructions when operating or performing maintenance on the machine.
- When working with another operator or a person on worksite traffic duty, be sure all personnel understand all hand signals that are to be used.

### SAFETY FEATURES

- Be sure all guards and covers are in their proper position. Have guards and covers repaired if damaged.  
**Proper position → See "12.1.1 WALK-AROUND CHECK".**
- Use safety features such as the safety lock and seat belts properly.
- NEVER remove any safety features. ALWAYS keep them in good operating condition.  
**Safety lever → See "12.10 PARKING MACHINE".**  
**Seat belts → See "27. USING SEAT BELT".**
- Improper use of safety features could result in serious bodily injury or death.

### CLOTHING AND PERSONAL PROTECTIVE ITEMS

- Avoid loose clothing, jewelry, and loose long hair. They can catch on controls or in moving parts and cause serious injury or death. Also, do not wear oily clothes because they are flammable.
- Wear a hard hat, safety glasses, safety shoes, mask or gloves when operating or maintaining the machine. Always wear safety goggles, hard hat and heavy gloves if your job involves scattering metal chips or minute materials - this is so particularly when driving pins with a hammer and when cleaning the air cleaner element with compressed air.  
Check also that there is no one near the machine.  
**Cleaning of air cleaner element → See "24.2 WHEN REQUIRED" in service procedure.**

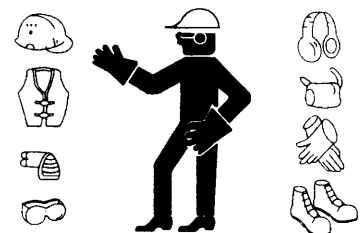

A0055010



### UNAUTHORIZED MODIFICATION

- Any modification made without authorization from Komatsu can create hazards.
- Before making a modification, consult your Komatsu distributor. Komatsu will not be responsible for any injury or damage caused by any unauthorized modification.

### STANDING UP FROM THE SEAT

To avoid hitting unlocked control levers, before standing up from operator's seat, do the following:

- Move gear shift lever to neutral and move SAFETY LEVER (located left of seat) to LOCK position.
- Lower work equipment to ground and move SAFETY LEVER (located right of seat) to LOCK position.
- Depress the brake pedal and move BRAKE LOCK LEVER (located right of seat) to LOCK position. Sudden and unwanted machine movement can cause serious injury or death.

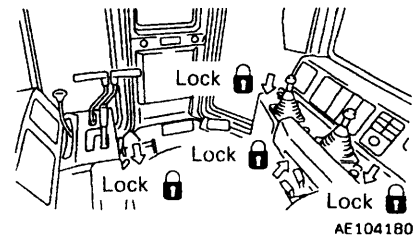

**MOUNTING AND DISMOUNTING**

- NEVER jump on or off the machine. NEVER get on or off a moving machine.
- When mounting and dismounting, face the machine and use the handholds and steps. Maintain three-point contact to be sure that you do not fall from the machine.
- Do not hold any control levers when getting on or off the machine.
- Repair any damaged handhold or step, and tighten any loose bolts. Handholds and steps must be free of oil, grease and excessive dirt.
- When mounting or dismounting, use the points marked with arrows in the diagram below.
- Use the parts marked by arrow A in the diagram below when getting on or off machine. Never use the parts marked by arrow B when getting on or off the machine. Use them only when moving along the top of the track or when checking or carrying out maintenance inside the side cover, or when filling the tank with oil.

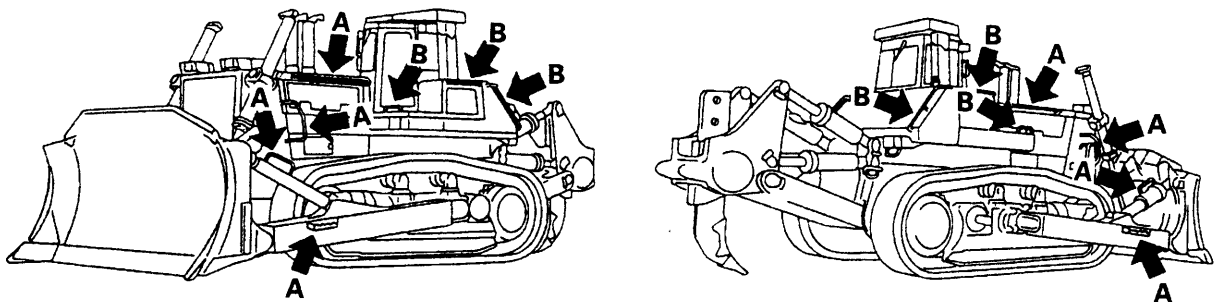

AE104190

### FIRE PREVENTION FOR FUEL AND OIL

Fuel, oil, and antifreeze can be ignited by a flame. Fuel is particularly **FLAMMABLE** and can be **HAZARDOUS**.

- Keep a flame away from flammable fluids.
- Stop the engine and do not smoke when refueling.
- Tighten all fuel and oil caps securely.
- Refueling and oiling should be made in well ventilated areas.
- Keep oil and fuel in the determined place and do not allow unauthorized persons to enter.



A0055020



A0055030

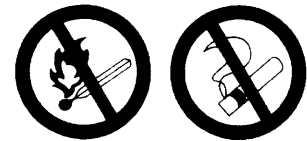

A0055040

### BURN HAZARD PREVENTION

- If the coolant, engine oil, power train oil or hydraulic oil is hot, use a heavy cloth, gloves, heavy clothing and safety glasses or goggles before checking or touching.
- To prevent hot water from spurting out:
  - 1) Turn engine off.
  - 2) Allow water to cool.
  - 3) Slowly loosen cap to relieve pressure before removing.
- To prevent hot oil from spurting out:
  - 1) Turn engine off.
  - 2) Allow oil to cool.
  - 3) Slowly loosen cap to relieve pressure before removing.

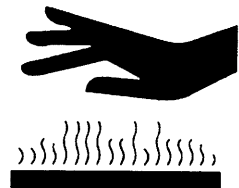

A0055050

### ASBESTOS DUST HAZARD PREVENTION

- Asbestos dust can be HAZARDOUS to your health if it is inhaled.
- If you handle materials containing asbestos fibers, follow these guidelines as given below:
  - 1) NEVER use compressed air for cleaning.
  - 2) Use water for cleaning to minimize dust cloud.
  - 3) Operate the machine with the wind to your back, whenever possible.
  - 4) Use an approved respirator if necessary.

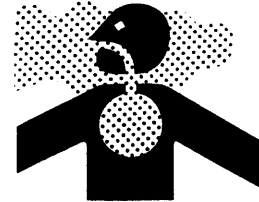

A0055060

### CRUSHING OR CUTTING PREVENTION

- Do not enter, or put your hand or arm or any other part of your body between movable parts such as between the work equipment and cylinders, or between the machine and the blade or ripper or any other attachment.  
If the work equipment is operated, the clearance will change and this may lead to serious damage or personal injury.

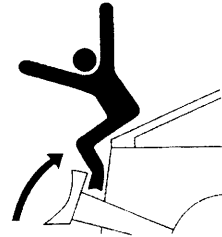

A0055230

### FIRE EXTINGUISHER AND FIRST AID KIT

- Be sure fire extinguishers have been provided and know how to use them.
- Know where a first aid kit is located.
- Know what to do in the event of a fire.
- Be sure you know the phone numbers of persons you should contact in case of an emergency.

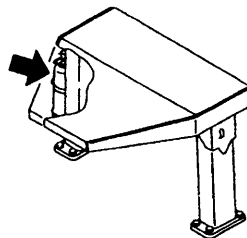

AE104200

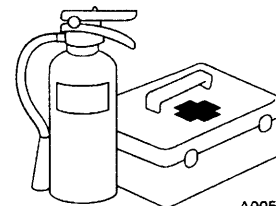

A0055070

### PRECAUTIONS FOR ROPS

- Do not operate machine with ROPS removed if equipped.
- The ROPS is installed to protect the operator if the machine should overturn. It is designed not only to take the load when the machine overturns, but also to absorb the impact energy.
- The Komatsu ROPS fulfills all worldwide regulations and standards, but if any unauthorized modification is carried out on it, or if it is damaged when the machine overturns, its strength will be reduced and it will not be able to provide its original capacity. It will be able to provide this capacity only if modifications and repairs are carried out in the specified way.
- When carrying out modification or repairs, always consult your Komatsu distributor first.
- Even when the ROPS is installed, if you do not fasten your seat belt securely, it cannot protect you properly. Always fasten your seat belt when operating the machine.  
**Seat belts → See "27. USING SEAT BELT."**

### PRECAUTIONS FOR ATTACHMENTS

- When installing and using an optional attachment, read the instruction manual for the attachment and the information related to attachments in this manual.
- Do not use attachments that are not authorized by Komatsu or your Komatsu distributor. Use of unauthorized attachments could create a safety problem and adversely affect the proper operation and useful life of the machine.
- Any injuries, accidents, product failures resulting from the use of unauthorized attachments will not be the responsibility of Komatsu.

## 7. PRECAUTIONS DURING OPERATION

**⚠ WARNING:** For reasons of safety, always follow these safety precautions.

### 7.1 BEFORE STARTING ENGINE

#### SAFETY AT WORKSITE

- Before starting the engine, thoroughly check the area for any unusual conditions that could be dangerous.
- Before starting the engine, examine the terrain and soil conditions of the worksite. Determine the best and safest method of operation.
- If you need to operate on a street, protect pedestrians and cars by designating a person for worksite traffic duty or by installing fences around the worksite.
- If water lines, gas lines, and high-voltage electrical lines may be buried under the worksite, contact each utility and identify their locations. Be careful not to sever or cut any of these lines.
- Check the depth and flow of water before operating in water or crossing a river. NEVER be in water which is in excess of the permissible water depth.

**Permissible water depth → See "12.9.1 PERMISSIBLE WATER DEPTH".**

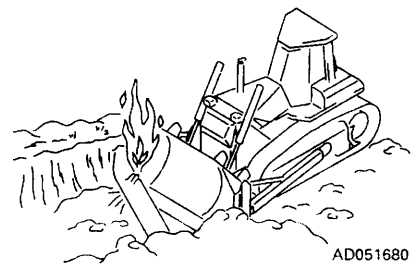

AD051680

#### FIRE PREVENTION

- Thoroughly remove wood chips, leaves, paper and other flammable things accumulated on the engine compartment. They could cause a fire.
- Check fuel, lubrication, and hydraulic systems for leaks. Have any leaks repaired. Wipe up any excess oil, fuel or other flammable fluids.  
**Check point → See "12.1.1 WALK-AROUND CHECK".**
- Be sure a fire extinguisher is present and working.



A0055020

**IN OPERATOR'S CAB**

- Do not leave tools or spare parts lying around in the operator's compartment. They may damage or break the control levers on switches.
- Keep the cab floor, controls, steps and handholds free of oil, grease, snow, and excess dirt.
- Check the seat belt, buckle and hardware for damage or wear. Replace any worn or damaged parts. Always use seat belts when operating your machine.  
**Seat belts → See "27. USING SEAT BELT".**

**VENTILATION FOR ENCLOSED AREAS**

- If it is necessary to start the engine within an enclosed area, provide adequate ventilation. Exhaust fumes from the engine can KILL.



A0055060

**PRECAUTIONS FOR MIRRORS, WINDOWS AND LIGHTS**

- Remove all dirt from the surface of the windows and lights to ensure that you can see well.
- Adjust the rear view mirror so that you can see clearly from the operator's seat, and always keep the surface of the mirror clean. If any glass is broken, replace it with a new part.
- Check that the head lamps and rear lamps are installed to match the operating conditions. Check also that they light up properly.

**PRECAUTIONS FOR SLIDING GLASS INTERMEDIATE LOCK**

The sliding glass intermediate lock is to prevent rattling of the glass. Even when the lock is used, the glass may move because of the shock when starting or stopping suddenly. Do not put your head or hands out of the window during operations.

**CHECK THOROUGHLY BEFORE STARTING**

Always carry out all checks before starting.

## 7.2 OPERATING MACHINE

### WHEN STARTING ENGINE

- Walk around your machine again just before mounting it, checking for people and objects that might be in the way.
- NEVER start the engine if a warning tag has been attached to the control.
- When starting the engine, sound the horn as an alert.
- Start and operate the machine only while seated.
- Do not allow anyone other than the operator to ride in the cab or on the machine body.
- For machines equipped with backup alarm, check that the warning device operates correctly.

### PRECAUTIONS WHEN MOVING FORWARD OR BACKWARD

Before moving machine or its attachments:

- Honk horn to alert people nearby.
- Be sure no one is around machine, particularly behind machine.
- Use spotter if necessary, particularly if you are moving in reverse.
- When operating in areas that may be hazardous or have poor visibility, designate a person to direct worksite traffic.
- Prevent people from entering the line of travel of the machine.

Follow above even if equipped with backup alarm and mirrors.

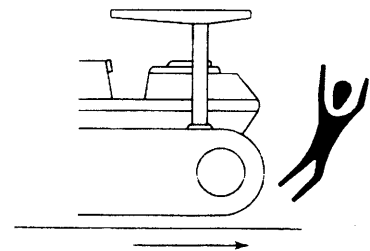

A0055080



### TRAVELING ON SLOPES

- Traveling on hills, banks or slopes that are steep could result in the machine tipping over or slipping.
- On hills, banks or slopes, carry the work equipment closer to the ground, approximately 20 to 30 cm (8 to 12 in) above the ground. In case of emergency, quickly lower the work equipment to the ground to help the machine stop and prevent it from tipping over.
- Do not change direction on slopes. Avoid sideways travel whenever possible: rather travel up and down the slopes.
- Do not travel up and down on grass, fallen leaves, and wet steel plates. These materials may allow the machine to slip, if it is traveling sideways. Keep travel speed very low.
- When traveling downhill, drive slowly and use the engine as a brake.
- When traveling downhill with the machine being pushed by its own weight, the machine may steer in the opposite direction, so be careful when steering.

**Reverse steering when traveling downhill → See "12.7.2 TURNING WHILE DESCENDING A SLOPE".**

**INCORRECT**

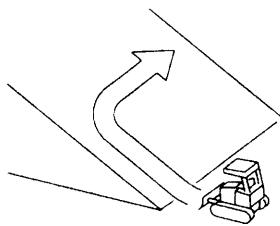

**CORRECT**

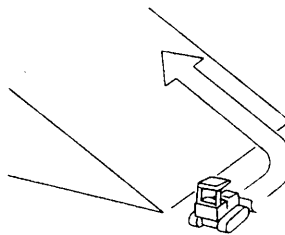

AD051690

### VISIBILITY

- Turn ON the head lamps and rear lamp, when working at night or at dark sites. Provide additional lights for the worksite if necessary.
- If visibility is diminished by fog, snow or rain, stop operation. Wait until there is adequate visibility for safe operation.

### WORKING ON SNOWY SITE

- Snow-covered and frozen ground may allow the machine to slip sideways, even if the grade is not steep. Slow down the machine when traveling on such ground. Avoid rapid starts, stops, and steering.
- In snow removal work, pay special attention to the edge of the road and to objects under the snow.

### WORKING ON LOOSE GROUND

- Avoid operating your machine too close to the edge of cliffs, overhangs, and deep ditches. If these areas collapse, your machine could fall or tip over and result in serious injury or death. Remember that the soil after heavy rain or blasting is weakened in these areas.
- Earth laid on the ground and the soil near ditches are loose. They can collapse under the weight or vibration of your machine.
- Install the HEAD GUARD or FOPS if working in areas where there is danger of falling rocks and dirt.
- When working in places where there is danger of falling rocks or danger of the machine turning over, install ROPS and a seat belt.

### PARKING THE MACHINE

- Park on level ground whenever possible. If not possible, block the tracks, lower the blade to the ground and thrust the edge of the blade in the ground.

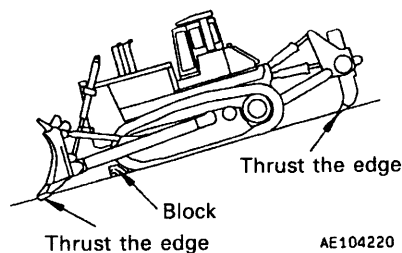

- When parking on public roads, provide fences and signs, such as flags or lights, on the machine to warn passersby to be careful. Be sure that the machine, flags or lights do not obstruct traffic.  
**Parking procedure → See "12.10 PARKING MACHINE".**
- Before leaving the machine, lower the work equipment to the ground, move the SAFETY LEVER to LOCK position, stop the engine, and lock all the doors, windows, and covers and remove the key(s).  
**Work equipment posture → See "12.10 PARKING MACHINE".**  
**Locks → See "12.14 LOCKING".**

### 7.3 TRANSPORTATION

#### LOADING AND UNLOADING

- Loading and unloading the machine always involves potential hazards. **EXTREME CAUTION SHOULD BE USED.**
- Perform loading and unloading on firm, level ground only. Maintain a safe distance from the edge of a road.
- **ALWAYS** block the wheels of the hauling vehicle and place blocks under both ramps before loading and unloading.
- **ALWAYS** use ramps of adequate strength. Be sure the ramps are wide and long enough to provide a safe loading slope.
- Be sure that the ramps are securely positioned and fastened, and that the two sides are at the same level as one another.
- Be sure the ramp surface is clean and free of grease, oil, ice and loose materials. Remove dirt from the machine tracks.
- **NEVER** correct your steering on the ramps. If necessary, drive away from the ramps and climb again.
- After loading, block the machine tracks and secure the machine with tie-downs.

Loading and unloading → See "13. TRANSPORTATION".

Tie-downs → See "13. TRANSPORTATION".

#### CORRECT

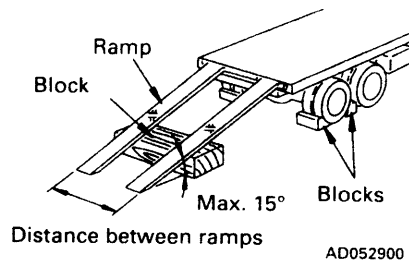

#### SHIPPING

- When shipping the machine on a hauling vehicle, obey all state and local laws governing the weight, width, and length of a load. Also obey all applicable traffic regulations.
- Determine the shipping route while taking into account the width, height and weight of the load.

## 7.4 BATTERY

### BATTERY HAZARD PREVENTION

- Battery electrolyte contains sulfuric acid and can quickly burn the skin and eat holes in clothing. If you spill acid on yourself, immediately flush the area with water.
- Battery acid could cause blindness if splashed into the eyes. If acid gets into the eyes, flush them immediately with large quantities of water and see a doctor at once.
- If you accidentally drink acid, drink a large quantity of water or milk, beaten egg or vegetable oil. Call a doctor or poison prevention center immediately.
- When working with batteries. ALWAYS wear safety glasses or goggles.
- Batteries generate hydrogen gas. Hydrogen gas is very EXPLOSIVE, and is easily ignited with a small spark or flame.
- Before working with batteries, stop the engine and turn the starting switch to the OFF position.
- Avoid short-circuiting the battery terminals through accidental contact with metallic objects, such as tools, across the terminals.
- Tighten the battery terminals securely. Loosened terminals can generate sparks and lead to an explosion.
- Tighten the battery cap.

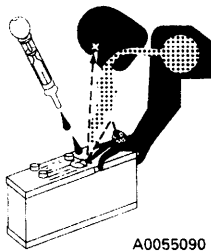

A0055090

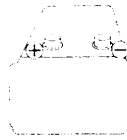

A0055100

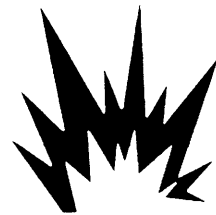

A0055110

### STARTING WITH BOOSTER CABLES

- ALWAYS wear safety glasses or goggles when starting the machine with booster cables.
- When starting from another machine, do not allow the two machines to touch.
- Be sure to connect the positive (+) cable first when installing the booster cables. Disconnect the ground or negative (-) cable first when removing them.
- Connect the batteries in parallel: positive to positive and negative to negative.
- When connecting the ground cable to the frame of the machine to be started, be sure to connect it as far as possible from the battery.

**Starting with booster cables → See "16.4 IF BATTERY IS DISCHARGED".**

**INCORRECT**

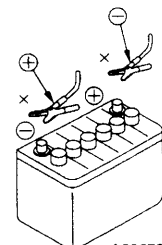

A0067320

## 7.5 TOWING

### FIT WIRE TO HOOK WHEN TOWING

- Injury or death could result if a disabled machine is towed incorrectly.
- If your machine is towed by another machine, **ALWAYS** use a wire rope with a sufficient towing capacity.
- If your machine is towed by another machine, stop the engine and release the brake. Please contact your Komatsu distributor to have the brake released.
- **NEVER** allow a disabled machine to be towed on a slope.
- Do not use a kinked or frayed wire rope.
- Do not straddle the towing cable or wire rope.
- When connecting up a towing machine, do not let anyone enter the area between the towing machine and the equipment being towed.
- Set the towing machine and the towing connection of the equipment being towed in a straight line when connecting it.
- Take up the slack in the wire rope and tow the machine.
- When lifting the machine up, use the towing hook.
- If the machine is stuck in sandy soil, dig out the soil around the towing hook, then use the towing hook to pull the machine out.

Permissible load for towing hook: 71500 kg (701175 N)

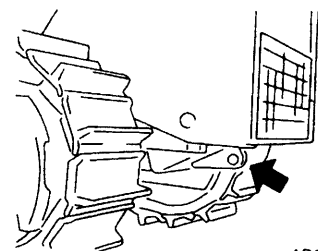

AD051710

## 8. PRECAUTIONS FOR MAINTENANCE

**⚠ WARNING:** For reasons of safety, always follow these safety precautions.

### 8.1 BEFORE CARRYING OUT MAINTENANCE

#### WARNING TAG

- If others start the engine or operate the controls while you are performing service or lubrication, you could suffer serious injury or death.
- ALWAYS attach the WARNING TAG to the control lever in the operator's cab to alert others that you are working on the machine. Attach additional warning tags around the machine, if necessary.
- These tags are available from your Komatsu distributor.

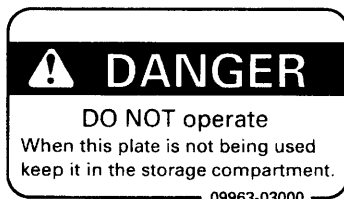

	Part No.
English	09963-03000
German	09963-02000
Spanish	09963-01000
French	09963-05000
Italian	09963-06000

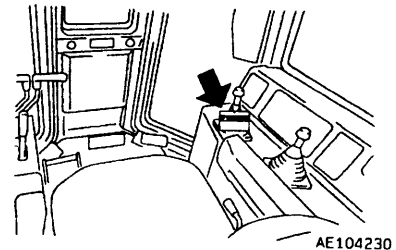

#### PROPER TOOLS

- Use only tools suited to the task. Using damaged, low quality, faulty, or makeshift tools could cause personal injury.  
**Tools → See "21.1 INTRODUCTION OF NECESSARY TOOLS".**



#### PERIODIC REPLACEMENT OF SAFETY CRITICAL PARTS

- Replace the following fire-related components periodically:  
Fuel system: Fuel hose, spilling hose, and fuel tube cap  
Hydraulic system: Pump outlet hoses
- Replace these components periodically with new ones, regardless of whether or not they appear to be defective. These components deteriorate over time.
- Replace or repair any such components if any defect is found, even though they have not reached the time specified.

**Replacement of safety critical components → See "22. PERIODIC REPLACEMENT OF SAFETY CRITICAL PARTS".**

**STOP THE ENGINE BEFORE CARRYING OUT INSPECTION AND MAINTENANCE**

- Always stop the machine on firm flat ground and stop the engine before carrying out inspection and maintenance.
- If it is necessary to run the engine when carrying out maintenance, such as when cleaning the inside of the radiator, place the safety lock lever at the LOCK position and carry out the operation with two workers.
- One worker should sit in the operator's seat so that he can stop the engine immediately if necessary. He should also be extremely careful not to touch any lever by mistake. Touch the levers only when they have to be operated.
- The worker carrying out the maintenance should be extremely careful not to touch or get caught in the moving parts.
- If maintenance is carried out with the work equipment raised, always support it securely with blocks.

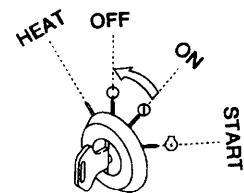

A0072030

## 8.2 DURING MAINTENANCE

### PERSONNEL

- Only authorized personnel can service and repair the machine. Extra precaution should be used when grinding, welding, and using a sledge-hammer.



### ATTACHMENTS

- Place attachments that have been removed from the machine in a safe place so that they do not fall. If they fall on you or others, serious injury could result.



### WORK UNDER THE MACHINE

- Always lower all movable work equipment to the ground or to their lowest position before performing service or repairs under the machine.
- Always block the tracks of the machine securely.
- Never work under the machine if the machine is poorly supported.



### KEEP THE MACHINE CLEAN

- Spilled oil or grease, or scattered tools or broken pieces are dangerous because they may cause you to slip or trip. Always keep your machine clean and tidy.
- If water gets into the electrical system, there is danger that the machine may not move or may move unexpectedly. Do not use water or steam to clean the sensors, monitors, controllers, connectors, or the inside of the operator's compartment.

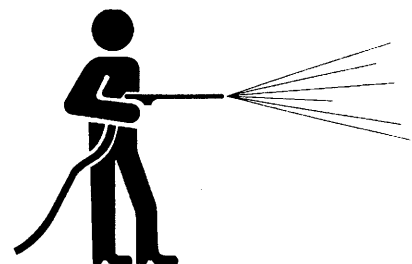



**RULES TO FOLLOW WHEN ADDING FUEL OR OIL**

- Spilled fuel and oil may cause you to slip, so always wipe it up immediately.
- Always tighten the cap of the fuel and oil fillers securely.
- Never use fuel for washing any parts.
- Always add fuel and oil in a well-ventilated place.



A0055020



A0055030



A0055040

**RADIATOR WATER LEVEL**

- When checking the water level, stop the engine and wait for the engine and radiator to cool down first.
- If removing the radiator cap, turn it slowly to release the internal pressure.

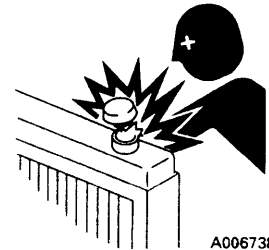

A0067380

**USE OF LIGHTING**

- When checking fuel, oil, coolant, or battery electrolyte, always use lighting with antiexplosion specifications. If such lighting equipment is not used, there is danger of explosion.

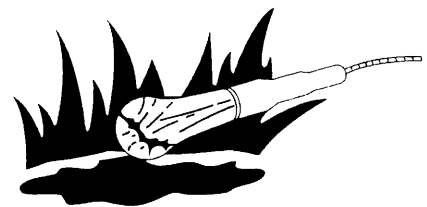

A0055160

**PRECAUTIONS WITH BATTERY**

- When repairing the electrical system or when carrying out electrical welding, remove the negative ⊖ terminal of the battery to stop the flow of current.

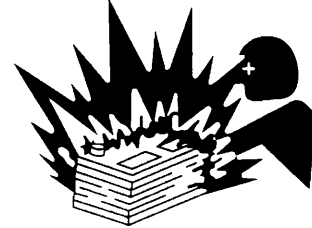

A0055170

**HANDLING HIGH-PRESSURE HOSES**

- Do not bend high-pressure hoses or hit them with hard objects. Do not use any bent or cracked piping, tubes or hoses. They may burst during use.
- Always repair any loose or broken fuel hoses or oil hoses. If fuel or oil leaks, it may cause a fire.
- Avoid torching, soldering, or welding on pipes, tubes and equipment that contain fuel or oils. If heated, they can generate flammable fumes or mist and could cause a fire or explosion.

**PRECAUTIONS WITH HIGH PRESSURE OIL**

- Do not forget that the work equipment circuits are always under pressure.
- Do not add oil, drain oil, or carry out maintenance or inspection before completely releasing the internal pressure.
- If oil is leaking under high pressure from small holes, it is dangerous if the jet of high-pressure oil hits your skin or enters your eyes. Always wear safety glasses and thick gloves, and use a piece of cardboard or a sheet of wood to check for oil leakage.
- If you are hit by a jet of high-pressure oil, consult a doctor immediately for medical attention.



A0055180

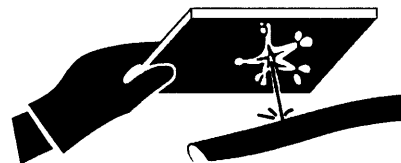

A0055190

**PRECAUTIONS WHEN CARRYING OUT MAINTENANCE AT HIGH TEMPERATURE OR HIGH PRESSURE**

- Immediately after stopping operations, the engine cooling water and oil at all parts is at high temperature and under high pressure. In this condition, if the cap is removed, or the oil or water are drained, or the filters are replaced, this may result in burns or other injury. Wait for the temperature to go down, then carry out the inspection and maintenance in accordance with the procedures given in this manual.

**Clean inside or cooling system → See "24.2 WHEN REQUIRED".**

**Check cooling water level, lubricating oil level, hydraulic oil level  
→ See "24.3 CHECK BEFORE STARTING".**

**Checking final drive case → See "24.4 PERIODIC MAINTENANCE".**

**Changing oil, replacing filters → See "24.5 - 7 PERIODIC MAINTENANCE".**



A0055050

**PRECAUTIONS WHEN USING HIGH PRESSURE GREASE TO ADJUST TRACK TENSION**

Grease is pumped into the track tension adjustment system under high pressure. If the specified procedure for maintenance is not followed when making adjustments, the plug or grease fitting may fly out and cause damage or personal injury.

- When loosening the grease drain plug, never loosen it more than one turn.
- Never put your face, hands, feet, or any other part of your body directly in front of any grease drain plug or valve.

**Adjusting track tension → See "24.2 WHEN REQUIRED".**



A0055200

**ROTATING FAN AND BELT**

- Keep away from rotating parts and be careful not to let anything get caught in them.
- If your body or tools touch the fan blades or fan belt, they may be cut off or sent flying, so never touch any rotating parts.

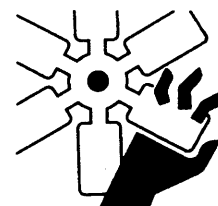

A0055210

**WASTE MATERIALS**

- Never dump waste oil in a sewer system, rivers, etc.
- Always put oil drained from your machine in containers. Never drain oil directly on the ground.
- Obey appropriate laws and regulations when disposing of harmful objects such as oil, fuel, coolant, solvent, filters, batteries, and others.

**INCORRECT**

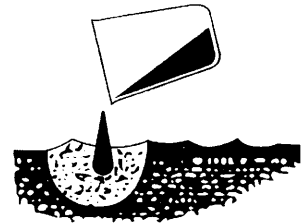

A0055220

## 9. POSITION FOR ATTACHING SAFETY LABELS

Always keep these labels clean. If they are lost or damaged, attaching them again or replace them with a new label.

There are other labels in addition to the safety labels listed as follows, so handle them in the same way.

Safety labels may be available in languages other than English.

To find out what labels are available, contact your Komatsu distributor.

### 9.1 POSITION FOR ATTACHING SAFETY LABELS

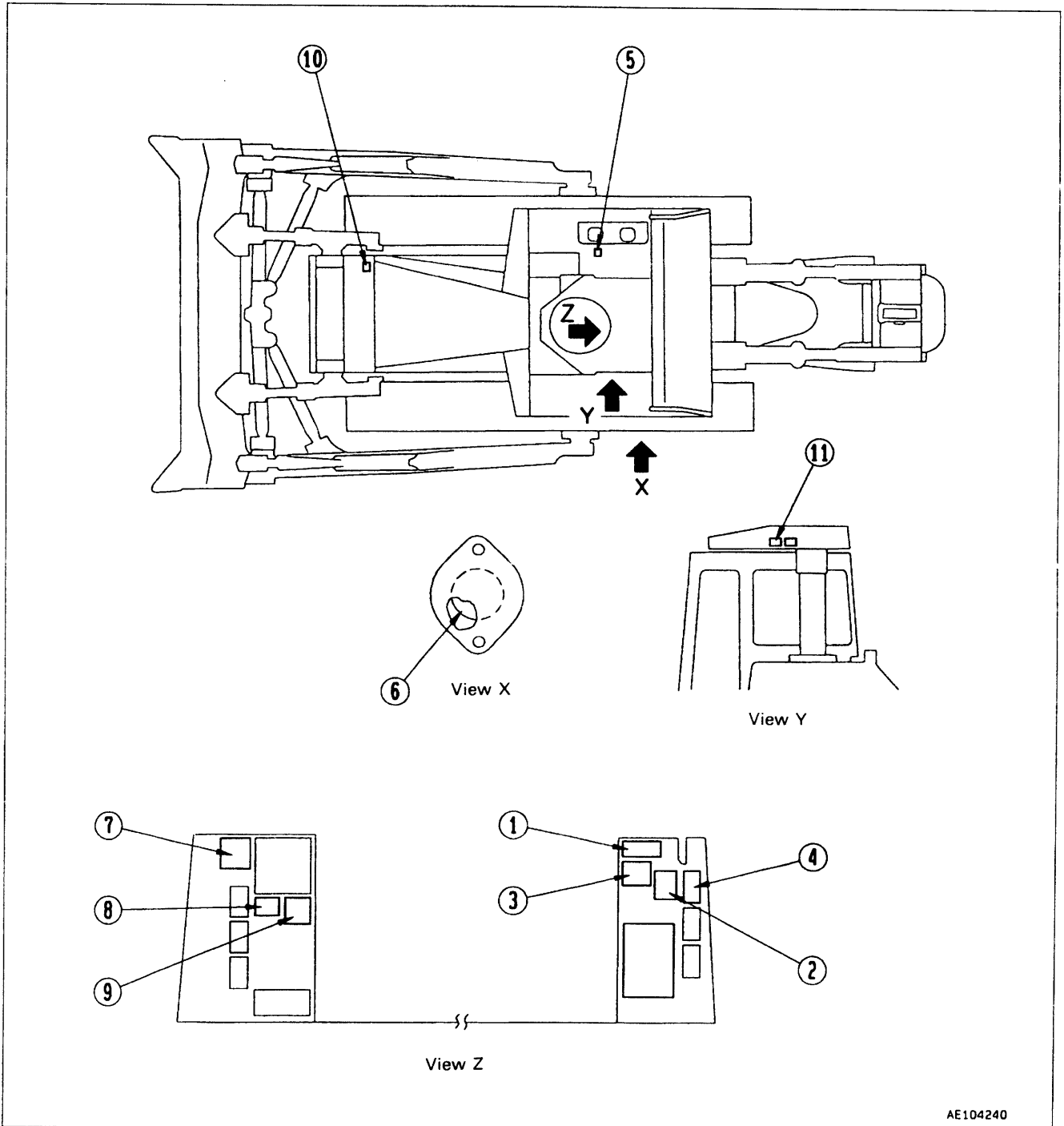

AE104240

9. POSITION FOR ATTACHING SAFETY LABELS

1. Cautions for traveling on a slope  
(175-900-2350)

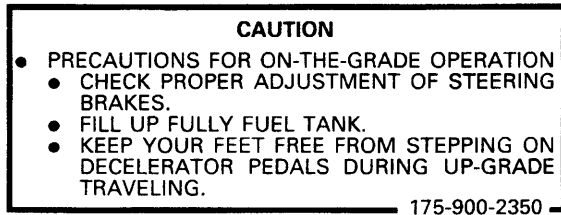

2. Cautions before operating machine  
(09651-03000)

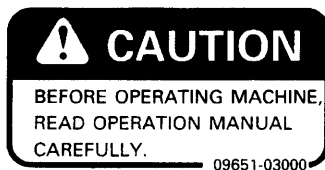

3. Warnings for starting engine and parking machine  
(09654-03000)

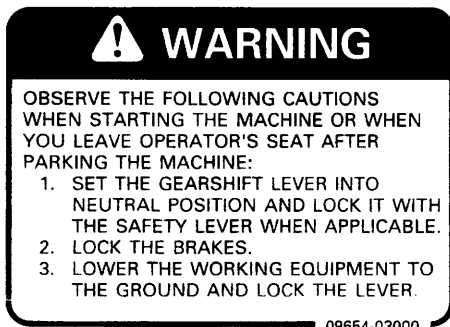

4. Cautions for checking engine room  
(09667-03000)

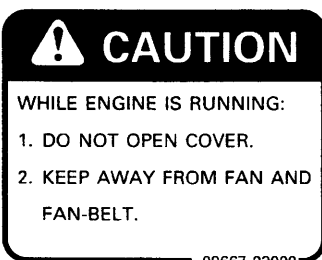

5. Cautions for opening cap of hydraulic tank  
(09653-03000)



6. Warnings for adjusting track tension  
(195-98-21380)

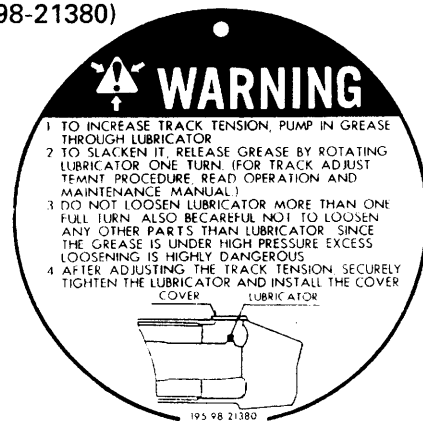

7. Cautions for preventing machine fire  
(09666-03000)

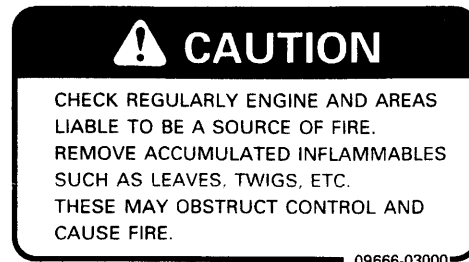

8. Cautions for inspection and maintenance  
(09173-03000)

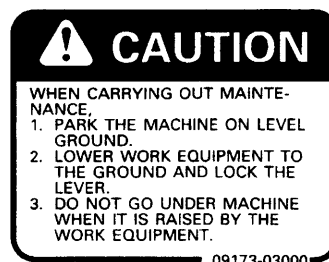

9. Warning for fastening seat belt  
(195-98-12940)

**CAUTION**

- ALWAYS USE SEAT BELT WHEN OPERATING MACHINE.
- ALWAYS CHECK CONDITION OF THE SEAT BELT, THE CONNECTING BRACKETS AND THE TIGHTENING BOLTS.
- ADJUST SEAT TO ALLOW FULL BRAKE PEDAL TRAVEL WITH OPERATOR'S BACK AGAINST SEAT BACK.
- AFTER ADJUSTING THE HEIGHT, FORE AND AFT POSITIONS OF THE SEAT, TIGHTEN THE TETHER BELT BEFORE SITTING IN THE SEAT.

195-98-12940

10. Warning for checking radiator  
(09668-03000)

**WARNING**

DO NOT LOOSEN CAP WHEN WATER TEMPERATURE IS HIGH. IF LOOSENED, BOILING WATER MAY GUSH OUT BECAUSE OF HIGH INTERNAL PRESSURE.

09668-03000

11. Warning for ROPS (09620-30202)

ROLL-OVER PROTECTIVE STRUCTURE (ROPS) CERTIFICATION  
THIS KOMATSU ROPS, MODEL & type No. [ ] SERIAL No. [ ] WHEN  
INSTALLED IN ACCORDANCE WITH THE MANUFACTURES INSTALLATION IN-  
STRUCTIONS ON A [ ] FOR MAXIMUM PRIME MOVER  
MASS NOT GREATER THAN [ ] LBS/(kg). IS CERTIFIED TO  
COMPLY WITH THE FOLLOWING REQUIREMENTS: a) OSHA 29CFR. 1926. 1001  
b) ISO 3471 (ROPS) c) SAE J [ ] & SAE J [ ]

---

**WARNING**

- Altering ROPS may weaken it. Consult Komatsu Distributor before altering.
- ROPS may provide less protection if it has been structurally damaged or involved in roll-over.
- Always wear seat belt when moving.

Komatsu Ltd. Japan
2-3-6 Akasaka, Minato-ku, Tokyo, Japan
09620-30202

## 9.2 Content and use of warning plates

1. Warning to prevent operation during maintenance  
(09963-00100)

Hang this warning plate on the controls in the operator's compartment.



2. Warning to prevent entry during maintenance  
Display this sign around the bulldozer.



	Part No.
English	17A-98-11530
German	17A-98-11730
Spanish	17A-98-11830
French	17A-98-11640
Italian	17A-98-12640



# **OPERATION**

# 10. GENERAL VIEW

## 10.1 GENERAL VIEW OF MACHINE

If directions are indicated in this section, they refer to the directions shown by the arrows in the diagram below.

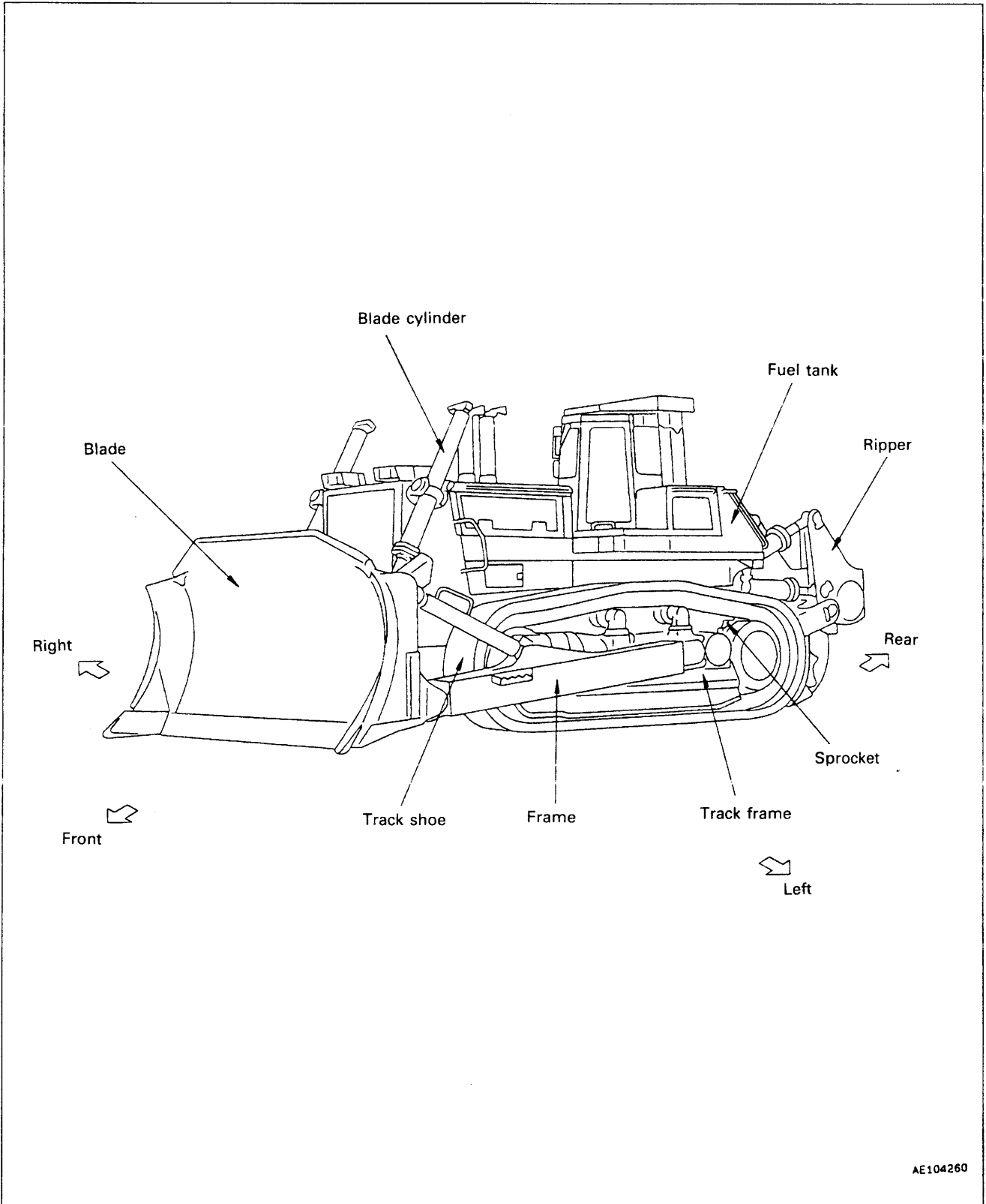

AE104260

10.2 GENERAL VIEW OF CONTROLS AND GAUGES

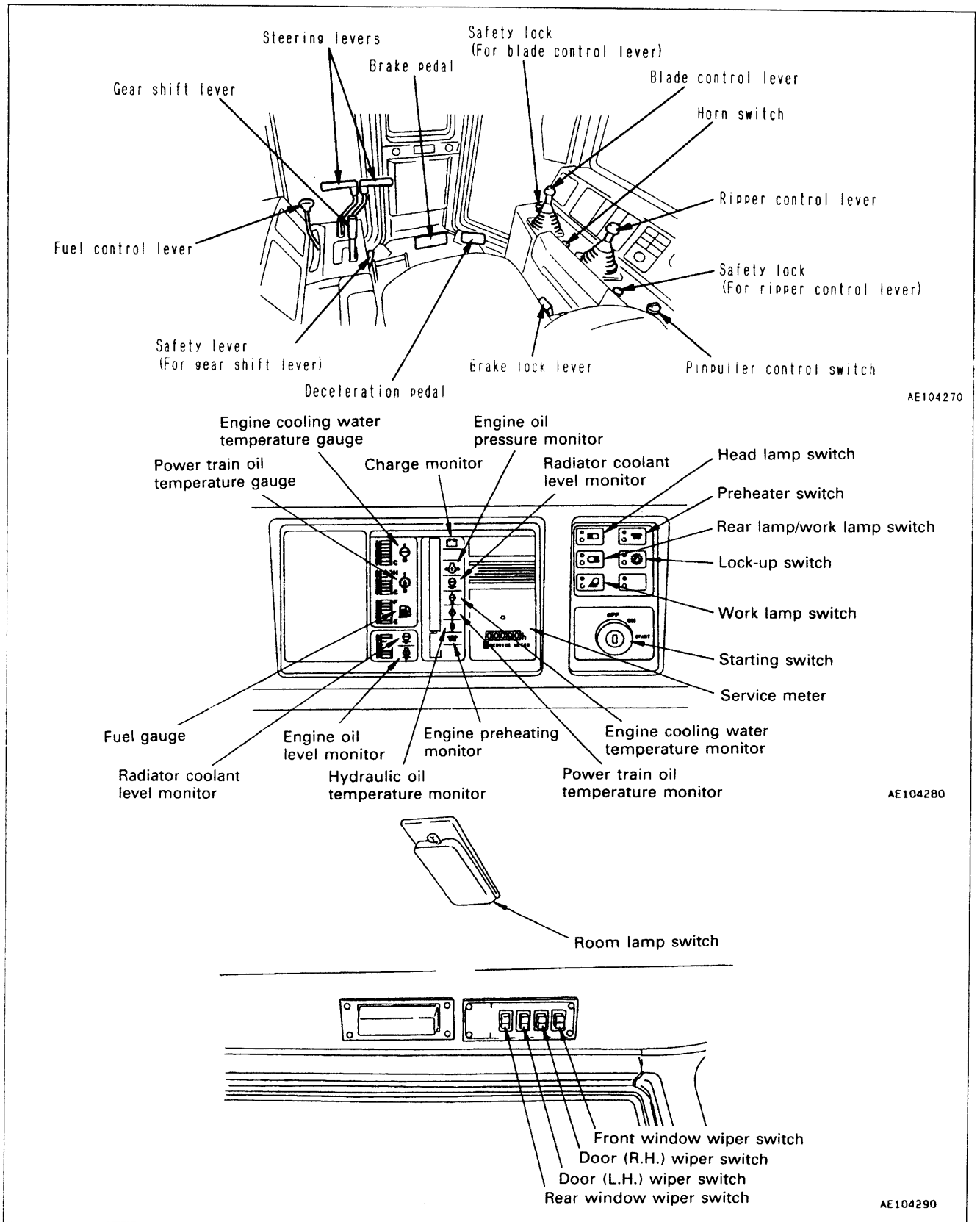

AE104270

AE104280

AE104290

# 11. EXPLANATION OF COMPONENTS

The following is an explanation of the devices needed for operating the machine.

To carry out suitable operations correctly and safely, it is important to understand fully the methods of operating the equipment and the meanings of the displays.

## 11.1 MONITOR PANEL

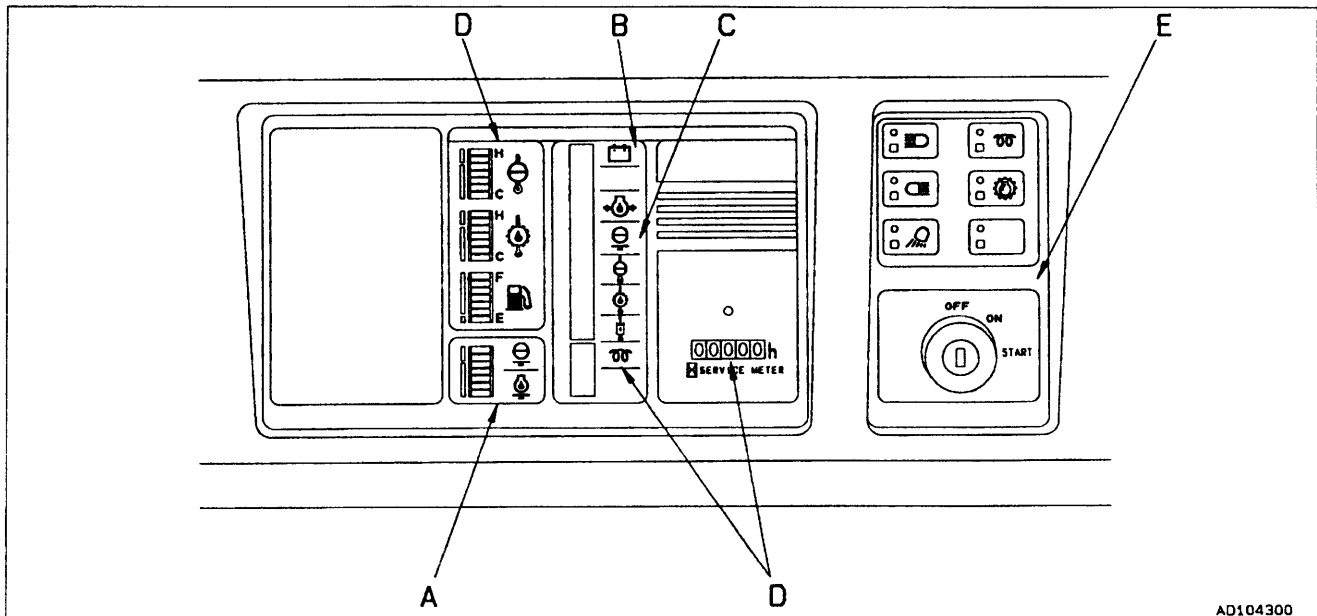

AD104300

### Ⓐ CHECK MONITOR GROUP (11.1.1) (Check items before starting)

If there is any abnormality, the appropriate monitor lamp will flash.

Check the location where the monitor lamp is flashing, and carry out the checks before starting.

When the engine is started, these monitor lamps will go off even if there are abnormalities.

### NOTICE

**When carrying out checks before starting, do not simply rely on the monitor. Always refer to the periodic maintenance items or "12. OPERATION" to carry out the checks.**

Ⓑ **CAUTION MONITOR GROUP (11.1.2)**  
(Caution items)

 **WARNING**

**If any monitor lamp flashes, repair it immediately.**

If the abnormality occurs while the engine is running, the appropriate monitor lamp will flash to indicate the abnormality.

Even if the monitor lamp flashes, the machine can operate, but it should be repaired as soon as possible.

Ⓒ **CAUTION MONITOR GROUP (11.1.3)**  
(Emergency caution items)

 **WARNING**

**If any monitor lamp flashes, stop the work, and repair it immediately.**

If any abnormality occurs while the engine is running, the appropriate monitor lamp will flash and the alarm buzzer will sound intermittently at the same time.

Even if the monitor lamp flashes, the machine can operate, but it should be repaired as soon as possible.

Ⓓ **METER GROUP (11.1.4)**

This group consists of engine water temperature gauge, power train oil temperature gauge, fuel gauge and service meter.

Ⓔ **SWITCH GROUP (11.1.5)**

This group consists of starting switch, lamp switches and quick start switch.

**Functional check of the machine monitor system**

When the starting switch is turned ON before starting the engine, the monitor lamps flash for 3 seconds, the warning lamp lights for 2 seconds, and the alarm buzzer sounds for 1 second.

- If any monitor lamp does not light up, there is probably a broken bulb or disconnection in the monitor, so ask your Komatsu distributor to inspect it.
- The monitor system cannot be checked for breakage until 30 seconds after the engine has been stopped.

**11.1.1 A: CHECK MONITOR GROUP  
(Check items before starting)**

**NOTICE**

When carrying out checks before starting, do not simply rely on the monitor. Always refer to the periodic maintenance items or "12. OPERATION" to carry out the checks.

Park the machine on level ground and check the monitor lamps.

Confirm that these monitor lamps light for about 3 seconds after the starting switch is turned to ON. If any monitor lamp does not light, ask your Komatsu distributor to inspect it.

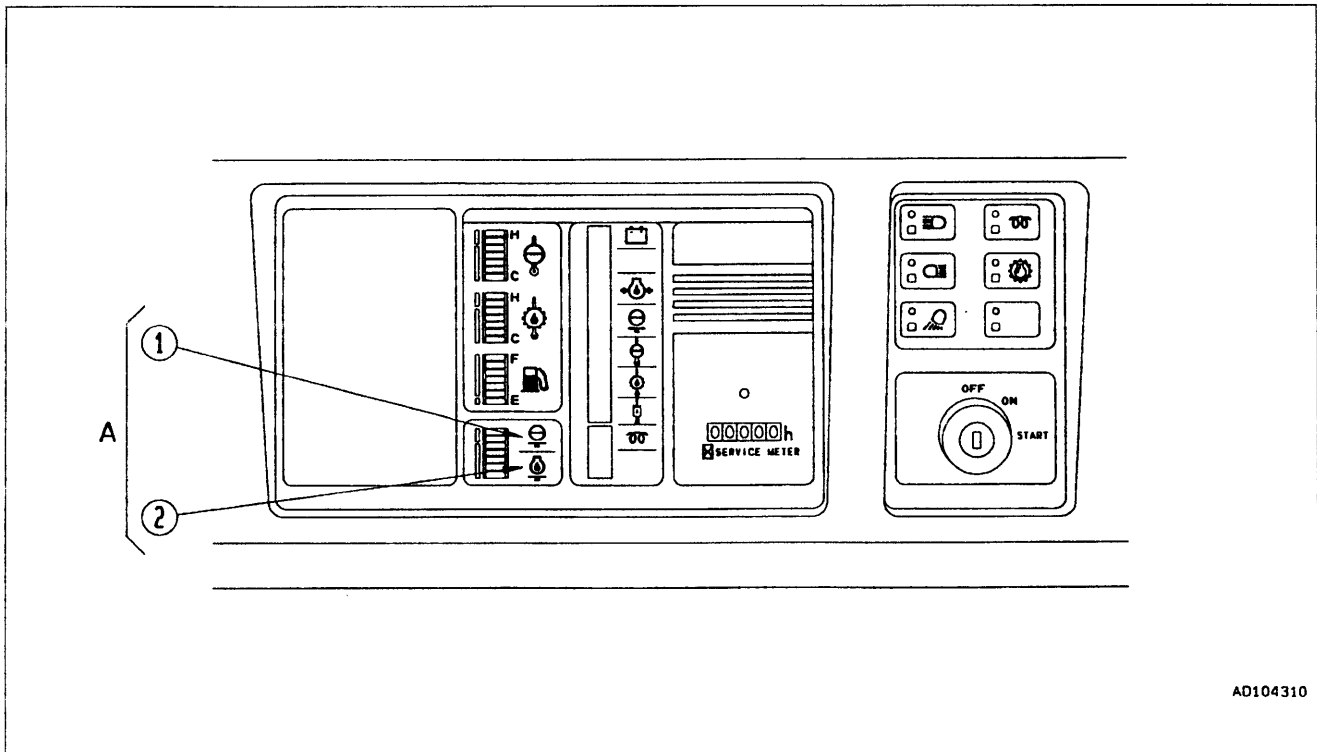

AD104310

**1. RADIATOR COOLANT LEVEL MONITOR**

This monitor indicates a low radiator coolant level.

If the monitor lamp flashes, check the coolant level and add water as required.

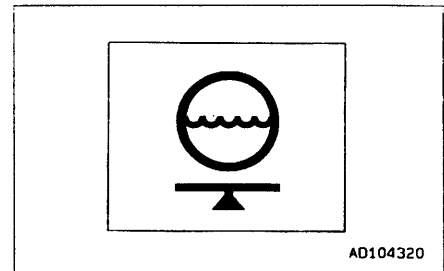

AD104320

**2. ENGINE OIL LEVEL MONITOR**

This monitor indicates a low oil level in the engine oil pan.

If the monitor lamp flashes, check the oil level in the engine oil pan and add oil as required.

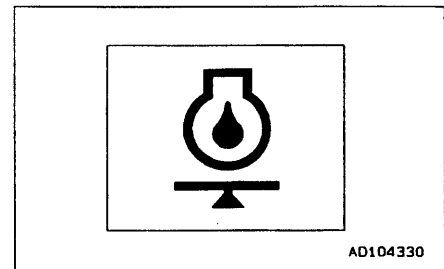

AD104330

### 11.1.2 B: CAUTION MONITOR GROUP (Caution items)

#### WARNING

If this monitor lamp flashes, repair it immediately.

#### NOTICE

Park the machine on level ground and check the monitor lamps.

Confirm that these monitor lamps light for about 3 seconds after the starting switch is turned to ON. If any monitor lamp does not light, ask your Komatsu distributor to inspect it.

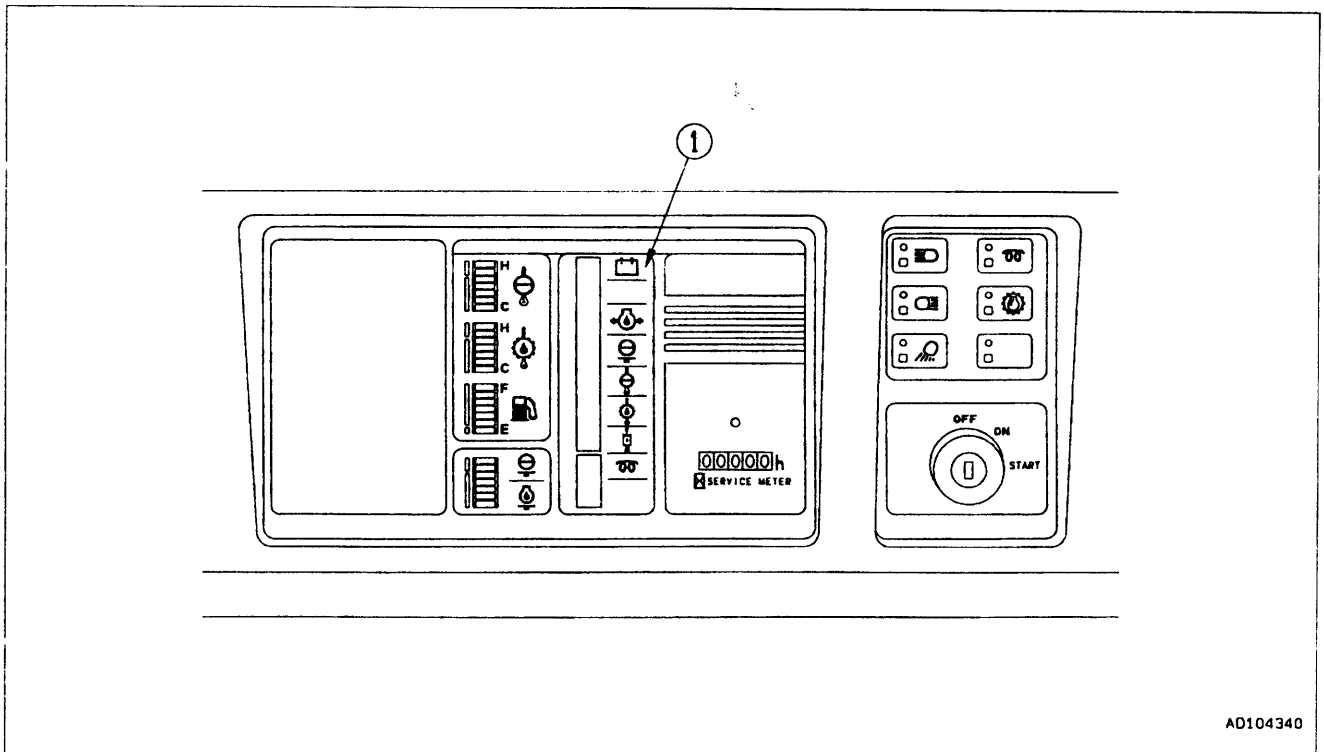

#### 1. CHARGE MONITOR

This monitor indicates an abnormality in the charging system while the engine is running.

If the monitor lamp flashes, stop the engine and check the V-belt tension. If any abnormality is found, see "16. TROUBLESHOOTING."

#### REMARK

This monitor lamp lights, when the starting switch is turned to ON immediately after the engine is started or immediately before the engine is stopped. It does not indicate an abnormality.

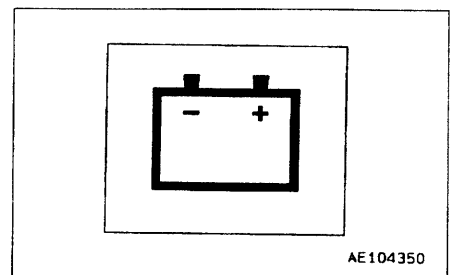

### 11.1.3 C: CAUTION MONITOR GROUP (Emergency caution items)

**WARNING**

If any monitor lamp flashes, stop the engine or run it at a low idling speed, and repair it immediately.

**NOTICE**

Park the machine on level ground and check the monitor lamps.  
Confirm that these monitor lamps light for about 3 seconds after the starting switch is turned to ON. If any monitor lamp does not light, ask your Komatsu distributor to inspect it.

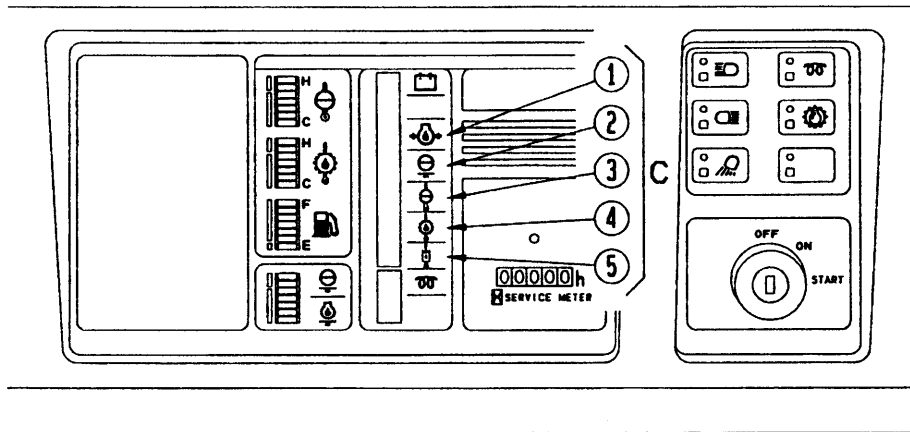

AD104370

#### 1. ENGINE OIL PRESSURE MONITOR

This monitor indicates a low engine oil pressure.

If the monitor lamp flashes, stop the engine and check it immediately.

**REMARK**

This monitor lamp flashes and the alarm buzzer sounds, when the starting switch is turned to ON immediately after the engine is started or immediately before the engine is stopped. It does not indicate an abnormality.

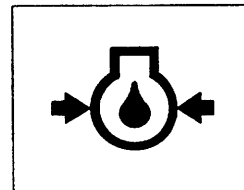

AD104380



**2. RADIATOR COOLANT LEVEL MONITOR**

This monitor indicates a low radiator coolant level.

When the monitor lamp flashes, stop the engine, check the coolant level and add water as required.

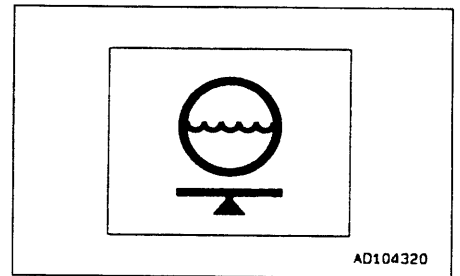
**3. ENGINE COOLING WATER TEMPERATURE MONITOR**

This monitor indicates a rise in the cooling water temperature.

When the monitor lamp flashes, run the engine at the low idling speed until the green range of the engine water temperature gauge lights.

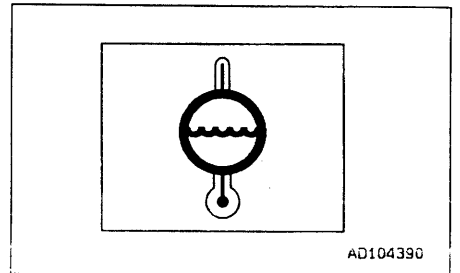
**4. POWER TRAIN OIL TEMPERATURE MONITOR**

This monitor indicates a rise in the oil temperature of the torque converter outlet.

When the monitor lamp flashes, run the engine at the low idling speed until the green range of the power train oil temperature gauge lights.

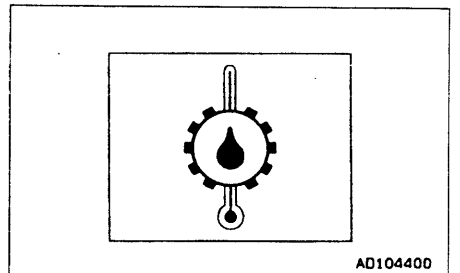
**5. HYDRAULIC OIL TEMPERATURE MONITOR**

This monitor indicates a rise in the hydraulic oil temperature.

When the monitor lamp flashes, stop the machine and run the engine at the low idling speed until oil temperature falls.

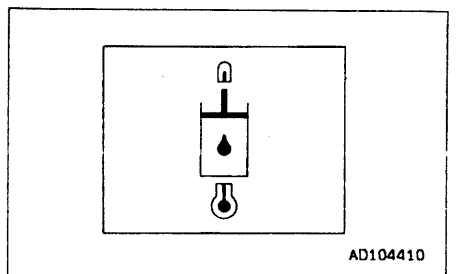

11.1.4 D: METER GROUP

NOTICE

While the engine is at rest, turn the starting switch ON to see if meter lamps ①, ② and ③ and the monitor lamp all come on. If they do not light, ask your Komatsu distributor to inspect them.

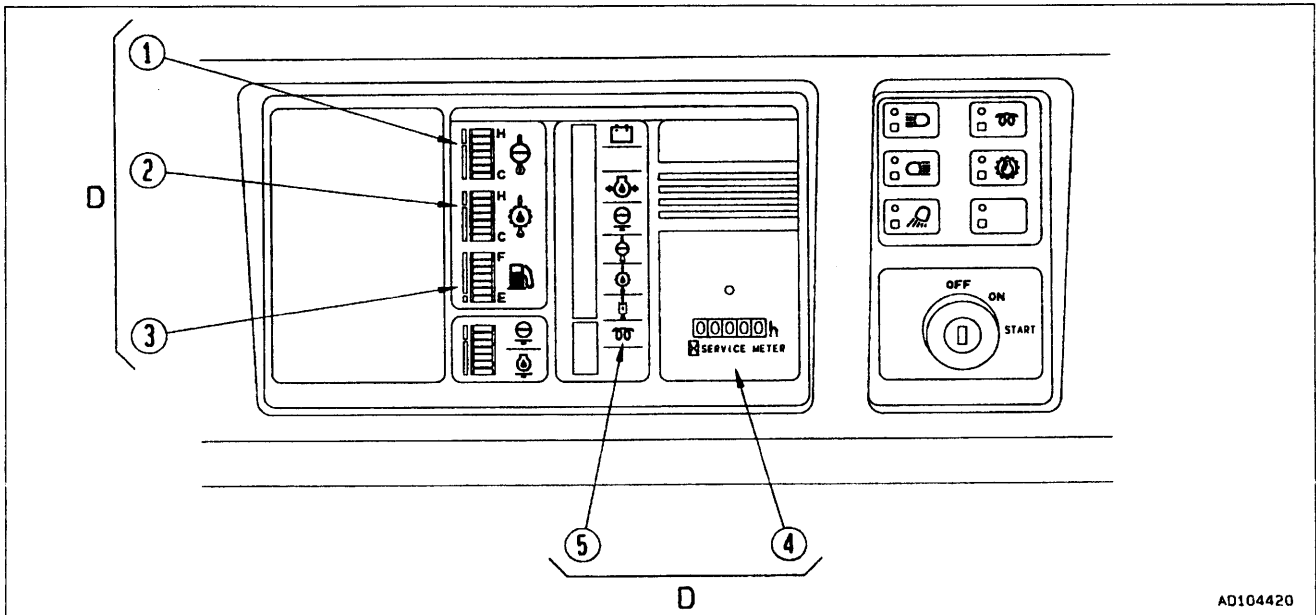

AD104420

1. ENGINE COOLING WATER TEMPERATURE GAUGE

This gauge indicates the temperature of the cooling water. If the temperature is normal during operation, the green range will light.

If the red range lights up during operation, move the fuel control lever to lower the engine speed to approx. 3/4 of the full speed, and run until the water temperature enters the green range.

If the engine cooling water temperature enters the red range, and the engine water temperature monitor flashes and the alarm buzzer sounds, stop the machine and run at low idling until the water temperature enters the green range.

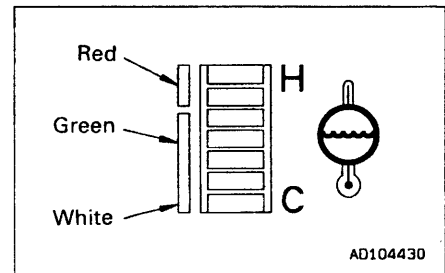

AD104430

NOTICE

If the water temperature gauge often enters the red range, check the radiator for clogging.

## 2. POWER TRAIN OIL TEMPERATURE GAUGE

This gauge indicates the oil temperature of the torque converter outlet. If the temperature is normal during operation, the green range will light.

If the red range lights up during operation, move the fuel control lever to lower the engine speed to approx. 3/4 of the full speed, reduce the load and run until the oil temperature enters the green range.

If the power train oil temperature enters the red range, and the power train oil temperature monitor flashes and the alarm buzzer sounds, stop the machine and run at low idling until the oil temperature enters the green range.

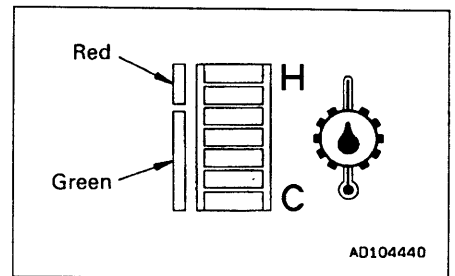

### NOTICE

If the power train oil temperature gauge often enters the red range, we recommend you to lower the travel speed one range (for example, F2 → F1) to reduce the load on the power train when operating.

## 3. FUEL GAUGE

This gauge indicates the amount of fuel in the fuel tank. If there is enough fuel in the tank while the engine is running, the green range lights. If the red range lights, there is less than 240 l (63.36 US gal, 52.8 UK gal) of fuel in the tank.

When the red range lights, add fuel.

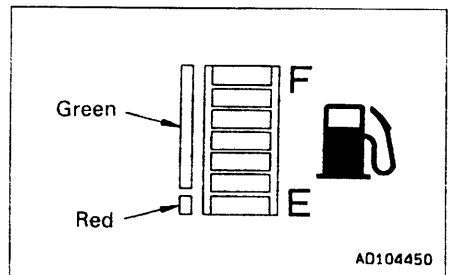

### REMARK

The display is not directly proportional with the remaining amount of fuel.

## 4. SERVICE METER

This meter shows the total operation hours of the machine. The service meter advances while the engine is running – even if the machine is not traveling.

Set the periodic maintenance intervals using this display.

When the engine is running, the green pilot lamp at the top of the meters flashes to indicate that the meter is advancing.

Meter will advance by 1 for each hour of operation regardless of the engine speed.

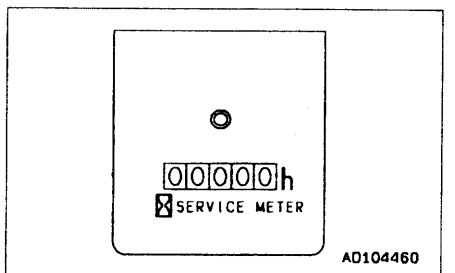

## 5. PREHEATING MONITOR

When the electrical heater is used to start the engine in cold weather, this monitor indicates that preheating is being carried out.

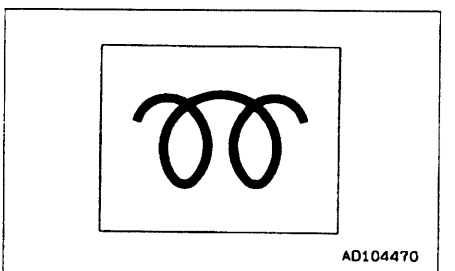

11.1.5 E: SWITCHES

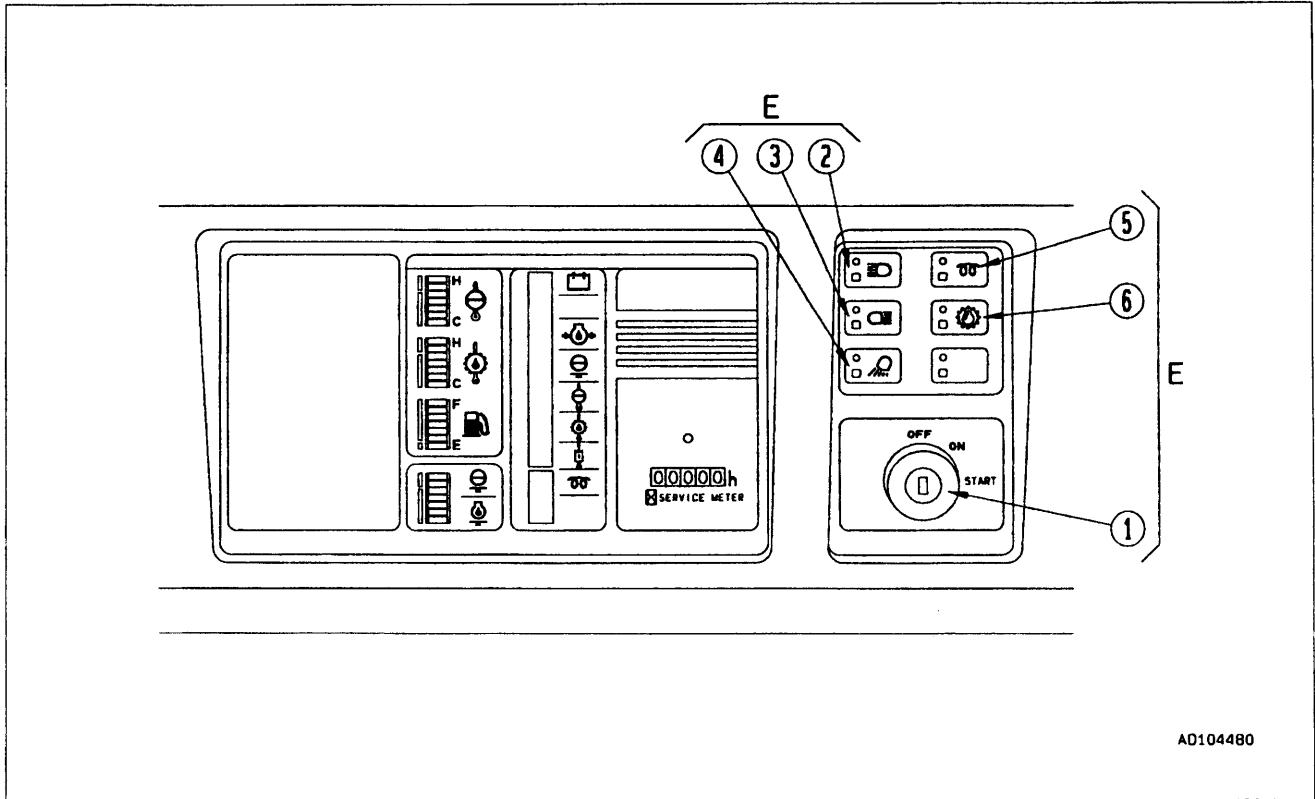

AD104480

1. STARTING SWITCH

This switch is used to start the engine.

**OFF**

Key insertion-withdrawal position. None of electrical circuits activate.

**ON**

Charging and electric device circuits activate. Keep key at ON after starting.

**START**

At this key position, the starting motor will crank the engine. Release key immediately after starting.

**HEAT**

Turn to this position to carry out preheating. For details, see "TO START THE ENGINE IN COLD WEATHER".

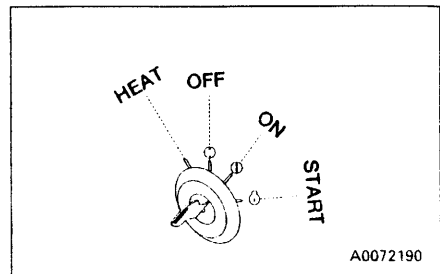

A0072190

To operate switches ② through ⑥ press the surface lightly. When the red lamp is lighted up, the switch is ON; when the lamp is out, the switch is OFF.

Press the switch lightly with your fingertip to switch it ON, and press it again to switch it OFF.

If the starting switch is moved to OFF when any of switches ② through ⑥ is on, all switches ② through ⑥ will go OFF. Then, if the starting switch is moved to ON, switches ② through ⑥ will remain OFF.

**2. HEAD LAMP SWITCH**

This switches on the head lamps and the panel lamp.

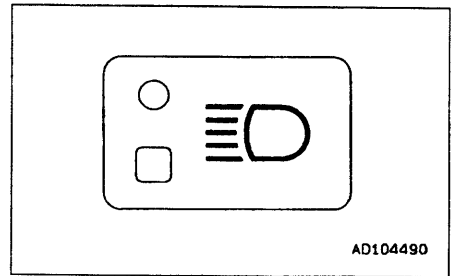
**3. REAR LAMP/WORKING LAMP SWITCH**

This switches on the rear lamp, the ripper lamp and the panel lamp.

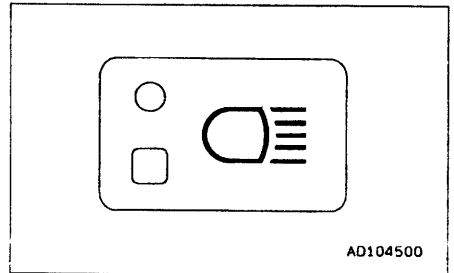
**4. WORKING LAMP SWITCH**

This switches on the working lamp is front of L.H. and R.H. fenders and the panel lamp.

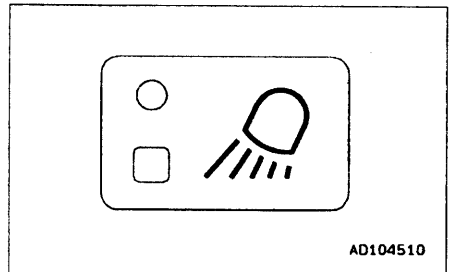
**5. PREHEATING SWITCH**

 **CAUTION**

**Do not use this switch on when the electrical intake air heater is not in use.**

This is used to actuate the electrical intake air heater when starting the engine. Turn the switch ON to warm the intake air.

When the switch is ON, the preheating monitor on the monitor panel lights up. (When the ambient temperature is below approx. -5°C.)

For details, see "12.2.2 STARTING ENGINE IN COLD WEATHER".

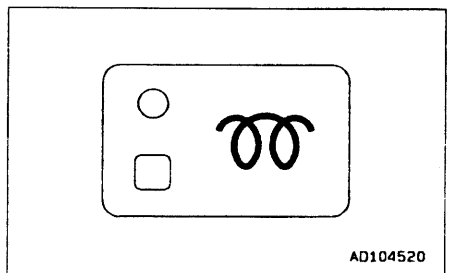
**6. LOCKUP SWITCH**

When this switch is ON (red lamp lighted up), the lockup function of the torque converter is actuated. When the lockup function is actuated, torque converter drive and direct drive are automatically selected according to the load condition of the machine. When the switch is OFF (red lamp OFF), only torque converter drive is used.

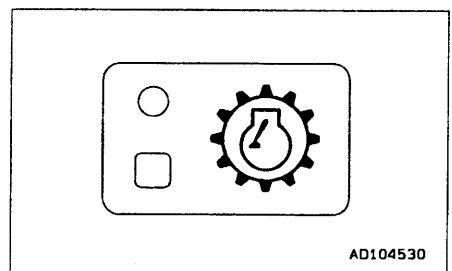

## 11.2 LAMPS

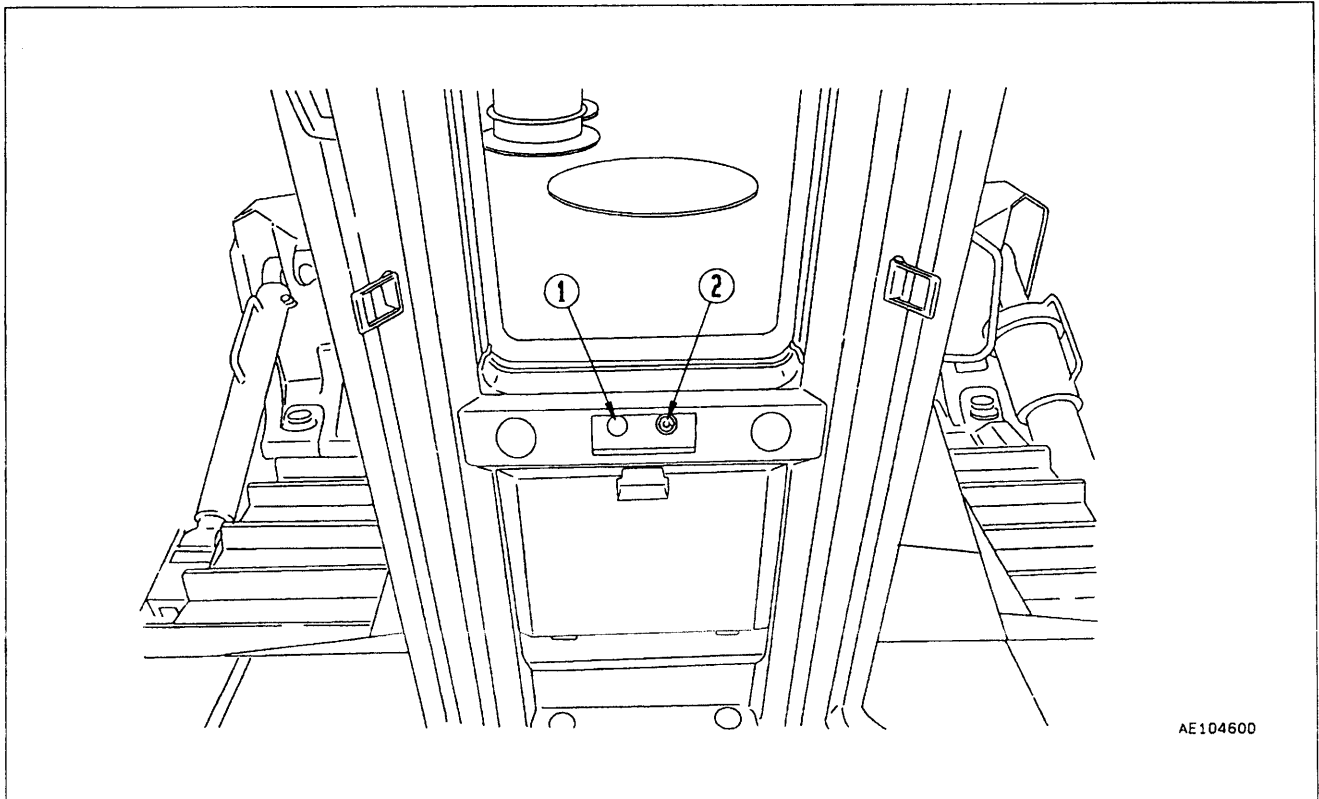

AE104600

### 1. WARNING LAMP

#### NOTICE

**If the alarm buzzer sounds, stop work immediately and carry out inspection and maintenance of the appropriate point.**

When the monitor for the B CAUTION and C CAUTION groups on the machine monitor system flashes, the warning lamp also flashes at the same time.

If the lamp flashes, check the monitor panel to locate the problem.

When the monitor inside the C CAUTION group flashes, the alarm buzzer also sounds continuously.

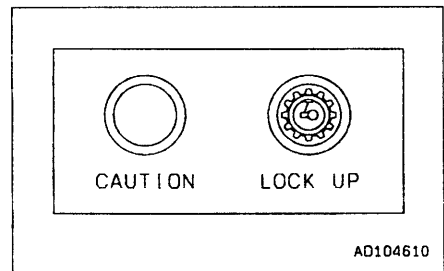

AD104610

### 2. TORQUE CONVERTER LOCKUP PILOT LAMP

When the lockup switch of the monitor lamp is switched ON, this lamp lights up automatically after the torque converter is locked up (when it changes to direct drive).

When the torque converter drive is being used, this lamp remains OFF.

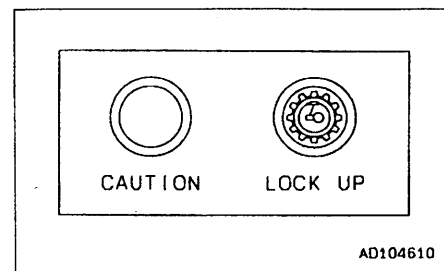

AD104610

11.3 SWITCHES

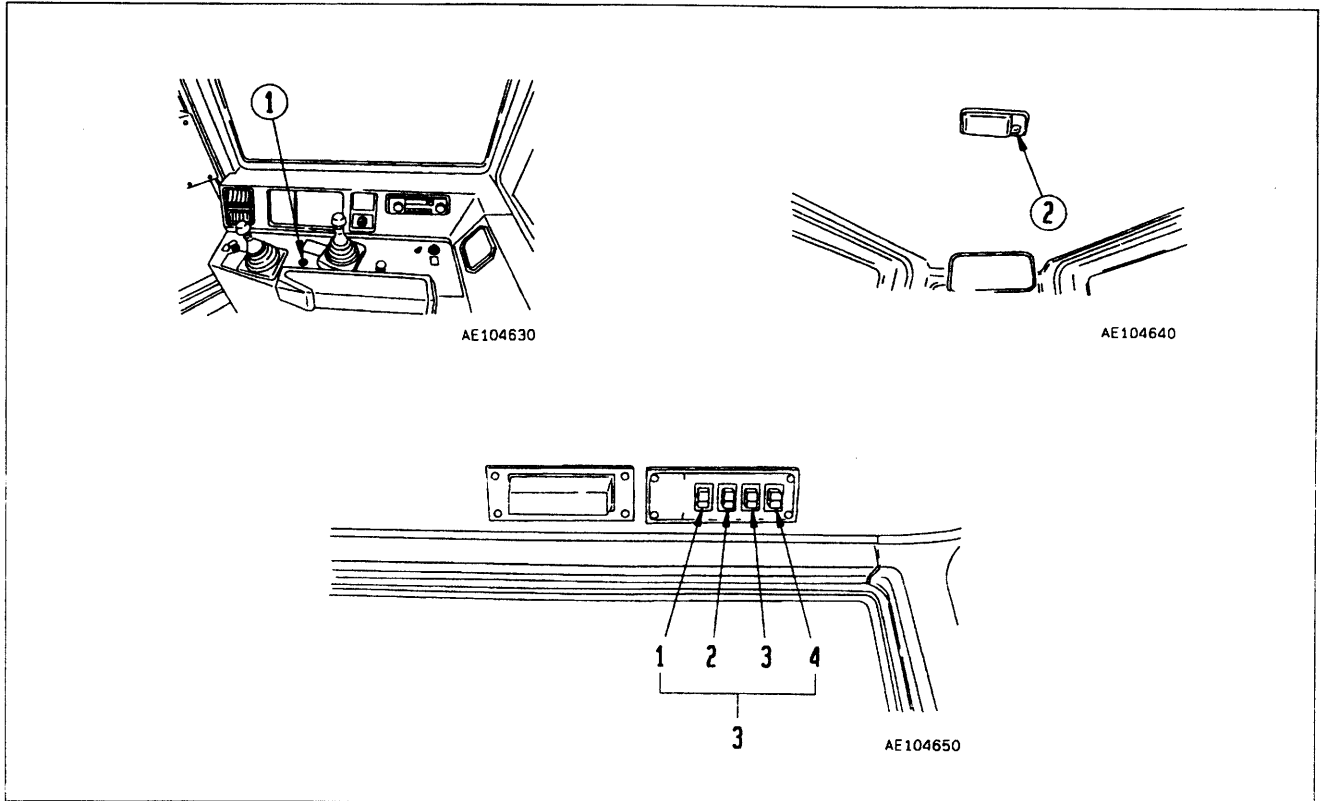

1. HORN SWITCH

When this switch is pressed, the horn will sound.

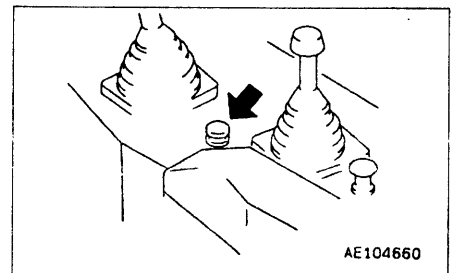

2. ROOM LAMP SWITCH

This lights up the room lamp.

ON position: Lamp lights up

OFF position: Lamp is out

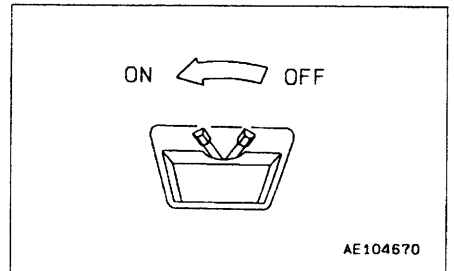

## 11. EXPLANATION OF COMPONENTS

---

### 3. WIPER SWITCH

This activates the wipers.

The wiper switches are as follows.

- ① Rear window
- ② Right door
- ③ Left door
- ④ Front window

This is also used as the window washer switch.

The switch is operated as follows.

- Window washer only  
Keep the switch pressed to the OFF position to spray out water.

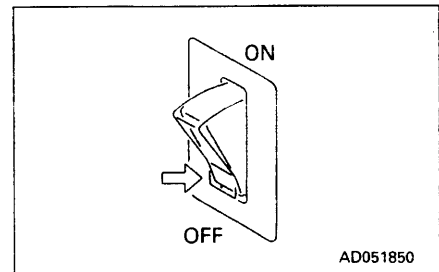

- Wiper only  
If this is switched on, the wiper will start.

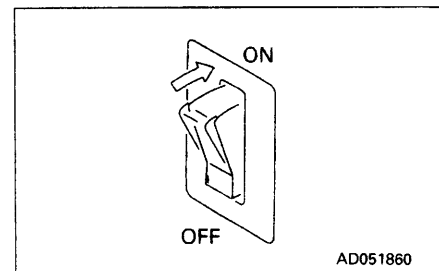

- Wiper and window washer  
If this is kept pressed to the ON position while the wiper is working, water will be sprayed out.

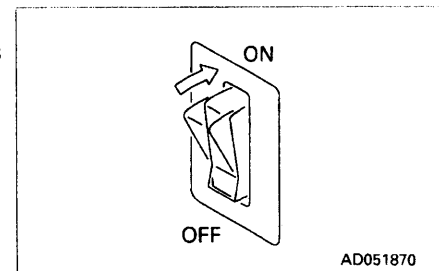

### 4. CIGARETTE LIGHTER

This is used to light cigarettes.

When the cigarette lighter is pushed in, it will return to its original position after a few seconds, so take it out to light your cigarette.

Cigarette lighter capacity: 120 W

#### NOTICE

**This cigarette lighter is 24V. Do not use it as the power source for 12 V equipment.**

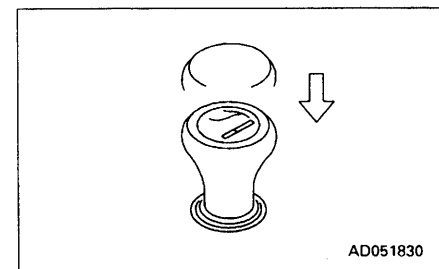



## 11.4 CONTROL LEVERS AND PEDALS

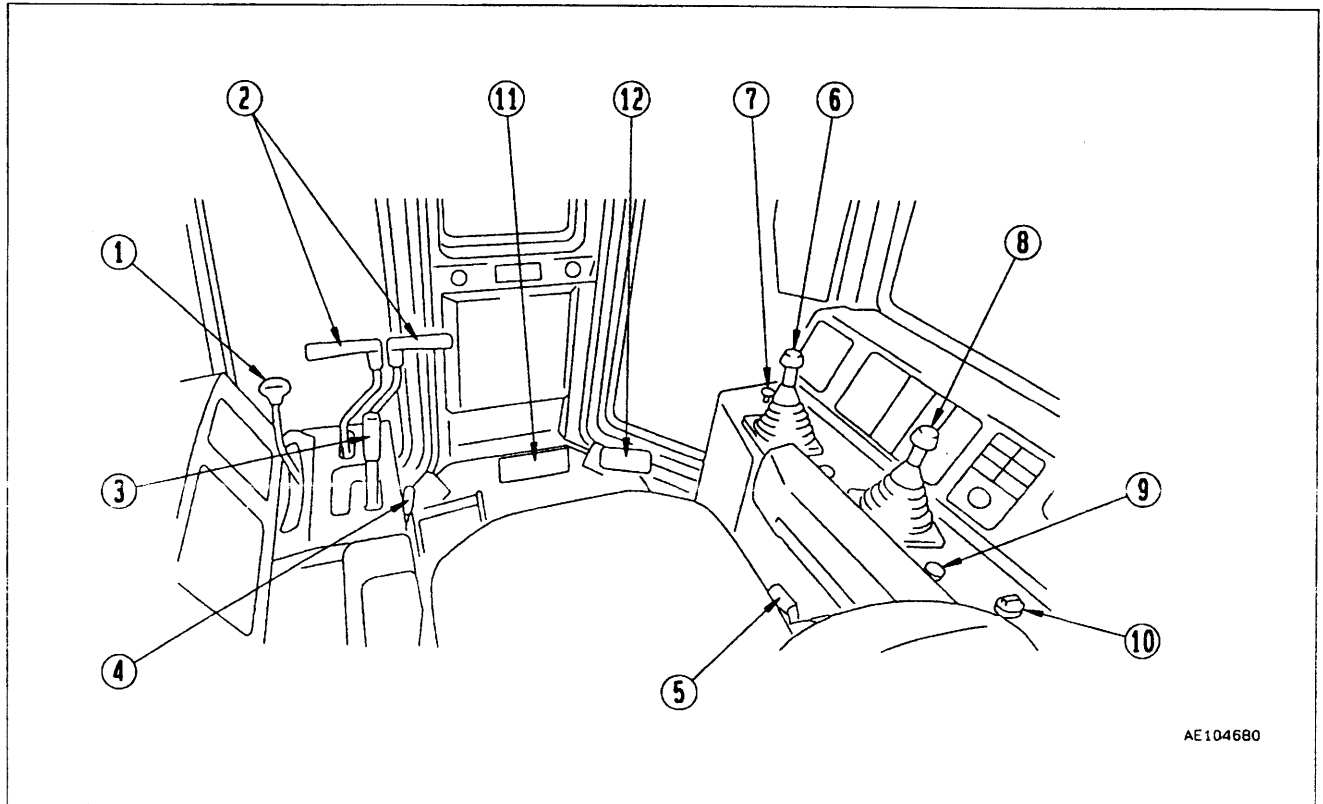

AE104680

### 1. FUEL CONTROL LEVER

This lever is used to control the engine speed and output.

- ① Engine stop position:  
Push the lever fully.
- ② Low idling position:  
Pull the lever from engine stop position ① until you feel the operating force falls off.
- ③ Full speed position:  
Pull the lever fully from low idling position ②.

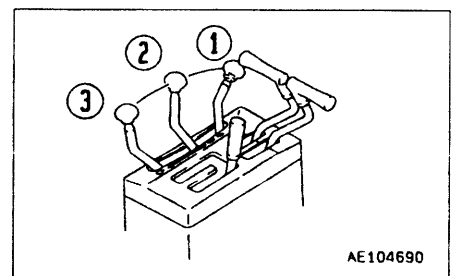

AE104690

### 2. STEERING LEVER

This lever is used to steer the machine. If the lever is moved partially in the direction of turn, the machine, the steering clutch is disengaged and the machine turns gradually.

If the lever is moved more, the steering brake is applied and the machine will turn on the spot.

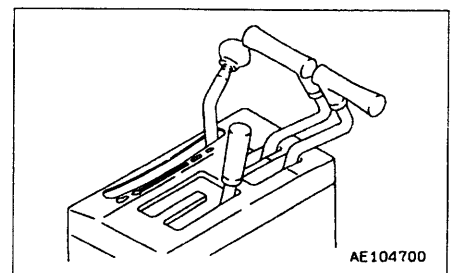

AE104700

### 3. GEAR SHIFT LEVER

This lever changes the transmission gear range. Three-speed forward and three-speed reverse travel can easily be selected by simply shifting the gear shift lever to any desired speed position.

#### REMARK

Place the gear shift lever in the neutral position before starting the engine.

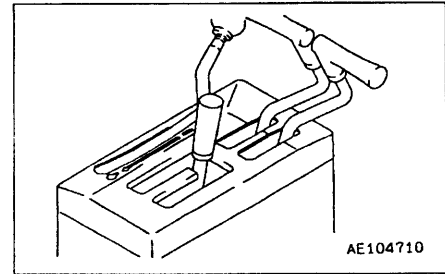

### 4. SAFETY LEVER (For gear shift lever)

#### WARNING

- When leaving the operator's compartment, set the safety lever securely to the LOCK position. If the gear shift lever is not locked, and it is touched by mistake, this may lead to a serious accident.
- When the machine is stopped for a while, be sure to set the gear shift lever in neutral and set the safety lever to LOCK.
- If the safety lever is not placed securely in the LOCK position, the control lever may not be properly locked.

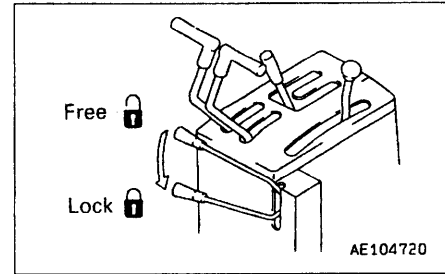

This is the locking device of the gear shift lever.

Set the gear shift lever in neutral and set the safety lever to LOCK.

### 5. BRAKE LOCK LEVER

#### WARNING

Whenever the machine is parked, set the brake lock lever to the LOCK position without fail.

This device is used to lock the brake pedal when parking.

Depress the brake pedal, both when applying the lock and when releasing the lock.

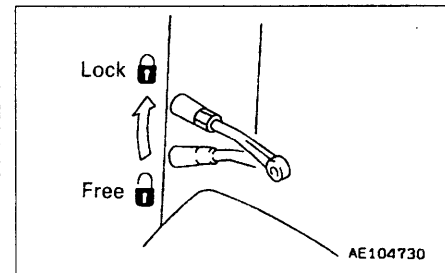

**6. BLADE CONTROL LEVER**

This lever is used to raise or tilt the blade.

**Lifting control**

① RAISE : (  )

② HOLD : (  )

Blade is stopped and held in this position.

③ LOWER : (  )

④ FLOAT : (  )

Blade will move freely according to external force.

**REMARK**

When released from FLOAT position, this lever will not return to HOLD position, so it must be moved back by hand.

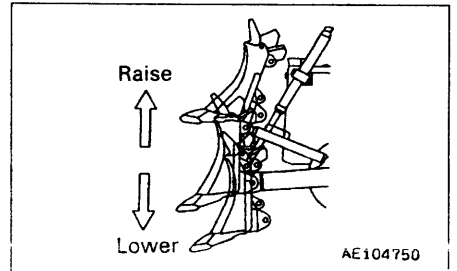
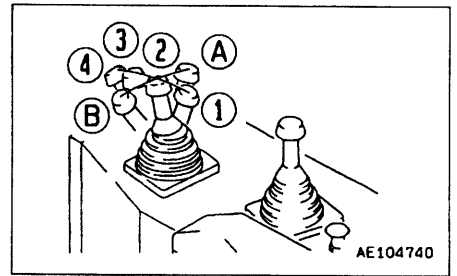

**Tilting control**

Ⓐ LEFT TILT : (  )

Ⓑ RIGHT TILT : (  )

**REMARK**

The blade can be tilted at any position of ① to ③.

The lever should be returned quickly to HOLD position at the end of tilt cylinder stroke.

Do not operate tilting when blade is at top or bottom position.

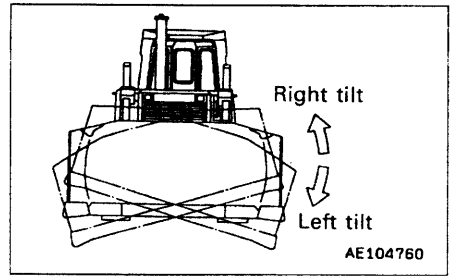

7. SAFETY LOCK (For blade control lever)

**WARNING**

- When leaving the operator's compartment, set the safety lock securely to the LOCK position. If the control lever is not locked, and it is touched by mistake, this may lead to a serious accident.
- If the safety lock is not placed securely in the LOCK position, the control lever may not be properly locked. Check that the situation is as shown in the diagram.
- When parking or servicing the machine, be sure to lower the blade and set the safety lock in the LOCK position.
- After stopping the engine, if the work equipment control lever is operated to the LOWER position, the work equipment will go down under its own weight.

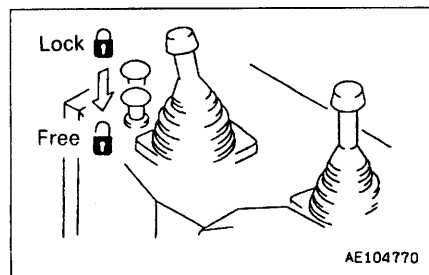

This is the locking device of blade control lever.

- Method of releasing pressure in work equipment circuit
  1. Lower the work equipment and stop the engine.
  2. After stopping the engine, operate the work equipment control lever fully to the front, rear, left, and right to release the pressure inside the work equipment circuit.

8. RIPPER CONTROL LEVER

This is used to operate the ripper.

- ① RAISE ( )
- ② HOLD ( ): Ripper is stopped and held in the same position.
- ③ LOWER ( )
- Ⓐ Digging angle reduced ( ) : Cutting angle ( $\alpha$ ) becomes smaller.
- Ⓑ Digging angle increased ( ) : Cutting angle ( $\alpha$ ) becomes larger.

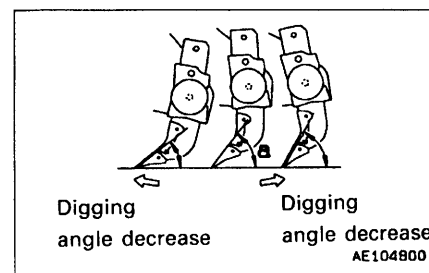
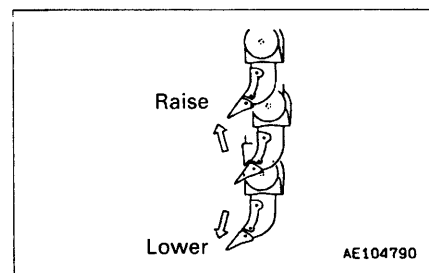
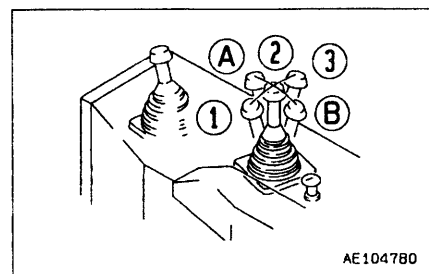

## 9. SAFETY LOCK (For ripper control lever)

**WARNING**

- When leaving the operator's compartment, set the safety lock securely to the LOCK position. If the control lever is not locked, and it is touched by mistake, this may lead to a serious accident.
- If the safety lock is not placed securely in the LOCK position, the control lever may not be properly locked. Check that the situation is as shown in the diagram.
- When parking or servicing the machine, be sure to lower the ripper and set the safety lock in the LOCK position.

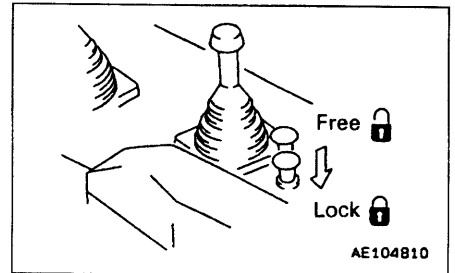

This device is used to lock the ripper control lever.

## 10. PIN PULLER CONTROL SWITCH

This is used to operate the pin puller.

- ① PULL OUT: Pin is pulled out.
- ② PUSH IN: Pin is pushed in.

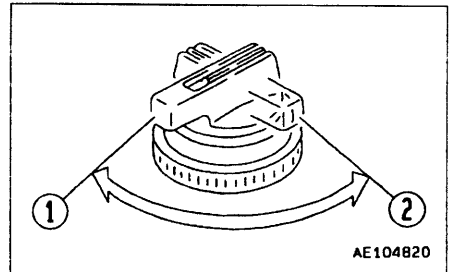

## 11. BRAKE PEDAL

**WARNING**

Do not place your foot on this pedal unnecessarily.

Depress the pedal to apply the right and left brakes.

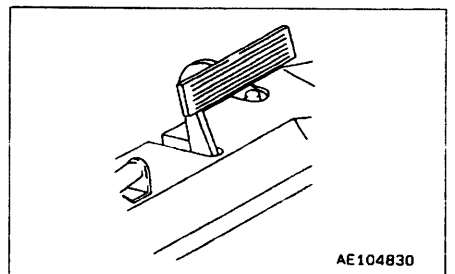

## 12. DECELERATION PEDAL

**WARNING**

- Do not place your foot on this pedal unnecessarily.
- When passing over the top of a hill or when a load is dumped over a cliff, the load is suddenly reduced, so there is danger that the travel speed will also increase suddenly. To prevent this, depress the decelerator pedal to reduce the travel speed.

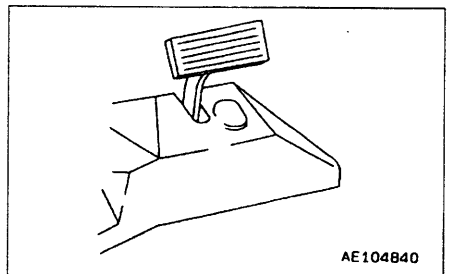

This pedal is used for reducing the engine speed or stopping the machine.

When switching between forward and reverse, or when stopping the machine, use this pedal to reduce speed.

### 11.5 DUST INDICATOR

This device indicates clogging of the air cleaner element.

When the red piston appears in transparent part ① of this indicator, the element is clogged. Clean the element immediately.

After cleaning, push indicator button ② to return the red piston to its original position.

The dust indicator is on the air cleaner bracket inside the engine room.

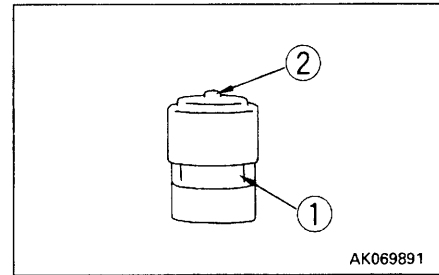

### 11.6 FUSE BOX

#### NOTICE

**Before replacing a fuse, be sure to turn off the starting switch.**

The fuses protect the electrical equipment and wiring from burning out.

If the fuse becomes corroded, or white powder can be seen, or the fuse is loose in the fuse holder, replace the fuse.

Replace a fuse with another of the same capacity.

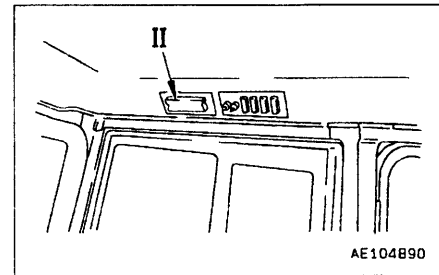
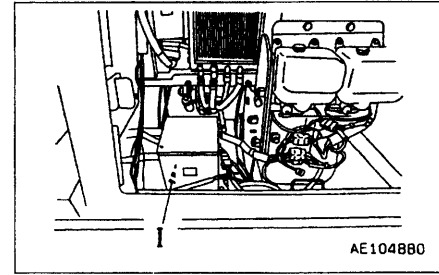

#### 11.6.1 FUSE CAPACITY AND CIRCUIT NAME

##### Fuse box I

No.	Fuse capacity	Circuit
①	20 A	Starting switch
②	20 A	Car stereo, cigarette lighter, room lamp
③	20 A	Wiper
④	20 A	Air conditioner
⑤	10 A	Night lighting
⑥	-	-
⑦	20 A	Fan control
⑧	10 A	Lockup switch
⑨	10 A	Panel lamp
⑩	10 A	Backup alarm
⑪	20 A	Engine preheating
⑫	10 A	Work lamp
⑬	20 A	Rear lamp
⑭	20 A	Head lamp
⑮	10 A	Monitor, horn, pin-puller switch

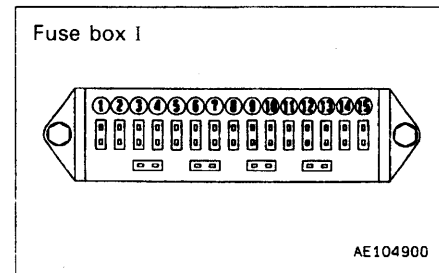

**Fuse box II**

No.	Fuse capacity	Circuit
①	10 A	Front window wiper
②	10 A	Rear window wiper
③	10 A	Left door wiper
④	10 A	Right door wiper
⑤	-	-
⑥	10 A	Room lamp
⑦	10 A	Cigarette lighter
⑧	10 A	Car stereo

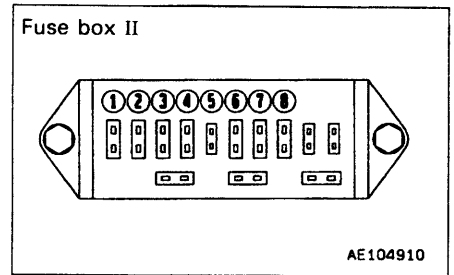

**11.7 DOOR LOCK**

This lock is used to lock the door in position when it is opened.

1. When the door is forced against catcher ①, the door will be locked in position.
2. To release the door, push knob ② above the catcher. The catcher will unlock the door.

**NOTICE**

When locking the door in position, be sure to force it firmly against the catcher.

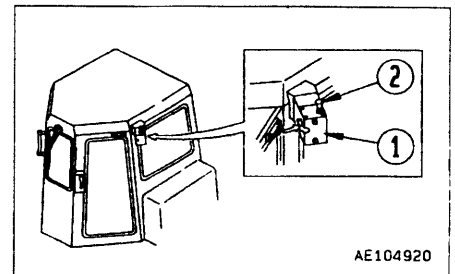

11.8 CAR STEREO

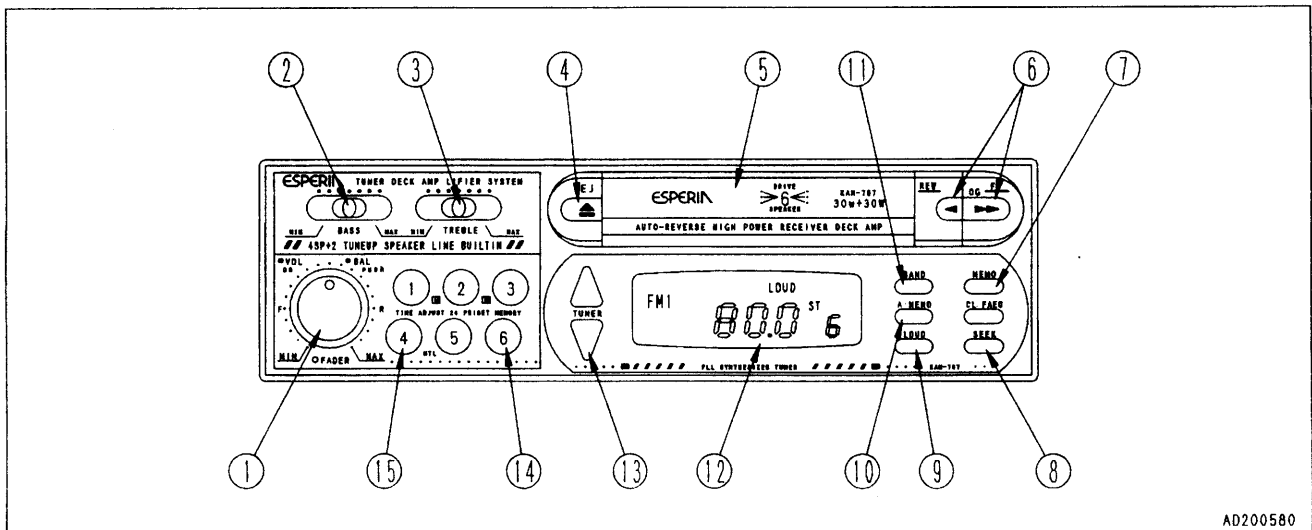

11.8.1 EXPLANATION OF COMPONENTS

1. POWER SWITCH/VOLUME CONTROL/BALANCE CONTROL KNOB

Turn this knob clockwise. The "click" sound indicates that the power supply is turned on. Further turning increases the speaker volume.

For balance control, depress the knob while turning it to left or right and regulate the sound balance between the left and right speakers.

2. BASS CONTROL SLIDE-KNOB

Slide this knob to the right to increase the bass sound and to the left to decrease the base.

3. TREBLE CONTROL SLIDE-KNOB

Slide this knob to the right to enhance high frequency sound and to the left to suppress high frequency sound.

4. EJECT BUTTON

Push this button to eject the cassette tape.

5. CASSETTE DOOR

Insert cassette tape with the exposed magnetic tape side facing to the right.

6. FAST-FORWARD/REWIND/PROGRAM CHANGEOVER KNOB

To fast-forward the tape, push the button matching the direction of program indication and to rewind, push the other button. To stop fast-forwarding or rewinding, lightly press the button which is not locked to cancel the operation. The system will then start playing the tape again normally. To change the program, press the fast-forward and rewind buttons simultaneously. The direction of tape feed will reverse.

7. MEMORY SWITCH

Press this button to preset the frequencies of desired stations. (ME flashes.)



**8. SEEK**

When the SEEK button is pressed, the system automatically searches for a receivable station, and automatically stops searching once a station is picked up.

**9. LOUD BUTTON**

This switch is used to operate the system at a lower sound volume but with enhanced bass and treble sound. ("LOUD" indication appears on the display.)

**10. AUTO-MEMORY**

When the "A.MEMO" button is pressed, the system tunes itself to stations receivable in the area in which the machine is currently located, one after another, and memorizes the frequencies in its preset memory, all automatically.

**11. FM/MW(AM) BAND SELECT SWITCH**

Pressing the "BAND" switch changes over between FM1, FM2, FM3 and MW(AM) bands. The display indicates the receiving band name and frequency.

**12. DISPLAY**

The display indicates the receiving frequency when receiving a radio broadcast or the current operation mode.

**13. TURN SWITCH (MANUAL TURNING)**

Pressing the ▲-shaped TUNER button raises the receiving frequency by 9 KHz in AM and by 0.1 MHz in FM for each press. Pressing the ▼-shaped TUNER button lowers the receiving frequency similarly. Pressing either of these buttons continuously shifts the receiving frequency continuously.

**14. PRESET SWITCH KEYS**

One station each in the FM1, FM2, FM3 and MW(AM) bands, respectively, can be preset for each of these preset keys. (Refer to the section "Presetting to selected stations".)

**15. METAL SWITCH**

Press the "MTL" ④ button before playing a metallic tape. "MTL" indication appears on the display.

### 11.8.2 WHEN RECEIVING RADIO BROADCASTS

1. Turn ON the ignition key or turn it to the ACC position before turning on the system power switch.
2. Select either AM or FM band with the FM/AM selector switch.
3. Tune to the desired station using the presetting or manual tuner switches.
4. Adjust the volume, the balance between left and right speakers and the sound quality to your choice using the respective buttons.
5. When turning off the radio, turn the VOL knob counter-clockwise until a click is heard.

#### REMARK

- When changing over to radio while listening to a cassette tape, press the EJECT button to stop the tape and the system will automatically change over to radio.
- Simply insert a tape to change over to cassette tape mode while listening to the radio.

#### Automatic tuning with SEEK button

Pressing the "SEEK" button shifts the receiving frequency in the higher frequency direction before automatically stopping at a position where a station is picked up.

#### Manual tuning

Pressing either the ▲ or ▼-shaped "TUNER" buttons shifts the receiving frequency in the steps given below. Pressing either of these buttons continuously, allows continuous shifting of the receiving frequency.

Areas	AM	FM
North, Central or South America	10 KHz	0.1 MHz
Other areas	9 KHz	0.025 MHz

#### Automatic selection between monaural and stereo receiving modes

When the FM stereo broadcasting waves currently being received are too weak for normal receiving (such as receiving a long distance from the broadcasting station or in mountain areas) the system automatically shifts from stereo to monaural mode to suppress disturbing noise. It automatically returns to stereo mode when the intensity of the radio wave being received recovers.

**Presetting to selected stations**

When listening to a preset station, select either of the AM, FM1, FM2, FM3 bands using the FM/AM select switch, then simply press the number key corresponding to the preset selected station.

The system can memorize 6 stations in AM band and 18 stations in FM bands (FM1: 6 stations, FM2: 6 stations and FM3: 6 stations).

Presetting procedures:

1. If the system is playing a cassette tape, press the eject button to stop the tape.
2. Tune to the desired station for presetting:  
First, select either of the MW(AM), FM1, FM2 or FM3 bands before tuning to the frequency of the desired station using the TUNING buttons.
3. Press the MEMO switch.
4. While "MEMO" is flashing, press the preset key of the channel number into which you want to memorize the preset station. (The preset channel and frequency will be indicated. This concludes presetting.)
5. Repeat the above procedure Steps 2 to 4 to preset to other desired stations.

**REMARK**

- To change the station in a preset key number, repeat above procedure Steps 2 to 4, as well.
- If the main power supply is interrupted, such as when exchanging machine battery, all presettings will be erased. Repeat the presetting procedure in such case.

**Auto memory**

When the "A.MEMO" button is pressed, the system tunes itself to stations receivable in the area where the machine is currently located, one after another, and memorizes the frequencies in its preset-memory, all automatically.

**Memory backup battery**

When pressing a preset key fails to tune into the programmed station, repeat the presetting procedure after operating the vehicle for a day. If, however, the memory is still defective the next day, the service life of the backup battery is likely over, unless an imperfect contact or wire breakage is found. In this case, replace with a new backup battery.

### 11.8.3 WHEN PLAYING A CASSETTE TAPE

1. Turn ON the ignition key or turn it to the ACC position before turning on the power switch of the stereo system.
2. Insert your cassette tape through the cassette opening in the direction with the exposed tape to the right. The tape will start playing automatically. When the tape running direction indication is ►, the upper channel of the tape is being played and when ◀ is indicated, the lower channel is being played.  
When the tape ends in one direction, the system automatically reverses the tape and plays the other side.
3. To stop the tape, press the eject button to eject it and the system will automatically change over to radio.

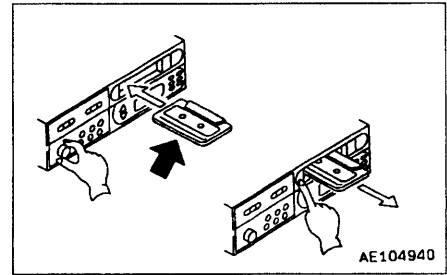

#### When changing tape channels

Lightly press both the PROG ◀ and ▶ keys simultaneously while the tape is being played.

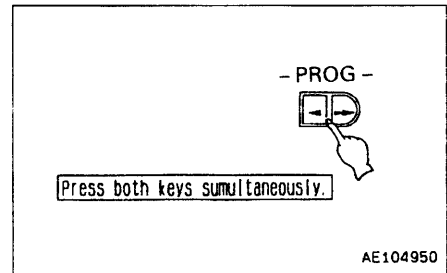

#### Fast-forwarding and rewinding

To fast-forward a tape during playing, fully press either the ◀ or ▶ keys according to the current tape-feed direction to lock the key. To reverse the tape direction, fully press the opposite-direction key to lock it.

To stop fast-forwarding or rewinding, lightly touch the unlocked key. This frees the locked key and normal playing resumes.

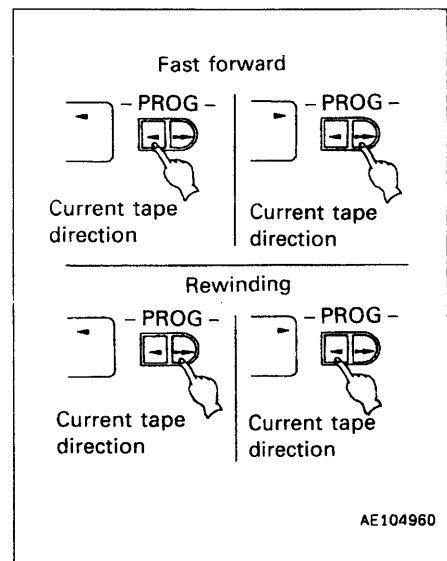

### 11.8.4 SPECIFICATIONS

#### Tape

Applicable cassette tape:	Phillips-tape
Track system:	4 track, 2-channel stereo
Tape speed:	4.75 cm/sec
Fast-forwarding and rewinding time:	185 sec (for a C-60 cassette)
Wow and flutter:	0.15% (WEMS)
S/N ratio:	55 dB

#### Radio

Receivable frequencies:	FM: 76.1 – 89.9 MHz, AM: 522 – 1,629 KHz.
Receiving sensitivity:	FM: 3 $\mu$ v (30 dB S/N) AM: 10 $\mu$ v (max.)
S/N ratio:	FM: 62 dB AM: 45 dB

#### Common to tape and radio

Frequency response:	(40 – 12,500 Hz.)
Max. output:	30 W + 30 W
Output impedance:	(4 ohms x 2) or (8 ohms x 4)
Current consumption:	5 A
Power source:	DC 12 V – 24 V
Polarity:	Negative grounding
Dimensions:	178(W) x 50(H) x 150(D) mm.
Weight:	1.4 kg.

- The appearance and specifications are subject to change without prior notice for improvement purposes.

### 11.9 OPERATING THE AIR CONDITIONER

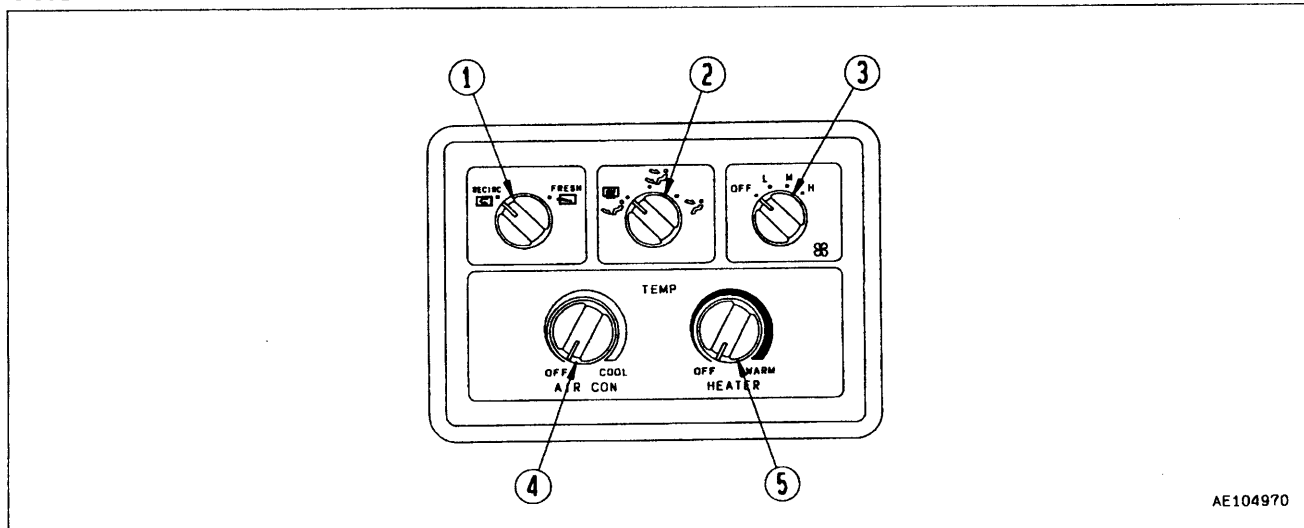



AE104970

#### 11.9.1 CONTROL PANEL

##### 1. INSIDE - OUTSIDE AIR SELECTOR SWITCH

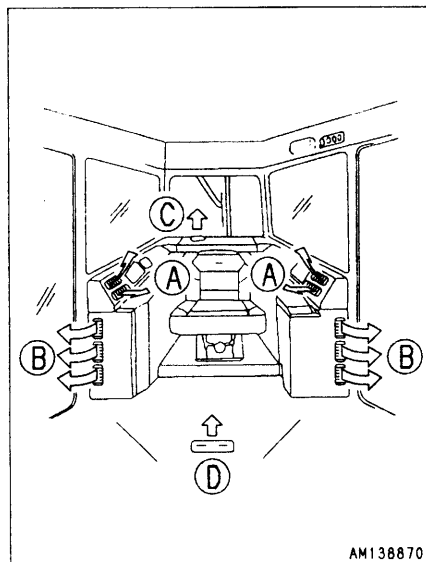

Use this switch to change over the intake vents when heating or cooling the cab.

- Inside air (RECIRC )  
Air is inhaled from inside the cab.  
(Generally used for cooling the inside of the cab.)
- Outside air (FRESH )  
Air is inhaled from outside the cab.  
(Generally used for ventilating and heating the inside of the cab.)



AM138870

##### 2. VENT SELECTOR SWITCH

Position of knob	Air outlet	Application
	DEF FOOT ⓑ ⓒ ⓓ	Mainly for heating
	FACE FOOT ⓐ ⓑ ⓒ ⓓ	Mainly for ventilation
	FACE ⓐ	Mainly for cooling

**3. BLOWER SWITCH**

This switch is used not only to control the flow of air in cooling and heating, but also as the main switch.

- The air flow is controlled in three ranges, High, Medium, and Low.
- When the switch is turned OFF, the power line is disconnected and the air conditioner stops.

**4. COOLER TEMPERATURE CONTROL SWITCH**

This switch controls the air temperature in the cooling operation and is also used as the cooler switch.

- The farther this switch is turned clockwise, the lower the temperature of the air coming out of the vent.
- When the switch is OFF, the cooler switch will go off and the cooling function will stop.

**5. HEATER TEMPERATURE CONTROL SWITCH**

This switch controls the air temperature in the heating operation.

- The farther this switch is turned clockwise, the higher the temperature of the air coming out of the vent.
- When the switch is in OFF, the water valve will be closed and the heating function will stop.

### 11.9.2 COOLING OPERATION

- **Control switches**

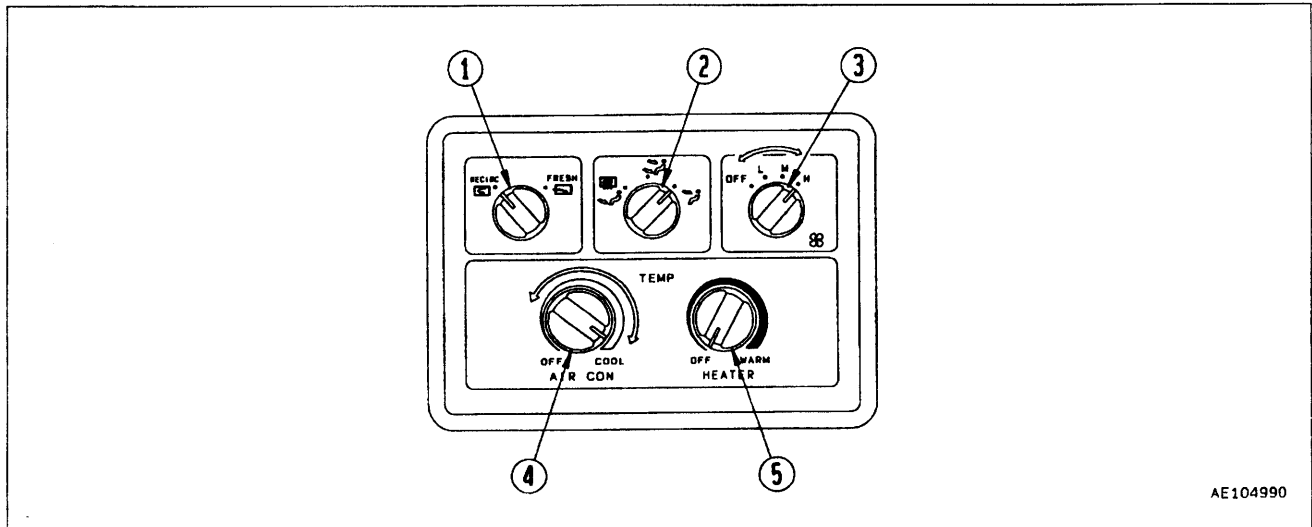

AE104990

#### Ordinary cooling

When control switches are used as shown, fresh cool air will be supplied into the cab.

- Set switches ①, ②, and ④ in the positions shown.
- Set switches ③ and ⑤ in the desired positions.

#### Ventilation and cooling

When the air in the cab gets dirty, move Inside-Outside air changeover switch ① to the outside air (FRESH ) position to let outside air into the cab.

The other switches are used in the same manner as in ordinary cooling.

#### REMARK

If ventilation cooling is used for many hours, the cooling effect may not be sufficient. When the cab has been sufficiently ventilated, move Inside-Outside air selector switch ① back to the inside air (RECIRC ) position.



### 11.9.3 HEATING OPERATION

- Control panel

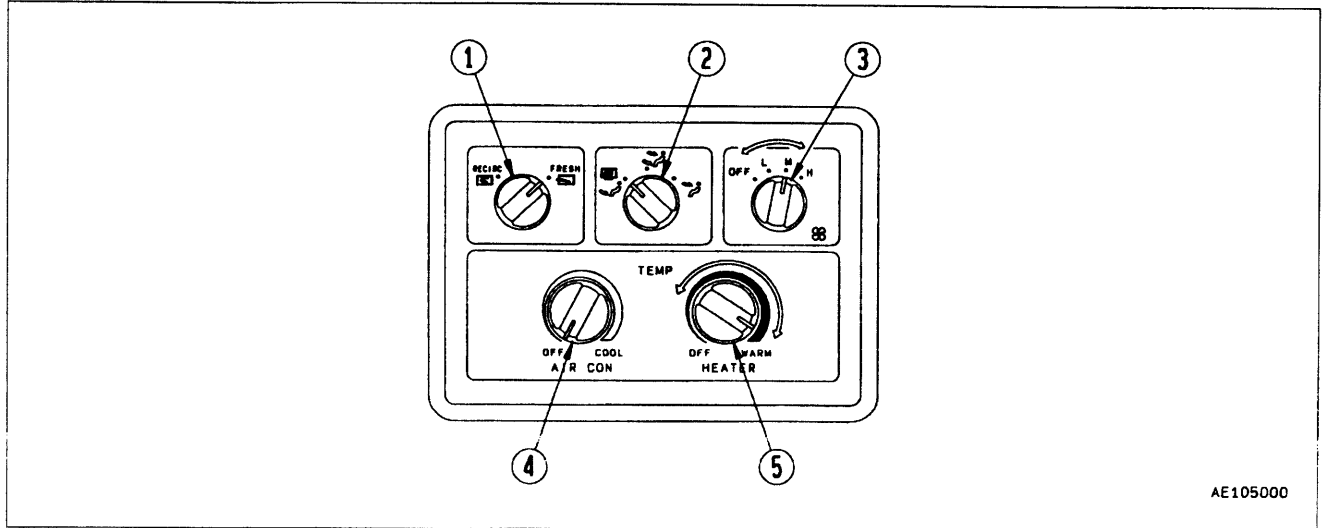

AE105000

#### Ordinary heating

When control switches are used as shown, warm air is supplied into the cab.

- Set switches ①, ②, and ④ in the positions shown.
- Set switches ③ and ⑤ in the desired positions.

#### Dehumidifying heating

When cooler temperature control knob ④ is placed in "COOL", dehumidified air will be supplied. The other switches are used in the same manner as in ordinary heating.

#### REMARK

When dehumidifying heating is used when the air in the cab is humid (in spring, autumn, or rainy weather, for example), the cab will be heated comfortably without clouding up the windows.

#### 11.9.4 PRECAUTIONS FOR USING AIR CONDITIONER

**When cooling, change the air occasionally.**

- When smoking and using the cooler, the eyes may begin to hurt. If this happens, use cooling at "OUTSIDE" for a short time to clear out smoke in the cab.
- When using the air conditioner for a long period, move the knob to RECIRC. + OUTSIDE once every hour to change the air.

**Be careful not to overcool the cab.**

- The cab should feel cool when entering there from outside (5°C or 6°C (9°F or 11°F) lower than the outside temperature). It is not good for the health to have the temperature in the cab too low. Always give careful consideration to temperature regulation.

**When using the cooler, make sure the hot water circuit is completely stopped.**

- If hot water is circulating in the heater, it is like having a hot water bottle in the cab. Always make sure the heater temperature knob is at the OFF position.
- When not using the heater for a long period, fully close the hot water outlet and inlet valves at the engine water manifold and the engine oil cooler.

#### 11.9.5 CHECK DURING OFF-SEASON

When the air conditioner is not being used, run the compressor at low speed for a few minutes every week to avoid loss of oil. (Run the engine at low speed with the cooler temperature control knob at LOW COOL.)

**REMARK**

In cold weather, do not run the compressor suddenly at high speed. This may cause failure in the compressor. When the temperature is below 2 to 6.5°C (36 to 44°F), the low pressure cut-off switch functions to stop the compressor from running even when the cooler temperature control switch is turned on.

### **11.9.6 CLEANING AIR FILTER**

If the air filter for the FRESH or RECIRC air intake becomes clogged, the cooling or heating capacity will drop. To prevent this, clean the air filter with compressed air once a week.

For details of the cleaning method, see "24.2 WHEN REQUIRED".

### **11.9.7 CHECK TENSION OF COMPRESSOR BELT AND VOLUME OF REFRIGERANT (GAS)**

If the compressor belt is loose or there is a lack of refrigerant, the cooling performance will be poor.

For details of the maintenance method, see "24.2 WHEN REQUIRED".

## 12. OPERATION

### 12.1 CHECK BEFORE STARTING ENGINE

#### 12.1.1 WALK-AROUND CHECK

**⚠ WARNING**

- Leakage of oil or fuel, or accumulation of flammable material around high temperature parts, such as the engine muffler or turbocharger, may cause fire. Check carefully, and if any abnormality is found, repair it or contact your Komatsu distributor.
- Do not get on or off the machine from the rear. Using this position is dangerous because it is easy to slip and you cannot be seen from the operator's compartment. Always use the handrail and step at the side when getting on or off the machine.

Before starting the engine, look around the machine and under the machine to check for loose nut or bolts, or leakage of oil, fuel, or coolant, and check the condition of the work equipment and hydraulic system. Check also for loose wiring, play, and collection of dust at places which reach high temperatures.

Always carry out the items in this section before starting the engine each day.

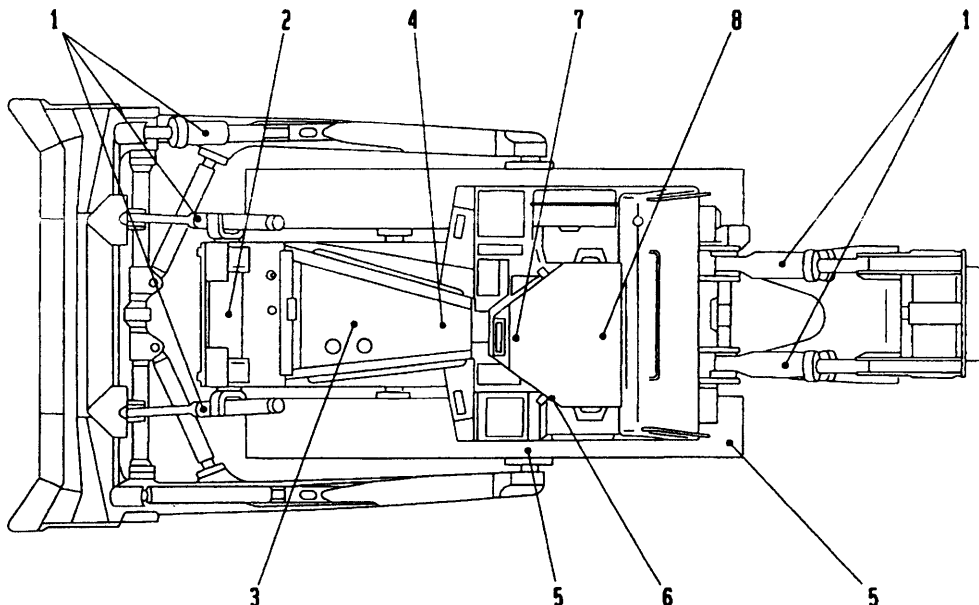

AE105010

- 1. Check for damage, wear, play in work equipment, cylinders, linkage, hoses**  
Check that there are no cracks, excessive wear, or play in the work equipment, cylinders, linkage, or hoses. If any abnormality is found, repair it.
- 2. Remove dirt and dust from around engine, battery radiator**  
Check if there is any dirt or dust accumulated around the engine or radiator. Check also if there is any flammable material (dead leaves, twigs, grass, etc.) accumulated around the battery or high temperature engine parts, such as the engine muffler or turbocharger. Remove all such dirt or flammable material.
- 3. Check for leakage of water or oil around engine**  
Check that there is no leakage of oil from the engine or leakage of water from the cooling system. If any abnormality is found, repair it.
- 4. Check for oil leakage of oil from power train case, final drive case, hydraulic tank, hose, joints**  
Check that there is no oil leakage. If any abnormality is found, repair the place where the oil is leaking.  
Check for leakage of oil from the undercover. Check the ground for traces of oil leakage.
- 5. Check the undercarriage (track, sprocket, idler, guard) for damage, wear, loose bolts, or leakage of oil from rollers**  
If any damage, wear, or oil leakage is found, repair the problem and tighten the bolts.
- 6. Check for damage to handrail, loose bolts**  
Repair any damage and tighten any loose.
- 7. Check for damage to gauges, lamps on instrument panel, loose bolts**  
Check that there is no damage to the panel, gauges and lamps. If any abnormality is found, replace the parts. Clean off any dirt on the surface.
- 8. Check for damage to seat belt and mounting clamps**  
Check that there is no abnormality in the seat belt or mounting clamps. If there is any damage, replace with new parts.

### 12.1.2 CHECK BEFORE STARTING

Always carry out the items in this section before starting the engine each day.

#### CHECK MACHINE MONITOR

1. Turn starting switch ① to the ON position.
2. Check that all monitor lamps and gauges light up for 3 seconds and the alarm buzzer sounds for about 2 seconds.

#### REMARK

If the lamps do not light up, there may be a failure or disconnection in the monitor, so please contact your Komatsu distributor.

#### NOTICE

When carrying out the checks before starting, do not rely only on the monitor. Always carry out all the items listed for the following check and maintenance.

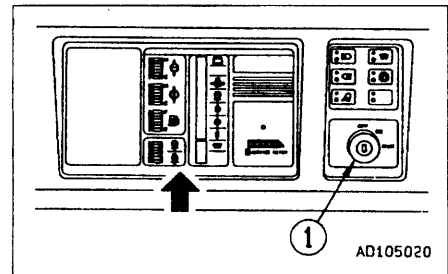

### CHECK COOLANT LEVEL, ADD WATER

#### ⚠ WARNING

Do not remove cap ①, ② while cooling water is hot. Hot water may spout out.

When removing cap ①, ②, wait until the water temperature goes down and release radiator pressure little by little by loosening caps slowly, then remove the cap.

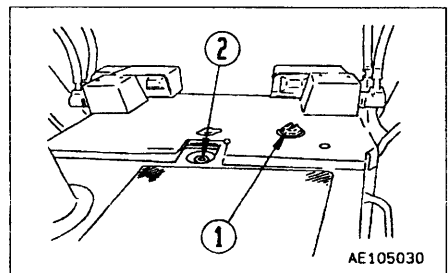

1. Remove radiator cap ① and check that coolant is above the bottom of the strainer as shown in the diagram. If necessary, add water through filler of radiator cap ①.
2. If the water level is low, add water through fillers of both radiator cap ① and subtank cap ②. Add into the subtank up to the level above the bottom of strainer through filler of cap ② as shown in the diagram.
3. To refill the radiator, first stop the engine and pour in water until the water overflows the filler opening. Then, start the engine, check the water level again after a five-minute idling, and add water if necessary.
4. If the volume of coolant added is more than usual, check for possible water leakage.

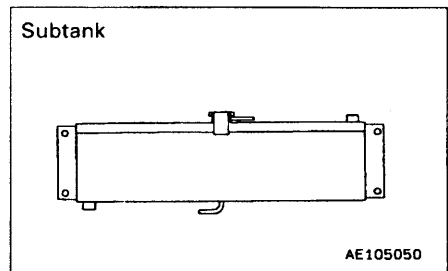
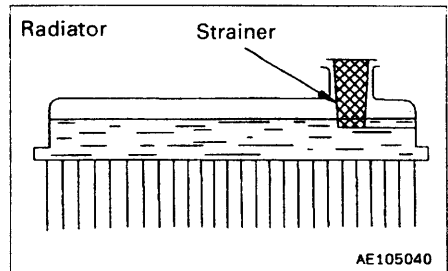

**CHECK FUEL LEVEL, ADD FUEL****⚠ WARNING**

When adding fuel, never let the fuel overflow. This may cause a fire.

1. Removed the cap and check the fuel level using fuel gauge ⑥.
2. After completing work, fill the fuel tank through oil filler port.

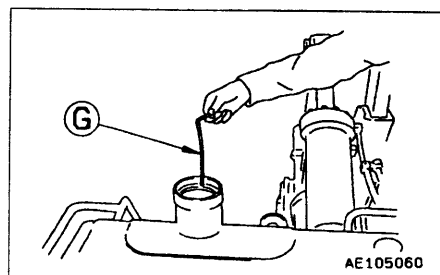
**NOTICE**

For details of the fuel to use, see "20. USE OF FUEL, COOLANT AND LUBRICANTS ACCORDING TO AMBIENT TEMPERATURE".

3. After adding fuel, tighten the cap securely.  
Fuel capacity: 1520 ℓ (401 US gal, 334 UK gal)

**REMARK**

- When dozing on a grade, make sure there is plenty of oil in the tank so that the engine fuel line does not become aerated.
- If breather hole ① on the cap is clogged, the pressure in the tank will drop and fuel will not flow.  
Clean the hole from time to time.

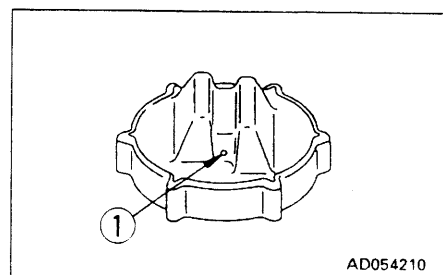

## 12. OPERATION

### CHECK OIL LEVEL IN ENGINE OIL PAN, ADD OIL

1. Open the engine side cover on the right side of the chassis.
2. Remove dipstick **G** and wipe the oil off with a cloth.
3. Insert dipstick **G** fully in the oil filler pipe, then take it out again.

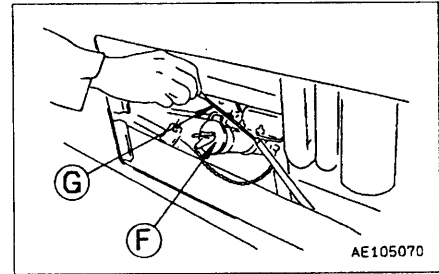

4. The oil level should be between the H and L marks on dipstick **G**.  
If the oil level is below the L mark, add engine oil through oil filler **F**.

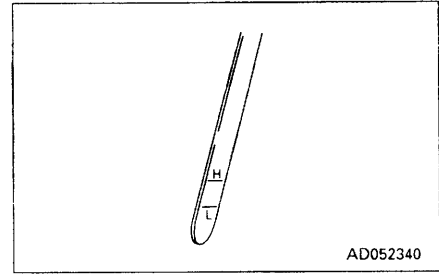

### NOTICE

For details of the oil to use, see "20. USE OF FUEL, COOLANT AND LUBRICANTS ACCORDING TO AMBIENT TEMPERATURE".

5. If the oil is above the H mark, remove drain plug **1**, loosen drain valve **2** to drain the excess oil, then check the oil level again.
6. If the oil level is correct, tighten the oil filler cap securely and close the engine side cover.

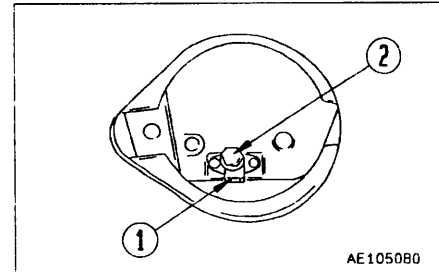

### REMARK

- Check the oil level with the engine stopped.
- When checking the oil level after the engine has been operated, wait for at least 15 minutes after stopping the engine before checking.
- If the machine is at an angle, make it horizontal before checking.
- When adding oil, remove the dipstick from the holder to release the air inside the crankcase.



**CHECK OIL LEVEL IN POWER TRAIN CASE (INCL. TRANSMISSION, TORQUE CONVERTER AND BEVEL GEAR CASES), ADD OIL**

1. Start the engine and run at idling for 3 – 5 minutes, then check the oil level with the COLD side of dipstick ③.  
Remove dipstick ③, and wipe the oil off with a cloth.
2. Insert dipstick ③ fully in the oil filler pipe, then take it out again.
3. The oil level should be between the H and L marks on dipstick ③.  
④.  
If the oil level is below the L mark, add engine oil through oil filler ⑤.

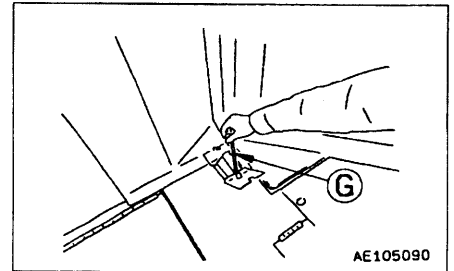
**NOTICE**

For details of the oil to use, see "20. USE OF FUEL, COOLANT AND LUBRICANTS ACCORDING TO AMBIENT TEMPERATURE".

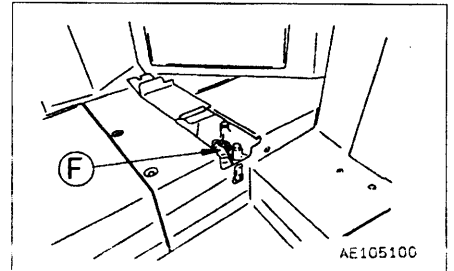

4. If the oil is above the H mark, pull out hose ①, and loosen drain plug ② to drain the excess oil, then check the oil level again.
5. If the oil level is correct, tighten the oil filler cap securely.

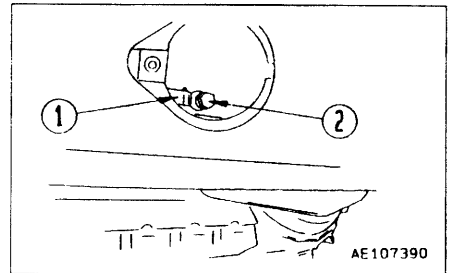
**REMARKS**

- If the machine is at an angle, make it horizontal before checking.
- When the engine is stopped, the oil level will rise, so it is impossible to check the oil level correctly. When checking while the engine is running, run the engine at idling and check with the HOT side of dipstick ③.
- When working on a slope of more than 20°, check that the oil is up to the H level.

**CHECK DAMPER CASE OIL LEVEL, ADD OIL**

1. Remove dipstick ⑥, and wipe the oil off with a cloth.
2. Insert dipstick ⑥ fully into the dipstick holder, then pull it out again.
3. The oil level should be between the H and L marks on dipstick ⑥.  
If the oil is below the L mark, add engine oil through the dipstick holder.

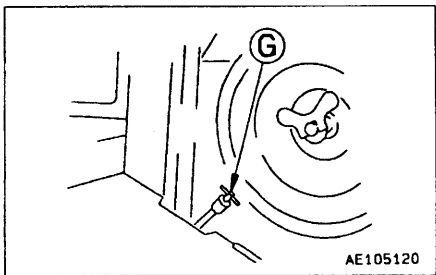

**NOTICE**

For details of the oil to use, see "20. USE OF FUEL, COOLANT AND LUBRICANTS ACCORDING TO AMBIENT TEMPERATURE".

4. If the oil is above the H mark, drain the excess oil from drain plug. After draining the oil, check the oil level again.

**REMARKS**

- Check the oil level with the engine stopped.
- When checking the oil level, if the machine is at an angle, move it to a horizontal position before carrying out the check.

**CHECK BRAKE PEDAL TRAVEL**

1. Depress the brake pedal all the way until it stops.
2. The distance of travel at the center of the pedal (position in the diagram on the right) should be  $100 \pm 5$  mm ( $3.9 \pm 0.2$  in).
3. When this value exceeds the specified range, or the brake fails to work, please contact your Komatsu distributor for adjustment.

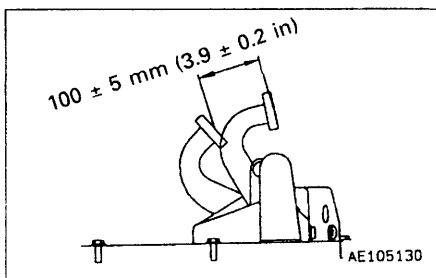

**CHECK DUST INDICATOR**

1. Check that the red piston has not appeared in the transparent portion of dust indicator ①.
2. If the red piston has appeared, clean or replace the element immediately.  
For details of the method of cleaning the element, see "24.2 WHEN REQUIRED".
3. After checking, cleaning, and replacing, press the knob of dust indicator ① to return the red piston to its original position.

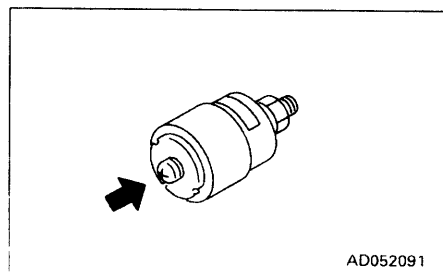
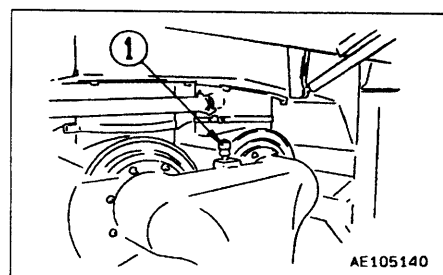
**CHECK ELECTRIC WIRINGS**

**⚠ WARNING**

- If fuses are frequently blown or if there are traces of short circuit on the electrical wiring, locate the cause and carry out repair.
- Accumulation of flammable material (dead leaves, twigs, grass, etc.) around the battery may cause fire, so always check and remove such material.
- Keep the top surface of the battery clean and check the breather hole in the battery cap. If it is clogged with dirt or dust, wash the battery cap to clear the breather hole.

Check for damage and wrong capacity of the fuse and any sign of disconnection or short circuit in the electric wiring. Check also for loose terminals and tighten any loose parts.

Check the wiring of the "battery", "starting motor" and "alternator" carefully, in particular.

When carrying out walk-around checks or checks before starting, always check if there is any accumulation of flammable material around the battery, and remove such flammable material.

Please contact your Komatsu distributor for investigation and correction of the cause.

**CHECK THAT LAMPS LIGHT UP**

Turn the head lamp switch and the rear lamp switch to the ON position and check that the head lamps and rear lamps light up.

If the lamps do not light up, there is probably a broken bulb or disconnection in the wiring, so contact your Komatsu distributor for repairs.

**CHECK HORN SOUND**

**CHECK BACKUP ALARM SOUND**

**CHECK SEAT BELT FOR WEAR OR DAMAGE**

Check the belt and mounting clamps, and if they are worn or damaged, replace the seat belt.

### 12.1.3 ADJUST OPERATOR'S SEAT

#### **⚠ WARNING**

- Adjust the seat position at the beginning of each shift or when operators change.
- Adjust the seat so that the brake pedal can be depressed all the way with the operator's back against the backrest.

- Ⓐ Fore-aft adjustment of seat  
Pull up handle ①, set the seat to the desired position, then release the handle.

Fore-aft adjustment: 160 mm (6.3 in) (12 stages)

- Ⓑ Weight adjustment of seat  
Turn knob ② so that the indicator of the weight display (kg) inside knob ② shows your own weight.  
Turn the knob to adjust the weight as follows.  
To make LIGHTER, turn COUNTERCLOCKWISE  
To make HEAVIER, turn CLOCKWISE

The weight can be adjusted within a range of 50 – 120 kg (110.3 – 117.8 lb)

- Ⓒ Adjusting reclining angle

#### **NOTICE**

**When reclining the seat back to the rear, check the space behind, and adjust to a suitable position.**

Pull lever ③, set the seatback to a position where it is easy to operate, then release the lever.

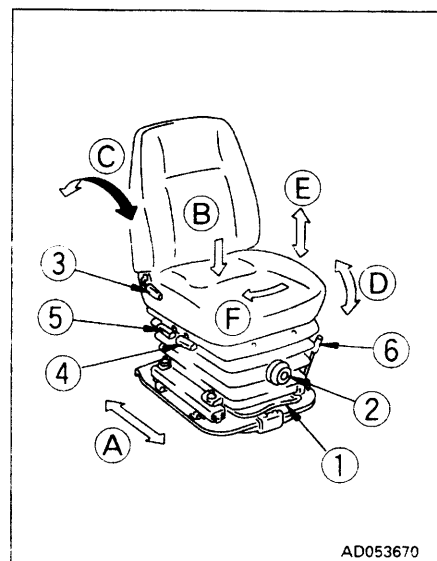

Ⓓ SEAT ANGLE

1. When lever ④ is pulled up, it is possible to adjust the angle of the seat front. (5 stages)
  1. To raise the seat front, keep the lever pulled up and apply your weight to the seat backrest.
  2. To lower the seat front, keep the lever pulled up and apply your weight to the seat front.
  
2. When lever ⑤ is pulled up, it is possible to adjust the angle of the seat back. (5 stages)
  1. To raise the seat back, keep the lever pulled up and stand up slightly.
  2. To lower the seat back, keep the lever pulled up and apply your weight to the seat back.

Ⓔ ADJUSTING VERTICAL HEIGHT OF SEAT

Pull up levers ④ and ⑤ in turn and adjust the angle. After adjusting, release the levers and lock them.  
(Vertical adjustment amount: 5 stages, 60 mm)

Ⓕ SEAT ADJUSTING DIRECTION

Move lever ⑥ back to release the lock, then turn the seat to the right by hand. It is possible to change the direction of the seat to the 15° position.

After changing the angle of the seat, return the lever securely and lock it in position.

- Adjusting the seat angle to the right is done to make it easier to carry out ripper operations or scraper towing operations.

### 12.1.4 ADJUSTING VOLUME OF BACKUP ALARM

When the gear shift lever is placed in REVERSE, the backup alarm sounds. When working at night or in other conditions where the environment makes it necessary to lower the volume of the alarm, adjust as follows.

(When the machine is shipped from the factory, the sound level is set to the highest (H) level.)

#### Adjusting

1. Remove cover ① at the rear of the right fender.

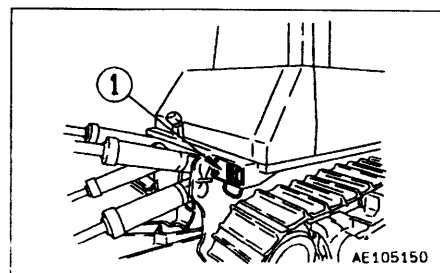

2. Remove cover ② from the backup alarm.

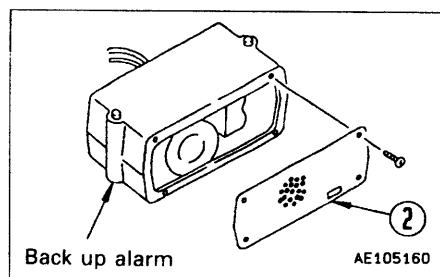

3. Change the position of the bridge to adjust the sound pressure.

- The sound pressure of the backup alarm can be adjusted in three stages as shown in table below.

	Connection of bridge	Level	Sound pressure dB(A)	Remarks
Ⓐ	L - H	H	112	Frequency 1300 Hz
Ⓑ	L - H	M	107	
Ⓒ	L - H	L	97	

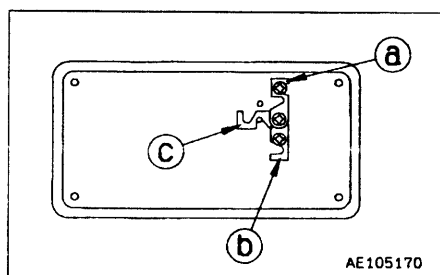

- Set the volume of the backup alarm so that it is at least 10 dB(A) louder than the surrounding noise.

### 12.1.5 OPERATIONS AND CHECKS BEFORE STARTING ENGINE

**⚠ WARNING**

If the blade control lever or the ripper control lever is touched by accident, the work equipment may move suddenly. When leaving the operator's compartment, always set the safety lever securely to the LOCK position.

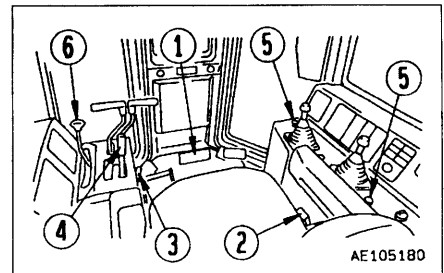

1. Is brake pedal ① locked with brake lock lever ②?

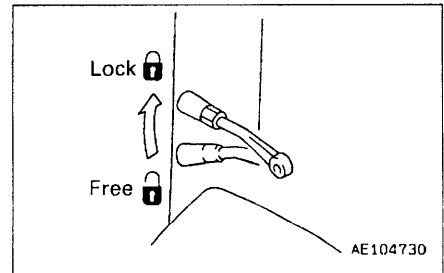

2. Is gear shift lever ④ in N (neutral) position and locked with safety lever ③?

**REMARK**

If the gear shift lever is not at the neutral position, the starting motor will not turn even when the starting switch is turned to the START position.

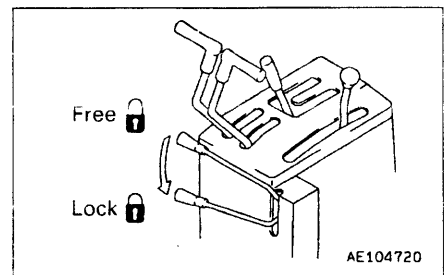

3. Are the blade and the ripper lowered on the ground?  
And are safety locks ⑤ for blade control lever and ripper control lever in the LOCK positions?

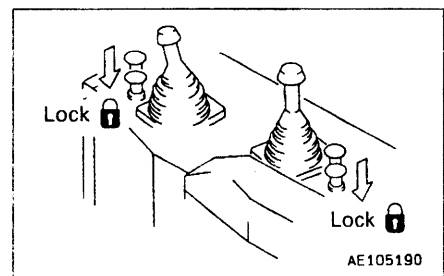

4. Is fuel control lever ⑥ in the engine stop position?

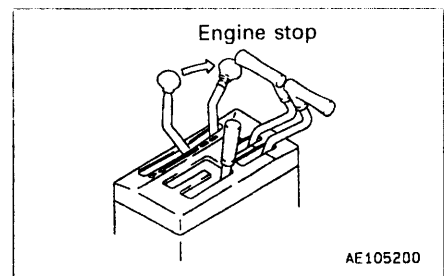



## 12.2 STARTING ENGINE

### 12.2.1 NORMAL STARTING

**⚠ WARNING**

Check that there are no persons or obstacles in the surrounding area, then sound the horn and start the engine.

**NOTICE**

Do not keep the starting motor rotating continuously for more than 20 seconds.

If the engine will not start, wait for at least 2 minutes before trying to start the engine again.

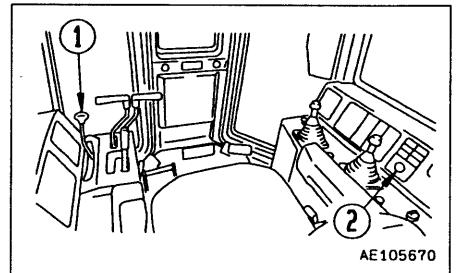

1. Pull fuel control lever ① a little toward you from the low idling position.

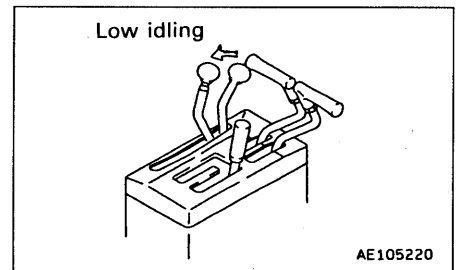

2. Insert the key into starting switch ② and turn the key to the START position. The engine will start.

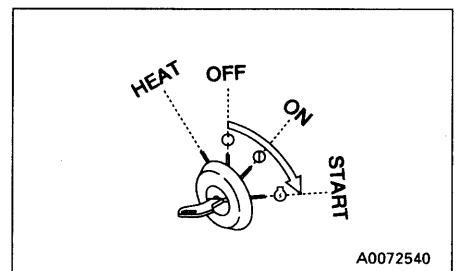

3. When the engine starts, release the key in starting switch ②. The key will return automatically to the ON position.

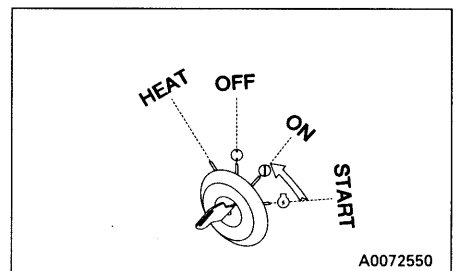

**12.2.2 STARTING IN COLD WEATHER**

When starting in low temperatures, do as follows.

**⚠ WARNING**

**Never use starting aid fluids as they may cause explosions.**

**NOTICE**

**Do not keep the starting motor rotating continuously for more than 20 seconds.**

**If the engine fails to start, repeat steps 3 and 4 after waiting for about 2 minutes.**

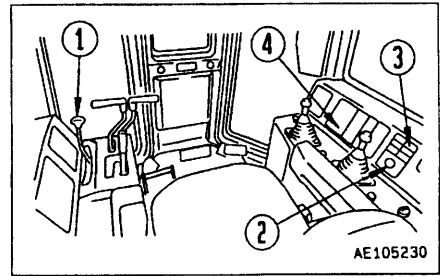

1. Pull fuel control lever ① to the center position between LOW IDLING and HIGH IDLING.

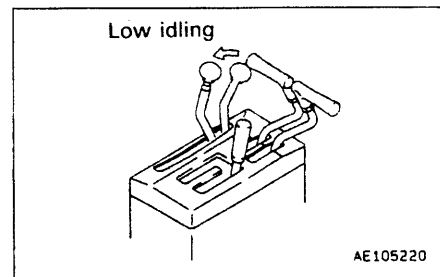

2. Insert the key into starting switch ② and turn the key to the ON position.

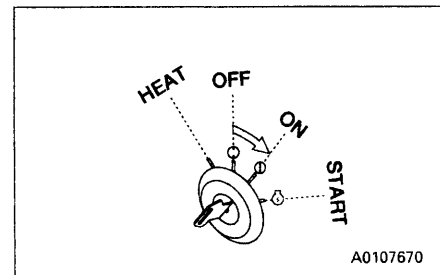

3. When preheating switch ③ is turned ON, the red lamp in the switch will light up, preheating monitor ④ will also light up, and preheating will automatically start. When the temperature is above  $-5^{\circ}\text{C}$ , the automatic preheating is not actuated.

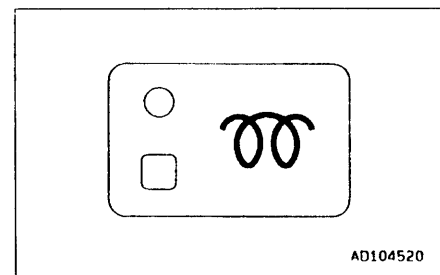

4. When preheater monitor lamp ④ goes off, turn the key of starting switch ② to the START position to crank the engine.

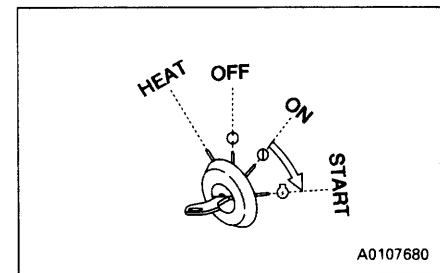

The time that preheater monitor lamp ④ stays on changes according to the ambient temperature as shown in the table below.

Ambient temperature	Preheat time
0°C to -10°C	0 to 15 seconds
-10°C to -20°C	15 to 30 seconds
-20°C to -30°C	30 to 50 seconds

5. When the engine starts, return the key of starting switch ② to the ON position. (Release the key and it will return automatically.)
6. After starting the engine, put preheater switch ③ in OFF position. The red lamp on the preheater switch goes off.
7. When the engine rotation stabilizes, move to low idling, and then carry out the warming-up operation.

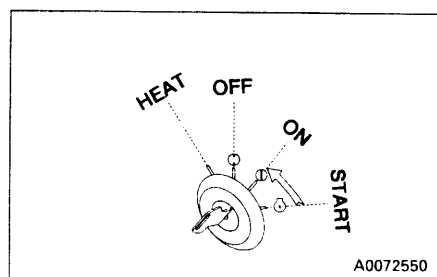

#### REMARK

- Regardless of the ambient temperature, if the key in starting switch ② is turned to the HEAT position, preheating monitor ④ will light up and preheating will start. (Preheating continues while the starting switch is held at the HEAT position.)  
For details of the preheating time, see the table.
- While preheating is being carried out, the preheating monitor lights up to show that preheating is being carried out. After it lights up for 36 seconds, it flashes for 16 seconds, then goes out. When it goes out, complete the preheating immediately.
- If the engine does not start with the above operation, wait for approx. 2 minutes and repeat Steps 3 - 4.

### 12.3 OPERATIONS AND CHECKS AFTER STARTING ENGINE

After starting the engine, do not immediately start operations. First, carry out the following operations and checks.

**NOTICE**

**Avoid abrupt acceleration until warm-up run is completed.**

**Do not run the engine at low idling or high idling for more than 20 minutes. If it is necessary to run the engine at idling, apply a load or run at a medium speed from time to time.**

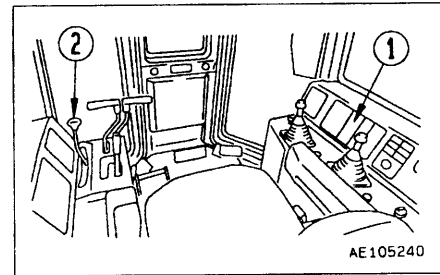

1. Run the engine at low idling speeds and make sure engine oil pressure monitor lamp ① goes off.

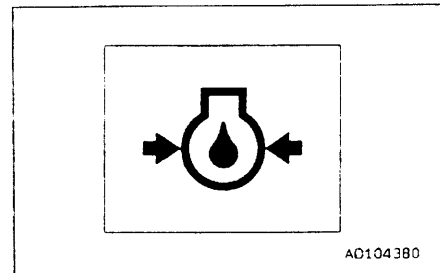

2. Pull fuel control lever ② and run the engine at a medium speed. Then run the engine at no load for about 5 minutes.

3. After warm-up run is completed, check gauges and caution lamps for proper operation. If any abnormality is found, repair it.

Continue to run the engine at light load until the green range of the engine water temperature gauge lights.

If the engine oil pressure monitor lamp starts flashing and the buzzer starts sounds intermittently, immediately stop the engine and check for the cause of trouble.

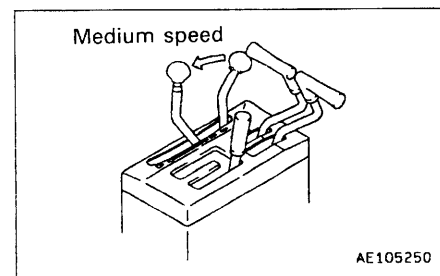

4. Check that there is no abnormal exhaust gas color, noise, or vibration. If any abnormality is found, repair it.

## 12.4 MOVING MACHINE

**⚠ WARNING**

- When moving machine, check that the area around the machine is safe, and sound the horn before moving. Clear all personnel from the machine and the area. Clear all obstacles from the path of the machine. Use extreme care when reversing the machine. Note there is an blind spot behind the machine.
- When starting on slopes, always keep brake pedal ③ depressed even after releasing brake lock lever ④.
- When starting on steep slopes, set fuel control lever ⑧ to the full speed position, depress brake pedal ③ and deceleration pedal ⑥. Then set gear shift lever ⑦ in 1st, and slowly release the deceleration pedal and brake pedal at the same time to allow the machine to start.

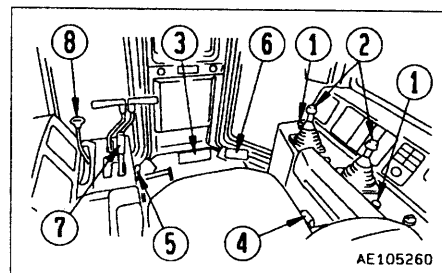

1. Set safety lock ① for blade control lever and ripper control lever to the FREE position.

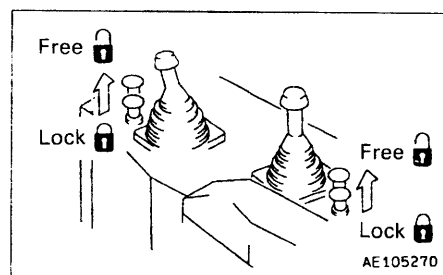

2. Operate blade control lever and ripper control lever ② to the RAISE position, raise the blade 40 – 50 cm (15.8 – 19.7 in) from the ground.

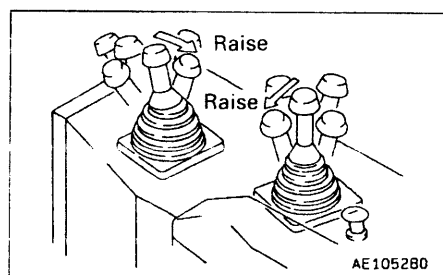

3. Depress brake pedal ③, place brake lock lever ④ in FREE, and return the brake pedal to home position.

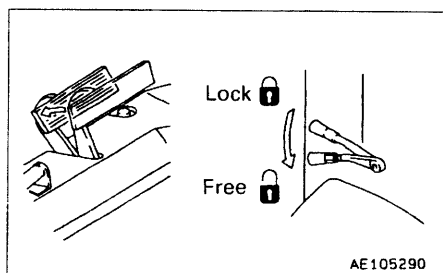

## 12. OPERATION

4. Unlock the gear shift lever with safety lever ⑤.

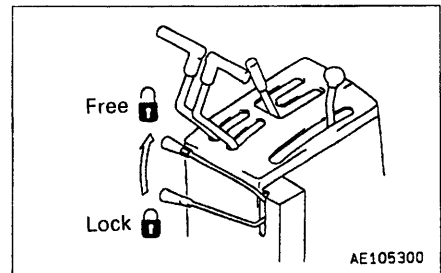

5. Depress decelerator pedal ⑥ to decrease engine speed so the machine can start off without jerking.

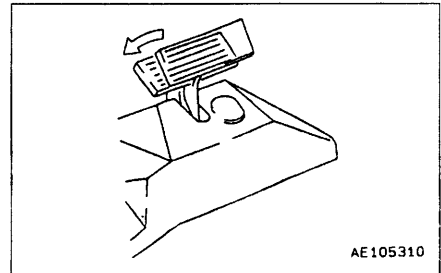

6. Shift gear shift lever ⑦ in a desired position and start the machine.

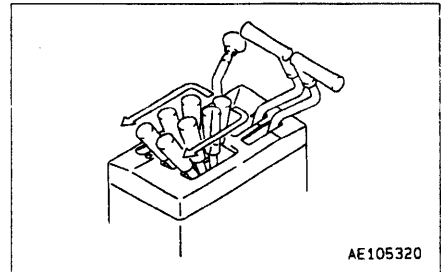

7. Pull fuel control lever ⑧ to increase engine speed.

### REMARK

If you are depressing the brake pedal, release the brake pedal slowly at the same time.

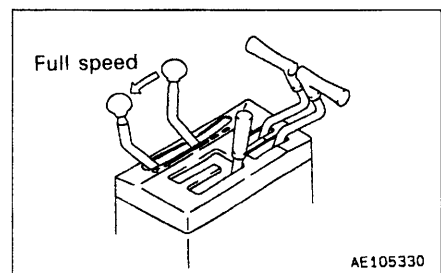

## 12.5 SHIFTING GEAR

There is no need to stop machine to shift gear.

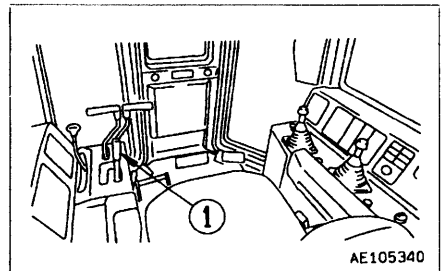

Set gear shift lever ① in the desired position to shift gear.

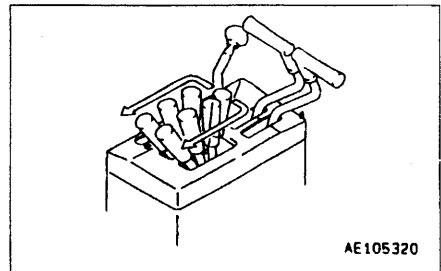

## 12.6 SHIFTING BETWEEN FORWARD AND REVERSE

### ⚠ WARNING

When switching between FORWARD and REVERSE, check first that the direction of travel is safe.

### ⚠ CAUTION

There is no need to stop the machine even when switching between FORWARD and REVERSE.

To increase safety, operator comfort, and the life of the transmission, leave the engine running at full speed, and always depress the decelerator pedal to lower the engine speed.

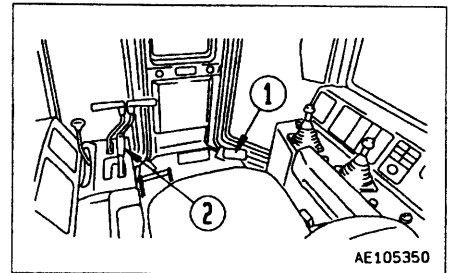

1. Depress decelerator pedal ① and reduce the engine speed.

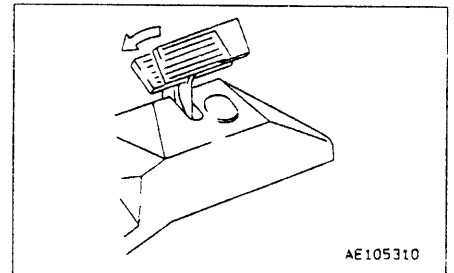

2. Shift gear shift lever ② to the desired position.

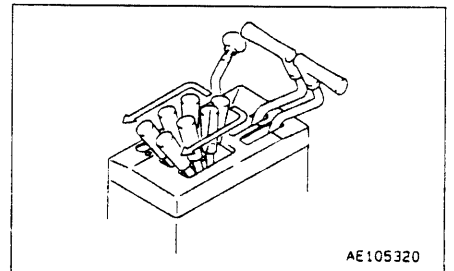

3. Release decelerator pedal ① to raise the engine speed.

### REMARK

When the gear shift lever is placed in REVERSE, the REVERSE warning buzzer will sound.

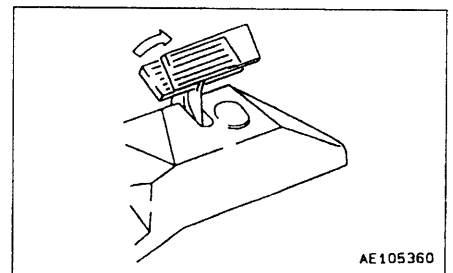

## 12.7 STEERING MACHINE

### WARNING

- Avoid as much as possible turning the machine on a slope. The machine will tend to slip sideways. Particular care should be taken on soft or clay land.
- Never make a pivot turn at high speed.

### 12.7.1 NORMAL TURNING

To turn the machine while traveling, pull steering lever ① on the side to turn.

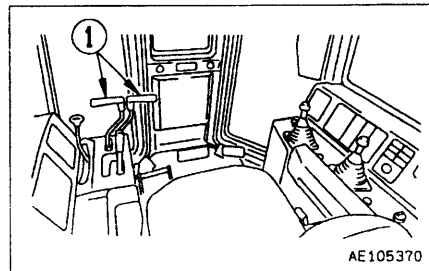

- Turnig to left while traveling forward

Pull the L.H. steering lever halfway (to the detent). The steering clutch will be disengaged, allowing the machine to make a gradual left turn.

#### REMARK

To make a gradual right turn, manipulate the R.H. steering lever in the same manner as described above.

Do the same when traveling in reverse.

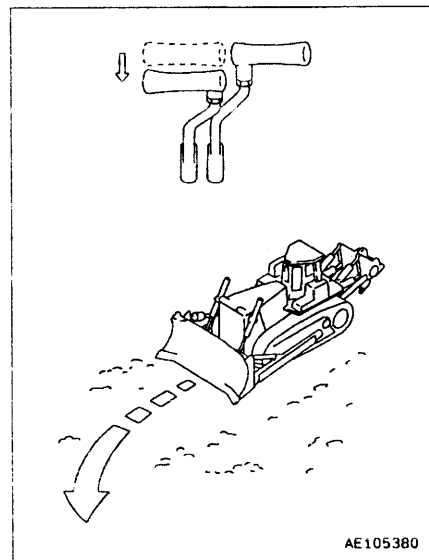

- Carrying out counterrotation turn to left

Pull the L.H. steering lever all the way backward. The steering clutch will be disengaged and the steering brake will be applied.

#### REMARK

To make a pivot right turn, manipulate the R.H. steering lever in the same manner as described above.

Do the same when traveling in reverse.

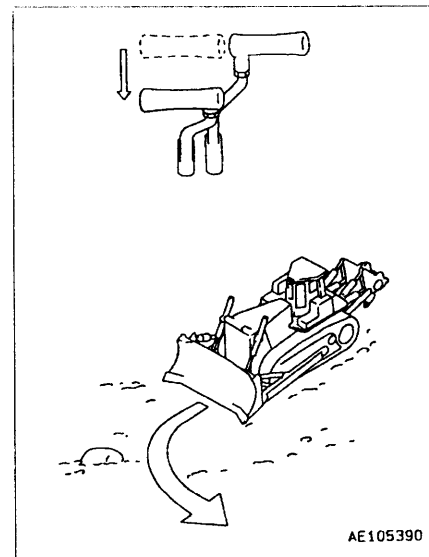



### 12.7.2 TURNING WHILE DESCENDING A SLOPE

#### WARNING

On steep downhill slopes where the machine may travel under its own weight, or on downhill slopes where it is being pushed by a towed machine, the machine will steer in the opposite direction, so do as follows.

- **Making gradual turns to left while traveling forward**

Pull the R.H. steering lever halfway to its stroke end. The machine will make a gradual left turn (compensation steering).

#### REMARK

To make a gradual right turn, manipulate the L.H. steering lever in the same manner as described above.

Do the same when traveling in reverse.

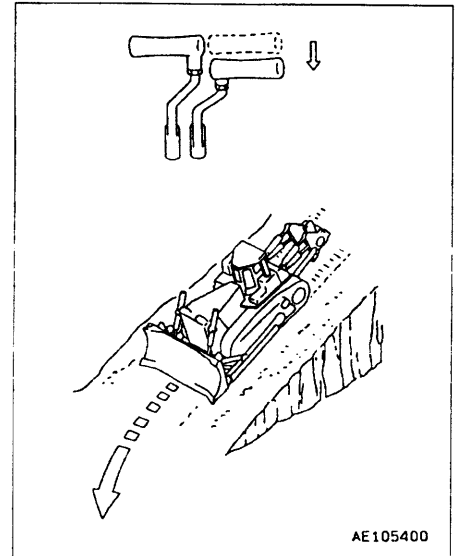

- **Making sharp turns to left while traveling forward**

Pull the L.H. steering lever all the way backward. Then, the machine will make a pivot left turn (no compensation steering).

#### REMARK

To make a pivot right turn, manipulate the R.H. steering lever in the same manner as described above.

Do the same when traveling in reverse.

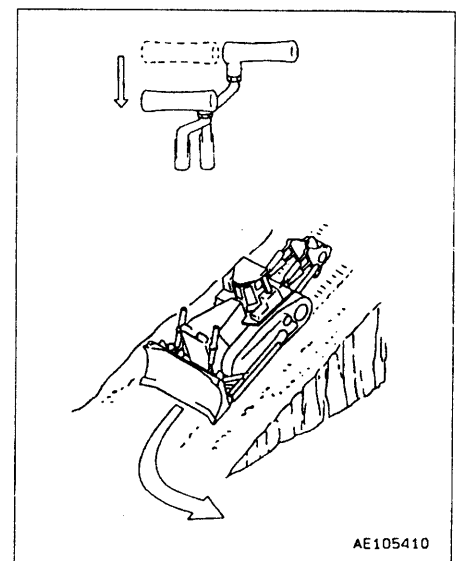

## 12.8 STOPPING MACHINE

**⚠ WARNING**

- Avoid stopping suddenly. Give yourself ample room when stopping.
- When stopping the machine, select flat hard ground and avoid dangerous places. If it is unavoidably necessary to park the machine on a slope, place the brake lock lever in the LOCK position and insert blocks underneath the track shoes. As an additional safety measure, thrust the blade into the ground.
- If the work equipment control lever is touched by accident, the work equipment may move suddenly, and this may lead to a serious accident. Before leaving the operator's seat, always operate the safety lever to place it securely at the LOCK position.

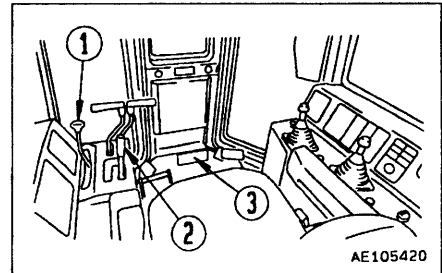

1. Lower engine speed by operating fuel control lever ①.

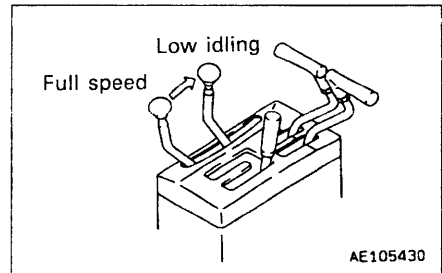

2. Place gear shift lever ② in N (neutral) position.

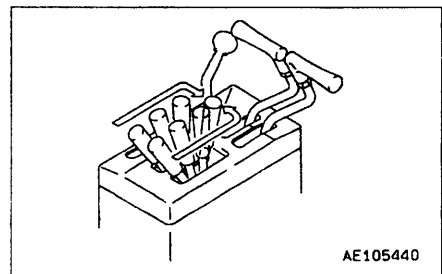

3. Depress brake pedal ③ to stop the machine.

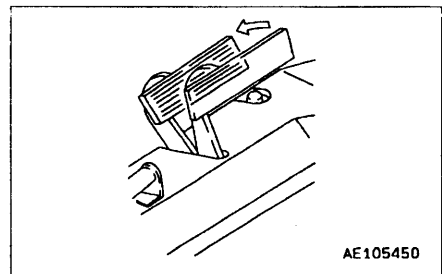

## 12.9 PRECAUTIONS FOR OPERATION

### 12.9.1 PAY ATTENTION TO GAUGES

When the red range lights on the power train oil temperature gauge while operating, reduce load and wait for lowering of temperature.

### 12.9.2 METHOD OF USING STEERING CLUTCH

If the steering clutch one side is used frequently or if many gradual turns are made with steering clutch half-engaged, the steering clutch will wear out in a short time. Design the travel road well and steer the machine properly.

### 12.9.3 PERMISSIBLE WATER DEPTH

When operating in water, always keep top surface ① of the track frame above the surface of the water.

Also, be careful that the engine cooling fan will not come in contact with water. The fan can be damaged.

### 12.9.4 PRECAUTIONS WHEN TRAVELING UP OR DOWN HILLS

#### Method of using decelerator pedal

When stepping on the decelerator pedal while going uphill, climbing ability will be reduced and the machine will stop. Furthermore, the engine sometimes will stall.

#### Use engine as brake

When going downhill, shift gear shift lever into low speed to run engine at slow speed and travel down slope using the engine as a brake.

When traveling down hills of more than 15°, shift down to 1st speed (R1 or F1).

#### Braking when traveling downhill

While descending a slope using the engine as a brake, also apply the brakes.

Failure to brake may result in overrunning, causing engine trouble.

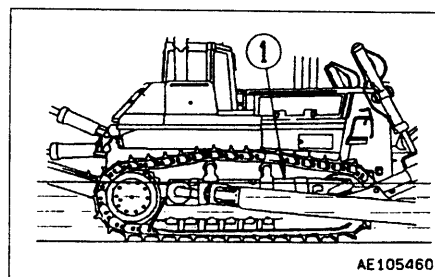

AE105460

### 12.9.5 PRECAUTIONS ON SLOPES

#### **Be careful of fuel level**

If the fuel level in the fuel tank becomes low when working on slopes, the engine may suck in air because of the angle of the machine or the swaying of the machine. If this makes the engine stop, so be careful not to let the fuel level in the fuel tank become too low.

#### **Be careful of oil level**

When operating machine on sloped areas of more than 20°, fill every place with oil to H level.

#### **Precautions when engine stops on slopes**

If the engine stops while working or traveling on a hill, immediately depress the brake pedal to bring the machine to a complete stop.

### 12.9.6 METHOD OF USING BRAKES

The following actions cause premature damage to the brakes, so avoid such operations.

- Using emergency brake at full speed
- Using brake with engine running at full speed in first gear (F1, R1) (Machine stall condition)

#### **REMARK**

Always depress the decelerator pedal to lower the engine speed before actuating the brakes.

## 12.10 WORK POSSIBLE USING BULLDOZER

In addition to the following, it is possible to further increase the range of applications by using various attachments.

### 12.10.1 DOZING

A bulldozer digs and transports dirt in a forward direction. Slope excavation can always be most effectively carried out by proceeding from the top downward.

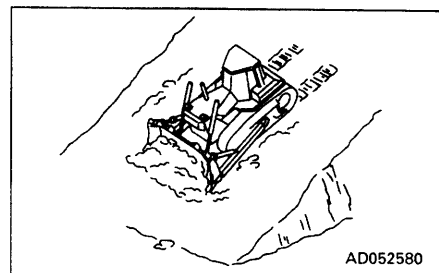

### 12.10.2 CUTTING INTO HARD OR FROZEN GROUND OR DITCHING

For digging and ditch excavation of hard or frozen ground, tilt the blade. Even hard ground can be dug effectively by a tilted or angled blade.

If the ground is harder, use a ripper attachment for better efficiency.

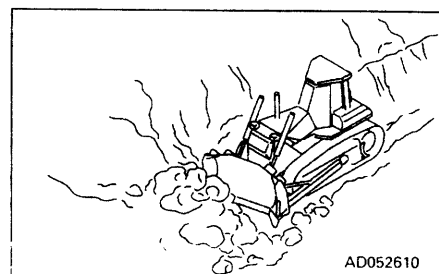

### 12.10.3 FELLING TREES, REMOVING STUMPS

#### NOTICE

**Do not up root trees or stumps or fell trees by angling or tilting the blade.**

For trees with a diameter of 10 – 30 cm (3.9 – 11.8 in), raise the blade high and push 2 or 3 times to fell the tree.

Next, travel in reverse, and dig the corner of the blade into the ground to cut and dig up the roots.

When doing this, never hit the tree at high speed or apply shock to fell the tree.

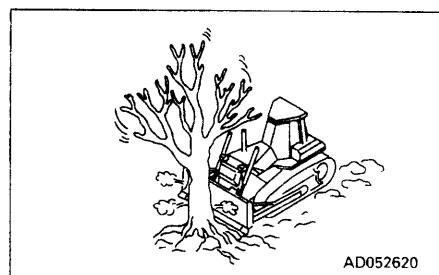

### 12.10.4 PUSHER OPERATIONS

When carrying out pusher operations, always install a pusher plate.

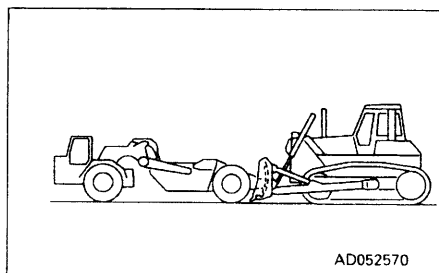

## 12.11 RIPPER OPERATION

### 12.11.1 EFFECTIVE METHOD OF USE

- The optimum digging angle for the shank is when the shank is perpendicular to the ground (ripping angle: 45°– 50° ).
- In comparatively soft rock (seismic velocity: 1500 m/s or below), it is also possible to carry out ripping with the shank tilted to the rear.
- On comparatively hard rock, if ripping is carried out with the shank tilted to the rear, there will be excessive wear of the point of tip ①, and the self-sharpening ability will be lost.
- During ripping operations, if the shoes slip because of boulders or resistance from the bedrock, use the tilt cylinder. When picking up a stone, advance the machine at a fixed gear speed (F1 or F2).

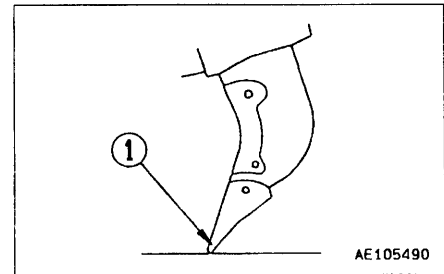
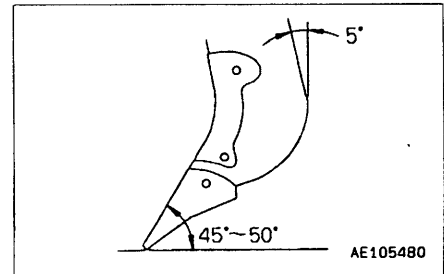

#### REMARK

When raising boulders or digging up rockbed, do not put the transmission in neutral. If the transmission is in neutral, the reaction of the tilt cylinder will push the machine back. Always operate the machine with the transmission in FORWARD.

#### REMARK

Choosing a suitable ripper point to match the type of rock is one of the most important elements in using the ripper effectively.

Ripper points are available for different types of rock, so select the most suitable ripper point from the list. For details, see "28. PROCEDURE FOR SELECTING RIPPER POINT."

### 12.11.2 DIGGING UP BOULDERS OR ROCKBED

During ripper operations, if stubborn boulders or rockbed cause the travel speed to become slower, operate the tilt cylinder to dig up the boulder/rockbed.

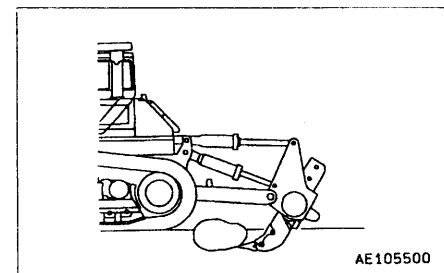

### 12.11.3 OPERATING ON SLOPES

When using the variable ripper, adjust the length of the tilt cylinder to select dimension L.

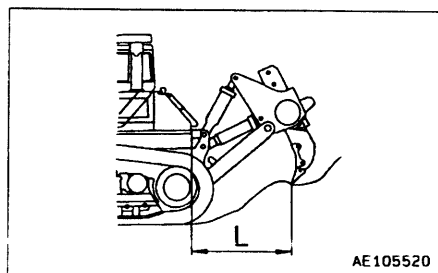
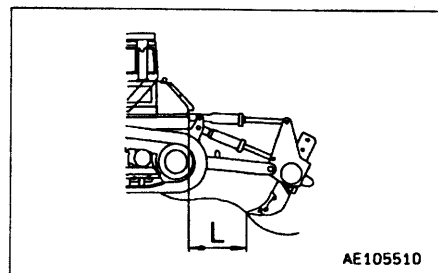

### 12.11.4 TANDEM OPERATION

When it is impossible for one machine to carry out ripping under its own power, ripping can be carried out in tandem.

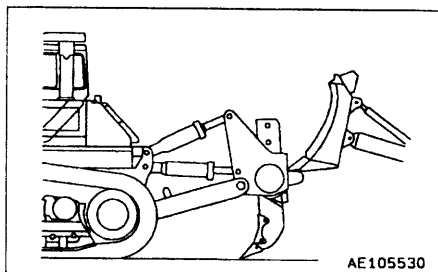

### 12.11.5 METHOD OF OPERATING PIN PULLER

This is used only on machines equipped with a giant ripper.

1. Stop the machine in a safe place and lower the shank to the ground.
2. Operate the pin puller controller switch to the PULL UP position and remove the mounting pin.
3. Move the ripper up or down to set to the desired shank position.

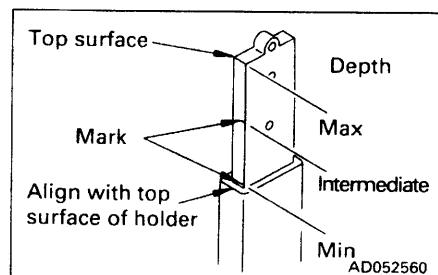
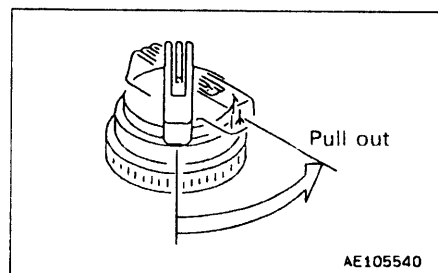

4. Operate the pin puller control switch to insert the mounting pin. If the pin does not match the position of the hole in the shank, set the pin puller control switch to the PUSH IN position and slowly move the ripper up or down.
  - When raising the pin position to increase the digging depth, use a long protector to prevent wear of the shank.

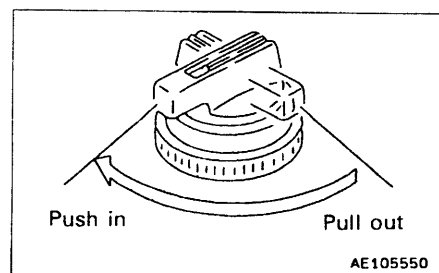

## 12.12 ADJUSTMENT OF WORK EQUIPMENT

### WARNING

When adjusting, it is dangerous if the work equipment is moved by mistake. Set the work equipment in a safe condition, then stop the engine and lock the work equipment securely with the safety lock.

### 12.12.1 BLADE ADJUSTMENT TILTING THE TILTDOZER

#### NOTICE

The maximum amount of tilt is 1250 mm (4.1 ft). (When the semi-U blade is used.)

Be sure not to exceed 1250 mm (4.1 ft) for the tilt.

The tiltdozer can be tilted by manipulating the blade control lever as indicated below.

Tilting adjustment to the right: 815 mm (2.7 ft) or more

Tilting adjustment to the left: 815 mm (2.7 ft) or more  
(When the semi-U blade is used.)

When a larger tilting adjustment is required, proceed as follows:  
By turning brace ① with handle bar ② secured to the L.H. brace, the blade can be tilted up to the max. adjustment of 1250 mm (4.1 ft) by changing the length of the brace (ℓ).

Standard distance (ℓ) between joints is 1740 mm (5.7 ft).

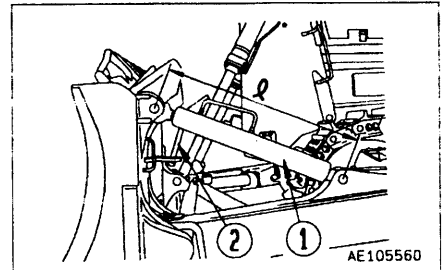

#### ADJUSTING SHIM IN BLADE CYLINDER CAP

Set the standard shim adjustment in the blade cylinder cap to 4 mm (0.16 in).

Remove shims to balance the wear of the cap and the ball at the end of the piston rod.

The proper clearance to be maintained with the shims is 0.2 to 0.6 mm (0.008 to 0.024 in).

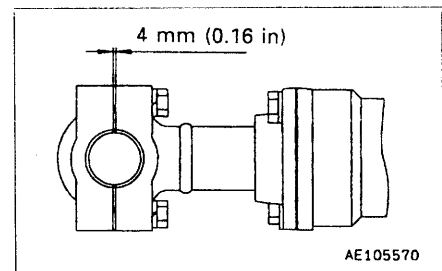



**ADJUSTING BRACE**

When adjusting with two worker

**⚠ WARNING**

If maintenance is carried out with the engine running, always have one worker sitting in the operator's seat while another worker carries out the maintenance. Both workers must mutually confirm the safety during the operation.

Start the engine and use inching control to tilt to the left and right. Adjustment can be carried out easily by rotating the brace handle while raising and lowering.

- When extending the brace  
Set the blade at FLOAT and rotate the brace handle to adjust.

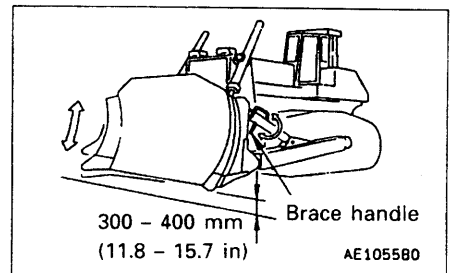
**REMARK**

When operated in this way, the blade is tilted, so the handle gradually becomes heavier. When this happens, return the blade from the tilt position to the horizontal position and turn the handle again according to the procedure given above.

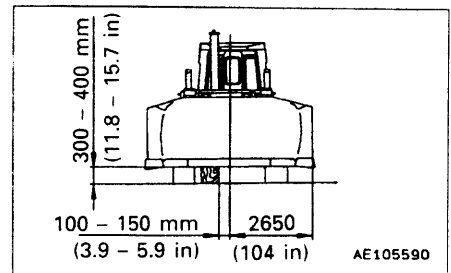
**When adjusting with one worker**

- When extending the brace  
Set the blade at FLOAT and rotate the brace handle to adjust.

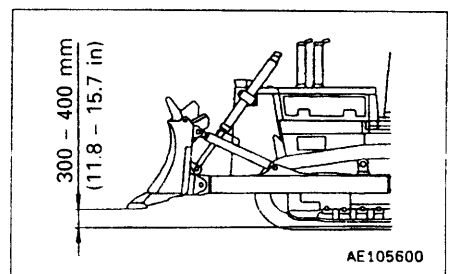
**REMARK**

When operated in this way, the blade is tilted, so the handle gradually becomes heavier. When this happens, return the blade from the tilt position to the horizontal position and turn the handle again according to the procedure given above.

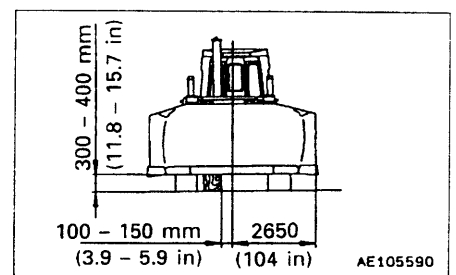

**SHIM ADJUSTMENT**

Adjust the thickness of shim so that the ball joint play (7 points) in the axial direction (shown by the arrow) does not exceed 1 mm (0.04 in).

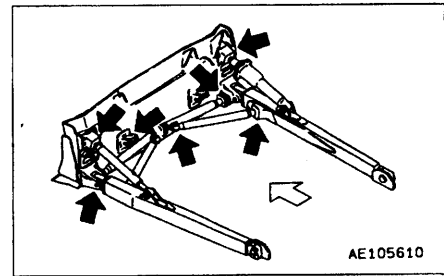

1. Remove shim ① and tighten bolts ② to eliminate the ball joint play.
2. Measure clearance "A" and remove bolts ②.
3. Install shim ① having its thickness of "A" mm to "A + 1" mm ("A" in. to "A + 0.04" in) in place with bolts ②.
4. Confirm that ball joint can move smoothly after tightening bolts.

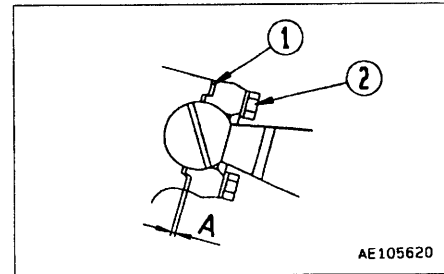

**12.12.2 ADJUSTING RIPPER  
ADJUSTING DIGGING DEPTH**

Mounting pin holes are provided in the shank and these are used according to the desired digging depth. For normal use, use the bottom hole, and when particularly deep digging is needed, use the top hole.

When changing the digging depth, refer to "12.11.5 METHOD OF OPERATING PIN PULLER".

**REPLACING POINT AND PROTECTOR**

To protect the shank, if the protector and point installed to the tip are worn, replace them.

Place a pin remover on the pin marked by the arrow, then hit with a hammer to remove from the opposite side.

**REMARK**

The pin is a unitized type, so insert the pin partially by hand, then knock it in fully with a hammer.

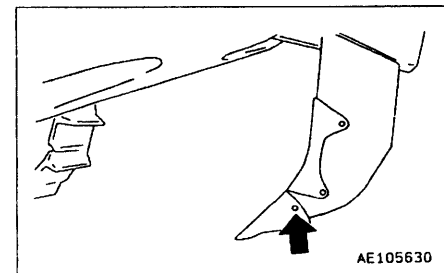

## 12.13 PARKING MACHINE

### WARNING

- Avoid stopping suddenly. Give yourself ample room when stopping.
- When stopping the machine, select flat hard ground and avoid dangerous places. If it is unavoidably necessary to park the machine on a slope, place the parking lever in the LOCK position and insert blocks underneath the track shoes. As an additional safety measure, thrust the blade into the ground.
- If the work equipment control lever is touched by accident, the work equipment may move suddenly, and this may lead to a serious accident. Before leaving the operator's seat, always operate the safety lock to place it securely at the LOCK position.

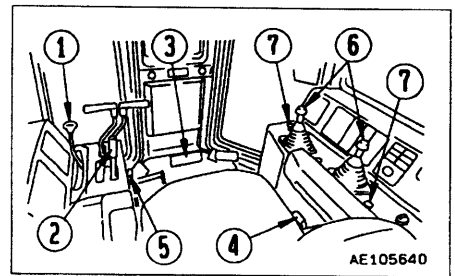

1. Lower engine speed by operating fuel control lever ①.

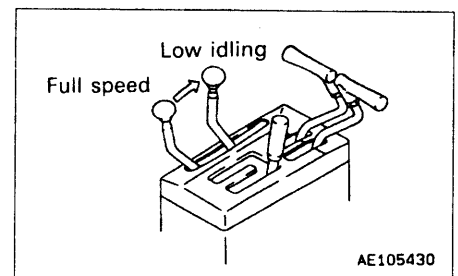

2. Place gear shift lever ② in N (neutral) position.

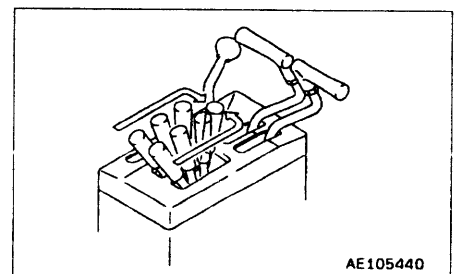

3. Depress brake pedal ③ to stop the machine and lock the brakes with brake lock lever ④.

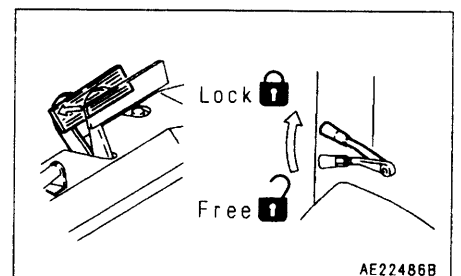

4. Lock gear shift lever with safety lever ⑤.

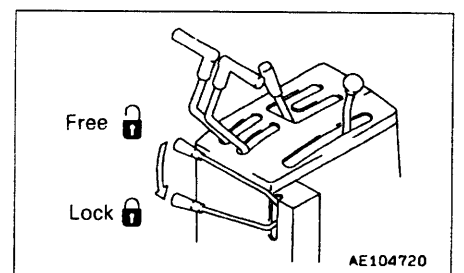

## 12. OPERATION

- Put blade control lever ⑥ and ripper control lever ⑥ in the LOWER positions to lower blade and ripper to the ground.

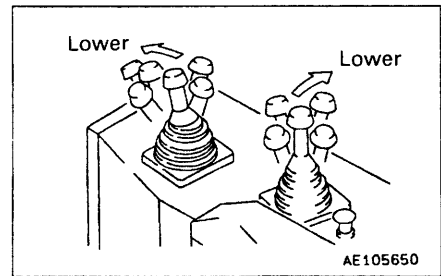

- Lock blade control lever ⑥ and ripper control lever ⑥ with safety locks ⑦.

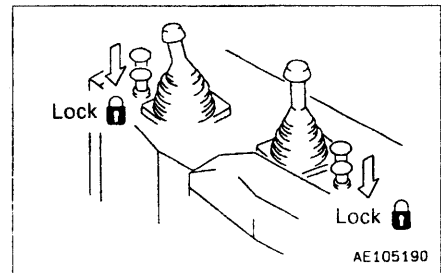

### 12.14 CHECK AFTER FINISHING WORK

- Use the meters and caution lamps to check the engine water temperature, engine oil pressure, fuel level, power train oil temperature.

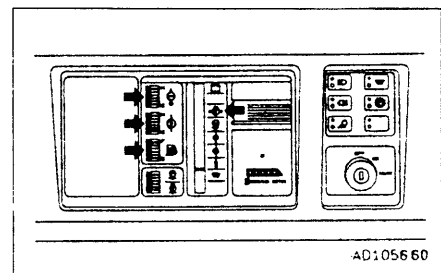

## 12.15 STOPPING ENGINE

### NOTICE

If the engine is abruptly stopped before it has cooled down, engine life may be greatly shortened. Consequently, do not abruptly stop the engine apart from an emergency.

In particular, if the engine has overheated, do not abruptly stop it but run it at low speed to allow it to cool gradually, then stop it.

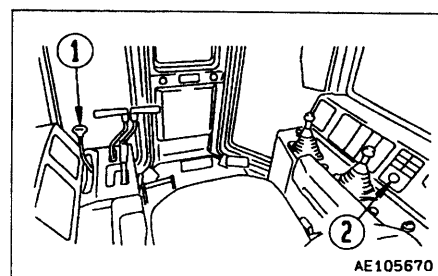

1. Place fuel control lever ① in the low idling position and run the engine at low idling speed for about 5 minutes to allow it to gradually cool down.

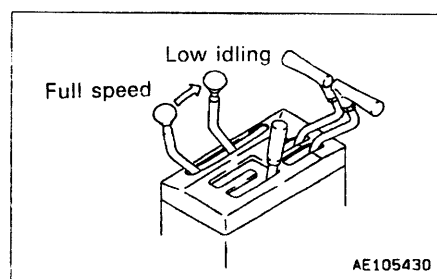

2. Push fuel control lever ① in the engine stop position and stop the engine.

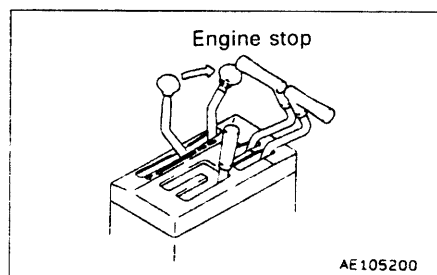

3. Turn the key in starting switch ② to the OFF position and remove the key.

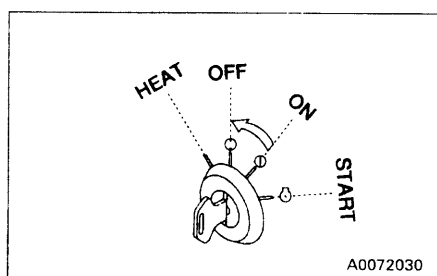

## 12.16 CHECK AFTER STOPPING ENGINE

1. Walk around the machine and check the work equipment, paint-work, and undercarriage, and check also for leakage of oil or water. If any abnormalities are found, repair them.
2. Fill the fuel tank.
3. Check the engine compartment for paper and debris. Clean out any paper and debris to avoid a fire hazard.
4. Remove any mud stuck to the undercarriage.

## 12.17 LOCKING

To prevent vandalism, there are locks at the following places.  
Places that can be locked with the starting switch key.

- Right and left engine side cover ①
- Air conditioner filter, tool box inspection cover ②
- Inspection cover for fuel tank drain valve ③
- Cab door opener ④
- Cap with lock ⑤
  - Radiator cap
  - Fuel tank cap
  - Hydraulic oil tank cap
  - Power train oil filler cap
- Battery inspection cover ⑥

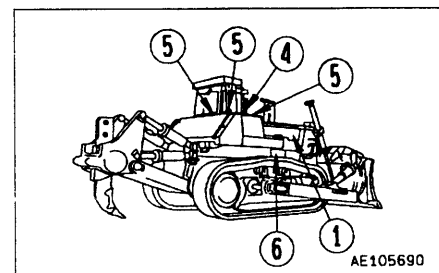
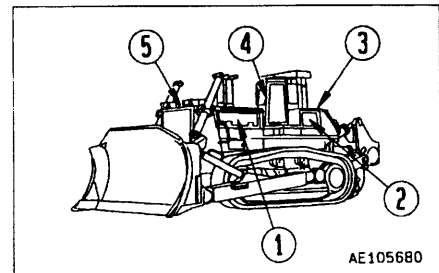

## 12.18 TIPS FOR LONGER UNDERCARRIAGE LIFE

Undercarriage life greatly varies depending on operation method, inspection and maintenance. For most efficient operation, keep the following point in mind.

### 12.18.1 OPERATION METHOD

- Select the track shoe that best suits the type of soil to be encountered in service.  
Please consult your Komatsu distributor when selecting track shoes.
- Do not allow shoe slipping to occur during operation. If shoe slipping occurs, reduce load to the blade until slipping stops.
- Avoid sudden starts, acceleration or stops, unnecessarily high speeds and sharp turns.
- Always operate machine in a straight line whenever possible. When making turns, be careful not to allow the machine to stay to one side, so operation in both turning directions can be done properly. Make turns with the largest possible radius.
- Prior to operation, clear boulders and obstacles to prevent machine from riding over them while operating.
- On a slope, operate the machine parallel to the inclination of the slope. Do not operate across the slope. Also when stopping the machine on a slope, the machine should face toward the top of the slope.
- When ground inclines to left or right during digging operation, do not continue to dig with machine inclined. Move machine back to level ground and start to dig again.
- Do not force the machine to carry out work that exceeds its working capability. Such work includes cases where the idler or sprocket come off the ground when the machine meets obstacles that resist the power of the machine during dozing or ripping operations.

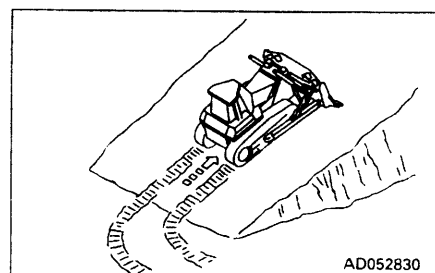

**12.18.2 INSPECTION AND ADJUSTMENT**

- Properly adjust track tension.  
Tension should be measured at clearance (A) shown in the diagram – usually 20 to 30 mm (0.8 to 1.2 in) at this point. For rocky terrain, tighten tracks slightly. In clay or sandy areas, slightly loosen them. (For inspection and adjustment procedures, refer to “24.2 WHEN REQUIRED”).
- Check idler rollers for oil leakage as well as for loose bolts and nuts. If any trouble is detected, repair immediately.

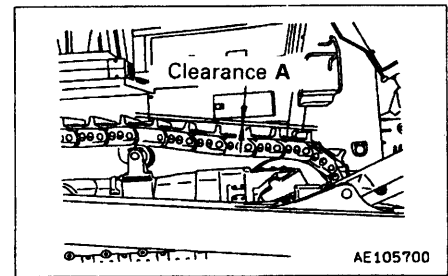

**12.18.3 INSPECTION AND REPAIR**

Frequent inspection and prompt repair will reduce repair costs. The following items for inspection will serve as a guide to maintenance service of each undercarriage part. Perform periodical inspection and contact the Komatsu distributor in your area when machine has approached repairable limits and reversing limits.

**MEASURING HEIGHT OF GROUSER**

After taking up slack in track shoes, measure height at center of shoe as shown below.

- Standard height (h): 105 mm (4.1 in)
- Repair limits: 30 mm (1.2 in)

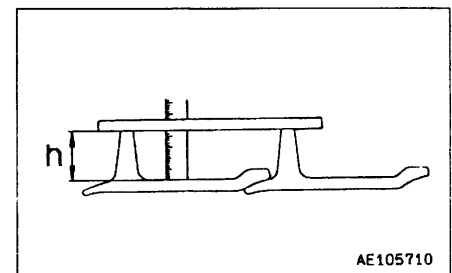

**MEASURING OUTSIDE DIAMETER OF TRACK ROLLER**

1. Measure height (size C) of link tread as shown.
2. Stop machine at position where link tread, whose size C has been measured completely, contacts roller tread. Then measure size B.
3. Calculate outside diameter of tread (size A):  
 $A = (B - C) \times 2$   
Standard size (A): 300 mm (11.8 in)  
Repair limits: 264 mm (10.4 in)

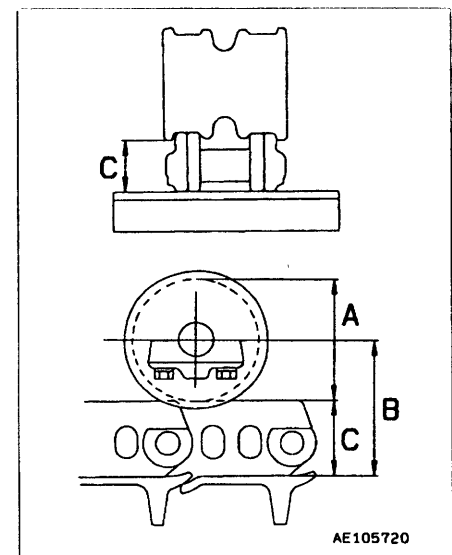



## 13. TRANSPORTATION

When transporting the machine, observe all related laws and regulations, and be careful to assure safety.

### 13.1 LOADING, UNLOADING WORK

#### WARNING

- **Make sure the ramp has sufficient width, length and thickness to enable the machine to be safely loaded and unloaded. If the ramp sags appreciably, reinforce it with blocks, etc.**
- **When loading and unloading the machine, park the trailer on a flat firm roadbed. Keep a fairly long distance between the road shoulder and the machine.**
- **Remove the mud from the undercarriage to prevent the machine from slipping to the side on slopes. Be sure the ramp surface is clean and free of grease, oil, ice and loose materials.**
- **Never change the direction of travel when on the ramps. If it is necessary to change direction, drive off the ramps and correct the direction, then drive on to the ramps again.**
- **Do not use the counterrotation turn.**

When loading or unloading, always use ramps or a platform and carry out the operations as follows.

1. Properly apply the brakes on the trailer and insert blocks beneath the tires to ensure that it does not move. Then fix the ramps in line with the centers of the trailer and the machine.
2. Set the machine in line with the ramps, set the max. speed setter to low speed, then load or unload the machine at slow travel.
3. Load the machine correctly in the specified position on the trailer.

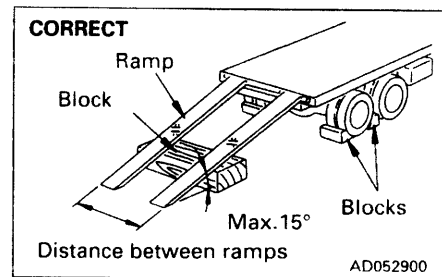

### 13.2 PRECAUTIONS FOR LOADING

After loading to the specified position, secure the machine as follows.

1. Lower the blade slowly.
2. Lock all the control levers securely with the safety lever.
3. Set the parking lever to the LOCK position.
4. Turn the starting switch to the OFF position, stop the engine, then remove the key.
5. Lock the cab door, left and right engine side covers, and the battery inspection cover.
6. Put blocks under the front and rear of both tracks and secure the machine in position with chains or wire rope of appropriate strength to prevent the machine from moving during transportation. Be particularly careful to tie the machine down securely so that it does not slip to the side.

### 13.3 LIFTING POSITION

Set the lifting position for the machine as shown in the diagram on the right.

Stop the engine and be sure to set the parking lever to the LOCK position.

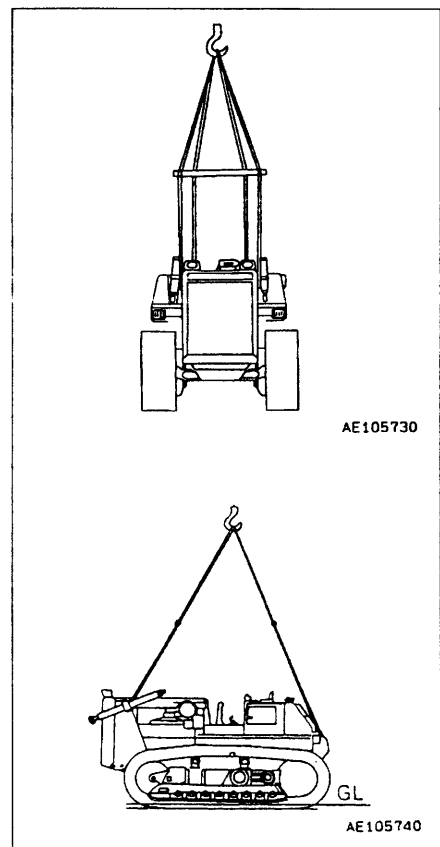

### 13.4 PRECAUTIONS FOR TRANSPORTATION

**⚠ WARNING**

**Determine the route for transporting the machine by taking into account the width, height and weight of the machine.**

Obey all state and local laws governing the weight, width and length of a load. Observe all regulations governing wide loads.

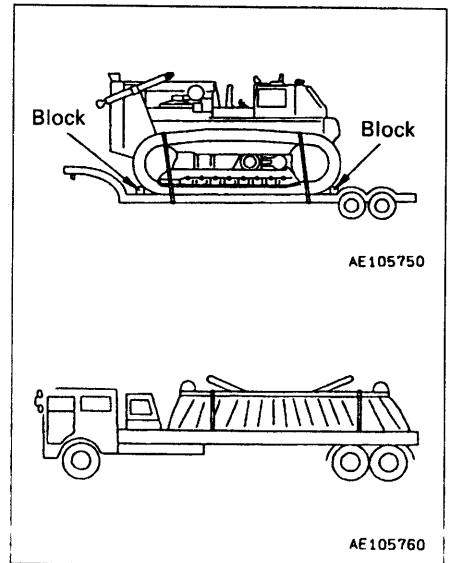

### 13.5 REMOVAL AND INSTALLATION OF CAB

When removing the cab for transportation, do as follows.

**⚠ WARNING**

**Always use lifting equipment of ample strength.**

**13.5.1 REMOVAL OF CAB**

1. Pull out left and right knobs ① of the car stereo and remove, then loosen the nuts and remove holder plate ②.
2. Remove 10 caps ③ installed to the top of the panel.
3. Remove 18 panel mounting screws ④ and washers ⑤, then remove panels ⑥, ⑦, and ⑧.
4. Remove 6 mounting screws ⑨ and washers ⑩ on the left and right, then remove 2 door seal protection plates ⑪ on the left and right.
5. Remove 7 blind caps ⑫ installed to the bottom front of the cab and the bottom of the left and right doors.  
After removing the cab, install blind caps ⑫ again.
6. Disconnect wiring harness connectors ⑬ and ⑭ extending from the left side of the cab.  
Hold concave portion ⑰ of the connector with your fingers, then pull up to remove.  
Connector ⑬: Air conditioner power source, 17 pins  
Connector ⑭: Cab, display power source, 21 pins
7. Pull up and remove 4 hoses ⑮ extending from the left side of the cab.

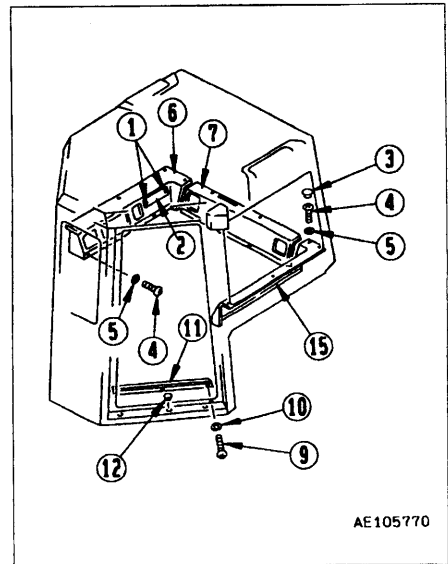

8. Remove 14 cab mounting bolts ① - ⑮.

**REMARK**

The 2 seal rubbers ⑯ (for blocking the clearance) are used again when the cab is installed, so keep them in a safe place.  
Cab weight: Approx. 450 kg (992 lb)

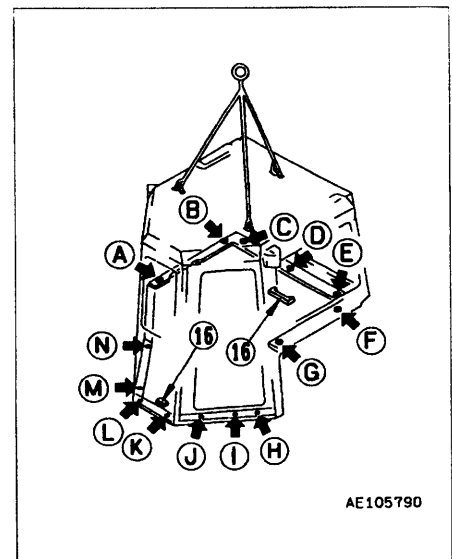
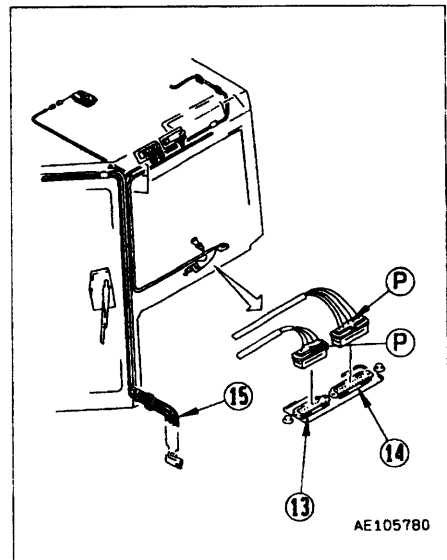

### 13.5.2 INSTALLATION OF CAB

Install the parts removed from the cab in the opposite order from removal, and connect the parts that were disconnected.

However, when installing the cab, install in the following order.

#### Installation of cab

1. Set height adjustment joint ⑰ installed to the cab so that dimension S in the diagram is less than 8 mm (0.3 in).
2. Lower the cab slowly from above the floor.
3. Align the cab with the floor frame, then install bolts and washers ① – ⑮.  
Do not screw in the bolts completely; screw in only 3 – 4 turns.
4. Tighten bolts ① – ⑮ completely.  
When tightening bolts ① – ⑮, check that height adjustment joint ⑰ for installing ① – ③ is not in contact with the floor frame mounting surface.
5. Screw in adjustment joint ⑰ of bolt sprocket ① – ③ until it contacts the floor frame mounting surface.

#### **⚠ WARNING**

**After the tip of the adjustment joint contacts the floor frame surface, do not tighten the joint with a wrench. This will deform the cab or floor frame and will generate initial stress.**

6. After adjusting the joint, tighten cab mounting bolts ① – ③.

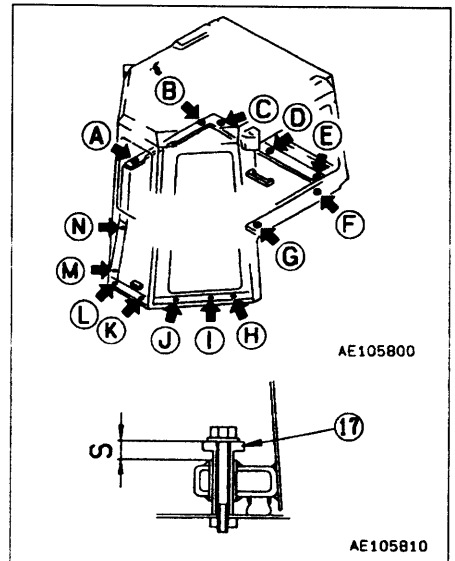

# 14. COLD WEATHER OPERATION

---

## 14.1 PRECAUTIONS FOR LOW TEMPERATURE

If the temperature becomes low, it becomes difficult to start the engine, and the coolant may freeze, so do as follows.

### 14.1.1 FUEL AND LUBRICANTS

Change to fuel and oil with low viscosity for all components.

For details of the specified viscosity, see "20. USE OF FUEL, COOLANT AND LUBRICANTS ACCORDING TO AMBIENT TEMPERATURE".

### 14.1.2 COOLANT

 **WARNING**

**Keep antifreeze fluid away from an open flame. Never smoke when using antifreeze.**

#### NOTICE

**Never use methanol, ethanol or propanol based antifreeze.**

Where no permanent antifreeze is available, an ethylene glycol antifreeze without corrosion inhibitor may be used only for the cold season. In this case, clean the cooling system twice a year (in spring and autumn). When refilling the cooling system, add antifreeze in autumn, but do not add any in spring.

Absolutely avoid using any water leak preventing agent irrespective of whether it is used independently or mixed with an antifreeze.

Do not mix one antifreeze with a different brand.

For details of the antifreeze mixture when changing the coolant, see "24.2 WHEN REQUIRED".

Use a Permanent Antifreeze (ethylene glycol mixed with corrosion inhibitor, antifoam agent, etc.) meeting the standard requirements as shown below. With permanent antifreeze, no change of coolant is required for a year. If it is doubtful that an available antifreeze meets the standard requirements, ask the supplier of that antifreeze for information.

Standard requirements for permanent antifreeze.

- SAE ..... J1034
- FEDERAL STANDARD ..... O-A-548D

### 14.1.3 BATTERY

**⚠ WARNING**

- To avoid gas explosions, do not bring fire or sparks near the battery.
- Battery electrolyte is dangerous. If it gets in your eyes or on your skin, wash it off with large amounts of water, and consult a doctor.

When the ambient temperature drops, the capacity of the battery will also drop. If the battery charge ratio is low, the battery electrolyte may freeze. Maintain the battery charge as close as possible to 100%, and insulate it against cold temperature so that the machine can be started easily the next morning.

Measure the specific gravity and calculate the rate of charge from the following conversion table.

Temp. of fluid Rate of charge	20°C	0°C	-10°C	-20°C
100%	1.28	1.29	1.30	1.31
90%	1.26	1.27	1.28	1.29
80%	1.24	1.25	1.26	1.27
75%	1.23	1.24	1.25	1.26

## 14.2 AFTER COMPLETION OF WORK

To prevent mud, water, or the undercarriage from freezing and making it impossible for the machine to move on the following morning, always observe the following precautions.

- Mud and water on the machine body should be completely removed. This is to prevent damage to the seal caused by mud or dirt getting inside the seal with frozen drops of water.
- Park the machine on concrete or hard ground. If this is impossible, park the machine on wooden boards.
- Open the drain valve and drain any water collected in the fuel system to prevent it from freezing.
- As the battery capacity drops markedly in low temperatures, cover the battery or remove it from the machine, keep it in a warm place, and install it again the next morning.

## 14.3 AFTER COLD WEATHER

When season changes and the weather becomes warmer, do as follows.

- Replace the fuel and oil for all parts with oil of the viscosity specified.  
For details, see "20. USE OF FUEL, COOLANT AND LUBRICANTS ACCORDING TO AMBIENT TEMPERATURE".
- If for any reason permanent antifreeze cannot be used, and an ethyl glycol base antifreeze (winter, one season type) is used instead, or if no antifreeze is used, drain the cooling system completely, then clean out the inside of the cooling system thoroughly, and fill with fresh water.
- When it is unnecessary to use the APS (Automatic Priming System) (when the ambient temperature is above 15°C), always keep the fuel valve closed.



# 15. LONG-TERM STORAGE

---

## 15.1 BEFORE STORAGE

When putting the machine in storage for more than one month, do as follows.

- After every part is washed and dried, the machine shall be housed in a dry building. Never leave it outdoors.  
In case it is indispensable to leave it outdoors, park the machine on the flat ground and cover it with canvas etc.
- Completely fill the fuel tank, lubricate and change the oil before storage.
- Apply a thin coat of grease to metal surface of the hydraulic piston rods and the idler adjusting rods.
- Disconnect the negative terminals of the battery and cover it, or remove it from the machine and store it separately.
- If the ambient temperature is expected to drop below 0°C, always add antifreeze to the cooling water.
- Place all control levers at the neutral position, operate the safety lever and parking lever to the LOCK position, then move the fuel control dial to the low idling position.

## 15.2 DURING STORAGE

 **WARNING**

**If it is unavoidably necessary to carry out the rustpreventive operation while the machine is indoors, open the doors and windows to improve ventilation and prevent gas poisoning.**

- Operate the engine and move the machine for a short distance once a month so that a new film of oil will be coated over movable parts and component surfaces. At the same time, also charge the battery.
- Before operating the work equipment, wipe off the grease on the hydraulic piston rod.

### 15.3 AFTER STORAGE

#### NOTICE

**If the machine is stored without carrying out the monthly rust prevention operation, request your Komatsu distributor for service.**

Carry out the following procedure when taking the machine out of long-term storage.

- Wipe off the grease from the hydraulic cylinder rods.
- Add oil and grease to all places.

## 16. TROUBLESHOOTING

### 16.1 AFTER RUNNING OUT OF FUEL

When starting after running out of fuel, fill with fuel and bleed the air from the fuel system before starting.

For details of bleeding the air, see "24.5 EVERY 500 HOURS SERVICE".

### 16.2 METHOD OF TOWING MACHINE

#### ⚠ WARNING

- When towing the machine, use a wire rope that has ample strength for the weight of the machine being towed.
- A shackle must always be used when using a towing hook.
- The wire rope should be horizontal and at a right angle to the track frame.
- Move the machine slowly.

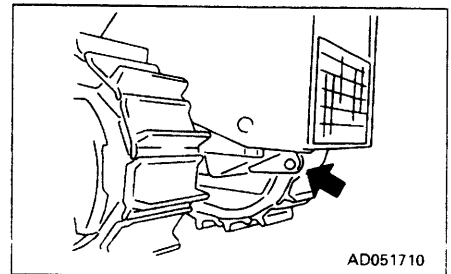

If the machine sinks in mud and cannot get out under its own power, or if being used to tow a heavy object, fit the wire to the towing hook as shown in the diagram on the right, or in the case of machines with a drawbar, fit the wire to the drawbar pin when towing.

Permissible load for towing hook: 71500 kg (701175 N)

### 16.3 IF BATTERY IS DISCHARGED

#### ⚠ WARNING

- When checking or handling the battery, stop the engine and turn the starting key to the OFF position before starting.
- The battery generates hydrogen gas, so there is danger of explosion. Do not bring lighted cigarettes near the battery, or do anything that will cause sparks.
- Battery electrolyte is dilute sulphuric acid, and it will attack your clothes and skin. If it gets on your clothes or on your skin, wash it immediately off with large amounts of water. If it gets in your eyes, wash it out with fresh water, and consult a doctor.
- When removing the battery, first disconnect the cable from the ground (normally, from the negative  $-$  terminal). When installing, install the positive  $+$  terminal first. If a tool touches the cable connecting the positive terminal and the chassis, there is danger that it will cause sparks.
- If the terminals are loose, there is danger that the defective contact may generate sparks that will cause an explosion. When installing the terminals, install them tightly.

When removing, disconnect the cable from the ground terminal first.

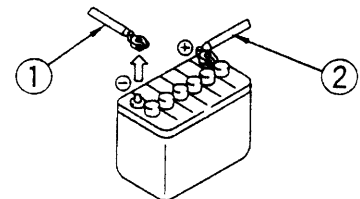

When installing, connect the cable to the positive  $+$  terminal first.

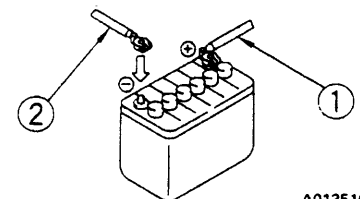

A0135160

### 16.3.1 STARTING ENGINE WITH BOOSTER CABLE

When starting the engine with a booster cable, do as follows:

#### PRECAUTIONS WHEN CONNECTING AND DISCONNECTING BOOSTER CABLE

**WARNING**

- When starting the engine from another machine, connect the batteries in parallel.
- When connecting the cables, never contact the positive  $\oplus$  and negative  $\ominus$  terminals.
- When starting the engine with a booster cable, always wear safety glasses.
- Be careful not to let the normal machine and problem machine contact each other. This prevents sparks from generating near the battery which could ignite the hydrogen gas given off by the battery. If hydrogen gas explodes. It could cause serious injury.
- Make sure that there is no mistake in the booster cable connections. The final connection is to the engine block of the problem machine, but sparks will be generated when this is done, so connect to a place as far as possible from the battery.
- Use care when removing the cables from the machine that has been started. Do not allow the cable ends to contact each other or the machine, to avoid hydrogen explosion.

**INCORRECT**

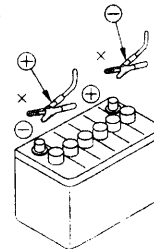

A0067321

#### NOTICE

- The size of the booster cable and clip should be suitable for the battery size.
- The battery of the normal machine must be the same capacity as that of the engine to be started.
- Check the cables and clips for damage or corrosion.
- Make sure that the cables and clips are firmly connected.

**CONNECTING THE BOOSTER CABLES**

Keep the starting switch at the OFF position.

Connect the booster cable as follows, in the order of the numbers marked in the diagram.

1. Make sure that the starting switches of the normal machine and problem machine are both at the OFF position.
2. Connect one clip of booster cable (A) to the positive  $\oplus$  terminal of the problem machine.
3. Connect the other clip of booster cable (A) to the positive  $\oplus$  terminal of the normal machine.
4. Connect one clip of booster cable (B) to the negative  $\ominus$  terminal of the normal machine.
5. Connect the other clip of booster cable (B) to the engine block of the problem machine.

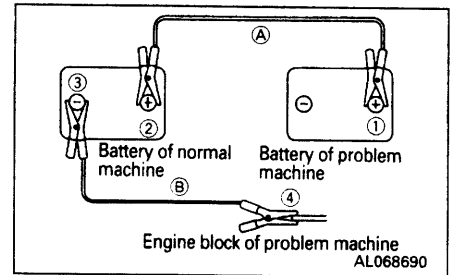
**STARTING THE ENGINE**

1. Make sure the clips are firmly connected to the battery terminals.
2. Start the engine of the normal machine and keep it to run at high idling speed.
3. Turn the starting switch of the problem machine to the START position and start the engine. Refer to "12.2 STARTING ENGINE".

**DISCONNECTING THE BOOSTER CABLES**

After the engine has started, disconnect the booster cables in the reverse of the order in which they were connected.

1. Remove one clip of booster cable (B) from the engine block of the problem machine.
2. Remove the other clip of booster cable (B) from the negative  $\ominus$  terminal of the normal machine.
3. Remove one clip of booster cable (A) from the positive  $\oplus$  terminal of the normal machine.
4. Remove the other clip of booster cable (A) from the positive  $\oplus$  terminal of the problem machine.

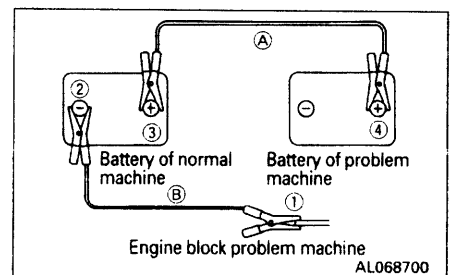

## 16.4 OTHER TROUBLE

- ( ): Always contact your Komatsu distributor when dealing with these items.
- In cases of abnormalities or causes which are not listed below, please contact your Komatsu distributor for repairs.

### 16.4.1 ELECTRICAL SYSTEM

Problem	Main causes	Remedy
Lamp does not glow brightly even when the engine runs at high speed	<ul style="list-style-type: none"> <li>● Defective wiring</li> <li>● Defective adjustment of fan belt tension</li> </ul>	<ul style="list-style-type: none"> <li>● Check, repair loose terminals, disconnections</li> <li>● Adjust fan belt tension</li> </ul> For details, see EVERY 250 HOURS SERVICE
Lamp flickers while engine is running		
Charge lamp does not go out even when engine is running	<ul style="list-style-type: none"> <li>● Defective alternator</li> <li>● Defective wiring</li> </ul>	<ul style="list-style-type: none"> <li>● Replace</li> <li>● Check, repair</li> </ul>
Abnormal noise is generated from alternator	<ul style="list-style-type: none"> <li>● Defective alternator</li> </ul>	<ul style="list-style-type: none"> <li>● Replace</li> </ul>
Starting motor does not turn when starting switch is turned to ON	<ul style="list-style-type: none"> <li>● Defective wiring</li> <li>● Insufficient battery charge</li> </ul>	<ul style="list-style-type: none"> <li>● Check, repair</li> <li>● Charge</li> </ul>
Pinion of starting motor keeps going in and out	<ul style="list-style-type: none"> <li>● Insufficient battery charge</li> </ul>	<ul style="list-style-type: none"> <li>● Charge</li> </ul>
Starting motor turns engine sluggishly	<ul style="list-style-type: none"> <li>● Insufficient battery charge</li> <li>● Defective starting motor</li> </ul>	<ul style="list-style-type: none"> <li>● Charge</li> <li>● Replace</li> </ul>
Starting motor disengages before engine starts	<ul style="list-style-type: none"> <li>● Defective wiring</li> <li>● Insufficient battery charge</li> </ul>	<ul style="list-style-type: none"> <li>● (Check, repair)</li> <li>● Charge</li> </ul>
Oil pressure monitor lamp does not light up when engine is stopped (starting switch at ON position)	<ul style="list-style-type: none"> <li>● Defective monitor lamp</li> <li>● Defective wiring</li> <li>● Defective sensor</li> </ul>	<ul style="list-style-type: none"> <li>● Replace</li> <li>● Replace</li> <li>● Check, repair</li> </ul>
Preheating monitor lamp does not light up	<ul style="list-style-type: none"> <li>● Defective wiring</li> <li>● Defective timer</li> <li>● Defective monitor lamp</li> <li>● Disconnection in electrical intake air heater</li> </ul>	<ul style="list-style-type: none"> <li>● Check, repair</li> <li>● Replace</li> <li>● Replace</li> <li>● Replace</li> </ul>
Outside of electrical intake air heater is not warm when touched by hand	<ul style="list-style-type: none"> <li>● Defective wiring</li> <li>● Disconnection in electrical intake air heater</li> <li>● Defective operation of heater relay switch</li> </ul>	<ul style="list-style-type: none"> <li>● Check, repair</li> <li>● Replace</li> <li>● Check, repair heater relay switch</li> </ul>

## 16.4.2 CHASSIS

Problem	Main causes	Remedy
Oil pressure in torque converter fails to rise	<ul style="list-style-type: none"> <li>● Improper tightening of oil pipe, pipe joint, air leaking in or oil leaking out because of damage</li> <li>● Wear, scuffing of gear pump</li> <li>● Insufficient oil in transmission case</li> <li>● Clogged oil filter element strainer in transmission case</li> </ul>	<ul style="list-style-type: none"> <li>(● Check, repair)</li> <li>(● Check, replace)</li> <li>● Add oil to the specified level. For details, see CHECK BEFORE STARTING</li> <li>● Clean. For details, see EVERY 1000 HOURS SERVICE</li> </ul>
Torque converter is overheats	<ul style="list-style-type: none"> <li>● Clogged radiator</li> <li>● Clogged oil cooler</li> <li>● Oil pressure too low</li> <li>● Lack of flow of lubricant caused by wear of power train gear pump</li> <li>● Lack of flow of lubricant caused by wear of fan pump motor</li> </ul>	<ul style="list-style-type: none"> <li>(● Clean or replace)</li> <li>(● Clean or replace)</li> <li>● Go to "Oil pressure in torque converter fails to rise"</li> <li>(● Replace gear pump)</li> <li>(● Replace fan pump motor)</li> </ul>
Torque converter oil temperature gauge does not work	<ul style="list-style-type: none"> <li>● Defective oil temperature gauge</li> <li>● Defective contact in wiring connection</li> </ul>	<ul style="list-style-type: none"> <li>(● Replace oil temperature gauge)</li> <li>(● Check, repair)</li> </ul>
Lacks drawbar pull (machine does not pick up speed)	<ul style="list-style-type: none"> <li>● Lack of engine horsepower</li> <li>● Oil pressure in torque converter is too low</li> <li>● Steering clutch is slipping</li> </ul>	<ul style="list-style-type: none"> <li>● See Engine related parts</li> <li>● Go to "Oil pressure in torque converter fails to rise"</li> <li>(● Check, repair)</li> </ul>
Machine doesn't start by engaging the gear shift lever	<ul style="list-style-type: none"> <li>● Lack of oil in steering clutch case</li> <li>● Transmission oil pressure does not rise</li> <li>● Steering clutch slips <ul style="list-style-type: none"> <li>○ Wear, scuffing of gear pump</li> <li>○ Clogged oil strainer element in steering clutch case</li> </ul> </li> </ul>	<ul style="list-style-type: none"> <li>● Add oil to the specified level. For details, see CHECK BEFORE STARTING</li> <li>● Go to "Oil pressure in torque converter fails to rise"</li> <li>(● Check, replace)</li> <li>○ Clean. For details, see EVERY 1000 HOURS SERVICE</li> </ul>
When steering lever on one side is pulled, machine continues to travel straight forward instead of turning	<ul style="list-style-type: none"> <li>● Brake is not applied on side which is pulled</li> </ul>	<ul style="list-style-type: none"> <li>(● Adjust linkage)</li> <li>(● Check brake pressure)</li> </ul>
Machine doesn't stop when brake pedal are depressed	<ul style="list-style-type: none"> <li>● Defective brake adjustment</li> </ul>	<ul style="list-style-type: none"> <li>(● Adjust linkage)</li> <li>(● Check brake pressure)</li> </ul>
Track comes off	<ul style="list-style-type: none"> <li>● Track is too loose</li> </ul>	<ul style="list-style-type: none"> <li>● Adjust track tension. For details, see WHEN REQUIRED.</li> </ul>
Sprocket develops abnormal wear	<ul style="list-style-type: none"> <li>● Track is too loose or too tight</li> </ul>	<ul style="list-style-type: none"> <li>● Adjust track tension. For details, see WHEN REQUIRED.</li> </ul>
Brake rises too slowly or does not rise at all (or blade tilts too slowly)	<ul style="list-style-type: none"> <li>● Lack of hydraulic oil</li> </ul>	<ul style="list-style-type: none"> <li>● Add oil to specified level. For details, see EVERY 250 HOURS SERVICE</li> </ul>
Ripper moves too slowly	<ul style="list-style-type: none"> <li>● Lack of hydraulic oil</li> </ul>	<ul style="list-style-type: none"> <li>● Add oil to specified level. For details, see EVERY 250 HOURS SERVICE</li> </ul>
Insufficient force of ripper	<ul style="list-style-type: none"> <li>● Leakage from piping</li> </ul>	<ul style="list-style-type: none"> <li>(● Tighten)</li> </ul>

16.4.3 ENGINE

Problem	Main causes	Remedy
Engine oil pressure monitor remains alight	<ul style="list-style-type: none"> <li>● Engine oil pan oil level is low (sucking in air)</li> <li>● Clogged oil filter cartridge</li> <li>● Defective tightening of oil pipe joint, oil leakage from damaged part</li> <li>● Defective caution lamp</li> </ul>	<ul style="list-style-type: none"> <li>● Add oil to specified level, see CHECK BEFORE STARTING</li> <li>● Replace cartridge, see EVERY 250 HOURS SERVICE</li> <li>(● Check, repair)</li> <li>(● Replace lamp)</li> </ul>
Steam is emitted from top part of radiator (pressure valve)	<ul style="list-style-type: none"> <li>● Cooling water level low, water leakage</li> <li>● Dirt or scale accumulated in cooling system</li> <li>● Clogged radiator fin or damaged fin</li> <li>● Defective thermostat</li> </ul>	<ul style="list-style-type: none"> <li>● Add cooling water, repair, see CHECK BEFORE STARTING</li> <li>● Change cooling water, clean inside of cooling system, see WHEN REQUIRED</li> <li>● Clean or repair, see WHEN REQUIRED</li> <li>(● Replace thermostat)</li> </ul>
Engine water temperature monitor remains alight	<ul style="list-style-type: none"> <li>● Loose radiator filler cap (high altitude operation)</li> <li>● Defective fan pump motor</li> <li>● Defective fan Lo-Hi selector switch</li> <li>● Defective water temperature monitor</li> </ul>	<ul style="list-style-type: none"> <li>● Tighten cap or replace packing</li> <li>(● Replace)</li> <li>(● Replace)</li> <li>(● Replace)</li> </ul>
Engine does not start when starting motor is turned	<ul style="list-style-type: none"> <li>● Lack of fuel</li> <li>● Air in fuel system</li> <li>● Defective fuel injection pump or nozzle</li> <li>● Starting motor cranks engine sluggishly</li> <li>● Defective compression                             <ul style="list-style-type: none"> <li>○ Defective valve clearance</li> </ul> </li> </ul>	<ul style="list-style-type: none"> <li>● Add fuel, see CHECK BEFORE STARTING</li> <li>● Repair place where air is sucked in</li> <li>(● Replace pump or nozzle)</li> <li>● See ELECTRICAL SYSTEM</li> <li>(○ Adjust valve clearance)</li> </ul>
Exhaust gas is white or blue	<ul style="list-style-type: none"> <li>● Too much oil in oil pan</li> <li>● Improper fuel</li> </ul>	<ul style="list-style-type: none"> <li>● Add oil to specified level, see CHECK BEFORE STARTING</li> <li>● Change to specified fuel</li> </ul>
Exhaust gas occasionally turns black	<ul style="list-style-type: none"> <li>● Clogged air cleaner element</li> <li>● Defective nozzle</li> <li>● Defective compression</li> <li>● Defective turbocharger</li> </ul>	<ul style="list-style-type: none"> <li>● Clean or replace, see WHEN REQUIRED</li> <li>(● Replace nozzle)</li> <li>(● Adjust valve clearance)</li> <li>(● Clean or replace turbocharger)</li> </ul>
Combustion noise occasionally makes breathing sound	<ul style="list-style-type: none"> <li>● Defective nozzle</li> </ul>	<ul style="list-style-type: none"> <li>(● Replace nozzle)</li> </ul>
Abnormal noise generated (combustion or mechanical)	<ul style="list-style-type: none"> <li>● Low grade fuel being used</li> <li>● Overheating</li> <li>● Damage inside muffler</li> <li>● Excessive valve clearance</li> </ul>	<ul style="list-style-type: none"> <li>● Change to specified fuel</li> <li>● See item "Indicator of water temperature gauge is in red range on right side of gauge".</li> <li>(● Replace muffler)</li> <li>(● Adjust valve clearance)</li> </ul>



# **MAINTENANCE**

## **17. GUIDES TO MAINTENANCE**

---

Do not carry out any inspection and maintenance operation that is not given in this manual.

Perform maintenance work on hard, flat ground.

### **Check service meter**

Check the service meter reading every day to see if the time has come for any necessary maintenance to be carried out.

### **Komatsu genuine replacement parts:**

Use Komatsu genuine parts specified in the parts list as replacement parts.

### **Komatsu genuine oils:**

Use Komatsu genuine oils and grease. Choose oils and grease with proper viscosities specified for ambient temperature.

### **Always use clean washer fluid:**

Use automobile window washer fluid and be careful not to let any dirt get into it.

### **Clean oil and grease:**

Use clean oil and grease. Also, keep containers of the oil and grease clean. Keep foreign materials away from oil and grease.

### **Keeping the machine clean:**

Always keep the machine clean. This makes it easier to find parts causing problems. Keep in particular grease fittings, breathers and oil level gauges clean and avoid foreign matters from getting in them.

### **Be careful of hot water and oil:**

Draining hot oils and coolants and removing their filters immediately after the engine stops are hazardous. Allow the engine to cool.

If the oil has to be drained when it is cold, warm up the oil to a suitable temperature (approx. 20 – 40°C) before draining it.

### **Checking foreign materials in drained oil:**

After oil is changed or filters are replaced, check the oil and filters for metallic particles and foreign materials. If large quantities of metallic particles or foreign materials are found, consult your Komatsu distributor.

### **Fuel strainer:**

If your machine is equipped with a fuel strainer, do not remove it while fueling.

### **Oil change:**

Check or change oils in the places where dust is scarce to keep foreign materials away from oils.

**Warning tag:**

Attach the warning tag to the starting switch or other appropriate control lever to avoid someone who is not aware of the circumstances from starting the engine.

**Obey precautions:**

During the operation, always obey the precautions on the safety label stuck to the machine.

**Welding instructions:**

- Turn off the engine starting switch.
- Do not apply more than 200 V continuously.
- Connect grounding the cable within 1 m from the area to be welded.
- Avoid seals or bearings from being between the area to be welded and the position of grounding point.

**Fire prevention:**

Use nonflammable cleaner or light oil for cleaning parts. Keep flame or cigarette light away from light oil.

**Clamp faces:**

When O-rings or gaskets are removed, clean the clamp faces and replace the O-rings and gaskets with new ones. Be sure to fit O-rings and gaskets when assembling.

**Objects in your pockets:**

Keep your pockets free of loose objects which can fall out and drop into the machinery; especially when you work on the machinery while bending over it.

**Checking undercarriage:**

When working in rocky areas, check for damage to the undercarriage and for looseness, flaws, wear and damage in bolts and nuts. Loosen the track tension a little when working in such areas.

**Cleaning machine:**

- Do not direct a high-pressure jet directly at the radiator.
- Do not splash water over the electrical equipment.

**Pre- and post-work checks:**

Before starting work in mud, rain, snow or at seashore, check plugs and valves for tightness. Wash the machine immediately after the work to protect components from rusting.

Lubricate components more frequently than usual. Be sure to lubricate work equipment pins daily if they are submerged in water.

**Dusty worksites:**

When working at dusty worksites, do as follows:

- Check the air cleaner for clogging more frequently. Clean the air cleaner at shorter intervals than specified.
- Clean the radiator core frequently to avoid clogging.
- Clean and replace the fuel filter frequently.
- Clean electrical components, especially the starting motor and alternator, to avoid accumulation of dust.

**Avoid mixing oils:**

Never mix oils of different brands. If you have only oil which is a different brand from the one that is used in the machine, do not add it but replace all the oil.

## 18. OUTLINES OF SERVICE

---

- Use Komatsu genuine parts for replacement.
- When changing or adding oil, do not use a different type of oil.
- Unless otherwise specified, the oil and coolant used at the time of shipment from the factory are as shown in the table below.

Item	Kind of fluid
Engine oil pan	SAE 15W-40 API classification CD
Power train oil pan (incl. transmission, torque converter and bevel gear cases) Damper case	SAE 30 API classification CD
Final drive case	SAE 140 API classification CD
Hydraulic tank	SAE 10W API classification CD
Fuel tank	ASTM D975 No. 2 (However, ASTM D975 No. 1 is used for the winter season (October to March))
Radiator	Komatsu Super Coolant (AF-ACL) 41% added to water

### 18.1 OUTLINE OF OIL, FUEL, COOLANT

#### 18.1.1 OIL

- Oil is used in the engine and work equipment under extremely severe conditions (high temperature, high pressure), and it deteriorates with use.  
Always use oil that matches the grade and temperature for use given in the Operation and Maintenance Manual. Even if the oil is not dirty, always replace the oil after the specified interval.
- Oil corresponds to blood in the human body, so always be careful when handling it to prevent any impurities (water, metal particles, dirt, etc.) from getting in.  
The majority of problems with machine are caused by the entry of such impurities.  
Take particular care not to let any impurities get in when storing or adding oil.
- Never mix oils of different grades or brands.
- Always add the specified amount of oil.  
Having too much oil or too little oil are both causes of problems.
- If the oil in the work equipment is not clear, there is probably water or air getting into the circuit.  
In such cases, please contact your Komatsu distributor.
- When changing the oil, always replace the related filters at the same time.
- We recommend you to have an analysis made of the oil periodically to check the condition of the machine. For those who wish to use this service, please contact your Komatsu distributor.

### 18.1.2 FUEL

- The fuel pump is a precision instrument, and if fuel containing water or dirt is used, it cannot work properly.
- Be extremely careful not to let impurities get in when storing or adding fuel.
- Always use the fuel specified in the Operation and Maintenance Manual.  
Fuel may congeal depending on the temperature when it is used (particularly in low temperature below  $-15^{\circ}\text{C}$ ), so it is necessary to change to a fuel that matches the temperature.
- To prevent the moisture in the air from condensing and forming water inside the fuel tank, always fill the fuel tank after completing the day's work.
- Before starting the engine, or when 10 minutes have passed after adding fuel, drain the sediment and water from the fuel tank.
- If the engine runs out of fuel, or if the filters have been replaced, it is necessary to bleed the air from the circuit.

### 18.1.3 COOLANT

- River water contains large amounts of calcium and other impurities, so if it is used, scale will stick to the engine and radiator, and this will cause defective heat exchange and overheating.  
Do not use water that is not suitable for drinking.
- When using anti-freeze, always observe the precautions given in the Operation and Maintenance Manual.
- Komatsu machines are supplied with Komatsu original anti-freeze in the coolant when the machine is shipped.  
This anti-freeze is effective in preventing corrosion of the cooling system.  
The anti-freeze can be used continuously for two years or 4000 hours. Therefore, it can be used as it is even in hot areas.
- Anti-freeze is inflammable, so be extremely careful not to expose it to flame or fire.
- The proportion of anti-freeze to water differs according to the ambient temperature.  
For details of the mixing proportions, see "24.2.1 CLEAN INSIDE OF COOLING SYSTEM".
- If the engine overheats, wait for the engine to cool before adding coolant.
- If the coolant level is low, it will cause overheating and will also cause problems with corrosion from the air in the coolant.

### 18.1.4 GREASE

 **WARNING**

**Do not carry out greasing when the engine is running.**

- Grease is used to prevent twisting and noise at the joints.
- The nipples not included in the maintenance section are nipples for overhaul, so they do not need grease.  
If any part becomes stiff after being used for a long time, add grease.
- Always wipe off all of the old grease that is pushed out when greasing. Be particularly careful to wipe off the old grease in places where sand or dirt sticking in the grease would cause wear of the rotating parts.

### 18.1.5 STORING OIL AND FUEL

- Keep indoors to prevent any water, dirt, or other impurities from getting in.
- When keeping drum cans for a long period, put the drum on its side so that the filler port of the drum can is at the side. (To prevent moisture from being sucked in)  
If drum cans have to be stored outside, cover them with a waterproof sheet or take other measures to protect them.
- To prevent any change in quality during long-term storage, be sure to use in the order of first in \_ first out (use the oldest oil or fuel first).

### 18.1.6 FILTERS

- Filters are extremely important safety parts. They prevent impurities in the fuel and air circuits from entering important equipment and causing problems.  
Replace all filters periodically. For details, see the Operation and Maintenance Manual.  
However, when working in severe conditions, it is necessary to consider replacing the filters at shorter intervals according to the oil and fuel (sulfur content) being used.
- Never try to clean the filters (cartridge type) and use them again. Always replace with new filters.
- When replacing oil filters, check if any metal particles are stuck to the old filter. If any metal particles are found, please contact your Komatsu distributor.
- Do not open packs of spare filters until just before they are to be used.
- Always use Komatsu genuine filters.

## 18.2 RELATING TO ELECTRIC SYSTEM

- If the wiring gets wet or the insulation is damaged, the electric system leaks and this could result in hazardous malfunction of the machine.
- Services relating to the electric system are (1) check of fan belt tension, (2) check of damage or wear in the fan belt and (3) check of battery fluid level.
- Never remove or disassemble any electric components installed in the machine.
- Never install any electric components other than these specified by Komatsu.
- Be careful to keep the electric system free of water when washing the machine or when it rains.
- When working on the seashore, carefully clean the electric system to prevent corrosion.
- Never connect any optional power source to the fuse, starting switch, battery relay, etc.

## 19. WEAR PARTS LIST

Wear parts such as the filter element, cutting edge, etc. are to be replaced at the time of periodic maintenance or before their abrasion limits.

The wear parts should be changed correctly in order to use the machine economically.

For part change, Komatsu genuine parts of excellent quality should be used.

The parts in parentheses are to be replaced at the same time.

Item	Part No.	Part Name	Q'ty	Replacement frequency	
Engine oil filter	600-211-1230	Cartridge	4	Every 250 hours service	
By-pass filter	600-212-1510	Cartridge	2		
Transmission filter	07063-01210 (07000-35117)	Element (O-ring)	1 (1)	Every 500 hours service	
Torque converter filter	07063-01210 (07000-35117)	Element (O-ring)	1 (1)		
Fuel filter	600-311-7110	Cartridge	2		
Corrosion resistor	600-411-1170	Cartridge	2	Every 1000 hours service	
Hydraulic oil filter	07063-01210 (07000-35180) (07000-35195)	Element (O-ring) (O-ring)	2 (2) (2)	Every 2000 hours service	
Air cleaner	6128-81-7042	Element ass'y	2	-	
	600-181-4400	Outer element ass'y	2		
Blade	198-71-31540	Cutting edge	2	-	
	198-71-31550	Cutting edge	2		
	(198-71-21850)	(Bolt)	(26)		
	(198-71-21890)	(Washer)	(26)		
	(198-71-21911)	(Nut)	(26)		
	198-71-31520	End bit (left)	1		
	198-71-31530	End bit (right)	1		
	(198-71-21870)	(Bolt)	(8)		
	(198-71-21860)	(Bolt)	(8)		
	(198-71-21880)	(Boss)	(8)		
(198-71-21890)	(Washer)	(8)			
(198-71-21911)	(Nut)	(16)			
Ripper	Giant	198-78-21330	Protector	1	-
		198-78-21340	Point	1	
		(198-78-21410)	(Pin)	3	

### NOTICE

When handling parts that weight more than 20 kg, remember that they are heavy objects, and take the necessary care.



# 20. USE OF FUEL, COOLANT AND LUBRICANTS ACCORDING TO AMBIENT TEMPERATURE

## PROPER SELECTION OF FUEL, COOLANT AND LUBRICANTS

RESERVOIR	KIND OF FLUID	AMBIENT TEMPERATURE							CAPACITY	
		-4 -20	14 -10	32 0	50 10	68 20	86 30	104°F 40°C	Specified amount	Refill capacity
Engine oil pan	Engine oil							<b>SAE 30</b>	107 ℓ 28.25 US gal 23.54 UK gal	95 ℓ 25.08 US gal 20.9 UK gal
								<b>SAE 10W</b>		
								<b>SAE 10W-30</b>		
								<b>SAE 15W-40</b>		
Power train oil pan (incl. transmission, torque converter and bevel gear cases)								<b>SAE 30</b>	410 ℓ 108.24 US gal 90.2 UK gal	210 ℓ 55.44 US gal 46.2 UK gal
								<b>SAE 10W</b>		
Damper case								<b>SAE 30</b>	2.4 ℓ 0.63 US gal 0.53 UK gal	2.4 ℓ 0.63 US gal 0.53 UK gal
Hydraulic system								<b>SAE 10W</b>	310 ℓ 81.84 US gal 68.2 UK gal	140 ℓ 36.96 US gal 30.8 UK gal
								<b>SAE 10W-30</b>		
							<b>SAE 15W-40</b>			
Final drive case (each)	Gear oil						<b>SAE 30</b>	75 ℓ 19.8 US gal 16.5 UK gal	75 ℓ 19.8 US gal 16.5 UK gal	
							<b>SAE 140</b>			
Fuel tank	Diesel fuel	*						1520 ℓ 401.28 US gal 334.4 UK gal	-	
							<b>ASTM D975 No.2</b>			
Cooling system	Water	<b>Add antifreeze</b>						183 ℓ 48.31 US gal 40.26 UK gal	-	

\* ASTM D975 No. 1

**REMARK**

- When fuel sulphur content is less than 0.5%, change oil in the oil pan every periodic maintenance hours described in this manual.  
Change oil according to the following table if fuel sulphur content is above 0.5%.

Fuel sulphur content	Change interval of oil in engine oil pan
0.5 to 1.0%	1/2 of regular interval
Above 1.0%	1/4 of regular interval

- When starting the engine in an atmospheric temperature of lower than 0°C, be sure to use engine oil of SAE10W, SAE10W-30 and SAE15W-40, even though an atmospheric temperature goes up to 10°C more or less in the day time.
- Use API classification CD as engine oil and if API classification CC, reduce the engine oil change interval to half.
- There is no problem if single grade oil is mixed with multigrade oil (SAE10W-30, 15W-40), but be sure to add single grade oil that matches the temperature in the table.
- We recommend Komatsu genuine oil which has been specifically formulated and approved for use in engine and hydraulic work equipment applications.

Specified capacity: Total amount of oil including oil for components and oil in piping.

Refill capacity: Amount of oil needed to refill system during normal inspection and maintenance.

ASTM: American Society of Testing and Material

SAE: Society of Automotive Engineers

API: American Petroleum Institute

**20. USE OF FUEL, COOLANT AND LUBRICANTS ACCORDING TO AMBIENT TEMPERATURE**

No.	Supplier	Engine Oil [CD or CE] SAE10W, 30, 40 10W30, 15W40 (The 15W40 oil marked * is CE.)	Gear Oil [GL-4 or GL-5] SAE80, 90, 140	Grease [Lithium-Base] NLGI No. 2	Anti-freeze Coolant [Ethylene Glycol Base] Permanent Type
1	KOMATSU	EO10-CD EO30-CD EO10-30CD EO15-40CD	GO90 GO140	G2-LI G2-LI-S	AF-ACL AF-PTL AF-PT (Winter, one season type)
2	AGIP	Diesel sigma S Super diesel multi- grade *Sigma turbo	Rotra MP	GR MU/EP	-
3	AMOCO	*Amoco 300	Multi-purpose gear oil	RYKON premium grease	-
4	ARCO	*Arcofleet S3 plus	Arco HD gear oil	Litholine HEP 2 Arco EP moly D	-
5	BP	Vanellus C3	Gear oil EP Hypogear EP	Energrease LS-EP2	Antifreeze
6	CALTEX	*RPM delo 400 RPM delo 450	Universal thuban Universal thuban EP	Marfak all purpose 2 Ultra-duty grease 2	AF engine coolant
7	CASTROL	*Turbomax *RX super CRD	EP EPX Hypoy Hypoy B Hypoy C	MS3 Spheerol EPL2	Anti-freeze
8	CHEVRON	*Delo 400	Universal gear	Ultra-duty grease 2	-
9	CONOCO	*Fleet motor oil	Universal gear lubricant	Super-sta grease	-
10	ELF	Multiperformance 3C Performance 3C	-	Tranself EP Tranself EP type 2	Glacelf
11	EXXON (ESSO)	Essolube D3 *Essolube XD-3 *Essolube XD-3 Extra *Esso heavy duty Exxon heavy duty	Gear oil GP Gear oil GX	Beacon EP2	All season coolant
12	GULF	Super duty motor oil *Super duty plus	Multi-purpose gear lubricant	Gulfcrown EP2 Gulfcrown EP special	Antifreeze and coolant
13	MOBIL	Delvac 1300 *Delvac super 10W-30, 15W-40	Mobilube GX Mobilube HD	Mobilux EP2 Mobilgrease 77 Mobilgrease special	-

20. USE OF FUEL, COOLANT AND LUBRICANTS ACCORDING TO AMBIENT TEMPERATURE

No.	Supplier	Engine Oil [CD or CE] SAE10W, 30, 40 10W30, 15W40 (The 15W40 oil marked * is CE.)	Gear Oil [GL-4 or GL-5] SAE80, 90, 140	Grease [Lithium-Base] NLGI No. 2	Anti-freeze Coolant [Ethylene Glycol Base] Permanent Type
14	PENNZOIL	*Supreme duty fleet motor oil	Multi-purpose 4092 Multi-purpose 4140	Multi-purpose white grease 705 707L White – bearing grease	Anti-freeze and summer coolant
15	PETROFINA	FINA kappa TD	FINA potonic N FINA potonic NE	FINA marson EPL2	FINA tamidor
16	SHELL	Rimula X	Spirax EP Spirax heavy duty	Alvania EP grease	–
17	SUN	–	Sunoco GL5 gear oil	Sunoco ultra prestige 2EP Sun prestige 742	Sunoco antifreeze and summer coolant
18	TEXACO	*Ursa super plus Ursa premium	Multigear	Multifak EP2 Starplex 2	Code 2055 startex antifreeze coolant
19	TOTAL	Rubia S *Rubia X	Total EP Total transmission TM	Multis EP2	Antigel/antifreeze
20	UNION	*Guardol	MP gear lube LS	Unoba EP	–
21	VEEDOL	*Turbostar *Diesel star MDC	Multigear Multigear B Multigear C	–	Antifreeze

# 21. STANDARD TIGHTENING TORQUES FOR BOLTS AND NUTS

## 21.1 INTRODUCTION OF NECESSARY TOOLS

The following tools are needed when carrying out maintenance.

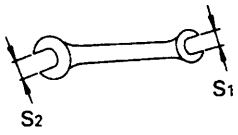
No.	Name of tool	Part No.	Remarks
1	Wrench set	09000-30006	Applicable width across flats ( $S_1 - S_2$ ) 8 mm – 10 mm, 12 mm – 14 mm 13 mm – 17 mm, 19 mm – 22 mm 24 mm – 27 mm, 30 mm – 32 mm
			 AD053370
2	Screwdriver	09033-00190	Interchangeable flat-head and cross-head type
3	Socket wrench set	09020-10284	Applicable width across flats 10 mm, 13 mm 14 mm, 17 mm 19 mm, 22 mm, 24 mm, 27 mm, 30 mm, 32 mm, 36 mm Extension, Handle, Joint
4	Wrench	09002-03641	36 mm – 41 mm
5	Socket	195-98-11590	Applicable wide across flats 41 mm
6	Socket	178-98-11120	Applicable wide across flats 46 mm
7	Plier	09036-00150	
8	Hammer	09039-00150	
9	Bar	09055-10390	
10	Filter wrench	09019-08035	For filter cartridges
11	Grease pump	07952-80002	For greasing work
12	Nozzle	07951-11400	For grease pump
13	Grease cartridge	07950-90403	(Lithium base grease, 400 g)
14	Gauge	09054-00009	

If any of the above tools are broken, please order them from your Komatsu distributor.

When not using the tools, always put them in the tool box on the inside of the battery inspection cover on the left side of the machine.

## 21.2 TORQUE LIST

Unless otherwise specified, tighten the metric bolts and nuts to the torque shown in the table.

The tightening torque is determined by the width across the flats

ⓑ of the nut and bolt.

If it is necessary to replace any nut or bolt, always use a Komatsu genuine part of the same size as the part that was replaced.

Nm (newton meter): 1Nm  $\approx$  0.1 kgm  
 $\approx$  0.74 lbft

Thread diameter of bolt (mm) (a)	Width across flat (mm) (b)	AD054300		
		Nm	kgm	lbft
6	10	13.2 ± 1.4	1.35 ± 0.15	9.73 ± 1.03
8	13	31.4 ± 2.9	3.2 ± 0.3	23.2 ± 2.1
10	17	65.7 ± 6.8	6.7 ± 0.7	48.5 ± 5.0
12	19	112 ± 9.8	11.5 ± 1.0	82.6 ± 7.2
14	22	177 ± 19	18.0 ± 2.0	131 ± 14
16	24	279 ± 29	28.5 ± 3	206 ± 21
18	27	383 ± 39	39 ± 3	282 ± 29
20	30	549 ± 58	56 ± 6	405 ± 43
22	32	745 ± 78	76 ± 8	549 ± 58
24	36	927 ± 98	94.5 ± 10	684 ± 72
27	41	1320 ± 140	135 ± 15	973 ± 100
30	46	1720 ± 190	175 ± 20	1270 ± 140
33	50	2210 ± 240	225 ± 25	1630 ± 180
36	55	2750 ± 290	280 ± 30	2030 ± 210
39	60	3280 ± 340	335 ± 35	2420 ± 250

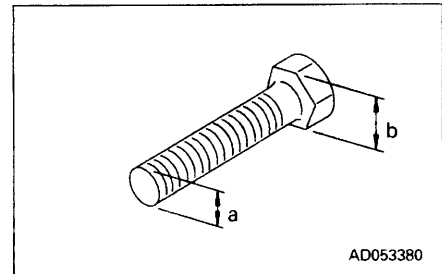

### NOTICE

When tightening panels or other parts having tightening fixtures made of plastic, be careful not to use excessive tightening torque: doing so will damage the plastic parts.

## **22. PERIODIC REPLACEMENT OF SAFETY CRITICAL PARTS**

To ensure safety at all times when operating or driving the machine, the user of the machine must always carry out periodic maintenance. In addition, to further improve safety, the user should also carry out periodic replacement of the parts given in the table. These parts are particularly closely connected to safety and fire prevention.

With these parts, the material changes as time passed, or they easily wear or deteriorate. However, it is difficult to judge the condition of the parts simply by periodic maintenance, so they should always be replaced after a fixed time has passed, regardless of their condition. This is necessary to ensure that they always maintain their function completely.

However, if these parts show any abnormality before the replacement interval has passed, they should be repaired or replaced immediately.

If the hose clamps show any deterioration, such as deformation or cracking, replace the clamps at the same as the hoses.

When replacing the hoses, always replace the O-rings, gaskets, and other such parts at the same time.

Ask your Komatsu distributor to replace the critical parts.

22. PERIODIC REPLACEMENT OF SAFETY CRITICAL PARTS

**SAFETY CRITICAL PARTS**

No.	Safety critical parts for periodic replacement	Q'ty	Replacement interval
1	Fuel hose (fuel filter – injection pump)	4	Every 2 years or 4000 hours, whichever comes sooner
2	Fuel return hose (between nozzles)	4	
3	Turbocharger lubricating hose	2	
4	Fuel hose (fuel strainer – left side feed pump)	1	
5	Fuel hose (fuel strainer – right side feed pump)	1	
6	Fuel hose (left side feed pump – fuel return hose)	1	
7	Fuel hose (right side feed pump – fuel return hose)	1	
8	Fuel hose (fuel tank – fuel strainer)	3	
9	Fuel return hose	2	
10	Hose (fan pump – fan motor)	2	
11	Hose (fan oil cooler – hydraulic tank)	2	
12	Hose (fan motor drain – hydraulic tank)	1	
13	Hose (torque converter outlet – torque converter oil cooler)	2	
14	Hose (torque converter oil cooler – steering case)	2	
15	Inspection hose assembly for power train pressure	1	
16	Hose (blade valve – blade cylinder)	4	
17	Hose (ripper low valve – centralized block)	4	
18	Hose (centralized block – ripper high valve)	4	
19	Hose (ripper high valve – work equipment pump)	1	
20	Hose (ripper high valve – ripper lift cylinder)	4	
21	Hose (ripper high valve – ripper tilt cylinder)	4	



22. PERIODIC REPLACEMENT OF SAFETY CRITICAL PARTS

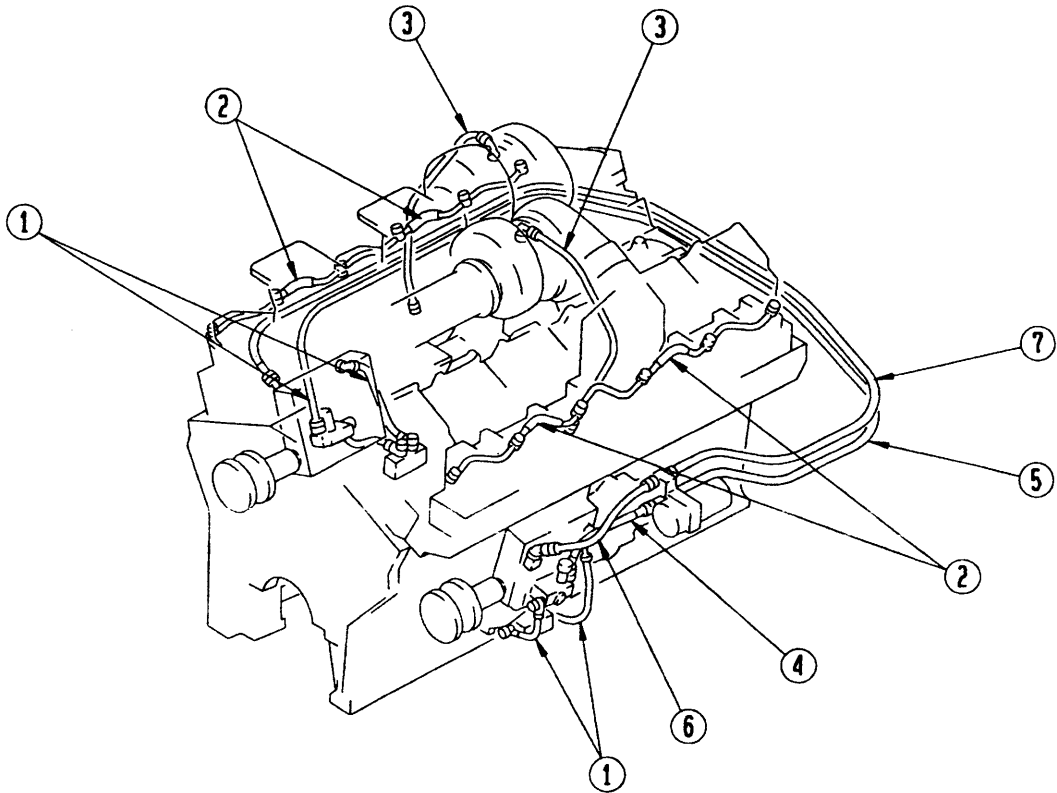

AE105820

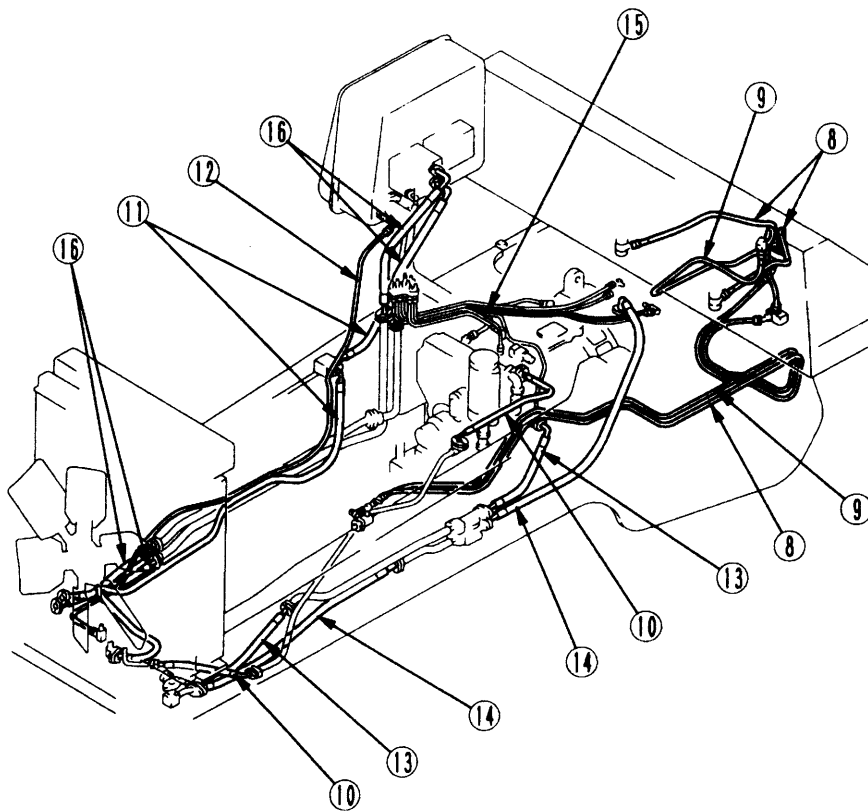

AE105830

22. PERIODIC REPLACEMENT OF SAFETY CRITICAL PARTS

---

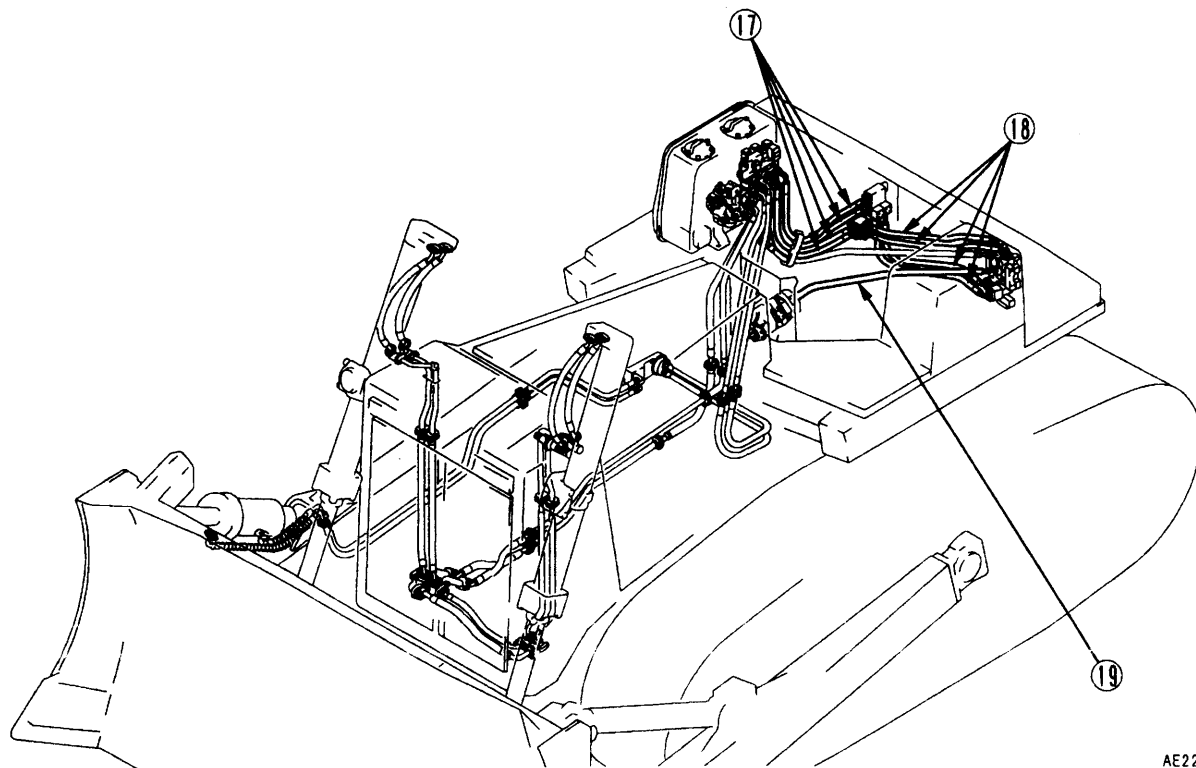

AE224810

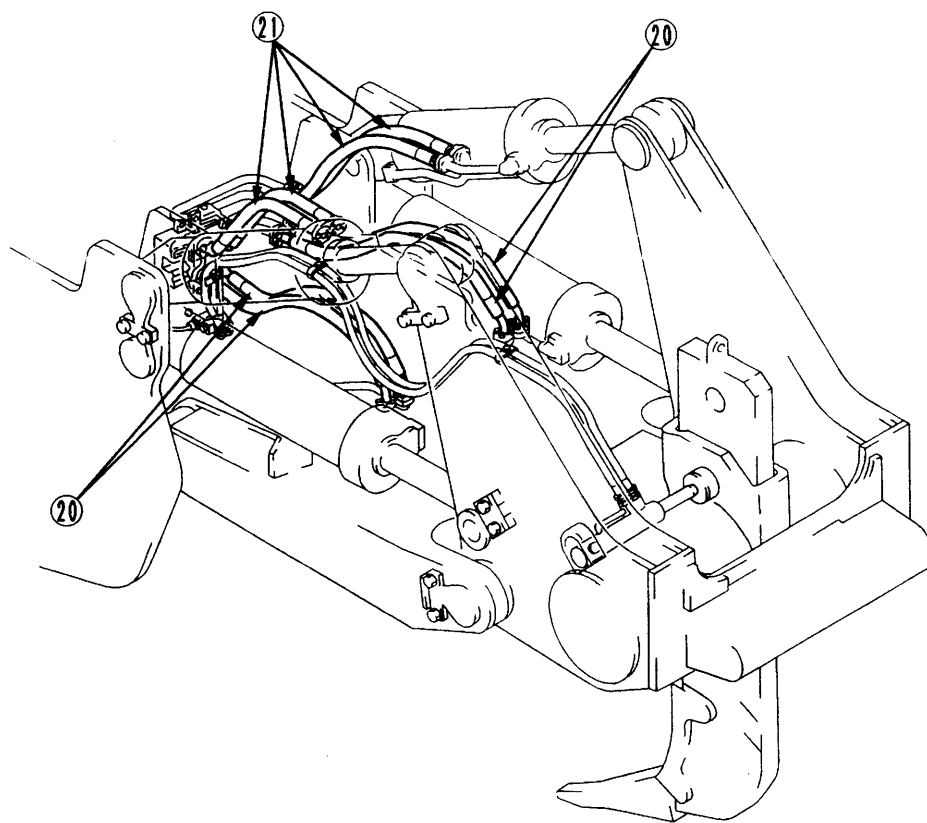

AE224820

## 23. MAINTENANCE SCHEDULE CHART

### 23.1 MAINTENANCE SCHEDULE CHART

SERVICE ITEM	PAGE
<b>INITIAL 250 HOURS SERVICE (only after the first 250 hours)</b>	
Replace fuel filter cartridge	3-55
Replace transmission filter element, transmission lubricating filter element and torque converter oil filter element	3-56
Change oil in power train oil pan, clean strainer (incl. transmission, torque converter and bevel gear cases)	3-57
Change oil hydraulic tank, replace hydraulic filter element	3-61
Change oil in final drive case	3-62
Check engine valve clearance, adjust	3-64
<b>WHEN REQUIRED</b>	
Clean inside of cooling system	3-23
Check, clean and replace air cleaner element	3-27
Check track tension	3-29
Check and tighten track shoe bolts	3-30
Adjust idler clearance	3-31
Reverse and replace the end bits and cutting edges	3-32
Check and clean radiator fin and oil cooler fin	3-34
Clean fuel tank strainer	3-35
Drain water and sediment in fuel tank	3-35
Clean, adjust air conditioner	3-36
Check window washer fluid level, add fluid	3-37
Check electrical intake air heater	3-37
Lubricating	3-38
● Fuel control lever shaft (6 places)	3-38
● Steering brake control lever shaft (8 places)	3-38
● Work equipment control lever shaft (4 places)	3-39
<b>CHECK BEFORE STARTING</b>	
Check machine monitor	3-40
Check coolant level, add water	3-40
Check fuel level, add fuel	3-41
Check oil level in engine oil pan, add oil	3-42
Check oil level in power train (incl. transmission, torque converter and bevel gear cases), add oil	3-43

23. MAINTENANCE SCHEDULE CHART

SERVICE ITEM	PAGE
<b>(CHECK BEFORE STARTING)</b>	
Check damper case oil level, add oil	3-44
Check brake pedal travel	3-44
Check dust indicator	3-45
Check electric wirings	3-45
Check that lamps light up	3-46
Check horn sound	3-46
Check backup alarm sound	3-46
Check seat belt for wear or damage	3-46
<b>EVERY 250 HOURS SERVICE</b>	
Lubricating	3-47
● Equalizer bar side shaft (2 places)	3-47
● Equalizer bar center shaft (1 place)	3-47
● Blade lift cylinder support shaft and yoke (6 places)	3-47
● Tilt cylinder bottom pin (2 places)	3-47
● Lift cylinder bottom pin (2 places)	3-47
● Tilt cylinder rod end pin (2 places)	3-47
● Lift cylinder rod end pin (2 places)	3-47
● Arm pin (front) (2 places)	3-47
● Arm pin (rear) (2 places)	3-47
● Arm ball joint (3 places)	3-48
● Oblique arm ball joint (2 places)	3-48
Change oil in engine oil pan, replace engine oil filter cartridge	3-49
Check oil level in hydraulic tank, add oil	3-51
Check, adjust alternator drive belt tension	3-52
Check level of battery electrolyte	3-53
Check brake performance	3-54

SERVICE ITEM	PAGE
<b>EVERY 500 HOURS SERVICE</b>	
Replace fuel filter cartridge	3-55
Replace transmission filter element, transmission lubricating filter element and torque converter oil filter element	3-56
Check oil level in final drive case, add oil	3-56
<b>EVERY 1000 HOURS SERVICE</b>	
Change oil in power train oil pan, clean strainers (incl. transmission case, torque converter case and bevel gear case)	3-57
Check, clean fuel strainer	3-58
Clean steering clutch case breather	3-59
Check oil level in recoil spring, add oil	3-59
Replace corrosion resistor cartridge	3-60
Check all tightening parts of turbocharger	3-60
<b>EVERY 2000 HOURS SERVICE</b>	
Change oil in hydraulic tank, replace hydraulic oil filter element	3-61
Change oil in final drive case	3-62
Change oil in damper case	3-63
Check pivot bearing oil level, add oil	3-64
Clean, check turbocharger	3-64
Check play of turbocharger rotor	3-64
Check alternator, starting motor	3-64
Check engine valve clearance, adjust	3-64
<b>EVERY 4000 HOURS SERVICE</b>	
Check water pump	3-65
Check vibration damper	3-65
Check, replace injection pump rack rubber boot	3-65

## **24. SERVICE PROCEDURE**

---

### **24.1 INITIAL 250 HOURS SERVICE**

Carry out the following maintenance only after the first 250 hours.

- **REPLACE FUEL FILTER CARTRIDGE**
- **REPLACE TRANSMISSION FILTER ELEMENT, TRANSMISSION LUBRICATING FILTER ELEMENT AND TORQUE CONVERTER OIL FILTER ELEMENT**
- **CHANGE OIL AND CLEAN STRAINER POWER TRAIN OIL PAN (INCL. TRANSMISSION, TORQUE CONVERTER AND BEVEL GEAR CASES)**
- **CHANGE OIL IN HYDRAULIC TANK, REPLACE HYDRAULIC FILTER ELEMENT**
- **CHANGE OIL IN FINAL DRIVE CASE**
- **CHECK ENGINE VALVE CLEARANCE, ADJUST**

For details of the method of replacing or maintaining, see the section on EVERY 500 HOURS, 1000 HOURS AND 2000 HOURS SERVICE.

## 24.2 WHEN REQUIRED

### 24.2.1 CLEAN INSIDE OF COOLING SYSTEM

**⚠ WARNING**

- Soon after the engine has been stopped, the coolant is hot and can cause personal injury. Allow the engine to cool before draining water.
  - Never be under the machine with the engine running. To avoid serious injury, always stop the engine before being under the machine to open the drain valve.
  - Never remove the radiator cap when the engine is at operating temperature. At operating temperature, the coolant is under pressure. Steam blowing up from the radiator could cause personal injury. Allow the engine to cool until the radiator filler cap is cool enough to touch with your hand. Remove the filler cap slowly to relieve pressure.
  - When removing drain plug, avoid pouring coolant on yourself.
  - Antifreeze is flammable, so keep it away from any flame.
- Clean the inside of the cooling system, change the coolant and replace the corrosion resistor according to the table below.

Kind of coolant	Cleaning inside of cooling system and changing coolant	Replacing corrosion resistor
Permanent type antifreeze (All season type)	Every year (autumn) or every 2000 hours whichever comes first	Every 1000 hours and when cleaning the inside of the cooling system and when changing coolant
Non permanent type antifreeze containing ethylene glycol (Winter, one season type)	Every 6 months (spring, autumn) (Drain antifreeze in spring, add antifreeze in autumn)	
When not using antifreeze	Every 6 months or every 1000 hours whichever comes first	

24. SERVICE PROCEDURE

---

- Use a permanent type of antifreeze.  
If, for some reason, it is impossible to use permanent type antifreeze, use an antifreeze containing ethylene glycol.
- Stop the machine on level ground when cleaning or changing the coolant.
- When deciding the ratio of antifreeze to water, check the lowest temperature in the past, and decide from the mixing rate table given below.  
It is actually better to estimate a temperature about 10°C (50°F) lower when deciding the mixing rate.

**Mixing rate of water and antifreeze**

Min. atmospheric temperature	°C	-5	-10	-15	-20	-25	-30
	°F	23	14	5	-4	-13	-22
Amount of antifreeze	ℓ	42.5	55	66	75.5	84.5	91.5
	US gal	11.2	14.5	17.4	19.9	22.3	24.2
	UK gal	9.35	12.1	14.5	16.6	18.6	20.1
Amount of water	ℓ	140.5	128	117	107.5	98.5	91.5
	US gal	37.1	33.8	30.9	28.4	26	24.2
	UK gal	30.9	28.2	25.7	23.7	21.7	20.1

- We recommend use of an antifreeze density gauge to control the mixing proportions.
- Use city water for the cooling water.  
If river water, well water or other such water supply must be used, contact your Komatsu distributor.



1. Stop the engine and tighten valve ① of the corrosion resistor.
2. Turn radiator cap ② slowly and remove it.
3. Set a container to catch the coolant, open drain valve ③ at the bottom of the radiator and drain plugs ④ at the both sides of cylinder block, and drain off the cooling water.

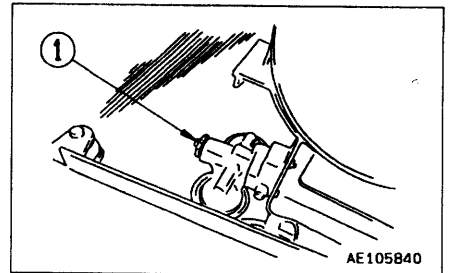

4. After draining, close up drain valve ③ and plugs ④ and pour in clean water (ex. city water) up to the vicinity of the water filler.
5. When the water reaches the vicinity of the water filler, put the engine at low idling, open drain valve ③ and plugs ④, then pass water through the cooling system for 10 minutes.  
When doing this, keep the radiator filled up to the filler with water.  
When filling with water, be careful to check that the hose supplying the water does not come out of the water filler port at the radiator cap.

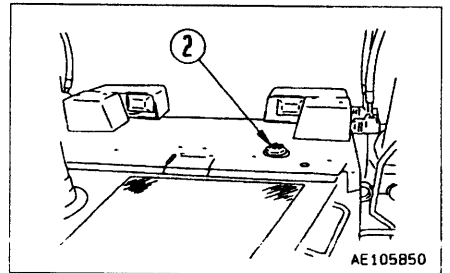

6. After washing the cooling system, stop the engine. Drain water and close drain valve ③ and plugs ④.

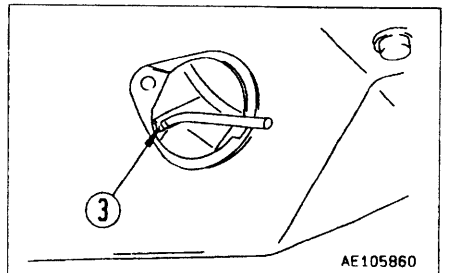

7. After draining the water, flush the system with a flushing agent. For details of the flushing method, see the instructions on the flushing agent.

8. After flushing, open drain valve ③ and drain plugs ④, completely drain all the water, then close the drain valve and drain plug, and fill with city water up to near the filler port.

9. When the tank is filled to near the water filler port, open drain valve ③ and drain plugs ④, start the engine, run at low idling, and continue the flushing operation until clean water comes out.

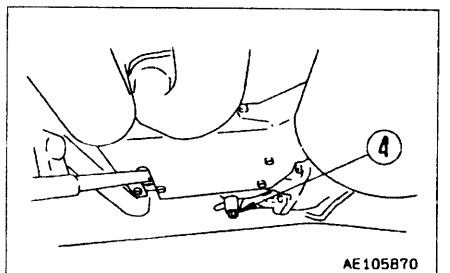

While flushing the radiator, adjust the incoming flow of water to match the drain flow so that the radiator is always kept full during the flushing operation. Be sure that the water supply hose does not slip out of the radiator water filler when flushing.

10. When clean water comes out, stop the engine and close drain valve ③ and drain plug ④.

11. Replace the corrosion resistor and open valve ①.  
For details on the corrosion resistor replacement method, see "24.6 EVERY 1000 HOURS SERVICE".

12. Add city water until the water overflows from the water filler port.

13. To remove the air in the cooling water, run for five minutes at low idling, then for another five minutes at high idling.  
(When doing this, leave the radiator cap off.)

## 24. SERVICE PROCEDURE

---

14. Open the cap of subtank ⑤ and add water, clean the inside of the sub-tank, then fill again with cooling water to a point midway between the FULL and LOW marks.
15. Stop the engine, wait for 3 minutes, add city water until the water level reaches near the water filler port, then tighten the cap ②.

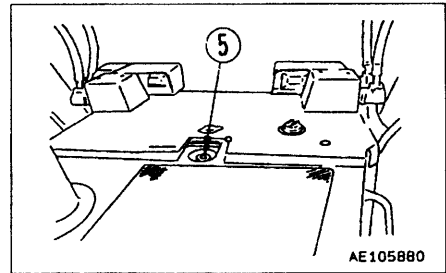

## 24.2.2 CHECK, CLEAN AND REPLACE AIR CLEANER ELEMENT

### WARNING

- Never clean or replace the air cleaner element with the engine running.
- When using pressure air to clean the element wear safety glasses or goggles to protect the eyes.

### CHECK

If the red piston can be seen in transparent portion of dust indicator ①, clean the air cleaner element.

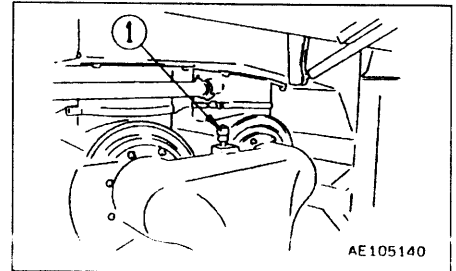

### CLEAN, REPLACE OUTER ELEMENT

1. Loosen wing nut ②, then remove the outer element ③.
2. Clean the air cleaner body interior.

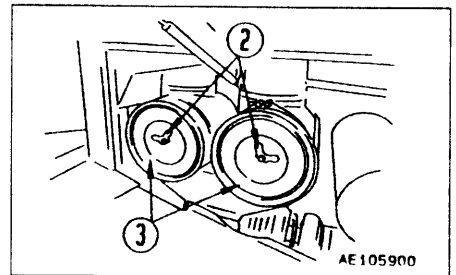

3. Direct dry compressed air (less than 700 kPa (7 kg/cm<sup>2</sup>, 100 psi)) to the element from inside along its folds, then direct it from outside along its folds and again from inside.

- 1) Remove one seal from the outer element. The number of times the outer element has been cleaned can be seen by the number of removed seals.
- 2) Replace the outer element which has been cleaned 6 times repeatedly or used throughout a year. Replace the inner element at the same time.

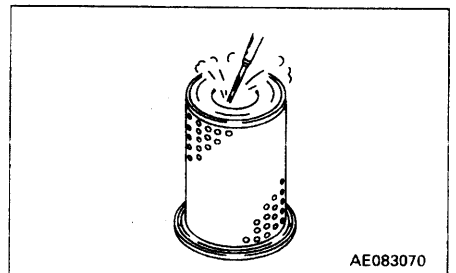

- 3) Replace the element when the air cleaner clogged warning lamp lights up soon after installing the cleaned element even though it has not been cleaned 6 times.
- 4) Check inner element mounting nuts for looseness and, if necessary, retighten.
- 5) Replace seal washer ④ or wing nut ② with new parts if they are broken.

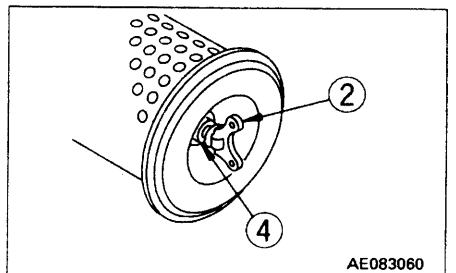

**NOTICE**

If small holes or thinner parts are found on the element when it is checked with an electric bulb after cleaning and drying, replace the element.

Do not use an element whose folds or gasket or seal are damaged.

When cleaning the element, do not hit it or beat it against something.

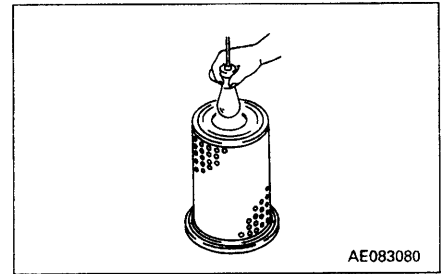

4. Set the cleaned element.
5. Cleaning or replacing for three outer elements should be carried out at the same time.

**REPLACING INNER ELEMENT**

1. First remove the outer element, and then remove the inner element.
2. To prevent dust from getting in, use a clean cloth or tape to cover the air connector (outlet side).
3. Clean the air cleaner body interior, then remove the cover installed in Step 2.
4. Fit a new inner element to the connector and tighten it with nuts. Do not clean and reinstall a inner element.
5. Install the outer element.
6. After replacing the element, press button of the dust indicator to return the red piston to its original position.

### 24.2.3 CHECK TRACK TENSION

The wear of pins and bushings on the undercarriage will vary with the working conditions and soil properties. It is thus necessary to continually inspect the track tension so as to maintain the standard tension.

Carry out the check and adjustment under the same conditions as when operating (on jobsites where the track becomes clogged with mud, measure with the track clogged with mud).

#### INSPECTION

Stop the machine on level ground (stop with the transmission in FORWARD without applying the brake). Then place a straight bar on the track shoes between the carrier roller and the idler as shown in the figure, and measure the clearance between the bar and the grouser at the midpoint. If the clearance is 20 – 30 mm (0.79 – 1.18 in), the tension is standard.

If the track tension is not at the standard value, adjust it in the following manner.

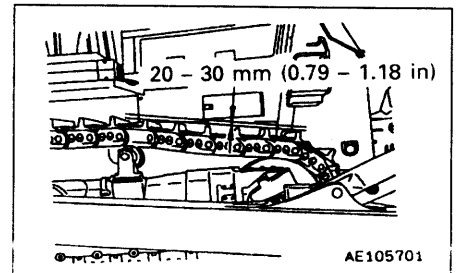

#### ADJUSTMENT

##### **⚠ WARNING**

Grease inside the adjusting mechanism is under high pressure. Grease coming from plug ④ under pressure can penetrate the body causing injury or death. For this reason, do not loosen plug ④ more than one turn. Do not loosen any part other than plug ④. Furthermore, do not bring your face in front of the grease fitting.

If the track tension is not relieved by this procedure, please contact your Komatsu distributor.

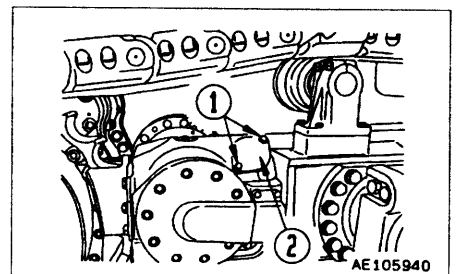

#### ● When increasing tension

1. First remove bolts ①, and then remove cover ②.

#### NOTICE

When removing cover ②, be careful not to let soil get in.

2. Pump in grease through grease fitting ③ with a grease pump.
3. To check that the correct tension has been achieved, move the machine backwards and forwards.
4. Check the track tension again, and if the tension is not correct, adjust it again.
5. Continue to pump in grease until S becomes 772 mm (30.4 in). If the tension is still loose, the pin and bushing are excessively worn, so they must be either turned or replaced. Please contact your Komatsu distributor.

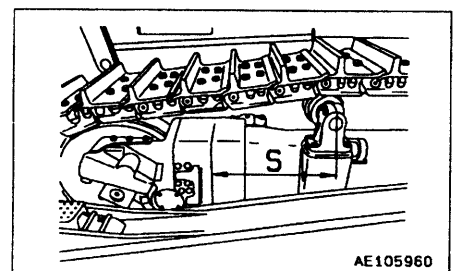
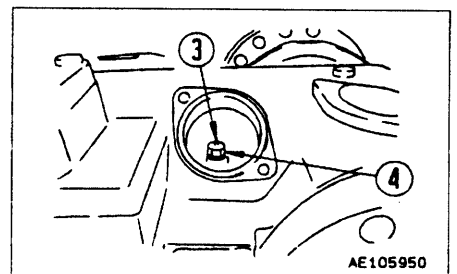

● When loosening tension

**⚠ WARNING**

It is extremely dangerous to release the grease by any method except the procedure given below. If the track tension is not relieved by this procedure, please contact your Komatsu distributor.

1. Loosen plug ④ gradually to release the grease.
2. Turn plug ④ a maximum of one turn.
3. If the grease does not come out smoothly, move the machine backwards and forwards a short distance.
4. Tighten plug ④.
5. To check that the correct tension has been achieved, move the machine backwards and forwards.
6. Check the track tension again, and if the tension is not correct, adjust it again.

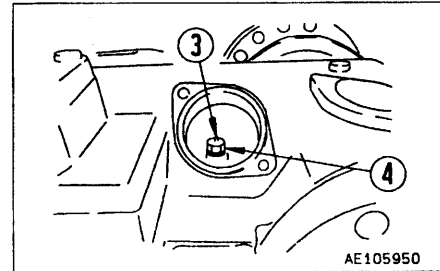

**24.2.4 CHECK AND TIGHTEN TRACK SHOE BOLTS**

If the machine is used with track shoe bolts loose, they will break, so tighten any loose bolts immediately.

● **Method for tightening (shoe bolt)**

1. First tighten to a tightening torque of  $785 \pm 78$  Nm ( $80 \pm 8$  kgm,  $579 \pm 58$  lbft) then check that the nut and shoe are in close contact with the link contact surface.
2. After checking, tighten a further  $180 \pm 10^\circ$ .

● **Method for tightening (master link connecting bolt)**

1. First tighten to a tightening torque of  $785 \pm 78$  Nm ( $80 \pm 8$  kgm,  $579 \pm 58$  lbft) then check that the link contact surfaces are in close contact.
2. After checking, tighten a further  $180 \pm 10^\circ$ .

**Order for tightening**

Tighten the bolts in the order shown in the diagram on the right.

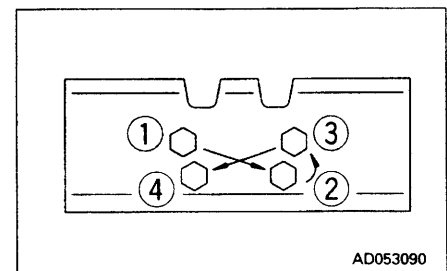

### 24.2.5 ADJUST IDLER CLEARANCE

The idler moves forward and backward under external pressure. When this happens, side guide ① and guide plate ② become worn. As they become worn, there is side play in the idler, or the idler turns at an angle, causing the track to come off or resulting in uneven wear, so adjust as follows.

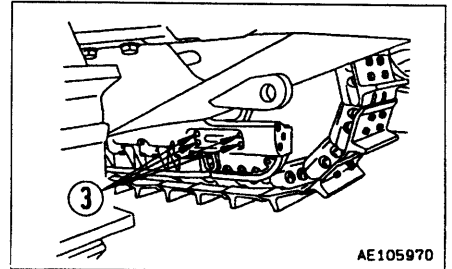

#### Adjustment

1. Drive the machine for 1 – 2 m (3 – 7 ft) on flat ground, then measure clearance A (4 places: left, right, inside, outside) between the track frame and side guide ①.
2. If clearance A is more than 3 mm (0.1 in), remove bolts ③, then take out shim ④, and adjust so that the clearance on one side is less than 0.5 mm (0.02 in).

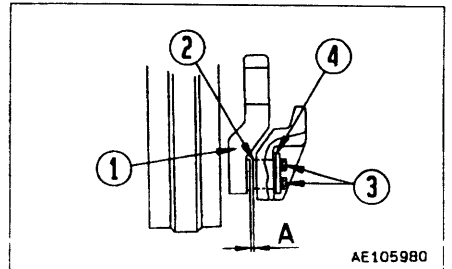

#### REMARK

There are two types of shim (thickness: 0.5 mm (0.02 in) and 1.0 mm (0.04 in)).

### 24.2.6 REVERSE AND REPLACE THE END BITS AND CUTTING EDGES

**⚠ WARNING**

It is dangerous if the work equipment moves by mistake when the cutting edges and end bits are being reversed or replaced. Set the work equipment in a stable condition, then stop the engine and lock the blade control lever securely with the safety lever.

Reverse or replace the end bits and cutting edges before it is worn out to the blade end.

1. Raise the blade to a proper height and apply a block to the frame so as to prevent fall of the blade.
2. Operate the safety lever to the LOCK position.

If the cutting edge and the end bit on both sides are worn out, replace with new one.

If it has been worn out up to the fitting surface, repair the fitting surface and then reverse or replace.

3. Loosen nut ① and remove bolt ②. Then remove the cutting edge and the end bit and clean the mounting surface.

4. Reverse or replace the cutting edge and the end bit when worn out.

If bolt ① and nut ② are damaged, replace them with new ones at the same time.

5. Install the edge to the blade, then tighten partially. Drop the blade three to five times on to the ground or rock to remove any play in bolt ②, then tighten it to the correct tightening torque. When installing end bit ③, put top surface ④ of the end bit in close contact with stopper ⑤, then tighten with the bolts.

Tightening torque:  $3344 \pm 373$  Nm ( $341 \pm 38$  kgm,  $2466 \pm 275$  lbft)

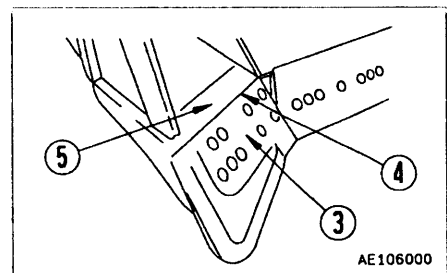
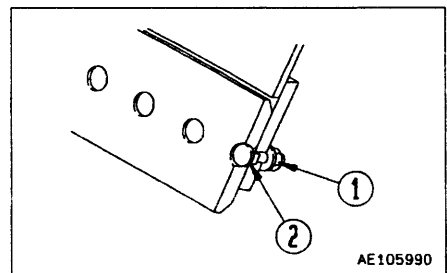

6. After several hours of running, retighten the nuts.

**REMARK**

The tightening operation is easier if the power wrench that has been supplied is used.



When the nut is rusted and is removed by gas cutting, cut on both sides ⑥ of the nut as shown in the diagram.

Be careful not to damage seat surface ⑦.

If it is damaged, repair it. Be careful not to get spatter on the mounting surface.

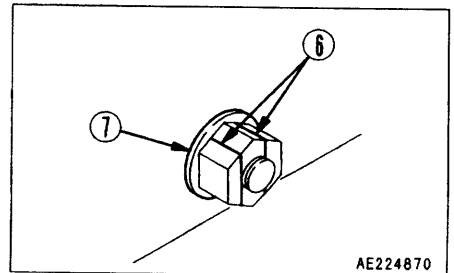

● **Method of using power wrench**

The power wrench set is equipped with a special socket. This socket is designed so that it grips the nut and prevents the wrench set from coming pull out. This means that the tightening operation can be carried out by one worker.

This socket has a double construction, and is designed so that the outside can rotate 30°. It is used as follows.

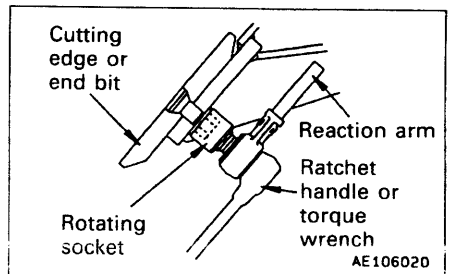

1. Align the hexagons of the inside socket and outside socket, then insert the nut that is to be tightened or loosened.
2. After inserting the nut, turn the outside socket 30° clockwise. When this is done, the outside socket will catch the notch in the nut seat surface, and the wrench will not come off.
3. Put the reaction arm in contact with the blade rib, and tighten or loosen.
4. Turn the outside socket counterclockwise, and remove the wrench.

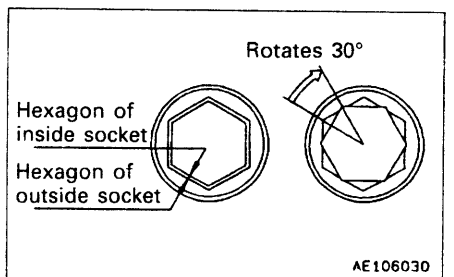

### 24.2.7 CHECK AND CLEAN RADIATOR FIN AND OIL COOLER FIN

**⚠ WARNING**

When carrying out cleaning or inspection, always stop the engine and check that the fan is not rotating before starting.

When the radiator fin and the oil cooler fin block with mud, dirt or leaves, clean it as follows.

1. Open the R.H. and L.H. side cover.
  
2. Loosen bolts ① and open radiator grille ②.

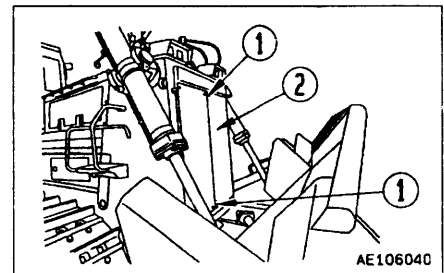

3. Clean the radiator fins clogged with mud, dust and leaves with compressed air. Steam or water may be used instead of compressed air.

**REMARK**

Check the rubber hose. If the hose is found to have cracks to be hardened by ageing, replace such hose with new one. Further, loosen hose clamp should also be checked.

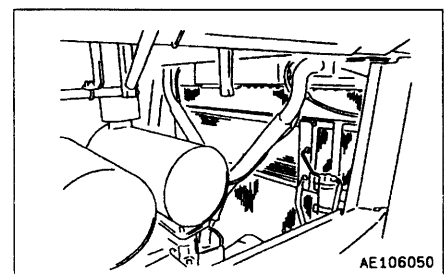

**24.2.8 CLEAN FUEL TANK STRAINER**

Clean the strainer if there is any dirt collected in it.

Remove the filler cap of the fuel tank and take out strainer ①.

If the strainer is dirty, clean it with diesel fuel.

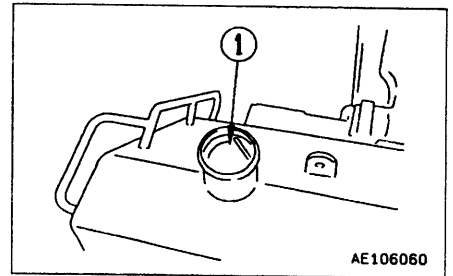
**24.2.9 DRAIN WATER AND SEDIMENT IN FUEL TANK**

Carry out this procedure after the machine has been at rest for a long time and after a long spell of rainy days.

Loosen valve ① at the bottom of the tank and drain sediment accumulated on the bottom together with mixed water and fuel.

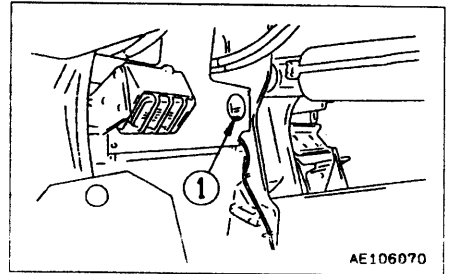

**24.2.10 CHECK, ADJUST AIR CONDITIONER**

**CHECKING TENSION OF COMPRESSOR BELT**

If the belt is loose, it will slip and the cooling effect will be reduced. From time to time, press a point midway between the drive pulley and compressor pulley with your finger (approx. 10 kg (22.05 lb)) and check that the tension is 13 – 17 mm (0.51 – 0.67 in).

When the belt is new, there will be initial elongation, so always adjust again after 2 or 3 days.

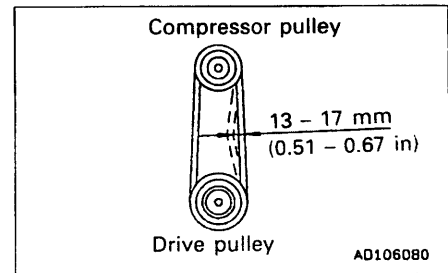

**CHECK LEVEL OF REFRIGERANT (GAS)**

**⚠ WARNING**

The refrigerant used in the cooler is colorless and odorless and does not harm the atmosphere, but if the liquid gets into your eyes or on your hands, it may cause loss of sight or frostbite, so never loosen any part of the refrigerant circuit.

If the level of the refrigerant (gas) is low, the cooling effect will be reduced. Run the engine at high idling, and check the flow of the refrigerant in the refrigerant circuit through the sight glass of the receiver when the cooler is running at high speed.

- No bubbles in refrigerant flow: Correct
- Bubbles in refrigerant flow (bubbles continuously pass through): Refrigerant level low
- Colorless, transparent: No refrigerant

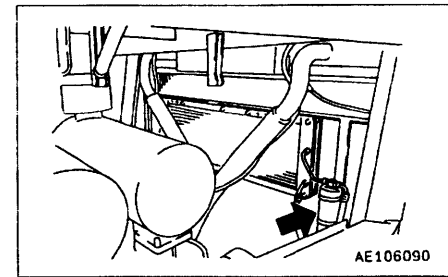

**REMARK**

When there are bubbles, the refrigerant gas level is low, so contact your refrigerant dealer to have refrigerant added. If the air conditioner is run with the refrigerant gas level low, it will cause damage to the compressor.

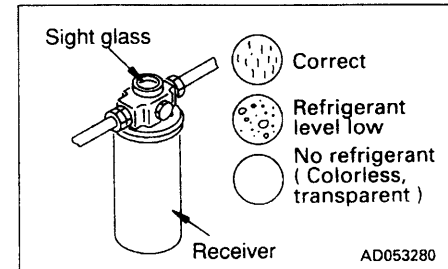

**CLEAN AIR CONDITIONER AIR FILTER**

If the air conditioner air filter is clogged or there is dirt or dust in it, clean the filter.

1. Open inspection cover, push up clip ①, then remove filter ② from the holder.
2. Clean filter ② with compressed air. If there is oil stuck to the filter, or it is extremely dirty, wash it in a neutral agent. After washing it, dry it completely before installing it again.

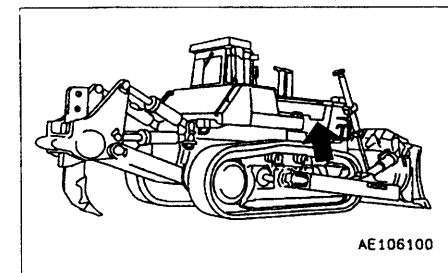

**REMARK**

If the clogging of the filter cannot be removed by washing or using compressed air, replace the filter with a new part.

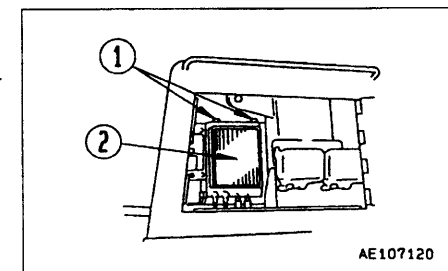

### 24.2.11 CHECK WINDOW WASHER FLUID LEVEL, ADD FLUID

If there is air in the window washer fluid, check the level and add fluid.

Open the engine R.H. side cover, check the level of the fluid in window washer tank ①, and if it is low, add automobile window washer fluid.

When adding fluid, be careful not to let dirt or dust get in.

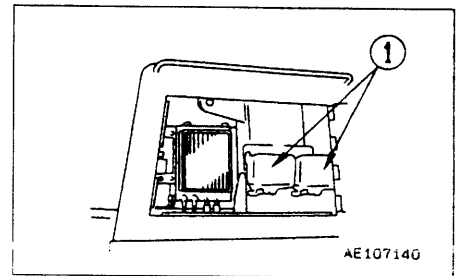
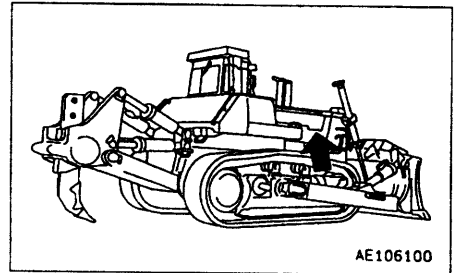

### 24.2.12 CHECK ELECTRIC HEATER

#### Check before starting in cold weather

Remove the electric heater from the engine intake manifold, and check for any disconnections or dirt.

When checking or installing, replace the electric heater gasket with a new part.

### 24.2.13 LUBRICATING

1. Lower the work equipment to the ground, then stop the engine.
2. Using a grease pump, pump in grease through the grease fittings shown by arrows.
3. After greasing, wipe off any old grease that was pushed out.

1. Fuel control lever shaft (6 places)

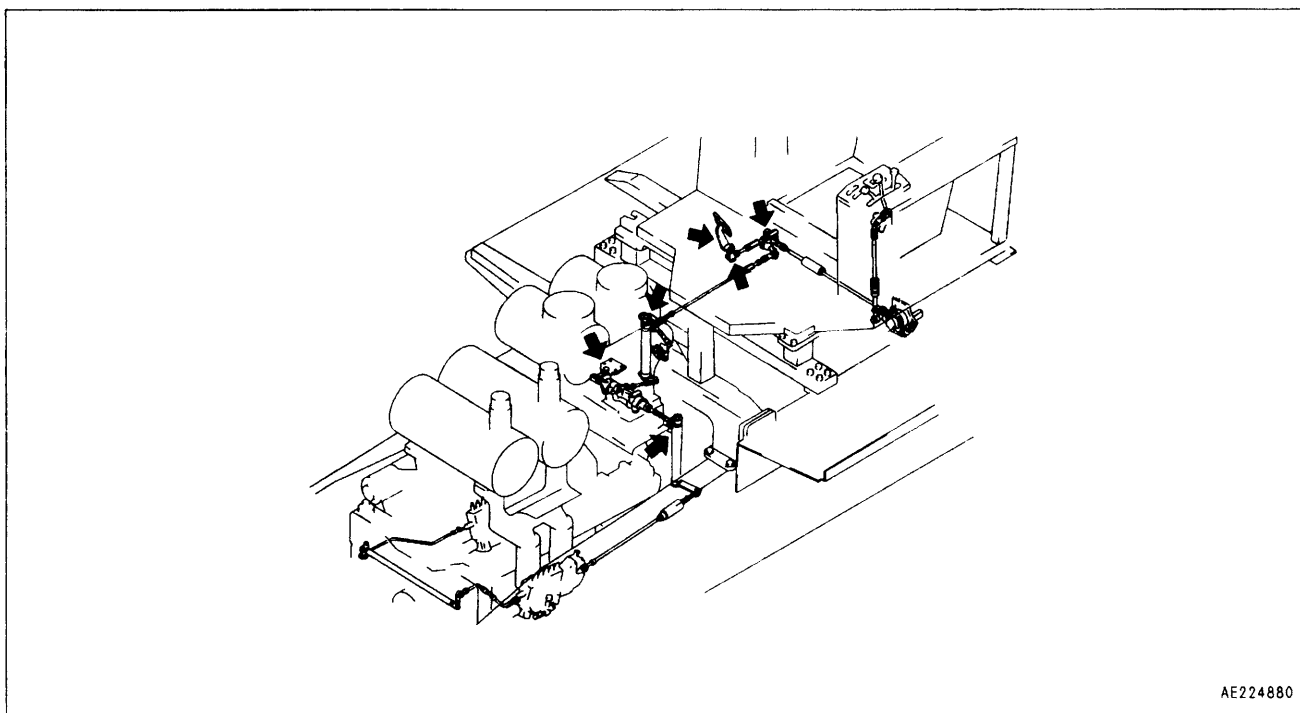

AE224880

2. Steering brake control lever shaft (8 places)

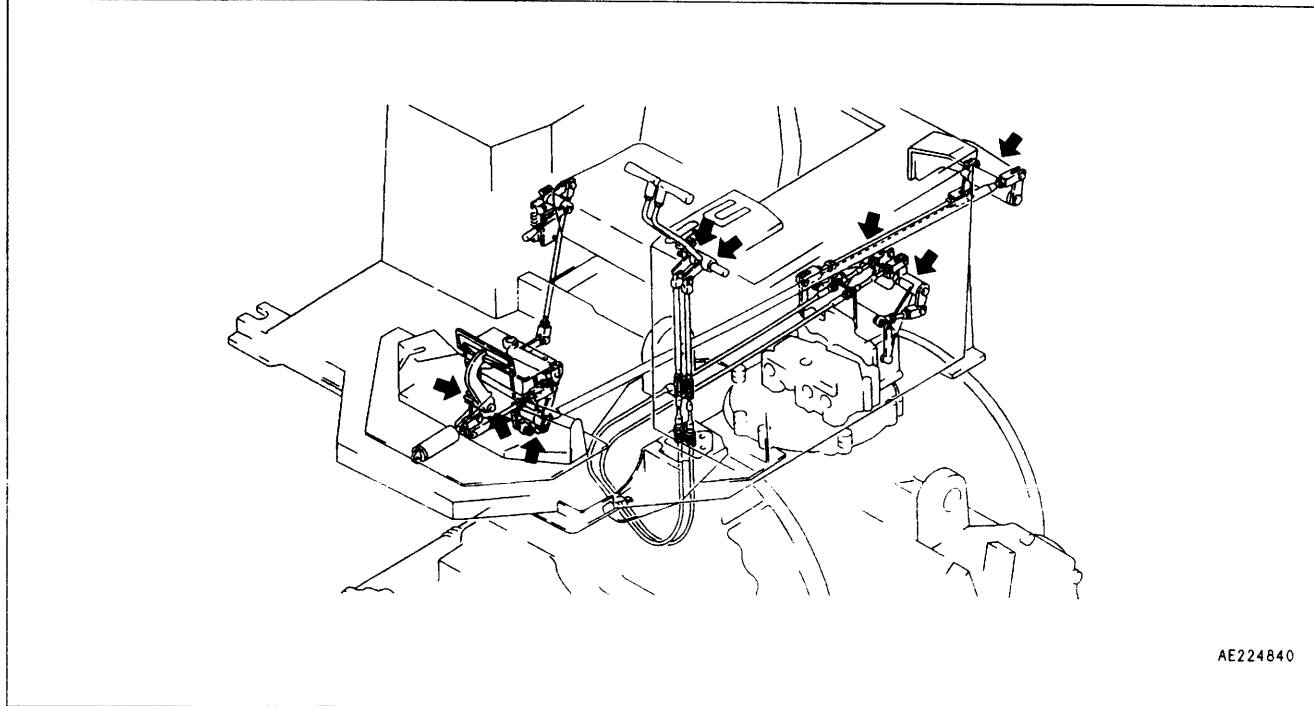

3. Work equipment control lever shaft (4 places)

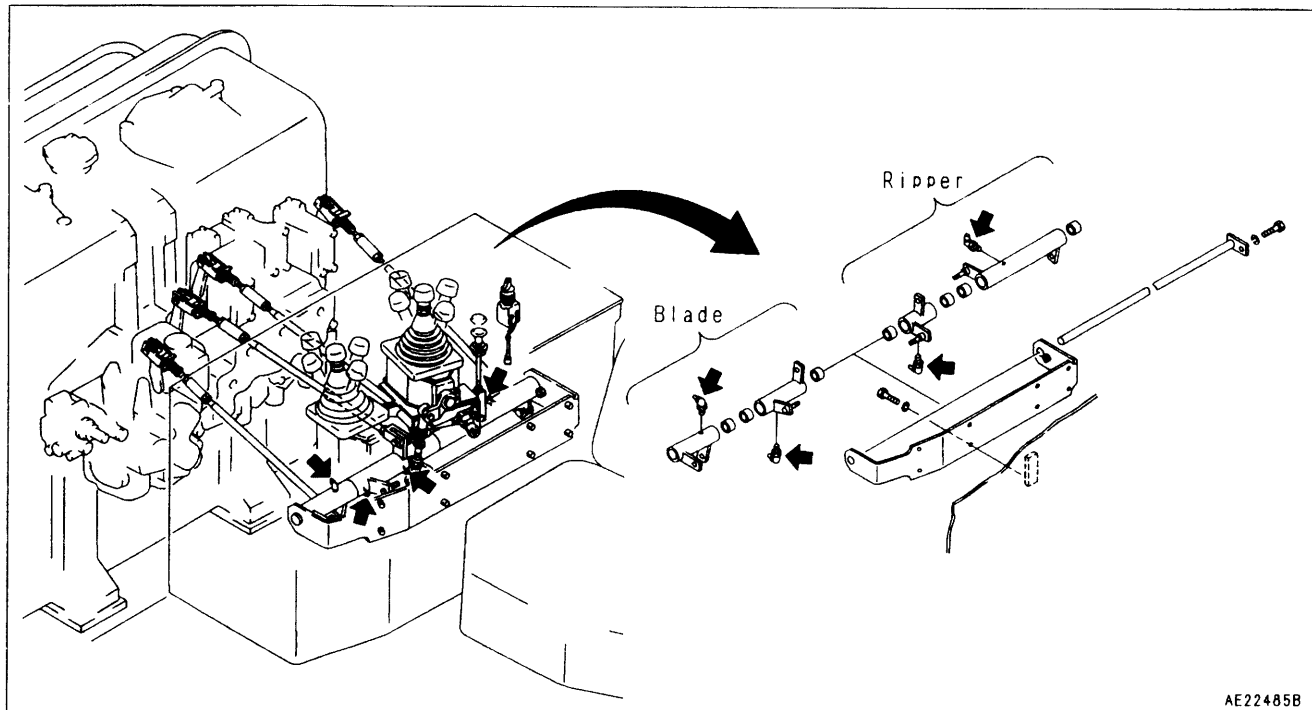

## 24.3 CHECK BEFORE STARTING

### 24.3.1 CHECK MACHINE MONITOR

1. Turn starting switch ① to the ON position.
2. Check that all monitor lamps and gauges light up for 3 seconds and the alarm buzzer sounds for about 2 seconds.

#### REMARK

If the lamps do not light up, there may be a failure or disconnection in the monitor, so please contact your Komatsu distributor.

#### NOTICE

When carrying out the checks before starting, do not rely only on the monitor. Always carry out all the items listed for the following check and maintenance.

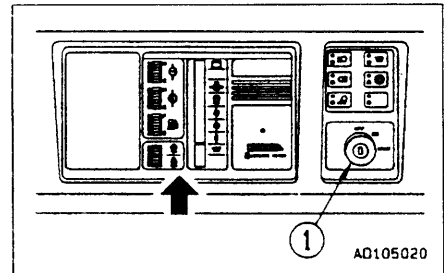

### 24.3.2 CHECK COOLANT LEVEL, ADD WATER

#### ⚠ WARNING

Do not remove cap ①, ② while cooling water is hot. Hot water may spout out.

When removing cap ①, ② wait until the water temperature goes down and release radiator pressure little by little by loosening caps slowly, then remove the cap.

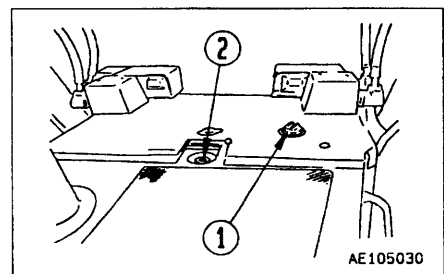

1. Remove radiator cap ① and check that coolant is above the bottom of the strainer as shown in the diagram. If necessary, add water through filler of radiator cap ①.
2. If the water level is low, add water through fillers of both radiator cap ① and subtank cap ②. Add into the subtank up to the level above the bottom of strainer through filler of cap ② as shown in the diagram.
3. To refill the radiator, first stop the engine and pour in water until the water overflows the filler opening. Then, start the engine, check the water level again after a five-minute idling, and add water if necessary.
4. If the volume of coolant added is more than usual, check for possible water leakage.

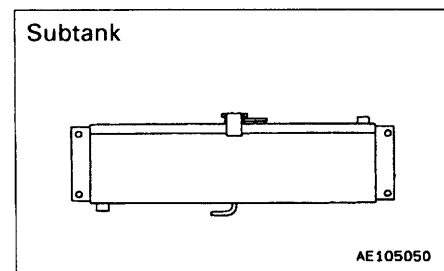
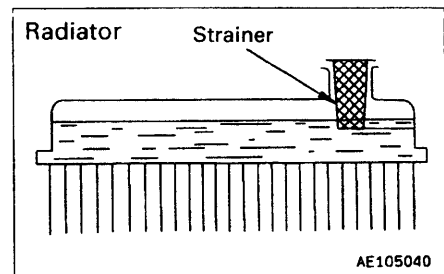



### 24.3.3 CHECK FUEL LEVEL, ADD FUEL

**WARNING**

When adding fuel, never let the fuel overflow. This may cause a fire.

1. Removed the cap and check the fuel level using fuel gauge ⑥.
2. After completing work, fill the fuel tank through oil filler port.

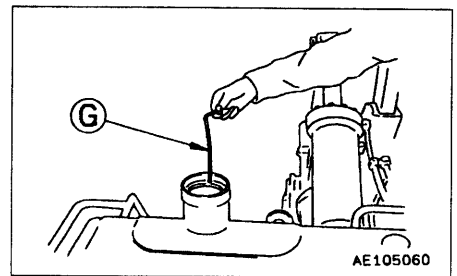

#### NOTICE

For details of the fuel to use, see "20. USE OF FUEL, COOLANT AND LUBRICANTS ACCORDING TO AMBIENT TEMPERATURE".

3. After adding fuel, tighten the cap securely.  
Fuel capacity: 1520 ℓ (401 US gal, 334 UK gal)

#### REMARK

- When dozing on a grade, make sure there is plenty of oil in the tank so that the engine fuel line does not become aerated.
- If breather hole ① on the cap is clogged, the pressure in the tank will drop and fuel will not flow.  
Clean the hole from time to time.

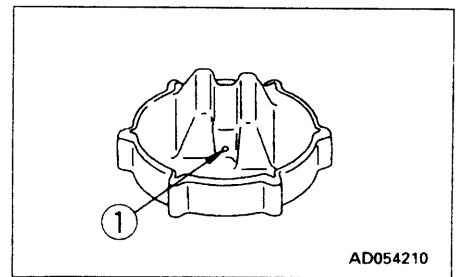

**24.3.4 CHECK OIL LEVEL IN ENGINE OIL PAN, ADD OIL**

1. Open the engine side cover on the right side of the chassis.
2. Remove dipstick **G** and wipe the oil off with a cloth.
3. Insert dipstick **G** fully in the oil filler pipe, then take it out again.

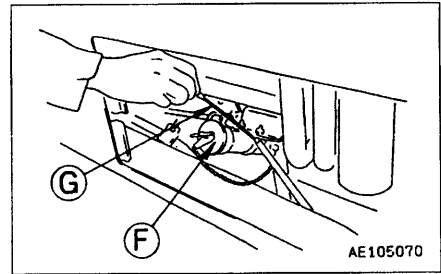

4. The oil level should be between the H and L marks on dipstick **G**.  
If the oil level is below the L mark, add engine oil through oil filler **F**.

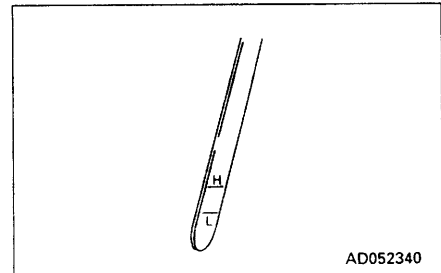

**NOTICE**

For details of the oil to use, see "20. USE OF FUEL, COOLANT AND LUBRICANTS ACCORDING TO AMBIENT TEMPERATURE".

5. If the oil is above the H mark, remove drain plug **1**, loosen drain valve **2** to drain the excess oil, then check the oil level again.
6. If the oil level is correct, tighten the oil filler cap securely and close the engine side cover.

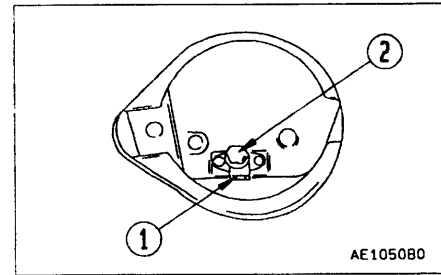

**REMARK**

- Check the oil level with the engine stopped.
- When checking the oil level after the engine has been operated, wait for at least 15 minutes after stopping the engine before checking.
- If the machine is at an angle, make it horizontal before checking.
- When adding oil, remove the dipstick from the holder to release the air inside the crankcase.

### 24.3.5 CHECK OIL LEVEL IN POWER TRAIN CASE (INCL. TRANSMISSION, TORQUE CONVERTER AND BEVEL GEAR CASES), ADD OIL

1. Start the engine and run at idling for 3 – 5 minutes, then check the oil level with the COLD side of dipstick ③.  
Remove dipstick ③, and wipe the oil off with a cloth.
2. Insert dipstick ③ fully in the oil filler pipe, then take it out again.
3. The oil level should be between the H and L marks on dipstick ③.  
If the oil level is below the L mark, add engine oil through oil filler ④.

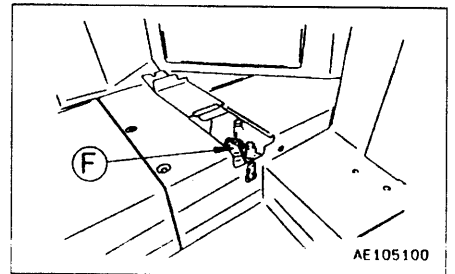
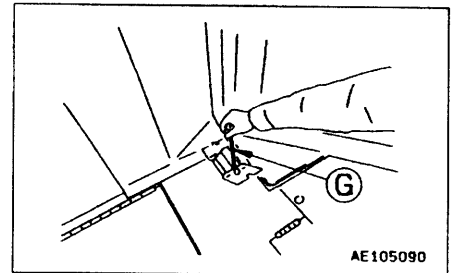

#### NOTICE

For details of the oil to use, see "20. USE OF FUEL, COOLANT AND LUBRICANTS ACCORDING TO AMBIENT TEMPERATURE".

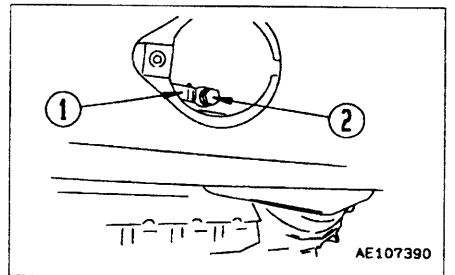

4. If the oil is above the H mark, pull out hose ①, and loosen drain plug ② to drain the excess oil, then check the oil level again.
5. If the oil level is correct, tighten the oil filler cap securely.



#### REMARKS

- If the machine is at an angle, make it horizontal before checking.
- When the engine is stopped, the oil level will rise, so it is impossible to check the oil level correctly. When checking while the engine is running, run the engine at idling and check with the HOT side of dipstick ③.
- When working on a slope of more than 20°, check that the oil is up to the H level.

### 24.3.6 CHECK DAMPER CASE OIL LEVEL, ADD OIL

1. Remove dipstick , and wipe the oil off with a cloth.
2. Insert dipstick  fully into the dipstick holder, then pull it out again.
3. The oil level should be between the H and L marks on dipstick .  
If the oil is below the L mark, add engine oil through the dipstick holder.

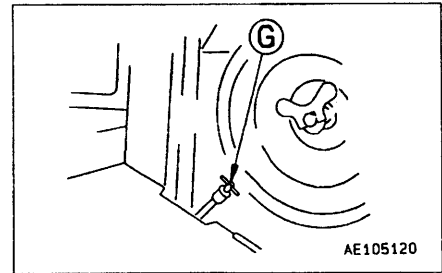

#### NOTICE

For details of the oil to use, see "20. USE OF FUEL, COOLANT AND LUBRICANTS ACCORDING TO AMBIENT TEMPERATURE".

4. If the oil is above the H mark, drain the excess oil from drain plug. After draining the oil, check the oil level again.

#### REMARKS

- Check the oil level with the engine stopped.
- When checking the oil level, if the machine is at an angle, move it to a horizontal position before carrying out the check.

### 24.3.7 CHECK BRAKE PEDAL TRAVEL

1. Depress the brake pedal all the way until it stops.
2. The distance of travel at the center of the pedal (position in the diagram on the right) should be  $100 \pm 5$  mm ( $3.9 \pm 0.2$  in).
3. When this value exceeds the specified range, or the brake fails to work, please contact your Komatsu distributor for adjustment.

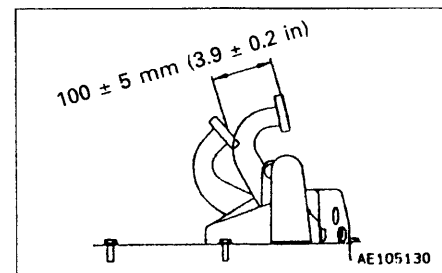

**24.3.8 CHECK DUST INDICATOR**

1. Check that the red piston has not appeared in the transparent portion of dust indicator ①.
2. If the red piston has appeared, clean or replace the element immediately.  
For details of the method of cleaning the element, see "24.2 WHEN REQUIRED".
3. After checking, cleaning, and replacing, press the knob of dust indicator ① to return the red piston to its original position.

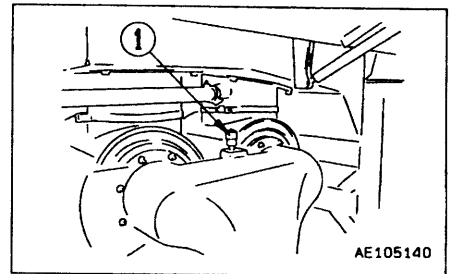

AE105140

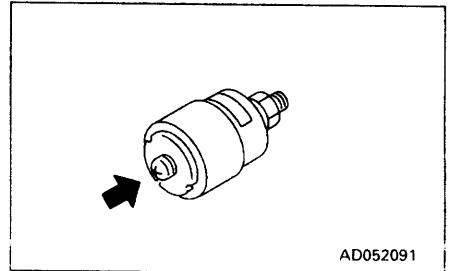

AD052091

**24.3.9 CHECK ELECTRIC WIRINGS****⚠ WARNING**

- If fuses are frequently blown or if there are traces of short circuit on the electrical wiring, locate the cause and carry out repair.
- Accumulation of flammable material (dead leaves, twigs, grass, etc.) around the battery may cause fire, so always check and remove such material.
- Keep the top surface of the battery clean and check the breather hole in the battery cap. If it is clogged with dirt or dust, wash the battery cap to clear the breather hole.

Check for damage and wrong capacity of the fuse and any sign of disconnection or short circuit in the electric wiring. Check also for loose terminals and tighten any loose parts.

Check the wiring of the "battery", "starting motor" and "alternator" carefully, in particular.

When carrying out walk-around checks or checks before starting, always check if there is any accumulation of flammable material around the battery, and remove such flammable material.

Please contact your Komatsu distributor for investigation and correction of the cause.

**24.3.10 CHECK THAT LAMPS LIGHT UP**

Turn the head lamp switch and the rear lamp switch to the ON position and check that the head lamps and rear lamps light up.

If the lamps do not light up, there is probably a broken bulb or disconnection in the wiring, so contact your Komatsu distributor for repairs.

**24.3.11 CHECK HORN SOUND**

**24.3.12 CHECK BACKUP ALARM SOUND**

**24.3.13 CHECK SEAT BELT FOR WEAR OR DAMAGE**

Check the belt and mounting clamps, and if they are worn or damaged, replace the seat belt.

## 24.4 EVERY 250 HOURS SERVICE

### 24.4.1 LUBRICATING

1. Lower the work equipment to the ground, then stop the engine.
2. Using a grease pump, pump in grease through the grease fittings shown by arrows.
3. After greasing, wipe off any old grease that was pushed out.

1. Equalizer bar side shaft (2 places)

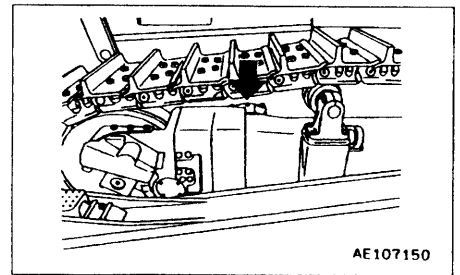

2. Equalizer bar center shaft (1 place)

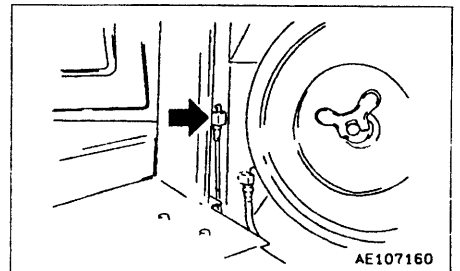

3. Blade lift cylinder support shaft and yoke (6 places)

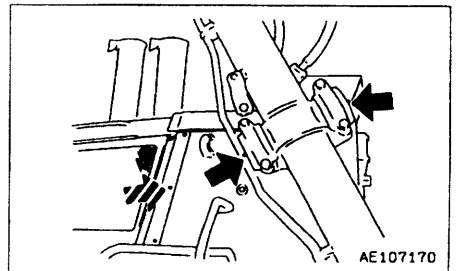

4. Tilt cylinder bottom pin (2 places)
5. Lift cylinder bottom pin (2 places)
6. Tilt cylinder rod end pin (2 places)
7. Lift cylinder rod end pin (2 places)
8. Arm pin (front) (2 places)
9. Arm pin (rear) (2 places)

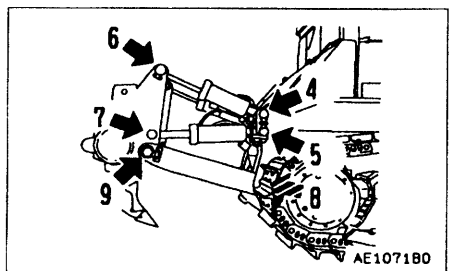

24. SERVICE PROCEDURE

---

- 10. Arm ball joint (3 places)
- 11. Oblique arm ball joint (2 places)

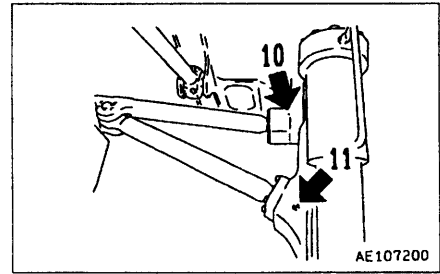
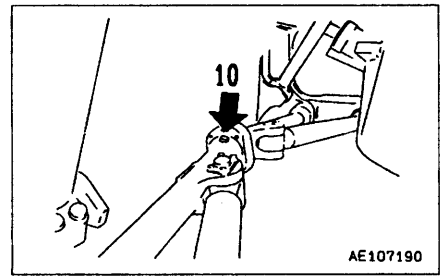



## 24.4.2 CHANGE OIL IN ENGINE OIL PAN, REPLACE ENGINE OIL FILTER CARTRIDGE

### WARNING

The oil is at high temperature after the engine has been operated, so never change the oil immediately after finishing operations. Wait for the oil to cool down before changing it.

Prepare the following.

- Container to catch drained oil: Min. 95 ℓ capacity
- Refill capacity: 95 ℓ (25.08 US gal, 20.9 UK gal)
- Socket wrench, filter wrench.

1. Open cover on the right side under the chassis, and remove the drain valve ①.
2. Loosen drain valve ② slowly to avoid getting oil on yourself, and drain the oil.

Take care not to loosen drain valve ② so much that the stopper pin in the valve is distorted.

Tightening torque drain valve ①:  $69 \pm 10$  Nm  
( $7 \pm 1$  kgm,  $51 \pm 7$  lbft)

Tightening torque drain valve ②:  $64 \pm 15$  Nm  
( $6.5 \pm 1.5$  kgm,  $47 \pm 11$  lbft)

3. Check the drained oil, and if there are excessive metal particles of foreign material, please contact your Komatsu distributor.
4. Fit the hose on the engine hook and tighten drain valve ②.

5. Using a filter wrench, remove full-flow filter cartridge ③ (four) and by-pass filter cartridge ④ (two) by turning it counterclockwise. When doing this, to prevent getting oil on yourself, do not carry out this operation from immediately under the cartridge. In particular, if this operation is carried out immediately after stopping the engine, a large amount of oil will come out, so wait for 10 minutes before starting the operation.
6. Clean the filter holder, fill a new cartridge with clean engine oil and coat the packing surface and thread of the new filter cartridge with engine oil (a thin coat of grease is also possible), then install the cartridge.

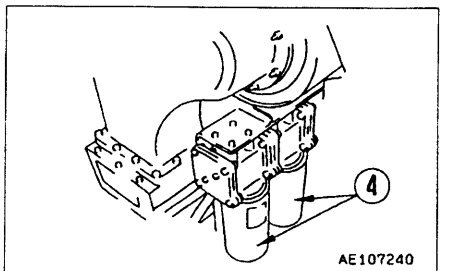
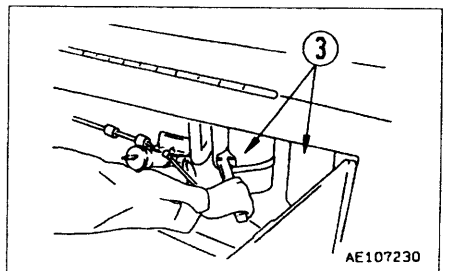
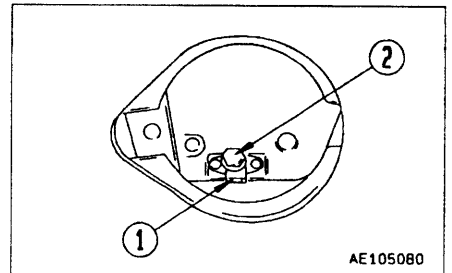
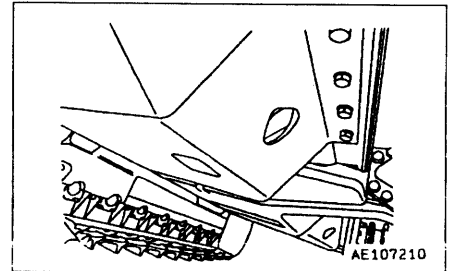

## 24. SERVICE PROCEDURE

---

7. When installing the filter cartridge, bring the packing surface into contact with the filter holder, then tighten a further 3/4 – 1 turn.
8. After replacing the filter cartridge, add engine oil through oil filler  $\text{\textcircled{F}}$  until the oil level is between the H and L marks on the dipstick.

### NOTICE

For details of the oil to use, see "20. USE OF FUEL, COOLANT AND LUBRICANTS ACCORDING TO AMBIENT TEMPERATURE".

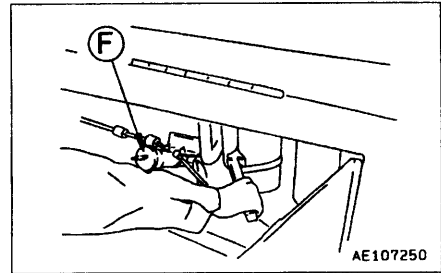

9. Run the engine at idling for a short time, then stop the engine, and check that the oil level is between the H and L marks on the dipstick. For details, see "24.3 CHECK BEFORE STARTING".

### NOTICE

Even if the machine has not been operated for 250 hours, the oil and filter cartridge must be replaced when the machine has been operated for 6 months.

In the same way, even if the machine has not been operated for 6 months, the oil and filter cartridge must be replaced when the machine has been operated for 250 hours.

### 24.4.3 CHECK OIL LEVEL IN HYDRAULIC TANK, ADD OIL

**⚠ WARNING**

- When removing the oil filler cap, oil may spurt out, so stop the engine and wait for the oil temperature to go down, then turn the cap slowly to release the internal pressure before removing the cap.
- If oil has been added to above the mark, stop the engine and wait for the hydraulic oil to cool down, then drain the excess oil from the drain plug.

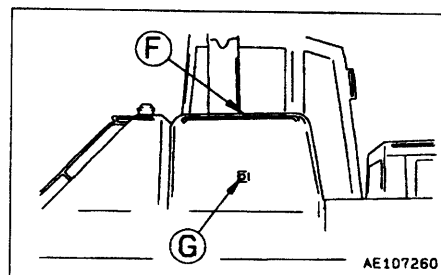

1. Lower the blade to the ground in horizontal position, lower the ripper shank vertically and put the tip of the shank in contact with the ground.
2. Stop the engine and wait for about 5 minutes before checking oil level. If oil level is between top and bottom of red circle sight gauge ③, it is normal.

**NOTICE**

Do not add oil if the level is above the H line. This will damage the hydraulic equipment and cause the oil to spurt out.

3. If the level is below the L mark, add engine oil through oil filler ④.

**NOTICE**

For details of the oil to use, see "20. USE OF FUEL, COOLANT AND LUBRICANTS ACCORDING TO AMBIENT TEMPERATURE".

### 24.4.4 CHECK, ADJUST ALTERNATOR DRIVE BELT TENSION

#### CHECK

The standard deflection for the drive belt is approx. 15 mm (0.59 in) when pressed by thumb (approx. 6 kg (13.23 lb)) at a point midway between the drive pulley and alternator pulley.

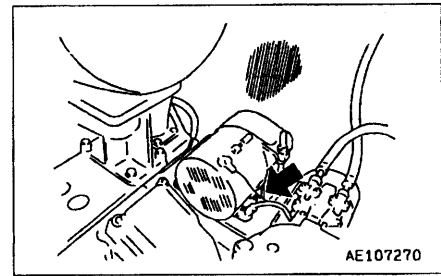

#### ADJUSTING

1. Loosen bolts and nuts ①, ②, and ③.
2. Loosen nut ④ and move alternator ⑤ so that the deflection of the belt is approx. 15 mm (0.6 in) (approx. 6 kg (13 lb)).
3. Tighten bolts and nuts ①, ②, ③, and ④ to secure alternator ⑤ in position.  
When tightening nut ④, hold the bolt on both sides to prevent it from turning together with the nut.

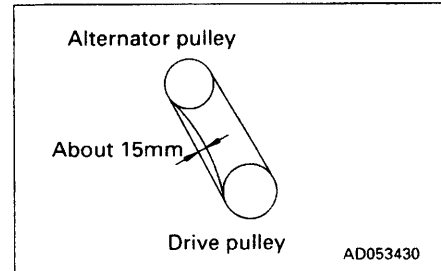

- Check for damage to each pulley, wear of the V-groove, and wear of the V-belt. Check in particular that the V-belt does not contact the bottom of the V-groove.
- If the V-belt is elongated and there is no more allowance for adjustment, or if the belt is cracked or cut, replace the belt.
- When adjusting the V-belt, do not push the alternator directly with a bar. Insert a wooden block and push the block with a bar.
- After replacing the V-belt, operate the machine for one hour, then check and adjust again.

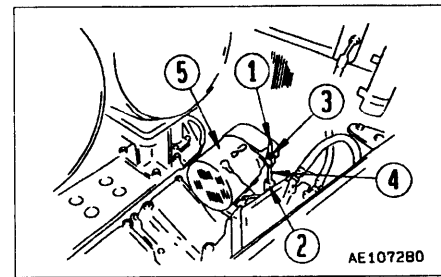

### 24.4.5 CHECK LEVEL OF BATTERY ELECTROLYTE

Carry out this check before operating the machine.

**⚠ WARNING**

- To avoid gas explosions, do not bring fire or sparks near the battery.
- Battery electrolyte is dangerous. If it gets in your eyes or on your skin, wash it off with large amounts of water, and consult a doctor.

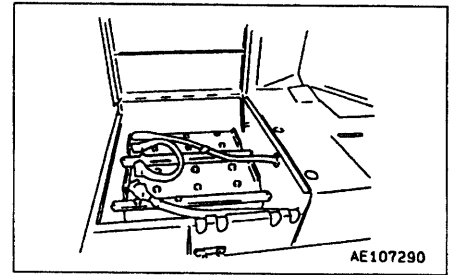

1. Open the battery cover.
2. Remove cap and check that the electrolyte is at the specified level (10 to 12 mm (0.39 to 0.47 in) above the plate). If the electrolyte level is low, add distilled water to the specified level. If the battery electrolyte is spilled, have dilute sulphuric acid added.
3. When adding distilled water to any cell at cap, add distilled water also to the other cells.
4. Clean the air hole in the battery cap, then tighten the cap securely.

#### NOTICE

When adding distilled water in cold weather, add it before starting operations in the morning to prevent the electrolyte from freezing.

### 24.4.6 CHECK BRAKE PERFORMANCE

**⚠ WARNING**

If the machine moves during the following operation, please contact your Komatsu distributor for repairs immediately.

Before starting the engine, check that the area around the machine is safe, then do as follows.

1. Start the engine.
2. Set safety lock ① to the FREE position then operate blade control lever and ripper control lever ② to raise the blade and ripper. Leave the safety lock to the FREE position.
3. Set brake lock lever ③ to the FREE position.
4. Depress brake pedal ④ and move lever ⑤ to the 2nd speed position.

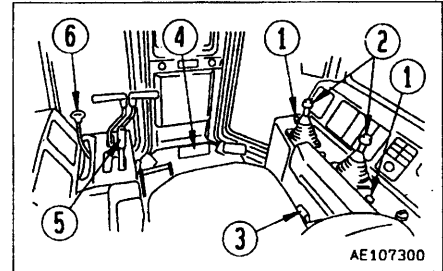

**NOTICE**

**Do not place the gear shift lever in the 1st speed position. Otherwise, it will cause damage to the machine.**

5. Operate fuel control lever ⑥ to raise the engine speed gradually to full throttle.
6. Check that the machine does not move. This indicates that brake performance is normal.

## 24.5 EVERY 500 HOURS SERVICE

Maintenance for every 250 hours service should be carried out at the same time.

### 24.5.1 REPLACE FUEL FILTER CARTRIDGE

#### **⚠ WARNING**

- Engine is at high temperature immediately after the machine has been operated. Wait for engine to cool down before replacing the filter.
- Do not bring fire or sparks near the fuel.
- When bleeding the air, be careful not to let the fuel overflow. It may cause a fire.

Prepare a filter wrench and a container to catch the fuel.

1. Set the container to catch the fuel under the filter cartridge.
2. Close valve ①.
3. Using a filter wrench, turn filter cartridges ② counterclockwise to remove it.
4. Clean the filter holder, fill a new filter cartridge with clean fuel, coat the packing surface with engine oil, then install it to the filter holder.
5. When installing, tighten until the packing surface contacts the seal surface of the filter holder, then tighten it up 1/2 to 3/4 of a turn.  
If the filter cartridge is tightened too far, the packing will be damaged and this will lead to leakage of fuel. If the filter cartridge is too loose, fuel will also leak from the packing, so always tighten to the correct amount.
6. Open valve ① and loosen air bleeding plugs ③.
7. Loosen the knob of feed pump ④ and move the pump up and down to draw off fuel until air ceases to come out of plugs ③.
8. Tighten air bleeding plugs ③, then push in the knob of feed pump ④, and tighten it.

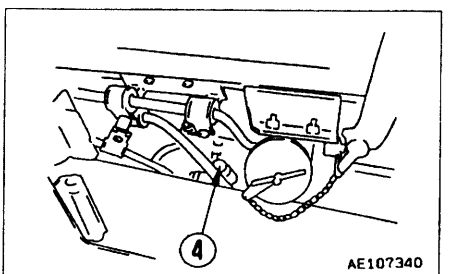
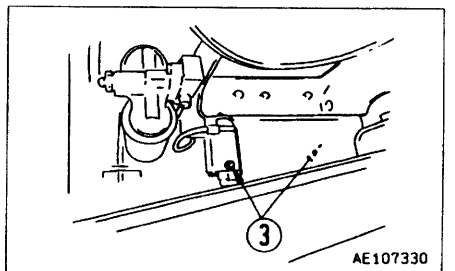
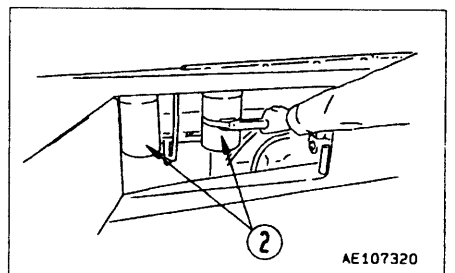
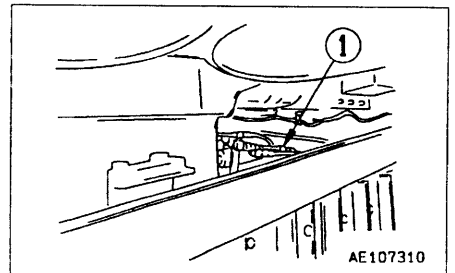

### 24.5.2 REPLACE TRANSMISSION FILTER ELEMENT, TRANSMISSION LUBRICATING FILTER ELEMENT AND TORQUE CONVERTER OIL FILTER ELEMENT

**⚠ WARNING**

Before opening the filter case, depress the brake pedal several times to release the pressure, then lock the brake pedal. If there is still pressure inside the filter, the oil may spurt out.

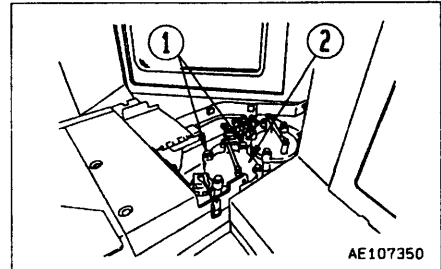

1. Open the floor cover in the middle of the machine.
2. Remove bolts ①, pull up cover ②, then remove the element and valve together with cover ②.
3. Remove the bolts tightening the valve, take out element ③, wash the removed parts and the inside of the case, then install a new element.  
Replace the O-ring at the same time.

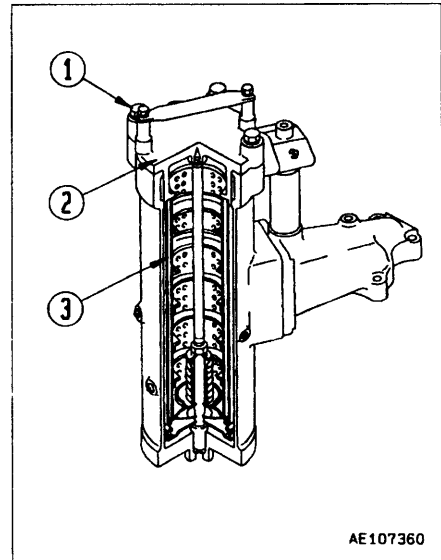

### 24.5.3 CHECK OIL LEVEL IN FINAL DRIVE CASE, ADD OIL

**⚠ WARNING**

There is danger that the oil may spurt out under internal pressure, so to the side, and gradually turn the plug to release the internal pressure before removing the plug completely.

1. Place the machine on a horizontal place.
2. Remove oil level plug ③ and check whether the final drive case is filled with oil to lower edge of the plug hole.
3. If the oil level is still too low, add gear oil through oil filter plug hole ⑤ until the oil overflows.  
Before removing oil plug ⑥, remove all the mud and dirt from around oil filler plug ⑥. Be careful not to let any dirt or sand get in when adding oil.

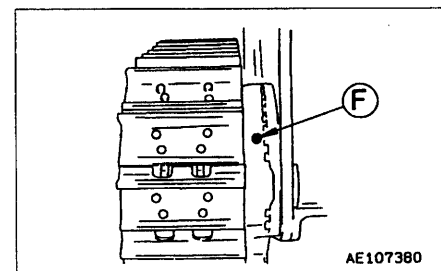
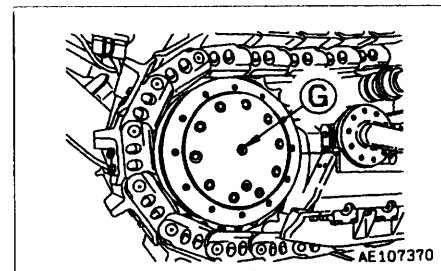

**NOTICE**

For details of the oil to use, see "20. USE OF FUEL, COOLANT AND LUBRICANTS ACCORDING TO AMBIENT TEMPERATURE".



## 24.6 EVERY 1000 HOURS SERVICE

Maintenance for every 250 and 500 hours service should be carried out at the same time.

### 24.6.1 CHANGE OIL IN POWER TRAIN CASE, CLEAN STRAINERS (INCL. TRANSMISSION CASE, TORQUE CONVERTER CASE AND BEVEL GEAR CASE)

**⚠ WARNING**

The oil is at high temperature immediately after the machine has been operated. Wait for the oil to cool down before starting the operation.

Prepare the following.

- Container to catch drained oil: Min. 210 ℓ capacity
- Refill capacity: 210 ℓ (55.44 US gal, 46.2 UK gal)

1. Remove the cover on the bottom of the rear body.
2. Pull out hose ① slowly to avoid getting oil on yourself, and loosen drain plug ② to drain the oil.
3. After draining, tighten drain plug ②.
4. Insert hose ① inside the cover, then install the cover.
5. Open the inspection cover on left fender, remove bolts ③ and cover ④.
6. Take out strainer ⑤ and magnet ⑥.  
If any damage to strainer ⑤ or magnet ⑥ is found, replace with a new one.
7. Remove all dirt from strainer, then wash in clean diesel oil or flushing oil.  
Clean the case interior and the plug.
8. Install the strainers to their original position.
9. After installing, replace the element in the power train oil filter.  
For details, see "24.5 EVERY 500 HOURS SERVICE".

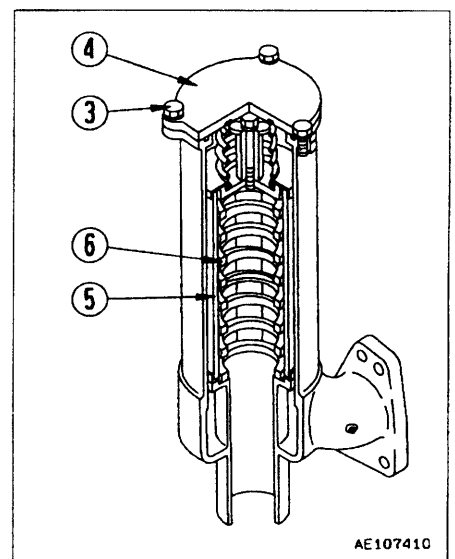
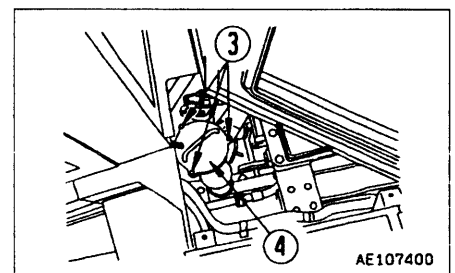
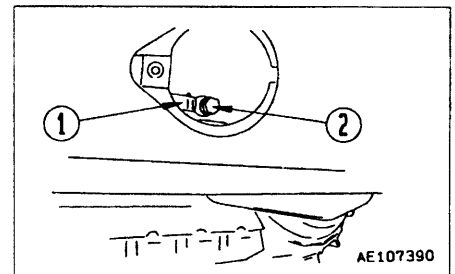

10. Refill the specified quantity of engine oil through oil filler (F).

**NOTICE**

For details of the oil to use, see "20. USE OF FUEL, COOLANT AND LUBRICANTS ACCORDING TO AMBIENT TEMPERATURE".

11. Check that the oil is at the specified level.  
For details, see "24.2 CHECK BEFORE STARTING".

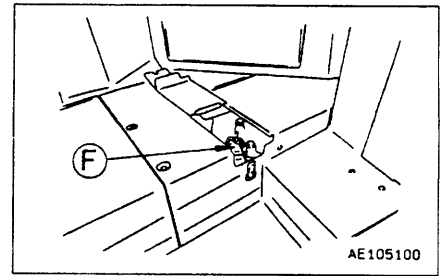

**24.6.2 CHECK, CLEAN FUEL STRAINER**

1. Tighten valve ①.
2. Remove cap ②, and wash the strainer and strainer case. The strainer forms one unit with the cap.
3. After checking and cleaning, set the strainer in the case, then tighten cap ②.
4. After installing, open valve ①.

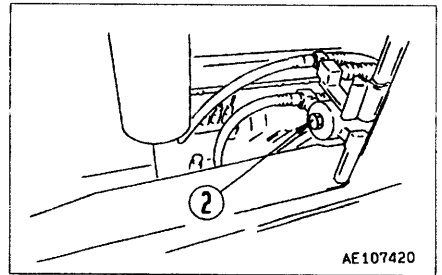
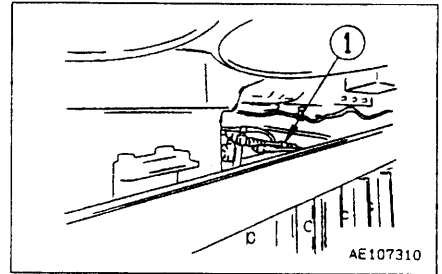

**24.6.3 CLEAN STEERING CLUTCH CASE BREATHER**

1. Open the rear cover.
2. Remove bolts ①, then remove cover ②.
3. Remove breather ③ on steering clutch case, and wash out dust remaining inside with diesel fuel or flushing oil.

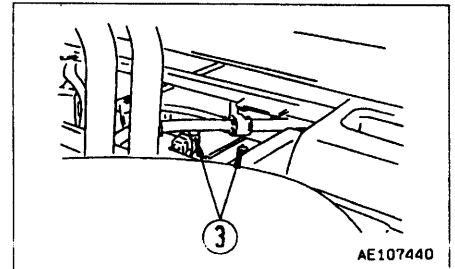
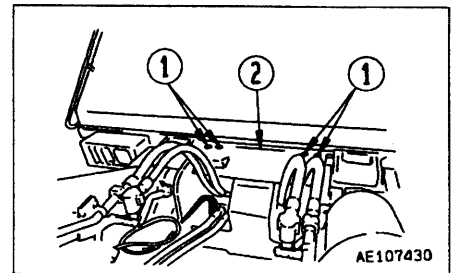
**24.6.4 CHECK OIL LEVEL IN RECOIL SPRING, ADD OIL****⚠ WARNING**

When checking the oil level or adding oil, the system is under internal pressure, so loosen plugs, and check that the internal pressure is released.

1. Remove bolts ①, then remove cover ②.  
When removing the cover, be careful not to let dirt or sand get in.
2. Insert the scale and check that the oil level is 80 – 90 mm (3.2 – 3.5 in) from the top surface of the grease cylinder.  
If the oil level is low, add engine oil.

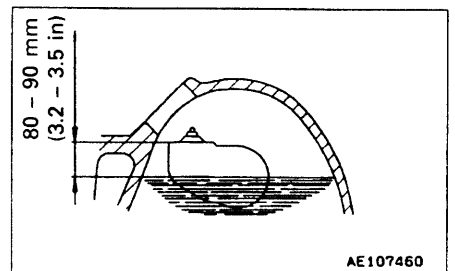
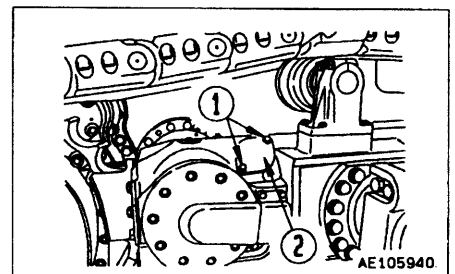
**NOTICE**

For details of the oil to use, see "20. USE OF FUEL, COOLANT AND LUBRICANTS ACCORDING TO AMBIENT TEMPERATURE".

### 24.6.5 REPLACE CORROSION RESISTOR CARTRIDGE

**⚠ WARNING**

If the engine has been operated, all parts will be at a high temperature, so never try to replace the cartridge immediately after stopping the engine.  
Always wait for the engine and other parts to cool down.

Prepare the following.

- Container to catch drained coolant
- Filter wrench

1. Close valve ① at the top of the corrosion resistor.
2. Set a container to catch the coolant under the cartridge.
3. Using a filter wrench, turn cartridge ② to the left and remove it.
4. Clean the filter holder, coat the packing surface and thread of the new cartridge with engine oil, then install it to the filter holder.
5. When installing, tighten until the packing surface contacts the seal surface of the filter holder, then tighten it up 2/3 of a turn. If the filter cartridge is tightened too far, the packing will be damaged and this will lead to leakage of coolant. If the filter cartridge is too loose, coolant will also leak from the packing, so always tighten to the correct amount.
6. Open valve ①.
7. After replacing the cartridge, start the engine and check for any leakage of water from the filter seal surface. If there is any water leakage, check if the cartridge is tightened properly.

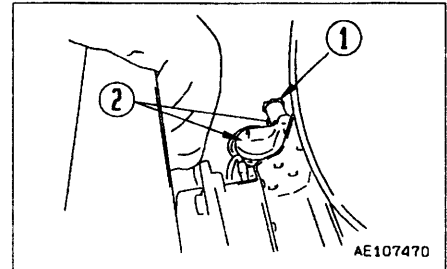

### 24.6.6 CHECK ALL TIGHTENING PARTS OF TURBOCHARGER

Contact your Komatsu distributor for inspection or adjustment.

## 24.7 EVERY 2000 HOURS SERVICE

Maintenance for every 250, 500 and 1000 hours service should be carried out at the same time.

### 24.7.1 CHANGE OIL IN HYDRAULIC TANK, REPLACE HYDRAULIC OIL FILTER ELEMENT AND CLEAN STRAINER

#### **WARNING**

The oil is at high temperature immediately after the machine has been operated. Wait for the oil to cool down before changing the oil. When removing the oil filler cap (F), turn it slowly to release the internal pressure, then remove it carefully.

Prepare the following.

- Container to catch drained oil: Min. 140 ℓ capacity
- Refill capacity: 140 ℓ (36.96 US gal, 30.8 UK gal)

1. Lower the blade and ripper on the ground securely, stop the engine and slowly turn the cap of oil filler (F) to release the internal pressure. Then, remove the cap.

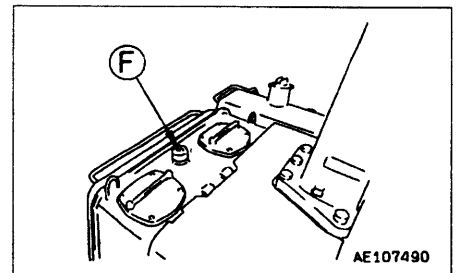

2. Remove drain plug (1) at the bottom of the tank and loosen drain valve (2). After draining the oil, tighten drain plug (1) and valve (2). When loosening drain plug (1) and valve (2), be careful not to get oil on yourself.

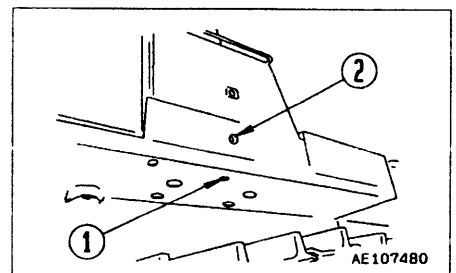

3. Remove bolt (3) and cover (4), then remove element (6) together with the valve and cover.
4. Remove nut (5) which is tightening element (6), clean the removed parts and the inside of the case, then install a new element.
5. Add engine oil through oil filler port (F) to the specified level.

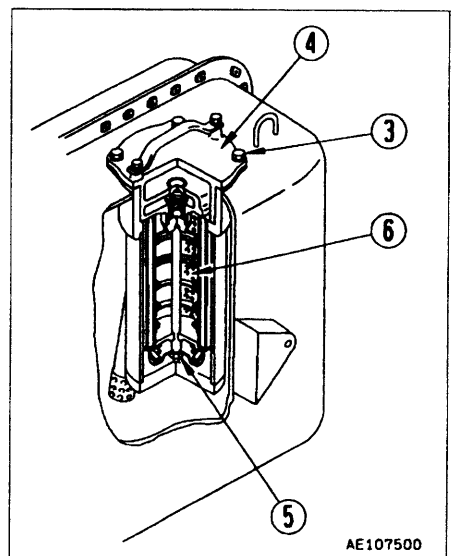

#### **NOTICE**

For details of the oil to use, see "20. USE OF FUEL, COOLANT AND LUBRICANTS ACCORDING TO AMBIENT TEMPERATURE".

6. After adding oil, check that the oil is at the specified level. For details, see "25.4 EVERY 250 HOURS SERVICE".

### 24.7.2 CHANGE OIL IN FINAL DRIVE CASE

**⚠ WARNING**

The oil is at high temperature immediately after the machine has been operated. Wait for the oil to cool down before starting the operation.

Prepare the following.

- Container to catch drained oil: Min. 75 ℓ capacity
- Refill capacity: each 75 ℓ (19.8 US gal, 16.5 UK gal)

1. Drain plug ① is directly at the bottom.
2. Remove oil filler plug ⑥, then remove drain plug ②, and drain the oil.  
Remove all the mud and dirt from around oil filler plug ⑥ before removing it. Be careful not to let any dirt or sand get in when adding oil.
3. After draining the oil, tighten the drain plug ①, ②.
4. Remove level plug ③, and refill the gear oil until oil overflows from plug hole ④, and tighten the plugs.

**NOTICE**

For details of the oil to use, see "20. USE OF FUEL, COOLANT AND LUBRICANTS ACCORDING TO AMBIENT TEMPERATURE".

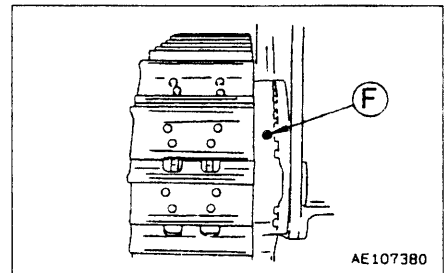
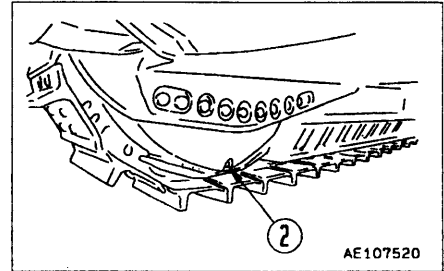
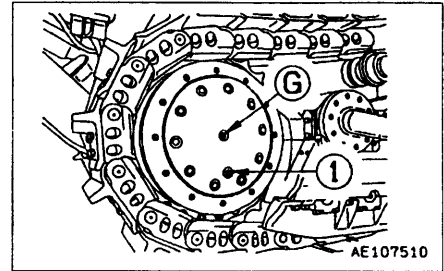

### 24.7.3 CHANGE OIL IN DAMPER CASE

#### **⚠ WARNING**

- The oil is at high temperature immediately after the machine has been operated. Wait for the oil to cool down before carrying out maintenance.
- The undercover is heavy. Never open or close the cover when directly underneath it. When open cover, carry out the operation at the rear of the point immediately under the cover so that it is always possible to escape.

- Container to catch drained oil: Min. 2.4 ℓ capacity
- Refill capacity 2.4 ℓ (0.63 US gal, 0.53 UK gal)

1. Open cover at the bottom of the machine.
2. Remove drain plug **Ⓟ** slowly to avoid getting oil on yourself, and drain the oil.  
After draining the oil, tighten plug **Ⓟ**.
3. Pull out dipstick **Ⓞ**, and add engine oil through the dipstick guide hole until oil overflows from plug hole **Ⓛ**.

#### **NOTICE**

For details of the oil to use, see "20. USE OF FUEL, COOLANT, LUBRICANTS ACCORDING TO AMBIENT TEMPERATURE".

4. Check that the oil level is between the H and L marks on dipstick **Ⓞ**. For details, see "24.3 CHECK BEFORE STARTING".
5. Close the inspection cover.

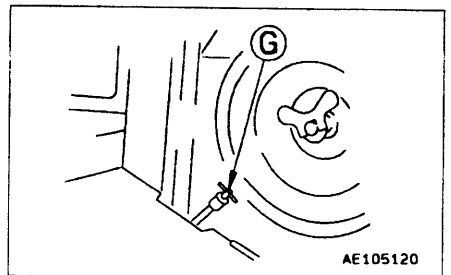
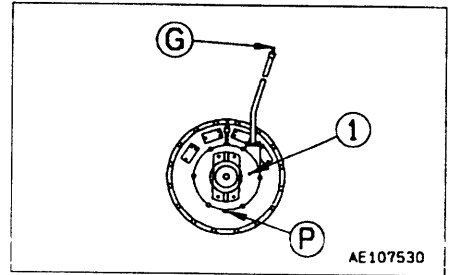

**24.7.4 CHECK PIVOT BEARING OIL LEVEL, ADD OIL**

1. Remove plug ①.  
When removing plug ①, be careful not to let dirt or dust get it.
2. Check that the oil is at the level shown in the diagram. If the oil level is low, add engine oil through the hole of plug ①.

**NOTICE**

For details of the oil to use, see "20. USE OF FUEL, COOLANT AND LUBRICANTS ACCORDING TO AMBIENT TEMPERATURE".

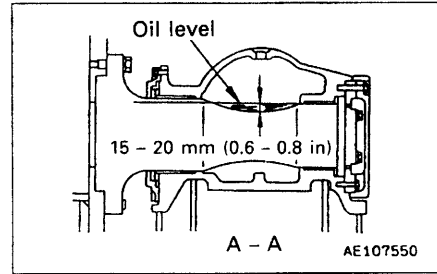
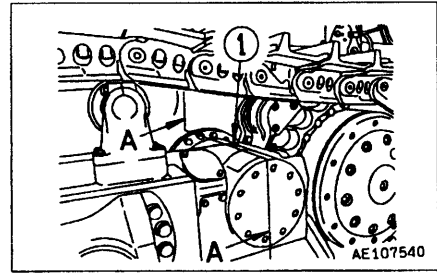

**24.7.5 CLEAN, CHECK TURBOCHARGER**

Contact your Komatsu distributor for cleaning or inspection.

**24.7.6 CHECK PLAY OF TURBOCHARGER ROTOR**

Contact your Komatsu distributor to have the play checked.

**24.7.7 CHECK ALTERNATOR, STARTING MOTOR**

The brush may be worn, or the bearing may have run out of grease, so contact your Komatsu distributor for inspection or repair.

If the engine is started frequently, carry out inspection every 1000 hours.

**24.7.8 CHECK ENGINE VALVE CLEARANCE, ADJUST**

As special tool is required for removing and adjusting the parts, you shall request Komatsu distributor for service.



## 24.8 EVERY 4000 HOURS SERVICE

Maintenance for every 250, 500, 1000 and 2000 hours service should be carried out at the same time.

### 24.8.1 CHECK WATER PUMP

Check that there is oil leakage, water leakage, or clogging of the drain hole. If any abnormality is found, contact your Komatsu distributor for disassembly and repair or replacement.

### 24.8.2 CHECK VIBRATION DAMPER

Check decrease of damper fluid, dent or out-of-flat. If there is any abnormality, contact Komatsu distributor for repair.

### 24.8.3 CHECK, REPLACE INJECTION PUMP RACK RUBBER BOOT

Check for any cracks or oil leakage in the rubber boot of the injection pump rack, and if there is any abnormality, please contact your Komatsu distributor for repairs.

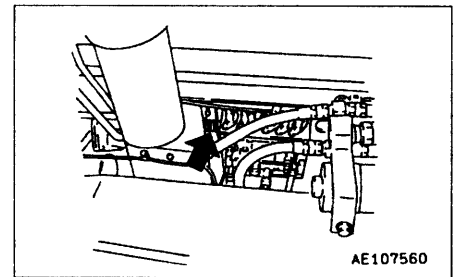

# **SPECIFICATIONS**

## 25. SPECIFICATIONS

<b>OPERATING WEIGHT (without operator)</b>		95000 kg (209475 lb)	
(with semi-U dozer, variable giant ripper, 710 mm (28 in) shoe, ROPS cab, and air conditioner)			
<b>PERFORMANCE</b>			
● Travel speed	Forward	1st	3.5 km/h (2.2 MPH)
		2nd	6.3 km/h (3.9 MPH)
		3rd	10.9 km/h (6.8 MPH)
	Reverse	1st	4.5 km/h (2.8 MPH)
		2nd	8.2 km/h (5.1 MPH)
		3rd	14.3 km/h (8.9 MPH)
<b>BLADE</b>			
● Weight of attachment (incl. tilt cylinder and cylinder support)		14600 kg (32193 lb)	
● Max. tilt		1250 mm (4 ft 1 in)	
<b>RIPPER (variable giant ripper)</b>			
● Weight of attachment		7360 kg (16229 lb)	
● Digging angle		Standard 45° (possible to adjust steplessly between 34° and 56°)	
<b>TOWING</b>			
● Towing force		71500 kg (701175 N)	
<b>ENGINE</b>			
● Model		Komatsu SA12V140-1 diesel engine	
● Flywheel horsepower		566 kW (770 HP)/2000 rpm	
● Maximum torque		3393 Nm (346 kgm)/1400 rpm	
● Starting motor		24 V 7.5 kW x 2 pieces	
● Alternator		24 V 50 A	
● Battery		12 V 170 Ah x 4 pieces	
<b>SOUND LEVEL</b>			
● Surrounding (Sound power level L WA)		118 dB(A)	
● Operator's (sound pressure level L PA) measurement procedure described in ISO 6394 or 86/622/ECC		83 dB(A)	
<b>VIBRATION LEVEL</b>			
● Hands/Arms	The weighted root mean square acceleration measurement standard; ISO 7096	2.5 m/S <sup>2</sup>	
● Whole body		1.25 m/S <sup>2</sup>	

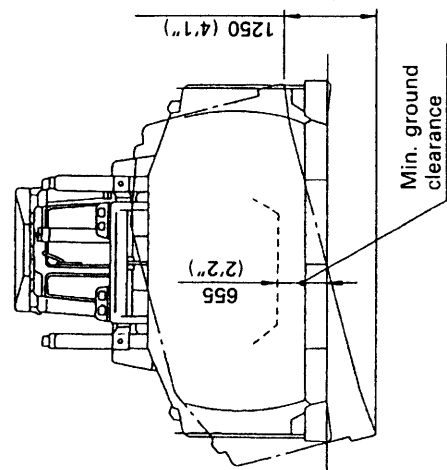
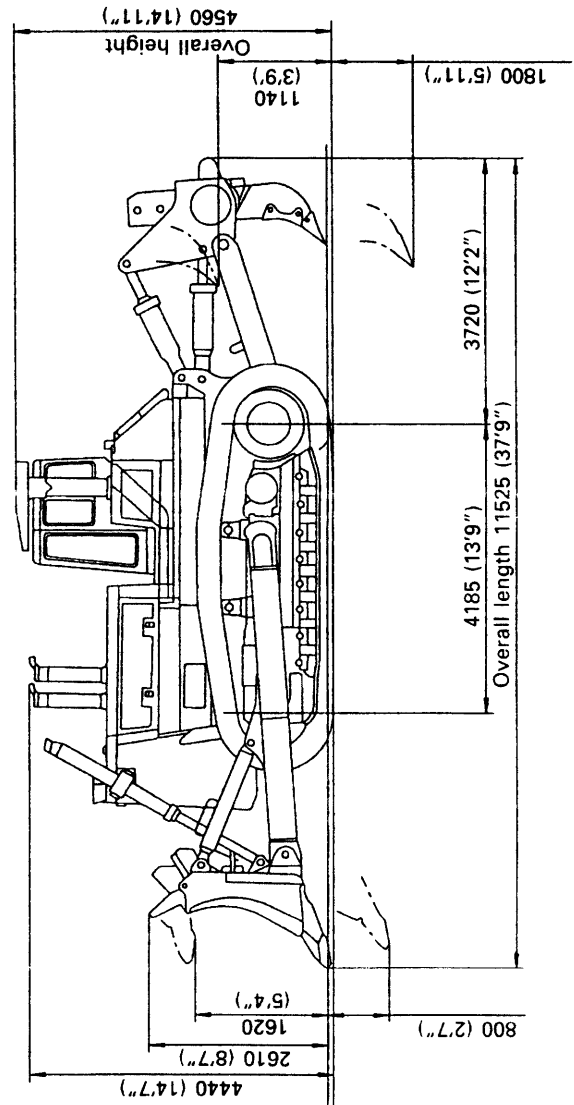
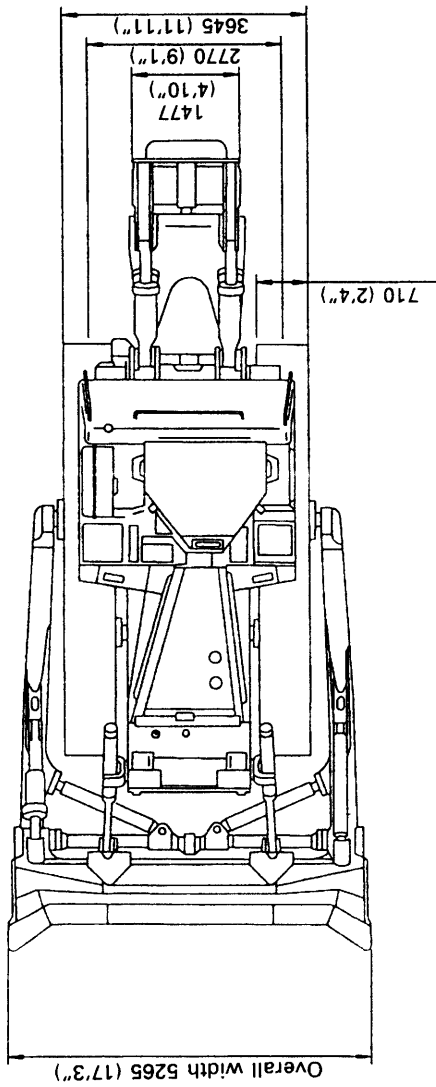

AE107570

# **OPTIONS, ATTACHMENTS**

## 26. GENERAL PRECAUTIONS

---

### 26.1 PRECAUTIONS RELATED TO SAFETY

If attachments or options other than those authorized by Komatsu are installed, this will not only affect the life of the machine, but will also cause problems with safety.

When installing attachments not listed in this Operation and Maintenance Manual, please contact your Komatsu distributor first.

If you do not contact Komatsu, we cannot accept any responsibility for any accident or failure.

#### WARNING

##### **Precautions for removal and installation operations**

- **When removing or installing attachments, obey the following precautions and take care to ensure safety during the operation.**
- **Carry out the removal and installation operations on a flat, firm ground surface.**
- **When the operation is carried out by two or more workers, determine signals and follow these during the operation.**
- **When carrying heavy objects (more than 25 kg (55 lb)), use a crane.**
- **When removing heavy parts, always support the part before removing it.  
When lifting such heavy parts with a crane, always pay careful attention to the position of the center of gravity.**
- **It is dangerous to carry out operations with the load kept suspended. Always set the load on a stand, and check that it is safe.**
- **When removing or installing attachments, make sure that they are in a stable condition and will not fall over.**
- **Never go under a load suspended front a crane.  
Always stand in a position that is safe even if the load should fall.**

#### **NOTICE**

**Qualifications are required to operate a crane. Never allow the crane to be operated by an unqualified person.**

For details of the removal and installation operations, please contact your Komatsu distributor.

## 27. USING SEAT BELT

When operating a machine equipped with ROPS, be sure to use the seat belt.

### **⚠ WARNING**

- Before fastening the seat belt, inspect the securing brackets and belt for abnormal conditions. Replace any worn or damaged seat belt or the securing brackets.
- Even if there appears to be no abnormality in the belt, always replace the seat belt once every 3 years. The date of manufacture is shown on the back of the belt.
- Adjust and fasten the seat belt before operating the machine.
- Always use seat belt when operating the machine.
- Fit the seat belt across your lap without twisting.

### 27.1 FASTEN THE BELT AND REMOVE IT IN THE FOLLOWING MANNER

1. Adjust the seat so that the brake pedal can be depressed all the way with the operator's back against the backrest.
2. After positioning the seat, adjust the tether belt ①. With the seat unoccupied, tense the belt slightly across the seat and install.
3. Sit in the seat, hold the tongue ④ of reel ②, and pull the belt out slowly to a length which fully covers your lap.
4. Insert the tongue ④ into buckle ③ and push until there is a click. Pull back reel ② until the belt fits securely across your lap. In this condition, the lock is applied to prevent the belt from extending any further.  
Fit the seat belt across your lap without twisting.

#### REMARK

If the lock is applied before the tongue is installed into the buckle, return the belt to the reel, then carry out the operation again from the beginning.

5. Tense the belt and check that the lock is applied.
6. To remove the belt, press the red button on buckle ②. The belt will automatically wind in.

Inspect bolts and fittings on the chassis for tightness. Retighten any loose bolts to 19.6 to 29.4 Nm (2 to 3 kgm, 14.5 to 21.7 lbft) torque.



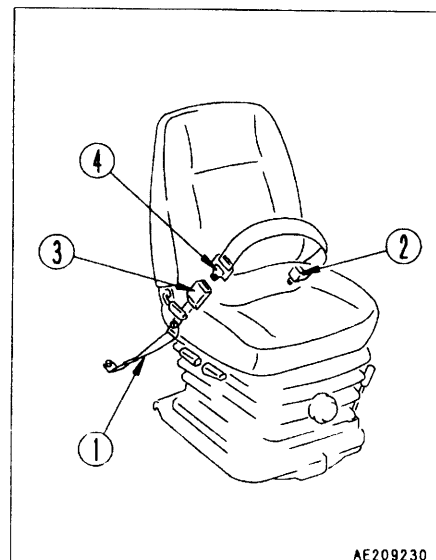

If the seat is scratched or frayed or if any of the fittings are broken or deformed from long service, replace the seat belt immediately.



AE209230

# 28. PROCEDURE FOR SELECTING RIPPER POINT

## 28.1 PROCEDURE FOR SELECTING RIPPER POINT

<p>Procedure ①</p> <p>Procedure ② Check wear</p> <p>Procedure ③ Check for cracks or breakage</p>						
Typical rock	Hardness	Soft ←→ Hard	Soft ←→ Hard		Soft ←→ Hard	
	Type of rock	shale, lime stone	General rock		Basalt, andesite, granite, chest	
	Features	<ul style="list-style-type: none"> <li>● Little quartz, little wear</li> <li>● Deposited in layers, so ripping is easy</li> </ul>	—		<ul style="list-style-type: none"> <li>● Fairly high proportion of quartz (40 – 70%)</li> <li>● Dose not form seams or layers, so there is excessive generation of heat from the point, the tip wears rapidly, and ripping is difficult</li> </ul>	
Suitable point	Features	<p>Ⓐ Point for lime stone</p> <ul style="list-style-type: none"> <li>● Non-symmetrical shape</li> <li>● Yellow</li> <li>● Short</li> </ul>	<p>Ⓑ Standard point</p> <ul style="list-style-type: none"> <li>● Non-symmetrical shape</li> <li>● Yellow</li> <li>● Short</li> </ul>	<p>Ⓒ</p> <ul style="list-style-type: none"> <li>● Symmetrical shape</li> <li>● Yellow</li> <li>● Short</li> </ul>	<p>Ⓓ</p> <ul style="list-style-type: none"> <li>● Symmetrical shape</li> <li>● Red</li> <li>● Short</li> </ul>	<p>Ⓔ</p> <ul style="list-style-type: none"> <li>● Symmetrical shape</li> <li>● Red</li> <li>● Short</li> </ul>
	Shape	 AE107610	 AE107610	 AE107630	 AE107610	 AE107630
	Part No.	198-78-21420	198-78-21340	198-78-21370	198-78-21350	198-78-21380



## 29. HANDLING CAP WITH LOCK

### 29.1 OPENING AND CLOSING LOCKABLE CAP

Lock-type caps are available for the radiator water filler cap, fuel tank filler cap, power train case oil filler cap, hydraulic tank oil filler cap, and hydraulic tank breather cap. The cap opening and closing method is as follows.

#### WHEN OPENING CAP

1. Insert the key. Make sure that you have inserted the key fully before turning it. If the key is turned when only partially inserted, it may break.
2. Turn the key counterclockwise to align the match mark on the cap with the rotor groove, then turn the cap slowly. When a click is heard, the lock is released, enabling the cap to be opened.

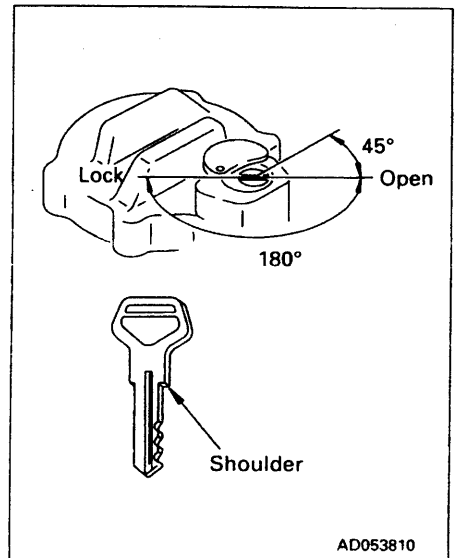

#### TO LOCK THE CAP

1. Turn the cap into place.
2. Turn the key clockwise and take the key out.

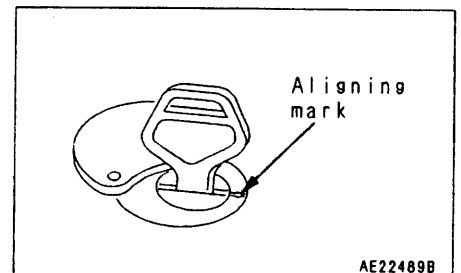

**D475A-2 BULLDOZER**

---

Form No. SEAM007603T