



**Operating Instructions for MAN Marine Diesel engines
Bedienungsanleitung für MAN-Schiffsdieselmotoren
Instrucciones de servicio para Motores Diesel MAN para barcos
Instruction de service pour Moteurs Diesel marins MAN
Norme di servizio per Motori Diesel MAN per applicazioni navali**

D 2842 LE 409

D 2842 LE 418

Operating Instructions – MAN Marine Diesel Engines



Dear Customer,

these Operating Instructions are intended to familiarize you with your new MAN Diesel engine and how it operates.

This manual contains information on “Fuels, Lubricants and Coolants for MAN Diesel Engines”.

This manual is supplemented by the publication “Service record book”.

**Note:**

All three publications belong to the engine and must always be kept ready to hand near the engine in the engine room.

Comply in full with instructions relating to operation, prevention of accidents and environmental protection.

MAN Diesel engines are developed and manufactured in line with the latest state of the art. However, trouble-free operation and high performance can only be achieved if the specified maintenance intervals are observed and only approved fuels, lubricants and coolants are used.

**Note:**

Only use fuel, coolants and lubricants in accordance with MAN’s regulations otherwise the manufacturer’s warranty will not apply!

For basic information on the fuels see the publication “Fuels, Lubricants and Coolants for MAN Diesel Engines”.

You can find the approved products in the internet under:

–<http://www.man-mn.com/> → **Products & Solutions** → **E-Business**–

It is imperative and in your own interest to entrust your MAN Local Service Centre with the removal of any disturbances and with the performance of checking, setting, and repair work.

Yours faithfully,
MAN Nutzfahrzeuge Aktiengesellschaft
Werk Nürnberg

Subject to change to keep abreast with technological progress.

© 2006 MAN Nutzfahrzeuge Aktiengesellschaft

No parts of this publication may be reproduced or translated without prior written permission of MAN. MAN explicitly reserves all rights according to copyright law.

Important instructions which concern technical safety and protection of persons are emphasised as shown below.

**Danger:**

This refers to working and operating procedures which must be complied with in order to rule out the risk to persons.

**Caution:**

This refers to working and operating procedures which must be complied with in order to prevent damage to or destruction of material.

**Note:**

Explanations useful for understanding the working or operating procedure to be performed.

Fitting flat seals / gaskets

Flat seals / gaskets are often inserted with sealing agents or adhesives to make fitting them easier or to achieve better sealing. Flat seals may slip in operation due to the “sewing-machine” effect, in particular if they are used between parts with different rates of linear expansion under heat (e.g. aluminium and cast iron), and leaks may then occur.

Example:

the cap of the front crankshaft seal. If a sealing agent or an adhesive is used here the flat seal will move inwards in the course of time as a result of the different expansion rates of the materials. Oil will be lost, for which the shaft seal may be thought to be responsible.

Flat seals / gaskets can be fitted properly only if the following points are observed:

- Use only genuine MAN seals / gaskets
- The sealing faces must be undamaged and clean
- Do not use any sealing agent or adhesive – as an aid to fitting the seals a little grease can be used if necessary so that the seal will stick to the part to be fitted
- Tighten bolts evenly to the specified torque

	Page
Preface	5
Instructions	6
Declaration	8
Nameplates	9
Safety regulations	10
Commissioning and operation	14
Engine views	14
First commissioning	16
Commissioning	18
Starting	19
Operation monitoring	20
Shutting down	59
Maintenance and care	60
Lubrication system	60
Fuel system	63
Cooling system	66
V-belts	69
Alternator	71
Temporary decommissioning of engines	71
Technical data	72
Troubleshooting table	74
Index	76

Declaration

In accordance with Article 4, paragraph 2, in conjunction with Appendix II, section B, of Directive 89/392/EEC, version 93/44/EEC

MAN Nutzfahrzeuge Aktiengesellschaft,

hereby declares that the engine described below is destined for installation in a machine as defined in the EC directive on machines.

Engine model:

Design:

For data see original declaration

Engine number:

If required this declaration is enclosed with the delivery note.

Rating / speed:



Note:

The manufacturer of the complete ready-to-use machine in which this engine is to be installed must take the further action necessary in the context of indirect safety-related engineering and provision of instructions to ensure that the ready-to-use machine complies with the requirements of the EC directive on machines. The engine must not be put into operation until the complete machine satisfies the conditions laid down in the EC directive on machines 89/392/EEC, most recently amended by 93/44/EEC, or the latest amendment of said directive.

MAN Nutzfahrzeuge Aktiengesellschaft

Vogelweiherstraße 33

D-90441 Nürnberg

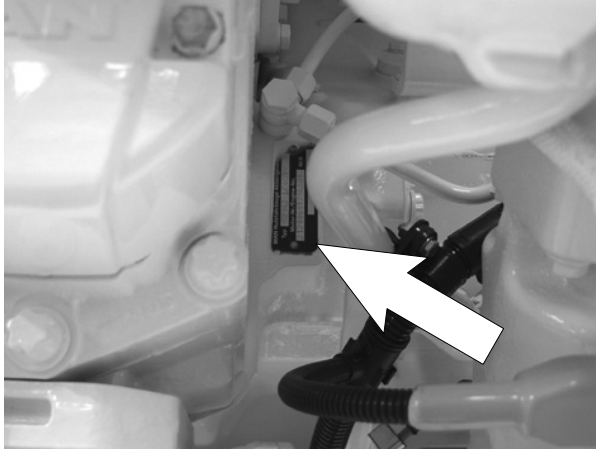

In all your correspondence please always quote engine model, serial number and job number (Order number).

For this reason it is advisable to read off the data from the engine type plates before putting the engine into operation and to enter them in the appropriate spaces.

The engine type plates are on the crankcase (see illustration).

MAN Nutzfahrzeuge Aktiengesellschaft
 Typ
 Motor-Nr. / Engine No. NI/II

Model

.....

delivered on

.....

installed on

.....

Engine serial number

.....

Order number

.....

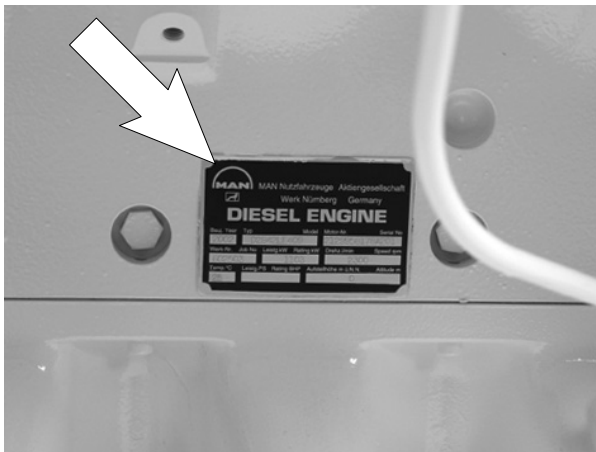

		MAN Nutzfahrzeuge Aktiengesellschaft Werk Nürnberg Germany			
DIESEL ENGINE					
Bauj. Year	Typ	Model	Motor-Nr.	Serial No	
<input type="text"/>	<input type="text"/>	<input type="text"/>	<input type="text"/>	<input type="text"/>	
Werk-Nr.	Job No	Leistung kW	Rating kW	Drehz. 1/min	Speed rpm
<input type="text"/>	<input type="text"/>	<input type="text"/>	<input type="text"/>	<input type="text"/>	<input type="text"/>
Temp.°C	Leistg. PS	Rating BHP	Aufstellhöhe m uNN	Altitude m	
<input type="text"/>	<input type="text"/>	<input type="text"/>	<input type="text"/>	<input type="text"/>	
-0219					

General notes

Handling diesel engines and the necessary resources is no problem when the personnel commissioned with operation and maintenance are trained accordingly and use their common sense.

This summary is a compilation of the most important regulations. These are broken down into main sections which contain the information necessary for preventing injury to persons, damage to property and pollution. In addition to these regulations those dictated by the type of engine and its site are to be observed also.

Important:

If, despite all precautions, an accident occurs, in particular through contact with caustic acids, fuel penetrating the skin, scalding from hot oil, anti-freeze being splashed in the eyes etc., **consult a doctor immediately.**

1. Regulations designed to prevent accidents with injury to persons

During commissioning, starting and operation

- Before putting the engine into operation for the first time, read the operating instructions carefully and familiarize yourself with the “critical” points. If you are unsure, ask your MAN representative.
- For reasons of safety we recommend you attach a notice to the door of the engine room prohibiting the access of unauthorized persons and that you draw the attention of the operating personal to the fact that they are responsible for the safety of persons who enter the engine room.
- The engine must be started and operated only by authorized personnel. Ensure that the engine cannot be started by unauthorized persons.
- When the engine is running, do not get too close to the rotating parts. Wear close-fitting clothing.
- Do not touch the engine with bare hands when it is warm from operation – risk of burns.
- Exhaust gases are toxic. Comply with the instructions for the installation of MAN Diesel engines which are to be operated in enclosed spaces. Ensure that there is adequate ventilation and air extraction.
- **For safety reasons a separate, functioning red emergency-stop-button for each engine must be installed at every bridge** (the engine must stop immediately when the button is pressed once).
- Keep vicinity of engine, ladders and stairways free of oil and grease. Accidents caused by slipping can have serious consequences.



During maintenance and care

- Always carry out maintenance work when the engine is switched off. If the engine has to be maintained while it is running, e.g. changing the elements of change-over filters, remember that there is a risk of scalding. Do not get too close to rotating parts.
- Change the oil when the engines is warm from operation.
Caution:
There is a risk of burns and scalding. Do not touch oil drain plugs or oil filters with bare hands.
- Take into account the amount of oil in the sump. Use a vessel of sufficient size to ensure that the oil will not overflow.
- Open the coolant circuit only when the engine has cooled down. If opening while the engine is still warm is unavoidable, comply with the instructions in the chapter entitled "Maintenance and Care".
- Neither tighten up nor open pipes and hoses (lube oil circuit, coolant circuit and any additional hydraulic oil circuit) during the operation. The fluids which flow out can cause injury.
- Fuel is inflammable. Do not smoke or use naked lights in its vicinity. The tank must be filled only when the engine is switched off.
- When using compressed air, e.g. for cleaning the radiator, wear goggles.
- Keep service products (anti-freeze) only in containers which can not be confused with drinks containers.
- Comply with the manufacturer's instructions when handling batteries.
Caution:
Accumulator acid is toxic and caustic. Battery gases are explosive.



2. Regulations designed to prevent damage to engine and premature wear

Do not demand more from the engine than it is able to supply in its intended application. Detailed information on this can be found in the sales literature. The injection pump must not be adjusted without prior written permission of MAN Nürnberg.



Safety regulations

If faults occur, find the cause immediately and have it eliminated in order to prevent more serious damage.

Use only genuine MAN spare parts. MAN will accept no responsibility for damage resulting from the installation of other parts which are supposedly “just as good”.

In addition to the above, note the following points:

- Never let the engine run when dry, i.e. without lube oil or coolant.
- When starting do not use any additional starting aids (e.g. injection with starting pilot).
- Use only MAN-approved service products (fuel, engine oil, anti-freeze and anti-corrosion agent). Pay attention to cleanliness. The Diesel fuel must be free of water. See “Maintenance and care”.
- Have the engine maintained at the specified intervals.
- Do not switch off the engine immediately when it is warm, but let it run without load for about 5 minutes so that temperature equalization can take place.
- Never put cold coolant into an overheated engine. See “Maintenance and care”.
- ***Do not add so much engine oil that the oil level rises above the max. marking on the dipstick. Do not exceed the maximum permissible tilt of the engine.***
Serious damage to the engine may result if these instructions are not adhered to.
- Always ensure that the testing and monitoring equipment (for battery charge, oil pressure, coolant temperature) function satisfactorily.
- It is advisable to switch off the engine if an alarm of any kind is displayed in the engine monitoring and diagnostic system. If this is not possible for any reason, the engine should be run no faster than 1200 rpm until the fault is remedied, see page 20.
- Comply with instructions for operation of the alternator. See “Maintenance and care”.
- Do not let the sea water pump run dry. If there is a risk of frost, drain the pump when the engine is switched off.

3. Regulations designed to prevent pollution

Engine oil and filter elements / cartridges, fuel / fuel filter

- Take old oil only to an old oil collection point.

- Take strict precautions to ensure that no oil or Diesel fuel gets into the drains or the ground.

Caution:

The drinking water supply could be contaminated.

- Filter elements are classed as dangerous waste and must be treated as such.

Coolant

- Treat undiluted anti-corrosion agent and / or anti-freeze as dangerous waste.
- When disposing of spent coolant comply with the regulations of the relevant local authorities.

4. Notes on safety in handling used engine oil *

Prolonged or repeated contact between the skin and any kind of engine oil decreases the skin. Drying, irritation or inflammation of the skin may therefore occur. Used engine oil also contains dangerous substances which have caused skin cancer in animal experiments. If the basic rules of hygiene and health and safety at work are observed, health risks are not to the expected as a result of handling used engine oil.

Health precautions:

- Avoid prolonged or repeated skin contact with used engine oil.
- Protect your skin by means of suitable agents (creams etc.) or wear protective gloves.
- Clean skin which has been in contact with engine oil.
 - Wash thoroughly with soap and water. A nailbrush is an effective aid.
 - Certain products make it easier to clean your hands.
 - Do not use petrol, Diesel fuel, gas oil, thinners or solvents as washing agents.
- After washing apply a fatty skin cream to the skin.
- Change oil-soaked clothing and shoes.
- Do not put oily rags into your pockets.

**Ensure that used engine oil is disposed of properly
– Engine oil can endanger the water supply –**

For this reason do not let engine oil get into the ground, waterways, the drains or the sewers. Violations are punishable.

Collect and dispose of used engine oil carefully. For information on collection points please contact the seller, the supplier or the local authorities.

* Adapted from "Notes on handling used engine oil".

Engine views D 2842 LE 409

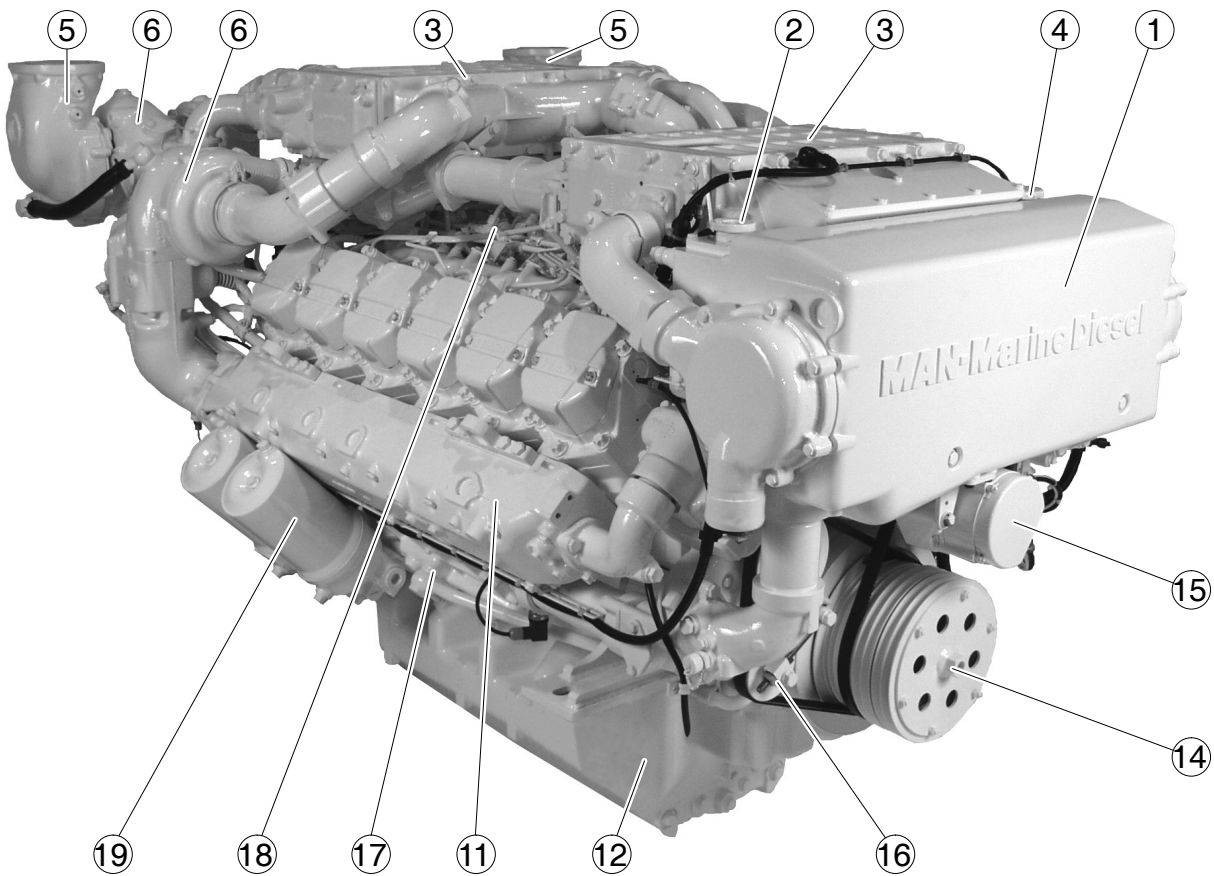
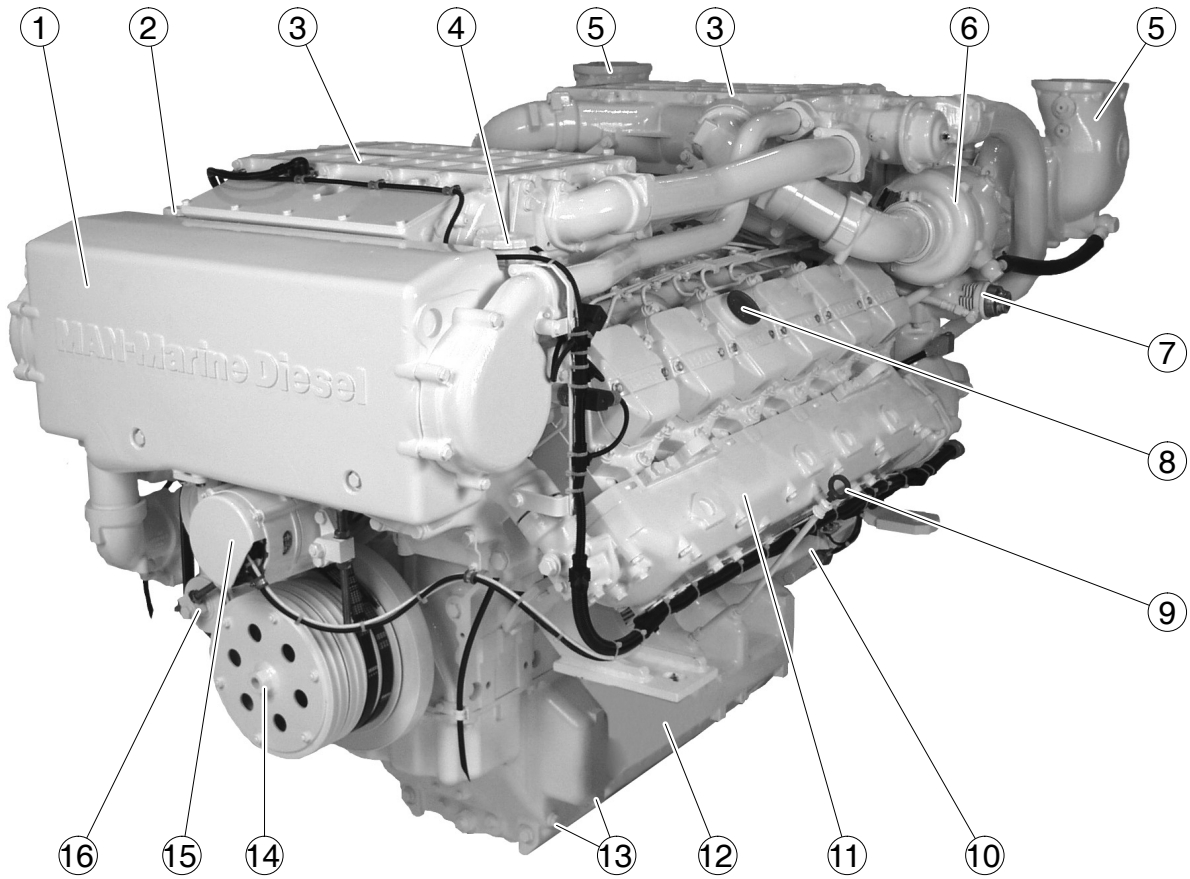

-
- ① Heat exchanger and coolant surge tank
 - ② Relief valve on coolant surge tank
 - ③ Intercooler
 - ④ Coolant filler neck
 - ⑤ Exhaust manifold
 - ⑥ Turbocharger
 - ⑦ Waste Gate
 - ⑧ Oil filler neck
 - ⑨ Oil dipstick
 - ⑩ Starter motor
 - ⑪ Exhaust pipe
 - ⑫ Oil sump
 - ⑬ Oil drain plug
 - ⑭ Engine cranking device
 - ⑮ Alternator
 - ⑯ Tensioning pulley
 - ⑰ Oil cooler
 - ⑱ Injection pump
 - ⑲ Oil filter

First commissioning

When putting a new or overhauled engine into operation for the first time pay attention to the “Installation instructions for MAN marine diesel engines” without fail.

It is recommended that new or overhauled engines should not be operated at a load higher than about 75% maximum load during the first few hours of operation. Initial run-in should be at varying speeds. After this initial run-in, the engine should be brought up to full output gradually.



Caution:

Use only approved fuels, lubricants etc. (see brochure “Fuels, lubricants etc.”).
Otherwise the liability for defects will become null and void!

Filling with fuel



Caution:

Fill the tank only when the engine is switched off. Pay attention to cleanliness.
Do not spill fuel.
Use only approved fuels (see “Fuels, Lubricants etc.”).

Filling-in of coolant

Fill the cooling system of the engine with a mixture of drinkable tap water and anti-freeze agent on ethylene glycole basis or anti-corrosion agent.

See Publication “Fuels, Lubricants and Coolants for MAN Diesel Engines”.

- Pour in coolant slowly via expansion tank, see page 67
- For coolant filling quantity, see “Technical data”

Sea water pump

Do not let sea water pump run dry.

Make sure that all valves / cocks in the sea water circuit are open.

If there is a risk of frost, drain the sea water pump.

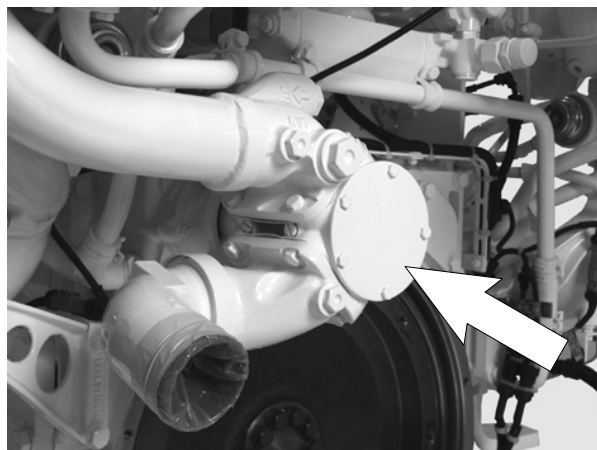

Filling with engine oil



Caution:

Do not add so much engine oil that the oil level rises above the max. marking on the dipstick. Overfilling will result in damage to the engine.

The engines are as a rule supplied without oil.

Pour oil into engine via filler neck (arrow), see page 61.

For the quantity required see “Technical Data”.

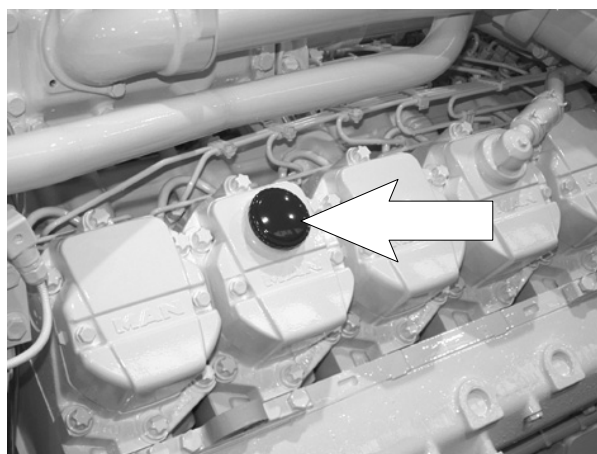

Commissioning

Before daily starting the engine, check fuel level, coolant level and engine oil level and replenish, if necessary.



Caution:

Use only approved fuels, lubricants etc. (see brochure “Fuels, lubricants etc.”). Otherwise the liability for defects will become null and void!

Checking oil level

Check engine oil level only approx. 20 minutes after the unit has been switched off.

- Pull out dipstick (arrow)
- wipe it with a clean, lintfree cloth
- and push it in again up to the stop
- Pull out dipstick again

The oil level should be between the two notches in the dipstick and must never fall below the lower notch. Top up oil as necessary.

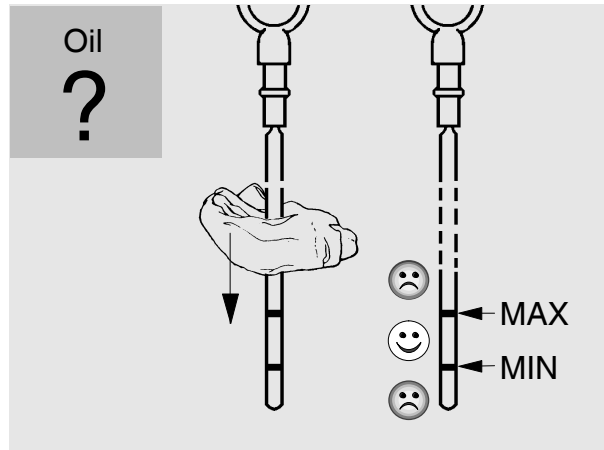
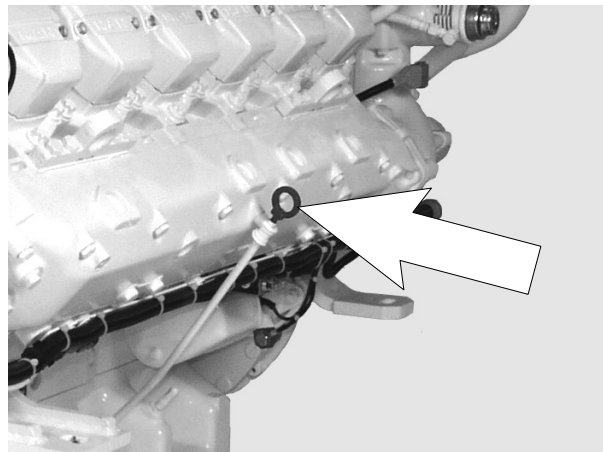

Caution:

Do not add so much engine oil that the oil level rises above the max. marking on the dipstick. Overfilling will result in damage to the engine.

Ensure utmost cleanliness when handling fuels, lubricants and coolants.

Starting

**Danger:**

Before starting make sure that no-one is in the engine's danger area.

**Caution:**

When starting do not use any additional starting aids (e.g. injection with starting pilot).

Ensure that the gearbox is in neutral.

Insert starter key and turn it to position "I". The check lamp comes on to show that the engine is ready for operation.

Turn starter key further to position "II" (pre-glow). The display lamp (usually in the driver's station) comes on.

After the pre-glow period the display lamp begins to flash. This signalizes that the engine is ready for starting.

**Note:**

If the engine is not equipped with a pre-glowing function, immediately turn the starter key through to position "III".

Turn key further up to the stop (position "III"). The display lamp goes out. The starter motor is actuated.

Lube oil pressure must build up at the oil pressure gauge. If it does not, switch off the engine immediately.

Do not operate starter for longer than 10 seconds at a time.

After ignition of the engine, release the starter button and adjust control lever for desired speed.

If engine fails to start, release the key, wait about 30 seconds, then operate starter again.

For repeated starting turn the key back to OFF.

If the engine is kept idling for long periods it may cool down and thus start to emit white or blue smoke.

We therefore recommend that you do not let the engine idle for more than 5 minutes. It is well known that with any internal combustion engine wear is higher during idling. Idling for longer periods is also an environmental nuisance.

Operation monitoring

**Caution:**

Do not overload the engine. Do not exceed the maximum permissible engine tilt. If faults occur, find their cause immediately and have them eliminated in order to prevent more serious damage!

If an engine / gearbox alarm is displayed on the monitoring devices, the engine is to be turned off or, i.e. operated at low load at max. 1200 rpm.

When the following alarms are displayed

- engine oil pressure / reduction of lubrication oil pressure
- engine coolant temperature / overheating of engine coolant
- engine charge-air temperature

the engine is to be turned off immediately and the cause of the fault properly remedied, i.e. in a specialist workshop.

Do not put this engine into operation again until the fault has been eliminated.

The engine is equipped as series standard with a monitoring and diagnostic system MMDS.

On the control console and alternatively on other control stands, the following display devices are available for monitoring operation:

Serially-controlled display devices:

1. Analog round instruments, see below
2. Display device MMDS-L, see page 21
3. Display device MMDS-LC, see page 23
4. Engine room panel MMDS-EP, see page 31

CAN bus-controlled display devices:

5. CAN-Bus round instruments, see page 32
6. Display device MMDS-CLC 6.3, see page 36

For operation and speed adjustment, MAN provides the following equipment:

7. Drive lever control system Mini Marex made by Bosch-Rexroth, see page 42
8. Optional: Emergency unit Em, see page 52

Serially-controlled display devices:

1. Round instruments

MAN can supply the following VDO round instruments for operation monitoring:

Revolution counter with integrated digital hours of operation counter

Oil pressure engine	0–6 bar
Oil pressure gearbox	0–25 bar
Oil temperature engine	50–150°C
Coolant temperature engine	40–120°C
Exhaust temperature engine	100–900°C
Voltmeter	18–32 V

2. Display device MMDS-L

The engine monitoring alarms the officer guiding the ship when important engine operating values are outside the permitted tolerance range.

- Acoustically by means of an integrated buzzer or horn connected at the ship-yard
- Visually in that the relevant warning lamp flashes

The engine operating parameters shown on the display device are monitored. If gearbox parameters are to be monitored, this depends whether the corresponding sensors have been fitted in the gearbox.

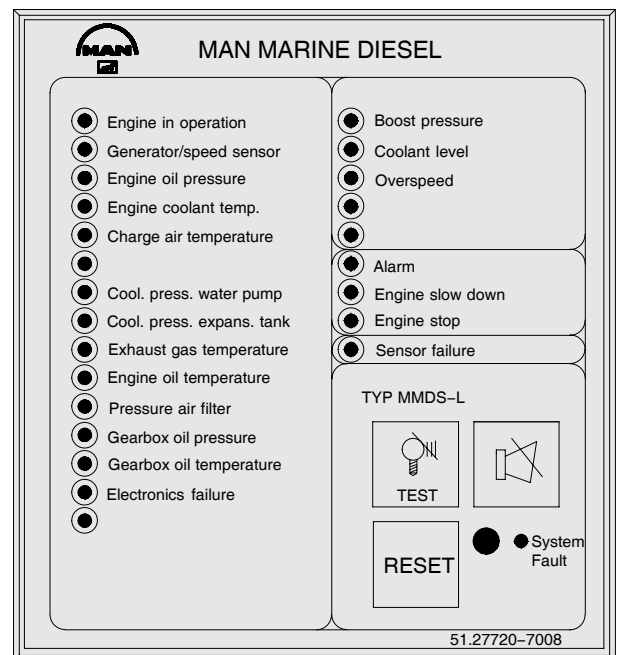

The device distinguishes between the following types of alarm, error messages:

- Preliminary alarm: the corresponding light-emitting diode flashes
- Main alarm: the corresponding light-emitting diode flashes
light-emitting diode “Alarm” flashes
In the case of an engine slow down alarm, “Engine slow down” also flashes
In the case of a stop alarm, “Engine stop” also flashes
- Sensor fault: the corresponding light-emitting diode flashes
light-emitting diode “Sensor fault” flashes

The alarm “Sensor fault” means that the corresponding sensor is classified by the monitoring system as defective, as it is returning an unrealistic value.
The engine speed is not reduced.

In the event of a fault in the electronic system, the warning lamp lights up continuously. There is then a defect in the electronic fuel injection (EDC).

So as not to endanger the engine, the engine power is automatically reduced in the case of selected main alarms.



Note for engines with electronically controlled diesel injection (EDC):

After the ignition has been switched on, the lamp “Electronic fault” lights up briefly (lamp test). If there is a fault in the electronically controlled diesel injection (EDC), the lamp “Electronic fault” lights up permanently.

Operation of the display device MMDS-L

The display device has the following operating keys:



Switches off the alarm horn and the integrated buzzer



Switches off the flashing signal of the relevant warning lamp, i.e. the flashing light switches to continuous light. Before the flashing signal is cleared, the alarm horn must be switched off.



Clears the alarm message (red warning lamp goes out)

Requirement for clearing an alarm message is:

- Pressing the keys “Horn off” and “Test” in that order
- Removing the cause of the alarm
- In the event of a reduction alarm the engine speed must be brought down below 800 rpm in order to be able to reach higher speeds again
- In the case of a stop alarm, the alarm can only be deleted if the engine is at a standstill

Function test of the warning lamps



If there is no alarm, the warning lamps can be tested.
When the “Test” key is pressed, all the warning lamps must light up

Dimming

All alarm LEDs are dimmed automatically depending on the ambient brightness. A photoelectric element integrated in the front plate ensures this.

Horn test

If the 'Clear horn' key is pressed for approx. 5 seconds, the fitted buzzer as well as possibly horns fitted at the shipyard go off.

System Failure

Two failure states are distinguished and indicated by the failure LED flashing or lighting up continuously:

- A flashing System Failure LED signals a communication fault, i.e. the data bus is interrupted or there is interference. In this case, the seating of plug-in connections for the MMDS-L and the serial distributor MMDS-SD are to be checked.
- Continuous lighting up of the System Failure LED indicates an internal fault. If this state remains after switching off and on again, the device is defective.

3. Display device MMDS-LC

The device serves to visualise analog engine data, as well as visual and acoustic notification of engine alarms. **All engine data is entered at the factory in the languages German, English, French, Italian and Spanish.**

“Scrolling” with the PAGE key enables the user to call up all the important engine data. Another key is used to show current alarms or warnings.

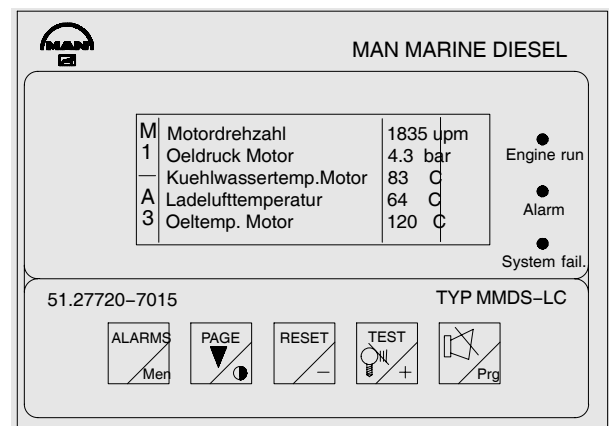

Representation of monitor pages

The analog engine data provided by the MMDS is distributed on 4 monitor pages. On each page, the current engine speed is displayed in the top line. The 1st page continues with the most important engine data such as oil pressure, coolant pressure, charge-air pressure and oil pressure in the gearbox. Other engine and gearbox data, as well as exhaust temperatures and supplementary information is shown on the subsequent pages:

Page 1 *Actual value (example)*

P1	Engine speed	2100	rpm
	Oil pressure, engine	4,3	bar
	Coolant temperature, engine	82	°C
	Charge-air temperature	41	°C
	Oil pressure, gearbox	19	bar

Page 2 *Actual value (example)*

P2	Engine speed	2100	rpm
	Coolant pressure compensator reservoir	830	mbar
	Coolant pressure coolant pump	3,9	bar
	Oil temperature, engine	103	°C
	Battery voltage	27,1	V

Page 3 *Actual value (example)*

P3	Engine speed	2100	rpm
	Intake air vacuum	30	mbar
	Charging pressure	1,86	bar
	Exhaust temperature T.A.	629	°C
	Exhaust temperature T.B.	613	°C

Page 4 *Actual value (example)*

P4	Engine speed	2100	rpm
	Oil temperature, gearbox	70	°C
	Fuel consumption	162	l/h
	Engine load	79	%

The pages are scrolled using the “**PAGE**” key. Each time the key is pressed, the screen moves up to the next page. After page 4, page 1 appears again.

For the display of current alarms and warnings, an alarm screen has been included. This is called up using the “**ALARMS**” key. If there is no alarm, the message “**no message**” appears on the screen.

A1	> no message	
-----------	--------------	--

If an alarm is activated, the device switches automatically to the alarm screen. Each new entry is made in the top line. Any messages that might already be present shift one line downwards. In a column to the right of this, the code and current time are added. Although a warning (message without alarm) is entered in the alarm screen, there is no automatic switch to that screen, e.g. in the case of a programmed ship alarm or ship-specific warning, see page 31.

The following codes are distinguished:

Warnings:	without code
Warnings (preliminary alarms):	WA
Main alarms:	AL
Sensor error alarms:	SE

Example:

	<i>Message text</i>	<i>Code</i>	<i>Time</i>
A1	Coolant temperature	WA	14:14
	Charge-air temperature	SE	13:57
	Coolant level		11:00
	Oil pressure, engine	AL	08:37
	Bilge pump ON		



Programmed ship-specific warning

If there are more than 5 alarms (e.g. during commissioning in the shipyard), the alarms can be displayed in groups of five (A2 to An) by pressing the “**ALARMS**” key again.

All alarms are always displayed in reverse order of their occurrence. The alarm generated last is therefore located in the first line of the alarm screen. As long as at least one alarm is active, the red LED “**Alarm**” to the right of the display lights up.

Alarms

If an engine alarm from the central unit MMDS or an alarm configured by the user is issued, the built-in buzzer is activated and the LED “Alarm” flashes. At the same time, the monitor switches automatically to the alarm screen. The new alarm is entered in the first line as a flashing message.

The alarms that would be issued if the engine is stopped but the engine ignition is on (e.g. lack of oil pressure) are suppressed (disabled) until the green LED “Engine run” lights up. This occurs approx. 8 seconds after ignition engine speed has been reached.

When the acoustic acknowledgement (Horn Quit key) has been pressed, the integrated buzzer switches off. With the visual acknowledgement (Visual Quit key), the flashing text and the LED “Alarm” switches to continuous display. When the fault has been remedied, the alarm text disappears from the monitor. The LED “Alarm” goes out unless another alarm has been issued.

In the case of alarms that have led to automatic stopping or reduction of the engine speed by the central unit MMDS, the “RESET” key must also be pressed. This function is only enabled in the case of a stop alarm at engine standstill and in the case of a slow down alarm below an engine speed of 800 rpm.

Horn test

If the 'Clear horn' key is pressed for approx. 5 seconds, the built-in buzzer sounds.

System Failure

The front plate of the device has a red LED with the description “System Failure”. This is activated in the following two cases:

- A** Failure of the serial data from the Safety, Alarm and Diagnosis system MMDS in the engine terminal box. In this case, LED “Alarm” also flashes and the message “System Failure” appears on the alarm screen.
- B** Fault in the LCD monitor itself. In this case, no other message appears.

Key functions

The front of the device has 5 keys that enable various functions such as scrolling, contrast adjustment, alarm acknowledgement and menu control. The keys have the following functions: Standard, Test, Menu and Special functions.

Horn Quit:



Standard function: acoustic acknowledgement or deactivation of the internal horn. All other monitoring devices in the system are acknowledged via the serial bus.

Test function: Holding the key for at least 5 seconds activates the built-in buzzer.

PRG menu function: adopt currently selected setting (Prg=program)

Visual Quit / Test: *Standard function:* visual acknowledgement, i.e. all flashing alarm texts in the currently visible alarm screen switch to constant representation if the horn was acknowledged beforehand; the red alarm LED integrated in the front plate is also switched from flashing to continuous lighting. All other monitoring devices in the system are acknowledged via the serial bus.



Test function if there is currently no alarm and / or all issued alarms have been visually acknowledged beforehand: Lamp test, i.e. the three LEDs in the front plate are activated as long as the key is pressed.

Special function: see explanation of key 

+menu function: Shift selection cursor to the right or increase input value.

RESET:



Standard function: The reset key can be used to reset a slow down or stop alarm:

A reduction alarm can only be reset after reduction of the speed below 800 rpm.

If the corresponding criteria have been met, horn and optics / test button pressed / activated and the cause of the alarm eliminated, the reduction or stop alarm in the central processing unit is reset.

Special function: see explanation of key 

--menu function: Shift selection cursor to the left or decrease input value.



PAGE:



Standard function: Switch to next highest display screen for analog engine data. The page number is indicated in the top left-hand side of the display with P1 to P4. Page 4 is followed again by page 1.

If this key is pressed while the alarm screen is on display, the monitor switches back to the analog engine data from which the alarm screen was originally called.

●-Special function: Key enables setting of the LCD contrast with simultaneous pressing of the keys

 or .

ALARMS:



Standard function: Calling up the alarm screen; the five alarms or warnings last issued and still present are displayed. At the top left of the monitor is the code A1. If there are more than 5 messages issued, the messages can be displayed in groups of five by pressing the key again. The page number is indicated in the top left with A1 to Ax. If the display jumps to the 1st alarm screen or the display remains unchanged when the key is pressed, no more messages are active.

Special function: Holding the key for at least 5 seconds activates the built-in configuration menu. There, the language, units, date and time can be set.

Menu function: Within the menu, this key has a cancel function (Esc). The program moves back by one menu level and / or from the main menu to the normal display function.

Menu functions

By holding the “ALARMS” key (for at least 5 seconds), you enter the configuration menu. The keys are now given the significance described at “*Menu function*”. The new allocation is shown in the bottom line in continuous black:

<i>Escape function</i> <i>Cancel</i>	<i>Move function</i> <i>Move selection cursor</i>	<i>Enter function</i> <i>Accept setting</i>
esc(Men)	move(+/-)	enter(Prg)



Menu guidance is in English and cannot be changed. You first enter the main menu, where the language and units for measurement point designations and measured values can be selected. There are also additional sub functions for time setting (set-time), as well as service functions, incl. PC communication (service). Each current selection can

be cancelled using the Escape function (menu key ). All other previously made settings are not influenced by this.

Selection of language and units



When the menu is opened, the current settings are shown highlighted in black. A flashing selection cursor marks the language currently set (e.g. English):

<i>English</i>	<i>German</i>	<i>French</i>	<i>Italian</i>	<i>Spanish</i>
> (US/GB) <	(D)	(F)	(I)	(E)

The selection cursor can be moved using the Move function (+– keys  ).

The Enter function (PRG key ) is used to accept each marked language and highlight it in black. The selection cursor then returns to the currently set unit for temperatures (e.g. °F):

<i>Display in degrees Celsius</i>	<i>Display in degrees Fahrenheit</i>
(°C)	> (°F) <

Selection is again using the Move function (+– keys  ) followed by accept-

ance using the Enter function (PRG key ). The selection is highlighted in black and the selection cursor jumps to the currently set unit for pressures (e.g. bar).

<i>Display in BAR</i>	<i>Display in PSI</i>
> (BAR) <	(PSI)

After selection and acceptance, all the settings for language and unit have been concluded and highlighted accordingly in black. The selection cursor jumps to the second last line to the item “**exit**”:

> exit <	back	set-time	service
-----------------	------	----------	---------

If this is confirmed using the Enter function (PRG key ) or you cancel at this point

using the Escape function (Menu key ) , you return with the currently marked mode to the normal display function. In the event of an input error, you can use the function “**back**” to repeat the input. The selection cursor jumps back to the initial position (language selection).

Setting the time

First, the selection cursor must be placed in the second last line. To do so, the current language and unit settings are confirmed each time with the key .

The selection cursor can now be positioned using the +- keys   to “**set-time**”.



exit	back	> set-time <	service
------	------	---------------------	---------

The function is called up using the PRG key .

A new page is opened and the current time (time / date) is displayed. The selection cursor jumps to “Hour”.



<i>set-time</i>		<i>hour</i>	<i>minute</i>	<i>second</i>
time	(H:M:S)	>13<	: 29	: 56
		<i>day</i>	<i>month</i>	<i>year</i>
date	(D:M:Y)	27	: 06	: 00

If nothing is to be changed, you can cancel using the Menu key . Otherwise, the

setting is made using the +- keys   and the PRG key  in the order

Hour, Minute, Second, Day, Month and Year. A correctly specified time or date is confirmed using the PRG key  and the selection cursor jumps to the next value. The year is given last, and the selection cursor jumps to the second last line to the item “**exit**”; the time setting is now concluded.

>exit<	Back	get-mmnds-time
--------	------	----------------

You return to the main menu by pressing the PRG key  or the Menu key .

In the event of an input error, you can use the function “**back**” to repeat the input.

An additional function makes it possible to download the system time of the MMDS central unit into the display module. To do so, the selection cursor is placed on “**get-mmnds-time**” and confirmed with

PRG . If the central unit is active (engine ignition on), the date and time are overwritten and the following message appears briefly in the display.

>>> LOAD MMDS-SYSTEM-TIME <<<

If the central unit is switched off (engine ignition off), nothing is changed and the following message appears:

>>> NO MMDS-TIME RECEIVED <<<

The selection cursor then jumps back to the second last line to the item “**exit**”:

Ship-specific alarms

There is the possibility to connect 11 ship-specific alarms or warnings and to generate these using software. The text of the alarms or warnings is entered by the shipyard. In the event of an alarm, the corresponding measurement point text appears on the alarm page; the program switches automatically into the alarm menu. In the case of warnings, the program does not switch automatically into the alarm menu.

4. Engine room panel MMDS-EP

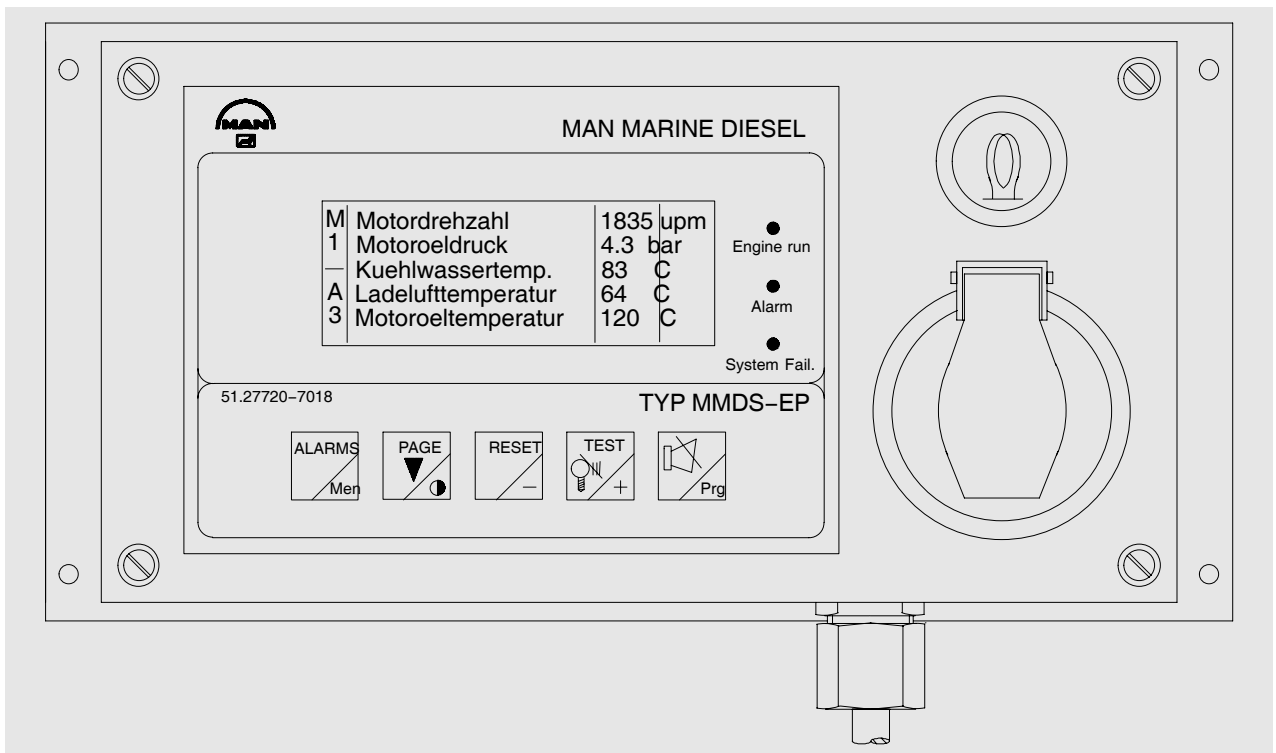

The functions of the keys and of the LCD displays are the same as those on the MMDS-LC (see operating instructions for MMDS-LC).

Differences to MMDS-LC:

- no ship-specific alarms can be programmed
- additional:
 - Ignition
 - Pre-glow plug



Note on pre-glow plug:

The pre-glow plug is not active in the in-line 6-cylinder engine (D 2876 LE401 /404), as this engine is not equipped with a pre-glow system. On V-engines, pre-glow can be fitted as an option. In ignition position “I”, the lamp lights up. Wait until the lamp begins to flash, then start.

CAN bus-controlled display devices:

5. CAN-Bus round instruments, rev counter with information display and buttons

- Rev counter (0–3000 rpm) with integrated LCD display for the following parameters and buttons for paging:
 - Engine oil pressure
 - Gearbox oil pressure
 - Engine coolant temperature
 - Engine oil temperature
 - Engine exhaust temperature
 - Charge air temperature
 - Charge air pressure
 - Load
 - Hours of operation
 - Fuel consumption
 - Battery voltage

- | | |
|------------------------------|-----------|
| ● Engine oil pressure | 0–10 bar |
| ● Engine oil gearbox | 0–25 bar |
| ● Engine oil temperature | 50–150°C |
| ● Engine coolant temperature | 40–120°C |
| ● Engine exhaust temperature | 100–900°C |
| ● Battery voltage | 18–32 V |

Tachometer CAN-Master

The VDO Ocean Link Tachometer (CAN-Bus Tachometer)









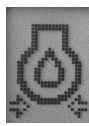
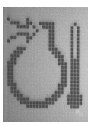

The VDO Ocean Link tachometer is a multifunctional instrument for indicating engine data, and is intended for use in navigation of sports ships. The tachometer shows the actual engine speed in operating, on the analogue scale. Further values and operating aids appear in the LC-display.

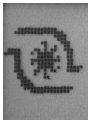
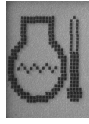
The instrument has a push-button key on the front side, with which all the functions can be selected. Handling of the instrument is thus easy and uncomplicated.

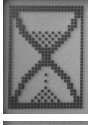

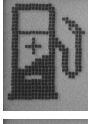
Main Functions

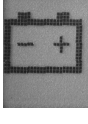
The main functions of the VDO Ocean Link can be called by pressing the push-button key. Each time the key was pressed, the next measured value is displayed.

	- Engine oil pressure		- Charge air temperature
	- Gearbox oil pressure		- Charge air pressure
	- Coolant temperature		- % Load
	- Engine oil temperature		- Running time
	- Exhaust gas temperature before turbine 1 D 28 in line- and V-engine		- Instantaneous fuel consumption
	- Exhaust gas temperature before turbine 2 D 28 V-engine		- Battery voltage
	- Exhaust gas temperature after turbine D 08 engine		

The exhaust temperature to be displayed must be set when the display messages (Screen on / off) are selected.

Setting possibilities

Further settings can be made by pressing the button:

- Selection of illumination intensity in 8 steps
- Selection of display unit in metric or english units
- Selection of transmitters for the analogue inputs

Selection of illumination intensity

If you keep the push-button key pressed for 4 seconds, the roll bar for the illumination setting appears. By repeated pressing of the key you can change the illuminating of the tachometer and the connected bus display in 8 steps. The display jumps back to the normal operating mode 8 seconds after the last key depression. The illumination setting is retained even switching off the power supply and switching on again.

Please note that setting of the illumination is possible only if external illumination is set to "Internal" in the settings menu.

Basic Settings

The basic settings necessary for perfect operation can be selected in the settings. These are obtained by pressing and holding the push-button key while switching on the power supply of the display.

Display Units:	Selection of display unit
Screens on / off:	Selection of display
Simulator Mode:	Activation of simulator mode
Exit Setup:	Ending the setting menu

In order to change a value (e.g. from NO to YES), press the push-button key briefly. In order to not change a value, keep the push-button key pressed until the set value flashes once. Then release the push-button key immediately. Through this the displayed setting is taken over. If the push-button key is not pressed, the displayed setting is automatically taken over after 10 seconds.

Selection of the display units

The values for temperatures and pressures can be displayed alternatively in the units °C/bar (METRIC) or °F/psi (ENGLISH). Selection of the units is carried out as follows:

In the example shown the unit is changed from METRIC to ENGLISH.



Setting the illumination (external illumination)

Select here whether illumination of the tachometer and the connected bus instruments are to be connected internally or externally.

EXTERNAL:	The illumination is switched on and off through an input of the 14-pole plug. Dimming of the illumination is thus not possible.
INTERNAL:	The illumination is regulated in the normal operating mode by pressing and holding the push-button key in 8 steps.

Selection of the displays (screen on / off)

Select here witch measured values are to be displayed in the normal operating mode.

- YES:** Here all measured values, with their ISO symbol, are displayed. By selecting "NO" the measured value can be removed from the normal operating mode. If the measured value is to be displayed again, select "YES" when the ISO symbol of the measured value is displayed.
- NO:** No change in the setting are made.

Activation of the simulation mode (simulator mode)

Select here whether the simulation mode is to be switched on.

- YES:** The simulation mode is switched on. The display now generates random values for all measuring channels and displays these. The measured values are also transmitted to the bus instruments.
- NO:** The simulation mode is switched off.

Please note that the simulation mode still remains after switching off and switching on again, if it has not been switched off by selecting NO.

Setting of the number of exhaust gas temperature measured values (charge boost amount)

Select here whether one or two measured values are to be displayed for the exhaust gas temperature before the turbine.

- 1:** One exhaust gas temperature measured value.
- 2:** Two exhaust gas temperature measured values.
(V-type engines)

Ending the settings (exit setup)

Select here whether the settings are to be exited.

- YES** The settings are exited, the display restarts in the normal operating mode.
- NO** The settings are restarted.

6. MMDS-CLC 6.3 display device (colour display)

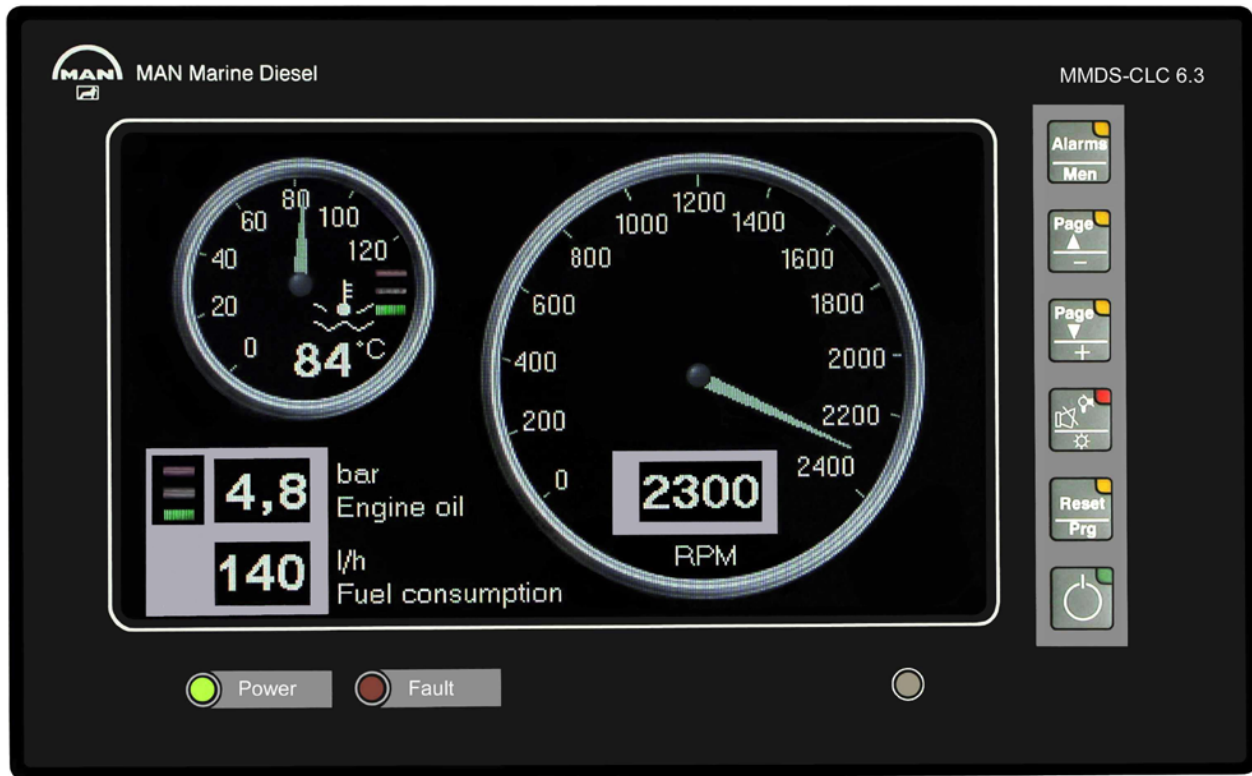

Introduction

This document describes how the MMDS-CMS 6.3 colour display with MMDS-CLCB 6.3 remote control operates and is used in its application as an engine display allowing monitoring of engine operation. Fitting, mounting and installation are explained in separate instructions for the device.

The engine and gearbox data are represented graphically on the colour display in the form of dials and digital displays. LED symbols are used to display alarms; these are complemented by a table which lists all alarms present with more detailed information.

A logo which will be displayed on all pages may be activated on commissioning. The shipyard can set this logo selection itself using integrated DIP switches.

Buttons

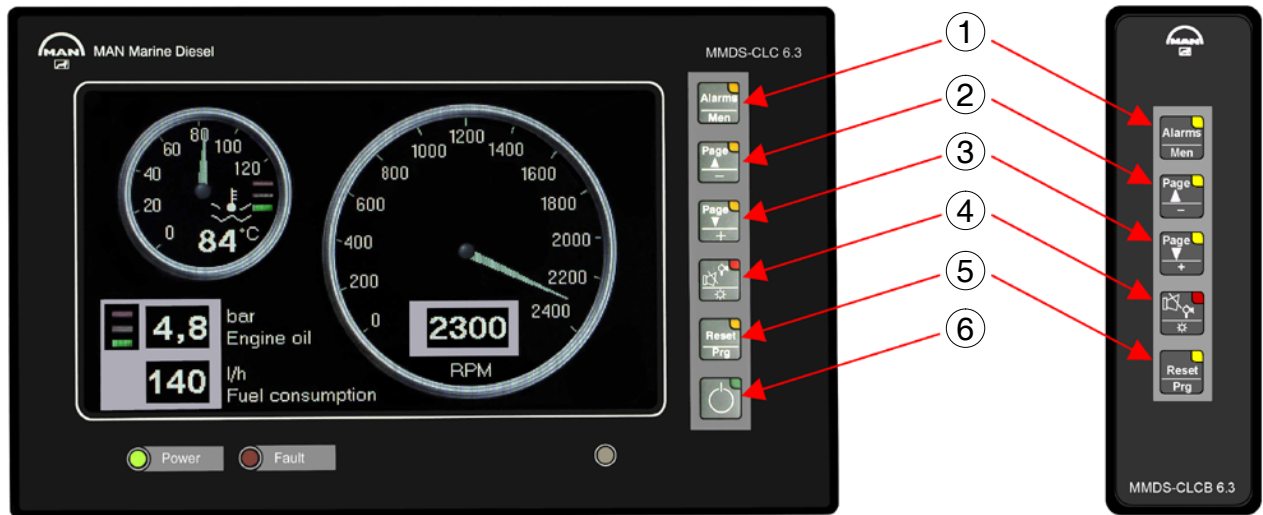

Figure: Numbering of the operating buttons

Operational functions and configuration

The display is switched on and off using the Power button (bottom right).

The system is operated and the display is configured using the buttons above this or the MMDS-CLCB 6.3 remote control.

The following functions are implemented:



Default function: Call the alarms table, or browse to further alarm pages.

Additional function: If pressed longer than 5 seconds => Switches configuration menu on and off.



Default function: Browse to the previous page

Additional function in the menu: Change parameters / Reduce value.



Default function: Browse to the next page.

Additional function in the menu: Change parameters / Increase value.



Default function: Acoustic and optical acknowledgement of all monitoring devices connected to the same CAN bus.

Additional function: –

Test function: If there is no alarm current at the time, or if all alarms previously occurring have been optically acknowledged, and if this button is pressed for more than 5 seconds, a horn test is performed, ie the internal buzzer and the horn relay are supplied for as long as the button is pressed.



Default function: A reset signal is sent on the CAN bus to the engine monitoring and diagnostic system control unit (engine terminal box) or to a data station. As long as the appropriate criteria are fulfilled, the engine slow down or shut-down alarms arising are reset.

Additional function in the menu: Accept change and pass to the next parameter.



Function: Switches display on and off (only on display, not on the remote control).

Function

The colour display is automatically activated when the supply voltage is applied. It can then be switched on and off manually using the “Power” button ⑥. There are two screen pages for displaying the most important engine and gearbox data. Alarms are displayed in an alarms table.

The engine speed display incorporates a damping algorithm to simulate mechanical instruments. This means that small variations do not lead to an unstable display, which could irritate the officer controlling the ship.

Graphical display of engine and gearbox data

When the display is switched on, it opens automatically on the start page which shows the engine speed and coolant temperature in representations of dials, and the engine oil pressure in digital form. If the engine has an electronic control system (EDC), the calculated fuel consumption is displayed at the bottom left.

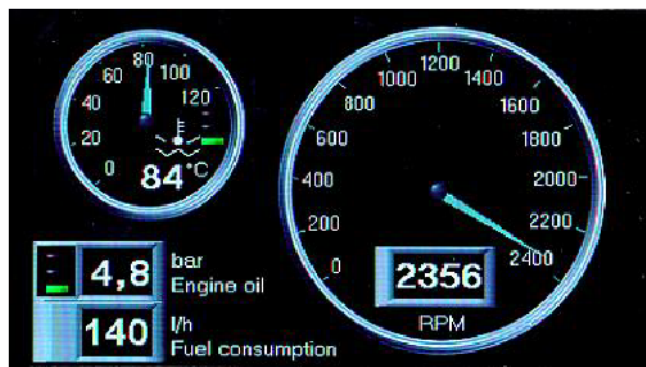

Figure: Page with analogue and digital display elements

A second page shows engine and gearbox data as digital display values. The engine speed is also displayed on a bar graph. This consists of 14 LEDs, 12 green, one orange and one red. Increasing numbers of green LEDs are lit with increasing engine speed. The orange LED is also switched on if the speed exceeds 2400 rpm, and the red LED once 2600 rpm is exceeded.



Figure: Page with digital display elements

The “Page ▲” ② and “Page ▼” ③ buttons can be used to toggle between the graphical pages. If the alarms table is currently active, the most recently displayed graphical page is called.

Alarms

Should an alarm condition occur, an alarms table is automatically displayed. This lists all advance warnings, alarms and sensor fault alarms. An internal buzzer and the horn relay are activated at the same time. The collective alarm relay drops out after three seconds. The collective alarm relay issues a repeat pulse if another alarm was already active. It is picks up for approximately 3 seconds, and then drops out again. In this way, it is possible to activate a visual call system for each new alarm or to send a telephone message if the ship is not occupied. Acoustic acknowledgement with the ⑤ button switches the internal buzzer off and the horn relay drops out.

Apart from the engine speed, all displays that are monitored for their value falling short of or exceeding limit values have LED symbols to display alarm conditions. As long as the green LED is lit, the value is in the “normal range”. When an advance warning occurs, the orange LED flashes. The red LED flashes for an alarm. All flashing displays return to steady illumination after optical acknowledgement (button ④). The alarm display only changes to the “normal state” once the fault has been rectified and acknowledged both acoustically and optically (button ④).

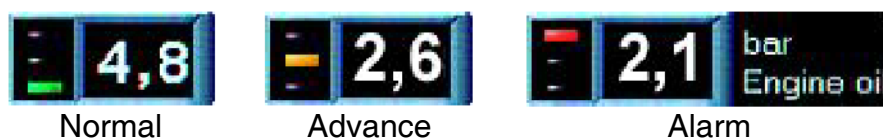

Figure: Example of a display with alarms

The engine monitoring and diagnostic system control unit monitors all important sensors for plausibility. If a sensor fault alarm occurs, the value is cleared from digital displays and the pointer is removed from dials. The LED indicating the alarm condition goes out.

The “Reset” button ⑤ must also be pressed in the case of alarms that have lead to the automatic shutdown or deceleration of the engine by the engine monitoring and diagnostic system control unit. This function is enabled for a shutdown alarm only when the engine is at a standstill and for a shutdown alarm below a speed of 800 rpm.

Menu functions

The device incorporates a clock that is set in the factory. The time can be reset. Pressing the “Men” button ① for approximately 5 seconds brings up the clock setting function. The value in the field currently highlighted in red can be adjusted using the – ② and + ③ buttons. Pressing the “Prg” button ⑤ switches the highlight to the next field. Pressing the “Men” button ① once more for approximately 5 seconds accepts the values set and quits the menu. The display switches to the alarms table.

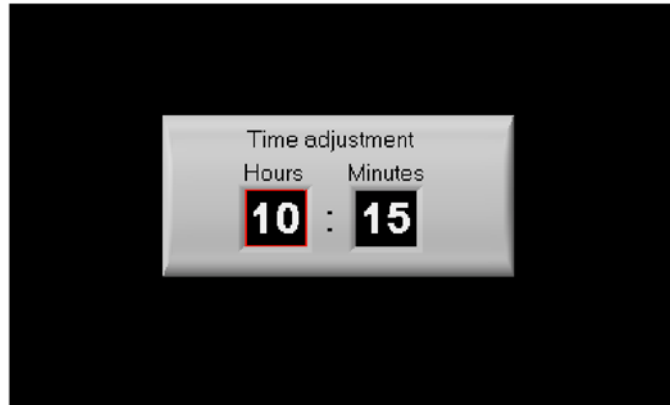

Figure: Setting the time

7. Drive lever control system Mini Marex



Danger:

For safety reasons a separate, functioning red emergency-stop-button for each engine must be installed at every bridge (the engine must stop immediately when the button is pressed once).

At the request of the shipyard or customer, it is possible to purchase from MAN an electronic drive lever control system made by Bosch-Rexroth, type Mini Marex.

This control system has plug connections specially configured for MAN.

Operation of the control system:

Command master

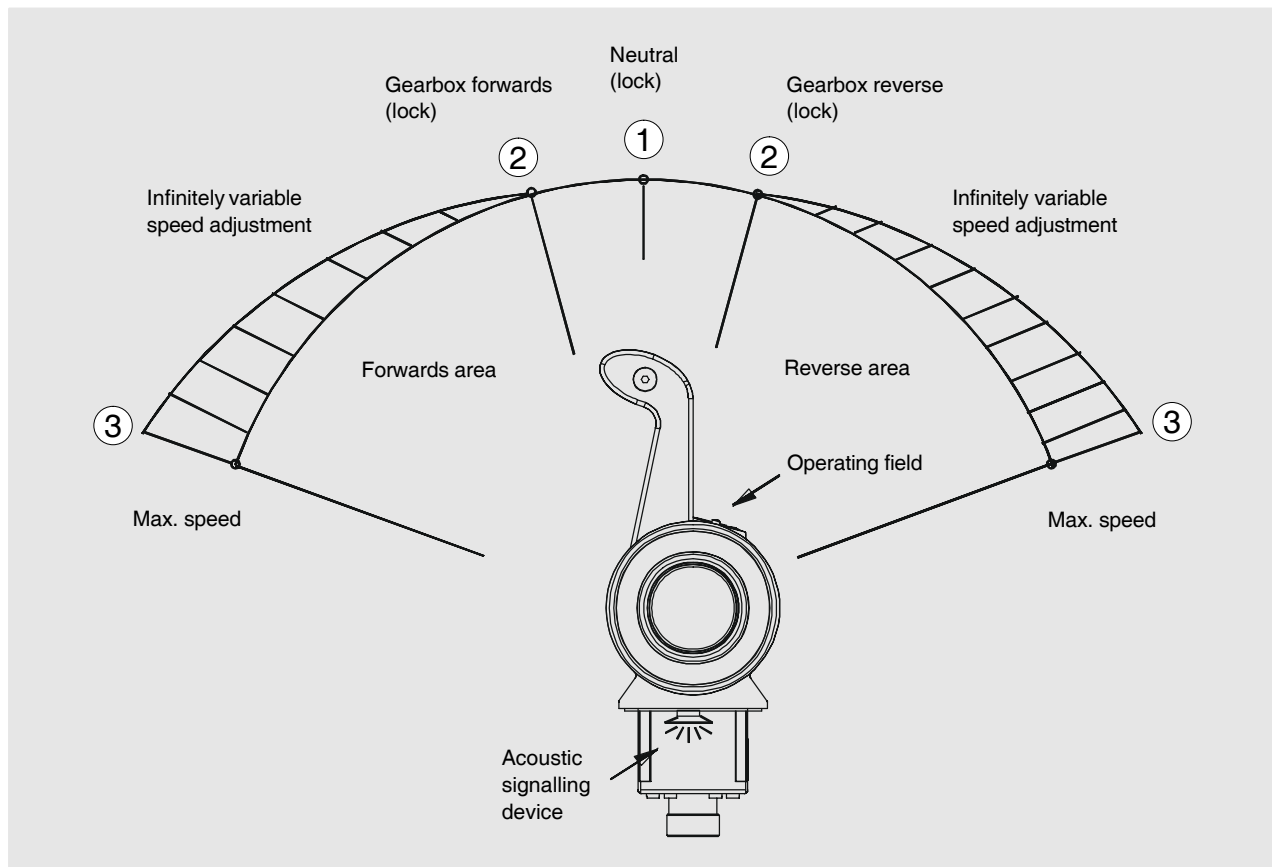

“Neutral” (lock) position ①

In this position, the gearbox clutch is disengaged and the power unit is idling. Each time the “Neutral position” is reached, the control system indicates this acoustically by means of a short “beep tone”.

“Gearbox forwards / reverse” (lock) position ②

In this lever position, two different functions are possible.

1. Standard function:

The gearbox clutch is engaged to “Forwards” or “Reverse”; the power unit is idling.

2. “Increase engine speed” function:

The “Increase engine speed” function is set. The engine speed of the power unit is raised prior to engaging the clutch and after disengaging the clutch it is lowered again to idling speed. Between the clutch engaging operations, individual delays (waiting periods BEFORE and AFTER clutch engaging) can be set.

“Maximum engine speed” position ③

Position ③ shows the “maximum engine speed” for the “Forwards and Backwards Range”. Between positions ② and ③, the engine speed can be set variably. The gearbox clutch is engaged to “Forwards” or “Reverse”.

Operating panel – command master for twin-engine systems

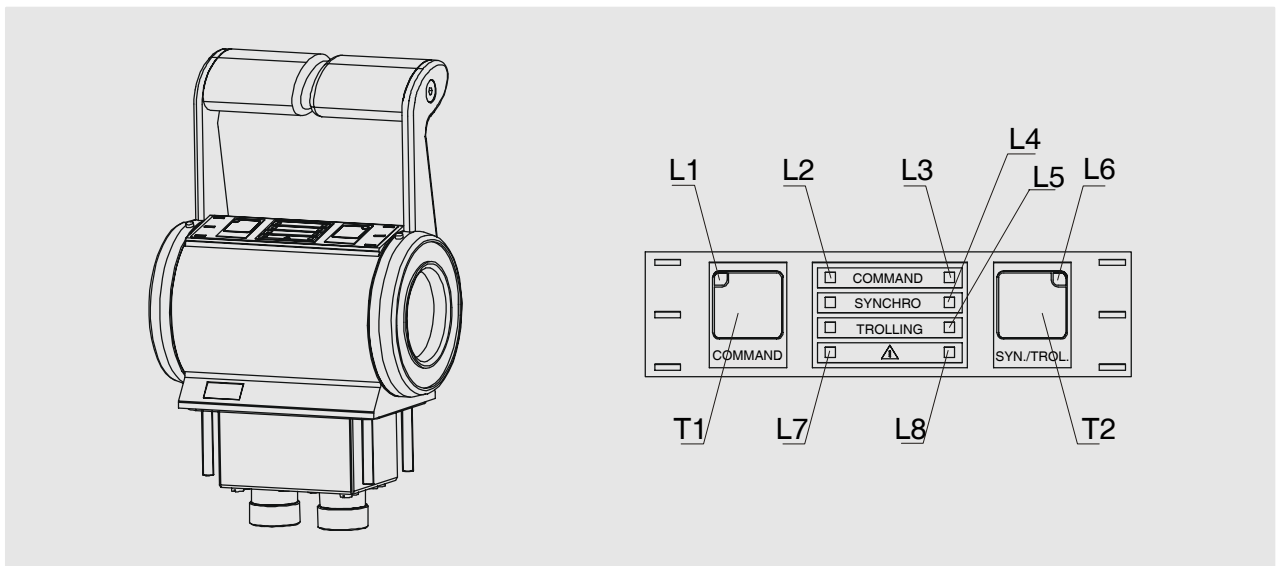

Key “Command takeover” T1



The “Command takeover” key occurs only once on the command master. The key is permanently illuminated weakly via LED L1 and indicates that the control system is being supplied with voltage. The key serves to take over commands onto the relevant control stand.

The key has two other additional functions.

Additional function “Warming Up”

The expression “Warming Up” means “engine running without shifting gear”, which enables, for example, warm-up of a cold power unit across the entire speed range. The gearbox clutch is not engaged in lever position ②.

Starting the “Warming Up” function:

☞ The “Warming Up” function can only be started at an active command master and only from the position “① neutral”.

1. Set the control lever of the command master in position “① neutral”.
2. Press the key “Command takeover” and keep it pressed.
3. Set the control lever of the command master in position “② gearbox forwards / reverse”.

The “Warming Up” function is indicated acoustically by a short “double beep” tone and visually by a brief, rhythmic extinguishing of the command master lighting.

4. Release the “Command takeover” key.

The engine idles and the gearbox clutch remains disengaged. The control lever can now be moved towards position “③ maximum engine speed”. The entire engine speed range between the positions ② and ③ is available.

☞ In the case of twin-engine systems, any power unit can be run separately.

Quitting the “Warming Up” function:

To exit from the “Warming Up” function, the control lever of the command master must be set to position “① neutral”. The normal “beep” tone sounds for the “Neutral position”. The command master lighting returns to continuous light. The function is disabled.

**Note:**

If the control lever is shifted from “Forwards” to “Reverse” or vice versa during the “Warming Up” function, the “Warming Up” function stops automatically when position “① neutral” is reached. When position “② gearbox forwards / reverse” is reached again, the gearbox clutch would be engaged again.

Additional function: switch error message to mute

The acoustic signal transmitter, which is activated for some alarms, can be disabled at the relevant control stand by pressing the “Command takeover” key.

☞ However, this does not delete the alarm!

Display Alarm L7 and L8



This display element is present on the command master twice (once for the port system / once for the starboard system). In the event of a fault, the “Alarm lamp” lights up continuously in red.

☞ When the control system is switched on, the “Alarm lamp” is also lit up continuously in red, but this is extinguished following command takeover.

Key Syn./Trol. T2



This key can be used to ENABLE and DISABLE special functions enabled beforehand in the setting unit (key is permanently illuminated weakly via LED 6).

The following special functions are available for this setting unit:

1. Engine speed synchronisation (only twin-engine systems)
2. Trolling

The “Syn./Trol.” key can be used to operate both functions in parallel, but not simultaneously.

Engine speed synchronisation (only possible with twin-engine systems)

If the special function “Engine speed synchronisation” has been enabled in the setting units, twin-engine systems provide the possibility to synchronise the engine speeds of both drive engines. For both drive engines to run synchronously, an engine speed feedback signal from a speed sensor is required for each engine.



Pressing the “Syn./Trol.” key (press once) enables the “Engine speed synchronisation” function. Pressing the key again (press once) disables the function once again.

It is only possible to enable or disable the engine speed synchronisation on the active control stand when both command master levers are in the engine speed range “Forwards” or during the “Warming Up” function. Before exiting from these areas, disable the “engine speed synchronisation”.

While the function is active, LED 4 “SYNCHRO” shows continuous light.

- ☞ As soon as one of the command masters leaves the engine speed range “Forwards” without terminating the synchronisation beforehand, it is switched off automatically. In this case, the LED “SYNCHRO” flashes rapidly (approx. 0.2 seconds on / 0.2 seconds off) and the acoustic signal transmitter issues a continuous tone at the active control stand (this is not a fault alarm but a warning). The second command master must then be set into the “Neutral” position to terminate the warnings. The engine speed of the relevant command master is kept at idling speed during this period.

While the control system is in the function “Synchronisation”, the engine speeds of both power units can **only** be changed using the control lever of the “Master system”. If there is a command change to another control stand, the active function “Engine speed synchronisation” is also taken over onto the new control stand.

Trolling

If the special function “Trolling” has been enabled in the setting units, there is the possibility to use the “Syn./Trol.” key to enable the trolling mode to continuously adjust the clutch slip.

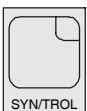

Pressing the “Syn./Trol.” key (press once) enables the “Trolling” function. Pressing again (press once) disables the function once again.

It is only possible to enable or disable the trolling function on the active control stand when the command master lever (both command master levers in the case twin-engine systems) is (are) in the “Neutral” position. While the function is active, LED L8 “Trolling” shows continuous light.

If there is a command change to another control stand, the active function “Trolling” is also taken over onto the new control stand.

- ☞ **In the trolling mode, the command master function changes in comparison to the power shift mode.**

The command master function in the trolling mode is described below.

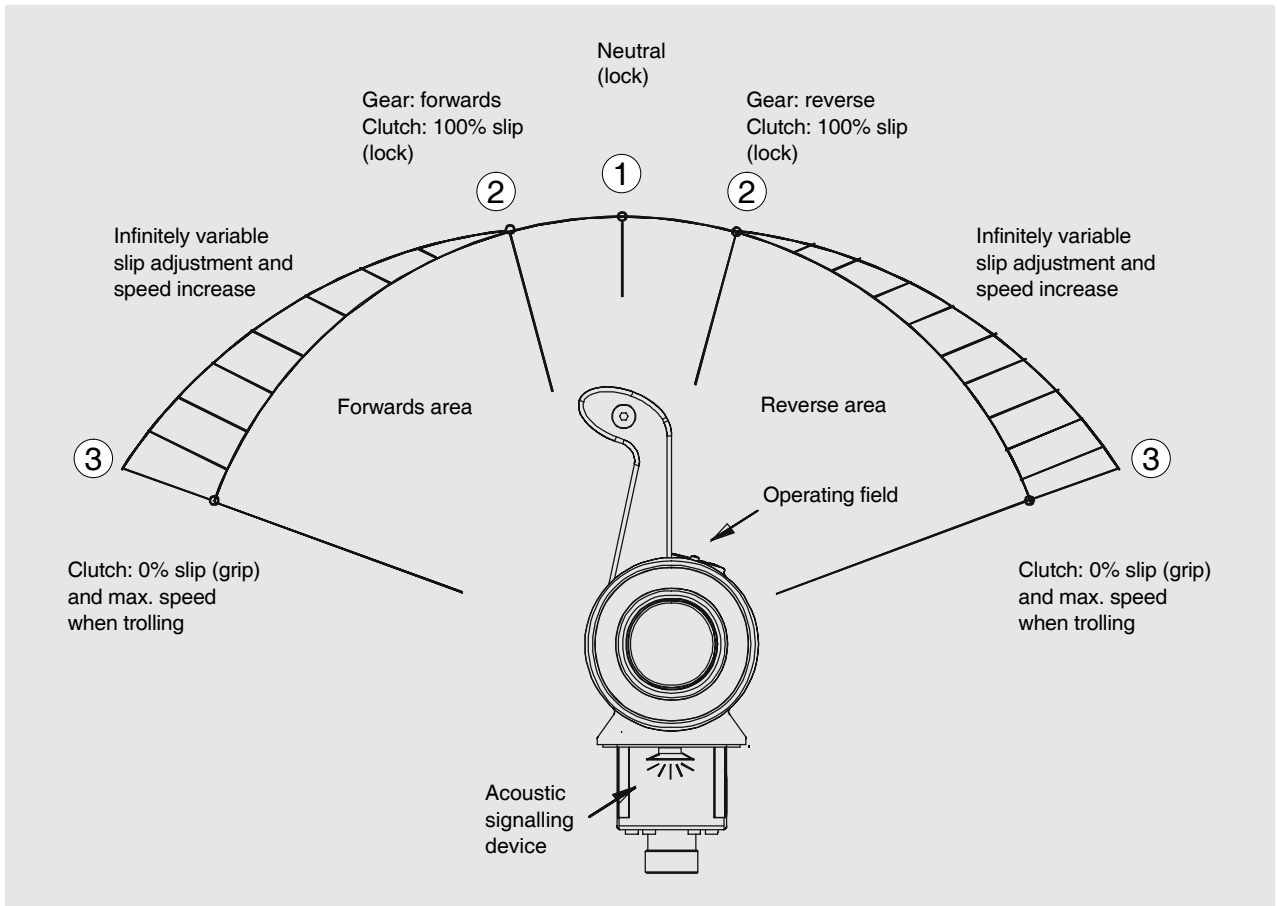

To enable the trolling function, the command master must be in position ① “Neutral” (lock). The engine idles and the gearbox is in neutral.

If the trolling mode is enabled, the clutch is set to its highest slip level (100% slip). The engine continues to idle and the gearbox is in neutral.

If the command master lever is set in position ② (lock), the gearbox is shifted into the “Forwards or Reverse” position. The engine idles, but due to the greatest possible clutch slip (100% slip) is not yet able to turn the propeller shaft, or can do so only very slowly.

If the command master lever is moved further towards position ③, the clutch slip drops continuously and at the same time the engine speed rises.

When position \hat{A} is reached, the clutch is in the smallest possible slip position (0% slip / frictional connection) and the engine speed has reached the set value for “Maximum engine speed for trolling”.

Acoustic signal transmitter



The acoustic signal transmitter is located below the command master and is present once on each system (once for the port system and once for the starboard system).

The signal transmitter supports the visual displays of the command master lighting and the alarm lamp with acoustic signals. In addition, each time the “Neutral position” of the control lever is reached, it issues a short “beep tone”. The start of the “Warming Up” function is indicated by a short “double beep” tone.

Display Command L2 and L3



Continuous light of the “Command” display indicates which command master is currently in command. The “Command” displays of the other control stands are disabled.

If the command is requested on this master, the “Command” display flashes.

If the command master is in the “Warming Up” function, this is indicated by a brief, rhythmic extinguishing of the “Command” display.

The “Command” display is present on the system once (once for the port system / once for the starboard system).

Enabling the control system with command masters

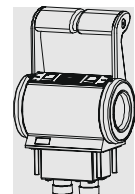

1. Switch on control system

Execution: – apply supply voltage.

Consequence: – Display “Alarm” (red) on all control stands lights up continuously.
– “Command” and “Syn./Trol.” keys. On all control stands weakly lit up (only visible in darkness).
– Acoustic signal transmitter sounds with slow intermittent tone on all control stands.

2. Command request:

The command can be requested at any control stand. The control levers of the command master on the requesting control stand must be set at the “Neutral position”.

☞ “Command master calibration and enable of control stands” must have been carried out. Otherwise, the command can only be taken over at control stand 1.

Execution: – Set the control lever of the command master to the “Neutral position”.
 – Press “Command” key once for command request.

Consequence: – Display “Alarm” (red) on all control stands remains lit up continuously.
 – Acoustic signal transmitter sounds with fast intermittent tone on all control stands.
 – The display “Command” flashes rapidly.

☞ If the control system continues to issue long lighting and tone intervals, it is usually the case that the control lever of a command master is not in the “Neutral position”.

3. Command takeover:

Execution: – Press “Command” key once again for confirmation of command request.

Consequence: – Display “Alarm” (red) goes out on all control stands.
 – Acoustic signal transmitter remains silent on all control stands.
 – “Command” display shows continuous light on the command master in command.
 On all other command masters, the “Command” display is off.

The command is now at this control stand. The control system is ready for operation (standby).

Command change between control stands

For a command change to a different control stand, there are two variants which have to be set using DIP switch 1–2 in the setting unit. Command change with **lever comparison** or **free** command change.

On twin-engine systems, **both setting units** must have the same setting.

☞ **“Command master calibration and enable of control stands” must have been carried out.**

Otherwise, the command can not be changed between the individual control stands.

Command change with lever comparison

The control system compares the lever positions of the command masters involved in the control stand change. A command change from one control stand to another can only take place if the **lever of the requesting command master** is either in the “Neutral position” or in the same travel direction position as the **lever of the command master that is in command**.

The command change for this variant takes place in two steps.

1st step: Command request on the selected control stand.

Execution:

- Set the control lever of the command master in the takeover position (“Neutral” position or same travel direction as the command master that is in command).
- Press “Command” key once to request the command on this control stand.

Consequence:

- The acoustic signal transmitter “beeps” in short intervals.
- The display “Command” flashes rapidly.

The command is now requested on this control stand. The control system has enabled the command takeover and indicates this by means of short tone and lamp intervals.

☞ If the control system issues long lamp and tone intervals, the subsequent command takeover is refused. In this case, the control levers of the command master are usually not in the correct position or there is a fault in the system.

2nd step: Command takeover on the selected control stand.

Execution: – Press “Command” key once to take over the command on this control stand.

Consequence: – The acoustic signal transmitter is silent.
– The “Command” display shows continuous light.

The command takeover is complete and the command is now at this control stand.

Free command change (without lever comparison)

With this variant, a control stand change takes place without taking account of the lever position of the command master involved in the command change. The command change takes place in one step.

Command takeover on the selected control stand

Execution: – Press “Command” key (white) to take over the command on this control stand.

Consequence: – The “Command” display on the selected control stand immediately shows continuous light.

The command is immediately at this control stand and the control system **instantly** runs the lever position of the command master set here.



In this variant, carelessness can lead to manoeuvres that are not intended.

Example: Lever of the active command master is in position “Full forwards”.
Lever of the requesting command master is in the position “Full reverse”. If there were a command change, a full reverse manoeuvre would be performed immediately.

8. Emergency operation unit:

The emergency operation control system – Em – is conceived as a simple engine speed and gearbox control system which enables safe continuation of a trip in the event of a failure in the electrical control lever system.

The operating unit for the emergency operation control system is integrated preferably near the control lever in the bridge control console. For safe ship operation, the keys on the front must be easily accessible. When the ignition is on, emergency operation can be activated using the corresponding function keys. A green LED indicates standby mode.

Operation is by means of six keys on the front, which light up when a requested mode is reached and thus return the corresponding operating mode or actual mode.

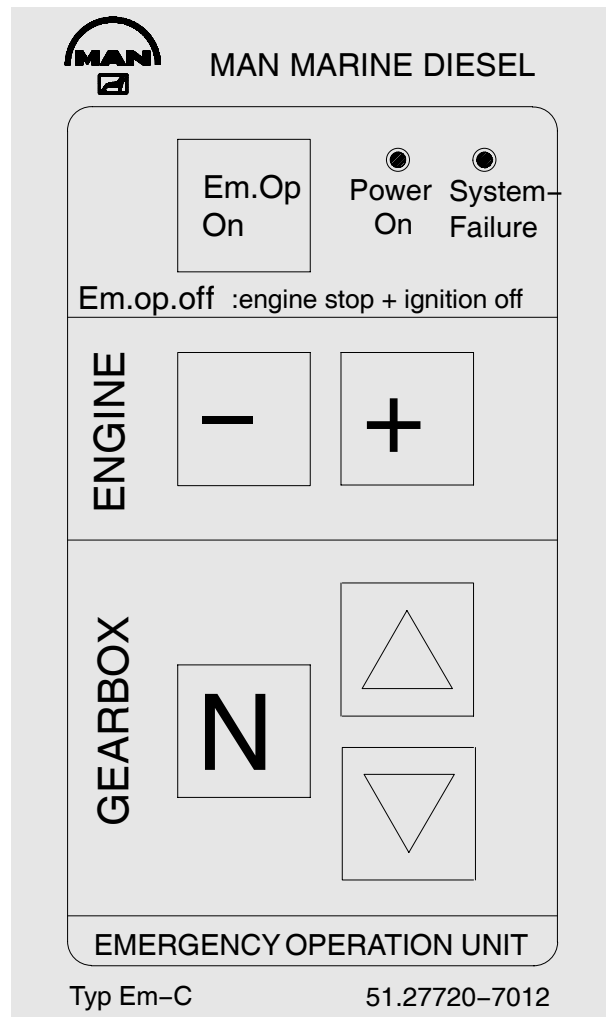

Key		Activate emergency operation
Key		Shift gearbox to neutral position
Key		Shift gearbox to forwards position
Key		Shift gearbox to reverse position
Key		Increase engine speed
Key		Decrease engine speed

LED Power On indicates the presence of supply voltage when the ignition is on

LED System Failure indicates failure status by flashing or with continuous light

Operating the emergency operation unit

Requirements for operation / activation / deactivation:

- Operation of the emergency operation control system is only permitted in neutral position of the command master of the control lever system
- The emergency operation control system should only be activated when the engine is running. Otherwise, the LED “System Failure” flashing indicates that the engine speed signal is missing
- The engine should be switched off using the ignition

When the emergency stop switch is activated while the ignition is on, the LED “System Failure” lights up on the Em-C operating unit, as the active systems EDC engine control and emergency operation unit are switched off by the emergency stop. The LED “System Failure” goes out when the emergency stop switch is unlocked.

Operation / function of emergency operation unit in operation:

Enabling emergency operation unit

The system is ready for operation (standby) after the ignition is switched on. This is indicated by the green LED “Power On”. The red LED (Failure) must not light up. Pressing the “**EM.Op On**” key twice can now activate the emergency operation system:

Em.Op On The first press of the key requests emergency operation. The key flashes for approx. 6 seconds in cycles and an acoustic signal is sounded. During this period, the request must be confirmed by a second press of the key. The key lights up permanently as soon as emergency operation has been activated.

If the confirmation by the second press of the key is not given, the system returns to the initial position (power on – standby).





Note:

Once the emergency operation system has been activated, switching back to normal control lever operation only takes place when the engine is switched off (at least 3 seconds ignition OFF).

Gearbox control

With emergency operation active, the gearbox is controlled using 3 key functions in the positions Neutral, Forwards or Reverse:

Key		Shift gearbox to neutral position
Key		Shift gearbox to forwards position
Key		Shift gearbox to reverse position



Gearbox shifting only takes place when the engine speed is in the idle range. It is advisable always to switch the gearbox into neutral first prior to reversing. However, if reverse is requested directly after forwards (or vice versa) and the engine is at a higher speed, the engine is automatically returned to idling speed prior to each active gear shift.

As long as the desired state has not yet been reached, the key that has been pressed flashes.

It goes out as soon as another control command is issued or it signals with continuous light that the gear shift has taken place (display of the actual state).

Engine speed control

If the gearbox is in forwards or reverse position, two key functions can be used to increase or decrease the current engine speed:

Key		Increase engine speed
Key		Decrease engine speed

As long as the + or – keys are pressed (“Tastensymbol einfügen”), there is a continuous change in the engine speed.

The rate of increase and / or rate of change is 50 revolutions per second.

With a single brief press of the key, the engine speed changes by 10 engine revolutions.

The engine speed is restricted downwards to the idling speed and upwards to the maximum permitted engine speed.

Disabling emergency operation

Emergency operation is always terminated automatically when the engine is switched off; the ignition must be switched off for at least 3 seconds.

After switching on again, normal control lever operation is enabled first, i.e. the emergency operation system must be reactivated if required.

Fault messages

Two LEDs on the Em-C operating unit (green LED “Power On” and red LED “Failure”) enable the distinction of various failure states:

Green LED off and red LED off

*Ignition switched off or no supply voltage
(emergency operation not possible)*

Green LED on, red LED flashing without any other operating key also flashing

*Failure of the internal engine speed signal
(function still possible with delayed shift times)*

Green LED on, red LED flashing together with the forwards key

*Fault following gear shift in forwards direction
(this travel direction can no longer be activated)*

Green LED on, red LED flashing together with the reverse key

*Fault following gear shift in reverse direction
(this travel direction can no longer be activated)*

Green LED and red LED continuously on

*System failure or no communication between Em-C and Em-R.
(emergency operation not possible)
Em-R is the receiver component in the terminal box.*

Fault states that are indicated by flashing on the Em-C operating unit must be acknowledged using the **(N) key** after the fault has been rectified. Until this acknowledgement, the fault message continues to flash.

Main fuses for + / - on the engine

Two main fuses with 20 A are fitted at the engine; these blow in the event of overcurrent or short circuit.

If a fuse as blown, the engine can no longer be started.

The fuses can be reset by the operator using the keys fitted.

There are two different possibilities for fitting the fuses:

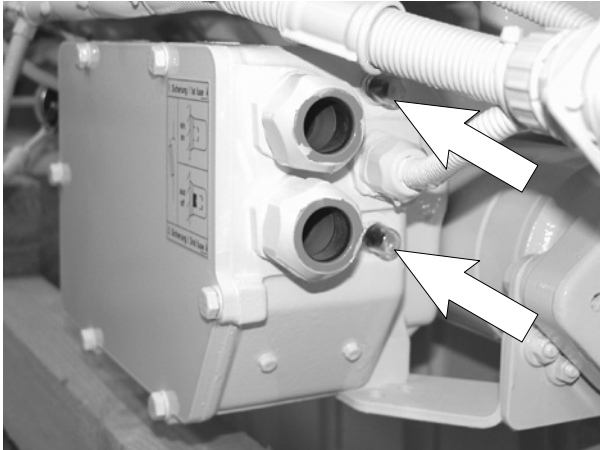

Fitting with fuse box

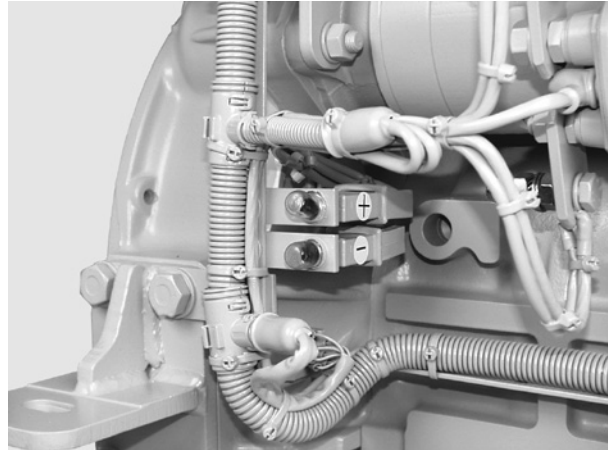

Fitting without fuse box

Main fuses on terminal box

Three more main fuses are fitted in the terminal box.

These fuses blow in the event of overcurrent or short circuit.

They separately protect

- the electronic fuel injection EDC, F5=16 A
- the diagnosis system, F6=10 A
- and the external electrical connections, F7=10 A

The fuses can be reset by the operator using the keys fitted.



Top side of terminal box with the keys for fuses F5 / F6 / F7

Charge control lamp on the terminal box

A charge control lamp is fitted on the terminal box.

This should only light up at “Ignition on”.

As soon as the engine is running, this lamp should go out.

If it lights up when the engine is running, there is a defect in the dynamo.

The battery is no longer being charged.

The monitoring system reports the fault “Failure of charge voltage”.

A restart can thus be a problem.

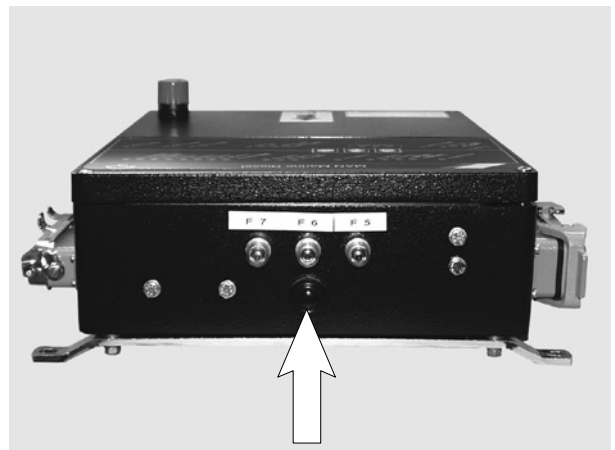

Top side of terminal box with charge control lamp

Terminal box in the engine room / interface with light-emitting diodes + keys

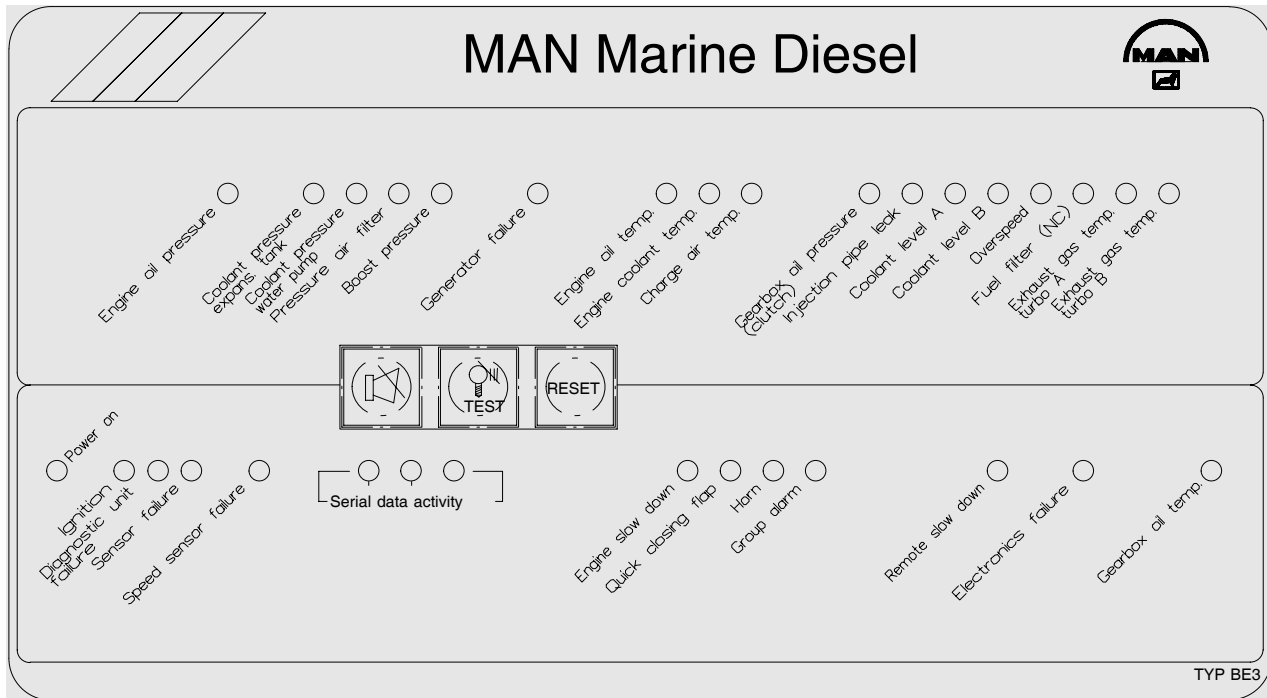

The terminal box with light-emitting diodes functions at the same time as an engine room monitoring panel.

If an alarm is issued, the corresponding light-emitting diode lights up. The following relays are activated on the diagnosis unit:

- Engine slow down (main alarm) = reduction of engine speed
- Horn = acoustic alarm
- Group alarm = collective fault indication

The keys are intended for:

- Horn off



Switches off the alarm horn and the integrated buzzer

- Flashing light off, transition to continuous light / test of light-emitting diodes



Switches off the flashing signal of the relevant warning lamp, i.e. the flashing light switches to continuous light. Before the flashing signal is cleared, the alarm horn must be switched off.

- Reset



Clearing the alarm message (red warning lamp goes out)

Requirement for clearing an alarm message is:

- Pressing the keys “Horn off” and “Test” in that order
- Removing the cause of the alarm

- In the case of an engine slow down alarm, short-term lowering of engine speed below 800 rpm so that higher engine speed can be reached
- In the case of a stop alarm, the alarm can only be deleted if the engine is at a standstill

The following light-emitting diodes function continuously:

- Power on: Diagnosis unit is receiving voltage
- Ignition: Ignition is on
- Serial data activity: Data interchange at the bridge.
If this fails, no more data is displayed on the bridge, neither on the display (MMDS-L /-LC) nor on the round instruments. The two light-emitting diodes below the “Horn off” key must always be functioning.
The light-emitting diode below the “Test” key only reacts when alarms are acknowledged.

If the following light-emitting diodes light up, there is a fault

- Diagnostic unit failure: The diagnosis unit is defective
- Sensor failure: A sensor is defective. The measurement point of the defective sensor flashes with the same frequency as “Sensor failure”
- Remote slow down: Remote reduction of speed.
Alarm at other engine. The defective engine reduces the intact engine.
This prevents a curving manoeuvre in the case of an alarm.

Shutting down

After the engine has been running at a high load level, do not shut it down immediately but allow it to idle about 5 minutes so that temperatures may equalize.

Set deck switch to “Neutral” and switch off the engine at the ignition key.

Remove key from starting lock.



Danger:

Ensure that the engine can not be started by unauthorized persons.

Lubrication system

Ensure utmost cleanliness when handling fuels, lubricants and coolants.

**Caution:**

Use only approved fuels, lubricants etc. (see brochure “Fuels, lubricants etc.”). Otherwise the liability for defects will become null and void!

Engine oil change

**Danger:**

The oil is hot- risk of scalding. Do not touch the oil drain plug with bare fingers. Oil is an environmental hazard. Handle it with care!

With the engine at operating temperature, remove the oil drain plugs on the oil sump and the oil filter bowl and allow the old oil to drain off completely.

Use a vessel of sufficient size to ensure that the oil does not overflow.

As the oil drain plug is often not accessible, a manually operated vane pump may be attached to the engine for draining the oil.

Pump the old oil out of the sump while the engine is still warm. Remove oil drain plugs in oil filter bowl and let old oil drain out of oil filters. Use a vessel of sufficient size to ensure that the oil does not overflow.

Refit the oil drain plugs with new gaskets.

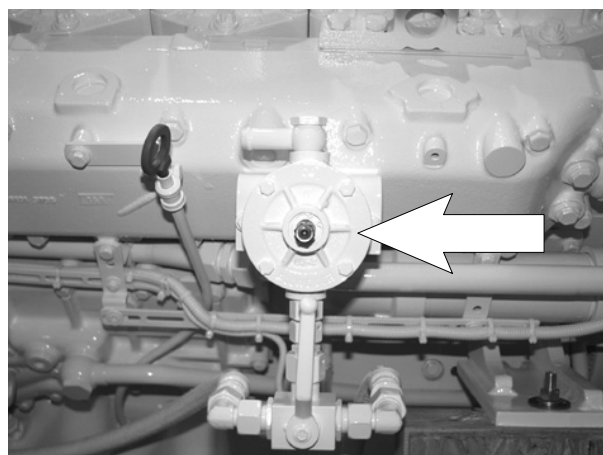
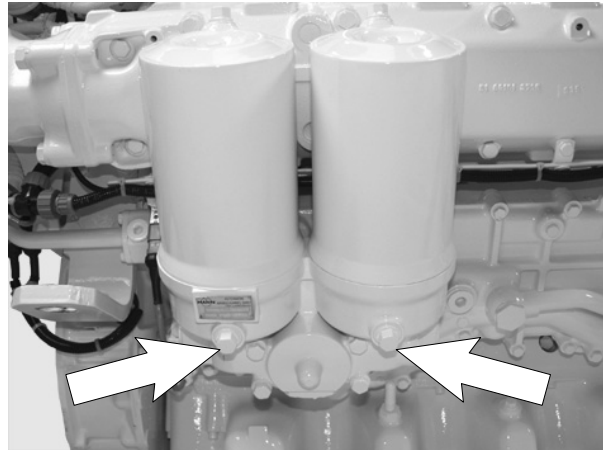
**Note:**

Change the oil filter elements every time the engine oil is changed

Refilling with oil



Caution:

Do not add so much engine oil that the oil level rises above the max. marking on the dipstick. Overfilling will result in damage to the engine.

Refill with fresh engine oil at the oil filler neck (arrow).

After filling start the engine and let it run for a few minutes at low speed.



Caution:

If no oil pressure builds up after approx. 10 seconds switch off the engine immediately.

Check oil pressure and check that there is no oil leakage.

Then shut down the engine. After about 20 minutes, check the oil level.

- Pull out dipstick (arrow)
- wipe it with a clean, lintfree cloth
- and push it in again up to the stop
- Pull out dipstick again

The oil level should be between the two notches in the dipstick and must never fall below the lower notch. Top up oil as necessary.

Changing oil filter

A changeover-type oil filter, the filter elements of which can be replaced even during operation, can be fitted on request.

However, oil filter cartridges must be changed at every oil change.

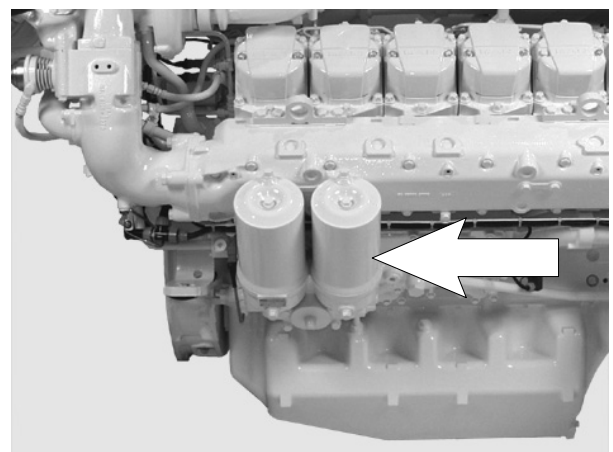
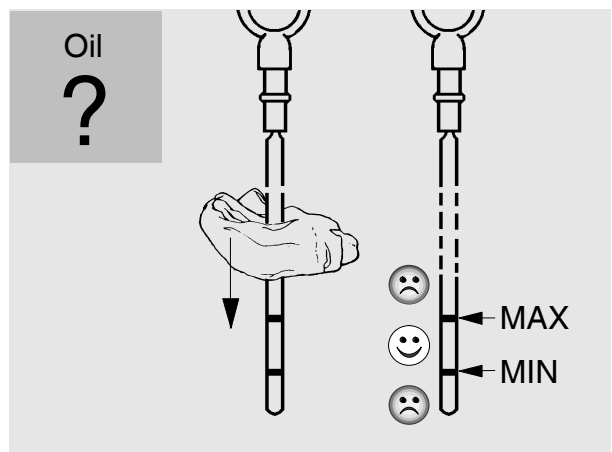
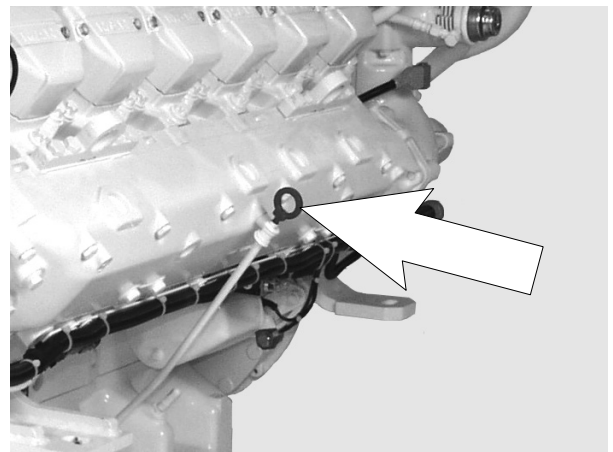
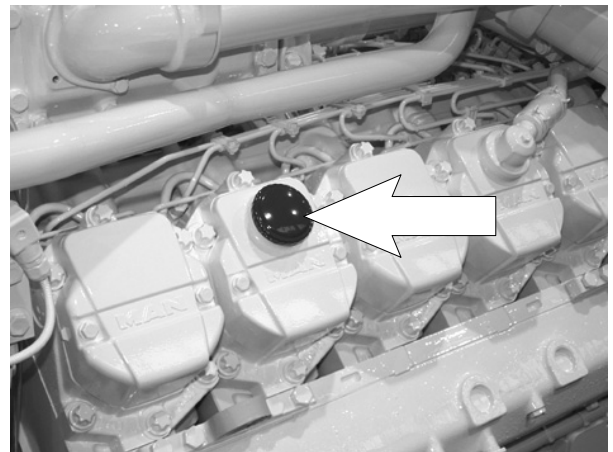

During continuous operation position the selector lever that both filter halves are in operation.

Observe positions of selector lever!



Caution:

Do not leave selector lever in any intermediate position because this would be liable to interfere with oil supply. If in doubt stop engine to change oil filter.

Renewal of filter cartridges

- Allow the filter content to run off along drain plugs ④.
Hold a suitable vessel under hole



Danger:

The oil is hot and under pressure when the drain plug is opened. Risk of burns and scalds.

- After releasing the clamping bolts ⑧ remove filter bowls ⑦
- Renew filter cartridges ⑤. Thoroughly clean all other parts in cleaning fluid (do not allow cleaning fluid to enter the oil circuit)
- Use new gaskets ⑥ for reassembly of filter bowls



Note:

To prevent the seal ⑥ from twisting hold the filter bowl ⑦ firmly when tightening the tensioning screw ⑧.



Caution:

Used oil filters are classed as dangerous waste and must be disposed of accordingly.

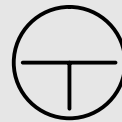

Continuous operation
(both filter halves
in operation)



Right-hand filter
cut out



Left-hand filter
cut out

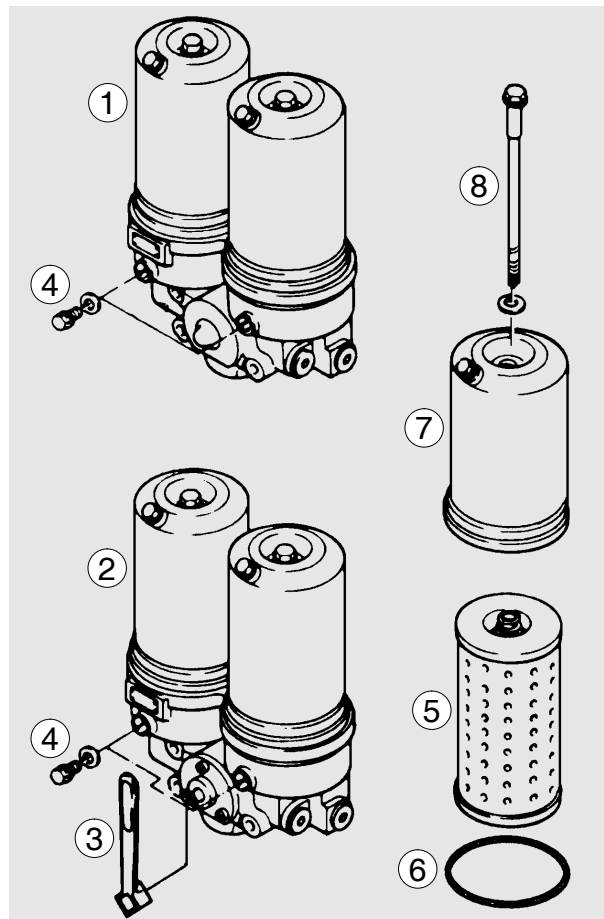

- 1 Oil filter, standard design (non-changeover)
- 2 Oil filter, changeover-type
- 3 Selector cock
- 4 Oil drain plugs
- 5 Filter cartridge
- 6 O-ring
- 7 Filter bowl
- 8 Clamping bolt

Fuel system

Fuel

If Diesel fuel which contains moisture is used the injection system and the cylinder liners / pistons will be damaged. This can be prevented to some extent by filling the tank as soon as the engine is switched off while the fuel tank is still warm (formation of condensation is prevented). Drain moisture from storage tanks regularly. Installation of a water trap upstream of the fuel filter is also advisable. Do not use any additives to improve flow properties in winter.



Caution:

Use only approved fuels, lubricants etc. (see brochure "Fuels, lubricants etc."). Otherwise the liability for defects will become null and void!

Injection pump

Neither the injection pump nor the control unit must be modified in any way. If the lead seal is damaged the engine warranty will become null and void.

Faults

We urgently recommend that you have faults in the injection pump rectified only in an authorized specialist workshop.

Cleaning fuel pre-cleaner

Strip the fuel pre-cleaner:

- Remove filter housing ①
 - Wash out filter housing ① and gauze filter ② in clean Diesel fuel and blow them out with compressed air
 - Reassemble using new seal
 - Screw on filter housing and tighten it to 10–12 Nm
-
- Actuate plunger of hand priming pump until the overflow valve of the injection pump opens audibly
 - Screw in the tappet of the hand pump again and tighten it
 - Start engine
 - Check fuel pre-cleaner for leaks

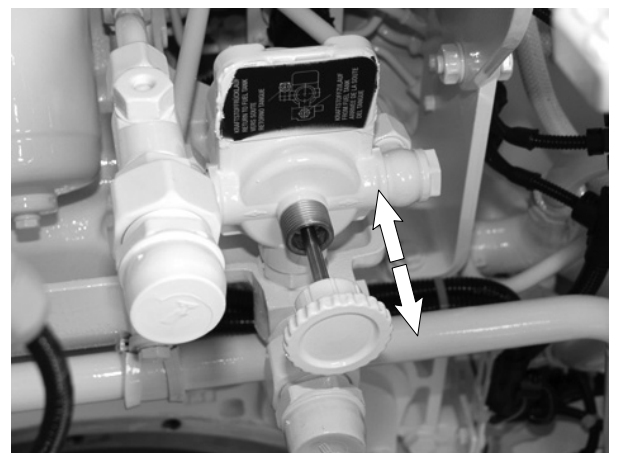
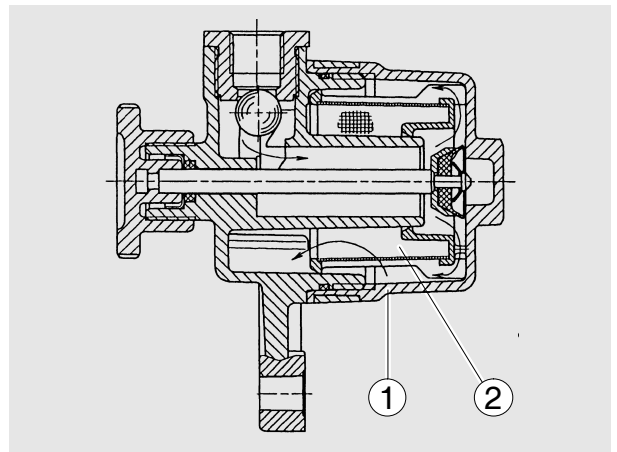

Parallel fuel filter

Draining moisture:

Unscrew drain plugs at every oil change until moisture has been discharged and clean fuel flows out.

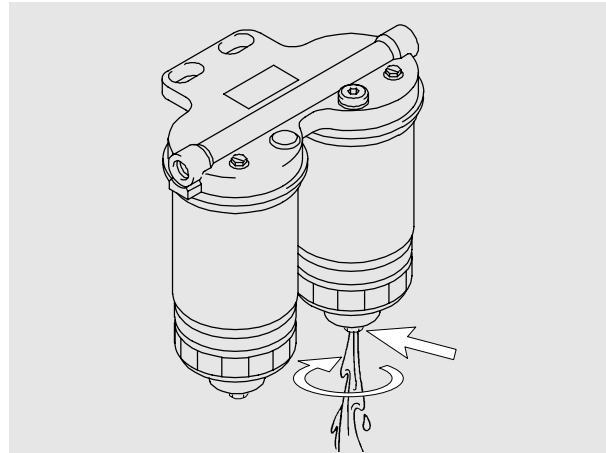

Changing fuel filter

Only when engine is switched off

- Loosen filter cartridge by means of tape wrench, unscrew it by hand and take it off
- Moisten the seals on the new filter cartridge with fuel
- Screw on the filter cartridges and tighten them vigorously by hand
- Bleed fuel system
- Check filter for leaks

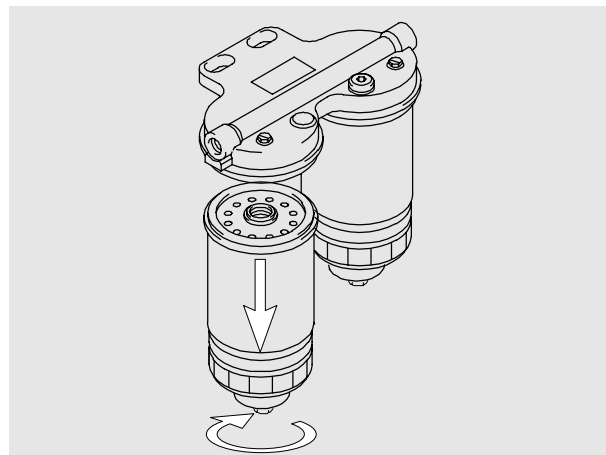

Caution:

Used fuel filters are classed as dangerous waste and must be disposed of accordingly.

Change-over fuel filter

Where the changeover-type filter is installed, the servicing procedure is for the filter side requiring to be shut off with the engine running. During continuous operation, the selector lever should be placed in a position where both filter halves are in operation.

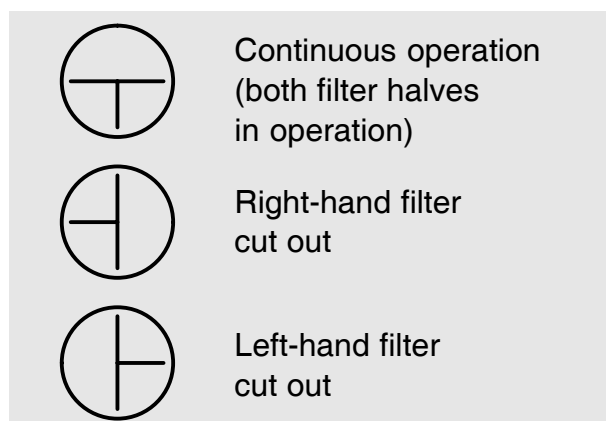

Caution:

Do not leave selector lever in any intermediate position because this would be liable to interfere with fuel supply. If in doubt stop the engine to change the fuel filter.

Changing fuel filter

- Loosen filter cartridge by means of tape wrench, unscrew it by hand and take it off
- Moisten the seals on the new filter cartridge with fuel
- Screw on the filter cartridges and tighten them vigorously by hand
- Bleed fuel system
- Check filter for leaks

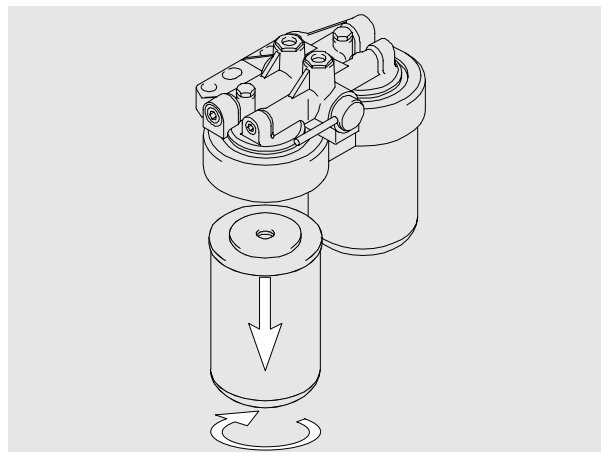

Caution:

Used fuel filters are classed as dangerous waste and must be disposed of accordingly.

Bleeding the fuel system



Note:

To bleed the fuel system switch on the "ignition" so that the EHAB will be open.

An arrow on the filter head indicates the direction of fuel flow.

- Unscrew bleed screw of first filter in direction of flow by one or two turns
- Actuate tappet of hand primer until fuel emerges without bubbles
- Screw in the tappet of the hand pump again and tighten it
- Close bleed screw again
- Repeat this procedure at the second bleed screw
- Check fuel system for leaks

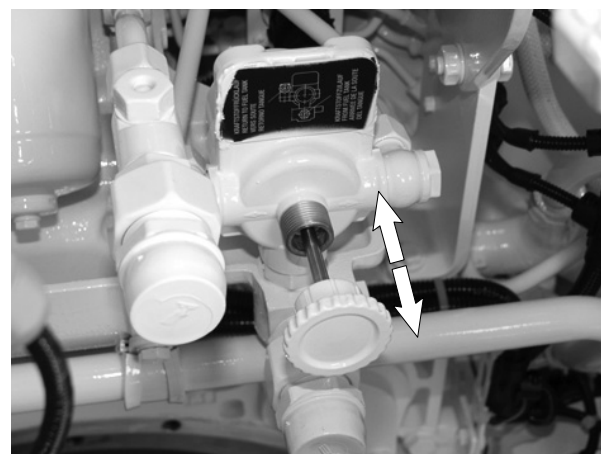
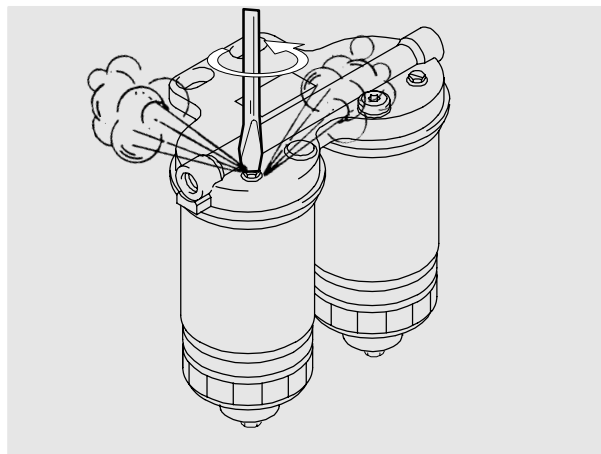

Cooling system



Danger:

Draining hot coolant involves a risk of scalding.

Draining the cooling system



Caution:

Drain coolant into a suitable container and dispose of it in accordance with regulations.

Drain coolant as follows, but only **when the engine has cooled down**:

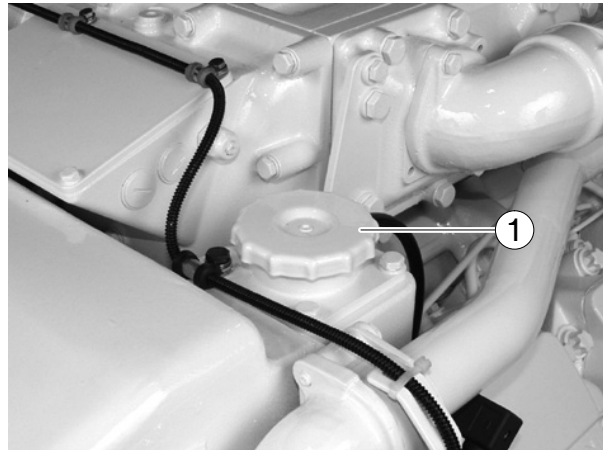

- Briefly open cap ① (large cap) on the filler neck of the expansion tank for pressure compensation
- Remove drain screws in exhaust manifold ②, oil cooler housing ③, coolant pipe ④ and crankcase ⑤

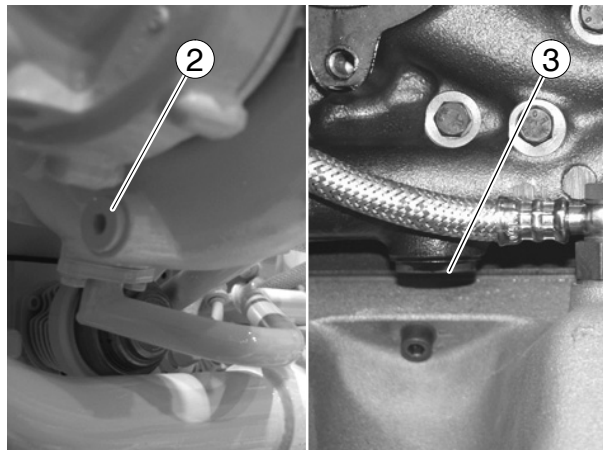

- Then remove cap ①
- Drain coolant into a container of adequate size
- Refit screw plugs

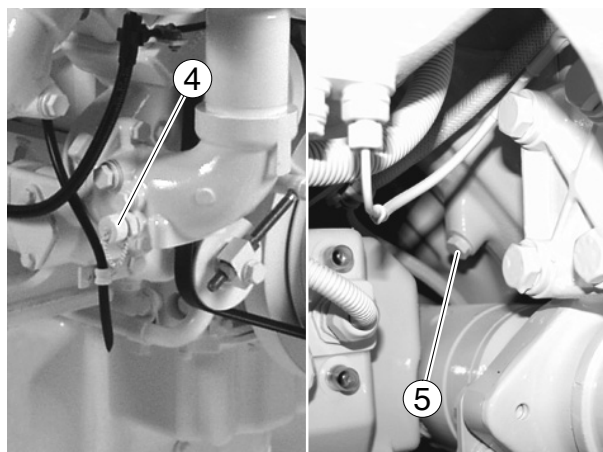

- Filling / bleeding the cooling system

Filling / bleeding the cooling system (only when engine has cooled down)

Fill the cooling system of the engine with a mixture of drinkable tap water and anti-freeze agent on ethylene glycole basis or anti-corrosion agent.



Caution:

Use only approved fuels, lubricants etc. (see brochure “Fuels, lubricants etc.”).
Otherwise the liability for defects will become null and void!

Coolant must be added at the filler neck only ① (large cap). When topping up do not add cold coolant if the engine is still warm from operation. Ensure that the ratio of water to anti-freeze is correct. Find the cause of the loss of coolant and have it eliminated.

- Remove cap ① (large cap)
- Fill in the coolant slowly
- The water-cooled exhaust manifold and the rear intercooler must be vented during the filling process. To this end, the exhaust manifold ② and the rear Intercooler ③ are fitted with vent screws which must remain open until the coolant flows free from bubbles or until the coolant reaches the filler neck (depending on the mounting position)
- Let engine run at a speed of 2,000 rpm for approx. 15 minutes
- Switch off engine, carefully turn cap ① with safety valve to the first detent to relieve pressure and then carefully remove cap and top up with coolant

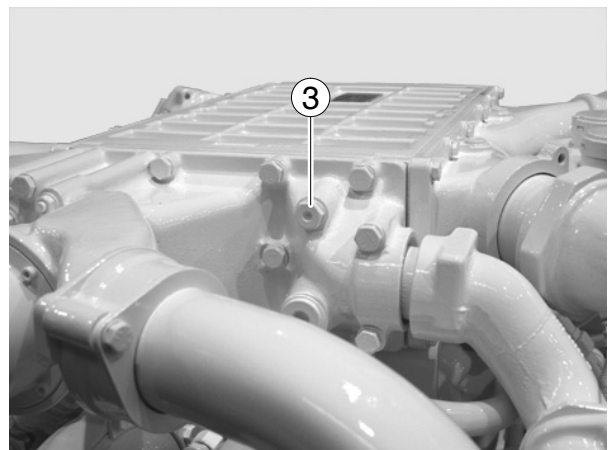
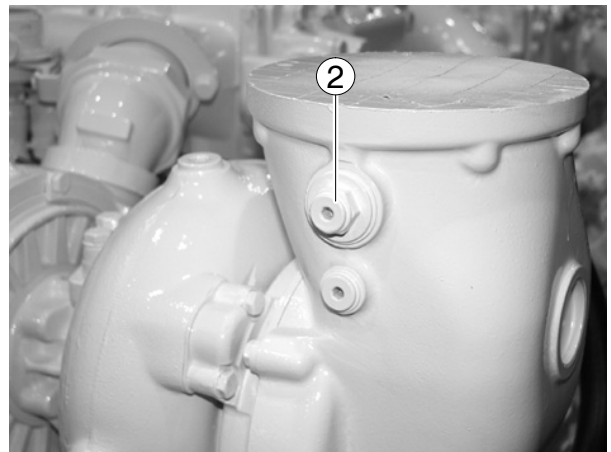
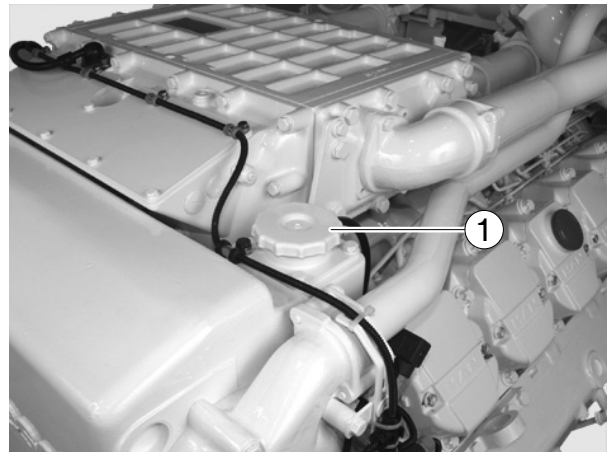

Danger:

Risk of scalding and burning yourself!

- Before the engine is next put into operation (with the engine cold) check the coolant level and top up if necessary
- Repeat this procedure until no more coolant can be added

**Note:**

The turbocharger and the intercooler may not be bled when the coolant system is topped up.

**Danger:**

If, in an **exceptional** case, the coolant level has to be checked in an engine that has reached operating temperature, first carefully turn the cap ① (large cap) with safety valve to the first stop, let off pressure, then open carefully.

**Note:**

Don't open the cooling system when the engine is at operating temperature. This causes a pressure loss in the cooling system.

If the cooling system has been opened when the engine is at operating temperature this can lead to the alarm "pressure in the expansion tank" when the engine is then put into operation and to a reduction in the engine output.

Coolant pressure in the expansion tank is only built up again when the engine has cooled down. The cooling system must therefore only be filled up when the engine is cold.

If the expansion tank needs to be filled up while the engine is at operating temperature, the following is to be heeded:

- To operate the hot engine without alarm again after the end cover has been opened, a pre-pressure of 0.7 bar must be present in the cooling system
- To achieve this pressure a pressure valve is fitted to the expansion tank. An air pump available on the open market can be connected to this valve. The system must be pumped up to 0.7 bar using this pump



V-belts

Checking condition

- Check V-belts for cracks, oil, overheating and wear
- Change damaged V-belts

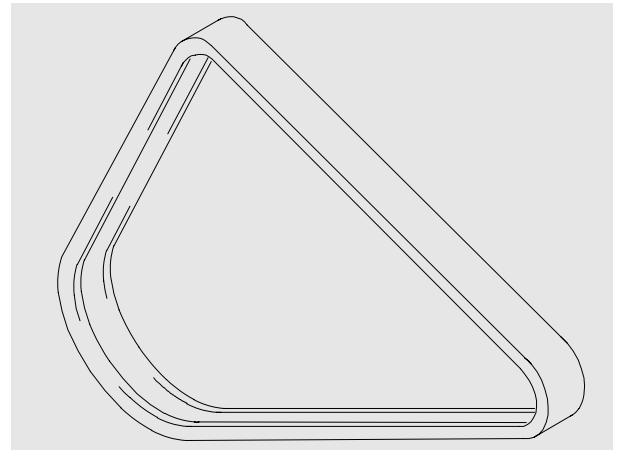

Checking tension

Use V-belt tension tester to check V-belt tension.

- Lower indicator arm ① into the scale
- Apply tester to belt at a point midway between two pulleys so that edge of contact surface ② is flush with the V-belt
- Slowly depress pad ③ until the spring can be heard to disengage. This will cause the indicator to move upwards

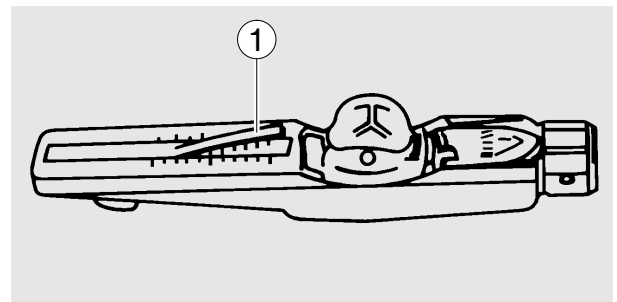

If pressure is maintained after the spring has disengaged a false reading will be obtained!

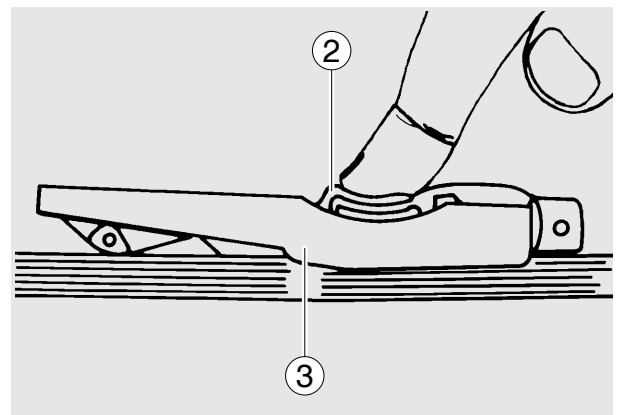

Reading of tension

- Read of the tensioning force of the belt at the point where the top surface of the indicator arm ① intersects with the scale
- Before taking readings make ensure that the indicator arm remains in its position

Drive belt width	Tensioning forces according to the kg graduation on the tester		
	New installation		When servicing after long running time
	Installation	After 10 min. running time	
2/3VX	90–100	70–80	60

If the value measured deviates from the setting value specified, the V-belt tension must be corrected.

Tensioning and changing V-belt

Alternator 120 A

- Remove mounting nut ①
- Turn setting screw ② in clockwise direction until the tension of the V-belts is correct.
- Retighten mounting nut.

To change the V-belts turn the setting screw anti-clockwise

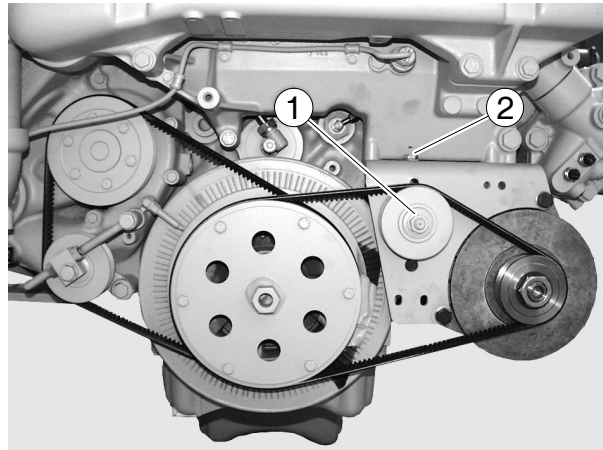

55 A alternator on heat exchanger

- Remove fixing bolts ①
- Remove lock-nut ②
- Adjust nut ③ until V-belts have correct tensions
- Retighten lock-nut and fixing bolts

To replace the V-belts loosen lock-nut and swing alternator inwards.

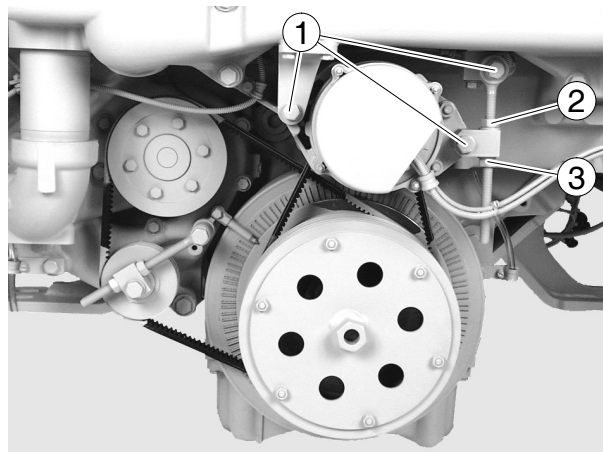

Tension pulley at bottom right

- Remove fixing bolts ①
- Remove lock-nut ②
- Adjust nut ③ until V-belts have correct tensions
- Retighten lock-nut and fixing bolts

To change the V-belts turn the adjusting nut back and swing the tension pulley inwards.

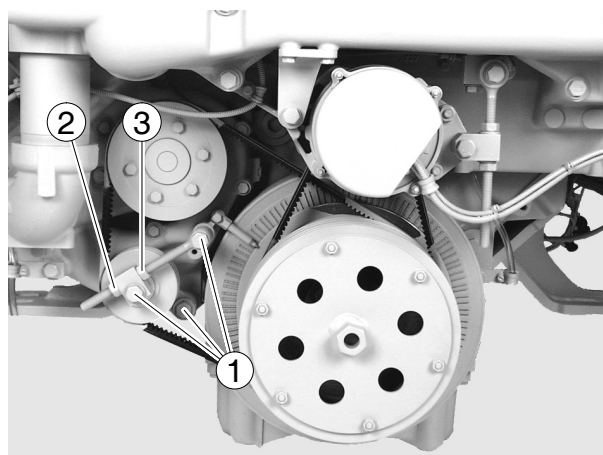

55 A alternator at bottom right

- Remove fixing bolts ①
- Remove lock-nut ②
- Adjust nut ③ until V-belts have correct tensions
- Retighten lock-nut and fixing bolts

To replace the V-belts loosen lock-nut and swing alternator inwards.

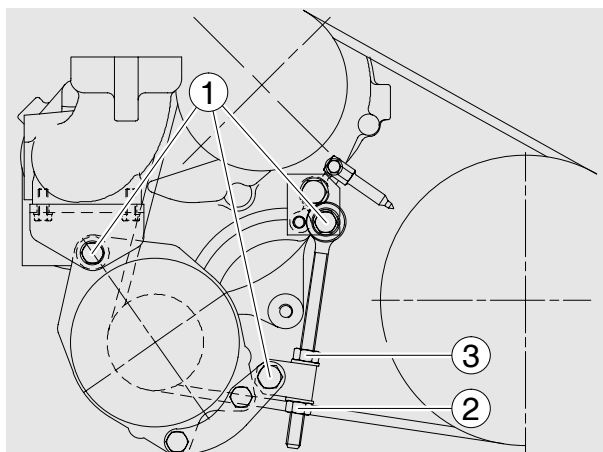

Alternator

The alternator is maintenance-free.

Nevertheless, it must be protected against dust and, above all, against moisture.

In order to avoid damage to the alternator, observe the following instructions:

While the engine is running

- Do not de-energize the main battery switch!
- Do not disconnect the battery or pole terminals or the cables!
- If, during operation, the battery charge lamp suddenly lights up, stop the engine immediately and remedy the fault in the electrical system!
- Do not run the engine unless the battery charge control is in satisfactory order!
- Do not short-circuit the connections of the alternator with those of the regulator or said connections with ground, not even by briefly bringing the connections into contact!
- Do not operate the alternator without battery connection!

Temporary decommissioning of engines

Temporary anti-corrosion protection according to MAN works norm M 3069 is required for engines which are to be put out of service for fairly long periods.

The works standard can be obtained from our After-Sales Service department in Nuremberg.



Technical data

Model	D 2842 LE 409 / 418
Design	V 90°
Cycle	4-stroke diesel with two-stage turbo-charger / intercooler and charge-air re-gulation (waste gate)
Combustion system	Direct injection
Turbocharging	2-stage exhaust turbocharger with inter-cooler and charge-air regulation
Number of cylinders	12
Bore	128 mm
Stroke	142 mm
Swept volume	21 930 cm ³
Compression ratio	15 : 1
Rating	
D 2842 LE 409	1103 kW / 1500 hp at 2300 rpm
D 2842 LE 418	919 kW / 1250 hp at 2100 rpm
Firing order	1-12-5-8-3-10-6-7-2-11-4-9
Valve clearance (cold engine)	
Intake	0.50 mm
Exhaust	0.60 mm
Valve timing	
Intake opens	24° before TDC
Intake closes	36° after BDC
Exhaust opens	63° before BDC
Exhaust closes	27° after TDC
Fuel system	
Injection	In-line pump
Governor	Electronic Diesel Control (EDC) – Model M(S) 5
Start of delivery	
D 2842 LE 409	16°±0,5° before OT
D 2842 LE 418	16°±0,5° before OT
Injectors	eight-hole nozzles
Opening pressure of injector	
New nozzle holder	320+8 bar
Used nozzle holder	320+8 bar

Technical data



Engine lubrication	Force feed
Oil capacity in oil sump (litres)	min. max. 60 l 70 l
Oil change quantity (with filter)	73 l
Oil pressure during operation (depending on oil temperature, oil viscosity class and engine rpm)	must be monitored by oil pressure monitors / gauges
Oil filter	Full flow filter with two paper cartridges
Engine cooling system	Liquid cooling
Coolant temperature	80–90°C, temporarily 95°C allowed
Coolant filling quantity	96 l
Electrical equipment	
Starter	24 V; 6.5 kW
Alternator	28 V; 55, 120 A



Troubleshooting table

Fault										
Engine does not start, or starts only with difficulty										
Engine starts but does not reach full speed or stalls										
Engine idles out of true when warm, misfiring										
Engine speed fluctuates during operation										
Power output unsatisfactory										
Coolant temperature too high, coolant being lost										
Lube oil pressure too low										
Lube oil pressure too high										
Black smoke accompanied by loss of power										
Blue smoke										
White smoke										
Knocking in the engine										
Engine "too loud"										
Reason										
•										Fuel tank empty
•										Fuel cock closed
•	•	•	•					•		Air in fuel system
•	•	•	•					•		Fuel pre-filter / pre-cleaner clogged
•										Condensation in fuel
•	•		•			•				Air filter clogged
•										Electric circuit interrupted
•										Batteries flat
•										Starter / solenoid switch defective
•	•					•		•	•	Start of delivery not correct / incorrectly set
•										Injection nozzles clogged
•										Internal damage to engine (piston seized, possibly caused by water in fuel)
	•		•					•		Fuel quality not in accordance with specifications or fueled severely contaminated
		•								Lower idling speed set too low
•	•							•	•	Valve clearance incorrect
		•								Injection nozzles of injection pipes leaking
		•								Too little fuel in tank
		•								Rev. counter defective
		•				•		•		Injection nozzles defective or carbonized
			•							Engine being asked to do more than it has to
			•							Fuel supply faulty, fuel too warm
			•					•		Oil level in sump too high
			•							Incorrect rated speed setting
				•						Coolant level too low
				•						Air in coolant circuit

Troubleshooting table



Fault										
Engine does not start, or starts only with difficulty										
Engine starts but does not reach full speed or stalls										
Engine idles out of true when warm, misfiring										
Engine speed fluctuates during operation										
Power output unsatisfactory										
Coolant temperature too high, coolant being lost										
Lube oil pressure too low										
Lube oil pressure too high										
Black smoke accompanied by loss of power										
Blue smoke										
White smoke										
Knocking in the engine										
Engine "too loud"										
Reason										
									●	Tension of coolant-pump V-belts incorrect (slip)
									●	Cap with working valves on expansion tank / radiator defective or leaking
									●	Temperature gauge defective
									●	Coolant pipes leaking, blocked or twisted
									●	Oil level in sump too low
									●	Engine temperature too high
									●	Oil filter clogged
									● ●	Oil pressure gauge defective
									● ●	Selected oil viscosity not suitable for ambient temperature (oil too thin)
									●	Oil in sump too thin (mixed with condensation or fuel)
									●	Engine cold
									● ●	Engine, coolant or intake air still too cold
									●	Lube oil getting into combustion chamber (piston worn, piston rings worn or broken)
									●	Overpressure in crankcase (crankcase breather clogged)
									●	long operation under a low load
									●	Coolant getting into combustion chamber (cylinder head / gasket leaking)
									●	Engine operating temperature incorrect
									●	Intake or exhaust pipe leaking

A		N	
Alternator	71	Nameplates	9
B		O	
Bleeding the fuel system	65	Operation monitoring	20–59
C		CAN bus-controlled display devices	32
Changing oil filter	61	Charge control lamp on the terminal box	57
Checking oil level	18	Display device MMDS-L	21
Cleaning fuel pre-cleaner	63	Display device MMDS-LC	23
Commissioning	18	Drive lever control system Mini Marex	42
Commissioning and operation	14–59	Emergency operation unit	52
CAN-Bus round instruments, rev counter		Engine room panel MMDS-EP	31
with information display and buttons	32	Main fuses for + / – on the engine	56
Tachometer CAN-Master	32	Main fuses on terminal box	57
Cooling system	66–68	MMDS-CLC display device (colour display) ..	36
D		Round instruments	21
Declaration	8	Serially-controlled display devices	21
Draining the cooling system	66	Terminal box in the engine room / interface	
E		with light-emitting diodes + keys	58
Engine oil change	60	R	
Engine views	14	Refilling with oil	61
F		S	
Filling / bleeding the cooling system	67	Safety regulations	10–13
Filling with engine oil	17	Handling used engine oil	13
Filling with fuel	16	Preventing accidents	
Filling-in of coolant	16	with injury to persons	10
First commissioning	16–17	Preventing damage to	
Fuel filters	64	engine and premature wear	11
Changing fuel filter	64, 65	Preventing environmental damage	12
Draining moisture	64	Sea water pump	17
Fuel system	63–65	Shutting down	59
I		Starting	19–20
Injection pump	63	T	
Instructions	6	Technical data	72–73
L		Temporary decommissioning	71
Lubrication system	60–63	Troubleshooting table	74–75
M		V	
Maintenance and care	60–71	V-belts	69–70

MAN Nutzfahrzeuge AG
Geschäftseinheit Motoren
Vogelweiherstraße 33
D-90441 Nürnberg

Ein Unternehmen der MAN Gruppe

Printed in Germany

51.99493-8525

