

HITACHI

TROUBLESHOOTING MANUAL

SIOV
Programmable Controller

TROUBLESHOOTING MANUAL

SIOV
Programmable Controller

First Edition, November 2005, SVE-3-001(B)

All Rights Reserved, Copyright © 2005, Hitachi, Ltd.

The contents of this publication may be revised without prior notice.

No part of this publication may be reproduced in any form or by any means without permission in writing from the publisher.

Printed in Japan.

BI-SN-YS<IC-IC> (FL-MW20, AI8.0)

SAFETY PRECAUTIONS

Be sure to read this manual and all other attached documents carefully before installing, operating inspecting or conducting maintenance on this unit. Always use this unit properly. Be sure to carefully read the information about the device, the safety information and precautions before using this unit. Be sure that the person(s) responsible for maintenance receives and understands this manual completely.

This manual divides the safety precautions into DANGERS and CAUTIONS.



: Failure to observe these warnings may result in death or serious injury.



: Failure to observe these cautions may result in injury or property damage.

Failure to observe any  may lead to serious consequences.

All of these DANGERS and CAUTIONS provide very important precautions and should always be observed.

Additional safety symbols representing a prohibition or a requirement are as follows:



: Prohibition. For example, “Do not disassemble” is represented by:



: Requirement. For example, if a ground is required, the following will be shown:



1. Installation Precautions



REQUIREMENT

- Fasten the mount base to a vertical surface. Fastening the mount base to a horizontal surface lessens the heat dissipation effects and allows the temperature to rise, thereby rendering the module defective or incurring component parts deterioration.
- Before installing the module, discharge any static buildup from your body because static electricity may render the module defective.
- Properly tighten the screws. If they are inadequately tightened, malfunction, smoke emission, or combustion may occur.



DANGER

- If an emergency stop circuit, interlock circuit, or similar circuit is to be formulated, it must be positioned external to this module. If you do not observe this precaution, equipment damage or accident may occur when this module becomes defective.
- Ensure that the employed external power source has overvoltage and overcurrent protection functions.
- The external power source voltage may create an electric shock hazard. If you disconnect/connect the module or cable with the power supply switched on, you may inadvertently touch a power supply terminal and receive an electric shock or the equipment may become damaged due to short circuit or noise. Switch off the power supply before disconnecting/connecting the module or cable.



CAUTION

- Use the module in an environment specified in the catalog and manual. If you use the module in an environment where the module is subjected to high temperature, high humidity, dust, corrosive gas, vibration, or impact, a risk of electric shock, fire, or malfunction may result.
- Observe the installation procedure stated in the manual. If the module is improperly installed, it may drop, become defective, or malfunction.
- Do not allow wire cuttings or other foreign matter to enter the module. The entry of foreign matter in the module may result in a fire or cause the module to become defective or malfunction.
- When the module is to be positioned at a location where it may become wet with water, place it within a drip-proof enclosure to prevent it from becoming defective.



CAUTION

- The module may become defective due to a high temperature, which may result from heat dissipation failure. It may also malfunction due to electromagnetic interference from nearby equipment. For heat dissipation and electromagnetic radiation minimization, provide the specified clearances among the module, its enclosure, and neighboring equipment.
- The degree of temperature rise varies depending on how the module is mounted. The mounting intervals specified in the manual should be used as a guide only. While a test run is conducted after completion of mounting, measure the temperature near the module to check whether it is within the specified range. If the measured temperature is beyond the specified range, increase the mounting intervals or provide forced air cooling with a cooling fan.
- Dust or other foreign matter might accumulate on the connector, resulting in poor contact. Immediately after the module is unpacked, perform the mounting and wiring procedures.
- To prevent the module from being damaged, observe the following precautions when you mount or demount the module:
 - Before mounting the module to the mount base connector, check that the connector pins are properly aligned and not bent, broken, or soiled with dirt or the like.
 - Ensure that the module is parallel to the mount base vertical surface as shown below when mounting. If you connect a module to or disconnect it from its connector while it is tilted, the connector pins may become damaged.

[Bad example]

[Good example]

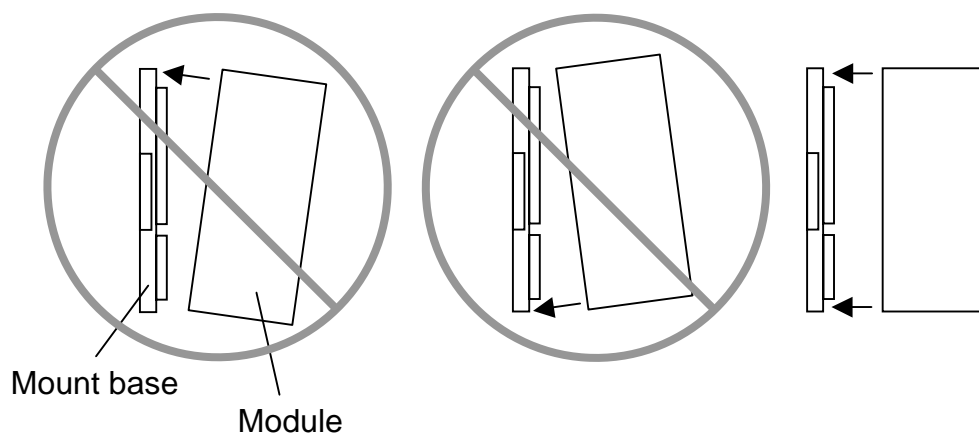



PROHIBITION

Do not take the insulation sheets off the mount base. These insulation sheets electrically insulate the modules from the mount base.



PROHIBITION

Do not disassemble or modify the module. Failure to observe this precaution may result in a fire or cause the module to become defective or malfunction.

2. Wiring Precautions



REQUIREMENT

- To provide protection against short circuit, furnish the external power source with a fuse or circuit protector. Ensure that the employed circuit protector is rated as specified.
- Before supplying power to the equipment, thoroughly check the wiring connections.
- Surge voltage may cause malfunction or damage to this product. When you connect coils, such as relays, to the PCsOK output circuit, be sure to add surge-absorbing diodes or the equivalent to that circuit. The peak reverse voltages of these diodes must be at least 10 times as high as the circuit voltage and their forward currents must be larger than the load current.
- Before making power supply wiring connections, make sure that no voltage is applied to the power cable. Immediately after completion of power supply wiring, be sure to install the terminal cover.
- Ensure that the communication, power supply, motive power, and other cables are routed apart from each other. It is essential that the inverter, motor, power regulator, and other motive power cables be routed at least 300 mm away from the other types of cables. Also, be sure that the communication and motive power cables are routed within separate conduits.



DANGER

Electric shock hazards exist so that you might suffer burns or become electrocuted. Further, the system might malfunction due to noise interference. Therefore, ground the line ground (LG), frame ground (FG), and shield cable (SHD).



REQUIREMENT

- Insulate the mount base from the enclosure. To keep the mount base insulated, avoid removing the insulation sheets that are supplied with the mount base.
- The LG is a ground terminal for power supply noise. The FG and SHD are ground terminals for the noise in the remote I/O, communication module and other external interface lines. To avoid interference between the ground terminals, separately ground the LG and FG.
- Connect each module's FG terminal to the FG terminal provided on the mount base and ground those terminals properly. The FG terminals for remote I/O lines and JPCN-1 (J.NET or IR.LINK) lines must be grounded at one place (LPU unit) for each line -- the FG terminals of remote I/O station and JPCN-1 station (J.Station or IR.Station) modules that can be grounded at the same place as is the LPU unit must all be grounded.



CAUTION

- If the input voltage for the power supply module is within the specified range but close to the upper or lower limit, you should conclude that an input power problem exists, and ask the power supply facility manager to conduct an inspection.
- Be sure that the power source for supplying power to various modules is rated as specified. The use of a differently rated power source may cause a risk of fire.
- Ensure that the same power source is used for output module external power source (for supplying power to the +V terminal) and load power supply. The use of different power sources may cause a risk of malfunction.
- Only qualified personnel should be allowed to make cable connections. Incorrect wiring connections may cause a risk of fire, malfunction, or electric shock.



PROHIBITION

To avoid noise-induced malfunction, do not bundle the 100 VAC/100 VDC wiring and network cable together, but route them at least 100 mm away from each other.

3. Operating Precautions



REQUIREMENT

- Before terminating this product (by shutting down or resetting), check that all the peripheral equipment is already stopped or will not be affected by the termination.
- Failure of an installed module may damage the contents of memory spaces. Be sure to make a backup copy of any important data in memory.
- Overheating may cause a fire or unit failure. Where the ambient temperature reaches 48°C or higher, lower the maximum output current that can be drawn from the power supply module. By taking into consideration the environment where the unit is mounted, install a cooling fan in the housing enclosure or reduce the number of modules mounted.



DANGER

- The input/output currents of I/O modules must be within their maximum allowable current values. If an overcurrent flows in the I/O module, its component parts may be damaged, resulting in an accident, fire, or failure.
- If the module emits smoke or foreign odor, immediately switch off the power supply and investigate the problem cause.
- While the power is applied, never touch a terminal strip or connector pin. If you touch a terminal strip or connector pin while the power is applied, you may receive an electric shock.



CAUTION

- Before changing the program, generating a forced output, or performing the RUN, STOP, or like procedure during an operation, thoroughly verify the safety because the use of an incorrect procedure may cause equipment damage or other accident.
- When you switch on the power supply, follow the specified power-on sequence. Failure to follow the specified sequence may cause equipment damage or other accident.



CAUTION

- Do not use a transceiver, cellular phone, or similar device near the unit because unit malfunction or system failure may occur due to noise.
- The parts, which used gallium arsenic (GaAs) for a photo coupler and LED, are included in this product. GaAs is specified as a harmful object by law. Take special care when handling the product, in particular, scrapping it. Before scrapping the product, ask a professional waste disposal dealer in charge of scrapping work.
- To avoid malfunction, ensure that the power supply is switched on and off at intervals of longer than 1 second.



PROHIBITION

- Do not carry out any installation, wiring, handling, and remodeling not covered in this manual. The manufacturer is not liable to any damage to the product and peripheral equipment and/or bodily injury due to such an improper practice.
- Never insert your finger or foreign matter into the gap between a connector and the mount base. Disregarding this rule may result in a bodily injury..

This manual provides troubleshooting information for the following hardware and program products:

(SVE-3-001(B))

<Hardware products>

LPU	(LQP510)	J.NET	(LQE540)
CMU	(LQP520)	J.NET-INT	(LQE545)
Power supplies	(LQV000/LQV100/LQV020)	IR.LINK	(LQE546)
ET.NET	(LQE520/LQE720)	D.NET	(LQE570/575)
SD.LINK	(LQP530)	SV.LINK	(LQE521)
OD.RING	(LQE510/515)	EQ.LINK	(LQE701)
FL.NET	(LQE500/502)	RI/O	(LQS000)
CPU LINK	(LQE550)	J.Station	(LQS020)
RS-232C	(LQE560)	IR.Station	(LQS021)
RS-422	(LQE565)	D.Station	(LQS070)

<Program products>

S-7895-01 "S10Tools SYSTEM"	01-08
S-7895-02 "LADDER CHART SYSTEM"	01-08
S-7895-03 "HI-FLOW SYSTEM"	01-06
S-7895-07 "CPMS DEBUGGER SYSTEM"	01-01
S-7895-09 "BACKUP RESTORE SYSTEM"	01-03
S-7895-10 "RPDP/S10V SYSTEM"	01-00B
S-7895-11 "NX/ACP-S10V"	01-00
S-7895-12 "NX/Ladder"	01-00
S-7895-13 "NX/Tools-S10V SYSTEM"	01-01
S-7895-14 "NX/HOST-S10V"	01-00
S-7895-22 "CPU LINK SYSTEM"	01-00
S-7895-24 "EXTERNAL SERIAL LINK SYSTEM"	01-00
S-7895-27 "J.NET SYSTEM"	01-01
S-7895-28 "OD.RING/SD.LINK SYSTEM"	01-00
S-7895-29 "ET.NET SYSTEM"	02-00
S-7895-30 "FL.NET SYSTEM"	01-00
S-7895-31 "D.NET SYSTEM"	01-01
S-7895-36 "IR.LINK SYSTEM"	01-00
S-7895-38 "BASE SYSTEM"	01-04
S-7895-41 "EQ.LINK SYSTEM"	01-01
S-7895-60 "RCTLNET"	01-00

<Changes added to this manual>

Description of added changes	Page
New information is added to Section 3.4, "Backing Up and Restoring."	64
Section 3.16, "ET.NET (LQE720) Error Information," is newly added.	165
Section 3.17, "Error Freeze Information," is newly added.	168
Section 3.18, "Memory Dump Procedure," is newly added.	173
Section 3.19, "Network Information," is newly added.	177
Section 3.20, "Network Maintenance Commands," is newly added.	200
Error log information is added to Subsection 4.2.2, "CMU (model LQP520) error log info and required actions."	222
Error log information is added to Subsection 4.2.13, "EQ.LINK (model LQE701) error log info and required actions."	244
Error log information is added to Subsection 4.2.14, "ET.NET (model LQE720) error log info and required actions."	246
Error log information is added to Subsection 4.2.15, "NCP-F (model LQE780-Z) error log info and required actions."	249
Error log information is added to Subsection 4.2.16, "LANCP (model LQE790-Z/LQE795-Z) error log info and required actions."	254
Section 4.3, "CMU Error Message Format," is newly added.	255
Section 4.4, "RPDP Error Log Display Guide," is newly added.	259
Section 4.5, "Maintenance Commands," is newly added.	340
New error messages are added to Subsection 5.1.12, "Error messages from the EQ.LINK SYSTEM."	370
New error messages are added to Subsection 5.1.13, "Error messages from the BACKUP RESTORE SYSTEM."	371
New error messages are added to Subsection 5.1.14, "Error messages from the NX/Tools-S10V SYSTEM."	372
New error messages are added to Subsection 5.1.15, "Error message from the tools."	376

(SVE-3-001(B))

<Changes added to program products>

Program product	Description of added changes
S-7895-29, "ET.NET SYSTEM", 02-00	ET.NET (LQE720) support is newly added.
S-7895-38, "BASE SYSTEM", 01-04	ET.NET (LQE720) support is newly added.
S-7895-41, "EQ.LINK SYSTEM", 01-01	EQ.LINK (LQE701) support is newly added.

In addition to the above changes, all the unclear descriptions and typographical errors found are also corrected without prior notice.

PREFACE

Thank you for purchasing Hitachi's programmable controller (S10V).

This manual provides information on how to perform troubleshooting correctly when a problem arises with the product. Please read this manual carefully when troubleshooting the product, and use the product properly.

The S10V product is available in two types: standard model and environmentally resistant model. The environmentally resistant model has thicker platings and coatings than those for the standard model.

The model number of the environmentally resistant model is marked by adding the suffix "-Z" to the model number of the standard model.

(Example) Standard model: LQP510

Environmentally resistant model: LQP510-Z

This manual is applicable to both the standard model and environmentally resistant models. Although the descriptions contained in this manual are based on the standard model, follow the instructions set forth in this manual for proper use of the product even if you use the environmentally resistant model.

<Trademarks>

- Microsoft® Windows® operating system, Microsoft® Windows® 95 operating system, Microsoft® Windows® 98 operating system, Microsoft® Windows® 2000 operating system, Microsoft® Windows® XP operating system are registered trademarks of Microsoft Corporation in the United States and/or other countries.
- Ethernet® is a registered trademark of Xerox Coporation.
- DeviceNet is a registered trademark of ODVA (Open DeviceNet Vendor Association, Inc.)
- MELSEC is a trademark of Mitsubishi Electric Corporation.

<Note for storage capacity calculations>

- Memory capacities and requirements, file sizes and storage requirements, etc. must be calculated according to the formula 2^n . The following examples show the results of such calculations by 2^n (to the right of the equals signs).
 - 1 KB (kilobyte) = 1024 bytes
 - 1 MB (megabyte) = 1,048,576 bytes
 - 1 GB (gigabyte) = 1,073,741,824 bytes
- As for disk capacities, they must be calculated using the formula 10^n . Listed below are the results of calculating the above example capacities using 10^n in place of 2^n .
 - 1 KB (kilobyte) = 1000 bytes
 - 1 MB (megabyte) = 1000² bytes
 - 1 GB (gigabyte) = 1000³ bytes

CONTENTS

1 PRELIMINARY CHECKING.....	1
2 TROUBLESHOOTING.....	5
2.1 Troubleshooting Procedure	6
2.2 Troubleshooting Maps	7
LPU	
● None of the LED indicators comes on.....	8
● The ERR indicator (LED) is lit.....	8
● The remote I/O process produces outputs but does not accept inputs.....	9
● The PCs OK output is OFF.	9
● The sequence program does not run.	10
● A DI/O or AI/O module mounted on the same mount base as is the LPU module does not run normally.....	10
CMU	
● Data communication is not possible with the Tool (personal computer or PC).....	11
PS Power supply	
● The POWER ON indicator (LED) does not come on.....	12
FL.NET	
● The TX and RX indicators (LEDs) do not come on normally.....	13
● The LER indicator (LED) is lit.....	13
● Other problems	13
● Common network problems and troubleshooting	14
● FL.NET usage precautions	17
OD.RING, SD.LINK	
● The TX and RX indicators (LEDs) do not come on normally.....	18
● The ERR indicator (LED) is lit.....	18
ET.NET (LQE520)	
● Communication is initially not possible.	19
● Communication is not possible with the Tool (PC)	20
SV.LINK	
● The TX and RX indicators (LEDs) do not come on normally.....	21
● The ERR indicator (LED) is lit.....	21
● Other problems	21

J.NET, J.NET-INT	
● The TX and RX indicators (LEDs) do not come on normally.....	22
● The ERR indicator (LED) is lit.....	23
● Other problems.....	23
IR.LINK	
● The TX and RX indicators (LEDs) do not come on normally.....	24
● The ERR indicator (LED) is lit.....	25
● Other problems.....	25
CPU LINK Inter-CPU link	
● The LINK indicator (LED) does not come on.....	26
RC-232C, RS-422	
● The TX and RX indicators (LEDs) do not come on normally.....	27
● The ERR indicator (LED) is lit.....	27
D.NET	
● The MNS indicators (LEDs) do not come on normally.....	28
● Other problems.....	28
EQ.LINK	
● The TX and RX indicators (LEDs) do not come on normally.....	29
● The LER indicator (LED) is lit.....	29
● Other problems.....	29
● Common network problems and troubleshooting.....	30
● EQ.LINK usage precautions.....	31
ET.NET (LQE720)	
● Communication is initially not possible.....	32
● Communication is not possible with the Tool (PC).....	33
● Data transmission is not possible from ladder applications.....	33
● Data transmission is not possible from HI-FLOW applications.....	33
RI/O	
● The RI/O indicator (LED) does not come on.....	34
J.Station	
● The J-NET indicator (LED) does not come on normally.....	35
● The ERR indicator (LED) is lit.....	35
IR.Station	
● The TX/RX indicator does not come on normally.....	36
● The ERR indicator (LED) is lit.....	36

D.Station	
● The MNS indicators (LEDs) do not come on normally.....	37
● Other problems	37
A.INPUT Analog input	
● Input data cannot be input normally.	38
A.INPUT Scan-type analog input	
● Input data cannot be input normally.	39
A.OUTPUT Analog output	
● The output voltage and current are abnormal.	40
D.INPUT Digital input	
● None of the input points is turned on.	41
● Only a particular input point is not turned on.....	41
● None of the input points is turned off.....	42
● The input is turned on of off irregularly.	42
● Only a particular input point is not turned off.	42
D.OUTPUT Digital output	
● None of the load points is turned on.....	43
● Only a particular load point is not turned on.	43
● None of the load points is turned off.	44
● Only a particular load point is not turned off.	44
● The load is turned on of off irregularly.....	45
D.IN/OUT Digital input/output	
● Input or output is malfunctioning.	46
COUNTER Pulse counter	
● The counter does not count pulses.....	47
● The count value is not correct.....	48
● No external comparison output is produced.	48
Tool (personal computer) connection	
● No connection can be established with the PCs (via RS-232C).....	49
● No connection can be established with the PCs (via Ethernet [ET.NET module]).....	49
3 TECHNICAL SUPPORT INFORMATION	51
3.1 Remote I/O Troubleshooting	52
3.2 LPU Error Information Detail Table.....	58
3.3 Clearing the Entire Memory.....	63
3.4 Backing Up and Restoring	64

3.5	Performance.....	85
3.6	Address Space Maps	88
3.7	Registers	93
3.7.1	Ladder instructions and usable registers.....	93
3.7.2	Register numbers.....	95
3.7.3	System registers.....	97
3.8	Memory Maps for Optional Modules.....	107
3.9	FL.NET (Model LQE500/LQE502) Error Information.....	116
3.10	OD.RING (Model LQE510/515) and SD.LINK (Model LQE530) Communication Traces.....	119
3.11	ET.NET (Model LQE520) Error Information.....	126
3.11.1	Error codes from the socket handler.....	126
3.11.2	Routing information setting error table	129
3.12	SV.LINK (Model LQE521) Error Information.....	130
3.13	J.NET (Model LQE541), J.NET-INT (Model LQE547), and IR.LINK (Model LQE548) Trace Information	132
3.13.1	Command and response buffers	132
3.13.2	Data send and data receive buffers	134
3.13.3	Error counters	136
3.13.4	Trace.....	137
3.14	RS-232C (Model LQE560) and RS-422 (Model LQE565) Trace Information	140
3.14.1	Communication tracing	140
3.14.2	Handler tracing	142
3.14.3	H-7338 error tracing.....	144
3.14.4	Error counters.....	146
3.15	D.NET (Model LQE570/575) Statistical and Error Information	147
3.16	ET.NET (Model LQE720) Error Information.....	165
3.16.1	Error codes from the socket handler.....	165
3.17	Error Freeze Information.....	168
3.18	Memory Dump Procedure.....	173
3.19	Network Information.....	177
3.19.1	Displaying network information.....	177
3.19.2	Network information details.....	179
3.20	Network Maintenance Commands.....	200
3.20.1	Usage	201

4	ERROR LOG INFORMATION	217
4.1	Displaying Error Log Information	218
4.2	Error Log Information and Required Actions	219
4.2.1	LPU (model LQP510) error log info and required actions	219
4.2.2	CMU (model LQP520) error log info and required actions.....	222
4.2.3	FL.NET (model LQE500/502) error log info and required actions	226
4.2.4	OD.RING (model LQE510/515) error log info and required actions	228
4.2.5	ET.NET (model LQE520) error log info and required actions	229
4.2.6	SV.LINK (model LQE521) error log info and required actions	230
4.2.7	SD.LINK (model LQE530) error log info and required actions	231
4.2.8	J.NET (model LQE541) / J.NET-INT (model LQE547) error log info and required actions	232
4.2.9	IR.LINK (model LQE548) error log info and required actions	235
4.2.10	CPU LINK (model LQE550) error log info and required actions	238
4.2.11	RS-232C (model LQE560) / RS-422 (model LQE565) error log info and required actions	239
4.2.12	D.NET (model LQE570/575) error log info and required actions.....	242
4.2.13	EQ.LINK (model LQE701) error log info and required actions	244
4.2.14	ET.NET (model LQE720) error log info and required actions	246
4.2.15	NCP-F (model LQE780-Z) error log info and required actions.....	249
4.2.16	LANCP (model LQE790-Z/795-Z) error log info and required actions	254
4.3	CMU Error Message Formats	255
4.3.1	Panic log error message formats	255
4.3.2	Non-panic log error message formats	256
4.4	RPDP Error Log Display Guide.....	259
4.4.1	Reading the error log.....	259
4.4.2	Types of error logs	261
4.4.3	Error log details and analysis	263
	(1) Program error	263
	(2) Macro parameter check error	270
	(3) I/O error.....	272
	(4) Watchdog timer timeout error.....	286
	(5) Module error	287
	(6) Kernel warning.....	297
	(7) Kernel information.....	298
	(8) System down -- system error.....	299

(9) System down -- kernel trap.....	301
(10) System down -- built-in subroutine error	302
(11) System down -- built-in subroutine stoppage.....	304
(12) ADT error	305
(13) Memory error.....	310
(14) System bus error.....	324
(15) Other error	334
4.4.4 Reading the DHP trace information	335
4.5 Maintenance Commands	340
5 APPENDIX	349
5.1 Tool Error Messages	350
5.1.1 Error messages from the LADDER CHART SYSTEM	350
5.1.2 Error messages from the HI-FLOW SYSTEM	359
5.1.3 Error messages from the BASE SYSTEM.....	362
5.1.4 Error messages from the FL.NET SYSTEM.....	363
5.1.5 Error messages from the OD.RING/SD.LINK SYSTEM.....	363
5.1.6 Error messages from the ET.NET SYSTEM	364
5.1.7 Error messages from the J.NET SYSTEM.....	365
5.1.8 Error messages from the IR.LINK SYSTEM.....	366
5.1.9 Error messages from the CPU LINK SYSTEM.....	367
5.1.10 Error messages from the EXTERNAL SERIAL LINK SYSTEM.....	367
5.1.11 Error messages from the D.NET SYSTEM	368
5.1.12 Error messages from the EQ.LINK SYSTEM	370
5.1.13 Error messages from the BACKUP RESTORE SYSTEM.....	371
5.1.14 Error messages from the NX/Tools-S10V SYSTEM.....	372
5.1.15 Error messages from the tools	376
5.2 Trouble Report	377

FIGURES

Figure 3-1	Address Space Map of the LPU Unit.....	88
Figure 3-2	Address Space Map to the PIO-RAM Bit Area	89
Figure 3-3	Address Space Map to the PIO-RAM Word Area (1)	90
Figure 3-4	Address Space Map to the PIO-RAM Word Area (2)	91
Figure 3-6	Trace Area Structure	137
Figure 3-7	Trace Data Area Structure (for J.NET and J.NET-INT).....	138
Figure 3-8	Trace Data Area Structure (for IR.LINK).....	139
Figure 3-9	Stack Frame Details (1)	171
Figure 3-10	Stack Frame Details (2)	172
Figure 3-11	Binary File Format for Memory Dumps	174
Figure 4-1	Example of a Displayed Error Log	259
Figure 4-2	Program Error Analysis Procedure	266

TABLES

Table 3-1	Memory Areas Subjected to Backing up and Restoring	64
Table 3-2	Backup Areas Used by Optional-Module Setting Tools	80
Table 3-3	Backup Areas	82
Table 3-4	Items Displayed in the [Performance] Window	85
Table 3-5	Usable Registers.....	93
Table 3-6	Register Numbers.....	95
Table 3-7	System Registers	97
Table 3-8	Error Codes from the Socket Handler (LQE520).....	126
Table 3-9	Trace Buffer Structure (for Communication Tracing)	140
Table 3-10	Trace Data Area Details (for Communication Tracing).....	141
Table 3-11	Trace Buffer Structure (for Handler Tracing)	142
Table 3-12	Trace Data Area Details (for Handler Tracing).....	143
Table 3-13	Trace Buffer Structure (for H-7338 Error Tracing)	144
Table 3-14	Trace Data Area Details (for H-7338 Error Tracing).....	145
Table 3-15	Error Codes in H-7338 Error Trace Information	145
Table 3-16	Error Counters.....	146
Table 3-17	Error Codes from the Socket Handler	165
Table 4-1	Panic Log Error Message Formats	255
Table 4-2	Panic Log Default Error Messages.....	255
Table 4-3	Non-Panic Log Error Message Formats.....	256
Table 4-4	Non-Panic Log Default Error Messages	257
Table 4-5	Types of OS Error Logs	261
Table 4-6	Types of NXACP Error Logs.....	262
Table 4-7	Program Error Message Format	264
Table 4-8	Error Codes, Subtitles, and Their Meanings (for Program Errors).....	265
Table 4-9	Macro Parameter Check Error Message Format.....	270
Table 4-10	Predefined Supervisory Macro Codes and Macro Names Identified by Them.....	271
Table 4-11	I/O Error Message Format.....	272
Table 4-12	Error Detail Data for Built-in LANCE-/LANCE-Detected I/O Errors (EC=0x078013XX).....	274
Table 4-13	Error Detail Data for Built-in LANCE PCI Bus I/O Errors (EC=0x078014XX).....	276
Table 4-14	Error Detail Data for LANCP I/O Errors (EC=0x078016XX)	281
Table 4-15	Error Detail Data for Driver-Detected I/O Errors (EC=0x078015XX)	282

Table 4-16	I/O Error Message Format	283
Table 4-17	Error Codes, Subtitles, and Their Meanings (for I/O Errors)	284
Table 4-18	Error Detail Data for ROM Board Errors	284
Table 4-19	Watchdog Timer Timeout Error Message Format.....	286
Table 4-20	Module Error Message Format	287
Table 4-21	Error Codes, Subtitles, and Their Meanings (for Module Errors)	288
Table 4-22	MSW Detail Data for Modules.....	291
Table 4-23	Kernel Warning Message Format	297
Table 4-24	Error Code and Its Meaning (for Kernel Warnings).....	297
Table 4-25	Kernel Information Message Format	298
Table 4-26	System Down (System Error) Message Format.....	299
Table 4-27	Error Codes, Subtitles, and Their Meanings (for System Errors).....	300
Table 4-28	Kernel Trap Message Format	301
Table 4-29	System Down (Built-in Subroutine Error) Message Format	302
Table 4-30	Error Codes, Subtitles, and Their Meanings (for Built-in Subroutine Errors)	303
Table 4-31	System Down (Built-in Subroutine Stoppage) Message Format	304
Table 4-32	ADT Error Message Format	305
Table 4-33	Memory Error Message Format.....	310
Table 4-34	The Set Values of MST_TYPE and MST_INFO	323
Table 4-35	System Bus Error Message Format.....	324
Table 4-36	Error Codes	333
Table 4-37	Other-Error Message Format	334
Table 4-38	DHP Codes	336

1 PRELIMINARY CHECKING

1 PRELIMINARY CHECKING

Perform the following preliminary checks to eliminate obvious problems before troubleshooting the product:

- Check that terminating resistors are connected to both ends of the inter-LPU links chain established.

Both ends of the inter-LPU link line must be terminated with terminating resistors.

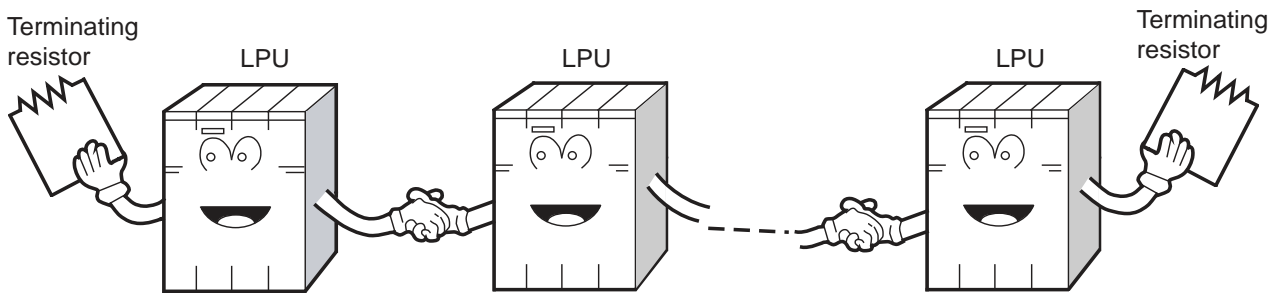

- Check that terminating resistors are connected to both ends of the remote I/O line.

Both ends of the remote I/O line must be terminated with terminating resistors.

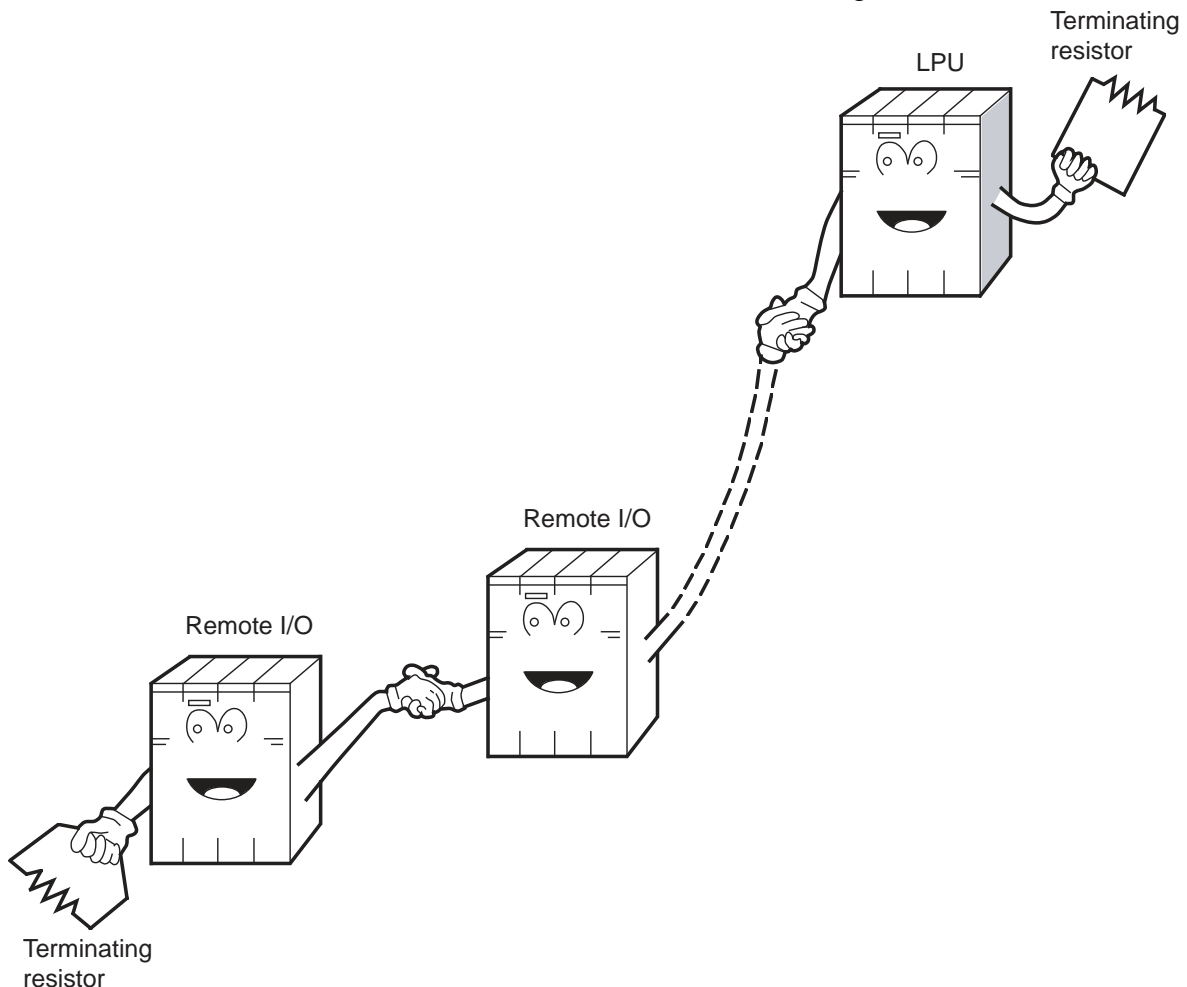

- Is the cabling correct?

Check the cables for disconnection or incorrect connection.

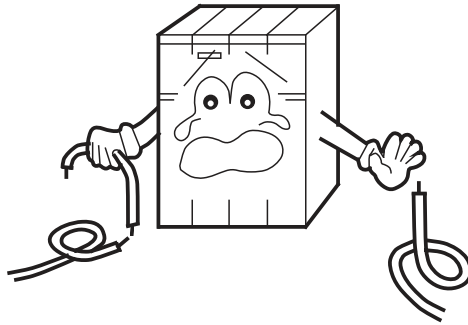

- Are the modules mounted correctly?

Check that no set screws are loosened.

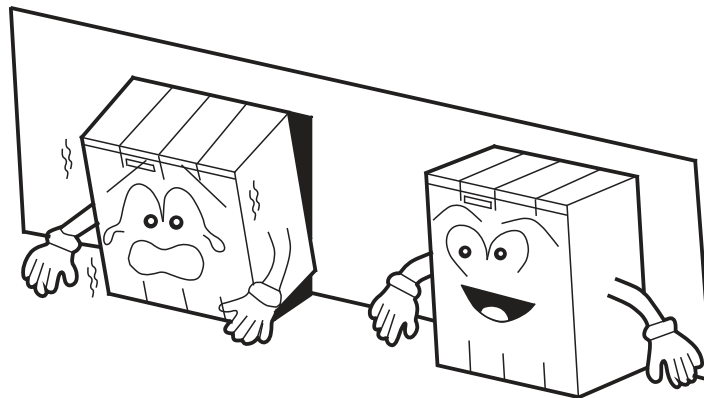

1 PRELIMINARY CHECKING

- Is grounding correct?
 - Do not ground the D.NET module in the same place where high-voltage equipment is grounded. They must be grounded in separate places.
 - Perform grounding work conforming to Class D* or higher grounding standard.

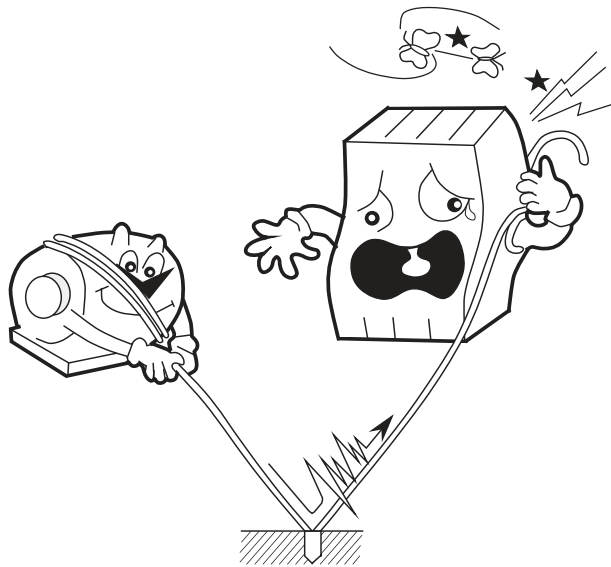

- Are the LG and FG separated?
 - Be sure to separate the LG from the FG or vice versa because power noise enters the FG via the LG. Failure to observe this rule may result in an equipment malfunction.
 - Ground the LG at the power supply side.

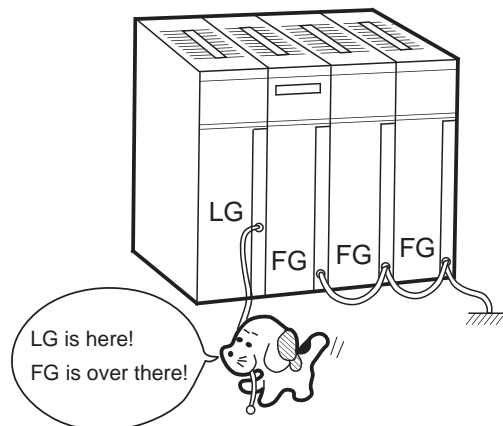

* Class D grounding is defined in the Technical Standard for Electrical Facilities of Japan. This standard states that the grounding resistance must be 100 ohms or less for equipment operating on 300 VAC or less, and 500 ohms or less for devices that shut down automatically within 0.5 seconds when shorting occurs in low tension lines.

2 TROUBLESHOOTING

2.1 Troubleshooting Procedure

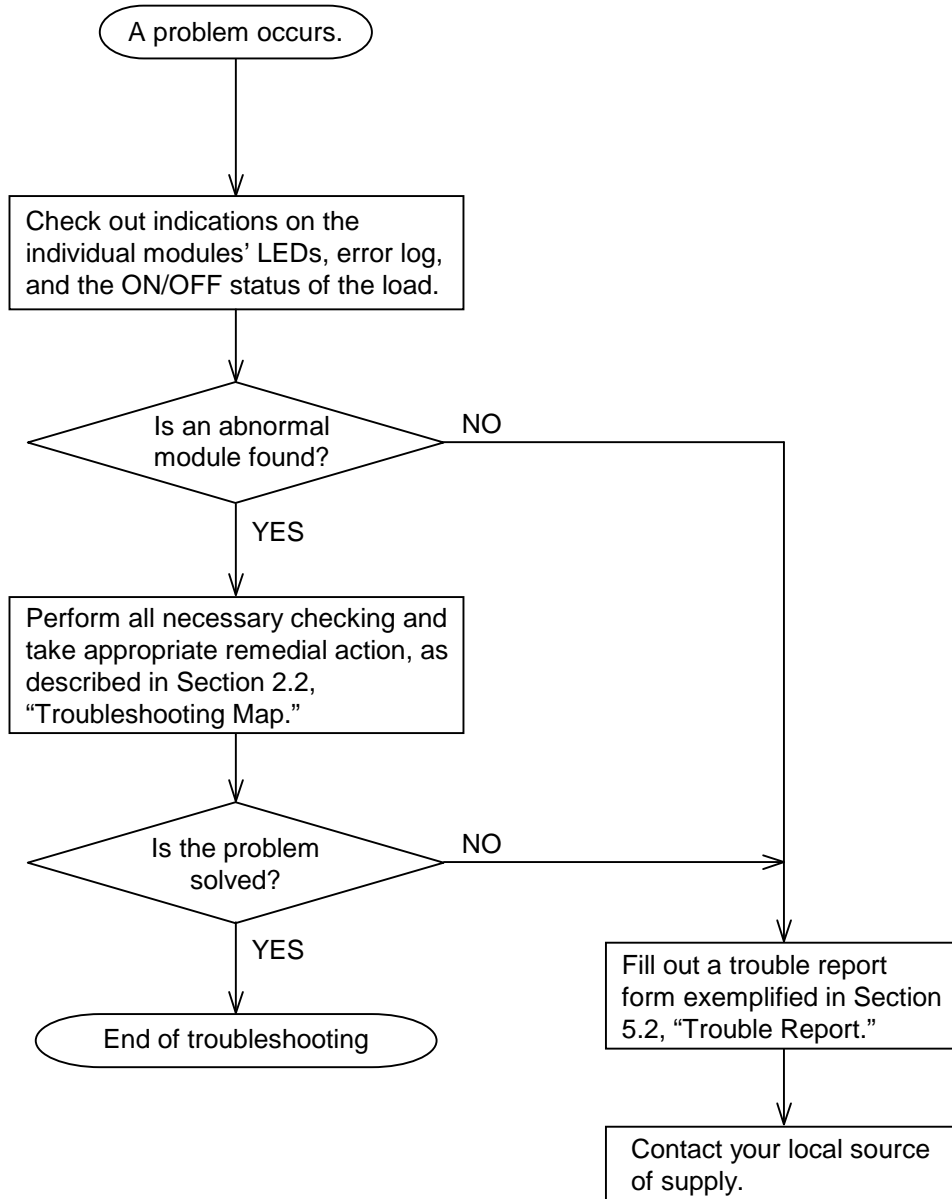

2.2 Troubleshooting Maps

The troubleshooting maps provided in this section serve as a guide to help users troubleshoot their systems as quickly as possible in the event of a problem. Each troubleshooting map has the following general format:

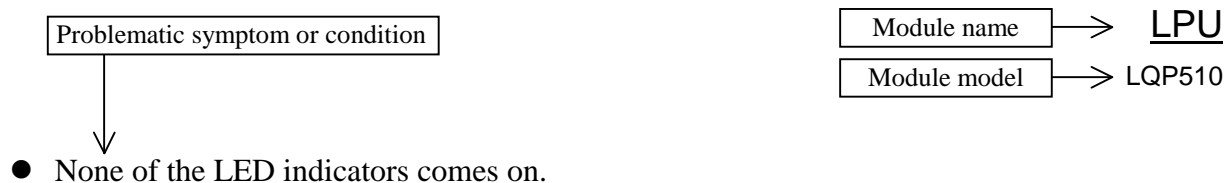

Check if:	What to do
The power supply module is operating abnormally.	If true, follow the troubleshooting map for the power supply module in order to check out the said module.
The LPU and/or the power supply module is installed incorrectly.	If true, install them correctly.
The supply voltage from the power supply module is abnormal.	If true, replace the power supply module.

Required checks
Required actions

2 TROUBLESHOOTING

LPU
LQP510

- None of the LED indicators comes on.

Check if:	What to do
The power supply module is operating abnormally.	If true, follow the troubleshooting map for the power supply module in order to check out the said module.
The LPU and/or the power supply module is installed incorrectly.	If true, install them correctly.
The supply voltage from the power supply module is abnormal.	If true, replace the power supply module.

- The ERR indicator (LED) is lit.

Check if:	What to do
An LPU error is recorded in the error log.	If true, troubleshoot according to the instructions given under “4 ERROR LOG INFORMATION.”

- The remote I/O process produces outputs but does not accept inputs.

Check if:	What to do
<p>A terminating resistor(s) are installed between the following terminals for the LPU:</p> <p>RI/O1 → $\left(\begin{array}{l} 100 \Omega : \text{Terminals A6 and A7} \\ 150 \Omega : \text{Terminals A5 and A7} \end{array} \right.$</p> <p>RI/O2 → $\left(\begin{array}{l} 100 \Omega : \text{Terminals B5 and B6} \\ 150 \Omega : \text{Terminals B4 and B6} \end{array} \right.$</p>	If not, install them.

- The PCs OK output is OFF.

Check if:	What to do
The LADDER switch is set in STOP position.	If true, set it in RUN position.
The LPU module's ERR indicator (LED) is lit.	If true, check the error log to see if an LPU error is recorded. If so, troubleshoot according to the instructions given under "4 ERROR LOG INFORMATION."
The SIMU indicator (LED) is lit.	If true, change the LADDER MODE to "NORM" in the S10V BASE SYSTEM.
The power supply module is abnormal.	If true, follow the troubleshooting map for the power supply module in order to check out the said module.
The wiring or connections are made correctly.	If not, correct them.

2 TROUBLESHOOTING

- The sequence program does not run.

Check if:	What to do
The LADDER switch is set in STOP position.	If true, set it in RUN position.
The LPU module's ERR indicator (LED) is lit.	If true, check the error log to see if an LPU error is recorded. If so, troubleshoot according to the instructions given under "4 ERROR LOG INFORMATION."
The SIMU indicator (LED) is lit.	If true, change the LADDER MODE to "NORM" in the S10V BASE SYSTEM.
External STOP input is in process.	If true, turn it off.
The program has a bug.	If true, correct it.

- A DI/O or AI/O module mounted on the same mount base as is the LPU module does not run normally.

Check if:	What to do
The LPU module's I/O number setting is missing or erroneous.	If true, set it correctly according to the instructions given under "7 SETTINGS" in the "S10V USER'S MANUAL BASIC MODULES (manual number SVE-1-100)."

- Data communication is not possible with the Tool (personal computer or PC).

Check if:		What to do
In cases where data communications are carried out by using the CMU module whose IP address is set to a fixed value of “192.192.192.1”:	The ST.No. U and L switches are both set in F-position.	If not, set both in F-position.
	The IP address of the Tool is set to a value of “192.192.192.***”, where *** is a number in the range 002 to 254.	If not, set it to a value of “192.192.192.***”, where *** is a number in the range 002 to 254.
In cases where data communications are carried out via a hub:	The ST.No. U and L switches are both set in 0-position.	If not, set both in 0-position.
	The CMU module’s IP address setting is made.	If not, set it.
	The IP address setting of the Tool contains the same network address as does that of the CMU module.	If not, use the same network address in both.
The CMU module’s T/M operational setting switch (T/M) is set in 0-position.		If not, set it in 0-position.
The “Ethernet” option is selected in the “Communication type” window on each system, which is displayed either at system startup time or by clicking the <input type="button" value="Change Connection"/> button.		If not, choose the “Ethernet” option.
The 10/100BASE-T cable used is the correct type.		If not, use a straight cable when connecting the CMU module to the hub, and a cross cable when connecting it directly to the personal computer or PC.

The CMU module runs with one of the following IP addresses, depending on the given settings of the ST.No. U and L switches:

ST.No. U and L : 0-position – The set IP address, if they are both set in 0-position.

: F-position – The IP address “192.192.192.1”, if they are both set in F-position.

2 TROUBLESHOOTING

PS

Power supply

LQV000

LQV020

LQV100

- The POWER ON indicator (LED) does not come on.

Check if:	What to do
The power cable is connected properly.	If not, connect it properly. (For details, refer to the “S10V USER’S MANUAL BASIC MODULES (manual number SVE-1-100)).”
The power cable is broken.	If true, replace the cable.
The external power supply is normal (in terms of voltage and wave form).	If not, make it normal.

FL.NET

LQE500

LQE502

- The TX and RX indicators (LEDs) do not come on normally.

Check if:	What to do
The MODU number is set correctly.	If not, set it correctly.
The set IP address of a remote node is duplicated with that of another node.	If true, set unique IP addresses for both nodes.
The IP address of the local node is set correctly.	Set the same network address for both the local and remote nodes. The recommended network address is "192.168.250".
The FL.NET module's parameters are set correctly.	If not, correct them.
In cases where the FL.NET module is networked by 10BASE-T connections, the cable used is the correct one.	Use a straight cable if you want to connect the FL.NET module to a given hub. If you want to connect it directly to the destination equipment, use a cross cable.
In cases where the FL.NET module is networked by 10BASE-5 connections, the transceiver's SQE switch is set correctly.	Turn on the SQE switch if you want to connect the FL.NET module to a single-port transceiver. If a multiport transceiver or repeater is connected with a single-port transceiver, and you want to connect the FL.NET module to that single-port transceiver, then turn off the SQE switch.
The cable connector is connected loose or about to fall off the mating connector of the FL.NET module.	If true, insert the connector completely into the mating connector and lock it.
In cases where the FL.NET module is networked by 10BASE-5 connections, it is connected to the 12-V external power supply.	If not, connect it to the said power supply.
A terminating resistor(s) are connected to the 10BASE-5 coaxial cable.	If not, connect them properly.
The 10BASE-5 coaxial cable is grounded properly.	If not, ground it properly.

- The LER indicator (LED) is lit.

Check if:	What to do
An FL.NET error is recorded in the error log.	If true, troubleshoot according to the instructions given under "4 ERROR LOG INFORMATION."
The FL.NET module mounted in this S10V controller is one whose parameters are previously set for use in an S10mini controller.	If true, open the parameter-setting window in the tool (FL.NET system) and add changes to the parameter settings for the mounted FL.NET module. Then, reset the controller, or turn off the power to the controller and back on again.

- Other problems

Check if:	What to do
Although a device is connected to the network to which the FL.NET module is connected, it does not support the FL.NET module's functions.	If true, disconnect the device from the network.

2 TROUBLESHOOTING

- Common network problems and troubleshooting

- Network-related problems (communication not possible) and troubleshooting

Symptom	Item to be checked	Check if:	What to do
Communication not possible	Power supply	Some equipment's main power indicator(s) are not lit.	If true, check the power supply and its voltage, and also check the power cables for any loose connections.
		The power indicator of the AUI's power supply unit is lit.	If not, check the power supply and its voltage, and also check the power cables for any loose connections.
		The output voltage of the AUI's power supply unit is equal to its prescribed voltage of 12 volts.	If not, check the power supply and its voltage, and also check the power cables for any loose connections.
		The power indicator of the hub is lit.	If not, check the power supply and its voltage, and also check the power cables for any loose connections.
		The AUI power cable is connected properly to the equipment.	If not, check the power supply and its voltage, and also check the power cables for any loose connections.
	Connection of communication cable and transceiver	The transceiver's cable is connected firmly.	If not, carry out installation work again properly according to the instructions given in Section 8.6 of the FL.NET (manual number SVE-1-101).
		A transceiver installation check device shows a problem with the transceiver.	If true, solve the problem by making necessary adjustments. If the same problem recurs, install the transceiver in a different place.
		The transceiver is electrically insulated properly.	If not, carry out installation work again properly according to the instructions given in Section 8.6 of the FL.NET (manual number SVE-1-101).
		The transceiver is connected properly at a marker on the communication cable.	If not, review the connection point according to the instructions given in Section 8.6 of the FL.NET (manual number SVE-1-101).
	Connection of transceiver cable and transceiver	The transceiver cable is connected firmly.	If not, review the installation work according to the instructions given in Section 8.6 of the FL.NET (manual number SVE-1-101) and, if necessary, apply additional tightening to the connection.
		A transceiver installation check device shows a problem with the transceiver.	If true, check the installation work according to the instruction manual on the check device.
		The transceiver is locked properly.	If not, lock it properly according to the instructions given in Section 8.6 of the FL.NET (manual number SVE-1-101).
		The transceiver's LED indicator(s) are all lit normally.	If not, check the power supply and its voltage, and also check the power cable for any loose connection.
	Connection of transceiver cable and other device	The transceiver cable is connected firmly.	If not, review the installation work according to the instructions given in Section 8.6 of the FL.NET (manual number SVE-1-101) and, if necessary, apply additional tightening to the connection.
		The device's TX (Transmit) and RX (Receive) indicators (LEDs) are lit normally.	If not, troubleshoot according to the instructions given in Chapter 7 of the FL.NET (manual number SVE-1-101).
		All the media switches, such as SQE, are set correctly.	Review the settings according to the instructions given in Section 8.6 of the FL.NET (manual number SVE-1-101).

(2) Network-related problems (communication unstable) and troubleshooting

Symptom	Item to be checked	Check if:	What to do
Communication not possible at all, or possible but unstable	Communication path	The external conductor of the coaxial cable is grounded at one place.	If not, ground it properly according to the instructions given in Section 8.6 of the FL.NET (manual number SVE-1-101).
		The shield wire of the AUI cable is grounded properly.	If not, ground it properly according to the instruction manual supplied by the cable maker.
		There is any station not responding correctly to a given ping command.	If true, check the power supply and cable wiring of the non-responding station.
		The collision indicator is lit frequently.	If true, check the cable wiring and connectors for any incomplete connection. Make sure of the nature of the problem by using a network analyzer.
		The number of repeaters on the path is 4 or less.	If not, review the configuration according to the instructions given in Section 8.6 of the FL.NET (manual number SVE-1-101).
		Each segment is within the prescribed length.	If not, review the configuration according to the instructions given in Section 8.6 of the FL.NET (manual number SVE-1-101).
		Terminating resistors are connected to both ends of the path.	If not, review the configuration according to the instructions given in Section 8.6 of the FL.NET (manual number SVE-1-101).
		The number of connected devices in each segment is within the prescribed limits.	If not, review the configuration according to the instructions given in Section 8.6 of the FL.NET (manual number SVE-1-101).
		The number of segments in which a device(s) are connected is 3 or less.	If not, review the configuration according to the instructions given in Section 8.6 of the FL.NET (manual number SVE-1-101).
		The power to the repeater(s) is ON.	If not, check the power supply and its voltage, and also check the power cables for any loose connections.
	Communication station's equipment settings	IP addresses are set correctly in the network.	Check the set IP addresses with the support tool and/or network analyzer.
		The station number of the station's equipment is set correctly.	Check the set station number with the support tool and/or network analyzer.
		The equipment's parameters are set correctly.	Check the set parameters with the support tool.
		The CD (Carrier Detect) indicator is lit continuously or intermittently.	If not, check the communication cable wiring and power to the AUI.
		The TX (Transmit) indicator is lit continuously or intermittently.	If not, check the equipment settings.
		The LK (Link) indicator is lit continuously.	If not, check the parameter settings on the equipment side.

2 TROUBLESHOOTING

(3) IP address checking using a PC's Ping function

Whether a given FL.NET module is networked properly or its IP address is set correctly can be checked by using a special function of a Windows® machine (PC), commonly known as Ping, rather than by using a special tool, such as the FL.NET network analyzer. The description below gives an outline of check operations using the Ping function.

If an IP connection is used with the FL.NET module, check the connection by using the Ping function, as follows:

- ① Choose [Start] – [Programs] – [Accessories] – [Command Prompt], and then the command prompt appears on screen.
- ② Enter the Ping command to carry out a basic communication test between the link unit (FL.NET) and PC. The form of the Ping command entered is either of the following:
Ping [IP address] or Ping [host name]

Example: Ping 192.168.250.13

If the FL.NET module under test is set up properly, the Ping command presents the following message:

```
Pinging 192.168.250. 13 with 32 bytes of data:  
Reply from 192.168.250. 13: bytes=32 time=2ms TTL=32  
Reply from 192.168.250. 13: bytes=32 time=1ms TTL=32  
Reply from 192.168.250. 13: bytes=32 time=1ms TTL=32  
Reply from JEMA 192.168.250. 13 : bytes=32 time=1ms TTL=32
```

- ③ If the FL.NET module is not connected yet, the Ping command presents the following message (timeout notifications):

```
Pinging 192.168.250. 13 with 32 bytes of data:  
Request timed out.  
Request timed out.  
Request timed out.  
Request timed out.
```

- FL.NET usage precautions

There are some precautions that must be observed when using the FL.NET module. These precautions are listed below along with the restrictions in the table below. For information on the standard related to FL.NET communication paths, refer to the FL.NET (manual number SVE-1-101) or IEEE802.3 standard.

- Do not carry data traffic from other Ethernet networks on the FL.NET communication cable.
- Do not connect the FL.NET module to any router.
- It will do you any good to use a switching hub for the FL.NET module.
- Use of such wireless media as infrared light and radio frequency radiation may greatly deteriorate the realtimeness of data communications.
- Use of a personal computer (PC) may greatly deteriorate the realtimeness of data communications, depending on the hardware, operating system, and applications used in the PC.
- Use only the predetermined IP address.

The network address used in the IP address must be consistent throughout the network (the standard network address is “192.168.250”). The node (station) number in the IP address must be in the following range:

Network address	Node number
192.168.250.	1 to 249

During initialization, the specified node number is not checked for any duplication. A duplicated node number is detected only when communication is first made using that node number. For this reason, special care must be taken when specifying a node number.

- Grounding must be made properly. The grounding wire’s diameter must be sufficiently large.
- Place the FL.NET module sufficiently away from any noise source. Never lay down AC power cables near the FL.NET module.
- In cases where cyclic data communication is used simultaneously with message data communication, their realtimeness may decrease depending on the volume of data being transmitted.
- Cyclic data communication area in memory, called the common memory area, need not be secured in a single continuous memory space.
- If the transceiver is provided with an SQE switch, set the SQE switch properly according to the instruction manual on that transceiver.
- The entire system’s on-time data communicability is affected by the overall performance of the networked equipment. In other words, data communication is performed at the transmission speed of the lowest-speed device, as well as at the transmission speeds of all other higher-speed devices connected to the same network. Thus, addition of a single device to the network may drastically deteriorate the realtimeness of the entire system, depending on the transmission speed of the added device.
- The header of messages transmitted by message data communication is represented in big-endian format, whereas their data is represented in little-endian format. The only exception to this is the data in profile read, which is the system parameters represented in big-endian format. (The big-endian format here is a format in which the most significant bit [MSB] is first sent out.)

2 TROUBLESHOOTING

OD.RING, SD.LINK

LQE510

LQE515

LQE530

- The TX and RX indicators (LEDs) do not come on normally.

Check if:	What to do
The MODU No. and CPL No. switches are set correctly.	If not, set them correctly.
The OD.RING/SD.LINK parameters are set correctly by using the S10V OD.RING/SD.LINK system.	If not, set them correctly.
The cable is connected properly. (For example, check if a cable line is broken or the cable is connected to the wrong destination.)	If not, connect it properly.
The cable connectors are inserted properly into the mating connectors.	Refer to Section 3.4, “Wiring,” of the OD.RING (manual number SVE-1-102) or SD.LINK (manual number SVE-1-115), and connect the cable properly.
The OD.RING/SD.LINK module of the communication destination functions normally.	If not, start up the OD.RING/SD.LINK module of the destination properly.
The optical fiber cable is bent sharply.	If true, replace the cable.

- The ERR indicator (LED) is lit.

Check if:	What to do
The MODU No. and CPL No. switches are set correctly.	If not, set them correctly.
The specified CPL No. is duplicated with the CPL No. of some other OD.RING/SD.LINK module.	If true, specify a unique CPL No.
An OD.RING/SD.LINK error is recorded in the error log.	If true, troubleshoot according to the instructions given under “4 ERROR LOG INFORMATION.”
The OD.RING/SD.LINK module mounted in this S10V controller is one whose parameters are previously set for use in an S10mini controller.	If true, open the parameter-setting window in the tool (OD.RING/SD.LINK system) and add changes to the parameter settings for the mounted OD.RING/SD.LINK module. Then, reset the controller, or turn off the power to the controller and back on again.

ET.NET

LQE520

- Communication is initially not possible.

Check if:	What to do
An error message is recorded in the error log.	If true, troubleshoot according to the instructions given under “4 Error Log Information.”
The module number is set correctly.	If not, set the rotary switch (MODU No.) at the front of the module housing correctly according to the instructions given under “2 NAMES AND FUNCTIONS OF EACH PART” in the “ET.NET (manual number SVE-1-103).”
The cable is disconnected.	If true, insert the cable connector into the mating connector and lock it.
The IP address is set correctly.	If not, set up the ET.NET module correctly by using the S10V ET.NET system.
The IP address of the ET.NET module is duplicated with the IP address of some other module.	If true, set unique IP addresses and subnet masks for the modules.
Terminating resistors are connected to both ends of the coaxial cable.	If not, connect them to both ends.
The ERR indicator (LED) of the ET.NET module is lit.	If true, push the RESET switch of the LPU module to restart it. If the ERR indicator is lit again, replace the ET.NET module.
In cases where the ET.NET module is networked by 10BASE-5 connections, it is connected to the 12-V external power supply.	If not, connect it to the said power supply.

2 TROUBLESHOOTING

- Communication is not possible with the Tool (PC)

Check if:		What to do
Where the Tool and ET.NET module are directly connected together by using a cross cable:	The ET.NET module's module no. setting switch (MODU No.) is set either in 4- or 5-position.	If not, and you are using 10BASE-T, then set it in 4-position if the ET.NET module is the main module, and in 5-position if it is a submodule.
	The IP address of the Tool is set to a value of "192.192.192.***", where *** is a number in the range 002 to 254.	If not, set it to a value of "192.192.192.***", where *** is a number in the range 002 to 254.
Where communication is performed via a hub:	The ET.NET module has its IP address set.	If not, set it.
	The IP addresses of the Tool and ET.NET module contain the same network address.	If not, specify the same network address in the two IP addresses.
	The module number is set correctly.	If not, and you are using 10BASE-5, then set it in 0-position if the ET.NET module is the main module, and in 1-position if it is a submodule. If not, and you are using 10BASE-T, then set it in 2-position if it is the main module, and in 3-position if it is a submodule.
The "Ethernet" option is selected in the "Communication type" window on each system, which is displayed either at system startup time or by clicking the "Change Connection" button.		If not, choose the "Ethernet" option.
The 10BASE-T cable used is the correct type.		If not, use a straight cable when connecting the ET.NET module to the hub, and a cross cable when connecting it directly to the PC.

SV.LINK

LQE521

- The TX and RX indicators (LEDs) do not come on normally.

Check if:	What to do
The MODU No. switch is set correctly.	If not, set it correctly.
The IP address of the SV.LINK module is duplicated with the IP address of some other module.	If true, set a unique IP address for the module.
The IP address is set correctly.	If not, set it correctly.
The SV.LINK module's parameters are set correctly.	If not, correct them.
In cases where the SV.LINK module is networked by 10BASE-T connections, the cable used is the correct one.	Use a straight cable if you want to connect the SV.LINK module to a given hub. If you want to connect it directly to the destination equipment, use a cross cable.
In cases where the SV.LINK module is networked by 10BASE-5 connections, the transceiver's SQE switch is set correctly.	Turn on the SQE switch if you want to connect the SV.LINK module to a single-port transceiver. If a multiport transceiver or repeater is connected with a single-port transceiver, and you want to connect the SV.LINK module to that single-port transceiver, then turn off the SQE switch.
The cable connector is connected loose or about to fall off the mating connector of the SV.LINK module.	If true, insert the connector completely into the mating connector.
In cases where the SV.LINK module is networked by 10BASE-5 connections, it is connected to the 12-V external power supply.	If not, connect it to the said power supply.

- The ERR indicator (LED) is lit.

Check if:	What to do
An SV.LINK error is recorded in the error log.	If true, troubleshoot according to the instructions given under "4 ERROR LOG INFORMATION."

- Other problems

Check if:	What to do
A non-SV.LINK station is connected to the same network to which an SV.LINK module is connected.	If true, disconnect the non-SV.LINK station from the network.

J.NET, J.NET-INT

LQE540

LQE545

- The TX and RX indicators (LEDs) do not come on normally.

Symptom	Check if:	What to do
Both TX and RX are OFF.	The system or NET information is set correctly.	If not, set it correctly.
	The MODU No. and BIT RATE switches are set correctly.	If not, set them correctly.
	The RI/O STOP terminal on the LPU's terminal block is shorted.	If true, open-circuit the terminal.
TX is flickering, but RX is OFF.	A J.NET error is recorded in the error log.	If true, troubleshoot according to the instructions given under "4 ERROR LOG INFORMATION."
	The cable is connected properly.	If not, connect it properly.
	Terminating resistors are connected properly.	If not, connect them properly.
	The slave is in an error condition.	If true, start up the slave normally.
	The set NET information is in conflict with the slave.	If true, set NET information again in conformity with the slave's specifications.
Both TX and RX are flickering.	A J.NET error is recorded in the error log.	If true, troubleshoot according to the instructions given under "4 ERROR LOG INFORMATION."
	The cable is connected properly.	If not, connect it properly.
	Terminating resistors are connected properly.	If not, connect them properly.
	The set NET information is in conflict with the slave.	If true, set NET information again in conformity with the slave's specifications.

- The ERR indicator (LED) is lit.

Check if:	What to do
The MODU No. or BIT RATE switch is set correctly.	If not, set them correctly.
The J.NET or J.NET-INT module mounted in this S10V controller is one whose parameters are previously set for use in an S10mini controller.	If true, open the parameter-setting window in the tool (J.NET or J.NET-INT SYSTEM) and add changes to the parameter settings for the mounted J.NET or J.NET-INT module. Then, reset the controller, or turn off the power to the controller and back on again.
A J.NET error is recorded in the error log.	If true, troubleshoot according to the instructions given under “4 ERROR LOG INFORMATION.”

- Other problems

Symptom	Check if:	What to do
Outputs from the DO are cleared erroneously.	The set value of the refresh cycle (monitoring time) is too small.	If true, set the refresh cycle (monitoring time, which is set with the J.NET SYSTEM by selecting [Edit NET1 (NET2) information] – ID – [Edit]) to a value that is at least five times as large as the NET1 (or NET2) refresh cycle value set in the “Edit system information” window. Alternatively, set it to 0.
The send/receive data is not updated as usual.	The transfer area for NET information is set up correctly.	If not, set it up correctly.
Communication timeouts are generated abnormally.	There is any AC power cable laid or any other noise source installed near the communication cable.	If true, place the communication cable away from the noise sources.

- The TX and RX indicators (LEDs) do not come on normally.

Symptom	Check if:	What to do
Both TX and RX are OFF.	The system or NET information is set correctly.	If not, set it correctly.
	The MODU No. and BIT RATE switches are set correctly.	If not, set them correctly.
	The RI/O STOP terminal on the LPU's terminal block is shorted.	If true, open-circuit the terminal.
TX is flickering, but RX is OFF.	An IR.LINK error is recorded in the error log.	If true, troubleshoot according to the instructions given under "4 ERROR LOG INFORMATION."
	The cable is connected properly.	If not, connect it properly.
	Terminating resistors are connected properly.	If not, connect them properly.
	The slave is in an error condition.	If true, start up the slave normally.
	The set NET information is in conflict with the slave.	If true, set NET information again in conformity with the slave's specifications.
Both TX and RX are flickering.	An IR.LINK error is recorded in the error log.	If true, troubleshoot according to the instructions given under "4 ERROR LOG INFORMATION."
	The cable is connected properly.	If not, connect it properly.
	Terminating resistors are connected properly.	If not, connect them properly.
	The set NET information is in conflict with the slave.	If true, set NET information again in conformity with the slave's specifications.

- The ERR indicator (LED) is lit.

Check if:	What to do
The MODU No. or BIT RATE switch is set correctly.	If not, set them correctly.
The IR.LINK module mounted in this S10V controller is one whose parameters are previously set for use in an S10mini controller.	If true, open the parameter-setting window in the tool (IR.LINK SYSTEM) and add changes to the parameter settings for the mounted IR.LINK module. Then, reset the controller, or turn off the power to the controller and back on again.
An IR.LINK error is recorded in the error log.	If true, troubleshoot according to the instructions given under “4 ERROR LOG INFORMATION.”

- Other problems

Symptom	Check if:	What to do
Outputs from the DO are cleared erroneously.	The set value of the refresh cycle (monitoring time) is too small.	If true, set the refresh cycle (monitoring time, which is set with the IR.LINK SYSTEM by selecting [Edit module information] – ID – [Edit]) to a value that is at least five times as large as the I/O refresh cycle value set in the “Edit information” window. Alternatively, set it to 0.
The send/receive data is not updated as usual.	The transfer area for NET information is set up correctly.	If not, set it up correctly.
Communication timeouts are generated abnormally.	There is any AC power cable laid or any other noise source installed near the communication cable.	If true, place the communication cable away from the noise sources.

CPU LINK

Inter-CPU link

LQE550

- The LINK indicator (LED) does not come on.

Check if:	What to do
The power supply module is operating abnormally.	If true, follow the troubleshooting map for the power supply module in order to check out the said module.
The MAIN/SUB setting switch is set correctly.	If not, set it correctly. For details, refer to the description under “4 OPERATION” in the “CPU LINK (manual number SVE-1-109).”
The PCs edition is set correctly by using the CPU Link system.	
The LPU module is operating abnormally.	If true, follow the troubleshooting map for the LPU module in order to check out the said module.
The voltage from the power supply module -- a measurement between the voltage check terminals -- is abnormal.	If true, replace the power supply module.
The LPU module’s LADDER switch is in STOP position.	If true, set it in RUN position.
The LPU module’s SIMU indicator (LED) is ON.	If true, change the LADDER MODE to “NORM” with the “S10V BASE SYSTEM.”
The “Receive only” option is checked in the CPU Link system’s “PCs edition” window.	If true, deselect the option and set up a send area.

RS-232C, RS-422

LQE560

LQE565

- The TX and RX indicators (LEDs) do not come on normally.

Check if:	What to do
The MODU No. switch is set correctly.	If not, set it correctly.
The RS-232C or RS-422 module's parameters are set correctly.	If not, set them correctly.
The cable is connected correctly.	Check the cable connections and, if a connection error is found, correct it.
The cable connector is connected loose or about to fall off the mating connector of the RS-232C or RS-422 module.	If true, insert the connector completely into the mating connector.

- The ERR indicator (LED) is lit.

Check if:	What to do
An RS-232C or RS-422 error is recorded in the error log.	If true, troubleshoot according to the instructions given under "4 ERROR LOG INFORMATION."

2 TROUBLESHOOTING

D.NET

LQE570

LQE575

- The MNS indicators (LEDs) do not come on normally.

Symptom	Check if:	What to do
The green LED is flickering, but the red LED is OFF.	The cable is connected properly or free from breakage.	If not, connect it properly.
	Terminating resistors are connected properly.	If not, connect them properly.
	The slave is registered properly.	If not, register it properly.
	The slave is started up normally.	If not, start it up normally.
The green LED is OFF but the red LED is lit.	The D.NET module's NA switch setting is duplicated with some other node's.	Set them uniquely.
	The NA, DR, and MODU No. switches are all set correctly.	If not, set them correctly.
	A D.NET error is recorded in the error log.	If true, troubleshoot according to the instructions given under "4 ERROR LOG INFORMATION."
	The D.NET module mounted in this S10V controller is one whose parameters are previously set for use in an S10mini controller.	If true, open the parameter-setting window in the tool (D.NET SYSTEM) and add changes to the parameter settings for the mounted D.NET module. Then, reset the controller, or turn off the power to the controller and back on again.
The green LED is OFF, but the red LED is flickering.	The cable is connected properly.	If not, connect it properly.
	Terminating resistors are connected properly.	If not, connect them properly.
	The connector is connected loose.	Insert the connector completely into the mating connector.
Both the green and red LEDs are OFF.	A D.NET error is recorded in the error log.	If true, troubleshoot according to the instructions given under "4 ERROR LOG INFORMATION."
	The NA, DR, and MODU No. switches are all set correctly.	If not, set them correctly.

- Other problems

Check if:	What to do
The communication (external) power supply is connected properly.	If not, connect it properly. For details, refer to the description under "3 MOUNTING AND WIRING" in the D.NET (manual number SVE-1-106). Although the model LQE570 module that self-feeds its own communication power source needs no external power supply, connection of the power supply to it causes no problem because the power wire is well isolated (both electrically and electro-magnetically) from the internal component parts.
In cases where the D.NET module is connected with a DI/O slave device from some other manufacturer, a setting is made to use the bit reversal (endian conversion) mode.	If not, make such a setting.

EQ.LINK

LQE701

- The TX and RX indicators (LEDs) do not come on normally.

Check if:	What to do
The MODU No. switch is set correctly.	If not, set it correctly.
The IP address of the EQ.LINK module is duplicated with some other node's.	If true, set them uniquely.
The IP address is set correctly.	Set the same network address for both the local and remote nodes. The recommended network address is "192.168.250".
The EQ.LINK module's parameters are set correctly.	If not, set them correctly.
The cable used by 10BASE-T connections is the right one.	If you want to connect the EQ.LINK module directly to the destination equipment, use a cross cable.
The cable connector is connected loose or about to fall off the mating connector of the EQ.LINK module.	If true, insert the connector completely into the mating connector and lock it.

- The LER indicator (LED) is lit.

Check if:	What to do
An EQ.LINK error is recorded in the error log.	If true, troubleshoot according to the instructions given under "4 ERROR LOG INFORMATION."
The EQ.LINK module is mounted in a non-S10V controller.	If true, mount it in an S10V controller.

- Other problems

Check if:	What to do
An SYS SW (model LQZ700) module is installed in the S10V controller.	If not, install it properly in the same S10V controller in which the EQ.LINK module is installed.

2 TROUBLESHOOTING

- Common network problems and troubleshooting

(1) Network-related problems (communication not possible) and troubleshooting

Symptom	Item to be checked	Check if:	What to do
Communication not possible	Power supply	Some equipment's main power indicator(s) are not lit.	If true, check the power supply and its voltage, and also check the power cables for any loose connections.

(2) Network-related problems (communication unstable) and troubleshooting

Symptom	Item to be checked	Check if:	What to do
Communication not possible at all, or possible but unstable	Communication station's equipment settings	IP addresses are set correctly in the network.	Check the set IP addresses with the support tool and/or network analyzer.
		The station number of the station's equipment is set correctly.	Check the set station number with the support tool and/or network analyzer.
		The equipment's parameters are set correctly.	Check the set parameters with the support tool.
		The TX (Transmit) indicator is lit continuously or intermittently.	If not, check the equipment settings.
		The LK (Link) indicator is lit continuously.	If not, check the parameter settings on the equipment side.

- EQ.LINK usage precautions

There are some precautions that must be observed when using the EQ.LINK module. These precautions are listed below. For information on the standard related to EQ.LINK communication paths, refer to the EQ.LINK (manual number SVE-1-124) or IEEE802.3 standard.

- Do not carry data traffic from other Ethernet networks on the EQ.LINK communication cable.
- Do not connect the EQ.LINK module to any router.
- Use of a switching hub for the EQ.LINK module does not produce the desired effect. (Use a 10BASE-T cross cable to connect the EQ.LINK module directly to the destination equipment.)
- Use of such wireless media as infrared light and radio frequency radiation may greatly deteriorate the realtimeness of data communications.
- Use of a personal computer (PC) may greatly deteriorate the realtimeness of data communications, depending on the hardware, operating system, and applications used in the PC.
- During initialization, a specified node number is not checked for any duplication. A duplicated node number is detected only when communication is first made using that node number. For this reason, special care must be taken when specifying a node number.
- Grounding must be made properly. The grounding wire's diameter must be sufficiently large.
- Place the EQ.LINK module sufficiently away from any noise source. Never lay down AC power cables near the EQ.LINK module.
- The header of messages transmitted by message data communication is represented in big-endian format, whereas their data is represented in little-endian format. The only exception to this is the data in profile read, which is the system parameters represented in big-endian format. (The big-endian format here is a format in which the most significant bit [MSB] is first sent out.)

- Communication is initially not possible.

Check if:	What to do
An error message is recorded in the error log.	If true, troubleshoot according to the instructions given under “4 ERROR LOG INFORMATION.”
The module number is set correctly.	If not, set the rotary switch (MODU No.) at the front of the module housing correctly according to the instructions given under “2 NAMES AND FUNCTIONS OF EACH PART” in the ET.NET (manual number SVE-1-103).
The cable is disconnected.	If true, insert the cable connector into the mating connector and lock it.
The IP address is set correctly.	If not, set up the ET.NET module correctly by using the S10V ET.NET system.
The IP address of the ET.NET module is duplicated with the IP address of some other module.	If true, set unique IP addresses and subnet masks for the modules.
The ERR indicator (LED) of the ET.NET module is lit.	If true, push the RESET switch of the LPU module to restart it. If the ERR indicator is lit again, replace the ET.NET module.
The ET.NET module is mounted in the same controller together with a model LQE520/LQE521 module.	If true, remove the model LQE520/LQE521 module from the controller. Mounting of model LQE520/LQE521 modules in the same controller in which the model LQE720 module is mounted is not allowed.
The UTP cable used is of Category 5 or higher.	Data communication at 100 Mbps requires a Category 5 or higher cable.

- Communication is not possible with the Tool (PC)

Check if:		What to do
Where the Tool and ET.NET module are directly connected together by using a cross cable:	The ET.NET module's ST No. setting switches are set to a value of /FF.	If not, set them to /FF.
	The IP address of the Tool is set to a value of "192.192.192.***", where *** is a number in the range 002 to 254.	If not, set it to a value of "192.192.192.***", where *** is a number in the range 002 to 254.
Where communication is performed via a hub:	The ET.NET module has its IP address set.	If not, set it.
	The IP addresses of the Tool and ET.NET module contain the same network address.	If not, specify the same network address in the two IP addresses.
	The MAIN/SUB setting switch is set correctly.	If not, set it in 0-position if the ET.NET module is the main module, and in 1-position if it is a submodule.
The "Ethernet" option is selected in the "Communication type" window on each system, which is displayed either at system startup time or by clicking the <input type="button" value="Change Connection"/> button.		If not, choose the "Ethernet" option.
The cable used is the correct type.		If not, use a straight cable when connecting the ET.NET module to the hub, and a cross cable when connecting it directly to the PC.

- Data transmission is not possible from ladder applications

Check if:	What to do
The LPU module used is compatible with the model LQE720 module.	Ethernet communication from a ladder application program using the model LQE720 module requires an LPU module of Rev.H (Ver-Rev of 0002-0002) or later.

- Data transmission is not possible from HI-FLOW applications

Check if:	What to do
The CMU module used is compatible with the model LQE720 module.	Ethernet communication from a HI-FLOW application program using the model LQE720 module requires an CMU module of Rev.E (Ver-Rev of 0004-0000) or later.

2 TROUBLESHOOTING

RI/O

Remote I/O station

LQS000

- The RI/O indicator (LED) does not come on.

Check if:		What to do
The LPU module's SIMU indicator (LED) is lit.		If true, change the LADDER MODE to "NORM" in the S10V BASE SYSTEM.
The LPU module is operating abnormally.		If true, follow the troubleshooting map for the LPU module in order to check out the said module.
The station number is set correctly.		If not, set it correctly. (For details, refer to the "S10V USER'S MANUAL BASIC MODULES (manual number SVE-1-100))."
The remote I/O cable is abnormal.	Line breakage	Replace the cable.
	Nonconforming wiring length	
	Incomplete connection	Connect it completely.
	Terminating resistor(s) missing	Connect them properly.
The set number of remote I/O transfer points is smaller than the number of such points actually used. (To make this check, select [Utility] – [PCs edition] – [Change capacity] in the S10V LADDER CHART SYSTEM.)		Change the set number in consideration of the number of remote I/O points actually used.
The I/O unit's power supply module is abnormal.		If true, follow the troubleshooting map for the power supply module in order to check out the said module.
The power supply and station (RI/O) modules in the I/O unit are mounted properly.		If not, mount them properly.
The voltage from the I/O unit's power supply module is abnormal. (Check the voltage.)		If true, replace the I/O unit's power supply module.
The RI/O STOP input that has its terminal provided on the LPU module's terminal block remains ON.		Turn it off.

J.Station

LQS020

- The J-NET indicator (LED) does not come on normally.

Check if:	What to do
The BIT RATE and ST No. switches are set correctly.	If not, set them correctly.
The J.Station module's terminal block has its terminals wired correctly.	If not, wire the terminals correctly.
The master side is started up normally.	If not, start it up normally. If the master is a J.NET module, see the error freeze information for the J.NET module.
The master-side settings made are in conflict with the J.Station module.	If true, make the settings again in conformity with the J.Station module's specifications.
The cable is wired correctly.	If not, wire it correctly.
The cable's wire(s) are connected loose or about to come off the terminals.	If true, connect the cable wire(s) firmly to the terminals on the terminal block.
Terminating resistors are connected properly.	If not, connect them properly.

- The ERR indicator (LED) is lit.

Check if:	What to do
The BIT RATE and ST No. switches are set correctly.	If not, set them correctly.

2 TROUBLESHOOTING

IR.Station

LQS021

- The TX/RX indicator does not come on normally.

Check if:	What to do
The BIT RATE and ST No. switches are set correctly.	If not, set them correctly.
The IR.Station module's terminal block has its terminals wired correctly.	If not, wire the terminals correctly.
The IR.LINK module is started up normally.	If not, start it up normally. If an IR.LINK error is reported, see the error freeze information for the IR.LINK module.
The IR.LINK module settings made are in conflict with the IR.Station module.	If true, make the settings again in conformity with the IR.Station module's specifications.
The cable is wired correctly.	If not, wire it correctly.
The cable's wire(s) are connected loose or about to come off the terminals.	If true, connect the cable wire(s) firmly to the terminals on the terminal block.
Terminating resistors are connected properly.	If not, connect them properly.

- The ERR indicator (LED) is lit.

Check if:	What to do
The BIT RATE and ST No. switches are set correctly.	If not, set them correctly.

D.Station

LQS070

- The MNS indicators (LEDs) do not come on normally.

Symptom	Check if:	What to do
The green LED is flickering, but the red LED is OFF.	The cable is connected properly (or free from wire breakage).	If not, connect it properly.
	Terminating resistors are connected properly.	If not, connect them properly.
	A registration of the D.Station module is missing on the master side.	If true, register it properly.
	A registration of the D.Station on the master side contains an error.	If true, register it again in conformity with the D.Station module's specifications.
	The master side is started up normally.	If not, start it up normally. If the master is a D.NET module, see the error freeze information for the D.NET module.
The green LED is OFF but the red LED is lit.	The D.Station module's NA switch setting is duplicated with some other node's.	Set them uniquely.
	The NA, SLOT, FUNC1, and FUNC2 switches are all set correctly.	If not, set them correctly.
The green LED is OFF, but the red LED is flickering.	The cable is connected properly.	If not, connect it properly.
	Terminating resistors are connected properly.	If not, connect them properly.
	The cable connector is connected loose or about to fall off the mating connector of the D.Station module.	Insert the connector completely into the mating connector.
Both the green and red LEDs are OFF.	The NA, SLOT, FUNC1, and FUNC2 switches are all set correctly.	If not, set them correctly.
	The D.Station module's NA switch setting is duplicated with some other node's.	Set them uniquely.

- Other problems

Check if:	What to do
In cases where the D.Station module is connected with a DeviceNet master from some other manufacturer, an external power supply for that master is connected to the network.	If not, connect one to the network. An external power supply must always be connected to the network in cases where the D.Station module is connected with a DeviceNet master from some other manufacturer.

A.INPUT

Analog input

LQA0**

LQA1**

LQA2**

- Input data cannot be input normally.

Check if:	What to do
The power supply module is operating abnormally.	If true, follow the troubleshooting map for the power supply module in order to check out the said module.
The station in which the A.INPUT module is installed is operating abnormally.	If true, follow the troubleshooting map for the station module in order to check out the said module.
The analog input module is mounted properly.	If not, mount it properly.
The right terminal block is attached to the A.INPUT module.	If not, attach the right one to it.
The input cable is wired correctly.	If not, wire it correctly.
The analog input module is grounded properly.	If not, ground it properly.
The allowable input data range is exceeded.	If true, use the analog input module within the proper input data range.
Where mode 2 is used by setting, the analog input module is registered in the LPU module.	If not, register it with the Tool.
The RANGE switch is set correctly.	If not, set it correctly.

A.INPUT

Scan-type analog input

LQA3**

LQA8**

- Input data cannot be input normally.

Check if:	What to do
The power supply module is operating abnormally.	If true, follow the troubleshooting map for the power supply module in order to check out the said module.
The station in which the A.INPUT module is installed is operating abnormally.	If true, follow the troubleshooting map for the station module in order to check out the said module. If the scan-type analog input module used is of model LQA301 or LQA310, use an RI/O station module. If it is of model LQA801 or LQA810, use an RI/O station or J.Station module.
The scan-type analog input module is mounted properly.	If not, mount it properly. For details, refer to the description under “4 HANDLING” in the “I/O MODULES (manual number SME-1-114).”
The right terminal block is attached to the A.INPUT module.	If not, attach the right one to it.
The input cable is wired correctly.	If not, wire it correctly.
The scan-type analog input module is grounded properly.	If not, ground it properly.
The allowable input data range is exceeded.	If true, use the scan-type analog input module within the proper input data range. For details, refer to the description under “4 HANDLING” in the “I/O MODULES (manual number SME-1-114).” The allocated data area (EW area) can be set up in the S10V LADDER CHART SYSTEM by selecting [Utility] – [PCs edition] – [Analog counter].

A.OUTPUT

Analog output

LQA5**

LQA6**

- The output voltage and current are abnormal.

Check if:	What to do
The power supply module is operating abnormally.	If true, follow the troubleshooting map for the power supply module in order to check out the said module.
The station in which the A.OUTPUT module is installed is operating abnormally.	If true, follow the troubleshooting map for the station module in order to check out the said module.
The analog output module is mounted properly.	If not, mount it properly.
The right terminal block is attached to the A.OUTPUT module.	If not, attach the right one to it.
The output cable is wired correctly.	If not, wire it correctly.
The analog output module is grounded properly.	If not, ground it properly.
The channel used for output is the wrong one.	If true, use the correct channel for data output.
Where mode 2 is used by setting, the analog output module is registered in the LPU module.	If not, register it with the Tool.
The RANGE switch is set correctly.	If not, set it correctly.

D.INPUT

Digital input

LQX***

- None of the input points is turned on.

Check if:		What to do	
The operation status indicators (LEDs) are all ON or OFF.	OFF	The right terminal block is attached to the D.INPUT module.	If not, attach the right one to it.
		The fixing screws of the digital input module are loose.	If true, apply additional tightening to the fixing screws.
		An external input power source is connected to the digital input module.	If not, connect one to it.
		The external power supply voltage is too low.	If true, raise it.
		The internal power supply voltage -- a measurement between the voltage check terminals on the power supply module -- is too low.	If true, replace the power supply module.
		The external wiring is correct.	If not, correct it.
	ON	The station module is operating abnormally.	If true, follow the troubleshooting map for the station module in order to check out the said module.

- Only a particular input point is not turned on.

Check if:		What to do	
The operation status indicator (LED) is ON or OFF.	OFF	The attached terminal block or inserted connector is getting loose.	If true, secure it in place.
		The terminal block or connector is broken.	If true, replace it.
		The ON-condition duration of the external input is too short.	If true, adjust the related component part of the external equipment.
		Part of the wiring is loose or broken.	If true, correct the wiring.
	ON	The I/O address used in a program is in error.	If true, correct the I/O address.

2 TROUBLESHOOTING

- None of the input points is turned off.

Check if:	What to do
The operation status indicator (LED) is OFF.	If true, replace the module.
The operation status indicator (LED) is ON.	If true, check if the external wiring is correct. If it is correct, replace the module.

- The input is turned on or off irregularly.

Check if:	What to do
The external input power voltage is too low.	If true, raise it.
Adequate noise reduction measures are taken.	If not: <ul style="list-style-type: none">• Use surge absorbers.• Lay the input cable away from any noise source. For more information, refer to the description under “4 HANDLING” in the “S10mini HARDWARE MANUAL, I/O MODULES (manual number SME-1-114).”

- Only a particular input point is not turned off.

Check if:	What to do
The external equipment used is operating abnormally.	If true, adjust the related component part of the external equipment.

D.OUTPUT

Digital output

LQY***

- None of the load points is turned on.

Check if:			What to do
The power supply module is operating abnormally.			If true, follow the troubleshooting map for the power supply module in order to check out the said module.
The digital output module is mounted properly.			If not, mount it properly.
The operation status indicator (LED) is ON or OFF.	OFF	The station module is malfunctioning.	If true, follow the troubleshooting map for the station module in order to check out the said module.
		The LPU module is malfunctioning.	If true, follow the troubleshooting map for the LPU module in order to check out the said module.
	ON	An external load power source is connected to the digital output module.	If not, connect one to it.
		The external load power voltage is too low.	If true, raise it.

- Only a particular load point is not turned on.

Check if:			What to do
The operation status indicator (LED) is ON or OFF.	OFF	The ON-condition duration in a program is too short.	Review the program.
		The I/O address used in a program is in error.	
	ON	The external load's wiring is broken.	Check the wiring.
		The attached terminal block or inserted connector is getting loose.	If true, secure it in place.
		The terminal block or connector is broken.	If true, replace it.
		The external wiring is correct.	If not, correct it.
The module is damaged due to an overcurrent.	Take a measure to prevent overcurrent from flowing in the load, and replace the module.		

2 TROUBLESHOOTING

- None of the load points is turned off.

Check if:	What to do
The station module is operating abnormally.	If true, follow the troubleshooting map for the station module in order to check out the said module.
The LPU module is operating abnormally.	If true, follow the troubleshooting map for the LPU module in order to check out the said module.

- Only a particular load point is not turned off.

Check if:		What to do	
The operation status indicator (LED) is ON or OFF.	OFF	The problem is a reset failure due to leakage current or saturation voltage.	If true, add a bleeder resistor to the load.
		The module is damaged due to an overcurrent.	Take a measure to prevent overcurrent from flowing to the load, and replace the module.
	ON	The station module is malfunctioning.	If true, follow the troubleshooting map for the station module in order to check out the said module.
		The LPU module is malfunctioning.	If true, follow the troubleshooting map for the LPU module in order to check out the said module.

- The load is turned on or off irregularly.

Check if:		What to do
The external load power voltage is too low.		If true, raise it.
Adequate noise reduction measures are taken.		<ul style="list-style-type: none"> • Use surge absorbers. • Take measures to protect the laid cables from any noise source. For more information, refer to the description under “4 HANDLING” in the “S10mini HARDWARE MANUAL, I/O MODULES (manual number SME-1-114).”
The remote I/O cable is abnormal.	Line breakage	Replace the cable
	Nonconforming wiring length	
	Incomplete connection	Connect it completely.
	Terminating resistor(s) missing	Connect them properly.
The program is error-free.		If not, correct the program.

D.IN/OUT

Digital input/output

LQZ***

- Input or output is malfunctioning.

Check if:	What to do
The allocation address setting switch (SW3) is set correctly.	If not, set it correctly.
Input is malfunctioning.	If true, follow the troubleshooting map for the digital input (D.INPUT) module in order to check out the said module.
Output is malfunctioning.	If true, follow the troubleshooting map for the digital output (D.OUTPUT) module in order to check out the said module.

COUNTER

Pulse counter

LQC000

- The counter does not count pulses.

Check if:		What to do
The power supply module is operating abnormally.		If true, follow the troubleshooting map for the power supply module in order to check out the said module.
The station is operating abnormally.		If true, follow the troubleshooting map for the station module in order to check out the said module.
The pulse counter module is mounted properly.		If not, mount it properly.
An external stop pulse is input.		Clear it.
The user program coded assumes that a “stop counting” signal continuously comes in.		Correct the coding.
The Up/Down direction indicator (LED) is blinking during the input of pulses.		If true, correct the wiring. For details, refer to the “I/O MODULES (manual number SME-1-114).”
Not blinking	The wiring for input pulses is incorrect.	
	An external input power source is connected to the counter module.	
	The external power supply voltage is too low.	
	The input pulses received do not meet the following requirements: (20K PPS) (50% duty cycle)	
The pulse counter is defined in the LPU.		If not, define it with the Tool. (To accomplish this, select [Utility] – [PCs edition] – [Analog counter] in the S10V LADDER CHART SYSTEM.) For information on the set values, refer to the “I/O MODULES (manual number SME-1-114).”

2 TROUBLESHOOTING

- The count value is not correct.

Check if:	What to do
The input pulses received exceeds 20K PPS.	If true, reduce them to 20K PPS or less.
Extra pulses are received due to noise.	If true, take a noise reduction measure.
Relay-generated pulses are received.	If true, receive only pulses generated by transistor or other semiconductor devices.

- No external comparison output is produced.

Check if:	What to do
An external power source is connected to the counter module.	If not, connect one to it.
The external power supply voltage is too low.	If true, raise it.
The external wiring is correct.	If not, correct it.

Tool (personal computer) connection

- No connection can be established with the PCs (via RS-232C)

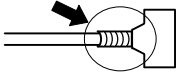
Check if:	What to do
The cable connector is screwed tightly.	If not, screw it tightly.
Any connector pins are bent.	If true, replace the cable.
The connection between the cable and connector is loose.	
	
A cable not conforming to the standard cable specifications is used.	

- No connection can be established with the PCs (via Ethernet [ET.NET module])
For details, see the table under “● Communication is not possible with the Tool (PC)” in the ET.NET section given earlier under “2 TROUBLESHOOTING.”

THIS PAGE INTENTIONALLY LEFT BLANK.

3 TECHNICAL SUPPORT INFORMATION

3.1 Remote I/O Troubleshooting

If the data read from or written to the X or Y area is not input or output normally, troubleshoot as described below.

- Checking if terminating resistors are connected

As exemplified below, terminating resistors need to be connected to both ends of a communication line on the LPU or the I/O unit.

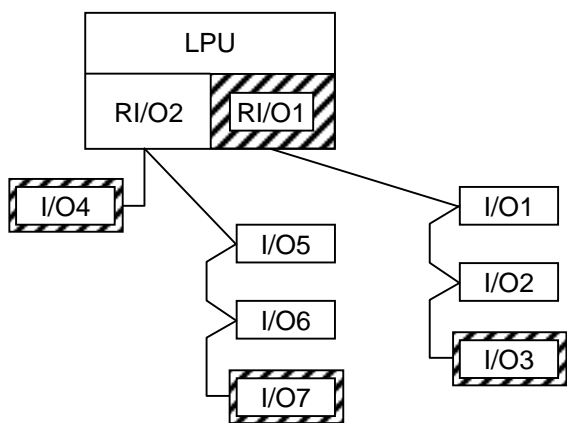

 : A place where a terminating resistor needs to be connected.

In the example shown left, the ends of the communication line on RI/O1 side are the LPU module's RI/O1 and the I/O unit numbered 3 (I/O3), each of which requires a terminating resistor. On RI/O2 side, each of I/O4 and I/O7 requires a terminating resistor.

Note: Any LPU module supports two remote I/O lines, RI/O1 and RI/O2, each of which has one of the following ranges of X/Y numbers assigned for it:

- RI/O1: 000 to 3FF
- RI/O2: 400 to 7FF

Connecting terminating resistors

When you want to use a conforming cable, terminate it with a built-in resistor of either 100 or 150 Ω. To use these resistors, short the terminal pairs shown below. If a non-conforming cable is selected and you want to terminate it with a termination value other than 100 and 150 Ω, then connect an appropriate resistor between the signal input terminals (A and B in the figures below).

	Terminating with 100 Ω resistor	Terminating with 150 Ω resistor	Terminating with arbitrarily selected resistor
LPU module	<p>Terminal block</p> <p>A: Wired together with the signal cable wire</p>	<p>Terminal block</p> <p>A: Wired together with the signal cable wire.</p> <p>Any port to which a remote I/O cable wire is not connected must also be terminated.</p>	<p>Terminal block</p> <p>R: Characteristic impedance of remote I/O cable wire A, B: Each wired together with the signal cable wire.</p>
RI/O station module	<p>Terminal block</p> <p>COM (A8) 100 Ω (A9)</p>	<p>Terminal block</p> <p>150 Ω (A7) COM (A8)</p>	<p>Terminal block</p> <p>R: Characteristic impedance of remote I/O cable wire A, B: Each wired together with the signal cable wire.</p>

Signal name	Terminal no. on terminal block			
	LPU module		RI/O module	
	RI/O1	RI/O2	RI/O1	RI/O2
150 Ω	A5	B4	A7	-
100 Ω	A6	B5	A9	-
COM	-	-	A8	-
A	A7	B6	A4	B5
B	A8	B7	A5	B6
SHD	A9	B8	A6	B7

- Specification of recommended terminating resistor:
Material: Metal oxide film or metal film
Resistance value: Same as the cable's impedance
Accuracy: ±10%
Capacity: 1/2 W
Shape: Axial-lead

3 TECHNICAL SUPPORT INFORMATION

- Checking if the I/O address is duplicated or is another station's
Check the address switch settings of the station module in the I/O unit.
- Checking if the remote I/O cable used is conforming to the standard cable spec
Use as the remote I/O cable a communication cable that conforms to the specifications shown below. Also, as the power and grounding cables, use those specified below.

Item		Spec	Remarks	
Remote I/O	Long-distance cable (at most 300 m per line)	Characteristic impedance	150 Ω	
		Attenuation factor	10 dB/km	750 kHz
		Cable size	• 0.75 mm ² (CO-EV-SX-1P × 0.75SQ) • 0.3 mm ² (CO-EV-SB-1P × 0.3SQ)	
		Recommended cable type	• CO-EV-SX-1P × 0.75SQ • CO-EV-SB-1P × 0.3SQ	Hitachi Cable, Ltd.
		Terminating resistance	150 Ω	
	Mid-distance cable (at most 200 m per line)	Characteristic impedance	150 Ω	
		Attenuation factor	12 dB/km	750 kHz
		Cable size	0.18 mm ²	
		Recommended cable type	CO-EV-SB-1P × 0.18SQ	Hitachi Cable, Ltd.
	Short-distance cable (at most 100 m per line)	Characteristic impedance	100 Ω	
		Attenuation factor	21 dB/km	750 kHz
		Cable size	0.3 mm ²	
Recommended cable type		CO-SPEV-SB-1P 0.3 mm ²	Hitachi Cable, Ltd.	
PCs OK	Cable type	Shielded twisted-pair cable		
	Cable length	100 m or less		
	Cable size	0.5 mm ² or more		
CPU STOP/RUN, R/O STOP	Cable type	Shielded twisted-pair cable		
	Cable length	100 m or less		
	Cable size	0.5 mm ² or more		
Power cable	Cable type	Shielded twisted-pair cable or 3-conductor twisted cable		
	Cable size	2 mm ² or more	The cable size depends on loads and cable lengths.	
Grounding cable	Cable size	2 mm ² or more		

The communication cable must be connected to the terminal block by using solder-less terminals:

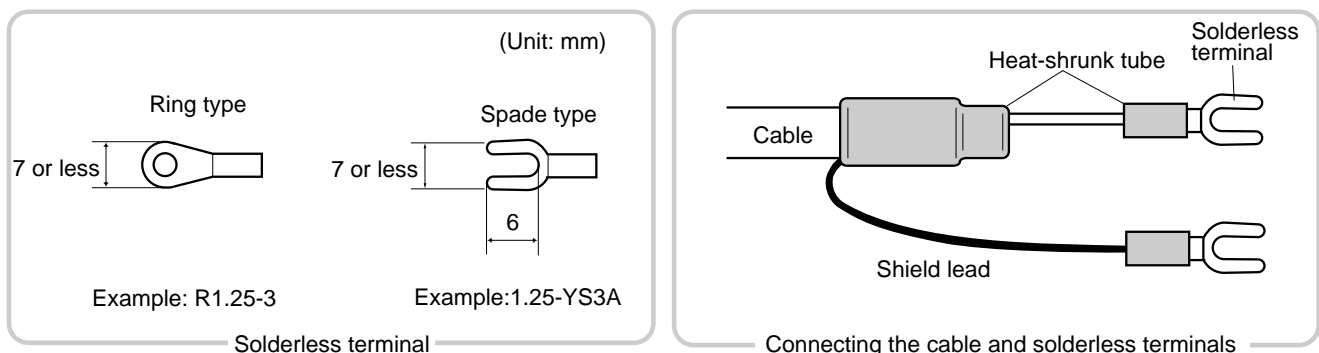

Note: Do not use more than one type of cable on the same communication path.

- Checking if extra X and Y numbers are registered

In some cases, an old I/O unit in which a station module of model PST350 or PST360 is installed in the left-end slot is connected to the LPU module. In such a case, if the number of remote I/O transfer points for the LPU module is set to 1024 or greater, decrease the number. To accomplish this, choose [Utility] – [PCs edition] – [Change capacity] in the S10V LADDER CHART SYSTEM and select a value of 512 or smaller as the “Remote I/O points.” Here, it should be noted that old I/O units may only be connected to the RI/O1 line of the two existing remote I/O lines on the LPU module. To avoid any trouble, use an S10/2 α I/O unit instead.

- Checking if power is supplied to the I/O unit

If the power supply module installed as the leftmost module in the I/O unit is a model LQV000, LQV020, or LQV100 module and its POWER indicator is not lit, then power must be supplied to that power supply module.

3 TECHNICAL SUPPORT INFORMATION

● Remote I/O and inter-CPU link line waveforms

(1) Transmission and reception waveforms
-- examples

(2) Enlarged view of normal waveform
-- example

1.0 V/div 20 μ s/div

1.0 V/div 0.5 μ s/div

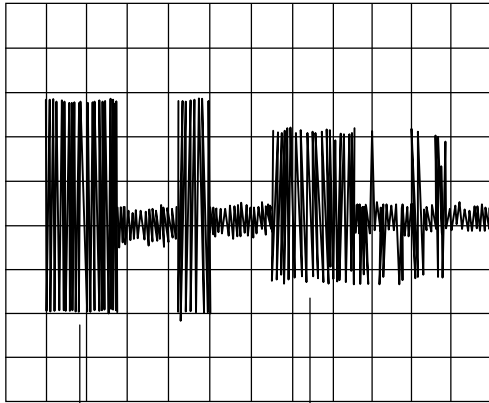

Transmission Reception

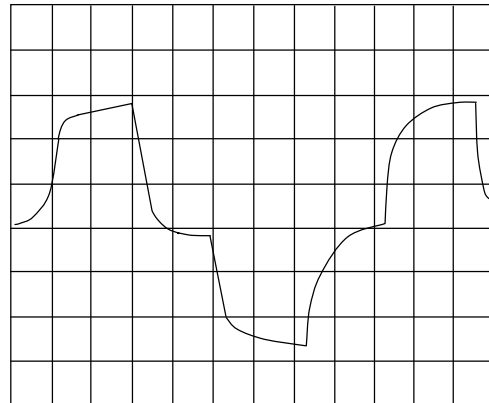

(3) Normal waveform on remote I/O line

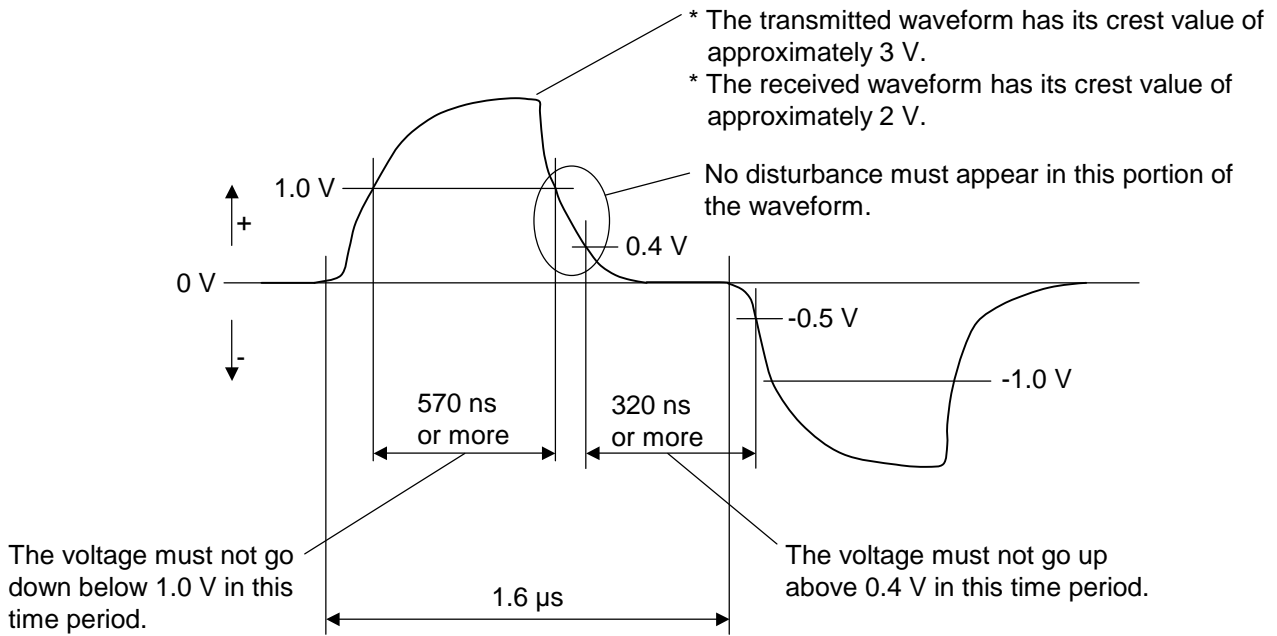

(4) Normal waveform on inter-CPU link line

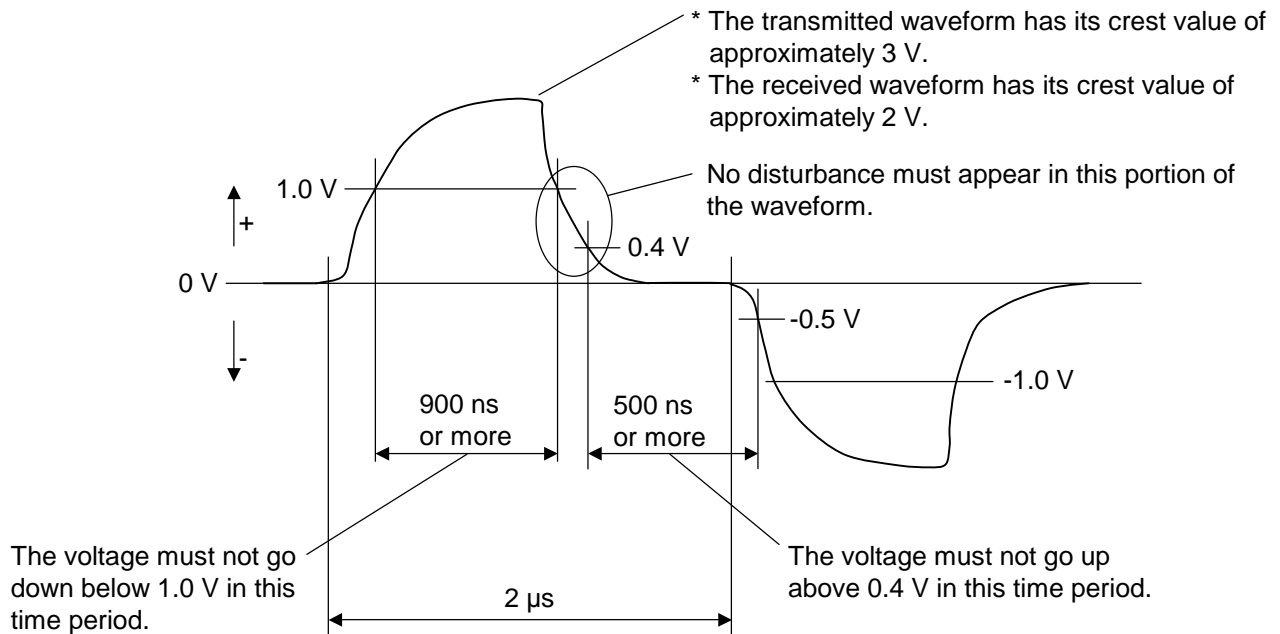

(5) Waveform due to non-matching terminating resistor (reflected waveform)



(6) Waveform on the 75 Ω cable terminated by 100 Ω resistor -- example

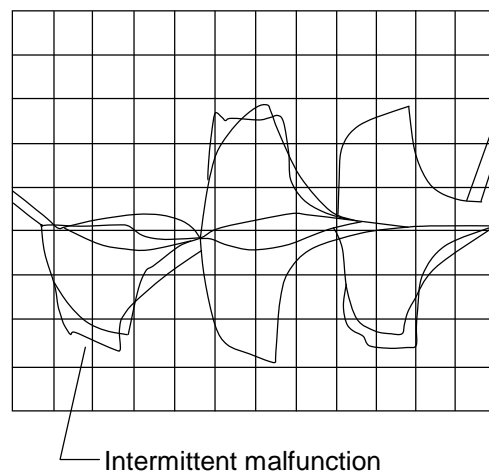

If the communication signal has such problems as waveform distortion and jitters, check if:

- Terminating resistors are connected to both ends of the line.
- There is any wire breakage in the cable.
- The cable used is a recommended one (i.e., it meets the prescribed characteristic requirements).
- The cable used is connected as part of a multidrop line, where no branch is allowed.
- Two or more different types of cables are used in the same link.

If the above troubleshooting does not solve the problem, the most conceivable cause is a hardware failure or a malfunction due to noise. Therefore, replace the module or place the noise source(s) away from the units, power cables, and remote I/O cables.

3.2 LPU Error Information Detail Table

If an error occurs in any of the installed LPU modules, detail error information is stored in a special table in the LPU module’s internal RAM. By accessing this table, called the LPU error information detail table, you can obtain more comprehensive error information than the error information supplied by the basic tool (S10V BASE SYSTEM). This table can be accessed with the MCS function of the basic tool.

The LPU error information detail table can contain up to eight cases of error information. If more than eight errors occur in the LPU module, the oldest case of error information is overwritten with the new error information. This memory content is backed up by battery power supply, so it is retained during periods when the power to the LPU module is OFF.

(1) Entire table structure

Address	
/004D D000	Validity flag
/004D D004	Case pointer
/004D D008	Case 0 (512 bytes)
/004D D208	Case 1 (512 bytes)
/004D D408	Case 2 (512 bytes)
/004D D608	Case 3 (512 bytes)
/004D D808	Case 4 (512 bytes)
/004D DA08	Case 5 (512 bytes)
/004D DC08	Case 6 (512 bytes)
/004D DE08	Case 7 (512 bytes)

Validity flag: Indicates whether meaningful data is present in the error detail info table. When this flag is set equal to /0000 0001, it indicates that meaningful error detail data is present in the table.

Case pointer: Points to the case in which to store error information next. This pointer has its initial value of /0000 0000 and is incremented each time an error occurs in the LPU module. When its value exceeds /0000 0007, this pointer is set back to /0000 0000. For example, if the current value of this pointer is /0000 0002, the case in which the latest error information is stored is case 1.

Cases 0 thru 7: Each is a set of detail error information stored in its dedicated area.

(2) Structure of each case

Offset from the beginning of case

+/0000 0000	Error code
+/0000 0002	Time of error occurrence: Seconds
+/0000 0004	: Minutes
+/0000 0006	: Hours
+/0000 0008	: Day of month
+/0000 000A	: Month
+/0000 000C	: Year
+/0000 000E	: Day of week (Note)
+/0000 0010	Detail info word count
+/0000 0014	Detail information
+/0000 01FF	

Error code: ID code of the error detected. For information on the error code, see Section 4.2.1, “LPU (LQP510) error log info and required actions.”

Time of error occurrence:
The time at which the error is detected. The time value stored in this location is based on the time maintained by the LPU module. Therefore, if the time maintained by the LPU module is not set correctly, the stored time value does not indicate the actual time at which an error is detected.

Detail info word count:
The number of meaningful bytes of detail information, which is stored in the detail info area, starting from its beginning (offset +/0000 0014). All the other bytes in that area are meaningless as detail information.

Detail information:
A piece of error detail information stored in its dedicated area. The format in which it is stored varies with the types of errors detected. For details, see the information provided under “(3) Detail information” below.

Note: The day of week is represented by one of the numbers /0001 through /0007, where /0001 stands for Sunday and /0007 for Saturday.

(3) Detail information

- Detail info for error codes 0x1101 and 0x1102
Offset from the beginning

of case	2^{31}	2^0
+/0000 0010	0x0000 0000 (detail word count)	
+/0000 0014	0x0000 0000	

- Detail info for error code 0x1105
Offset from the beginning

of case	2^{31}	2^0
+/0000 0010	0x0000 000C (detail word count)	
+/0000 0014	Address at which error is detected	
+/0000 0018	Read data	
+/0000 001C	Read data	

- Detail info for error code 0x1108
Offset from the beginning

of case	2^{31}	2^0
+/0000 0010	0x0000 0008 (detail word count)	
+/0000 0014	Starting address of area	
+/0000 0018	Sum value	

- Detail info for error code 0x110A
Offset from the beginning

of case	2^{31}	2^0
+/0000 0010	0x0000 000C (detail word count)	
+/0000 0014	Address at which error is detected	
+/0000 0018	Write data	
+/0000 001C	Read data	

- Detail info for error code 0x2301
Offset from the beginning

of case	2^{31}	2^0
+/0000 0010	0x0000 0000 (detail word count)	
+/0000 0014	0x0000 0000	

- Detail info for error code 0x2401
Offset from the beginning

of case	2^{31}	2^0
+/0000 0010	0x0000 0040 (detail word count)	
+/0000 0014	I/F register address 1	
	:	
+/0000 0050	I/F register address 16	

(Note 2)

- Detail info for error codes 0x1209 and 0x120C
Offset from the beginning

of case	2^{31}	2^0
+/0000 0010	0x0000 0020 (detail word count)	
+/0000 0014	Access error-detected address	
+/0000 0018	0x0000 0000	
+/0000 001C	0x0000 0000	
+/0000 0020	0x0000 0000	
+/0000 0024	0x0000 0000	
+/0000 0028	0x0000 0000	
+/0000 002C	0x0000 0000	
+/0000 0030	0x0000 0000	

- Detail info for error code 0x1103
Offset from the beginning

of case	2^{31}	2^0
+/0000 0010	0x0000 000C (detail word count)	
+/0000 0014	Address at which error is detected	
+/0000 0018	Write data	
+/0000 001C	Read data	

- Detail info for error code 0x1106
Offset from the beginning

of case	2^{31}	2^0
+/0000 0010	0x0000 0008 (detail word count)	
+/0000 0014	Starting address of ROM area	
+/0000 0018	Sum value	

- Detail info for error code 0x1109
Offset from the beginning

of case	2^{31}	2^0
+/0000 0010	0x0000 0004 (detail word count)	
+/0000 0014	Error No. (Note 1)	

Note 1: 0x0000 0001: Indicates that processing is finished earlier than the specified time limit.
0x0000 0002: Indicates that processing is finished later than the specified time limit.

- Detail info for error code 0x110B
Offset from the beginning

of case	2^{31}	2^0
+/0000 0010	0x0000 0004 (detail word count)	
+/0000 0014	Set value of switch	

- Detail info for error code 0x120D
Offset from the beginning

of case	2^{31}	2^0
+/0000 0010	0x0000 002C (detail word count)	
+/0000 0014	N-coil number	
+/0000 0018	Ladder program counter (SPC)	
+/0000 001C	0x0000 0000	
+/0000 0020	Ladder instruction in which the error is detected	
+/0000 0024	0x0000 0000	
+/0000 0028	0x0000 0000	
+/0000 002C	0x0000 0000	
+/0000 0030	0x0000 0000	
+/0000 0034	0x0000 0000	
+/0000 0038	0x0000 0000	
+/0000 003C	0x0000 0000	

3 TECHNICAL SUPPORT INFORMATION

Note 2: The table below is a list of I/F register addresses and the corresponding optional modules in which errors of this type are detected.

I/F register address	Corresponding optional module
/41F800, F810	CPU link (/41F800: Main module, /41F810: Submodule)
/41F820, F830	OD.RING (/41F820: Main module, /41F830: Submodule)
/41F920, F930	J.NET/J.NET-INT/IR.LINK (/41F920: Main module, /41F930: Submodule)
/41FA00, FA10, FA20, FA30	RS-232C/RS-422 (/41FA00: Channel 0, /41FA10: Channel 1, /41FA20: Channel 2, /41FA30: Channel 3)
/41FD20, FD30	ET.NET/SV.LINK (/41FD20: Main module, /41FD30: Submodule)
/41FE20, FE30	FL.NET/EQ.LINK (/41FE20: Main module, /41FE30: Submodule)
/41FF00, FF10, FF20, FF30	D.NET (/41F00: Channel 0, /41F10: Channel 1, /41F20: Channel 2, /41F30: Channel 3)

- Detail info for error codes other than the above

Offset from the beginning of case	2 ³¹	2 ⁰	Offset from the beginning of case	2 ³¹	2 ¹⁶	2 ¹⁵	2 ⁰
+/0000 0010	0x000001EC (detail word count)		+/0000 00C4	BCR1		BCR2	
+/0000 0014	N-coil number	(Note 1)	+/0000 00C8	WCR1		RAMER	
+/0000 0018	Ladder program counter (SPC)	(Note 2)	+/0000 00CC	PADR		PBDR	
+/0000 001C	HI-FLOW executed process No.	(Note 3)	+/0000 00D0	PCDR		PDDR	
+/0000 0020	R0 register		+/0000 00D4	PEDR		PFDR	
+/0000 0024	R1 register		+/0000 00D8	PGDR		PHDR	
+/0000 0028	R2 register		+/0000 00DC	PJDR		PKDR	
+/0000 002C	R3 register		+/0000 00E0	PLDR		/0000	
+/0000 0030	R4 register		+/0000 00E4	IRQSEL		IRQSTS	
+/0000 0034	R5 register		+/0000 00E8	REV		BUSTOUT	
+/0000 0038	R6 register		+/0000 00EC	BTOADRH		BTOADRL	
+/0000 003C	R7 register		+/0000 00F0	RIOMODE		RIOSTART	
+/0000 0040	R8 register		+/0000 00F4	RIOSTS		RIOINTMASK	
+/0000 0044	R9 register		+/0000 00F8	RIOFIFOADR		ROPFIFODT	
+/0000 0048	R10 register		+/0000 00FC	IOMODE		STSCHK	
+/0000 004C	R11 register		+/0000 0100	IOSTS		STATUS0	
+/0000 0050	R12 register		+/0000 0104	STATUS1		STATUS2	
+/0000 0054	R13 register		+/0000 0108	STATUS3		PIOSTS	
+/0000 0058	R14 register		+/0000 010C	PERRADRH		PERRADRL	
+/0000 005C	Stack pointer		+/0000 0110	PERRDATAH		PERRDATAL	
+/0000 0060	Program counter		+/0000 0114	PRTYMODE		SEQREG0	
+/0000 0064	Status register		+/0000 0118	SEQREG1		SEQREG2	
+/0000 0068	GBR		+/0000 011C	SEQREG3		SEQREG4	
+/0000 006C	VBR		+/0000 0120	SEQREG5		SEQREG6	
+/0000 0070	MACH		+/0000 0124	SEQREG7		SEQREG8	
+/0000 0074	MACL		+/0000 0128	SEQREG9		SEQREG10	
+/0000 0078	PR		+/0000 012C	SEQREG11		SEQREG12	
+/0000 007C	FR0 register		+/0000 0130	SEQREG13		SEQREG14	
+/0000 0080	FR1 register		+/0000 0134	SEQREG15		SEQPCH	
+/0000 0084	FR2 register		+/0000 0138	SEQPCL		RESET	
+/0000 0088	FR3 register		+/0000 013C	SEQSTS		SEQINTSTS	
+/0000 008C	FR4 register		+/0000 0140	SEQINTMSK		SEQRUN	
+/0000 0090	FR5 register		+/0000 0144	SPERRADRH		SPERRADRL	
+/0000 0094	FR6 register		+/0000 0148	SPERRDATAH		SPERRDATAL	
+/0000 0098	FR7 register		+/0000 014C	SEQMODE		SEQSHADRH	
+/0000 009C	FR8 register		+/0000 0150	SEQSHADRL		/0000	
+/0000 00A0	FR9 register		+/0000 0154			MSW0	
+/0000 00A4	FR10 register		+/0000 0158			MSW1	
+/0000 00A8	FR11 register		+/0000 015C			MSW2	
+/0000 00AC	FR12 register		+/0000 0160			MSW3	
+/0000 00B0	FR13 register		+/0000 0164			MSW4	
+/0000 00B4	FR14 register		+/0000 0168			MSW5	
+/0000 00B8	FR15 register		+/0000 016C			MSW6	
+/0000 00BC	FPUL		+/0000 0170			MSW7	
+/0000 00C0	FPSCR		+/0000 0174			MSW8	

Note 1: This location is used to store the nesting-coil number that is being executed in a ladder program at the occurrence of an error. If no ladder program is running at that time, the value /0000 0000 is stored in this location.

Note 2: This location is used to store the value of the program counter in a ladder program that is running at the occurrence of an error. This program counter value is an address used in the ladder processor and is calculated by evaluating the following mathematical formula:

$$\text{Address at the occurrence of an error} = \text{program counter (SPC)} \times 4 + /10\ 0000$$

Note 3: This location is used to store the process number of a HI-FLOW process that is running at the occurrence of an error. If no HI-FLOW process is running or HI-FLOW is not already loaded in at that time, either the value 0x0000 0000 or 0x0000 00FF is stored in this location.

3 TECHNICAL SUPPORT INFORMATION

(Continued from preceding page)

Offset from the beginning of case	2^{31}	2^{16} 2^{15}	2^0
+/0000 0178	MCW0		LPU's internal registers
+/0000 017C	MCW1		
+/0000 0180	MCW3		
+/0000 0184	MCW4		
+/0000 0188	IRW0		
+/0000 018C	IRW1		
+/0000 0190	IRW2		
+/0000 0194	IRW3		
+/0000 0198	IRW4		
+/0000 019C	RERRLOG		
+/0000 01A0	RSBACR		
+/0000 01A4	RERRSTATSLV	RERENLSLV	
+/0000 01A8	RERRSTATCP	RERENCP	
+/0000 01AC	RLERRSTAT	RLERREN	
+/0000 01B0	RBUSMNT	RBRQTMR	
+/0000 01B4	RTRANSTMR	RACYCTMER	
+/0000 01B8	RACKBUSYTMR	RNOACKTMR	
+/0000 01BC	RSTDACKTMR	RSBACR	
+/0000 01C0	PARBMODE	RINTSTAT	
+/0000 01C4	RINTEN	/0000	
+/0000 01C8	/0000 0000		
+/0000 01CC	/0000 0000		
+/0000 01D0	Content of location indicated by SPC-20		
+/0000 01D4	Content of location indicated by SPC-16		
+/0000 01D8	Content of location indicated by SPC-12		
+/0000 01DC	Content of location indicated by SPC-8		
+/0000 01E0	Content of location indicated by SPC-4		
+/0000 01E4	Content of location indicated by SPC		
+/0000 01E8	Content of location indicated by SPC+4		
+/0000 01EC	Content of location indicated by SPC+8		
+/0000 01F0	Content of location indicated by SPC+12		
+/0000 01F4	Content of location indicated by SPC+16		
+/0000 01F8	/0000 0000		
+/0000 01FC	/0000 0000		
+/0000 0200			

3.3 Clearing the Entire Memory

- Clearing the LPU module's memory

The entire memory of any LPU module can be cleared (to a condition at shipment) by performing the following procedure:

- ① Turn off the power to the LPU unit.
- ② Set the LPU module's operational setting switch (T/M) in E-position.
- ③ Turn on the power to the LPU unit and wait about three seconds.
- ④ Turn off the power to the LPU unit.
- ⑤ Set the LPU module's operational setting switch (T/M) in F-position.
- ⑥ Turn on the power to the LPU unit again and wait about 20 seconds. Then, the LPU module's six LED indicators will all come on to indicate the completion of clearing its entire memory.
- ⑦ Turn off the power to the LPU unit.
- ⑧ Set the LPU module's operational setting switch (T/M) in 0-position.

- Clearing the CMU module's memory

By using such tools as the HI-FLOW SYSTEM, clear the user programs in the CMU module's memory. (No dedicated clear command is provided for this purpose.)

3 TECHNICAL SUPPORT INFORMATION

3.4 Backing Up and Restoring

Replacement of an existing module may sometimes requires prior backing up and subsequent replacement of the entire software system. In these cases, use the S10V BACKUP RESTORE SYSTEM (also called the batch saving/loading system).

- Backup/restore areas

The BACKUP RESTORE SYSTEM backs up all the memory areas listed in the table below at one time.

Table 3-1 Memory Areas Subjected to Backing up and Restoring (1/3)

No.	User area name		Addresses	Remarks
1	PCs edition	PCs No., sequence cycle time, watchdog timer, 10-ms timer, N-coil master resetting-time operation mode, timer (T), one-shot (U) points, PI/O settings, ladder program, I/O comment, user (arithmetic) function area size, RI/O settings	/004B 0200 to /004B 02FE	
		Analog counter	/004B 0300 to /004B 03C2	
2	Ladder chart	Ladder program, I/O comment, user (arithmetic) function	/0010 0000 to /0016 7FFE	(Note 1)
		Keep coil, K000 to FFF (not battery-backed up)	/0040 1000 to /0040 11FE	
		C-contact, CW000 to 0FF (not battery-backed up)	/0040 1700 to /0040 171E	
		Work register, FW000 to BFF (not battery-backed up)	/0040 2000 to /0040 37FE	
		Long-word register, BD000 to 1FE (not battery-backed up)	/0040 3800 to /0040 3FFE	
		Data register, DW000 to FFF (not battery-backed up)	/0047 0000 to /0047 1FFE	
		Counter count, CC000 to 0FF	/0048 0600 to /0048 07FE	
		Keep coil, K000 to FFF (battery-backed up)	/0048 1000 to /0048 11FE	
		C-contact, CW000 to 0FF (battery-backed up)	/0048 1700 to /0048 17FE	
		Work register, FW000 to BFF (battery-backed up)	/0048 2000 to /0048 37FE	
		Long-word register, BD000 to 1FE (battery-backed up)	/0048 3800 to /0048 3FFE	
		Long-word register, LML0000 to 1FFF	/0049 0000 to /0049 7FFE	
		Floating-point register, LG0000 to 1FFF	/0049 8000 to /0049 FFFE	
		Word register, LXW0000 to 3FFF	/004A 0000 to /004A 7FFE	
Ethernet communication management table	/004A 8000 to /004A AF FE			
Data register, DW000 to FFF (battery-backed up)	/004F 0000 to /004F 1FFE			
3	HI-FLOW	User program	/0308 0000 to /033F FF FE	(Note 2) (Note 3)
		Ethernet management table	/004A 8000 to /004A AF FE	
4	RPDP	MAP	/2000 0000 to /200B 943E	(Note 3)
		GAMMT	/2800 D000 to /2800 D0FE	(Note 3)
		Task space	/3000 0000 to /3FFF FF FE	(Note 2) (Note 3)
		GLBR	/4000 0000 to /4FFF FF FE	(Note 2) (Note 3)
		GLBW	/5000 0000 to /5FFF FF FE	(Note 2) (Note 3)
		IRSUB	/6000 0000 to /6FFF FF FE	(Note 2) (Note 3)
	Site name	/7C00 2000 to /7C00 200E	(Note 3)	

Table 3-1 Memory Areas Subjected to Backing Up and Restoring (2/3)

No.	User area name	Addresses	Remarks	
5	NX-HOST	GAMMT	/2800 D000 to /2800 D0FE	(Note 3)
		NX-ACP program	/2000 0000 to /2000 003E	(Note 3)
			/2000 3440 to /2000 383E	
			/2000 40C4 to /2000 40C6	
			/2000 40E4 to /2000 40E6	
			/2000 4104 to /2000 4106	
			/2000 4204 to /2000 4206	
			/2000 4440 to /2000 4442	
			/2000 5250 to /2000 53CE	
			/3000 0000 to /3003 FFFE	
	/6000 0000 to /6001 7FFE			
	NX/Ladder program	/2000 0000 to /2000 003E	(Note 3)	
		/2000 19C0 to /2000 1A7E		
		/3004 0000 to /3005 1FFE		
	NX/ACP control table (local DF)	/2001 0440 to /2001 0442	(Note 3)	
		/2001 08F0 to /2001 096E		
		/2001 4440 to /2001 44FE		
/2001 5440 to /2001 5676				
/2002 4440 to /2002 46C6				
/5000 0000 to /5006 2FFE				
/2001 0440 to /2001 0442				
/2001 08F0 to /2001 096E				
/2001 4440 to /2001 44FE				
/2001 5440 to /2001 568A				
/2002 4440 to /2002 46C6				
/5000 0000 to /500B E000				
User (arithmetic) function program, NXSAT	/004F 2000 to /004F 224A	(Note 3)		
User (arithmetic) function program, NXACP	/004F 3000 to /004F 32EE	(Note 3)		
6	ET.NET	IP address, subnet mask, broadcast address, routing info	/004B 0620 to /004B 073E	
		Comment	/007B 0D00 to /007B 0D3E	
7	OD.RING/SD.LINK	Module installation info area for main module	/0097 8002 to /0097 802E	
		Module installation info area for submodule	/009F 8002 to /009F 802E	
8	J.NET/ J.NET-INT/ IR.LINK	J.NET-INT/IR.LINK task registration area	/004B 07C0 to /004B 07FE	
		Slave parameter table for main module	/00A7 8008 to /00A7 FFFE	
		Slave parameter table for submodule	/00AF 8008 to /00AF FFFE	
9	FL.NET	IP address, subnet mask, node name	/004B 0740 to /004B 076E	
		Local-node status table for main module	/00D4 1A00 to /00D4 1A32	
		Local-node initialization table for main module	/00D7 0020 to /00D7 004E	
		Other(participating)-node allotment table for main module	/00D7 0050 to /00D7 1E4E	
		Local-node status table for submodule	/00DC 1A00 to /00DC 1A32	
		Local-node initialization table for submodule	/00DF 0020 to /00DF 004E	
		Other(participating)-node allotment table for submodule	/00DF 0050 to /00DF 1E4E	

3 TECHNICAL SUPPORT INFORMATION

Table 3-1 Memory Areas Subjected to Backing Up and Restoring (3/3)

No.	User area name	Addresses	Remarks	
10	D.NET	Parameter table, peer, slave parameter table for ch0	/00E3 0000 to /00E3 5AFE	
		Slave operation table for ch0	/00E3 6000 to /00E3 608E	
		Parameter table, peer, slave parameter table for ch1	/00E7 0000 to /00E7 5AFE	
		Slave operation table for ch1	/00E7 6000 to /00E7 608E	
		Parameter table, peer, slave parameter table for ch2	/00EB 0000 to /00EB 5AFE	
		Slave operation table for ch2	/00EB 6000 to /00EB 608E	
		Parameter table, peer, slave parameter table for ch3	/00EF 0000 to /00EF 5AFE	
		Slave operation table for ch3	/00EF 6000 to /00EF 608E	
11	Inter-CPU link	PCs edition information	/004B 0600 to /004B 061E	
12	RS-232C/RS-422	LGB table for ch0	/00F4 8100 to /00F4 81FE	
		LGB table for ch1	/00F5 8100 to /00F5 81FE	
		LGB table for ch2	/00F6 8100 to /00F6 81FE	
		LGB table for ch3	/00F7 8100 to /00F7 81FE	
13	EQ.LINK	IP address, subnet mask, node name	/004B 0740 to /004B 076E	
		Local-node status table for main module	/00D4 1A00 to /00D4 1A32	
		Local-node initialization table for main module	/00D7 0020 to /00D7 1E4E	
		Local-/remote-node initialization table for main module	/00D7 2058 to /00D7 2060	
		Local-/remote-node area division table for main module	/00D7 2140 to /00D7 23FE	
		Local-node status table for submodule	/00DC 1A00 to /00DC 1A32	
		Local-node initialization table for submodule	/00DF 0020 to /00DF 1E4E	
		Local-/remote-node initialization table for submodule	/00DF 2058 to /00DF 2060	
Local-/remote-node area division table for submodule	/00DF 2140 to /00DF 23FE			
14	BASE SYSTEM	IP address, subnet mask, and broadcast address of CMU	/004B 0770 to /004B 07FE	
		CMU routing information	/004B 0800 to /004B 0848	
		Time setting	/0047 3234 to /0047 3244	

Note 1: The range of address space allocated varies with PCs edition settings.

Note 2: The range of address space allocated varies with user-provided settings.

Note 3: This memory area is not subjected to backing up and restoring if an RS-232C or ET.NET (LQE520) connection is used. To back up and restore this memory area, use Ethernet communication via a CMU or an ET.NET (LQE720) module.

- Backing up procedure

Choose [Start] – [Programs] – [Hitachi S10V] – [S10V Backup Restore System] on the personal computer (PC) connected with the S10V system. The Backup Restore System then starts. As described in detail below, click on the **Backup** button in the [BACKUP RESTORE SYSTEM] window, and then the [Backup] window appears on the screen. Now the BACKUP RESTORE SYSTEM is ready for backing up the S10V system. For details on the S10V BACKUP RESTORE SYSTEM, refer to the “BACKUP RESTORE For Windows® (manual number SVE-3-127).”

- (1) Click the **Backup** button in the [BACKUP RESTORE SYSTEM] window. The [Backup] window then appears on screen.

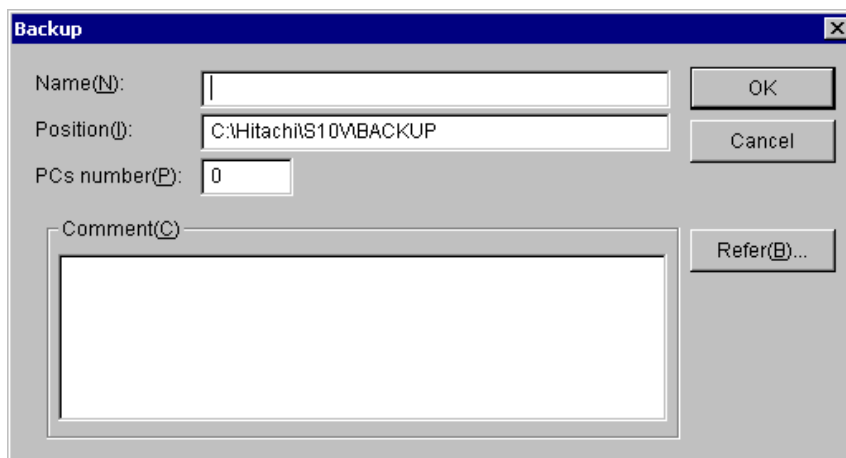

At the same time, if a CMU module is installed and a connection is established by using an RS-232C or an ET.NET (model LQE520) module, the following warning message is also presented:

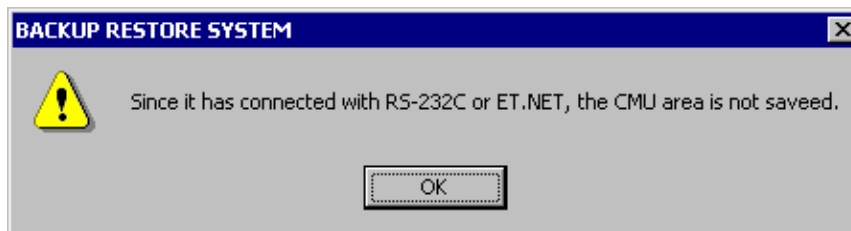

In this case, data backing up is not performed for the CMU module. If you want to perform backing up for the CMU module, re-establish a connection by using the Ethernet support provided by that CMU module or an ET.NET (model LQE720) module.

3 TECHNICAL SUPPORT INFORMATION

- (2) Enter the name and position finder of the folder to which to save the contents of the memory areas, and the desired PCs number, along with a comment, if necessary.

The following information describes the input items and buttons displayed in the aforementioned [Backup] window.

Name: Is the name of the folder in which to place the files backed up. This folder name is defaulted to none; the box is displayed blank.

Position: Is the directory path to the specified folder name. This position can be specified either by entering the directory path beginning with the drive name directly into the text box, or by clicking the button and choosing that directory path. This position is defaulted to the installation directory for the BACKUP RESTORE SYSTEM.

PCs number: Is a PCs number for use in backup. Use the displayed PCs number (default) for usual backup operations. The default PCs number is the PCs number of the PCs with which the BACKUP RESTORE SYSTEM is connected.

Comment: Is an optionally entered piece of text of up to 256 characters in length.

button: Is clicked to start a backup operation. When this button is clicked, the BACKUP RESTORE SYSTEM first checks each input value for error.

The input items checked for error are as follows:

Name -- if this item is omitted, an error results.

Position -- if this item is omitted or an invalid drive name is specified as this item, an error results.

PCs number -- if a number outside the range 0 to 9999 is specified as this item, an error results.

Upon completion of the above check, the BACKUP RESTORE SYSTEM starts the backup process.

button: Is clicked when you want to return to the [BACKUP RESTORE SYSTEM] window without backing up the files.

button: Is clicked when you want to change the displayed position. Clicking this button presents the [Reference] window.

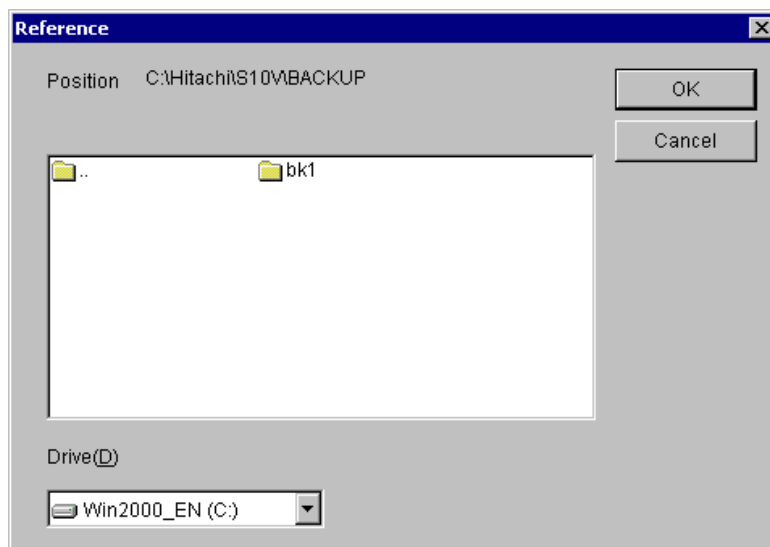

Select the desired folder and click the button. Then, the [Reference] window disappears and the [Backup] window appears again. The folder you have just selected in the [Reference] window is displayed with its full path name in the Position (I) text box. If you click the button in place of the button, the [Reference] window disappears and the [Backup] window appears again as usual, but the folder you have selected in the [Reference] window is not displayed in the Position (I) text box.

- (3) When you finish entering all necessary values, click the button. Then, the backup process begins.

If you do not want to start the backup process, click the button in place of the button. Then, the [Backup] window disappears and the [BACKUP RESTORE SYSTEM] window appears again.

- (4) When the backup process begins, the “Do you ABORT all tasks?” message is presented:

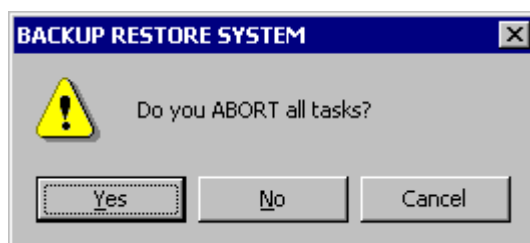

In this dialog box, if you click the button, all the active tasks are aborted. If you click the button instead, none of the tasks is aborted. If you click the button in place of the above two, the BACKUP RESTORE SYSTEM displays the [Backup] window again without backing up the files.

3 TECHNICAL SUPPORT INFORMATION

<Aborting all the tasks>

If the entire plant equipment under control can be stopped, abort all the active tasks in your system. When the tasks are aborted, they are automatically post-processed properly, so that the files can be backed up safely.

If the backup process is started without aborting the tasks, the files will be backed up in a condition in which the memory areas being accessed by the tasks are dynamically changing in their contents. In addition to this, if the operating system is stopped by performing the steps described below, the tasks are forcibly stopped even if they are running. In these cases, some contents of the areas accessed by the tasks may remain undefined, and this condition may lead to an error during backup.

(5) If the PCs is currently in RUN state, the following message is displayed:

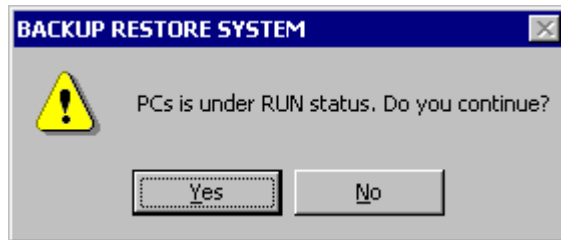

In this dialog box, if you click the button, the BACKUP RESTORE SYSTEM continues the backup process. If you click the button, it displays the [Backup] window again without backing up the files.

(6) The BACKUP RESTORE SYSTEM displays the following message:

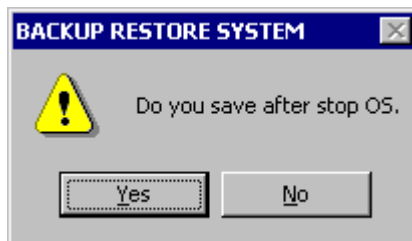

In this dialog box, if you click the button, the BACKUP RESTORE SYSTEM stops the operating system and starts the backup process. If you click the button, it starts the backup process without stopping the operating system.

When you click the button in the above dialog box, the following confirmation message is displayed to confirm that you really want to reset the PCs.



Clicking the button starts the PCs resetting process.

The same confirmation message as above is also displayed at the end of the backup process. When it is displayed, do the same as you have done to the above confirmation message.

<Stopping the operation system>

If the entire plant equipment under control can be stopped, stop the operating system (OS). If the backup process is started without stopping the OS, the files will be backed up in a condition in which the work registers in use are dynamically changing in their contents. In this case, some contents of the work registers may remain undefined, and this condition may lead to an error during backup.

- (7) The window showing the progress of the backup process appears:

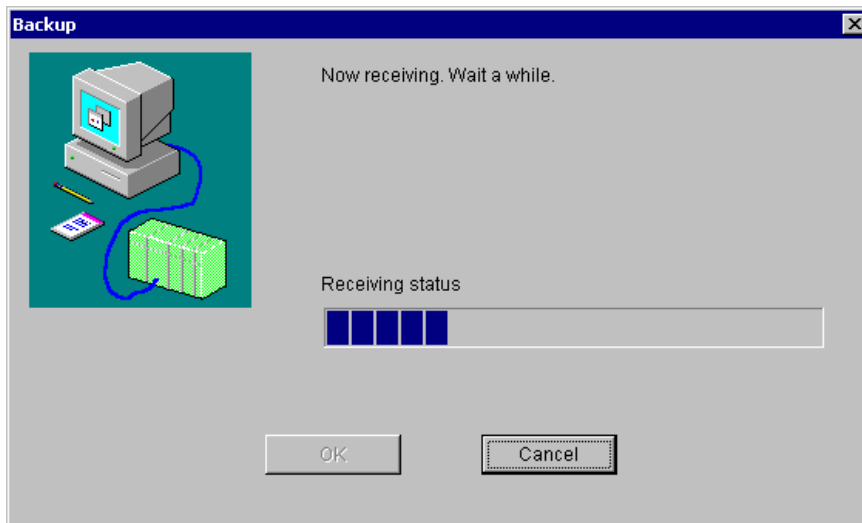

When the backup process is completed, click the button. (This button is not selectable until the backup process is complete.) Then, the [Backup] window appears again.

If you click the button instead, the BACKUP RESTORE SYSTEM discontinues the backup process and displays the [Backup] window again. In this case, the file(s) that have been backed up before your clicking the button remain undeleted. Do not use these files for backup. They may cause a malfunction.

- (8) Finish your backup operation by clicking the button in the [Backup] window.

3 TECHNICAL SUPPORT INFORMATION

<Restrictions>

The size of save area cannot be changed for each individual module.

If the backup process in progress is canceled and ends up with an error, the OS may remain in a stop state. Therefore, be sure to check if the OS is in RUN state by using an appropriate utility command. If it is not, put it back into RUN state by using the same utility command.

<Estimate of the time required for a backup>

If you back up approximately 22 MB of data (maximum save size) for both the LPU and CMU modules by using a personal computer with 1-GHz CPU, the backup will require approximately three minutes. However, this time requirement varies depending on the performance of the machine you use.

- Restoring procedure

As is done in file backup, start the S10V BACKUP RESTORE SYSTEM on the personal computer (PC) connected with the S10V system. Then, as described in detail below, click on the **Restore** button in the [BACKUP RESTORE SYSTEM] window. The [Select Restore File] window then appears on the screen. Now the BACKUP RESTORE SYSTEM is ready for restoring the S10V system's backed up files.

(1) Click the **Restore** button in the [BACKUP RESTORE SYSTEM] window.

(2) The [Select Restore File] window appears:

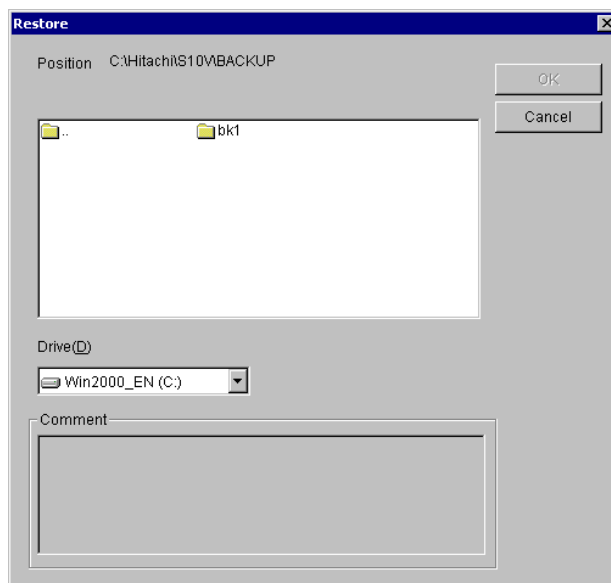

Select the folder you want to restore, and click the **OK** button. (The **OK** button cannot be clicked if the selected folder is not a folder containing the backup files.) Then, the [Restore Information] window appears. If the backup files are stored on floppy disk or some other storage media, choose the drive from the “Drive” pulldown menu.

If you do not want to restore the backup files, click the **Cancel** button. Then, the BACKUP RESTORE SYSTEM closes the [Select Restore File] window and displays the [BACKUP RESTORE SYSTEM] window again without restoring the backup files.

The “Comment” box in the [Select Restore File] window is displayed but does not allow the input of text. If a comment was entered in the previous backup operation, it is displayed when you have selected the backup files.

(3) Click the **OK** button in the [Select Restore File] window. The [Restore Information] window is then displayed.

3 TECHNICAL SUPPORT INFORMATION

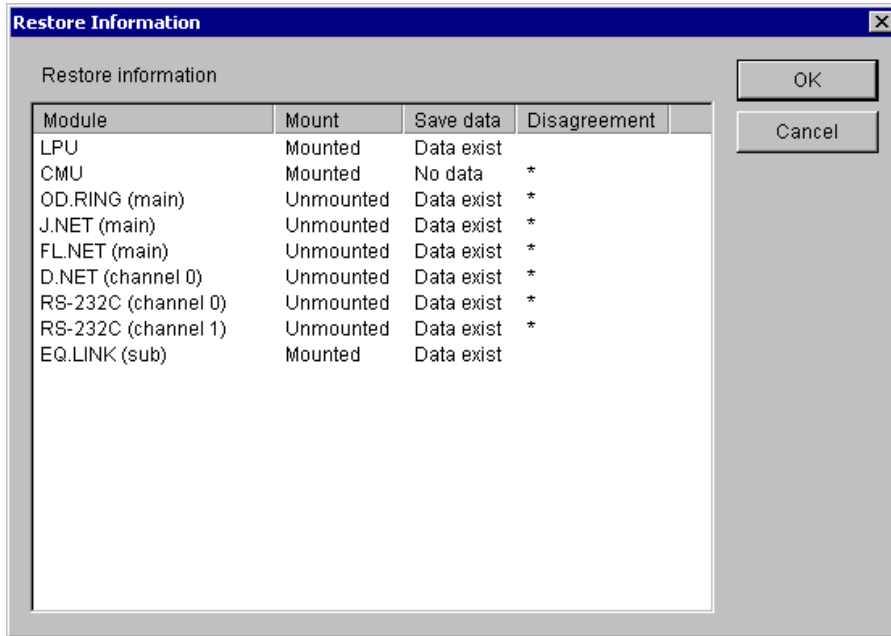

At the same time, if a CMU module is installed, and there is data backed up for that CMU module, and a connection is established by using the RS-232C or ET.NET (LQE520) module, then the following warning message appears:

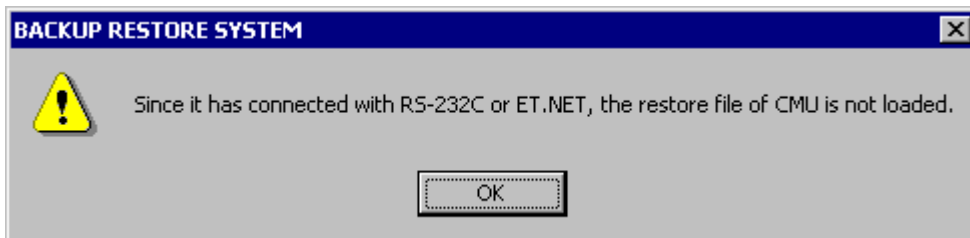

In this case, data restoring is not performed for the CMU module. If you want to perform data restoring for the CMU module, re-establish a connection by using the Ethernet support provided by that CMU module or an ET.NET (model LQE720) module.

In addition, if there is a mismatch between the installed (mounted) modules and backed up files, and some of the modules do not require restoration, then the following warning message is displayed:



The [Restoration Information] window provides, in a list form, information as to whether each predefined type of module is actually installed in the system and whether the corresponding data is backed up. However, this window provides no such information on any predefined type of module for which no data is backed up. Take a look at the displayed list and, if you want to restore all the backup data in the list, click the button. Then, the BACKUP RESTORE SYSTEM starts the restoration process. (Note)

If you do not want to restore the backup data, click the button. Then, the [Restore Information] window disappears and the [Select Restore File] window appears again.

The following information describes the items displayed in the [Restoration Information] window.

Module: Is the name of a predefined module type for which the BACKUP RESTORE SYSTEM can perform a restore operation. If two or more modules are defined in the same area by installation, all of their module names are presented in the Module column. For information on the types of modules whose names are presented in the Module column, see Table 3-3, "Backup Areas." If no module is installed for a predefined type of module, one of the following module names is presented in the Module column, if necessary:

OD.RING -- presented for OD.RING and SD.LINK modules

J.NET -- presented for J.NET, J.NET-INT, and IR.LINK modules

RS-232C -- presented for RS-232C and RS-422 modules

Mount: Indicates whether a listed module type is actually installed or not. If a module is installed, the string "Mounted" is presented in the Mount column. If not, the string "Unmounted" is presented in the same column.

Save data: Indicates whether data is backed up for a listed module type or module. If the data is backed up, the string "Data exist" is presented in the Save data column. If not, the string "No data" is presented in the same column.

Disagreement: Indicates whether there is a mismatch between the installed modules and backed up files. If a module is installed but no data is backed up for it, or if a module is not installed but data is backed up for the module type, then an asterisk ("*") is displayed in the Disagreement column, indicating that the BACKUP RESTORE SYSTEM will not perform a restore operation for the module type. If a module is installed and the data is backed up for it, nothing is displayed in the same column, indicating that it will perform a restore operation for the module type.

Note: If there is a mismatch between the PCs number in a backup file and the PCs number in a restoration destination, the [PCsNo. Check] window shown below is displayed. In this case, select the desired radio button and click the button. However, if the PCs number in a backup file's header is 9999, it is not subjected to a check. In this case, care must be taken because the PCs number of the restoration destination PCs is overwritten with the PCs number in the backup file's body.

3 TECHNICAL SUPPORT INFORMATION

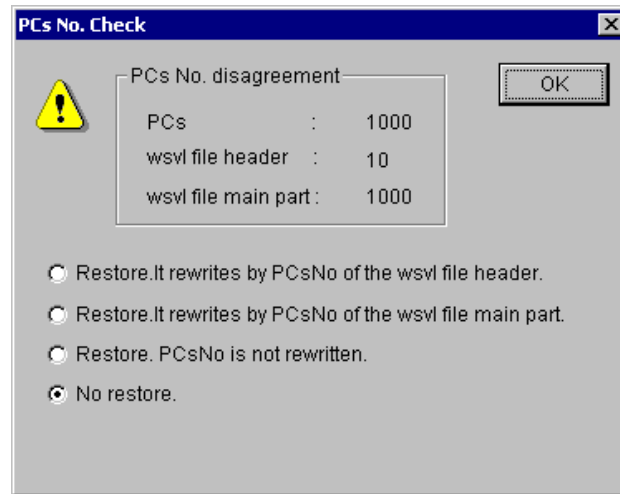

Restore.It rewrites by PCsNo of the wsvl file header.:

Is an option to carry out a restore operation while overwriting the PCs number in the restoration destination with the PCs number in the backup file's header.

The PCs number in the backup file's header is one that is specified at the time of backup.

Restore.It rewrites by PCsNo of the wsvl file main part.:

Is an option to carry out a restore operation while overwriting the PCs number in the restoration destination with the PCs number in the backup file's body. The PCs number in the backup file's body is one that is set in the PCs data backed up.

Restore.PCsNo is not rewritten.:

Is an option to carry out a restore operation without overwriting the PCs number in the restoration destination.

No restore.: Is an option not to carry out a restore operation.

Of these, the default option is "No restore".

In addition, if a connection is established by using the Ethernet support provided by a CMU module or ET.NET (model LQE720) module, and there is a mismatch between the IP address for that connection and the IP address in a backup file, then the [IP Address Check] window shown below is displayed. In this case, select the desired radio button and click the button. However, if the IP address for the connection is "192.192.192.1", it is not subjected to a check, assuming that the module with which the connection is established is operating using a fixed-IP address setting. In this case, care must be taken because a communication line error may occur during restore operation.

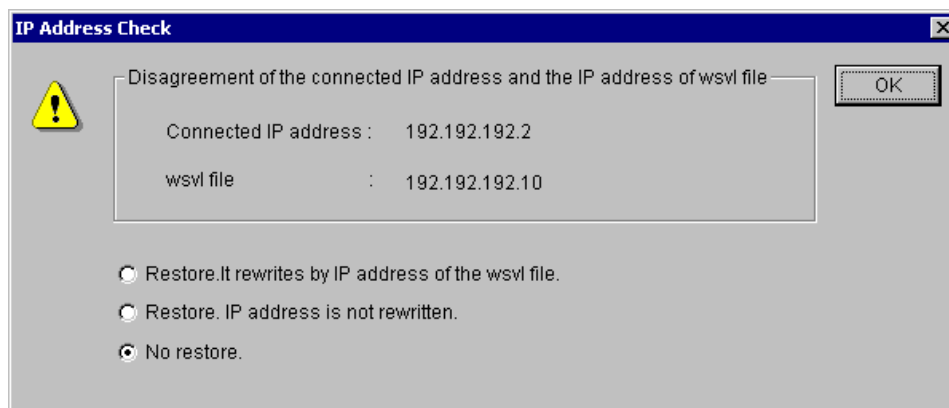

Restore.It rewrites by IP address of the wsvl file.:

Is an option to carry out a restore operation while overwriting the IP address in the restoration destination with the IP address in the backup file. In this case, the IP address-related information (subnet mask, broadcast address, and routing information) is also subjected to overwriting.

Restore.IP address is not rewritten.:

Is an option to carry out a restore operation without overwriting the IP address in the restoration destination.

No restore.: Is an option not to carry out a restore operation.

Of these, the default option is “No restore”.

If the “Restore.It rewrites by IP address of the wsvl file.” option is selected in the [IP Address Check] window, the following IP address change message is presented at the end of a restore operation:



At this moment, the restored IP address value is not effective. To make it effective, first ensure that a change of the prevailing IP address setting will not cause any problem. Then, reset the PCs manually, or turn off the power to it and back on again.

- (4) If the PCs is in RUN state, a confirmation message is presented to check if you really want to carry out a restore operation. If so, click the **Yes** button. Then, the BACKUP RESTORE SYSTEM starts a restore operation. If not, click the **No** button. Then, it displays the [Backup] window again without starting a restore operation.

3 TECHNICAL SUPPORT INFORMATION

- (5) When a restore operation is started, a message to ask permission to reset the PCs is presented. Click the button in the dialog. The PCs is then reset.
- (6) Upon completion of the PCs resetting, the following confirmation message is presented:

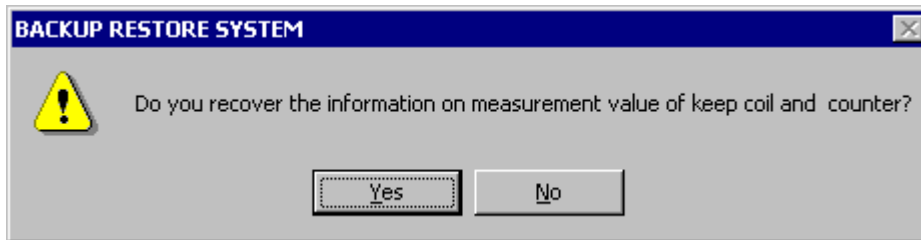

If you click the button in the above dialog, the keep-coil and counter-count backup information is restored.

If you click the button instead, it is not restored. Here:

Keep-coil: Keep-relay (blackout hold latch type) in the range KW000 to KWFFF.

Counter count: Up-down counter (count) in the range CC000 to CC0FF.

- (7) When the or button is clicked in the above “Do you recover the information on?” confirmation dialog, the [Restoration of keep relay coil and count value information] window disappears and the following window indicating the progress of the restore operation is displayed.

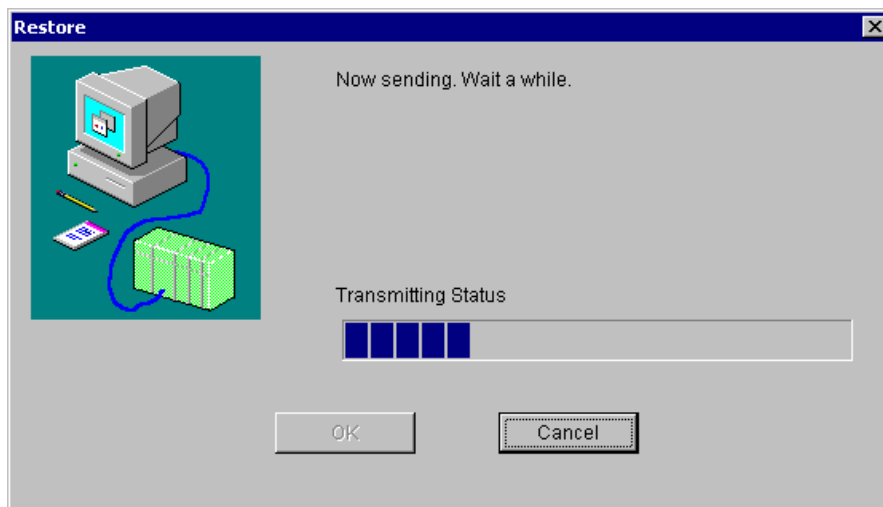

If you click the button during the restore operation, the [Restore] window disappears and the [Select Restore File] window appears again. In this case, the BACKUP RESTORE SYSTEM has finished only part of the requested restore operation, so your system cannot still be used normally. Any attempt to use your system in that condition will cause a malfunction. To avoid a malfunction, carry out the restore operation all over again. When the restore operation is completed, a message to ask permission to reset the PCs is presented again. Click the button. Then, resetting of the PCs is started.

When the PCs resetting is completed, click the button. Then, the [Restore] window disappears and the [Select Restore File] window appears again.

- (8) Finish your restore operation by clicking the button in the [Select Restore File] window.

If the restoration process in progress is canceled and ends up with an error, the OS may remain in a stop state. Therefore, be sure to check if the OS is in RUN state by using an appropriate utility command. If it is not, put it back into RUN state by using the same utility command.

<Estimate of the time required for a restoration>

If you restore approximately 22 MB of data (maximum save size) for both the LPU and CMU modules by using a personal computer with 1-GHz CPU, the restoration will require approximately seven minutes. However, this time requirement varies depending on the performance of the machine you use.

3 TECHNICAL SUPPORT INFORMATION

- Backup and restoration using optional-module setting tools

It is a common practice to carry out a backup and a restore operation using the BACKUP RESTORE SYSTEM when a module(s) need to be replaced and when they are replaced, respectively. However, if the number of optional modules to be replaced is only one, you can carry out a backup and a restore operation using the optional-module setting tool for that module. To carry out a backup and a restore operation using the optional-module setting tool, use the F/D and parameter save capabilities of that tool. For details on the optional-module setting tool, refer to the optional-module manual that comes with an optional module.

As regards ET.NET and inter-CPU link modules, they require no backup and restore operations at all as long as the LPU module need not be replaced. This is because their settings are all stored in the LPU module's memory.

Table 3-2 Backup Areas Used by Optional-Module Setting Tools (1/2)

No.	Setting tool		Header storage location (address)	Content	Remarks
1	OD.RING/SD.LINK SYSTEM	Main	/0097 8002 to /0097 802E	Main-module-side installation info area	
		Sub	/009F 8002 to /009F 802E	Submodule-side installation info area	
2	J.NET SYSTEM	Main	/00A7 8008 to /00A7 FFFE	Main-module-side slave parameter table	
		Sub	/00AF 8008 to /00AF FFFE	Submodule-side slave parameter table	
3	IR.LINK SYSTEM	Main	/00A7 8008 to /00A7 FFFE	Main-module-side slave parameter table	
		Sub	/00AF 8008 to /00AF FFFE	Submodule-side slave parameter table	
4	FL.NET SYSTEM	Main	/00D4 1A00 to /00D4 1A33	Main-module-side local-node status table	
			/00D7 0020 to /00D7 004E	Main-module-side local-node initialization table	
			/00D7 0050 to /00D7 1E4E	Main-module-side other(participating)-node allotment table	
			/004B 0750 to /004B 0758	Main-module-side node name	
			/004B 0740 to /004B 0746	Main-module-side IP address, subnet mask	
		Sub	/00DC 1A00 to /00DC 1A33	Submodule-side local-node status table	
			/00DF 0020 to /00DF 004E	Submodule-side local-node initialization table	
			/00DF 0050 to /00DF 1E4E	Submodule-side other(participating)-node allotment table	
			/004B 075A to /004B 0762	Submodule-side node name	
			/004B 0748 to /004B 074E	Submodule-side IP address, subnet mask	

Table 3-2 Backup Areas Used by Optional-Module Setting Tools (2/2)

No.	Setting tool	Header storage location (address)	Content	Remarks
5	D.NET SYSTEM	ch0	/00E3 0000 to /00E3 5AFE	Ch0-side parameter table, peer/slave parameter table
			/00E3 6000 to /00E3 608E	Ch0-side slave operation table
		ch1	/00E7 0000 to /00E7 5AFE	Ch1-side parameter table, peer/slave parameter table
			/00E7 6000 to /00E7 608E	Ch1-side slave operation table
		ch2	/00EB 0000 to /00EB 5AFE	Ch2-side parameter table, peer/slave parameter table
			/00EB 6000 to /00EB 608E	Ch2-side slave operation table
ch3	/00EF 0000 to /00EF 5AFE	Ch3-side parameter table, peer/slave parameter table		
	/00EF 6000 to /00EF 608E	Ch3-side slave operation table		
6	EXTERNAL SERIAL LINK SYSTEM	ch0	/00F4 8100 to /00F4 81FE	Ch0-side LGB table
		ch1	/00F5 8100 to /00F5 81FE	Ch1-side LGB table
		ch2	/00F6 8100 to /00F6 81FE	Ch2-side LGB table
		ch3	/00F7 8100 to /00F7 81FE	Ch3-side LGB table
7	EQ.LINK SYSTEM	Main	/00D4 1A00 to /00D4 1A32	Main-module-side local-node status table
			/00D7 0020 to /00D7 1E4E	Main-module-side local-node initialization table
			/00D7 2058 to /00D7 2060	Main-module-side local-/remote-node initialization table
			/00D7 2140 to /00D7 23FE	Main-module-side local-/remote-node area division table
		Sub	/00DC 1A00 to /00DC 1A32	Submodule-side local-node status table
			/00DF 0020 to /00DF 1E4E	Submodule-side local-node initialization table
			/00DF 2058 to /00DF 2060	Submodule-side local-/remote-node initialization table
			/00DF 2140 to /00DF 23FE	Submodule-side local-/remote-node area division table

3 TECHNICAL SUPPORT INFORMATION

- Backup areas

The table below shows the memory addresses for modules that are subjected to backup operations.

Table 3-3 Backup Areas (1/2)

No.	Module (backup file name)		Backup address	Remarks
1	LPU (backup1.wsvl)		/0010 0000 to (changeable)	(Note 1)
			/0040 1700 to /0040 171E	
			/0040 2000 to /0040 3FFE	
			/0047 0000 to /0047 1FFE	
			/0048 0000 to /0048 05FE	
			/0048 0800 to /0048 0FFE	
			/0048 1200 to /004C FFEE	
			/004D 0000 to /004F FFFE	
			/0048 0600 to /0048 07FE	
			/0040 1000 to /0040 11FE	
			/0048 1000 to /0048 11FE	
2	CMU (backup2.wsvl)		/0300 0000 to /0307 FFFE	(Note 2)
			/0308 0000 to (changeable)	
			/2000 0000 to /200B 943E	(Note 3)
			/2800 D000 to /2800 00FE	
			/7C00 2000 to /7C00 200E	
			/3000 0000 to (changeable)	
			/4000 0000 to (changeable)	
			/5000 0000 to (changeable)	
			/6000 0000 to (changeable)	
3	OD.RING/SD.LINK (backup3.wsvl)	Main module	/0097 8002 to /0097 802E	
		Submodule	/009F 8002 to /009F 802E	
4	J.NET/J.NET-INT/IR.LINK (backup4.wsvl)	Main module	/00A7 8008 to /00A7 FFFE	
		Submodule	/00AF 8008 to /00AF FFFE	

Table 3-3 Backup Areas (2/2)

No.	Module (backup file name)		Backup address	Remarks		
5	FL.NET (backup5.wsvl)	Main module	/00D4 1A00 to /00D4 1A32			
			/00D7 0050 to /00D7 1E4E			
			/00D7 0020 to /00D7 0048			
		Submodule	/00DC 1A00 to /00DC 1A32			
			/00DF 0050 to /00DF 1E4E			
			/00DF 0020 to /00DF 0048			
6	D.NET (backup6.wsvl)	Channel 0	/00E3 0000 to /00E3 5AFE			
			/00E3 6000 to /00E3 608E			
		Channel 1	/00E7 0000 to /00E7 5AFE			
			/00E7 6000 to /00E7 608E			
		Channel 2	/00EB 0000 to /00EB 5AFE			
			/00EB 6000 to /00EB 608E			
		Channel 3	/00EF 0000 to /00EF 5AFE			
			/00EF 6000 to /00EF 608E			
		7	RS-232C/RS-422 (backup7.wsvl)	Channel 0	/00F4 8100 to /00F4 81FE	
				Channel 1	/00F5 8100 to /00F5 81FE	
				Channel 2	/00F6 8100 to /00F6 81FE	
				Channel 3	/00F7 8100 to /00F7 81FE	
8	EQ.LINK (Primary: backup8.wsvl Standby: backup9.wsvl)	Main module	/00D4 1A00 to /00D4 1A32			
			/00D7 0020 to /00D7 1E4E			
			/00D7 2058 to /00D7 2060			
			/00D7 2140 to /00D7 23FE			
		Submodule	/00DC 1A00 to /00DC 1A32			
			/00DF 0020 to /00DF 1E4E			
			/00DF 2058 to /00DF 2060			
			/00DF 2140 to /00DF 23FE			

3 TECHNICAL SUPPORT INFORMATION

Note 1: As this backup area, only the range of addresses actually used to store a ladder program's body, comment data, and user (arithmetic) functions' bodies is subjected to backup.

The end address of this area is changeable in the range: /0010 4406 to /0016 7FFE

Note 2: These backup areas are defined only when HI-FLOW is stored in place. As the backup area from /0308 0000 onwards, in particular, only the range of addresses used to store an HI-FLOW user program is subjected to backup. If the end address of this backup area is /0308 0000, it indicates that an HI-FLOW user program is not used. In this case, this backup area is not subjected to backup.

The end address of this area is changeable in the range: /0308 0000 to /033F FFFE

Note 3: These backup areas are defined only when the RPDP (Real-Time Program Development System) is defined. The backup areas from /3000 0000 onwards, /4000 0000 onwards, /5000 0000 onwards, and /6000 0000 onwards, respectively, are changeable depending on the defined RPDP, and up to 16 MB of their total contents are subjected to backup.

3.5 Performance

Performance information for the S10V controller can be viewed on screen. To accomplish this, start up the S10V BASE SYSTEM by choosing [Start] – [Programs] – [Hitachi S10V] – [S10V BASE SYSTEM] on the personal computer connected with the S10V controller, and click the **Performance** button. Then, the [Performance] window appears which present the performance information. For details on the S10V BASE SYSTEM, refer to the description under “6 TOOLS” in the “BASIC MODULES (manual number SVE-1-100).”

(1) [Performance] window

The [Performance] window presents sequence cycle and CMU load percentage information, as shown below.

The screenshot shows a window titled "Performance" with two main sections: "Sequence Cycle" and "CMU Load percentage".

- Sequence Cycle:**
 - Current value: 1 (ms)
 - Maximum value: 1 (ms)
 - Minimum value: 1 (ms)
 - Setting value: 30 (ms)
 - Buttons: Clear
- CMU Load percentage:**
 - Current value: 2 (%)
 - Maximum value: 26 (%)
 - Minimum value: 1 (%)
 - Measurement time: 1 (Sec) with a "Change Time" button
 - Buttons: Clear, OK, Refresh

The table below is a list of the items displayed in the [Performance] window.

Table 3-4 Items Displayed in the [Performance] Window

Group	Item	Unit	Description
Sequence Cycle	Current value	ms	The present value of combined ladder program and HI-FLOW process execution time (Note)
	Maximum value	ms	The largest possible value of combined ladder program and HI-FLOW process execution time (Note)
	Minimum value	ms	The smallest possible value of combined ladder program and HI-FLOW process execution time (Note)
	Setting value	ms	The set value of the sequence cycle timer
CMU Load percentage	Current value	%	The present value of CMU load percentage
	Maximum value	%	The largest possible value of CMU load percentage
	Minimum value	%	The smallest possible value of CMU load percentage
	Measurement time	sec	The measuring time of CMU load percentage

3 TECHNICAL SUPPORT INFORMATION

- **Clear** button (for sequence cycle):
Used to clear the current value, maximum value, and minimum value of sequence cycle and restart measurement. When the three values are cleared, they are displayed as zero (0).
- **Clear** button (for CMU load percentage):
Used to clear the current value, maximum value, and minimum value of CMU load percentage and restart measurement. When the three values are cleared, they are displayed as zero (0).
- **Change Time** button:
When clicked, displays the [Change Measurement Time] window to allow changing of the measurement time. In this window, you can set a new measurement time, which can later be displayed in the “Measurement time” box after confirmation.
In addition, this button also clears the current value, maximum value, and minimum value in the “CMU load percentage” group and restarts the measurement of CMU load percentage with the newly set measurement time value.
- **Refresh** button:
When clicked, displays the current values.
- **OK** button:
Used to exit the [Performance] window.

Note: The term “combined ladder program and HI-FLOW process execution time” refers to each of the shaded portions in the diagram below.

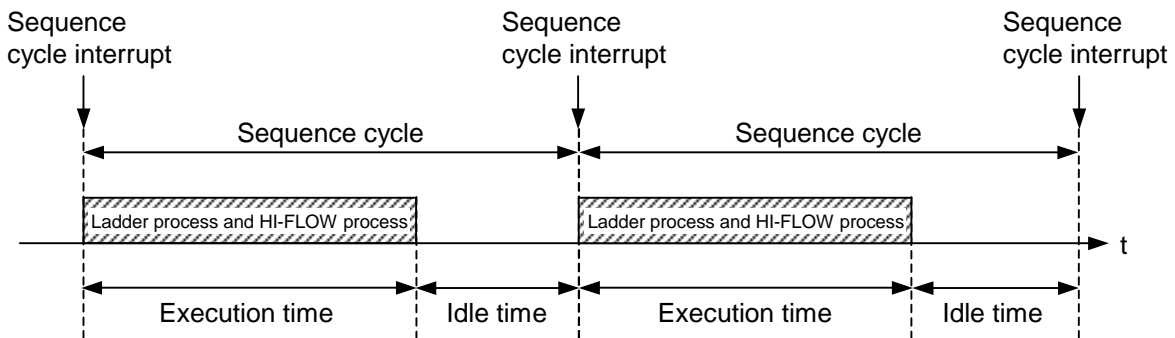

(2) [Change Measurement Time] window

The [Change Measurement Time] window allows you to change the current value of CMU load percentage measurement time.

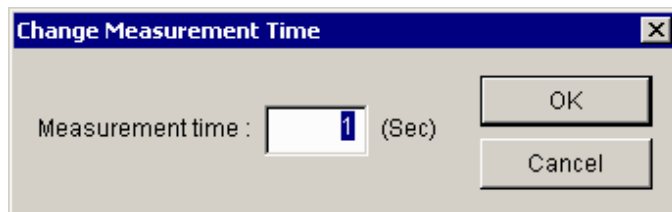

- [Measurement time] box:
Allows you to enter a new value of CMU load percentage measurement time expressed in seconds in the range 1 to 60. This measurement time is defaulted to 1. The entered value appears as a new default value when this window is displayed next time.
- button:
Used to confirm the value entered in the “Measurement time” box and exit the [Change Measurement Time] window.
- button:
Clicked to exit the [Change Measurement Time] window without changing the current measurement time value.

3 TECHNICAL SUPPORT INFORMATION

3.6 Address Space Maps

● Address space map of the LPU unit

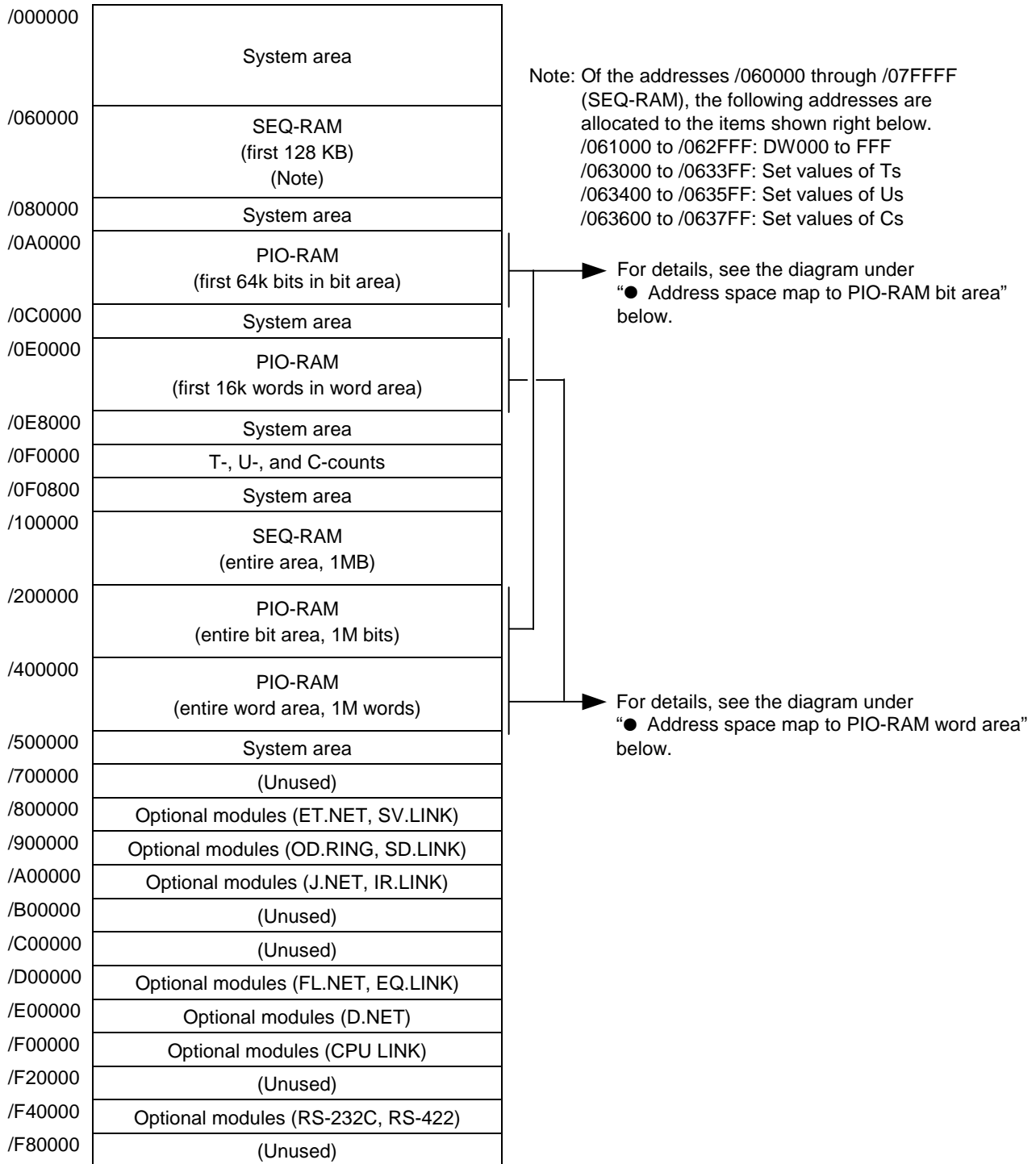

Figure 3-1 Address Space Map of the LPU Unit

● Address space map to PIO-RAM bit area

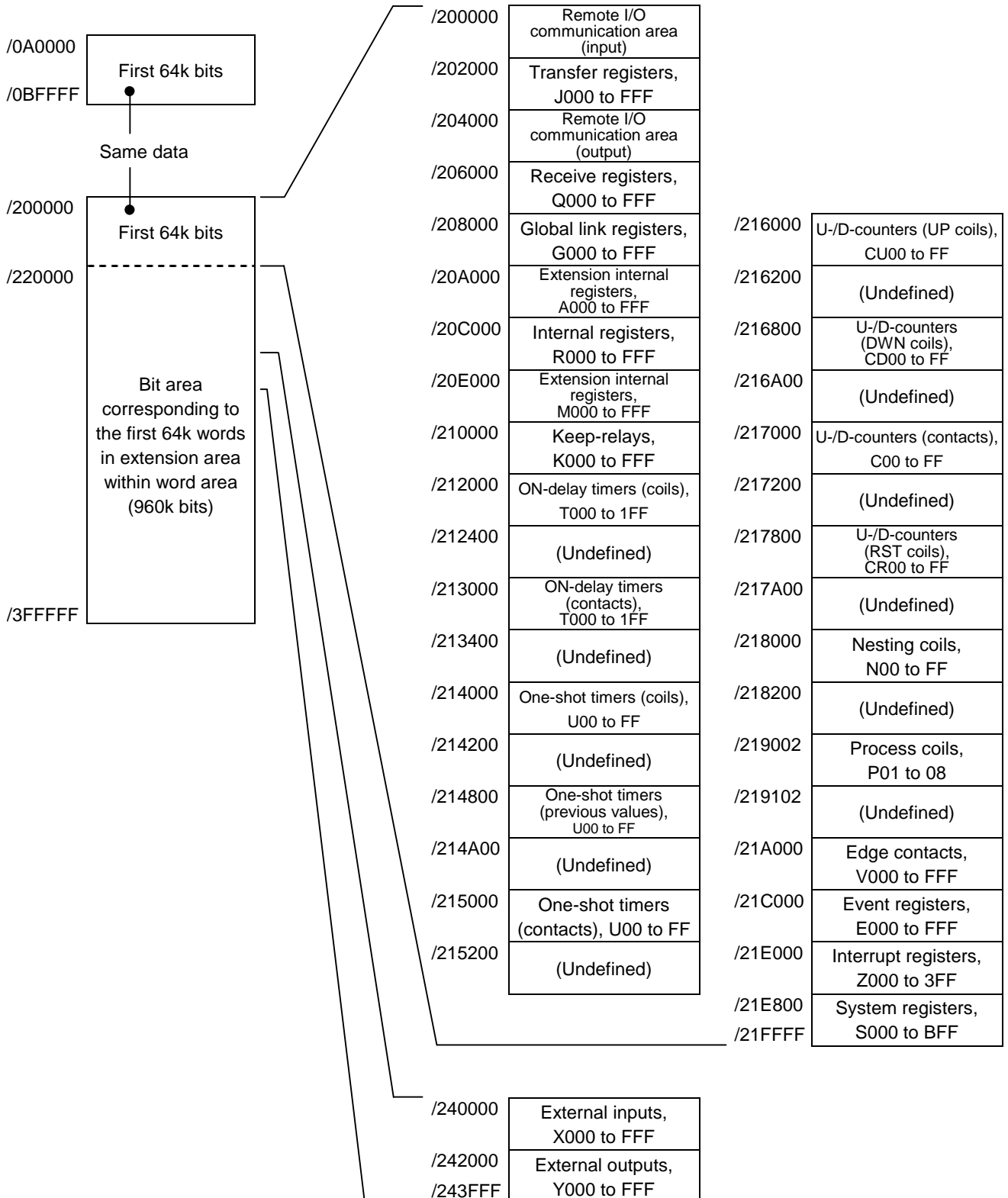

Figure 3-2 Address Space Map to the PIO-RAM Bit Area

3 TECHNICAL SUPPORT INFORMATION

● Address space map to PIO-RAM word area

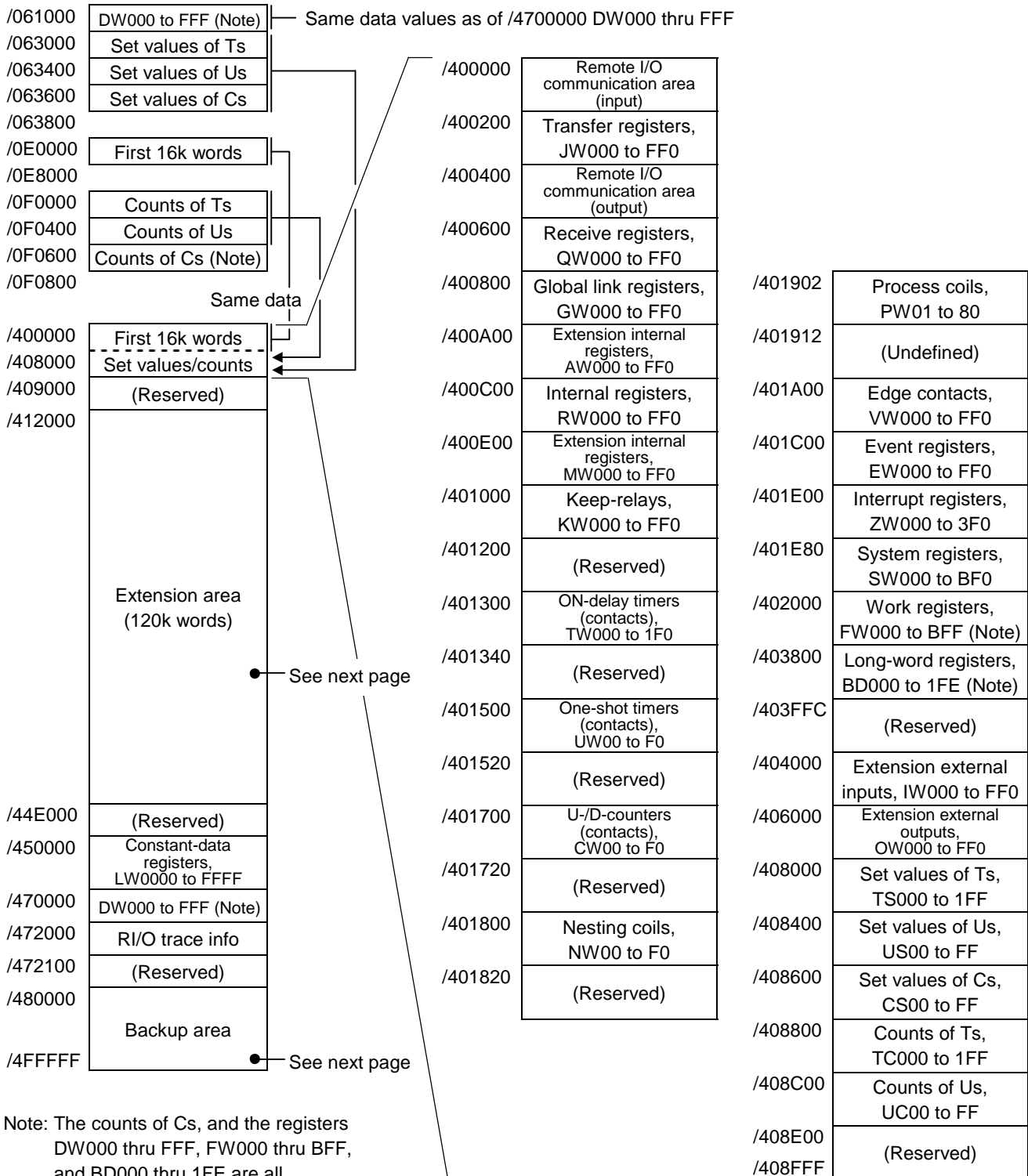

Figure 3-3 Address Space Map to the PIO-RAM Word Area (1)

Address space map to PIO-RAM word area (continued from preceding page):

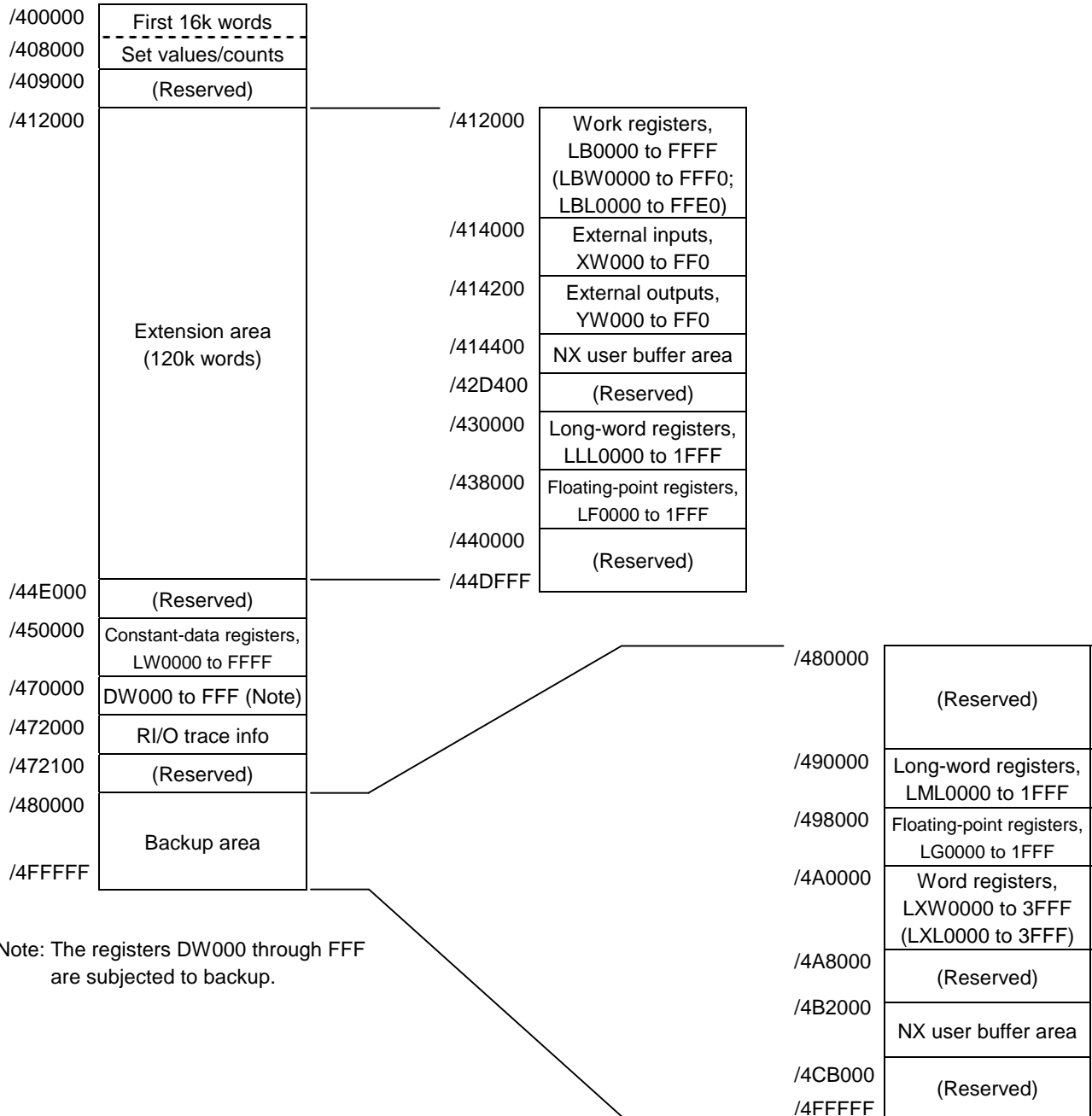
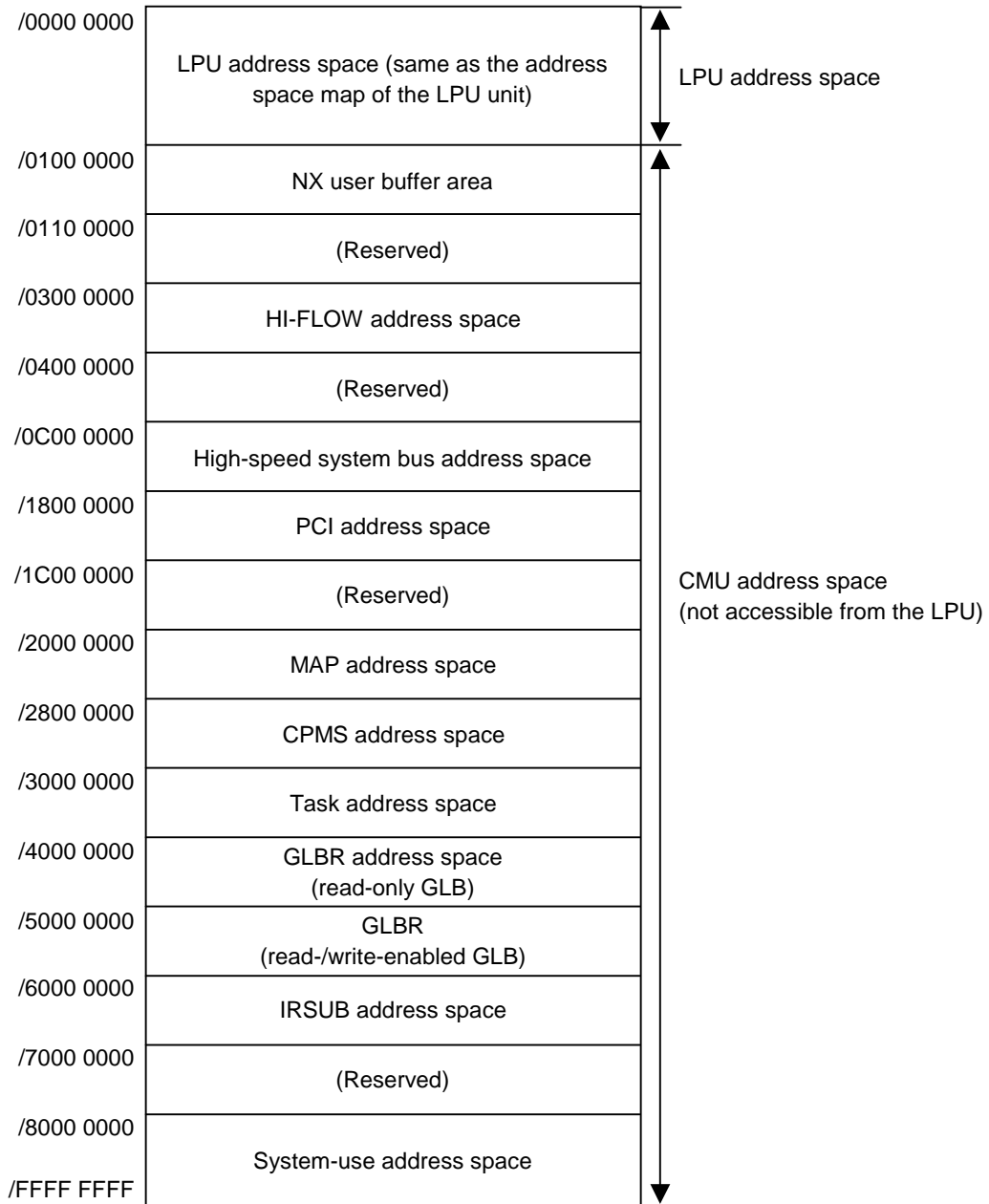

Figure 3-4 Address Space Map to the PIO-RAM Word Area (2)

3 TECHNICAL SUPPORT INFORMATION

- Address space map of the CMU unit









3.7 Registers

3.7.1 Ladder instructions and usable registers

The table below shows all registers usable in ladder instructions.

Table 3-5 Usable Registers (1/2)







	Function name	Register name	Ladder symbols						Status after reset or power recovery	
										
I/O	External input	X	√	cu	cu	cu	√	√	Cleared	
	External output	Y	√	cu	√	cu	√	√	Cleared	
Internal auxiliary functions	Internal register	R	√	cu	√	cu	√	√	Cleared	
	Extension internal register	M, A	√	cu	√	cu	√	√	Cleared	
	Keep relay	K	√	cu	cu	√	√	√	Remaining unchanged	
	ON-delay timer	Contact, coil	T	√	cu	√	cu	√	√	Cleared
		Set value	TS	cu	cu	cu	cu	√	√	Remaining unchanged
		Count value	TC	cu	cu	cu	cu	√	√	Cleared
	One-shot timer	Contact, coil	U	√	cu	√	cu	√	√	Cleared
		Set value	US	cu	cu	cu	cu	√	√	Remaining unchanged
		Count value	UC	cu	cu	cu	cu	√	√	Cleared
	Up-down counter	Contact, coil	CU	cu	cu	√	cu	cu	cu	Remaining unchanged
			CD	cu	cu	√	cu	cu	cu	Remaining unchanged
			CR	cu	cu	√	cu	cu	cu	Remaining unchanged
			C0	√	cu	cu	cu	√	√	Remaining unchanged
		Set value	CS	cu	cu	cu	cu	√	√	Remaining unchanged
		Count value	CC	cu	cu	cu	cu	√	√	Remaining unchanged
	Global link register	G	√	cu	√	cu	√	√	Cleared	
	Nesting coil	NM	cu	cu	√	cu	cu	cu	Cleared	
		NZ	cu	cu	√	cu	cu	cu	Cleared	
N0		√	cu	cu	cu	√	√	Cleared		
Process register	P	√	cu	√	cu	√	√	Cleared		

√: Usable register.

cu: Non-usable register.

3 TECHNICAL SUPPORT INFORMATION

Table 3-5 Usable Registers (2/2)

	Function name	Register name	Ladder symbols						Status after reset or power recovery
									
Internal auxiliary functions	Event register	E	√	cu	√	cu	√	√	Cleared
	Edge contact	V	cu	√	cu	cu	√	√	Cleared
	Zee register	Z	√	cu	√	cu	√	√	Cleared
	System register	S	√	cu	cu	cu	√	√	Initialized
	Shared-data register between HI-FLOW and ladder	J	√	cu	cu	cu	√	√	Cleared
		Q	√	cu	√	cu	√	√	Cleared
	Register between HI-FLOW processes	HH	cu	cu	cu	cu	cu	cu	Cleared
	Extension internal register	LB	√	cu	√	cu	√	√	Cleared
	Converter-specific internal register	LR	√	cu	√	cu	√	√	Cleared
	Converter-specific edge contact register	LV	cu	√	cu	cu	√	√	Cleared
	Input register (reserved for future use)	IW	cu	cu	cu	cu	√	√	Cleared
	Output register (reserved for future use)	OW	cu	cu	cu	cu	√	√	Cleared
	Internal register	BD	cu	cu	cu	cu	cu	√	Remaining unchanged
		BW (*)	cu	cu	cu	cu	cu	√	Depending on BD
	Function data register	DW	cu	cu	cu	cu	√	√	Remaining unchanged
	Function work register	FW	cu	cu	cu	cu	√	√	Remaining unchanged
	Extension function work register	LW	cu	cu	cu	cu	√	√	Cleared
	Long-word work register	LL	cu	cu	cu	cu	cu	√	Cleared
	Single-precision floating-point work register	LF	cu	cu	cu	cu	cu	√	Cleared
	Backup word work register	LX	cu	cu	cu	cu	√	√	Remaining unchanged
Backup long-word work register	LM	cu	cu	cu	cu	cu	√	Remaining unchanged	
Backup single-precision floating-point work register	LG	cu	cu	cu	cu	cu	√	Remaining unchanged	

√: Usable register.

cu: Non-usable register.

(*) Accessed by indirect addressing.

3.7.2 Register numbers

The table below is a list of all register numbers that can be used in ladder programs. As shown, the range of usable register numbers depends on the types of registers accessed by their generic register names.

Table 3-6 Register Numbers (1/2)

No.	Register name	Register types accessed			
		Bit	Word	Long-word	Single-precision floating-point
1	X	X000 to XFFF	XW000 to XWFF0	XL000 to XLFE0	–
2	Y	Y000 to YFFF	YW000 to YWFF0	YL000 to YLFE0	–
3	R	R000 to RFFF	RW000 to RWFF0	RL000 to RLFE0	–
4	M	M000 to MFFF	MW000 to MWFF0	ML000 to MLFE0	–
5	A	A000 to AFFF	AW000 to AWFF0	AL000 to ALFE0	–
6	K	K000 to KFFF	KW000 to KWFF0	KL000 to KLFE0	–
7	T	T000 to T1FF	TW000 to TW1F0	TL000 to TL1E0	–
8	TS	–	TS000 to TS1FF	–	–
9	TC	–	TC000 to TC1FF	–	–
10	U	U000 to UOFF	UW000 to UW0F0	UL000 to UL0E0	–
11	US	–	US000 to US0FF	–	–
12	UC	–	UC000 to UC0FF	–	–
13	CU	CU00 to CUFF	–	–	–
14	CD	CD00 to CDFF	–	–	–
15	CR	CR00 to CRFF	–	–	–
16	C0	C000 to C0FF	CW000 to CW0F0	CL000 to CL0E0	–
17	CS	–	CS000 to CS0FF	–	–
18	CC	–	CC000 to CC0FF	–	–
19	G	G000 to GFFF	GW000 to GWFF0	GL000 to GLFE0	–
20	NM	NM01 to NMFF	–	–	–
21	NZ	NZ01 to NZFF	–	–	–
22	N0	N001 to N0FF	NW000 to NW0F0	NL000 to NL0E0	–

–: Not accessible.

3 TECHNICAL SUPPORT INFORMATION

Table 3-6 Register Numbers (2/2)

No.	Register name	Register types accessed			
		Bit	Word	Long-word	Single-precision floating-point
23	P	P001 to P080	PW000 to PW080	PL000 to PL060	–
24	E	E000 to EFFF	EW000 to EWFF0	EL000 to ELFE0	–
25	V	V000 to VFFF	VW000 to VWFF0	VL000 to VLFE0	–
26	Z	Z000 to Z3FF	ZW000 to ZW3F0	ZL000 to ZL3E0	–
27	S	S000 to SBFF	SW000 to SWBF0	ZL000 to ZLBEO	–
28	J	J000 to JFFF	JW000 to JWFF0	JL000 to JLFE0	–
29	Q	Q000 to QFFF	QW000 to QWFF0	QL000 to QLFE0	–
30	LB	LB0000 to LBFFFF	LBW0000 to LBWFFF0	LBL0000 to LBLFFE0	–
31	LR	LR0000 to LR0FFF	LRW0000 to LRW0FF0	LRL0000 to LRL0FE0	–
32	LV	LV0000 to LV0FFF	LVW0000 to LVW0FF0	LVL0000 to LVL0FE0	–
33	IW	–	IW000 to IWFFF	IL000 to ILFFE	–
34	OW	–	OW000 to OWFFF	OL000 to OLFFE	–
35	BD	–	–	BD000 to BD1FE	–
36	BW (*)	–	BW000 to BW1FE	BL000 to BL1FE	–
37	DW	–	DW000 to DWFFF	DL000 to DLFFE	–
38	FW	–	FW000 to FWBFF	FL000 to FLBFE	–
39	LW	–	LWW0000 to LWWFFFF	LWL0000 to LWLFFFE	–
40	LL	–	–	LLL0000 to LLL1FFF	–
41	LF	–	–	–	LF0000 to LF1FFF
42	LX	–	LXW0000 to LXW3FFF	LXL0000 to LXL3FFE	–
43	LM	–	–	LML0000 to LML1FFF	–
44	LG	–	–	–	LG0000 to LG1FFF

–: Not accessible.

(*) Accessed by indirect addressing.

3.7.3 System registers

Range of numbers	000 to BFF
------------------	------------

System registers are read-only registers reflecting the system's operation performed or other things relating to the system.

The table below is a list of all available system registers.

Table 3-7 System Registers

No.	Register numbers	Register naming
1	S000 to S00F	Arithmetic-function flag registers
2	S010 to S01F	Ladder program control registers
3	S020 to S02F	HI-FLOW application-instruction execution-result flag registers
4	S030 to S0FF	(Reserved for system use)
5	S100 to S15F	Ladder program control counter
6	S160 to S1FF	(Reserved for system use)
7	S200 to S20F	Time control registers
8	S210 to S27F	(Reserved for system use)
9	S280 to S2EF	Time setting registers
10	S2F0 to S2FF	(Reserved for system use)
11	S300 to S47F	Remote I/O status registers
12	S480 to S4FF	(Reserved for system use)
13	S500 to S6FF	Optional-module status registers
14	S700 to S8FF	(Reserved for system use)
15	S900 to S93F	Sequence-cycle scan-time registers
16	S940 to S97F	Ladder execution-time registers
17	S980 to S9BF	Optional-module status registers (D.NET)
18	S9C0 to S9FF	Ethernet communication result flag registers
19	SA00 to SA8F	Optional-module status registers (J.NET/IR.LINK)
20	SA90 to SAFF	(Reserved for system use)
21	SB00 to SB1F	LPU-unit I/O information registers
22	SB20 to SBEF	(Reserved for system use)
23	SBF0 to SBFF	LPU status registers

3 TECHNICAL SUPPORT INFORMATION

(1) Arithmetic-function flag registers

Arithmetic-function flag registers indicate the set/reset statuses of predefined flags that occur upon the execution of system arithmetic-function instructions. These registers cannot be referenced from the ladder circuit monitor and MCS functions (if an attempt is made to do so, the registers are always displayed as “OFF”).

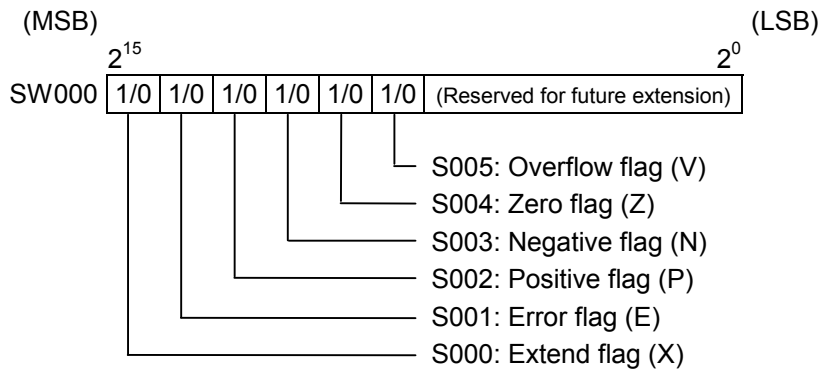

(2) Ladder program control registers

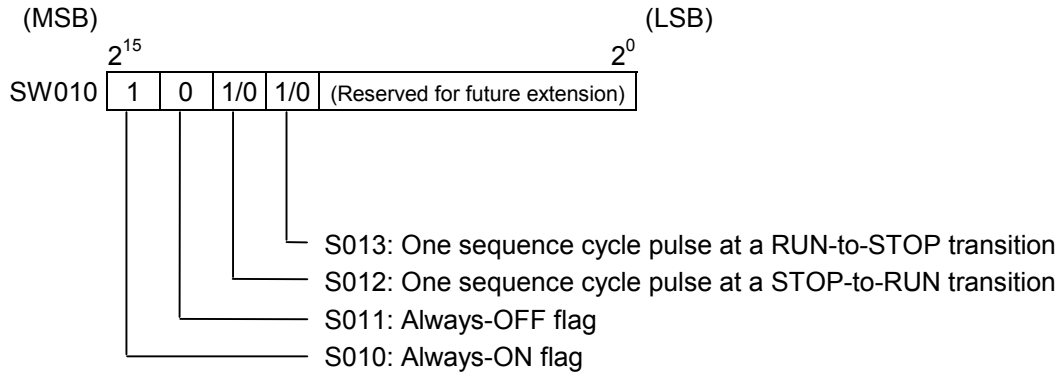

Timing chart:

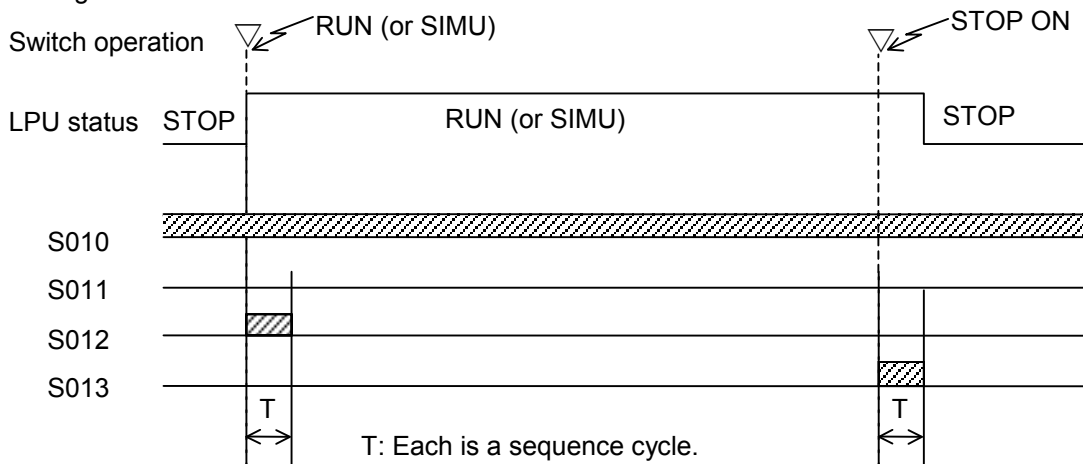

Note: None of the above bit registers, S010 through S013, become ON in the event of a power outage.

(3) HI-FLOW application-instruction execution-result flag registers

HI-FLOW application-instruction execution-result flag registers indicate the statuses of predefined flags that occur upon the execution of HI-FLOW application instructions.

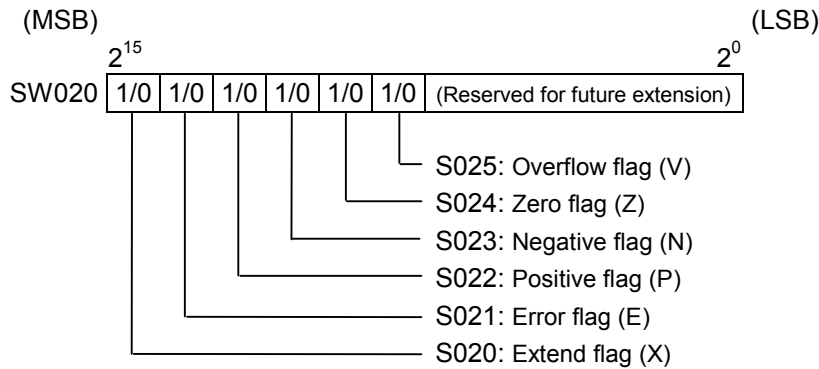

(4) Ladder program control registers

Ladder program control registers are counters that can be used in sequence control.

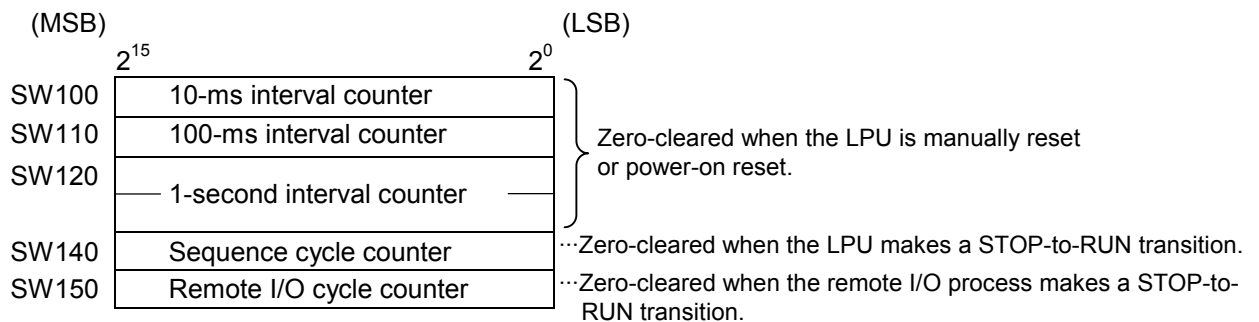

- All the above counters start counting from 0 again when they overflow.
- Any of the above counters will have an error of approximately $\pm 10\%$ because their precision depends on interrupts handled by the operating system (OS).

(5) Time control registers

Time control registers are provided as a means of controlling the setting of current time in the LPU. They are used when setting the current time in the LPU.

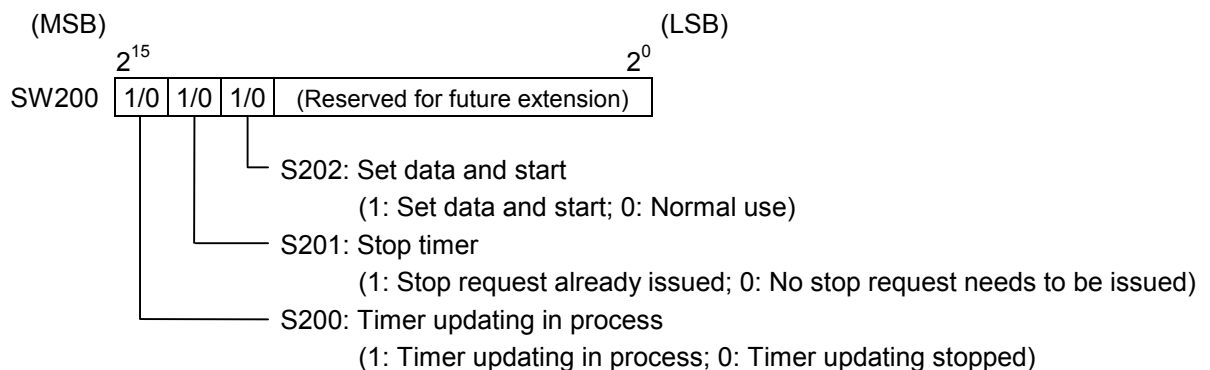

3 TECHNICAL SUPPORT INFORMATION

(6) Time setting registers

Time setting registers are used to store values indicating the year, month, day of month, hours, minutes, seconds, and day of week. When you make time settings in the LPU, store time information in these registers. Data stored in these registers must be in binary format.

	(MSB)	2 ¹⁵	2 ⁸ 2 ⁷	2 ⁰	(LSB)
SW280		(Unused)		Seconds	
SW290		(Unused)		Minutes	
SW2A0		(Unused)		Hours	
SW2B0		(Unused)		Day of month	
SW2C0		(Unused)		Month	
SW2D0		Year			
SW2E0		(Unused)		Day of week	

Seconds: Must be in the range 0 to 59.

Minutes: Must be in the range 0 to 59.

Hours: Must be in the range 0 to 23.

Day of month: Must be in the range 1 to 31.

Month: Must be in the range 1 to 12.

Year: Must be in the range 1970 to 2069.

Day of week: Must be in the range 1 to 7.

(1: Sun; 2: Mon; 3: Tue; 4: Wed; 5: Thu; 6: Fri; 7: Sat)

(7) Remote I/O status registers

Remote I/O status registers present remote I/O station information, such as station registered or not, timeout error detected or not, and fuse blown or not.

<Register assignment>

S300	Registered stations
S380	Timed-out stations
S400	Fuse-blown stations
S47F	

- All stations that are currently connected to the communication line and that have thus far responded normally at least once have their associated registers set to 1. (*)
 - All registered stations in which a timeout error has been detected have their associated registers set to 1. (*)
 - All registered stations in which a fuse-blown condition (DO module fuse blown) has been detected have their associated registers set to 1. (*)
- (*) One-to-one correspondence between stations and bits:

No.	X- or Y-number	Registered station	Timed-out station	Fuse-blown station
0	000 to 00F	S300	S380	S400
1	010 to 01F	S301	S381	S401
2	020 to 02F	S302	S382	S402
3	030 to 03F	S303	S383	S403
4	040 to 04F	S304	S384	S404
⋮	⋮	⋮	⋮	⋮
124	7C0 to 7CF	S37C	S3FC	S47C
125	7D0 to 7DF	S37D	S3FD	S47D
126	7E0 to 7EF	S37E	S3FE	S47E
127	7F0 to 7FF	S37F	S3FF	S47F

3 TECHNICAL SUPPORT INFORMATION

(8) Optional-module status registers

Optional-module status registers are used to store error information for inter-CPU links, external-equipment links, etc. As shown below, these registers are organized into four groups according to the module types used. Data is set in each group of registers by a system program provided for its associated module type. For details on the bit configuration unique to each type of optional module, refer to the user's manual on the optional module.

<Register assignment for optional modules>

S500	(Reserved for system use)
S580	Inter-CPU link module information
S5C0	RS-232C module information
S640	(Reserved for system use)
S6FF	

The above registers are zero-cleared when the S10V unit is power-on reset or the LPU module is manually or remotely reset.

(9) Sequence-cycle scan-time registers

Sequence-cycle scan-time registers are used to store the result of measurements of sequence cycles.

	(MSB) 2^{15}	(LSB) 2^0	
SW900	Latest measurement value (ms)		} Zero-cleared when the status of the LPU module is switched from STOP to RUN.
SW910	Maximum measurement value (ms)		
SW920	Minimum measurement value (ms)		
SW930	Average value of latest 16 measurements (ms) (Note)		

Note: The above average value is not stored in place until the 16th measurement is completed.

(10) Ladder execution-time registers

Ladder execution-time registers are used to store the result of measurements of ladder execution times. Where HI-FLOW is used, the ladder and the HI-FLOW execution time are added together and the result is stored in place.

	(MSB) 2^{15}	(LSB) 2^0	
SW940	Latest measurement value (ms)		} Zero-cleared when the status of the LPU module is switched from STOP to RUN.
SW950	Maximum measurement value (ms)		
SW960	Minimum measurement value (ms)		
SW970	Average value of latest 16 measurements (ms) (Note)		

Note: The above average value is not stored in place until the 16th measurement is completed.

(11) Optional-module status registers (D.NET)

These optional-module status registers are used to store error information on errors detected in each D.NET module (one of channels 0 through 3). For details, refer to the “D.NET (manual number SVE-1-106).”

	(MSB) 2^{15}	(LSB) 2^0
SW980	Channel-0 module error information	
SW990	Channel-1 module error information	
SW9A0	Channel-2 module error information	
SW9B0	Channel-3 module error information	

3 TECHNICAL SUPPORT INFORMATION

(12) Optional-module status registers (J.NET/IR.LINK)

These optional-module status registers are used to store error information on errors detected in each J.NET or IR.LINK module (main or submodule). For details, refer to the “J.NET (manual number SVE-1-104)” and “J.NET-INT (manual number SVE-1-107),” or the “IR.LINK (manual number SVE-1-117).”

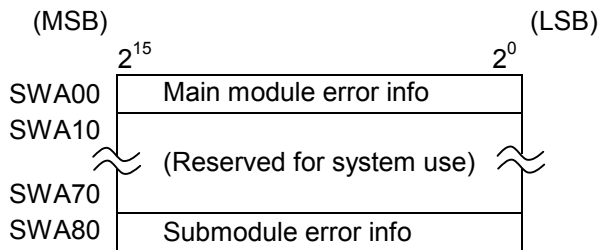

(13) LPU-unit I/O information registers

LPU-unit I/O information registers are used to store I/O unit information for the LPU module. Each bit in the information is in one-to-one correspondence with one of the slots involved.

Bit configuration for LPU unit I/O info:

	(MSB)	2^{15}	2^{14}	2^{13}	2^{12}	2^{11}	2^{10}	2^9	2^8	2^7	2^6	2^5	2^4	2^3	2^2	2^1	2^0	(LSB)
SWB00	Error info (=0: Normal; =1: Fuse blown)								Mounting info (=0: Not mounted; =1: Mounted)									
SWB10	I/O type (=0: DI/DO; =1: AI/AO/PCT (*))								0 (fixed; reserved for future use)									
Bit No.	0	1	2	3	4	5	6	7	8	9	A	B	C	D	E	F		

(*) PCT: Pulse counter.

Slot No.	Bit register		
	Error info	Mounting info	I/O type
0	SB00	SB08	SB10
1	SB01	SB09	SB11
2	SB02	SB0A	SB12
3	SB03	SB0B	SB13
4	SB04	SB0C	SB14
5	SB05	SB0D	SB15
6	SB06	SB0E	SB16
7	SB07	SB0F	SB17

(14) LPU status registers

LPU status registers indicates the current state of the LPU.

LPU status bit configuration

(MSB)	2^{15} 2^{14} 2^{13} 2^{12} 2^{11} 2^{10} 2^9 2^8 2^7 2^6 2^5 2^4 2^3 2^2 2^1 2^0	(LSB)																
SWBF0	<table style="width: 100%; border-collapse: collapse;"> <tr> <td style="border: 1px solid black; width: 15px; text-align: center;">1/0</td> <td style="border: 1px solid black; width: 15px; text-align: center;">1/0</td> <td style="border: 1px solid black; width: 15px; text-align: center;">*</td> <td style="border: 1px solid black; width: 15px; text-align: center;">1/0</td> <td style="border: 1px solid black; width: 15px; text-align: center;">1/0</td> <td style="border: 1px solid black; width: 15px; text-align: center;">*</td> <td style="border: 1px solid black; width: 15px; text-align: center;">1/0</td> <td style="border: 1px solid black; width: 15px; text-align: center;">*</td> <td style="border: 1px solid black; width: 15px; text-align: center;">1/0</td> <td style="border: 1px solid black; width: 15px; text-align: center;">1/0</td> <td style="border: 1px solid black; width: 15px; text-align: center;">1/0</td> <td style="border: 1px solid black; width: 15px; text-align: center;">1/0</td> <td style="border: 1px solid black; width: 15px; text-align: center;">*</td> <td style="border: 1px solid black; width: 15px; text-align: center;">1/0</td> <td style="border: 1px solid black; width: 15px; text-align: center;">1/0</td> <td style="border: 1px solid black; width: 15px; text-align: center;">0</td> </tr> </table>	1/0	1/0	*	1/0	1/0	*	1/0	*	1/0	1/0	1/0	1/0	*	1/0	1/0	0	
1/0	1/0	*	1/0	1/0	*	1/0	*	1/0	1/0	1/0	1/0	*	1/0	1/0	0			
Bit No.	<table style="width: 100%; border-collapse: collapse;"> <tr> <td style="width: 15px; text-align: center;">0</td> <td style="width: 15px; text-align: center;">1</td> <td style="width: 15px; text-align: center;">2</td> <td style="width: 15px; text-align: center;">3</td> <td style="width: 15px; text-align: center;">4</td> <td style="width: 15px; text-align: center;">5</td> <td style="width: 15px; text-align: center;">6</td> <td style="width: 15px; text-align: center;">7</td> <td style="width: 15px; text-align: center;">8</td> <td style="width: 15px; text-align: center;">9</td> <td style="width: 15px; text-align: center;">A</td> <td style="width: 15px; text-align: center;">B</td> <td style="width: 15px; text-align: center;">C</td> <td style="width: 15px; text-align: center;">D</td> <td style="width: 15px; text-align: center;">E</td> <td style="width: 15px; text-align: center;">F</td> </tr> </table>	0	1	2	3	4	5	6	7	8	9	A	B	C	D	E	F	
0	1	2	3	4	5	6	7	8	9	A	B	C	D	E	F			

* Each of these bits is reserved for future extension.

Bit No.	Bit register No.	Meanings of bits	
		ON (=1)	OFF (=0)
0	SBF0	Currently in STOP state.	Currently in RUN state.
1	SBF1	Simulation currently in process.	Currently running normally.
2	SBF2	(Reserved for future extension)	
3	SBF3	Protection switch currently in ON state.	Protection switch currently in OFF state.
4	SBF4	Remote I/O operation currently in progress.	Remote I/O operation currently stopped.
5	SBF5	(Reserved for future extension)	
6	SBF6	Ladder-rewriting process currently in progress.	Ladder-rewriting process completed.
7	SBF7	(Reserved for future extension)	
8	SBF8	CELL error (*1) warning.	CELL normal.
9	SBF9	Timed-out station existent.	No timed-out station existent.
A	SBFA	Fuse-blown station existent.	No fuse-blown station existent.
B	SBFB	Optional-module error (*2) detected.	No optional-module error (*2) detected.
C	SBFC	(Reserved for future extension)	
D	SBFD	Zero-cleared in a general (power-on) reset (GR) or manual/remote reset.	
E	SBFE	LPU currently down.	LPU currently up and running normally.
F	SBFF	-	LPU's OS currently running.

(*1) The CELL error is a "battery low" condition of the memory backup battery provided in the LPU.

(*2) The optional-module error is a parity error detected during accessing the internal memory of the optional module from the LPU.

3 TECHNICAL SUPPORT INFORMATION

(15) Ethernet communication result flag registers

Ethernet communication result flag registers are used to store special flags for indicating the result of execution of Ethernet communication instructions.

Execution results are flagged in the system registers S9C0 through S9FF according to the management numbers, which are predefined in one-to-one correspondence with all available sockets. When the execution of an Ethernet communication instruction is terminated normally or abnormally, the result is flagged by setting the system register associated with the management number to 0 or 1, respectively.

Register type		Management number	Remarks
Word	Bit		
SW9C0	S9C0	1	Provided for CMU Ethernet communications.
	S9C1	2	
	⋮	⋮	
	S9CE	15	
	S9CF	16	
SW9D0	S9D0	17	Provided for ET.NET (main module) Ethernet communications.
	S9D1	18	
	⋮	⋮	
	S9DE	31	
	S9DF	32	
SW9E0	S9E0	33	Provided for ET.NET (submodule) Ethernet communications.
	S9E1	34	
	⋮	⋮	
	S9EE	47	
	S9EF	48	
SW9F0	S9F0	(Reserved for future extension)	
	⋮		
	S9FF		

3.8 Memory Maps for Optional Modules

As shown below, optional modules are mapped into memory, starting from the address /800000.

Address	
/000000	
≈	≈
/800000	ET.NET/SV.LINK (main module)
/880000	ET.NET/SV.LINK (submodule)
/900000	OD.RING/SD.LINK (main module)
/980000	OD.RING/SD.LINK (submodule)
/A00000	J.NET/J.NET-INT/IR.LINK (main module)
/A80000	J.NET/J.NET-INT/IR.LINK (submodule)
/B00000	(Reserved for future extension; unused area)
/D00000	FL.NET/EQ.LINK (main module)
/D80000	FL.NET/EQ.LINK (submodule)
/E00000	D.NET (channel 0)
/E40000	D.NET (channel 1)
/E80000	D.NET (channel 2)
/EC0000	D.NET (channel 3)
/F00000	Inter-CPU link (main module)
/F10000	Inter-CPU link (submodule)
/F20000	(Reserved for future extension; unused area)
/F40000	RS-232C/422 (channel 0)
/F50000	RS-232C/422 (channel 1)
/F60000	RS-232C/422 (channel 2)
/F70000	RS-232C/422 (channel 3)
/F80000	(Reserved for future extension; unused area)
/1000000	

3 TECHNICAL SUPPORT INFORMATION

- Memory map for the ET.NET (model LQE520) module

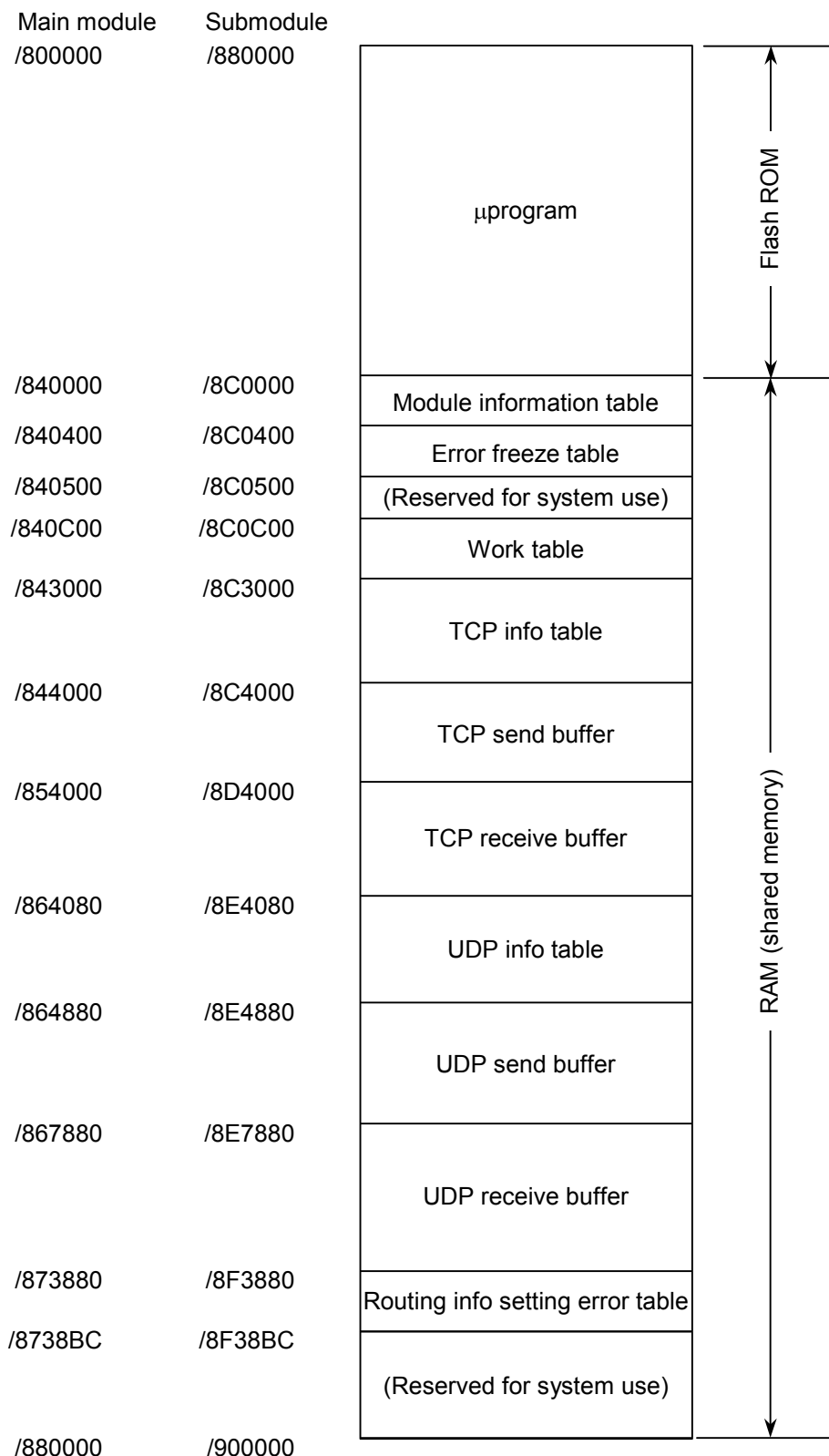

● Memory map for the SV.LINK (model LQE521) module

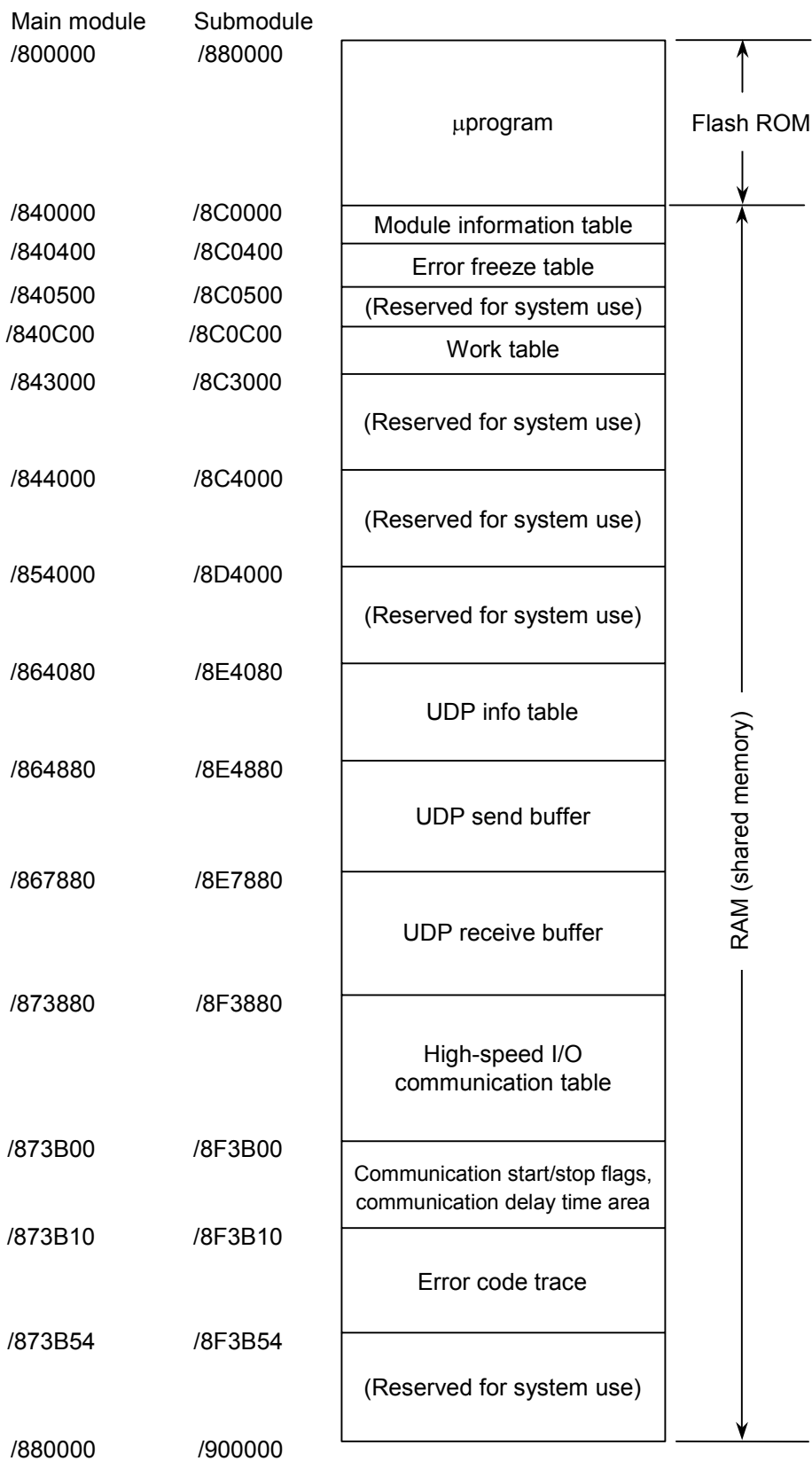

3 TECHNICAL SUPPORT INFORMATION

- Memory map for the OD.RING (model LQE510/515)/SD.LINK (model LQE530) modules

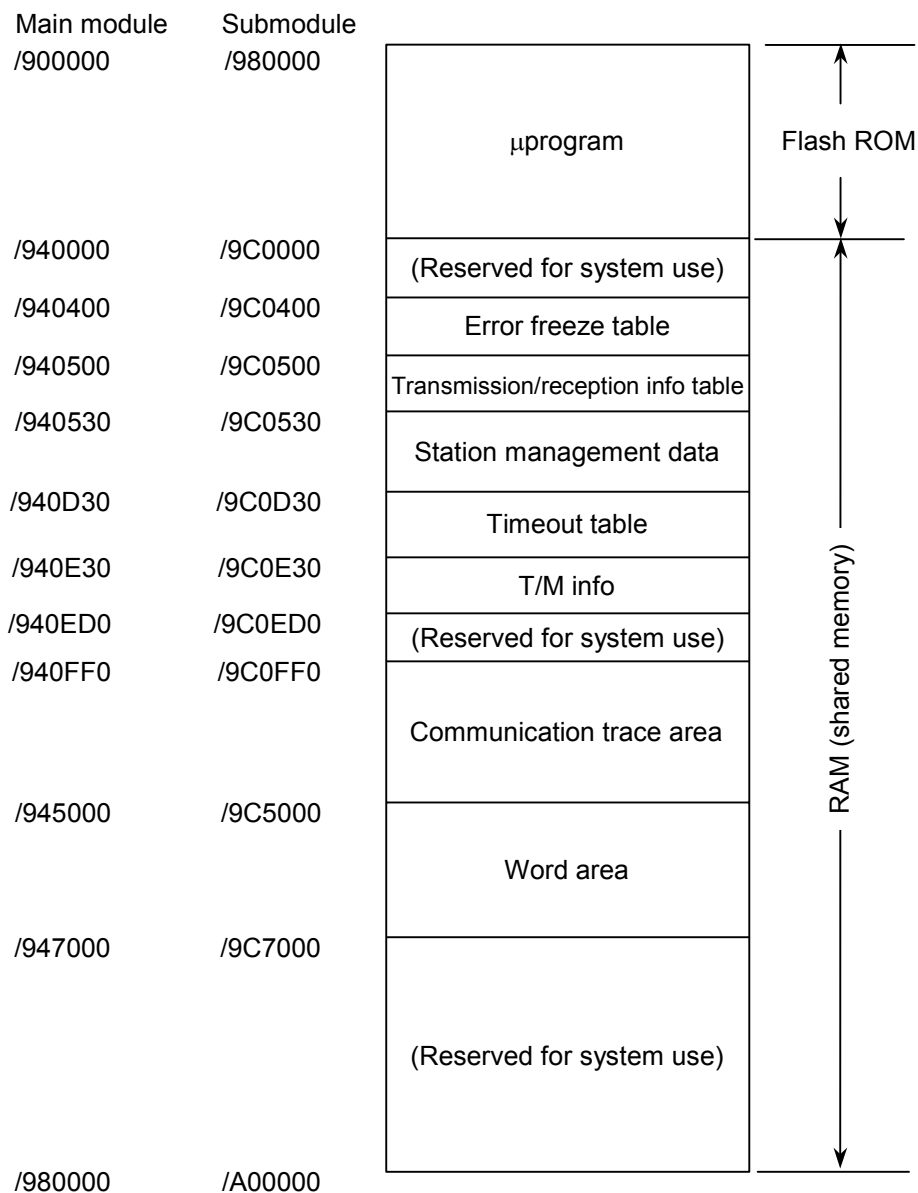

- Memory map for the J.NET (model LQE540), J.NET-INT (model LQE545), and IR.LINK (model LQE546) modules

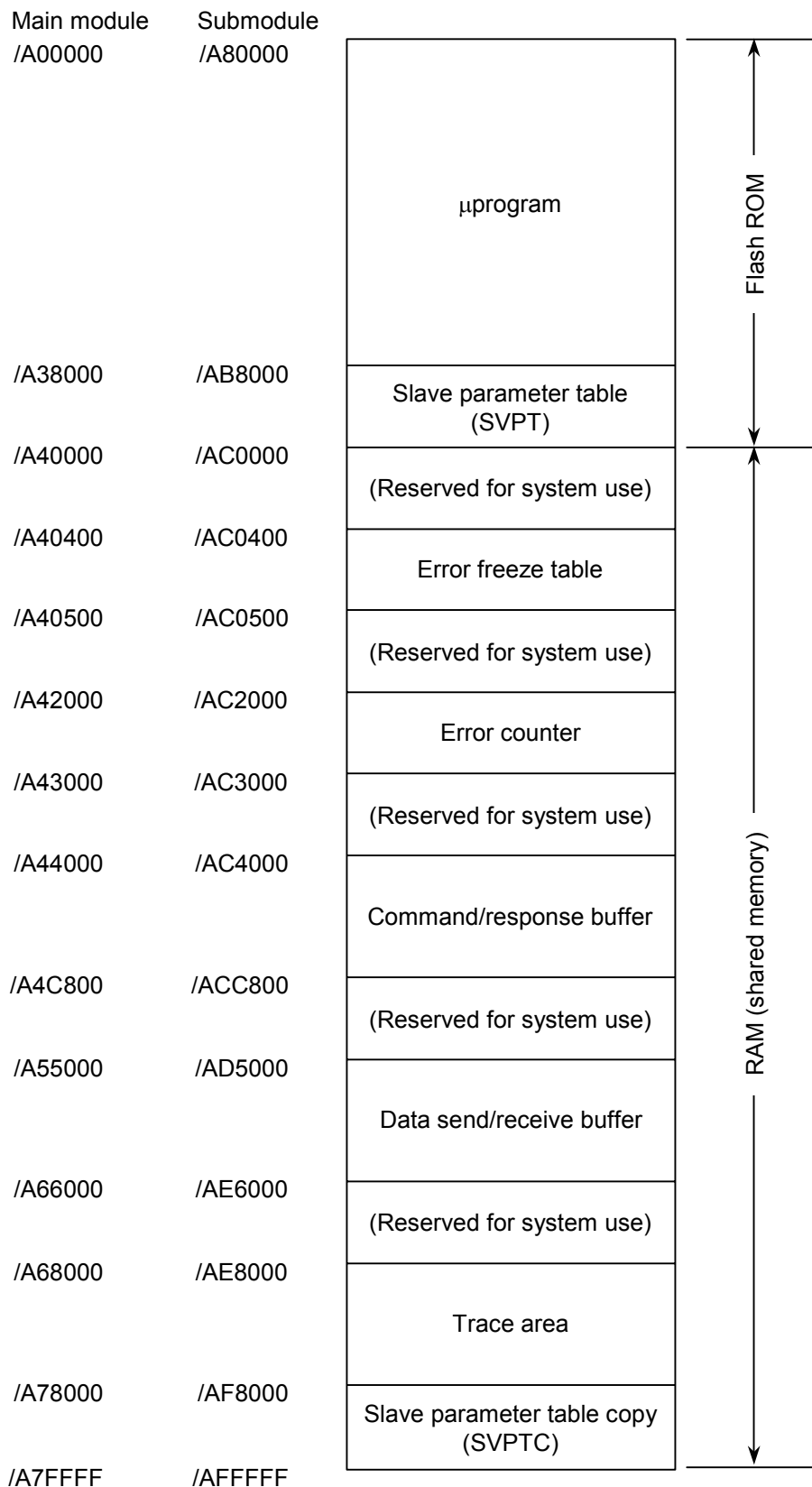

3 TECHNICAL SUPPORT INFORMATION

- Memory map for the FL.NET (model LQE500 or LQE502) module

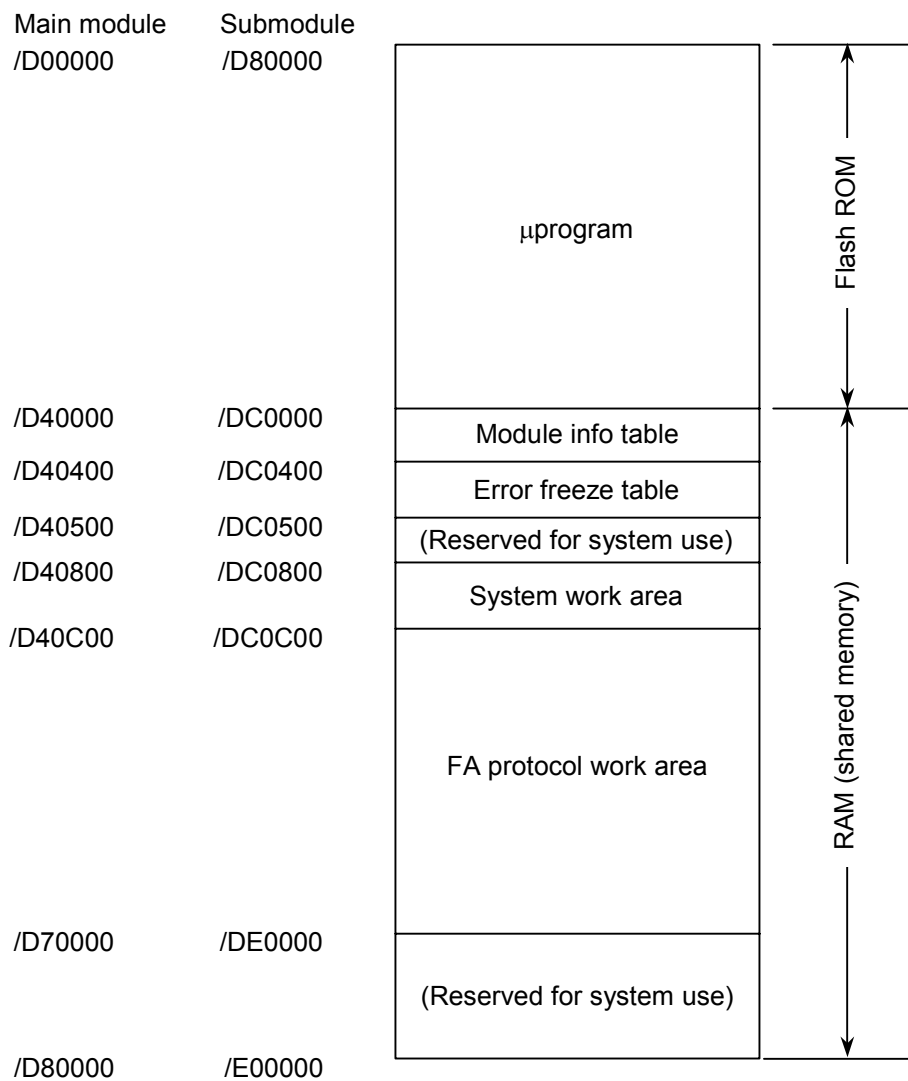

● Memory map for the EQ.LINK (model LQE701) module

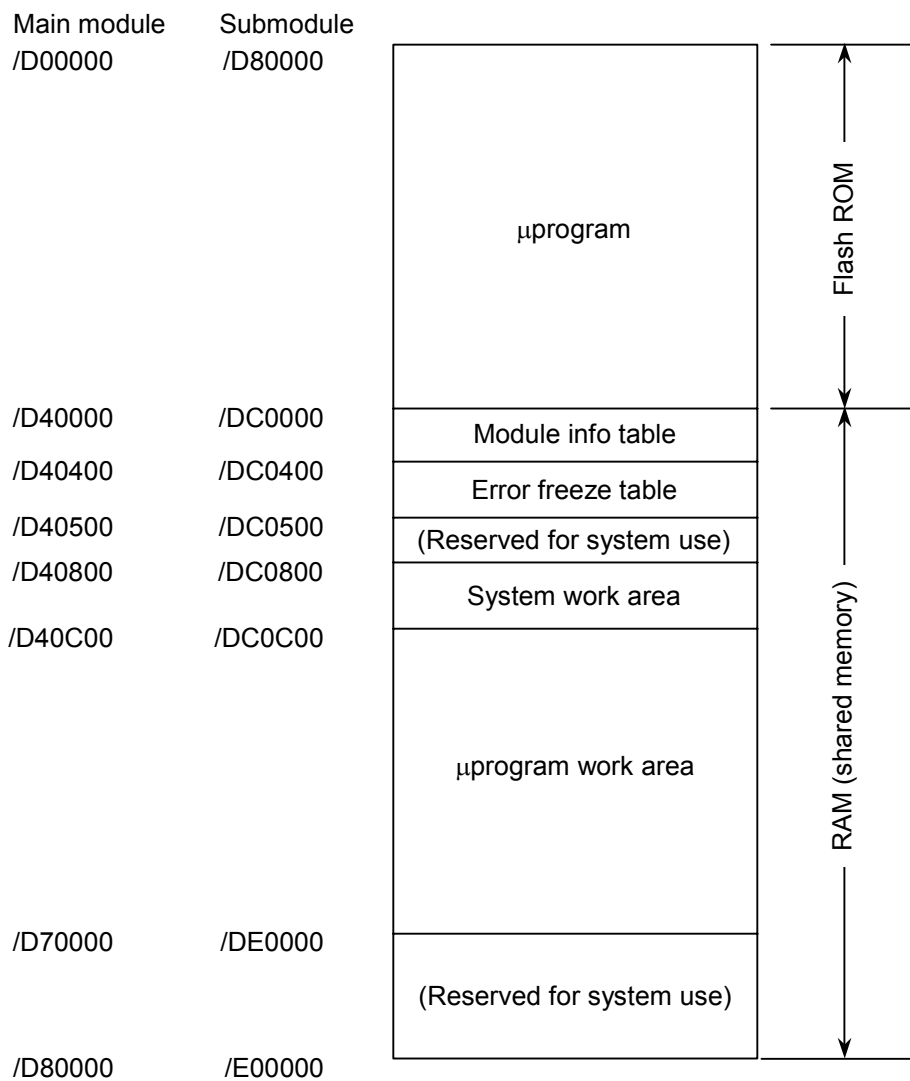

3 TECHNICAL SUPPORT INFORMATION

- Memory map for the D.NET (model LQE570/575) module

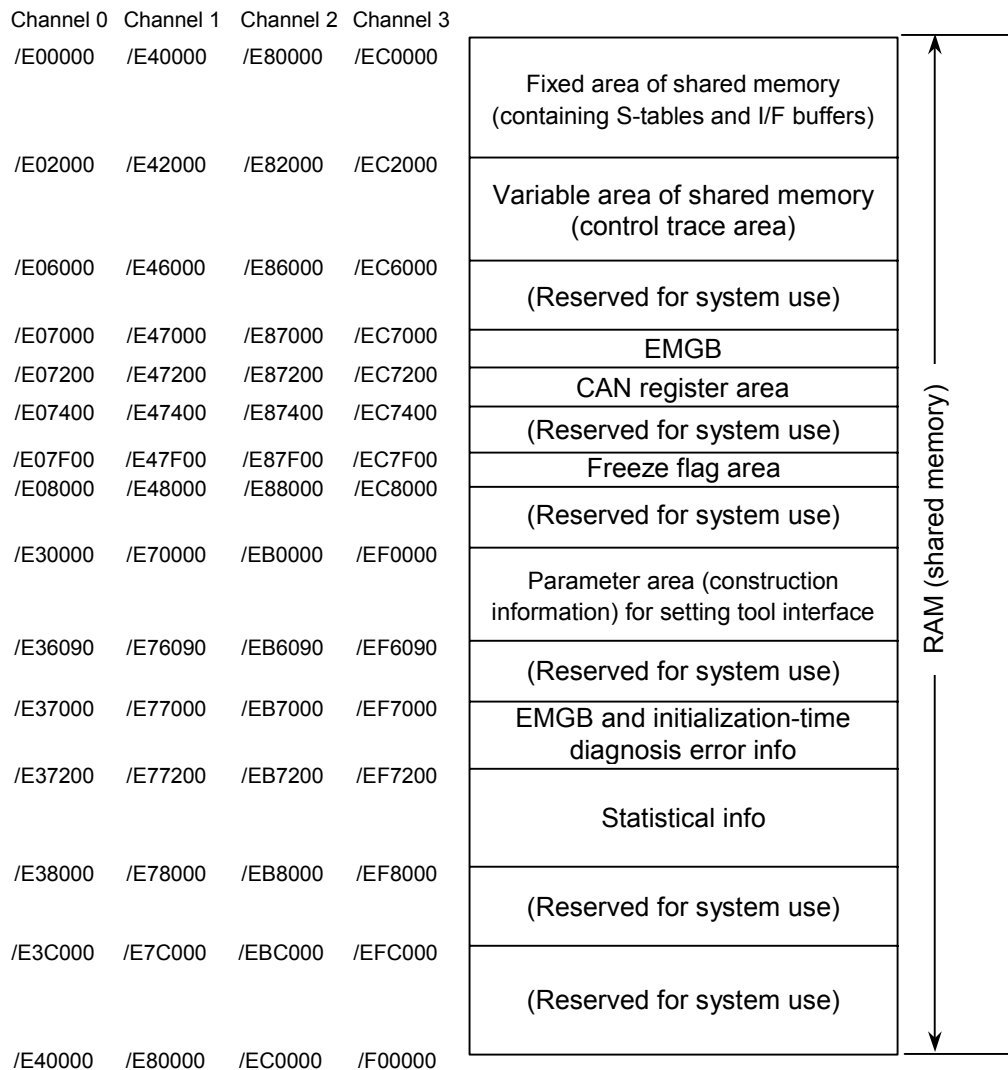

● Memory map for the RS-232C/422 (model LQE560/565) module

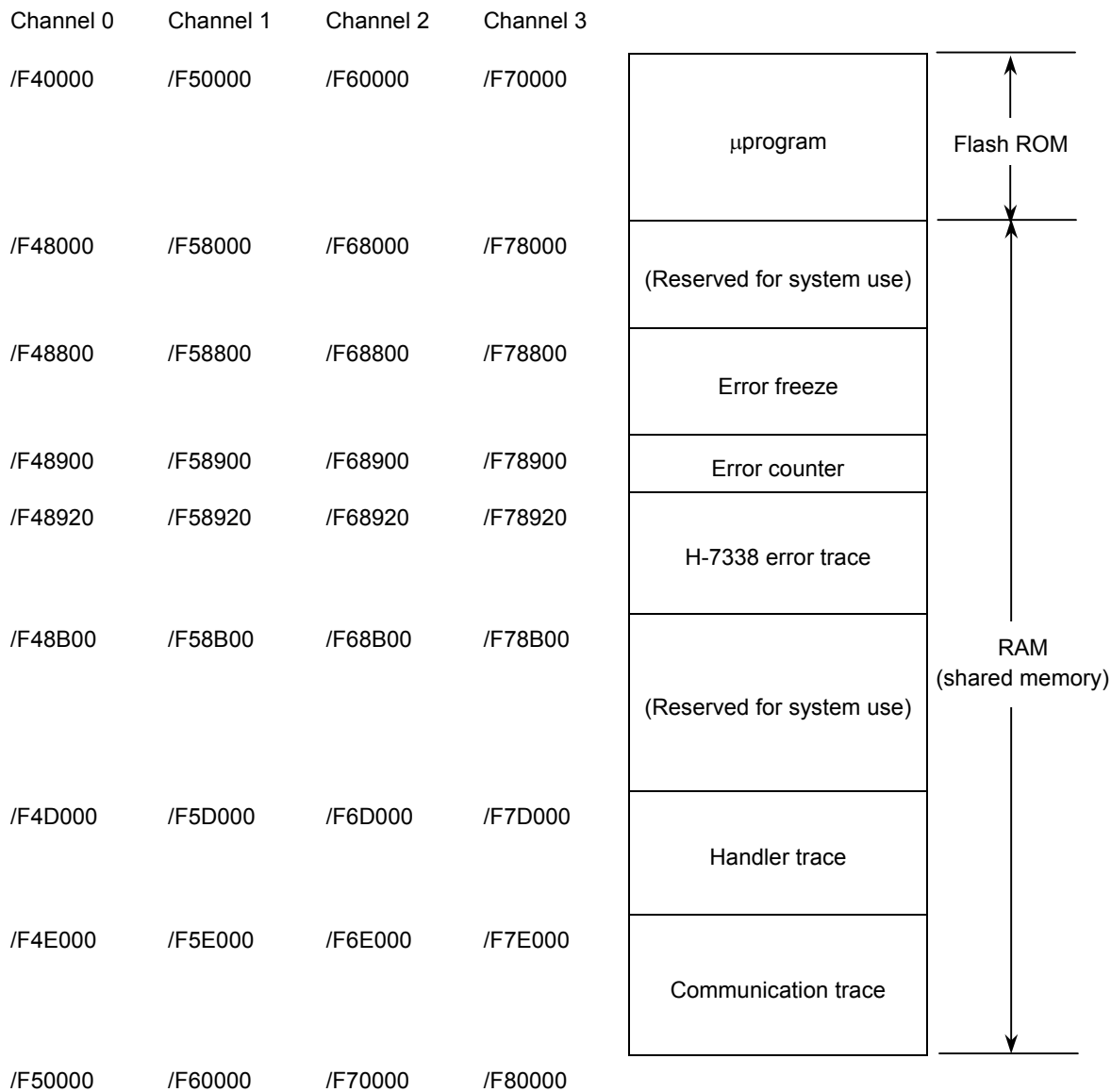

3 TECHNICAL SUPPORT INFORMATION

3.9 FL.NET (Model LQE500/LQE502) Error Information

- Error message data table

The error message table is a data table provided in the FL.NET module and used as follows: If a message is received as a response to a message request issued by the local node and is found abnormal, its message data is stored in the error message table.

The information given below is the detailed specification of the error message table.

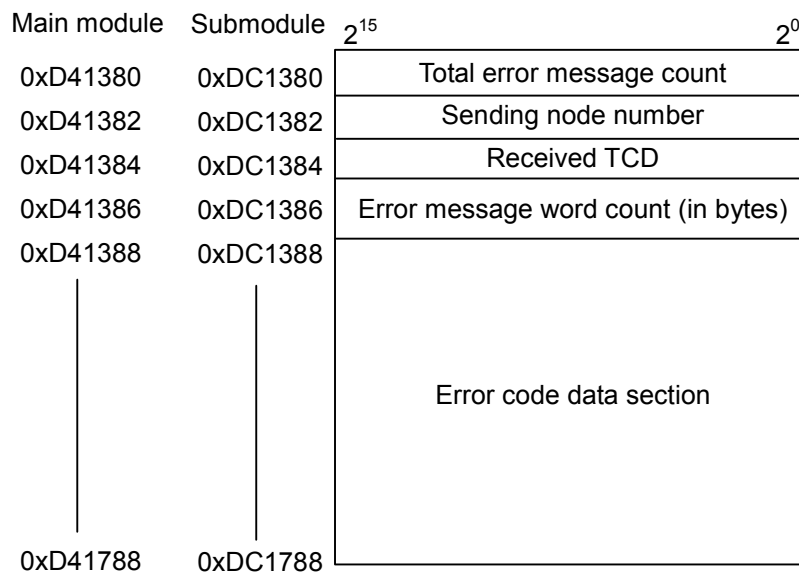

Item	Description
Total error message count	Total number of abnormal response messages received after power-up
Sending node number	Node number of the sending node from which the (latest) abnormal response message is received.
Received TCD	TCD number of the (latest) abnormal response message received
Error message word count	Size in bytes of the data section of the (latest) abnormal response message received (error code size).
Error code data section	Memory area in which the data section (error code) of the (latest) abnormal response message received is stored. This area can contain up to 1024 bytes of data.

Note: If an abnormal response message is stored in the error message table, and an additional abnormal response message is received, then the total error message count is increased by one, and the existing error message information is overwritten with the new information.

- Error codes for C-mode handler- and arithmetic function-detected errors

The table below enumerates all error codes that are returned when errors are detected in requests issued from C-mode handlers and arithmetic functions to the FL.NET module. In addition to these error codes, the table also provides information on the error causes and the user actions required to solve the problems.

(1/2)

Error code	Brief description	Cause	Required action
0x0000	Normal end of message	_____	_____
0x0001	Message response error	An abnormal response message is received from the specified node.	The content of the received abnormal response message is stored in the error message table. Check the condition of the specified node by referring to the manual supplied with the specified node.
0x0002	Non-supported message	The specified node does not support the user-requested message function.	Do not issue any non-supported message to the node.
0xFE00	Parameter error	A user-specified parameter is in error. Although a transparent message reception request is issued, no transparent message is already received.	Check the parameters used in the issued request. A transparent message reception request may be issued only when such a message is already received.
0xFE01	Local node not connected yet	The FL.NET module is currently not a participant in the network.	Issue a request when the FL.NET module is a participant of the network.
0xFE02	Specified node not connected yet	The user-specified node number does not identify any currently participating node in the network.	Specify only the node number of a currently participating node in the network.
0xFE03	Processing of some other message is in progress.	A request issued this time is not acceptable, because the previously issued request is currently under processing.	Issue the request again after the processing of the previously issued request has been completed.
0xFE04	No message ACK response received yet	No ACK response is received yet from the specified node.	Module failure is conceivable. Replace the module.
0xFE06	No data received	Although 30 seconds have elapsed since the last issuance of a message request to the specified node, a response to that message request has not been received.	Module failure is conceivable. Replace the module.

3 TECHNICAL SUPPORT INFORMATION

(2/2)

Error code	Brief description	Cause	Required action
0xFE08	ACK reception sequence-number error	An ACK response containing a sequence-number error is received from the specified node.	Module failure is conceivable. Replace the module.
0xFE09	ACK reception sequence-number version error	An ACK response containing a sequence-number version error is received from the specified node.	
0xFE12	Message queue full	The message queue of the specified node is full, so the specified node is unable to receive any more requests.	Wait for a while and then issue the request again. Alternatively, reduce the number of requests issued to the specified node.
0xFE13	Initialization error	The specified node has not finished initialization for message processing.	Wait for a while and then issue the request again.
0xFE16	Message size error	The specified node has reported that the size of a message requested by the local node is abnormal.	Module failure is conceivable. Replace the module.
0xF0XX or 0xFFXX	Driver abnormality	An abnormality is detected in the driver in the transmission of a user-requested message	

3.10 OD.RING (Model LQE510/515) and SD.LINK (Model LQE530) Communication Traces

The OD.RING and SD.LINK modules are capable of tracing communications and their details. By using this capability, you can generate trace data and use it for troubleshooting.

(1) Trace buffer structure

The trace buffer used consists of an 8-word trace control table and 256 cases (32 words per case) of trace data, as shown below. In this buffer, trace data is stored cyclically by means of a pointer.

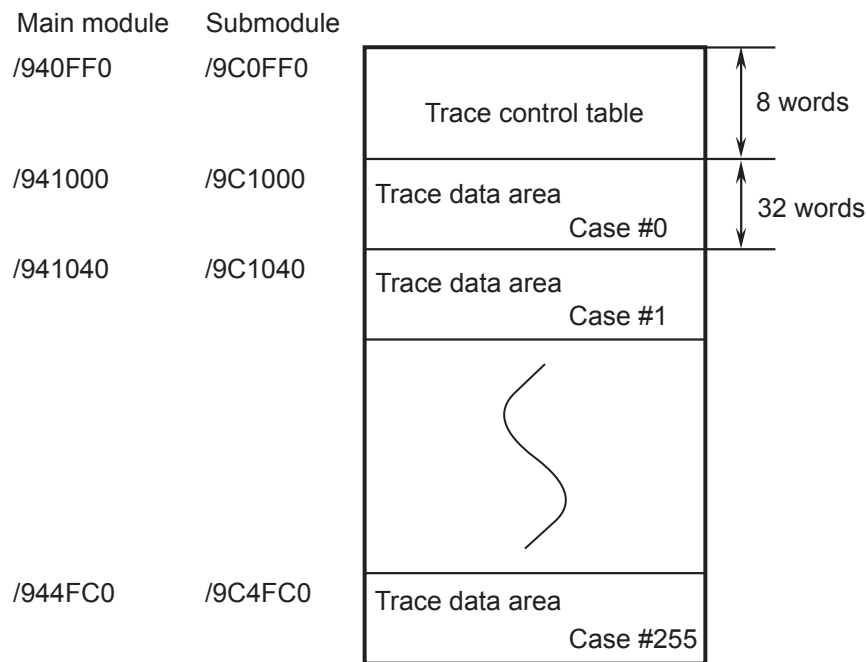

Trace data is stored in the trace buffer sequentially, starting from the case #0 area. When trace data is stored in the last case area (case #255), any remaining trace data is stored in the case #0 area onwards again.

3 TECHNICAL SUPPORT INFORMATION

(2) Trace control table

The trace control table consists of eight words, as shown below.

Main module	Submodule	
/940FF0	/9C0FF0	① Perform/Stop
/940FF2	/9C0FF2	(Unused)
/940FF4	/9C0FF4	② Trace target address
/940FF8	/9C0FF8	③ Mask data
/940FFA	/9C0FFA	④ Comparison data
/940FFC	/9C0FFC	⑤ Pointer
/940FFE	/9C0FFE	(Unused)

① Perform/Stop

This table entry is used to set one of the following directives to the tracing capability:

0: Stop tracing.

1: Perform tracing continuously until a given condition is met.

2: Perform tracing continuously until a given condition is met or an error occurs.

Upon a power recovery or the completion of a reset, this item is automatically set to “2”.

If an error occurs or a given tracing condition is met, the tracing is automatically stopped and the item is set to “0”.

② Trace target address

This specifies the starting address of a target area for conditional tracing.

③ Mask data

This specifies mask data for conditional tracing. The entry is used to mask out only 0-bits in bit data.

④ Comparison data

This entry is used in conditional tracing. It is compared with the result of ANDing of the trace target address ② and mask data. If they match, this means that the condition is met.

⑤ Pointer

This entry points to the next case area in which to store trace data. The latest trace data stored is located at the address pointed to by the pointer minus 1 (255 if the pointer value is 0).

<Usage example 1>

Assume that G002 must always be equal to 1, and that, if it is set equal to 0, tracing needs to be stopped. Then, set the following entries in the trace control table.

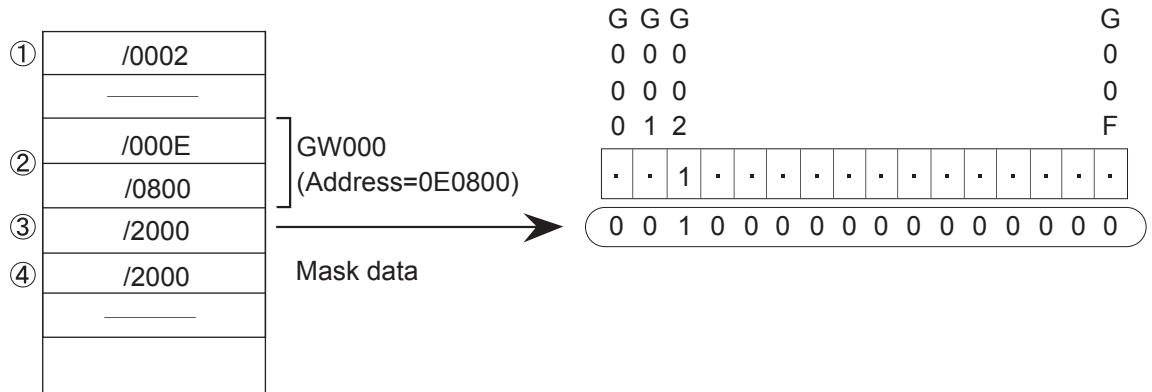

<Usage example 2>

Assume that FW000 must always be equal to 1234, and that, if FW000 is set equal to 1111, tracing needs to be stopped. Then, set the following entries in the trace control table.

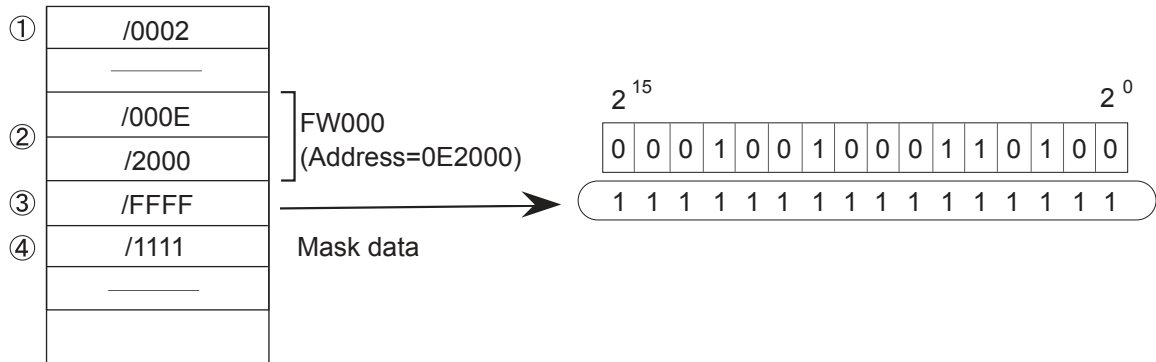

3 TECHNICAL SUPPORT INFORMATION

(3) Trace data

The trace data for each case of tracing consists of 32 words, as shown below.

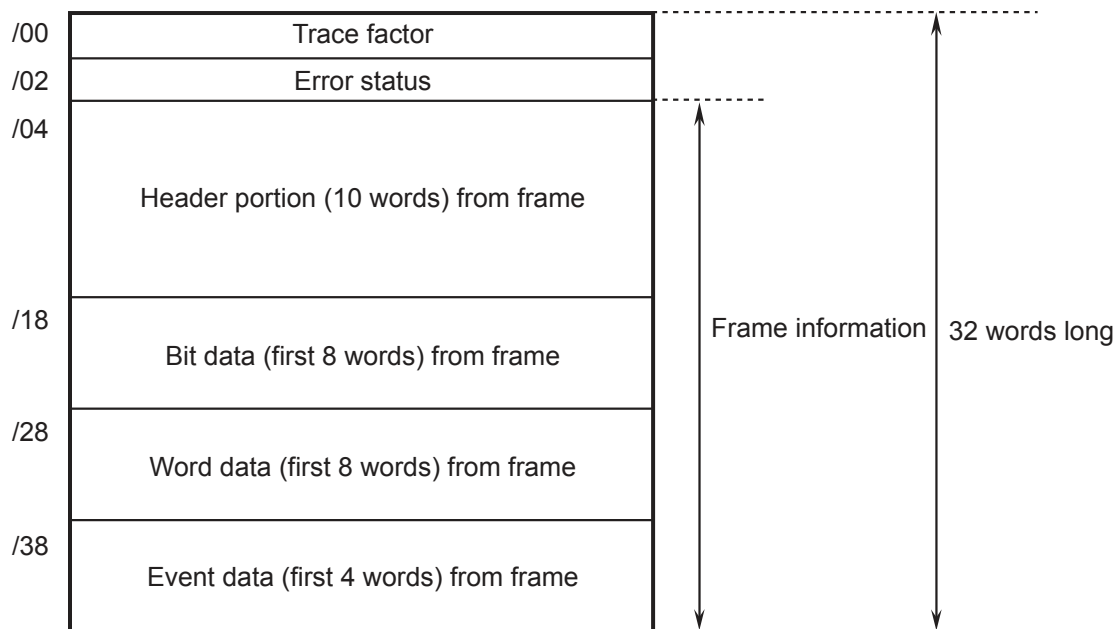

<Details of frame header portion>

	15		8	7		0
/04	Destination CPL No.			Source CPL No.		
/06	Entire-frame byte count					
/08	Bit data byte count					
/0A	Word data byte count					
/0C	Event data byte count					
/0E	CPU status					
/10	Bit area address					
/14	Byte area address					

(4) Trace events and processes performed on their occurrence

The table below shows the relationships between events causing the generation of trace data and processes performed on the occurrence of the events.

Event	Condition testing	Stop on error	Trace factor	Error status	Frame information
Start of transmission	Performed	Not performed	Effective	Insignificant	Significant
Transmission terminated normally	Not performed	Not performed	Effective	Insignificant	Insignificant
Transmission terminated on error	Not performed	Performed	Effective	Significant	Insignificant
Transmission timed out	Not performed	Performed	Effective	Insignificant	Insignificant
Reception started	Not performed	Not performed	Effective	Insignificant	Insignificant
Reception terminated normally	Performed	Not performed	Effective	Insignificant	Significant
Reception terminated on error	Performed	Performed	Effective	Significant	Significant
Reception timed out	Not performed	Performed	Effective	Significant	Significant

- Condition testing

Conditions are tested and, if they are satisfied, tracing is terminated, the fact being flagged in the trace factor.

3 TECHNICAL SUPPORT INFORMATION

- Termination on error

If the “perform/stop” entry in the table is set equal to 2, communication tracing is terminated on the occurrence of an error.

- Trace factor

The “trace factor” entry in the table consists of flags to indicate a variety of causes of trace data generation:

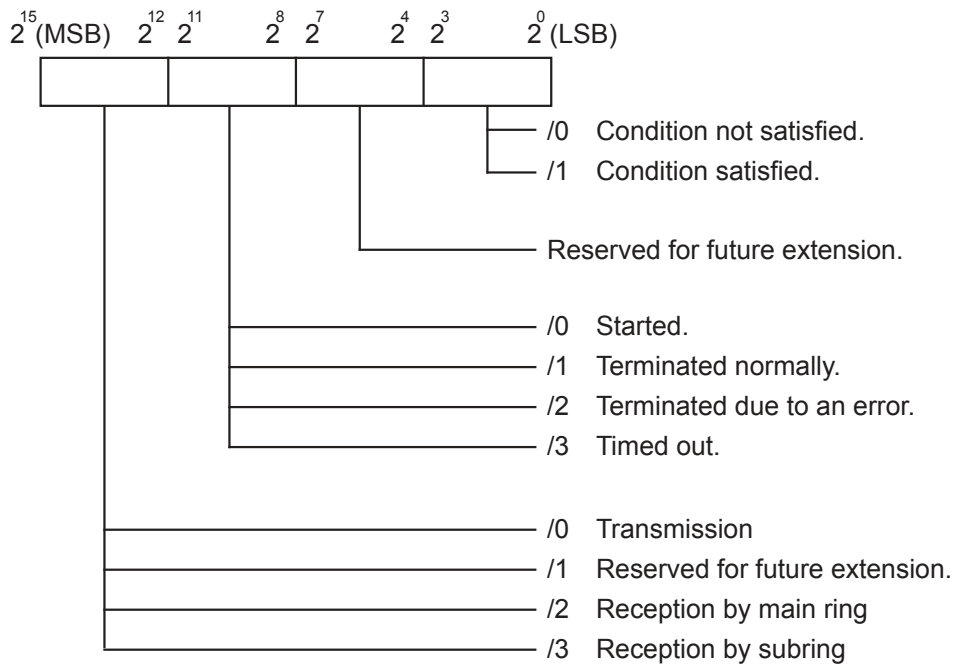

- Error status

<Error status of transmission>

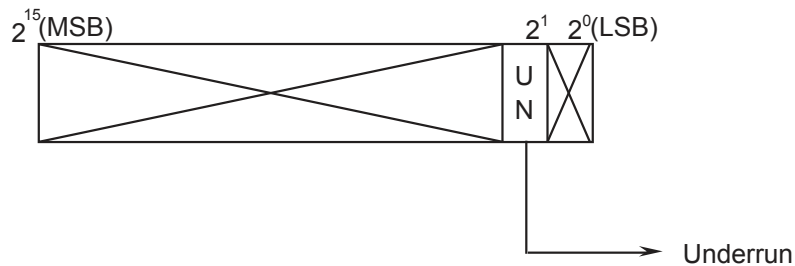

<Error status of reception>

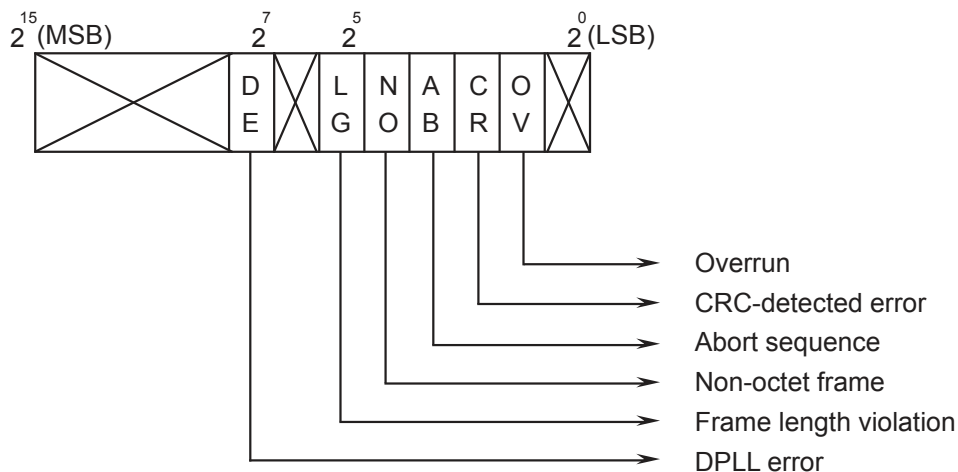

NOTE

The error status is set to “FFFF” when a reception time-out error is detected.

The table below sets forth the details of the error status.

Transmission /Reception	Error name	Error description
Transmission	Underrun	While an HDLC controller is transmitting data from the corresponding data buffer, an underrun occurs at the transmitter.
Reception	DPLL error	In a coding mode in which transitions occur with regard to each bit, a missing transition is detected, resulting in setting of the DE bit.
	Frame length violation	An illegal frame length is detected which is larger than its maximum permitted value defined for this channel.
	Non-octet frame	An illegal frame is received whose length in bits is not exactly divisible by 8.
	Abort sequence	Seven or more 1s are received consecutively during frame reception.
	CRC-detected error	An error is detected in a frame by a CRC.
	Overrun	An overrun has occurred at the receiver during frame reception.
	Reception time-out error	An attempt is made to transmit or receive more frames than permitted.

- Frame information

Frame information is stored in the predetermined locations.

3.11 ET.NET (Model LQE520) Error Information

3.11.1 Error codes from the socket handler

The table below enumerates all error codes that are returned from the socket handler to report on the occurrence of errors. In addition to these error codes, the table also provides information on the error causes and the user actions required to solve the problems.

Table 3-8 Error Codes from the Socket Handler (LQE520) (1/3)

Error code	Brief description	Cause	Required action
F000	Connection not established yet	A connection is not established yet, or the port is released when the handler is called.	Establish a connection by calling <code>tcp_open()</code> or <code>tcp_popen()</code> , and then call the handler.
F002	FIN received	An FIN is received when the handler is called.	Clear the connection by calling <code>tcp_close()</code> and then re-establish a connection by calling <code>tcp_open()</code> or <code>tcp_popen()</code> .
F010	Invalid socket ID	<ul style="list-style-type: none"> The socket ID is not within the permitted range (for TCP, $1 \leq ID \leq 15$; for UDP, $20 \leq ID \leq 27$); or An unused socket ID or an already released socket ID is specified; or A connection is not made or opened yet (only in <code>tcp_accept()</code>). 	Check the user program (e.g., check if a return value from <code>tcp_open()</code> or <code>tcp_popen()</code> is used as the socket ID).
F011	Socket count limit exceeded	An attempt has been made to register more sockets than permitted. (For TCP, up to 12; for UDP, up to 8.)	Close any unused sockets (by calling <code>tcp_close()</code> or <code>udp_close()</code>) and then re-establish a connection by calling <code>tcp_open()</code> or <code>tcp_popen()</code> .
F012	Socket driver timed out	<ul style="list-style-type: none"> No response has been obtained from the socket driver within a fixed time period; or The requested transmission is timed out due to a "send window full" condition or some other cause (only in <code>tcp_send()</code>). 	Clear the connection by calling <code>tcp_close()</code> , and then try to re-establish a connection by calling <code>tcp_open()</code> or <code>tcp_popen()</code> . If communication cannot be achieved by repeating such an attempt, check if the connectors, cables, and remote station involved are all functioning normally. If the same error has occurred in <code>tcp_close()</code> , clear the connection by calling <code>tcp_abort()</code> and then re-establish a connection by calling <code>tcp_open()</code> or <code>tcp_popen()</code> .
F013	Module stopped	A socket driver has not been able to be initialized completely within 100 seconds when the handler was called.	Call <code>tcp_close()</code> repeatedly as long as the application does not complain. Then, try to re-establish a connection by calling <code>tcp_open()</code> or <code>tcp_popen()</code> .

Table 3-8 Error Codes from the Socket Handler (LQE520) (2/3)

Error code	Brief description	Cause	Required action
F020	Illegal send data length	A send data length used exceeded the permitted limit (for TCP, $1 \leq \text{data length} \leq 4096$; for UDP, $1 \leq \text{data length} \leq 1472$).	Check the user program (to see if all the send data lengths specified are within the stated limits).
F021	Illegal receive data length	A receive data length used exceeded the permitted limit ($1 \leq \text{data length} \leq 4096$).	Check the user program (to see if all the receive data lengths specified are within the stated limits).
F0FF	Port released	<ul style="list-style-type: none"> A port has been released (due to an RST reception) when the handler was called (this error is related to <code>tcp_open()</code>); or A port was already released when the handler was called (this error is related to <code>tcp_send()</code> or <code>tcp_receive()</code>). 	<ul style="list-style-type: none"> Re-establish a connection by calling <code>tcp_open()</code> or <code>tcp_popen()</code>; or Clear the connection by calling <code>tcp_close()</code>, and then re-establish a connection by calling <code>tcp_open()</code> or <code>tcp_popen()</code>.
FFF0	Invalid address	<ul style="list-style-type: none"> As the IP address and/or port number of a destination station, zero values (0s) are used in both <code>udp_open()</code> and <code>udp_send()</code>; or An Ethernet-level error (e.g., a collision) has occurred in <code>udp_send()</code>; or An attempt has been made to send data to a remote station for which no routing information is set yet (this error is only related to <code>udp_send()</code>). 	<ul style="list-style-type: none"> Check the user program; or When the traffic decreases, try <code>udp_send()</code> again; or Check the existing routing information.
FFF3	Illegal parameter	An illegal parameter has been detected.	Check the user program.
FFF5	Connection operation timed out	No response has been obtained from the remote station.	Clear the connection by calling <code>tcp_close()</code> , and then try to re-establish a connection by calling <code>tcp_open()</code> or <code>tcp_popen()</code> . If communication cannot be achieved by repeating such an attempt, check if the connectors, cables, and remote station involved are all functioning normally.
FFF6	Already closed	A command has been issued for a socket ID whose connection was already terminated (by closing or aborting).	Re-establish a connection by calling <code>tcp_open()</code> or <code>tcp_popen()</code> .
FFF8	FIN received	An FIN has been received from the remote station.	Close the socket by calling <code>tcp_close()</code> .
FFFA	Connection forcibly terminated	The connection has been forcibly terminated by (transmission of an RST from) the remote station. (<code>tcp_receive()</code> was called after the RST reception.)	Clear the connection by calling <code>tcp_close()</code> , and then re-establish a connection by calling <code>tcp_open()</code> or <code>tcp_popen()</code> .
FFFC	Illegal net handle	An attempt has been made to transmit or receive data with a handle number not opened in the TCP or UDP. This kind of error may occur when an RST is received (in <code>tcp_receive()</code> waiting for data to be received).	Close the socket by calling <code>tcp_close()</code> , and then re-establish a connection by calling <code>tcp_open()</code> or <code>tcp_popen()</code> .

3 TECHNICAL SUPPORT INFORMATION

Table 3-8 Error Codes from the Socket Handler (LQE520) (3/3)

Error code	Brief description	Cause	Required action
FFFD	Duplicate socket	The same socket (using the remote station's IP address or port number, or the local station's port number) is already existent.	Check the user program.
FFFE	Illegal control block	The maximum permitted number of usable sockets has been exceeded.	Close unused sockets (by calling <code>tcp_close()</code> or <code>udp_close()</code>) and re-establish a connection by calling <code>tcp_open()</code> or <code>tcp_popen()</code> .
FFFF	Internal buffer full	<ul style="list-style-type: none">• The send buffer has become full (in <code>udp_send()</code>); or• Internal registered area has become full (in <code>route_add()</code> or <code>arp_list()</code>).	<ul style="list-style-type: none">• Wait for a while and then call <code>udp_send()</code> again; or• Delete unused registration information and then call it again.

3.11.2 Routing information setting error table

When routing-information setting ends up with an error, the corresponding error code is set in the following table:

Main module	Submodule	2 ³¹ _____ 2 ⁰	
/873880	/8F3880	Default	+0
/873884	/8F3884	User (1)	+2
/873888	/8F3888	User (2)	
/87388C	/8F388C	User (3)	
/873890	/8F3890	User (4)	
/873894	/8F3894	User (5)	
/873898	/8F3898	User (6)	
/87389C	/8F389C	User (7)	
/8738A0	/8F38A0	User (8)	
/8738A4	/8F38A4	User (9)	
/8738A8	/8F38A8	User (10)	
/8738AC	/8F38AC	User (11)	
/8738B0	/8F38B0	User (12)	
/8738B4	/8F38B4	User (13)	
/8738B8	/8F38B8	User (14)	

Error code
Duplicate user number

Error code: See the table below.

Duplicate user number:
A set user number that is duplicated.
(Default = 0; other user number = 1 to 14.)

No.	Error code	Description	User number duplicated or not
1	/0010	The remote station's IP address is duplicated with the local station's IP address.	Not duplicated
2	/0011	The remote station's IP address is duplicated with another gateway's IP address.	Duplicated
3	/0012	The remote station's IP address is duplicated with another remote station's IP address.	Duplicated
4	/0013	The same network address as the local station's is set as the network address in the remote station's IP address.	Not duplicated
5	/0014	The network address in the remote station's IP address is duplicated with the network address in another remote station's IP address.	Duplicated
6	/0016	The remote station's IP address is 255.255.255.255.	Not duplicated
7	/0020	The gateway's IP address is duplicated with the local station's IP address.	Not duplicated
8	/0022	The gateway's IP address is duplicated with another remote station's IP address.	Duplicated
9	/0023	The same network address as the local station's is set as the network address in a gateway's IP address.	Not duplicated
10	/0024	The network address in a gateway's IP address is duplicated with the network address in another remote station's IP address.	Duplicated
11	/0026	The gateway's IP address is 255.255.255.255.	Not duplicated
12	/0030	The subnetwork identified by a gateway's IP address matches the subnetwork of the local station.	Not duplicated

3 TECHNICAL SUPPORT INFORMATION

3.12 SV.LINK (Model LQE521) Error Information

Parameter setting and communication errors, if detected, are reported by setting error codes in the status register area (BD000). These error codes are listed in the table below.

No.	Error name	Error code		Required action
		Upper word	Lower word	
1	Control register setting error	H1100	H0000	A parameter whose set value is in error is detected. Check the parameter's set value by referring to the description under "5.4 Status and Communication Parameter Areas" in the "SV.LINK (manual number SVE-1-116)," and set the parameter correctly. Then, reset the controller, or turn off the power to the controller and back on again.
2	Communication response wait time setting error	H1101	H0000	
3	Communication retry count setting error	H1102	H0000	
4	Cyclic-communication protocol setting error	H1103	H0000	
5	Remote-station IP address setting error	H1104	H0000	
6	Bit-reversal setting error	H1105	H0000	
7	Module-number setting error	H1106	H0000	
8	Local-station send/receive starting-address setting error	H1107	H0000	
9	Remote-station send/receive starting-address setting error	H1108	H0000	
10	Bits/word mismatch error	H1109	H0000	
11	Send/receive data size setting error	H110A	H0000	
12	Port opening error	H1200	Hxxxx	Take an appropriate action according to the information provided in the table below. Then, if the same error recurs, replace the SV.LINK module. Here, note that the digits "xxxx" in the lower word represents an internal error code. For details, see the table below.
13	Port closing error	H1201	Hxxxx	
14	Data transmission error in cyclic communication	H2301	Hxxxx	
15	Data reception error in cyclic communication	H2302	Hxxxx	MELSEC is stopped, or the set value of wait time (BD009) is too small. Make the correct setting.
16	Timeout error in cyclic communication	H2303	H0000	
17	Data size error in cyclic communication	H2304	H0000	The send/receive word count is not identical between the S10V and MELSEC controllers. Make the correct setting.
18	Response error in cyclic communication	H2305	H0000	A problem is found in the way in which communication is performed. Check the user program running on the MELSEC side.

Internal error code (xxxx in the above table) of the SV.LINK module

Error code	Brief description	Cause	Required action
0xFFFF0	Address or network error	An attempt is made to transmit data to the local station.	Check the remote station's IP address setting (BD00D), and set the correct IP address.
		An Ethernet-level error (e.g., collision) has occurred in data transmission.	Check if any of the connectors, cable, and remote station is abnormal. Check, also, if there is any possibility of noise interference with the cable. If so, correct the cable laying and/or wiring.
		The cable is disconnected.	Check the cable.

The error code (BD000) in the status register area described above is cleared to zero (0) when an error recovery is made by, for instance, communication retries. Any error(s) that occurred in the past can be identified by referencing the error code trace area shown below. This trace area can contain information on up to 16 past error codes reported. If more than 16 errors occurred in the past, the trace area has been overwritten with the new error information, starting from the oldest error information in the trace area. In addition, this trace area is cleared when the controller is reset or the power to the controller is turned off and back on again.

Error code trace area

Address (submodule)		
0x873B10(0x8F3B10)	Write pointer	...Case number for which to write trace data to the associated trace area next (0 to 15).
+0x02	(Reserved for future extension)	
+0x04	Error code (long word) Case No. 0	
+0x08	Error code Case No. 1	
+0x0A	Error code Case No. 2	
	:	
	:	
	:	
+0x40	Error code Case No. 15	
+0x44		

3 TECHNICAL SUPPORT INFORMATION

3.13 J.NET (Model LQE541), J.NET-INT (Model LQE547), and IR.LINK (Model LQE548) Trace Information

3.13.1 Command and response buffers

- Command buffer

In the information given below, the “Main module [N1]” stands for the IR.LINK module.

Main module		Submodule				2 ⁷ ————— 2 ⁰
[N1]	[N2]	[N1]	[N2]			
/A44110	/A46310	/AC4110	/AC6310	Station ID = 01	+000	CFLAG
/A44220	/A46420	/AC4220	/AC6420	Station ID = 02	1	—
/A44330	/A46530	/AC4330	/AC6530	Station ID = 03	2	Return code (H)
/A44440	/A46640	/AC4440	/AC6640	Station ID = 04	3	(L)
/A44550	/A46750	/AC4550	/AC6750	Station ID = 05	4	Station number
/A44660	/A46860	/AC4660	/AC6860	Station ID = 06	5	(Unused; 4 bytes)
/A44770	/A46970	/AC4770	/AC6970	Station ID = 07	6	
/A44880	/A46A80	/AC4880	/AC6A80	Station ID = 08	7	
/A44990	/A46B90	/AC4990	/AC6B90	Station ID = 09	8	
/A44AA0	/A46CA0	/AC4AA0	/AC6CA0	Station ID = 0A	9	Service code
/A44BB0	/A46DB0	/AC4BB0	/AC6DB0	Station ID = 0B	A	Data length (H)
/A44CC0	/A46EC0	/AC4CC0	/AC6EC0	Station ID = 0C	B	(L)
/A44DD0	/A46FD0	/AC4DD0	/AC6FD0	Station ID = 0D	C	Data (max. of 250 bytes)
/A44EE0	/A470E0	/AC4EE0	/AC70E0	Station ID = 0E		
/A44FF0	/A471F0	/AC4FF0	/AC71F0	Station ID = 0F		
/A45100	/A47300	/AC5100	/AC7300	Station ID = 10		
/A45210	/A47410	/AC5210	/AC7410	Station ID = 11		
/A45320	/A47520	/AC5320	/AC7520	Station ID = 12	/105	
/A45430	/A47630	/AC5430	/AC7630	Station ID = 13	/106	
/A45540	/A47740	/AC5540	/AC7740	Station ID = 14		
/A45650	/A47850	/AC5650	/AC7850	Station ID = 15		
/A45760	/A47960	/AC5760	/AC7960	Station ID = 16		
/A45870	/A47A70	/AC5870	/AC7A70	Station ID = 17		
/A45980	/A47B80	/AC5980	/AC7B80	Station ID = 18		
/A45A90	/A47C90	/AC5A90	/AC7C90	Station ID = 19		
/A45BA0	/A47DA0	/AC5BA0	/AC7DA0	Station ID = 1A		
/A45CB0	/A47EB0	/AC5CB0	/AC7EB0	Station ID = 1B		
/A45DC0	/A47FC0	/AC5DC0	/AC7FC0	Station ID = 1C		
/A45ED0	/A480D0	/AC5ED0	/AC80D0	Station ID = 1D		
/A45FE0	/A481E0	/AC5FE0	/AC81E0	Station ID = 1E		
/A460F0	/A482F0	/AC60F0	/AC82F0	Station ID = 1F	/10F	(Unused; 10 bytes)

● Response buffer

In the information given below, the “Main module [N1]” stands for the IR.LINK module.

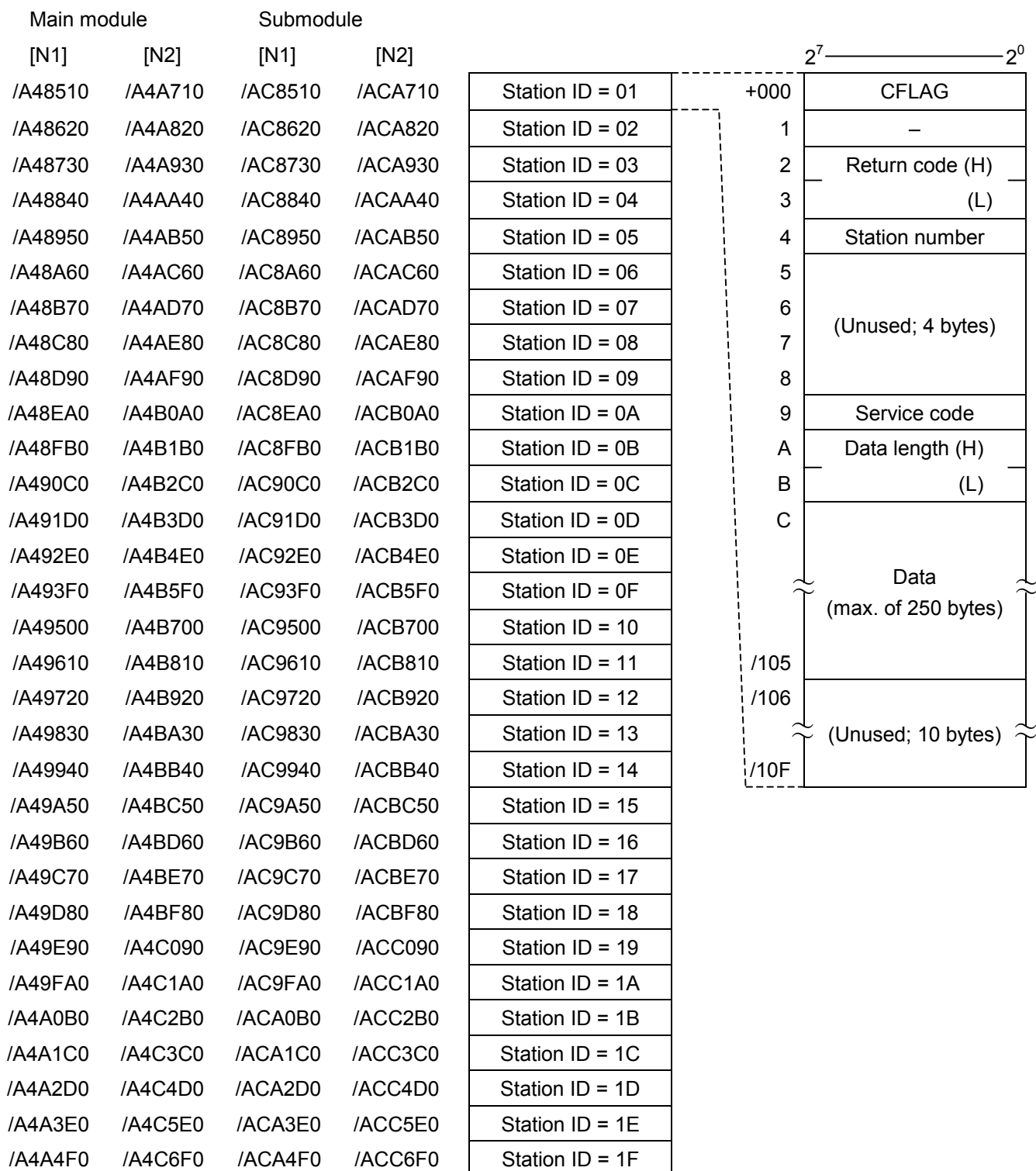

3 TECHNICAL SUPPORT INFORMATION

3.13.2 Data send and data receive buffers

- Data send buffer

In the information given below, the “Main module [N1]” stands for the IR.LINK module.

Main module		Submodule				2 ⁷ ————— 2 ⁰
[N1]	[N2]	[N1]	[N2]			
/A55220	/A59620	/AD5220	/AD9620	Station ID = 01	+000	Send data length (H)
/A55440	/A59840	/AD5440	/AD9840	Station ID = 02	1	(L)
/A55660	/A59A60	/AD5660	/AD9A60	Station ID = 03	2	Control flag (H)
/A55880	/A59C80	/AD5880	/AD9C80	Station ID = 04	3	(L)
/A55AA0	/A59EA0	/AD5AA0	/AD9EA0	Station ID = 05	4	Error code (H)
/A55CC0	/A5A0C0	/AD5CC0	/ADA0C0	Station ID = 06	5	(L)
/A55EE0	/A5A2E0	/AD5EE0	/ADA2E0	Station ID = 07	6	(Unused; 4 bytes)
/A56100	/A5A500	/AD6100	/ADA500	Station ID = 08	7	
/A56320	/A5A720	/AD6320	/ADA720	Station ID = 09	8	
/A56540	/A5A940	/AD6540	/ADA940	Station ID = 0A	9	
/A56760	/A5AB60	/AD6760	/ADAB60	Station ID = 0B	A	Data (max. of 512 bytes)
/A56980	/A5AD80	/AD6980	/ADAD80	Station ID = 0C		
/A56BA0	/A5AFA0	/AD6BA0	/ADAF A0	Station ID = 0D		
/A56DC0	/A5B1C0	/AD6DC0	/ADB1C0	Station ID = 0E		
/A56FE0	/A5B3E0	/AD6FE0	/ADB3E0	Station ID = 0F		
/A57200	/A5B600	/AD7200	/ADB600	Station ID = 10		
/A57420	/A5B820	/AD7420	/ADB820	Station ID = 11		
/A57640	/A5BA40	/AD7640	/ADBA40	Station ID = 12	/209	
/A57860	/A5BC60	/AD7860	/ADBC60	Station ID = 13	/20A	
/A57A80	/A5BE80	/AD7A80	/ADBE80	Station ID = 14		
/A57CA0	/A5C0A0	/AD7CA0	/ADC0A0	Station ID = 15		
/A57EC0	/A5C2C0	/AD7EC0	/ADC2C0	Station ID = 16		
/A580E0	/A5C4E0	/AD80E0	/ADC4E0	Station ID = 17		
/A58300	/A5C700	/AD8300	/ADC700	Station ID = 18		
/A58520	/A5C920	/AD8520	/ADC920	Station ID = 19		
/A58740	/A5CB40	/AD8740	/ADCB40	Station ID = 1A		
/A58960	/A5CD60	/AD8960	/ADCD60	Station ID = 1B		
/A58B80	/A5CF80	/AD8B80	/ADCF80	Station ID = 1C		
/A58DA0	/A5D1A0	/AD8DA0	/ADD1A0	Station ID = 1D		
/A58FC0	/A5D3C0	/AD8FC0	/ADD3C0	Station ID = 1E		
/A591E0	/A5D5E0	/AD91E0	/ADD5E0	Station ID = 1F	/21F	(Unused; 22 bytes)

● Data receive buffer

In the information given below, the “Main module [N1]” stands for the IR.LINK module.

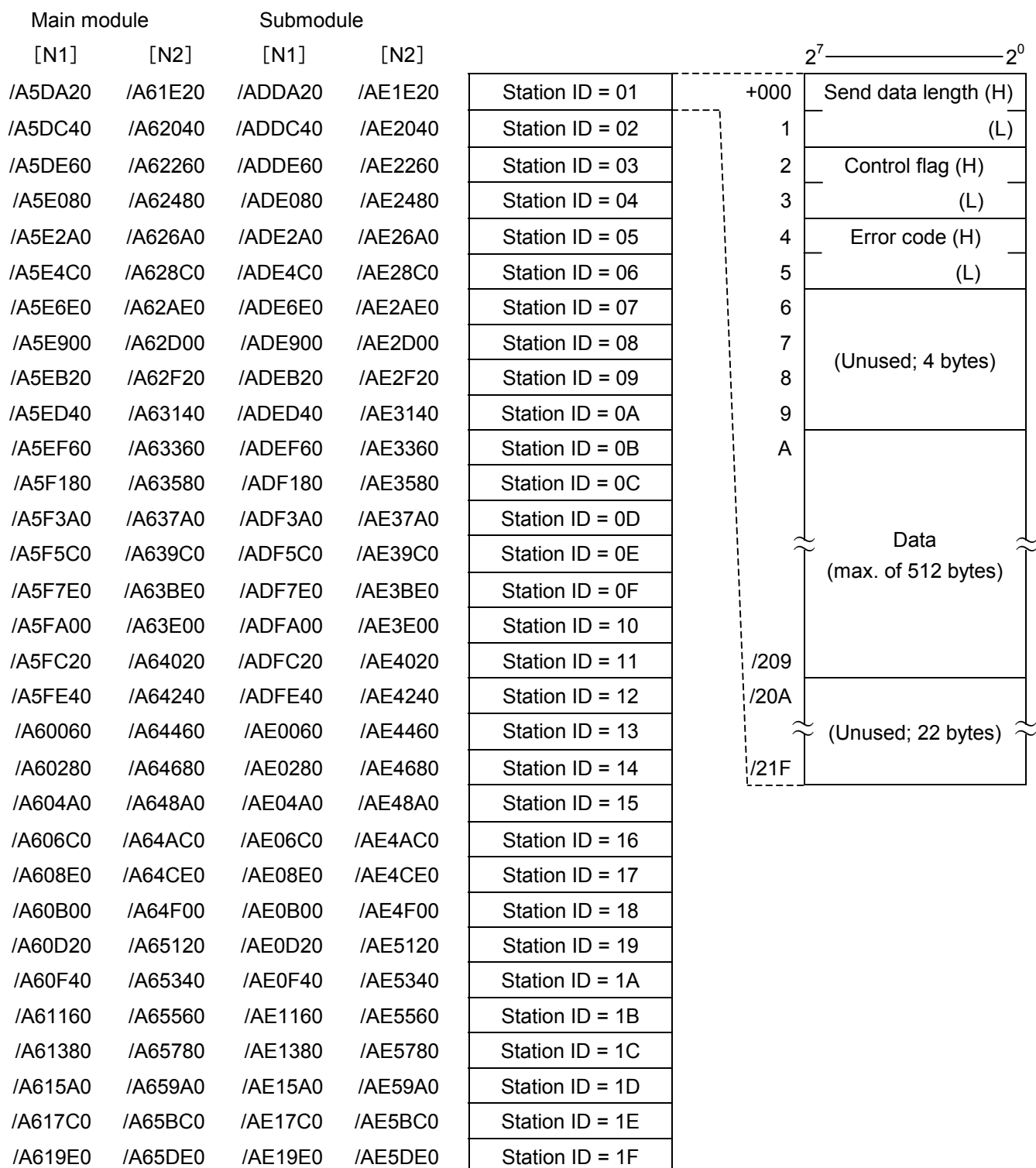

3 TECHNICAL SUPPORT INFORMATION

3.13.3 Error counters

Communication errors in the J.NET, J.NET-INT, and IR.LINK modules (master stations) and stations (slave stations) are counted in the counters shown below. These error counters are initialized when the controller is reset.

In the information given below, the “Main module [N1]” stands for the IR.LINK module.

Main module		Submodule				
[N1]	[N2]	[N1]	[N2]			
/A42000	/A42400	/AC2000	/AC2400	(At broadcast time)	+00	Transmitter underrun (TXUN)
/A42020	/A42420	/AC2020	/AC2420	Station ID = 01	02	CTS lost (TXCT)
/A42040	/A42440	/AC2040	/AC2440	Station ID = 02	04	Illegal frame length (RXLG)
/A42060	/A42460	/AC2060	/AC2460	Station ID = 03	06	Non-octet based frame (RXNO)
/A42080	/A42480	/AC2080	/AC2480	Station ID = 04	08	Abort sequence (RSAB)
/A420A0	/A424A0	/AC20A0	/AC24A0	Station ID = 05	0A	CRC error (RXCR)
/A420C0	/A424C0	/AC20C0	/AC24C0	Station ID = 06	0C	Overrun (RXOV)
/A420E0	/A424E0	/AC20E0	/AC24E0	Station ID = 07	0E	CD lost (RXCD)
/A42100	/A42500	/AC2100	/AC2500	Station ID = 08	10	Timeout (RXTO)
/A42120	/A42520	/AC2120	/AC2520	Station ID = 09	12	(Unused; 14 bytes)
/A42140	/A42540	/AC2140	/AC2540	Station ID = 0A	+1E	
/A42160	/A42560	/AC2160	/AC2560	Station ID = 0B		
/A42180	/A42580	/AC2180	/AC2580	Station ID = 0C		
/A421A0	/A425A0	/AC21A0	/AC25A0	Station ID = 0D		
/A421C0	/A425C0	/AC21C0	/AC25C0	Station ID = 0E		
/A421E0	/A425E0	/AC21E0	/AC25E0	Station ID = 0F		
/A42200	/A42600	/AC2200	/AC2600	Station ID = 10		
/A42220	/A42620	/AC2220	/AC2620	Station ID = 11		
/A42240	/A42640	/AC2240	/AC2640	Station ID = 12		
/A42260	/A42660	/AC2260	/AC2660	Station ID = 13		
/A42280	/A42680	/AC2280	/AC2680	Station ID = 14		
/A422A0	/A426A0	/AC22A0	/AC26A0	Station ID = 15		
/A422C0	/A426C0	/AC22C0	/AC26C0	Station ID = 16		
/A422E0	/A426E0	/AC22E0	/AC26E0	Station ID = 17		
/A42300	/A42700	/AC2300	/AC2700	Station ID = 18		
/A42320	/A42720	/AC2320	/AC2720	Station ID = 19		
/A42340	/A42740	/AC2340	/AC2740	Station ID = 1A		
/A42360	/A42760	/AC2360	/AC2760	Station ID = 1B		
/A42380	/A42780	/AC2380	/AC2780	Station ID = 1C		
/A423A0	/A427A0	/AC23A0	/AC27A0	Station ID = 1D		
/A423C0	/A427C0	/AC23C0	/AC27C0	Station ID = 1E		
/A423E0	/A427E0	/AC23E0	/AC27E0	Station ID = 1F		

3.13.4 Trace

The J.NET, J.NET-INT, and IR.LINK modules are capable of tracing the status of communication in respect to each network (N1 or N2). Tracing begins on the occurrence of an LPU reset or error stop mode (due to an error or tracing stop) following power-on and performs recording for transmissions and receptions in each service.

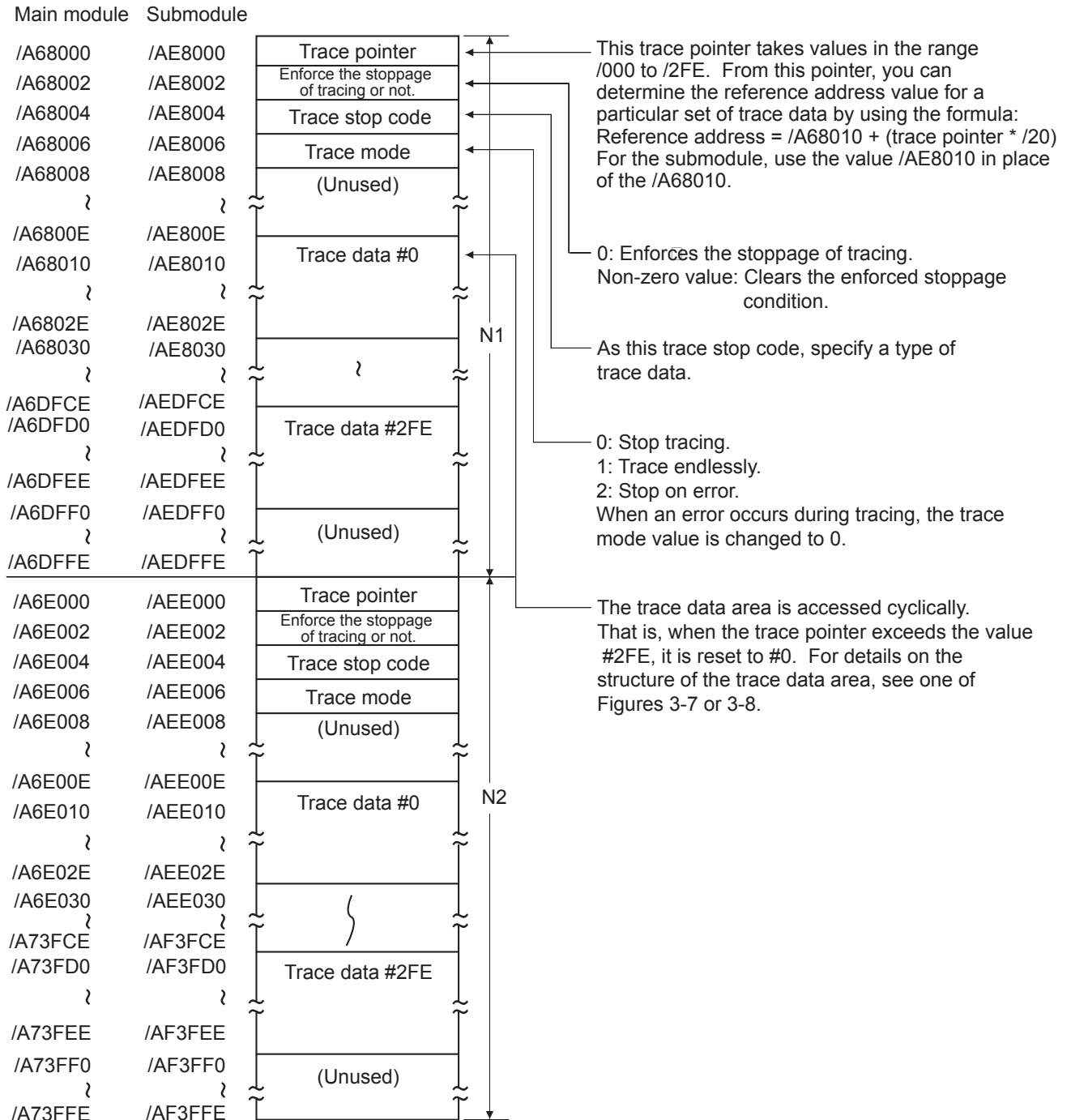

Figure 3-6 Trace Area Structure

3 TECHNICAL SUPPORT INFORMATION

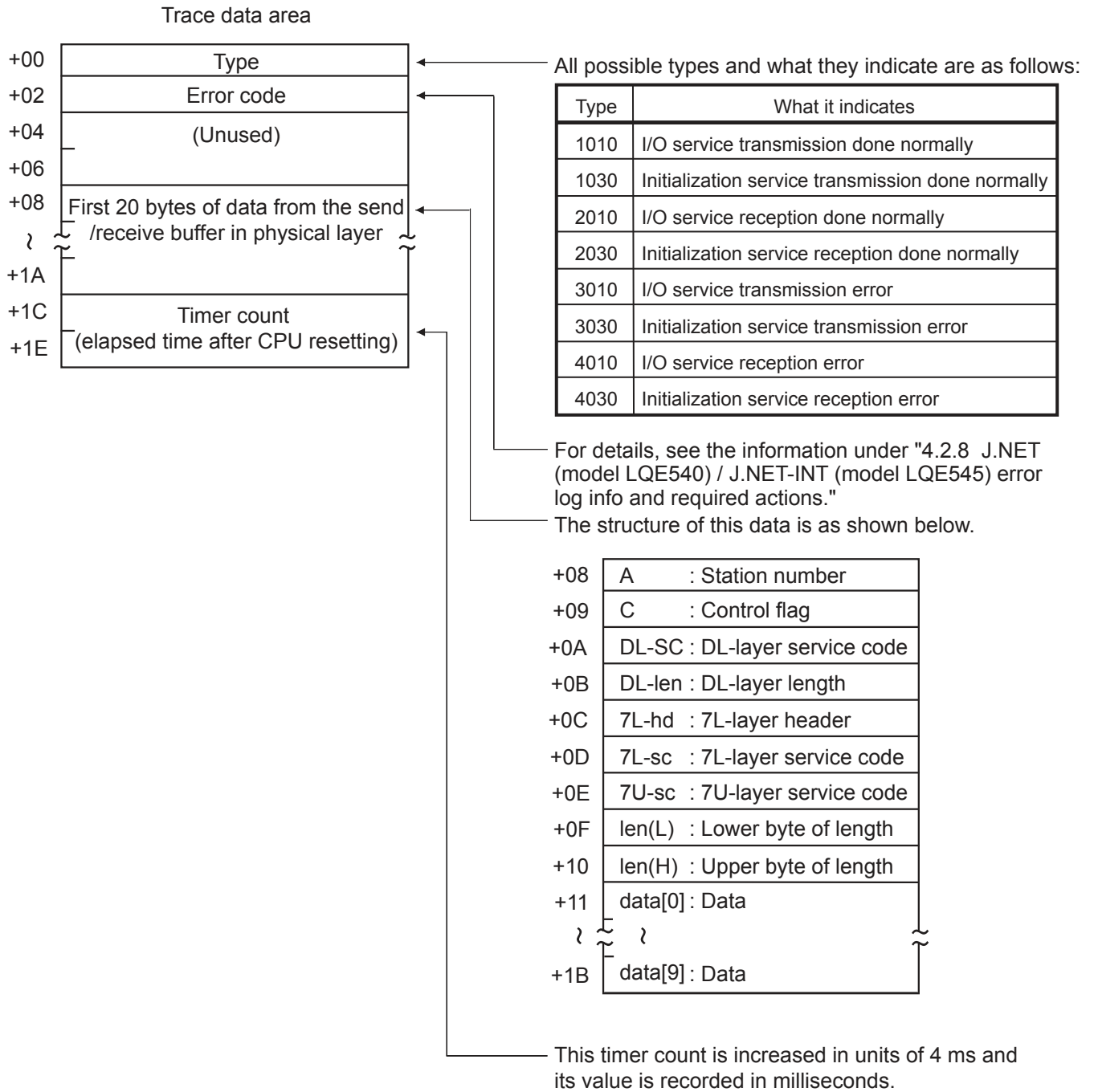

Figure 3-7 Trace Data Area Structure (for J.NET and J.NET-INT)

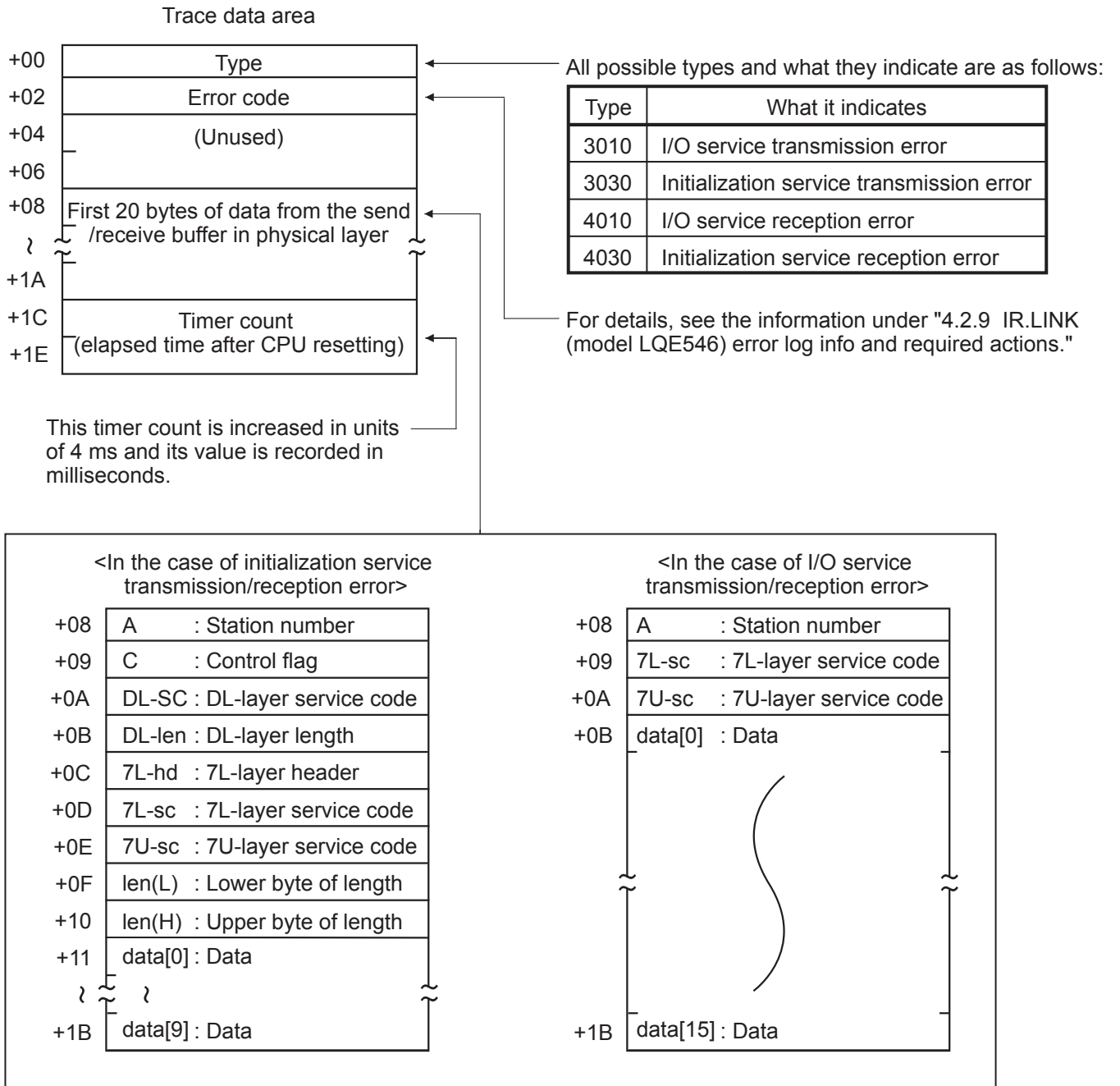

Figure 3-8 Trace Data Area Structure (for IR.LINK)

3.14 RS-232C (Model LQE560) and RS-422 (Model LQE565) Trace Information

3.14.1 Communication tracing

The RS-232C and RS-422 modules are capable of tracing communications and their details. By using this capability, you can generate trace data and use it for troubleshooting.

Table 3-9 Trace Buffer Structure (for Communication Tracing)

Channel				Format
0	1	2	3	2 ¹⁵ ... 2 ⁰
/F4E000	/F5E000	/F6E000	/F7E000	Trace pointer
/F4E002	/F5E002	/F6E002	/F7E002	Perform/Stop tracing
/F4E004	/F5E004	/F6E004	/F7E004	Type as stop condition
/F4E006	/F5E006	/F6E006	/F7E006	Trace mode
/F4E008 to /F4E01E	/F5E008 to /F5E01E	/F6E008 to /F6E01E	/F7E008 to /F7E01E	(Unused)
/F4E020 to /F4E03E	/F5E020 to /F5E03E	/F6E020 to /F6E03E	/F7E020 to /F7E03E	Trace data #0
/F4E040 to /F4E05E	/F5E040 to /F5E05E	/F6E040 to /F6E05E	/F7E040 to /F7E05E	Trace data #1
/F4FFE0 to /F4FFFE	/F5FFE0 to /F5FFFE	/F6FFE0 to /F6FFFE	/F7FFE0 to /F7FFFE	Trace data #254

- ① Trace pointer
This pointer points to the location in which to store trace data next. It contains a relative address value to the beginning of the trace buffer and is initialized to /20. The range of values it takes is from /20 to /1FE0.
- ② Perform/Stop tracing
This item is used to set one of the following directives to the tracing capability:
= 0: Stop tracing; ≠ 0: Perform tracing (defaulted to 1).
- ③ Type as stop condition
This item can be used to specify the same type as specified in the first word of a set of trace data. If it is specified, the tracing is stopped when an occurrence of the specified type is traced.
- ④ Trace mode
This item specifies one of the tracing modes:
= 0: Stop tracing; = 1: Trace endlessly; = 2: Stop on error (default); = 3: Stop when handler tracing is stopped.
- ⑤ Trace data
The trace data area is accessed cyclically. That is, when the trace pointer exceeds the value #254, it is reset to #0. (For details on the structure of the trace data area, see below.)

Table 3-10 Trace Data Area Details (for Communication Tracing)

Address	Format
/00	Type
/02	Control signal statuses
/04 /1A	Send/receive data (24 bytes)
/1C /1E	Elapsed time (ms) after resetting

① Type

This item indicates one of the following occurrences:

/1000: Transmission has been performed normally.

/2000: Reception has been performed normally.

/30**: Transmission has ended up with an error.

/40**: Reception has ended up with an error.

where ** is the lower byte of the error code.

② Control signal status

This item indicates the input or output statuses of the control signals, as shown below.

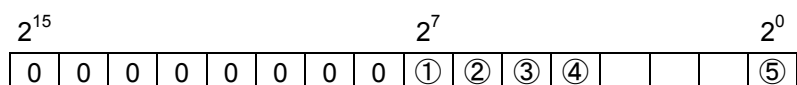

- | | |
|--------------------|---------------------------|
| ① RS output status | } 0: ON (*)
1: OFF (*) |
| ② CS input status | |
| ③ CD input status | |
| ④ ER output status | } 0: OFF (*)
1: ON (*) |
| ⑤ DR input status | |

(*) ON: Indicates that the communication line is in high level.

OFF: Indicates that the communication line is in low level.

3 TECHNICAL SUPPORT INFORMATION

3.14.2 Handler tracing

The RS-232C and RS-422 modules are capable of tracing the activation of handlers from applications and the response from the handlers thereafter.

Table 3-11 Trace Buffer Structure (for Handler Tracing)

Channel				Format
0	1	2	3	2 ¹⁵ ... 2 ⁰
/F4D000	/F5D000	/F6D000	/F7D000	Trace pointer
/F4D002	/F5D002	/F6D002	/F7D002	Perform/Stop tracing
/F4D004	/F5D004	/F6D004	/F7D004	Type as stop condition
/F4D006	/F5D006	/F6D006	/F7D006	Trace mode
/F4D008	/F5D008	/F6D008	/F7D008	(Unused)
/F4D010 to /F4D01E	/F5D010 to /F5D01E	/F6D010 to /F6D01E	/F7D010 to /F7D01E	Trace data #0
/F4D020 to /F4D02E	/F5D020 to /F5D02E	/F6D020 to /F6D02E	/F7D020 to /F7D02E	Trace data #1
/F4DFF0 to /F4DFFE	/F5DFF0 to /F5DFFE	/F6DFF0 to /F6DFFE	/F7DFF0 to /F7DFFE	Trace data #254

① Trace pointer

This pointer points to the location in which to store trace data next. It contains a relative address value to the beginning of the trace buffer and is initialized to /10. The range of values it takes is from /10 to /FF0.

② Perform/Stop tracing

This item is used to set one of the following directives to the tracing capability:
= 0: Stop tracing; ≠ 0: Perform tracing (defaulted to 1).

③ Type as stop condition

This item can be used to specify the same type as specified in the first word of a set of trace data. If it is specified, the tracing is stopped when an occurrence of the specified type is traced.

④ Trace mode

This item specifies one of the tracing modes:
= 0: Stop tracing; = 1: Trace endlessly; = 2: Stop on error (default); = 3: Stop when communication tracing is stopped.

⑤ Trace data

The trace data area is accessed cyclically. That is, when the trace pointer exceeds the value #254, it is reset to #0. (For details on the structure of the trace data area, see below.)

Table 3-12 Trace Data Area Details (for Handler Tracing)

Address	Format
/00	Type
/02	Error code
/04	Parameter 1
/06	
/08	Parameter 2
/0A	
/0C	Elapsed time (ms) after resetting
/0E	

① Type

This item indicates one of the following occurrences:

/8000: Transmission handler has been activated normally.

/9000: Reception handler has been activated normally.

/8800: Transmission handler has ended up with an error.

/9800: Reception handler has ended up with an error.

② Error code

This item contains an error code from the handler. For details, see the information under “4 ERROR LOG INFORMATION.”

③ Parameters 1, 2

Each of these items contains a parameter passed from the application to the handler.

3 TECHNICAL SUPPORT INFORMATION

3.14.3 H-7338 error tracing

The RS-232C and RS-422 modules are capable of tracing H-7338 communication errors and the communication data involved in H-7338 communications.

Table 3-13 Trace Buffer Structure (for H-7338 Error Tracing)

Channel				Format
0	1	2	3	2^{15} ... 2^0
/F48920	/F58920	/F68920	/F78920	Error trace case number
/F48922	/F58922	/F68922	/F78922	(Unused)
/F48940 to /F4895E	/F58940 to /F5895E	/F68940 to /F6895E	/F78940 to /F7895E	Trace data #0
/F48960 to /F4897E	/F58960 to /F5897E	/F68960 to /F6897E	/F78960 to /F7897E	Trace data #1
/F48AE0 to /F48AFE	/F58AE0 to /F58AFE	/F68AE0 to /F68AFE	/F78AE0 to /F78AFE	Trace data #13

① Error trace case number

This item is a case number for which to write trace data to the associated trace area next. (This item is initialized to /0, and the range of values it takes is from /0 to /0D.)

② Trace data

The trace data area is accessed cyclically. That is, when the error trace case number exceeds #13, it is reset to #0. (For details on the structure of the trace data area, see below.)

Table 3-14 Trace Data Area Details (for H-7338 Error Tracing)

Address	Format
/00	Error code
/04	Command code
/08	Parameter 1
/0C	Parameter 2
/10	Parameter 3
/14	Parameter 4
/18	Elapsed time (ms) after resetting
/1C	(Unused)

① Error code

This item identifies a reported command or communication line error.

Table 3-15 Error Codes in H-7338 Error Trace Information

Error code	Meaning	Required action
/00000001	No delimiting space character is detected between parameters.	Check the destination's device settings.
/00000002	A parameter whose set value is outside the permitted range is detected.	
/00000101	Reception parity error	Check the destination's device settings. Check, also, if the cable is broken or there is any noise source near the laid cable.
/00000102	Reception overrun error	
/00000103	Reception framing error	
/00000104	Reception noise error	

② Command code

This item identifies the command that has been issued for H-7338 communication.

③ Parameters 1 thru 4

Each of these parameters is one that has been provided for H-7338 communication.

3 TECHNICAL SUPPORT INFORMATION

3.14.4 Error counters

The RS-232C and RS-422 modules are provided with error counters to count communication errors. These error counters are initialized when the controller is reset.

Table 3-16 Error Counters

Channel				Format
0	1	2	3	2^{15} ... 2^0
/F48900	/F58900	/F68900	/F78900	Transmission done normally
/F48902	/F58902	/F68902	/F78902	CS lost during transmission
/F48904	/F58904	/F68904	/F78904	Temporarily stopped transmission timed out
/F48906	/F58906	/F68906	/F78906	Reception done normally
/F48908	/F58908	/F68908	/F78908	Reception overrun error
/F4890A	/F5890A	/F6890A	/F7890A	CD lost during reception
/F4890C	/F5890C	/F6890C	/F7890C	Reception framing error
/F4890E	/F5890E	/F6890E	/F7890E	Reception parity error
/F48910	/F58910	/F68910	/F78910	Reception noise error
/F48912	/F58912	/F68912	/F78912	Break sequence received
/F48914	/F58914	/F68914	/F78914	Reception monitoring timeout error
/F48916	/F58916	/F68916	/F78916	Received-data discard counter
/F48918 to /F4891E	/F58918 to /F5891E	/F68918 to /F6891E	/F78918 to /F7891E	(Unused)

3.15 D.NET (Model LQE570/575) Statistical and Error Information

- Statistical information

Each unit of statistical information is 2 bytes long, and each counter takes values in the range 0 to 0xFFFF cyclically, i.e., when it exceeds the value 0xFFFF, it is reset to 0 and goes on counting.

(1) Event buffer usage rate counts (provided for future extension)

0xE*7200	Event queue overflow detection count	*=3 (channel 0)
0xE*7202	Event queue buffer current use count	7 (channel 1)
0xE*7204	Event queue buffer peak use count	B (channel 0)
0xE*7206	Event queue overflow detection count	F (channel 0)
0xE*7208	Event queue buffer current use count	
0xE*720A	Event queue buffer peak use count	
0xE*720C	Event queue overflow detection count	
0xE*720E	Event queue buffer current use count	
0xE*7210	Event queue buffer peak use count	
0xE*7212	Reserved for future extension	
0xE*721E		

(2) Data buffer usage rate counts

0xE*7220	Transmission buffer overflow detection count	*=3 (channel 0)
0xE*7222	Transmission buffer current use count	7 (channel 1)
0xE*7224	Transmission buffer peak use count	B (channel 0)
0xE*7226	Reception buffer overflow detection count	F (channel 0)
0xE*7228	Reception buffer current use count	
0xE*722A	Reception buffer peak use count	
0xE*722C	System reception buffer overflow detection count	
0xE*722E	System reception buffer current use count	
0xE*7230	System reception buffer peak use count	
0xE*7232	Reserved for future extension	
0xE*723E		

3 TECHNICAL SUPPORT INFORMATION

(3) CAN control counts

0xE*7240	Stack error detection count	*=3 (channel 0) 7 (channel 1) B (channel 0) F (channel 0)
0xE*7242	Form error detection count	
0xE*7244	Ack. error detection count	
0xE*7246	Bit-1 error detection count	
0xE*7248	Bit-0 error detection count	
0xE*724A	CRC error detection count	
0xE*724C	CAN error overcount detection count	
0xE*724E	Transmission path bus-OFF detection count	
0xE*7250	Transmission path bus-OFF recovery count	
0xE*7252	CAN invalid-interrupt count	
0xE*7254	Remote frame-reception detection count	
0xE*7256	CAN chip error passive-condition occurrence count	
0xE*7258	REC count-up detection count	
0xE*725A	TEC count-up detection count	
0xE*725C	HCAN reset completion wait retry count	
0xE*725E	HCAN initialization completion wait retry count	

(4) Activity information counts

0xE*7260	Transmission completion count	*=3 (channel 0) 7 (channel 1) B (channel 0) F (channel 0)
0xE*7262	Reception completion count	
0xE*7264	Successful I/O data read count	
0xE*7266	Successful I/O data write count	
0xE*7268	Command request acceptance count	
0xE*726A	Command acceptance completion report count	
0xE*726C	Command response report count	
0xE*726E	Service request acceptance count	
0xE*7270	Open acceptance count	
0xE*7272	Close acceptance count	
0xE*7274	Explicit acceptance count	
0xE*7276	Service acceptance completion report count	
0xE*7278	Service response report count	
0xE*727A	System message report count	
0xE*727C	AI report count	
0xE*727E	Successful I/O data high-speed write count	

(5) User error 1 counts

0xE*7280	Unsuccessful I/O data read count	*=3 (channel 0) 7 (channel 1) B (channel 0) F (channel 0)
0xE*7282	Unsuccessful I/O data write count (unused)	
0xE*7284	Effective data length error detection count	
0xE*7286	Service double-start detection count	
0xE*7288	Open double-start detection count	
0xE*728A	Open issuance destination error detection count	
0xE*728C	Close issuance destination error detection count	
0xE*728E	MACID error detection count	
0xE*7290	Service issuance status error detection count	
0xE*7292	Service acceptance failure detection count	
0xE*7294	Service start failure detection count	
0xE*7296	UCMM start failure detection count	
0xE*7298	Fragmentation Ack timeout detection count for clients	
0xE*729A	Fragmentation Ack timeout detection count for servers	
0xE*729C	Fragmentation transmission data excessive length detection count for clients	
0xE*729E	Fragmentation transmission data excessive length detection count for servers	

(6) User error 2 counts

0xE*72A0	Transmission connection error detection count for clients	*=3 (channel 0) 7 (channel 1) B (channel 0) F (channel 0)
0xE*72A2	Transmission connection error detection count for servers	
0xE*72A4	Explicit connection timeout detection count for clients	
0xE*72A6	Explicit connection timeout detection count for servers	
0xE*72A8	CAN transmission timeout detection count	
0xE*72AA	Explicit frame cancel detection count (CAN transmission timeout)	
0xE*72AC	Transmission frame cancel count (NetStatus inconsistency)	
0xE*72AE	Reception frame cancel count (NetStatus inconsistency)	
0xE*72B0	User suppression occurrence count	
0xE*72B2	Reception protocol error count for clients	
0xE*72B4	Reception protocol error count for servers	
0xE*72B6	Transmission connection error detection count for I/O	
0xE*72B8	Reception connection error detection count for I/O	
0xE*72BA	Transmission connection error detection count for UCMM	
0xE*72BC	Transmission protocol error detection count for UCMM	
0xE*72BE	I/O connection timeout detection count	

3 TECHNICAL SUPPORT INFORMATION

(7) System error counts

0xE*72C0	Service double-start detection count (TI wait)	*=3 (channel 0)
0xE*72C0	Service acceptance completion buffer-busy detection count	7 (channel 1)
0xE*72C0	Service response queue-busy detection count	B (channel 0)
0xE*72C0	Service response report wait detection count	F (channel 0)
0xE*72C0	System message queue-busy detection count	
0xE*72C0	System message buffer-busy detection count	
0xE*72C0	AI queue-busy detection count	
0xE*72C0	AI buffer-busy detection count	
0xE*72D0	Exclusive allocation failure detection count for io_Write	
0xE*72D0	Exclusive allocation failure detection count for io_Read	
0xE*72D0	Mismatched fragmentation reception count (for I/O)	
0xE*72D0	Abnormal fragmentation reception count (for I/O)	
0xE*72D0	Excessive data volume detection count (for I/O)	
0xE*72D0	CPU monitoring timeout detection count	
0xE*72D0	CPU monitoring timeout recovery detection count	
0xE*72D0	Reserved for future extension	

(8) User error 3 counts

0xE*72E0	IoSeq frame cancel count (CAN transmission timeout)	*=3 (channel 0)
0xE*72E2	IoSeq reception report queue-busy detection count	7 (channel 1)
0xE*72E4	IoSeq reception report wait detection count	B (channel 0)
0xE*72E6	IoSeq transmission double-start detection count (TI wait)	F (channel 0)
0xE*72E8	IoSeq transmission acceptance completion buffer-busy detection count	
0xE*72EA	Reception protocol error detection count (for proxies)	
0xE*72EC	Explicit transmission right acquisition failure detection count for user/master start	
0xE*72EE	Explicit transmission right acquisition failure detection count for proxy start	
0xE*72F0	Reserved for future extension	
0xE*72FE		

● Trace information

(1) Normal trace table structure

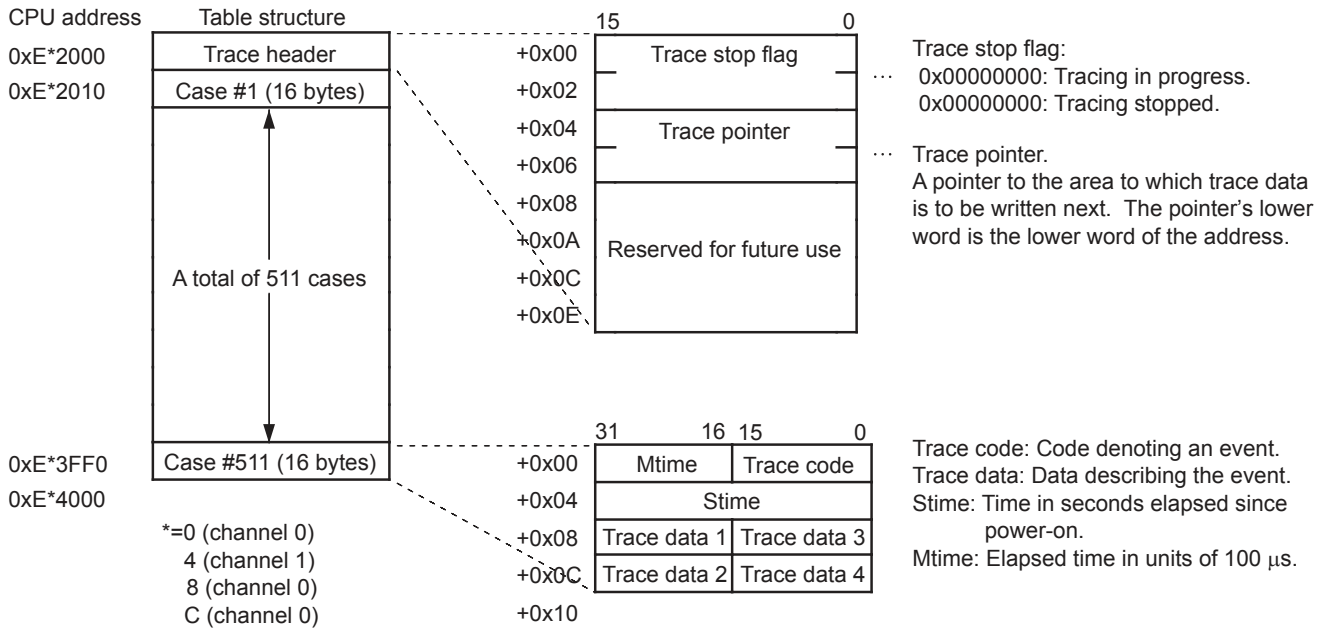

(2) Special trace table structure

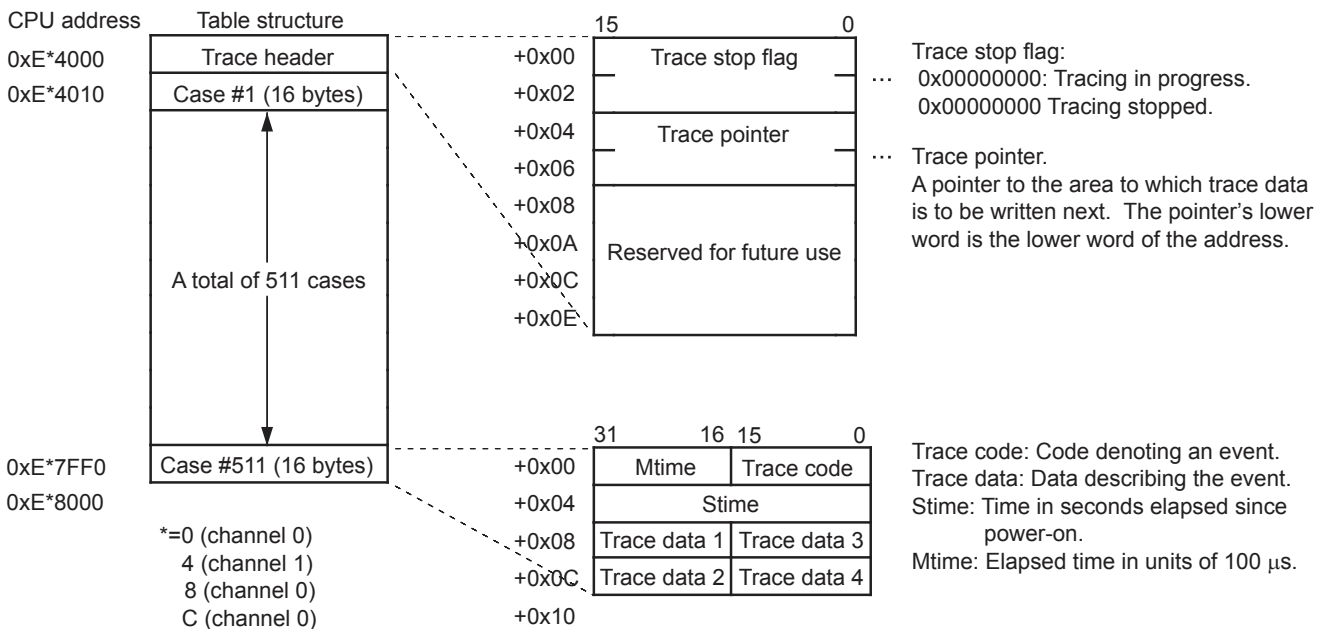

3 TECHNICAL SUPPORT INFORMATION

(3) Trace information list

Message Router Object

No.	Trace name	Trace code	Type	Trace data [0]		Trace data [1]		Trace data [2]		Trace data [3]		AI report	Log name
				Reception In	ClassID	Local station MACID	Service code	ClassID	InstanceID	Received data [0]	Received data [1]		
1	In a command reception, the specified class ID was out of range.	0x2001	0	0		Received CANID (*)	0	0		0	0		
2	In a request reception, the specified class ID was out of range.	0x2002	0	ClassID		Received CANID (*)	0	0		0	0		
3	Error response transmission buffer acquisition was not successful.	0x2003	0	Reception In		0	Remote station MACID	0x94	Gen_Err	Add_Err			

DeviceNet Object

No.	Trace name	Trace code	Type	Trace data [0]	Trace data [1]	Trace data [2]	Trace data [3]	AI report	Log name
1	Bus-OFF retry limit exceeded (special).	0x3000	1	Retry counter	0	0	0		

Master Object

No.	Trace name	Trace code	Type	Trace data [0]	Trace data [1]	Trace data [2]	Trace data [3]	AI report	Log name
1	The connection establishment process was ended normally.	0x6010	0	Remote station MACID	Issued command code	Slave management information	0	-	-
2	The connection establishment process was ended abnormally (send-buffer acquisition failed).	0x6020	1	Remote station MACID	Issued command code	Slave management information	0	-	-
3	The connection establishment process was ended abnormally (error response received).	0x6021	1	Remote station MACID	Issued command code	Slave management information	Gen_Err	Add_Err	-
4	The connection establishment process was ended abnormally (response timed out).	0x6022	1	Remote station MACID	Issued command code	Slave management information	0	-	-
5	The connection establishment process was abnormal (data length improper).	0x6023	0	Remote station MACID	Issued command code	Slave management information	0	-	-
6	The connection establishment process was ended abnormal (service code improper).	0x6024	0	Remote station MACID	Issued command code	Slave management information	0	-	-
7	The connection establishment process was ended abnormally (connection size mismatch).	0x6025	1	Remote station MACID	Slave management information	ProducedConnectionSize	ConsumedConnectionSize	-	-
8	A response was received in the connection establishment process.	0x6030	0	Remote station MACID	Slave management information	Data section [0][1]	Data section [2][3]	-	-
9	The connection establishment process was ended abnormal (response timed out).	0x6040	0	Remote station MACID	0	Slave management information	0	-	-
10	The connection establishment process was ended abnormal (data length or service code improper).	0x6041	0	Remote station MACID	Issued command code	Slave management information	Data section [0][1]	-	-

Type:

0 = Normal trace.

1 = Special trace.

(*) A byte-swapped value is set.

Event Object

No.	Trace name	Trace code	Type	Trace data [0]		Trace data [1]		Trace data [2]	Trace data [3]	AI report	Log name
				Data length of detailed data section	TV flag	Specified MACID	Service code				
1	A command was received.	0x8010	0	0	0			Detailed data section 1	Detailed data section 2		com_accept
2	Command TI report	0x8020	0	0		Error code		Error data	0		com_ti_rpt
3	A command double-start was attempted.	0x8011	0	TV flag		RV flag		"Busy" flag	0		ser_dup
4	Command response report.	0x8030	0	Data length of detailed data section		Specified MACID	Service code	Detailed data section 1	Detailed data section 2		com_rsp_rpt
5	AI report	0x8040	0	System Msg code, data size		Error code	Error code	Error data	0		ai_rpt
6	The AI report queue table was full.	0x8041	0	0		Error code	Error code	Error data	0		ai_que_busy
7	An AI report was awaited (AI report buffer full or TI not reported yet).	0x8042	0	System message buffer PP/CP		Error code	Error code	Error data	"Busy" flag		ai_wait

µOS link function

No.	Trace name	Trace code	Type	Trace data [0]	Trace data [1]	Trace data [2]	Trace data [3]	AI report	Log name
1	Error stop	0xf000	0	Error code	0	0	0		com_accept

Type:

- 0 = Normal trace.
- 1 = Special trace.

3 TECHNICAL SUPPORT INFORMATION

Connection Object

No.	C	S	Trace name	Trace code	Type	Trace data [0]	Trace data [1]	Trace data [2]	Trace data [3]	AI report	Log name
1	✓	✓	An Explicit transmission was accepted.	0x4001	0	InstanceID Transmission In	0	Transmitted data[0] Transmitted data[1] Transmitted data[2] Transmitted data[3]	Received data[0] Received data[1] Received data[2] Received data[3]		
2	✓	✓	An Explicit reception was accepted.	0x4002	0	InstanceID Reception In	Received CANID (*)	Received data[0] Received data[1] Received data[2] Received data[3]	Received data[0] Received data[1] Received data[2] Received data[3]		
3	✓	✓	Transmission was unachievable (the connection status was other than "Established" [starting source: IFO]).	0x4101	1	InstanceID state	0	Transmitted data[0] Transmitted data[1] Transmitted data[2] Transmitted data[3]	Received data[0] Received data[1] Received data[2] Received data[3]	0x7105	send_err_client
4	✓	✓	Transmission was unachievable (the connection status was other than "Established" [starting source: MO]).	0x4102	1	InstanceID state	0	Transmitted data[0] Transmitted data[1] Transmitted data[2] Transmitted data[3]	Received data[0] Received data[1] Received data[2] Received data[3]		send_err_client
5	✓	✓	Transmission was unachievable (the connection status was other than "Established").	0x4103	0	InstanceID state	0	Transmitted data[0] Transmitted data[1] Transmitted data[2] Transmitted data[3]	Received data[0] Received data[1] Received data[2] Received data[3]		send_err_server
6	✓	✓	Transmission was unachievable (the instance type was I/O).	0x4104	0	InstanceID Instance type	0	Transmitted data[0] Transmitted data[1] Transmitted data[2] Transmitted data[3]	Received data[0] Received data[1] Received data[2] Received data[3]		send_err_server
7	✓	✓	Transmission was unachievable (the transmission buffer destination MACID did not match the MACID of the connection destination).	0x4105	0	InstanceID Remote station MACID	0	Transmitted data[0] Transmitted data[1] Transmitted data[2] Transmitted data[3]	Received data[0] Received data[1] Received data[2] Received data[3]		send_err_server
8	✓	✓	Transmission was unachievable (the server process was not being performed).	0x4106	0	InstanceID Remote station MACID	0	Transmitted data[0] Transmitted data[1] Transmitted data[2] Transmitted data[3]	Received data[0] Received data[1] Received data[2] Received data[3]		send_err_server
9	✓	✓	Transmission was unachievable (a transmission double-start was attempted [starting source: IFO]).	0x4107	1	InstanceID Remote station MACID	0	Transmitted data[0] Transmitted data[1] Transmitted data[2] Transmitted data[3]	Received data[0] Received data[1] Received data[2] Received data[3]	0x5102	ser_dup
10	✓	✓	Transmission was unachievable (a transmission double-start was attempted [starting source: MO]).	0x4108	1	InstanceID Remote station MACID	0	Transmitted data[0] Transmitted data[1] Transmitted data[2] Transmitted data[3]	Received data[0] Received data[1] Received data[2] Received data[3]		ser_dup_client
11	✓	✓	A reception was canceled (the effective data length of one frame was 0 or 1 byte).	0x4201	1	InstanceID Reception In	Received CANID (*)	Received data[0] Received data[1] Received data[2] Received data[3]	Received data[0] Received data[1] Received data[2] Received data[3]		prot_err_client
12	✓	✓	A reception was canceled (the effective data length of one frame was 0 or 1 byte).	0x4202	1	InstanceID Reception In	Received CANID (*)	Received data[0] Received data[1] Received data[2] Received data[3]	Received data[0] Received data[1] Received data[2] Received data[3]		prot_err_server
13	✓	✓	A reception was canceled (the fragmented effective data of received response was 0 bytes [there was no data before ServiceCode]).	0x4203	1	InstanceID Remote station MACID	Received data cumulative length	0	0		prot_err_client
14	✓	✓	A reception was canceled (the fragmented effective data of received request was 0 bytes [there was no data before ServiceCode]).	0x4204	1	InstanceID Remote station MACID	Received data cumulative length	0	0		prot_err_server
15	✓	✓	A reception was canceled (the fragmented effective data of received request was 1 or 2 bytes [there was no data before InstanceID]).	0x4205	1	InstanceID Remote station MACID	Received data cumulative length	0	0		prot_err_server
16	✓	✓	A reception was canceled (a 2-byte non-fragmented request was received [there was no data before InstanceID]).	0x4206	1	InstanceID Reception In	Received CANID (*)	Received data[0] Received data[1] Received data[2] Received data[3]	Received data[0] Received data[1] Received data[2] Received data[3]		prot_err_server
17	✓	✓	A reception was canceled (the cumulative length of received fragmented data exceeded 71 bytes).	0x4207	1	InstanceID Reception In	Received data cumulative length	Received data[0] Received data[1] Received data[2] Received data[3]	Received data[0] Received data[1] Received data[2] Received data[3]		prot_err_client
18	✓	✓	A reception was canceled (the cumulative length of received fragmented data exceeded 71 bytes).	0x4208	1	InstanceID Reception In	Received data cumulative length	Received data[0] Received data[1] Received data[2] Received data[3]	Received data[0] Received data[1] Received data[2] Received data[3]		prot_err_server
19	✓	✓	A reception was canceled (a request was received in a fragmentation transmission to a client).	0x4209	1	InstanceID Reception In	Received CANID (*)	Received data[0] Received data[1] Received data[2] Received data[3]	Received data[0] Received data[1] Received data[2] Received data[3]		prot_err_client
20	✓	✓	A reception was canceled (a response was received in a fragmentation transmission to a server).	0x420A	1	InstanceID Reception In	Received CANID (*)	Received data[0] Received data[1] Received data[2] Received data[3]	Received data[0] Received data[1] Received data[2] Received data[3]		prot_err_server
21	✓	✓	A reception was canceled (a request was received in a non-fragmentation transmission to a client port).	0x420B	1	InstanceID Reception In	Received CANID (*)	Received data[0] Received data[1] Received data[2] Received data[3]	Received data[0] Received data[1] Received data[2] Received data[3]		prot_err_client
22	✓	✓	A reception was canceled (a response was received in a non-fragmentation transmission to a server port).	0x420C	1	InstanceID Reception In	Received CANID (*)	Received data[0] Received data[1] Received data[2] Received data[3]	Received data[0] Received data[1] Received data[2] Received data[3]		prot_err_server
23	✓	✓	A reception was canceled (fragmented data was received with FragCnt ≠ 0 when Type = beginning).	0x420D	1	InstanceID Reception In	Received CANID (*)	Received data[0] Received data[1] Received data[2] Received data[3]	Received data[0] Received data[1] Received data[2] Received data[3]		prot_err_client
24	✓	✓	A reception was canceled (fragmented data was received with FragCnt ≠ 0 when Type = beginning).	0x420E	1	InstanceID Reception In	Received CANID (*)	Received data[0] Received data[1] Received data[2] Received data[3]	Received data[0] Received data[1] Received data[2] Received data[3]		prot_err_server
25	✓	✓	A reception was canceled (fragmented data whose type was other than the beginning was received in a wait for the beginning).	0x420F	0	InstanceID Reception In	Received CANID (*)	Received data[0] Received data[1] Received data[2] Received data[3]	Received data[0] Received data[1] Received data[2] Received data[3]		prot_err_client

C: Client.

S: Server.

✓: Applicable.

(*) A byte-swapped value is set.

No.	C	S	Trace name	Trace code	Type	Trace data [0]		Trace data [1]		Trace data [2]			Trace data [3]			AI report	Log name
26	✓		A reception was canceled (fragmented data whose type was other than the beginning was received in a wait for the beginning).	0x4210	0	InstanceID	Reception In	Received CANID (*)	Received data[0]	Received data[1]	Received data[2]	Received data[3]			prot_err_server		
27	✓		A reception was canceled (fragmented data having an abnormal FragmentCount was received in a wait for the next Frag).	0x4211	1	InstanceID	Reception In	Received CANID (*)	Received data[0]	Received data[1]	Received data[2]	Received data[3]			prot_err_client		
28	✓		A reception was canceled (fragmented data having an abnormal FragmentCount was received in a wait for the next Frag).	0x4212	1	InstanceID	Reception In	Received CANID (*)	Received data[0]	Received data[1]	Received data[2]	Received data[3]			prot_err_server		
29	✓		A reception was canceled (the beginning was received in a wait for the next Frag (processing was continued with this situation handled as the reception of the beginning)).	0x4213	0	InstanceID	Received number	Received CANID (*)	Received data[0]	Received data[1]	Received data[2]	Received data[3]			prot_err_client		
30	✓		A reception was canceled (the beginning was received in a wait for the next Frag (processing was continued with this situation handled as the reception of the beginning)).	0x4214	0	InstanceID	Received number	Received CANID (*)	Received data[0]	Received data[1]	Received data[2]	Received data[3]			prot_err_server		
31	✓		A reception was canceled (fragmented data whose count was not 0 was received in the reception of the beginning in a wait for the next Frag).	0x4215	0	InstanceID	Reception In	Received CANID (*)	Received data[0]	Received data[1]	Received data[2]	Received data[3]			prot_err_client		
32	✓		A reception was canceled (fragmented data whose count was not 0 was received in the reception of the beginning in a wait for the next Frag).	0x4216	0	InstanceID	Reception In	Received CANID (*)	Received data[0]	Received data[1]	Received data[2]	Received data[3]			prot_err_server		
33	✓		A reception was canceled (the FragType was changed to "last" in a retry operation).	0x4217	0	InstanceID	Reception In	Received CANID (*)	Received data[0]	Received data[1]	Received data[2]	Received data[3]			prot_err_client		
34	✓		A reception was canceled (the FragType was changed to "last" in a retry operation).	0x4218	0	InstanceID	Reception In	Received CANID (*)	Received data[0]	Received data[1]	Received data[2]	Received data[3]			prot_err_server		
35	✓		A reception was canceled (a response was received although a request was not transmitted [Fragment]).	0x4219	1	InstanceID	Reception In	Received CANID (*)	Received data[0]	Received data[1]	Received data[2]	Received data[3]			prot_err_client		
36	✓		A reception was canceled (a response was received although a request was not transmitted [Non-Fragment]).	0x421A	1	InstanceID	Reception In	Received CANID (*)	Received data[0]	Received data[1]	Received data[2]	Received data[3]			prot_err_server		
37	✓		A reception was canceled (a server reception occurred during a server reception process [Fragment]).	0x421B	0	InstanceID	Reception In	Received CANID (*)	Received data[0]	Received data[1]	Received data[2]	Received data[3]			prot_err_client		
38	✓		A reception was canceled (a server reception occurred during a server reception process [Non-Fragment]).	0x421C	0	InstanceID	Reception In	Received CANID (*)	Received data[0]	Received data[1]	Received data[2]	Received data[3]			prot_err_server		
39	✓		A reception was canceled (the received CANID did not match the Instance reception CANID).	0x421D	0	InstanceID	Remote station MACID	Received CANID (*)	Received data[0]	Received data[1]	Received data[2]	Received data[3]			prot_err_client		
40	✓		A reception was canceled (the received CANID did not match the Instance reception CANID).	0x421E	0	InstanceID	Remote station MACID	Received CANID (*)	Received data[0]	Received data[1]	Received data[2]	Received data[3]			prot_err_server		
41	✓		A reception was canceled (the connection status was other than "Established").	0x421F	0	InstanceID	state	Received CANID (*)	Received data[0]	Received data[1]	Received data[2]	Received data[3]			prot_err_client		
42	✓		A reception was canceled (the connection status was other than "Established").	0x4220	0	InstanceID	state	Received CANID (*)	Received data[0]	Received data[1]	Received data[2]	Received data[3]			prot_err_server		
43	✓		A reception was canceled (InstanceType was I/O).	0x4221	0	InstanceID	Reception In	Received CANID (*)	Received data[0]	Received data[1]	Received data[2]	Received data[3]			prot_err_server		
44	✓		A reception was canceled (the Explicit port of Group 2 server received data from other than the master).	0x4222	0	InstanceID	Reception In	Received CANID (*)	Received data[0]	Received data[1]	Received data[2]	Received data[3]			prot_err_server		
45	✓		A reception was canceled during a hold (non-fragmented data was received during a fragmentation reception [processing was continued]).	0x4301	0	InstanceID	Reception In	Received CANID (*)	Received data[0]	Received data[1]	Received data[2]	Received data[3]			prot_err_client		
46	✓		A reception was canceled during a hold (non-fragmented data was received during a fragmentation reception [processing was continued]).	0x4302	0	InstanceID	Reception In	Received CANID (*)	Received data[0]	Received data[1]	Received data[2]	Received data[3]			prot_err_server		
47	✓		An Ack reception was canceled (the received Ack data length was abnormal).	0x4401	0	InstanceID	Reception In	Received CANID (*)	Received data[0]	Received data[1]	Received data[2]	Received data[3]			prot_err_client		
48	✓		An Ack reception was canceled (the received Ack data length was abnormal).	0x4402	0	InstanceID	Reception In	Received CANID (*)	Received data[0]	Received data[1]	Received data[2]	Received data[3]			prot_err_server		
49	✓		An Ack reception was canceled (the received Ack sequence number did not agree with the Ack sequence number whose reception was awaited).	0x4403	0	InstanceID	Remote station MACID	Ack number for the next reception awaited	Received data[0]	Received data[1]	Received data[2]	Received data[3]			prot_err_client		

(*) A byte-swapped value is set.

3 TECHNICAL SUPPORT INFORMATION

No.	C	S	Trace name	Trace code	Type	Trace data [0]	Trace data [1]	Trace data [2]	Trace data [3]	AI report	Log name
50	✓		An Ack reception was canceled (the received Ack sequence number did not agree with the Ack sequence number whose reception was awaited).	0x4404	0	InstanceID Remote station MACID	Ack number for the next reception awaited	Received data[0] Received data[1]	Received data[2] Received data[3]		prot_err_server
51	✓		An Ack reception was canceled (Ack was received while no fragmentation transmission was performed).	0x4405	0	InstanceID Reception In	Received CANID (*)	Received data[0] Received data[1]	Received data[2] Received data[3]		prot_err_client
52	✓		An Ack reception was canceled (Ack was received while no fragmentation transmission was performed).	0x4406	0	InstanceID Reception In	Received CANID (*)	Received data[0] Received data[1]	Received data[2] Received data[3]		prot_err_server
53	✓		Transmission was unachievable (the received Ack status was abnormal).	0x4501	0	InstanceID Reception In	Received CANID (*)	Received data[0] Received data[1]	Received data[2] Received data[3]	0x7103	ack_sts1_client
54	✓		Transmission was unachievable (the received Ack status was abnormal).	0x4502	0	InstanceID Reception In	Received CANID (*)	Received data[0] Received data[1]	Received data[2] Received data[3]		ack_sts1_server
55	✓		Transmission was unachievable (fragmentation transmission buffer acquisition failed).	0x4601	0	InstanceID Remote station MACID	SysBufGet return code	Received data[0] Received data[1]	Received data[2] Received data[3]	0x5142	
56	✓		Transmission was unachievable (fragmentation transmission buffer acquisition failed).	0x4602	0	InstanceID Remote station MACID	SysBufGet return code	Received data[0] Received data[1]	Received data[2] Received data[3]		
57	✓		Response transmission was unachievable (response transmission buffer acquisition for a short request failed).	0x4603	0	InstanceID Remote station MACID	SysBufGet return code	0	0		
58	✓		Response transmission was unachievable (response transmission buffer acquisition for a short request failed).	0x4604	0	InstanceID Reception In	Received CANID (*)	Received data[0] Received data[1]	Received data[2] Received data[3]		
59	✓		Ack transmission was unachievable (Ack transmission buffer acquisition failed).	0x4605	0	InstanceID Reception In	Received CANID (*)	Received data[0] Received data[1]	Received data[2] Received data[3]		
60	✓		Ack transmission was unachievable (Ack transmission buffer acquisition failed).	0x4606	0	InstanceID Reception In	Received CANID (*)	Received data[0] Received data[1]	Received data[2] Received data[3]		
61	✓		A WDT timeout occurred (Explicit).	0x4701	0	InstanceID Remote station MACID	Produced ConnectionID (*)	Consumed ConnectionID (*)	0	0x7107	ex_wdto_client
62	✓		A WDT timeout occurred (Explicit).	0x4702	0	InstanceID Remote station MACID	Produced ConnectionID (*)	Consumed ConnectionID (*)	0		ex_wdto_server
63	✓		A WDT timeout occurred (I/O).	0x4703	0	InstanceID Remote station MACID	Produced ConnectionID (*)	Consumed ConnectionID (*)	0		ex_wdto_io
64	✓		Ack timeout occurred (1st occurrence).	0x4801	0	InstanceID Remote station MACID	Produced ConnectionID (*)	Consumed ConnectionID (*)	0		ack_to_client
65	✓		Ack timeout occurred (1st occurrence).	0x4802	0	InstanceID Remote station MACID	Produced ConnectionID (*)	Consumed ConnectionID (*)	0		ack_to_server
66	✓		Ack timeout occurred (2nd occurrence = Ack retry limit exceeded).	0x4803	0	InstanceID Remote station MACID	Produced ConnectionID (*)	Consumed ConnectionID (*)	0	0x7101	ack_to_client
67	✓		Ack timeout occurred (2nd occurrence = Ack retry limit exceeded).	0x4804	0	InstanceID Remote station MACID	Produced ConnectionID (*)	Consumed ConnectionID (*)	0		ack_to_server
68	-		I/O transmission was unachievable (transmission data acquisition failed).	0x4901	0	InstanceID 0	IF_IdxRead return code	Produced ConnectionID (*)	0		sendc_err_io
69	-		I/O transmission was unachievable (a TransportClassTrigger mismatch occurred).	0x4902	0	InstanceID 0	TransportClass Trigger	Produced ConnectionID (*)	0		sendc_err_io
70	-		I/O transmission was unachievable (the connection status was other than "Established").	0x4903	0	InstanceID 0	state	Produced ConnectionID (*)	0		sendc_err_io
71	-		An I/O reception was canceled (a TransportClassTrigger mismatch occurred).	0x4904	0	InstanceID 0	TransportClass Trigger	Consumed ConnectionID (*)	0		sendc_err_io
72	-		An I/O reception was canceled (the connection status was other than "Established").	0x4905	0	InstanceID 0	Received CANID (*)	Instance Type	0		recv_err_io
73	-		An I/O reception was canceled (the received CANID did not match the Instance reception CANID).	0x4906	0	InstanceID 0	Received CANID (*)	InitialComm Characteristics	0		sendc_err_io
74	-		I/O transmission was unachievable (an Instance Type mismatch occurred).	0x4907	0	InstanceID 0	state	Transmitted CANID (*)	0		recv_err_io
75	-		I/O transmission was unachievable (an InitialCommCharacteristics mismatch occurred).	0x4908	0	InstanceID 0	Transmitted CANID (*)	Consumed ConnectionID (*)	0		recv_err_io

(*) A byte-swapped value is set.

No.	C	S	Trace name	Trace code	Type	Trace data [0]	Trace data [1]	Trace data [2]	Trace data [3]	AI report	Log name	
76	-		A transfer menu table was created (the I/O communication count setting was exceeded).	0x4A07	1	CreateCycleMenu return code	0x5108	0	0			
77	-		A transfer menu table was created (the I/O transmission port was not found).	0x4A08	0	CreateCycleMenu return code	0	0	0			
78	✓		A CAN transmission was started (Non-Fragment).								co_send	
79	✓		A CAN transmission was started (Non-Fragment).								co_send	
80	✓		A CAN transmission was started (fragmentation transmission).								co_send	
81	✓		A CAN transmission was started (fragmentation transmission).								co_send	
82	✓		A CAN transmission was started (Ack transmission).								co_send	
83	✓		A CAN transmission was started (Ack transmission).								co_send	
84	✓		A CAN transmission was started (error response transmission to a short request).								co_send	
85	✓		A local station-addressed Explicit message was received.								co_rcv	
86	✓		A local station-addressed Explicit message was received.								co_rcv	
87			A local station-addressed I/O message was received.								co_rcv	
88	-		An I/O reception was canceled (the connection status was other than "Established").	0x4B01	0	InstanceID	state	Received CANID	0		recv_err_io	
89	-		An I/O reception was canceled (the received CANID did not match the Instance reception CANID).	0x4B02	0	InstanceID	Received CANID (*)	Consumed ConnectionID (*)	0		recv_err_io	
90	-		An I/O reception was canceled (the beginning was received in a wait for the next Frag (processing was continued with this situation handled as the reception of the beginning)).	0x4B03	0	InstanceID	Received CANID (*)	Received data[0]	Received data[1]	Received data[2]	Received data[3]	io_frag_ilg
91	-		An I/O reception was canceled (fragmented data having an improper count was received in a wait for the beginning although Type = beginning).	0x4B04	0	InstanceID	Received CANID (*)	Received data[0]	Received data[1]	Received data[2]	Received data[3]	io_frag_err
92	-		An I/O reception was canceled (the cumulative length of received fragmented data exceeded the maximum permissible received data length).	0x4B05	0	InstanceID	Received CANID (*)	Received data[0]	Received data[1]	Received data[2]	Received data[3]	io_frag_over
93	-		An I/O reception was canceled (fragmented data having an improper count was received in a wait for the next Frag).	0x4B06	0	InstanceID	Received CANID (*)	Received data[0]	Received data[1]	Received data[2]	Received data[3]	io_frag_ilg
94	-		An I/O reception was canceled (fragmented data whose Type was other than the beginning was received in a wait for the beginning).	0x4B07	0	InstanceID	Received CANID (*)	Received data[0]	Received data[1]	Received data[2]	Received data[3]	io_frag_ilg
95	-		An I/O reception was canceled (Ack was received).	0x4B08	0	InstanceID	Received CANID (*)	Received data[0]	Received data[1]	Received data[2]	Received data[3]	io_frag_err
96	-		An I/O reception was canceled (0-byte data was received).	0x4B09	0	InstanceID	Received CANID (*)	Received data[0]	Received data[1]	Received data[2]	Received data[3]	io_frag_err
97	-		An I/O reception was canceled (an Instance Type mismatch occurred).	0x4B0A	0	InstanceID	Received CANID (*)	InstanceType	0		recv_err_io	
98	-		An I/O reception was canceled (an InitialCommCharacteristics mismatch occurred).	0x4B0B	0	InstanceID	Received CANID (*)	InitialComm Characteristics	TransportClassTrigger		recv_err_io	

(*) A byte-swapped value is set.

3 TECHNICAL SUPPORT INFORMATION

UCMM Object

No.	Trace name	Trace code	Type	Trace data [0]		Trace data [1]	Trace data [2]			Trace data [3]			AI report	Log name	
				Remote station MACID	Transmission In		Transmitted data[0]	Transmitted data[1]	Transmitted data[2]	Transmitted data[3]	Transmitted data[0]	Transmitted data[1]	Transmitted data[2]	Transmitted data[3]	
1	"Open" transmission was unachievable (the State was the Configuring state).	0x5001	1			0	Transmitted data[0]	Transmitted data[1]	Transmitted data[2]	Transmitted data[3]					prot_err_ucmm
2	"Close" transmission was unachievable (the State was the Configuring state).	0x5002	1			0	Transmitted data[0]	Transmitted data[1]	Transmitted data[2]	Transmitted data[3]					prot_err_ucmm
3	"Open" transmission was unachievable (a connection with the remote device was already established).	0x5003	0			0	Transmitted data[0]	Transmitted data[1]	Transmitted data[2]	Transmitted data[3]				0x5103	dup_open
4	Heartbeat transmission was unachievable (the heartbeat transmission buffer was not successfully acquired).	0x5004	0				Transmitted data[0]	Transmitted data[1]	Transmitted data[2]	Transmitted data[3]					ucmm_sbuf_err
5	DupMacReq transmission was unachievable (the transmission buffer was not successfully acquired).	0x5005	1				Transmitted data[0]	Transmitted data[1]	Transmitted data[2]	Transmitted data[3]					
6	DupMacReq transmission was unachievable (the transmission buffer was not successfully acquired [a local event was restarted]).	0x5006	0				Transmitted data[0]	Transmitted data[1]	Transmitted data[2]	Transmitted data[3]					
7	Response transmission was unachievable (the OpenResponse transmission buffer was not successfully acquired).	0x5007	0		Reception In		Received data[0]	Received data[1]	Received data[2]	Received data[3]					
8	Response transmission was unachievable (the CloseResponse transmission buffer was not successfully acquired).	0x5008	0		Reception In		Received data[0]	Received data[1]	Received data[2]	Received data[3]					
9	Response transmission was unachievable (the error response transmission buffer was not successfully acquired).	0x5009	0		Reception In		Received data[0]	Received data[1]	Received data[2]	Received data[3]					
10	A response reception was canceled (the State was the Configuring state).	0x5101	0		Reception In		Received data[0]	Received data[1]	Received data[2]	Received data[3]					prot_err_ucmm
11	A response reception was canceled (the Group did not match the remote device type).	0x5102	0		Remote type		Received data[0]	Received data[1]	Received data[2]	Received data[3]					prot_err_ucmm
12	A response reception was canceled (a request was received [R/R = 0]).	0x5103	1		Reception In		Received data[0]	Received data[1]	Received data[2]	Received data[3]					prot_err_ucmm
13	A response reception was canceled (the received data did not contain data before the service code).	0x5104	1		Reception In		Received data[0]	Received data[1]	Received data[2]	Received data[3]					prot_err_ucmm
14	A response reception was canceled (a connection with the remote device was already established).	0x5105	0		Reception In		Received data[0]	Received data[1]	Received data[2]	Received data[3]					prot_err_ucmm
15	A response reception was canceled (the message body format value was illegal).	0x5106	1		Reception In		Received data[0]	Received data[1]	Received data[2]	Received data[3]					prot_err_ucmm
16	A response reception was canceled (the G3 received data length was illegal).	0x5107	1		Reception In		Received data[0]	Received data[1]	Received data[2]	Received data[3]					prot_err_ucmm
17	A response reception was canceled (the transmitting end MsgID was illegal).	0x5108	1		Reception In		Received data[0]	Received data[1]	Received data[2]	Received data[3]					prot_err_ucmm
18	A response reception was canceled (the G2 received data length was illegal).	0x5109	1		Reception In		Received data[0]	Received data[1]	Received data[2]	Received data[3]					prot_err_ucmm
19	A response reception was canceled (the response to an Open request was improperly timed).	0x510A	0		Reception In		Received data[0]	Received data[1]	Received data[2]	Received data[3]					
20	A response reception was canceled (Create was not successful).	0x510B	1		Create return code		Received data[0]	Received data[1]	Received data[2]	Received data[3]					prot_err_ucmm
21	A response reception was canceled (CloseResponse was improperly timed).	0x510C	0		Reception In		Received data[0]	Received data[1]	Received data[2]	Received data[3]					
22	A response reception was canceled (the CloseResponse data length was illegal).	0x510D	1		Reception In		Received data[0]	Received data[1]	Received data[2]	Received data[3]					prot_err_ucmm
23	A response reception was canceled (the heartbeat data length was illegal).	0x510E	1	0	Reception In		Received data[0]	Received data[1]	Received data[2]	Received data[3]					prot_err_ucmm
24	A response reception was canceled (an illegal response other than Error Response was received).	0x510F	1	0	Reception In		Received data[0]	Received data[1]	Received data[2]	Received data[3]					prot_err_ucmm
25	A response reception was canceled (the Shutdown data length was illegal).	0x5110	1	0	Reception In		Received data[0]	Received data[1]	Received data[2]	Received data[3]					prot_err_ucmm

(*) A byte-swapped value is set.

No.	Trace name	Trace code	Type	Trace data [0]		Trace data [1]		Trace data [2]		Trace data [3]		AI report	Log name
				Remote station MACID	Reception In	Received CANID (*)	Received data[0]	Received data[1]	Received data[2]	Received data[3]	Received data[0]		
26	A request reception was canceled (the State was the Configuring state).	0x5201	0	Remote station MACID	Reception In	Received CANID (*)	Received data[0]	Received data[1]	Received data[2]	Received data[3]		prot_err_ucmm	
27	A request reception was canceled (Fragment [Frag = 1] or Response [R/R = 1]).	0x5102	1	Remote station MACID	Reception In	Received CANID (*)	Received data[0]	Received data[1]	Received data[2]	Received data[3]		prot_err_ucmm	
28	A request reception was canceled (the received data did not contain data before the service code).	0x5103	1	Remote station MACID	Reception In	Received CANID (*)	Received data[0]	Received data[1]	Received data[2]	Received data[3]		prot_err_ucmm	
29	A request reception was canceled (the OpenRequest received data length was illegal).	0x5104	1	Remote station MACID	Reception In	Received CANID (*)	Received data[0]	Received data[1]	Received data[2]	Received data[3]		prot_err_ucmm	
30	A request reception was canceled (the CloseRequest received data length was illegal).	0x5105	1	Remote station MACID	Reception In	Received CANID (*)	Received data[0]	Received data[1]	Received data[2]	Received data[3]		prot_err_ucmm	
31	A DupMAC reception was canceled (the received data length was illegal).	0x5106	1	0	Reception In	Received CANID (*)	Received data[0]	Received data[1]	Received data[2]	Received data[3]		prot_err_ucmm	
32	Reception reporting of a locally transmitted heartbeat was unachievable (the system message reception buffer was not successfully acquired).	0x5301	0	SysBufGet return code		Received CANID (*)	Transmitted data[0]	Transmitted data[1]	Transmitted data[2]	Transmitted data[3]			
33	Reception reporting of locally transmitted DupMacRsp was unachievable (the reception buffer was not successfully acquired).	0x5302	0	SysBufGet return code		Received CANID (*)	Transmitted data[0]	Transmitted data[1]	Transmitted data[2]	Transmitted data[3]			
34	Reception reporting of locally transmitted DupMacReq was unachievable (the reception buffer was not successfully acquired).	0x5303	0	SysBufGet return code		Received CANID (*)	Transmitted data[0]	Transmitted data[1]	Transmitted data[2]	Transmitted data[3]			
35	A duplicate MACID was reported (problems at remote stations).	0x5401	0	0	Reception In	Received CANID (*)	Received data[0]	Received data[1]	Received data[2]	Received data[3]	0x4101		
36	A duplicate MACID was reported (remote station illegality at remote and local stations).	0x5402	1	0	Reception In	Received CANID (*)	Received data[0]	Received data[1]	Received data[2]	Received data[3]	0x4101		
37	A duplicate MACID was detected (local-station graceful degradation).	0x5403	1	0x4201		0	0	0	0	0	0x4201		
38	An error response was transmitted.	0x5501	0	Remote station MACID	Reception In	Error code	Received data[0]	Received data[1]	Received data[2]	Received data[3]			
39	An "Open" start was accepted.	0x5601	0	Remote station MACID	Transmission In	Remote station device type	Transmitted data[0]	Transmitted data[1]	Transmitted data[2]	Transmitted data[3]			
40	A "Close" start was accepted.	0x5602	0	Remote station MACID	Transmission In	Remote station device type	Transmitted data[0]	Transmitted data[1]	Transmitted data[2]	Transmitted data[3]			
41	A "Heartbeat" start was accepted.	0x5603	0	0		0	Transmitted data[5]	Transmitted data[6]	Transmitted data[7]	Transmitted data[8]			
42	A "Duplicate MACID Request" start was accepted (1st).	0x5611	0	0		0	0	0	0	0			
43	A "Duplicate MACID Request" start was accepted (2nd).	0x5612	0	0		0	0	0	0	0			
44	A "Duplicate MACID Response" start was accepted.	0x5613	0	0		0	0	0	0	0			
45	A response was received at the UCM port.	0x5701	0	Remote station MACID	Reception In	Received CANID (*)	Received data[0]	Received data[1]	Received data[2]	Received data[3]			
46	A request was received at the UCM port.	0x5702	0	Remote station MACID	Reception In	Received CANID (*)	Received data[0]	Received data[1]	Received data[2]	Received data[3]			
47	Heartbeat was received.	0x5703	0	Remote station MACID	Reception In	Received CANID (*)	Received data[0]	Received data[1]	Received data[2]	Received data[3]			
48	Shutdown was received.	0x5704	0	Remote station MACID	Reception In	Received CANID (*)	Received data[0]	Received data[1]	Received data[2]	Received data[3]			
49	Reception occurred at a Duplicate MACID port.	0x5711	0	0	Reception In	Received CANID (*)	Received data[0]	Received data[1]	Received data[2]	Received data[3]			

(*) A byte-swapped value is set.

3 TECHNICAL SUPPORT INFORMATION

InterFace Object

No.	Trace name	Trace code	Type	Trace data [0]		Trace data [1]		Trace data [2]	Trace data [3]	AI report	Log name
1	A service request was accepted.	0x7010	0	Data length of detailed data section	Service code	Specified MACID		Detailed data section 1	Detailed data section 2		ser_accept
2	"Open" was accepted.					Specified MACID		Detailed data section 1			open_accept
3	"Close" was accepted.					Specified MACID		Detailed data section 1			close_accept
4	"Explicit" was accepted.					Specified MACID		Detailed data section 1			exp_accept
5	A service was called before the report of a previous service TI.	0x7011	0	Data length of detailed data section	Service code	Specified MACID		Detailed data section 1	Detailed data section 2		ser_dup_wait
6	A service TI was reported.	0x7020	0	MACID	Error code	Error code		Error data	0		ser_ti_rpt
7	Service request acceptance was completed with the buffer full.	0x7021	0	MACID	Error code	Error code		Error data	0		ser_ti_buf_busy
8	A response was reported.	0x7030	0	Data length of detailed data section	Service code	Specified MACID		Detailed data section 1	Detailed data section 2		ser_rsp_rpt
9	A response was reported with the queue table full.	0x7031	0	Buffer type	CANID (*)	CANID (*)		Data section 1	Data section 2		ser_rsp_que_busy
10	A response report was awaited (the service response buffer was full or a TI report was not made yet).	0x7032	0	MACID	Response buffer PP/CP	Response buffer PP/CP		"Busy" flag	0		ser_rsp_wait
11	A system message was reported.	0x7040	0	System message code	Data size	CANID (*)		Data section 1	Data section 2		sys_msg_rpt
12	A system message was reported with the queue table full.	0x7041	0	Buffer type	Effective data length	CANID (*)		Data section 1	Data section 2		sys_msg_que_busy
13	The buffer for system message reception was full.	0x7042	0	CANID (*)	System message buffer PP/CP	System message buffer PP/CP		0	0		sys_msg_buf_busy

(*) A byte-swapped value is set.

CAN Object

No.	Trace name	Trace code	Type	Trace data [0]	Trace data [1]	Trace data [2]	Trace data [3]	AI report	Log name
1	A reception buffer acquisition failure trace was performed.	0x9010	0	SysBufferGet return code	Received CANID	Received data[0]	Received data[1]	Received data[2]	Received data[3]
2	A transmission buffer cancel trace was performed due to NetStatus inadequacy.	0x9020	1	NetStatus	Transmitted CANID	Transmitted data[0]	Transmitted data[1]	Transmitted data[2]	Transmitted data[3]
3	A reception buffer cancel trace was performed due to NetStatus inadequacy.	0x9021	0	NetStatus	Received CANID	Received data[0]	Received data[1]	Received data[2]	Received data[3]
4	A bus-OFF occurrence trace was performed.	0x9030	0	0	0	0	0	0	can_busoff
5	A bus -OFF recovery trace was performed.	0x9031	0	0	0	0	0	0	can_busoff_recover
6	A CAN transmission timeout detection trace was performed.	0x9040	0	0	Transmitted CANID	Transmitted data[0]	Transmitted data[1]	Transmitted data[2]	Transmitted data[3]
7	An explicit message cancel trace was performed due to a CAN transmission timeout.	0x9050	0	Remote station MACID	Transmitted CANID	Transmitted data[0]	Transmitted data[1]	Transmitted data[2]	Transmitted data[3]
8	A CAN chip error trace was performed.	0x9060	1	LEC	0	0	0	0	6 types including stuff_err
9	A trace was performed on the completion of a transmission message write into the CAN chip (other than I/O).	0x9070	0	Frame type	Transmitted CANID	Transmitted data[0]	Transmitted data[1]	Transmitted data[2]	Transmitted data[3]
10	A CAN transmission completion trace was performed (other than I/O).	0x9080	0	0	Transmitted CANID	Transmitted data[0]	Transmitted data[1]	Transmitted data[2]	Transmitted data[3]
11	A CAN invalid interrupt was generated.	0x9090	1	Interrupt ID	0	0	0	0	can_invalid_int

S10 Interface Object

No.	Trace name	Trace code	Type	Trace data [0]	Trace data [1]	Trace data [2]	Trace data [3]	AI report	Log name
1	An internal Set_Bind call trace was performed.	0xB001	0	0	0	0	0		
2	An internal Finish_Conf call trace was performed.	0xB002	0	0	0	0	0		
3	An internal Start_Conf call trace was performed.	0xB003	0	0	0	0	0		
4	Internal Start call trace was performed.	0xB004	0	0	0	0	0		
5	A "recovery from 'bus-OFF retry limit exceeded' condition" trace was performed.	0xB010	0	0	0	0	0		

(*) A byte-swapped value is set.

3 TECHNICAL SUPPORT INFORMATION

Connection Object (trace information stored by LQE570/575 only)

No.	C	S	Trace name	Trace code	Type	Trace data [0]		Trace data [1]	Trace data [2]		Trace data [3]		AI report	Log name
						InstanceID	Transmission In	Transmitted CANID ^(*)	Received data[0]	Transmitted data[1]	Received data[2]	Transmitted data[3]		
1	√		(Proxy) An Explicit request transmission to the slave was accepted (starting source: Proxy).	0x4003	0	InstanceID	Transmission In	Transmitted CANID ^(*)	Received data[0]	Transmitted data[1]	Received data[2]	Transmitted data[3]		
2	√		(Proxy) An Explicit request reception from the tool was accepted.	0x4004	0	InstanceID	Reception In	Received CANID ^(*)	Received data[0]	Received data[1]	Received data[2]	Received data[3]		
3	√		(Proxy) An Explicit response transmission to the tool was accepted (starting source: Proxy).	0x4005	0	InstanceID	Transmission In	0 (invalid)	Transmitted data[0]	Transmitted data[1]	Transmitted data[2]	Transmitted data[3]		
4	√		(Proxy) Transmission was unachievable (the connection status was other than "Established" [starting source: Proxy]).	0x4109	1	InstanceID	state	Transmitted CANID ^(*)	Transmitted data[0]	Transmitted data[1]	Transmitted data[2]	Transmitted data[3]		prot_err_client
5	√		(Proxy) Transmission was unachievable (InitialCommCharacteristics indicates other than G2OnliClient [starting source: Proxy]).	0x410A	1	InstanceID	Init.Comm.	Transmitted CANID ^(*)	Transmitted data[0]	Transmitted data[1]	Transmitted data[2]	Transmitted data[3]		prot_err_client
6	√		(Proxy) Transmission was unachievable (a transmission double-start was attempted [starting source: Proxy]).	0x410B	1	InstanceID	Remote station MACID	Transmitted CANID ^(*)	Transmitted data[0]	Transmitted data[1]	Transmitted data[2]	Transmitted data[3]		ser_dup
7	√		(Proxy) Transmission was unachievable (the ProxyConnection status was other than "Established" [starting source: Proxy]).	0x410C	0	InstanceID	ProxyState	Transmitted CANID ^(*)	Transmitted data[0]	Transmitted data[1]	Transmitted data[2]	Transmitted data[3]		prot_err_server
8	√		(Proxy) Transmission was unachievable (the server process was not being performed).	0x410D	0	InstanceID	Remote station MACID	Transmitted CANID ^(*)	Transmitted data[0]	Transmitted data[1]	Transmitted data[2]	Transmitted data[3]		prot_err_server
9	√		(Proxy) A reception was canceled (a non-fragmented request was received with no data provided before InstanceID).	0x4223	1	InstanceID	Reception In	Received CANID ^(*)	Received data[0]	Received data[1]	Received data[2]	Received data[3]		prot_err_server
10	√		(Proxy) A reception was canceled (a fragmented request was received with no data provided before FragCount).	0x4224	1	InstanceID	Remote station MACID	Received CANID ^(*)	Received data[0]	Received data[1]	Received data[2]	Received data[3]		prot_err_server
11	√		(Proxy) Response transmission was unachievable (response transmission buffer acquisition for a short request failed).	0x4607	1	InstanceID	Reception In	Received CANID ^(*)	Received data[0]	Received data[1]	Received data[2]	Received data[3]		
12	-		(IoFragment) I/O transmission was unachievable (transmission data acquisition failed).	0x4909	0	InstanceID	0	IF_IfRead return code	Produced ConnectionID (*)	0	0	0		prot_err_io
13	-		(IoNonFragment) An I/O reception was canceled (the cumulative length of received data exceeded the maximum permissible received data length).	0x490A	0	InstanceID	Data length	Received CANID ^(*)	Received data[0]	Received data[1]	Received data[2]	Received data[3]		io_data_ovf
14	-		(IoSequence) I/O transmission was unachievable (an Instance Type mismatch occurred).	0x490B	0	InstanceID	0	Transmitted CANID ^(*)	Instance Type	0	0	0		prot_err_io
15	-		(IoSequence) I/O transmission was unachievable (an InitialCommCharacteristics mismatch occurred).	0x490C	0	InstanceID	0	Transmitted CANID ^(*)	InitialCommCharacter.	TransportClassTrigger	TransportClassTrigger	TransportClassTrigger		prot_err_io
16	-		(IoSequence) An I/O reception was canceled (the cumulative length of received data exceeded the maximum permissible received data length).	0x4B0C	0	InstanceID	Data length	Received CANID ^(*)	Received data[0]	Received data[1]	Received data[2]	Received data[3]		io_data_ovf
17	-		(IoSequence) An I/O reception was canceled (an Instance Type mismatch occurred).	0x4B0D	0	InstanceID	0	Consumed ConnectionID (*)	Instance Type	0	0	0		recv_err_io
18	-		(IoSequence) An I/O reception was canceled (an InitialCommCharacteristics mismatch occurred).	0x4B0E	0	InstanceID	0	Consumed ConnectionID (*)	InitialCommCharacter.	TransportClassTrigger	TransportClassTrigger	TransportClassTrigger		recv_err_io
19	-		(IoSequence) An I/O reception was canceled (the received CANID did not match the Instance reception CANID).	0x4B0F	0	InstanceID	0	Received CANID	Consumed ConnectionID (*)	0	0	0		recv_err_io
20	-		(IoSequence) An I/O reception was canceled (the connection status was other than "Established").	0x4B10	0	InstanceID	0	state	Received CANID (*)	0	0	0		recv_err_io
21	-		(IoSequence) An I/O reception was canceled (fragmented data of 0 bytes long was received [the fragmented data header was missing]).	0x4B11	0	InstanceID	0	Received CANID ^(*)	Received data[0]	Received data[1]	Received data[2]	Received data[3]		io_frag_err
22	-		(IoSequence) An I/O reception was canceled (the beginning was received in a wait for the next Frag (processing was continued with this situation handled as the reception of the beginning)).	0x4B12	0	InstanceID	FragCnt	Received CANID ^(*)	Received data[0]	Received data[1]	Received data[2]	Received data[3]		io_frag_ile
23	-		(IoSequence) An I/O reception was canceled (fragmented data whose type was other than the beginning or end to which FragCnt is set equal, was received in a wait for the beginning).	0x4B13	0	InstanceID	FragCnt	Received CANID ^(*)	Received data[0]	Received data[1]	Received data[2]	Received data[3]		io_frag_err
24	-		(IoSequence) An I/O reception was canceled (the cumulative length of received fragmented data exceeded the maximum permissible received data length).	0x4B14	0	InstanceID	Data length	Received CANID ^(*)	Received data[0]	Received data[1]	Received data[2]	Received data[3]		io_data_ovf

(*) A byte-swapped value is set.

No.	C	S	Trace name	Trace code	Type	Trace data [0]		Trace data [1]	Trace data [2]			Trace data [3]			AI report	Log name
25	-	-	(IoSequence) An I/O reception was canceled (fragmented data having an improper fragment count was received in a wait for the next Frag).	0xaB15	0	InstanceID	FragCnt	Received CANID ^(*)	Received data[0]	Received data[1]	Received data[2]	Received data[3]			io_frag_flg	
26	-	-	(IoSequence) An I/O reception was canceled (fragmented data whose Type was other than the beginning was received in a wait for the beginning).	0xaB16	0	InstanceID	FragCnt	Received CANID ^(*)	Received data[0]	Received data[1]	Received data[2]	Received data[3]			io_frag_flg	
27	-	-	(IoSequence) An I/O reception was canceled (Ack was received).	0xaB17	0	InstanceID	FragCnt	Received CANID ^(*)	Received data[0]	Received data[1]	Received data[2]	Received data[3]			io_frag_err	
28	√	-	(Proxy) Explicit transmission semaphore flag acquisition failed (G2OnliClient).	0x4C01	0	InstanceID	Starting source type	0 (invalid)	Transmitted data[0]	Transmitted data[1]	Transmitted data[2]	Transmitted data[3]	0x710B		exp_sem_busy	
29	√	-	(Proxy) Explicit transmission semaphore flag acquisition failed (G2OnliClient).	0x4C02	0	InstanceID	Starting source type	Transmitted CANID ^(*)	Transmitted data[0]	Transmitted data[1]	Transmitted data[2]	Transmitted data[3]			exp_sem_busy_proxy	
30	√	-	(Proxy) Proxy non-fragmented data delivery was unachievable (slave-to-tool delivery transmission buffer acquisition failed).	0x4C03	1	InstanceID	Reception In	Received CANID ^(*)	Received data[0]	Received data[1]	Received data[2]	Received data[3]				
31	√	-	(Proxy) Proxy non-fragmented data delivery was unachievable (tool-to-slave delivery transmission buffer acquisition failed).	0x4C04	1	InstanceID	Reception In	Received CANID ^(*)	Received data[0]	Received data[1]	Received data[2]	Received data[3]				
32	√	-	(Proxy) Proxy fragmented data delivery was unachievable (slave-to-tool delivery transmission buffer acquisition failed).	0x4C05	1	InstanceID	Reception In	Received CANID ^(*)	Received data[0]	Received data[1]	Received data[2]	Received data[3]				
33	√	-	(Proxy) Proxy non-fragmented data delivery was unachievable (tool-to-slave delivery transmission buffer acquisition failed).	0x4C06	1	InstanceID	Reception In	Received CANID ^(*)	Received data[0]	Received data[1]	Received data[2]	Received data[3]				

(*) A byte-swapped value is set.

3 TECHNICAL SUPPORT INFORMATION

UCMM Object (trace information stored by LQE570/575 only)

No.	Trace name	Trace code	Type	Trace data [0]	Trace data [1]	Trace data [2]	Trace data [3]	AI report	Log name
1	(Proxy): A request reception was canceled (the OpenRequest received data length was illegal).	0x5801	1	Remote station MACID Reception In	Received CANID (*)	Received data[0] Received data[1]	Received data[2] Received data[3]		prot_err_proxy
2	(Proxy): Response transmission was unachievable (the OpenResponse transmission buffer was not successfully acquired).	0x5802	0	Remote station MACID Reception In	SysBufGet return code	Received data[0] Received data[1]	Received data[2] Received data[3]		
3	(Proxy): A request reception was canceled (the OpenRequest received data length was illegal).	0x5803	1	Remote station MACID Reception In	Received CANID (*)	Received data[0] Received data[1]	Received data[2] Received data[3]		prot_err_proxy
4	(Proxy): Response transmission was unachievable (the OpenResponse transmission buffer was not successfully acquired).	0x5804	0	Remote station MACID Reception In	SysBufGet return code	Received data[0] Received data[1]	Received data[2] Received data[3]		
5	(Proxy): An error response was transmitted.	0x5805	0	Remote station MACID Reception In	Error code	Received data[0] Received data[1]	Received data[2] Received data[3]		
6	(Proxy): Response transmission was unachievable (the ErrorResponse transmission buffer was not successfully acquired).	0x5806	0	Remote station MACID Reception In	SysBufGet return code	Received data[0] Received data[1]	Received data[2] Received data[3]		

Interface Object (trace information stored by LQE570/575 only)

No.	Trace name	Trace code	Type	Trace data [0]	Trace data [1]	Trace data [2]	Trace data [3]	AI report	Log name
1	An I/O transmission start was accepted.	0x7012	0	Port number	Transmission request data length	Transmitted data[0] Transmitted data[1]	Transmitted data[2] Transmitted data[3]		io_rcv_que_busy
2	I/O reception P. TI reporting was completed.	0x7050	0	Port number	Error code	Error data	0		io_rcv_wait
3	An I/O reception was accepted.	0x7051	0	Port number	0	Received data[0] Received data[1]	Received data[2] Received data[3]		io_send_dup_wait
4	The I/O reception report queue table was full.	0x7052	0	Port number	Queue PP	Queue CP	Received data[0] Received data[1]		io_rcv_que_busy
5	An I/O reception report was awaited (the reception notification buffer was full).	0x7053	0	Port number	Reception notification area PP	Reception notification area CP	0		io_rcv_wait
6	An I/O transmission was started before the previous I/O transmission TI was reported.	0x7054	0	Port number	Queue PP	Queue CP	0 Detailed data section 2		io_send_dup_wait
7	The service request acceptance completion buffer was full.	0x7055	0	Port number	P.TI report area PP	P.TI report area CP	0		io_rcv_buf_busy
8	I/O reception reporting was completed.	0x7056	0	Port number	Received data length	Received data[0] Received data[1]	Received data[2] Received data[3]		io_send_dup_wait

CAN Object (trace information stored by LQE570/575 only)

No.	Trace name	Trace code	Type	Trace data [0]	Trace data [1]	Trace data [2]	Trace data [3]	AI report	Log name
1	An I/O sequence control frame cancel trace was performed due to a CAN transmission timeout.	0x9051	0	Transmission In	Transmitted CANID	Transmitted data[0] Transmitted data[1]	Transmitted data[2] Transmitted data[3]		can_txout_ioseq
2	An I/O sequence control frame cancel trace was performed due to a CAN transmission timeout.	0x9052	0	Transmission In	Transmitted CANID (*)	Transmitted data[0] Transmitted data[1]	Transmitted data[2] Transmitted data[3]		can_txout_ioseq
3	A CAN chip error trace was performed.	0x9061	1	IRR register	Rec internal work area Rec register	Tec internal work area Tec register	0		can_errpassive can_rec_cntup can_rec_cntup
4	A CAN invalid interrupt was generated.	0x9061	1	IRR register	0	0	0		can_invalid_int
5	A remote frame reception was performed.	0x90A0	1	IRR register	RXPR register	RFPFR register	0		can_rmrtrcv

(*) A byte-swapped value is set.

3.16 ET.NET (Model LQE720) Error Information

3.16.1 Error codes from the socket handler

The table below enumerates all error codes that are returned from the socket handler to report on the occurrence of errors. In addition to these error codes, the table also provides information on the error causes and the user actions required to solve the problems.

Table 3-17 Error Codes from the Socket Handler (1/2)

Error code	Brief description	Cause	Required action
/F000	Connection not established yet	A connection is not established yet, or the port is released when the handler is called.	Establish a connection by calling <code>tcp_open()</code> or <code>tcp_popen()</code> , and then call the handler.
/F010	Invalid socket ID	<ul style="list-style-type: none"> The socket ID is not within the permitted range (for TCP, $01 \leq ID \leq /18$; for UDP, $/20 \leq ID \leq /37$); or An unused socket ID or an already released socket ID is specified; or A connection is not made or opened yet (only in <code>tcp_accept()</code>). 	Check the user program (e.g., check if a return value from <code>tcp_open()</code> or <code>tcp_popen()</code> is used as the socket ID).
/F011	Socket count limit exceeded	An attempt has been made to register more sockets than permitted. (The combined total of all sockets for TCP and UDP must be 24 or less.)	Close any unused sockets (by calling <code>tcp_close()</code> or <code>udp_close()</code>) and then re-establish a connection by calling <code>tcp_open()</code> or <code>tcp_popen()</code> .
/F012	Socket driver timed out	<ul style="list-style-type: none"> No response has been obtained from the socket driver within a fixed time period; or The requested transmission is timed out due to a "send window full" condition or some other cause (only in <code>tcp_send()</code>). 	Clear the connection by calling <code>tcp_close()</code> , and then try to re-establish a connection by calling <code>tcp_open()</code> or <code>tcp_popen()</code> . If communication cannot be achieved by repeating such an attempt, check if the connectors, cables, and remote station involved are all functioning normally. If the same error has occurred in <code>tcp_close()</code> , clear the connection by calling <code>tcp_abort()</code> and then re-establish a connection by calling <code>tcp_open()</code> or <code>tcp_popen()</code> .
/F013	Module stopped	A socket driver has not been able to be initialized completely within 100 seconds when the handler was called.	Replace the module.
/F020	Illegal send data length	A send data length used exceeded the permitted limit (for TCP, $1 \leq \text{data length} \leq 4096$; for UDP, $1 \leq \text{data length} \leq 1472$).	Check the user program.
/F021	Illegal receive data length	A receive data length used exceeded the permitted limit ($1 \leq \text{data length} \leq 4096$).	Check the user program.

3 TECHNICAL SUPPORT INFORMATION

Table 3-17 Error Codes from the Socket Handler (2/2)

Error code	Brief description	Cause	Required action
/FOFF	Port released	<ul style="list-style-type: none"> A port has been released (due to an RST reception) when the handler was called (this error is related to tcp_open()); or A port was already released when the handler was called (this error is related to tcp_send() or tcp_receive()). 	<ul style="list-style-type: none"> Re-establish a connection by calling tcp_open() or tcp_popen(); or Clear the connection by calling tcp_close(), and then re-establish a connection by calling tcp_open() or tcp_popen().
/FFF0	Invalid address	<ul style="list-style-type: none"> As the IP address and/or port number of a destination station, zero values (0s) are used in both udp_open() and udp_send(); or An attempt has been made to send data to a remote station for which no routing information is set yet (this error is only related to udp_send()). 	<ul style="list-style-type: none"> Check the user program; or Set routing information for the remote station.
/FFF3	Illegal parameter	An illegal parameter has been detected.	Check the user program (specifically, the set values of the arguments padr, buf, outinf, and tim).
/FFF5	Connection operation timed out	No response has been obtained from the remote station.	Clear the connection by calling tcp_close(), and then try to re-establish a connection by calling tcp_open() or tcp_popen(). If communication cannot be achieved by repeating such an attempt, check if the connectors, cables, and remote station involved are all functioning normally.
/FFF8	FIN received	An FIN has been received from the remote station.	Close the socket by calling tcp_close().
/FFFA	Connection forcibly terminated	The connection has been forcibly terminated by (transmission of an RST from) the remote station. (tcp_receive() was called after the RST reception.)	Clear the connection by calling tcp_close(), and then re-establish a connection by calling tcp_open() or tcp_popen().
/FFFD	Duplicate socket	The same socket (using the remote station's IP address or port number, or the local station's port number) is already existent.	Check the user program. This type of error may occur when an attempt is made to close the socket by calling tcp_close() in the local station. (*)
/FFFE	Illegal control block	The maximum permitted number of usable sockets has been exceeded.	Close unused sockets (by calling tcp_close() or udp_close()) and re-establish a connection by calling tcp_open() or tcp_popen().
/FFFF	Internal buffer full	<ul style="list-style-type: none"> The send buffer has become full (in udp_send()); or Internal registered area has become full (in route_add() or arp_list()). 	<ul style="list-style-type: none"> Wait for a while and then call udp_send() again; or Delete unused registration information and then call them again.

(*) A “duplicate socket” error occurs in the following way:

If a socket is opened by calling `tcp_open()` or `tcp_popen()` with a specification of the local station’s port number, and an attempt is made to close that socket by calling `tcp_close` in the same local station, then the socket will immediately enter the TIMEWAIT state (see the connection state transitions diagram under “3.19.2 Network information details”) and will remain open for approximately 20 seconds after the end of execution of that `tcp_close()`. In this situation, if an attempt is made to open that socket by calling `tcp_open()` or `tcp_popen()` with a specification of the same port number, a “duplicate socket” error (error code = /FFFD) will result.

If a “duplicate socket” error occurs, do one of the following:

- Wait 20 seconds or more after calling `tcp_close()` and then call `tcp_open()` or `tcp_popen()`.
- Close the socket by calling `tcp_abort()`.
- Open the socket by calling `tcp_open()` or `tcp_popen()` with no specification of the local station’s port number, in which case a port number currently not in use is obtained from among those in the range 1024 to 2047.

3 TECHNICAL SUPPORT INFORMATION

3.17 Error Freeze Information

On detection of a hardware error, the modules listed below light the error LED indicator, save the error freeze information in a predetermined area, and then stop their operation.

ET.NET, SV.LINK, OD.RING, SD.LINK, J.NET, J.NET-INT, IR.LINK, FL.NET, EQ.LINK, RS-232C, RS-422

For the address at which the error freeze is saved, see the information under “3.8 Memory Maps for Optional Modules.” The error freeze information is stored in the following format:

Address	2 ³¹ ————— 2 ¹⁶	2 ¹⁵ ————— 2 ⁰
/**0400	Error code	—
/**0404	Time (ms) elapsed since a reset was completed.	
	—	
	—	
/**0410	D0 register	
/**0414	D1 register	
/**0418	D2 register	
/**041C	D3 register	
/**0420	D4 register	
/**0424	D5 register	
/**0428	D6 register	
/**042C	D7 register	
/**0430	A0 register	
/**0434	A1 register	
/**0438	A2 register	
/**043C	A3 register	
/**0440	A4 register	
/**0444	A5 register	
/**0448	A6 register	
/**044C	A7 register	
/**0450	Stack frame (4-word, 6-word, or bus-error)	
/**0454		
/**04FC		

...This piece of information is saved only for J.NET, J.NET-INT, IR.LINK, RS-232C, and RS-422 modules.

Note: The “**” portion of each address above varies with the module type in which a hardware error is detected and with the main/sub setting used.

The table below lists the error codes stored as error freeze information.

No.	Error code	Meaning			
		J.NET, J.NET-INT	IR.LINK	OD.RING, SD.LINK	
1	/0010	Bus error			
2	/0011	Invalid address			
3	/0012	Invalid instruction			
4	/0013	Division by zero			
5	/0014	Privilege violation			
6	/0015	WDT timeout error			
7	/0016	Format error			
8	/0017	Spurious Interrupt			
9	/0018	Unused exception			
10	/0019	Parity error			
11	/001A	Power failure warning			
12	/0100	Module switch setting error			
13	/0101	Baud rate switch setting error	CPL switch setting error		
14	/0102	ROM1 checksum error			
15	/0103	RAM1 compare error			
16	/0105	RAM2 compare error			
17	/0107	DMA1 send error	-		
18	/0108	DMA2 send error			
19	/0109	DMA1 receive error			-
20	/010A	DMA2 receive error			-
21	/010B	ROM3 checksum error			
22	/010C	ROM erasing error (program)	ROM erasing error (program)		
23	/010D	ROM writing error (program)	ROM writing error (program)		
24	/010E	ROM erasing error (parameter)	ROM erasing error (parameter)		
25	/010F	ROM writing error (parameter)	ROM writing error (parameter)		
26	/0110	ROM writing error (writing over 50000 times)			
27	/0111	-	-	Duplicate CPL No.	
28	/0112	-	-	-	
29	/0113	-	-	-	
30	/0114	-	-	-	
31	/0200	-	-	-	

3 TECHNICAL SUPPORT INFORMATION

No.	Error code	Meaning		
		ET.NET, FL.NET, SV.LINK	EQ.LINK	RS-232C, RS-422
1	/0010	Bus error		
2	/0011	Invalid address		
3	/0012	Invalid instruction		
4	/0013	Division by zero		
5	/0014	Privilege violation		
6	/0015	WDT timeout error		
7	/0016	Format error		-
8	/0017	Spurious Interrupt		
9	/0018	Unused exception		
10	/0019	Parity error		
11	/001A	Power failure warning		-
12	/0100	Module switch setting error		
13	/0101	-	-	-
14	/0102	ROM1 checksum error		
15	/0103	RAM1 compare error		
16	/0105	RAM2 compare error		-
17	/0107	-	-	
18	/0108			
19	/0109			
20	/010A			
21	/010B	ROM3 checksum error		
22	/010C	-	-	
23	/010D			
24	/010E			
25	/010F			
26	/0110			
27	/0111			
28	/0112	Microprogram error		LGB setting error
29	/0113	IP address not registered		-
30	/0114	MAC address not registered		
31	/0200	Route information setting error	-	

The figure below shows the contents of the stack frame provided in the error freeze information table.

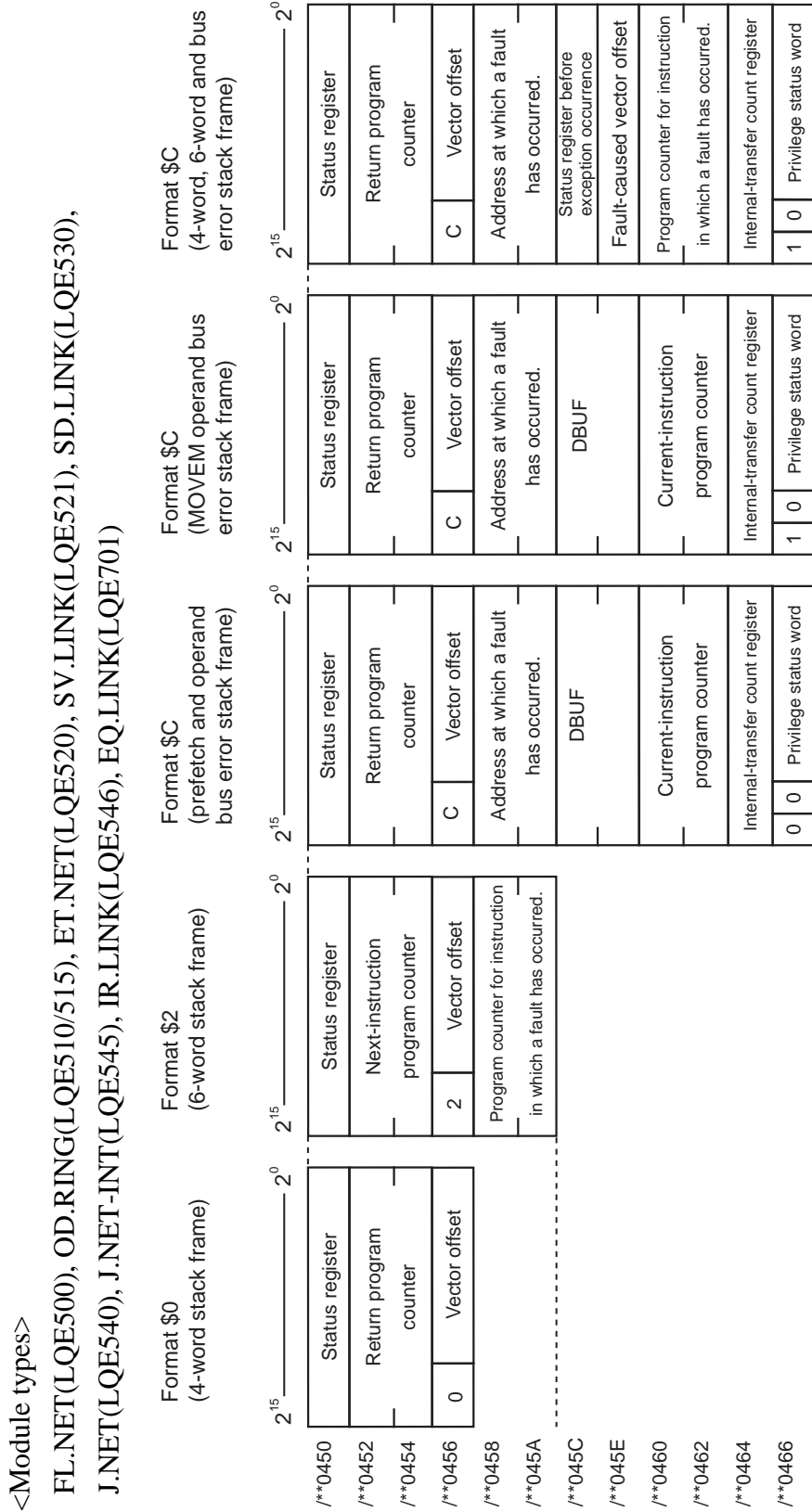
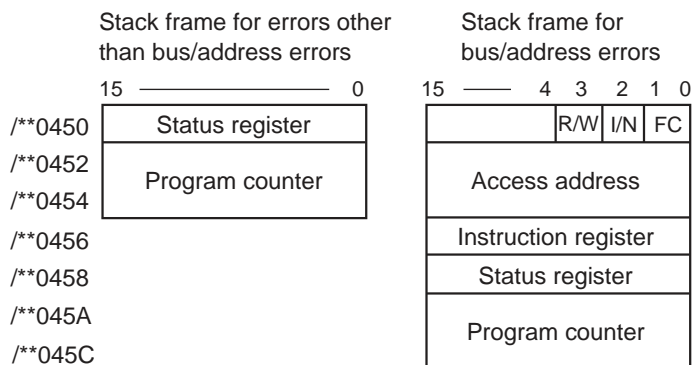

Figure 3-9 Stack Frame Details (1)

3 TECHNICAL SUPPORT INFORMATION

<Module types>

RS-232C (LQE560), RS-422 (LQE565)



R/W (Read/Write): = 0: Write; = 1: Read.

I/N (Instruction/Non-instruction): = 0: Instruction; = 1: Non-instruction.

FC: Function code

Figure 3-10 Stack Frame Details (2)

3.18 Memory Dump Procedure

To dump the S10V controller's memory, start the S10V BASE SYSTEM by choosing [Start] – [Programs] – [Hitachi S10V] – [S10V BASE SYSTEM] on the personal computer connected with the S10V controller. Then, click the **Memory Dump** button. The [Memory Dump] window shown below then appears, which enables you to dump the S10V controller's memory. For details on the S10V BASE SYSTEM, refer to the “BASIC MODULES (manual number SVE-1-100).”

- (1) The [Memory Dump] window shown below appears, which enables you to dump the memory to a specified file.

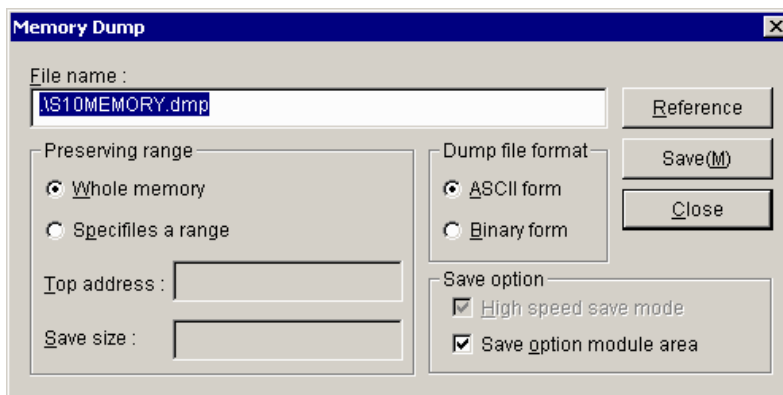

- (2) If you want to change the displayed file name, use one of the two methods: 1) directly enter the desired file name, or 2) click the **Reference** button to display the [Save As] window, and when the window appears, specify the desired folder and file:

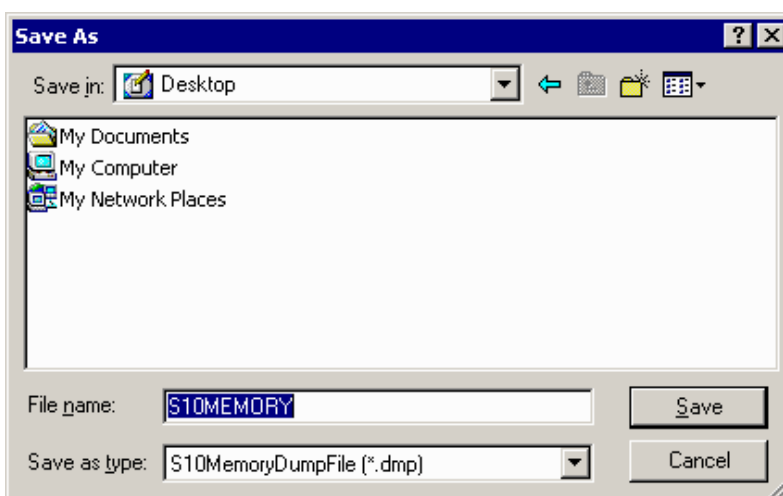

- (3) When you have specified the desired folder and file, click the **Save** button. Then, the specified folder and file appears in the “File name” box. If you need not change the folder and file displayed in Step (2), just click the **Cancel** button.

3 TECHNICAL SUPPORT INFORMATION

- (4) Choose either the “Whole memory” or the “Specifies a range” option in the “Preserving range” group. If you have chosen the latter option, you can enter values in both the “Top address” and “Save size” boxes. In these boxes, specify the starting address of the memory area you want to dump and the size of that area.

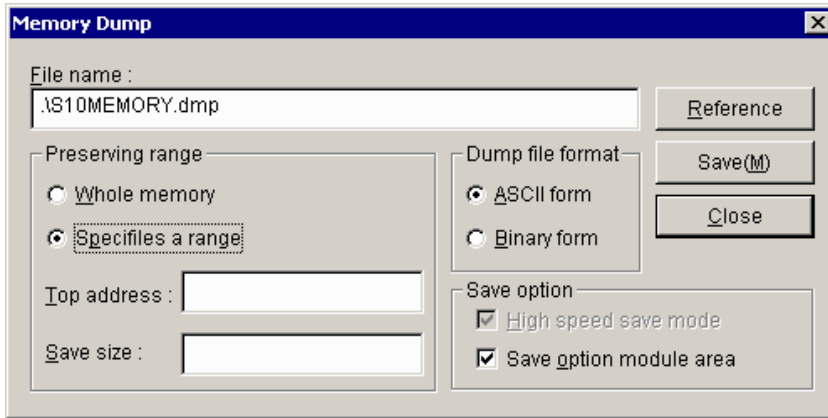

- (5) Choose either the “ASCII form” or the “Binary form” option in the “Dump file format” group. If you choose the former option, the requested memory dump will be converted to ASCII format and stored in the specified file. If you choose the latter, it will be stored in binary format, where all numeric values are represented two characters per byte, as described below.

■ **Binary file format**

Any file in binary file format has 4K bytes of 16-bytes-per-area header information added to its beginning as the header. If the specified “Preserving range” extends over non-dumpable areas, only dumpable-areas information is output to the header. All non-dumpable areas are marked with dots (“.”) in binary file format.

Dumpable and non-dumpable areas information is represented in units of four bytes in binary file format, as shown below.

- Offsets in file (i.e., line numbers relative to the beginning of a collection of memory dump information)
- Starting addresses of areas subjected to dumping
- Sizes of areas subjected to dumping
- Unused

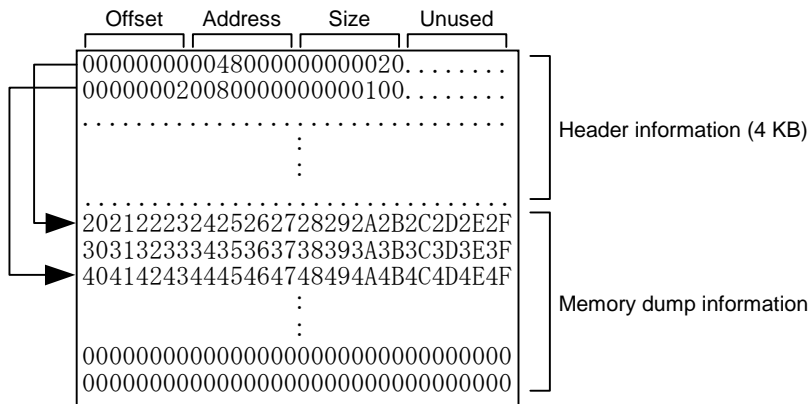

Figure 3-11 Binary File Format for Memory Dumps

- (6) If you want to carry out a memory dump at high speed, check the “High speed save mode” checkbox. If not (i.e., you are carrying it out at standard speed), make sure that the said checkbox is deselected.
- (7) If you want to save the content of the optional-modules area (/0080 0000 to /00FF FFFF), check the “Save option module area” checkbox. In this case, only the information on the installed optional modules will be saved.
If you need not save the optional-modules area content, make sure that the said checkbox is deselected. If the said checkbox is deselected but the starting address of an optional-modules area is specified, a starting-address specification error will result.
- (8) To carry out a memory dump in the specified file format, click the button.
- (9) When the memory dump is complete, click the button.

Memory dumps in high-speed save mode may cause an increased CPU load in the S10V controller. In these cases, if a ladder program or task is running, their performance may be adversely affected. To avoid this, before you carry out a memory dump in high-speed save mode, make sure that nothing is running on the controller's CPU.

If an Ethernet connection is used for memory dump, the “High speed save mode” checkbox is always dimmed in a checked state and a requested memory dump is performed in high-speed save mode.

3 TECHNICAL SUPPORT INFORMATION

■ Dumpable memory ranges

The figure below shows all memory ranges that can be subjected to memory dumps. If you dump the entire memory, only all the dumpable memory ranges are dumped. If you dump a specified memory range, it is dumped as long as its starting address is not within any non-dumpable range. In addition, if a specified memory range includes a non-dumpable range(s), only the dumpable portion is dumped.

If an RS-232C or ET.NET connection is used for memory dump, the CMU area cannot be dumped because it is not accessible.

Dumpable memory ranges for the task space, GLBR, GLBW, and IRSUB areas vary depending on RPD P's memory area definitions. The defined ranges for these four areas total up to 16 MB.

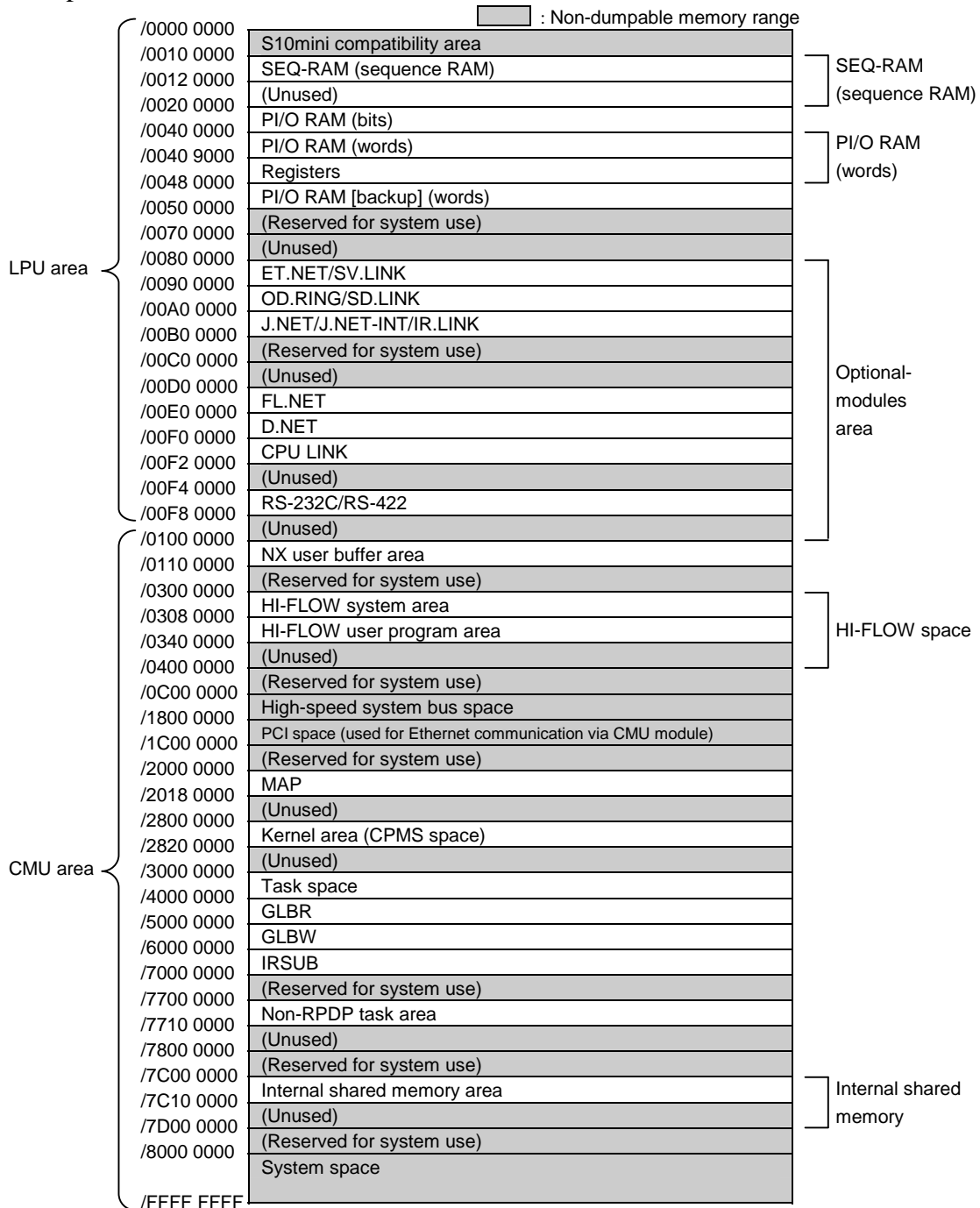

Figure 3-12 Dumpable Memory Ranges

3.19 Network Information

3.19.1 Displaying network information

To display system-maintained network information on screen, start the S10V BASE SYSTEM by choosing [Start] – [Programs] – [Hitachi S10V] – [S10V BASE SYSTEM] on the personal computer connected with the S10V controller. Then, click the **Display Status of Network** button. The network information functions list window then appears. In this window, click the **Display Status of Network** button. Then, the [Display Status of Network] window shown below appears, which enables you to view CMU/ET.NET network information. For details on the S10V BASE SYSTEM, refer to the “BASIC MODULES (manual number SVE-1-100).”

This network information display feature may be used only when CMU (model LQP520) and ET.NET (model LQE720) modules are installed. It may not be used with ET.NET (model LQE520) modules.

(1) The [Display Status of Network] window appears on screen:

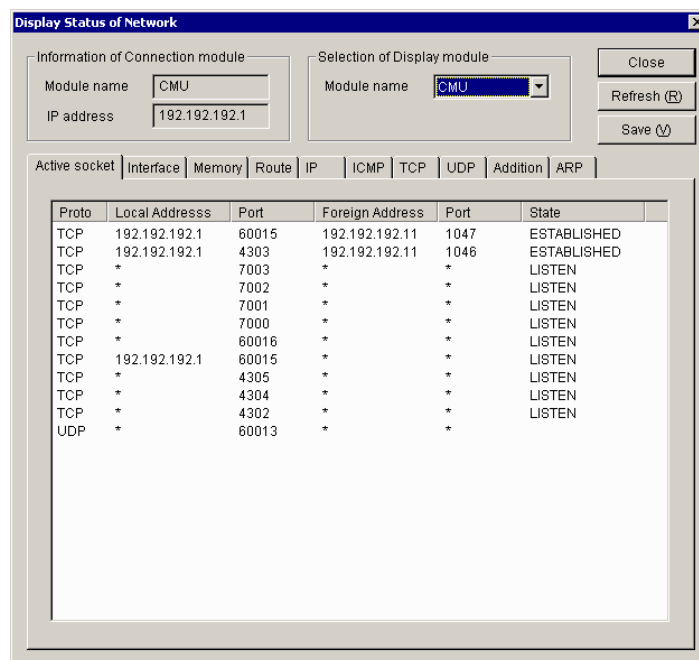

3 TECHNICAL SUPPORT INFORMATION

- (2) From the “Module name” pulldown menu in the “Selection of Display module” box, choose the module for which you want to display network information. Then, by clicking the desired tab in the window, choose the type of network information you want to display on screen.

The table below is a list of all displayable network information types:

Type (tab item)	Description
Active socket	Active socket information
Interface	Active network interface information
Memory	Send-receive-buffer management information
Route	Routing information
IP	IP-protocol statistical information
ICMP	ICMP-protocol statistical information
TCP	TCP-protocol statistical information
UDP	UDP-protocol statistical information
Addition	Interface count information
ARP	ARP table information

- (3) When you have selected all necessary items, click the button. Then, the requested network information is displayed on screen. For details on the displayed information, see the description under “3.19.2 Network information details.”

3.19.2 Network information details

(1) Socket information

The socket information displayed as shown below is a list of the currently existing network connections.

The screenshot shows a window titled "Display Status of Network" with a blue title bar. It contains two input fields for "Information of Connection module" (Module name: CMU, IP address: 192.192.192.1) and "Selection of Display module" (Module name: CMU). Below these are buttons for "Close", "Refresh (R)", and "Save (V)". A tabbed interface is visible with "Active socket" selected. The main area displays a table of network connections.

Proto	Local Addresss	Port	Foreign Address	Port	State
TCP	192.192.192.1	60015	192.192.192.11	1047	ESTABLISHED
TCP	192.192.192.1	4303	192.192.192.11	1046	ESTABLISHED
TCP	*	7003	*	*	LISTEN
TCP	*	7002	*	*	LISTEN
TCP	*	7001	*	*	LISTEN
TCP	*	7000	*	*	LISTEN
TCP	*	60016	*	*	LISTEN
TCP	192.192.192.1	60015	*	*	LISTEN
TCP	*	4305	*	*	LISTEN
TCP	*	4304	*	*	LISTEN
TCP	*	4302	*	*	LISTEN
UDP	*	60013	*	*	

where:

- Proto

The name of the protocol used over the connection.

- Local Address

The IP address of the local host (source of connection). If the IP address is not bound with a socket, an asterisk (“*”) is displayed instead.

- Port

The port number of the local host (source of connection).

- Foreign Address

The IP address of the remote host (destination of connection). If the IP address is not bound with a socket, an asterisk (“*”) is displayed instead.

3 TECHNICAL SUPPORT INFORMATION

- Port

The port number of the remote host (destination of connection). If the IP address is not bound with a socket, an asterisk (“*”) is displayed instead.

- State

The connection status of the TCP protocol. The connection state is one of the following 11 states:

Displayed symbol	Meaning
CLOSED	Currently not in use.
LISTEN	Waiting for a port to become available.
SYN_SENT	Although it issued a connect (SYN) request to the server, has not received a response (ACK) from it.
SYN_RECEIVED	Has just received a connect (SYN) request from a client.
ESTABLISHED	Currently performing data communication using an established TCP connection.
FINWAIT1	Server has sent out a FIN.
FINWAIT2	Has received an ACK.
CLOSEWAIT	Has received a FIN from the server.
LASTACK	Waiting for an ACK response to be sent out to the FIN.
CLOSING	Has received a FIN and is closing the connection.
TIMEWAIT	Waiting for the connection to be terminated.

All possible state transitions between the connection states are as follows:

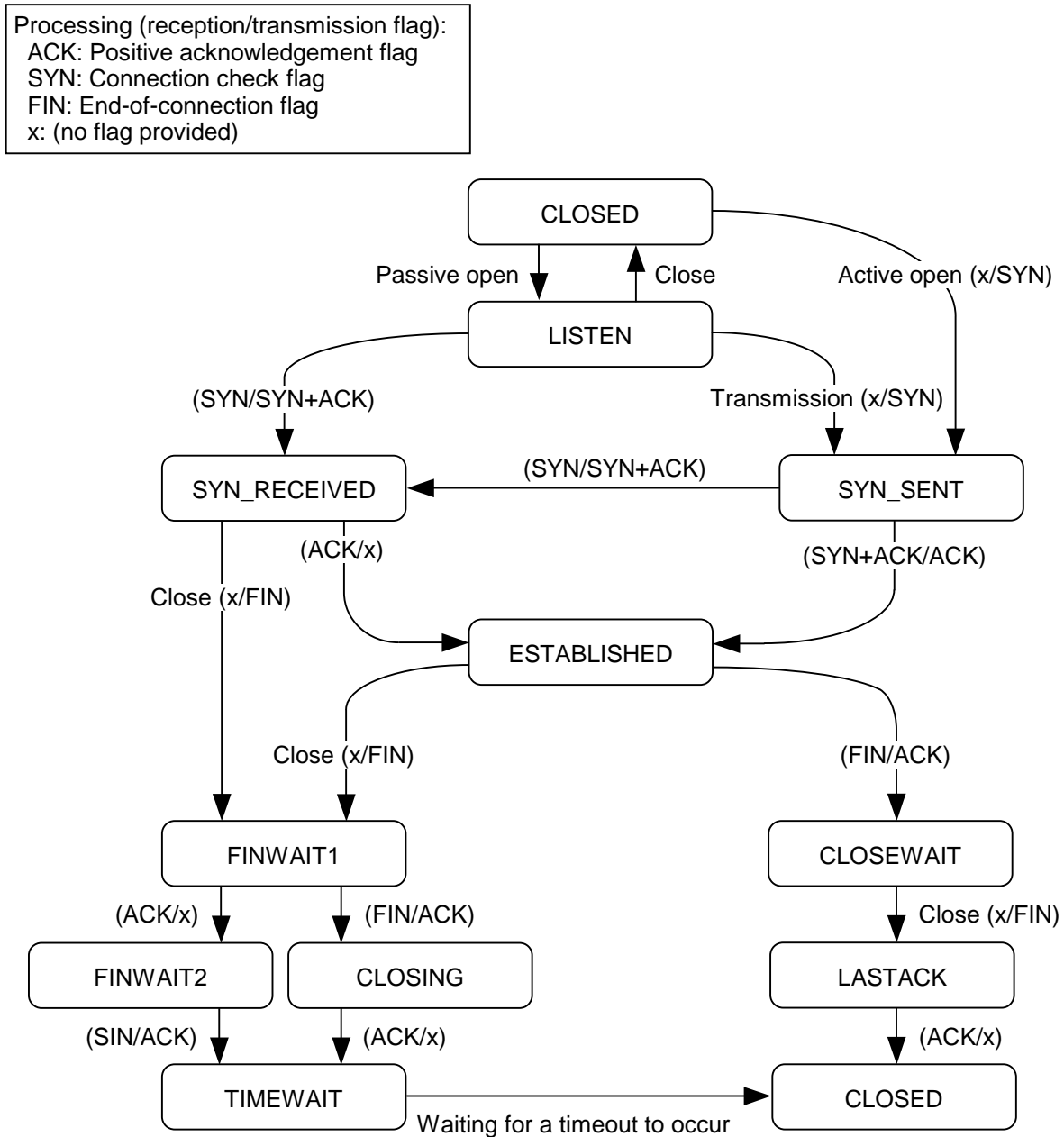

- If the TCP protocol is used over more than 150 ports, no socket information is displayed for the excess port(s) and the UDP protocol.
- If the TCP protocol is used over more than 80 ports, some of the socket information for the UDP protocol may not be displayed.

3 TECHNICAL SUPPORT INFORMATION

(2) Interface information

The interface information displayed as shown below is concerning the network interfaces currently in operation and includes input/output packet count information.

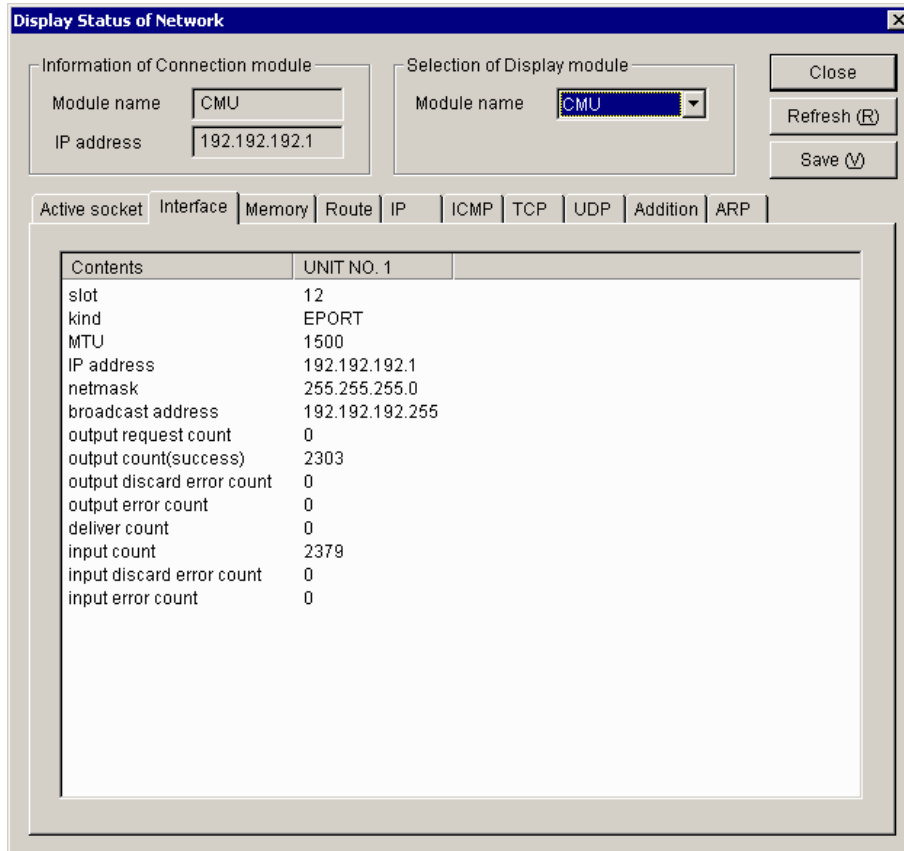

where:

① slot

The slot number of the slot in which a module subjected to this display process is mounted.

② kind

Always the string "EPORT" is displayed as this item.

③ MTU

The maximum transmission unit (MTU) that refers to the maximum size of data blocks into which a set of data is divided and that is transmittable by a single transfer.

④ IP address

IP address used.

⑤ netmask

Subnet mask used.

⑥ broadcast address

Broadcast address used.

- ⑦ output request count
A count of the number of send requests that were accepted for message transmission.
- ⑧ output count(success)
A count of the number of message transmissions that were done successfully.
- ⑨ output discard error count
A count of the number of message transmissions that failed due to memory shortage.
- ⑩ output error count
A count of the number of message transmission failure reports that were made by hardware following a send request issued by the driver to the hardware.
- ⑪ deliver count
A count of the number of received-message deliveries that were made to users.
- ⑫ input count
A count of the number of message reception reports that were made by hardware.
- ⑬ input discard error count
A count of the number of message receptions that failed due to memory shortage.
- ⑭ input error count
A count of the number of message reception failure reports that were made by hardware following a “get message” request issued by the driver to the hardware.

3 TECHNICAL SUPPORT INFORMATION

(3) Memory information

The memory information displayed as shown below is the statistics maintained by the memory management routine.

The screenshot shows a window titled "Display Status of Network" with a close button (X) in the top right corner. It contains two input sections: "Information of Connection module" with fields for "Module name" (CMU) and "IP address" (192.192.192.1); and "Selection of Display module" with a dropdown menu showing "CMU". To the right are buttons for "Close", "Refresh (R)", and "Save (V)". Below these are tabs for "Active socket", "Interface", "Memory", "Route", "IP", "ICMP", "TCP", "UDP", "Addition", and "ARP". The "Memory" tab is selected, showing "Cluster top address : 0x84923000". A table displays memory statistics:

Contents	CURRENT	MAX	HIGH	DROP
mbufs in use	40/48	32/48	48	0/0
data	1	1	7	0
packet headers	2	0	3	0
socket structures	12	10	12	0
protocol control blocks	23	19	23	0
routing table entries	1	1	1	0
socket names and addresses	0	0	1	0
socket options	0	0	1	0
interface addresses	1	1	1	0
Kbytes allocated	6/1060	10/1060	10	0/0
mbufs	6	6	6	0
clusters	0	4	4	0

where:

- **CURRENT:** The current state of mbuf.
- **MAX:** The status of mbuf at its maximum utilization.
- **HIGH:** Peak value for each item.
- **DROP:** The status of mbuf in the event of an overflow.

① Cluster top address

The starting address of the cluster memory.

② mbufs in use

The number of mbufs currently in use, and the total number of allocated mbufs. The following table shows details of the mbufs currently in use.

Item	Description
data	The number of mbufs in which communication data is stored.
packet headers	The number of mbufs in which a packet header is stored.
socket structures	The number of mbufs in which a socket structure is stored.
protocol control blocks	The number of mbufs in which a protocol control block is stored.
routing table entries	The number of mbufs in which routing table entries are stored.
IP reassembly-awaiting data	The number of mbufs in which IP reassembly-awaiting data is stored.
socket names and addresses	The number of mbufs in which a socket address is stored.
socket options	The number of mbufs in which a socket option is stored.
interface addresses	The number of mbufs in which the address of a network interface is stored.

③ Kbytes allocated

The size of the cluster memory or mbufs currently in use, and the total size of the memory allocated to clusters. For details on the size of the cluster memory currently in use, see the following items:

Item	Description
mbuf	The size of the memory used as mbufs.
clusters	The size of the memory used as clusters.

④ Mbuf/cluster allocation failures count

A count of the number of mbuf/cluster allocation failures due to a “cluster full” condition.

⑤ Cluster request count

A count of the number of cluster requests issued after the number of clusters used reached the upper limit.

Any item with CURRENT, MAX, HIGH, and DROP each set equal to 0 is excluded from the displayed list.

3 TECHNICAL SUPPORT INFORMATION

(4) Routing information

The routing information displayed as shown below is concerning the routes registered in the CMU and ET.NET modules.

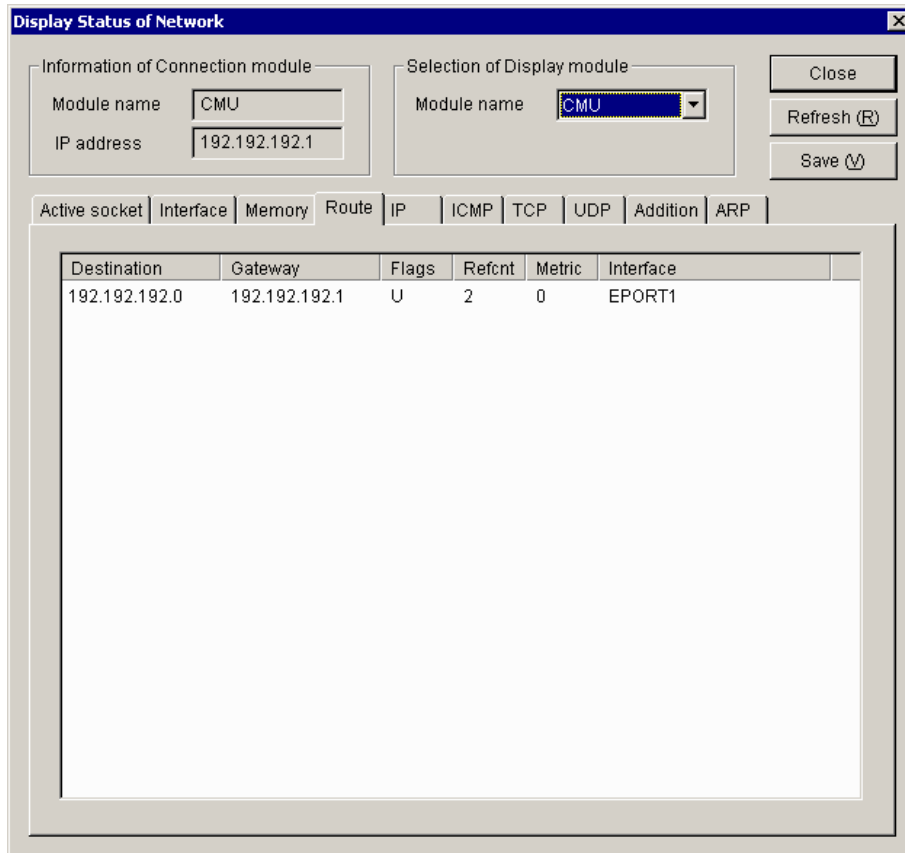

where:

① Destination

The network address of the destination. In the case of virtual network addresses, an asterisk (“*”) is appended to the end of the address value.

② Gateway

The IP address of the gateway associated with the destination.

③ Flags

Information indicating the status of the route. These flags are classified into the following three types:

Flag symbol	Description
U	Indicates that the route is currently in operation.
G	Indicates that the routing is to a gateway.
H	Indicates that the routing is to a host.

- ④ Refcnt
A count of the number of users who are using the route.
- ⑤ Metric
A hop count of the number of gateways that are present in the route to the destination.
- ⑥ Interface
Always the string “EPORT” is displayed as this item.

3 TECHNICAL SUPPORT INFORMATION

(5) IP statistical information

The IP statistical information displayed as shown below is a set of statistics concerning the IP protocol.

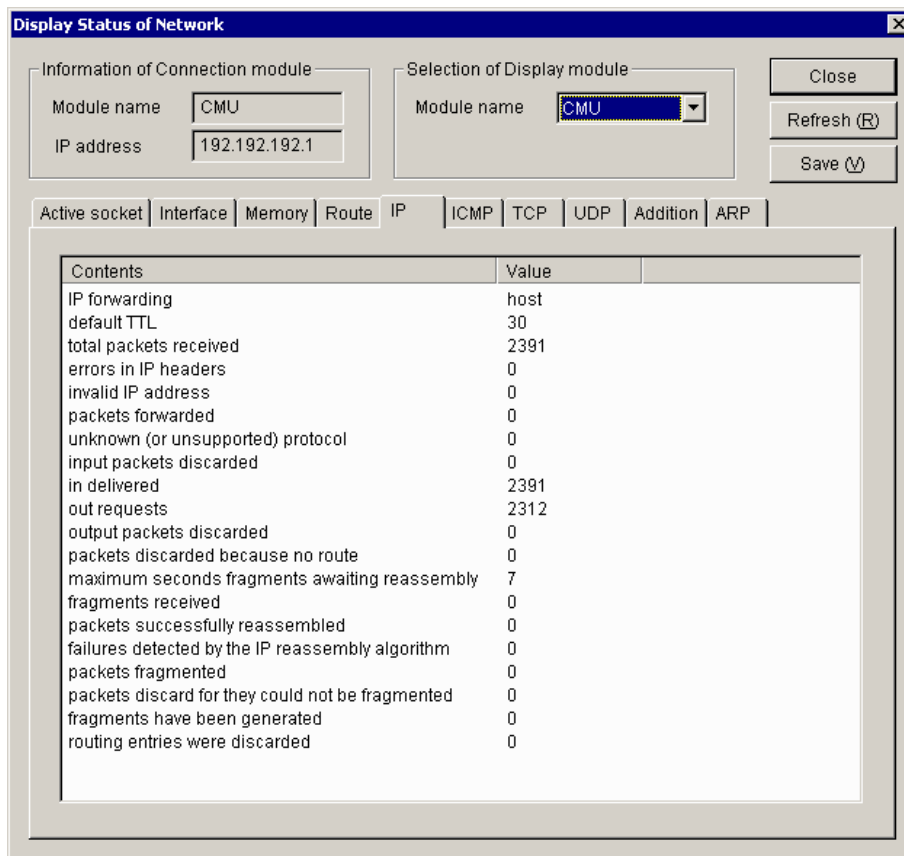

where:

① IP forwarding

Since forwarding is not supported, the string "host" is displayed as this item. If it was supported, an indication would be displayed which indicates whether it is operating as a forwarding gateway.

② default TTL

The default value of TTL (Time To Live) that determines the maximum hop count.

③ total packets received

The total number of IP packets that were received from all existing network interfaces.

④ errors in IP headers

The total number of IP packets that were discarded because of an error, such as a checksum or version error in the IP header.

⑤ invalid IP address

The total number of IP packets that were discarded because the destination IP address was incorrect.

- ⑥ packets forwarded
The total number of IP packets that were forwarded (or routed to another interface).
- ⑦ unknown (or unsupported) protocol
The total number of IP packets whose IP header contained a specification of an undefined upper protocol.
- ⑧ input packets discarded
The total number of IP packets that were received but discarded without being delivered to an upper protocol because of a buffer area shortage, or that the upper protocol refused to receive.
- ⑨ in delivered
The total number of IP packets that were delivered to an upper protocol, such as TCP or UDP.
- ⑩ out requests
The total number of IP packets for which a send request was issued by an upper protocol.
- ⑪ output packets discarded
The total number of IP packets that were discarded because of a buffer shortage or some other cause.
- ⑫ packets discarded because no route
The total number of IP packets that were discarded because they could not be routed due to a routing information setting error or some other cause.
- ⑬ maximum seconds fragments awaiting reassembly
The maximum number of seconds during which a fragment awaiting reassembly may be placed in hold state.
- ⑭ fragments received
The total number of fragment packets that were received.
- ⑮ packets successfully reassembled
The number of fragments that were reassembled successfully.
- ⑯ failures detected by the IP reassembly algorithm
The number of failures in fragment reassembly that were caused by a timeout, resource shortage, or some other cause.
- ⑰ packets fragmented
The total number of transmission IP packets that were fragmented at transmission time because they exceeded the MTU size.
- ⑱ packets discard for they could not be fragmented
The total number of transmission IP packets that could not be fragmented because of a resource shortage or some other cause.
- ⑲ fragments have been generated
The total number of fragment packets that were created by the fragmentation of transmission IP packets.
- ⑳ routing entries were discarded
The number of routing entries that were discarded.

3 TECHNICAL SUPPORT INFORMATION

(6) ICMP statistical information

The ICMP statistical information displayed as shown below is a set of statistics concerning the ICMP protocol.

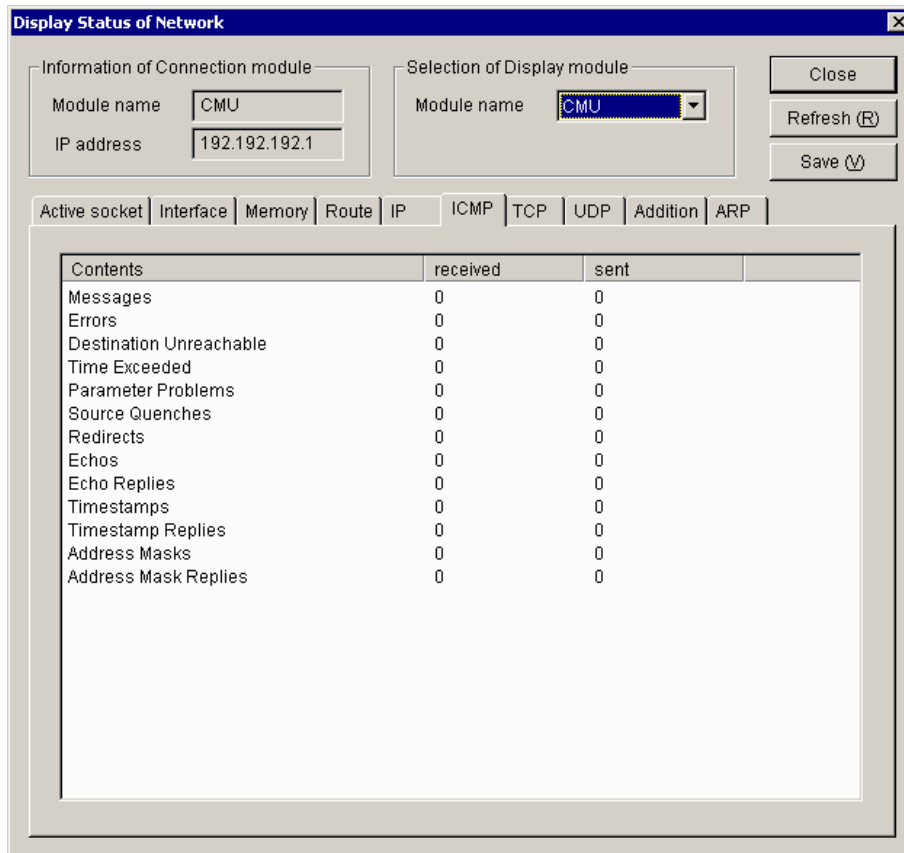

Contents	received	sent
Messages	0	0
Errors	0	0
Destination Unreachable	0	0
Time Exceeded	0	0
Parameter Problems	0	0
Source Quenches	0	0
Redirects	0	0
Echos	0	0
Echo Replies	0	0
Timestamps	0	0
Timestamp Replies	0	0
Address Masks	0	0
Address Mask Replies	0	0

where:

- ① Messages
The total number of ICMP messages that were processed.
- ② Errors
The total number of ICMP error messages that were processed.
- ③ Destination Unreachable
The total number of ICMP messages that could not be transmitted to the destination.
- ④ Time Exceeded
The total number of ICMP messages that were discarded during routing because of a TTL (Time To Live) shortage.
- ⑤ Parameter Problems
The total number of ICMP messages that reported on a parameter error.

⑥ Source Quenches

The total number of ICMP messages that requested the control of transmissions because of a resource shortage on the receiving side.

⑦ Redirects

The total number of ICMP messages that reported on the existence of a more suitable route to the destination.

⑧ Echos

The total number of ICMP messages that were transmitted from the sending side of ping.

⑨ Echo Replies

The total number of ICMP messages that were returned from the receiving side of ping.

⑩ Timestamps

The total number of ICMP messages that were used as Timestamp requests.

⑪ Timestamp Replies

The total number of ICMP messages that were used as responses to Timestamp requests.

⑫ Address Masks

The total number of ICMP messages that were used as Address Mask Requests.

⑬ Address Mask Replies

The total number of ICMP messages that were used as responses to Address Mask Requests.

3 TECHNICAL SUPPORT INFORMATION

(7) TCP statistical information

The TCP statistical information displayed as shown below is a set of statistics concerning the TCP protocol.

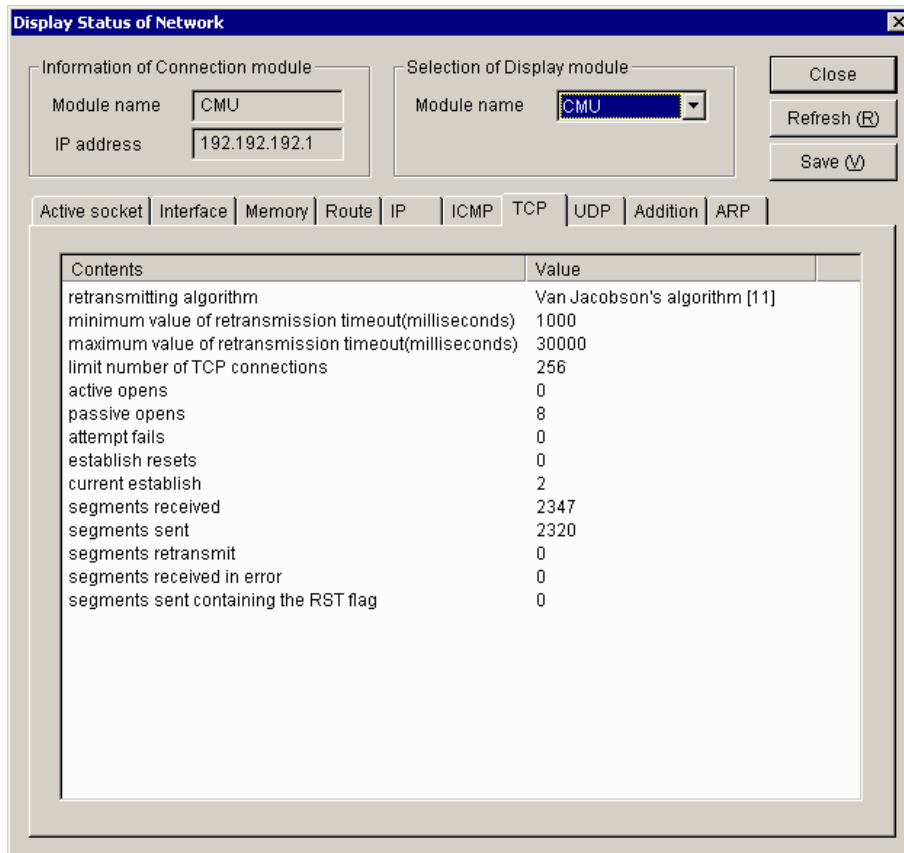

where:

① retransmitting algorithm

Name of the retransmission timeout (RTO) algorithm used.

② minimum value of retransmission timeout(millisecons)

The minimum value of retransmission timeout period expressed in milliseconds.

③ maximum value of retransmission timeout(millisecons)

The maximum value of retransmission timeout period expressed in milliseconds.

④ limit number of TCP connections

The maximum number of connections that can be established at a time.

⑤ active opens

The number of connections that were established to satisfy the connection requests issued to the outside.

⑥ passive opens

The number of connection requests that were received from the outside.

- ⑦ attempt fails
The number of connection requests whose attempt to connect failed.
- ⑧ establish resets
The number of connection requests that were rejected during their processing.
- ⑨ current establish
The total number of TCP connections currently active.
- ⑩ segments received
The total number of segments (units of data each transmitted by TCP at a time) that were received.
- ⑪ segments sent
The total number of segments that were transmitted.
- ⑫ segments retransmit
The total number of segments that were retransmitted because a reception acknowledgement was received from the destination.
- ⑬ segments received in error
The number of received segments that contained an error.
- ⑭ segments send containing the RST flag
The number of received segments that contained a reset flag.

3 TECHNICAL SUPPORT INFORMATION

(8) UDP statistical information

The UDP statistical information displayed as shown below is a set of statistics concerning the UDP protocol.

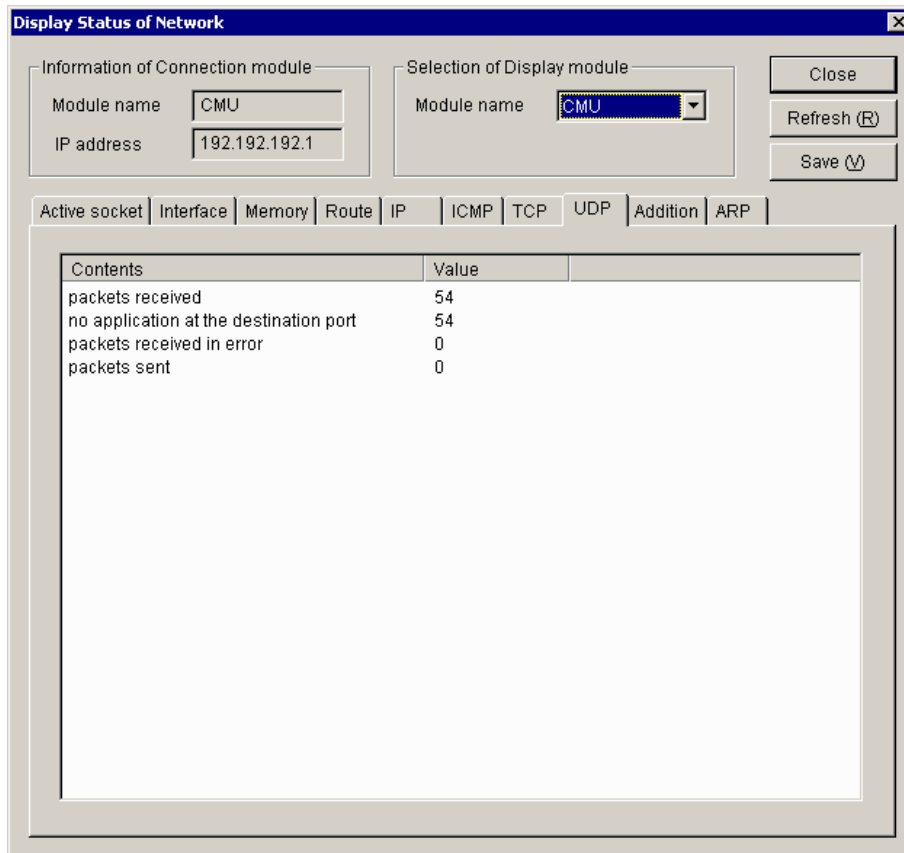

where:

- ① packets received
The total number of UDP packets that were received.
- ② no application at the destination port
The number of UDP packets for which no receiving application (port number) could be found at the destination.
- ③ packets received in error
The total number of UDP packets that could not be delivered to upper services because of an error or some other cause.
- ④ packets sent
The total number of UDP packets that were transmitted.

(9) Cumulative information

The cumulative information displayed as shown below is a variety of counts maintained in the existing interface modules.

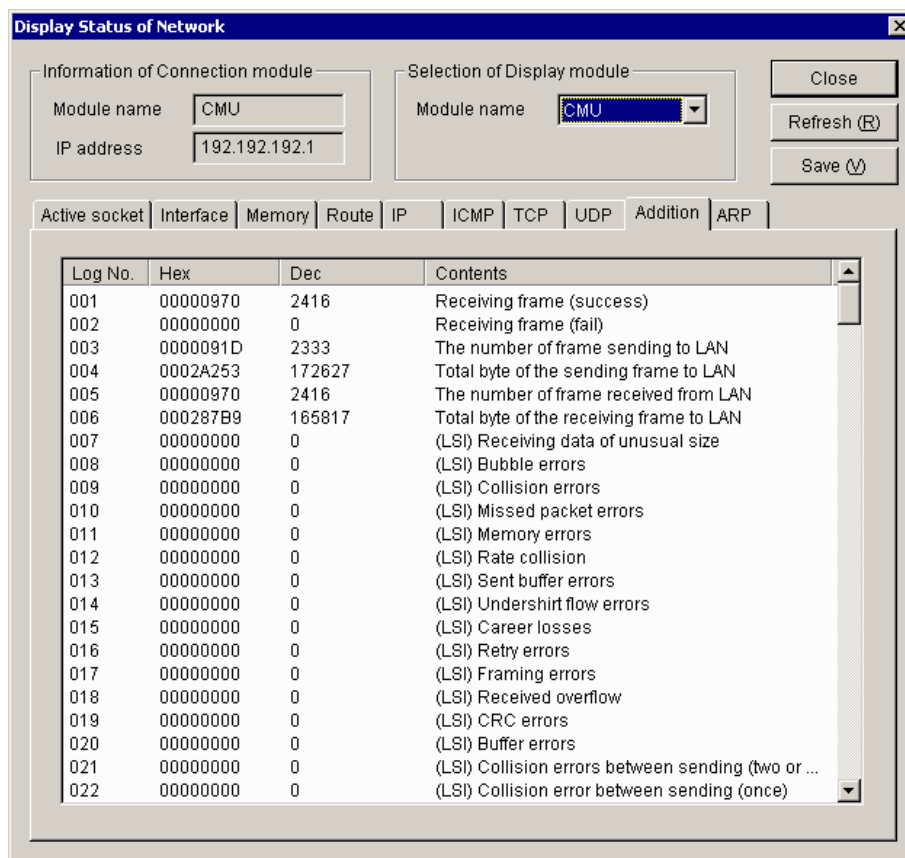

<Details of major cumulative info>

The following is a description of the log numbers 001 through 129 displayed as cumulative information. All log numbers other than listed are used as internal information for maintenance purposes.

- Log number 001: Receiving frame (success)
The number of frames that were received normally.
- Log number 002: Receiving frame (fail)
The number of frames that caused an error during reception.
- Log number 003: The number of frame sending to LAN
The number of frames that were sent out to the communication line.
- Log number 004: Total byte of the sending frame to LAN
The total number of bytes of the frames that were sent out to the communication line.
- Log number 005: The number of frame received from LAN
The number of frames that were received from the communication line. This number includes the frames that were received normally or abnormally.

3 TECHNICAL SUPPORT INFORMATION

- Log number 006: Total byte of the receiving frame to LAN
The total number of bytes of the frames that were received from the communication line.
- Log number 007: (LSI) Receiving data of unusual size
The number of frames whose frame length was abnormal.
- Log number 008:
CMU: (LSI) Bubble errors
Unused
ET.NET: (LSI) The number of times which failed in sending since 3.2msec was exceeded
The number of transmissions that failed due to a transmission delay (i.e., those transmissions that could not be started within 3.2 milliseconds or more after the issuance of the send request).
- Log number 009:
CMU: (LSI) Collision errors
The number of collision errors detected.
ET.NET: (LSI) Sending errors
The number of transmissions aborted.
- Log number 010: (LSI) Missed packet errors
The number of packets that were lost during operation because the communication LSI's internal buffer was full.
- Log number 011:
CMU: (LSI) Memory errors
The number of errors detected in accessing the communication LSI device's internal memory.
ET.NET: (LSI) Receiving status FIFO buffer overrun
The number of reception status FIFO buffer overruns detected in the communication LSI device at reception time.
- Log number 012:(LSI) Late collision
The number of late collisions (i.e., collisions detected during the transmission of the 64th or subsequent byte of data after the preamble) that occurred during transmission.
- Log number 013:
CMU: (LSI) Sent buffer errors
The number of times the communication buffer became full.
ET.NET: (LSI) sending data FIFO buffer undershirt run
The number of send-data FIFO buffer underruns detected in the communication LSI device at transmission time.
- Log number 014: (LSI) Undershirt flow errors
The number of send-buffer underflow errors that occurred during transmission.
- Log number 015: (LSI) Career losses
The number of carrier losses that occurred due to a disconnected cable, a power-off condition of the hub, or some other cause during transmission.

- Log number 016: (LSI) Retry errors
The number of retry errors (i.e., attempts to do more retries than permitted) that occurred during transmission.
- Log number 017: (LSI) Framing errors
The number of framing errors that occurred during reception.
- Log number 018: (LSI) Received overflow
The number of receive-buffer overflows that occurred during reception.
- Log number 019: (LSI) CRC errors
The number of frame CRC errors that occurred during reception.
- Log number 020:
CMU: (LSI) Buffer errors
The number of times the receive buffer became full.
ET.NET: (LSI) Receiving data FIFO buffer overrun
The number of receive-data FIFO buffer overruns detected in the communication LSI device at reception time.
- Log number 021: (LSI) Collision errors between sending (two or more)
The number of times more than one collision was detected during transmission.
- Log number 022: (LSI) Collision error between sending (once)
The number of times a single collision was detected during transmission.
- Log number 023: (LSI) Delay between sending
The number of delays that occurred during transmission, where each transmission was terminated normally.
- Log number 024: Frame-send-timeout
The number of frame-send-timeouts that occurred.
- Log number 129: Adapter state (top 2 bytes), LINK, 10M/100Mbps, Full-duplex / half-duplex state (bottom 2 bytes)
Data communication speed and full-duplex/half-duplex state of the CMU/ET.NET module used.

Read this information according to the following table:

Connection type		Displayed value (*)	
		Hexadecimal	Decimal
10 Mbps	Half-duplex	00000001	1
	Full-duplex	00000005	5
100 Mbps	Half-duplex	00000003	3
	Full-duplex	00000007	7

(*) If a connection is not established over the communication line, the displayed value will be 0 (fixed).

3 TECHNICAL SUPPORT INFORMATION

(10) ARP table information

The ARP table information displayed as shown below is the contents of the translation table that is used by the ARP (Address Resolution Protocol) for translation of IP addresses to physical addresses.

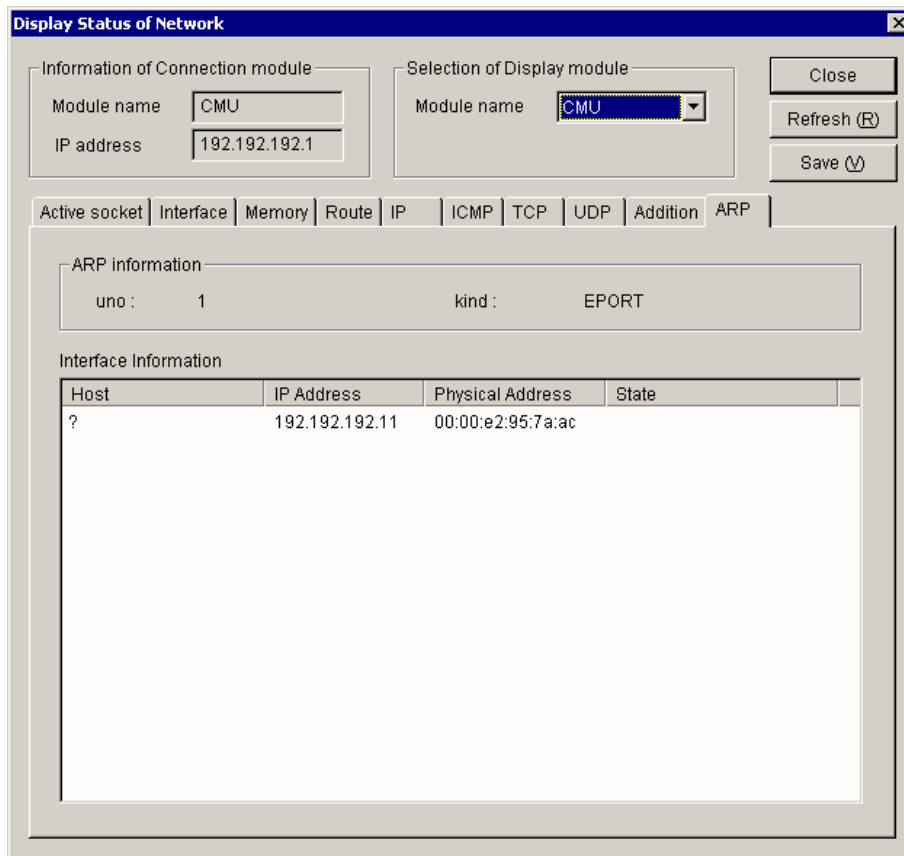

where:

- ARP information

- ① uno

A value of 1 is always displayed as this item.

- ② kind

The string "EPORT" is always displayed as this item.

- Interface Information

ARP entries that are registered.

- ① Host

The host name associated with the IP address displayed.

The host names displayed under this heading are those which are listed in the "hosts" file in the Tool currently in operation. If no host names are registered in that file, a question mark ("?") is displayed instead.

② IP Address

The IP address of the destination registered in the ARP table.

③ Physical Address

The physical address(es) of the destination(s) registered in the ARP table. If an ARP entry is found invalid, the string “(incomplete)” is displayed instead.

④ State

The current state(s) of the ARP entry (entries). The possible states are as follows:

State name displayed	Meaning
permanent	Fixed entry
published	Proxy ARP entry

3 TECHNICAL SUPPORT INFORMATION

3.20 Network Maintenance Commands

Command	Function	CMU	ET.NET	NCP-F	LANCP
svarp	Displays or modifies the address translation table.	√	√	√	√
svnetstat	Displays the network status.	√	√	√	√
svfrstat	Displays the ring map, the station configuration, and operation information.	nu	nu	√	nu
svfrtest	Instructs configuration modification for the specified machine on the ring, or performs a loopback test.	nu	nu	√	nu
svnetlog	Displays the cumulative information.	√	√	nu	√

√: Can be used; nu: Cannot be used.

3.20.1 Usage

To use network management commands, specify the following storage location and enter each command in the general command form shown below.

<Storage location>

C:\Hitachi\S10V\S10BASE\bin

The above pathname assumes that the S10V BASE SYSTEM is installed in the folder identified by the pathname “C:\Hitachi\S10V\S10BASE”.

<General command form>

command_name target_ctrl interface [arg]

Where target_ctrl is the host name or internet address of an S10V controller in need of maintenance, and interface is the unit number of an interface in need of maintenance. The unit number here may be the unit number of any network interface installed in the S10V controller specified by target_ctrl. (In the case of a CMU or ET.NET [model LQE720] module used by Ethernet connection, their unit number is always 1.)

Any interface used by the S10V controller for communication with the PC can be specified in target_ctrl. When using svfrtest, however, be sure to specify the interface you are not maintaining. To work on interface 1 in the example shown below, be sure to specify the internet address of interface 0 in target_ctrl and the unit number of interface 1 in the interface.

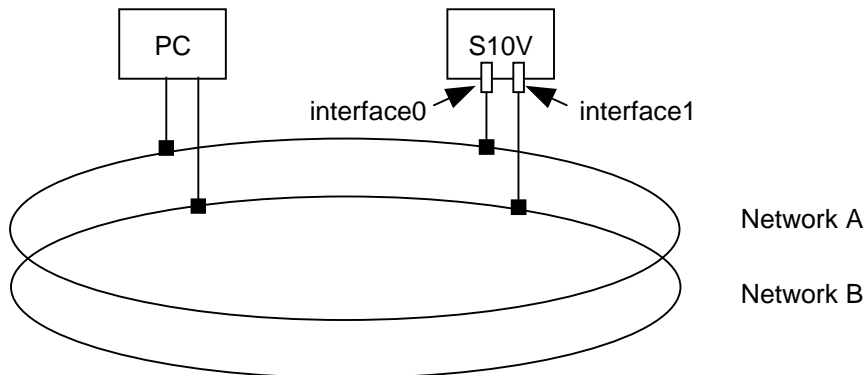

When specifying a host name in arg, make sure that the host name is already registered in the ‘/etc/hosts’ in the PC. This assures that the PC translates the host name to an IP address before sending it to the S10V controller.

The values set in the network maintenance commands have no effect when the system is started again.

3 TECHNICAL SUPPORT INFORMATION

svarp

<NAME>

svarp -- display or modify ARP information (correspondence between internet addresses and MAC addresses).

<SYNOPSIS>

```
svarp target_ctlr interface host
```

```
svarp target_ctlr interface -a
```

```
svarp target_ctlr interface -d host
```

```
svarp target_ctlr interface -s host etaddr
```

<DESCRIPTION>

The svarp command displays or modifies the table that translates Internet addresses used by the address resolution protocol (ARP) to MAC addresses.

target_ctlr: Specifies the host name or dot internet address of the target controller.

interface: Specifies the unit number of the target interface.

host: Specifies the host name or dot internet address of the host for which ARP information is to be displayed, registered, or deleted.

etaddr: Specifies the MAC address of the host to be registered.

No option: Displays the ARP information for the host specified in host.

-a: Displays all the ARP information for a specified interface of the controller in need of maintenance.

-d: Deletes the ARP information piece for the host specified in host. This option may be used only by the superuser. When the specified entry is not found, this command results in an error.

-s: Sets an MAC address for the host specified in host. Specify addr in the form of xx:xx:xx:xx:xx:xx, where each xx is a hexadecimal number. Only superusers can use this option. The entry registered by this option remains in effect until the entry is deleted with "arp -d". Up to 30 entries can be registered. An attempt to register more than this limit results in an error.

The values set in this command have no effect when the system is started again.

<Display format>

This command displays information on the ARP table in the following format when no options or the -a option is specified:

hostname (IPaddress) at MACaddress

Example:

romeo (192.0.1.1) at 0:0:87:a0:0:23

svnetstat

<NAME>

svnetstat -- display the network status.

<SYNOPSIS>

```
svnetstat target_ctrlr interface [ -a | -i | -m | -r | -s | -rs ]
```

```
svnetstat target_ctrlr interface -fm sn
```

<DESCRIPTION>

The svnetstat command displays the data structures related to various networks.

target_ctrlr: Specifies the host name or dot internet address of the controller in need of maintenance.

interface: Specifies the unit number of the interface in need of maintenance.

No options: Displays a list of all active sockets for each protocol. (*)

-a: In addition to the list displayed when no options are specified, displays status information for all sockets. (*)

-i: Displays status information for the network interfaces in operation.

-m: Displays the statistics maintained by the memory management routine. The CMU and LANCP modules are collectively subjected to the same memory management process. For this reason, when you want to view statistical information on these nodules, specify the value 1 as the unit number.

-r: Displays route information.

-rs: Displays statistical information on routing.

-s: Displays statistical information on each protocol. (*)

-fm sn: Displays MIB information on the FDDI interface of the station identified by a specified station number. Make sure that the specified controller and interface in need of maintenance are connected to the ring to which the interface requesting FDDI MIB is connected.

(*) If you specify the unit number for the CMU and LANCP modules used in combination, the status information to be displayed is derived with regard to their actual unit numbers.

3 TECHNICAL SUPPORT INFORMATION

<Display format>

The following examples of displays show the display formats used by the `svnetstat` command, which vary depending on the type of option used.

(1) Socket status display format (when no option or the `-a` option is used)

Proto	Local Address	Foreign Address	(state)
tcp	158.212.107.198.1105	158.212.109.150.1122	SYN_SENT

Proto: The name of the protocol used.

Local Address: The IP address and port number of the local host.

Foreign Address: The IP address and port number of the remote host.

(state): The status of the TCP protocol, displayed only when Proto is tcp.

Note: If the TCP protocol is used over more than 150 ports of modules other than the NCP-F, no status information will be displayed for the excess port(s) and UDP protocol. If the TCP protocol is used over more than 80 ports, no status information may be displayed for the UDP protocol.

(2) Routing information display format (when the `-r` option is used)

Destination	Gateway	Flags	Refcnt	Metric	Interface
158.212.109	158.212.102.3	U	1	1	NCP-F6

Destination: The network address of the last destination network.

Gateway: The host name or IP address of the gateway.

Flags: The following status flags for gateway routing information for the destination:

U: Indicates that the route is in operation.

G: Indicates that it is a route to a gateway.

H: Indicates that it is a route to a host.

Refcnt: The number of interfaces currently using the routing information.

Metric: A hop count of the number of gateways through which data passes to reach the destination network or host.

Interface: The interface having the routing information, and its unit number.

(3) Interface information display format (when the -i option is used)

```

UNIT NO. 5:
  slot = 5
  kind = LANCP
  MTU = 1500
  IP address      = 160.160.0.1
  Netmask         = 255.255.0.0
  broadcast address = 160.160.255.255
  output request count      = 0
  output count(success)    = 532
  output discard error count = 1
  output error count       = 1
  deliver count            = 0
  input count               = 622
  input discard error count = 13
  input error count        = 10

```

slot: Slot number

kind: Interface type

MTU: Maximum number of transferable bytes

IP address: (Self-explanatory)

netmask: Net mask

broadcast address: (Self-explanatory)

output request count: A count of the number of accepted message transmission requests -- only for NCP-F.

output count (success): A count of the number of successful message transmissions -- not applicable to LANCP (10BASE-5).

output discard error count: A count of the number of message transmissions failed due to insufficient memory.

output error count: A count of the number of times hardware reported the number of message transmissions -- with LANCP (10BASE-5), this count includes the number of transmissions done successfully.

deliver count: A count of the number of times transmitted messages were passed to the user -- only for NCP-F.

input count: A count of the number of times hardware reported message receptions.

input discard error count: A count of the number of message receptions failed due to insufficient memory.

input error count: A count of the number of times hardware reported the number of message transmissions.

3 TECHNICAL SUPPORT INFORMATION

(4) Statistical information display format (when the -s option is used)

ip:

ip forwarding:host	...	(a)
0 default TTL	...	(b)
0 total packets received	...	(c)
0 errors in IP headers	...	(d)
0 invalid IP address	...	(e)
0 packets forwarded	...	(f)
0 unknown (or unsupported) protocol	...	(g)
0 input packets discarded	...	(h)
0 in delivered	...	(i)
0 out requests	...	(j)
0 output packets discarded	...	(k)
0 packets discarded because no route	...	(l)
0 maximum seconds fragments awaiting reassembly	...	(m)
0 fragments received	...	(n)
0 packets successfully reassembled	...	(o)
0 failures detected by the IP reassembly algorithm	...	(p)
0 packets fragmented	...	(q)
0 packets discard for they could not be fragmented	...	(r)
0 fragments have been generated	...	(s)
0 routing entries were discarded	...	(t)

icmp:		
	0 messages recieved	... (A)
	0 error messages	... (B)
	0 destination unreachable	... (C)
	0 time exceeded	... (D)
	0 parameter problem	... (E)
	0 source quench	... (F)
	0 redirect	... (G)
	0 echo	... (H)
	0 echo reply	... (I)
	0 timestamp	... (J)
	0 timestamp reply	... (K)
	0 address mask request	... (L)
	0 address mask reply	... (M)
	0 messages sent	... (N)
	0 error messages	... (O)
	0 destination unreachable	... (P)
	0 time exceeded	... (Q)
	0 parameter problem	... (R)
	0 source quench	... (S)
	0 redirect	... (T)
	0 echo	... (U)
	0 echo reply	... (V)
	0 timestamp	... (W)
	0 timestamp reply	... (X)
	0 address mask request	... (Y)
	0 address mask reply	... (Z)
tcp:		
	retransmitting algorithm:	... ①
	0 minimum value of retransmission timeout (milliseconds)	... ②
	0 maximum value of retransmission timeout (milliseconds)	... ③
	0 limit number of TCP connections	... ④
	0 active opens	... ⑤
	0 passive opens	... ⑥
	0 attempt fails	... ⑦
	0 establish resets	... ⑧
	0 current establish	... ⑨
	0 segments received	... ⑩
	0 segments sent	... ⑪
	0 segments retransmit	... ⑫
	0 segments received in error	... ⑬
	0 segments sent containing the RST flag	... ⑭
udp:		
	0 packets recieved	... ⑮
	0 no application at the destination port	... ⑯
	0 packets recieved in error	... ⑰
	0 packets sent	... ⑱

3 TECHNICAL SUPPORT INFORMATION

<Description of IP information>

- (a) Indicates whether it is operating as an IP gateway.
(“gateway”: Operating as a gateway; host: Not operating as a gateway)
- (b) Default value of Time-to-Live for IP packets.
- (c) Total number of received IP packets.
- (d) The number of packets discarded due to IP header errors.
- (e) The number of packets discarded due to destination address errors.
- (f) The number of forwarded packets.
- (g) The number of packets discarded due to unclear protocols or unsupported protocols.
- (h) The number of packets received but discarded due to insufficient buffers and other causes.
- (i) The number of packets received and passed to upper protocols.
- (j) The number of packets for which transmission is requested by upper protocols -- this number does not include (f).
- (k) The number of packets transmitted but discarded due to insufficient buffers and other causes.
- (l) The number of packets discarded due to the lack of information on routing to the destination address.
- (m) Maximum time during which the received fragment waits to be reconfigured (in seconds).
- (n) The number of received fragments.
- (o) The number of fragments successfully reconfigured.
- (p) The number of detected unsuccessful reconfigurations.
- (q) The number of packets successfully fragmented.
- (r) The number of packets discarded due to unsuccessful fragmentation.
- (s) The number of created fragments.
- (t) The number of discarded routing entries.

<Description of ICMP information>

The accumulated values Except for (A), (B), (N), and (O), all counts are displayed only when they indicate packets were actually sent or received.

- (A) The number of received ICMP messages -- this number includes (B).
- (B) The number of ICMP messages resulting in reception errors.
- (C) The number of received ICMP Destination Unreachable messages.
- (D) The number of received ICMP Time Exceeded messages.
- (E) The number of received ICMP Parameter Problem messages.
- (F) The number of received ICMP Source Quench messages.
- (G) The number of received ICMP Redirect messages.
- (H) The number of received ICMP Echo messages.
- (I) The number of received ICMP Echo Reply messages.
- (J) The number of received ICMP Timestamp messages.
- (K) The number of received ICMP Timestamp Reply messages.
- (L) The number of received ICMP Address Mask Request messages.
- (M) The number of received ICMP Address Mask Reply messages.
- (N) The number of transmitted ICMP messages -- this number includes (O).
- (O) The number of ICMP messages resulting in transmission errors.
- (P) The number of transmitted ICMP Destination Unreachable messages.
- (Q) The number of transmitted ICMP Time Exceeded messages.
- (R) The number of transmitted ICMP Parameter Problem messages.
- (S) The number of transmitted ICMP Source Quench messages.
- (T) The number of transmitted ICMP Redirect messages.
- (U) The number of transmitted ICMP Echo messages.
- (V) The number of transmitted ICMP Echo Reply messages.
- (W) The number of transmitted ICMP Timestamp messages.
- (X) The number of transmitted ICMP Timestamp Reply messages.
- (Y) The number of transmitted ICMP Address Mask Request messages.
- (Z) The number of transmitted ICMP Address Mask Reply messages.

3 TECHNICAL SUPPORT INFORMATION

<Description of TCP information>

- ① Retransmission algorithm type.
- ② Minimum retransmission time-out value (milliseconds).
- ③ Maximum retransmission time-out value (milliseconds).
- ④ Maximum number of TCP connections that can be opened concurrently.
- ⑤ The number of active opens made.
- ⑥ The number of passive opens made.
- ⑦ The number of state transitions made from SYN-SENT or SYN-RCVD to CLOSE.
- ⑧ The number of state transitions made from ESTABLISHED or CLOSE-WAIT to CLOSE.
- ⑨ The number of TCP connections currently in the ESTABLISHED or CLOSE-WAIT state.
- ⑩ The number of received packets.
- ⑪ The number of transmitted packets.
- ⑫ The number of retransmitted packets.
- ⑬ The number of errors in received packets.
- ⑭ The number of TCP packets transmitted with the RST flag turned on.

<Description of UDP information>

- ⑮ The number of received packets.
- ⑯ The number of received packets for which there were no applications at the destination.
- ⑰ The number of received packets in error, except for ⑯.
- ⑱ The number of transmitted packets.

(5) Memory statistical info display format (when the -m option is used)

Format used when an NCP-F interface is specified:

<SRBUFF Information>

Top	Free	Aline	Total	Use	Wait	Peack	Overflow
addr	addr	addr	buff cnt	cnt	cnt	cnt	cnt
0XXXXXXXX	0XXXXXXXX	0XXXXXXXX	0	0	0	0	0

<Page Information>

Page	Refcnt	Aline
0	0	0
0	0	0

<Block Information>

Page	Block	Use	Aline	Addr	CBIX
0	0	0	0	0XXXXXXXX	0XXXXXXXX
0	0	0	0	0XXXXXXXX	0XXXXXXXX
0	0	0	0	0XXXXXXXX	0XXXXXXXX
0	0	0	0	0XXXXXXXX	0XXXXXXXX
0	0	0	0	0XXXXXXXX	0XXXXXXXX
0	0	0	0	0XXXXXXXX	0XXXXXXXX

SRBUFF Information

Top addr: Starting address of the buffer used.

Free addr: Starting address of the free buffer list.

Aline addr: Address of the buffer that extends beyond a 1Mth-byte boundary.

Total buff cnt: Total number of existing buffer cases.

Use cnt: The number of buffers in use.

Wait cnt: The number of waits for available buffers.

Peack cnt: Maximum number of usable buffers.

Overflow cnt: The number of buffer overflows detected.

Page Information

Page: The number of pages under management.

Refcnt: The number of intra-page buffers in use.

Aline: 1Mth-byte boundary flag.

Block Information

Page: Page number

Block: Block number

Use: Buffer-in-use flag.

Aline: 1Mth-byte boundary flag.

Addr: Intra-page buffer address.

CBIX: Address of the page management table.

3 TECHNICAL SUPPORT INFORMATION

Format used when a built-in LANCE or LANCP interface is specified:

CURRENT:

XXX/XXX mbufs in use: ... (a)
 XXX mbufs allocated to data ... (b)
 XXX mbufs allocated to packet headres ... (c)
 XXX mbufs allocated to socket structures ... (d)
 XXX mbufs allocated to protocol control blocks ... (e)
 XXX mbufs allocated to routing table entries ... (f)
 XXX mbufs allocated to fragment reassemble queue headers ... (g)
 XXX mbufs allocated to socket names and addresses ... (h)
 XXX mbufs allocated to socket options ... (i)
 XXX mbufs allocated to interface addresses ... (j)
XXX/XXX Kbytes allocated:(top address 0xXXXXXXXX) ... (k)
 XXX Kbytes allocated to mbufs ... (l)
 XXX Kbytes allocated to clusters ... (m)
XXX requests for memory denied ... (n)
XXX overflows ... (o)

MAX:

XXX/XXX mbufs in use:
 XXX mbufs allocated to data
 XXX mbufs allocated to packet headres
 XXX mbufs allocated to socket structures
 XXX mbufs allocated to protocol control blocks
 XXX mbufs allocated to routing table entries
 XXX mbufs allocated to fragment reassemble queue headers
 XXX mbufs allocated to socket names and addresses
 XXX mbufs allocated to socket options
 XXX mbufs allocated to interface addresses
XXX/XXX Kbytes allocated:
 XXX Kbytes allocated to mbufs
 XXX Kbytes allocated to clusters

HIGH:

XXX mbufs in use:
 XXX mbufs allocated to data
 XXX mbufs allocated to packet headres
 XXX mbufs allocated to socket structures
 XXX mbufs allocated to protocol control blocks
 XXX mbufs allocated to routing table entries
 XXX mbufs allocated to fragment reassemble queue headers
 XXX mbufs allocated to socket names and addresses
 XXX mbufs allocated to socket options
 XXX mbufs allocated to interface addresses
XXX Kbytes allocated:
 XXX Kbytes allocated to mbufs
 XXX Kbytes allocated to clusters

DROP:

XXX/XXX mbufs in use:

XXX mbufs allocated to data

XXX mbufs allocated to packet headers

XXX mbufs allocated to socket structures

XXX mbufs allocated to protocol control blocks

XXX mbufs allocated to routing table entries

XXX mbufs allocated to fragment reassemble queue headers

XXX mbufs allocated to socket names and addresses

XXX mbufs allocated to socket options

XXX mbufs allocated to interface addresses

XXX/XXX Kbytes allocated:

XXX Kbytes allocated to mbufs

XXX Kbytes allocated to clusters

XXX requests for memory denied

XX overflows

CURRENT: The current state of mbufs in use.

MAX: The status of mbufs at their peak usage.

HIGH: Peak values of listed items.

DROP: The status of mbufs on the occurrence of an overflow -- this item is not displayed when no overflow was detected.

- (a) The number of mbufs in use/total number of mbufs.
- (b) The number of mbufs containing communication data.
- (c) The number of mbufs containing packet headers.
- (d) The number of mbufs containing socket tables.
- (e) The number of mbufs containing protocol control tables.
- (f) The number of mbufs containing routing table entries.
- (g) The number of mbufs containing data waiting to be IP-reassembled.
- (h) The number of mbufs containing socket addresses.
- (i) The number of mbufs containing socket options.
- (j) The number of mbufs containing network interface addresses.
- (k) Size of cluster memory currently in use/total size of memory allocated to mbufs or clusters.
- (l) Size of memory used as mbufs.
- (m) Size of memory used as clusters.
- (n) The number of unsuccessful allocations of mbufs or clusters due to full clusters.
- (o) The number of requests for clusters that were made after the maximum usable number of clusters was reached.

Of the above items, (b) through (j), (l), and (m) are not displayed when their value is 0.

3 TECHNICAL SUPPORT INFORMATION

(6) Routing statistical info display format (when the -rs option is used)

-- IP Routing Statistics --

IP Addr(uno)	Ipkts	Ierrs	D_uno	Routing	Opkts	Oerrs
*160.10.0.10(3)	50	10	5	20	10	1
			6	20	10	0
170.10.0.20(5)	25	5	3	20	10	0
			4	0	0	0
170.20.0.20(6)	20	0	3	20	10	0
			4	0	0	0
160.20.0.160(4)	0	0	5	0	0	0
			6	0	0	0

IP Addr: IP address of the NCP-F interface that reported packet reception to the routing feature.

(An interface currently not performing routing is displayed with its IP address prefixed with an asterisk [“*”].)

uno: Unit number of the NCP-F interface indicated by IP Addr.

Ipkts: The number of packets stored in the routing reception buffer by the NCP-F interface indicated by IP Addr -- this number does not include Ierrs.

Ierrs: The number of packets that were discarded by the NCP-F interface indicated by IP Addr, due to routing reception buffer overflows.

D_uno: Unit number of the NCP-F interface to which the routing feature forwarded packets.

Routing: The number of times the NCP-F interface indicated by IP Addr instructed packet forwarding to the destination NCP-F interface identified by D_uno.

Opkts: The number of times the routing feature sent a packet to the destination NCP-F interface -- this number includes Oerrs.

Oerrs: The number of unsuccessful transmissions to the destination NCP-F interface.

svnetlog**<NAME>**

svnetlog -- display count information.

<SYNOPSIS>

svnetlog target_ctrlr interface

<DESCRIPTION>

The svnetlog command displays count information for a specified interface.

target_ctrlr: Specifies the host name or Internet address in dot-separated format of a controller in need of maintenance.

interface: Specifies the unit number of an interface in need of maintenance.

<Display format>

The following example of a display shows the display format used by the svnetlog command. For details on count information displays, see the information provided under “(9) Addition information” of “3.19.2 Network information details.”

```
UNIT NO. = 1: LANCP LOGOUT:
LOGOUT:001          499
LOGOUT:002           0
LOGOUT:003          39
LOGOUT:004         7154
LOGOUT:005          499
LOGOUT:006        57030
LOGOUT:007           0
LOGOUT:008           0
LOGOUT:009           0
LOGOUT:010           0
LOGOUT:011           0
LOGOUT:012           0
LOGOUT:013           0
LOGOUT:014           0
    ⋮
LOGOUT:255           0
LOGOUT:256           0
```

THIS PAGE INTENTIONALLY LEFT BLANK.

4 ERROR LOG INFORMATION

4.1 Displaying Error Log Information

To display error log information on screen, start the S10V Base System by choosing [Start] – [Programs] – [Hitachi S10V] – [S10V BASE SYSTEM] on the Windows® personal computer connected with the LPU unit. Then, the [S10BASE] window appears. In this window, click the **Error Log** button. The [Error log information] window then appears, which enables you to view the information on errors that occurred in individual modules.

To view error information for the CMU or ET.NET (model LQE720) module, click the **Error Log Detail** button in the [Error log information] window. Then, the [Error Log Detail] window appears, which enables you to view the error log detail information for the CMU or ET.NET (model LQE720) module.

For details of the [Error log information] window, see the information provided under “4.2 Error Log Information and Required Actions.” For details of the [Error Log Detail] window, see the information provided under “4.4 RPDP Error Log Display Guide.”

For information on how to operate a variety of available tools, refer to the description under “6 TOOLS” in the “USER’S MANUAL BASIC MODULES (manual number SVE-1-100).”

4.2 Error Log Information and Required Actions

4.2.1 LPU (model LQP510) error log info and required actions

(1/3)

Error code	Meaning	Required action
0x1101	Processor register compare-check error	At startup, the self-diagnosis capability detected an error. Reset the LPU module and then check if the same error recurs. If so, replace the LPU module.
0x1102	Processor mathematical/logical operation check error	
0x1103	RAM compare-check error	
0x1105	ROM compare-check error	
0x1106	ROM checksum error	
0x1108	Ladder program checksum error	
0x1109	Timer diagnosis error	
0x110A	Ladder processor diagnosis error	
0x110B	Rotary switch setting range violation	A setting of the T/M or operation setting switch is outside the permitted range. Refer to the information provided under “3 NAMES AND FUNCTIONS OF EACH PART” in the “BASIC MODULES (manual number SVE-1-100),” set the switch again, and then reset the LPU module.
0x1201	RAM parity error	Reset the LPU module. Then, if the same error recurs, replace the module.
0x1202	RAM parity error (detected by the ladder processor)	
0x1203	Ladder illegal instruction detected	
0x1204	Ladder illegal instruction detected (by the ladder processor)	
0x1205	Watchdog timer timeout	
0x1206	Ladder program watchdog timer timeout	The processing time required by a ladder program exceeded the set time value of the watchdog timer. Set a larger value for the set time value of the watchdog timer, or reduce the required processing time of the ladder program.
0x1207	Stack overflowed	Reset the LPU module. Then, if the same error recurs, replace the module.
0x1208	Ladder program nesting overflowed	The depth of a nesting in a ladder program is five levels or more. Reduce the nesting depth to four levels or less.
0x1209	Protection error	An attempt to write data to a protected area in a ladder program was detected. Review the ladder program. For information on the protected area, refer to the information provided under “8 OPERATION” in the “BASIC MODULES (manual number SVE-1-100).”

4 ERROR LOG INFORMATION

(2/3)

Error code	Meaning	Required action
0x120A	User arithmetic function registration address error	A registration address for a user arithmetic function is set outside SEQ-RAM. Review the setting.
0x120B	RAM parity error (detected when an access was made to it from the system bus)	Reset the LPU module. Then, if the same error recurs, replace the module.
0x120C	Arithmetic function address error	An attempt to access a long word was made from a word boundary during execution of an arithmetic function. Review the user ladder program so that it will access a long word from a long-word boundary.
0x13XX	Undefined exception detected. (Except for the below, the “XX” in this error code is a vector number in hexadecimal in the range 00 to FF.) XX = 04 or 06: Illegal instruction detected. XX = 09 or 0A: Address error.	Reset the LPU module. Then, if the same error recurs, replace the module.
0x14XX	Optional-module memory parity error. (As shown below, the “XX” in this error code is a hexadecimal number in the range 80 to FF and identifies the optional module.)	A parity error occurred during accessing the optional module’s internal RAM from the LPU module. Reset the LPU module. Then, if the same error recurs, replace the optional module.
	XX	Identifies the optional module.
	80/81	Inter-CPU link module (80: main module; 81: submodule)
	82/83	OD.RING/SD.LINK (82: main module; 83: submodule)
	92/93	J.NET/J.NET-INT/IR.LINK (92: main module, 93: submodule)
	A0 to A3	RS-232C/RS-422 (A0: channel 0; A1: channel 1; A2: channel 2; A3: channel 3)
	D2/D3	ET.NET/SV.LINK (D2: main module, D3: submodule)
	E2/E3	FL.NET/EQ.LINK (E2: main module, E3: submodule)
F0 to F3	D.NET(F0: channel 0, F1: channel 1, F2: channel 2, F3:channel 3)	
0x15XX	Optional-module memory protection error. (The “XX” in this error code has the same meaning as the “XX” in the error code “0x14XX” above.)	A memory protection error occurred during accessing the optional module’s internal RAM from the LPU module. Reset the LPU module. Then, if the same error recurs, replace the optional module.
0x1601	CMU response monitoring timeout	No response was received from the CMU module. Reset the LPU module. Then, if the same error recurs, the CMU module may be in a failure condition. Replace the module.
0x1602	CMU down	The CMU module is down. Reset the LPU module. Then, if the same error recurs, the CMU module may be in a failure condition. Replace the module.

4 ERROR LOG INFORMATION

(3/3)

Error code	Meaning	Required action
0x2301	LPU battery low	The backup battery is low. Replace the battery. For details, refer to the information provided under “10.2 Replacing the Backup Battery” in the “BASIC MODULES (manual number SVE-1-100).”
0x2401	Optional-module startup check error	One of the mounted optional modules is not up and running. View the error log on the optional module and remove the cause of the error.

4 ERROR LOG INFORMATION

4.2.2 CMU (model LQP520) error log info and required actions

CMU-related errors are reported by presenting error messages in one of the formats shown under “4.3 CMU Error Message Formats.”

(1/4)

No.	Error code	Error message	Brief description	Error classification	Error location	Abend type	Required action
1	EC=03620000	Program error (Invalid Data Access)	Data access error	Software	TASK	TASK ABORT	Program correction
2	EC=03660000	Program error (Data Access Protection)	Data access protection error	Software	TASK	TASK ABORT	Program correction
3	EC=03600000	Program error (Data Page Fault)	Data access page fault	Software	TASK	TASK ABORT	Program correction
4	EC=03420000	Program error (Invalid Inst. Access)	Instruction access error	Software	TASK	TASK ABORT	Program correction
5	EC=03460000	Program error (Inst. Access Protection)	Instruction access protection error	Software	TASK	TASK ABORT	Program correction
6	EC=03400000	Program error (Instruction Page Fault)	Instruction access page fault	Software	TASK	TASK ABORT	Program correction
7	EC=03030000	Program error (Inst. Alignment Error)	Instruction alignment error	Software	TASK	TASK ABORT	Program correction
8	EC=03080000	Program error (Privileged Instruction)	Privileged-instruction violation	Software	TASK	TASK ABORT	Program correction
9	EC=03040000	Program error (Illegal Instruction)	Illegal instruction error	Software	TASK	TASK ABORT	Program correction
10	EC=03390000	Program error (FP Program Error)	Floating-point arithmetic error	Software	TASK	TASK ABORT	Program correction
11	EC=03470000	Program error (Data Alignment Error)	Data alignment error	Software	TASK	TASK ABORT	Program correction
12	EC=05130000	Macro parameter error	Undefined macro issued	Software	TASK	TASK ABORT	Program correction
13	EC=05110000	Macro parameter error	Macro parameter abnormal	Software	TASK	TASK ABORT	Program correction
14	EC=07xxxxxx	I/O error (error detail message)	Network I/O error	Hardware	I/O	–	For details, see 4.2.15 and 4.2.16.
15	EC=05C70000	WDT timeout error	Watchdog timer timeout	Hardware	TASK	–	Program correction
16	EC=03B70000	Module error (Bus Target Abort)	Bus target abort	Hardware	I/O	–	Hardware replacement or program correction (*)
17	EC=05000000	Module error (Invalid Interrupt)	Invalid interrupt	Hardware	CMU	–	Hardware replacement
18	EC=05000001	Module error (Undefined Invalid Interrupt)	Undefined invalid interrupt	Hardware	CMU	–	Hardware replacement
19	EC=05000002	Module error (INTEVT Invalid Interrupt)	INTEVT invalid interrupt	Hardware	CMU	–	Hardware replacement
20	EC=0500F001	Module error (HERST Invalid Interrupt)	Serious-error invalid interrupt	Hardware	CMU	–	Hardware replacement
21	EC=0500F002	Module error (HERST2 Invalid Interrupt)	Serious-error invalid interrupt 2	Hardware	CMU	–	Hardware replacement
22	EC=0500F003	Module error (BUERRSTAT Invalid Interrupt)	Bus serious-error interrupt status invalid	Hardware	CMU	–	Hardware replacement
23	EC=0500F006	Module error (NHPMCLG Invalid Interrupt)	Memory serious-error interrupt status invalid	Hardware	CMU	–	Hardware replacement
24	EC=0500F007	Module error (ECC 2bit Master Invalid Interrupt)	Memory ECC-detected 2-bit serious error status invalid	Hardware	CMU	–	Hardware replacement
25	EC=0500F008	Module error (RERRMST Invalid Interrupt)	RERR interrupt status invalid	Hardware	CMU	–	Hardware replacement
26	EC=0500C001	Module error (NINTR Invalid Interrupt)	NINT status invalid	Hardware	CMU	–	Hardware replacement
27	EC=0500B001	Module error (PUINTR Invalid Interrupt)	PUINT status invalid	Hardware	CMU	–	Hardware replacement
28	EC=05005001	Module error (RINTR Invalid Interrupt)	RINT status invalid	Hardware	CMU	–	Hardware replacement
29	EC=05003001	Module error (LV3 INTST Invalid Interrupt)	Level-3 interrupt status invalid	Hardware	CMU	–	Hardware replacement
30	EC=05003002	Module error (RQI6 INF Invalid Interrupt)	RQI6 status invalid	Hardware	CMU	–	Hardware replacement
31	EC=05001001	Module error (RQI3 INT Invalid Interrupt)	RQI3 status invalid	Hardware	CMU	–	Hardware replacement
32	EC=05001002	Module error (RQI3 Link Invalid Interrupt)	RQI3 link status invalid	Hardware	CMU	–	Hardware replacement
33	EC=05001003	Module error (RQI3 Module Invalid Interrupt)	RQI3 module status invalid	Hardware	CMU	–	Hardware replacement
34	EC=0D010000	Module error (Memory Alarm)	Memory 1-bit error (solid)	Hardware	CMU	–	Hardware replacement

(*) This type of error may also occur when the target module is under initialization or in a stop state. In these cases, hardware replacement is unnecessary.

4 ERROR LOG INFORMATION

(2/4)

No.	Error code	Error message	Brief description	Error classification	Error location	Abend type	Required action
35	EC=0D320000	Module error (Memory Error)	Memory error	Hardware	CMU, I/O	–	Hardware replacement
36	EC=0D330000	Module error (Hardware WDT timeout)	Hardware WDT timeout	Hardware	CMU, I/O	–	Hardware replacement
37	EC=0D340000	Module error (Software WDT Timeout)	Software WDT timeout	Hardware	CMU, I/O	–	Hardware replacement or program correction
38	EC=0D350000	Module error (RAM Sum Check Error)	RAM checksum error	Hardware	CMU, I/O	–	Hardware replacement or program correction
39	EC=0D360000	Module error (ROM Sum Check Error)	ROM checksum error	Hardware	CMU, I/O	–	Hardware replacement
40	EC=0D370000	Module error (Clock Stop Error)	Clock stop error	Hardware	CMU, I/O	–	Hardware replacement
41	EC=0D380000	Module error (OS Clear Error)	OS clear error	Hardware	CMU, I/O	–	Program loading
42	EC=0D800000	Module error (TOD Error)	Backup clock error	Hardware	CMU	–	Hardware replacement
43	EC=05A00000	Kernel warning	Kernel warning	Hardware	–	–	–
44	EC=05D00000	Kernel information	Kernel information	Hardware	–	–	–
45	EC=0D810000	System down (BPU Error)	BPU error	Hardware	CMU	CMU STOP	Hardware replacement
46	EC=03820000	System down (Memory Error)	Memory error	Hardware	CMU	CMU STOP	Hardware replacement
47	EC=038A0000	System down (Memory Access Error)	Memory access error	Hardware	CMU	CMU STOP	Hardware replacement
48	EC=038B0000	System down (Internal Bus Parity)	Internal-bus parity error	Hardware	CMU	CMU STOP	Hardware replacement
49	EC=038C0000	System down (System Bus Parity)	System-bus parity error	Hardware	CMU	CMU STOP	Hardware replacement
50	EC=038F0000	System down (Undefined Machine Check)	Undefined-machine check error	Hardware	CMU	CMU STOP	Hardware replacement
51	EC=07394720	System down (Invalid Interrupt Panic)	Invalid interrupt (10 times successively)	Hardware	DPIO IFX	CMU STOP	DPIO IFX module replacement
52	EC=03620000	System down (Invalid Data Access)	Data access error	Software	CPMS	CMU STOP	Program correction
53	EC=03660000	System down (Data Access Protection)	Data access protection error	Software	CPMS	CMU STOP	Program correction
54	EC=03600000	System down (Data Page Fault)	Data access page fault	Software	CPMS	CMU STOP	Program correction
55	EC=03420000	System down (Invalid Inst. Access)	Instruction access error	Software	CPMS	CMU STOP	Program correction
56	EC=03460000	System down (Inst. Access Protection)	Instruction access protection error	Software	CPMS	CMU STOP	Program correction
57	EC=03400000	System down (Instruction Page Fault)	Instruction access page fault	Software	CPMS	CMU STOP	Program correction
58	EC=03030000	System down (Inst. Alignment Error)	Instruction alignment error	Software	CPMS	CMU STOP	Program correction
59	EC=03040000	System down (Illegal Instruction)	Privileged instruction error	Software	CPMS	CMU STOP	Program correction
60	EC=03380000	System down (FP Unavailable)	Floating-point unavailability exception	Software	CPMS	CMU STOP	Program correction
61	EC=03390000	System down (FP System down)	Floating-point arithmetic error	Software	CPMS	CMU STOP	Program correction
62	EC=03470000	System down (Data Alignment Error)	Data alignment error	Software	CPMS	CMU STOP	Program correction
63	EC=030F0000	System down (Illegal Exception)	Illegal exception	Software	CPMS	CMU STOP	Program correction
64	EC=05700000	System down (System Error)	System down (System error)	Software	CPMS	CMU STOP	Program correction
65	EC=05800000	System down (Kernel Trap)	System down (Kernel trap)	Software	CPMS	CMU STOP	Program correction
66	EC=03620000	ULSUB down (Invalid Data Access)	Data access error	Software	ULSUB	CMU STOP	Program correction
67	EC=03660000	ULSUB down (Data Access Protection)	Data access protection error	Software	ULSUB	CMU STOP	Program correction
68	EC=03600000	ULSUB down (Data Page Fault)	Data access page fault	Software	ULSUB	CMU STOP	Program correction
69	EC=03420000	ULSUB down (Invalid Inst. Access)	Instruction access error	Software	ULSUB	CMU STOP	Program correction
70	EC=03460000	ULSUB down (Inst. Access Protection)	Instruction access protection error	Software	ULSUB	CMU STOP	Program correction
71	EC=03400000	ULSUB down (Instruction Page Fault)	Instruction access page fault	Software	ULSUB	CMU STOP	Program correction
72	EC=03030000	ULSUB down (Inst. Alignment Error)	Instruction alignment error	Software	ULSUB	CMU STOP	Program correction
73	EC=03080000	ULSUB down (Privileged Instruction)	Privileged-instruction violation	Software	ULSUB	CMU STOP	Program correction
74	EC=03040000	ULSUB down (Illegal Instruction)	Illegal instruction error	Software	ULSUB	CMU STOP	Program correction

4 ERROR LOG INFORMATION

(3/4)

No.	Error code	Error message	Brief description	Error classification	Error location	Abend type	Required action
75	EC=03380000	ULSUB down (FP Unavailable)	Floating-point unavailability exception	Software	ULSUB	CMU STOP	Program correction
76	EC=03390000	ULSUB down (FP System down)	Floating-point arithmetic error	Software	ULSUB	CMU STOP	Program correction
77	EC=03470000	ULSUB down (Data Alignment Error)	Data alignment error	Software	ULSUB	CMU STOP	Program correction
78	EC=030F0000	ULSUB down (Illegal Exception)	Illegal exception	Software	ULSUB	CMU STOP	Program correction
79	EC=05140000	System down (ULSUB Stop)	CPU stopped upon completion of the execution of a built-in subroutine	Software	ULSUB	CMU STOP	-
80	EC=05F00000	Program Error (ADT Error)	Memory access attempt detected	Software	Task	Log	Program correction
81	EC=0000201	Message frame error	Message frame error	Software	NXACP	-	-
82	EC=0000401	Buffer status	Buffer status report	Software	NXACP	-	-
83	EC=0000501	Socket error	Socket error	Software	NXACP	-	-
84	EC=0000601	Transfer memory address error	Transfer memory areas overlapping	Software	TASK	-	Program correction
85	EC=08xxxxxx	Msoft log01	Report from middleware	Software	Depending on middleware	-	-
86	EC=08xxxxxx	Msoft log02	Report from middleware	Software	Depending on middleware	-	-
87	EC=08xxxxxx	Msoft log03	Report from middleware	Software	Depending on middleware	-	-
88	EC=08xxxxxx	Msoft log04	Report from middleware	Software	Depending on middleware	-	-
89	EC=08xxxxxx	Msoft log05	Report from middleware	Software	Depending on middleware	-	-
90	EC=08xxxxxx	Msoft log06	Report from middleware	Software	Depending on middleware	-	-
91	EC=08xxxxxx	Msoft log07	Report from middleware	Software	Depending on middleware	-	-
92	EC=08xxxxxx	Msoft log08	Report from middleware	Software	Depending on middleware	-	-
93	EC=08xxxxxx	Msoft log09	Report from middleware	Software	Depending on middleware	-	-
94	EC=08xxxxxx	Msoft log10	Report from middleware	Software	Depending on middleware	-	-
95	EC=08xxxxxx	Msoft log11	Report from middleware	Software	Depending on middleware	-	-
96	EC=08xxxxxx	Msoft log12	Report from middleware	Software	Depending on middleware	-	-
97	EC=08xxxxxx	Msoft log13	Report from middleware	Software	Depending on middleware	-	-
98	EC=08xxxxxx	Msoft log14	Report from middleware	Software	Depending on middleware	-	-
99	EC=08xxxxxx	Msoft log15	Report from middleware	Software	Depending on middleware	-	-
100	EC=08xxxxxx	Msoft log16	Report from middleware	Software	Depending on middleware	-	-
101	EC=09xxxxxx	User log01	Report from application software	Software	Depending on middleware	-	-
102	EC=09xxxxxx	User log02	Report from application software	Software	Depending on middleware	-	-
103	EC=09xxxxxx	User log03	Report from application software	Software	Depending on middleware	-	-
104	EC=09xxxxxx	User log04	Report from application software	Software	Depending on middleware	-	-
105	EC=09xxxxxx	User log05	Report from application software	Software	Depending on middleware	-	-
106	EC=09xxxxxx	User log06	Report from application software	Software	Depending on middleware	-	-
107	EC=09xxxxxx	User log07	Report from application software	Software	Depending on middleware	-	-
108	EC=09xxxxxx	User log08	Report from application software	Software	Depending on middleware	-	-
109	EC=09xxxxxx	User log09	Report from application software	Software	Depending on middleware	-	-

4 ERROR LOG INFORMATION

(4/4)

No.	Error code	Error message	Brief description	Error classification	Error location	Abend type	Required action
110	EC=09xxxxxx	User log10	Report from application software	Software	Depending on middleware	-	-
111	EC=09xxxxxx	User log11	Report from application software	Software	Depending on middleware	-	-
112	EC=09xxxxxx	User log12	Report from application software	Software	Depending on middleware	-	-
113	EC=09xxxxxx	User log13	Report from application software	Software	Depending on middleware	-	-
114	EC=09xxxxxx	User log14	Report from application software	Software	Depending on middleware	-	-
115	EC=09xxxxxx	User log15	Report from application software	Software	Depending on middleware	-	-
116	EC=09xxxxxx	User log16	Report from application software	Software	Depending on middleware	-	-

4 ERROR LOG INFORMATION

4.2.3 FL.NET (model LQE500/502) error log info and required actions

(1/2)

Error code	Meaning	Required action
0x0010	Bus error	Reset the LPU module. Then, if the same error recurs, the FL.NET module may be in a failure condition. Replace the module.
0x0011	Address error	
0x0012	Illegal instruction	
0x0013	Division by zero	
0x0014	Privileged-instruction violation	
0x0016	Format error	
0x0017	Spurious interrupt	
0x0018	Unsupported exception	
0x0019	Parity error	
0x0100	Module no. setting error	The module no. setting switch is set incorrectly. Correct the module no. setting by referring to the information provided under “3.3 Setting the Module Number Selector Switch” in the “FL.NET (manual number SVE-1-101).”
0x0102	ROM1 checksum error	Reset the LPU module. Then, if the same error recurs, the FL.NET module may be in a failure condition. Replace the module.
0x0103	RAM1 compare error	
0x0105	RAM2 compare error	
0x010B	Non-matching parameter type detected (e.g., a parameter specified for use in an S10mini controller), or ROM3 checksum error	The module’s link or other parameter may be incorrect (for example, although the module is mounted in the S10V controller, it may contain parameter values for an S10mini controller). Set the correct parameters. Then, if the problem is still not solved, the module may be in a failure condition. Replace the module.
0x0112	Microprogram error	Reset the LPU module. Then, if the same error recurs, the FL.NET module may be in a failure condition. Replace the module.
0x0113	IP address not defined yet	Define the IP address.
0x0114	MAC address not defined yet	Reset the LPU module. Then, if the same error recurs, the FL.NET module may be in a failure condition. Replace the module.
0x0200	Module not participating in the network	The FL.NET module is currently not a member of the network (or is performing the participation process). For information on how to solve this problem, refer to the information provided under “7 TROUBLESHOOTING” in the “FL.NET (manual number SVE-1-101).”
0x0201	Common memory settings duplicated	The local node’s common memory settings are duplicated with a remote node’s. Compare the common memory settings of the two nodes and correct the duplicated settings. If it becomes necessary to correct the local node’s settings, use the FL.NET For Windows® setup tool. (If this type of error occurs, the common memory settings [area address and word count] of the node in which the error is detected are automatically set to 0.)

4 ERROR LOG INFORMATION

(2/2)

Error code	Meaning	Required action
0x0202	Node number duplicated	The set node number of the FL.NET module is duplicated with another node's in the same network. Check the node number of the other node and correct the duplicated node number. (If this type of error occurs, the node for which the duplicated node number is set is blocked from participating in the network, as is prescribed in the FA link protocol's rules. After correcting the error, you can make the node participate in the network by turning the power to the module off and back on again, or by issuing a participation request from the FL.NET For Windows® setup tool.)
0x0203	FL.NET module setting error	A setting error is detected in the FL.NET module. Check the module's internal settings by using the FL.NET setup tool (FL.NET system) and, if any error is found, correct it. Then, if the same error recurs, the FL.NET module may be in a failure condition. Replace the module.
0x0204	Token hold timeout	The set value of token hold time is exceeded three or more times successively. The FL.NET module may be in a failure condition. Replace the module. (If this type of error occurs, the node in which the error is detected is blocked from participating in the network, as is prescribed in the FA link protocol's rules.)

4 ERROR LOG INFORMATION

4.2.4 OD.RING (model LQE510/515) error log info and required actions

Error code	Meaning	Required action
0x0010	Bus error	Reset the LPU module. Then, if the same error recurs, the OD.RING module may be in a failure condition. Replace the module.
0x0011	Address error	
0x0012	Illegal instruction	
0x0013	Division by zero	
0x0014	Privileged-instruction violation	
0x0015	WDT error	
0x0016	Format error	
0x0017	Spurious interrupt	
0x0018	Unsupported exception	
0x0019	Parity error	
0x001A	GR warning	
0x0100	Module no. setting error	The module no. setting switch is set incorrectly. Correct the module no. setting by referring to the information provided under “2 NAMES AND FUNCTIONS OF EACH PART” in the “OD.RING (manual number SVE-1-102).” Then, reset the controller, or turn off the power to the controller and back on again.
0x0101	CPL switch setting error	The CPL no. setting switch is set incorrectly. Correct the CPL no. setting by referring to the information provided under “2 NAMES AND FUNCTIONS OF EACH PART” and “4.2 Setting Switches” in the “OD.RING (manual number SVE-1-102).” Then, reset the controller, or turn off the power to the controller and back on again.
0x0102	ROM1 checksum error	Reset the LPU module. Then, if the same error recurs, the OD.RING module may be in a failure condition. Replace the module.
0x0103	RAM1 compare error	
0x0105	RAM2 compare error	
0x010B	ROM3 checksum error	
0x010C	ROM3 clear error, program-related	
0x010D	ROM3 write error, program-related	
0x010E	ROM3 clear error, parameter-related	Reset the LPU module and set all necessary parameters again.
0x010F	ROM3 write error, parameter-related	Then, if the same error recurs, the OD.RING module may be in a failure condition. Replace the module.
0x0110	Too many ROM rewrites attempted	Replace the module.
0x0111	CPL no. duplicated	A duplicated CPL no. is detected. Correct the CPL no. setting by referring to the information provided under “2 NAMES AND FUNCTIONS OF EACH PART” and “4.2 Setting Switches” in the “OD.RING (manual number SVE-1-102).”
0x0112	Non-matching parameter type detected (e.g., a parameter specified for use in an S10mini controller), or parameter error (incorrect SUM value)	A parameter previously set for use in an S10mini controller, or a parameter error is detected. Correct the parameters by referring to the information provided under “4.6 Commands” in the “OD.RING (manual number SVE-1-102).” Then, reset the controller, or turn off the power to the controller and back on again.

4.2.5 ET.NET (model LQE520) error log info and required actions

Error code	Meaning	Required action
0x0010	Bus error	Reset the LPU module. Then, if the same error recurs, the ET.NET module may be in a failure condition. Replace the module.
0x0011	Address error	
0x0012	Illegal instruction	
0x0013	Division by zero	
0x0014	Privileged-instruction violation	
0x0016	Format error	
0x0017	Spurious interrupt	
0x0018	Unsupported exception	
0x0019	Parity error	
0x0100	Module no. setting error	The module no. setting switch is set incorrectly. Correct the module no. setting by referring to the information provided under “2.1 Names and Functions of Each Part” in the “ET.NET (manual number SVE-1-103).” Then, reset the controller, or turn off the power to the controller and back on again.
0x0102	ROM1 checksum error	Reset the LPU module. Then, if the same error recurs, the ET.NET module may be in a failure condition. Replace the module.
0x0103	RAM1 compare error	
0x0105	RAM2 compare error	
0x010B	ROM3 checksum error	
0x0112	Microprogram error	
0x0113	IP address not defined yet	Define an IP address. Then, reset the controller, or turn off the power to the controller and back on again.
0x0114	MAC address not defined yet	Reset the LPU module. Then, if the same error recurs, the ET.NET module may be in a failure condition. Replace the module.
0x0200	Routing information setting error	An error is detected in the routing information settings. Correct the error by referring to the information provided under “7.3.4 Route information setting error table” in the “ET.NET (manual number SVE-1-103).

4 ERROR LOG INFORMATION

4.2.6 SV.LINK (model LQE521) error log info and required actions

Error code	Meaning	Required action
0x0010	Bus error	Reset the LPU module. Then, if the same error recurs, the SV.LINK module may be in a failure condition. Replace the module.
0x0011	Address error	
0x0012	Illegal instruction	
0x0013	Division by zero	
0x0014	Privileged-instruction violation	
0x0016	Format error	
0x0017	Spurious interrupt	
0x0018	Unsupported exception	
0x0019	Parity error	
0x0100	Module no. setting error	The module no. setting switch is set incorrectly. Correct the module no. setting by referring to the information provided under “4.1 Start-up Procedure” in the “SV.LINK (manual number SVE-1-116).” Then, reset the controller, or turn off the power to the controller and back on again.
0x0102	ROM1 checksum error	Reset the LPU module. Then, if the same error recurs, the SV.LINK module may be in a failure condition. Replace the module.
0x0103	RAM1 compare error	
0x0105	RAM2 compare error	
0x010B	ROM3 checksum error	
0x0112	Microprogram error	
0x0113	IP address not defined yet	Define an IP address. Then, reset the controller, or turn off the power to the controller and back on again.
0x0114	MAC address not defined yet	Reset the LPU module. Then, if the same error recurs, the SV.LINK module may be in a failure condition. Replace the module.
0x0201	Communication parameter setting error	The set value of a parameter is in error. Correct the error by referring to the information provided under “5.4 Status and Communication Parameter Areas” in the “SV.LINK (manual number SVE-1-116).” Then, reset the controller, or turn off the power to the controller and back on again.

4.2.7 SD.LINK (model LQE530) error log info and required actions

Error code	Meaning	Required action
0x0010	Bus error	Reset the LPU module. Then, if the same error recurs, the SD.LINK module may be in a failure condition. Replace the module.
0x0011	Address error	
0x0012	Illegal instruction	
0x0013	Division by zero	
0x0014	Privileged-instruction violation	
0x0015	WDT error	
0x0016	Format error	
0x0017	Spurious interrupt	
0x0018	Unsupported exception	
0x0019	Parity error	
0x001A	GR warning	
0x0100	Module no. setting error	The module no. setting switch is set incorrectly. Correct the module no. setting by referring to the information provided under “2 NAMES AND FUNCTIONS OF EACH PART” in the “SD.LINK (manual number SVE-1-115).” Then, reset the controller, or turn off the power to the controller and back on again.
0x0101	CPL switch setting error	The CPL no. setting switch is set incorrectly. Correct the CPL no. setting by referring to the information provided under “2 NAMES AND FUNCTIONS OF EACH PART” and “4.2 Setting Switches” in the “SD.LINK (manual number SVE-1-115).” Then, reset the controller, or turn off the power to the controller and back on again.
0x0102	ROM1 checksum error	Reset the LPU module. Then, if the same error recurs, the SD.LINK module may be in a failure condition. Replace the module.
0x0103	RAM1 compare error	
0x0105	RAM2 compare error	
0x010B	ROM3 checksum error	
0x010C	ROM3 clear error, program-related	
0x010D	ROM3 write error, program-related	Reset the LPU module and set all necessary parameters again. Then, if the same error recurs, the SD.LINK module may be in a failure condition. Replace the module.
0x010E	ROM3 clear error, parameter-related	
0x010F	ROM3 write error, parameter-related	
0x0110	Too many ROM rewrites attempted	Replace the module.
0x0111	CPL no. duplicated	A duplicated CPL no. is detected. Correct the CPL no. setting by referring to the information provided under “2 NAMES AND FUNCTIONS OF EACH PART” and “4.2 Setting Switches” in the “SD.LINK (manual number SVE-1-115).”
0x0112	Non-matching parameter type detected (e.g., a parameter specified for use in an S10mini controller), or parameter error (incorrect SUM value)	A parameter previously set for use in an S10mini controller, or a parameter error is detected. Correct the parameters by referring to the information provided under “4.6 Commands” in the “SD.LINK (manual number SVE-1-115).” Then, reset the controller, or turn off the power to the controller and back on again.

4 ERROR LOG INFORMATION

4.2.8 J.NET (model LQE541) / J.NET-INT (model LQE547) error log info and required actions

(1/3)

Error code	Meaning	Required action
0x0010	Bus error	Reset the LPU module. Then, if the same error recurs, the J.NET/J.NET-INT module may be in a failure condition. Replace the module.
0x0011	Address error	
0x0012	Illegal instruction	
0x0013	Division by zero	
0x0014	Privileged-instruction violation	
0x0015	WDT error	
0x0016	Format error	
0x0017	Spurious interrupt	
0x0018	Unsupported exception	
0x0019	Parity error	
0x0100	Module no. setting error	The module no. setting switch is set incorrectly. Correct the module no. setting by referring to the information provided under “2.1 Names and Functions of Each Part” in the “J.NET (manual number SVE-1-132)” or “J.NET-INT (manual number SVE-1-133).” Then, reset the controller, or turn off the power to the controller and back on again.
0x0101	Bit rate setting error	The bit rate setting switch is set incorrectly. Correct the bit rate setting by referring to the information provided under “2.1 Names and Functions of Each Part” in the “J.NET (manual number SVE-1-132)” or “J.NET-INT (manual number SVE-1-133).” Then, reset the controller, or turn off the power to the controller and back on again.
0x0102	ROM1 checksum error	Reset the LPU module. Then, if the same error recurs, the J.NET/J.NET-INT module may be in a failure condition. Replace the module.
0x0103	RAM1 compare error	
0x0105	RAM2 compare error	
0x0107	DMA1 transfer error, transmission-related	
0x0108	DMA2 transfer error, transmission-related	
0x0109	DMA1 transfer error, reception-related	
0x010A	DMA2 transfer error, reception-related	
0x010B	ROM3 checksum error	
0x010C	ROM clear error, program-related	
0x010D	ROM write error, program-related	
0x010E	ROM clear error, parameter-related	Reset the LPU module and set all necessary parameters again. Then, if the same error recurs, the J.NET/J.NET-INT module may be in a failure condition. Replace the modules.
0x010F	ROM write error, parameter-related	
0x0110	Too many ROM rewrites attempted	Replace the module.

Error code	Meaning	Required action
0x0112	Non-matching parameter type detected (e.g., a parameter specified for use in an S10mini controller), or parameter error (incorrect SUM value)	A parameter previously set for use in an S10mini controller, or a parameter error is detected. Correct the parameters by referring to the information provided under “4.2 Commands” in the “J.NET (manual number SVE-1-132)” or “J.NET-INT (manual number SVE-1-133).” Then, reset the controller, or turn off the power to the controller and back on again.
0x2010	CRC check error	<ul style="list-style-type: none"> • Check if the communication line is functioning properly. • Check if there is any mismatch between the parameter settings and remote-station settings. • After the above checks and troubleshooting, if the same error recurs, replace the J.NET/J.NET-INT module.
0x2020	Station number error -- a station number outside the range 128 to 254 is detected, or the station number of the receiving station is incorrect.	
0x2030	Undefined service requested	
0x2040	I-/UI-frame length error -- an I-frame 137 or more bytes long, or a UI-frame 134 or more bytes long is detected.	
0x2041	I-frame (response) error -- a response I-frame to an I-frame not transmitted before is received.	
0x2042	S-frame error -- an I-frame is received in place of an expected S-frame.	
0x2050	Data link procedure error	
0x2060	Timeout generated -- no response is received from the slave.	<ul style="list-style-type: none"> • Turn off the power to the remote station and back on again. • Check if the switch settings of both the J.NET/J.NET-INT module and remote station are all correct. • If the above actions do not solve the problem, replace the remote station.
0x2061	The error could not be recovered by retry.	
0x2070	Frame transmission/reception error -- no frame can be sent out to the communication line, or an error is detected in frame reception.	<ul style="list-style-type: none"> • Check if the communication line is connected to the J.NET/J.NET-INT module properly, and if terminating resistors are connected to both ends of the line. • Check if there is any mismatch between the parameter settings and remote-station settings. • Reset the LPU module. Then, if the same error recurs, restart the LPU module. • If the above actions do not solve the problem, replace the J.NET/J.NET-INT module.
0x2080	Error detected -- an error other than the above.	
0x7061	Input of input data is in progress -- the input of input data is not completed at the remote station yet.	<ul style="list-style-type: none"> • This is not an error. • Processing will go on normally upon completion of the input of input data.

4 ERROR LOG INFORMATION

(3/3)

Error code	Meaning	Required action
0x7110	Undefined service requested	<ul style="list-style-type: none"> Reset the LPU module. Then, if the same error recurs, restart the LPU module. If the above action does not solve the problem, replace the J.NET/J.NET-INT module.
0x7120	Data length error	
0x7130	Packet structure error	
0x8020	SVPT error -- an initialization request is rejected.	<ul style="list-style-type: none"> There is a mismatch between the parameter settings and remote-station settings. Set the parameters correctly so that they match the remote-station settings. If the above action does not solve the problem, replace the remote station.
0x8081	SVPT error -- in AUTO mode, the defined number of transfer bytes does not match the response I/O size from the remote station.	
0x8082	SVPT error -- with a specified slot, the defined number of transfer bytes does not match the response I/O size from the remote station.	
0x9001	Remote station stopped	<ul style="list-style-type: none"> Turn off the power to the remote station and back on again, and then reset the CPU. If the above action does not solve the problem, replace the remote station.
0x9002	Remote station abnormal	
0x9003	Remote station abnormal and stopped	
0xA020	PUT/GET error -- address data is insufficient.	Review the PUT/GET service request used on the remote-station side.
0xA021	PUT/GET error -- address field count error.	
0xA022	PUT/GET error -- an address field contains a numeric value.	
0xA040	PUT/GET error -- an odd-numbered address is detected.	

4.2.9 IR.LINK (model LQE548) error log info and required actions

(1/3)

Error code	Meaning	Required action
0x0010	Bus error	Reset the LPU module. Then, if the same error recurs, the IR.LINK module may be in a failure condition. Replace the module.
0x0011	Address error	
0x0012	Illegal instruction	
0x0013	Division by zero	
0x0014	Privileged-instruction violation	
0x0015	WDT error	
0x0016	Format error	
0x0017	Spurious interrupt	
0x0018	Unsupported exception	
0x0019	Parity error	
0x0100	Module no. setting error	The module no. setting switch is set incorrectly. Correct the module no. setting by referring to the information provided under “2 NAMES AND FUNCTIONS OF EACH PART” in the “IR.LINK (manual number SVE-1-134)”. Then, reset the controller, or turn off the power to the controller and back on again.
0x0101	Bit rate setting error	The bit rate setting switch is set incorrectly. Correct the bit rate setting by referring to the information provided under “2 NAMES AND FUNCTIONS OF EACH PART” in the “IR.LINK (manual number SVE-1-134).” Then, reset the controller, or turn off the power to the controller and back on again.
0x0102	ROM1 checksum error	Reset the LPU module. Then, if the same error recurs, the IR.LINK module may be in a failure condition. Replace the module.
0x0103	RAM1 compare error	
0x0105	RAM2 compare error	
0x010B	ROM3 checksum error	Reset the LPU module. Then, if the same error recurs, the IR.LINK module may be in a failure condition. Replace the module.
0x010C	ROM clear error, program-related	
0x010D	ROM write error, program-related	
0x010E	ROM clear error, parameter-related	Reset the LPU module and set all necessary parameters again. Then, if the same error recurs, the IR.LINK module may be in a failure condition. Replace the module.
0x010F	ROM write error, parameter-related	
0x0110	Too many ROM rewrites attempted	An attempt is made to rewrite the ROM more than 50,000 times. Replace the module.
0x0112	Non-matching parameter type detected (e.g., a parameter specified for use in an S10mini controller), or parameter error (incorrect SUM value)	A parameter previously set for use in an S10mini controller, or a parameter error is detected. Correct the parameters by referring to the information provided under “4.3 Commands” in the “IR.LINK (manual number SVE-1-134).” Then, reset the controller, or turn off the power to the controller and back on again.

4 ERROR LOG INFORMATION

(2/3)

Error code	Meaning	Required action
0x2010	CRC check error	<ul style="list-style-type: none"> • Check if the communication line is functioning properly. • Check if there is any mismatch between the parameter settings and remote-station settings. • After the above checks and troubleshooting, if the same error recurs, replace the IR.LINK module.
0x2020	Station number error -- a station number outside the range 128 to 254 is detected, or the station number of the receiving station is incorrect	
0x2030	Undefined service requested	
0x2040	I-/UI-frame length error -- an I-frame 137 or more bytes long, or a UI-frame 134 or more bytes long is detected.	
0x2041	I-frame (response) error -- a response I-frame to an I-frame not transmitted before is received.	
0x2042	S-frame error -- an I-frame is received in place of an expected S-frame.	
0x2050	Data link procedure error	
0x2060	Timeout generated -- no response is received from the slave.	<ul style="list-style-type: none"> • Turn off the power to the remote station and back on again. • If the above action does not solve the problem, check if the switch settings of both the IR.LINK module and remote station are all correct. • If none of the above actions solves the problem, replace the remote station.
0x2061	The error could not be recovered by retry.	
0x2070	Frame transmission/reception error -- no frame can be sent out to the communication line, or an error is detected in frame reception.	<ul style="list-style-type: none"> • Check if the communication line is connected to the IR.LINK module properly, and if terminating resistors are connected to both ends of the line. • Check if there is any mismatch between the parameter settings and remote-station settings. • Reset the LPU module. Then, if the same error recurs, restart the LPU module. • If the above actions do not solve the problem, replace the IR.LINK module.
0x2080	Error detected -- an error other than the above.	
0x7110	Undefined service requested	
0x7120	Data length error	<ul style="list-style-type: none"> • Reset the LPU module. Then, if the same error recurs, restart the controller. • If the above action does not solve the problem, replace the IR.LINK module.
0x7130	Packet structure error	

Error code	Meaning	Required action
0x8020	SVPT error -- an initialization request is rejected.	<ul style="list-style-type: none"> • There is a mismatch between the parameter settings and remote-station settings. Set the parameters correctly so that they match the remote-station settings. • If the above action does not solve the problem, replace the remote station.
0x8081	SVPT error -- in AUTO mode, the defined number of transfer bytes does not match the response I/O size from the remote station.	
0x8082	SVPT error -- with a specified slot, the defined number of transfer bytes does not match the response I/O size from the remote station.	
0x9001	Remote station stopped	<ul style="list-style-type: none"> • Turn off the power to the remote station and back on again, and then reset the LPU. • If the above action does not solve the problem, replace the remote station.
0x9002	Remote station abnormal	
0x9003	Remote station abnormal and stopped	

4 ERROR LOG INFORMATION

4.2.10 CPU LINK (model LQE550) error log info and required actions

Error code	Meaning	Required action
0x0002	WDT timeout error	Reset the LPU module. Then, if the same error recurs, the inter-CPU link module may be in a failure condition. Replace the module.
0x0004	ROM checksum error -- an error is detected in the ROM.	
0x0008	RAM check error -- an error is detected in the system program.	
0x0010	RAM parity error -- a parity error is detected in the RAM.	
0x0020	Stack fence exceeded	
0x0040	G-register areas overlapping -- the send G-register area subjected to transmission by this module overlaps the receive G-register area containing received data.	Check the transfer word count setting for the inter-CPU link module connected to the inter-CPU link line, and correct the setting so that it will not overlap.
0x0080	System program running normally -- the inter-CPU link module is running normally.	This is not an error; it is displayed when the module is running normally.
0x00C0	CPU no. setting error	The CPU no. setting switch is set incorrectly. Correct the CPU no. setting by referring to the information provided under “2 NAMES AND FUNCTIONS OF EACH PART” in the “CPU LINK (manual number SVE-1-109).”
0x00E0	Link line error -- reception errors are detected successively or intermittently during G-register area transfer.	Reset the LPU module. Then, if the same error recurs, the inter-CPU link module may be in a failure condition. Replace the module.

4.2.11 RS-232C (model LQE560) / RS-422 (model LQE565) error log info and required actions

(1/3)

Error code	Meaning	Required action
0x0010	Bus error	Reset the LPU module. Then, if the same error recurs, the RS-232C/RS-422 module may be in a failure condition. Replace the module.
0x0011	Address error	
0x0012	Illegal instruction	
0x0013	Division by zero	
0x0014	Privileged-instruction violation	
0x0015	WDT timeout error	
0x0018	Unsupported exception	
0x0019	RAM parity error	
0x0100	Module no. setting error	The module no. setting switch is set incorrectly. Correct the module no. setting by referring to the information provided under "2.1 Names and Functions of Each Part" in the "RS-232C/422 (manual number SVE-1-121)."
0x0102	ROM checksum error	Reset the LPU module. Then, if the same error recurs, the RS-232C/RS-422 module may be in a failure condition. Replace the module.
0x0103	RAM compare error	
0x0112	LGB setting error	Correct the LGB setting. Then, if the same error recurs, the RS-232C/RS-422 module may be in a failure condition. Replace the module.
0x1000	Reception process aborted because of "local station first" -- due to the start of a transmission requested on a "local station first" basis during data reception, the data reception is aborted and a data transmission is started.	Change the LGB priority control setting to "no priority control" (full-duplex communication).
0x1080	Transmission unachievable because of "remote station first" -- data transmission cannot be done because a data reception is currently in process on a "remote station first" basis.	Data transmission will be started after the data reception is completed.
0x1081	Transmission unachievable because of a missing send request (CS) in CS input	<ul style="list-style-type: none"> • Check if there is any incorrect control signal setting in the destination device. • Check if the cable wiring for the RS-232C/RS-422 module is done properly.
0x1082	Transmission unachievable because a "not ready" DR (data set ready) input condition is detected by a DR check.	

4 ERROR LOG INFORMATION

(2/3)

Error code	Meaning	Required action
0x1083	Transmission suspension timed out -- after a transmission in progress was suspended by a suspend code, it has not been resumed by a resume code within a specified transmission suspension monitoring time period.	<ul style="list-style-type: none"> • Check the destination device settings and communication program. • Check the LGB settings.
0x1084	Send request (CS) timed out -- after a transmission in progress was suspended due to a change in indication of the CS (send request) input to “send request not present”, it has not been resumed due to a change in indication of the CS input to “send request present”.	<ul style="list-style-type: none"> • Check if there is any incorrect control signal setting in the destination device. • Check if the cable wiring for the RS-232C/RS-422 module is done properly.
0x1085	DR timed out -- a transmission in progress was suspended because it was found by a specified DR (data set ready) check that the indication of the DR input changed to “not ready” during the transmission; then, the suspended transmission has not been resumed, because the indication of the DR input did not change to “ready” within a specified transmission suspension monitoring time period.	
0x2002	Buffer with the reception process aborted -- due to the start of a transmission requested on a “local station first” basis during a data reception, there is a buffer that has the data reception process aborted.	Change the LGB priority control setting to “no priority control” (full-duplex communication).
0x2080	Parity error in reception -- a parity error is detected in the received data.	<ul style="list-style-type: none"> • Check if there is any mismatch between the LGB settings and the destination device’s communication settings.
0x2081	Overrun error in reception -- an overrun error is detected in handling the received data.	<ul style="list-style-type: none"> • Check if there is any noise source near the laid cable.
0x2082	Framing error in reception -- a framing error is detected in the received data.	
0x2083	Reception timed out -- not all the expected data has been received within a specified reception monitoring time period.	Check the reception monitoring time period setting among the LGB settings.

Error code	Meaning	Required action
0x2084	ASCII conversion error -- in a requested ASCII conversion, data outside the ranges "0" to "9" and "A" to "F" is received.	Review the application running on the destination device.
0x2085	End code error -- in a requested ASCII conversion, data outside the ranges "0" to "9" and "A" to "F", or a non-end code is received.	
0x2086	BCC error -- in a BCC reception, a BCC mismatch is detected by a specified BCC check.	
0x2087	Carrier detection timed out -- the CD (carrier detection) input indicated no carrier present, resulting in the suspended reception; then, the suspended reception has not been resumed, because the CD input did not indicate a carrier present within the reception monitoring time period.	<ul style="list-style-type: none"> • Check if there is any incorrect setting made for the destination device. • Check if the connecting cable to the RS-232C/RS-422 module is broken.
0x2088	Receive buffer full -- new received data is discarded because a maximum of eight cases of data are already stored in the receive buffer.	Input the received data by starting the reception handler.
0x2089	Reception error due to noise -- an error due to noise is detected in the received data.	Check if there is any noise source near the laid cable.

4 ERROR LOG INFORMATION

4.2.12 D.NET (model LQE570/575) error log info and required actions

Error code	Meaning	Required action
0x1401	MPU register compare error	Reset the LPU module. Then, if the same error recurs, the D.NET module may be in a failure condition. Replace the module.
0x1402	MPU operation check error	
0x1403	CAN register compare error	
0x1405	ROM compare error	
0x1406	ROM checksum error, program-related	
0x1407	RAM compare error	
0x1409	MPU built-in timer diagnosis error	
0x140A	Module no. setting error	The module no. setting switch is set incorrectly. Correct the module no. setting by referring to the information provided under “2 NAMES AND FUNCTIONS OF EACH PART” in the “D.NET (manual number SVE-1-106).”
0x140D	ROM checksum error, parameter-related	Reset the LPU module. Then, if the same error recurs, the D.NET module may be in a failure condition. Replace the module.
0x2404	WDT timeout error	
0x34XX	Undefined interrupt detected. (Except for the below, the “XX” in this error code is a vector number.) XX = 04: Common illegal instruction detected. XX = 06: Slot illegal instruction detected. XX = 09: Address error.	
0x4281	Duplicated MAC ID	Check the set value of the Node Address setting switch.
0x5188	Communication word count setting error	Check the parameter settings.
0x5189	Non-matching parameter type detected (e.g., a parameter specified for use in an S10mini controller), or ROM3 checksum error	A parameter previously set for use in an S10mini controller, or a parameter error is detected. Correct the parameters by referring to the information provided under “4.5 Setting Parameters” in the “D.NET (manual number SVE-1-106).” Then, reset the controller, or turn off the power to the controller and back on again.
0x7381	Transmission path bus-OFF detected	Check the connector connections (for looseness), cable wiring, and transmission speed, MAC ID, and module no. settings.
0x8181	CAN transmission timeout error	Check the connector connections (for looseness), cable wiring, and transmission speed, MAC ID, and module no. settings. This type of error also occurs in the following cases, but the D.NET module is functioning properly: <ul style="list-style-type: none"> • The communication connector of the D.NET module is not connected yet. • The remote station is not found or powered off. • The transmission speed of the remote station does not match the local station’s. However, this type of error will not occur if the network has another station installed except this D.NET module (even when the station does not communicate with the D.NET module directly).

D.NET (model LQE770/775) error log info and required actions

Error code	Meaning	Required action
0x1401	MPU register compare error	Reset the LPU module. Then, if the same error recurs, the D.NET module may be in a failure condition. Replace the module.
0x1402	MPU operation check error	
0x1403	CAN register compare check error	
0x1405	FROM compare check error	
0x1406	FROM checksum error, microprogram-related	
0x1407	SRAM compare check error	
0x1409	MPU built-in timer diagnosis error	
0x140A	Module no. setting error	The module no. setting switch is set incorrectly. Correct the module no. setting by referring to the information provided under “2 NAMES AND FUNCTIONS OF EACH PART” in the “D.NET (manual number SVE-1-129).”
0x518C	Module combination mounting error	Reset the LPU module. Then, if the same error recurs, the D.NET module may be in a failure condition. Replace the module.
0x140D	FROM checksum error, parameter-related	
0x2404	WDT timeout error	
0x34XX	Undefined interrupt detected. (Except for the below, the “XX” in this error code is a vector number.) XX = 04: Common illegal instruction detected. XX = 06: Slot illegal instruction detected. XX = 09: Address error.	
0x4281	Duplicated MAC ID	Check the set value of the Node Address setting switch.
0x5188	Communication word count setting error	Check the parameter settings.
0x5189	Parameter setting error	The set value of a parameter is in error. Correct the error by referring to the information provided under “4.5 Parameter Setting” in the “D.NET (manual number SVE-1-129).” Then, reset the controller, or turn off the power to the controller and back on again.
0x7381	Transmission path bus-OFF detected	Check the connector connections (for looseness), cable wiring, and transmission speed, MAC ID, and module no. settings.
0x8181	CAN transmission timeout error	Check the connector connections (for looseness), cable wiring, and transmission speed, MAC ID, and module no. settings. This type of error also occurs in the following cases, but the D.NET module is functioning properly: <ul style="list-style-type: none"> • The communication connector of the D.NET module is not connected yet. • The remote station is not found or powered off. • The transmission speed of the remote station does not match the local station’s. However, this type of error will not occur if the network has another station installed except this D.NET module (even when the station does not communicate with the D.NET module directly).

4 ERROR LOG INFORMATION

4.2.13 EQ.LINK (model LQE701) error log info and required actions

(1/2)

Error code	Meaning	Required action
0x0010	Bus error	Reset the LPU module. Then, if the same error recurs, the EQ.LINK module may be in a failure condition. Replace the module.
0x0011	Address error	
0x0012	Illegal instruction	
0x0013	Division by zero	
0x0014	Privileged-instruction violation	
0x0016	Format error	
0x0017	Spurious interrupt	
0x0018	Unsupported exception	
0x0019	Parity error	
0x0100	Module no. setting error	The module no. setting switch is set incorrectly. Correct the module no. setting by referring to the information provided under “3.3 Setting the Module Number Selector Switch” in the “EQ.LINK (manual number SVE-1-124).”
0x0102	ROM1 checksum error	Reset the LPU module. Then, if the same error recurs, the EQ.LINK module may be in a failure condition. Replace the module.
0x0103	RAM1 compare error	
0x0105	RAM2 compare error	
0x010B	ROM3 checksum error	The set value of a parameter is in error. Correct the error by referring to the information provided under “5.2.3 Setting of link parameters” and “5.2.4 Setup common memory division” in the “EQ.LINK (manual number SVE-1-124).” Then, reset the controller, or turn off the power to the controller and back on again.
0x0112	Microprogram error	Reset the LPU module. Then, if the same error recurs, the EQ.LINK module may be in a failure condition. Replace the module.
0x0113	IP address not defined yet	Set an IP address parameter by referring to the information provided under “5 Operation” in the “EQ.LINK (manual number SVE-1-124).”
0x0114	MAC address not defined yet	Reset the LPU module. Then, if the same error recurs, the EQ.LINK module may be in a failure condition. Replace the module.
0x0120	LPU switched to master (CPU RUN)	These pieces of information are presented not to report module errors but to notify the completion of system startup or LPU switching between master and slave.
0x0121	LPU switched to slave (CPU STOP)	
0x0122	Module logically separated from the network (CPU down)	This error code is presented when the LPU has detected a serious problem. For details, see the LPU’s error log.
0x0200	Not participating in the network	The EQ.LINK module is currently not a member of the network (or is performing the participation process). For information on how to solve this problem, refer to the information provided under “6.3 Network Problems and Repairing” in the “EQ.LINK (manual number SVE-1-124).”

Error code	Meaning	Required action
0x0201	Common memory settings duplicated	In the common memory division setup given, the local node's common memory area is duplicated with the remote node's. By referring to the information provided under "5.2.4 Setup common memory division" in the "EQ.LINK (manual number SVE-1-124)," correct the setup so that the common memory offset value may not be duplicated between the local and the remote node. (If this type of error occurs, the common memory settings [area address and word count] of the node in which the error is detected are automatically set to 0.)
0x0202	Node number duplicated	The set node number of the EQ.LINK module is duplicated with another node's in the same network. By referring to the information provided under "5.2.3 Setting of link parameters" in the "EQ.LINK (manual number SVE-1-124)," correct the duplicated setting so that the node number will not be duplicated between the local and the remote node. (If this type of error occurs, the node for which the duplicated node number is set is blocked from participating in the network. After correcting the error, you can make the node participate in the network by turning the power to the module off and back on again, or by issuing a participation request from the EQ.LINK system.)
0x0203	EQ.LINK module setting error	A setting error is detected in the EQ.LINK module. Check the module's internal link parameter settings and common memory division setup by using the EQ.LINK system and, if any error is found, correct it. Then, if the same error recurs, the EQ.LINK module may be in a failure condition. Replace the module.
0x0204	Token hold timeout	The set value of token hold time is exceeded three or more times successively. The EQ.LINK module may be in a failure condition. Replace the module. (If this type of error occurs, the node in which the error is detected is blocked from participating in the network.)

4 ERROR LOG INFORMATION

4.2.14 ET.NET (model LQE720) error log info and required actions

ET.NET-related errors are reported by presenting error messages in one of the formats shown under “4.3 CMU Error Message Formats.”

(1/3)

No.	Error log title	Error code	Error message	Brief description	ALARM LED	ERR LED	Required action
1	%CPMS-E-SOFT-0001	EC=03620000	Program error (Invalid Data Access)	Data access error	– (OFF)	– (OFF)	Hardware replacement
2	%CPMS-E-SOFT-0001	EC=03660000	Program error (Data Access Protection)	Data access protection error	–	–	Hardware replacement
3	%CPMS-E-SOFT-0001	EC=03600000	Program error (Data Page Fault)	Data access page fault	–	–	Hardware replacement
4	%CPMS-E-SOFT-0001	EC=03420000	Program error (Invalid Inst. Access)	Instruction access error	–	–	Hardware replacement
5	%CPMS-E-SOFT-0001	EC=03460000	Program error (Inst. Access Protection)	Instruction access protection error	–	–	Hardware replacement
6	%CPMS-E-SOFT-0001	EC=03400000	Program error (Instruction Page Fault)	Instruction access page fault	–	–	Hardware replacement
7	%CPMS-E-SOFT-0001	EC=03030000	Program error (Inst. Alignment Error)	Instruction alignment error	–	–	Hardware replacement
8	%CPMS-E-SOFT-0001	EC=03080000	Program error (Privileged Instruction)	Privileged-instruction violation	–	–	Hardware replacement
9	%CPMS-E-SOFT-0001	EC=03040000	Program error (Illegal Instruction)	Illegal instruction error	–	–	Hardware replacement
10	%CPMS-E-SOFT-0001	EC=03390000	Program error (FP Program Error)	Floating-point arithmetic error	–	–	Hardware replacement
11	%CPMS-E-SOFT-0001	EC=03470000	Program error (Data Alignment Error)	Data alignment error	–	–	Hardware replacement
12	%CPMS-E-SOFT-0002	EC=05130000	Macro parameter error	Undefined macro issued	–	–	Hardware replacement
13	%CPMS-E-SOFT-0002	EC=05110000	Macro parameter error	Macro parameter abnormal	–	–	Hardware replacement
14	%CPMS-E-SOFT-0005	EC=05C70000	WDT timeout error	Watchdog timer timeout	–	ON	Hardware replacement
15	%CPMS-E-HARD-0006	EC=03B70000	Module error (Bus Target Abort)	Bus target abort	–	–	Hardware replacement
16	%CPMS-E-HARD-0006	EC=05000000	Module error (Invalid Interrupt)	Invalid interrupt	–	–	Hardware replacement
17	%CPMS-E-HARD-0006	EC=05000001	Module error (Undefined Invalid Interrupt)	Undefined invalid interrupt	–	–	Hardware replacement
18	%CPMS-E-HARD-0006	EC=05000002	Module error (INTEVT Invalid Interrupt)	INTEVT invalid interrupt	–	–	Hardware replacement
19	%CPMS-E-HARD-0006	EC=0500F001	Module error (HERST Invalid Interrupt)	Serious-error invalid interrupt	–	–	Hardware replacement
20	%CPMS-E-HARD-0006	EC=0500F002	Module error (HERST2 Invalid Interrupt)	Serious-error invalid interrupt 2	–	–	Hardware replacement
21	%CPMS-E-HARD-0006	EC=0500F003	Module error (BUERRSTAT Invalid Interrupt)	Bus serious-error interrupt status invalid	–	–	Hardware replacement
22	%CPMS-E-HARD-0006	EC=0500F006	Module error (NHPMCLG Invalid Interrupt)	Memory serious-error interrupt status invalid	–	–	Hardware replacement
23	%CPMS-E-HARD-0006	EC=0500F007	Module error (ECC 2bit Master Invalid Interrupt)	Memory ECC-detected 2-bit serious-error status invalid	–	–	Hardware replacement
24	%CPMS-E-HARD-0006	EC=0500F008	Module error (RERRMST Invalid Interrupt)	RERR interrupt status invalid	–	–	Hardware replacement
25	%CPMS-E-HARD-0006	EC=0500C001	Module error (NINTR Invalid Interrupt)	NINT status invalid	–	–	Hardware replacement
26	%CPMS-E-HARD-0006	EC=0500B001	Module error (PUINTR Invalid Interrupt)	PUINT status invalid	–	–	Hardware replacement
27	%CPMS-E-HARD-0006	EC=05005001	Module error (RINTR Invalid Interrupt)	RINT status invalid	–	–	Hardware replacement
28	%CPMS-E-HARD-0006	EC=05003001	Module error (LV3 INTST Invalid Interrupt)	Level-3 interrupt status invalid	–	–	Hardware replacement
29	%CPMS-E-HARD-0006	EC=05003002	Module error (RQI6 INF Invalid Interrupt)	RQI6 status invalid	–	–	Hardware replacement
30	%CPMS-E-HARD-0006	EC=05001001	Module error (RQI3 INT Invalid Interrupt)	RQI3 status invalid	–	–	Hardware replacement
31	%CPMS-E-HARD-0006	EC=05001002	Module error (RQI3 Link Invalid Interrupt)	RQI3 link status invalid	–	–	Hardware replacement
32	%CPMS-E-HARD-0006	EC=05001003	Module error (RQI3 Module Invalid Interrupt)	RQI3 module status invalid	–	–	Hardware replacement
33	%CPMS-E-HARD-0006	EC=07D00001	Module error (INVALID EXCEPTION)	Invalid exception generated	–	ON	Hardware replacement
34	%CPMS-E-HARD-0006	EC=07D00010	Module error (INVALID MAIN/SUB SWITCH SETTING)	Main-module/submodule setting error	–	ON	Correct the main-module/submodule switch setting.
35	%CPMS-E-HARD-0006	EC=07D00011	Module error (INVALID MAC ADDRESS)	MAC address error	–	ON	Hardware replacement
36	%CPMS-E-HARD-0006	EC=07D00012	Module error (MAIN/SUB SWITCH SETTING DUPLICATION)	Main-module/submodule setting duplicated	Blinking	ON	Correct the main-module/submodule switch setting.
37	%CPMS-E-HARD-0006	EC=07D00013	Module error (ETHERNET LSI CHECK ERROR)	LANCE diagnosis error	–	ON	Hardware replacement
38	%CPMS-E-HARD-0006	EC=07D00014	Module error (SDRAM CHECK ERROR)	SDRAM initialization error	–	ON	Hardware replacement
39	%CPMS-E-HARD-0006	EC=07D00015	Module error (OS-ROM CHECKSUM ERROR)	ROM checksum error, CPMS-related	–	ON	Hardware replacement

4 ERROR LOG INFORMATION

(2/3)

No.	Error log title	Error code	Error message	Brief description	ALARM LED	ERR LED	Required action
40	%CPMS-E-HARD-0006	EC=07D00016	Module error (CAN NOT MOUNTING WITH LQE520 MODULE)	LQE720 and LQE520 combination mounting error	-	ON	The model LQE720 module cannot be mounted along with a model LQE520 module on the same mount base. Remove the model LQE520 module.
41	%CPMS-E-HARD-0006	EC=07D00018	Module error (TASK-ROM CHECKSUM ERROR)	ROM checksum error, communication task-related	-	ON	Hardware replacement
42	%CPMS-W-HARD-0006	EC=07D01003	Module error (THE VERSION OF CMU MODULE IS OLD)	Model LQE720 module is mounted along with the CMU module not supporting it.	ON	-	Replace the CMU module with its version supporting the model LQE720 module.
43	%CPMS-W-HARD-0006	EC=0D010000	Module error (Memory Alarm)	Memory 1-bit error (solid)	-	-	Hardware replacement
44	%CPMS-E-HARD-0006	EC=0D330000	Module error (Hardware WDT timeout)	Hardware WDT timeout	-	-	Hardware replacement
45	%CPMS-E-HARD-0006	EC=0D340000	Module error (Software WDT Timeout)	Software WDT Timeout	-	-	Hardware replacement
46	%CPMS-F-HARD-0009	EC=0D810000	System down (BPU Error)	BPU error	-	ON	Hardware replacement
47	%CPMS-F-HARD-0009	EC=03820000	System down (Memory Error)	Memory error	-	ON	Hardware replacement
48	%CPMS-F-HARD-0009	EC=038A0000	System down (Memory Access Error)	Memory access error	-	ON	Hardware replacement
49	%CPMS-F-HARD-0009	EC=038B0000	System down (Internal Bus Parity)	Internal-bus parity error	-	ON	Hardware replacement
50	%CPMS-F-HARD-0009	EC=038C0000	System down (System Bus Parity)	System-bus parity error	-	ON	Hardware replacement
51	%CPMS-F-HARD-0009	EC=038F0000	System down (Undefined Machine Check)	Undefined-machine check error	-	ON	Hardware replacement
52	%CPMS-F-CPMS-0009	EC=03620000	System down (Invalid Data Access)	Data access error	-	ON	Hardware replacement
53	%CPMS-F-CPMS-0009	EC=03660000	System down (Data Access Protection)	Data access protection error	-	ON	Hardware replacement
54	%CPMS-F-CPMS-0009	EC=03600000	System down (Data Page Fault)	Data access page fault	-	ON	Hardware replacement
55	%CPMS-F-CPMS-0009	EC=03420000	System down (Invalid Inst. Access)	Instruction access error	-	ON	Hardware replacement
56	%CPMS-F-CPMS-0009	EC=03460000	System down (Inst. Access Protection)	Instruction access protection error	-	ON	Hardware replacement
57	%CPMS-F-CPMS-0009	EC=03400000	System down (Instruction Page Fault)	Instruction access page fault	-	ON	Hardware replacement
58	%CPMS-F-CPMS-0009	EC=03030000	System down (Inst. Alignment Error)	Instruction alignment error	-	ON	Hardware replacement
59	%CPMS-F-CPMS-0009	EC=03040000	System down (Illegal Instruction)	Privileged instruction error	-	ON	Hardware replacement
60	%CPMS-F-CPMS-0009	EC=03380000	System down (FP Unavailable)	Floating-point unavailability exception	-	ON	Hardware replacement
61	%CPMS-F-CPMS-0009	EC=03390000	System down (FP System down)	Floating-point arithmetic error	-	ON	Hardware replacement
62	%CPMS-F-CPMS-0009	EC=03470000	System down (Data Alignment Error)	Data alignment error	-	ON	Hardware replacement
63	%CPMS-F-CPMS-0009	EC=030F0000	System down (Illegal Exception)	Illegal Exception	-	ON	Hardware replacement
64	%CPMS-F-CPMS-0009	EC=05700000	System down (System Error)	System down (System error)	-	ON	Hardware replacement
65	%CPMS-F-CPMS-000A	EC=05800000	System down (Kernel Trap)	System down (Kernel trap)	-	ON	Hardware replacement
66	%LNET-W-HARD-004	EC=07801308	I/O error (SEND_TIMEOUT)	Transmission timeout error	-	-	Error recovery done automatically
67	%LNET-E-HARD-004	EC=07801308	I/O error (SEND_TIMEOUT)	Transmission timeout error	-	ON	If error recovery is not achievable by turning off the power to the model LQE720 module and back on again, replace the module.
68	%LNET-W-HARD-004	EC=0780130A	I/O error (RESET_ERROR)	Hardware resetting error	-	-	Error recovery done automatically
69	%LNET-E-HARD-004	EC=0780130A	I/O error (RESET_ERROR)	Hardware resetting error	-	ON	If error recovery is not achievable by turning off the power to the model LQE720 module and back on again, replace the module.
70	%LNET-W-HARD-004	EC=0780130E	I/O error (MEMORY)	Memory error	-	-	Error recovery done automatically
71	%LNET-E-HARD-004	EC=0780130E	I/O error (MEMORY)	Memory error	-	ON	If error recovery is not achievable by turning off the power to the model LQE720 module and back on again, replace the module.
72	%LNET-W-HARD-004	EC=07801310	I/O error (LOSS)	Carrier loss error	-	-	Check the communication path. (*1)

4 ERROR LOG INFORMATION

(3/3)

No.	Error log title	Error code	Error message	Brief description	ALARM LED	ERR LED	Required action
73	%LNET-W-HARD-004	EC=07801311	I/O error (RETRY)	Retry error	–	–	Check the communication path (*3)
74	%LNET-W-HARD-004	EC=07801312	I/O error (LATE)	Late collision error	–	–	Check the communication path (*5)
75	%LNET-W-HARD-004	EC=07801351	I/O error (TX_ABORT)	Transmission aborted	–	–	Check the communication path
76	%LNET-W-HARD-004	EC=07801353	I/O error (TX_DEFER)	Transmission error due to transmission delay	–	–	Check the communication path
77	%LNET-W-HARD-004	EC=07801370	I/O error (EC_PCI_ERROR)	PCI error detected by communication LSI device	–	–	Hardware replacement (*6)
78	%LNET-W-HARD-004	EC=07801376	I/O error (TX_DATA_UNDER)	Communication data FIFO underrun	–	–	Check the communication path (*6)
79	%LNET-W-HARD-004	EC=07801375	I/O error (RX_STAT_OVER)	Reception-status FIFO overrun	–	–	Check the communication line load. (*6)
80	%LNET-W-HARD-004	EC=07801377	I/O error (RX_DATA_OVER)	Receive-data FIFO overrun	–	–	Check the communication line load. (*7)
81	%LNET-E-HARD-004	EC=07D01001	I/O error (IP_ADDERSS_NOT_REGISTERED)	IP address not set yet	ON	–	Set an IP address.
82	%LNET-E-HARD-004	EC=07801400	I/O error (PCI_BUS_ERR)	PCI bus error	–	–	Hardware replacement
83	%LNET-E-HARD-004	EC=07801505	I/O error (INV_INTR)	Invalid interrupt generated from communication line	–	–	Hardware replacement
84	%LNET-E-SOFT-004	EC=07801508	I/O error (BUF_OVF)	OS-managed send/receive buffer overflowed	–	–	Check the communication line load. (*2)
85	%LNET-W-SOFT-004	EC=0780150F	I/O error (SOCKET_OVF)	Socket table full	–	–	Check the user program.
86	%LNET-W-SOFT-004	EC=07801510	I/O error (IFCONFIG_UP)	Network interface initialization error	–	–	Check the settings.
87	%LNET-W-SOFT-004	EC=07801512	I/O error (IPADDR_DUPL)	IP address duplicated	Blinking (*4)	–	Check the settings. (*4)

(*1) The listed error message is output once when an LSI carrier loss condition is detected 32 times successively. An LSI carrier loss condition occurs when data transmission is attempted in the OFF (link not established yet) condition of the LINK LED indicator. Therefore, an LSI carrier loss condition also occurs when upon completion of the startup of the CPU an application program running on the CPU has issued 32 or more transmission requests before the LINK LED indicator is turned on. In this case, the application program must be corrected so that it will issue transmission requests only after the LINK LED indicator is turned on.

(*2) This type of error occurs due to a buffer shortage in high-communication-load condition.

(*3) The listed error message is output once when this type of error occurs 32 times successively.

(*4) The IP address of the model LQE720 module is duplicated with the IP address of another computer. If an attempt is made to establish a connection over the communication line that the other computer is using with an already established connection, the ALARM LED indicator starts blinking.

(*5) The listed error message is output once when this type of error is detected eight times successively. If it is detected more than 16 times successively, the error message is output once when it is detected 256 times.

(*6) The listed error message is output once when this type of error is detected five times successively.

(*7) The listed error message is output once when this type of error is detected 10 times successively.

4.2.15 NCP-F (model LQE780-Z) error log info and required actions

NCP-F-related errors are reported by presenting error messages in one of the formats shown under “4.3 CMU Error Message Formats.”

(1/5)

No.	Error log title	Error code	Error message	Brief description	Error classification	Error location	Required action
1	%LNET-E-HARD-0004	EC=07017104	I/O error (PROCESSOR DOWN)	Common illegal instruction	MPU exception error	Hardware	(*1)
2	%LNET-E-HARD-0004	EC=07017106	I/O error (PROCESSOR DOWN)	Slot illegal instruction, exception error			(*1)
3	%LNET-E-HARD-0004	EC=07017109	I/O error (PROCESSOR DOWN)	CPU address error			(*1)
4	%LNET-E-HARD-0004	EC=0701710A	I/O error (PROCESSOR DOWN)	DMA address error			(*1)
5	%LNET-E-HARD-0004	EC=0701710B	I/O error (PROCESSOR DOWN)	NMI interrupt error			(*1)
6	%LNET-E-HARD-0004	EC=0701710C	I/O error (PROCESSOR DOWN)	User break generated			(*1)
7	%LNET-E-HARD-0004	EC=07117140	I/O error (PROCESSOR DOWN)	IRL1 interrupt generated (invalid interrupt generated 10 times successively)			(*1)
8	%LNET-E-HARD-0004	EC=07117141	I/O error (PROCESSOR DOWN)	IRL2/3 interrupt generated (invalid interrupt generated 10 times successively)			(*1)
9	%LNET-E-HARD-0004	EC=07117142	I/O error (PROCESSOR DOWN)	IRL4/5 interrupt generated (invalid interrupt generated 10 times successively)			(*1)
10	%LNET-E-HARD-0004	EC=07117143	I/O error (PROCESSOR DOWN)	IRL6/7 interrupt generated (invalid interrupt generated 10 times successively)			(*1)
11	%LNET-E-HARD-0004	EC=07117144	I/O error (PROCESSOR DOWN)	IRL8/9 interrupt generated (invalid interrupt generated 10 times successively)			(*1)
12	%LNET-E-HARD-0004	EC=0701714A	I/O error (PROCESSOR DOWN)	FRT interrupt generated (invalid interrupt generated 10 times successively)			(*1)
13	%LNET-E-HARD-0004	EC=07017145	I/O error (PROCESSOR DOWN)	IRL10/11 interrupt generated			(*1)
14	%LNET-E-HARD-0004	EC=07017146	I/O error (PROCESSOR DOWN)	IRL12/13 interrupt generated			(*1)
15	%LNET-E-HARD-0004	EC=07017147	I/O error (PROCESSOR DOWN)	IRL14/15 interrupt generated			(*1)
16	%LNET-E-HARD-0004	EC=0701714F	I/O error (PROCESSOR DOWN)	SCI interrupt generated			(*1)
17	%LNET-E-HARD-0004	EC=070171FF	I/O error (PROCESSOR DOWN)	Exception other than the above generated			(*1)
18	%LNET-E-HARD-0004	EC=07187101	I/O error (PROCESSOR DOWN)	MPU register write-read-compare check error	BOOT diagnosis error	(*1)	
19	%LNET-E-HARD-0004	EC=07187102	I/O error (PROCESSOR DOWN)	MPU operation check error		(*1)	
20	%LNET-E-HARD-0004	EC=07187103	I/O error (PROCESSOR DOWN)	FRAM read-read-compare check error		(*1)	
21	%LNET-E-HARD-0004	EC=07187104	I/O error (PROCESSOR DOWN)	FRAM checksum error		(*1)	
22	%LNET-E-HARD-0004	EC=07187105	I/O error (PROCESSOR DOWN)	LS write-read-compare check error		(*1)	
23	%LNET-E-HARD-0004	EC=07187106	I/O error (PROCESSOR DOWN)	HKP FRAM-to-LS copy error		(*1)	
24	%LNET-E-HARD-0004	EC=0718710B	I/O error (PROCESSOR DOWN)	Timer diagnostic-check error		(*1)	
25	%LNET-E-HARD-0004	EC=0718710E	I/O error (PROCESSOR DOWN)	DRAM diagnosis-time single-bit ECC error; detected two times		(*1)	
26	%LNET-E-HARD-0004	EC=0718710F	I/O error (PROCESSOR DOWN)	Incorrect MAC address detected		(*1)	
27	%LNET-E-HARD-0004	EC=0718711B	I/O error (PROCESSOR DOWN)	Timer diagnostic-check error, FRT timer-related		(*1)	
28	%LNET-E-HARD-0004	EC=0718712X	I/O error (PROCESSOR DOWN)	FDDI chipset diagnosis error (X: 0, 1, 2, A, B, or C)		(*1)	
29	%LNET-E-HARD-0004	EC=07207101	I/O error (PROCESSOR DOWN)	DRAM expansion area access error (NMI)	Internal error	(*1)	
30	%LNET-E-HARD-0004	EC=07207102	I/O error (PROCESSOR DOWN)	LS protected-area access error (NMI)		(*1)	
31	%LNET-E-HARD-0004	EC=07207104	I/O error (PROCESSOR DOWN)	WDT error (NMI)		(*1)	
32	%LNET-E-HARD-0004	EC=07207105	I/O error (PROCESSOR DOWN)	POP signal abnormality detected		(*1)	
33	%LNET-E-HARD-0004	EC=07217101	I/O error (PROCESSOR DOWN)	DRAM ECC-uncorrectable error (IRL13)		(*1)	
34	%LNET-E-HARD-0004	EC=07217111	I/O error (PROCESSOR DOWN)	LS parity error (IRL13)		(*1)	
35	%LNET-E-HARD-0004	EC=07217121	I/O error (PROCESSOR DOWN)	Buffer memory read parity error (IRL13)		(*1)	

4 ERROR LOG INFORMATION

(2/5)

No.	Error log title	Error code	Error message	Brief description	Error classification	Error location	Required action
36	%LNET-E-HARD-0004	EC=07217131	I/O error (PROCESSOR DOWN)	M-bus timeout error (IRL13)	Internal error	Hardware	(*1)
37	%LNET-E-HARD-0004	EC=07217141	I/O error (PROCESSOR DOWN)	F-bus timeout error (IRL13)			(*1)
38	%LNET-E-HARD-0004	EC=07217151	I/O error (PROCESSOR DOWN)	P-bus timeout error (IRL13)			(*1)
39	%LNET-E-HARD-0004	EC=07217161	I/O error (PROCESSOR DOWN)	P-bus target abort received (IRL13)			(*1)
40	%LNET-E-HARD-0004	EC=07217171	I/O error (PROCESSOR DOWN)	P-bus parity error (IRL13)			(*1)
41	%LNET-E-HARD-0004	EC=07217181	I/O error (PROCESSOR DOWN)	P-bus access retry count limit exceeded (IRL13)			(*1)
42	%LNET-E-HARD-0004	EC=07227201	I/O error (PROCESSOR DOWN)	Error injection command error (error injection command failed to generate an error)			(*1)
43	%LNET-E-HARD-0004	EC=07837202	I/O error (R_DMAP_ERR)	DMA-P transfer failed (DMA-P access to the routing report table failed)	OS-detected error	Resetting (*1)	
44	%LNET-E-HARD-0004	EC=07837203	I/O error (DMAP_ERR)	DMA-P transfer failed (between MS-DRAM locations during command processing)		Resetting (*1)	
45	%LNET-W-HARD-0004	EC=07837203	I/O error (DMAP_ERR)	DMA-P transfer failed (between MS-DRAM locations during command processing)		—	
46	%LNET-E-HARD-0004	EC=07217201	I/O error (SOFT TIMEOUT)	Response-to-command-initiation-request timeout detected	Software error	Error handling in interface	(*1)
47	%LNET-E-HARD-0004	EC=07C87201	I/O error (CMD ILG)	Undefined command received			(*1)
48	%LNET-E-SOFT-0004	EC=07C87202	I/O error (COMMAND STS)	Erroneous command-issuing procedure used			Program correction (*2)
49	%LNET-E-SOFT-0004	EC=07C87203	I/O error (PARA ILG)	Parameter error			Program correction (*2)
50	%LNET-E-SOFT-0004	EC=07C87204	I/O error (IF BUSY)	Interface block busy			Program correction (*2)
51	%LNET-E-HARD-0004	EC=07C87207	I/O error (COM BUSY)	Multiple command initiation attempted			(*1)
52	%LNET-E-SOFT-0004	EC=07C87208	I/O error (PORT ILG)	Use of specified port no. prohibited; it is an SETIPA-dedicated port.			Program correction (*2)
53	%LNET-W-SOFT-0004	EC=07C87209	I/O error (ROUTE BUF FULL)	Routing reporting was unachievable due to MS routing report buffer full.			Program correction (*2)
54	%LNET-E-HARD-0004	EC=07C8720C	I/O error (SYSBUSINTILG)	Illegal system bus interrupt detected			(*1)
55	%LNET-E-HARD-0004	EC=07C8720D	I/O error (NO LOGSAVE)	Individual-module stoppage requested without issuing a LOGSAVE command			(*1)
56	%LNET-E-SOFT-0004	EC=07C97204	I/O error (NO RESOURCE)	TCP/IP resource shortage detected			Program correction (*2)
57	%LNET-E-SOFT-0004	EC=07C97205	I/O error (ADDR IN USE)	Double-socket error			Program correction (*2)
58	%LNET-E-HARD-0004	EC=07C97206	I/O error (SOCKET ILG)	Illegal socket detected			
59	%LNET-E-HARD-0004	EC=07C97207	I/O error (SEND_PENDING)	Transmission in pending state			(*1)
60	%LNET-E-HARD-0004	EC=07C9720A	I/O error (DEST UNREACH)	Destination unreachable			(*1)
61	%LNET-E-HARD-0004	EC=07C9720B	I/O error (RECV_PENDING)	Reception in pending state			(*1)
62	%LNET-W-HARD-0004	EC=07C9720C	I/O error (SHUTDOWN)	Already closed or shut down			(*1)
63	%LNET-E-HARD-0004	EC=07C9720F	I/O error (ADR_ILG)	Illegal address detected			(*1)
64	%LNET-E-HARD-0004	EC=07C97210	I/O error (ACCEPT_PENDING)	Acceptance in pending state			(*1)
65	%LNET-E-HARD-0004	EC=07CF7102	I/O error (SOFT_IF_ILG)	C_USE register's ON condition detected in command initiation; detected by OS			(*1)
66	%LNET-E-HARD-0004	EC=07CF7103	I/O error (SOFT_IF_ILG)	Inappropriate response to a requesting command; detected by OS			(*1)
67	%LNET-E-HARD-0004	EC=07CF7104	I/O error (SOFT_IF_ILG)	Illegal response detected in a pending state of processing; detected by OS			(*1)
68	%LNET-E-HARD-0004	EC=07CF7105	I/O error (SOFT_IF_ILG)	Invalid interrupt generated; detected by OS			(*1)
69	%LNET-E-HARD-0004	EC=07CF7106	I/O error (SOFT_IF_ILG)	Illegal response code or AI code received; detected by OS	(*1)		
70	%LNET-E-HARD-0004	EC=07CF7107	I/O error (SOFT_IF_ILG)	Response received from the I/F block in a "command not initiated yet" condition; detected by OS	(*1)		
71	%LNET-E-SOFT-0004	EC=07CF7108	I/O error (BUF_OVF)	OS-managed send-/receive-buffer overflowed	Review the system design. (*2) (*3)		

4 ERROR LOG INFORMATION

(3/5)

No.	Error log title	Error code	Error message	Brief description	Error classification	Error location	Required action
72	%LNET-W-SOFT-0004	EC=07CF7109	I/O error (ECD_ENXIO)	OS-detected system abnormality -- no such card existent	Software interface error	Error handling in interface	Review the system design. (*2)
73	%LNET-W-SOFT-0004	EC=07CF710A	I/O error (ADAPTER_TYPE)	OS-detected system abnormality -- non-matching card type detected			Review the system design. (*2)
74	%LNET-E-HARD-0004	EC=07CF710B	I/O error (HARD_ERR)	OS-detected card initialization error -- hardware fault			(*1)
75	%LNET-E-HARD-0004	EC=07CF710C	I/O error (INITIAL)	OS-detected card initialization error -- hardware not initialized yet			(*1)
76	%LNET-W-SOFT-0004	EC=07CF710D	I/O error (STATION_NUM)	OS-detected system abnormality, station-related			Review the system design. (*2)
77	%LNET-E-HARD-0004	EC=07CF710E	I/O error (STATUS)	OS-detected card initialization error -- hardware status abnormal			(*1)
78	%LNET-W-SOFT-0004	EC=07CF710F	I/O error (SOCKET_OVF)	Socket table full			Review the system design. (*2)
79	%LNET-W-SOFT-0004	EC=07CF71E0	I/O error (IPROUT_WARN)	Packet forwarding failed			Review the system design. (*2)
80	%LNET-W-SOFT-0004	EC=07CF71E1	I/O error (IPROUT_WARN)	Packet receive-buffer reset			Review the system design. (*2)
81	%LNET-W-SOFT-0004	EC=07CF71E2	I/O error (IPROUT_WARN)	Packet length exceeded the set limit			Review the system design. (*2)
82	%LNET-W-SOFT-0004	EC=07CF71E3	I/O error (IPROUT_WARN)	Packet-forwarding destination not supported by routing function			Review the system design. (*2)
83	%LNET-W-SOFT-0004	EC=07CF71E4	I/O error (IPROUT_WARN)	Response detected after timeout handling was finished.			Review the system design. (*2)
84	%LNET-W-SOFT-0004	EC=07CF71E5	I/O error (IPROUT_WARN)	IP routing information setting failed			Review the system design. (*2)
85	%LNET-W-SOFT-0004	EC=07CF71E6	I/O error (IPROUT_WARN)	Interface control block could not be obtained.			Review the system design. (*2)
86	%LNET-E-SOFT-0004	EC=07CF72E0	I/O error (IPROUT_ERR)	Packet transmission timed out			Restart the system. (*1)
87	%LNET-E-SOFT-0004	EC=07CF72E1	I/O error (IPROUT_ERR)	IP routing information overflowed			Restart the system. (*1)
88	%LNET-E-SOFT-0004	EC=07CF72E2	I/O error (IPROUT_ERR)	An attempt made to use in a command an IP address that requires the use of routing function.			Restart the system. (*1)
89	%LNET-E-SOFT-0004	EC=07CF72E3	I/O error (IPROUT_ERR)	Packet forwarding resulted in a parameter error.			Restart the system. (*1)
90	%LNET-W-HARD-0004	EC=07317201	I/O error (ISOLATE2)	Transmission unachievable due to the ring in Ring_Non_op state (including ISOLATE state)			Channel error
91	%LNET-E-SOFT-0004	EC=07317204	I/O error (SEND_TO)	Transmission timed out	Correct the destination station's program. (*2)		
92	%LNET-E-HARD-0004	EC=07317205	I/O error (FDDI_LSI_ERR)	FDDI control LSI device failed	Restart the system. (*1)		
93	%LNET-E-HARD-0004	EC=07317206	I/O error (DMA_B_ERR)	DMA-B failed	Restart the system. (*1)		
94	%LNET-E-HARD-0004	EC=07327201	I/O error (LOOP_TST_ERR)	Loopback test error detected (in tst_chn command)	Restart the system. (*1)		
95	%LNET-E-SOFT-0004	EC=07517201	I/O error (SEND_AREA_DUPL)	An overlap detected between this NCP's cyclic transmission area and another NCP's transmission area.	Area overlap	Correct the program. (*2)	
96	%LNET-W-HARD-0004	EC=07527201	I/O error (TTRG)	A trace code found identical to a trace trap code	Trace trigger	-	
97	%LNET-I-HARD-0004	EC=07537211	I/O error (ISOLATE)	ISOLATED condition detected	Network configuration change	Connect the transmission path properly. (*1)	
98	%LNET-I-HARD-0004	EC=07537213	I/O error (WRAP_A_AI)	WRAP-A condition detected (A-system transmission path looped back)		Connect the transmission path properly. (*1)	
99	%LNET-I-HARD-0004	EC=07537214	I/O error (WRAP_B_AI)	WRAP-B condition detected (B-system transmission path looped back)		Connect the transmission path properly. (*1)	

4 ERROR LOG INFORMATION

(4/5)

No.	Error log title	Error code	Error message	Brief description	Error classification	Error location	Required action
100	%LNET-I-HARD-0004	EC=07537216	I/O error (THRU_AI)	THRU condition detected	Network configuration change	Error handling in communication line	(Error recovery)
101	%LNET-I-HARD-0004	EC=07537218	I/O error (ISOLATE(LE))	ISOLATE condition caused by a transmission exceeding the link rate			Connect the transmission path properly. (*1)
102	%LNET-I-HARD-0004	EC=07537219	I/O error (WRAP_A_AI(LE))	WRAP-A condition caused by a transmission exceeding the link rate			Connect the transmission path properly. (*1)
103	%LNET-I-HARD-0004	EC=0753721A	I/O error (WRAP_B_AI(LE))	WRAP-B condition caused by a transmission exceeding the link rate			Connect the transmission path properly. (*1)
104	%LNET-I-HARD-0004	EC=07537221	I/O error (UPER_ST_CHNG)	Upstream neighboring station changed			(*1)
105	%LNET-I-HARD-0004	EC=07537222	I/O error (LOWR_ST_CHNG)	Downstream neighboring station changed			(*1)
106	%LNET-W-HARD-0004	EC=07537231	I/O error (ERR_FRAM_OVR)	Condition change made from "below error frame count" to "above error frame count"	Transmission path error (warning)	Connect the transmission path properly. (*1)	
107	%LNET-I-HARD-0004	EC=07537232	I/O error (ERR_FRAM_NON)	Condition change made from "above error frame count" to "below error frame count"; this is a normal condition.		(Error recovery)	
108	%LNET-W-HARD-0004	EC=07537241	I/O error (LINK_ERR_OV(A))	Condition change made from "below link error ratio" to "above link error ratio" in A-port		Connect the transmission path properly. (*1)	
109	%LNET-I-HARD-0004	EC=07537242	I/O error (LINK_ERR_NO(A))	Condition change made from "above link error ratio" to "below link error ratio" in A-port; this is a normal condition.		(Error recovery)	
110	%LNET-W-HARD-0004	EC=07537243	I/O error (LINK_ERR_OV(B))	Condition change made from "below link error ratio" to "above link error ratio" in B-port		Connect the transmission path properly. (*1)	
111	%LNET-I-HARD-0004	EC=07537244	I/O error (LINK_ERR_NO(B))	Condition change made from "above link error ratio" to "below link error ratio" in B-port; this is a normal condition.		(Error recovery)	
112	%LNET-E-HARD-0004	EC=07537251	I/O error (LINK_EVENT(A))	Connection error -- a prohibited connection attempted in A-port of NCP-F	Duplicated address	Connect the transmission path properly. (*1)	
113	%LNET-E-HARD-0004	EC=07537252	I/O error (LINK_EVENT(B))	Connection error -- a prohibited connection attempted in B-port of NCP-F		Connect the transmission path properly. (*1)	
114	%LNET-E-HARD-0004	EC=07537261	I/O error (MAC_ADR_ERR1)	Duplicated MAC address detected; automatically separated from the ring.		(*1)	
115	%LNET-E-HARD-0004	EC=07537262	I/O error (MAC_ADR_ERR2)	Duplicated MAC address detected; logical separation from the ring was requested.		(*1)	
116	%LNET-E-HARD-0004	EC=07537263	I/O error (MAC_ADR_ERR3)	Duplicated MAC address detected; My_Claim received.		(*1)	
117	%LNET-E-HARD-0004	EC=07537264	I/O error (MAC_ADR_ERR4)	Duplicated MAC address detected		(*1)	
118	%LNET-E-HARD-0004	EC=07537265	I/O error (ST_ADR_ERR)	Duplicated station address detected	FDDI control LSI device abnormality	Set the rotary switch correctly. (*1)	
119	%LNET-E-HARD-0004	EC=07537271	I/O error (FDDI_LSI_ERR1)	FDDI control LSI device abnormality detected; a bus test failed because the local station was in a failure condition and isolated.		(*1)	
120	%LNET-E-HARD-0004	EC=07537272	I/O error (FDDI_LSI_ERR2)	FDDI control LSI device abnormality detected; FM+ is abnormal.		(*1)	
121	%LNET-E-HARD-0004	EC=07537273	I/O error (FDDI_LSI_ERR3)	FDDI control LSI device abnormality detected; PLC-S is abnormal.		(*1)	
122	%LNET-E-HARD-0004	EC=07537281	I/O error (TOKEN_DUAL)	A double-token condition detected in the transmission path		(*1)	
123	%LNET-E-HARD-0004	EC=07537282	I/O error (ILG_TOKEN)	Restricted token mode detected in the transmission path		(*1)	
124	%LNET-W-HARD-0004	EC=07537283	I/O error (BUF_MEM_BUSY)	Receive-buffer in buffer memory was busy.	Transmission path abnormality	Check the load on the transmission path.	

4 ERROR LOG INFORMATION

(5/5)

No.	Error log title	Error code	Error message	Brief description	Error classification	Error location	Required action
125	%LNET-W-HARD-0004	EC=07417201	I/O error (ISOLATE2)	Transmission unachievable due to the ring in Ring_Non_op condition (including ISOLATE condition)	Network configuration change	Error handling in communication line	Re-issue it after the node's participation in the ring. (*1)
126	%LNET-E-HARD-0004	EC=07417202	I/O error (SEND_ABORT)	Transmission aborted due to MAC resetting or ring recovery	FDDI control LSI device abnormality		Restart the system. (*1)
127	%LNET-E-HARD-0004	EC=07417203	I/O error (SEND_ABORT2)	Transmission aborted and resetting made due to a parity error in send-buffer memory (*1)			Restart the system. (*1)
128	%LNET-E-SOFT-0004	EC=07417204	I/O error (SEND_TO)	Transmission timed out			Correct the destination station's program. (*2)
129	%LNET-E-HARD-0004	EC=07537291	I/O error (CYC_BLK_ILG)	Cyclic-block no. error detected in cyclic reception	Connection error		Connect the transmission path properly. (*1)
130	%LNET-E-HARD-0004	EC=075372A1	I/O error (DRAM_ERR1)	Single-bit error detected in DRAM	Module LSI device abnormality		(*1)
131	%LNET-E-HARD-0004	EC=075372A2	I/O error (DRAM_ERR2)	DMA-B transfer timed out in DRAM			(*1)
132	%LNET-W-SOFT-0004	EC=07557201	I/O error (RECV_BUF_BUSY)	UDP frame receive-buffer busy	Receive-buffer error		Correct the program. (*2)
133	%LNET-E-HARD-0004	EC=07567201	I/O error (RESP_TO)	Response-monitoring timeout error (in tst_wio, ring_ctl, or get_mibfddi)	Destination station error		(*1)
134	%LNET-E-HARD-0004	EC=07567202	I/O error (DATA_CMP_ERR)	Send-/receive-data compare-check error (in tst_wio)		(*1)	
135	%LNET-E-HARD-0004	EC=0718711C	I/O error (PROCESSOR DOWN)	FPGA diagnosis error or system-bus read error	FPGA failure	Hardware	(*1)
136	%LNET-E-HARD-0004	EC=0718711D	I/O error (PROCESSOR DOWN)	PCI configuration register setting not finished yet		(*1)	

(*1) Carry out maintenance and recovery work by referring to the "MAINTENANCE MANUAL FOR μΣNETWORK-100 (manual number CC-97012)."

(*2) Carry out maintenance work by referring to the "MAINTENANCE MANUAL FOR μΣNETWORK-100 (manual number CC-97012)."

(*3) This type of error occurs due to a buffer shortage in high-communication-load condition.

4 ERROR LOG INFORMATION

4.2.16 LANCP (model LQE790-Z/795-Z) error log info and required actions

LANCP-related errors are reported by presenting error messages in one of the formats shown under “4.3 CMU Error Message Formats.”

No.	Error log title	Error code	Error message	Brief description	Error classification	Error location	Required action
1	%LNET-E-HARD-0004	EC=07801308	I/O error (SEND_TIMEOUT)	Transmission timeout error	LSI device error	Hardware	Hardware replacement
2	%LNET-E-HARD-0004	EC=0780130A	I/O error (RESET_ERROR)	Hardware resetting error			Hardware replacement
3	%LNET-E-HARD-0004	EC=0780130E	I/O error (MEMORY)	Memory error			Hardware replacement
4	%LNET-W-HARD-0004	EC=07801308	I/O error (SEND_TIMEOUT)	Transmission timeout error -- error recovery done automatically			--
5	%LNET-W-HARD-0004	EC=0780130A	I/O error (RESET_ERROR)	Hardware resetting error -- error recovery done automatically			--
6	%LNET-W-HARD-0004	EC=0780130E	I/O error (MEMORY)	Memory error -- error recovery done automatically			--
7	%LNET-W-HARD-0004	EC=07801310	I/O error (LOSS)	Carrier loss error	Channel error	Error handling in communication line	Check the transmission path. (*1)
8	%LNET-W-HARD-0004	EC=07801311	I/O error (RETRY)	Retry error			Check the transmission path.
9	%LNET-W-HARD-0004	EC=07801312	I/O error (LATE)	Late-collision error			Check the transmission path.
10	%LNET-E-HARD-0004	EC=07801400	I/O error (PCI_BUS_ERR)	Built-in LANCE PCI bus error	Bus error, etc.	Hardware	Hardware replacement
11	%LNET-E-HARD-0004	EC=07801600	I/O error (LPCL_BUS_ERR)	LANCP internal-PCI bus error			Hardware replacement
12	%LNET-E-HARD-0004	EC=07801601	I/O error (R700_BUS_ERR)	LANCP R700 bus error			Hardware replacement
13	%LNET-E-HARD-0004	EC=07801602	I/O error (P3V_ERR)	Module error			Hardware replacement
14	%LNET-E-HARD-0004	EC=07801505	I/O error (INV_INTR)	Invalid interrupt generated; detected by OS	Software interface error	Error handling in interface	Hardware replacement
15	%LNET-E-SOFT-0004	EC=07801508	I/O error (BUF_OVF)	OS-managed send/receive-buffer overflowed			Review the system design. (*2)
16	%LNET-W-SOFT-0004	EC=07801509	I/O error (ECD_ENXIO)	OS-detected system abnormality -- no such card existent			Review the system construction.
17	%LNET-W-SOFT-0004	EC=0780150A	I/O error (ADAPTER_TYPE)	OS-detected system abnormality -- non-matching card type detected			Review the system construction.
18	%LNET-E-HARD-0004	EC=0780150C	I/O error (INITIAL)	OS-detected LANCP hardware initialization error			Hardware replacement
19	%LNET-W-SOFT-0004	EC=0780150D	I/O error (STATION_NUM)	OS-detected system abnormality -- non-matching station number			Review the system construction.
20	%LNET-W-SOFT-0004	EC=0780150F	I/O error (SOCKET_OVF)	Socket table full; detected by OS			Review the system design.
21	%LNET-W-SOFT-0004	EC=07801510	I/O error (IFCONFIG_UP)	OS-detected initialization error			Review the system design.
22	%LNET-W-SOFT-0004	EC=07801511	I/O error (NETADDR_DUPL)	Duplicated network address; detected by OS			Review the system construction. (*3)
23	%LNET-W-SOFT-0004	EC=07801512	I/O error (IPADDR_DUPL)	Duplicated IP address; detected by OS			Review the system construction. (*4)

(*1) The listed error message is output once when an LSI carrier loss condition is detected 32 times successively. With the built-in LANCE and LNC550 LANCP (10BASE-T) modules, an LSI carrier loss condition occurs when data transmission is attempted in the OFF (link not established yet) condition of the LINK LED indicator. Therefore, an LSI carrier loss condition also occurs when upon completion of the startup of the CPU an application program running on the CPU has issued 32 or more transmission requests before the LINK LED indicator is turned on. In this case, the application program must be corrected so that it will issue transmission requests only after the LINK LED indicator is turned on.

(*2) This type of error occurs due to a buffer shortage in high-communication-load condition.

(*3) The network addresses of the built-in LANCE and LANCP module must be defined uniquely.

(*4) The IP address of the LANCP module is duplicated with the IP address of another computer.

4.3 CMU Error Message Formats

CMU-related errors are reported in the following formats.

4.3.1 Panic log error message formats

①	②	③	④
---	---	---	---

Table 4-1 Panic Log Error Message Formats

Format type	Error message format
System down -- system error	①+②+③+④
System down -- built-in subroutine error	①+②+③+④

① Error severity ID symbols

[F]: Fatal error

[FU]: Built-in subroutine error

② Error message

For details, see the information supplied under “4.2 Error Log Information and Required Actions.” If the error code displayed is not listed in any error message list, the error message displayed along with the error code is one of the default error messages listed below.

Table 4-2 Panic Log Default Error Messages

Format type	Error message
System down -- system error	System down
System down -- built-in subroutine error	System down

③ Program counter

④ Fault address

4 ERROR LOG INFORMATION

4.3.2 Non-panic log error message formats

Possible format elements -- form 1:

①	②	③	④	⑤
---	---	---	---	---

Table 4-3 Non-Panic Log Error Message Formats

Format type	Error message format
Program error	①+②+④
Macro parameter check error	①+②+④
I/O error	①+②+③
WDT timeout error	①+②
Module error	①+②+⑤
Kernel warning	①+②+④
Kernel information	①+②+④
System down -- kernel trap	①+②
System down -- built-in subroutine stoppage	①+②
ADT error	①+②+④
Memory error	①+②+④
System-bus error	①+②+⑤
Message frame error	①+②
Buffer status report	①+②
Socket error	①+②

① Error severity ID symbols

[F]: Fatal error [W]: Warning
 [E]: Error [I]: Information

② Error message

For details, see the information supplied under “4.2 Error Log Information and Required Actions.” If the error code displayed is not listed in any error message list, the error message displayed along with the error code is one of the default error messages listed in Table 4-4.

Table 4-4 Non-Panic Log Default Error Messages

Format type	Error message
Program error	Program error
Macro parameter check error	Macro parameter error
I/O error	I/O error
WDT timeout error	WDT timeout error
Module error	Module Error
Kernel warning	Kernel Warning
Kernel information	Kernel Information
System down -- kernel trap	System down
System down -- built-in subroutine stoppage	System down
ADT error	Program error
Memory error	Memory error
System-bus error	System Bus Error
Message frame error	Message frame error
Buffer status report	Buffer status
Socket error	Socket error

③ Unit number and device number

Unit number range: 1 to 24

Device number range: 0x00000000 to 0xFFFFFFFF

④ Task number

Task number range: 1 to 300 (or 1 to 229 for user tasks)

⑤ Slot number

Slot number range: 0 to 7

4 ERROR LOG INFORMATION

Possible format elements -- form 2:

Non-panic log error messages of form 2 are displayed in the following format:

<pre>%*****_*_*****_***** ① ② ③ ④</pre>

- ① ID name of a system in which the error is detected
 - CPMS: CPMS (basic OS)
 - LNET: RCTLNET (network driver)
 - NX: NXACP (autonomous distributed platform)
 - MSxx: Middleware numbered xx, where xx is a 2-digit number in the range 01 to 16.
 - USxx: Application software numbered xx, where xx is a 2-digit number in the range 01 to 16.
- ② Error severity ID symbol
 - F: Fatal error E: Error
 - W: Warning I: Information
 - ?: Other kind of error
- ③ Error location ID symbol
 - HARD: Hardware
 - CPMS: CPMS
 - SOFT: Software other than the CPMS
 - ????: Other type of error
- ④ Code
 - This code is a 4-digit hexadecimal number indicating a format type.

4.4 RPDP Error Log Display Guide

4.4.1 Reading the error log

This section serves as a short guide on how to read the content of the “Error Log Detail” window displayed by the svelog command of RPDP or by the S10V BASE SYSTEM. The following is an example of the “Error Log Detail” window displayed.

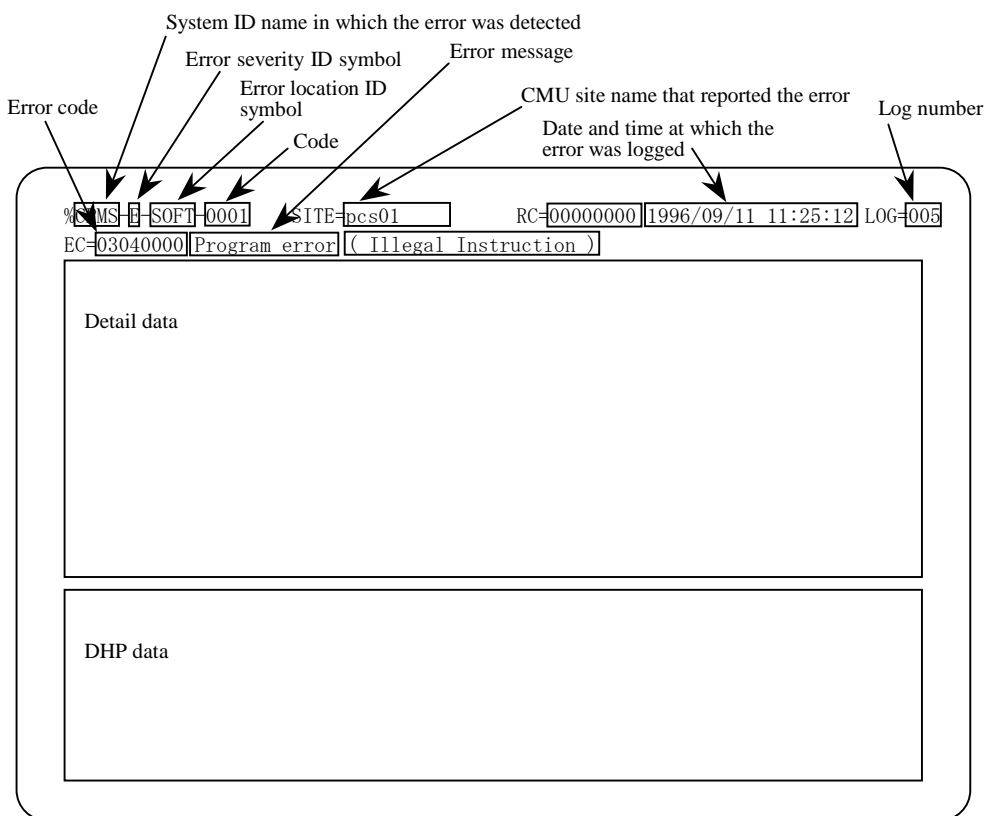

Figure 4-1 Example of a Displayed Error Log

4 ERROR LOG INFORMATION

- System ID name in which the error was detected
 - CPMS: CPMS (basic OS)
 - LNET: RCTLNET (network driver)
 - NX: NXACP (autonomous distributed platform)
 - MSxx: Middleware numbered xx, where xx is a 2-digit number in the range 01 to 16.
 - USxx: Application software numbered xx, where xx is a 2-digit number in the range 01 to 16.
- Error message (listed under “4.2 Error Log Information and Required Actions”)
 - Program error: An error that affects the normal execution of the program.
 - Macro parameter check error: A parameter error detected in a macro instruction of the OS.
 - WDT timeout error: An error generated by the watchdog timer.
 - I/O error: An error related to input/output operation.
 - Module error: Mainly a hardware error.
 - PI/O error: An error related to process input/output operation.

For details on the other types of errors, see the information supplied under “4.4.2 Types of error logs.”
- Error severity ID symbol
 - F: Fatal Error
 - E: Error
 - W: Warning
 - I: Information
- Error location ID symbol
 - HARD: Hardware
 - CPMS: CPMS
 - SOFT: Software product other than CPMS
- Code
 - A code indicating a type of an error log.

4.4.2 Types of error logs

(1) Types of OS error logs

The error logs maintained by the OS can be classified as shown below. For information on the error messages in these error logs, see the error message lists provided under “4.2 Error Log Information and Required Actions.”

Table 4-5 Types of OS Error Logs

Code	Log format name	Error message	Major error information			
			EC	TN	PC	FADR
/0001	Program error	Program error (subtitle)	EC	TN	PC	FADR
/0002	Macro parameter error	Macro parameter error	EC	TN	SVC	
/0004	I/O error	I/O error (subtitle)	EC	UNO	DEV	
/0005	WDT timeout error	WDT timeout error	EC			
/0006	Module error	Module error (subtitle)	EC	SLOT		
/0007	Kernel warning	Kernel warning	EC			
/0008	Kernel information	Kernel Information	EC			
/0009	System down -- system error	System down (subtitle)	EC	TN	PC	FADR
/000A	System down -- kernel trap	System down (Kernel trap)	EC	FILE	LINE	
/000B	System down -- built-in subroutine error	ULSUB down (subtitle)	EC	NEST	POINT	ENTRY
/000C	System down -- built-in subroutine stoppage	System down (ULSUB stop)	EC	NEST	POINT	
/000D	ADT error	Program error (Address Detect Trap Error)	EC	TN	PC	
/000E	Memory error	Memory error	EC	HERST		
/000F	System-bus error	System Bus error	EC	HERST		

Each “(subtitle)” message portion above is a detail message reporting on the detected error.

Description of symbols:

EC: Error code

TN: Task number

SVC: Macro code

PC: Instruction address

FADR: Fault address

UNO: I/O unit number

DEV: Device number

SLOT: Slot number

FILE: File name

LINE: Line number

NEST: Nest

POINT: Point

ENTRY: Entry

HERST: Serious-error register

4 ERROR LOG INFORMATION

(2) Types of NXACP error logs

The table below is a list of all predefined types of NXACP error logs.

Table 4-6 Types of NXACP Error Logs

Code	Log format name	Error message	Major error information				
0x0102	Message frame error	Message frame error	DFN	PORTNO	NXHD		
0x0103	Buffer status report	Buffer status	DFN	SPEAK	RPEAK	CNT	
0x0104	Socket error	Socket error	DFN	DADDR	DPORT		
0x0105	Transfer memory area overlap error	Transfer memory address error	DFN	TMID	CASENO	BLKNO	BLKCNT

Description of symbols:

DFN: Data field number

PORTNO: Port number

NXHD: NeXUS header

SPEAK: Send-buffer peak usage

RPEAK: Receive-buffer peak usage

CNT: The number of events that occurred.

DADDR: Destination IP address

DPORT: Destination port number

TMID: Transfer memory ID number

CASENO: Transmission case number

BLKNO: Transmission block number

BLKCNT: Transmission block count

SLOTNO: Slot number

UNO: Unit number

MCODE: Macro number

MERRNO: Error code from macro

4.4.3 Error log details and analysis

(1) Program error

This type of error is reported when a fault in a program causes the program to access an abnormal address in memory or execute an illegal instruction. When analyzing this type of error, use the following two-step preliminary procedure:

- Determine the nature of the error from the error name and other information in the displayed error message. For the meaning of the error message, see Table 4-7, “Program Error Message Format,” and Table 4-8, “Error Codes, Subtitles, and Their Meanings.”
- Locate the cause of the error by referring to the register and stack information in the displayed error message.

The subsequent comprehensive analysis procedure is shown in Figure 4-2.

4 ERROR LOG INFORMATION

Table 4-7 Program Error Message Format

```

%CPMS-E-SOFT-0001 SITE=xxxxxxxxxxxxxxxx RC=xxxxxxxx yyyy/mm/dd hh:mm:ss LOG=xxx
EC=xxxxxxxx Program error (subtitle)
TN =xxxxxxxx PC =xxxxxxxx EXPEV=xxxxxxxx FADR =xxxxxxxx SR =xxxxxxxx
PR =xxxxxxxx SP =xxxxxxxx GBR =xxxxxxxx MACH =xxxxxxxx MACL =xxxxxxxx
R0 =xxxxxxxx R1 =xxxxxxxx R2 =xxxxxxxx R3 =xxxxxxxx R4 =xxxxxxxx
R5 =xxxxxxxx R6 =xxxxxxxx R7 =xxxxxxxx R8 =xxxxxxxx R9 =xxxxxxxx
R10 =xxxxxxxx R11 =xxxxxxxx R12 =xxxxxxxx R13 =xxxxxxxx R14 =xxxxxxxx
R15 =xxxxxxxx FPSCR=xxxxxxxx FPUL =xxxxxxxx
FR0 =xx. xxxxxxExxx FR1 =xx. xxxxxxExxx FR2 =xx. xxxxxxExxx FR3 =xx. xxxxxxExxx
FR4 =xx. xxxxxxExxx FR5 =xx. xxxxxxExxx FR6 =xx. xxxxxxExxx FR7 =xx. xxxxxxExxx
FR8 =xx. xxxxxxExxx FR9 =xx. xxxxxxExxx FR10 =xx. xxxxxxExxx FR11 =xx. xxxxxxExxx
FR12 =xx. xxxxxxExxx FR13 =xx. xxxxxxExxx FR14 =xx. xxxxxxExxx FR15 =xx. xxxxxxExxx
XF0 =xx. xxxxxxExxx XF1 =xx. xxxxxxExxx XF2 =xx. xxxxxxExxx XF3 =xx. xxxxxxExxx
XF4 =xx. xxxxxxExxx XF5 =xx. xxxxxxExxx XF6 =xx. xxxxxxExxx XF7 =xx. xxxxxxExxx
XF8 =xx. xxxxxxExxx XF9 =xx. xxxxxxExxx XF10 =xx. xxxxxxExxx XF11 =xx. xxxxxxExxx
XF12 =xx. xxxxxxExxx XF13 =xx. xxxxxxExxx XF14 =xx. xxxxxxExxx XF15 =xx. xxxxxxExxx
DR0 =xx. xxxxxxExxx DR2 =xx. xxxxxxExxx DR4 =xx. xxxxxxExxx DR6 =xx. xxxxxxExxx
DR8 =xx. xxxxxxExxx DR10 =xx. xxxxxxExxx DR12 =xx. xxxxxxExxx DR14 =xx. xxxxxxExxx
XD0 =xx. xxxxxxExxx XD2 =xx. xxxxxxExxx XD4 =xx. xxxxxxExxx XD6 =xx. xxxxxxExxx
XD8 =xx. xxxxxxExxx XD10 =xx. xxxxxxExxx XD12 =xx. xxxxxxExxx XD14 =xx. xxxxxxExxx
INST =xxxxxxxx xxxxxxxx xxxxxxxx xxxxxxxx xxxxxxxx xxxxxxxx xxxxxxxx xxxxxxxx
      xxxxxxxx (PC =) xxxxxxxx xxxxxxxx
PC =xxxxxxxx ( )
FADR=xxxxxxxx ( )
PR =xxxxxxxx ( )
    
```

(1/2)

Item	Meaning
RC	Return code
EC	Error code (see Table 4-8)
TN	The task number of the task in which the error occurred.
PC	The content of the program counter.
EXPEV	The content of the exception code register, which is a 32-bit register and identifies the cause of data access and alignment exceptions.
FADR	Fault address
SR	Status register
PR	The content of the procedure register, which is used in calling a subroutine and stores the return address to the calling routine.
SP	The content of the stack pointer -- the register R15 is used as the stack pointer.
GBR	The content of the global base register, which stores base addresses to be used in GBR-indirect addressing with displacement and in indexed GBR-indirect addressing.
MACH	The content of the MAC register high, which saves the accumulated value of a MAC (Multiply and Accumulate) instruction or the result of a MAC or a MUL instruction. When the result of a MAC operation is a 64-bit value, this register contains the upper 32-bit value.
MACL	The content of the MAC register low, which serves the same purpose as MACH. When the result of a MAC operation is a 64-bit value, this register contains the lower 32-bit value. When the result of a MAC operation is a 32-bit value, it contains the entire 32-bit value.
Rxx	The content of the general register numbered xx.
FPSCR	The content of the floating-point status/control register.
FPUL	The content of the floating-point communication register, a register via which data transfer is done between general and floating-point registers.
FRxx	The content of the 32-bit floating-point register numbered xx. When FPSCR.PR (19th bit of the bits 31 thru 0) = 0, these registers contain values of FPRxx_BANK0. When FPSCR.PR = 1, they contain values of FPRxx_BANK1.

(2/2)

Item	Meaning
XFxx	The content of the 32-bit floating-point extension register numbered xx. When FPSCR.PR (19th bit of the bits 31 thru 0) = 0, these registers contain values of FPRxx_BANK1. When FPSCR.PR = 1, they contain values of FPRxx_BANK0.
DRxx	The content of the 64-bit floating-point register numbered xx. When FPSCR.PR (19th bit of the bits 31 thru 0) = 0, these registers contain values of FPRxx_BANK0. When FPSCR.PR = 1, they contain values of FPRxx_BANK1.
XDxx	The content of the 64-bit floating-point register numbered xx. When FPSCR.PR (19th bit of the bits 31 thru 0) = 0, these registers contain values of FPRxx_BANK1. When FPSCR.PR = 1, they contain values of FPRxx_BANK0.
INST	Instruction code
PC	The content of the program counter. Information on the address value contained in the program counter is presented, enclosed in parentheses. If the address value identifies a memory location in a program, the following information is presented: (name = program name type = program type [program component] raddr = relative address to the beginning of the program)
FADR	Fault address. Information on the fault address is presented, enclosed in parentheses.
PR	The content of the procedure register. Information on the address value contained in the procedure register is presented, enclosed in parentheses. If the address value identifies a memory location in a program, the following information is presented: (name = program name type = program type [program component] raddr = relative address to the beginning of the program)

Table 4-8 Error Codes, Subtitles, and Their Meanings (for Program Errors)

No.	Error code	Subtitle	Brief description	Meaning
1	EC=03030000	Inst. Alignment Error	Instruction alignment error	An instruction's operand was not aligned on word boundaries.
2	EC=03040000	Illegal Instruction	Illegal instruction error	An attempt was made to execute an illegal instruction.
3	EC=03080000	Privileged Instruction	Privileged instruction violation	A privileged instruction, an instruction that may be executed only in system mode, was executed.
4	EC=03090000	Illegal Breakpoint	Illegal-breakpoint exception error	An instruction causing a breakpoint exception was executed.
5	EC=03390000	FP Program Error	Floating-point arithmetic error	An error was encountered during the execution of a floating-point arithmetic instruction
6	EC=03400000	Instruction Page Fault	Instruction access page fault	An instruction in a page not listed in the page table was executed.
7	EC=03420000	Invalid Inst. Access	Instruction access error	An attempt was made to access an address space beginning with the address 0x80000000. (This instruction address error is one that is reported by a specific error code other than "03400000" and "03460000".)
8	EC=03460000	Inst. Access Protection	Instruction access protection error	Memory protection was violated by fetching an instruction.
9	EC=03600000	Data Page Fault	Data access page fault	Data in a page not listed in the page table was fetched.
10	EC=03620000	Invalid Data Access	Data access error	An attempt was made to access an address space beginning with the address 0x80000000. (This data address error is one that is reported by a specific error code other than "03600000" and "03660000".)
11	EC=03660000	Data Access Protection	Data access protection error	Memory protection was violated by fetching data.
12	EC=03470000	Data Alignment Error	Data alignment error	Word data was accessed beyond word boundaries (2n + 1), or long word data was accessed beyond long word boundaries (4n + 1, 4n + 2, 4n + 3), or quad word data was accessed beyond quad word boundaries (8n + 1, 8n + 2, ..., 8n + 7).

4 ERROR LOG INFORMATION

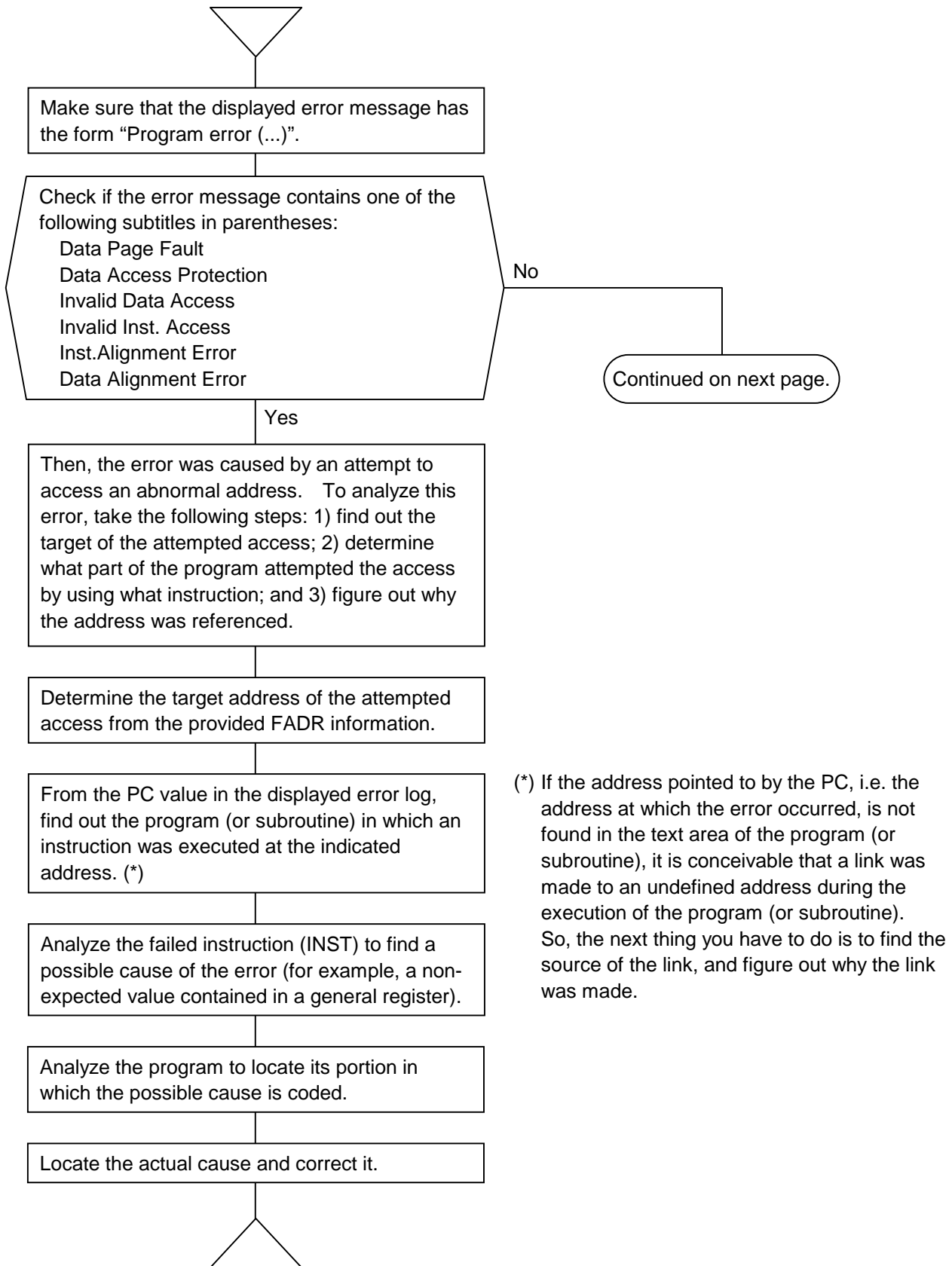

Figure 4-2 Program Error Analysis Procedure (1/2)

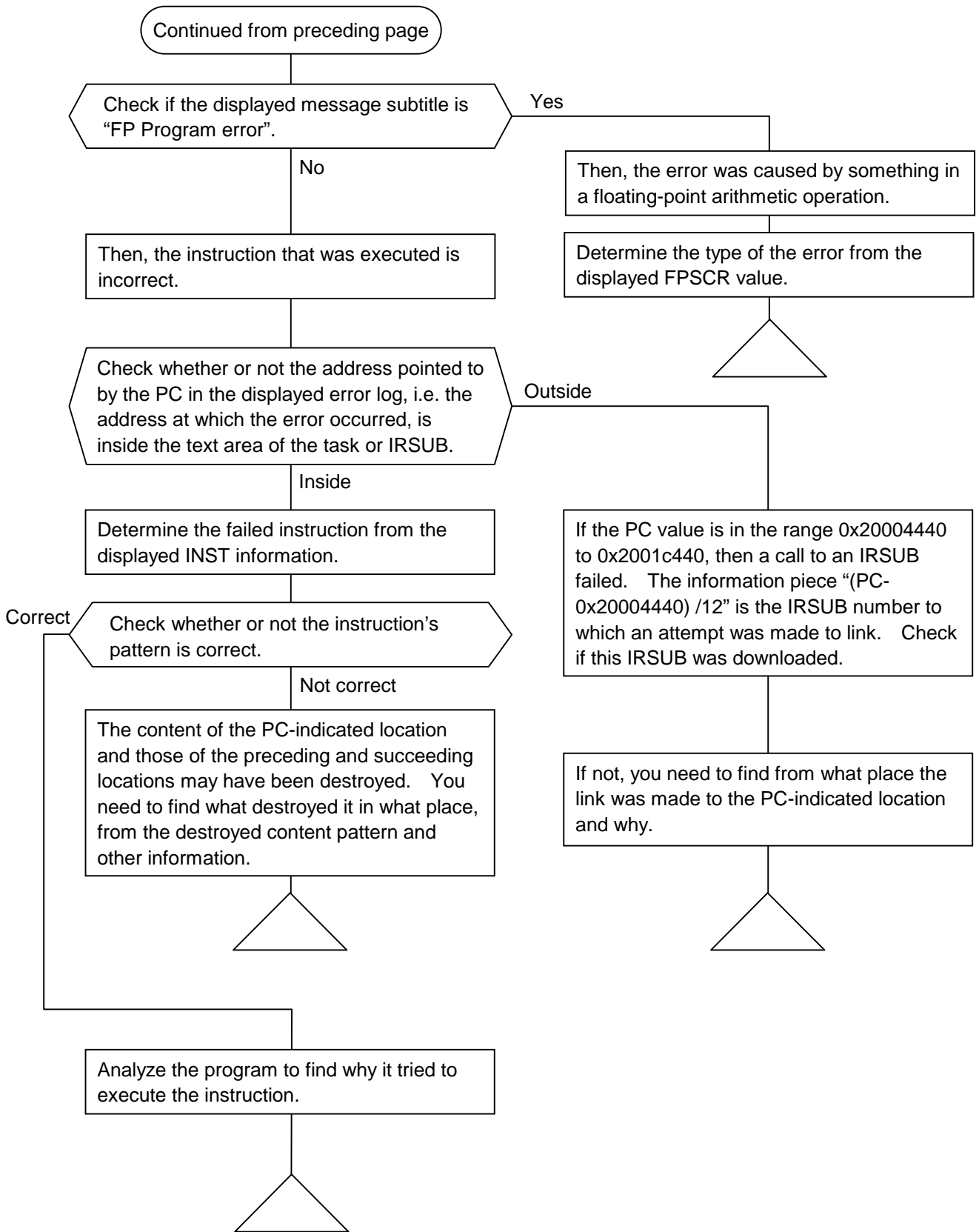

Figure 4-2 Program Error Analysis Procedure (2/2)

4 ERROR LOG INFORMATION

The following is an example of a program error analysis based on an actually displayed error message.

```
%CPMS-E-SOFT-0001  SITE=got_cp          RC=00000000 2002/04/29 13:48:54 LOG=005
EC=03600000 Program error (Data Page Fault)
TN  =00000067 PC   =300321cc  EXPEV=00000060  FADR =48000000  SR   =00008001
PR  =300321ca SP   =30034584  GBR  =00000000  MACH =00000000  MACL =00000000
R0  =00000000 R1   =00018930  R2   =00000001  R3   =000003e8  R4   =30032d5c
R5  =ffffffff R6   =0003d090  R7   =fffdb8a0  R8   =00000043  R9   =0003d090
R10 =00000000 R11  =00000088  R12  =300328b4  R13  =48000000  R14  =fffdb8a0
R15 =30034584 FPSCR=00040e00  FPUL =00000000
FR0 =0.000000E+000 FR1  =0.000000E+000 FR2  =0.000000E+000 FR3  =0.000000E+000
FR4 =0.000000E+000 FR5  =0.000000E+000 FR6  =0.000000E+000 FR7  =0.000000E+000
FR8 =0.000000E+000 FR9  =0.000000E+000 FR10 =0.000000E+000 FR11 =0.000000E+000
FR12 =0.000000E+000 FR13 =0.000000E+000 FR14 =0.000000E+000 FR15 =0.000000E+000
XF0 =0.000000E+000 XF1  =0.000000E+000 XF2  =0.000000E+000 XF3  =0.000000E+000
XF4 =0.000000E+000 XF5  =0.000000E+000 XF6  =0.000000E+000 XF7  =0.000000E+000
XF8 =0.000000E+000 XF9  =0.000000E+000 XF10 =0.000000E+000 XF11 =0.000000E+000
XF12 =0.000000E+000 XF13 =0.000000E+000 XF14 =0.000000E+000 XF15 =0.000000E+000
DR0 =0.000000E+000 DR2  =0.000000E+000 DR4  =0.000000E+000 DR6  =0.000000E+000
DR8 =0.000000E+000 DR10 =0.000000E+000 DR12 =0.000000E+000 DR14 =0.000000E+000
XD0 =0.000000E+000 XD2  =0.000000E+000 XD4  =0.000000E+000 XD6  =0.000000E+000
XD8 =0.000000E+000 XD10 =0.000000E+000 XD12 =0.000000E+000 XD14 =0.000000E+000
INST =d5523e28 02fe6693 ed483e28 67e34c0b 4d18d24f 619360e3 420b4d28 d44d4c0b
      6503e201 (PC =) 2d22e3bc 633c3f3c
PC  =300321cc(name = dry type = task(TEXT) raddr = 000001cc)
FADR=48000000(unaccessible address)
PR  =300321ca(name = dry type = task(TEXT) raddr = 000001ca)
```

<Step 1>

Read the error message “Program error (Data Page Fault)”. It means that data in a page not listed in the page table was fetched.

<Step 2>

From FADR=48000000, you can figure out that the error occurred in an access to the address 0x48000000.

<Step 3>

From PC=300321cc, you can figure out that the failed instruction is located at the address 0x300321cc.

<Step 4>

The displayed piece of information “PC=300321cc(name = dry type = task(TEXT) raddr = 000001cc)” conveys the meaning of “the address 0x300321cc (name=program name type=program type [program component] raddr=relative address to the beginning of the program)”. From this information piece, figure out what instruction in what program was defeated by the error during the execution. (If the address 0x300321cc is not existent in the text area of the program [or subroutine], it is conceivable that a link was made to an undefined address. From the displayed PR information, figure out from what place the link was made.)

<Step 5>

The displayed INST information reports on the failed instruction plus the preceding and succeeding instructions. From this information piece, you can determine the failed instruction from the code 0x2d22e3bc, which represents the following machine instructions:

```
MOV.L R2,@R13
MOV #-68,R3
```

Of these, the first instruction stores the content of general register 2 in the location indicated by the content of general register 13.

The content of general register 13 is the value 48000000, which is the same as the displayed FADR value. This means that the value 48000000 stored in R13 is the direct cause of the error.

<Step 6>

By referring to the displayed INST information, you need to identify the instructions before and after the failed instruction. From the information, you can find out the 18 instruction before the failed instruction and the three instructions thereafter. The 18 preceding instructions are as follows:

PC-36	MOV.L	L76+58, R5
PC-34	SUB	R2, R14
PC-32	MOV.L	@(R0, R15), R2
PC-30	MOV	R9, R6
PC-28	MOV	#72, R13
PC-26	SUB	R2, R14
PC-24	MOV	R14, R7
PC-22	JSR	@R12
PC-20	SHLL8	R13
PC-18	MOV.L	L76+62, R2
PC-16	MOV	R9, R1
PC-14	MOV	R14, R0
PC-12	JSR	@R2
PC-10	SHLL16	R13
PC-8:	MOV.L	L76+66, R4
PC-6:	JSR	@R12
PC-4:	MOV	R0, R5
PC-2:	MOV	#1, R2
PC :	MOV.L	R2, @R13

Then, based on the fact that the content of R13 is the value 48000000, you need to find what instruction loaded that value into R13. This can be accomplished as described below.

Looking at the above 18 instructions, you can learn the following: 1) the instruction at PC-28 loaded the value 0x00000048 into R13, and 2) the instructions at PC-20 and PC-10 shifted the content of R13 24 bits to the left, resulting in the value 0x48000000.

<Step 7>

From the results of the above steps, it is very likely that the value 0x48000000 was assigned directly to a pointer variable. So, you have to check if there was any improper processing done in the program.

It is also likely that the incorrect address value 0x48000000 was transferred from memory to R13. In this case, you have to figure out what stored it in memory in what place and why.

4 ERROR LOG INFORMATION

(2) Macro parameter check error

This type of error is reported when an erroneous parameter is detected in a macro instruction issued in a program to the CPMS. When such a parameter is detected, the issuing task is aborted. Find the erroneous parameter by referring to the displayed error message.

The table below shows the general format of error messages for macro parameter check errors and describes each format element.

Table 4-9 Macro Parameter Check Error Message Format

```
%CPMS-E-SOFT-0002  SITE=xxxxxxxxxxxxxxxx RC=xxxxxxx  yyyy/mm/dd hh:mm:ss LOG=xxx
EC=xxxxxxx Macro parameter error
TN  =xxxxxxx          SVC  =xxxxxxx
EPN =xxxxxxx  PARA1=xxxxxxx  PARA2=xxxxxxx  PARA3=xxxxxxx  PARA4=xxxxxxx
PARA5=xxxxxxx  PARA6=xxxxxxx  PARA7=xxxxxxx
```

Item	Description						
EC	<p>Error Code: Identifies the type of the error detected.</p> <table border="1"> <thead> <tr> <th>EC</th> <th>Meaning</th> </tr> </thead> <tbody> <tr> <td>05130000</td> <td>An undefined macro instruction was issued -- an abnormal SVC was used.</td> </tr> <tr> <td>05110000</td> <td>An erroneous parameter was detected. The parameter number of the erroneous parameter is reported as EPN and its value as PARAn.</td> </tr> </tbody> </table>	EC	Meaning	05130000	An undefined macro instruction was issued -- an abnormal SVC was used.	05110000	An erroneous parameter was detected. The parameter number of the erroneous parameter is reported as EPN and its value as PARAn.
EC	Meaning						
05130000	An undefined macro instruction was issued -- an abnormal SVC was used.						
05110000	An erroneous parameter was detected. The parameter number of the erroneous parameter is reported as EPN and its value as PARAn.						
TN	Task Number: Is the task number of the task that issued the macro instruction.						
SVC	SuperVisory Macro Code Identifies the type of the issued macro instruction. All predefined macro codes and the macro names identified by them are listed in Table 4-10.						
EPN	Error Parameter Number Is the ordinal number assigned to the erroneous parameter. This item is significant only when EC=05110000.						
PARAn	Parameter n Each shows the value of the numbered parameter. PARA1 shows the value of the first parameter; PARA2 shows the value of the second parameter; and so on. Example: If SVC=0000000A (timer macro), then each of the PARAn shows one of the following: PARA1: id PARA2: tn PARA3: fact PARA4: t PARA5: cyt Therefore, if EPN=00000004, it indicates that the value of PARA4, i.e. "t", was in error.						

Table 4-10 Predefined Supervisory Macro Codes and Macro Names Identified by Them

SVC i	0000000i	0000001i	0000002i	0000003i	0000004i	0000005i
0	–	prsrv	usrel		atmcas	
1	queue	pfree	elset	gtkmem	prog_start	
2	rleas	gfact	(cpms_ginfo)	wrtmem	prog_switch	
3	sfact	gtime	(chml)	chkbmem	prog_exit	
4	abort	exit	(taskenv)	chktaer	prog_call	
5	susp	asusp	(printf)	getsysinfo		
6	rsum	arsum		gettaskinfo		
7	ctime	open		save_env		
8	wait	close	wdtset	resume_env		
9	post	read		gettimebase		
A	timer	write		atmswap		
B	delay	ioctl		atmand		
C	stime	usrdhp		atmor		
D	chap	dhpset		atmxor		
E	resrv	dhpctl		atmadd		
F	free	dhpread		atmtas		

4 ERROR LOG INFORMATION

(3) I/O error

- Network I/O error

This type of error is reported when an abnormality occurs in the network's hardware or transmission path during accessing the network in a program using network access macros and libraries.

The table below shows the general format of error messages for network I/O errors and describes each format element.

Table 4-11 I/O Error Message Format

```
%LNET-x-xxxx-0004  SITE=xxxxxxxxxxxxxxxx RC=xxxxxxxx yyyy/mm/dd hh:mm:ss LOG=xxx  
EC=xxxxxxxx I/O Error (subtitle)  
UNO =xxxxxxxx DEV =xxxxxxxx DVA =xxxxxxxx IOEC =xxxxxxxx  
TN =xxxxxxxx  
DAT000=xxxxxxxx DAT001=xxxxxxxx DAT002=xxxxxxxx DAT003=xxxxxxxx DAT004=xxxxxxxx  
DAT005=xxxxxxxx DAT006=xxxxxxxx DAT007=xxxxxxxx DAT008=xxxxxxxx DAT009=xxxxxxxx  
DAT010=xxxxxxxx DAT011=xxxxxxxx DAT012=xxxxxxxx DAT013=xxxxxxxx DAT014=xxxxxxxx  
DAT015=xxxxxxxx DAT016=xxxxxxxx DAT017=xxxxxxxx DAT018=xxxxxxxx DAT019=xxxxxxxx  
DAT020=xxxxxxxx DAT021=xxxxxxxx DAT022=xxxxxxxx DAT023=xxxxxxxx DAT024=xxxxxxxx  
DAT025=xxxxxxxx DAT026=xxxxxxxx DAT027=xxxxxxxx DAT028=xxxxxxxx DAT029=xxxxxxxx  
DAT030=xxxxxxxx DAT031=xxxxxxxx DAT032=xxxxxxxx DAT033=xxxxxxxx DAT034=xxxxxxxx  
DAT035=xxxxxxxx DAT036=xxxxxxxx DAT037=xxxxxxxx DAT038=xxxxxxxx DAT039=xxxxxxxx  
DAT040=xxxxxxxx DAT041=xxxxxxxx DAT042=xxxxxxxx DAT043=xxxxxxxx DAT044=xxxxxxxx  
DAT045=xxxxxxxx DAT046=xxxxxxxx DAT047=xxxxxxxx DAT048=xxxxxxxx DAT049=xxxxxxxx  
DAT050=xxxxxxxx DAT051=xxxxxxxx DAT052=xxxxxxxx DAT053=xxxxxxxx DAT054=xxxxxxxx  
DAT055=xxxxxxxx DAT056=xxxxxxxx DAT057=xxxxxxxx DAT058=xxxxxxxx DAT059=xxxxxxxx  
DAT060=xxxxxxxx DAT061=xxxxxxxx DAT062=xxxxxxxx DAT063=xxxxxxxx DAT064=xxxxxxxx  
DAT065=xxxxxxxx DAT066=xxxxxxxx DAT067=xxxxxxxx DAT068=xxxxxxxx DAT069=xxxxxxxx  
DAT070=xxxxxxxx DAT071=xxxxxxxx DAT072=xxxxxxxx DAT073=xxxxxxxx DAT074=xxxxxxxx  
DAT075=xxxxxxxx DAT076=xxxxxxxx DAT077=xxxxxxxx DAT078=xxxxxxxx DAT079=xxxxxxxx  
DAT080=xxxxxxxx DAT081=xxxxxxxx DAT082=xxxxxxxx DAT083=xxxxxxxx DAT084=xxxxxxxx  
DAT085=xxxxxxxx DAT086=xxxxxxxx DAT087=xxxxxxxx DAT088=xxxxxxxx DAT089=xxxxxxxx  
DAT090=xxxxxxxx DAT091=xxxxxxxx DAT092=xxxxxxxx DAT093=xxxxxxxx DAT094=xxxxxxxx  
DAT095=xxxxxxxx DAT096=xxxxxxxx DAT097=xxxxxxxx DAT098=xxxxxxxx DAT099=xxxxxxxx  
DAT100=xxxxxxxx DAT101=xxxxxxxx DAT102=xxxxxxxx DAT103=xxxxxxxx DAT104=xxxxxxxx  
DAT105=xxxxxxxx DAT106=xxxxxxxx DAT107=xxxxxxxx DAT108=xxxxxxxx DAT109=xxxxxxxx
```

Item	Description																
EC	Error Code: Identifies the type of the error detected. For details, see the information under “4.2.15 NCP-F error log info and required actions.”																
UNO	I/O Unit number: Is the unit number of the I/O unit used.																
DEV	<p>Device number Identifies the type and mounting slot of the I/O device in which the error occurred.</p> <table border="1" style="margin-left: 40px;"> <tr> <td style="text-align: center;">0</td> <td style="text-align: center;">15</td> <td style="text-align: center;">16</td> <td style="text-align: center;">19</td> <td style="text-align: center;">20</td> <td style="text-align: center;">23</td> <td style="text-align: center;">24</td> <td style="text-align: center;">31</td> </tr> <tr> <td style="text-align: center;">Major Number (=Driver ID)</td> <td style="text-align: center;">SLOT</td> <td style="text-align: center;">CH</td> <td colspan="5" style="text-align: center;">Others</td> </tr> </table> <p>Major Number = 2: NCP-F = 3: LANCP The CMU's built-in LANCE SLOT: Slot number CH: Channel (Interface) number Others: Depend on Device Driver</p>	0	15	16	19	20	23	24	31	Major Number (=Driver ID)	SLOT	CH	Others				
0	15	16	19	20	23	24	31										
Major Number (=Driver ID)	SLOT	CH	Others														
DVA	<p>Device Address Identifies the memory location at which the device is installed; always set to 0 when an error of this type is detected.</p>																
IOEC	<p>I/O Error Code Is one of the following detail error codes: 0x8xxxxxxx: Indicates that the I/O process stopped due to an adapter abnormality. 0x4xxxxxxx: Indicates that the CPMS issued a LOGSAVE command. (Applicable only to the NCP-F.) 0x2xxxxxxx: Indicates that the CPMS restarted the device. (Applicable only to the built-in LANCE and LANCP.)</p>																
TN	<p>Task Number Is the task number of the task in which the error occurred.</p>																
DATn	<p>Data n Each is a detail error data piece, which varies depending on the EC's values. If the reported error is related to the built-in LANCE or the LANCP module, see Tables 4-12 through 4-15.</p>																

Note: If any of the above items is reported with the value 0xFFFFFFFF, it means nothing.

4 ERROR LOG INFORMATION

Table 4-12 Error Detail Data for Built-in LANCE-/LANCE-Detected I/O Errors
(EC=0x078013XX) (1/2)

DATn	Data name	Detail data																																																							
DAT0	PCISTATUS info																																																								
		<table border="1"> <thead> <tr> <th>Bit(s)</th> <th>Name</th> <th>Set value and its meaning</th> <th>Description</th> </tr> </thead> <tbody> <tr> <td>31</td> <td>detectPerr</td> <td>1: An A-/D-parity error was detected. 0: No A-/D-parity error was detected.</td> <td>The SUWA detected an address or a data parity error.</td> </tr> <tr> <td>30</td> <td>sigSerr</td> <td>1: SERR was asserted. 0: SERR was not asserted.</td> <td>The SUWA asserted the SERR signal.</td> </tr> <tr> <td>29</td> <td>recMasterAbort</td> <td>1: A Master Abort was received. 0: A Master Abort was not received.</td> <td>The SUWA ended its operation during master access, due to a master abort.</td> </tr> <tr> <td>28</td> <td>recTargetAbort</td> <td>1: A Target Abort was received. 0: A Target Abort was not received.</td> <td>The SUWA ended its operation during master access, due to a target abort.</td> </tr> <tr> <td>27</td> <td>sigTargetAbort</td> <td>1: Palette snoop was enabled. 0: Palette snoop was disabled.</td> <td>Due to a target abort, the SUWA ended a bus cycle during which it was subjected to a target access.</td> </tr> <tr> <td>26 to 25</td> <td>DEVSELtiming</td> <td> <table border="1"> <thead> <tr> <th>Bit 10</th> <th>Bit 9</th> <th></th> </tr> </thead> <tbody> <tr> <td>0</td> <td>0</td> <td>High speed</td> </tr> <tr> <td>0</td> <td>1</td> <td>Mid speed</td> </tr> <tr> <td>1</td> <td>0</td> <td>Low speed</td> </tr> <tr> <td>1</td> <td>1</td> <td>(Reserved)</td> </tr> </tbody> </table> </td> <td>This bit pair determines the timing of the assertion of the device select signal.</td> </tr> <tr> <td>24</td> <td>dataPerr</td> <td>1: A data parity error was detected. 0: No data parity error was detected.</td> <td>When the SUWA is bus master, this bit is set if all of the following three conditions are met: <ul style="list-style-type: none"> • It is detected that the SUWA or target has asserted PERR. • The SUWA has detected a data parity error. • The perrResponse bit in the PCICOMMAND register is set. </td> </tr> <tr> <td>23</td> <td>FastBackToBackCapable</td> <td>1: FastBackToBack was capable of being done. 0: FastBackToBack was not capable of being done.</td> <td>When the SUWA is subjected to target access, this bit indicates whether or not the fast back-to-back access between different targets is supported.</td> </tr> <tr> <td>22 to 16</td> <td>(Reserved)</td> <td>0x00</td> <td>(Reserved)</td> </tr> </tbody> </table>	Bit(s)	Name	Set value and its meaning	Description	31	detectPerr	1: An A-/D-parity error was detected. 0: No A-/D-parity error was detected.	The SUWA detected an address or a data parity error.	30	sigSerr	1: SERR was asserted. 0: SERR was not asserted.	The SUWA asserted the SERR signal.	29	recMasterAbort	1: A Master Abort was received. 0: A Master Abort was not received.	The SUWA ended its operation during master access, due to a master abort.	28	recTargetAbort	1: A Target Abort was received. 0: A Target Abort was not received.	The SUWA ended its operation during master access, due to a target abort.	27	sigTargetAbort	1: Palette snoop was enabled. 0: Palette snoop was disabled.	Due to a target abort, the SUWA ended a bus cycle during which it was subjected to a target access.	26 to 25	DEVSELtiming	<table border="1"> <thead> <tr> <th>Bit 10</th> <th>Bit 9</th> <th></th> </tr> </thead> <tbody> <tr> <td>0</td> <td>0</td> <td>High speed</td> </tr> <tr> <td>0</td> <td>1</td> <td>Mid speed</td> </tr> <tr> <td>1</td> <td>0</td> <td>Low speed</td> </tr> <tr> <td>1</td> <td>1</td> <td>(Reserved)</td> </tr> </tbody> </table>	Bit 10	Bit 9		0	0	High speed	0	1	Mid speed	1	0	Low speed	1	1	(Reserved)	This bit pair determines the timing of the assertion of the device select signal.	24	dataPerr	1: A data parity error was detected. 0: No data parity error was detected.	When the SUWA is bus master, this bit is set if all of the following three conditions are met: <ul style="list-style-type: none"> • It is detected that the SUWA or target has asserted PERR. • The SUWA has detected a data parity error. • The perrResponse bit in the PCICOMMAND register is set. 	23	FastBackToBackCapable	1: FastBackToBack was capable of being done. 0: FastBackToBack was not capable of being done.	When the SUWA is subjected to target access, this bit indicates whether or not the fast back-to-back access between different targets is supported.	22 to 16	(Reserved)	0x00	(Reserved)
Bit(s)	Name	Set value and its meaning	Description																																																						
31	detectPerr	1: An A-/D-parity error was detected. 0: No A-/D-parity error was detected.	The SUWA detected an address or a data parity error.																																																						
30	sigSerr	1: SERR was asserted. 0: SERR was not asserted.	The SUWA asserted the SERR signal.																																																						
29	recMasterAbort	1: A Master Abort was received. 0: A Master Abort was not received.	The SUWA ended its operation during master access, due to a master abort.																																																						
28	recTargetAbort	1: A Target Abort was received. 0: A Target Abort was not received.	The SUWA ended its operation during master access, due to a target abort.																																																						
27	sigTargetAbort	1: Palette snoop was enabled. 0: Palette snoop was disabled.	Due to a target abort, the SUWA ended a bus cycle during which it was subjected to a target access.																																																						
26 to 25	DEVSELtiming	<table border="1"> <thead> <tr> <th>Bit 10</th> <th>Bit 9</th> <th></th> </tr> </thead> <tbody> <tr> <td>0</td> <td>0</td> <td>High speed</td> </tr> <tr> <td>0</td> <td>1</td> <td>Mid speed</td> </tr> <tr> <td>1</td> <td>0</td> <td>Low speed</td> </tr> <tr> <td>1</td> <td>1</td> <td>(Reserved)</td> </tr> </tbody> </table>	Bit 10	Bit 9		0	0	High speed	0	1	Mid speed	1	0	Low speed	1	1	(Reserved)	This bit pair determines the timing of the assertion of the device select signal.																																							
Bit 10	Bit 9																																																								
0	0	High speed																																																							
0	1	Mid speed																																																							
1	0	Low speed																																																							
1	1	(Reserved)																																																							
24	dataPerr	1: A data parity error was detected. 0: No data parity error was detected.	When the SUWA is bus master, this bit is set if all of the following three conditions are met: <ul style="list-style-type: none"> • It is detected that the SUWA or target has asserted PERR. • The SUWA has detected a data parity error. • The perrResponse bit in the PCICOMMAND register is set. 																																																						
23	FastBackToBackCapable	1: FastBackToBack was capable of being done. 0: FastBackToBack was not capable of being done.	When the SUWA is subjected to target access, this bit indicates whether or not the fast back-to-back access between different targets is supported.																																																						
22 to 16	(Reserved)	0x00	(Reserved)																																																						

Table 4-12 Error Detail Data for Built-in LANCE-/LANCE-Detected I/O Errors (EC=0x078013XX) (2/2)

DATn	Data name	Detail data																																								
DAT1	CSR0 register	<table border="1"> <thead> <tr> <th>Bit</th> <th>15</th> <th>14</th> <th>13</th> <th>12</th> <th>11</th> <th>10</th> <th>9</th> <th>8</th> <th>7</th> <th>6</th> <th>5</th> <th>4</th> <th>3</th> <th>2</th> <th>1</th> <th>0</th> </tr> </thead> <tbody> <tr> <td>CSR0</td> <td>ERR</td> <td>RES</td> <td>CERR</td> <td>MISS</td> <td>MERR</td> <td>RINT</td> <td>TINT</td> <td>IDON</td> <td>INTR</td> <td>IENA</td> <td>RXON</td> <td>TXON</td> <td>TDMD</td> <td>STOP</td> <td>STRT</td> <td>INIT</td> </tr> </tbody> </table> <p>(Bits 31 thru 16 are reserved.) ERR : An error occurred. RES : Reserved CERR : Collision error MISS : Missed packet MERR: Memory error RINT : Reception interrupt TINT : Transmission interrupt IDON : Initialization completed INTR : Interrupt flag IENA : Interrupt enabled RXON: Receiver ON TXON: Transmitter ON TDMD: Transmission demand STOP : Stop STRT : Start INIT : Initialization</p>	Bit	15	14	13	12	11	10	9	8	7	6	5	4	3	2	1	0	CSR0	ERR	RES	CERR	MISS	MERR	RINT	TINT	IDON	INTR	IENA	RXON	TXON	TDMD	STOP	STRT	INIT						
Bit	15	14	13	12	11	10	9	8	7	6	5	4	3	2	1	0																										
CSR0	ERR	RES	CERR	MISS	MERR	RINT	TINT	IDON	INTR	IENA	RXON	TXON	TDMD	STOP	STRT	INIT																										
DAT2 to 4	Receive descriptors 1 to 3 (RMD1 to 3)	<table border="1"> <thead> <tr> <th>Bit</th> <th>15</th> <th>14</th> <th>13</th> <th>12</th> <th>11</th> <th>10</th> <th>9</th> <th>8</th> <th>7-0</th> </tr> </thead> <tbody> <tr> <td>RMD1</td> <td>OWN</td> <td>ERR</td> <td>FRAM</td> <td>OFLO</td> <td>CRC</td> <td>BUFF</td> <td>STP</td> <td>ENP</td> <td>RBADR[23:16]</td> </tr> <tr> <td>RMD2</td> <td>1</td> <td>1</td> <td>1</td> <td>1</td> <td colspan="5">BCNT</td> </tr> <tr> <td>RMD3</td> <td>0</td> <td>0</td> <td>0</td> <td>0</td> <td colspan="5">MCNT</td> </tr> </tbody> </table> <p>(Bits 31 thru 16 are reserved.) RBADR: Receive buffer address OWN : Owner flag ERR : Error flag (the result of ORing of FRAM, OFLO, CRC, BUFF, and BPE) FRAM : Framing error flag OFLO : Overflow error flag CRC : CRC error flag BUFF : Buffer error flag STP : Start packet flag ENP : End packet flag BCNT : Receive buffer size MCNT : Receive packet length</p>	Bit	15	14	13	12	11	10	9	8	7-0	RMD1	OWN	ERR	FRAM	OFLO	CRC	BUFF	STP	ENP	RBADR[23:16]	RMD2	1	1	1	1	BCNT					RMD3	0	0	0	0	MCNT				
Bit	15	14	13	12	11	10	9	8	7-0																																	
RMD1	OWN	ERR	FRAM	OFLO	CRC	BUFF	STP	ENP	RBADR[23:16]																																	
RMD2	1	1	1	1	BCNT																																					
RMD3	0	0	0	0	MCNT																																					
DAT5 to 7	Send descriptors 1 to 3 (TMD1 to 3)	<table border="1"> <thead> <tr> <th>Bit</th> <th>15</th> <th>14</th> <th>13</th> <th>12</th> <th>11</th> <th>10</th> <th>9</th> <th>8</th> <th>7-0</th> </tr> </thead> <tbody> <tr> <td>TMD1</td> <td>OWN</td> <td>ERR</td> <td>ADD_FCS/NO_FCS</td> <td>MORE/LTINT</td> <td>ONE</td> <td>ONE</td> <td>STP</td> <td>ENP</td> <td>TBADDR[23:16]</td> </tr> <tr> <td>TMD2</td> <td>1</td> <td>1</td> <td>1</td> <td>1</td> <td colspan="5">BCNT</td> </tr> <tr> <td>TMD3</td> <td>BUFF</td> <td>ULFO</td> <td>EXDEF</td> <td>LCOL</td> <td>LCAR</td> <td>RTRY</td> <td colspan="3">TDR</td> </tr> </tbody> </table> <p>(Bits 31 thru 16 are reserved.) TBADDR: Send buffer address OWN : Owner flag ERR : Error flag (the result of ORing of UFLO, LCOL, LCAR, RTRY, and BPE) ADD FCS/NO FCS: FCS-generation control flag MORE/LTINT: Flag either indicating the occurrence of more than one retry in transmission or suppressing interrupt at the normal end of transmission ONE : Flag indicating the occurrence of only one retry in transmission DEF : Flag indicating the occurrence of delay due to a "channel busy" condition in transmission STP : Start packet flag ENP : End packet flag BCNT : Transmission byte count BUFF : Buffer error flag ULFO : Underflow error flag EXDEF: Excessive-deferral flag LCOL : Late-collision flag LCAR : Loss of Carrier/Link Fail State RTRY : Retry error flag TDR : Time Domain Reflectometer</p>	Bit	15	14	13	12	11	10	9	8	7-0	TMD1	OWN	ERR	ADD_FCS/NO_FCS	MORE/LTINT	ONE	ONE	STP	ENP	TBADDR[23:16]	TMD2	1	1	1	1	BCNT					TMD3	BUFF	ULFO	EXDEF	LCOL	LCAR	RTRY	TDR		
Bit	15	14	13	12	11	10	9	8	7-0																																	
TMD1	OWN	ERR	ADD_FCS/NO_FCS	MORE/LTINT	ONE	ONE	STP	ENP	TBADDR[23:16]																																	
TMD2	1	1	1	1	BCNT																																					
TMD3	BUFF	ULFO	EXDEF	LCOL	LCAR	RTRY	TDR																																			

The data pieces DAT8 thru DAT109 are driver table information.

4 ERROR LOG INFORMATION

Table 4-13 Error Detail Data for Built-in LANCE PCI Bus I/O Errors
(EC=0x078014XX) (1/5)

DATn	Data name	Detail data																																																				
DAT0	PCISTATUS info	See the description of DAT0 in Table 4-12.																																																				
DAT1	BUERRSTAT info	<div style="text-align: center;"> </div> <table border="1" style="width: 100%; border-collapse: collapse;"> <thead> <tr> <th>Bit(s)</th> <th>Name</th> <th>Set value and its meaning</th> <th>Description</th> </tr> </thead> <tbody> <tr> <td>31 to 11</td> <td>(Reserved)</td> <td>0x0000 00</td> <td>(Reserved)</td> </tr> <tr> <td>10</td> <td>detBUSBUSY</td> <td>1: Bus access was attempted in a bus deadlock condition. 0: No bus access was attempted in a bus deadlock condition.</td> <td>After the previous PCI master access had been stopped due to a timeout (detBRQTO or detTRDYTO), bus access was attempted in a bus deadlock condition.</td> </tr> <tr> <td>9</td> <td>detBRQTO</td> <td>1: A bus request timeout was detected. 0: A bus request timeout was not detected.</td> <td>When the SUWA was master, the time from the reception of a request, up until the expected start of PCI bus access exceeded the timeout period specified in the BUREQTMR register.</td> </tr> <tr> <td>8</td> <td>recEINTO</td> <td>1: B_INT0_N was received. 0: B_INT0_N was not received.</td> <td>A B_INT0_N error interrupt was received. This bit is also used as the recINT0 bit of BUINTSTAT.</td> </tr> <tr> <td>7</td> <td>(Reserved)</td> <td>0</td> <td>(Reserved)</td> </tr> <tr> <td>6</td> <td>detTRDYTO</td> <td>1: A TRDY timeout was detected. 0: A TRDY timeout was not detected.</td> <td>When the SUWA was master, the time from the assertion of DEVSEL by the target, up until the expected assertion of TRDY by it exceeded the timeout period specified in the UTRDYTMR register.</td> </tr> <tr> <td>5</td> <td>obsrvTA</td> <td>1: A target abort was observed. 0: A target abort was not observed.</td> <td>A target abort was executed on the PCI bus.</td> </tr> <tr> <td>4</td> <td>obsrvMA</td> <td>1: A master abort was observed. 0: A master abort was not observed.</td> <td>A master abort was executed on the PCI bus.</td> </tr> <tr> <td>3</td> <td>recSERR</td> <td>1: B_SERR_N was received. 0: B_SERR_N was not received.</td> <td>B_SERR_N was asserted on the PCI bus.</td> </tr> <tr> <td>2</td> <td>detAPE</td> <td>1: An address parity error was detected. 0: An address parity error was not detected.</td> <td>When the SUWA was target, it detected an address parity error.</td> </tr> <tr> <td>1</td> <td>detWDPE</td> <td>1: A write-data parity error was detected. 0: A write-data parity error was not detected.</td> <td>When the SUWA was master, it detected a write-data parity error.</td> </tr> <tr> <td>0</td> <td>detRDPE</td> <td>1: A read-data parity error was detected. 0: A read-data parity error was not detected.</td> <td>When the SUWA was master, it detected a read-data parity error.</td> </tr> </tbody> </table>	Bit(s)	Name	Set value and its meaning	Description	31 to 11	(Reserved)	0x0000 00	(Reserved)	10	detBUSBUSY	1: Bus access was attempted in a bus deadlock condition. 0: No bus access was attempted in a bus deadlock condition.	After the previous PCI master access had been stopped due to a timeout (detBRQTO or detTRDYTO), bus access was attempted in a bus deadlock condition.	9	detBRQTO	1: A bus request timeout was detected. 0: A bus request timeout was not detected.	When the SUWA was master, the time from the reception of a request, up until the expected start of PCI bus access exceeded the timeout period specified in the BUREQTMR register.	8	recEINTO	1: B_INT0_N was received. 0: B_INT0_N was not received.	A B_INT0_N error interrupt was received. This bit is also used as the recINT0 bit of BUINTSTAT.	7	(Reserved)	0	(Reserved)	6	detTRDYTO	1: A TRDY timeout was detected. 0: A TRDY timeout was not detected.	When the SUWA was master, the time from the assertion of DEVSEL by the target, up until the expected assertion of TRDY by it exceeded the timeout period specified in the UTRDYTMR register.	5	obsrvTA	1: A target abort was observed. 0: A target abort was not observed.	A target abort was executed on the PCI bus.	4	obsrvMA	1: A master abort was observed. 0: A master abort was not observed.	A master abort was executed on the PCI bus.	3	recSERR	1: B_SERR_N was received. 0: B_SERR_N was not received.	B_SERR_N was asserted on the PCI bus.	2	detAPE	1: An address parity error was detected. 0: An address parity error was not detected.	When the SUWA was target, it detected an address parity error.	1	detWDPE	1: A write-data parity error was detected. 0: A write-data parity error was not detected.	When the SUWA was master, it detected a write-data parity error.	0	detRDPE	1: A read-data parity error was detected. 0: A read-data parity error was not detected.	When the SUWA was master, it detected a read-data parity error.
Bit(s)	Name	Set value and its meaning	Description																																																			
31 to 11	(Reserved)	0x0000 00	(Reserved)																																																			
10	detBUSBUSY	1: Bus access was attempted in a bus deadlock condition. 0: No bus access was attempted in a bus deadlock condition.	After the previous PCI master access had been stopped due to a timeout (detBRQTO or detTRDYTO), bus access was attempted in a bus deadlock condition.																																																			
9	detBRQTO	1: A bus request timeout was detected. 0: A bus request timeout was not detected.	When the SUWA was master, the time from the reception of a request, up until the expected start of PCI bus access exceeded the timeout period specified in the BUREQTMR register.																																																			
8	recEINTO	1: B_INT0_N was received. 0: B_INT0_N was not received.	A B_INT0_N error interrupt was received. This bit is also used as the recINT0 bit of BUINTSTAT.																																																			
7	(Reserved)	0	(Reserved)																																																			
6	detTRDYTO	1: A TRDY timeout was detected. 0: A TRDY timeout was not detected.	When the SUWA was master, the time from the assertion of DEVSEL by the target, up until the expected assertion of TRDY by it exceeded the timeout period specified in the UTRDYTMR register.																																																			
5	obsrvTA	1: A target abort was observed. 0: A target abort was not observed.	A target abort was executed on the PCI bus.																																																			
4	obsrvMA	1: A master abort was observed. 0: A master abort was not observed.	A master abort was executed on the PCI bus.																																																			
3	recSERR	1: B_SERR_N was received. 0: B_SERR_N was not received.	B_SERR_N was asserted on the PCI bus.																																																			
2	detAPE	1: An address parity error was detected. 0: An address parity error was not detected.	When the SUWA was target, it detected an address parity error.																																																			
1	detWDPE	1: A write-data parity error was detected. 0: A write-data parity error was not detected.	When the SUWA was master, it detected a write-data parity error.																																																			
0	detRDPE	1: A read-data parity error was detected. 0: A read-data parity error was not detected.	When the SUWA was master, it detected a read-data parity error.																																																			

Table 4-13 Error Detail Data for Built-in LANCE PCI Bus I/O Errors (EC=0x078014XX) (2/5)

DATn	Data name	Detail data																																																				
DAT2	BUERRINTENB info	<div style="text-align: center;"> </div> <table border="1" style="width: 100%; border-collapse: collapse;"> <thead> <tr> <th>Bit(s)</th> <th>Name</th> <th>Set value and its meaning</th> <th>Description</th> </tr> </thead> <tbody> <tr> <td>31 to 11</td> <td>(Reserved)</td> <td>0x0000 00</td> <td>(Reserved)</td> </tr> <tr> <td>10</td> <td>enbBUSBUSY</td> <td>1: An interrupt was generated due to an attempted bus access in a bus deadlock condition. 0: An interrupt was not generated due to an attempted bus access in a bus deadlock condition.</td> <td>When this bit is set, an interrupt has been generated due to the setting of detBUSBUSY.</td> </tr> <tr> <td>9</td> <td>enbBRQTO</td> <td>1: An interrupt was generated due to a detected bus request timeout. 0: An interrupt was not generated due to a detected bus request timeout.</td> <td>When this bit is set, an interrupt has been generated due to the setting of detREQTO.</td> </tr> <tr> <td>8</td> <td>enbEINTO</td> <td>1: An interrupt was generated due to received B_INT0_N. 0: An interrupt was not generated due to received B_INT0_N.</td> <td>When this bit is set, an interrupt has been generated due to the setting of recEINTO.</td> </tr> <tr> <td>7</td> <td>(Reserved)</td> <td>0</td> <td>(Reserved)</td> </tr> <tr> <td>6</td> <td>enbTRDYTO</td> <td>1: An interrupt was generated due to a detected TRDY timeout. 0: An interrupt was not generated due to a detected TRDY timeout.</td> <td>When this bit is set, an interrupt has been generated due to the setting of detTRDYTO.</td> </tr> <tr> <td>5</td> <td>enbTA</td> <td>1: An interrupt was generated due to an observed target abort. 0: An interrupt was not generated due to an observed target abort.</td> <td>When this bit is set, an interrupt has been generated due to the setting of obsrvTA.</td> </tr> <tr> <td>4</td> <td>enbMA</td> <td>1: An interrupt was generated due to an observed master abort. 0: An interrupt was not generated due to an observed master abort.</td> <td>When this bit is set, an interrupt has been generated due to the setting of obsrvMA.</td> </tr> <tr> <td>3</td> <td>enbSERR</td> <td>1: An interrupt was generated due to a received B_SERR_N signal. 0: An interrupt was not generated due to a received B_SERR_N signal.</td> <td>When this bit is set, an interrupt has been generated due to the setting of detSERR.</td> </tr> <tr> <td>2</td> <td>enbAPE</td> <td>1: An interrupt was generated due to a detected address parity error. 0: An interrupt was not generated due to a detected address parity error.</td> <td>When this bit is set, an interrupt has been generated due to the setting of detAPE.</td> </tr> <tr> <td>1</td> <td>enbWDPE</td> <td>1: An interrupt was generated due to a detected write-data parity error. 0: An interrupt was not generated due to a detected write-data parity error.</td> <td>When this bit is set, an interrupt has been generated due to the setting of detWDPE.</td> </tr> <tr> <td>0</td> <td>enbRDPE</td> <td>1: An interrupt was generated due to a detected read-data parity error. 0: An interrupt was not generated due to a detected read-data parity error.</td> <td>When this bit is set, an interrupt has been generated due to the setting of detRDPE.</td> </tr> </tbody> </table>	Bit(s)	Name	Set value and its meaning	Description	31 to 11	(Reserved)	0x0000 00	(Reserved)	10	enbBUSBUSY	1: An interrupt was generated due to an attempted bus access in a bus deadlock condition. 0: An interrupt was not generated due to an attempted bus access in a bus deadlock condition.	When this bit is set, an interrupt has been generated due to the setting of detBUSBUSY.	9	enbBRQTO	1: An interrupt was generated due to a detected bus request timeout. 0: An interrupt was not generated due to a detected bus request timeout.	When this bit is set, an interrupt has been generated due to the setting of detREQTO.	8	enbEINTO	1: An interrupt was generated due to received B_INT0_N. 0: An interrupt was not generated due to received B_INT0_N.	When this bit is set, an interrupt has been generated due to the setting of recEINTO.	7	(Reserved)	0	(Reserved)	6	enbTRDYTO	1: An interrupt was generated due to a detected TRDY timeout. 0: An interrupt was not generated due to a detected TRDY timeout.	When this bit is set, an interrupt has been generated due to the setting of detTRDYTO.	5	enbTA	1: An interrupt was generated due to an observed target abort. 0: An interrupt was not generated due to an observed target abort.	When this bit is set, an interrupt has been generated due to the setting of obsrvTA.	4	enbMA	1: An interrupt was generated due to an observed master abort. 0: An interrupt was not generated due to an observed master abort.	When this bit is set, an interrupt has been generated due to the setting of obsrvMA.	3	enbSERR	1: An interrupt was generated due to a received B_SERR_N signal. 0: An interrupt was not generated due to a received B_SERR_N signal.	When this bit is set, an interrupt has been generated due to the setting of detSERR.	2	enbAPE	1: An interrupt was generated due to a detected address parity error. 0: An interrupt was not generated due to a detected address parity error.	When this bit is set, an interrupt has been generated due to the setting of detAPE.	1	enbWDPE	1: An interrupt was generated due to a detected write-data parity error. 0: An interrupt was not generated due to a detected write-data parity error.	When this bit is set, an interrupt has been generated due to the setting of detWDPE.	0	enbRDPE	1: An interrupt was generated due to a detected read-data parity error. 0: An interrupt was not generated due to a detected read-data parity error.	When this bit is set, an interrupt has been generated due to the setting of detRDPE.
Bit(s)	Name	Set value and its meaning	Description																																																			
31 to 11	(Reserved)	0x0000 00	(Reserved)																																																			
10	enbBUSBUSY	1: An interrupt was generated due to an attempted bus access in a bus deadlock condition. 0: An interrupt was not generated due to an attempted bus access in a bus deadlock condition.	When this bit is set, an interrupt has been generated due to the setting of detBUSBUSY.																																																			
9	enbBRQTO	1: An interrupt was generated due to a detected bus request timeout. 0: An interrupt was not generated due to a detected bus request timeout.	When this bit is set, an interrupt has been generated due to the setting of detREQTO.																																																			
8	enbEINTO	1: An interrupt was generated due to received B_INT0_N. 0: An interrupt was not generated due to received B_INT0_N.	When this bit is set, an interrupt has been generated due to the setting of recEINTO.																																																			
7	(Reserved)	0	(Reserved)																																																			
6	enbTRDYTO	1: An interrupt was generated due to a detected TRDY timeout. 0: An interrupt was not generated due to a detected TRDY timeout.	When this bit is set, an interrupt has been generated due to the setting of detTRDYTO.																																																			
5	enbTA	1: An interrupt was generated due to an observed target abort. 0: An interrupt was not generated due to an observed target abort.	When this bit is set, an interrupt has been generated due to the setting of obsrvTA.																																																			
4	enbMA	1: An interrupt was generated due to an observed master abort. 0: An interrupt was not generated due to an observed master abort.	When this bit is set, an interrupt has been generated due to the setting of obsrvMA.																																																			
3	enbSERR	1: An interrupt was generated due to a received B_SERR_N signal. 0: An interrupt was not generated due to a received B_SERR_N signal.	When this bit is set, an interrupt has been generated due to the setting of detSERR.																																																			
2	enbAPE	1: An interrupt was generated due to a detected address parity error. 0: An interrupt was not generated due to a detected address parity error.	When this bit is set, an interrupt has been generated due to the setting of detAPE.																																																			
1	enbWDPE	1: An interrupt was generated due to a detected write-data parity error. 0: An interrupt was not generated due to a detected write-data parity error.	When this bit is set, an interrupt has been generated due to the setting of detWDPE.																																																			
0	enbRDPE	1: An interrupt was generated due to a detected read-data parity error. 0: An interrupt was not generated due to a detected read-data parity error.	When this bit is set, an interrupt has been generated due to the setting of detRDPE.																																																			

4 ERROR LOG INFORMATION

Table 4-13 Error Detail Data for Built-in LANCE PCI Bus I/O Errors
(EC=0x078014XX) (3/5)

DATn	Data name	Detail data																																
DAT3	BUERRADR info	<div style="text-align: center;"> 31 0 <div style="border: 1px solid black; width: 100%; height: 20px; margin: 5px 0;"></div> <p style="text-align: center; margin: 0;">errADR</p> </div> <table border="1" style="width: 100%; border-collapse: collapse;"> <thead> <tr> <th style="width: 10%;">Bits</th> <th style="width: 15%;">Name</th> <th style="width: 35%;">Set value and its meaning</th> <th style="width: 40%;">Description</th> </tr> </thead> <tbody> <tr> <td>31 to 0</td> <td>errADR</td> <td> PCI address: Set when the PCI bus master has encountered the error. Processor address: Set when a “bus busy” condition or bus request timeout error is detected. </td> <td>This information piece is a log of the address at which the error reported in the BUERRPTR register was detected.</td> </tr> </tbody> </table>	Bits	Name	Set value and its meaning	Description	31 to 0	errADR	PCI address: Set when the PCI bus master has encountered the error. Processor address: Set when a “bus busy” condition or bus request timeout error is detected.	This information piece is a log of the address at which the error reported in the BUERRPTR register was detected.																								
Bits	Name	Set value and its meaning	Description																															
31 to 0	errADR	PCI address: Set when the PCI bus master has encountered the error. Processor address: Set when a “bus busy” condition or bus request timeout error is detected.	This information piece is a log of the address at which the error reported in the BUERRPTR register was detected.																															
DAT4	BUERRPTR info	<div style="text-align: center;"> 31 0 <div style="border: 1px solid black; width: 100%; height: 20px; margin: 5px 0;"></div> <div style="display: flex; justify-content: space-between; width: 100%; margin: 5px 0;"> (Reserved) 11 10 9 8 7 6 5 4 3 2 1 0 </div> <div style="display: flex; justify-content: space-around; width: 100%; margin: 5px 0;"> <div style="text-align: center;"> pntBRQTO pntBUSBUSY </div> <div style="text-align: center;"> pntTRDYTO pntTA pntMA </div> <div style="text-align: center;"> pntAPE pntWDPE pntRDPE </div> </div> </div> <table border="1" style="width: 100%; border-collapse: collapse;"> <thead> <tr> <th style="width: 10%;">Bit(s)</th> <th style="width: 15%;">Name</th> <th style="width: 35%;">Set value and its meaning</th> <th style="width: 40%;">Description</th> </tr> </thead> <tbody> <tr> <td>31 to 11</td> <td>(Reserved)</td> <td>0x0000 00</td> <td>(Reserved)</td> </tr> <tr> <td>10</td> <td>pntBUSBUSY</td> <td>1: Bus access was attempted in a bus deadlock condition. 0: Bus access was not attempted in a bus deadlock condition.</td> <td>After the previous PCI master access had been stopped due to a timeout (detBRQTO or detTRDYTO), bus access was attempted in a bus deadlock condition.</td> </tr> <tr> <td>9</td> <td>pntBRQTO</td> <td>1: A bus request timeout was detected. 0: A bus request timeout was not detected.</td> <td>When the SUWA was master, the time from the reception of a request, up until the expected start of PCI bus access exceeded the timeout period specified in the BUREQTMR register.</td> </tr> <tr> <td>8</td> <td>(Reserved)</td> <td>0</td> <td>(Reserved)</td> </tr> <tr> <td>7</td> <td>(Reserved)</td> <td>0</td> <td>(Reserved)</td> </tr> <tr> <td>6</td> <td>pntTRDYTO</td> <td>1: A TRDY timeout was detected. 0: A TRDY timeout was not detected.</td> <td>When the SUWA was master, the time from the assertion of DEVSEL by the target, up until the expected assertion of TRDY by it exceeded the timeout period specified in the UTRDYTMR register.</td> </tr> <tr> <td>5</td> <td>pntTA</td> <td>1: A target abort was observed. 0: A target abort was not observed.</td> <td>A target abort was executed on the PCI bus.</td> </tr> </tbody> </table>	Bit(s)	Name	Set value and its meaning	Description	31 to 11	(Reserved)	0x0000 00	(Reserved)	10	pntBUSBUSY	1: Bus access was attempted in a bus deadlock condition. 0: Bus access was not attempted in a bus deadlock condition.	After the previous PCI master access had been stopped due to a timeout (detBRQTO or detTRDYTO), bus access was attempted in a bus deadlock condition.	9	pntBRQTO	1: A bus request timeout was detected. 0: A bus request timeout was not detected.	When the SUWA was master, the time from the reception of a request, up until the expected start of PCI bus access exceeded the timeout period specified in the BUREQTMR register.	8	(Reserved)	0	(Reserved)	7	(Reserved)	0	(Reserved)	6	pntTRDYTO	1: A TRDY timeout was detected. 0: A TRDY timeout was not detected.	When the SUWA was master, the time from the assertion of DEVSEL by the target, up until the expected assertion of TRDY by it exceeded the timeout period specified in the UTRDYTMR register.	5	pntTA	1: A target abort was observed. 0: A target abort was not observed.	A target abort was executed on the PCI bus.
Bit(s)	Name	Set value and its meaning	Description																															
31 to 11	(Reserved)	0x0000 00	(Reserved)																															
10	pntBUSBUSY	1: Bus access was attempted in a bus deadlock condition. 0: Bus access was not attempted in a bus deadlock condition.	After the previous PCI master access had been stopped due to a timeout (detBRQTO or detTRDYTO), bus access was attempted in a bus deadlock condition.																															
9	pntBRQTO	1: A bus request timeout was detected. 0: A bus request timeout was not detected.	When the SUWA was master, the time from the reception of a request, up until the expected start of PCI bus access exceeded the timeout period specified in the BUREQTMR register.																															
8	(Reserved)	0	(Reserved)																															
7	(Reserved)	0	(Reserved)																															
6	pntTRDYTO	1: A TRDY timeout was detected. 0: A TRDY timeout was not detected.	When the SUWA was master, the time from the assertion of DEVSEL by the target, up until the expected assertion of TRDY by it exceeded the timeout period specified in the UTRDYTMR register.																															
5	pntTA	1: A target abort was observed. 0: A target abort was not observed.	A target abort was executed on the PCI bus.																															

Table 4-13 Error Detail Data for Built-in LANCE PCI Bus I/O Errors (EC=0x078014XX) (4/5)

DATn	Data name	Detail data																																																																																																																																																																													
DAT4	BUERRPTR info	<table border="1"> <thead> <tr> <th>Bit(s)</th> <th>Name</th> <th>Set value and its meaning</th> <th>Description</th> </tr> </thead> <tbody> <tr> <td>4</td> <td>pntMA</td> <td>1: A master abort was observed. 0: A master abort was not observed.</td> <td>A master abort was executed on the PCI bus.</td> </tr> <tr> <td>3</td> <td>(Reserved)</td> <td>0</td> <td>(Reserved)</td> </tr> <tr> <td>2</td> <td>pntAPE</td> <td>1: An address parity error was detected. 0: An address parity error was not detected.</td> <td>When the SUWA was target, it detected an address parity error.</td> </tr> <tr> <td>1</td> <td>pntWDPE</td> <td>1: A write-data parity error was detected. 0: A write-data parity error was not detected.</td> <td>When the SUWA was master, it detected a write-data parity error.</td> </tr> <tr> <td>0</td> <td>pntRDPE</td> <td>1: A read-data parity error was detected. 0: A read-data parity error was not detected.</td> <td>When the SUWA was master, it detected a read-data parity error.</td> </tr> </tbody> </table>				Bit(s)	Name	Set value and its meaning	Description	4	pntMA	1: A master abort was observed. 0: A master abort was not observed.	A master abort was executed on the PCI bus.	3	(Reserved)	0	(Reserved)	2	pntAPE	1: An address parity error was detected. 0: An address parity error was not detected.	When the SUWA was target, it detected an address parity error.	1	pntWDPE	1: A write-data parity error was detected. 0: A write-data parity error was not detected.	When the SUWA was master, it detected a write-data parity error.	0	pntRDPE	1: A read-data parity error was detected. 0: A read-data parity error was not detected.	When the SUWA was master, it detected a read-data parity error.																																																																																																																																																		
Bit(s)	Name	Set value and its meaning	Description																																																																																																																																																																												
4	pntMA	1: A master abort was observed. 0: A master abort was not observed.	A master abort was executed on the PCI bus.																																																																																																																																																																												
3	(Reserved)	0	(Reserved)																																																																																																																																																																												
2	pntAPE	1: An address parity error was detected. 0: An address parity error was not detected.	When the SUWA was target, it detected an address parity error.																																																																																																																																																																												
1	pntWDPE	1: A write-data parity error was detected. 0: A write-data parity error was not detected.	When the SUWA was master, it detected a write-data parity error.																																																																																																																																																																												
0	pntRDPE	1: A read-data parity error was detected. 0: A read-data parity error was not detected.	When the SUWA was master, it detected a read-data parity error.																																																																																																																																																																												
DAT5	BUERRINTMST info	<table border="1"> <tr> <td style="text-align: center;">31</td> <td style="text-align: center;">14</td> <td style="text-align: center;">13</td> <td style="text-align: center;">12</td> <td style="text-align: center;">11</td> <td style="text-align: center;">10</td> <td style="text-align: center;">9</td> <td style="text-align: center;">8</td> <td style="text-align: center;">7</td> <td style="text-align: center;">6</td> <td style="text-align: center;">5</td> <td style="text-align: center;">4</td> <td style="text-align: center;">3</td> <td style="text-align: center;">2</td> <td style="text-align: center;">1</td> <td style="text-align: center;">0</td> </tr> <tr> <td colspan="3" style="text-align: center;">(Reserved)</td> <td style="text-align: center;">↑</td> <td></td> <td></td> <td></td> <td></td> <td></td> <td colspan="6" style="text-align: center;">(Reserved)</td> <td></td> <td></td> <td></td> </tr> <tr> <td colspan="13"></td> <td style="text-align: center;">errMSTGNT0</td> <td colspan="3" style="text-align: center;">errMSTPU</td> </tr> <tr> <td colspan="13"></td> <td colspan="2" style="text-align: center;">errMSTGNT1</td> <td colspan="3" style="text-align: center;">errMSTNU</td> </tr> <tr> <td colspan="13"></td> <td colspan="2" style="text-align: center;">errMSTGNT2</td> <td colspan="3" style="text-align: center;">errMSTBU</td> </tr> <tr> <td colspan="13"></td> <td colspan="3" style="text-align: center;">errMSTGNT3</td> </tr> <tr> <td colspan="13"></td> <td colspan="2" style="text-align: center;">errMSTGNT4</td> </tr> <tr> <td colspan="13"></td> <td colspan="3" style="text-align: center;">errMSTSUWA</td> </tr> </table> <table border="1"> <thead> <tr> <th>Bit(s)</th> <th>Name</th> <th>Set value and its meaning</th> <th>Description</th> </tr> </thead> <tbody> <tr> <td>31 to 14</td> <td>(Reserved)</td> <td>0x0000 00</td> <td>(Reserved)</td> </tr> <tr> <td>13</td> <td>errMSTSUWA</td> <td>1: The SUWA caused an error while it was master. 0: The SUWA did not cause any error.</td> <td>The SUWA caused the error reported in BUERRPTR.</td> </tr> <tr> <td>12</td> <td>errMSTGNT4</td> <td>1: GNT4 caused an error when it was master. 0: GNT4 did not cause any error.</td> <td>The master connected to B_GNT4_N caused the error reported in BUERRPTR.</td> </tr> <tr> <td>11</td> <td>errMSTGNT3</td> <td>1: GNT3 caused an error when it was master. 0: GNT4 did not cause any error.</td> <td>The master connected to B_GNT3_N caused the error reported in BUERRPTR.</td> </tr> <tr> <td>10</td> <td>errMSTGNT2</td> <td>1: GNT2 caused an error when it was master. 0: GNT4 did not cause any error.</td> <td>The master connected to B_GNT2_N caused the error reported in BUERRPTR.</td> </tr> <tr> <td>9</td> <td>errMSTGNT1</td> <td>1: GNT1 caused an error when it was master. 0: GNT4 did not cause any error.</td> <td>The master connected to B_GNT1_N caused the error reported in BUERRPTR.</td> </tr> <tr> <td>8</td> <td>errMSTGNT0</td> <td>1: GNT0 caused an error when it was master. 0: GNT4 did not cause any error.</td> <td>The master connected to B_GNT0_N caused the error reported in BUERRPTR.</td> </tr> <tr> <td>7 to 3</td> <td>(Reserved)</td> <td>0x00</td> <td>(Reserved)</td> </tr> </tbody> </table>				31	14	13	12	11	10	9	8	7	6	5	4	3	2	1	0	(Reserved)			↑						(Reserved)																						errMSTGNT0	errMSTPU																errMSTGNT1		errMSTNU																errMSTGNT2		errMSTBU																errMSTGNT3																errMSTGNT4															errMSTSUWA			Bit(s)	Name	Set value and its meaning	Description	31 to 14	(Reserved)	0x0000 00	(Reserved)	13	errMSTSUWA	1: The SUWA caused an error while it was master. 0: The SUWA did not cause any error.	The SUWA caused the error reported in BUERRPTR.	12	errMSTGNT4	1: GNT4 caused an error when it was master. 0: GNT4 did not cause any error.	The master connected to B_GNT4_N caused the error reported in BUERRPTR.	11	errMSTGNT3	1: GNT3 caused an error when it was master. 0: GNT4 did not cause any error.	The master connected to B_GNT3_N caused the error reported in BUERRPTR.	10	errMSTGNT2	1: GNT2 caused an error when it was master. 0: GNT4 did not cause any error.	The master connected to B_GNT2_N caused the error reported in BUERRPTR.	9	errMSTGNT1	1: GNT1 caused an error when it was master. 0: GNT4 did not cause any error.	The master connected to B_GNT1_N caused the error reported in BUERRPTR.	8	errMSTGNT0	1: GNT0 caused an error when it was master. 0: GNT4 did not cause any error.	The master connected to B_GNT0_N caused the error reported in BUERRPTR.	7 to 3	(Reserved)	0x00	(Reserved)
31	14	13	12	11	10	9	8	7	6	5	4	3	2	1	0																																																																																																																																																																
(Reserved)			↑						(Reserved)																																																																																																																																																																						
													errMSTGNT0	errMSTPU																																																																																																																																																																	
													errMSTGNT1		errMSTNU																																																																																																																																																																
													errMSTGNT2		errMSTBU																																																																																																																																																																
													errMSTGNT3																																																																																																																																																																		
													errMSTGNT4																																																																																																																																																																		
													errMSTSUWA																																																																																																																																																																		
Bit(s)	Name	Set value and its meaning	Description																																																																																																																																																																												
31 to 14	(Reserved)	0x0000 00	(Reserved)																																																																																																																																																																												
13	errMSTSUWA	1: The SUWA caused an error while it was master. 0: The SUWA did not cause any error.	The SUWA caused the error reported in BUERRPTR.																																																																																																																																																																												
12	errMSTGNT4	1: GNT4 caused an error when it was master. 0: GNT4 did not cause any error.	The master connected to B_GNT4_N caused the error reported in BUERRPTR.																																																																																																																																																																												
11	errMSTGNT3	1: GNT3 caused an error when it was master. 0: GNT4 did not cause any error.	The master connected to B_GNT3_N caused the error reported in BUERRPTR.																																																																																																																																																																												
10	errMSTGNT2	1: GNT2 caused an error when it was master. 0: GNT4 did not cause any error.	The master connected to B_GNT2_N caused the error reported in BUERRPTR.																																																																																																																																																																												
9	errMSTGNT1	1: GNT1 caused an error when it was master. 0: GNT4 did not cause any error.	The master connected to B_GNT1_N caused the error reported in BUERRPTR.																																																																																																																																																																												
8	errMSTGNT0	1: GNT0 caused an error when it was master. 0: GNT4 did not cause any error.	The master connected to B_GNT0_N caused the error reported in BUERRPTR.																																																																																																																																																																												
7 to 3	(Reserved)	0x00	(Reserved)																																																																																																																																																																												

4 ERROR LOG INFORMATION

Table 4-13 Error Detail Data for Built-in LANCE PCI Bus I/O Errors
(EC=0x078014XX) (5/5)

DATn	Data name	Detail data																							
DAT5	BUERRINTMST info	<table border="1"> <thead> <tr> <th>Bit(s)</th> <th>Name</th> <th>Set value and its meaning</th> <th>Description</th> </tr> </thead> <tbody> <tr> <td>2</td> <td>errMSTBU</td> <td>1: The CALINK caused an error when it was master. 0: The CALINK did not cause any error.</td> <td>When it was master, the CALINK (BU) caused the error reported in BUERRPTR.</td> </tr> <tr> <td>1</td> <td>errMSTNU</td> <td>1: The NPU caused an error when it was master. 0: The NPU did not cause any error.</td> <td>When it was master, the NPU caused the error reported in BUERRPTR.</td> </tr> <tr> <td>0</td> <td>errMSTPU</td> <td>1: The CPU caused an error when it was master. 0: The CPU did not cause any error.</td> <td>When it was master, the CPU caused the error reported in BUERRPTR.</td> </tr> </tbody> </table>				Bit(s)	Name	Set value and its meaning	Description	2	errMSTBU	1: The CALINK caused an error when it was master. 0: The CALINK did not cause any error.	When it was master, the CALINK (BU) caused the error reported in BUERRPTR.	1	errMSTNU	1: The NPU caused an error when it was master. 0: The NPU did not cause any error.	When it was master, the NPU caused the error reported in BUERRPTR.	0	errMSTPU	1: The CPU caused an error when it was master. 0: The CPU did not cause any error.	When it was master, the CPU caused the error reported in BUERRPTR.				
Bit(s)	Name	Set value and its meaning	Description																						
2	errMSTBU	1: The CALINK caused an error when it was master. 0: The CALINK did not cause any error.	When it was master, the CALINK (BU) caused the error reported in BUERRPTR.																						
1	errMSTNU	1: The NPU caused an error when it was master. 0: The NPU did not cause any error.	When it was master, the NPU caused the error reported in BUERRPTR.																						
0	errMSTPU	1: The CPU caused an error when it was master. 0: The CPU did not cause any error.	When it was master, the CPU caused the error reported in BUERRPTR.																						
DAT6	BUERRCMD info	<table border="1"> <tr> <td style="text-align: right;">31</td> <td style="text-align: right;">4</td> <td style="text-align: right;">3</td> <td style="text-align: right;">0</td> </tr> <tr> <td colspan="3" style="text-align: center;">(Reserved)</td> <td style="text-align: center;">errCMD</td> </tr> </table> <table border="1"> <thead> <tr> <th>Bit(s)</th> <th>Name</th> <th>Set value and its meaning</th> <th>Description</th> </tr> </thead> <tbody> <tr> <td>31 to 4</td> <td>(Reserved)</td> <td>0x0000 00</td> <td>(Reserved)</td> </tr> <tr> <td>3 to 0</td> <td>errCMD</td> <td>PCI command: Set when the PCI bus master has encountered the error: 0001: A write was attempted in a BUSBUSY or a timeout error condition. 0000: A read was attempted in a BUSBUSY or a timeout error condition.</td> <td>This information piece indicates the command (PCI command or read/write) that was attempted in the error condition reported in the BUERRPTR register.</td> </tr> </tbody> </table>				31	4	3	0	(Reserved)			errCMD	Bit(s)	Name	Set value and its meaning	Description	31 to 4	(Reserved)	0x0000 00	(Reserved)	3 to 0	errCMD	PCI command: Set when the PCI bus master has encountered the error: 0001: A write was attempted in a BUSBUSY or a timeout error condition. 0000: A read was attempted in a BUSBUSY or a timeout error condition.	This information piece indicates the command (PCI command or read/write) that was attempted in the error condition reported in the BUERRPTR register.
31	4	3	0																						
(Reserved)			errCMD																						
Bit(s)	Name	Set value and its meaning	Description																						
31 to 4	(Reserved)	0x0000 00	(Reserved)																						
3 to 0	errCMD	PCI command: Set when the PCI bus master has encountered the error: 0001: A write was attempted in a BUSBUSY or a timeout error condition. 0000: A read was attempted in a BUSBUSY or a timeout error condition.	This information piece indicates the command (PCI command or read/write) that was attempted in the error condition reported in the BUERRPTR register.																						
DAT7	(Unused)																								

The data pieces DAT8 thru DAT109 are driver table information.

Table 4-14 Error Detail Data for LANCP I/O Errors (EC=0x078016XX)

DATn	Data name	Detail data																																												
DAT0	LANCP MSW6																																													
DAT4 to 6	LANCP MSW3 to 5 (Meaningful only when EC=0x07801601)	<table border="1"> <thead> <tr> <th>Register name</th> <th>Bit(s)</th> <th>Name</th> <th>Description</th> </tr> </thead> <tbody> <tr> <td rowspan="8">MSW3</td> <td>31</td> <td>ADDRVAL</td> <td>If it is set to 1, indicates that the contents of MSW3 and MSW4 (bus error address) are significant; if it is set to 0, indicates that they are insignificant.</td> </tr> <tr> <td>30</td> <td>DATAVAL</td> <td>If it is set to 1, indicates that the contents of MSW3 and MSW5 (bus error data) are significant; if it is set to 0, indicates that they are insignificant.</td> </tr> <tr> <td>29</td> <td>(Unused)</td> <td>Always 0.</td> </tr> <tr> <td>28</td> <td>PTYINFO</td> <td>Indicates the status of the parity at the occurrence of the error. (This bit is set when a bus error is detected at the time the LANCP is master.)</td> </tr> <tr> <td>27 to 24</td> <td>(Unused)</td> <td>Always 0.</td> </tr> <tr> <td>23 to 20</td> <td>COMMD</td> <td>Indicates the status of the command at the occurrence of the error. (These bits are set when a bus error is detected at the time the LANCP is master.)</td> </tr> <tr> <td>19 to 16</td> <td>BYTE</td> <td>Indicates the status (enabled or not) of the bytes. (These bits are set when an R-/W-data parity error is detected at the time the LANCP is master.)</td> </tr> <tr> <td>15 to 0</td> <td>(Unused)</td> <td>Always 0.</td> </tr> <tr> <td rowspan="2">MSW4</td> <td>31 to 16</td> <td rowspan="2">Bus error address</td> <td rowspan="2">Is the address at the occurrence of the bus error. (These bits are set when a bus error is detected at the time the LANCP is master.)</td> </tr> <tr> <td>15 to 0</td> </tr> <tr> <td rowspan="2">MSW5</td> <td>31 to 16</td> <td rowspan="2">Bus error data</td> <td rowspan="2">Is the data at the occurrence of the bus error. (These bits are set when a bus error is detected in the LANCP's master read.)</td> </tr> <tr> <td>15 to 0</td> </tr> <tr> <td>MSW6</td> <td>31 to 0</td> <td>PCI_CONF1</td> <td>PCISTATUS information from PCIREG (/04) in LNCE</td> </tr> </tbody> </table>	Register name	Bit(s)	Name	Description	MSW3	31	ADDRVAL	If it is set to 1, indicates that the contents of MSW3 and MSW4 (bus error address) are significant; if it is set to 0, indicates that they are insignificant.	30	DATAVAL	If it is set to 1, indicates that the contents of MSW3 and MSW5 (bus error data) are significant; if it is set to 0, indicates that they are insignificant.	29	(Unused)	Always 0.	28	PTYINFO	Indicates the status of the parity at the occurrence of the error. (This bit is set when a bus error is detected at the time the LANCP is master.)	27 to 24	(Unused)	Always 0.	23 to 20	COMMD	Indicates the status of the command at the occurrence of the error. (These bits are set when a bus error is detected at the time the LANCP is master.)	19 to 16	BYTE	Indicates the status (enabled or not) of the bytes. (These bits are set when an R-/W-data parity error is detected at the time the LANCP is master.)	15 to 0	(Unused)	Always 0.	MSW4	31 to 16	Bus error address	Is the address at the occurrence of the bus error. (These bits are set when a bus error is detected at the time the LANCP is master.)	15 to 0	MSW5	31 to 16	Bus error data	Is the data at the occurrence of the bus error. (These bits are set when a bus error is detected in the LANCP's master read.)	15 to 0	MSW6	31 to 0	PCI_CONF1	PCISTATUS information from PCIREG (/04) in LNCE	
Register name	Bit(s)	Name	Description																																											
MSW3	31	ADDRVAL	If it is set to 1, indicates that the contents of MSW3 and MSW4 (bus error address) are significant; if it is set to 0, indicates that they are insignificant.																																											
	30	DATAVAL	If it is set to 1, indicates that the contents of MSW3 and MSW5 (bus error data) are significant; if it is set to 0, indicates that they are insignificant.																																											
	29	(Unused)	Always 0.																																											
	28	PTYINFO	Indicates the status of the parity at the occurrence of the error. (This bit is set when a bus error is detected at the time the LANCP is master.)																																											
	27 to 24	(Unused)	Always 0.																																											
	23 to 20	COMMD	Indicates the status of the command at the occurrence of the error. (These bits are set when a bus error is detected at the time the LANCP is master.)																																											
	19 to 16	BYTE	Indicates the status (enabled or not) of the bytes. (These bits are set when an R-/W-data parity error is detected at the time the LANCP is master.)																																											
	15 to 0	(Unused)	Always 0.																																											
MSW4	31 to 16	Bus error address	Is the address at the occurrence of the bus error. (These bits are set when a bus error is detected at the time the LANCP is master.)																																											
	15 to 0																																													
MSW5	31 to 16	Bus error data	Is the data at the occurrence of the bus error. (These bits are set when a bus error is detected in the LANCP's master read.)																																											
	15 to 0																																													
MSW6	31 to 0	PCI_CONF1	PCISTATUS information from PCIREG (/04) in LNCE																																											
DAT1	LANCP MSW0	For details, see the LANCP-related information under “(5) Module error.”																																												
DAT2	LANCP MSW1																																													
DAT3	LANCP MSW2 (Meaningful only when EC=0x07801601)																																													
DAT7	LANCP ICW2	<table border="1"> <thead> <tr> <th>Register name</th> <th>Bit(s)</th> <th>Name</th> <th>Description</th> </tr> </thead> <tbody> <tr> <td rowspan="5">ICW2</td> <td>31</td> <td>VAL</td> <td>If it is set to 1, indicates that an interrupt was generated; if it is set to 0, indicates that it was not.</td> </tr> <tr> <td>30</td> <td>HERR</td> <td>Indicates that the cause of an MSW2 error was detected.</td> </tr> <tr> <td>29</td> <td>P3V</td> <td>3.3V ON/OFF=1/0</td> </tr> <tr> <td>28 to 16</td> <td>(Unused)</td> <td>Always 0.</td> </tr> <tr> <td>15 to 0</td> <td>Reserved</td> <td>(Reserved for future extension) always 0.</td> </tr> </tbody> </table>	Register name	Bit(s)	Name	Description	ICW2	31	VAL	If it is set to 1, indicates that an interrupt was generated; if it is set to 0, indicates that it was not.	30	HERR	Indicates that the cause of an MSW2 error was detected.	29	P3V	3.3V ON/OFF=1/0	28 to 16	(Unused)	Always 0.	15 to 0	Reserved	(Reserved for future extension) always 0.																								
Register name	Bit(s)	Name	Description																																											
ICW2	31	VAL	If it is set to 1, indicates that an interrupt was generated; if it is set to 0, indicates that it was not.																																											
	30	HERR	Indicates that the cause of an MSW2 error was detected.																																											
	29	P3V	3.3V ON/OFF=1/0																																											
	28 to 16	(Unused)	Always 0.																																											
	15 to 0	Reserved	(Reserved for future extension) always 0.																																											

The data pieces DAT8 thru DAT109 are driver table information.

4 ERROR LOG INFORMATION

Table 4-15 Error Detail Data for Driver-Detected I/O Errors (EC=0x078015XX)

DATn	Data name	Detail data
DAT0	(Unused)	
DAT1	LANCP MSW0	MSW0 when the error is related to the LANCP. For details, see the LANCP-related information under “(5) Module error.”
DAT2	LANCP MSW1	MSW1 when the error is related to the LANCP. For details, see the LANCP-related information under “(5) Module error.”
DAT3	IP address	This IP address information is set only when EC=0x07801512 (duplicated IP address detected).
DAT4	MAC address 1	This information piece is set only when EC=0x07801512 (duplicated IP address detected). It is the upper four bytes of the duplicated MAC address.
DAT5	MAC address 2	This information piece is set only when EC=0x07801512 (duplicated IP address detected). It is the lower two bytes of the duplicated MAC address.
DAT6	(Unused)	
DAT7	(Unused)	

The data pieces DAT8 thru DAT109 are driver table information.

- I/O error

This type of error is reported when a problem is detected during input or output with devices. The error detail data varies with devices in which an I/O error is detected.

Table 4-16 I/O Error Message Format

```
%CPMS-E-HARD-000x SITE=xxxxxxxxxxxxxx RC=xxxxxxxx yyyy/mm/dd hh:mm:ss LOG=xxx
EC=xxxxxxxx I/O Error (subtitle)
UNO =xxxxxxxx DEV =xxxxxxxx DVA =xxxxxxxx IOEC =xxxxxxxx TN =xxxxxxxx
DAT0 =xxxxxxxx DAT1 =xxxxxxxx DAT2 =xxxxxxxx DAT3 =xxxxxxxx DAT4 =xxxxxxxx
DAT5 =xxxxxxxx DAT6 =xxxxxxxx DAT7 =xxxxxxxx DAT8 =xxxxxxxx DAT9 =xxxxxxxx
DAT10 =xxxxxxxx DAT11 =xxxxxxxx DAT12 =xxxxxxxx DAT13 =xxxxxxxx DAT14 =xxxxxxxx
DAT15 =xxxxxxxx DAT16 =xxxxxxxx DAT17 =xxxxxxxx DAT18 =xxxxxxxx DAT19 =xxxxxxxx
DAT20 =xxxxxxxx DAT21 =xxxxxxxx DAT22 =xxxxxxxx DAT23 =xxxxxxxx DAT24 =xxxxxxxx
DAT25 =xxxxxxxx DAT26 =xxxxxxxx DAT27 =xxxxxxxx DAT28 =xxxxxxxx DAT29 =xxxxxxxx
DAT30 =xxxxxxxx DAT31 =xxxxxxxx DAT32 =xxxxxxxx DAT33 =xxxxxxxx DAT34 =xxxxxxxx
DAT35 =xxxxxxxx DAT36 =xxxxxxxx DAT37 =xxxxxxxx DAT38 =xxxxxxxx DAT39 =xxxxxxxx
DAT40 =xxxxxxxx DAT41 =xxxxxxxx DAT42 =xxxxxxxx DAT43 =xxxxxxxx DAT44 =xxxxxxxx
DAT45 =xxxxxxxx DAT46 =xxxxxxxx DAT47 =xxxxxxxx DAT48 =xxxxxxxx DAT49 =xxxxxxxx
```

Item	Description										
EC	Error Code: Identifies the type of the error detected. For details, see Table 4-17.										
UNO	I/O Unit number: Is the unit number of the I/O unit used.										
DEV	<p>Device number</p> <p>Identifies the type and mounting slot of the I/O device in which the error occurred.</p> <table border="1" style="margin-left: 40px;"> <tr> <td style="text-align: center;">0</td> <td style="text-align: center;">15 16</td> <td style="text-align: center;">19 20</td> <td style="text-align: center;">23 24</td> <td style="text-align: center;">31</td> </tr> <tr> <td style="text-align: center;">Major Number (=Driver ID)</td> <td style="text-align: center;">SLOT</td> <td style="text-align: center;">CH</td> <td colspan="2" style="text-align: center;">Others</td> </tr> </table> <p>SLOT: Slot number CH: Channel (Interface) number Others: Depend on Device Driver</p>	0	15 16	19 20	23 24	31	Major Number (=Driver ID)	SLOT	CH	Others	
0	15 16	19 20	23 24	31							
Major Number (=Driver ID)	SLOT	CH	Others								
DVA	<p>Device Address</p> <p>Identifies the memory location at which the device is installed; always set to 0 when an error of this type is detected.</p>										
IOEC	<p>I/O Error Code</p> <p>Is the detail error code for the error. If this information piece is not provided for a detected I/O error, it is always 0.</p>										
TN	<p>Task Number</p> <p>Is the task number of the task in which the error occurred.</p>										
DATn	<p>Data n</p> <p>Each is an error analysis data piece.</p>										

4 ERROR LOG INFORMATION

Table 4-17 Error Codes, Subtitles, and Their Meanings (for I/O Errors)

No.	Error code	Subtitle	Meaning	Content of DATn
1	EC=07395010	ROM Board Error	A hardware abnormality was detected during accessing the ROM (CF) board.	For details on DATn, see Table 4-18.

Table 4-18 Error Detail Data for ROM Board Errors (1/2)

DATn	Data name	Detail data																																												
DAT0	Write completion flag	Used to test if data from system memory is written in the ROM board: 0x12345678: Indicates that data writing from system memory to the ROM board is ended normally. 0x00000000: Indicates that data writing from system memory to the ROM board is not completed yet or is ended abnormally.																																												
DAT1	Write count	Indicates the cumulative number of data writes that have been done to the ROM board.																																												
DAT2	Sum value for write-data	Meaningful only when data from system memory is written in the ROM board; and is the sum value for the written data.																																												
DAT3	Error logging count	Indicates how many times log information has been recorded due to errors during accesses to the ROM board.																																												
DAT4	Status code	<p>Indicates the status of ROM board access:</p> <table border="1" style="width: 100%; text-align: center;"> <tr> <td>0</td> <td>15</td> <td>16</td> <td>19</td> <td>20</td> <td>23</td> <td>24</td> <td>27</td> <td>28</td> <td>31</td> </tr> <tr> <td colspan="3">0 ————— 0</td> <td>Access source</td> <td colspan="2">0 ————— 0</td> <td>OS macro type</td> <td colspan="3">Processing progress</td> </tr> </table> <table border="1" style="width: 100%; text-align: center;"> <thead> <tr> <th>Bit no.</th> <th>Bit name</th> <th>Read-in value</th> <th>Meaning</th> </tr> </thead> <tbody> <tr> <td>0 to 15</td> <td>—</td> <td>Always 0.</td> <td>—</td> </tr> <tr> <td>16 to 19</td> <td>Access source</td> <td>1: OS macro. Other than 1: Something other than OS macros.</td> <td>A source of access to the ROM board.</td> </tr> <tr> <td>20 to 23</td> <td>—</td> <td>Always 0.</td> <td>—</td> </tr> <tr> <td>24 to 27</td> <td>OS macro type</td> <td>1: romread macro. 2: romwrite macro.</td> <td>A type of OS macro that accessed the ROM board.</td> </tr> <tr> <td>28 to 31</td> <td>Processing progress</td> <td>1: Data read or write not finished yet. 2: Data read or write already finished. 3: Processing in the stage of data compare-check.</td> <td>Progress of OS macro processing.</td> </tr> </tbody> </table>	0	15	16	19	20	23	24	27	28	31	0 ————— 0			Access source	0 ————— 0		OS macro type	Processing progress			Bit no.	Bit name	Read-in value	Meaning	0 to 15	—	Always 0.	—	16 to 19	Access source	1: OS macro. Other than 1: Something other than OS macros.	A source of access to the ROM board.	20 to 23	—	Always 0.	—	24 to 27	OS macro type	1: romread macro. 2: romwrite macro.	A type of OS macro that accessed the ROM board.	28 to 31	Processing progress	1: Data read or write not finished yet. 2: Data read or write already finished. 3: Processing in the stage of data compare-check.	Progress of OS macro processing.
0	15	16	19	20	23	24	27	28	31																																					
0 ————— 0			Access source	0 ————— 0		OS macro type	Processing progress																																							
Bit no.	Bit name	Read-in value	Meaning																																											
0 to 15	—	Always 0.	—																																											
16 to 19	Access source	1: OS macro. Other than 1: Something other than OS macros.	A source of access to the ROM board.																																											
20 to 23	—	Always 0.	—																																											
24 to 27	OS macro type	1: romread macro. 2: romwrite macro.	A type of OS macro that accessed the ROM board.																																											
28 to 31	Processing progress	1: Data read or write not finished yet. 2: Data read or write already finished. 3: Processing in the stage of data compare-check.	Progress of OS macro processing.																																											
DAT5	Issued command	Is one of the following values written in the Command register among the task file registers: 0x20: Sector read 0x30: Sector write																																												

Table 4-18 Error Detail Data for ROM Board Errors (2/2)

DATn	Data name	Detail data																																																		
DAT6	Status register value	<p>Is a value read in from the Status register among the task file registers.</p> <p>0 23 24 25 26 27 28 29 30 31</p> <table border="1"> <tr> <td>0</td> <td>0</td> <td>BUSY</td> <td>RDY</td> <td>DWF</td> <td>DSC</td> <td>DRQ</td> <td>CORR</td> <td>0</td> <td>ERR</td> </tr> </table> <table border="1"> <thead> <tr> <th>Bit no.</th> <th>Bit name</th> <th>Read-in value</th> <th>Meaning</th> </tr> </thead> <tbody> <tr> <td>0 to 23</td> <td>—</td> <td>Always 0.</td> <td>—</td> </tr> <tr> <td>24</td> <td>BUSY</td> <td>0: Cause found. 1: Cause not found.</td> <td>Access to the command buffer or registers was in progress.</td> </tr> <tr> <td>25</td> <td>RDY</td> <td>0: Cause found. 1: Cause not found.</td> <td>Operation could be started immediately.</td> </tr> <tr> <td>26</td> <td>DWF</td> <td>0: Cause found. 1: Cause not found.</td> <td>Data write failed.</td> </tr> <tr> <td>27</td> <td>DSC</td> <td>0: Cause found. 1: Cause not found.</td> <td>Preparations for access to the ROM (CF) board were complete.</td> </tr> <tr> <td>28</td> <td>DRQ</td> <td>0: Cause found. 1: Cause not found.</td> <td>A read or write request was issued to read data from or write data to the Data register.</td> </tr> <tr> <td>29</td> <td>CORR</td> <td>0: Cause found. 1: Cause not found.</td> <td>A correctable error occurred and was corrected automatically.</td> </tr> <tr> <td>30</td> <td>—</td> <td>Always 0.</td> <td>—</td> </tr> <tr> <td>31</td> <td>ERR</td> <td>0: Cause found. 1: Cause not found.</td> <td>An issued command abended due to the occurrence of an error.</td> </tr> </tbody> </table>	0	0	BUSY	RDY	DWF	DSC	DRQ	CORR	0	ERR	Bit no.	Bit name	Read-in value	Meaning	0 to 23	—	Always 0.	—	24	BUSY	0: Cause found. 1: Cause not found.	Access to the command buffer or registers was in progress.	25	RDY	0: Cause found. 1: Cause not found.	Operation could be started immediately.	26	DWF	0: Cause found. 1: Cause not found.	Data write failed.	27	DSC	0: Cause found. 1: Cause not found.	Preparations for access to the ROM (CF) board were complete.	28	DRQ	0: Cause found. 1: Cause not found.	A read or write request was issued to read data from or write data to the Data register.	29	CORR	0: Cause found. 1: Cause not found.	A correctable error occurred and was corrected automatically.	30	—	Always 0.	—	31	ERR	0: Cause found. 1: Cause not found.	An issued command abended due to the occurrence of an error.
0	0	BUSY	RDY	DWF	DSC	DRQ	CORR	0	ERR																																											
Bit no.	Bit name	Read-in value	Meaning																																																	
0 to 23	—	Always 0.	—																																																	
24	BUSY	0: Cause found. 1: Cause not found.	Access to the command buffer or registers was in progress.																																																	
25	RDY	0: Cause found. 1: Cause not found.	Operation could be started immediately.																																																	
26	DWF	0: Cause found. 1: Cause not found.	Data write failed.																																																	
27	DSC	0: Cause found. 1: Cause not found.	Preparations for access to the ROM (CF) board were complete.																																																	
28	DRQ	0: Cause found. 1: Cause not found.	A read or write request was issued to read data from or write data to the Data register.																																																	
29	CORR	0: Cause found. 1: Cause not found.	A correctable error occurred and was corrected automatically.																																																	
30	—	Always 0.	—																																																	
31	ERR	0: Cause found. 1: Cause not found.	An issued command abended due to the occurrence of an error.																																																	
DAT7	Logical block address	Is the logical block address (LBA) in ROM to which access was being made at the time the error occurred.																																																		
DAT8	Error register value	<p>Is a value read in from the Error register among the task file registers.</p> <p>0 23 24 25 26 27 28 29 30 31</p> <table border="1"> <tr> <td>0</td> <td>0</td> <td>BBK</td> <td>UNC</td> <td>0</td> <td>IDNF</td> <td>0</td> <td>ABRT</td> <td>0</td> <td>AMNF</td> </tr> </table> <table border="1"> <thead> <tr> <th>Bit no.</th> <th>Bit name</th> <th>Read-in value</th> <th>Meaning</th> </tr> </thead> <tbody> <tr> <td>0 to 23</td> <td>—</td> <td>Always 0.</td> <td>—</td> </tr> <tr> <td>24</td> <td>BBK</td> <td>0: Cause found. 1: Cause not found.</td> <td>A defective block was detected.</td> </tr> <tr> <td>25</td> <td>UNC</td> <td>0: Cause found. 1: Cause not found.</td> <td>An uncorrectable error occurred.</td> </tr> <tr> <td>26</td> <td>—</td> <td>Always 0.</td> <td>—</td> </tr> <tr> <td>27</td> <td>IDNF</td> <td>0: Cause found. 1: Cause not found.</td> <td>Requested sector ID was in error or non-existent.</td> </tr> <tr> <td>28</td> <td>—</td> <td>Always 0.</td> <td>—</td> </tr> <tr> <td>29</td> <td>ABRT</td> <td>0: Cause found. 1: Cause not found.</td> <td>A command was aborted.</td> </tr> <tr> <td>30</td> <td>—</td> <td>Always 0.</td> <td>—</td> </tr> <tr> <td>31</td> <td>AMNF</td> <td>0: Cause found. 1: Cause not found.</td> <td>A common error occurred.</td> </tr> </tbody> </table>	0	0	BBK	UNC	0	IDNF	0	ABRT	0	AMNF	Bit no.	Bit name	Read-in value	Meaning	0 to 23	—	Always 0.	—	24	BBK	0: Cause found. 1: Cause not found.	A defective block was detected.	25	UNC	0: Cause found. 1: Cause not found.	An uncorrectable error occurred.	26	—	Always 0.	—	27	IDNF	0: Cause found. 1: Cause not found.	Requested sector ID was in error or non-existent.	28	—	Always 0.	—	29	ABRT	0: Cause found. 1: Cause not found.	A command was aborted.	30	—	Always 0.	—	31	AMNF	0: Cause found. 1: Cause not found.	A common error occurred.
0	0	BBK	UNC	0	IDNF	0	ABRT	0	AMNF																																											
Bit no.	Bit name	Read-in value	Meaning																																																	
0 to 23	—	Always 0.	—																																																	
24	BBK	0: Cause found. 1: Cause not found.	A defective block was detected.																																																	
25	UNC	0: Cause found. 1: Cause not found.	An uncorrectable error occurred.																																																	
26	—	Always 0.	—																																																	
27	IDNF	0: Cause found. 1: Cause not found.	Requested sector ID was in error or non-existent.																																																	
28	—	Always 0.	—																																																	
29	ABRT	0: Cause found. 1: Cause not found.	A command was aborted.																																																	
30	—	Always 0.	—																																																	
31	AMNF	0: Cause found. 1: Cause not found.	A common error occurred.																																																	

4 ERROR LOG INFORMATION

(4) Watchdog timer timeout error

This type of error is reported when a timeout is generated by the watchdog timer (WDT). A generated timeout indicates that, because a user task periodically executed to update the watchdog timer was not executed for some reason, the set time value could not be updated within the set timeout period.

If this type of error occurs, a link is automatically made to the built-in subroutine called WDTES. Users can create their own process as this subroutine.

The table below shows the general format of error messages for WDT timeout errors and describes each format element.

Table 4-19 Watchdog Timer Timeout Error Message Format

```
%CPMS-E-SOFT-0005    SITE=xxxxxxxxxxxxxx RC=xxxxxxx yyyy/mm/dd hh:mm:ss LOG=xxx  
EC=05c70000 WDT timeout error  
TIME =xxxxxxx
```

Item	Description
EC	Error Code: Identifies the type of the error detected. (This error code is always “05c70000”.)
TIME	WDT set time: Is the monitoring time period in milliseconds at the end of which the timeout was generated.

(5) Module error

This type of error is reported when a hardware abnormality is detected in a module.

The table below shows the general format of error messages for module errors and describes each format element.

Table 4-20 Module Error Message Format

```
%CPMS-x-HARD-0006 SITE=xxxxxxxxxxxxxxxx RC=xxxxxxxx yyyy/mm/dd hh:mm:ss LOG=xxx
EC=xxxxxxxx Module Error (subtitle)
SLOT =xxxxxxxx MSW0 =xxxxxxxx MSW1 =xxxxxxxx
DAT0 =xxxxxxxx DAT1 =xxxxxxxx DAT2 =xxxxxxxx DAT3 =xxxxxxxx DAT4 =xxxxxxxx
DAT5 =xxxxxxxx DAT6 =xxxxxxxx DAT7 =xxxxxxxx
```

Item	Description
EC	Error Code: Identifies the type of the error detected. For details, see Table 4-21.
SLOT	Slot number: Is the slot number of the slot in which the error-detected module is mounted.
MSW0	Module Status Word 0: Is one of the registers indicating the status of the module. The content of this item varies depending on modules. For details, see Table 4-22.
MSW1	Module Status Word 1: Is one of the registers indicating the status of the module. The content of this item varies depending on modules. For details, see Table 4-22.
DATn	Data n: Each is a piece of error analysis data. The content of each data piece varies depending on modules. For details, see Table 4-21.

4 ERROR LOG INFORMATION

Table 4-21 Error Codes, Subtitles, and Their Meanings (for Module Errors) (1/3)

No.	Error code	Subtitle	Meaning	Content of MSW0, MSW1, and DATn
1	EC=05000000	Invalid Interrupt	An invalid interrupt was detected.	The contents of MSW0, MSW1, and DAT0 are insignificant.
2	EC=05000001	Undefined Interrupt	An interrupt code for which an interrupt-handling process is undefined was detected.	DAT0: Is the interrupt code (INTEVT) of the generated interrupt. The contents of MSW0 and MSW1 are insignificant.
3	EC=05000002	INTEVT Invalid Interrupt	An invalid interrupt code was detected.	DAT0: Is the interrupt code (INTEVT) of the generated interrupt. The contents of MSW0 and MSW1 are insignificant.
4	EC=0500F001	HERST Invalid Interrupt	A serious-error interrupt was detected, but its cause could not be recognized (before done by the master).	DAT0: Is the interrupt code (INTEVT) of the generated interrupt. The contents of MSW0 and MSW1 are insignificant.
5	EC=0500F002	HERST Invalid Interrupt (2)	A serious-error interrupt was detected, but its cause could not be recognized (before done by the master).	DAT0: Is the interrupt code (INTEVT) of the generated interrupt. The contents of MSW0 and MSW1 are insignificant.
6	EC=0500F003	BUERRSTAT Invalid Interrupt	A serious-error interrupt was detected in relation to the PCI bus, but its detail cause was not recorded.	DAT0: Is the interrupt code (INTEVT) of the generated interrupt. The contents of MSW0 and MSW1 are insignificant.
7	EC=0500F006	MHPMCLG Invalid Interrupt	A serious-error interrupt was detected in relation to the memory, but its detail cause was not recorded.	DAT0: Is the interrupt code (INTEVT) of the generated interrupt. The contents of MSW0 and MSW1 are insignificant.
8	EC=0500F007	ECC 2bit Master Invalid Interrupt	A serious-error interrupt report was detected in relation to the memory, but the master could not be identified.	DAT0: Is the interrupt code (INTEVT) of the generated interrupt. The contents of MSW0 and MSW1 are insignificant.
9	EC=0500F008	RERRMST Invalid Interrupt	A serious-error interrupt was detected in relation to the system bus, but master information was not recorded.	DAT0: Is the interrupt code (INTEVT) of the generated interrupt. The contents of MSW0 and MSW1 are insignificant.

Table 4-21 Error Codes, Subtitles, and Their Meanings (for Module Errors) (2/3)

No.	Error code	Subtitle	Meaning	Content of MSW0, MSW1, and DATn
10	EC=0500C001	NINTR Invalid Interrupt	The module that reported on the occurrence of a communication interrupt could not be found.	DAT0: Is the interrupt code (INTEVT) of the generated interrupt. The contents of MSW0 and MSW1 are insignificant.
11	EC=05005001	RINTR Invalid Interrupt	The module that reported on the occurrence of an I/O interrupt could not be found.	DAT0: Is the interrupt code (INTEVT) of the generated interrupt. The contents of MSW0 and MSW1 are insignificant.
12	EC=0D010000	Memory Alarm	A total of five 1-bit errors were detected successively in memory.	DAT0: Time when the first error was detected. DAT1: Time when the second error was detected. DAT2: Time when the third error was detected. DAT3: Time when the fourth error was detected. DAT4: Time when the fifth error was detected. For information on the contents of MSW0 and MSW1, see the information under "CPU" in Table 4-22.
13	EC=0d320000	Memory Error	An unrecoverable error (2-bit error) was detected while the built-in processor was accessing the internal memory.	DAT0: Is the MSW2 information for the module in which the error occurred. For information on the contents of MSW0, MSW1, and MSW2, see the information for that module in Table 4-22.
14	EC=0d330000	Hardware WDT Timeout	A hardware watchdog timer timeout was detected.	DAT0: Is the MSW2 information for the module in which the error occurred. For information on the contents of MSW0, MSW1, and MSW2, see the information for that module in Table 4-22.
15	EC=0d340000	Software WDT Timeout	A software watchdog timer timeout was detected.	DAT0: Is the MSW2 information for the module in which the error occurred. For information on the contents of MSW0, MSW1, and MSW2, see the information for that module in Table 4-22.

4 ERROR LOG INFORMATION

Table 4-21 Error Codes, Subtitles, and Their Meanings (for Module Errors) (3/3)

No.	Error code	Subtitle	Meaning	Content of MSW0, MSW1, and DATn
16	EC=0d350000	RAM Sum Check Error	A RAM checksum error was detected.	DAT0: Is the MSW2 information for the module in which the error occurred. For information on the contents of MSW0, MSW1, and MSW2, see the information for that module in Table 4-22.
17	EC=0d360000	ROM Sum Check Error	A ROM checksum error was detected.	DAT0: Is the MSW2 information for the module in which the error occurred. For information on the contents of MSW0, MSW1, and MSW2, see the information for that module in Table 4-22.
18	EC=0d370000	Clock Stop Error	A hardware error (clock stoppage) was detected.	DAT0: Is the MSW2 information for the module in which the error occurred. For information on the contents of MSW0, MSW1, and MSW2, see the information for that module in Table 4-22.
19	EC=0d380000	OS Clear Error	The OS was cleared or not loaded in yet.	DAT0: Is the MSW2 information for the module in which the error occurred. For information on the contents of MSW0, MSW1, and MSW2, see the information for that module in Table 4-22.

Table 4-22 MSW Detail Data for Modules (1/6)

Module name	MSW	Detail data																																																																																								
CPU	MSW0	<table border="1" style="width: 100%; text-align: center;"> <tr> <td style="width: 8%;">0</td> <td style="width: 8%;">7</td> <td style="width: 8%;">8</td> <td style="width: 8%;">15</td> <td style="width: 8%;">16</td> <td style="width: 8%;">23</td> <td style="width: 8%;">24</td> <td style="width: 8%;">25</td> <td style="width: 8%;">29</td> <td style="width: 8%;">30</td> <td style="width: 8%;">31</td> </tr> <tr> <td colspan="3">Interface ID</td> <td colspan="3">Module ID</td> <td>0</td> <td>0</td> <td>BIST Cpbl</td> <td>0</td> <td>0</td> <td>BIST</td> <td>MHI</td> </tr> </table>				0	7	8	15	16	23	24	25	29	30	31	Interface ID			Module ID			0	0	BIST Cpbl	0	0	BIST	MHI																																																													
		0	7	8	15	16	23	24	25	29	30	31																																																																														
Interface ID			Module ID			0	0	BIST Cpbl	0	0	BIST	MHI																																																																														
		<table border="1" style="width: 100%;"> <thead> <tr> <th>Bit no.</th> <th>Bit name</th> <th>Read-in value</th> <th>Meaning</th> </tr> </thead> <tbody> <tr> <td>0 to 7</td> <td>Interface ID</td> <td>Interface ID</td> <td>Module ID code provided for use in software</td> </tr> <tr> <td>8 to 15</td> <td>Module ID</td> <td>Module ID</td> <td>Module ID code provided for use in hardware</td> </tr> <tr> <td>16 to 23</td> <td>—</td> <td>Always 0.</td> <td>—</td> </tr> <tr> <td>24</td> <td>BIST Cpbl</td> <td>0: Not supported. 1: Supported.</td> <td>Indicates whether or not the module supports self-diagnosis. (This item is optional.)</td> </tr> <tr> <td>25 to 29</td> <td>—</td> <td>Always 0.</td> <td>—</td> </tr> <tr> <td>30</td> <td>BIST</td> <td>0: Self-diagnosis ended. 1: Self-diagnosis was in process.</td> <td>Is the operation status of the module's self-diagnosis function. (This item is optional.)</td> </tr> <tr> <td>31</td> <td>MHI</td> <td>0: Initialization ended. 1: Initialization was in process.</td> <td>Is the initialization status of the module's hardware.</td> </tr> </tbody> </table>				Bit no.	Bit name	Read-in value	Meaning	0 to 7	Interface ID	Interface ID	Module ID code provided for use in software	8 to 15	Module ID	Module ID	Module ID code provided for use in hardware	16 to 23	—	Always 0.	—	24	BIST Cpbl	0: Not supported. 1: Supported.	Indicates whether or not the module supports self-diagnosis. (This item is optional.)	25 to 29	—	Always 0.	—	30	BIST	0: Self-diagnosis ended. 1: Self-diagnosis was in process.	Is the operation status of the module's self-diagnosis function. (This item is optional.)	31	MHI	0: Initialization ended. 1: Initialization was in process.	Is the initialization status of the module's hardware.																																																					
Bit no.	Bit name	Read-in value	Meaning																																																																																							
0 to 7	Interface ID	Interface ID	Module ID code provided for use in software																																																																																							
8 to 15	Module ID	Module ID	Module ID code provided for use in hardware																																																																																							
16 to 23	—	Always 0.	—																																																																																							
24	BIST Cpbl	0: Not supported. 1: Supported.	Indicates whether or not the module supports self-diagnosis. (This item is optional.)																																																																																							
25 to 29	—	Always 0.	—																																																																																							
30	BIST	0: Self-diagnosis ended. 1: Self-diagnosis was in process.	Is the operation status of the module's self-diagnosis function. (This item is optional.)																																																																																							
31	MHI	0: Initialization ended. 1: Initialization was in process.	Is the initialization status of the module's hardware.																																																																																							
	MSW1	<table border="1" style="width: 100%; text-align: center;"> <tr> <td style="width: 2%;">0</td><td style="width: 2%;">1</td><td style="width: 2%;">2</td><td style="width: 2%;">3</td><td style="width: 2%;">4</td><td style="width: 2%;">5</td><td style="width: 2%;">6</td><td style="width: 2%;">7</td><td style="width: 2%;">8</td><td style="width: 2%;">9</td><td style="width: 2%;">10</td><td style="width: 2%;">11</td><td style="width: 2%;">12</td><td style="width: 2%;">13</td><td style="width: 2%;">14</td><td style="width: 2%;">15</td><td style="width: 2%;">16</td><td style="width: 2%;">17</td><td style="width: 2%;">18</td><td style="width: 2%;">19</td><td style="width: 2%;">20</td> <td style="width: 2%;">27</td><td style="width: 2%;">28</td><td style="width: 2%;">29</td><td style="width: 2%;">30</td><td style="width: 2%;">31</td> </tr> <tr> <td>0</td><td></td><td></td><td>0</td><td></td><td></td><td></td><td></td><td></td><td></td><td>0</td><td></td><td></td><td></td><td></td><td>0</td><td></td><td></td><td></td><td></td><td></td><td></td><td></td><td></td><td></td><td></td><td></td><td>0</td><td>0</td><td></td><td></td> </tr> </table> <p style="text-align: right;"> NINT RINT Module-specific status MRDY MASTER PCS OK ETH2ACTV ETH2LINK ETH1ACTV ETH1LINK MERRF STBYF ERRF RUNF MERR STBY ERROR RUN </p> <table border="1" style="width: 100%;"> <thead> <tr> <th>Bit no.</th> <th>Bit name</th> <th>Read-in value</th> <th>Meaning</th> </tr> </thead> <tbody> <tr> <td>0</td> <td>—</td> <td>Always 0.</td> <td>—</td> </tr> <tr> <td>1</td> <td>RUN</td> <td>1: Module was in RUN state.</td> <td>Indicates a state of the module -- the RUN LED was lit or blinking.</td> </tr> <tr> <td>2</td> <td>ERROR</td> <td>0: An error was detected. 1: No error was detected.</td> <td>Presents error status info -- the ERR LED was lit or blinking.</td> </tr> <tr> <td>3</td> <td>—</td> <td>Always 0.</td> <td>—</td> </tr> <tr> <td>4</td> <td>STBY</td> <td>1: Module was in STANDBY state.</td> <td>Indicates a state of the module -- the STBY LED was lit or blinking.</td> </tr> <tr> <td>5</td> <td>MERR</td> <td>1: A module error was detected.</td> <td>Presents module error status info -- the MERR LED was lit or blinking.</td> </tr> </tbody> </table>				0	1	2	3	4	5	6	7	8	9	10	11	12	13	14	15	16	17	18	19	20	27	28	29	30	31	0			0							0					0												0	0			Bit no.	Bit name	Read-in value	Meaning	0	—	Always 0.	—	1	RUN	1: Module was in RUN state.	Indicates a state of the module -- the RUN LED was lit or blinking.	2	ERROR	0: An error was detected. 1: No error was detected.	Presents error status info -- the ERR LED was lit or blinking.	3	—	Always 0.	—	4	STBY	1: Module was in STANDBY state.	Indicates a state of the module -- the STBY LED was lit or blinking.	5	MERR	1: A module error was detected.	Presents module error status info -- the MERR LED was lit or blinking.
0	1	2	3	4	5	6	7	8	9	10	11	12	13	14	15	16	17	18	19	20	27	28	29	30	31																																																																	
0			0							0					0												0	0																																																														
Bit no.	Bit name	Read-in value	Meaning																																																																																							
0	—	Always 0.	—																																																																																							
1	RUN	1: Module was in RUN state.	Indicates a state of the module -- the RUN LED was lit or blinking.																																																																																							
2	ERROR	0: An error was detected. 1: No error was detected.	Presents error status info -- the ERR LED was lit or blinking.																																																																																							
3	—	Always 0.	—																																																																																							
4	STBY	1: Module was in STANDBY state.	Indicates a state of the module -- the STBY LED was lit or blinking.																																																																																							
5	MERR	1: A module error was detected.	Presents module error status info -- the MERR LED was lit or blinking.																																																																																							

4 ERROR LOG INFORMATION

Table 4-22 MSW Detail Data for Modules (2/6)

Module name	MSW	Detail data																																																																															
CPU (continued from preceding page)	MSW1	<table border="1"> <thead> <tr> <th>Bit no.</th> <th>Bit name</th> <th>Read-in value</th> <th>Meaning</th> </tr> </thead> <tbody> <tr> <td>6</td> <td>RUNF</td> <td>1: RUN was flickering.</td> <td>Is a state of the module -- the RUN LED was flickering.</td> </tr> <tr> <td>7</td> <td>ERRF</td> <td>1: ERR was flickering.</td> <td>Is a state of the module -- the ERR LED was flickering.</td> </tr> <tr> <td>8</td> <td>STBYF</td> <td>1: STBY was flickering.</td> <td>Is a state of the module -- the STBY LED was flickering.</td> </tr> <tr> <td>9</td> <td>MERRF</td> <td>1: MERR was flickering.</td> <td>Is a state of the module -- the MERR LED was flickering.</td> </tr> <tr> <td>10</td> <td>—</td> <td>Always 0.</td> <td>—</td> </tr> <tr> <td>11</td> <td>ETH1LINK</td> <td>1: Transmission was in normal progress.</td> <td>Is the link setup status of port Ether1.</td> </tr> <tr> <td>12</td> <td>ETH1ACTV</td> <td>Reception was in normal progress.</td> <td>Is the TX/RX status of port Ether1.</td> </tr> <tr> <td>13</td> <td>ETH2LINK</td> <td>Reception was in normal progress.</td> <td>Is the TX/RX status of port Ether1.</td> </tr> <tr> <td>14</td> <td>ETH2ACTV</td> <td>Reception was in normal progress.</td> <td>Is the TX/RX status of port Ether1.</td> </tr> <tr> <td>15</td> <td>—</td> <td>Always 0.</td> <td>CPU: Was in PCsOK state. (Related to output.)</td> </tr> <tr> <td>16</td> <td>PCS OK</td> <td>1: PCS OK</td> <td>CPU: Was in MASTER state. (Related to output.)</td> </tr> <tr> <td>17</td> <td>MASTER</td> <td>1: MASTER</td> <td>Is Master Ready state. (Applicable only to the CPU.)</td> </tr> <tr> <td>18</td> <td>MRDY</td> <td>1: MRDY</td> <td>Is PU Ready state. (Applicable only to the PU.)</td> </tr> <tr> <td>19</td> <td>—</td> <td>Always 0.</td> <td>—</td> </tr> <tr> <td>20 to 27</td> <td>Module-specific status</td> <td>Module-specific status</td> <td>Module-specific status</td> </tr> <tr> <td>28 to 29</td> <td>—</td> <td>Always 0.</td> <td>—</td> </tr> <tr> <td>30</td> <td>RINT</td> <td>0: Cause found. 1: Cause not found.</td> <td>Indicates whether or not a common interrupt other than the network-related was generated.</td> </tr> <tr> <td>31</td> <td>NINT</td> <td>0: Cause found. 1: Cause not found.</td> <td>Indicates whether or not a network-related interrupt was generated.</td> </tr> </tbody> </table>	Bit no.	Bit name	Read-in value	Meaning	6	RUNF	1: RUN was flickering.	Is a state of the module -- the RUN LED was flickering.	7	ERRF	1: ERR was flickering.	Is a state of the module -- the ERR LED was flickering.	8	STBYF	1: STBY was flickering.	Is a state of the module -- the STBY LED was flickering.	9	MERRF	1: MERR was flickering.	Is a state of the module -- the MERR LED was flickering.	10	—	Always 0.	—	11	ETH1LINK	1: Transmission was in normal progress.	Is the link setup status of port Ether1.	12	ETH1ACTV	Reception was in normal progress.	Is the TX/RX status of port Ether1.	13	ETH2LINK	Reception was in normal progress.	Is the TX/RX status of port Ether1.	14	ETH2ACTV	Reception was in normal progress.	Is the TX/RX status of port Ether1.	15	—	Always 0.	CPU: Was in PCsOK state. (Related to output.)	16	PCS OK	1: PCS OK	CPU: Was in MASTER state. (Related to output.)	17	MASTER	1: MASTER	Is Master Ready state. (Applicable only to the CPU.)	18	MRDY	1: MRDY	Is PU Ready state. (Applicable only to the PU.)	19	—	Always 0.	—	20 to 27	Module-specific status	Module-specific status	Module-specific status	28 to 29	—	Always 0.	—	30	RINT	0: Cause found. 1: Cause not found.	Indicates whether or not a common interrupt other than the network-related was generated.	31	NINT	0: Cause found. 1: Cause not found.	Indicates whether or not a network-related interrupt was generated.			
	Bit no.	Bit name	Read-in value	Meaning																																																																													
6	RUNF	1: RUN was flickering.	Is a state of the module -- the RUN LED was flickering.																																																																														
7	ERRF	1: ERR was flickering.	Is a state of the module -- the ERR LED was flickering.																																																																														
8	STBYF	1: STBY was flickering.	Is a state of the module -- the STBY LED was flickering.																																																																														
9	MERRF	1: MERR was flickering.	Is a state of the module -- the MERR LED was flickering.																																																																														
10	—	Always 0.	—																																																																														
11	ETH1LINK	1: Transmission was in normal progress.	Is the link setup status of port Ether1.																																																																														
12	ETH1ACTV	Reception was in normal progress.	Is the TX/RX status of port Ether1.																																																																														
13	ETH2LINK	Reception was in normal progress.	Is the TX/RX status of port Ether1.																																																																														
14	ETH2ACTV	Reception was in normal progress.	Is the TX/RX status of port Ether1.																																																																														
15	—	Always 0.	CPU: Was in PCsOK state. (Related to output.)																																																																														
16	PCS OK	1: PCS OK	CPU: Was in MASTER state. (Related to output.)																																																																														
17	MASTER	1: MASTER	Is Master Ready state. (Applicable only to the CPU.)																																																																														
18	MRDY	1: MRDY	Is PU Ready state. (Applicable only to the PU.)																																																																														
19	—	Always 0.	—																																																																														
20 to 27	Module-specific status	Module-specific status	Module-specific status																																																																														
28 to 29	—	Always 0.	—																																																																														
30	RINT	0: Cause found. 1: Cause not found.	Indicates whether or not a common interrupt other than the network-related was generated.																																																																														
31	NINT	0: Cause found. 1: Cause not found.	Indicates whether or not a network-related interrupt was generated.																																																																														
	MSW2	<table border="1"> <thead> <tr> <th>Bit no.</th> <th>Bit name</th> <th>Read-in value</th> <th>Meaning</th> </tr> </thead> <tbody> <tr> <td>0</td> <td>VAL</td> <td>1: Significant. 0: Insignificant.</td> <td>Indicates whether or not this register is significant.</td> </tr> <tr> <td>1 to 2</td> <td>—</td> <td>Always 0.</td> <td>—</td> </tr> <tr> <td>3</td> <td>MEME</td> <td>1: Error detected. 0: Error not detected.</td> <td>An unrecoverable error occurred during access to the internal memory.</td> </tr> </tbody> </table>				Bit no.	Bit name	Read-in value	Meaning	0	VAL	1: Significant. 0: Insignificant.	Indicates whether or not this register is significant.	1 to 2	—	Always 0.	—	3	MEME	1: Error detected. 0: Error not detected.	An unrecoverable error occurred during access to the internal memory.																																																												
Bit no.	Bit name	Read-in value	Meaning																																																																														
0	VAL	1: Significant. 0: Insignificant.	Indicates whether or not this register is significant.																																																																														
1 to 2	—	Always 0.	—																																																																														
3	MEME	1: Error detected. 0: Error not detected.	An unrecoverable error occurred during access to the internal memory.																																																																														

Table 4-22 MSW Detail Data for Modules (3/6)

Module name	MSW	Detail data			
CPU (continued from preceding page)	MSW2	Bit no.	Bit name	Read-in value	Meaning
		4	HWDT	1: Error detected. 0: Error not detected.	A hardware watchdog timer timeout was generated. (For the CPU, this type of error is included in the category of EXE errors.)
		5	SWDT	1: Error detected. 0: Error not detected.	A software watchdog timer timeout was generated.
		6	RAMS	1: Error detected. 0: Error not detected.	A RAM checksum error occurred.
		7	ROMS	1: Error detected. 0: Error not detected.	A ROM checksum error occurred.
		8	EXE	1: Error detected. 0: Error not detected.	A hardware error occurred. (For the CPU, this type of error is either an HWDT or an SWDT stoppage.)
		9	CLKSTP	1: Clock stopped. 0: Clock normal.	The clock stopped. (For the CPU, this type of error is an EXE stoppage.)
		10	OSCLR	1: OS cleared. 0: OS normal.	The OS was cleared.
		11 to 15	—	Always 0.	—
		16	RAPE	1: Error detected. 0: Error not detected.	A received-address parity error was detected (when the module was master).
		17	AAPE	1: Error detected. 0: Error not detected.	An asserted-address parity error was detected (when the module was target).
		18	RDPE	1: Error detected. 0: Error not detected.	A received-data parity error was detected (during a write by the master or during a read by the target).
		19	ADPE	1: Error detected. 0: Error not detected.	An asserted-data parity error was detected (during a read by the master or a write by the target).
		20	ATE	1: Error detected. 0: Error not detected.	An address cycle timeout error occurred. (Applicable only to the master.)
		21	TTE	1: Error detected. 0: Error not detected.	A transaction timeout error occurred. (Applicable only to the master.)
		22	BBTE	1: Error detected. 0: Error not detected.	A “BGACK signal busy” timeout error occurred. (Applicable only to the CPU.)
		23	MSAW	1: Error detected. 0: Error not detected.	A misalignment access was attempted.
		24	UDTW	1: Error detected. 0: Error not detected.	An unsupported-transaction error was detected.
		25	WPAW	1: Error detected. 0: Error not detected.	A write-protected area write error was detected. (This type of error is limited to cases where write-protection is supported.)
		26	RERTR	1: Error detected. 0: Error not detected.	A received error transaction was detected. (Applicable only to the master.)
27	AERTR	1: Error detected. 0: Error not detected.	An asserted error transaction was detected.		
28	BRTOE	1: Error detected. 0: Error not detected.	A bus request timeout was generated. (Applicable only to the master.)		
29 to 31	—	Always 0.	—		

4 ERROR LOG INFORMATION

Table 4-22 MSW Detail Data for Modules (4/6)

Module name	MSW	Detail data																											
NCP-F	MSW0	0	1	2	5	6	7	8	15	16	23	24	31	MHI	BIST	0	0	RMVBL Cpbl	BIST Cpbl	0	0	Hardware ID	Interface ID						
		Bit no.	Bit name	Read-in value		Meaning																							
		0	MHI	1: Initialization in progress. 0: Initialization ended.		Indicates whether the module's hardware is in reset condition.																							
		1	BIST	Always 0.		The operation status of the module's self-diagnosis function																							
		2 to 5	—	Always 0.		—																							
		6	RMVBL Cpbl	Always 1.		Indicates whether the module is hot-swappable.																							
		7	BIST Cpbl	0: Not supported.		Indicates whether or not the module supports self-diagnosis.																							
		8 to 15	—	Always 0.		—																							
		16 to 23	Hardware ID	Always 0x00.		A code identifying the module's hardware model																							
		24 to 31	Interface ID	0x30: LNC500		A module ID code provided for use in software																							
NCP-F	MSW1	0	1	2	3	4	5	6	7	8	9	10	11	12	21	MINT	RINT	0	0	R6TO	R6MA	R6TA	R6WP	R6RP	R7U8	R7DPE	R7BE	0	0
		22	23	24	25	26	27	28	29	30	31	WRAPB	WRAPA	NETONLN	WDTO	MEME	BTO	0	ERR	RUN	RMVBLREQ								
		Bit no.	Bit name	Read-in value		Meaning																							
		0	MINT	1: Interrupt not generated. 0: Interrupt generated.		Indicates whether or not a network-related interrupt was generated.																							
		1	RINT	Always 0.		Indicates whether or not an interrupt other than network-related was generated.																							
		2 to 3	—	Always 0.		—																							
		4	R6TO	1: Detected. 0: Not detected.		Indicates whether or not an internal timeout was detected during access from the CPU.																							
		5	R6MA	1: Detected. 0: Not detected.		Indicates whether or not an internal master abort was detected during access from the CPU.																							
		6	R6TA	1: Detected. 0: Not detected.		Indicates whether or not an internal target abort was detected during access from the CPU.																							
		7	R6WP	1: Detected. 0: Not detected.		Indicates whether or not an internal parity error was detected during write-access from the CPU.																							
		8	R6RP	1: Detected. 0: Not detected.		Indicates whether or not an internal parity error was detected during read-access from the CPU.																							
		9	R7U8	1: Less than 8 0: Greater than or equal to 8.		Indicates whether or not the RTRDY count reached 8 (times) during burst read.																							
		10	R7DPE	1: Detected. 0: Not detected.		Indicates whether or not a parity error was detected during write-access from the CPU.																							
		11	R7BE	1: Detected. 0: Not detected.		Indicates whether or not an undefined-pattern CBE was detected during write-access from the CPU.																							

Table 4-22 MSW Detail Data for Modules (5/6)

Module name	MSW	Detail data																											
NCP-F (continued from preceding page)	MSW1	Bit no.	Bit name	Read-in value	Meaning																								
		12 to 21	—	Always 0.	—																								
		22	WRAPB	1: Lit. 0: Not lit.	WRAPB LED status																								
		23	WRAPA	1: Lit. 0: Not lit.	WRAPA LED status																								
		24	NETONLN	1: Lit. 0: Not lit.	NETONLN LED status																								
		25	WDTO	1: Lit. 0: Not lit.	WDTO LED status																								
		26	MEME	1: Lit. 0: Not lit.	MEME LED status																								
		27	BTO	1: Lit. 0: Not lit.	BTO LED status																								
		28	0	Always 0.	—																								
		29	ERR	1: Lit. 0: Not lit.	ERR LED status																								
		30	RUN	1: Lit. 0: Not lit.	RUN LED status																								
		31	RMVBLREQ	1: Requested. 0: Not requested.	Indicates whether or not hot swapping was requested.																								
LANCP	MSW0	<table border="1" style="width: 100%; text-align: center;"> <tr> <td>0</td> <td>1</td> <td>2</td> <td>5</td> <td>6</td> <td>7</td> <td>8</td> <td>15</td> <td>16</td> <td>23</td> <td>24</td> <td>31</td> </tr> <tr> <td>MHI</td> <td>BIST</td> <td>0 ——— 0</td> <td>RMVBL Cpbl</td> <td>BIST Cpbl</td> <td>0 ——— 0</td> <td>Hardware ID</td> <td>Interface ID</td> <td colspan="4"></td> </tr> </table>				0	1	2	5	6	7	8	15	16	23	24	31	MHI	BIST	0 ——— 0	RMVBL Cpbl	BIST Cpbl	0 ——— 0	Hardware ID	Interface ID				
		0	1	2	5	6	7	8	15	16	23	24	31																
		MHI	BIST	0 ——— 0	RMVBL Cpbl	BIST Cpbl	0 ——— 0	Hardware ID	Interface ID																				
		Bit no.	Bit name	Read-in value	Meaning																								
		0	MHI	1: Initialization in progress. 0: Initialization ended.	Indicates whether the module's hardware is in reset condition.																								
		1	BIST	Always 0.	The operation status of the module's self-diagnosis function																								
		2 to 5	—	Always 0.	—																								
		6	RMVBL Cpbl	Always 1.	Indicates whether the module is hot-swappable.																								
		7	BIST Cpbl	Always 0.	Indicates whether the module supports self-diagnosis.																								
		8 to 15	—	0: Not supported.	—																								
16 to 23	Hardware ID	0x32: LNC550 0x33: LNC560	A code identifying the module's hardware model																										
24 to 31	Interface ID	Always 0x31.	A module ID code provided for use in software																										

4 ERROR LOG INFORMATION

Table 4-22 MSW Detail Data for Modules (6/6)

Module name	MSW	Detail data																																																																													
LANCP	MSW1	<table border="1" style="width:100%; text-align:center;"> <tr> <td>0</td><td>1</td><td>2</td><td>3</td><td>4</td><td>5</td><td>6</td><td>7</td><td>8</td><td>9</td><td>10</td><td>11</td><td>12</td><td>28</td> </tr> <tr> <td>MINT</td><td>RINT</td><td>0—</td><td>0</td><td>R6TO</td><td>R6MA</td><td>R6TA</td><td>R6WP</td><td>R6RP</td><td>0</td><td>R7DPE</td><td>R7BE</td><td>0—</td><td>0</td> </tr> </table>														0	1	2	3	4	5	6	7	8	9	10	11	12	28	MINT	RINT	0—	0	R6TO	R6MA	R6TA	R6WP	R6RP	0	R7DPE	R7BE	0—	0																																				
		0	1	2	3	4	5	6	7	8	9	10	11	12	28																																																																
		MINT	RINT	0—	0	R6TO	R6MA	R6TA	R6WP	R6RP	0	R7DPE	R7BE	0—	0																																																																
		<table border="1" style="width:100%; text-align:center;"> <tr> <td>29</td><td>30</td><td>31</td> </tr> <tr> <td>ERR</td><td>RUN</td><td>RMVBLREQ</td> </tr> </table>														29	30	31	ERR	RUN	RMVBLREQ																																																										
		29	30	31																																																																											
		ERR	RUN	RMVBLREQ																																																																											
		<table border="1" style="width:100%; border-collapse: collapse;"> <thead> <tr> <th style="width:10%;">Bit no.</th> <th style="width:15%;">Bit name</th> <th style="width:25%;">Read-in value</th> <th style="width:50%;">Meaning</th> </tr> </thead> <tbody> <tr> <td>0</td> <td>MINT</td> <td>1: Interrupt not generated. 0: Interrupt generated.</td> <td>Indicates whether or not a network-related interrupt was generated.</td> </tr> <tr> <td>1</td> <td>RINT</td> <td>Always 0.</td> <td>Indicates whether or not an interrupt other than network-related was generated.</td> </tr> <tr> <td>2 to 3</td> <td>—</td> <td>Always 0.</td> <td>—</td> </tr> <tr> <td>4</td> <td>R6TO</td> <td>1: Detected. 0: Not detected.</td> <td>Indicates whether or not an internal timeout was detected during access from the CPU.</td> </tr> <tr> <td>5</td> <td>R6MA</td> <td>1: Detected. 0: Not detected.</td> <td>Indicates whether or not an internal master abort was detected during access from the CPU.</td> </tr> <tr> <td>6</td> <td>R6TA</td> <td>1: Detected. 0: Not detected.</td> <td>Indicates whether or not an internal retry was detected during access from the CPU.</td> </tr> <tr> <td>7</td> <td>R6WP</td> <td>1: Detected. 0: Not detected.</td> <td>Indicates whether or not an internal parity error was detected during write-access from the CPU.</td> </tr> <tr> <td>8</td> <td>R6RP</td> <td>1: Detected. 0: Not detected.</td> <td>Indicates whether or not an internal parity error was detected during read-access from the CPU.</td> </tr> <tr> <td>9</td> <td>—</td> <td>Always 0.</td> <td>—</td> </tr> <tr> <td>10</td> <td>R7DPE</td> <td>1: Detected. 0: Not detected.</td> <td>Indicates whether or not a parity error was detected during write-access from the CPU.</td> </tr> <tr> <td>11</td> <td>R7BE</td> <td>1: Detected. 0: Not detected.</td> <td>Indicates whether an undefined-pattern CBE was detected during write-access from the CPU.</td> </tr> <tr> <td>12 to 28</td> <td>—</td> <td>Always 0.</td> <td>—</td> </tr> <tr> <td>29</td> <td>ERR</td> <td>1: Lit. 0: Not lit.</td> <td>ERR LED status</td> </tr> <tr> <td>30</td> <td>RUN</td> <td>1: Lit. 0: Not lit.</td> <td>RUN LED status</td> </tr> <tr> <td>31</td> <td>RMVBLREQ</td> <td>1: Requested. 0: Not requested.</td> <td>Indicates whether or not hot swapping was requested.</td> </tr> </tbody> </table>														Bit no.	Bit name	Read-in value	Meaning	0	MINT	1: Interrupt not generated. 0: Interrupt generated.	Indicates whether or not a network-related interrupt was generated.	1	RINT	Always 0.	Indicates whether or not an interrupt other than network-related was generated.	2 to 3	—	Always 0.	—	4	R6TO	1: Detected. 0: Not detected.	Indicates whether or not an internal timeout was detected during access from the CPU.	5	R6MA	1: Detected. 0: Not detected.	Indicates whether or not an internal master abort was detected during access from the CPU.	6	R6TA	1: Detected. 0: Not detected.	Indicates whether or not an internal retry was detected during access from the CPU.	7	R6WP	1: Detected. 0: Not detected.	Indicates whether or not an internal parity error was detected during write-access from the CPU.	8	R6RP	1: Detected. 0: Not detected.	Indicates whether or not an internal parity error was detected during read-access from the CPU.	9	—	Always 0.	—	10	R7DPE	1: Detected. 0: Not detected.	Indicates whether or not a parity error was detected during write-access from the CPU.	11	R7BE	1: Detected. 0: Not detected.	Indicates whether an undefined-pattern CBE was detected during write-access from the CPU.	12 to 28	—	Always 0.	—	29	ERR	1: Lit. 0: Not lit.	ERR LED status	30	RUN	1: Lit. 0: Not lit.	RUN LED status	31	RMVBLREQ	1: Requested. 0: Not requested.	Indicates whether or not hot swapping was requested.
		Bit no.	Bit name	Read-in value	Meaning																																																																										
		0	MINT	1: Interrupt not generated. 0: Interrupt generated.	Indicates whether or not a network-related interrupt was generated.																																																																										
		1	RINT	Always 0.	Indicates whether or not an interrupt other than network-related was generated.																																																																										
2 to 3	—	Always 0.	—																																																																												
4	R6TO	1: Detected. 0: Not detected.	Indicates whether or not an internal timeout was detected during access from the CPU.																																																																												
5	R6MA	1: Detected. 0: Not detected.	Indicates whether or not an internal master abort was detected during access from the CPU.																																																																												
6	R6TA	1: Detected. 0: Not detected.	Indicates whether or not an internal retry was detected during access from the CPU.																																																																												
7	R6WP	1: Detected. 0: Not detected.	Indicates whether or not an internal parity error was detected during write-access from the CPU.																																																																												
8	R6RP	1: Detected. 0: Not detected.	Indicates whether or not an internal parity error was detected during read-access from the CPU.																																																																												
9	—	Always 0.	—																																																																												
10	R7DPE	1: Detected. 0: Not detected.	Indicates whether or not a parity error was detected during write-access from the CPU.																																																																												
11	R7BE	1: Detected. 0: Not detected.	Indicates whether an undefined-pattern CBE was detected during write-access from the CPU.																																																																												
12 to 28	—	Always 0.	—																																																																												
29	ERR	1: Lit. 0: Not lit.	ERR LED status																																																																												
30	RUN	1: Lit. 0: Not lit.	RUN LED status																																																																												
31	RMVBLREQ	1: Requested. 0: Not requested.	Indicates whether or not hot swapping was requested.																																																																												

(6) Kernel warning

Although this type of message is not an error message, it indicates that an abnormality affecting the execution of the user program was detected.

The table below shows the general format of kernel warning messages and describes each format element.

Table 4-23 Kernel Warning Message Format

```
%CPMS-W-xxxx-0007  SITE=xxxxxxxxxxxxxx RC=xxxxxxx yyyy/mm/dd hh:mm:ss LOG=xxx
EC=xxxxxxx Kernel Warning
TN  =xxxxxxx
DAT0 =xxxxxxx DAT1 =xxxxxxx DAT2 =xxxxxxx DAT3 =xxxxxxx DAT4 =xxxxxxx
DAT5 =xxxxxxx DAT6 =xxxxxxx DAT7 =xxxxxxx
MESSAGE=xxxxxxxxxxxxxxxxxxxxxxxxxxxxxxxxxxxxxxxxxxxxxxxxxxxxxxxxxxxxxxxxxxxx
xxxxxxxxxxxxxxxxxxxxxxxxxxxxxxxxxxxxxxxxxxxxxxxxxxxxxxxxxxxxxxxxxxxxxxxxxxxx
```

Item	Description
EC	Error Code: Identifies the type of the warning made. For details, see Table 4-24.
TN	Task Number: Is the task number of the task in which the warning became necessary.
DATn	Each is a piece of error analysis data. For details, see Table 4-24.
MESSAGE	See Table 4-24.

Table 4-24 Error Code and Its Meaning (for Kernel Warnings)

No.	Error code	Message	Meaning	Contents of TN and DATn
1	EC=05A00001	No message is displayed.	A difference of 15 seconds or more was detected between the TOD time and the timer's time value during system time synchronization.	TN: The task number of the task that was running at the time of system time synchronization. DAT0: The difference in seconds. DAT1: The difference in subseconds. DAT2: The seconds count of the specified time. DAT3: The difference in subseconds from the specified time. DAT4: The seconds count of the TOD. DAT5: The subseconds count of the TOD.

4 ERROR LOG INFORMATION

(7) Kernel information

This type of error is reported when a transient abnormality not affecting the execution of the user program at all is detected in the CPMS.

The table below shows the general format of kernel information messages, followed by a short description.

Table 4-25 Kernel Information Message Format

```
%CPMS-I-xxxx-0008  SITE=xxxxxxxxxxxxxx RC=xxxxxxx  yyyy/mm/dd hh:mm:ss LOG=xxx
EC=xxxxxxx Kernel information
TN  =xxxxxxx
DAT0 =xxxxxxx  DAT1 =xxxxxxx  DAT2 =xxxxxxx  DAT3 =xxxxxxx  DAT4 =xxxxxxx
DAT5 =xxxxxxx  DAT6 =xxxxxxx  DAT7 =xxxxxxx
MESSAGE=xxxxxxxxxxxxxxxxxxxxxxxxxxxxxxxxxxxxxxxxxxxxxxxxxxxxxxxxxxxxxxxxxxxx
      xxxxxxxxxxxxxxxxxxxxxxxxxxxxxxxxxxxxxxxxxxxxxxxxxxxxxxxxxxxxxxxxxxxxxxx
```

Item	Description
EC	Error Code: Identifies the type of information presented. At present, the system does not produce any report on this type of error.

(8) System down -- system error

This type of error is reported when an abnormality making further processing impossible is detected by the CPMS.

The table below shows the general format of error messages for system errors and describes each format element.

Table 4-26 System Down (System Error) Message Format

```
%CPMS-F-CPMS-0009 SITE=xxxxxxxxxxxxxxxx RC=xxxxxxxx yyyy/mm/dd hh:mm:ss LOG=xxx
EC=xxxxxxxx System down (subtitle)
TN =xxxxxxxx PC =xxxxxxxx EXPEV=xxxxxxxx FADR =xxxxxxxx SR =xxxxxxxx
EXECD=xxxxxxxx
PR =xxxxxxxx SP =xxxxxxxx GBR =xxxxxxxx MACH =xxxxxxxx MACL =xxxxxxxx
R0 =xxxxxxxx R1 =xxxxxxxx R2 =xxxxxxxx R3 =xxxxxxxx R4 =xxxxxxxx
R5 =xxxxxxxx R6 =xxxxxxxx R7 =xxxxxxxx R8 =xxxxxxxx R9 =xxxxxxxx
R10 =xxxxxxxx R11 =xxxxxxxx R12 =xxxxxxxx R13 =xxxxxxxx R14 =xxxxxxxx
R15 =xxxxxxxx FPSCR=xxxxxxxx FPUL =xxxxxxxx
INST =xxxxxxxx xxxxxxxx xxxxxxxx xxxxxxxx xxxxxxxx xxxxxxxx xxxxxxxx xxxxxxxx
(PC =) xxxxxxxx xxxxxxxx xxxxxxxx xxxxxxxx xxxxxxxx xxxxxxxx xxxxxxxx xxxxxxxx
STACK=xxxxxxxx xxxxxxxx xxxxxxxx xxxxxxxx xxxxxxxx xxxxxxxx xxxxxxxx xxxxxxxx
(SP =) xxxxxxxx xxxxxxxx xxxxxxxx xxxxxxxx xxxxxxxx xxxxxxxx xxxxxxxx xxxxxxxx
PC =xxxxxxxx ( )
FADR=xxxxxxxx ( )
```

Item	Description
EC	Error code (see Table 4-27).
TN	The task number of the task in which the error occurred.
PC	The content of the program counter.
EXPEV	The content of the exception code register, which is a 32-bit register and identifies the cause of data access and alignment exceptions.
FADR	Fault address
SR	Status register, which identifies the status of the processor.
EXECD	The instruction that encountered the error during its execution.
PR	The content of the procedure register, which is used in calling a subroutine and stores the return address to the calling routine.
SP	The content of the stack pointer -- the register R15 is used as the stack pointer.
GBR	The content of the global base register, which stores base addresses to be used in GBR-indirect addressing with displacement and in indexed GBR-indirect addressing.
MACH	The content of the MAC register high, which saves the accumulated value of a MAC (Multiply and Accumulate) instruction or the result of a MAC or a MUL instruction. When the result of a MAC operation is a 64-bit value, this register contains the upper 32-bit value.
MACL	The content of the MAC register low, which serves the same purpose as MACH. When the result of a MAC operation is a 64-bit value, this register contains the lower 32-bit value. When the result of a MAC operation is a 32-bit value, it contains the entire 32-bit value.
FPSCR	The content of the floating-point status/control register.
FPUL	The content of the floating-point communication register, a register via which data transfer is done between general and floating-point registers.
Rxx	The content of the general register numbered xx.
INST	Eight instructions before and after the address pointed to by the PC.
PC	Instruction at the address pointed to by the PC.
STACK	Eight long words of data before and after the address pointed to by the SP.
SP	The content of the location pointed to by the SP (i.e., part of the stack content).
PC	The content of the program counter. Information on the address value contained in the program counter is presented, enclosed in parentheses. If the address value identifies a memory location in a program, the following information is presented: (name = program name type = program type [program component] raddr = relative address to the beginning of the program)
FADR	Fault address. Information on the fault address is presented, enclosed in parentheses.

4 ERROR LOG INFORMATION

Table 4-27 Error Codes, Subtitles, and Their Meanings (for System Errors)

No.	Error code	Subtitle	Brief description	Meaning
1	EC=03030000	Alignment Error	Alignment error	An instruction's operand was not aligned on word boundaries.
2	EC=03040000	Illegal Instruction	Illegal-instruction error	An attempt was made to execute an illegal instruction.
3	EC=03080000	Privileged Instruction	Privileged instruction violation	A privileged instruction, an instruction that may be executed only in system mode, was executed.
4	EC=03090000	Illegal Breakpoint	Illegal-breakpoint exception error	An instruction causing a breakpoint exception was executed.
5	EC=030f0000	Illegal Exception	Illegal exception	An undefined exception was reported.
6	EC=03380000	FP Unavailable	Floating-point unavailable	An attempt was made to execute an unavailable floating-point instruction during the execution of CPMS.
7	EC=03390000	FP System Down	Floating-point arithmetic error	An error was encountered during the execution of a floating-point arithmetic instruction.
8	EC=03400000	Instruction Page Fault	Instruction access page fault	An instruction in a page not listed in the page table was fetched.
9	EC=03420000	Invalid Inst. Access	Instruction access error	An attempt was made to access an undefined address space. (This instruction address error is one that is reported by a specific error code other than "03400000" and "03460000".)
10	EC=03460000	Inst. Access Protection	Instruction access protection error	Memory protection was violated by fetching an instruction.
11	EC=03600000	Data Page Fault	Data access page fault	Data in a page not listed in the page table was fetched.
12	EC=03620000	Invalid Data Access	Data access error	An attempt was made to access an undefined address space. (This data address error is one that is reported by a specific error code other than "03600000" and "03660000".)
13	EC=03660000	Data Access Protection	Data access protection error	Memory protection was violated by fetching data.
14	EC=03820000	Memory Error	Memory error	A memory error was detected by hardware.
15	EC=038a0000	Memory Access Error	Memory access error	A memory access error was detected by hardware.
16	EC=038b0000	Internal Bus Parity	Internal-bus parity error	A parity error was detected on the internal bus by hardware.
17	EC=038c0000	System Bus Parity	System-bus parity error	A parity error was detected on the system bus by hardware.
18	EC=038f0000	Undefined Machine Check	Undefined machine check	An undefined hardware error was detected.
19	EC=07394720	Invalid Interrupt Panic	Invalid interrupt generated successively (10 times)	An invalid interrupt was generated 10 times successively.
20	EC=05700000	System Error	CPMS error	A consistency error was detected during the execution of CPMS.
21	EC=0d810000	BPU Error	BPU miscalculation	A miscalculation by the BPU was detected by the CPMS.

(9) System down -- kernel trap

This type of error is reported when an internal irrationality in the CPMS is detected during the execution of the CPMS.

The table below shows the general format of error messages for kernel traps and describes each format element.

Table 4-28 Kernel Trap Message Format

```

%CPMS-F-xxxx-000A  SITE=xxxxxxxxxxxxx RC=xxxxxxx yyyy/mm/dd hh:mm:ss LOG=xxx
EC=05800000 System down (Kernel trap)
FILE =xxxxxxxxxxxxxxxxxxxxxxxxxxxxxxxxxxxxxxxxxxxxxxxxxxxxxxxxxxxxxxxxxxxx
      xxxxxxxxxxxxxxxxxxxxxxxxxxxxxxxxxxxxxxxxxxxxxxxxxxxxxxxxxxxxxxxxxxxxxxx
LINE =xxxxxxx
ERROR=xxxxxxxxxxxxxxxxxxxxxxxxxxxxxxxxxxxxxxxxxxxxxxxxxxxxxxxxxxxxxxxxxxxx
      xxxxxxxxxxxxxxxxxxxxxxxxxxxxxxxxxxxxxxxxxxxxxxxxxxxxxxxxxxxxxxxxxxxxxxx
    
```

Item	Description
FILE	The file name of the CPMS's internal file in which the irrationality was detected.
LINE	The place in the CPMS's internal file at which the irrationality was detected.
ERROR	The conditional expression that caused the irrationality.

4 ERROR LOG INFORMATION

(10) System down -- built-in subroutine error

This type of error is reported when an error making further processing impossible is detected by the CPMS during the execution of a built-in subroutine.

The table below shows the general format of error messages for built-in subroutine errors and describes each format element.

Table 4-29 System Down (Built-in Subroutine Error) Message Format

```
%CPMS-F-SOFT-000B SITE=xxxxxxxxxxxxxxxx RC=xxxxxxxx yyyy/mm/dd hh:mm:ss LOG=xxx
EC=xxxxxxxx ULSUB down (subtitle)
NEST =xxxxxxxx POINT=xxxxxxxx ENTRY=xxxxxxxx
PC =xxxxxxxx EXPEV=xxxxxxxx FADR =xxxxxxxx SR =xxxxxxxx
PR =xxxxxxxx SP =xxxxxxxx GBR =xxxxxxxx MACH =xxxxxxxx MACL =xxxxxxxx
R0 =xxxxxxxx R1 =xxxxxxxx R2 =xxxxxxxx R3 =xxxxxxxx R4 =xxxxxxxx
R5 =xxxxxxxx R6 =xxxxxxxx R7 =xxxxxxxx R8 =xxxxxxxx R9 =xxxxxxxx
R10 =xxxxxxxx R11 =xxxxxxxx R12 =xxxxxxxx R13 =xxxxxxxx R14 =xxxxxxxx
R15 =xxxxxxxx FPSCR=xxxxxxxx FPUL =xxxxxxxx
INST =xxxxxxxx xxxxxxxx xxxxxxxx xxxxxxxx xxxxxxxx xxxxxxxx xxxxxxxx xxxxxxxx
(PC =) xxxxxxxx xxxxxxxx xxxxxxxx xxxxxxxx xxxxxxxx xxxxxxxx xxxxxxxx xxxxxxxx
STACK=xxxxxxxx xxxxxxxx xxxxxxxx xxxxxxxx xxxxxxxx xxxxxxxx xxxxxxxx xxxxxxxx
(SP =) xxxxxxxx xxxxxxxx xxxxxxxx xxxxxxxx xxxxxxxx xxxxxxxx xxxxxxxx xxxxxxxx
PC =xxxxxxxx ( )
FADR=xxxxxxxx ( )
```

Item	Description
EC	Error code (see Table 4-30).
NEST	The number of calls made to the same built-in subroutine during its execution.
POINT	The point number of a point at which the built-in subroutine was integrated.
ENTRY	The entry number of an entry in the built-in subroutine.
PC	The content of the program counter.
EXPEV	The content of the exception code register, which is a 32-bit register and identifies the cause of data access and alignment exceptions.
FADR	Fault address
SR	Status register, which identifies the status of the processor.
EXECD	The instruction that encountered the error during its execution.
PR	The content of the procedure register, which is used in calling a subroutine and stores the return address to the calling routine.
SP	The content of the stack pointer -- the register R15 is used as the stack pointer.
GBR	The content of the global base register, which stores base addresses to be used in GBR-indirect addressing with displacement and in indexed GBR-indirect addressing.
MACH	The content of the MAC register high, which saves the accumulated value of a MAC (Multiply and Accumulate) instruction or the result of a MAC or a MUL instruction. When the result of a MAC operation is a 64-bit value, this register contains the upper 32-bit value.
MACL	The content of the MAC register low, which serves the same purpose as MACH. When the result of a MAC operation is a 64-bit value, this register contains the lower 32-bit value. When the result of a MAC operation is a 32-bit value, it contains the entire 32-bit value.
FPSCR	The content of the floating-point status/control register.
FPUL	The content of the floating-point communication register, a register via which data transfer is done between general and floating-point registers.
Rxx	The content of the general register numbered xx.
INST	Eight instructions before and after the address pointed to by the PC.
PC	Instruction at the address pointed to by the PC.
STACK	Eight long words of data before and after the address pointed to by the SP.
SP	The content of the location pointed to by the SP (i.e., part of the stack content).
PC	The content of the program counter. Information on the address value contained in the program counter is presented, enclosed in parentheses. If the address value identifies a memory location in a program, the following information is presented: (name = program name type = program type [program component] raddr = relative address to the beginning of the program)
FADR	Fault address. Information on the fault address is presented, enclosed in parentheses.

Table 4-30 Error Codes, Subtitles, and Their Meanings (for Built-in Subroutine Errors)

No.	Error code	Subtitle	Brief description	Meaning
1	EC=03030000	Alignment Error	Alignment error	An instruction's operand was not aligned on word boundaries.
2	EC=03040000	Illegal Instruction	Illegal-instruction error	An attempt was made to execute an illegal instruction.
3	EC=03080000	Privileged Instruction	Privileged instruction violation	A privileged instruction, an instruction that may be executed only in system mode, was executed.
4	EC=03090000	Illegal Breakpoint	Illegal-breakpoint exception error	An instruction causing a breakpoint exception was executed.
5	EC=030f0000	Illegal Exception	Illegal exception	An undefined exception was reported.
6	EC=03380000	FP Unavailable	Floating-point unavailable	An attempt was made to execute an unavailable floating-point instruction during the execution of the built-in subroutine.
7	EC=03390000	FP System Down	Floating-point arithmetic error	An error was encountered during the execution of a floating-point arithmetic instruction.
8	EC=03400000	Instruction Page Fault	Instruction access page fault	An instruction in a page not listed in the page table was fetched.
9	EC=03420000	Invalid Inst. Access	Instruction access error	An attempt was made to access an undefined address space. (This instruction address error is one that is reported by a specific error code other than "03400000" and "03460000".)
10	EC=03460000	Inst. Access Protection	Instruction access protection error	Memory protection was violated by fetching an instruction.
11	EC=03600000	Data Page Fault	Data access page fault	Data in a page not listed in the page table was fetched.
12	EC=03620000	Invalid Data Access	Data access error	An attempt was made to access an undefined address space. (This data address error is one that is reported by a specific error code other than "03600000" and "03660000".)
13	EC=03660000	Data Access Protection	Data access protection error	Memory protection was violated by fetching data.

4 ERROR LOG INFORMATION

(11) System down -- built-in subroutine stoppage

This type of error is reported when a return value for a CPU stop request is returned from a built-in subroutine at the end of its execution.

The table below shows the general format of error messages for built-in subroutine stoppages and describes each format element.

Table 4-31 System Down (Built-in Subroutine Stoppage) Message Format

```
%CPMS-F-SOFT-000C  SITE=xxxxxxxxxxxxxxxx RC=xxxxxxxx yyyy/mm/dd hh:mm:ss LOG=xxx
EC=05140000 System down (ULSUB stop)
NEST =xxxxxxxx POINT=xxxxxxxx
RET  =xxxxxxxx RET0 =xxxxxxxx RET1 =xxxxxxxx RET2 =xxxxxxxx RET3 =xxxxxxxx
SUBFM=xxxxxxxx SUBSZ=xxxxxxxx SUBEC=xxxxxxxx
DAT0 =xxxxxxxx DAT1 =xxxxxxxx DAT2 =xxxxxxxx DAT3 =xxxxxxxx DAT4 =xxxxxxxx
DAT5 =xxxxxxxx DAT6 =xxxxxxxx DAT7 =xxxxxxxx DAT8 =xxxxxxxx DAT9 =xxxxxxxx
DAT10=xxxxxxxx DAT11=xxxxxxxx DAT12=xxxxxxxx DAT13=xxxxxxxx DAT14=xxxxxxxx
DAT15=xxxxxxxx DAT16=xxxxxxxx DAT17=xxxxxxxx DAT18=xxxxxxxx DAT19=xxxxxxxx
DAT20=xxxxxxxx DAT21=xxxxxxxx DAT22=xxxxxxxx DAT23=xxxxxxxx DAT24=xxxxxxxx
DAT25=xxxxxxxx DAT26=xxxxxxxx DAT27=xxxxxxxx DAT28=xxxxxxxx DAT29=xxxxxxxx
DAT30=xxxxxxxx DAT31=xxxxxxxx DAT32=xxxxxxxx DAT33=xxxxxxxx DAT34=xxxxxxxx
DAT35=xxxxxxxx DAT36=xxxxxxxx DAT37=xxxxxxxx DAT38=xxxxxxxx DAT39=xxxxxxxx
~
```

Item	Description
NEST	The number of calls made to the same built-in subroutine during its execution.
POINT	The point number of a point at which the built-in subroutine was integrated.
RET	Termination information for the built-in subroutine
RETn	Termination information for the entries numbered 0 through n in the built-in subroutine
SUBFM	The format type passed by argument to the built-in subroutine
SUBSZ	The number of data bytes passed by argument to the built-in subroutine
SUBEC	Sub Error Code, an error code which identifies the cause of a CPU stop that was detected in the built-in subroutine.
DATn	Data for the format type identified by SUBFM

(12) ADT error

This type of error is reported when a specified access (R/W) is made to an address (trap) set by the user using the debugger.

The table below shows the general format of error messages for ADT errors and describes each format element.

Table 4-32 ADT Error Message Format

```

%CPMS-I-SOFT-000d  SITE=xxxxxxxxxxxxxx RC=xxxxxxxx yyyy/mm/dd hh:mm:ss LOG=xxx
EC=05f00000 Program error (Address Detect Trap Error)
TN  =xxxxxxxx PC  =xxxxxxxx SR  =xxxxxxxx PR  =xxxxxxxx SP  =xxxxxxxx
GBR =xxxxxxxx MACH =xxxxxxxx MACL =xxxxxxxx
R0  =xxxxxxxx R1  =xxxxxxxx R2  =xxxxxxxx R3  =xxxxxxxx R4  =xxxxxxxx
R5  =xxxxxxxx R6  =xxxxxxxx R7  =xxxxxxxx R8  =xxxxxxxx R9  =xxxxxxxx
R10 =xxxxxxxx R11 =xxxxxxxx R12 =xxxxxxxx R13 =xxxxxxxx R14 =xxxxxxxx
R15 =xxxxxxxx FPSCR=xxxxxxxx FPUL =xxxxxxxx
FR0 =x.xxxxxxE+xxx FR1 =x.xxxxxxE+xxx FR2 =x.xxxxxxE+xxx FR3 =x.xxxxxxE+xxx
FR4 =x.xxxxxxE+xxx FR5 =x.xxxxxxE+xxx FR6 =x.xxxxxxE+xxx FR7 =x.xxxxxxE+xxx
FR8 =x.xxxxxxE+xxx FR9 =x.xxxxxxE+xxx FR10 =x.xxxxxxE+xxx FR11 =x.xxxxxxE+xxx
FR12 =x.xxxxxxE+xxx FR13 =x.xxxxxxE+xxx FR14 =x.xxxxxxE+xxx FR15 =x.xxxxxxE+xxx
XF0 =x.xxxxxxE+xxx XF1 =x.xxxxxxE+xxx XF2 =x.xxxxxxE+xxx XF3 =x.xxxxxxE+xxx
XF4 =x.xxxxxxE+xxx XF5 =x.xxxxxxE+xxx XF6 =x.xxxxxxE+xxx XF7 =x.xxxxxxE+xxx
XF8 =x.xxxxxxE+xxx XF9 =x.xxxxxxE+xxx XF10 =x.xxxxxxE+xxx XF11 =x.xxxxxxE+xxx
XF12 =x.xxxxxxE+xxx XF13 =x.xxxxxxE+xxx XF14 =x.xxxxxxE+xxx XF15 =x.xxxxxxE+xxx
DR0 =x.xxxxxxE+xxx DR2 =x.xxxxxxE+xxx DR4 =x.xxxxxxE+xxx DR6 =x.xxxxxxE+xxx
DR8 =x.xxxxxxE+xxx DR10 =x.xxxxxxE+xxx DR12 =x.xxxxxxE+xxx DR14 =x.xxxxxxE+xxx
XD0 =x.xxxxxxE+xxx XD2 =x.xxxxxxE+xxx XD4 =x.xxxxxxE+xxx XD6 =x.xxxxxxE+xxx
XD8 =x.xxxxxxE+xxx XD10 =x.xxxxxxE+xxx XD12 =x.xxxxxxE+xxx XD14 =x.xxxxxxE+xxx
BARA =xxxxxxxx BAMRA=xxxxxxxx BBRA =xxxxxxxx BASRA=xxxxxxxx
BARB =xxxxxxxx BAMRB=xxxxxxxx BBRB =xxxxxxxx BASRB=xxxxxxxx BRCR =xxxxxxxx
INST =xxxxxxxx xxxxxxxx xxxxxxxx xxxxxxxx xxxxxxxx xxxxxxxx xxxxxxxx xxxxxxxx
      xxxxxxxx (PC =) xxxxxxxx xxxxxxxx
PC  =xxxxxxxx(_____)
PR  =xxxxxxxx(_____)

```

4 ERROR LOG INFORMATION

Item	Description																
TN	The task number of the task in which the error occurred.																
PC	The content of the program counter.																
SR	The content of the status register.																
PR	The content of the procedure register, which is used in calling a subroutine and stores the return address to the calling routine.																
SP	The content of the stack pointer -- the register R15 is used as the stack pointer.																
GBR	The content of the global base register, which stores base addresses to be used in GBR-indirect addressing with displacement and in indexed GBR-indirect addressing.																
MACH	The content of the MAC register high, which saves the accumulated value of a MAC (Multiply and Accumulate) instruction or the result of a MAC or a MUL instruction. When the result of a MAC operation is a 64-bit value, this register contains the upper 32-bit value.																
MACL	The content of the MAC register low, which serves the same purpose as MACH. When the result of a MAC operation is a 64-bit value, this register contains the lower 32-bit value. When the result of a MAC operation is a 32-bit value, it contains the entire 32-bit value.																
Rxx	The content of the general register numbered xx.																
FPSCR	The content of the floating-point status/control register.																
FPUL	The content of the floating-point communication register, a register via which data transfer is done between general and floating-point registers.																
FRxx	The content of the 32-bit floating-point register numbered xx. When FPSCR.PR (19th bit of the bits 31 thru 0) = 0, these registers contain values of FPRxx_BANK0. When FPSCR.PR = 1, they contain values of FPRxx_BANK1.																
XFxx	The content of the 32-bit floating-point extension register numbered xx. When FPSCR.PR (19th bit of the bits 31 thru 0) = 0, these registers contain values of FPRxx_BANK1. When FPSCR.PR = 1, they contain values of FPRxx_BANK0.																
DRxx	The content of the 64-bit floating-point register numbered xx. When FPSCR.PR (19th bit of the bits 31 thru 0) = 0, these registers contain values of FPRxx_BANK0. When FPSCR.PR = 1, they contain values of FPRxx_BANK1.																
XDxx	The content of the 64-bit floating-point register numbered xx. When FPSCR.PR (19th bit of the bits 31 thru 0) = 0, these registers contain values of FPRxx_BANK1. When FPSCR.PR = 1, they contain values of FPRxx_BANK0.																
BARA	<div style="text-align: center;"> </div> <table border="1" style="width: 100%; border-collapse: collapse;"> <thead> <tr> <th>Bit no.</th> <th>Bit name</th> <th>Read-in value</th> <th>Meaning</th> </tr> </thead> <tbody> <tr> <td>0 to 31</td> <td>BARA</td> <td>Specified value</td> <td>Is the logical address used as a break condition for channel A.</td> </tr> </tbody> </table>	Bit no.	Bit name	Read-in value	Meaning	0 to 31	BARA	Specified value	Is the logical address used as a break condition for channel A.								
Bit no.	Bit name	Read-in value	Meaning														
0 to 31	BARA	Specified value	Is the logical address used as a break condition for channel A.														
BAMRA	<div style="text-align: center;"> </div> <table border="1" style="width: 100%; border-collapse: collapse;"> <thead> <tr> <th>Bit no.</th> <th>Bit name</th> <th>Read-in value</th> <th>Meaning</th> </tr> </thead> <tbody> <tr> <td>0 to 27</td> <td>—</td> <td>Always 0.</td> <td>—</td> </tr> <tr> <td>29</td> <td>BASMA</td> <td>0: Included. 1: Not included.</td> <td>Indicates whether or not all bits in BASRA are included in the break condition.</td> </tr> <tr> <td>28, 30, 31</td> <td>BAMA2, BAMA1, BAMA0</td> <td>Specified value</td> <td>Used in combination, specify the bits to be included in the break address (break condition) for channel A: 0, 0, 0: Do not mask in or out all the bits of BARA. 0, 0, 1: Mask in or out only the low-order 10 bits of BARA. 0, 1, 0: Mask in or out only the low-order 12 bits of BARA. 0, 1, 1: Mask in or out all the bits of BARA. 1, 0, 0: Mask in or out only the low-order 16 bits of BARA. 1, 0, 1: Mask in or out only the low-order 20 bits of BARA. 1, 1, 0: Reserved (may not be used). 1, 1, 1: Reserved (may not be used). </td> </tr> </tbody> </table>	Bit no.	Bit name	Read-in value	Meaning	0 to 27	—	Always 0.	—	29	BASMA	0: Included. 1: Not included.	Indicates whether or not all bits in BASRA are included in the break condition.	28, 30, 31	BAMA2, BAMA1, BAMA0	Specified value	Used in combination, specify the bits to be included in the break address (break condition) for channel A: 0, 0, 0: Do not mask in or out all the bits of BARA. 0, 0, 1: Mask in or out only the low-order 10 bits of BARA. 0, 1, 0: Mask in or out only the low-order 12 bits of BARA. 0, 1, 1: Mask in or out all the bits of BARA. 1, 0, 0: Mask in or out only the low-order 16 bits of BARA. 1, 0, 1: Mask in or out only the low-order 20 bits of BARA. 1, 1, 0: Reserved (may not be used). 1, 1, 1: Reserved (may not be used).
Bit no.	Bit name	Read-in value	Meaning														
0 to 27	—	Always 0.	—														
29	BASMA	0: Included. 1: Not included.	Indicates whether or not all bits in BASRA are included in the break condition.														
28, 30, 31	BAMA2, BAMA1, BAMA0	Specified value	Used in combination, specify the bits to be included in the break address (break condition) for channel A: 0, 0, 0: Do not mask in or out all the bits of BARA. 0, 0, 1: Mask in or out only the low-order 10 bits of BARA. 0, 1, 0: Mask in or out only the low-order 12 bits of BARA. 0, 1, 1: Mask in or out all the bits of BARA. 1, 0, 0: Mask in or out only the low-order 16 bits of BARA. 1, 0, 1: Mask in or out only the low-order 20 bits of BARA. 1, 1, 0: Reserved (may not be used). 1, 1, 1: Reserved (may not be used).														

Item	Description			
BBRA	<div style="display: flex; justify-content: space-between; align-items: center;"> 0 24 25 26 27 28 29 30 31 </div> <div style="border: 1px solid black; padding: 2px; display: flex; justify-content: space-between; align-items: center;"> 0 0 SZA2 IDA1 IDA0 RWA1 RWA0 SZA1 SZA0 </div>			
	Bit no.	Bit name	Read-in value	Meaning
	0 to 24	—	Always 0.	—
	25, 30, 31	SZA2, SZA1, SZA0	Specified value	Used in combination, specify an operand size for the bus cycle used as a break condition for channel A: 0, 0, 0: Do not use an operand size as part of the break condition. 0, 0, 1: Use byte access. 0, 1, 0: Use word access. 0, 1, 1: Use long-word access. 1, 0, 0: Use quad-word access. 1, 0, 1: Reserved (may not be used). 1, 1, 0: Reserved (may not be used). 1, 1, 1: Reserved (may not be used).
	26, 27	IDA1, IDA0	Specified value	Used in combination, choose the bus cycle (instruction/operand) to be used as a break condition for channel A: 0, 0: Do not compare bus cycles. 0, 1: Use instruction access cycle. 1, 0: Use operand access cycle. 1, 1: Use both the instruction and operand access cycles.
28, 29	RWA1, RWA0	Specified value	Used in combination, choose the bus cycle (read/write) to be used as a break condition for channel A: 0, 0: Do not compare bus cycles. 0, 1: Use read cycle. 1, 0: Use write cycle. 1, 1: Use both the read and write cycles.	
BASRA	<div style="display: flex; justify-content: space-between; align-items: center;"> 0 23 24 31 </div> <div style="border: 1px solid black; padding: 2px; display: flex; justify-content: space-between; align-items: center;"> 0 0 BASRA </div>			
	Bit no.	Bit name	Read-in value	Meaning
	0 to 23	—	Always 0.	—
24 to 31	BASRA	Specified value	Is the ASID used as a break condition for channel A.	
BARB	<div style="display: flex; justify-content: space-between; align-items: center;"> 0 31 </div> <div style="border: 1px solid black; padding: 2px; display: flex; justify-content: center; align-items: center;"> BARB </div>			
	Bit no.	Bit name	Read-in value	Meaning
0 to 31	BARB	Specified value	Is the logical address used as a break condition for channel B.	

4 ERROR LOG INFORMATION

Item	Description									
BAMRB	0	27	28	29	30	31				
	0	0		BAMB2	BASMB	BAMB1	BAMBO			
	Bit no.	Bit name	Read-in value	Meaning						
	0 to 27	—	Always 0.	—						
	29	BASMB	0: Included. 1: Not included.	Indicates whether or not all bits in BASRB are included in the break condition.						
28, 30, 31	BAMB2, BAMB1, BAMBO	Specified value	Used in combination, specify the bits to be included in the break address (break condition) for channel B: 0, 0, 0: Do not mask in or out all the bits of BARB. 0, 0, 1: Mask in or out only the low-order 10 bits of BARB. 0, 1, 0: Mask in or out only the low-order 12 bits of BARB. 0, 1, 1: Mask in or out all the bits of BARA. 1, 0, 0: Mask in or out only the low-order 16 bits of BARB. 1, 0, 1: Mask in or out only the low-order 20 bits of BARB. 1, 1, 0: Reserved (may not be used). 1, 1, 1: Reserved (may not be used).							
BBRB	0	24	25	26	27	28	29	30	31	
	0	0		SZB2	IDB1	IDB0	RWB1	RWB0	SZB1	SZB0
	Bit no.	Bit name	Read-in value	Meaning						
	0 to 24	—	Always 0.	—						
	25, 30, 31	SZB2, SZB1, SZB0	Specified value	Used in combination, specify an operand size for the bus cycle used as a break condition for channel B: 0, 0, 0: Do not use an operand size as part of the break condition. 0, 0, 1: Use byte access. 0, 1, 0: Use word access. 0, 1, 1: Use long-word access. 1, 0, 0: Use quad-word access. 1, 0, 1: Reserved (may not be used). 1, 1, 0: Reserved (may not be used). 1, 1, 1: Reserved (may not be used).						
26, 27	IDB1, IDB0	Specified value	Used in combination, choose the bus cycle (instruction/operand) to be used as a break condition for channel B: 0, 0: Do not compare bus cycles. 0, 1: Use instruction access cycle. 1, 0: Use operand access cycle. 1, 1: Use both the instruction and operand access cycles.							
28, 29	RWB1, RWB0	Specified value	Used in combination, choose the bus cycle (read/write) to be used as a break condition for channel B: 0, 0: Do not compare bus cycles. 0, 1: Use read cycle. 1, 0: Use write cycle. 1, 1: Use both the read and write cycles.							

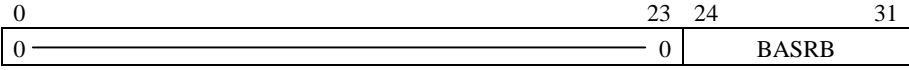
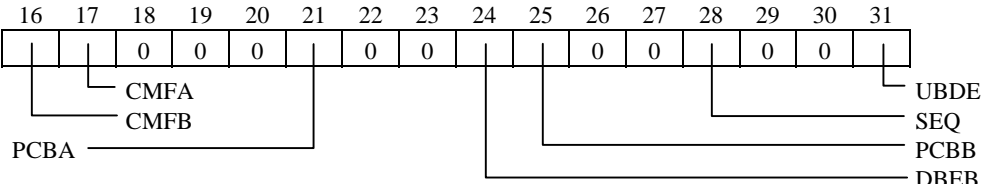
Item	Description																																																				
BASRB	<div style="text-align: center;">  </div> <table border="1" data-bbox="379 431 1369 560"> <thead> <tr> <th>Bit no.</th> <th>Bit name</th> <th>Read-in value</th> <th>Meaning</th> </tr> </thead> <tbody> <tr> <td>0 to 23</td> <td>—</td> <td>Always 0.</td> <td>—</td> </tr> <tr> <td>24 to 31</td> <td>BASRB</td> <td>Specified value</td> <td>Is the ASID used as a break condition for channel B.</td> </tr> </tbody> </table>	Bit no.	Bit name	Read-in value	Meaning	0 to 23	—	Always 0.	—	24 to 31	BASRB	Specified value	Is the ASID used as a break condition for channel B.																																								
Bit no.	Bit name	Read-in value	Meaning																																																		
0 to 23	—	Always 0.	—																																																		
24 to 31	BASRB	Specified value	Is the ASID used as a break condition for channel B.																																																		
	<div style="text-align: center;">  </div> <table border="1" data-bbox="379 873 1369 1692"> <thead> <tr> <th>Bit no.</th> <th>Bit name</th> <th>Read-in value</th> <th>Meaning</th> </tr> </thead> <tbody> <tr> <td>0 to 15</td> <td>—</td> <td>Always 0.</td> <td>—</td> </tr> <tr> <td>16</td> <td>CMFA</td> <td>0: False 1: True</td> <td>Indicates whether or not the break condition set for channel A was evaluated as true.</td> </tr> <tr> <td>17</td> <td>CMFB</td> <td>0: False 1: True</td> <td>Indicates whether or not the break condition set for channel B was evaluated as true.</td> </tr> <tr> <td>18 to 20</td> <td>—</td> <td>Always 0.</td> <td>—</td> </tr> <tr> <td>21</td> <td>PCBA</td> <td>0: Before instruction execution 1: After instruction execution</td> <td>Specifies the break timing in the instruction access cycle on channel A.</td> </tr> <tr> <td>22 to 23</td> <td>—</td> <td>Always 0.</td> <td>—</td> </tr> <tr> <td>24</td> <td>DBEB</td> <td>0: Include. 1: Do not include.</td> <td>Indicates whether to include the data bus condition among the break conditions for channel B.</td> </tr> <tr> <td>25</td> <td>PCBB</td> <td>0: Before instruction execution 1: After instruction execution</td> <td>Specifies the break timing in the instruction access cycle on channel B.</td> </tr> <tr> <td>26 to 27</td> <td>—</td> <td>Always 0.</td> <td>—</td> </tr> <tr> <td>28</td> <td>SEQ</td> <td>0: Choose on A and B independently. 1: Choose on A and B sequentially.</td> <td>Indicates whether to choose the break conditions for both channels A and B sequentially.</td> </tr> <tr> <td>29 to 30</td> <td>—</td> <td>Always 0.</td> <td>—</td> </tr> <tr> <td>31</td> <td>UBDE</td> <td>0: Do not use. 1: Use.</td> <td>Indicates whether to use a user break debugging facility.</td> </tr> </tbody> </table>	Bit no.	Bit name	Read-in value	Meaning	0 to 15	—	Always 0.	—	16	CMFA	0: False 1: True	Indicates whether or not the break condition set for channel A was evaluated as true.	17	CMFB	0: False 1: True	Indicates whether or not the break condition set for channel B was evaluated as true.	18 to 20	—	Always 0.	—	21	PCBA	0: Before instruction execution 1: After instruction execution	Specifies the break timing in the instruction access cycle on channel A.	22 to 23	—	Always 0.	—	24	DBEB	0: Include. 1: Do not include.	Indicates whether to include the data bus condition among the break conditions for channel B.	25	PCBB	0: Before instruction execution 1: After instruction execution	Specifies the break timing in the instruction access cycle on channel B.	26 to 27	—	Always 0.	—	28	SEQ	0: Choose on A and B independently. 1: Choose on A and B sequentially.	Indicates whether to choose the break conditions for both channels A and B sequentially.	29 to 30	—	Always 0.	—	31	UBDE	0: Do not use. 1: Use.	Indicates whether to use a user break debugging facility.
Bit no.	Bit name	Read-in value	Meaning																																																		
0 to 15	—	Always 0.	—																																																		
16	CMFA	0: False 1: True	Indicates whether or not the break condition set for channel A was evaluated as true.																																																		
17	CMFB	0: False 1: True	Indicates whether or not the break condition set for channel B was evaluated as true.																																																		
18 to 20	—	Always 0.	—																																																		
21	PCBA	0: Before instruction execution 1: After instruction execution	Specifies the break timing in the instruction access cycle on channel A.																																																		
22 to 23	—	Always 0.	—																																																		
24	DBEB	0: Include. 1: Do not include.	Indicates whether to include the data bus condition among the break conditions for channel B.																																																		
25	PCBB	0: Before instruction execution 1: After instruction execution	Specifies the break timing in the instruction access cycle on channel B.																																																		
26 to 27	—	Always 0.	—																																																		
28	SEQ	0: Choose on A and B independently. 1: Choose on A and B sequentially.	Indicates whether to choose the break conditions for both channels A and B sequentially.																																																		
29 to 30	—	Always 0.	—																																																		
31	UBDE	0: Do not use. 1: Use.	Indicates whether to use a user break debugging facility.																																																		
INST	Eight instructions before and after the address pointed to by the PC.																																																				
PC	The content of the program counter. Information on the address value contained in the program counter is presented, enclosed in parentheses. If the address value identifies a memory location in a program, the following information is presented: (name = program name type = program type [program component] raddr = relative address to the beginning of the program)																																																				
PR	The content of the procedure register. Information on the address value contained in the procedure register is presented, enclosed in parentheses. If the address value identifies a memory location in a program, the following information is presented: (name = program name type = program type [program component] raddr = relative address to the beginning of the program)																																																				

4 ERROR LOG INFORMATION

(13) Memory error

This type of error is reported when a serious error (2-bit error by memory ECC) is detected in relation to memory.

The table below shows the general format of error messages for memory-related serious errors and describes each format element.

Table 4-33 Memory Error Message Format

```
%CPMS-E-HARD-000e  SITE=xxxxxxxxxxxxxxxx RC=xxxxxxxx yyyy/mm/dd hh:mm:ss LOG=xxx
EC=03820000 Memory Error
TN  =xxxxxxxx PC   =xxxxxxxx EXPEV=xxxxxxxx SR   =xxxxxxxx
PR  =xxxxxxxx SP   =xxxxxxxx GBR  =xxxxxxxx MACH =xxxxxxxx MACL =xxxxxxxx
R0  =xxxxxxxx R1   =xxxxxxxx R2   =xxxxxxxx R3   =xxxxxxxx R4   =xxxxxxxx
R5  =xxxxxxxx R6   =xxxxxxxx R7   =xxxxxxxx R8   =xxxxxxxx R9   =xxxxxxxx
R10 =xxxxxxxx R11  =xxxxxxxx R12  =xxxxxxxx R13  =xxxxxxxx R14  =xxxxxxxx
R15 =xxxxxxxx FPSCR=xxxxxxxx FPUL  =xxxxxxxx
FR0 =x. xxxxxxE+xxx FR1  =x. xxxxxxE+xxx FR2  =x. xxxxxxE+xxx FR3  =x. xxxxxxE+xxx
FR4 =x. xxxxxxE+xxx FR5  =x. xxxxxxE+xxx FR6  =x. xxxxxxE+xxx FR7  =x. xxxxxxE+xxx
FR8 =x. xxxxxxE+xxx FR9  =x. xxxxxxE+xxx FR10 =x. xxxxxxE+xxx FR11 =x. xxxxxxE+xxx
FR12 =x. xxxxxxE+xxx FR13 =x. xxxxxxE+xxx FR14 =x. xxxxxxE+xxx FR15 =x. xxxxxxE+xxx
XF0 =x. xxxxxxE+xxx XF1  =x. xxxxxxE+xxx XF2  =x. xxxxxxE+xxx XF3  =x. xxxxxxE+xxx
XF4 =x. xxxxxxE+xxx XF5  =x. xxxxxxE+xxx XF6  =x. xxxxxxE+xxx XF7  =x. xxxxxxE+xxx
XF8 =x. xxxxxxE+xxx XF9  =x. xxxxxxE+xxx XF10 =x. xxxxxxE+xxx XF11 =x. xxxxxxE+xxx
XF12 =x. xxxxxxE+xxx XF13 =x. xxxxxxE+xxx XF14 =x. xxxxxxE+xxx XF15 =x. xxxxxxE+xxx
INST =xxxxxxxx xxxxxxxx xxxxxxxx xxxxxxxx xxxxxxxx xxxxxxxx xxxxxxxx xxxxxxxx
      xxxxxxxx (PC =) xxxxxxxx xxxxxxxx
HERST =xxxxxxxx MERRADR =xxxxxxxx MERRDAT =xxxxxxxx MSYNDR =xxxxxxxx
MHPMCLG =xxxxxxxx MLPMCLG =xxxxxxxx MECC =xxxxxxxx MSW2 =50000000
STATNP =xxxxxxxx STATCP =xxxxxxxx STATSLV =xxxxxxxx RERRLOG =xxxxxxxx
RERRADR =xxxxxxxx RERRDAT =xxxxxxxx RERRMST =xxxxxxxx RERRCMD =xxxxxxxx
MST_TYPE=xxxxxxxx MST_INFO=xxxxxxxx
PC  =xxxxxxxx (_____)
PR  =xxxxxxxx (_____)

```

Item	Description																												
TN	The task number of the task in which the error occurred.																												
PC	The content of the program counter.																												
EXPEV	The content of the exception code register.																												
SR	The content of the status register.																												
PR	The content of the procedure register, which is used in calling a subroutine and stores the return address to the calling routine.																												
SP	The content of the stack pointer -- the register R15 is used as the stack pointer.																												
GBR	The content of the global base register, which stores base addresses to be used in GBR-indirect addressing with displacement and in indexed GBR-indirect addressing.																												
MACH	The content of the MAC register high, which saves the accumulated value of a MAC (Multiply and Accumulate) instruction or the result of a MAC or a MUL instruction. When the result of a MAC operation is a 64-bit value, this register contains the upper 32-bit value.																												
MACL	The content of the MAC register low, which serves the same purpose as MACH. When the result of a MAC operation is a 64-bit value, this register contains the lower 32-bit value. When the result of a MAC operation is a 32-bit value, it contains the entire 32-bit value.																												
Rxx	The content of the general register numbered xx.																												
FPSCR	The content of the floating-point status/control register.																												
FPUL	The content of the floating-point communication register, a register via which data transfer is done between general and floating-point registers.																												
FRxx	The content of the 32-bit floating-point register numbered xx. When FPSCR.PR (19th bit of the bits 31 thru 0) = 0, these registers contain values of FPRxx_BANK0. When FPSCR.PR = 1, they contain values of FPRxx_BANK1.																												
XFxx	The content of the 32-bit floating-point extension register numbered xx. When FPSCR.PR (19th bit of the bits 31 thru 0) = 0, these registers contain values of FPRxx_BANK1. When FPSCR.PR = 1, they contain values of FPRxx_BANK0.																												
INST	Instruction code																												
HERST	<div style="text-align: center;"> <p>0 24 25 26 27 28 29 30 31</p> <p>0 0 </p> <p>N2P_HER ———— ————— MU_HER</p> <p>P2N_HER ———— ————— SU_HER</p> <p>Reserved ———— ————— EU_HER</p> <p>————— ————— BU_HER</p> </div> <table border="1" style="width: 100%; border-collapse: collapse;"> <thead> <tr> <th>Bit no.</th> <th>Bit name</th> <th>Read-in value</th> <th>Meaning</th> </tr> </thead> <tbody> <tr> <td>0 to 26</td> <td>—</td> <td>Always 0.</td> <td>—</td> </tr> <tr> <td>27</td> <td>Reserve</td> <td>Always 0.</td> <td>(Reserved for future extension)</td> </tr> <tr> <td>28</td> <td>BU_HER</td> <td>0: Generated. 1: Not generated.</td> <td>Indicates whether or not a serious-error interrupt was generated in relation to the PCI bus.</td> </tr> <tr> <td>29</td> <td>EU_HER</td> <td>0: Generated. 1: Not generated.</td> <td>Indicates whether or not a serious-error interrupt was generated in relation to the system bus.</td> </tr> <tr> <td>30</td> <td>SU_HER</td> <td>0: Generated. 1: Not generated.</td> <td>Indicates whether or not a serious-error interrupt was generated in relation to the system.</td> </tr> <tr> <td>31</td> <td>MU_HER</td> <td>0: Generated. 1: Not generated.</td> <td>Indicates whether or not a serious-error interrupt was generated in relation to the memory.</td> </tr> </tbody> </table>	Bit no.	Bit name	Read-in value	Meaning	0 to 26	—	Always 0.	—	27	Reserve	Always 0.	(Reserved for future extension)	28	BU_HER	0: Generated. 1: Not generated.	Indicates whether or not a serious-error interrupt was generated in relation to the PCI bus.	29	EU_HER	0: Generated. 1: Not generated.	Indicates whether or not a serious-error interrupt was generated in relation to the system bus.	30	SU_HER	0: Generated. 1: Not generated.	Indicates whether or not a serious-error interrupt was generated in relation to the system.	31	MU_HER	0: Generated. 1: Not generated.	Indicates whether or not a serious-error interrupt was generated in relation to the memory.
Bit no.	Bit name	Read-in value	Meaning																										
0 to 26	—	Always 0.	—																										
27	Reserve	Always 0.	(Reserved for future extension)																										
28	BU_HER	0: Generated. 1: Not generated.	Indicates whether or not a serious-error interrupt was generated in relation to the PCI bus.																										
29	EU_HER	0: Generated. 1: Not generated.	Indicates whether or not a serious-error interrupt was generated in relation to the system bus.																										
30	SU_HER	0: Generated. 1: Not generated.	Indicates whether or not a serious-error interrupt was generated in relation to the system.																										
31	MU_HER	0: Generated. 1: Not generated.	Indicates whether or not a serious-error interrupt was generated in relation to the memory.																										

4 ERROR LOG INFORMATION

Item	Description			
MERRADR	<div style="display: flex; justify-content: space-between; align-items: center;"> 0 3 4 29 30 31 </div> <div style="display: flex; align-items: center; margin-top: 5px;"> <div style="border: 1px solid black; padding: 2px; margin-right: 10px;">0 ——— 0</div> <div style="border: 1px solid black; padding: 2px; flex-grow: 1; text-align: center;">ERROR_ADR</div> <div style="border: 1px solid black; padding: 2px; margin-left: 10px; display: flex; flex-direction: column; align-items: center;"> <div style="display: flex; justify-content: space-around; width: 100%;"> 293031 </div> <div style="width: 100%; border-bottom: 1px solid black;"></div> </div> </div> <div style="margin-left: 150px; margin-top: 5px;">Reserve</div>			
	Bit no.	Bit name	Read-in value	Meaning
	0 to 3	—	Always 0.	—
	4 to 29	ERROR_ ADR	Specified value	Is the access address at which the memory-related serious error was detected.
30 to 31	—	Always 0.	—	
MERRDAT	<div style="display: flex; justify-content: space-between; align-items: center;"> 0 31 </div> <div style="border: 1px solid black; padding: 5px; text-align: center; margin-top: 5px;">ERROR_DAT</div>			
	Bit no.	Bit name	Read-in value	Meaning
	0 to 31	ERROR_ DAT	Specified value	Is the data piece that encountered the above-mentioned error.
MSYNDR	<div style="display: flex; justify-content: space-between; align-items: center;"> 0 24 25 31 </div> <div style="display: flex; align-items: center; margin-top: 5px;"> <div style="border: 1px solid black; padding: 2px; margin-right: 10px;">0 ——— 0</div> <div style="border: 1px solid black; padding: 2px; margin-left: 10px; display: flex; align-items: center;"> SYNDR </div> </div>			
	Bit no.	Bit name	Read-in value	Meaning
	0 to 24	—	Always 0.	—
	25 to 31	SYNDR	Specified value	Is the characteristic signs of the above-mentioned error.

Item	Description																																																																						
MHPMCLG																																																																							
	<table border="1"> <thead> <tr> <th>Bit no.</th> <th>Bit name</th> <th>Read-in value</th> <th>Meaning</th> </tr> </thead> <tbody> <tr> <td>0 to 10</td> <td>—</td> <td>Always 0.</td> <td>—</td> </tr> <tr> <td>11</td> <td>BU_ERROR</td> <td>0: Not any I/O. 1: I/O.</td> <td>Indicates whether or not the access source that encountered the memory-related serious error was an I/O device under the PCI bus.</td> </tr> <tr> <td>12</td> <td>MU_ERROR</td> <td>Always 0.</td> <td>(Reserved for functional enhancement)</td> </tr> <tr> <td>13</td> <td>—</td> <td>Always 0.</td> <td>—</td> </tr> <tr> <td>14</td> <td>NU_ERROR</td> <td>0: Not CMU. 1: CMU.</td> <td>Indicates whether or not the access source that encountered the above-mentioned error was the CMU.</td> </tr> <tr> <td>15</td> <td>BRST_ACS</td> <td>0: Not burst. 1: Burst.</td> <td>Indicates whether or not the access that encountered the above-mentioned error was a burst access.</td> </tr> <tr> <td>16</td> <td>MLT_LG</td> <td>0: Not a log. 1: A log.</td> <td>Indicates whether or not the content of this register is a log of a multiple serious error.</td> </tr> <tr> <td>17 to 20</td> <td>—</td> <td>Always 0.</td> <td>—</td> </tr> <tr> <td>21</td> <td>CLK_CHK_LG</td> <td>Always 0.</td> <td>(Reserved for functional enhancement)</td> </tr> <tr> <td>22</td> <td>HPMC_CHK_LG</td> <td>Always 0.</td> <td>(Reserved for functional enhancement)</td> </tr> <tr> <td>23</td> <td>ECC_2BIT_LG</td> <td>0: Not a log. 1: A log.</td> <td>Indicates whether or not the content of this register is a log of a 2-bit ECC error.</td> </tr> <tr> <td>24</td> <td>MLT</td> <td>0: Did not occur. 1: Occurred.</td> <td>Indicates whether or not multiple unserious errors of the same type occurred.</td> </tr> <tr> <td>25 to 28</td> <td>—</td> <td>Always 0.</td> <td>—</td> </tr> <tr> <td>29</td> <td>CLK_CHK</td> <td>Always 0.</td> <td>(Reserved for functional enhancement)</td> </tr> <tr> <td>30</td> <td>HPMC_CHK</td> <td>Always 0.</td> <td>(Reserved for functional enhancement)</td> </tr> <tr> <td>31</td> <td>ECC_2BIT</td> <td>0: Did not occur. 1: Occurred.</td> <td>Indicates whether or not an 2-bit ECC error occurred.</td> </tr> </tbody> </table>				Bit no.	Bit name	Read-in value	Meaning	0 to 10	—	Always 0.	—	11	BU_ERROR	0: Not any I/O. 1: I/O.	Indicates whether or not the access source that encountered the memory-related serious error was an I/O device under the PCI bus.	12	MU_ERROR	Always 0.	(Reserved for functional enhancement)	13	—	Always 0.	—	14	NU_ERROR	0: Not CMU. 1: CMU.	Indicates whether or not the access source that encountered the above-mentioned error was the CMU.	15	BRST_ACS	0: Not burst. 1: Burst.	Indicates whether or not the access that encountered the above-mentioned error was a burst access.	16	MLT_LG	0: Not a log. 1: A log.	Indicates whether or not the content of this register is a log of a multiple serious error.	17 to 20	—	Always 0.	—	21	CLK_CHK_LG	Always 0.	(Reserved for functional enhancement)	22	HPMC_CHK_LG	Always 0.	(Reserved for functional enhancement)	23	ECC_2BIT_LG	0: Not a log. 1: A log.	Indicates whether or not the content of this register is a log of a 2-bit ECC error.	24	MLT	0: Did not occur. 1: Occurred.	Indicates whether or not multiple unserious errors of the same type occurred.	25 to 28	—	Always 0.	—	29	CLK_CHK	Always 0.	(Reserved for functional enhancement)	30	HPMC_CHK	Always 0.	(Reserved for functional enhancement)	31	ECC_2BIT	0: Did not occur. 1: Occurred.
Bit no.	Bit name	Read-in value	Meaning																																																																				
0 to 10	—	Always 0.	—																																																																				
11	BU_ERROR	0: Not any I/O. 1: I/O.	Indicates whether or not the access source that encountered the memory-related serious error was an I/O device under the PCI bus.																																																																				
12	MU_ERROR	Always 0.	(Reserved for functional enhancement)																																																																				
13	—	Always 0.	—																																																																				
14	NU_ERROR	0: Not CMU. 1: CMU.	Indicates whether or not the access source that encountered the above-mentioned error was the CMU.																																																																				
15	BRST_ACS	0: Not burst. 1: Burst.	Indicates whether or not the access that encountered the above-mentioned error was a burst access.																																																																				
16	MLT_LG	0: Not a log. 1: A log.	Indicates whether or not the content of this register is a log of a multiple serious error.																																																																				
17 to 20	—	Always 0.	—																																																																				
21	CLK_CHK_LG	Always 0.	(Reserved for functional enhancement)																																																																				
22	HPMC_CHK_LG	Always 0.	(Reserved for functional enhancement)																																																																				
23	ECC_2BIT_LG	0: Not a log. 1: A log.	Indicates whether or not the content of this register is a log of a 2-bit ECC error.																																																																				
24	MLT	0: Did not occur. 1: Occurred.	Indicates whether or not multiple unserious errors of the same type occurred.																																																																				
25 to 28	—	Always 0.	—																																																																				
29	CLK_CHK	Always 0.	(Reserved for functional enhancement)																																																																				
30	HPMC_CHK	Always 0.	(Reserved for functional enhancement)																																																																				
31	ECC_2BIT	0: Did not occur. 1: Occurred.	Indicates whether or not an 2-bit ECC error occurred.																																																																				

4 ERROR LOG INFORMATION

Item	Description																																																														
MLPMCLG																																																															
	<table border="1"> <thead> <tr> <th>Bit no.</th> <th>Bit name</th> <th>Read-in value</th> <th>Meaning</th> </tr> </thead> <tbody> <tr> <td>0 to 10</td> <td>Reserve</td> <td>Always 0.</td> <td>—</td> </tr> <tr> <td>11</td> <td>BU_ERROR</td> <td>0: Not any I/O. 1: I/O.</td> <td>Indicates whether or not the access source that encountered the memory-related unserious error was an I/O device under the PCI bus.</td> </tr> <tr> <td>12</td> <td>MU_ERROR</td> <td>Always 0.</td> <td>(Reserved for functional enhancement)</td> </tr> <tr> <td>13</td> <td>Reserve</td> <td>Always 0.</td> <td>—</td> </tr> <tr> <td>14</td> <td>PU_ERROR</td> <td>0: Not CMU. 1: CMU.</td> <td>Indicates whether or not the access source that encountered the above-mentioned error was the CMU.</td> </tr> <tr> <td>15</td> <td>BRST_ACS</td> <td>0: Not burst. 1: Burst.</td> <td>Indicates whether or not the access that encountered the above-mentioned error was a burst access.</td> </tr> <tr> <td>16</td> <td>MLT_LG</td> <td>0: Not a log. 1: A log.</td> <td>Indicates whether or not the content of this register is a log of a multiple unserious error.</td> </tr> <tr> <td>17</td> <td>Reserve</td> <td>Always 0.</td> <td>—</td> </tr> <tr> <td>18</td> <td>RCNFG_LG</td> <td>Always 0.</td> <td>(Reserved for functional enhancement)</td> </tr> <tr> <td>19</td> <td>CPY_PE_LG</td> <td>Always 0.</td> <td>(Reserved for functional enhancement)</td> </tr> <tr> <td>20</td> <td>Reserve</td> <td>Always 0.</td> <td>—</td> </tr> <tr> <td>21</td> <td>CPU_WR_ERR_LG</td> <td>0: Not a log. 1: A log.</td> <td>Indicates whether or not the content of this register is a log of an attempt of illegal write by the CMU to protected memory area.</td> </tr> <tr> <td>22</td> <td>WR_ECC2_LG</td> <td>0: Not a log. 1: A log.</td> <td>Indicates whether or not the content of this register is a log of a 2-bit ECC error in write of two data bytes or less.</td> </tr> <tr> <td>23</td> <td>ECC_1BIT_LG</td> <td>0: Not a log. 1: A log.</td> <td>Indicates whether or not the content of this register is a log of a 1-bit ECC error.</td> </tr> </tbody> </table>				Bit no.	Bit name	Read-in value	Meaning	0 to 10	Reserve	Always 0.	—	11	BU_ERROR	0: Not any I/O. 1: I/O.	Indicates whether or not the access source that encountered the memory-related unserious error was an I/O device under the PCI bus.	12	MU_ERROR	Always 0.	(Reserved for functional enhancement)	13	Reserve	Always 0.	—	14	PU_ERROR	0: Not CMU. 1: CMU.	Indicates whether or not the access source that encountered the above-mentioned error was the CMU.	15	BRST_ACS	0: Not burst. 1: Burst.	Indicates whether or not the access that encountered the above-mentioned error was a burst access.	16	MLT_LG	0: Not a log. 1: A log.	Indicates whether or not the content of this register is a log of a multiple unserious error.	17	Reserve	Always 0.	—	18	RCNFG_LG	Always 0.	(Reserved for functional enhancement)	19	CPY_PE_LG	Always 0.	(Reserved for functional enhancement)	20	Reserve	Always 0.	—	21	CPU_WR_ERR_LG	0: Not a log. 1: A log.	Indicates whether or not the content of this register is a log of an attempt of illegal write by the CMU to protected memory area.	22	WR_ECC2_LG	0: Not a log. 1: A log.	Indicates whether or not the content of this register is a log of a 2-bit ECC error in write of two data bytes or less.	23	ECC_1BIT_LG	0: Not a log. 1: A log.
Bit no.	Bit name	Read-in value	Meaning																																																												
0 to 10	Reserve	Always 0.	—																																																												
11	BU_ERROR	0: Not any I/O. 1: I/O.	Indicates whether or not the access source that encountered the memory-related unserious error was an I/O device under the PCI bus.																																																												
12	MU_ERROR	Always 0.	(Reserved for functional enhancement)																																																												
13	Reserve	Always 0.	—																																																												
14	PU_ERROR	0: Not CMU. 1: CMU.	Indicates whether or not the access source that encountered the above-mentioned error was the CMU.																																																												
15	BRST_ACS	0: Not burst. 1: Burst.	Indicates whether or not the access that encountered the above-mentioned error was a burst access.																																																												
16	MLT_LG	0: Not a log. 1: A log.	Indicates whether or not the content of this register is a log of a multiple unserious error.																																																												
17	Reserve	Always 0.	—																																																												
18	RCNFG_LG	Always 0.	(Reserved for functional enhancement)																																																												
19	CPY_PE_LG	Always 0.	(Reserved for functional enhancement)																																																												
20	Reserve	Always 0.	—																																																												
21	CPU_WR_ERR_LG	0: Not a log. 1: A log.	Indicates whether or not the content of this register is a log of an attempt of illegal write by the CMU to protected memory area.																																																												
22	WR_ECC2_LG	0: Not a log. 1: A log.	Indicates whether or not the content of this register is a log of a 2-bit ECC error in write of two data bytes or less.																																																												
23	ECC_1BIT_LG	0: Not a log. 1: A log.	Indicates whether or not the content of this register is a log of a 1-bit ECC error.																																																												

Item	Description			
MLPMCLG (continued from preceding page)	Bit no.	Bit name	Read-in value	Meaning
	24	MLT	0: Did not occur. 1: Occurred.	Indicates whether or not multiple unserious errors of the same type occurred.
	25	Reserve	Always 0.	—
	26	RCNFG	Always 0.	(Reserved for functional enhancement)
	27	SRAM_WERR	0: Request not issued. 1: Write failed.	Indicates whether or not a write failed due to an SRAM byte write request issued in SRAM ECC mode.
	28	Reserve	Always 0.	—
	29	CPU_WR_ERR	0: Not made. 1: Made.	Indicates whether or not an attempt of illegal write to protected memory area was made.
	30	WR_BYT_ECC	0: Not made. 1: Made.	Indicates whether or not a 2-bit ECC error occurred in a write of two data bytes or less.
31	ECC_1BIT	0: Not made. 1: Made.	Indicates whether or not a 1-bit ECC error occurred.	
MECC				
	Bit no.	Bit name	Read-in value	Meaning
	0 to 24	—	Always 0.	—
2 to 31	ECC	Specified value	Is the ECC that was in use at the occurrence of a memory-related serious error.	

4 ERROR LOG INFORMATION

Item	Description																																																
MSW2																																																	
	0	1	2	3	4	5	6	7	8	9	10	11	12	13	14	15	16	17	18	19	20	21	22	23	24	25	26	27	28	29	30	31																	
	VAL	VBC	IVRT	MEME	HWDT	SWDT	RAMS	ROMS										RAPE	AAPE	RDPE	ADPE	ATE	TTE	BBTE	MSAW									Reserve	Reserve	Reserve	Reserve	Reserve	OSCLR	CLKSTP	EXE	Reserve	Reserve	Reserve	BRTOE	AERTR	RERTR	WPAW	UDTW
	Bit no.	Bit name	Read-in value	Meaning																																													
	0	VAL	0: Not significant. 1: Significant.	Indicates whether or not the content of this register is significant.																																													
	1	IVBC	0: Battery normal. 1: Battery abnormal.	Indicates whether or not a “battery voltage low” or “battery capacity low” condition was detected, or whether or not a battery is installed.																																													
	2	IVRT	0: Succeeded. 1: Failed.	Indicates whether or not data retention at a power outage succeeded.																																													
	3	MEME	0: Did not occur. 1: Occurred.	Indicates whether or not an unrecoverable error occurred during access to the internal memory.																																													
	4	HWDT	0: Did not occur. 1: Occurred.	Indicates whether or not a hardware WDT timeout error occurred. (For the CPU, this type of error is included in the category of EXE errors.)																																													
	5	SWDT	0: Did not occur. 1: Occurred.	Indicates whether or not a software WDT timeout error occurred.																																													
	6	RAMS	0: Did not occur. 1: Occurred.	Indicates whether or not a RAM checksum error occurred.																																													
	7	ROMS	0: Did not occur. 1: Occurred.	Indicates whether or not a ROM checksum error occurred.																																													
	8	EXE	0: Did not occur. 1: Occurred.	Indicates whether or not a hardware error occurred.																																													
	9	CLKSTP	0: Did not stop. 1: Stopped.	Indicates whether or not the clock stopped. (For the CPU, this type of error is included in the category of EXE errors.)																																													
	10	OSCLR	0: Was not cleared. 1: Cleared.	Indicates whether or not the OS was cleared.																																													

Item	Description			
MSW2 (continued from preceding page)	Bit no.	Bit name	Read-in value	Meaning
	11 to 15	Reserve	Always 0.	—
	16	RAPE	0: Error not detected. 1: Error detected.	Indicates whether or not a received-address parity error was detected (when the CMU was master).
	17	AAPE	0: Error not detected. 1: Error detected.	Indicates whether or not an asserted-address parity error was detected (when the CMU was target).
	18	RDPE	0: Error not detected. 1: Error detected.	Indicates whether or not a received-data parity error was detected (during master write or target read).
	19	ADPE	0: Error not detected. 1: Error detected.	Indicates whether or not an asserted-data parity error was detected (during master write or target read).
	20	ATE	0: Error not detected. 1: Error detected.	Indicates whether or not an address-cycle timeout error was detected. (Applicable only to the master.)
	21	TTE	0: Error not detected. 1: Error detected.	Indicates whether or not a transaction timeout error was detected. (Applicable only to the master.)
	22	BBTE	0: Error not detected. 1: Error detected.	Indicates whether or not a “BGACK busy” timeout error was detected. (Applicable only to the CPU.)
	23	MSAW	0: Error not detected. 1: Error detected.	Indicates whether or not a misalignment-access error was detected.
	24	UDTW	0: Error not detected. 1: Error detected.	Indicates whether or not an unsupported-transaction error was detected.
	25	WPAW	0: Error not detected. 1: Error detected.	Indicates whether or not a write-protected area write error was detected.
	26	RERTR	0: Error not detected. 1: Error detected.	Indicates whether or not a received error transaction was detected. (Applicable only to the master.)
	27	AERTR	0: Error not detected. 1: Error detected.	Indicates whether or not an asserted error transaction was detected.
	28	BRTOE	0: Error not detected. 1: Error detected.	Indicates whether or not a bus request timeout was generated. (Applicable only to the master.)
29 to 31	Reserve	Always 0.	—	

4 ERROR LOG INFORMATION

Item	Description																																				
STATNP	Unused																																				
STATCP	<div style="text-align: center;"> </div> <table border="1" style="margin-top: 10px;"> <thead> <tr> <th>Bit no.</th> <th>Bit name</th> <th>Read-in value</th> <th>Meaning</th> </tr> </thead> <tbody> <tr> <td>0 to 24</td> <td>—</td> <td>Always 0.</td> <td>—</td> </tr> <tr> <td>25</td> <td>MWDPE</td> <td>0: Not received. 1: Received.</td> <td>Indicates whether or not, when the CMU was bus master, a write-data parity error was detected and an error notification was received from the target.</td> </tr> <tr> <td>26</td> <td>RTA</td> <td>0: Not received. 1: Received.</td> <td>Indicates whether or not, when the CMU was bus master, an error transaction was received (and the bus operation was ended).</td> </tr> <tr> <td>27</td> <td>TRNSTO</td> <td>0: Not received. 1: Received.</td> <td>Indicates whether or not, when the CMU was bus master, a transaction timeout was received (and the bus operation was ended).</td> </tr> <tr> <td>28</td> <td>MAPE</td> <td>0: Not received. 1: Received.</td> <td>Indicates whether or not, when the CMU was bus master, an address parity error was received.</td> </tr> <tr> <td>29</td> <td>MRDPE</td> <td>0: Not received. 1: Received.</td> <td>Indicates whether or not, when the CMU was bus master, a read-data parity error was detected and an error notification was received from the target.</td> </tr> <tr> <td>30</td> <td>MA</td> <td>0: Not received. 1: Received.</td> <td>Indicates whether or not, when the CMU was bus master, an address-cycle timeout was received (and the bus operation was ended).</td> </tr> <tr> <td>31</td> <td>BRQTO</td> <td>0: Not received. 1: Received.</td> <td>Indicates whether or not, when the CMU was bus master, a bus-request timeout was received (and the bus operation was ended).</td> </tr> </tbody> </table>	Bit no.	Bit name	Read-in value	Meaning	0 to 24	—	Always 0.	—	25	MWDPE	0: Not received. 1: Received.	Indicates whether or not, when the CMU was bus master, a write-data parity error was detected and an error notification was received from the target.	26	RTA	0: Not received. 1: Received.	Indicates whether or not, when the CMU was bus master, an error transaction was received (and the bus operation was ended).	27	TRNSTO	0: Not received. 1: Received.	Indicates whether or not, when the CMU was bus master, a transaction timeout was received (and the bus operation was ended).	28	MAPE	0: Not received. 1: Received.	Indicates whether or not, when the CMU was bus master, an address parity error was received.	29	MRDPE	0: Not received. 1: Received.	Indicates whether or not, when the CMU was bus master, a read-data parity error was detected and an error notification was received from the target.	30	MA	0: Not received. 1: Received.	Indicates whether or not, when the CMU was bus master, an address-cycle timeout was received (and the bus operation was ended).	31	BRQTO	0: Not received. 1: Received.	Indicates whether or not, when the CMU was bus master, a bus-request timeout was received (and the bus operation was ended).
Bit no.	Bit name	Read-in value	Meaning																																		
0 to 24	—	Always 0.	—																																		
25	MWDPE	0: Not received. 1: Received.	Indicates whether or not, when the CMU was bus master, a write-data parity error was detected and an error notification was received from the target.																																		
26	RTA	0: Not received. 1: Received.	Indicates whether or not, when the CMU was bus master, an error transaction was received (and the bus operation was ended).																																		
27	TRNSTO	0: Not received. 1: Received.	Indicates whether or not, when the CMU was bus master, a transaction timeout was received (and the bus operation was ended).																																		
28	MAPE	0: Not received. 1: Received.	Indicates whether or not, when the CMU was bus master, an address parity error was received.																																		
29	MRDPE	0: Not received. 1: Received.	Indicates whether or not, when the CMU was bus master, a read-data parity error was detected and an error notification was received from the target.																																		
30	MA	0: Not received. 1: Received.	Indicates whether or not, when the CMU was bus master, an address-cycle timeout was received (and the bus operation was ended).																																		
31	BRQTO	0: Not received. 1: Received.	Indicates whether or not, when the CMU was bus master, a bus-request timeout was received (and the bus operation was ended).																																		

Item	Description			
STATSLV				
	Bit no.	Bit name	Read-in value	Meaning
	0 to 20	—	Always 0.	—
	21	MAAE	0: Not detected. 1: Detected	Indicates whether or not, when the target was in operation, an illegal byte-enable was detected in a write.
	22	PIOME	0: Not detected. 1: Detected	Indicates whether or not, when the PIO master was in operation, a 2-bit ECC error was detected in memory.
	23	Reserve	Always 0.	—
	24	ACKBUSYTO	0: Not detected. 1: Detected	Indicates whether or not a “BGACK busy” timeout was detected.
	25	RSERR	0: Not received. 1: Received.	Indicates whether or not an SERROR signal was received.
	26	INVCMD	0: Not detected. 1: Detected	Indicates whether or not, when the target was in operation, an illegal command was detected.
	27	STA	0: Not sent out. 1: Sent out.	Indicates whether or not, when the target was in operation, an error transaction was sent out.
	28	TAPE	0: Not detected. 1: Detected	Indicates whether or not an address parity error was detected.
	29	TDPE	0: Not detected. 1: Detected	Indicates whether or not, when the target was in operation, a write-data parity error was detected.
30	ME	0: Not detected. 1: Detected	Indicates whether or not, when the target was in operation handling a high-speed bus/S10 bus read, a 2-bit ECC error was detected in memory.	
31	NODTACK	0: Not detected. 1: Detected	Indicates whether or not, after the start of the S10 bus, a timeout due to no DTACK output was detected.	

4 ERROR LOG INFORMATION

Item	Description																																																												
RERRLOG																																																													
	<table border="1"> <thead> <tr> <th>Bit no.</th> <th>Bit name</th> <th>Read-in value</th> <th>Meaning</th> </tr> </thead> <tbody> <tr> <td>0 to 12</td> <td>Reserve</td> <td>Always 0.</td> <td>—</td> </tr> <tr> <td>13</td> <td>MAAE</td> <td>0: Not detected. 1: Detected</td> <td>Indicates whether or not, when the target was in operation, an illegal byte-enable was detected in a write.</td> </tr> <tr> <td>14</td> <td>Reserve</td> <td>Always 0.</td> <td>—</td> </tr> <tr> <td>15</td> <td>NOACK TO</td> <td>0: Not detected. 1: Detected</td> <td>Indicates whether or not a timeout due to no BGACK output within fixed time period was detected.</td> </tr> <tr> <td>16</td> <td>ACK BUSYTO</td> <td>0: Not detected. 1: Detected</td> <td>Indicates whether or not a timeout due to an endless BGACK output was detected.</td> </tr> <tr> <td>17</td> <td>RSERR</td> <td>0: Not received. 1: Received.</td> <td>Indicates whether or not an SERROR signal was received.</td> </tr> <tr> <td>18</td> <td>INVCMD</td> <td>0: Not detected. 1: Detected</td> <td>Indicates whether or not, when the target was in operation, an illegal command was detected.</td> </tr> <tr> <td>19</td> <td>STA</td> <td>0: Not sent out. 1: Sent out.</td> <td>Indicates whether or not, when the target was in operation, an error transaction was sent out.</td> </tr> <tr> <td>20</td> <td>TAPE</td> <td>0: Not detected. 1: Detected</td> <td>Indicates whether or not, when the target was in operation, an address parity error was detected.</td> </tr> <tr> <td>21</td> <td>TDPE</td> <td>0: Not detected. 1: Detected</td> <td>Indicates whether or not, when the target was in operation, a data parity error was detected.</td> </tr> <tr> <td>22</td> <td>ME</td> <td>0: Not detected. 1: Detected</td> <td>Indicates whether or not, when the target was in operation handling a high-speed bus/S10 bus read, a 2-bit ECC error was detected in memory.</td> </tr> <tr> <td>23</td> <td>NODT ACK</td> <td>Always 0.</td> <td>—</td> </tr> <tr> <td>24</td> <td>Reserve</td> <td>Always 0.</td> <td>—</td> </tr> <tr> <td>25</td> <td>MWDPE</td> <td>0: Not received. 1: Received.</td> <td>Indicates whether or not, when the CMU was bus master, a write-data parity error notification was received from the target.</td> </tr> </tbody> </table>		Bit no.	Bit name	Read-in value	Meaning	0 to 12	Reserve	Always 0.	—	13	MAAE	0: Not detected. 1: Detected	Indicates whether or not, when the target was in operation, an illegal byte-enable was detected in a write.	14	Reserve	Always 0.	—	15	NOACK TO	0: Not detected. 1: Detected	Indicates whether or not a timeout due to no BGACK output within fixed time period was detected.	16	ACK BUSYTO	0: Not detected. 1: Detected	Indicates whether or not a timeout due to an endless BGACK output was detected.	17	RSERR	0: Not received. 1: Received.	Indicates whether or not an SERROR signal was received.	18	INVCMD	0: Not detected. 1: Detected	Indicates whether or not, when the target was in operation, an illegal command was detected.	19	STA	0: Not sent out. 1: Sent out.	Indicates whether or not, when the target was in operation, an error transaction was sent out.	20	TAPE	0: Not detected. 1: Detected	Indicates whether or not, when the target was in operation, an address parity error was detected.	21	TDPE	0: Not detected. 1: Detected	Indicates whether or not, when the target was in operation, a data parity error was detected.	22	ME	0: Not detected. 1: Detected	Indicates whether or not, when the target was in operation handling a high-speed bus/S10 bus read, a 2-bit ECC error was detected in memory.	23	NODT ACK	Always 0.	—	24	Reserve	Always 0.	—	25	MWDPE	0: Not received. 1: Received.
Bit no.	Bit name	Read-in value	Meaning																																																										
0 to 12	Reserve	Always 0.	—																																																										
13	MAAE	0: Not detected. 1: Detected	Indicates whether or not, when the target was in operation, an illegal byte-enable was detected in a write.																																																										
14	Reserve	Always 0.	—																																																										
15	NOACK TO	0: Not detected. 1: Detected	Indicates whether or not a timeout due to no BGACK output within fixed time period was detected.																																																										
16	ACK BUSYTO	0: Not detected. 1: Detected	Indicates whether or not a timeout due to an endless BGACK output was detected.																																																										
17	RSERR	0: Not received. 1: Received.	Indicates whether or not an SERROR signal was received.																																																										
18	INVCMD	0: Not detected. 1: Detected	Indicates whether or not, when the target was in operation, an illegal command was detected.																																																										
19	STA	0: Not sent out. 1: Sent out.	Indicates whether or not, when the target was in operation, an error transaction was sent out.																																																										
20	TAPE	0: Not detected. 1: Detected	Indicates whether or not, when the target was in operation, an address parity error was detected.																																																										
21	TDPE	0: Not detected. 1: Detected	Indicates whether or not, when the target was in operation, a data parity error was detected.																																																										
22	ME	0: Not detected. 1: Detected	Indicates whether or not, when the target was in operation handling a high-speed bus/S10 bus read, a 2-bit ECC error was detected in memory.																																																										
23	NODT ACK	Always 0.	—																																																										
24	Reserve	Always 0.	—																																																										
25	MWDPE	0: Not received. 1: Received.	Indicates whether or not, when the CMU was bus master, a write-data parity error notification was received from the target.																																																										

Item	Description																															
RERRLOG (continued from preceding page)	<table border="1" data-bbox="424 383 1417 1289"> <thead> <tr> <th data-bbox="424 383 544 426">Bit no.</th> <th data-bbox="549 383 699 426">Bit name</th> <th data-bbox="703 383 946 426">Read-in value</th> <th data-bbox="951 383 1417 426">Meaning</th> </tr> </thead> <tbody> <tr> <td data-bbox="424 426 544 584">26</td> <td data-bbox="549 426 699 584">RTA</td> <td data-bbox="703 426 946 584">0: Not received. 1: Received.</td> <td data-bbox="951 426 1417 584">Indicates whether or not, when the CMU was bus master, an error transaction was received (and the bus operation was ended).</td> </tr> <tr> <td data-bbox="424 584 544 741">27</td> <td data-bbox="549 584 699 741">TRNSTO</td> <td data-bbox="703 584 946 741">0: Not detected. 1: Detected.</td> <td data-bbox="951 584 1417 741">Indicates whether or not, when the CMU was bus master, a transaction timeout was detected (and the bus operation was ended).</td> </tr> <tr> <td data-bbox="424 741 544 858">28</td> <td data-bbox="549 741 699 858">MAPE</td> <td data-bbox="703 741 946 858">0: Not received. 1: Received.</td> <td data-bbox="951 741 1417 858">Indicates whether or not, when the CMU was bus master, an address parity error notification was received.</td> </tr> <tr> <td data-bbox="424 858 544 974">29</td> <td data-bbox="549 858 699 974">MRDPE</td> <td data-bbox="703 858 946 974">0: Not detected. 1: Detected.</td> <td data-bbox="951 858 1417 974">Indicates whether or not, when the CMU was bus master, a read-data parity error was detected.</td> </tr> <tr> <td data-bbox="424 974 544 1131">30</td> <td data-bbox="549 974 699 1131">MA</td> <td data-bbox="703 974 946 1131">0: Not detected. 1: Detected.</td> <td data-bbox="951 974 1417 1131">Indicates whether or not, when the CMU was bus master, an address-cycle timeout was detected (and the bus operation was ended).</td> </tr> <tr> <td data-bbox="424 1131 544 1289">31</td> <td data-bbox="549 1131 699 1289">BRQTO</td> <td data-bbox="703 1131 946 1289">0: Not detected. 1: Detected.</td> <td data-bbox="951 1131 1417 1289">Indicates whether or not, when the CMU was bus master, a bus-request timeout was detected (and the bus operation was ended).</td> </tr> </tbody> </table>				Bit no.	Bit name	Read-in value	Meaning	26	RTA	0: Not received. 1: Received.	Indicates whether or not, when the CMU was bus master, an error transaction was received (and the bus operation was ended).	27	TRNSTO	0: Not detected. 1: Detected.	Indicates whether or not, when the CMU was bus master, a transaction timeout was detected (and the bus operation was ended).	28	MAPE	0: Not received. 1: Received.	Indicates whether or not, when the CMU was bus master, an address parity error notification was received.	29	MRDPE	0: Not detected. 1: Detected.	Indicates whether or not, when the CMU was bus master, a read-data parity error was detected.	30	MA	0: Not detected. 1: Detected.	Indicates whether or not, when the CMU was bus master, an address-cycle timeout was detected (and the bus operation was ended).	31	BRQTO	0: Not detected. 1: Detected.	Indicates whether or not, when the CMU was bus master, a bus-request timeout was detected (and the bus operation was ended).
Bit no.	Bit name	Read-in value	Meaning																													
26	RTA	0: Not received. 1: Received.	Indicates whether or not, when the CMU was bus master, an error transaction was received (and the bus operation was ended).																													
27	TRNSTO	0: Not detected. 1: Detected.	Indicates whether or not, when the CMU was bus master, a transaction timeout was detected (and the bus operation was ended).																													
28	MAPE	0: Not received. 1: Received.	Indicates whether or not, when the CMU was bus master, an address parity error notification was received.																													
29	MRDPE	0: Not detected. 1: Detected.	Indicates whether or not, when the CMU was bus master, a read-data parity error was detected.																													
30	MA	0: Not detected. 1: Detected.	Indicates whether or not, when the CMU was bus master, an address-cycle timeout was detected (and the bus operation was ended).																													
31	BRQTO	0: Not detected. 1: Detected.	Indicates whether or not, when the CMU was bus master, a bus-request timeout was detected (and the bus operation was ended).																													
RERRADR	<div style="text-align: center; margin-bottom: 10px;"> 0 2 3 31 </div> <div style="border: 1px solid black; padding: 5px; margin-bottom: 10px;"> 0 ADR </div> <table border="1" data-bbox="424 1461 1417 1634"> <thead> <tr> <th data-bbox="424 1461 544 1504">Bit no.</th> <th data-bbox="549 1461 699 1504">Bit name</th> <th data-bbox="703 1461 946 1504">Read-in value</th> <th data-bbox="951 1461 1417 1504">Meaning</th> </tr> </thead> <tbody> <tr> <td data-bbox="424 1504 544 1548">0 to 2</td> <td data-bbox="549 1504 699 1548">—</td> <td data-bbox="703 1504 946 1548">Always 0.</td> <td data-bbox="951 1504 1417 1548">—</td> </tr> <tr> <td data-bbox="424 1548 544 1634">3 to 31</td> <td data-bbox="549 1548 699 1634">ADR</td> <td data-bbox="703 1548 946 1634">Specified value</td> <td data-bbox="951 1548 1417 1634">Is the bus address at which the high-speed bus/S10 bus error occurred.</td> </tr> </tbody> </table>				Bit no.	Bit name	Read-in value	Meaning	0 to 2	—	Always 0.	—	3 to 31	ADR	Specified value	Is the bus address at which the high-speed bus/S10 bus error occurred.																
Bit no.	Bit name	Read-in value	Meaning																													
0 to 2	—	Always 0.	—																													
3 to 31	ADR	Specified value	Is the bus address at which the high-speed bus/S10 bus error occurred.																													
RERRDAT	<div style="text-align: center; margin-bottom: 10px;"> 0 31 </div> <div style="border: 1px solid black; padding: 5px; margin-bottom: 10px;"> DAT </div> <table border="1" data-bbox="424 1806 1417 1936"> <thead> <tr> <th data-bbox="424 1806 544 1849">Bit no.</th> <th data-bbox="549 1806 699 1849">Bit name</th> <th data-bbox="703 1806 946 1849">Read-in value</th> <th data-bbox="951 1806 1417 1849">Meaning</th> </tr> </thead> <tbody> <tr> <td data-bbox="424 1849 544 1936">0 to 31</td> <td data-bbox="549 1849 699 1936">—</td> <td data-bbox="703 1849 946 1936">Specified value</td> <td data-bbox="951 1849 1417 1936">Is the bus data that encountered the high-speed bus/S10 bus error.</td> </tr> </tbody> </table>				Bit no.	Bit name	Read-in value	Meaning	0 to 31	—	Specified value	Is the bus data that encountered the high-speed bus/S10 bus error.																				
Bit no.	Bit name	Read-in value	Meaning																													
0 to 31	—	Specified value	Is the bus data that encountered the high-speed bus/S10 bus error.																													

4 ERROR LOG INFORMATION

Item	Description																																																
RERRMST	<div style="text-align: center;"> </div> <table border="1" style="width: 100%; border-collapse: collapse; margin-top: 10px;"> <thead> <tr> <th>Bit no.</th> <th>Bit name</th> <th>Read-in value</th> <th>Meaning</th> </tr> </thead> <tbody> <tr> <td>0 to 18</td> <td>—</td> <td>Always 0.</td> <td>—</td> </tr> <tr> <td>19</td> <td>CP</td> <td>0: Other than CMU. 1: CMU.</td> <td>Indicates whether or not the master that encountered the error was the CMU.</td> </tr> <tr> <td>20 to 23</td> <td>Reserve</td> <td>Always 0.</td> <td>—</td> </tr> <tr> <td>24</td> <td>SLOT7</td> <td>0: Other than slot #7. 1: Slot #7.</td> <td>Indicates whether or not the master that encountered the error was the module mounted in slot #7.</td> </tr> <tr> <td>25</td> <td>SLOT6</td> <td>0: Other than slot #6. 1: Slot #6.</td> <td>Indicates whether or not the master that encountered the error was the module mounted in slot #6.</td> </tr> <tr> <td>26</td> <td>SLOT5</td> <td>0: Other than slot #5. 1: Slot #5.</td> <td>Indicates whether or not the master that encountered the error was the module mounted in slot #5.</td> </tr> <tr> <td>27</td> <td>SLOT4</td> <td>0: Other than slot #4. 1: Slot #4.</td> <td>Indicates whether or not the master that encountered the error was the module mounted in slot #4.</td> </tr> <tr> <td>28</td> <td>SLOT3</td> <td>0: Other than slot #3. 1: Slot #3.</td> <td>Indicates whether or not the master that encountered the error was the module mounted in slot #3.</td> </tr> <tr> <td>29</td> <td>SLOT2</td> <td>0: Other than slot #2. 1: Slot #2.</td> <td>Indicates whether or not the master that encountered the error was the module mounted in slot #2.</td> </tr> <tr> <td>30</td> <td>SLOT1</td> <td>0: Other than slot #1. 1: Slot #1.</td> <td>Indicates whether or not the master that encountered the error was the module mounted in slot #1.</td> </tr> <tr> <td>31</td> <td>SLOT0</td> <td>0: Other than slot #0. 1: Slot #0.</td> <td>Indicates whether or not the master that encountered the error was the module mounted in slot #0.</td> </tr> </tbody> </table>	Bit no.	Bit name	Read-in value	Meaning	0 to 18	—	Always 0.	—	19	CP	0: Other than CMU. 1: CMU.	Indicates whether or not the master that encountered the error was the CMU.	20 to 23	Reserve	Always 0.	—	24	SLOT7	0: Other than slot #7. 1: Slot #7.	Indicates whether or not the master that encountered the error was the module mounted in slot #7.	25	SLOT6	0: Other than slot #6. 1: Slot #6.	Indicates whether or not the master that encountered the error was the module mounted in slot #6.	26	SLOT5	0: Other than slot #5. 1: Slot #5.	Indicates whether or not the master that encountered the error was the module mounted in slot #5.	27	SLOT4	0: Other than slot #4. 1: Slot #4.	Indicates whether or not the master that encountered the error was the module mounted in slot #4.	28	SLOT3	0: Other than slot #3. 1: Slot #3.	Indicates whether or not the master that encountered the error was the module mounted in slot #3.	29	SLOT2	0: Other than slot #2. 1: Slot #2.	Indicates whether or not the master that encountered the error was the module mounted in slot #2.	30	SLOT1	0: Other than slot #1. 1: Slot #1.	Indicates whether or not the master that encountered the error was the module mounted in slot #1.	31	SLOT0	0: Other than slot #0. 1: Slot #0.	Indicates whether or not the master that encountered the error was the module mounted in slot #0.
Bit no.	Bit name	Read-in value	Meaning																																														
0 to 18	—	Always 0.	—																																														
19	CP	0: Other than CMU. 1: CMU.	Indicates whether or not the master that encountered the error was the CMU.																																														
20 to 23	Reserve	Always 0.	—																																														
24	SLOT7	0: Other than slot #7. 1: Slot #7.	Indicates whether or not the master that encountered the error was the module mounted in slot #7.																																														
25	SLOT6	0: Other than slot #6. 1: Slot #6.	Indicates whether or not the master that encountered the error was the module mounted in slot #6.																																														
26	SLOT5	0: Other than slot #5. 1: Slot #5.	Indicates whether or not the master that encountered the error was the module mounted in slot #5.																																														
27	SLOT4	0: Other than slot #4. 1: Slot #4.	Indicates whether or not the master that encountered the error was the module mounted in slot #4.																																														
28	SLOT3	0: Other than slot #3. 1: Slot #3.	Indicates whether or not the master that encountered the error was the module mounted in slot #3.																																														
29	SLOT2	0: Other than slot #2. 1: Slot #2.	Indicates whether or not the master that encountered the error was the module mounted in slot #2.																																														
30	SLOT1	0: Other than slot #1. 1: Slot #1.	Indicates whether or not the master that encountered the error was the module mounted in slot #1.																																														
31	SLOT0	0: Other than slot #0. 1: Slot #0.	Indicates whether or not the master that encountered the error was the module mounted in slot #0.																																														
RERRCMD	<div style="text-align: center;"> </div> <table border="1" style="width: 100%; border-collapse: collapse; margin-top: 10px;"> <thead> <tr> <th>Bit no.</th> <th>Bit name</th> <th>Read-in value</th> <th>Meaning</th> </tr> </thead> <tbody> <tr> <td>0 to 19</td> <td>—</td> <td>Always 0.</td> <td>—</td> </tr> <tr> <td>20 to 23</td> <td>BE</td> <td>Specified value.</td> <td>Is the byte enable that encountered the error.</td> </tr> <tr> <td>24 to 27</td> <td>—</td> <td>Always 0.</td> <td>—</td> </tr> <tr> <td>28 to 31</td> <td>CMD</td> <td>Specified value.</td> <td>Is the bus command that encountered the error.</td> </tr> </tbody> </table>	Bit no.	Bit name	Read-in value	Meaning	0 to 19	—	Always 0.	—	20 to 23	BE	Specified value.	Is the byte enable that encountered the error.	24 to 27	—	Always 0.	—	28 to 31	CMD	Specified value.	Is the bus command that encountered the error.																												
Bit no.	Bit name	Read-in value	Meaning																																														
0 to 19	—	Always 0.	—																																														
20 to 23	BE	Specified value.	Is the byte enable that encountered the error.																																														
24 to 27	—	Always 0.	—																																														
28 to 31	CMD	Specified value.	Is the bus command that encountered the error.																																														
MST_TYPE	Is the type of master that encountered the error (see Table 4-34).																																																
MST_INFO	Is supplementary information for the master type that encountered the error (see Table 4-34).																																																

Table 4-34 The Set Values of MST_TYPE and MST_INFO

Set value of MST_TYPE	Type of master	Set value of MST_INFO
0x1	CMU	0x00000055: Denotes CMU master. 0xFFFFFFFF: Master unidentifiable.
0x2	I/O device under PCI bus	0x00000001: Denotes LANCE(CH1) master. 0x00000002: Denotes LANCE(CH2) master. 0xFFFFFFFF: Master unidentifiable.
0x3	I/O module under R700 (S10) bus	Master slot number (8 for the CPU)

Item	Description
PC	The content of the program counter. Information on the address value contained in the program counter is presented, enclosed in parentheses. If the address value identifies a memory location in a program, the following information is presented: (name = program name type = program type [program component] raddr = relative address to the beginning of the program)
PR	The content of the procedure register. Information on the address value contained in the procedure register is presented, enclosed in parentheses. If the address value identifies a memory location in a program, the following information is presented: (name = program name type = program type [program component] raddr = relative address to the beginning of the program)

4 ERROR LOG INFORMATION

(14) System bus error

This type of error is reported when a serious error is detected on the system bus.

The table below shows the general format of error messages for system bus errors and describes each format element.

Table 4-35 System Bus Error Message Format

```

%CPMS-E-HARD-000f  SITE=xxxxxxxxxxxxxx RC=xxxxxxxx yy/yy/mm/dd hh:mm:ss LOG=xxx
EC=xxxxxxxx System Bus Error (Subtitle)
SLOT      =xxxxxxxx MSW0      =xxxxxxxx MSW1      =xxxxxxxx
HERST     =xxxxxxxx DIRNP    =xxxxxxxx DIRCP    =xxxxxxxx STATNP  =xxxxxxxx
ENNP      =xxxxxxxx STATCP   =xxxxxxxx ENCP     =xxxxxxxx LOG      =xxxxxxxx
ADR       =xxxxxxxx DAT      =xxxxxxxx MST      =xxxxxxxx CMD      =xxxxxxxx
STATSLV   =xxxxxxxx ENSLV    =xxxxxxxx RBUSMNT  =xxxxxxxx
    
```

Item	Description																																																						
EC	Error code (see Table 4-36).																																																						
SLOT	Master slot number																																																						
MSW0	<div style="display: flex; align-items: center;"> <div style="margin-right: 20px;"> <table border="1" style="border-collapse: collapse; text-align: center;"> <tr> <td style="width: 100px;">0</td> <td style="width: 100px;">7</td> <td style="width: 100px;">8</td> <td style="width: 100px;">15</td> <td style="width: 100px;">16</td> <td style="width: 100px;">23</td> <td style="width: 100px;">24</td> <td style="width: 100px;">25</td> <td style="width: 100px;">29</td> <td style="width: 100px;">30</td> <td style="width: 100px;">31</td> </tr> <tr> <td colspan="2">Interface ID</td> <td colspan="2">Module ID</td> <td>0</td> <td>0</td> <td>0</td> <td>0</td> <td></td> <td></td> <td></td> </tr> </table> </div> <div> <p style="margin-left: 20px;">MHI</p> <p style="margin-left: 20px;">BIST</p> <p style="margin-left: 20px;">BISTCpbl</p> </div> </div> <table border="1" style="border-collapse: collapse; width: 100%;"> <thead> <tr> <th>Bit no.</th> <th>Bit name</th> <th>Read-in value</th> <th>Meaning</th> </tr> </thead> <tbody> <tr> <td>0 to 7</td> <td>Interface ID</td> <td>Interface ID</td> <td>Module ID code provided for use in software</td> </tr> <tr> <td>8 to 15</td> <td>Module ID</td> <td>Module ID</td> <td>Module ID code provided for use in hardware</td> </tr> <tr> <td>16 to 23</td> <td>Reserve</td> <td>Always 0.</td> <td>—</td> </tr> <tr> <td>24</td> <td>BISTCpbl</td> <td>0: Not supported. 1: Supported.</td> <td>Indicates whether the module supports self-diagnosis. (This item is optional.)</td> </tr> <tr> <td>25 to 29</td> <td>Reserve</td> <td>Always 0.</td> <td>—</td> </tr> <tr> <td>30</td> <td>BIST</td> <td>0: Self-diagnosis ended. 1: Self-diagnosis was in process.</td> <td>Is the operation status of the module's self-diagnosis function. (This item is optional.)</td> </tr> <tr> <td>31</td> <td>MHI</td> <td>0: Initialization ended. 1: Initialization was in process.</td> <td>Is the initialization status of the module's hardware.</td> </tr> </tbody> </table>	0	7	8	15	16	23	24	25	29	30	31	Interface ID		Module ID		0	0	0	0				Bit no.	Bit name	Read-in value	Meaning	0 to 7	Interface ID	Interface ID	Module ID code provided for use in software	8 to 15	Module ID	Module ID	Module ID code provided for use in hardware	16 to 23	Reserve	Always 0.	—	24	BISTCpbl	0: Not supported. 1: Supported.	Indicates whether the module supports self-diagnosis. (This item is optional.)	25 to 29	Reserve	Always 0.	—	30	BIST	0: Self-diagnosis ended. 1: Self-diagnosis was in process.	Is the operation status of the module's self-diagnosis function. (This item is optional.)	31	MHI	0: Initialization ended. 1: Initialization was in process.	Is the initialization status of the module's hardware.
0	7	8	15	16	23	24	25	29	30	31																																													
Interface ID		Module ID		0	0	0	0																																																
Bit no.	Bit name	Read-in value	Meaning																																																				
0 to 7	Interface ID	Interface ID	Module ID code provided for use in software																																																				
8 to 15	Module ID	Module ID	Module ID code provided for use in hardware																																																				
16 to 23	Reserve	Always 0.	—																																																				
24	BISTCpbl	0: Not supported. 1: Supported.	Indicates whether the module supports self-diagnosis. (This item is optional.)																																																				
25 to 29	Reserve	Always 0.	—																																																				
30	BIST	0: Self-diagnosis ended. 1: Self-diagnosis was in process.	Is the operation status of the module's self-diagnosis function. (This item is optional.)																																																				
31	MHI	0: Initialization ended. 1: Initialization was in process.	Is the initialization status of the module's hardware.																																																				

Item	Description																																																								
MSW1	<div style="text-align: center;"> </div> <table border="1" style="width: 100%; border-collapse: collapse;"> <thead> <tr> <th data-bbox="427 763 547 814">Bit no.</th> <th data-bbox="547 763 708 814">Bit name</th> <th data-bbox="708 763 952 814">Read-in value</th> <th data-bbox="952 763 1417 814">Meaning</th> </tr> </thead> <tbody> <tr> <td data-bbox="427 814 547 858">0</td> <td data-bbox="547 814 708 858">Reserve</td> <td data-bbox="708 814 952 858">Always 0.</td> <td data-bbox="952 814 1417 858">—</td> </tr> <tr> <td data-bbox="427 858 547 978">1</td> <td data-bbox="547 858 708 978">RUN</td> <td data-bbox="708 858 952 978">0: Not in RUN state. 1: In RUN state.</td> <td data-bbox="952 858 1417 978">Is the module status. (The RUN LED is either lit or blinking.)</td> </tr> <tr> <td data-bbox="427 978 547 1099">2</td> <td data-bbox="547 978 708 1099">ERROR</td> <td data-bbox="708 978 952 1099">0: Error not detected. 1: Error detected.</td> <td data-bbox="952 978 1417 1099">Is the error status. (The ERR LED is either lit or blinking.)</td> </tr> <tr> <td data-bbox="427 1099 547 1142">3</td> <td data-bbox="547 1099 708 1142">Reserve</td> <td data-bbox="708 1099 952 1142">Always 0.</td> <td data-bbox="952 1099 1417 1142">—</td> </tr> <tr> <td data-bbox="427 1142 547 1278">4 to 15</td> <td data-bbox="547 1142 708 1278">Module-specific info</td> <td data-bbox="708 1142 952 1278">Module-specific information (LED)</td> <td data-bbox="952 1142 1417 1278">Is the hardware module-specific LED status.</td> </tr> <tr> <td data-bbox="427 1278 547 1321">16</td> <td data-bbox="547 1278 708 1321">Reserve</td> <td data-bbox="708 1278 952 1321">Always 0.</td> <td data-bbox="952 1278 1417 1321">—</td> </tr> <tr> <td data-bbox="427 1321 547 1414">17</td> <td data-bbox="547 1321 708 1414">MASTER</td> <td data-bbox="708 1321 952 1414">0: Not output. 1: Output.</td> <td data-bbox="952 1321 1417 1414">Is the MASTER status (output).</td> </tr> <tr> <td data-bbox="427 1414 547 1507">18</td> <td data-bbox="547 1414 708 1507">MRDY</td> <td data-bbox="708 1414 952 1507">0: MRDY OFF. 1: MRDY ON.</td> <td data-bbox="952 1414 1417 1507">Is the MASTER READY status. (Applicable only to the CPU.)</td> </tr> <tr> <td data-bbox="427 1507 547 1558">19</td> <td data-bbox="547 1507 708 1558">Reserve</td> <td data-bbox="708 1507 952 1558">Always 0.</td> <td data-bbox="952 1507 1417 1558">—</td> </tr> <tr> <td data-bbox="427 1558 547 1651">20 to 27</td> <td data-bbox="547 1558 708 1651">Module status</td> <td data-bbox="708 1558 952 1651">Module status</td> <td data-bbox="952 1558 1417 1651">Module status</td> </tr> <tr> <td data-bbox="427 1651 547 1694">28 to 29</td> <td data-bbox="547 1651 708 1694">Reserve</td> <td data-bbox="708 1651 952 1694">Always 0.</td> <td data-bbox="952 1651 1417 1694">—</td> </tr> <tr> <td data-bbox="427 1694 547 1830">30</td> <td data-bbox="547 1694 708 1830">RINT</td> <td data-bbox="708 1694 952 1830">0: Not generated. 1: Generated.</td> <td data-bbox="952 1694 1417 1830">Indicates whether or not a common interrupt other than the network-related was generated.</td> </tr> <tr> <td data-bbox="427 1830 547 1923">31</td> <td data-bbox="547 1830 708 1923">NINT</td> <td data-bbox="708 1830 952 1923">0: Not generated. 1: Generated.</td> <td data-bbox="952 1830 1417 1923">Indicates whether or not a network-related interrupt was generated.</td> </tr> </tbody> </table>	Bit no.	Bit name	Read-in value	Meaning	0	Reserve	Always 0.	—	1	RUN	0: Not in RUN state. 1: In RUN state.	Is the module status. (The RUN LED is either lit or blinking.)	2	ERROR	0: Error not detected. 1: Error detected.	Is the error status. (The ERR LED is either lit or blinking.)	3	Reserve	Always 0.	—	4 to 15	Module-specific info	Module-specific information (LED)	Is the hardware module-specific LED status.	16	Reserve	Always 0.	—	17	MASTER	0: Not output. 1: Output.	Is the MASTER status (output).	18	MRDY	0: MRDY OFF. 1: MRDY ON.	Is the MASTER READY status. (Applicable only to the CPU.)	19	Reserve	Always 0.	—	20 to 27	Module status	Module status	Module status	28 to 29	Reserve	Always 0.	—	30	RINT	0: Not generated. 1: Generated.	Indicates whether or not a common interrupt other than the network-related was generated.	31	NINT	0: Not generated. 1: Generated.	Indicates whether or not a network-related interrupt was generated.
Bit no.	Bit name	Read-in value	Meaning																																																						
0	Reserve	Always 0.	—																																																						
1	RUN	0: Not in RUN state. 1: In RUN state.	Is the module status. (The RUN LED is either lit or blinking.)																																																						
2	ERROR	0: Error not detected. 1: Error detected.	Is the error status. (The ERR LED is either lit or blinking.)																																																						
3	Reserve	Always 0.	—																																																						
4 to 15	Module-specific info	Module-specific information (LED)	Is the hardware module-specific LED status.																																																						
16	Reserve	Always 0.	—																																																						
17	MASTER	0: Not output. 1: Output.	Is the MASTER status (output).																																																						
18	MRDY	0: MRDY OFF. 1: MRDY ON.	Is the MASTER READY status. (Applicable only to the CPU.)																																																						
19	Reserve	Always 0.	—																																																						
20 to 27	Module status	Module status	Module status																																																						
28 to 29	Reserve	Always 0.	—																																																						
30	RINT	0: Not generated. 1: Generated.	Indicates whether or not a common interrupt other than the network-related was generated.																																																						
31	NINT	0: Not generated. 1: Generated.	Indicates whether or not a network-related interrupt was generated.																																																						

4 ERROR LOG INFORMATION

Item	Description																												
MSW0	<div style="text-align: center;"> </div> <table border="1" style="width: 100%; border-collapse: collapse;"> <thead> <tr> <th>Bit no.</th> <th>Bit name</th> <th>Read-in value</th> <th>Meaning</th> </tr> </thead> <tbody> <tr> <td>0 to 26</td> <td>—</td> <td>Always 0.</td> <td>—</td> </tr> <tr> <td>27</td> <td>Reserve</td> <td>Always 0.</td> <td>(Reserved for future extension)</td> </tr> <tr> <td>28</td> <td>BU_HER</td> <td>0: Not generated. 1: Generated.</td> <td>Indicates whether or not a serious-error interrupt was generated in relation to the PCI bus.</td> </tr> <tr> <td>29</td> <td>EU_HER</td> <td>0: Not generated. 1: Generated.</td> <td>Indicates whether or not a serious-error interrupt was generated in relation to the system bus.</td> </tr> <tr> <td>30</td> <td>SU_HER</td> <td>0: Not generated. 1: Generated.</td> <td>Indicates whether or not a serious-error interrupt was generated in relation to the system.</td> </tr> <tr> <td>31</td> <td>MU_HER</td> <td>0: Not generated. 1: Generated.</td> <td>Indicates whether or not a serious-error interrupt was generated in relation to the memory.</td> </tr> </tbody> </table>	Bit no.	Bit name	Read-in value	Meaning	0 to 26	—	Always 0.	—	27	Reserve	Always 0.	(Reserved for future extension)	28	BU_HER	0: Not generated. 1: Generated.	Indicates whether or not a serious-error interrupt was generated in relation to the PCI bus.	29	EU_HER	0: Not generated. 1: Generated.	Indicates whether or not a serious-error interrupt was generated in relation to the system bus.	30	SU_HER	0: Not generated. 1: Generated.	Indicates whether or not a serious-error interrupt was generated in relation to the system.	31	MU_HER	0: Not generated. 1: Generated.	Indicates whether or not a serious-error interrupt was generated in relation to the memory.
Bit no.	Bit name	Read-in value	Meaning																										
0 to 26	—	Always 0.	—																										
27	Reserve	Always 0.	(Reserved for future extension)																										
28	BU_HER	0: Not generated. 1: Generated.	Indicates whether or not a serious-error interrupt was generated in relation to the PCI bus.																										
29	EU_HER	0: Not generated. 1: Generated.	Indicates whether or not a serious-error interrupt was generated in relation to the system bus.																										
30	SU_HER	0: Not generated. 1: Generated.	Indicates whether or not a serious-error interrupt was generated in relation to the system.																										
31	MU_HER	0: Not generated. 1: Generated.	Indicates whether or not a serious-error interrupt was generated in relation to the memory.																										
DIRNP	Unused																												
DIRCP	<div style="text-align: center;"> </div> <table border="1" style="width: 100%; border-collapse: collapse;"> <thead> <tr> <th>Bit no.</th> <th>Bit name</th> <th>Read-in value</th> <th>Meaning</th> </tr> </thead> <tbody> <tr> <td>0 to 28</td> <td>—</td> <td>Always 0.</td> <td>—</td> </tr> <tr> <td>29</td> <td>EUMCN</td> <td>0: Not detected. 1: detected.</td> <td>Indicates whether or not the EU detected a system bus error.</td> </tr> <tr> <td>30</td> <td>MUMCN</td> <td>0: Not detected. 1: detected.</td> <td>Indicates whether or not the MU detected a system bus error.</td> </tr> <tr> <td>31</td> <td>BUMCN</td> <td>0: Not detected. 1: detected.</td> <td>Indicates whether or not the BU detected a system bus error.</td> </tr> </tbody> </table>	Bit no.	Bit name	Read-in value	Meaning	0 to 28	—	Always 0.	—	29	EUMCN	0: Not detected. 1: detected.	Indicates whether or not the EU detected a system bus error.	30	MUMCN	0: Not detected. 1: detected.	Indicates whether or not the MU detected a system bus error.	31	BUMCN	0: Not detected. 1: detected.	Indicates whether or not the BU detected a system bus error.								
Bit no.	Bit name	Read-in value	Meaning																										
0 to 28	—	Always 0.	—																										
29	EUMCN	0: Not detected. 1: detected.	Indicates whether or not the EU detected a system bus error.																										
30	MUMCN	0: Not detected. 1: detected.	Indicates whether or not the MU detected a system bus error.																										
31	BUMCN	0: Not detected. 1: detected.	Indicates whether or not the BU detected a system bus error.																										
STATNP	Unused																												
ENNP	Unused																												

4 ERROR LOG INFORMATION

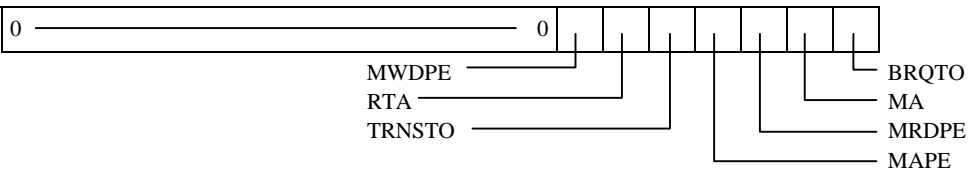
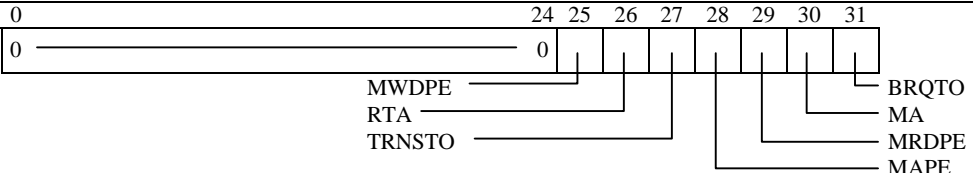
Item	Description																																				
STATCP	<div style="text-align: right; margin-bottom: 10px;"> 0 24 25 26 27 28 29 30 31 </div>  <table border="1" style="width: 100%; border-collapse: collapse; margin-top: 10px;"> <thead> <tr> <th style="width: 10%;">Bit no.</th> <th style="width: 15%;">Bit name</th> <th style="width: 25%;">Read-in value</th> <th style="width: 50%;">Meaning</th> </tr> </thead> <tbody> <tr> <td>0 to 24</td> <td>—</td> <td>Always 0.</td> <td>—</td> </tr> <tr> <td>25</td> <td>MWDPE</td> <td>0: Not received. 1: Received.</td> <td>Indicates whether or not, when the CMU was bus master, a write-data parity error was detected and an error notification was received from the target.</td> </tr> <tr> <td>26</td> <td>RTA</td> <td>0: Not received. 1: Received.</td> <td>Indicates whether or not, when the CMU was bus master, an error transaction was received (and the bus operation was ended).</td> </tr> <tr> <td>27</td> <td>TRNSTO</td> <td>0: Not received. 1: Received.</td> <td>Indicates whether or not, when the CMU was bus master, a transaction timeout was received (and the bus operation was ended).</td> </tr> <tr> <td>28</td> <td>MAPE</td> <td>0: Not received. 1: Received.</td> <td>Indicates whether or not, when the CMU was bus master, an address parity error was received.</td> </tr> <tr> <td>29</td> <td>MRDPE</td> <td>0: Not received. 1: Received.</td> <td>Indicates whether or not, when the CMU was bus master, a read-data parity error was detected and an error notification was received from the target.</td> </tr> <tr> <td>30</td> <td>MA</td> <td>0: Not received. 1: Received.</td> <td>Indicates whether or not, when the CMU was bus master, an address-cycle timeout was received (and the bus operation was ended).</td> </tr> <tr> <td>31</td> <td>BRQTO</td> <td>0: Not received. 1: Received.</td> <td>Indicates whether or not, when the CMU was bus master, a bus-request timeout was received (and the bus operation was ended).</td> </tr> </tbody> </table>	Bit no.	Bit name	Read-in value	Meaning	0 to 24	—	Always 0.	—	25	MWDPE	0: Not received. 1: Received.	Indicates whether or not, when the CMU was bus master, a write-data parity error was detected and an error notification was received from the target.	26	RTA	0: Not received. 1: Received.	Indicates whether or not, when the CMU was bus master, an error transaction was received (and the bus operation was ended).	27	TRNSTO	0: Not received. 1: Received.	Indicates whether or not, when the CMU was bus master, a transaction timeout was received (and the bus operation was ended).	28	MAPE	0: Not received. 1: Received.	Indicates whether or not, when the CMU was bus master, an address parity error was received.	29	MRDPE	0: Not received. 1: Received.	Indicates whether or not, when the CMU was bus master, a read-data parity error was detected and an error notification was received from the target.	30	MA	0: Not received. 1: Received.	Indicates whether or not, when the CMU was bus master, an address-cycle timeout was received (and the bus operation was ended).	31	BRQTO	0: Not received. 1: Received.	Indicates whether or not, when the CMU was bus master, a bus-request timeout was received (and the bus operation was ended).
Bit no.	Bit name	Read-in value	Meaning																																		
0 to 24	—	Always 0.	—																																		
25	MWDPE	0: Not received. 1: Received.	Indicates whether or not, when the CMU was bus master, a write-data parity error was detected and an error notification was received from the target.																																		
26	RTA	0: Not received. 1: Received.	Indicates whether or not, when the CMU was bus master, an error transaction was received (and the bus operation was ended).																																		
27	TRNSTO	0: Not received. 1: Received.	Indicates whether or not, when the CMU was bus master, a transaction timeout was received (and the bus operation was ended).																																		
28	MAPE	0: Not received. 1: Received.	Indicates whether or not, when the CMU was bus master, an address parity error was received.																																		
29	MRDPE	0: Not received. 1: Received.	Indicates whether or not, when the CMU was bus master, a read-data parity error was detected and an error notification was received from the target.																																		
30	MA	0: Not received. 1: Received.	Indicates whether or not, when the CMU was bus master, an address-cycle timeout was received (and the bus operation was ended).																																		
31	BRQTO	0: Not received. 1: Received.	Indicates whether or not, when the CMU was bus master, a bus-request timeout was received (and the bus operation was ended).																																		
ENCP	<div style="text-align: right; margin-bottom: 10px;"> 0 24 25 26 27 28 29 30 31 </div>  <table border="1" style="width: 100%; border-collapse: collapse; margin-top: 10px;"> <thead> <tr> <th style="width: 10%;">Bit no.</th> <th style="width: 15%;">Bit name</th> <th style="width: 25%;">Read-in value</th> <th style="width: 50%;">Meaning</th> </tr> </thead> <tbody> <tr> <td>0 to 24</td> <td>—</td> <td>Always 0.</td> <td>—</td> </tr> <tr> <td>25</td> <td>MWDPE</td> <td>0: Not reported. 1: Reported.</td> <td>Indicates whether or not a write-data parity error was received by the CMU and reported as a serious error.</td> </tr> <tr> <td>26</td> <td>RTA</td> <td>0: Not reported. 1: Reported.</td> <td>Indicates whether or not an error transaction was received by the CMU and reported as a serious error.</td> </tr> <tr> <td>27</td> <td>TRNSTO</td> <td>0: Not reported. 1: Reported.</td> <td>Indicates whether or not a transaction timeout was received by the CMU and reported as a serious error.</td> </tr> <tr> <td>28</td> <td>MAPE</td> <td>0: Not reported. 1: Reported.</td> <td>Indicates whether or not an address parity error was received by the CMU and reported as a serious error.</td> </tr> <tr> <td>29</td> <td>MRDPE</td> <td>0: Not reported. 1: Reported.</td> <td>Indicates whether or not a read-data parity error was received by the CMU and reported as a serious error.</td> </tr> <tr> <td>30</td> <td>MA</td> <td>0: Not reported. 1: Reported.</td> <td>Indicates whether or not an address-cycle timeout was received by the CMU and reported as a serious error.</td> </tr> <tr> <td>31</td> <td>BRQTO</td> <td>0: Not reported. 1: Reported.</td> <td>Indicates whether or not a bus request timeout was received by the CMU and reported as a serious error.</td> </tr> </tbody> </table>	Bit no.	Bit name	Read-in value	Meaning	0 to 24	—	Always 0.	—	25	MWDPE	0: Not reported. 1: Reported.	Indicates whether or not a write-data parity error was received by the CMU and reported as a serious error.	26	RTA	0: Not reported. 1: Reported.	Indicates whether or not an error transaction was received by the CMU and reported as a serious error.	27	TRNSTO	0: Not reported. 1: Reported.	Indicates whether or not a transaction timeout was received by the CMU and reported as a serious error.	28	MAPE	0: Not reported. 1: Reported.	Indicates whether or not an address parity error was received by the CMU and reported as a serious error.	29	MRDPE	0: Not reported. 1: Reported.	Indicates whether or not a read-data parity error was received by the CMU and reported as a serious error.	30	MA	0: Not reported. 1: Reported.	Indicates whether or not an address-cycle timeout was received by the CMU and reported as a serious error.	31	BRQTO	0: Not reported. 1: Reported.	Indicates whether or not a bus request timeout was received by the CMU and reported as a serious error.
Bit no.	Bit name	Read-in value	Meaning																																		
0 to 24	—	Always 0.	—																																		
25	MWDPE	0: Not reported. 1: Reported.	Indicates whether or not a write-data parity error was received by the CMU and reported as a serious error.																																		
26	RTA	0: Not reported. 1: Reported.	Indicates whether or not an error transaction was received by the CMU and reported as a serious error.																																		
27	TRNSTO	0: Not reported. 1: Reported.	Indicates whether or not a transaction timeout was received by the CMU and reported as a serious error.																																		
28	MAPE	0: Not reported. 1: Reported.	Indicates whether or not an address parity error was received by the CMU and reported as a serious error.																																		
29	MRDPE	0: Not reported. 1: Reported.	Indicates whether or not a read-data parity error was received by the CMU and reported as a serious error.																																		
30	MA	0: Not reported. 1: Reported.	Indicates whether or not an address-cycle timeout was received by the CMU and reported as a serious error.																																		
31	BRQTO	0: Not reported. 1: Reported.	Indicates whether or not a bus request timeout was received by the CMU and reported as a serious error.																																		

4 ERROR LOG INFORMATION

Item	Description																																																										
LOG																																																											
	<table border="1"> <thead> <tr> <th>Bit no.</th> <th>Bit name</th> <th>Read-in value</th> <th>Meaning</th> </tr> </thead> <tbody> <tr> <td>0 to 12</td> <td>Reserve</td> <td>Always 0.</td> <td>—</td> </tr> <tr> <td>13</td> <td>MAAE</td> <td>0: Not detected. 1: Detected</td> <td>Indicates whether or not, when the target was in operation, an illegal byte-enable was detected in a write.</td> </tr> <tr> <td>14</td> <td>Reserve</td> <td>Always 0.</td> <td>—</td> </tr> <tr> <td>15</td> <td>NOACK TO</td> <td>0: Not detected. 1: Detected</td> <td>Indicates whether or not a timeout due to no BGACK output within fixed time period was detected.</td> </tr> <tr> <td>16</td> <td>ACK BUSYTO</td> <td>0: Not detected. 1: Detected</td> <td>Indicates whether or not a timeout due to an endless BGACK output was detected.</td> </tr> <tr> <td>17</td> <td>RSERR</td> <td>0: Not received. 1: Received.</td> <td>Indicates whether or not an SERROR signal was received.</td> </tr> <tr> <td>18</td> <td>INVCMD</td> <td>0: Not detected. 1: Detected</td> <td>Indicates whether or not, when the target was in operation, an illegal command was detected.</td> </tr> <tr> <td>19</td> <td>STA</td> <td>0: Not sent out. 1: Sent out.</td> <td>Indicates whether or not, when the target was in operation, an error transaction was sent out.</td> </tr> <tr> <td>20</td> <td>TAPE</td> <td>0: Not detected. 1: Detected</td> <td>Indicates whether or not, when the target was in operation, an address parity error was detected.</td> </tr> <tr> <td>21</td> <td>TDPE</td> <td>0: Not detected. 1: Detected</td> <td>Indicates whether or not, when the target was in operation, a data parity error was detected.</td> </tr> <tr> <td>22</td> <td>ME</td> <td>0: Not detected. 1: Detected</td> <td>Indicates whether or not, when the target was in operation handling a high-speed bus/S10 bus read, a 2-bit ECC error was detected in memory.</td> </tr> <tr> <td>23</td> <td>NODT ACK</td> <td>Always 0.</td> <td>—</td> </tr> <tr> <td>24</td> <td>Reserve</td> <td>Always 0.</td> <td>—</td> </tr> </tbody> </table>	Bit no.	Bit name	Read-in value	Meaning	0 to 12	Reserve	Always 0.	—	13	MAAE	0: Not detected. 1: Detected	Indicates whether or not, when the target was in operation, an illegal byte-enable was detected in a write.	14	Reserve	Always 0.	—	15	NOACK TO	0: Not detected. 1: Detected	Indicates whether or not a timeout due to no BGACK output within fixed time period was detected.	16	ACK BUSYTO	0: Not detected. 1: Detected	Indicates whether or not a timeout due to an endless BGACK output was detected.	17	RSERR	0: Not received. 1: Received.	Indicates whether or not an SERROR signal was received.	18	INVCMD	0: Not detected. 1: Detected	Indicates whether or not, when the target was in operation, an illegal command was detected.	19	STA	0: Not sent out. 1: Sent out.	Indicates whether or not, when the target was in operation, an error transaction was sent out.	20	TAPE	0: Not detected. 1: Detected	Indicates whether or not, when the target was in operation, an address parity error was detected.	21	TDPE	0: Not detected. 1: Detected	Indicates whether or not, when the target was in operation, a data parity error was detected.	22	ME	0: Not detected. 1: Detected	Indicates whether or not, when the target was in operation handling a high-speed bus/S10 bus read, a 2-bit ECC error was detected in memory.	23	NODT ACK	Always 0.	—	24	Reserve	Always 0.	—		
Bit no.	Bit name	Read-in value	Meaning																																																								
0 to 12	Reserve	Always 0.	—																																																								
13	MAAE	0: Not detected. 1: Detected	Indicates whether or not, when the target was in operation, an illegal byte-enable was detected in a write.																																																								
14	Reserve	Always 0.	—																																																								
15	NOACK TO	0: Not detected. 1: Detected	Indicates whether or not a timeout due to no BGACK output within fixed time period was detected.																																																								
16	ACK BUSYTO	0: Not detected. 1: Detected	Indicates whether or not a timeout due to an endless BGACK output was detected.																																																								
17	RSERR	0: Not received. 1: Received.	Indicates whether or not an SERROR signal was received.																																																								
18	INVCMD	0: Not detected. 1: Detected	Indicates whether or not, when the target was in operation, an illegal command was detected.																																																								
19	STA	0: Not sent out. 1: Sent out.	Indicates whether or not, when the target was in operation, an error transaction was sent out.																																																								
20	TAPE	0: Not detected. 1: Detected	Indicates whether or not, when the target was in operation, an address parity error was detected.																																																								
21	TDPE	0: Not detected. 1: Detected	Indicates whether or not, when the target was in operation, a data parity error was detected.																																																								
22	ME	0: Not detected. 1: Detected	Indicates whether or not, when the target was in operation handling a high-speed bus/S10 bus read, a 2-bit ECC error was detected in memory.																																																								
23	NODT ACK	Always 0.	—																																																								
24	Reserve	Always 0.	—																																																								

Item	Description															
LOG (continued from preceding page)	Bit no.	Bit name	Read-in value	Meaning												
	25	MWDPE	0: Not received. 1: Received.	Indicates whether or not, when the CMU was bus master, a write-data parity error notification was received from the target.												
	26	RTA	0: Not received. 1: Received.	Indicates whether or not, when the CMU was bus master, an error transaction was received (and the bus operation was ended).												
	27	TRNSTO	0: Not detected. 1: Detected.	Indicates whether or not, when the CMU was bus master, a transaction timeout was detected (and the bus operation was ended).												
	28	MAPE	0: Not received. 1: Received.	Indicates whether or not, when the CMU was bus master, an address parity error notification was received.												
	29	MRDPE	0: Not detected. 1: Detected.	Indicates whether or not, when the CMU was bus master, a read-data parity error was detected.												
	30	MA	0: Not detected. 1: Detected.	Indicates whether or not, when the CMU was bus master, an address-cycle timeout was detected (and the bus operation was ended).												
	31	BRQTO	0: Not detected. 1: Detected.	Indicates whether or not, when the CMU was bus master, a bus-request timeout was detected (and the bus operation was ended).												
ADR	<div style="display: flex; justify-content: space-between; align-items: center;"> 0 2 3 31 </div> <div style="border: 1px solid black; padding: 5px; margin: 5px 0;"> 0 — 0 ADR </div> <table border="1" style="width: 100%; border-collapse: collapse;"> <thead> <tr> <th>Bit no.</th> <th>Bit name</th> <th>Read-in value</th> <th>Meaning</th> </tr> </thead> <tbody> <tr> <td>0 to 2</td> <td>—</td> <td>Always 0.</td> <td>—</td> </tr> <tr> <td>3 to 31</td> <td>ADR</td> <td>Specified value</td> <td>Is the bus address at which the high-speed bus/S10 bus error occurred.</td> </tr> </tbody> </table>				Bit no.	Bit name	Read-in value	Meaning	0 to 2	—	Always 0.	—	3 to 31	ADR	Specified value	Is the bus address at which the high-speed bus/S10 bus error occurred.
Bit no.	Bit name	Read-in value	Meaning													
0 to 2	—	Always 0.	—													
3 to 31	ADR	Specified value	Is the bus address at which the high-speed bus/S10 bus error occurred.													
DAT	<div style="display: flex; justify-content: space-between; align-items: center;"> 0 31 </div> <div style="border: 1px solid black; padding: 5px; margin: 5px 0;"> DAT </div> <table border="1" style="width: 100%; border-collapse: collapse;"> <thead> <tr> <th>Bit no.</th> <th>Bit name</th> <th>Read-in value</th> <th>Meaning</th> </tr> </thead> <tbody> <tr> <td>0 to 31</td> <td>—</td> <td>Specified value</td> <td>Is the bus data that encountered the high-speed bus/S10 bus error.</td> </tr> </tbody> </table>				Bit no.	Bit name	Read-in value	Meaning	0 to 31	—	Specified value	Is the bus data that encountered the high-speed bus/S10 bus error.				
Bit no.	Bit name	Read-in value	Meaning													
0 to 31	—	Specified value	Is the bus data that encountered the high-speed bus/S10 bus error.													

4 ERROR LOG INFORMATION

Item	Description			
MST				
	Bit no.	Bit name	Read-in value	Meaning
	0 to 18	—	Always 0.	—
	19	CP	0: Other than CMU. 1: CMU.	Indicates whether or not the master that encountered the error was the CMU.
	20 to 23	Reserve	Always 0.	—
	24	SLOT7	0: Other than slot #7. 1: Slot #7.	Indicates whether or not the master that encountered the error was the module mounted in slot #7.
	25	SLOT6	0: Other than slot #6. 1: Slot #6.	Indicates whether or not the master that encountered the error was the module mounted in slot #6.
	26	SLOT5	0: Other than slot #5. 1: Slot #5.	Indicates whether or not the master that encountered the error was the module mounted in slot #5.
	27	SLOT4	0: Other than slot #4. 1: Slot #4.	Indicates whether or not the master that encountered the error was the module mounted in slot #4.
	28	SLOT3	0: Other than slot #3. 1: Slot #3.	Indicates whether or not the master that encountered the error was the module mounted in slot #3.
CMD				
	Bit no.	Bit name	Read-in value	Meaning
	0 to 19	—	Always 0.	—
	20 to 23	BE	Specified value.	Is the byte enable that encountered the error.
	24 to 27	—	Always 0.	—
28 to 31	CMD	Specified value.	Is the bus command that encountered the error.	

Item	Description			
MST				
	Bit no.	Bit name	Read-in value	Meaning
	0 to 20	—	Always 0.	
	21	MAAE	0: Not detected. 1: Detected	Indicates whether or not, when the target was in operation, an illegal byte-enable was detected in a write.
	22 to 23	Reserve	Always 0.	
	24	ACKBUSYTO	0: Not detected. 1: Detected.	Indicates whether or not a “BGACK busy” timeout was detected.
	25	RSERR	0: Not received. 1: Received.	Indicates whether or not an SERROR signal was received.
	26	INVCMD	0: Not received. 1: Received.	Indicates whether or not, when the target was in operation, an illegal command was detected.
	27	STA	0: Not sent out. 1: Sent out.	Indicates whether or not, when the target was in operation, an error transaction was sent out.
	28	TAPE	0: Not received. 1: Received.	Indicates whether or not an address parity error was detected.
	29	TDPE	0: Not received. 1: Received.	Indicates whether or not, when the target was in operation, a write-data parity error was detected.
	30	ME	0: Not received. 1: Received.	Indicates whether or not, when the target was in operation handling a high-speed bus/S10 bus read, a 2-bit ECC error was detected in memory.
	31	NODTACK	0: Not received. 1: Received.	Indicates whether or not, after the start of the S10 bus, a timeout due to no DTACK output was detected.

4 ERROR LOG INFORMATION

Item	Description			
ENSLV				
	Bit no.	Bit name	Read-in value	Meaning
	0 to 20	—	Always 0.	—
	21	MAAE	0: Not reported. 1: Reported.	Indicates whether or not a misalignment error was detected during target operation and reported as a serious error. (Related only to the CMU.)
	22 to 23	Reserve	Always 0.	—
	24	ACK BUSYTO	0: Not reported. 1: Reported.	Indicates whether or not a “BGACK busy” timeout was detected by the CPU and reported as a serious error. (Related only to the CMU.)
	25	RSERR	0: Not reported. 1: Reported.	Indicates whether or not an SERROR assertion was detected and reported as a serious error. (Related only to the CMU.)
	26	INVCMD	0: Not reported. 1: Reported.	Indicates whether or not an illegal command was detected during target operation and reported as a serious error. (Related only to the CMU.)
	27	STA	0: Not reported. 1: Reported.	Indicates whether or not an error transaction response was detected during target operation and reported as a serious error. (Related only to the CMU.)
	28	TAPE	0: Not reported. 1: Reported.	Indicates whether or not an address parity error was detected during target operation and reported as a serious error. (Related only to the CMU.)
	29	TDPE	0: Not reported. 1: Reported.	Indicates whether or not a write-data parity error was detected during target operation and reported as a serious error. (Related only to the CMU.)
	30	ME	0: Not reported. 1: Reported.	Indicates whether or not a 2-bit ECC error was detected during target operation and reported as a serious error. (Related only to the CMU.)
	31	NODTACK	0: Not reported. 1: Reported.	Indicates whether or not an NODTACK timeout was detected by the CPU and reported as a serious error. (Related only to the CMU.)

Item	Description										
RBUSMNT											
	Bit no.	Bit name	Read-in value	Meaning							
	0 to 18	—	Always 0.	—							
	19	CP	0: Other than CMU. 1: CMU.	Indicates whether or not the current master executing a bus transaction was the CMU.							
	20 to 23	Reserve	Always 0.	—							
	24	SLOT7	0: Other than slot #7. 1: Slot #7.	Indicates whether or not the current master executing a bus transaction was the module mounted in slot #7.							
	25	SLOT6	0: Other than slot #6. 1: Slot #6.	Indicates whether or not the current master executing a bus transaction was the module mounted in slot #6.							
	26	SLOT5	0: Other than slot #5. 1: Slot #5.	Indicates whether or not the current master executing a bus transaction was the module mounted in slot #5.							
	27	SLOT4	0: Other than slot #4. 1: Slot #4.	Indicates whether or not the current master executing a bus transaction was the module mounted in slot #4.							
	28	SLOT3	0: Other than slot #3. 1: Slot #3.	Indicates whether or not the current master executing a bus transaction was the module mounted in slot #3.							
	29	SLOT2	0: Other than slot #2. 1: Slot #2.	Indicates whether or not the current master executing a bus transaction was the module mounted in slot #2.							
	30	SLOT1	0: Other than slot #1. 1: Slot #1.	Indicates whether or not the current master executing a bus transaction was the module mounted in slot #1.							
31	SLOT0	0: Other than slot #0. 1: Slot #0.	Indicates whether or not the current master executing a bus transaction was the module mounted in slot #0.								

Table 4-36 Error Codes

No.	Error code	Subtitle	Meaning
1	EC=03b80001	System Bus Error (CPU Master)	When it was master, the CPU went down due to the occurrence of a serious error on the system bus.
2	EC=03b80002	System Bus Error (CPU Target)	When the CPU was target, a serious error was detected on the system bus.
3	EC=03b70000	System Bus Error (Master/Target Abort)	When the CPU was master, a master or a target abort was detected on the system bus.

4 ERROR LOG INFORMATION

(15) Other error

This type of error is one that is output by the user. The ECs and their meanings for other errors are defined by the user.

Table 4-37 Other-Error Message Format

```

%xxxx-x-xxxx-xxxx  SITE=xxxxxxxxxxxxxxxx RC=xxxxxxx  yyyy/mm/dd hh:mm:ss
LOG=xxx
EC=xxxxxxxx
0x0000000  xxxxxxxx xxxxxxxx xxxxxxxx xxxxxxxx ~ xxxxxxxxxxxxxxxxxxxx ~
0x0000010  xxxxxxxx xxxxxxxx xxxxxxxx xxxxxxxx ~ xxxxxxxxxxxxxxxxxxxx ~
0x0000020  xxxxxxxx xxxxxxxx xxxxxxxx xxxxxxxx ~ xxxxxxxxxxxxxxxxxxxx ~
0x0000030  xxxxxxxx xxxxxxxx xxxxxxxx xxxxxxxx ~ xxxxxxxxxxxxxxxxxxxx ~
0x0000040  xxxxxxxx xxxxxxxx xxxxxxxx xxxxxxxx ~ xxxxxxxxxxxxxxxxxxxx ~
0x0000050  xxxxxxxx xxxxxxxx xxxxxxxx xxxxxxxx ~ xxxxxxxxxxxxxxxxxxxx ~
0x0000060  xxxxxxxx xxxxxxxx xxxxxxxx xxxxxxxx ~ xxxxxxxxxxxxxxxxxxxx ~
0x0000070  xxxxxxxx xxxxxxxx xxxxxxxx xxxxxxxx ~ xxxxxxxxxxxxxxxxxxxx ~
~

```

RC: Return Code

EC: Error Code

Title: Is presented in the output format shown below. If the data for the title is unrecognizable by the CPMS, the title is presented in hexadecimal format.

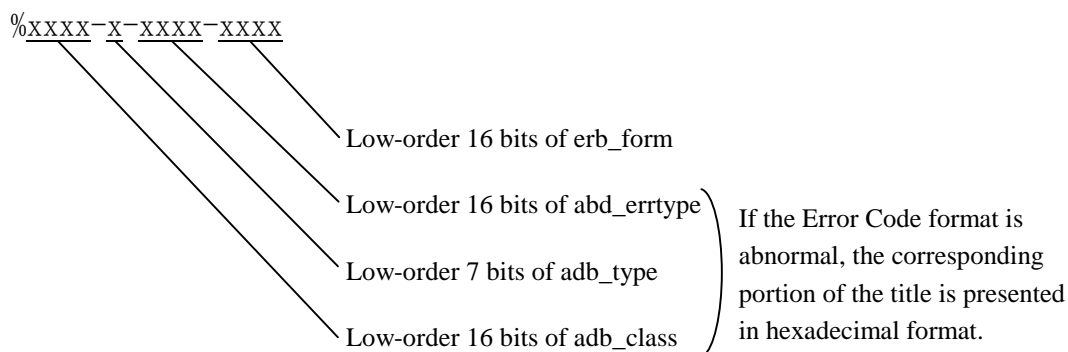

4.4.4 Reading the DHP trace information

DHP trace information is displayed in the following format:

- The DHP facility displays trace information in reverse chronological order.
- DHP trace information is classified into three categories of task, idle, and OS, based on DISPATCH_E events.
- For each DISPATCH_E event, DATA1 values in the range 0x00000001 to 0x0000012C are the task numbers of tasks executed.
- Time information is displayed in seconds and fractions of a second, up to six decimal places (i.e., microseconds).
- For information on the one-to-one correspondence between DHP events and data pieces, see Table 4-38.

<Example of DHP display>

Shown below is an example of a DHP display. Under the heading “Operation explanation” is explained what task was executed and what the OS did for tasks.

								Operation explanation
	165	40.901912	TASK_PRI	112	10	00000071	00000032	Task 112 placed into execution.
	166	40.901901	RLEAS	112	10	00000071		
New ↑	167	40.901883	DISPATCH_E	112	10	00000070	00000032 84DB2000 00000002	
	168	40.901868	DISPATCH	111	10	0000006F	00000032 84DAF000	
	169	40.901832	DISPATCH_E	111	10	0000006F	00000032 84DAF000 00000002	The OS aborted task 111 and placed task 112 into execution.
	170	40.901815	RUNQ	112	10	00000070		
	171	40.901810	DISPATCH	112	10	00000070	00000032 84DB2000	
	172	40.901796	RUNQ	112	10	0000006F		
	173	40.901785	WAKEUP	112	10	F0000000		
	174	40.901771	ABORT	112	10	0000006F		Task 112 placed into execution.
	175	40.901748	GFACT	112	10	00000003		
	176	40.901727	DISPATCH_E	112	10	00000070	00000032 84DB2000 00000002	
	177	40.901703	DISPATCH	111	10	0000006F	0000001C 84DAF000	The OS delayed task 111 and placed task 112 into execution.
	178	40.901691	TASK_PRI	111	10	0000006F	0000001C 00000000	
	179	40.901611	DELAY	111	10	00000BB8		
	180	40.901600	RUNQ	111	10	00000070		
	181	40.901590	QUEUE	111	10	00000070	00000003	Task 111 placed into execution.
	182	40.901579	TASK_PRI	111	10	00000070	00000032	
	183	40.901568	RLEAS	111	10	00000070		
	184	40.901546	GFACT	111	10	00000002		
	185	40.901525	DISPATCH_E	111	10	0000006F	00000032 84DAF000 00000002	
	186	40.901507	DISPATCH	110	10	0000006E	00000032 84DAC000	The OS placed task 110 in wait state and task 111 into execution.
	187	40.901493	SLEEP	110	10	841C982C	00000032	
	188	40.901483	WAIT	110	10	5004502C		
	189	40.901471	RUNQ	110	10	0000006F		Task 110 placed into execution.
	190	40.901459	QUEUE	110	10	0000006F	00000002	
	191	40.901446	TASK_PRI	110	10	0000006F	00000032	
	192	40.901434	RLEAS	110	10	0000006F		
	193	40.901408	DISPATCH_E	110	10	0000006E	00000032 84DAC000 00000001	
	194	40.901399	RUNQ	110	10	0000006E		The OS terminated task 119 and placed task 110 into execution.
	195	40.901393	DISPATCH	110	10	0000006E	00000032 84DAC000	
	196	40.901373	DISPATCH_E	110	10	0000006E	00000032 84DAC000 00000002	
	197	40.901348	DISPATCH	119	10	00000077	00000032 84DC7000	
	198	40.901323	EXIT	119	10			
	199	40.901311	RUNQ	119	10	0000006E		Task 110 placed into execution.
	200	40.901300	WAKEUP	119	10	841C982C		
Old ↓	201	40.901288	POST	119	10	5004502C	00001234	

4 ERROR LOG INFORMATION

Table 4-38 DHP Codes (1/4)

● CPMS processing -- tracing							
Code value	DHP display name	Trace point	DATA1	DATA2	DATA3	DATA4	DATA5
0x010001	TRACE_ON	Start of tracing					
0x010002	TRACE_OFF	Stop of tracing					
0x010003	TRACE_TBU	Time recording	old tbu (Time Base Upper)	new tbu (Time Base Upper)			
● CPMS processing -- scheduling							
Code value	DHP display name	Trace point	DATA1	DATA2	DATA3	DATA4	DATA5
0x020001	WAKEUP	WAKEUP processing	WAKEUP address				
0x020002	SLEEP	SLEEP event	SLEEP address	pri (priority level)			
0x020003	DISPATCH	Before thread_invoke processing	tn (task number)	pri (priority level)	cont (CPMS stack information)		
0x020008	DISPATCH_E	After thread_invoke processing	tn (task number)	pri (priority level)	cont (CPMS stack information)		
0x020004	RUNQ	RUNQ connection	tn (task number)				
0x020005	IDLE	IDLE processing					
0x020006	TASK_PRI	Priority level control	tn (task number)	pri (priority level)			
● CPMS processing -- error logging and built-in subroutine-related processing							
Code value	DHP display name	Trace point	DATA1	DATA2	DATA3	DATA4	DATA5
0x030001	ULSUBLN	Before built-in subroutine linking	Calls to the same built-in subroutine during its execution	Built-in subroutine point number			
0x030081	ULSUBLN_E	After built-in subroutine linking	Calls to the same built-in subroutine during its execution	Built-in subroutine point number	Built-in subroutine return value		
0x030002	ELSETK	elset processing	Error type	Error class	Error format	Error code	
0x030003	IOERR	I/O error handling	uno (unit number)	Device number	Device address	Detail error code	
0x030004	PRGERR	Program error handling	tn (task number)	Fault address	Program counter	Program counter	
0x030005	WDTERR	WDT error handling	time				
0x030006	PIOERR	PIO error handling	slot				
0x030007	MODERR	Module error handling	Error code	Slot number	HERST register	INTST register	
0x030008	KERN_PANIC	Panic handling	tn (task number)	Fault address	Program counter	Extension error code	
0x030009	ULSUB_ERR	Built-in subroutine error handling	Built-in subroutine point number				
0x03000a	ASSERT	Assertion panic handling	Component in which the error occurred	Line in which the error occurred	Test condition		
0x03000b	CPUSTOP	CPU stoppage handling	Calls to the same built-in subroutine during its execution	Built-in subroutine point number	Built-in subroutine return value		
● CPMS processing -- startup and stop processing							
Code value	DHP display name	Trace point	DATA1	DATA2	DATA3	DATA4	DATA5
0x040001	SETUP_MAIN	Startup processing	Always 1				
0x040002	HDUTL_STOP	Stop processing					
0x040003	HDUTL_RSUM	Restart processing					
0x040004	HDUTL_ERR	ERROR handling					
● CPMS processing -- exception handling							
Code value	DHP display name	Trace point	DATA1	DATA2	DATA3	DATA4	DATA5
0x050001	EXCEPTION	Exception handling	Exception type				
0x050002	SLJH_SRES	System reset exception	NMI cause register	Program counter			
0x050005	SLJH_SM	System management interrupt exception	MSW register				
0x050007	SLJH_HERR	Serious-error interrupt handling	Serious-error cause register				

Table 4-38 DHP Codes (2/4)

Code value	DHP display name	Trace point	DATA1	DATA2	DATA3	DATA4	DATA5
0x100000	NOSYS	Undefined macro issued					
0x100001	QUEUE	queue macro issued	tn (task number)	fact (start factor)			
0x100002	RELEASE	reas macro issued	tn (task number)				
0x100003	SFACT	sfact macro issued	tn (task number)	fact (start factor)			
0x100004	ABORT	abort macro issued	tn (task number)				
0x100005	SUSP	susp macro issued	tn (task number)				
0x100006	RSUM	rsun macro issued	tn (task number)				
0x100007	CTIME	ctime macro issued	tn (task number)	fact (start factor)			
0x100008	WAIT	wait macro issued	ecb (ECB address)				
0x100009	POST	post macro issued	ecb (ECB address)	pcode (post code)			
0x10000a	TIMER	timer macro issued	id (event type)	tn (task number)	fact (start factor)		cyt (cycle time)
0x10000b	DELAY	delay macro issued	t (milliseconds)				
0x10000c	STIME	stime macro issued	year (year)	month (month)	day (day)		
0x10000d	CHAP	chap macro issued	tn (task number)	chgp (priority level)			
0x10000e	RSERV	rserv macro issued	n (the number of shared resources)	para1	para2	para3	para4
0x10000f	FREE	free macro issued	n (the number of shared resources)	para1	para2	para3	para4
0x100010	PRSERV	prserv macro issued	n (the number of shared resources)	para1	para2	para3	para4
0x100011	PFREE	pfree macro issued	n (the number of shared resources)	para1	para2	para3	para4
0x100012	GFAC	Before or after the issuance of gfact macro	fact (start factor)				
0x100013	GTIME	gtime macro issued	time (time_t address)				
0x100014	EXIT	exit macro issued					
0x100015	ASUSP	asusp macro issued					
0x100016	ARSUM	arsun macro issued					
0x10001e	DHPCCTL	dhpctl macro issued	cmd (command)	id (trace range)	Trace info output address		
0x10001f	DHPREAD	dhpread macro issued	Logical address	size			
0x100023	CHML	chml macro issued	Logical address	para1	para2	para3	para4
0x100056	CFREAD	Flash-memory read	Sector number	size	Buffer address		
0x100057	CFWRITE	Flash-memory write	Sector number	size	Buffer address		

● CPMS processing -- RPPD processing

Code value	DHP display name	Trace point	DATA1	DATA2	DATA3	DATA4	DATA5
0x200004	SETTCB	setcb macro issued	ID number of the task table to be registered	The number of tasks to be registered	Task management table address		
0x200005	CLRTCB	clrtcb macro issued	tn (task number)				
0x200006	ADTSET	adtset macro issued	ADT mode (1: Set; 2: Delete)	Set channel	Set address	Address mask pattern	Mode (1: Read; 2: Write; 3: Read/write)
0x200007	ADTREAD	adtread macro issued	Register storage area address	ADTB storage area address	Instruction code address		
0x200008	SETBRK	setbrk macro issued	Mode (1: Set; 2: Delete)	Breakpoint address			
0x200009	GETBRK	getbrk macro issued	Mode (0: Usual read; 1: Break test-read)	Breakpoint read destination address			
0x20000a	GOTASK	gotask macro issued					
0x20000c	REGSET	Task register setting	Register	Data address			

4 ERROR LOG INFORMATION

Table 4-38 DHP Codes (3/4)

Code value	DHP display name	Trace point	DATA1	DATA2	DATA3	DATA4	DATA5
0x300001	SOCKET	SOCKET macro issued	unit (unit number)	Type	Protocol	Work area	Work area
0x300002	BIND	BIND macro issued	Socket ID	Port number	IP address	Work area	Work area
0x300003	LISTEN	LISTEN macro issued	Socket ID	Maximum number of waits for connection	Work area	Work area	Work area
0x300004	ACCEPT	ACCEPT macro issued	Socket ID	Address info pointer	Address info length	Work area	Work area
0x300005	CONNECT	CONNECT macro issued	Socket ID	Port number	IP address	Work area	Work area
0x300006	SEND	SEND macro issued	Socket ID	Buffer address	Upper word: Data length Lower word: Transmission flags	Work area	Work area
0x300007	SENDTO	SENDTO macro issued	Socket ID	Upper word: Data length Lower word: Transmission flags	Port number	IP address	Internal task info
0x300008	RECV	RECV macro issued	Socket ID	Buffer address	Upper word: Data length Lower word: Reception flags	Work area	Work area
0x300009	RECVFROM	RECVFROM macro issued	Socket ID	Buffer address	Upper word: Data length Lower word: Reception flags	Address info pointer	Address info length
0x30000a	SETSOCKOPT	SETSOCKOPT macro issued	Socket ID	Level	Options	Option info address	Option info length address
0x30000b	GETSOCKOPT	GETSOCKOPT macro issued	Socket ID	Level	Options	Option info address	Option info length address
0x30000c	SHUTDOWN	SHUTDOWN macro issued	Socket ID	Socket shutdown method	Work area	Work area	Work area
0x30000d	NET_END	Macroabend	Socket ID	Error number	Work area	Work area	Work area
0x300010	NET_CTLR	IOCTL macro issued	Unit number and slot number	Control info	Control info	Control info	Control info
0x300010	NET_CTLR	Remote CPU control accepted	Station number and command	Frame length and transmission no.	Controlled type and data length	Data address	Work area
0x300011	NET_START	NCP-F/I/O start	Socket ID	Task info	Command code and socket status	Start info 1	Start info 2
0x300011	NET_START	Built-in LANCE/LANCP transmission	Socket ID+ETHER_TYPE	Packet header info			
0x300012	NET_TERM	NCP-F termination interrupt	Socket ID	Task info	Response info	Status code	Interrupt info
0x300012	NET_TERM	Built-in LANCE/LANCE termination interrupt	Socket ID+FFFF	LANCE descriptor info (TMD0, TMD1, TMD2, TMD3)			
0x300013	NET_ATEN	NCP-F attention interrupt	Socket ID	Task info	Response info	Status code	Interrupt info
0x300013	NET_ATEN	Built-in LANCE/LANCP reception	Socket ID+ETHER_TYPE	Packet header info			
0x300014	NET_STO	Software timeout	Socket ID	Task info	Start info	Start info	Start info
0x300015	NET_SUB	Error detected	Error type	Error info	Error info	Error info	Error info

● RCTLNET (network driver) processing

Table 4-38 DHP Codes (4/4)

● CPMS library processing							
Code value	DHP display name	Trace point	DATA1	DATA2	DATA3	DATA4	DATA5
0x500028	WDTSET	wdtset macro issued	WDT monitoring time				
0x500032	WRTMEM	wrtmem macro issued	Transfer source address	Transfer destination address	Transfer size (bytes)		
● User-specific processing							
Code value	DHP display name	Trace point	DATA1	DATA2	DATA3	DATA4	DATA5
0x600000	USR0	User-defined					
0x600001	USR1	User-defined					
0x600002	USR2	User-defined					
0x600003	USR3	User-defined					
0x600004	USR4	User-defined					
0x600005	USR5	User-defined					
0x600006	USR6	User-defined					
0x600007	USR7	User-defined					

4 ERROR LOG INFORMATION

4.5 Maintenance Commands

<Name>

svelog -- output error log information.

<Form>

svelog [-u site] [-f format] [-logno] [+case] [-d fname] [-o fname]

one screenful of error log information

{ p }

{ - }

{ ±nl }

{ n }

{ no input }

{ q }

<Description>

The svelog command reads error log information from the error log buffer in the controller and outputs it. The following are the options usable in this command.

-u site: Specifies the site name of the site to be acted on. This option is defaulted to the site name specified in the RSSITE environment variable.

-f format: Selects one of the following output formats in which to output the error log information. This option is defaulted to m.

s: Outputs the error information in short format.

m: Outputs all the error information.

l: Outputs the error information along with the DHP trace information.

-logno: Outputs the error log information whose log number is specified by logno.

+case: Specifies the number of log cases to be displayed. This option is defaulted to “all existing error log information”, in which case the option displays it in reverse chronological order.

-d fname: Specifies a file in which to store the history of window operations (results of the operations). If the specified file is already existent, this option adds the new history data to the end of the existing file.

-o fname: Specifies a file in which to store the error log information. If the specified file is already existent, this option deletes the existing file and creates a new file.

The display of the error log information can be controlled by using the following perusal commands:

p, no input: Each displays the next page.

-: Displays the previous page.

n: Displays the information, starting from the n-th line from the beginning of the file.

q: Exits the error log display process.

<Usage precautions>

- The svelog command can be used only when the user task is in RUN or STOP state.
- If the log number specified by -logno is greater than that of the latest error log information, the -logno option displays the latest error log information.
- If both of the options -logno and +case are given, the +case option has priority.
- If the -f format option is omitted, m is assumed.

<Exit codes>

The svelog command returns one of the following exit codes at the end of its execution:

0: Normal termination made.

1: Parameter error detected.

2: Communication error detected.

3: Signal received.

4 ERROR LOG INFORMATION

<Name>

svdhp -- display DHP trace information.

<Form>

svdhp [-u site] [+count] [-on|-off] [-d fname] [-o fname] [-f fname]

one screenful of DHP information

{ p }

{ - }

{ ±nl }

{ n }

{ no input }

{ q }

<Description>

The svdhp command displays in reverse chronological order the DHP trace information that is stored in the DHP trace buffer inside the PCs. The following are the options usable in this command.

-u site: Specifies the site name of the site to be acted on. This option is defaulted to the site name specified in the RSSITE environment variable.

+count: Displays only the trace information piece specified by count. This option is defaulted to “all existing trace information”.

-on: Changes the DHP recording mode to “enable”.

-off: Changes the DHP recording mode to “disable”.

-d fname: Specifies a file in which to store the history of window operations (results of the operations). If the specified file is already existent, this option adds the new history data to the end of the existing file.

-o fname: Specifies a file in which to store the DHP display result. If the specified file is already existent, this option deletes the existing file and creates a new file.

-f fname: Specifies the file name of a DHP log input file. When specifying this file name, specify an S10V site name as the site name.

The following is an example program using dhpread:

<Example program>

```
#include <cpms_dhp.h>
extern char dhp_g[4096];
main(){
    long size;
    size=4096;
    dhpread(dhp_g, &size);
}
```

The display of the DHP trace information can be controlled by using the following perusal commands:

p, no input: Each displays the next page.

-: Displays the previous page.

n: Displays the information, starting from the n-th line from the beginning of the file.

q: Exits the DHP display process.

The svdhp command presents the DHP trace information in the following output format:

```
Debugging helper trace list      [XXXXXX]      Tue Oct 31 15:37:05 2001
                                ⑦
DHP TIME      EVENT      TN LV DATA1  DATA2  DATA3  DATA4  DATA5
nnnn tt. tttttt  ssssssssss xxx xx xxxxxxxx xxxxxxxx xxxxxxxx xxxxxxxx xxxxxxxx
① ② ③ ⑤ ⑥ ④
```

- ① ID number of a DHP trace info display
- ② Time of tracing done:

tt. tttttt	tt. tttttt
Seconds	Microseconds
- ③ Trace point type
- ④ Trace data (output in hexadecimal format)
- ⑤ Task number
- ⑥ Priority level
- ⑦ Site name, or the file name when the -f option was given.

4 ERROR LOG INFORMATION

<Usage precaution>

- When the -on or -off option is given, this command does not display any DHP trace information.

<Exit codes>

The svdhp command returns one of the following exit codes at the end of its execution:

- 0: Normal termination made.
- 1: Parameter error detected.
- 2: Communication error detected.
- 3: Signal received.

<Name>

svcpunow -- display the CMU's load ratio.

<Form>

svcpunow [-u site] [-t second]

<Description>

The svcpunow command obtains accumulated IDLE time and point-in-time information for a specified site (CMU), computes a load ratio from the obtained information, and displays the result.

Computation formula used:

PU load ratio = (measuring time - IDLE time) / measuring time

The following are the options usable in this command.

-u site: Specifies the site name of the site to be acted on. This option is defaulted to the site name specified in the RSSITE environment variable.

-t second: Specifies a measuring time in seconds (in the range 1 to 3600) for use in computing a PU load ratio. This option is defaulted to 1 (second).

<Usage precaution>

The svcpunow command cannot be input if another svcpunow command is already executing.

<Exit codes>

The svcpunow command returns one of the following exit codes at the end of its execution:

0: Normal termination made.

1: Abnormal termination made.

2: Communication error detected.

3: Signal received.

<Output format>

The svcpunow command uses the output format exemplified below.

```
2002/04/24 17:57:33 SITE=pcs01b_cp ** 1 second wait **
CPU(pcs01b_cp) load ratio = 0.06%
```

4 ERROR LOG INFORMATION

<Name>

svtimex -- display task utilization information.

<Form>

```
svtimex [-u site] [tn] [-t second]
[tname]
```

<Description>

The svtimex command displays the following task utilization information: 1) the number of times a specified task was executed during a specified measuring time, 2) the accumulated execution time during that time period, and 3) the point in time at which the svtimex command is executed.

The following are the options usable in this command.

-u site: Specifies the site name of the site to be acted on. This option is defaulted to the site name specified in the RSSITE environment variable.

tn: Specifies a task number in the range 1 to 255, which must be expressed either in decimal or hexadecimal (prefixed with "0x") format.

tname: Specifies a task name.

If neither of the tn and tname options is given, this command enters conversational mode and prompts you to enter a measuring time. Enter the desired measuring time value in the range 1 to 86400. Then, the command prompts you to enter task names or task numbers. You can enter up to 10 task names or numbers. Then, when you execute the svtimex command, just press the [Enter] key at the prompt.

-t second: Specifies a task utilization measuring time in seconds (in the range 1 to 86400). This option is defaulted to 1 (second).

<Usage precautions>

- If the -t option is entered to specify a measuring time, also enter the tn (task number) or tname (task name) option.
- The svtimex command is not accepted if another svtimex command is already executing.
- The tn and tname options may not be used in combination (i.e., they are mutually exclusive). In conversational mode, up to 10 task names or task numbers may be entered.

<Exit codes>

The svtimex command returns one of the following exit codes at the end of its execution:

- 0: Normal termination made.
- 1: Abnormal termination made.
- 2: Communication error detected.
- 3: Signal received.

<Output format>

The svtimex command presents task utilization information in the following output format:

```
2002/04/24 18:02:18 SITE=pcs01b_cp ** 1 second wait **  
sist(255) load ratio=0.00% execute count=0 total time=0.000sec average time=0.000sec
```

THIS PAGE INTENTIONALLY LEFT BLANK.

5 APPENDIX

5.1 Tool Error Messages

5.1.1 Error messages from the LADDER CHART SYSTEM

Error message	Required action
Specify the key code that is not multidefined.	Use a non-duplicated key code.
This key code cannot be used. Use numeric or alphabet.	Use the correct key code.
<File name> Cannot loaded this library.	Restart the LADDER CHART SYSTEM and try it again. If the same error recurs, reinstall the LADDER CHART SYSTEM.
Input number.	Enter a numeric value.
Not compiled after changed.	Compile it.
Shortage of resource	Restart the personal computer and try it again.
Use after compile edited N coil.	Compile it.
Error Specify PI/O Symbol.	Use the correct PIO symbol.
<File name> Specified file is wrong.	Specify the correct file.
Ncoil Number is irregular (0-%X)	Use the correct N-coil number.
Cannot use this function in offline.	Switch the operation mode to online.
Cannot use this function in online.	Switch the operation mode to offline.
No change can be made with monitor window open.	Close both the MSC and monitor windows.
This function can be used offline only after compilation.	Compile it.
This processing can be used only when it agrees with PCs data completely. Send or receive data.	Carry out either data transmission or reception.
Rewrite failed under RUN status.	Check the connection with the PCs.
A specified symbol is illegal.	Specify the correct symbol.
Saving in PSE file is not supported.	Save it in the supported file format (wsvl format).
PCs type error.	Check if it is an S10V ladder program. If not, use an S10V ladder program.
It damaged with the Send history file whether there is not it.	Use the correct or a non-damaged file.
It is broken whether file form appointed is wrong.	Use the correct or a non-damaged file.
Input symbol name.	Enter a symbol name.
The specified extension has not supported.	Use a supported extension.

Error message	Required action
It failed in time read-out (timeout error).	Reinstall the LADDER CHART SYSTEM.
Time information is unfixed.	Set a time value by using the BASE SYSTEM.
The number of label registration exceeded maximum.	Check the registered labels.
N coil number is outside the range.	Use the correct N-coil number.
A label name overlaps within same N coil.	Use a non-duplicated label name.
The timeout occurred during ladder program rewriting.	Check the connection with the PCs.
It failed in rewriting of a ladder program.	
I/O comment storing area is not secured.	Secure an I/O comment area.
I/O comment file which transmits are too large. (I/O comment area Size: xx Byte)	Check the I/O comment file.
Abnormalities occurred during collection of a sequence cycle time.	Check the connection with the PCs.
It failed in preservation of sequence cycle time collection data.	Check the specified file.
An extension is invalid.	Use the correct extension.
I/O comment storing area is too small (xx Byte is insufficient).	Expand the I/O comment area.
A page number is abnormal.	Use the correct page number.
A circuit number is abnormal.	Use the correct circuit number.
"%s" of a system extension operation function is not mounted.	Check if an optional module necessary for the system extension arithmetic function is installed.
Read Error	Check the connection with the PCs.
Communication error	
%s is Used at %s. The unit cannot be put online.	Wait for its use to come to an end, or, by selection, forcibly release it from the exclusively used state.
Canceling occupancy of PCs failed.	Restart this tool and, by selection, forcibly release the PCs from the exclusively used state. To accomplish this, both the personal computer and S10V controller need to be in a connected state.

5 APPENDIX

Error message	Required action
It failed in check sum setup.	Check the connection with the PCs.
It failed in the setup of transmitting time.	
It failed in time read-out (timeout error).	
Cannot find system file	Check the specified file.
Type of PCs disagrees	Specify a file provided for use with the S10V controller.
Number of PCs disagrees	Check the PCs number.
Capacity of disc is insufficient.	Terminate some of the active application programs and try it again.
This address value cannot be specified. Setup address once more.	Set the correct address.
This name cannot be used	Use a different name.
If you use ufet data at editing circuit, you must restart system.	To use the set UFET data in circuit editing, receive it from the PCs.
An operation function address overlaps.	Use a non-duplicated arithmetic (operation) function address.
An operation function name overlaps.	Use a non-duplicated arithmetic (operation) function name.
Operation function registration address range excess	Use a valid arithmetic (operation) function address.
There is no user operation function registration area.	Define a user arithmetic (operation) function area through interaction with the "Change capacity" window.
It failed in rewriting of a ladder program.	Check the connection with the PCs.
The timeout occurred during ladder program rewriting.	
It failed in time read-out (timeout error).	
Please set up in even-number size.	Set the size by specifying an even number.
The sum total of the specified area size is too large.	Check the area size.
Please enter an integer between xx and xx.	Enter an integer in the range xx to xx.
Error in the range of branch code.	Correct the erroneous circuit.
Relay code is irregular.	
Function type code is illegal.	
Error in changing timer.	Set each timer to a value in the range 1 to 9999.
Error in changing one shot.	
Error in changing counter.	

Error message	Required action
Setting value of timer is illegal.	Enter the timer value again.
Setting value of one shot is illegal.	Enter the one-shot timer value again.
Setting value of counter is illegal.	Enter the counter value again.
Parameter is irregular in operation function.	Specify the correct parameter.
Number of parameters over limit in operation function.	Specify only as many parameters as permitted.
PI/O address error in operation function.	Specify a symbol number in the permitted range.
Address error in user operation function.	Correct the erroneous circuit.
Address error in system operation function.	
Unregistered operation function.	Use only a specifiable arithmetic (operation) function.
Number of parameters disagrees in operation function.	Specify only as many parameters as permitted.
Irregular format was found in operation function.	Specify it in the correct format for the arithmetic (operation) function.
Failed in changing absolute address to character string.	Correct the erroneous circuit.
Immediate data is out of range	Specify an immediate data value in the range permitted for the word type of data.
A number of long register extends into word boundary.	Specify a register number not violating word boundaries.
Error in range of branch code.	Correct the erroneous circuit.
Address error in N coil or P coil.	Use a number in the range 01 to 0x99 for the N-coil, or in the range 01 to 0x80 for the P-coil.
Function type "X", "J", "S" is used to coil.	Specify only a permitted register for the coil.
Error in PI/O address.	Change the register number to a permitted value.
Error in PI/O address of counter.	Specify a counter number in the range 0 to 0xFF.
Error in PI/O address of nesting.	Specify a nesting coil number in the range 0 to 0x99.
Error in PI/O address of P coil.	Specify a P-coil number in the range 0 to 0x80.
Except function type "K" is used to set coil or reset coil.	Use a K-register.
Except function type "V", "LV" is used for rising edge contact or falling edge contact.	Use a V- or an LV-register.

5 APPENDIX

Error message	Required action
Function type "C", "K", "N" cannot be applied to coil.	Specify only a permitted register for the coil.
Function type "CU", "CD", "CR", "NM", "NZ" cannot be applied to connecting point A or B.	Specify only a permitted register for the a- or b-contact.
Function type "V", "LV" cannot be used except to rising edge contact or falling edge contact.	Use a register other than the V- and LV-registers.
Exceeded in maximum number of rows for one circuit.	Construct one single circuit of up to 16 lines.
Cannot compensate because column position is full.	Reduce the number of symbols used in the single line.
Exceeded in maximum number of rows for one circuit.	Construct one single circuit of up to 16 lines.
Exceeded in number of rows for one circuit in the process of compensation.	Construct one single circuit of up to 16 lines.
No effective circuit data is included.	The ladder chart may have been destroyed. End the ladder chart without saving, and read it in again. Then, if the same error recurs, create the ladder chart again.
Setup error in N coil.	Compile the ladder chart again.
Error in getting information about SQET setup value.	Compile the ladder chart again.
Error in disagreement in branch connecting top to bottom.	Match the number of downward/upward branches between the two successive lines (downward branches in the one line and upward branches in the next line) in the circuit.
Error in disagreement in branch connecting to last row.	Correct the circuit so that the last line in the circuit does not contain a downward branch.
Connection between left and right is irregular.	Correct the circuit so that it is not broken in its middle.
Irregular usage of turn mark.	Use wraparound marks in both the last box of the line whose end is wrapped around to the beginning of the next line, and the first box of that next line. Alternatively, correct the circuit so that no parallel logic path is wrapped around.
Branch of top and bottom was used in the line after turn.	Correct the circuit so that the line to which the preceding line is wrapped around is a serial logic path.
Area for sequence program is too long.	Increase the ladder program size or reduce the number of circuits used.

Error message	Required action
Cannot read sequence program.	The ladder chart may have been destroyed. End the ladder chart without saving, and read it in again. Then, if the same error recurs, create the ladder chart again.
Cannot read SQET.	
Cannot read setup value of timer.	
Cannot read setup value of one shot.	
Cannot read setup value of counter.	
Information about SQET is not created.	
Error in multiple output of coils.	Specify a coil not in use.
Error occurred in receiving data of sequencer program.	Check the connection with the PCs.
Error occurred in sending data of sequencer program.	
No file.	Specify an existing file.
The circuit which includes this error is deleted.	Correct the erroneous circuit.
PEND is added to ladder program because the number of SEND exceeded the limit.	Compile the ladder chart again.
SQET information is damaged. SQET information is made from the ladder program.	Compile the ladder chart again.
The ladder program is damaged. SEND is added to the ladder program.	Compile the ladder chart again.
Cannot open this file PCs type is not correct.	Specify a ladder file provided for use with the S10V controller.
Error in redundant address of function type "V".	Specify a V-register number not in use.
Error of function type code occurred.	Specify a usable register.
Register Name is irregular.	
Register Number is irregular.	Specify a usable register number.
Specified N coil number is out of range.	Specify a usable N-coil number.
Specified measure data position is out of range.	Specify a specifiable box data position.
Specified insert line position is out of range.	Specify a specifiable line.
TUC setup value is irregular.	Specify a TUC value in the range 1 to 9999.
The setting is made at a point where no change can be made.	Specify a place at which a change can be made.
Step insert position is irregular.	Specify a place at which steps can be inserted.
No space for insert step.	

5 APPENDIX

Error message	Required action
Step cannot be deleted.	Delete a step at any of the boxes in lines 1 through 11.
Relay symbol on the last line is irregular.	Set a wraparound mark at the end of the line.
Comment file open error.	Specify a comment file that can be opened.
Comment file read error.	This error is a system error in the personal computer. Restart the personal computer.
Comment file write error.	This error is a system error (due to, for example, a storage shortage on hard disk) in the personal computer. Take an appropriate action on the personal computer so that data may be written to a file on its hard disk.
Comment character count is out of range.	Reduce the number of characters used in the comment to 32 characters if only half-size characters are used, or to 16 characters if only full-size characters are used.
Range of TUC setup value is irregular. (1-9999)	Specify a TUC value in the range 1 to 9999.
Return input point is irregular.	Specify a wraparound mark either in the first box of the line or in the last box of the preceding line.
Number of instructions exceeds maximum.	Increase the ladder program size or reduce the number of circuits used.
PIO is not set.	Create the ladder chart again.
LPET data is not generated.	Compile the ladder chart.
Specified relay code is irregular	Specify only an allowable relay code.
Parameter is irregular in operation function.	Specify the correct parameter in the arithmetic (operation) function.
Parameter dose not specify.	Enter a parameter(s).
Number of characters of PIO string is irregular.	Specify the register characters (string) correctly.
The width for display is not enough, change to more small character size of comment.	Reduce the character size as far as the characters can be printed.
Number of addresses of data with an old name is out of range.	Specify the correct symbol for the data with the old name.
Number of addresses of data with a new name is out of range.	Specify the correct symbol for the data with the new name.
Data with an old name is not replaceable type data.	Specify data of a replaceable type as data under the old name.
Data with a new name is not replaceable type data.	Specify data of a replaceable type as data under the new name.
Replacement processing cannot be executed between two cases of specified data in contact.	Specify, for the contact, a symbol allowing symbol name replacement.

Error message	Required action
Replacement processing cannot be executed between two cases of specified data in coil and contact.	Specify, for the coil and contact, symbols allowing symbol name replacement.
Replacement cannot be executed because data with a new name is already used in coil.	Specify, for data under a new name, a symbol that is not used for any coil.
Replacement cannot be executed because data with a new name is already used in contact.	Specify, for data under a new name, a symbol that is not used for any contact.
Copy is interrupted because the number of instructions exceeded the maximum.	Increase the ladder program size or reduce the number of circuits used.
Substitution handling can't be executed between two data appointed in "Function".	Specify, for the arithmetic (operation) function, a symbol allowing symbol name replacement.
Substitution handling can't be executed between two data appointed in "All".	Specify, for all the ladder symbols, a symbol allowing symbol name replacement.
Cannot repair the circuit because the instruction is irregular.	The ladder chart may have been destroyed. End the ladder chart without saving, and read it in again. Then, if the same error recurs, create the ladder chart again.
Instruction is damaged.	
The relay of parallel circuit is irregular.	Correct the ladder chart so that the parallel logic paths may be connected at the proper connecting point.
The first symbol of the circuit is not the symbol which can be specified.	Use an appropriate symbol other than branch paths, not including horizontal lines, at the beginning of the logic path.
The connection of symbol is irregular.	Use an allowable combination of symbols before and after the detected symbol.
An item is unjust.	Specify a count of the number of points in the range 0x001 to 0x100.
Specification of index register is inaccurate.	Specify the index register correctly.
The functional classification of index register is inaccurate.	Specify an allowable register as the index register.
It failed in the address conversion to SPU2.	Specify a usable symbol.
Specification of an operand is inaccurate.	Specify a symbol correctly as the operand.
Specification of the constant of the operand2 is inaccurate.	Specify a symbol or immediate data correctly as operand 2.
Register except a word type cannot use it for index register.	Specify a word-type register.

5 APPENDIX

Error message	Required action
There is no work register.	Change the duplicated edge-contact symbol to a non-duplicated one.
Unregistered label name.	Additionally register the label, or specify an already registered label name.
The setting of label is irregular.	Specify the label of a specifiable place.
Error in redundant address of function type "LV".	Specify an LV-register whose number is not used.
Cannot open command file.	Specify a comment file that can be opened.
Cannot read command file.	This error is a system error (due to, for example, a storage shortage on hard disk) in the personal computer. Take an appropriate action on the personal computer so that data may be written to a file on its hard disk.
Cannot write command file.	This error is a system error in the personal computer. Restart the personal computer.
Data is invalid (line xx).	Correct the reported line in the instruction file, or create the ladder chart again.
There is no N coil index (line xx).	Enter an N-coil line immediately before the reported line in the instruction file. Alternatively, create the ladder chart again.
There is no circuit index (line xx).	Enter a logic-path line immediately before the reported line in the instruction file. Alternatively, create the ladder chart again.
There is no user operation function index (line xx).	Enter a user arithmetic (operation) function line immediately before the reported line in the instruction file. Alternatively, set the user arithmetic (operation) function again.
Error in data format (line xx).	Change the reported line in the instruction file into the correct format.
The name of label is irregular (line xx).	Enter the correct label in the reported logic-path line in the instruction file.
The position of the ladder program is irregular (line xx).	Correct the position information in the instruction file so that the position may come within the permitted range.
The number of user operation function is irregular (line xx).	Change the user arithmetic (operation) function number in the instruction file to any number in the range 1 to 128.
The address of user operation function is irregular (line xx).	Change the address of the user arithmetic (operation) function in the instruction file to a proper decimal or hexadecimal number.
Index register cannot use it.	Do not use any index register.

5.1.2 Error messages from the HI-FLOW SYSTEM

Error message	Required action
Setup for starting process and termination process are not correct	A larger number than the ending process number was given as the starting process number in the range-of-processes specification for process deletion. Supply the correct range specification.
PCs is under down status now	Restart the PCs and try it again.
HI-FLOW system doesn't exist in PCs.	Load the HI-FLOW SYSTEM into the PCs.
It is rationality error.	The HI-FLOW SYSTEM in the PCs is destroyed. Replace the HI-FLOW SYSTEM in the PCs.
Memory of PCs isn't enough.	The program is too large. Correct the program size.
Memory of tool side is short.	A memory shortage occurred in the personal computer (PC). Terminates some of the currently active processes and try it again.
A process of HI-FLOW doesn't exist in PCs.	No such process is existent in the PCs. Correct the process specification.
Error of PCs under STOP status	The specified process could not be placed in ACT state because the PCs was in STOP state. Place the PCs in RUN state and try it again.
Specified process of PCs is under RUN status.	Check the status of the process.
Specified process of PCs is under RST status.	
Specified process of PCs doesn't start.	
Specified process is under STP status.	
Break setup is finished in specified step.	Check the break settings.
Break setup constant is over range.	
Break setup is not finished in specified step.	
Break has not yet occurred in specified step.	
The PI/O doesn't exist by specified process.	Check the specified timer-monitoring or trace conditions.
It failed in renewal during RUN for the volume increase.	Renewal in RUN state failed due to an increased comment size or object size. Correct the renewal process that was executed in RUN state.
It failed in renewal during RUN for renewal prohibition mode during RUN.	Exit the renewal prohibition mode in RUN state and try it again.

5 APPENDIX

Error message	Required action
Same condition is setting being completed in timer monitor information in PCs.	Correct the specified timer-monitoring information.
Setting number of timer monitor information exceeds a limit.	Check the specified timer-monitoring information.
Timer monitor Information Systems specified doesn't exist in PCs top.	Correct the specified timer-monitoring information.
Trace condition specified is established already.	Correct the specified trace condition.
The step specified doesn't exist.	Correct the specified step number.
Stop sending under RUN status.	The transmission was ended abnormally because the PCs was already in RUN state.
It failed in opening of system file.	The HI-FLOW SYSTEM may have been installed improperly. Install it properly.
Error in reading system file	
System file doesn't exist.	
It isn't under unstarted status.	The specified process was already started. Check the status of the process.
Cannot write to flash memory	An internal error occurred in the HI-FLOW SYSTEM. Refer to the error log for information.
C/F backup kind error	
Cannot purge CMU cache	
Canceling occupancy of PCs failed.	Retry it. If the HI-FLOW tool can establish a connection with the PCs, there is no problem.
The object has broken. Does it receive continuously? It becomes an application error when an object cannot be restored.	The program on the PCs may have been destroyed. It is recommended that the program be replaced.
HI-FLOW program of tool and HI-FLOW program of CPU are disagreement. You had better let a program of CPU agree with a program of tool.	It is recommended that the program be made identical between the tool and CPU by transmission or reception.
It is syntax error. Review a construction.	Review the syntax.
Stack did overflow.	An internal error occurred in the HI-FLOW SYSTEM. Refer to the event log for information.
It is stack error. (System error)	
User area did overflow.	
The cash register who can't use it is used.	Correct the register specification.
Figure label isn't defined.	Check the figure label and solve the problem.
Double definition in figure label	

Error message	Required action
Several of symbol in 1 sentence exceed a limit. (Cross-reference table overflow).	Reduce the number of symbols used in the sentence.
The output disk volume of object isn't enough.	A storage shortage occurred on the PC's hard disk. Delete unnecessary files and try it again.
A character number of symbol exceeds a limit.	Reduce the number of characters used in the symbol.
It is jump symbol error.	Check the jump symbol and solve the problem.
It is label error. Review a label.	Check the label and solve the problem.
Label number is double definition.	
Label number isn't defined.	
It is statement error. Review a construction or a label.	Check the syntax or label, and solve the problem.
Root-structure is an error.	Check the root-structure and solve the problem.
A position of cell wait is unjust.	Check the position of the cell wait and solve the problem.
The renewal of label and construction to increase of volume isn't completed.	The maximum number of characters that can be used in the sentence construction, label, and comment is 70. Reduce the number of the characters to 70 or less.
The renewal of comment to increase of volume isn't completed.	
Failed in information of socket for Windows.	Socket initialization failed due to an error in the Windows system. Restart the personal computer.
This is a program of a maximum line. It cannot be inserted.	The maximum number of lines that can be used in a single program is 999. Reduce the number of the lines used to 999 or less.
Specify the key code that is not multidefined.	Specify a non-duplicated key code.
This key code cannot be used. Use numeric or alphabet.	Specify the key code with digits and/or letters of the alphabet.

5 APPENDIX

5.1.3 Error messages from the BASE SYSTEM

Error message	Required action
Cannot reset PCs.	Check the connection with the PCs and try it again.
LPU is running. After stopping, clear a battery backup memory.	Stop the LPU and then clear the data in the backup memory.
A malfunction was detected while the battery backup memory is clear. There is possibility that a battery backup memory isn't cleared.	Check the connection with the PCs and try it again.
Cannot save memory dump.	Check the connection with the PCs and try it again.
The specification of the save file is illegal.	Check the file name of the memory dump file and solve the problem.
The specification of the top address is illegal.	Specify a proper address as the starting address for memory dump saving.
The specification of the save size is illegal.	Specify the correct memory dump save size with a hexadecimal number.
The address is not inputted.	Enter an address for the box for which an address has not been input yet.
The network ID of IP address and broadcast address is different.	Make the network address portion identical between the IP address and broadcast address.
Invalid specification	The IP address is set incorrectly. Set the correct address value.
A specified IP address is invalid.	Check the address and solve the problem.
A specified IP address is already used at <Parameter name>	Check the address and solve the problem.
The IP address of route xx is invalid.	Check the address and solve the problem.
The IP address of route xx is already used at <Parameter name>	Check the address and solve the problem.

5.1.4 Error messages from the FL.NET SYSTEM

Error message	Required action
No option module is mounted.	Check if the FL.NET module is installed properly.
Now computing. Please try again later.	The FL.NET module was unable to write the specified values in place because it was busy. Wait for a while and try it again.
Timeout error	The write to the PCs failed. Check the connection settings to connect with the PCs.
Please Reset or Power OFF/ON PCs.	Although resetting was attempted, a check could not be made to see if the PCs was reset properly. Try to remote-reset the PCs. Alternatively, manually reset the PCs, or turn off the power to the PCs and back on again.
Please enter alphanumeric.	A prohibited character(s) are used in the node name. Enter a string of only half-size alphanumeric characters as a node name.
Address is out of bounds.	An invalid address was detected. Set a valid address value.
Address is duplicated.	The addresses of areas 1 and 2 and of the FA link status are duplicated. Check the addresses and solve the problem.
It is not FL.NET file.	The specified PSE file was not an FL.NET file. Specify an FL.NET file.
Input ""*.PSE"" file.	The specified file extension was not "PSE". Specify an FL.NET file.
Sending failed.	The connection was terminated abruptly during data communication. Check the connection status of the communication line.

5.1.5 Error messages from the OD.RING/SD.LINK SYSTEM

Error message	Required action
No option module is mounted.	Check if the OD.RING or SD.LINK module is installed properly.
Beyond address	An invalid address was detected. Set a valid address value.
RAS table address error	Set the RAS table again.
Cable NG	The cable wiring may have been done incorrectly. Check the cable wiring.

5 APPENDIX

5.1.6 Error messages from the ET.NET SYSTEM

Error message	Required action
The S10V BASE SYSTEM was not installed. Please install it, first.	The S10V BASE SYSTEM may not have been installed or may have been destroyed. Install the S10V BASE SYSTEM again.
No option module is mounted.	Check if the FL.NET module is installed properly.
Line error	An attempt to communicate with the PCs failed. Check the connection with the PCs.
IP address is outside the range. Setting range from class A to class C.	An incorrect IP address was specified. Set the correct IP address value.
A specified IP address is invalid.	The set IP address value was out of the permitted range. Set the correct IP address value.
A specified IP address is already used at xx.	The specified IP address was duplicated in the set routing information. Set the correct IP address.
Please enter alphanumeric.	A character other than the half-size alphanumeric characters and hyphen was entered as part of a comment.
It failed in reset. Please Reset or Power OFF/ON PCs.	Although resetting was attempted, a check could not be made to see if the PCs was reset properly. Try to remote-reset the PCs. Alternatively, manually reset the PCs, or turn off the power to the PCs and back on again.
It failed in reset. Is an IP address setup again?	Although resetting was attempted, a check could not be made to see if the PCs was reset properly. Try to remote-reset the PCs. Alternatively, manually reset the PCs, or turn off the power to the PCs and back on again.
It failed in a setup of an IP address. Is an IP address setup again?	A check could not be made to see if the IP address was set completely. Set the IP address again and, if the same error recurs, check the condition of the communication line.
Duplicate station No. was found.	The specified ST No. of the ET.NET module was duplicated. Check the ST No. and solve the problem.
IP address duplicates.	The specified IP address of the ET.NET module was duplicated. Check the IP address and solve the problem.

5.1.7 Error messages from the J.NET SYSTEM

Error message	Required action
No option module is mounted.	Check if the J.NET or J.NET-INT module is installed properly.
The form of J.NET module is unknown.	The J.NET or J.NET-INT module may be in a failure condition. Replace the module.
Enter an address.	Although the check box to indicate "addresses not used" is deselected, no addresses were entered. Enter address values for the NET1 and NET2 status table addresses.
No station type is selected.	Select the desired value as the station type.
Duplicated station ID	The specified station number is duplicated with another ID's. Set a non-duplicated station number.
The sum of input bytes and output bytes cannot exceed /100.	Reduce the total number of input and output bytes to /100 or less.
Neither input byte nor output byte may be 0.	When the station type is AUTO, both the input byte and output byte may not be set to 0. Set either the input or output byte to a non-zero value.
The address is out of bounds.	Incorrect address setting was made. Set the correct address values.
Duplicated address	
Enter between xxbps to 19200bps	The input value was out of the permitted range. Set the transmission speed to a value in the range xx to 19200, or change the set value of transmission delay time.
Enter 0 Please enter an integer between xxx and xxx.	Enter a value of 0 or an integer in the range xx to 32767.
Sending failed	The connection was terminated abruptly during data communication. Check the connection status of the communication line.

5 APPENDIX

5.1.8 Error messages from the IR.LINK SYSTEM

Error message	Required action
No option module is mounted.	Check if the IR.LINK module is installed properly.
Enter the refresh cycle time.	Enter an I/O refresh cycle value selected from among the values 1.5, 2, 2.5, and 3 through 3000.
The refresh cycle time is out of range (1.5, 2, 2.5, 3-3000).	
The status table address is out of range.	An invalid address was detected. Set a valid address value.
Duplicated station ID	The specified station number is duplicated with another ID's. Set a non-duplicated station number.
The sum of input bytes and output bytes cannot exceed /100.	Reduce the total number of input and output bytes to /100 or less.
Neither input byte nor output byte may be 0.	When the station type is AUTO, both the input byte and output byte may not be set to 0. Set either the input or output byte to a non-zero value.
The address is out of bounds.	An invalid address was detected. Set a valid address value.
Duplicated address	
The transfer byte is out of range (/01-/10).	Specify the number of transfer bytes with a hexadecimal number in the range /01 to /10.
The sum of transfer byte exceeded /100 (/XX bytes over).	Reduce the total number of transfer bytes to /100 or less.
The transfer address is out of range.	Set a valid address value.
Sending failed	The connection was terminated abruptly during data communication. Check the connection status of the communication line.
Receiving failed.	
or up to 128 characters.	A total of 129 characters or more was entered as a file comment. Reduce them to 128 characters or less.
The task number is out of range (1-255).	Set a task number within the range 1 to 255.
The start factor is out of range (0-32).	Set a start factor within the range 0 to 32.
Enter the task number.	Enter the desired task number.
Enter the start factor.	Enter the desired start factor.

5.1.9 Error messages from the CPU LINK SYSTEM

Error message	Required action
Please enter an integer between xxx and xxx.	Enter hexadecimal numbers in the range shown in the error message into the inter-CPU link and inter-sub-CPU link send areas.

5.1.10 Error messages from the EXTERNAL SERIAL LINK SYSTEM

Error message	Required action
No option module is mounted.	Check if the RS-232C or RS-422 module is installed properly.
The address is out of bounds.	The value that was entered as the starting address was out of the permitted range. Enter a hexadecimal number in the range 0 to 7FFF as the starting address.
The system is not loaded.	The Channel No. switch is set incorrectly. Correct the setting.
Please Reset or Power OFF/ON PCs.	Although resetting was attempted, a check could not be made to see if the PCs was reset properly. Try to remote-reset the PCs. Alternatively, manually reset the PCs, or turn off the power to the PCs and back on again.
Out of bounds	The value that was entered was out of the permitted range. Enter the desired value in one of the following ranges: <ul style="list-style-type: none"> • 0 to 512 for text size; • 0 to 32767 for transmission suspend monitoring time; or • 0 to 32767 for reception monitoring time.
Enter between xxxbps to 19200bps	Set the transmission speed to a value in the range xx to 19200, or change the set value of transmission delay time.
Enter 19200bps	Set the transmission speed to 19200, or change the set value of transmission delay time.
Please enter an integer between xxx and 32767.	Set the transmission delay time to a value in the range xx to 32767, or change the set value of transmission speed.
Input characters and input value are out of range. Input once more.	Correct the input value.
Please enter an integer between 0 and 32.	Set the start factor to a value in the range 0 to 32.
Please enter an integer between 0 and 255.	Set the start task number to a value in the range 0 to 255.

5 APPENDIX

5.1.11 Error messages from the D.NET SYSTEM

Error message	Required action
No option module is mounted.	Check if the D.NET module is installed properly.
The refresh time is out of range (3ms-1000ms)	The input value was out of the permitted range. Set the correct value.
Since PCs is occupied, it cannot set up.	An attempt was made to write setting information from more than one place simultaneously. Do not write it simultaneously.
Please Reset or Power OFF/ON PCs.	Although resetting was attempted, a check could not be made to see if the PCs was reset properly. Try to remote-reset the PCs. Alternatively, manually reset the PCs, or turn off the power to the PCs and back on again.
Sending frames have exceeded maximum sending frames per 10ms. Reduce output bytes, or increase refresh time.	Reduce the number of output bytes or increase the refresh time.
The address of data format conversion of D.STATION (No XX) is not same station.	Make the specified input and output addresses identical to those set in the same station.
The entry number of station (Port XX) is exceeded 8.	Reduce the number of set entries using the same address as specified in the station to 8 for D.STATION data format conversion.
The assignment data area of data format conversion of D.STATION (No XX) is duplicated the address which is set at the station.	Change the address of the data area assigned for D.STATION data format conversion to an address other than that set in the station.
The assignment data area of data format conversion of D.STATION (No XX) is duplicated the slave timeout detection register.	Change the address of the data area assigned for D.STATION data format conversion to an address other than that of the slave timeout detection register.
The address of data format conversion of D.STATION (No XX) is out of bounds of the address which is set at the station.	Correct the address used for D.STATION data format conversion.
Please input ID.	ID setting was done improperly. Set the correct value.
Duplicated ID	
Enter an address.	Enter the desired address value.
Address is out of bounds.	An invalid address was detected. Set a valid address value.
Address is duplicated.	
Input 0 or 8.	Enter one of the values 0 or 8.
MACID of self-node is overlapped.	Specify a MAC ID other than the local station's.

Error message	Required action
Slave timeout detection register is duplicated.	In the system parameter setting window, the address of the slave timeout detection register is duplicated with the specified input address, output address, or information storage address. Specify a non-duplicated address.
The port to reserve has exceeded under use or the last port. Please enter an integer between 0 and /xx.	Port reservation failed. Specify the number of input or output bytes within the permitted range.
Please enter an integer between 0 and 3000.	Enter an integer in the range 0 to 3000.
Station No. [out of range]	Set the station number with a hexadecimal number in the range 0x00 to 0x7F.
Station No. [registered]	Specify a non-duplicated station number.
It is not D.NET file.	The specified PSE file was not a PSE file provided for use with the D.NET module. Specify the correct PSE file.

5 APPENDIX

5.1.12 Error messages from the EQ.LINK SYSTEM

Error message	Required action
No option module is mounted.	Check if the EQ.LINK module is installed properly.
Now computing. Please try again later.	The EQ.LINK module was unable to write the specified values in place because it was busy. Wait for a while and try it again.
Timeout error	The write to the PCs failed. Check the connection settings to connect with the PCs.
Please Reset or Power OFF/ON PCs.	Although resetting was attempted, a check could not be made to see if the PCs was reset properly. Try to remote-reset the PCs. Alternatively, manually reset the PCs, or turn off the power to the PCs and back on again.
Please enter alphanumeric.	A prohibited character(s) are used in the node name. Enter a string of only half-size alphanumeric characters as a node name.
Node number is duplicated.	The node number of the local node is duplicated with a remote node's.
Address is out of bounds.	An invalid address was detected. Set a valid address value.
Address is duplicated.	An address set as a link parameter for PCs allocation is duplicated with an address set for common memory division. Correct the duplicated address setting.
Input PCs address.	Enter the PCs address together with a PCs word count, or vice versa.
Input PCs words.	
Address is out of bounds.	An invalid common memory offset was detected. Set a valid offset value.
Area is duplicated.	
PCs words is out bounds.	An invalid PCs word count was detected. Set a valid word count.
It has not initialized.	The setup could not be initialized. Check the connection settings to connect with the PCs.
It is not EQ.LINK file (Main module).	The specified PSE file was not a PSE file provided for use with the EQ.LINK module. Specify the correct PSE file.
It is not EQ.LINK file (Sub module).	
Input ""*.PSE"" file.	The specified file extension was not "PSE". Specify an EQ.LINK file.
Node information has not been set up.	Parameters are not set for the EQ.LINK module yet. Set parameters via the link parameter setting window.
Sending failed.	The connection was terminated abruptly during data communication. Check the connection status of the communication line.
Receiving failed.	

5.1.13 Error messages from the BACKUP RESTORE SYSTEM

Error message	Required action
Disc is full. Insert new disc.	Replace the storage media piece in the drive.
Disc is full.	Increase the available storage space on the hard disk.
Cannot write to disc. Confirm if disc is not full or write protect switch is not set.	Increase the available storage space on the hard disk.
File is not found.	Check if the file and path to it were specified correctly.
The specified backup file does not exist.	Specify the folder that was created in the backup operation.
Specify a position.	Specify in the "Position" box the path to the folder in which to store the result of a backup operation.
A specified position is invalid.	Check if the folder identified by a position specification is one in which the result of a backup operation can be stored.
There is no information on the specified address.	Specify the address of the memory location whose contents were backed up.
There is an address which overlapped in the backup file.	Specify the folder that was created in the backup operation.
Backup1.wsvl does not exist.	Specify the folder that was created in the backup operation.
Please Reset or Power OFF/ON PCs.	Check the connection with the PCs and try it again.
The timeout occurred during flash memory rewriting.	Try it again. If the same error recurs, the CMU module needs to be replaced.
It failed in rewriting of a flash memory.	Try it again. If the same error recurs, carry out a restore operation.
Type of PCs disagrees.	Specify the backup file for the S10V controller.
PCs number disagrees.	The specified PCs number for the backup file must be the same as the PCs number used with the S10V controller.
Cannot find system file.	Check if the specified file is existent in the machine.

5 APPENDIX

5.1.14 Error messages from the NX/Tools-S10V SYSTEM

Error message	Required action
A file to transfer is not chosen.	Choose the file to be transferred.
A specified file is not the setup information file of NX.	Check the specified file.
A setup can not be done any further because it exceeds the number which TCD information can be established to.	The maximum number of TCD information cases that can be registered is 96.
A wrong point was detected during the file access.	Check the specified file.
A setup information file not found. Confirm whether you do not mistake the designation of the folder.	Check the specified folder.
A system program file not found. Confirm whether you do not mistake the designation of the folder.	Check the specified folder.
Please Reset PCs.	Try to remote-reset the PCs. Alternatively, manually reset the PCs, or turn off the power to the PCs and back on again.
NX/HOST-S10V system is not found.	Check the specified folder.
Unjust information is included in the changed file. Does it correct ?	Correct the file.
It failed in preservation of a file.	Try it again.
The specified file is the type which is not convertible.	Check the specified file.
Data field number is not found. Set a data field number.	Specify a data field (DF) number.
Data field number is out of range. Set a data field number between 1 and 255.	Specify a DF number in the range 1 to 255.
Data field number is multiple defined. Set a unique number.	Specify a unique DF number.
Node name is not found. Set a node name.	Specify a node name.
Logical node number is not found. Set a logical node number.	Specify a logical node number.
Logical node number is out of range. Set a logical node number between 1 and 255.	Specify a logical node number in the range 1 to 255.
Alive message timeout is not found. Set a alive message timeout.	Set an "alive" message timeout period and try it again.

Error message	Required action
Alive message timeout is out of range. Set a alive message timeout between 1 and 43200.	Specify an “alive” message timeout period in the range 1 to 43200.
Alive message interval is not found. Set a Alive message interval.	Set an “alive” message transmission interval and try it again.
Alive message interval is out of range. Set a alive message interval between 1 and 3600.	Specify an “alive” message transmission interval in the range 1 to 3600.
Alive port is not found. Set a alive port number.	Set an “alive” message destination port number and try it again.
Alive port is out of range. Set a alive port number between 1 and 65535.	Specify an “alive” message destination port number in the range 1 to 65535.
Alive port number is multiple defined. Set a unique number.	Specify a unique “alive” message destination port number.
Send my port is not found. Set a send my port number.	Set a send local-port number and try it again.
Send my port is out of range. Set a send my port number between 1 and 65535.	Specify a send local-port number in the range 1 to 65535.
Send my port number is multiple defined. Set a unique number.	Specify a unique “alive” message destination port number.
Send MCG No. is not found. Set a send MCG No.	Sea a send MCG number and try it again.
Send MCG No. is out of range. Set a send MCG No. between 0 and 255.	Specify a send MCG number in the range 0 to 255.
Send MCG No. is multiple defined. Set a unique number.	Specify a unique send MCG number
Send port No. is not found. Set a send port No.	Set a send port number and try it again.
Send port No. is out of range. Set a send port No. between 1 and 65535.	Specify a send port number in the range 1 to 65535.
Send MCG No. is multiple defined. Set a unique number.	Specify a unique send port number.
Receive MCG No. is not found. Set a receive MCG No.	Set a receive MCG number and try it again.
Receive MCG No. is out of range. Set a receive MCG No. between 0 and 255.	Specify a receive MCG number in the range 0 to 255.
Receive MCG No. is multiple defined. Set a unique number.	Specify a unique receive MCG number.

5 APPENDIX

Error message	Required action
Receive port No. is not found. Set a receive port No.	Define the receive port number and try it again.
Receive port No. is out of range. Set a receive port No. between 1 and 65535.	Specify a receive port number in the range 1 to 65535.
Receive MCG No. is multiple defined. Set a unique number.	Specify a unique receive port number.
Port number is multiple defined. Set a unique number.	Specify a unique port number.
MCG number is multiple defined. Set a unique number.	Specify a unique MCG number.
Alive message timeout is smaller than a Alive message interval.	Specify an “alive” message timeout period that is longer than the “alive” message transmission interval.
TCD number is out of range. Set a tcd number between 0 and 59999.	Specify a TCD number in the range 0 to 59999.
TCD number is multiple defined. Set a unique number.	Specify a unique TCD number.
Send byte number is not found. Set a send byte number.	Set a send byte count and try it again.
Send byte number is out of range. Set a send byte number between 0 and 1408.	Specify a send byte count in the range 0 to 1408.
Receive byte number is not found. Set a receive byte number.	Set a receive byte count and try it again.
Receive byte number is out of range. Set a receive byte number between 0 and 1408.	Specify a receive byte count in the range 0 to 1408.
TCD information on send or receive is not found. Set a TCD information on send or receive.	Set a send/receive TCD information and try it again.
During send register is not found. Set a during send register.	Set a during-send register name and try it again.
The receive completion register is the same as during send register.	Specify two different registers, one as the during-send register and one as the receive completion register.
During send register is multiple defined. Set a unique number.	Specify a unique during-send register.
During send register is inaccurate.	Check the during-send register.
Send address is not found. Set a send address.	Set a send address and try it again.

Error message	Required action
Transmitting area overlaps.	Check the send area and solve the problem.
Send address is inaccurate.	Correct the send address.
Receive completion register is not found. Set a receive completion register.	Set a receive completion register name and try it again.
Receive completion register is multiple defined. Set a unique number.	Specify a unique receive completion register.
Receive completion register is inaccurate.	Check the receive completion register.
Receive address is not found. Set a receive address.	Set a receive address and try it again.
Receiving area overlaps.	Check the receive area and solve the problem.
Receive address is inaccurate.	Correct the receive address.
Retrial number of times is not found. Set a retrial number of times.	Set a retry count and try it again.
Retrial number of times is out of range. Set a Retrial number of times between 1 and 2147483647.	Specify a retry count in the range 1 to 2147483647.
Receiving waiting time is not found. Set a receiving waiting time.	Set a receive wait time and try it again.
Receiving waiting time is out of range. Set a receiving waiting time between 10 and 1000.	Specify a receive wait time in the range 10 to 1000.
An odd-byte setup cannot be performed. Please set up by even bytes.	Set it up by even-numbered bytes.
Send MCG No. is out of range. Set a send MCG No. between 1 and 255.	Specify a send MCG number in the range 1 to 255.

5 APPENDIX

5.1.15 Error messages from the tools

Error message	Required action
Failed in initialization of OLE. Confirm if the OLE library is right version or not.	No such OLE library is existent or, if it is existent, its version is old. Install the latest version of the OLE library.
Line error <Detail information> ID = type of issued command Access address (address of the PCs) Access word count error code = error code from the Windows system Error message corresponding to the above error code, presented by the Windows system	The communication line's connections or settings may be incomplete, or the PCs may not be up and running. Check the connections of the physical communication line and, if necessary, change the connected PCs by redoing its settings.
A required execution module is not found.	The tool may have been installed improperly or destroyed. Restart it. If the same error recurs, reinstall it.
Cannot read drive %1. Confirm if drive is shut, disc has no error or disc is formatted, etc..	Check the FD drive.
Capacity of disc is insufficient.	Increase the available storage space on disk so that the file may be saved there. Alternatively, choose a disk drive with sufficiently large empty storage space.

5.2 Trouble Report

Fill out this form and submit it to local source.

Your company name				Person in charge		
Data and time of occurrence	(year / month / day / hour / minute)					
Where to make contact	Address					
	Telephone					
	FAX					
	E-mail					
Model of defective module				LPU model		
OS	Ver.	Rev.	Program name:		Ver.	Rev.
Support program			Program name:		Ver.	Rev.
Symptom of defect						
Connection load	Type					
	Model					
	Wiring state					
System configuration and switch setting						
Space for correspondence						