

Diagnostic Trouble Codes

Diagnostic Trouble Code Priorities

IMPORTANT: These Diagnostic Trouble Codes are listed for reference only. See your John Deere dealer for specific diagnostic information.

Each Diagnostic Trouble Code (DTC) has a priority. The priority of the DTC is indicated in the way the DTC is displayed to the operator:

- Priority 1 - The Cornerpost Display 1 will stop normal function and the DTC will be displayed. This indicates a problem that requires the combine be stopped, the engine turned off immediately and the problem corrected. The Cornerpost Display 1 will show the DTC until the problem is resolved.
- Priority 2 - The Cornerpost Display 1 Diagnostic Indicator comes on. This indicates a problem that should be checked immediately
- Priority 3 - DTC's will be stored, but it is not indicated to the operator.

OUZXMAG,00018B6 -19-10OCT02-1/27

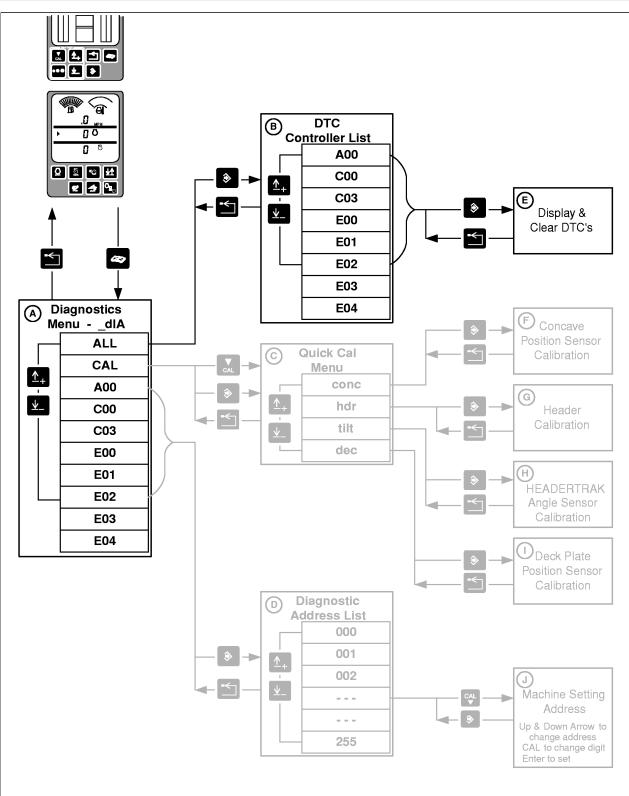

OUZXMAG,00018B6 -19-10OCT02-2/27

- A-Diagnostics Menu**
- B-Diagnostic Trouble Code Controller List**
- C-Quick Cal Menu**
- D-Diagnostic Address List**
- E-Display and Clear Diagnostic Trouble codes**
- F-Concave Position Sensor Calibration**
- G-Header Calibration**
- H-HeaderTrak Angle Sensor Calibration**
- I-Deck Plate Position Sensor Calibration**
- J-Machine Setting Addresses - Up & Down Arrow Button to change address - CAL Button to change digit - Enter Button to set change into memory**

Accessing Diagnostic Trouble Codes

- Turn the key switch to the run position.

Prepare Combine:

OUZXMAG,00018B6 -19-10OCT02-3/27

Press the diagnostic switch, dIA will appear on the Cornerpost Display 1.

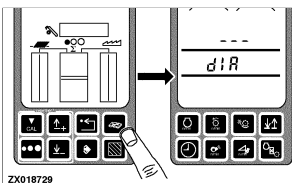

OUZXMAG,00018B6 -19-10OCT02-4/27

Press the up or down arrow switch to obtain the desired address. For example A00 appears on the Cornerpost Display 1.

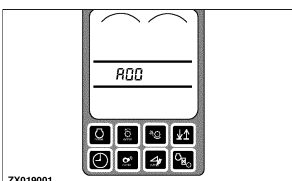

OUZXMAG,00018B6 -19-10OCT02-5/27

Press the enter switch.

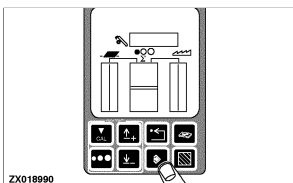

OUZXMAG,00018B6 -19-10OCT02-6/27

Press the up arrow switch once. If diagnostic trouble codes are available A00 and codE will appear on Cornerpost Display 1.

If no DTC is available A00 and nonE will appear on Cornerpost Display 1.

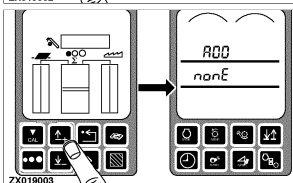
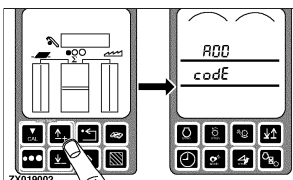

OUZXMAG,00018B6 -19-10OCT02-7/27

To read and record diagnostic trouble codes press the enter switch.

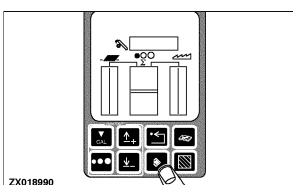

OUZXMAG,00018B6 -19-10OCT02-8/27

Press the up or down arrow switch to scroll through the diagnostic trouble codes.

- Record each control unit name
- Record each suspected parameter number
- Record each failure mode identifier

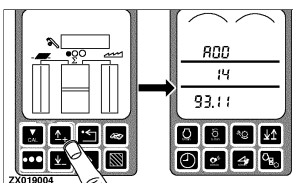

OUZXMAG,00018B6 -19-10OCT02-9/27

After all codes have been displayed, there is an option to clear these codes.

Scroll to end of code list until CLr? is displayed.

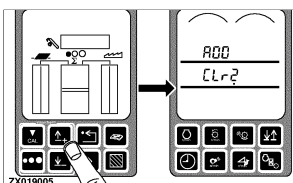

OUZXMAG,00018B6 -19-10OCT02-10/27

Press the enter switch to clear codes. A00 and donE will appear on Cornerpost Display 1.

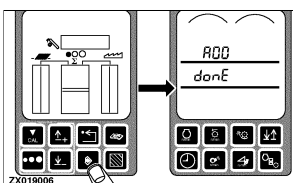

OUZXMAG,00018B6 -19-10OCT02-11/27

NOTE: Priority 1 codes cannot be cleared until the problem is solved.

Press back arrow switch three times to return to normal operation.

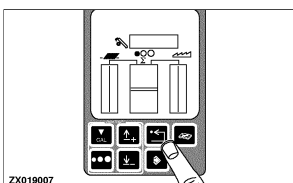

OUZXMAG,00018B6 -19-10OCT02-12/27

A00 - Engine Control Unit Diagnostic Trouble Codes

Control Unit	SPN	FMI	Pri.	Description
A00	91	09	3	Throttle input not valid or not received
A00	94	01	1	Fuel pressure too low - less than 80kPa / 11.6 PSI (9540)
A00	94	03	1	Fuel Pressure Sensor (cc# 131) voltage out of range high - greater than 4 V DC (9640, 9560, 9660, 9580, 9680)
A00	94	04	1	Fuel Pressure Sensor (cc# 131) voltage out of range low. (9640, 9560, 9660, 9580, 9680)
A00	94	10	2	The rail pressure drops too fast when the engine is motoring and the high pressure pump is off. (9640, 9560, 9660, 9580, 9680)

A00	94	13	1	Fuel Pressure Sensor reading is incorrect. (9640, 9560, 9660, 9580, 9680)
A00	94	17	2	During starting, rail pressure is not developed after a short time cranking. (9640, 9560, 9660, 9580, 9680)
A00	94	18	2	Fuel pressure too low - less than 100 kPa / 14.7 PSI at low idle (9540)
A00	97	03	2	Water in Fuel Sensor (cc# 136) voltage out of range high (9640, 9560-Engine Type B, 9660, 9580, 9680)
A00	97	04	2	Water in Fuel Sensor (cc# 136) voltage out of range low (9640, 9560-Engine Type B, 9660, 9580, 9680)
A00	97	31	2	Water is detected in fuel. (9640, 9560-Engine Type B, 9660, 9580, 9680)
A00	100	01	1	Oil Pressure Sensor is open after engine rpm is above cranking speed
A00	100	04	2	Oil Pressure Sensor is closed when engine is not running (9640, 9560, 9660, 9580, 9680)
A00	105	00	1	Engine Manifold Air Temperature Sensor is above 100°C (9560-Engine Type C only)
A00	105	03	2	Engine Manifold Air Temperature Sensor voltage is out of range high. The device or wiring is faulty. (9640, 9560, 9660, 9580, 9680)
A00	105	04	2	Engine Manifold Air Temperature Sensor voltage is out of range low. The device or wiring is faulty. (9640, 9560, 9660, 9580, 9680)
A00	105	16	2	Engine Manifold Air temperature above 88°C / 190°F (moderately severe level). Maximum power level is derated. Power boost is disabled.
A00	107	00	2	Air Filter Restricted Switch indicates a plugged air filter.
A00	110	00	1	Engine coolant temperature above 115°C / 240°F (most severe level). Maximum power level is derated. Power boost is disabled.
A00	110	03	2	Engine Coolant Temperature Sensor voltage is out of range high. The device or wiring is faulty.
A00	110	04	2	Engine Coolant Temperature Sensor voltage is out of range low. The device or wiring is faulty.
A00	110	15	2	Engine Coolant Temperature is above 105°C. (9560-Engine Type C)
A00	110	16	2	Engine coolant temperature above 110°C / 230°F for 9640, 9560, 9660, 9580 and 9680 or above 100°C / 212°F for 9540. Maximum power level is derated. Power boost is disabled.
A00	111	01	1	Coolant level low. Engine coolant temperature above 125°C / 257°F. Maximum power level is derated. Power boost is disabled.
A00	158	17	2	Controller not powered down properly. (9640, 9560, 9660, 9580, 9680)
A00	174	00	2	Engine fuel temperature is too high (greater than 75°C / 167°F). Injector pump may be damaged because hot fuel loses its lubrication properties. (9540)
A00	174	03	2	Engine Fuel Temperature Sensor voltage is out of range high. The device or wiring is faulty. Injector pump may be damaged because hot fuel loses its lubrication properties. (9640, 9560, 9660, 9580, 9680)

OUZXMAG,00018B6 -19-100CT02-13-27

Control Unit	SPN	FMI	Pri.	Description
A00	174	04	2	Engine Fuel Temperature Sensor voltage is out of range low. The device or wiring is faulty. Injector pump may be damaged because hot fuel loses its lubrication properties. (9640, 9560, 9660, 9580, 9680)
A00	174	15	2	Engine fuel temperature above normal range (greater than 65°C / 149°F). Maximum power level and power boost are derated. (9540)
A00	174	16	2	Engine fuel temperature above normal range (greater than 65°C / 149°F for 9640, 9560, 9660, 9580, 9680 or greater than 73°C / 163°F for 9540). Maximum power level and power boost are derated.
A00	174	31	2	Engine Fuel Temperature Sensor is out of range. Maximum power level and power boost are derated. (9540)
A00	189	00	3	Low fuel pressure (9540)
A00	190	00	1	Engine over-speed (greater than 2800 rpm). (9540)
A00	190	16	3	Engine speed too high (greater than 2800 rpm). Engine Control Unit reduce fuel flow until speed is below 2200 rpm (9540)
A00	611	03	1	The injector driver has detected a short to battery in the injector wiring. (9640, 9560, 9660, 9580, 9680)
A00	611	04	1	The injector driver has detected a short to ground in the injector wiring. (9640, 9560, 9660, 9580, 9680)
A00	627	01	2	All injector currents are out of specification. The injector pull-in current is too low or the injector hold-in current is incorrect. (9640, 9560, 9660, 9580, 9680)
A00	627	04	2	Engine Control Unit Power (cc# 042) missing at Engine Control Unit while Electronic Power (cc# 021) is on. (9540)
A00	629	19	2	Engine Control Unit not receiving messages from Pump. (9540)
A00	632	02	2	Fuel shutoff error condition detected. (9540)
A00	632	05	2	The Engine Control Unit does not detect a change in engine speed after the Key Switch is turned off. Fuel shutoff not functioning correctly. (9540)
A00	636	02	2	Electrical noise detected on Pump Position Sensor + (cc# 172) and/or Pump Position Sensor - (cc# 173)
A00	636	08	2	Pump Position Sensor signal is missing
A00	636	10	2	Pump Position Sensor signal has incorrect pulse pattern
A00	637	02	2	Electrical noise detected on Pump Position Sensor + (cc# 174) and/or Pump Position Sensor - (cc# 175)
A00	637	07	2	Position relationship between Engine Speed Sensor and Pump Position Sensor not correct (9640, 9560, 9660, 9580, 9680)
A00	637	08	2	Engine Speed Sensor signal is missing
A00	637	10	2	Engine Speed Sensor signal has incorrect pulse pattern
A00	651	05	2	The current to Injector #1 is less than expected. (9640, 9560, 9660, 9580, 9680)
A00	651	06	2	The current to Injector #1 increases too rapidly. (9640, 9560, 9660, 9580, 9680)
A00	651	07	2	The fuel flow to cylinder #1 is lower than expected. (9640, 9560-Engine Type B, 9660, 9580)

A00	652	05	2	The current to Injector #1 is less than expected. (9640, 9560, 9660, 9580, 9680)
A00	652	06	2	The current to Injector #2 increases too rapidly. (9640, 9560, 9660, 9580, 9680)
A00	652	07	2	The fuel flow to cylinder #2 is lower than expected. (9640, 9560-Engine Type B, 9660, 9580, 9680)

OUZXMAG,00018B6 -19-10OCT02-14/27

Control Unit	SPN	FMI	Pri.	Description
A00	653	05	2	The current to Injector #3 is less than expected. (9640, 9560, 9660, 9580, 9680)
A00	653	06	2	The current to Injector #3 increases too rapidly. (9640, 9560, 9660, 9580, 9680)
A00	653	07	2	The fuel flow to cylinder #3 is lower than expected. (9640, 9560-Engine Type B, 9660, 9580, 9680)
A00	654	05	2	The current to Injector #4 is less than expected. (9640, 9560, 9660, 9580, 9680)
A00	654	06	2	The current to Injector #4 increases too rapidly. (9640, 9560, 9660, 9580, 9680)
A00	654	07	2	The fuel flow to cylinder #4 is lower than expected. (9640, 9560-Engine Type B, 9660, 9580, 9680)
A00	655	05	2	The current to Injector #5 is less than expected. (9640, 9560, 9660, 9580, 9680)
A00	655	06	2	The current to Injector #5 increases too rapidly. (9640, 9560, 9660, 9580, 9680)
A00	655	07	2	The fuel flow to cylinder #5 is lower than expected. (9640, 9560-Engine Type B, 9660, 9580, 9680)
A00	656	05	2	The current to Injector #6 is less than expected. (9640, 9560, 9660, 9580, 9680)
A00	656	06	2	The current to Injector #6 increases too rapidly. (9640, 9560, 9660, 9580, 9680)
A00	656	07	2	The fuel flow to cylinder #6 is lower than expected. (9640, 9560-Engine Type B, 9660, 9580)
A00	676	03	2	The Glow Plug Relay output is on when the relay is not energized by the Engine Control Unit. (9560-Engine Type C)
A00	676	05	2	The Glow Plug Relay output is off when the relay is energized by the Engine Control Unit. (9560-Engine Type C)
A00	729	03	2	Inlet Air Heater Relay Output (cc# 189) is high when Engine Control Unit is not energizing the Glow Plug Relay. (9540)
A00	729	05	2	Inlet Air Heater Relay Output (cc# 189) is low when Engine Control Unit is energizing the Inlet Air Heater Relay. (9540)
A00	1076	02	2	The High Pressure Solenoid within the pump is continuously energized, the Pump Control Unit is unable to detect closure of the High Pressure Solenoid Valve or the internal pump speed sensor is broken. (9540)
A00	1077	07	2	The High Pressure Solenoid Valve is closed when the Engine Control Unit is commanding the Pump Control Unit to stop delivering fuel. (9540)
A00	1077	11	2	The Pump Control Unit senses an abnormal voltage on Pump Power (cc# 061). (9540)
A00	1077	12	2	The Pump Control Unit detects an error during a self test. (9540)
A00	1077	19	2	The Pump Control Unit is not receiving any ECU/CAN messages while detecting a signal on Crank Speed Out (cc# 187). (9540)
A00	1077	31	1	Injection Pump initiated engine protection due to Diagnostic Trouble Code 174.31, 1076.02, 1077.12, 1078.07 or 1078.31. Engine will derate. (9540)
A00	1078	07	2	The Pump Control Unit receives a crank signal from the Engine Control Unit that is moderately different than the internal timing within the Pump. Engine will be derated. (9540)
A00	1078	11	2	The Engine Control Unit detects a difference between the internal pump timing and engine speed. (9540)
A00	1078	31	2	The Pump Control Unit receives a crank signal from the Engine Control Unit that is extremely different than the internal timing within the Pump. Engine will be derated. (9540)
A00	1079	03	2	Sensor Supply Voltage 1 (cc# 131) too high (greater than 4.95 V DC). (9540)
A00	1079	04	3	Sensor Supply Voltage 1 (cc# 131) too low (less than 4.0 V DC). (9540)
A00	1080	03	1	Rail Pressure Sensor Power (cc# 721) voltage too high. (9640, 9560, 9660, 9580, 9680)

OUZXMAG,00018B6 -19-10OCT02-15/27

Control Unit	SPN	FMI	Pri.	Description
A00	1080	04	1	Rail Pressure Sensor Power (cc# 721) voltage too low. (9640, 9560, 9660, 9580, 9680)
A00	1080	04	3	Rail Pressure Sensor Power (cc# 721) voltage too low. (9540)
A00	1347	03	1	CC# 178 Shorted to power. (9560-Engine Type C)
A00	1347	05	2	Driver detects problem in circuit to Pump Solenoid 1 Low (cc# 178). (9640, 9560, 9660, 9580, 9680)
A00	1347	07	2	Rail Pressure Control is unable to match required rail pressure. It may be too high or too low. (9640, 9560, 9660, 9580, 9680)
A00	1347	10	2	Pump Solenoid 1 is not delivering expected fuel flow. (9640, 9560-Engine Type B, 9660, 9580, 9680)
A00	1348	05	2	Driver detects problem in circuit to Pump Solenoid 2 Low (cc# 179). (9640, 9560-Engine Type B, 9660, 9580, 9680)
A00	1348	10	2	Pump Solenoid 2 is not delivering expected fuel flow. (9640, 9560-Engine Type B, 9660, 9580, 9680)
A00	1485	02	2	Pump Power (cc# 061) is powered when Engine Control Unit is off. (9540)
A00	1569	31	2	Engine protection - power derated due to other faults. This code occurs in conjunction with 105.16, 110.00, 110.03, 110.04, and

A00	2000	13	1	Engine Control Unit security violation.
-----	------	----	---	---

C00 - Armrest Control Unit Diagnostic Trouble Codes

Control Unit	SPN	FMI	Pri.	Description
C00	158	04	3	Control Circuit Power (cc# 023) is below 10.5 V DC.
C00	170	03	3	CLIMATRAK Cab Air Temperature Sensor voltage too high - greater than 4.8 V DC. Indicates that the sensor resistance is greater than 60K Ω (-22°F or -30°C).
C00	170	04	3	CLIMATRAK Cab Air Temperature Sensor voltage too low - less than 0.1 V DC. Indicates that the sensor resistance is less than 50 Ω (293°F or 145°C).
C00	172	03	3	CLIMATRAK Outside Air Temperature Sensor voltage too high - greater than 4.8 V DC. Indicates that the sensor resistance is greater than 60K Ω (-22°F or -30°C).
C00	172	04	3	CLIMATRAK Outside Air Temperature Sensor voltage too low - less than 0.1 V DC. Indicates that the sensor resistance is less than 50 Ω (293°F or 145°C).
C00	190	09	3	CAN Bus message missing from Engine Control Unit - Engine Speed
C00	605	04	3	CLIMATRAK Lo Pressure Switch (cc#914) is 12 V DC. A CAN Bus message from the Left Control Unit indicates that the CLIMATRAK Hi Pressure Switch (cc#915) is 0 V DC. The CLIMATRAK Hi Pressure Switch is open or there is a harness problem.
C00	627	03	1	Delayed Power (cc# 006) voltage is above 16 V DC. High voltage situation must be resolved.
C00	627	04	3	Delayed Power (cc# 006) is below 10.5 V DC.
C00	628	12	1	Controller cannot exit boot block program. Disconnect Armrest Control Unit connectors X653 and X654. Reconnect connectors. Replace Armrest Control Unit if condition persists.
C00	630	11	1	Controller failed EEPROM test at power-up. Replace Armrest Control Unit if condition persists.
C00	639	19	3	CAN Bus messages are not being transmitted or received correctly. Possible effects are none, slow response, or machine down.
C00	875	04	3	CAN Bus message from Left Control Unit indicates that CLIMATRAK Clutch Signal (cc# 913) is 12 V DC. CLIMATRAK Lo Pressure Switch (cc# 914) is 0 V DC. The CLIMATRAK Lo Pressure Switch is open or there is a harness problem.
C00	1490	08	2	Backshaft speed unknown. Damage could occur to feeder house if reverser is engaged while backshaft is rotating in forward direction.
C00	1498	11	3	The header engage output transistor detects an open, short, over voltage, or over temperature condition. The Armrest Control Unit will disengage the header. The fault condition must be removed before the header can be engaged.
C00	1499	11	3	The separator engage output transistor detects an open, short, over voltage, or over temperature condition. The Armrest Control Unit will disengage the separator. The fault condition must be removed before the separator can be engaged.
C00	1499	12	2	The Separator Engage fault detection circuit indicates a failure. This is an important disengagement override system. Replace the Armrest Control Unit if condition persists.
C00	1504	11	1	The Seat Switch has been closed continuously for 6 hours. The switch or the wiring harness is shorted. The header will not disengage when the operator has left the seat. This must be corrected.
C00	1505	03	3	HEADERTRAK Sensitivity Adjust voltage is too high - greater than 4.5 V DC. The device or wiring is faulty.
C00	1505	04	3	HEADERTRAK Sensitivity Adjust voltage is too low - less than 0.5 V DC. The device or wiring is faulty.
C00	1506	03	3	HEADERTRAK Rate Adjust voltage is too high - greater than 4.5 V DC. The device or wiring is faulty.

Control Unit	SPN	FMI	Pri.	Description
C00	1506	04	3	HEADERTRAK Rate Adjust voltage is too low - less than 0.5 V DC. The device or wiring is faulty.
C00	1505	10	3	HEADERTRAK Rate Adjust calibration fault: The potentiometer was calibrated in the wrong direction or the difference between the two calibration endpoints is less than 2.00 volts. This diagnostic trouble code is only displayed during a calibration fault and is not stored.
C00	1547	03	3	CLIMATRAK Core Temperature Sensor voltage too high - greater than 4.47 V DC. Indicates that the sensor resistance is greater than 101K Ω (-4°F or -20°C).
C00	1547	04	3	CLIMATRAK Core Temperature Sensor voltage too low - less than 0.1 V DC. Indicates that the sensor resistance is less than 52 Ω (356°F or 180°C).
C00	1548	03	3	CLIMATRAK Outlet Air Temperature Sensor voltage too high - greater than 4.8 V DC. Indicates that the sensor resistance is greater than 60K Ω (-22°F or -30°C).
C00	1548	04	3	CLIMATRAK Outlet Air Temperature Sensor voltage too low - less than 0.1 V DC. Indicates that the sensor resistance is less than 50 Ω (293°F or 145°C).
C00	1549	07	3	CLIMATRAK Water Valve position is greater than 30% different than the commanded position.
C00	200011	03	3	CLIMATRAK Solar Sensor voltage is too high - greater than 4.8 V DC. The device or wiring is faulty.
C00	200011	04	3	CLIMATRAK Solar Sensor voltage is too low - less than 1.5 V DC. The device or wiring is faulty.
C00	200017	09	3	CAN Bus message(s) missing from Cornerpost Control Unit.

C00	200018	09	3	CAN Bus message(s) missing from Left Control Unit.
C00	200201	11	3	Separator Engage Switch inputs are incorrect.
C00	200202	11	3	Header Engage Switch inputs are incorrect.

OUZXMAG,00018B6 -19-10OCT02-18/27

C03 - Cornerpost Control Unit Diagnostic Trouble Codes

Control Unit	SPN	FMI	Pri.	Description
C03	96	09	3	CAN Bus message missing from Right Control Unit - Fuel Level.
C03	110	09	3	CAN Bus message missing from Engine Control Unit - Engine Coolant Temperature
C03	190	09	3	CAN Bus message missing from Engine Control Unit - Engine Speed
C03	627	03	3	Delayed Power (cc# 006) voltage out of range high - greater than 16 V DC.
C03	628	12	1	Controller cannot exit boot block program. Disconnect Cornerpost Control Unit connector X500. Reconnect connector. Replace Cornerpost Control Unit if condition persists.
C03	630	11	1	EEPROM failed test at power up. Replace Cornerpost Control Unit if condition persists.
C03	639	19	3	CAN Bus messages are not being transmitted or received correctly. Possible effects are none, slow response, or machine down.
C03	1079	03	3	Concave Position Sensor supply voltage high - greater than 5.5 V DC.
C03	1079	04	3	Concave Position Sensor supply voltage low - less than 4.5 V DC.
C03	1486	03	3	Concave Position Sensor voltage is too high - greater than 4.5 V DC. The device or wiring is faulty.
C03	1486	04	3	Concave Position Sensor voltage is too low - less than 0.5 V DC. The device or wiring is faulty.
C03	1487	03	3	Dimmer voltage is too high - greater than 4.5 V DC. The device or wiring is faulty.
C03	1487	04	3	Dimmer voltage is too low - less than 0.5 V DC. The device or wiring is faulty.
C03	1492	08	3	Cab interior backlighting output transistor detects an open, short, over voltage, or over temperature condition. The Cornerpost Control Unit will turn off the backlighting. The fault condition must be removed before the backlighting can be turned on.
C03	1493	09	3	CAN Bus message missing from Master Tailings Sensor - Tailings Volume
C03	1500	11	3	A switch on Cornerpost Display Unit 1 is closed for longer than 30 Seconds.
C03	1501	11	3	A switch on Cornerpost Display Unit 2 is closed for longer than 30 Seconds.
C03	1502	11	3	A switch on Cornerpost Display Unit 3 is closed for longer than 30 Seconds.
C03	1503	09	3	CAN Bus message missing from Armrest Control Unit - Armrest Switch Status
C03	1510	09	3	CAN Bus message missing from Right Control Unit - Combine Temperatures
C03	1511	09	3	CAN Bus message missing from Right Control Unit - Grain Loss
C03	1515	09	3	CAN Bus message missing from Header Control Unit - Header Data
C03	1552	03	3	CLIMATRAK Temperature Setpoint Adjust voltage too high - greater than 4.5 V DC. Device or wiring is faulty.
C03	1552	04	3	CLIMATRAK Temperature Setpoint Adjust voltage too low - less than 0.5 V DC. Device or wiring is faulty.
C03	1552	13	3	CLIMATRAK Temperature Setpoint Adjust not calibrated. Refer to Diagnostic Address C03-135 for calibration.
C03	1553	03	3	CLIMATRAK Fan Speed Adjust voltage too high - greater than 4.5 V DC. Device or wiring is faulty.
C03	1553	04	3	CLIMATRAK Fan Speed Adjust voltage too low - less than 0.5 V DC. Device or wiring is faulty.
C03	1553	13	3	CLIMATRAK Fan Speed Adjust not calibrated. Refer to Diagnostic Address C03-134 for calibration.
C03	1565	09	3	CAN Bus message missing from Armrest Control Unit - Separator and Header Engage Status

OUZXMAG,00018B6 -19-10OCT02-19/27

Control Unit	SPN	FMI	Pri.	Description
C03	1567	09	3	CAN Bus message missing from Header Control Unit - Control Mode
C03	100100	09	3	CAN Bus message missing from Left Control Unit - System Data
C03	100101	09	3	CAN Bus message missing from Left Control Unit 2 - System Data
C03	100106	11	3	A switch on Cornerpost Display Unit 4 is closed for longer than 30 Seconds.

E00 - Tailings Control Unit Diagnostic Trouble Codes

Control Unit	SPN	FMI	Pri.	Description
E00	190	09	3	CAN Bus message missing from Engine Control Unit - Engine Speed
E00	628	12	2	Controller cannot exit boot block program. Turn Key Switch to the OFF position. Wait 30 seconds. Replace Master Tailings Sensor if condition persists.
E00	630	11	2	EEPROM failed test at power up. Replace the Master Tailings Sensor if condition persists.

E00	639	09	3	CAN Bus messages are not being transmitted or received correctly. Possible effects are none, slow response, or machine down. Other Diagnostic Trouble Codes will indicate the lost message.
E00	639	19	3	CAN Bus messages are not being transmitted or received correctly. Possible effects are none, slow response, or machine down.
E00	1493	11	3	Tailings system failure. Cause unknown.
E00	1493	15	3	Tailings system calibration is out of range high (sensor detectors are receiving too little light). Recalibrate. If situation persists, possible dirty sensor or failed sensor.
E00	1493	17	3	Tailings system calibration is out of range low (sensor detectors are receiving too much light). Recalibrate. If situation persists, possible missing elevator paddle or failed sensor.
E00	1494	08	3	Stuck photo receiver detected in Master Tailings Sensor. Clean master tailings sensor. If condition persists, replace sensor.
E00	1494	11	3	Master Tailings Sensor failure. Cause unknown.
E00	1495	08	3	Stuck photo receiver detected in Slave Tailings Sensor. Clean Slave Tailings Sensor. If condition continues, replace sensor.
E00	1495	11	3	Slave Tailings Sensor failure. Cause unknown.
E00	1496	07	3	Tailings elevator paddle missing
E00	1511	09	3	CAN Bus message missing from Right Control Unit - Seed Size
E00	1565	09	3	CAN Bus message missing from Armrest Control Unit - Header and Separator Engaged

OUZXMAG,00018B6 -19-10OCT02-20/27

E01 - Header Control Unit Diagnostic Trouble Codes

Control Unit	SPN	FMI	Pri.	Description
E01	84	09	3	CAN Bus message missing from Cornerpost Control Unit - Wheel Speed
E01	190	09	3	CAN Bus message missing from Engine Control Unit - Engine Speed
E01	627	03	1	Controller Supply voltage out of range high - greater than 16 V DC.
E01	628	12	1	Controller cannot exit boot block program. Disconnect Header Control Unit connector X205. Reconnect connector. Replace Header Control Unit if condition persists.
E01	630	11	3	System not calibrated or EEPROM failed test at power up. Calibrate header. Replace the Header Control Unit if condition persists.
E01	639	13	3	Multiple CAN Bus messages have not been received by the Header Control Unit in a timely manner. Possible effects are no effect, slowed response, or no response.
E01	1079	03	2	Height Sensor Power (cc# 481) voltage is too high - greater than 5.25 V DC. Height Sensor Power is used to power the Return To Cut Sensor, Reel Fore/Aft Position Sensor, Deck Plate Position Sensor, Right HEADERTRAK Sensor, Center HEADERTRAK Sensor and Left HEADERTRAK Sensor. The voltage regulator of the Header Control Unit is bad or there is a short in the wiring.
E01	1079	04	2	Height Sensor Power (cc# 481) voltage is too low - less than 4.75 V DC. Height Sensor Power is used to power the Return To Cut Sensor, Reel Fore/Aft Position Sensor, Deck Plate Position Sensor, Right HEADERTRAK Sensor, Center HEADERTRAK Sensor and Left HEADERTRAK Sensor. The voltage regulator of the Header Control Unit is bad or there is a short in the wiring.
E01	1080	03	2	Height Sensor Power 2 (cc# 471) voltage is too high - greater than 5.25 V DC. Height Sensor Power 2 is used to power the HEADERTRAK Angle Sensor and the Header Raise Pressure Sensor. The voltage regulator of the Header Control Unit is bad or there is a short in the wiring.
E01	1080	04	2	Height Sensor Power 2 (cc# 471) voltage is too low - less than 4.75 V DC. Height Sensor Power 2 is used to power the HEADERTRAK Angle Sensor and the Header Raise Pressure Sensor. The voltage regulator of the Header Control Unit is bad or there is a short in the wiring.
E01	1515	13	2	HEADERTRAK system not calibrated for currently attached header. Perform the calibration procedure.
E01	1516	13	2	HEADERTRAK - Ground Pressure system not calibrated for currently attached header. Perform the calibration procedure.
E01	1517	04	2	Header Raise Pressure (cc# 706) voltage is too low - less than 0.25 V DC.
E01	1518	02	3	Circuit codes 436, 487, 488, and 489 changed while the HEADERTRAK was in the automatic mode. These are the header select lines that identify the type of header on the combine.
E01	1518	07	3	Header not connected or invalid connection. Circuit codes 436, 487, 488, and 489 are the header select lines that identify the type of header on the combine.
E01	1518	14	3	Cannot activate HEADERTRAK Stubble Height or HEADERTRAK Tilt Header sensors are not available.
E01	1519	11	2	Header raise valve driver detects an open, short, over voltage, or over temperature condition. The Header Control Unit will not actuate the Header Raise Valve until the fault condition is removed.
E01	1520	11	2	Header lower valve driver detects an open, short, over voltage, or over temperature condition. The Header Control Unit will not actuate the Header Lower Valve until the fault condition is removed.
E01	1521	11	2	Tilt left valve driver detects an open, short, over voltage, or over temperature condition. The Header Control Unit will not actuate the HEADERTRAK Tilt Left Valve until the fault condition is removed.

OUZXMAG,00018B6 -19-10OCT02-21/27

Control Unit	SPN	FMI	Pri.	Description
E01	1522	11	2	Tilt right valve driver detects an open, short, over voltage, or over temperature condition. The Header Control Unit will not actuate the HEADERTRAK Tilt Right Valve until the fault condition is removed.

E01	1524	11	3	Reel forward valve driver detects an open, short, over voltage, or over temperature condition. The Header Control Unit will not actuate the Reel Forward Valve until the fault condition is removed.
E01	1525	11	3	Reel Aft valve driver detects an open, short, over voltage, or over temperature condition. The Header Control Unit will not actuate the Reel Aft Valve until the fault condition is removed.
E01	1526	11	3	Reel Raise valve driver detects an open, short, over voltage, or over temperature condition. The Header Control Unit will not actuate the Reel Raise Valve until the fault condition is removed.
E01	1527	11	3	Reel Lower valve driver detects an open, short, over voltage, or over temperature condition. The Header Control Unit will not actuate the Reel Lower Valve until the fault condition is removed.
E01	1528	11	3	Drop Rate valve driver detects an open, short, over voltage, or over temperature condition. The Header Control Unit will not actuate the Drop Rate Valve until the fault condition is removed.
E01	1529	11	3	Accumulator Shutoff valve driver detects an open, short, over voltage, or over temperature condition. The Header Control Unit will not actuate the Accumulator Shutoff Valve until the fault condition is removed.
E01	1531	06	2	Reel Speed Increase driver detects an open, short, over voltage, or over temperature condition. The Header Control Unit will not actuate the Reel Speed Actuator in the increase speed mode until the fault condition is removed.
E01	1532	06	2	Reel Speed Decrease driver detects an open, short, over voltage, or over temperature condition. The Header Control Unit will not actuate the Reel Speed Actuator in the decrease speed mode until the fault condition is removed.
E01	1533	03	2	HEADERTRAK - Return to Cut Sensor (cc# 828) voltage is too high - greater than 4.5 V DC. Faulty device or wiring.
E01	1533	04	2	HEADERTRAK - Return to Cut Sensor (cc# 828) voltage is too low - less than 0.5 V DC. Faulty device or wiring.
E01	1534	03	2	Left HEADERTRAK Sensor (cc# 412) voltage is too high - greater than 4.5 V DC. Faulty device or wiring.
E01	1534	04	2	Left HEADERTRAK Sensor (cc# 412) voltage is too low less than 0.5 V DC. Faulty device or wiring.
E01	1535	03	2	Right HEADERTRAK Sensor (cc# 454) voltage is too high - greater than 4.5 V DC. Faulty device or wiring.
E01	1535	04	2	Right HEADERTRAK Sensor (cc# 454) voltage is too low - less than 0.5 V DC. Faulty device or wiring.
E01	1536	03	2	Center HEADERTRAK Sensor (cc# 414) voltage is too high - greater than 4.5 V DC. Faulty device or wiring.
E01	1536	04	2	Center HEADERTRAK Sensor (cc# 414) voltage is too low - less than 0.5 V DC. Faulty device or wiring.
E01	1537	03	3	Reel Fore/Aft Position Sensor or Deck Plate Position Sensor (cc# 834) voltage too high - greater than 4.5 V DC. Faulty device or wiring.
E01	1537	04	3	Reel Fore/Aft Position Sensor or Deck Plate Position Sensor (cc# 834) voltage too low - less than 0.5 V DC. Faulty device or wiring.
E01	1538	03	3	Reel Height Sensor (cc# 835) voltage too high - greater than 4.5 V DC. Faulty device or wiring.
E01	1538	04	3	Reel Height Sensor (cc# 835) voltage too low - less than 0.5 V DC. Faulty device or wiring.

OUZXMAG,00018B6 -19-10OCT02-22/27

Control Unit	SPN	FMI	Pri.	Description
E01	1539	03	3	HEADERTRAK Angle Sensor (cc# 833) voltage too high - greater than 4.5 V DC. Faulty device or wiring.
E01	1539	04	3	HEADERTRAK Angle Sensor (cc# 833) voltage too low - less than 0.5 V DC. Faulty device or wiring.
E01	1541	02	2	Reel speed unknown.
E01	1544	09	3	CAN Bus message missing from Armrest Control Unit - Multifunction Lever Switch Status

E02 - Right Control Unit Diagnostic Trouble Codes

Control Unit	SPN	FMI	Pri.	Description
E02	96	03	3	Fuel Level Signal (cc# 652) voltage is too high - greater than 1.96 V DC. The device or wiring is faulty.
E02	96	04	3	Fuel Level Signal (cc# 652) voltage is too low - less than 0.12 V DC. The device or wiring is faulty.
E02	627	03	1	Electronic Power (cc# 021) voltage is too high - greater than 16 V DC.
E02	628	12	1	Controller cannot exit boot block program. Turn Key Switch to the OFF position. Wait for 30 seconds. Replace Right Control Unit if condition persists.
E02	630	11	2	EEPROM failed test on power up. Replace the Right Control Unit if condition persists.
E02	639	09	3	CAN Bus messages are not received by the Right Control Unit in a timely manner. Possible effects are none, slow response, or machine down. Other Diagnostic Trouble Codes will indicate the lost message.
E02	639	19	2	CAN Bus messages are not being transmitted or received correctly. Possible effects are none, slow response, or machine down.
E02	1498	09	3	CAN Bus message missing from Armrest Control Unit - Header Engage Status
E02	1500	09	3	CAN Bus message missing from Cornerpost Control Unit - Machine Configuration
E02	1500	11	3	CAN Bus message from Cornerpost Control Unit invalid - Machine Configuration
E02	1508	03	2	Hydraulic Oil Temperature Sensor (cc# 775) voltage is too high - greater than 4.97 V DC. The device or wiring is faulty.
E02	1508	04	2	Hydraulic Oil Temperature Sensor (cc# 775) voltage is too low - less than 0.29 V DC. The device or wiring is faulty.
E02	1509	03	2	Main Gearcase Oil Temperature Sensor (cc# 774) voltage is too

high - greater than 4.97 V DC. The device or wiring is faulty.

E02	1509	04	2	Main Gearcase Oil Temperature Sensor (cc# 774) voltage is too low - less than 0.29 V DC. The device or wiring is faulty.
E02	1510	03	3	Chopper Vane Angle Sensor (cc# 781) voltage is too high (above 4.97 V DC). The device or wiring is faulty.
E02	1510	13	3	Chopper Vane Angle Sensor out of calibration. Perform the calibration procedure.
E02	1565	09	3	CAN Bus message missing from Armrest Control Unit - Discrete Input Status

OUZXMAG,00018B6 -19-10OCT02-23/27

E03 - Left Control Unit Diagnostic Trouble Codes

Control Unit	SPN	FMI	Pri.	Description
E03	190	09	3	CAN Bus message(s) missing from Engine Control Unit - Engine Speed
E03	627	03	1	Electronic Power (cc# 021) voltage is too high - greater than 15.5 V DC.
E03	628	12	1	Controller cannot exit boot block program. Disconnect Left Control Unit connector X213. Reconnect connector. Replace Left Control Unit if condition persists.
E03	630	11	3	EEPROM failed test on power up. Replace the Left Control Unit if condition persists.
E03	639	19	3	CAN Bus messages are not being transmitted or received correctly. Possible effects are none, slow response, or machine down.
E03	876	11	2	The CLIMATRAK Compressor driver detects an open, short, over voltage, or over temperature condition.
E03	1497	11	3	Unloading Auger Engage driver detects an open, short, over voltage, or over temperature condition. The Left Control Unit cannot engage the auger until the fault condition is removed.
E03	1500	09	3	CAN Bus message(s) missing from Cornerpost Control Unit - Ground Speed and/or Machine Configuration.
E03	1503	09	3	CAN Bus message(s) missing from Armrest Control Unit
E03	1515	09	3	CAN Bus message(s) missing from Header Control Unit
E03	200112	03	2	12 V DC is detected at the output of Grain Tank Cover Fold relay (K7) of the Control Relay Board when it is not energized. Indicates possible problem with K7 or Control Power (cc# 016) short circuit to 12 V DC.
E03	200112	04	2	12 V DC is not detected at the output of Grain Tank Cover Fold relay (K7) of the Control Relay Board when it is energized. Indicates possible problem with K7 or Control Power (cc# 016).
E03	200126	11	3	The Unloading Auger Swing In driver or the Unloading Auger Swing Out driver detects an open, short, over voltage, or over temperature condition. The Left Control Unit cannot swing the auger until the fault condition is removed.
E03	200128	03	1	HILLMASTER II Engage is not ON, but 12 V DC is detected on the Hillmaster Engage Signal (cc# 447) of the Left Control Unit. Possible problem with Left Control Unit or Hillmaster Engage Signal (cc# 447) shorted to 12 V DC
E03	200128	04	1	Hillmaster Engage Signal (cc# 447) is not 12 V DC when ON. Possible problem with Left Control Unit or Hillmaster Engage Signal (cc# 447) wiring. When HILLMASTER II is disengaged, the Diagnostic Trouble Code becomes a stored code.
E03	200129	11	3	The Combine Lower driver detects an open, short, over voltage, or over temperature condition. The Left Control Unit cannot engage Combine Lower until the fault condition is removed.
E03	200132	11	1	The Left Brake Light driver detects an open, short, over voltage, or over temperature condition. Only active in the ROAD mode.
E03	200133	11	1	The Right Brake Light driver detects an open, short, over voltage, or over temperature condition. Only active in the ROAD mode.
E03	200134	11	1	The Left Marker Light driver detects an open, short, over voltage, or over temperature condition. Only active in the ROAD mode.
E03	200135	11	1	The Right Marker Light driver detects an open, short, over voltage, or over temperature condition. Only active in the ROAD mode.
E03	200137	11	2	The Feeder House Reverser driver detects an open, short, over voltage, or over temperature condition.
E03	200140	03	2	12 V DC detected on Ground (cc# 010) of Control Relay Board. Indicates problem with ground connections.

OUZXMAG,00018B6 -19-10OCT02-24/27

Control Unit	SPN	FMI	Pri.	Description
E03	200141	04	2	12 V DC not detected on Unswitched Electronic Power (cc# 022) of Control Relay Board. Indicates problem with Unswitched Electronic Power connection, wiring or Fuse F20 of the Engine Compartment Relay Panel.
E03	200142	04	2	12 V DC not detected on Light Power (cc# 014) of Control Relay Board. Indicates problem with Light Power connection, wiring or Fuse F18 of the Engine Compartment Relay Panel.
E03	200143	04	2	12 V DC not detected on Control Power (cc# 016) of Control Relay Board. Indicates problem with Control Power connection, wiring, Fuse F8 or Relay K4 of the Engine Compartment Relay Panel.
E03	200144	04	2	12 V DC not detected on Light Power 2 (cc# 046) of Control Relay Board. Indicates problem with Light Power 2 connection, wiring or Fuse F5 of the Engine Compartment Relay Panel.
E03	200145	04	2	12 V DC not detected on Light Power 3 (cc# 047) of Control Relay Board. Indicates problem with Light Power 3 connection, wiring or Fuse F3 of the Engine Compartment Relay Panel.
E03	200146	04	3	12 V DC not detected on Light Power 4 (cc# 048) of Control Relay Board. Indicates problem with Light Power 4 connection, wiring or Fuse F4 of the Engine Compartment Relay Panel.

E03	200147	04	2	12 V DC not detected on Fan Speed Adjust Power (cc# 051) of Control Relay Board. Indicates problem with Fan Speed Adjust Power connection, wiring or Fuse F11 or Relay K5 of the Engine Compartment Relay Panel.
E03	200148	04	2	12 V DC not detected on Light Power 5 (cc# 049) of Control Relay Board. Indicates problem with Light Power 5 connection, wiring or Fuse F9 of the Engine Compartment Relay Panel.
E03	200149	11	2	Indicates a problem in the serial communication link between the Left Control Unit and the Control Relay Board.

Left Control Unit 2 Type Identification

The Left Control Unit 2 will have 1 or 2 connectors.

If the Left Control Unit 2 has one 30 pin connector, it is a Type A control unit. If the Left Control Unit 2 has 2 connectors, it is a Type B control unit

OUZXMAG,00018B6 -19-10OCT02-25/27

E04 - Left Control Unit 2 Diagnostic Trouble Codes

Control Unit	SPN	FMI	Pri.	Description
E04	190	09	3	CAN Bus message(s) missing from Engine Control Unit - Engine Speed
E04	627	03	1	Delayed Power (cc# 006) voltage is too high - greater than 15.5 V DC.
E04	628	12	2	Controller cannot exit boot block program. Disconnect Left Control Unit 2 connectors X314 and X315. Reconnect connectors. Replace Armrest Control Unit if condition persists. (Type B only)
E04	630	11	3	EEPROM failed test on power up. Replace the Left Control Unit 2 if condition persists.
E04	639	19	3	CAN Bus off - There are more than 256 CAN Bus errors (Type B only)
E04	1500	09	3	CAN Bus message(s) missing from Cornerpost Control Unit
E04	1503	09	2	CAN Bus message(s) missing from Armrest Control Unit
E04	200150	11	3	Threshing Speed failed to reach commanded speed after 50 seconds
E04	200151	11	3	Threshing Clearance failed to reach commanded clearance after 30 seconds
E04	200152	11	3	Cleaning Fan Speed failed to reach commanded speed after 130 seconds
E04	200310	11	3	Left Chaffer Actuator Limit Switch problem. Pulses present on Chaffer 1 Position (cc# 824). Limit switch remains on. (Type B only)
E04	200311	11	3	Left Sieve Actuator Limit Switch problem. Pulses present on Sieve 1 Position (cc# 825). Limit switch remains on. (Type B only)
E04	200312	11	3	Left Precleaner Actuator Limit Switch problem. Pulses present on Precleaner 1 Position (cc# 823). Limit switch remains on. (Type B only)
E04	200313	11	3	Right Chaffer Actuator Limit Switch problem. Pulses present on Chaffer 2 Position (cc# 819). Limit switch remains on. (Type B only)
E04	200314	11	3	Right Sieve Actuator Limit Switch problem. Pulses present on Sieve 2 Position (cc# 827). Limit switch remains on. (Type B only)
E04	200315	11	3	Right Precleaner Actuator Limit Switch problem. Pulses present on Precleaner 2 Position (cc# 818). Limit switch remains on. (Type B only)
E04	200316	11	3	Left Chaffer Actuator commanded to move, but no pulses present on Chaffer 1 Position (cc# 824). Actuator is in a valid position. (Type B only)
E04	200317	11	3	Left Sieve Actuator commanded to move, but no pulses present on Sieve 1 Position (cc# 825). Actuator is in a valid position. (Type B only)
E04	200318	11	3	Left Precleaner Actuator commanded to move, but no pulses present on Precleaner 1 Position (cc# 823). Actuator is in a valid position. (Type B only)
E04	200319	11	3	Right Chaffer Actuator commanded to move, but no pulses present on Chaffer 2 Position (cc# 819). Actuator is in a valid position. (Type B only)
E04	200320	11	3	Right Sieve Actuator commanded to move, but no pulses present on Sieve 2 Position (cc# 827). Actuator is in a valid position. (Type B only)
E04	200321	11	3	Right Precleaner Actuator commanded to move, but no pulses present on Precleaner 2 Position (cc# 818). Actuator is in a valid position. (Type B only)
E04	200322	11	3	Power present on Chaffer Open Signal (cc# 374) for longer than 30 seconds. (Type B only)
E04	200323	11	3	Power present on Chaffer Close Signal (cc# 375) for longer than 30 seconds. (Type B only)
E04	200324	11	3	Power present on Sieve Open Signal (cc# 376) for longer than 30 seconds. (Type B only)
E04	200325	11	3	Power present on Sieve Close Signal (cc# 377) for longer than 30 seconds. (Type B only)
E04	200326	11	3	Power present on Precleaner Open Signal (cc# 372) for longer than 30 seconds. (Type B only)
E04	200327	11	3	Power present on Precleaner Close Signal (cc# 373) for longer than 30 seconds. (Type B only)

OUZXMAG,00018B6 -19-10OCT02-26/27

Control Unit	SPN	FMI	Pri.	Description

E04	200328	03	3	A short circuit to ground detected on cc# 385. The Left Control Unit 2 will not actuate the Left Chaffer Actuator until the fault condition is removed. (Type B only)
E04	200329	04	3	A short circuit to power detected on cc# 385 or 384. The Left Control Unit 2 will not actuate the Left Chaffer Actuator until the fault condition is removed. (Type B only)
E04	200330	03	3	A short circuit to ground detected on cc# 384. The Left Control Unit 2 will not actuate the Left Chaffer Actuator until the fault condition is removed. (Type B only)
E04	200331	03	3	A short circuit to ground detected on cc# 387. The Left Control Unit 2 will not actuate the Left Sieve Actuator until the fault condition is removed. (Type B only)
E04	200332	04	3	A short circuit to power detected on cc# 387 or 386. The Left Control Unit 2 will not actuate the Left Sieve Actuator until the fault condition is removed. (Type B only)
E04	200333	03	3	A short circuit to ground detected on cc# 386. The Left Control Unit 2 will not actuate the Left Sieve Actuator until the fault condition is removed. (Type B only)
E04	200334	03	3	A short circuit to ground detected on cc# 383. The Left Control Unit 2 will not actuate the Left Precleaner Actuator until the fault condition is removed. (Type B only)
E04	200335	04	3	A short circuit to power detected on cc# 383 or 382. The Left Control Unit 2 will not actuate the Left Precleaner Actuator until the fault condition is removed. (Type B only)
E04	200336	03	3	A short circuit to ground detected on cc# 382. The Left Control Unit 2 will not actuate the Left Precleaner Actuator until the fault condition is removed. (Type B only)
E04	200337	03	3	A short circuit to ground detected on cc# 393. The Left Control Unit 2 will not actuate the Right Chaffer Actuator until the fault condition is removed. (Type B only)
E04	200338	04	3	A short circuit to power detected on cc# 393 or 392. The Left Control Unit 2 will not actuate the Right Chaffer Actuator until the fault condition is removed. (Type B only)
E04	200339	03	3	A short circuit to ground detected on cc# 392. The Left Control Unit 2 will not actuate the Right Chaffer Actuator until the fault condition is removed. (Type B only)
E04	200340	03	3	A short circuit to ground detected on cc# 395. The Left Control Unit 2 will not actuate the Right Sieve Actuator until the fault condition is removed. (Type B only)
E04	200341	04	3	A short circuit to power detected on cc# 395 or 394. The Left Control Unit 2 will not actuate the Right Sieve Actuator until the fault condition is removed. (Type B only)
E04	200342	03	3	A short circuit to ground detected on cc# 394. The Left Control Unit 2 will not actuate the Right Sieve Actuator until the fault condition is removed. (Type B only)
E04	200343	03	3	A short circuit to ground detected on cc# 389. The Left Control Unit 2 will not actuate the Right Precleaner Actuator until the fault condition is removed. (Type B only)
E04	200344	04	3	A short circuit to power detected on cc# 389 or 388. The Left Control Unit 2 will not actuate the Right Precleaner Actuator until the fault condition is removed. (Type B only)
E04	200345	03	3	A short circuit to ground detected on cc# 388. The Left Control Unit 2 will not actuate the Right Precleaner Actuator until the fault condition is removed. (Type B only)
E04	200352	11	3	Chaffer Actuators not calibrated. (Type B only)
E04	200353	11	3	Sieve Actuators not calibrated. (Type B only)
E04	200354	11	3	Precleaner Actuators not calibrated. (Type B only)