

SECTION 7 ELECTRICAL SYSTEM

GROUP 1 COMPONENT LOCATION

1. LOCATION 1

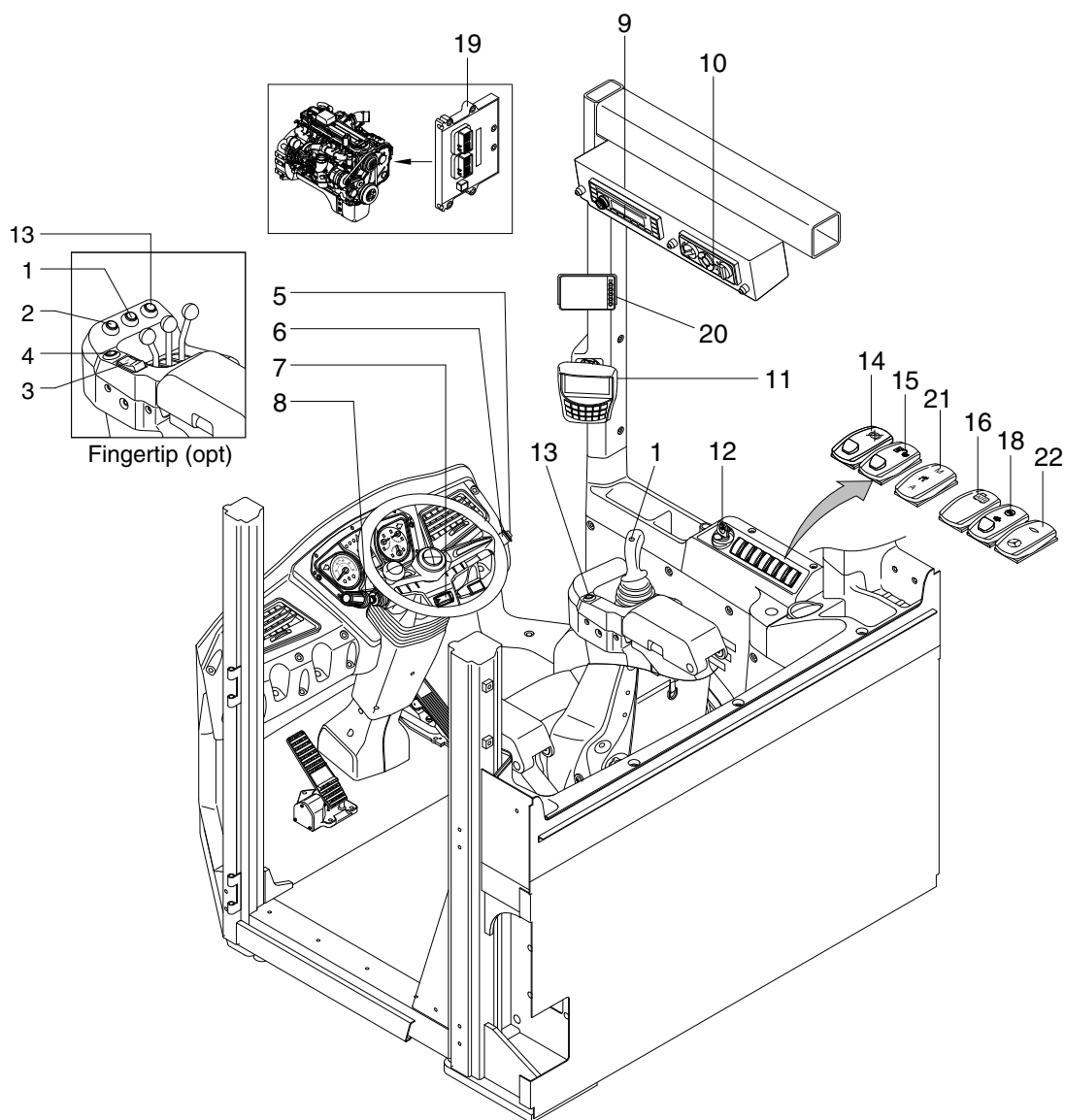

940A7EL20

- | | | |
|-------------------------|---------------------------|-----------------------------------|
| 1 Kick down button | 8 Gear select lever | 14 Parking brake switch |
| 2 Horn button | 9 Radio & USB player | 15 Pilot cut off switch |
| 3 FNR switch | 10 Aircon & heater switch | 16 Air compressor switch (opt) |
| 4 FNR select button | 11 Monitor | 18 Exhaust system cleaning switch |
| 5 Hone button | 12 Starting switch | 19 Engine control unit (ECU) |
| 6 Multi function switch | Starting button (opt) | 20 Camera monitor (opt) |
| 7 Hazard switch | 13 Work load button | 21 Differential lock switch (opt) |
| | | 22 Emergency test switch (opt) |

2. LOCATION 2

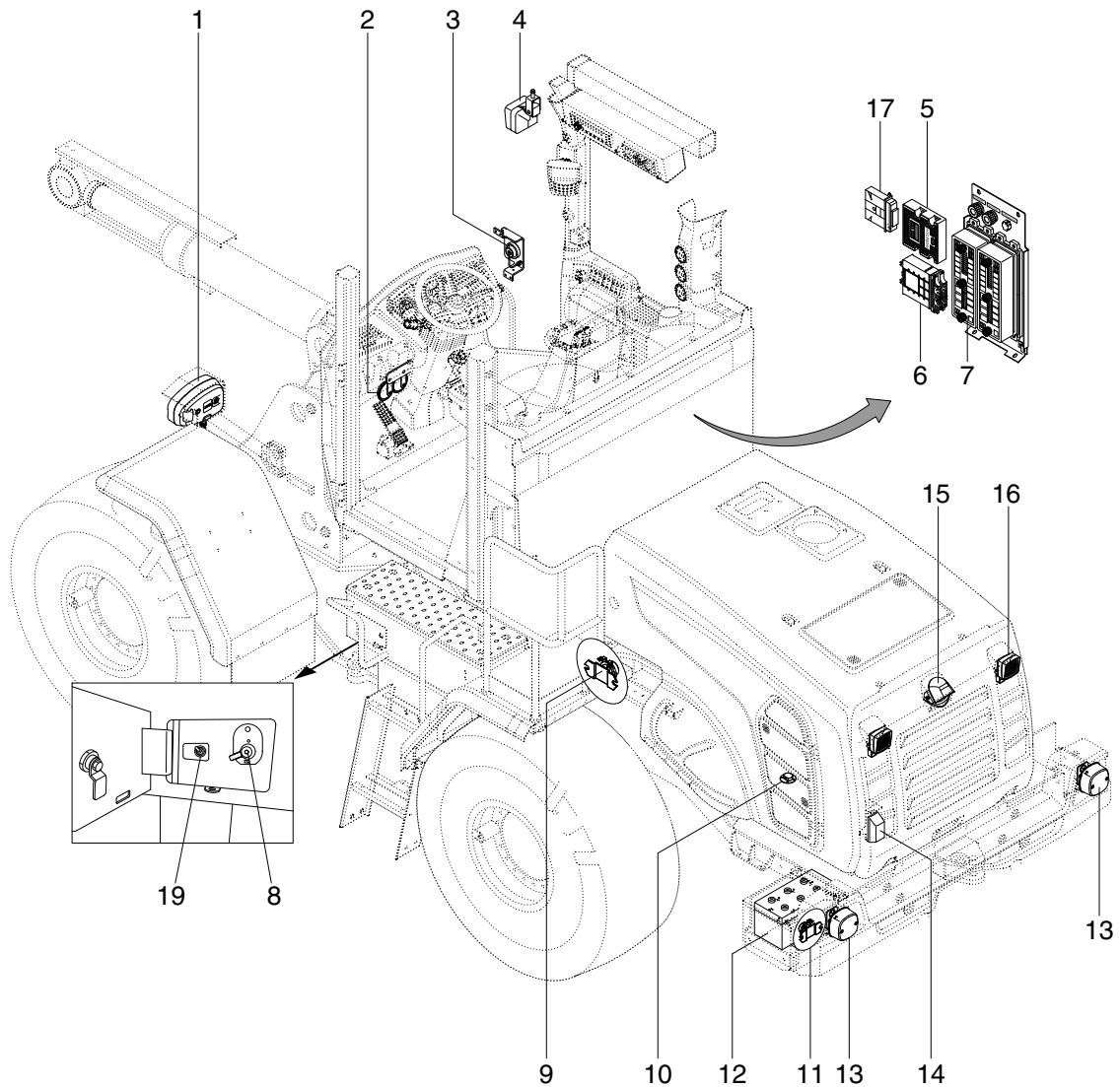

960A7EL21

- | | | | | | |
|---|---------------------------------|----|-------------------|----|--|
| 1 | Head lamp | 8 | Master switch | 15 | Camera (opt) |
| 2 | Horn | 9 | Start relay | 16 | Work lamp |
| 3 | Angle sensor | 10 | Fuel sender | 17 | Control unit (electro hydraulic & joystick steering) |
| 4 | Work lamp | 11 | Battery relay | 19 | Engine hood open switch |
| 5 | Machine control unit (MCU) | 12 | Battery | | |
| 6 | Transmission control unit (TCU) | 13 | Rear combi lamp | | |
| 7 | Fuse and relay box | 14 | Number plate lamp | | |

GROUP 2 ELECTRICAL CIRCUIT

- ELECTRICAL CIRCUIT (1/3)

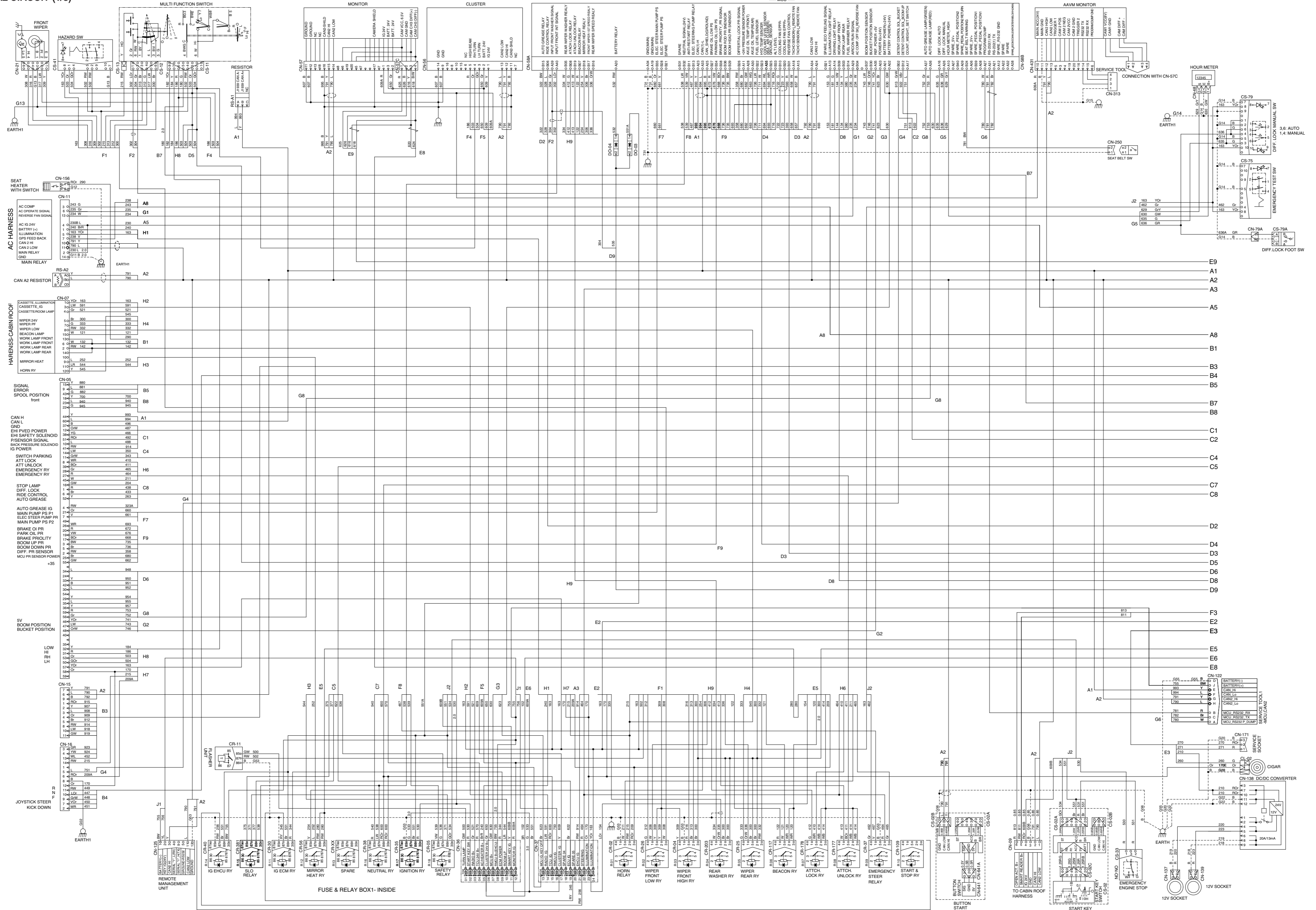

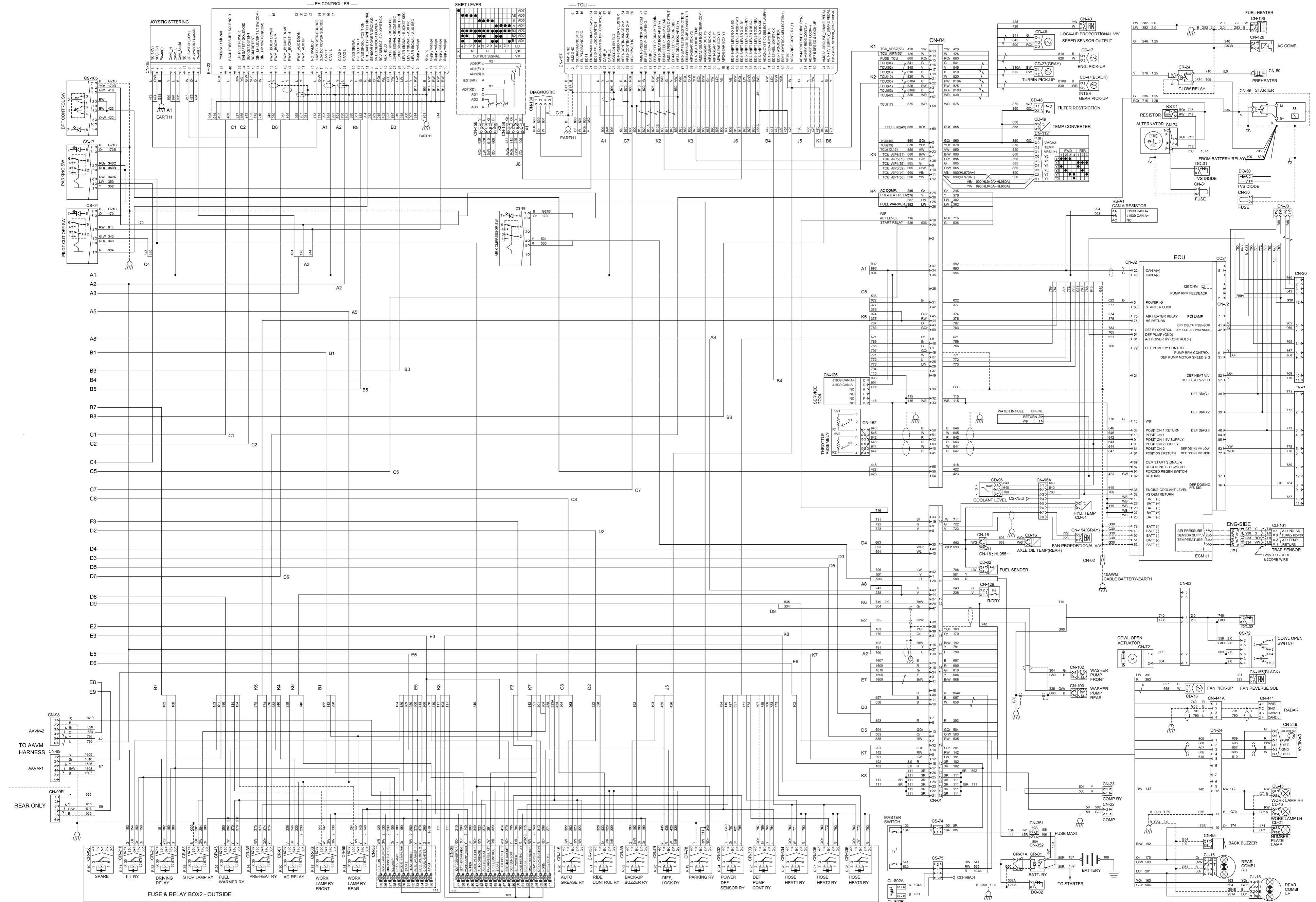

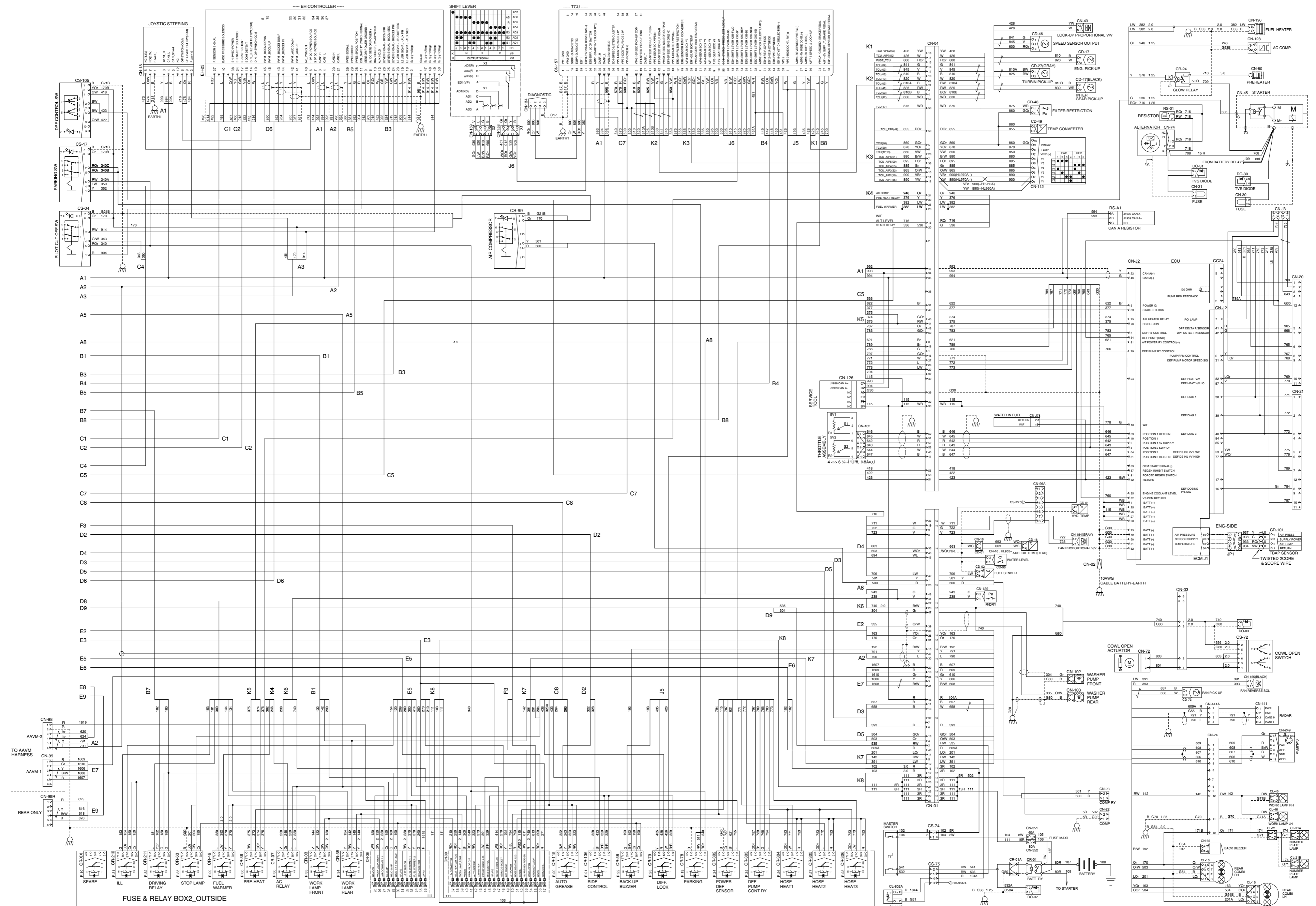

ELECTRICAL CIRCUIT (3/3)

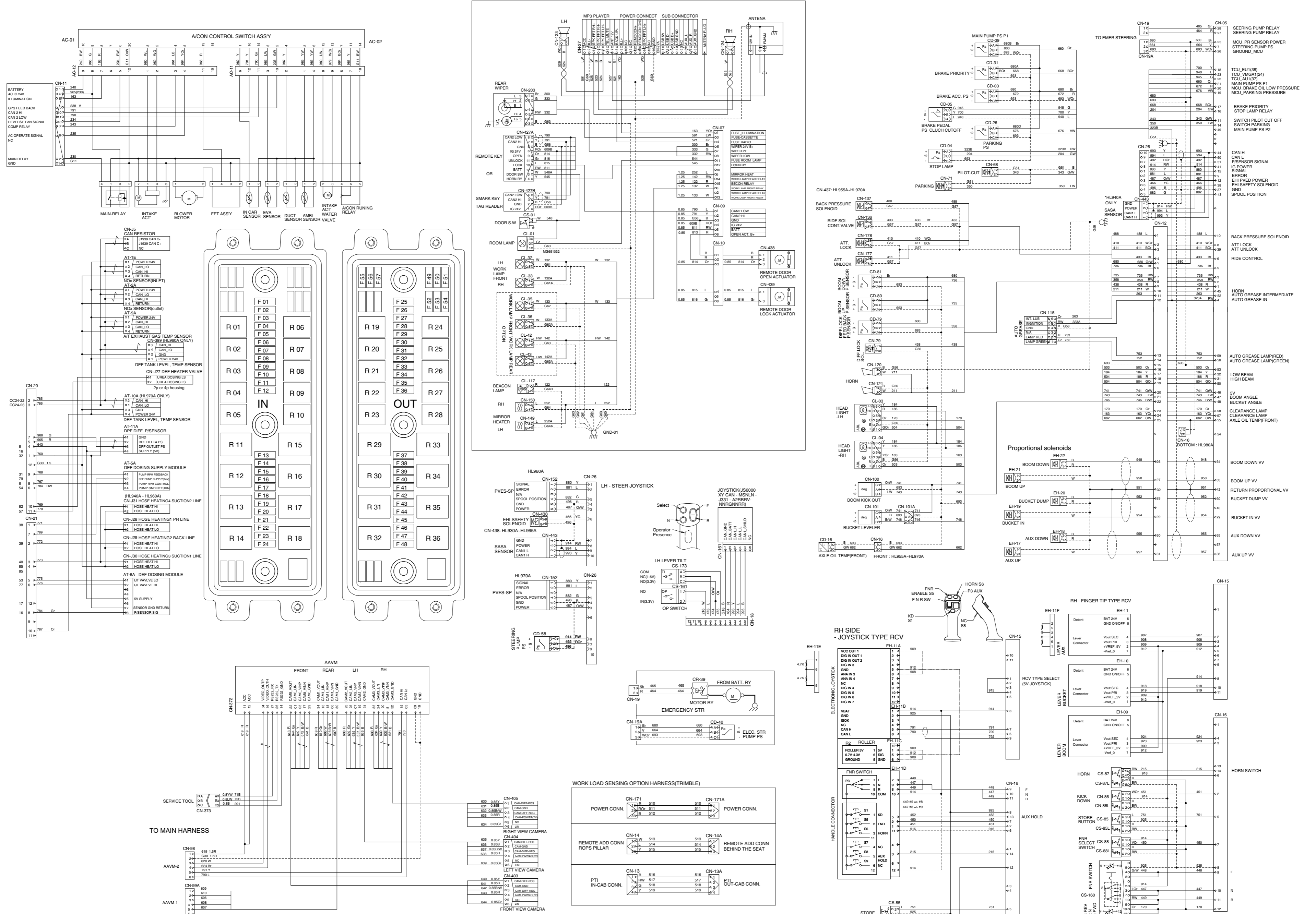

MEMORANDUM

1. ILLUMINATION CIRCUIT

1) OPERATING FLOW

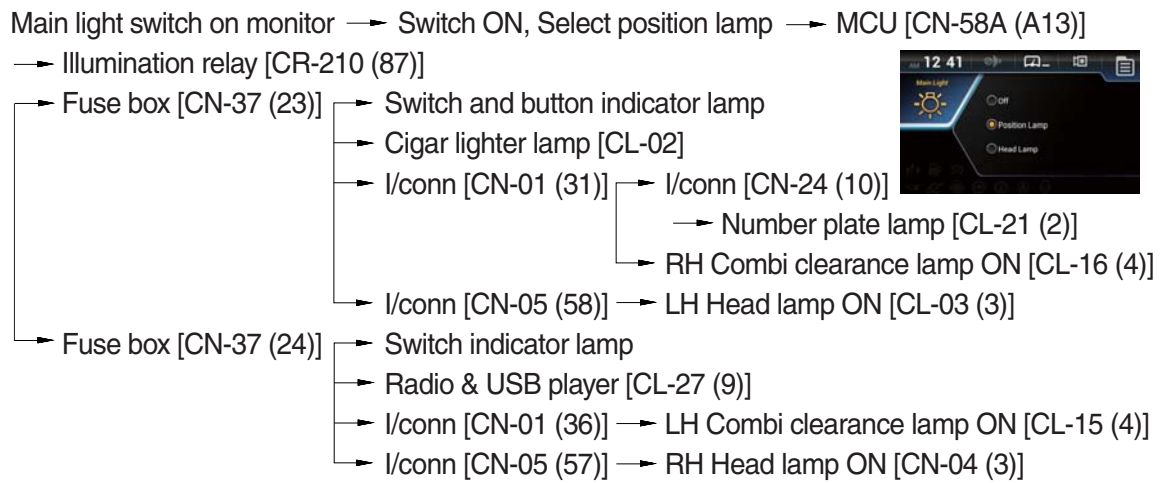

2) CHECK POINT

Engine	Key switch	Check point	Voltage
OFF	ON	① - GND (relay input) ② - GND (relay output) ③ - GND (to light)	20~25V

※ GND : Ground

ILLUMINATION CIRCUIT

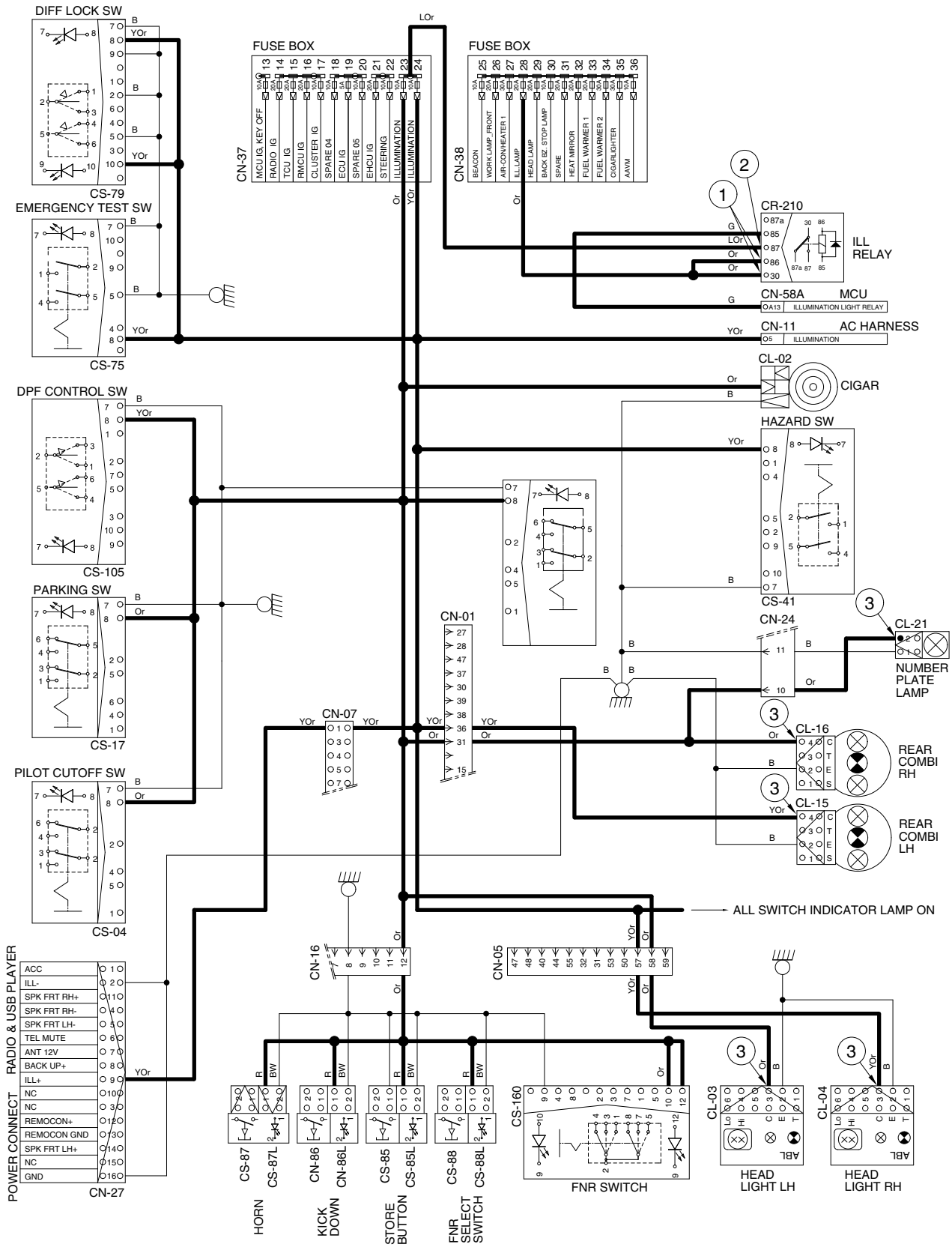

2. HEAD LIGHT CIRCUIT

1) OPERATING FLOW

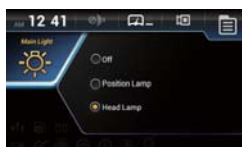
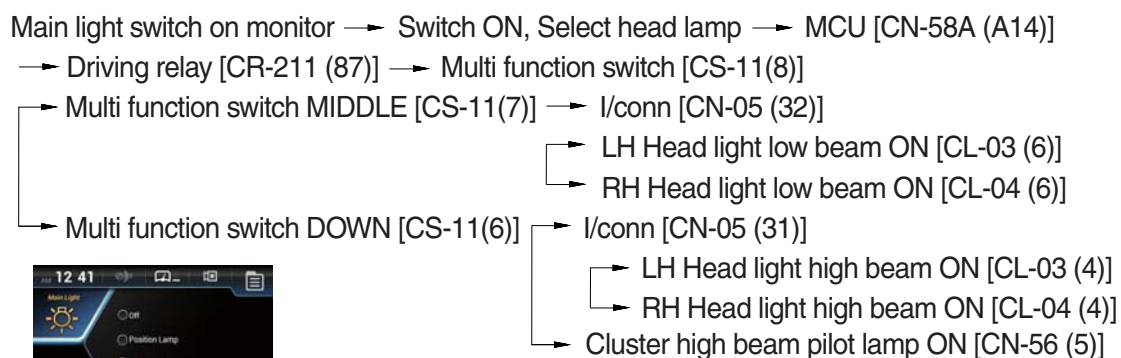

2) CHECK POINT

Engine	Key switch	Check point	Voltage
OFF	ON	① - GND (relay input) ② - GND (relay output) ③ - GND (multi function input) ④ - GND (multi function output) ⑤ - GND (multi function output) ⑥ - GND (low beam) ⑦ - GND (high beam) ⑧ - GND (passing B ⁺)	20~25V

※ GND : Ground

3. WORK LIGHT SWITCH

1) OPERATING FLOW

※ Main light switch on monitor : Select position lamp.

(1) Work lamp switch (select Front)

MCU [CN-58B (B09)] → Front work lamp relay [CR-03 (87)] → I/conn [CN-07 (06)]

- LH Front work lamp ON [CL-32 (1)]
- RH Front work lamp ON [CL-33 (1)]



(2) Work lamp switch (select Rear)

MCU [CN-58B (B03)] → Rear work lamp relay [CR-55 (87)] → I/conn [CN-01 (05)]

- I/conn [CN-24 (12)]
 - LH Rear work lamp ON [CL-46 (1)]
 - RH Rear work lamp ON [CL-45 (1)]



2) CHECK POINT

Engine	Key switch	Check point	Voltage
OFF	ON	① - GND (work lamp power input) ② - GND (work lamp power output) ③ - GND (front work lamp) ④ - GND (rear work lamp)	20~25V

※ GND : Ground

WORK LIGHT SWITCH

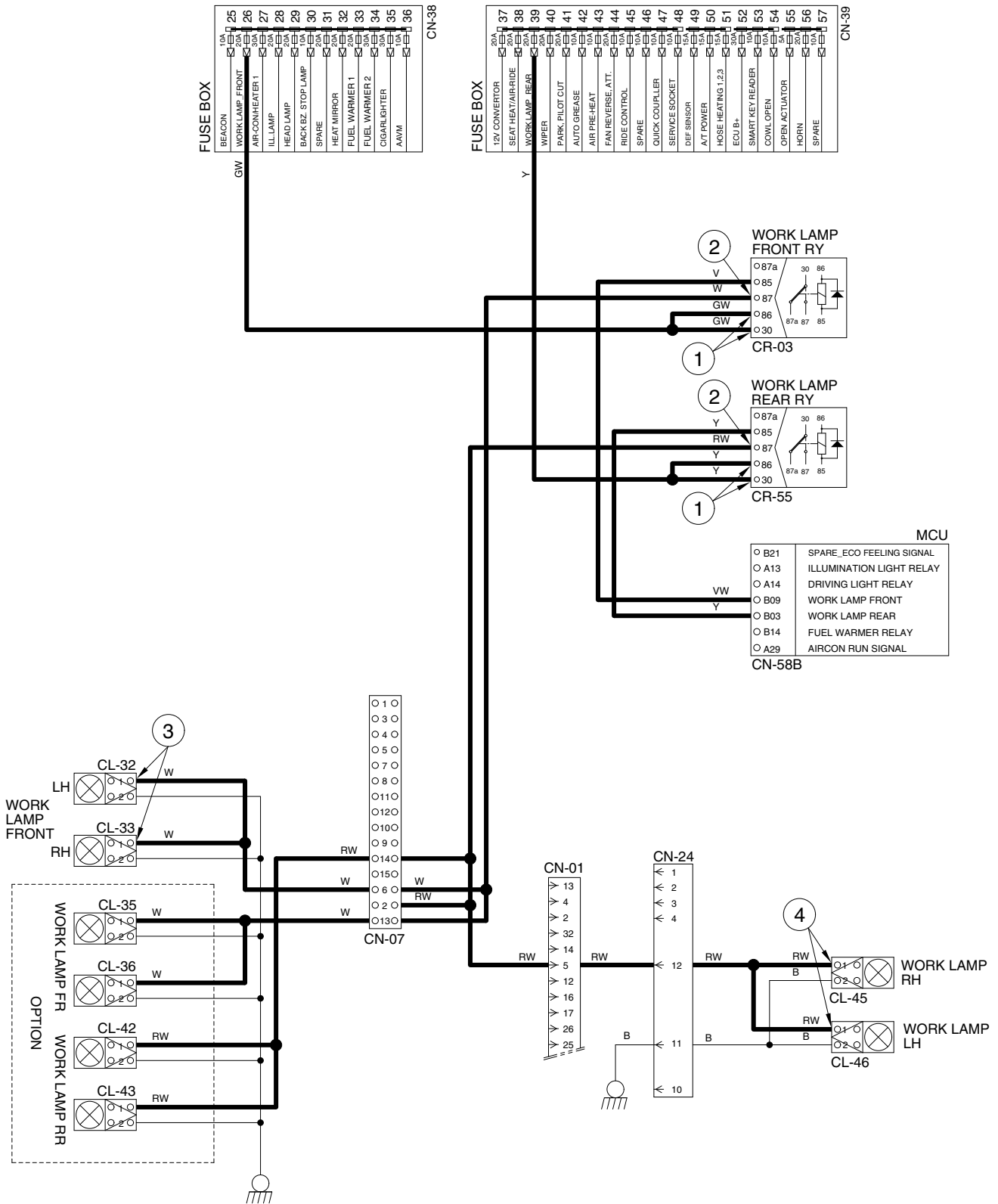

960A7EL06

STARTING CIRCUIT

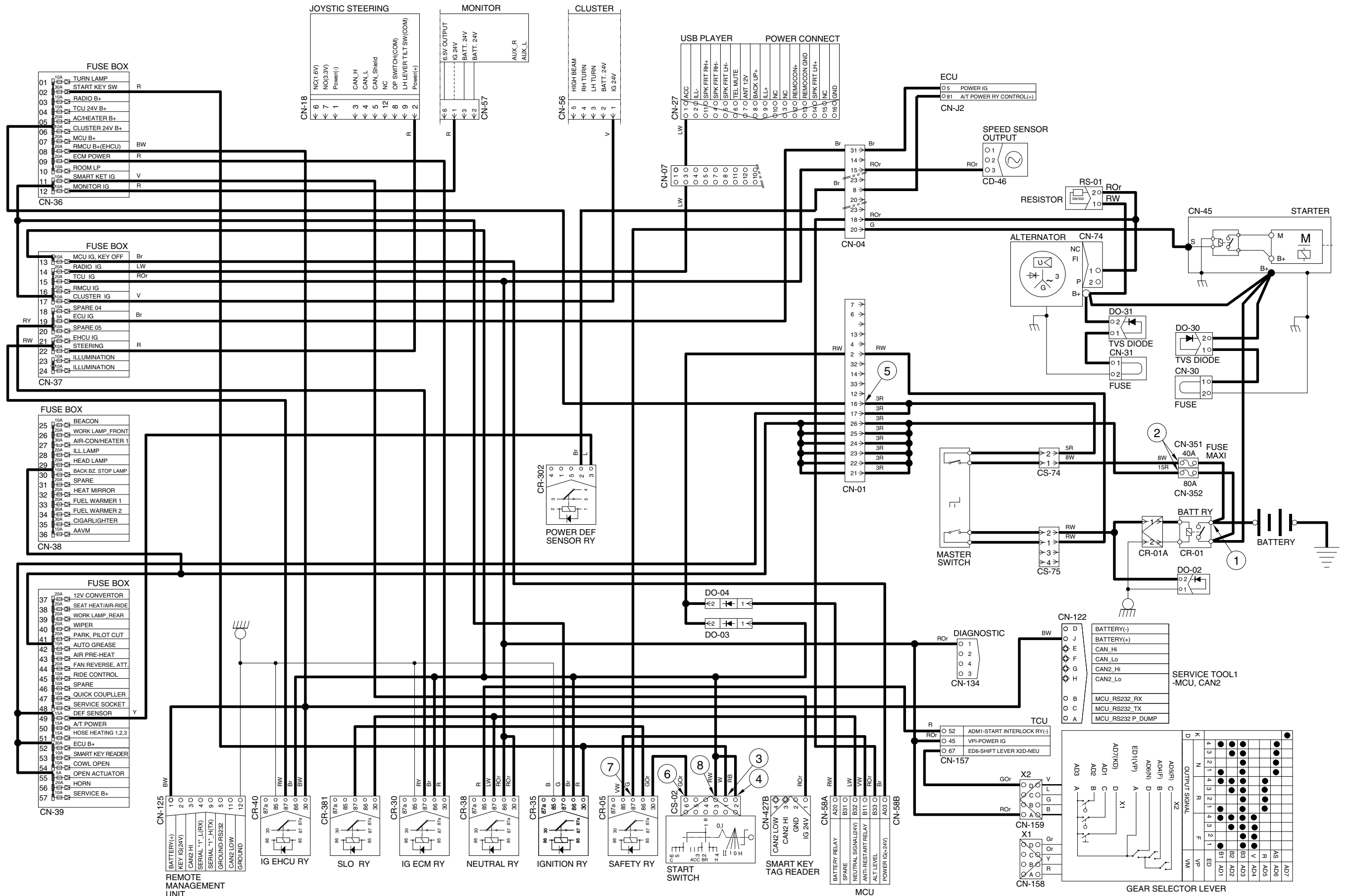

5. CHARGING CIRCUIT

When the starter is activated and the engine is started, the operator releases the key switch to the ON position.

Charging current generated by operating alternator flows into the battery through the battery relay (CR-01).

The current also flows from alternator to each electrical component and controller through the fuse box.

1) OPERATING FLOW

(1) Warning flow

Alternator [CN-74 (1)] → I/conn [CN-04 (18)] → MCU [CN-58B (B33)]

→ Cluster charge warning lamp ON

(2) Charging flow

Alternator → Starter [CN-45 (B⁺)] → Battery relay [CR-01]

→ Battery (+) terminal → Charging

→ Fusible link [CN-351 (40A)] → Master switch [CS-74 (1)→(2)] → I/conn [CN-01 (16, 17)]

→ Fuse box [CN-36, 39]

→ Fusible link [CN-352 (80A)] → I/conn [CN-01 (21~26)] → Fuse box [CN-38, 39]

2) CHECK POINT

Engine	Key switch	Check point	Voltage
OFF	ON	① - GND (battery) ② - GND (battery relay) ③ - GND (alternator B ⁺) ④ - GND (alternator 2) ⑤ - GND (MCU) ⑥ - GND (fuse box)	20~28V

※ GND : Ground

※ MCU : Machine control unit

CHARGING CIRCUIT

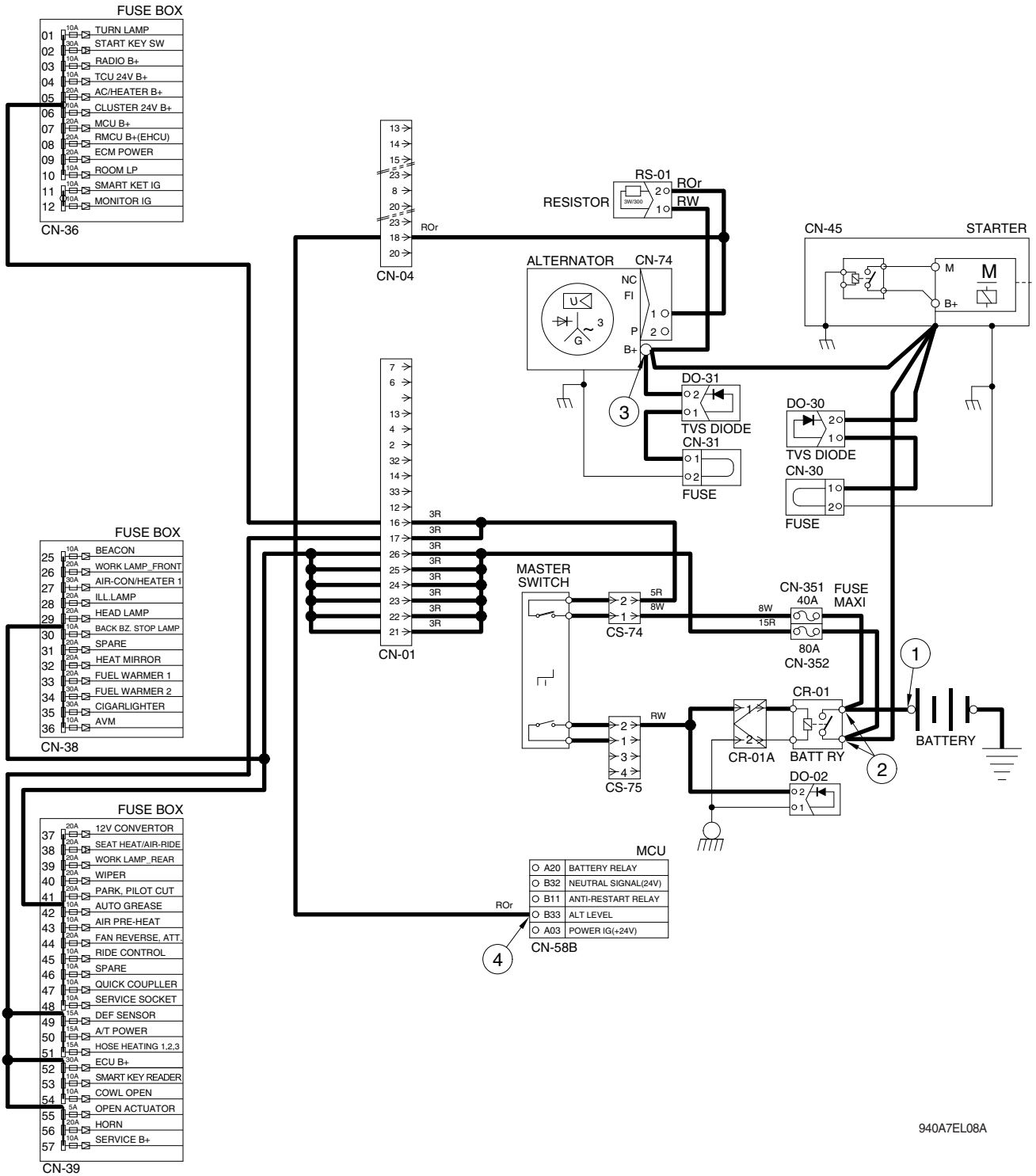

940A7EL08A

6. ELECTRIC PARKING, PILOT CUT OFF CIRCUIT

1) OPERATING FLOW

(1) Parking OFF

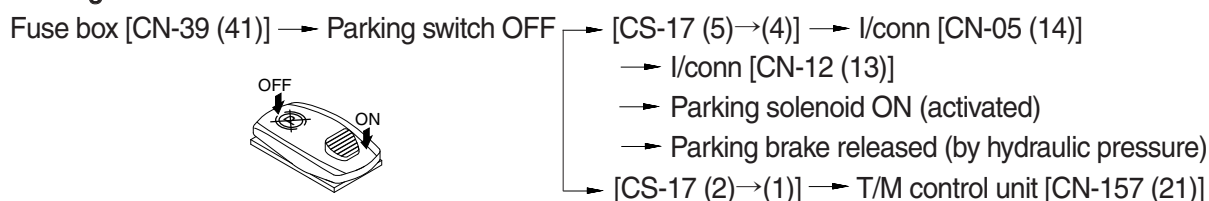

(2) Parking ON

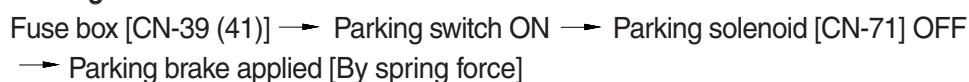

(3) Pilot cut off ON

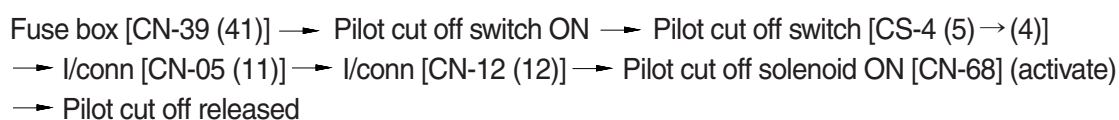

(4) Pilot cut off OFF

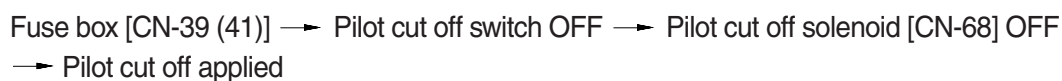

2) CHECK POINT

Engine	Key switch	Check point	Voltage
Running	ON	① - GND (parking switch input) ② - GND (parking switch output) ③ - GND (pilot cut off switch input) ④ - GND (pilot cut off switch output) ⑤ - GND (parking solenoid) ⑥ - GND (pilot cut off solenoid)	20~25V

※ GND : Ground

ELECTRIC PARKING, PILOT CUT OFF CIRCUIT

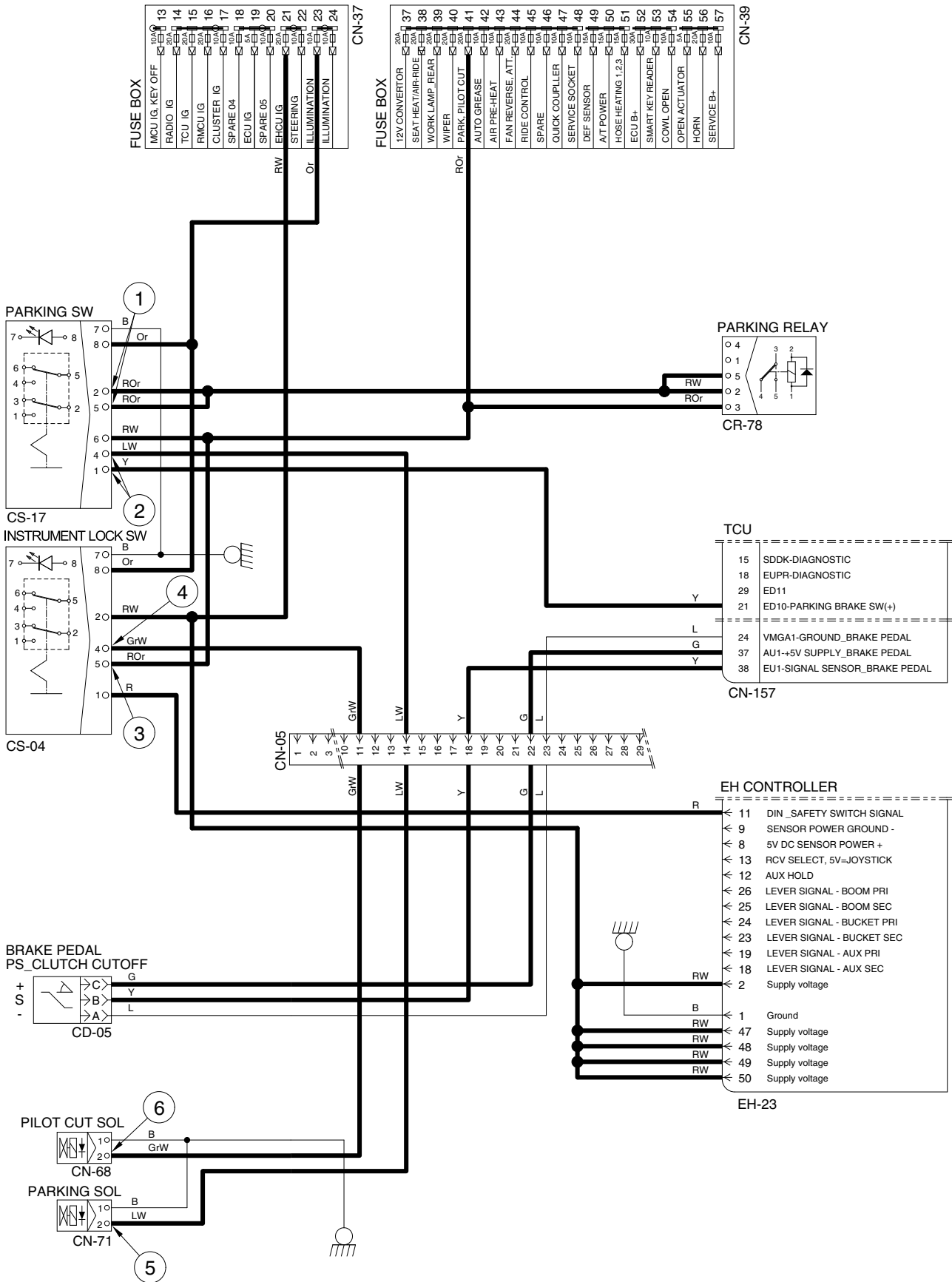

7. WIPER AND WASHER CIRCUIT

1) OPERATING FLOW

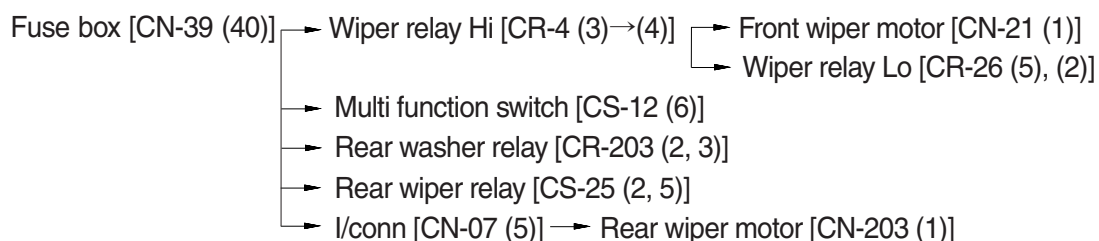

(1) Front washer switch ON

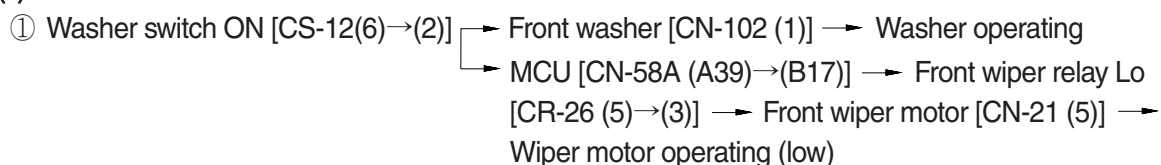

(2) Front wiper switch ON

① INT position

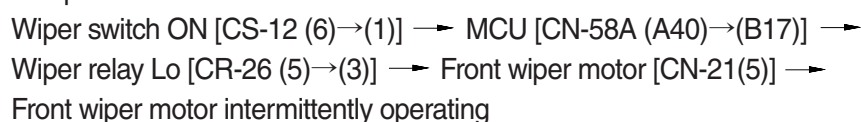

② Lo position

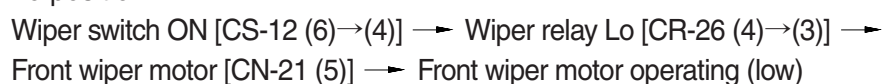

③ Hi position

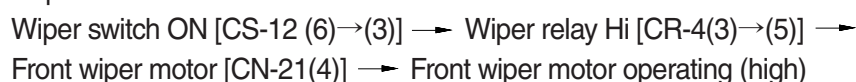

(3) Auto-parking (when switch OFF)

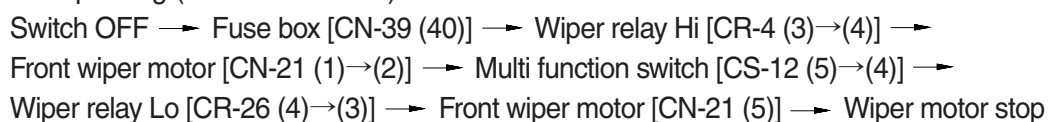

(4) Rear wiper and washer switch

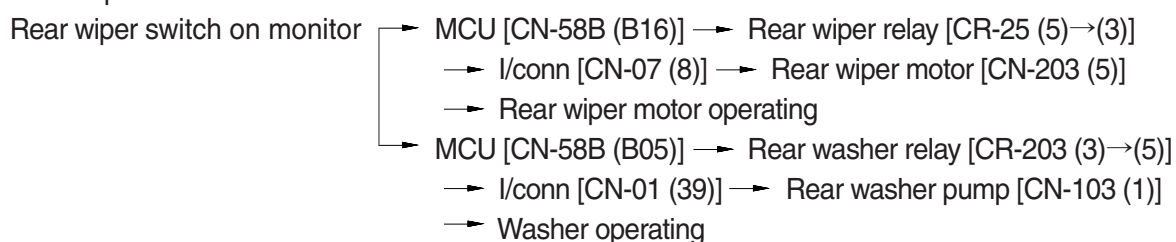

2) CHECK POINT

Condition	Check point	
Engine : Stop	① - GND (front wiper switch power input)	⑥ - GND (wiper relay power input)
Key switch : ON	② - GND (rear wiper relay power input)	⑦ - GND (front washer power output)
Voltage : 20~25V	③ - GND (wiper relay power input)	⑧ - GND (rear washer power output)
	④ - GND (front wiper motor Lo power input)	⑨ - GND (front wiper motor power output)
	⑤ - GND (front wiper motor High power input)	⑩ - GND (rear wiper motor power output)

※ GND : Ground

WIPER AND WASHER CIRCUIT

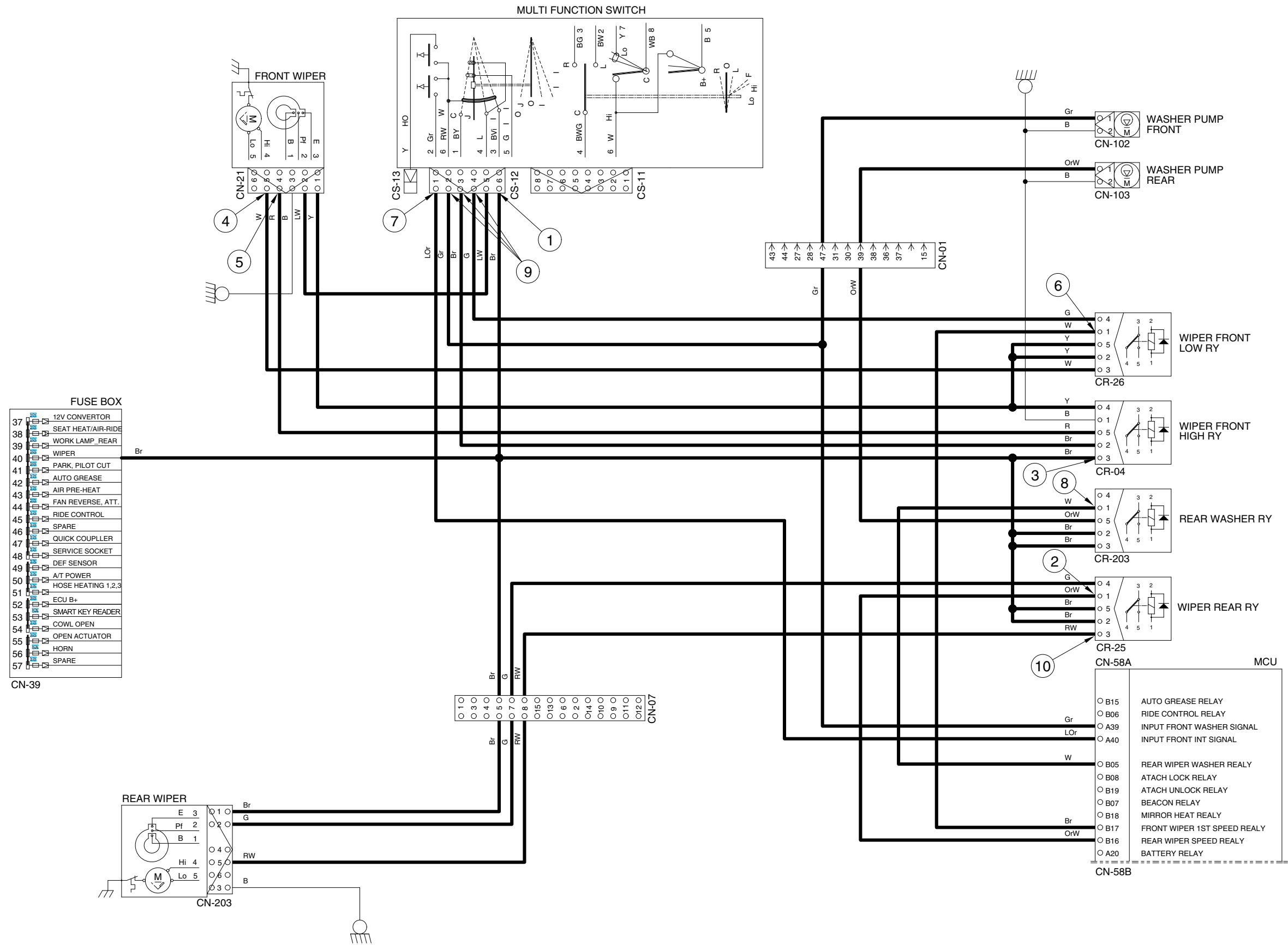

HAZARD, TURN AND ROTARY CIRCUIT

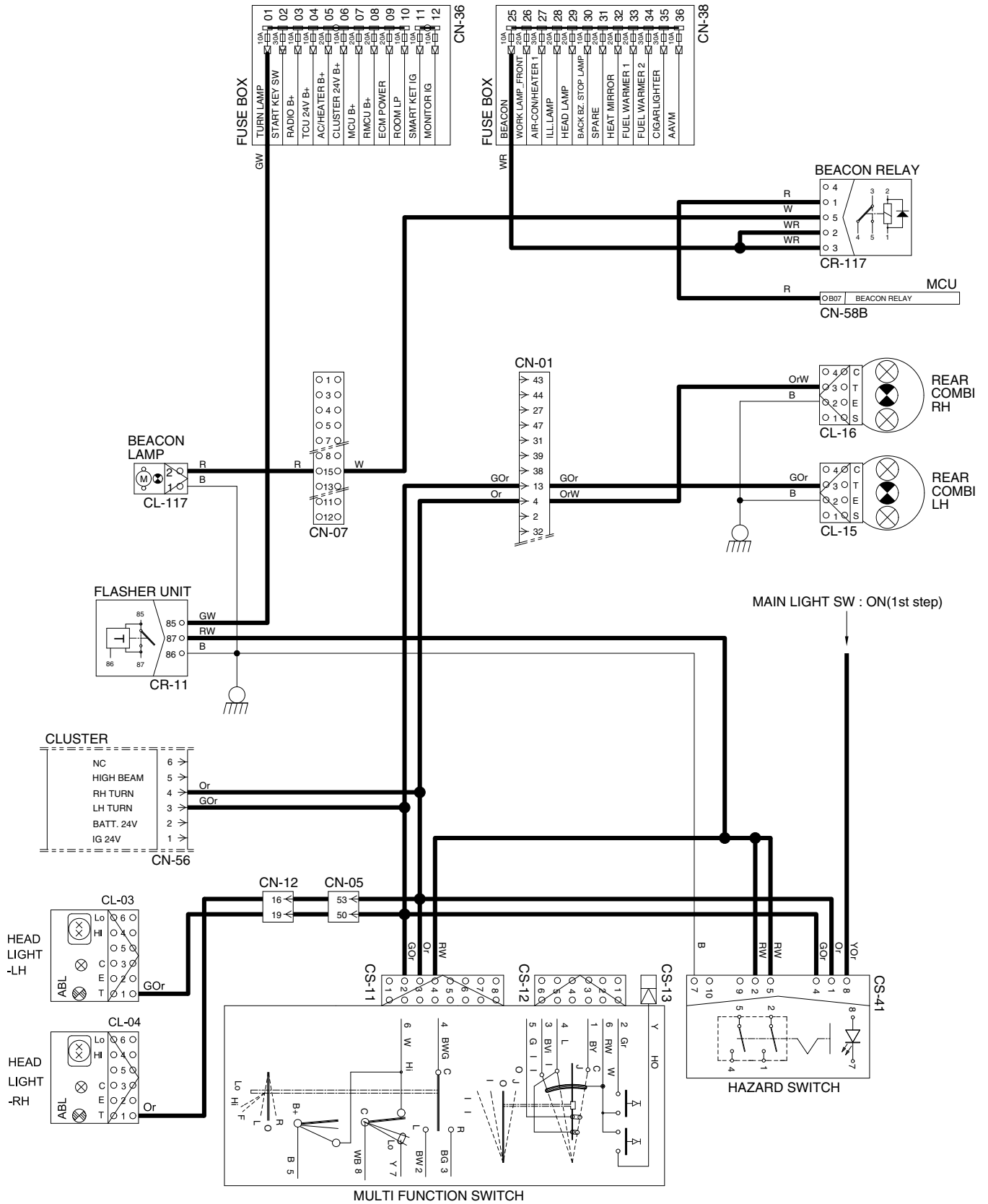

GROUP 3 MONITORING SYSTEM

1. CLUSTER

1) STRUCTURE

The cluster consists of gauges, lamps and LCD as shown below, to warn the operator in case of abnormal machine operation or conditions for the appropriate operation and inspection.

- Gauges : Indicate operating status of the machine.
 - Warning lamps : Indicate abnormality of the machine.
 - Pilot lamps : Indicate operating status of the machine.
 - LCD : Indicates selected the driving speed and direction.
- ※ The cluster installed on this machine does not entirely guarantee the condition of the machine. Daily inspection should be performed according to chapter 6, MAINTENANCE.
- ※ When the cluster provides a warning immediately check the problem, and perform the required action.

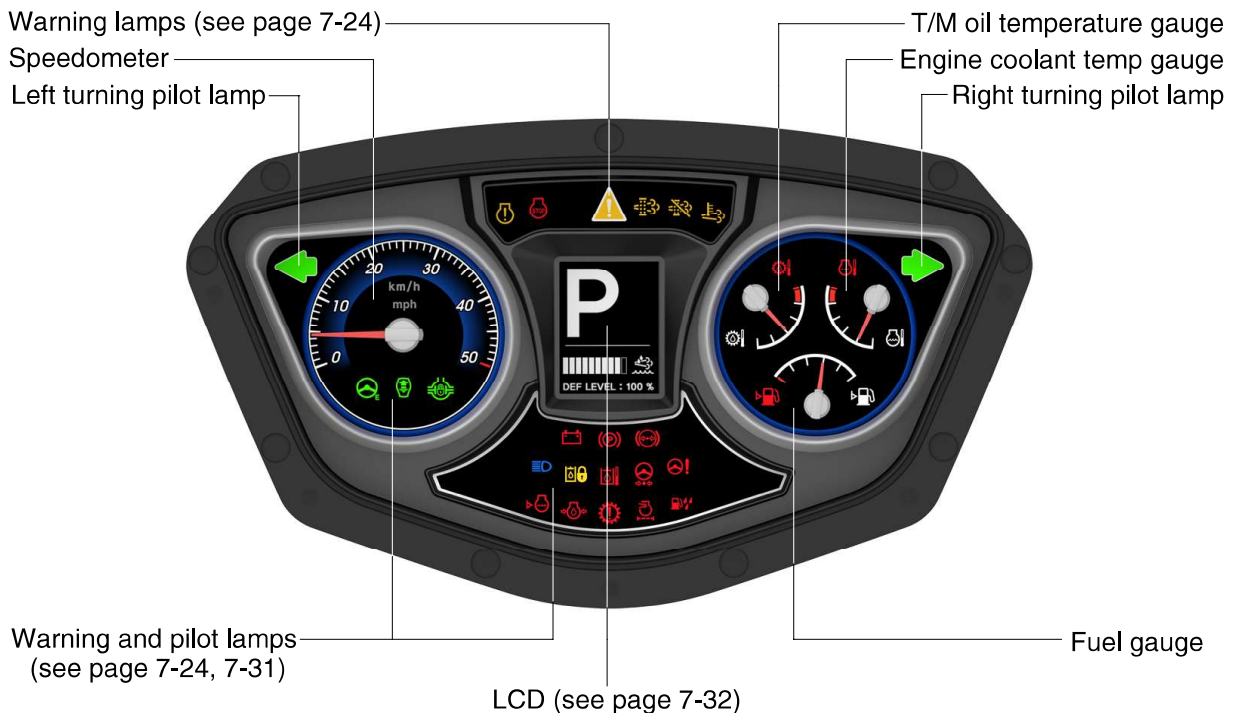

960A7EL50

2) GAUGE

(1) Speedometer

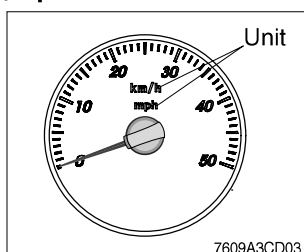

- ① The speedometer displays the speed of machine in mph and km/h.
- ※ The unit (km/h or mph) can be set by the display set up menu of the monitor and selected unit is displayed. Refer to page 7-55.

(2) Fuel gauge

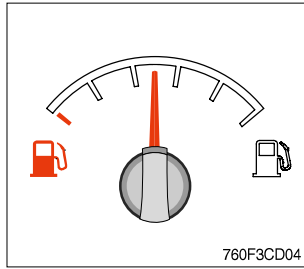

- ① This gauge indicates the amount of fuel in the fuel tank.
 - ② Fill the fuel when the indicator moves red range or  lamp blinks in red, refuel as soon as possible to avoid running out of fuel.
- ※ If the gauge indicates red range even though the machine is on the normal condition, check the electric device as that can be caused by the poor connection of electricity or sensor.

(3) Engine coolant temperature gauge

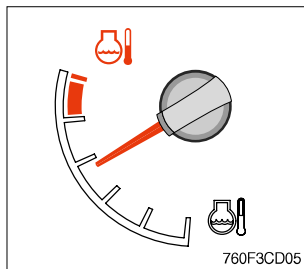

- ① This gauge indicates the temperature of coolant.
 - White range : 40~105°C (104~221°F)
 - Red range : Above 105°C (221°F)
 - ② If the indicator is in the red range or  lamp blinks in red, turn OFF the engine and check the radiator and engine.
- ※ If the gauge indicates red range even though the machine is on the normal condition, check the electric device as that can be caused by the poor connection of electricity or sensor.

(4) Transmission oil temperature gauge

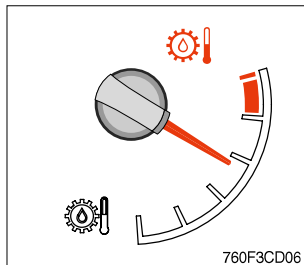

- ① This gauge indicates the temperature of transmission oil.
 - White range : 40~107°C (104~225°F)
 - Red range : Above 107°C (225°F)
 - ② If the indicator is in the red range or  lamp blinks in red, it means the transmission is overheated. Be careful that the indicator does not move into the red range.
- ※ If the gauge indicates red range even though the machine is on the normal condition, check the electric device as that can be caused by the poor connection of electricity or sensor.

3) WARNING LAMPS

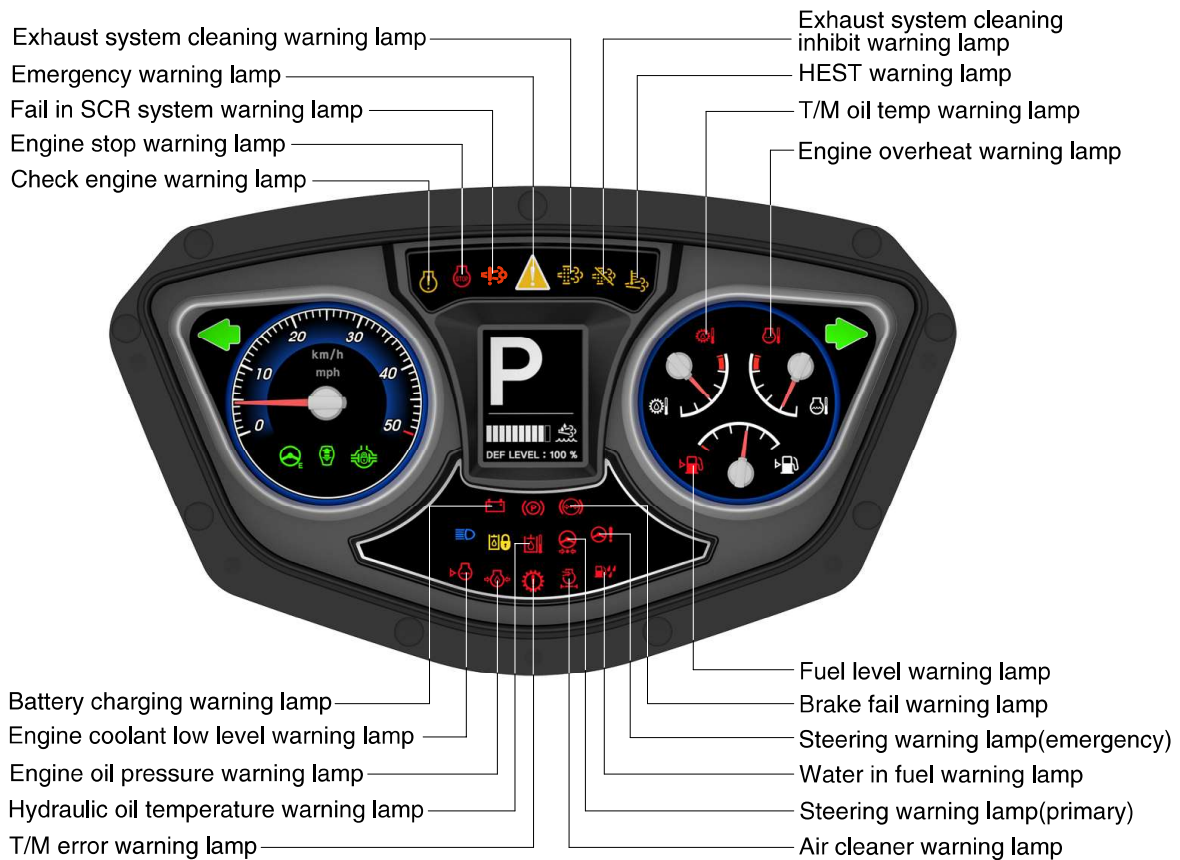

960A3CD09A

(1) Emergency warning lamp

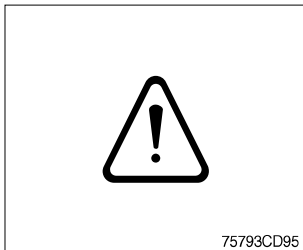

- ① This lamp blinks when each of the below warnings is happened.
 - Warning lamps light ON
 - MCU input voltage abnormal
 - Monitor communication data error
 - Engine ECM and TCU communication data error
- ② When this warning lamp blinks, machine must be checked and service immediately.

(2) Engine overheat warning lamp

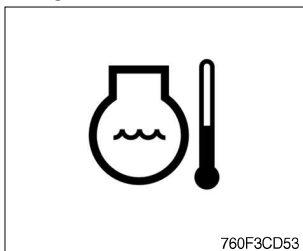

- ① This lamp is turned ON when the temperature of coolant is over the normal temperature (105°C, 221°F).
- ② Check the cooling system when the lamp is ON.

(3) Transmission oil temperature warning lamp

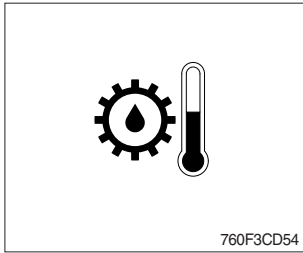

- ① This lamp is turned ON when the temperature of transmission oil is over the normal temperature (107°C, 225°F).
- ② When this lamp lights up during operation, stop the engine and check the machine.

(4) Hydraulic oil temperature warning lamp

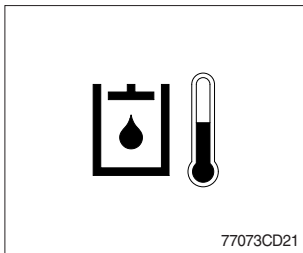

- ① This warning lamp operates and the buzzer sounds when the temperature of hydraulic oil is over 106°C (223°F).
 - ② Check the hydraulic oil level when the lamp is turned ON and the buzzer sounds.
 - ③ Check for debris between oil cooler and radiator.
- ※ If you want to stop buzzer sound, just touch the  icon.

(5) Fuel level warning lamp

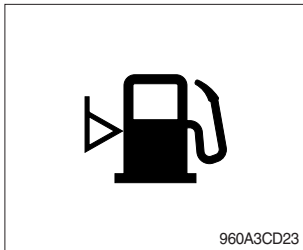

- ① This warning lamp lights ON when the fuel level is low. Refuel the machine as soon as possible.

(6) Transmission error warning lamp

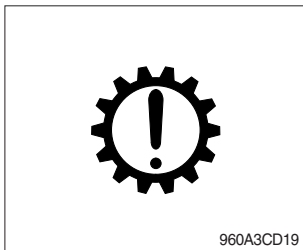

- ① This lamp lights ON and the LCD display show the error codes when an error occurs in the transmission.
 - ② Immediately pull the machine to a convenient stop. Stop the engine. Investigate the cause.
- ※ Consult a HD Hyundai Construction Equipment dealer to investigate the cause.
- ※ Do not operate until the cause has been corrected.

(7) Air cleaner warning lamp

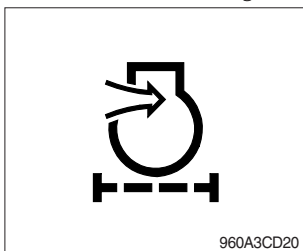

- ① This lamp lights ON and the buzzer sounds when the filter of air cleaner is clogged.
 - ② When the air cleaner warning lamp is ON and the buzzer sounds, check and clean the primary element.
- ※ If you want to stop buzzer sound, just touch the  icon.
- ※ The primary element should be replaced if the warning lamp is ON after installation of a clean primary element.
- ※ Replace the primary element after 4 times cleanings.

(8) Engine oil pressure warning lamp

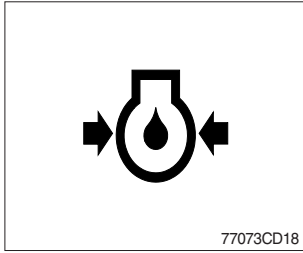

- ① This lamp is comes ON and the buzzer sounds after starting the engine because of the low engine oil pressure.
 - ② If the lamp comes ON and the buzzer sounds during engine operation, shut OFF engine immediately. Check engine oil level.
- ※ If you want to stop buzzer sound, just touch the  icon.

(9) Steering warning lamp



① Primary

This lamp indicates that the primary steering has failed. When the indicator comes ON and the action alarm sounds, steer the machine immediately to a convenient location and stop the machine. Stop the engine and investigate the cause.

- ※ If you want to stop buzzer sound, just touch the  icon.
- ※ Do not operate the machine until the cause has been corrected.





② Emergency

This lamp indicates the emergency steering system is active.

- ※ Immediately pull the machine to a convenient stop and stop the engine.
- ※ The emergency steering system can be manually tested. Refer to page 3-45.

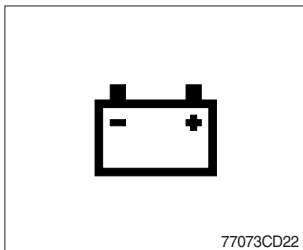
(10) Battery charging warning lamp



- ① This lamp is ON and the buzzer sounds when key ON, it is turned OFF after starting the engine.
 - ② Check the battery charging circuit when this lamp comes ON and the buzzer sounds, during engine operation.
- ※ If you want to stop buzzer sound, just touch the  icon.

(11) Brake fail warning lamp

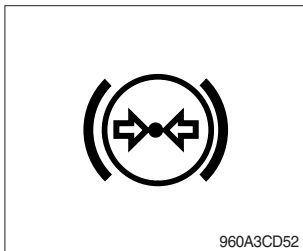

- ① The lamp lights ON and the buzzer sounds when the oil pressure of service brake drops below the normal range.
 - ② When the lamp is ON and the buzzer sounds, stop the engine and check for its cause.
- ※ If you want to stop buzzer sound, just touch the  icon.
- ※ Do not operate until any problems are corrected.

(12) Check engine warning lamp

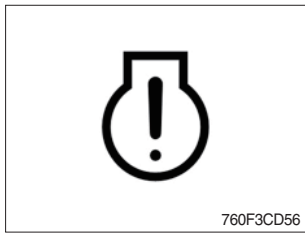

① This lamp lights ON and the buzzer sounds when the communication between MCU and engine ECM on the engine is abnormal, or if the cluster received specific fault code from engine ECM.

② Check the communication line between them.

If the communication line is OK, then check the fault codes on the monitor.

※ If you want to stop buzzer sound, just touch the  icon.

(13) Engine stop warning lamp

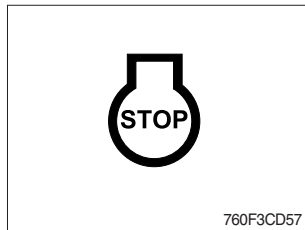

① This warning lamp pops up and the buzzer sounds when 30 minutes elapsed with empty condition of the DEF/AdBlue® tank, stop the engine immediately and check the DEF/AdBlue® tank.

② Fill the DEF/AdBlue® immediately in the DEF/AdBlue® tank.

※ Refer to page 7-30.

③ This lamp lights ON when the stationary exhaust system cleaning is not performed.

※ Refer to page 7-28.

※ Please contact your HD Hyundai Construction Equipment service center or local dealer.

※ "Engine shutdown" cluster message up when the exhaust gas temperature reaches above 800°C.

(14) Engine coolant low level warning lamp

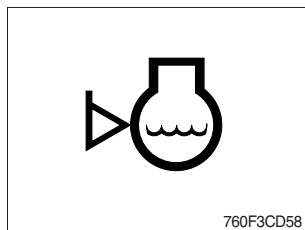

① This warning lamp lights ON when the level of coolant is low.

② Fill the coolant immediately when the lamp is ON.

(15) Water in fuel warning lamp

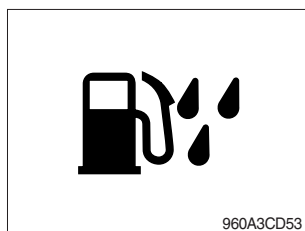



① This warning lamp lights ON when the water separator is full of water or malfunctioning.

※ When this lamp lights ON, stop the machine and spill water out of the separator.

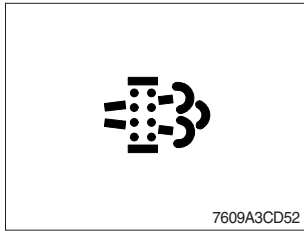
(16) Exhaust system cleaning warning lamp



① This warning lamp lights ON or blinks when the exhaust system cleaning is needed as table below.

Warning lamp			Description
Exhaust	Check engine	Stop engine	
			
Off	Off	Off	· Automatic exhaust system cleaning
Blink	Off	Off	· The status of a manual (stationary) exhaust system cleaning when the exhaust system cleaning switch has been activated. ※ Refer to page 7-29.
On	On	Off	· The aftertreatment exhaust system needs to be cleaned immediately. · Engine power will be reduced automatically if action is not taken. ※ The exhaust system cleaning can be accomplished by : - Changing to more challenging duty cycle. - Performing a manual exhaust system cleaning.
On	On	On	· These lamps will be ON when a stationary (manual) exhaust system cleaning is not performed. · Stop the engine immediately. · Please contact your HD Hyundai Construction Equipment service center or local dealer.

(17) Exhaust system cleaning inhibit warning lamp

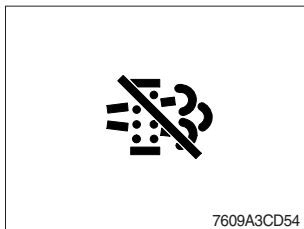

① This warning lamp indicates, when illuminated, the exhaust system cleaning switch is pushed inhibit position, therefore automatic and manual exhaust system cleaning can not occur.
※ Refer to the page 7-69 for the exhaust system cleaning switch.

※ Manual exhaust system cleaning

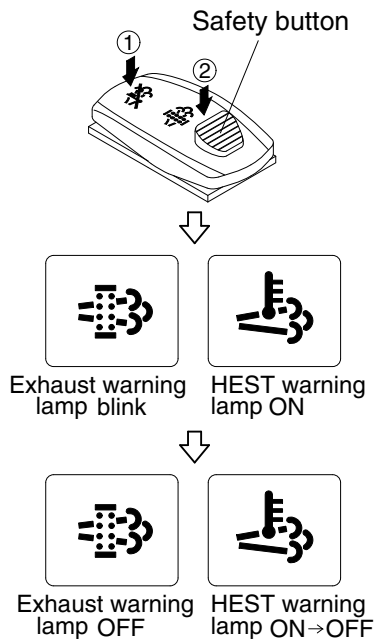

9753CD129A

※ Manual exhaust system cleaning applies if the machine is in a fireproof area.

※ To stop a manual exhaust system cleaning before it has completed, set to the exhaust system cleaning switch to the inhibit position or turn OFF the engine.

① Stop and park the machine.

② Pull the safety button and push the switch to position ② to initiate the manual exhaust system cleaning.

※ Refer to the page 7-69 for the exhaust system cleaning switch operation.

※ The engine speed may increase to 950~1050 rpm and exhaust system cleaning begins and it will take approximately 20~30 minutes.

③ The exhaust system cleaning warning lamp will blink and HEST warning lamp will light ON during the exhaust system cleaning is operating.

④ The exhaust system cleaning and/or HEST warning lamp will light OFF when the exhaust system cleaning is completed.

(18) HEST (High exhaust system temperature) warning lamp

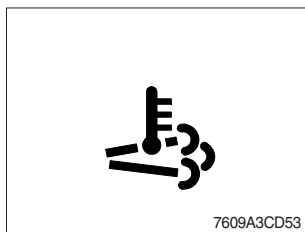

① This warning lamp indicates, when illuminated, that exhaust temperatures are high due to exhaust system cleaning.

② The lamp will also illuminate during a manual exhaust system cleaning.

③ When this lamp is illuminated, be sure the exhaust pipe outlet is not directed at any surface or material that can melt, burn, or explode.

▲ When this lamp is illuminated, the exhaust gas temperature could reach 800°C [1500°F], which is hot enough to ignite or melt common materials, and to burn people.

※ The lamp does not signify the need for any kind of equipment or engine service; It merely alerts the equipment operator to high exhaust temperatures. It will be common for the lamp to illuminate on and off during normal equipment operation as the engine completes exhaust system cleaning.

(19) DEF/AdBlue® level warning lamp



- ① This warning lamp indicates when ON or blinking, that the DEF/AdBlue® level is low as table below.
- ※ It is recommended that the DEF/AdBlue® tank be filled completely full of the DEF/AdBlue® in order to correct any fault conditions.

Warning lamp				Description
Fail in SCR system	DEF/AdBlue® level	Check engine	Stop engine	
On	On	Off	Off	<ul style="list-style-type: none"> · The DEF/AdBlue® level has fallen below the initial warning level (10%).
On	On	On	Off	<ul style="list-style-type: none"> · The DEF/AdBlue® level has fallen below the initial derate level (2.5%). · The engine power will be limited automatically.
On	Blink	On	On	<ul style="list-style-type: none"> · This is happened when 30 minutes elapsed with empty conditions (0%) of the DEF/AdBlue® tank. · The engine will enter the final derate level which may include low idle lock or engine shutdown with restart limitations. · In order to remove the final derate, the DEF/AdBlue® tank must be filled to above 10 percent gauge reading.

(20) Fail in SCR system warning lamp

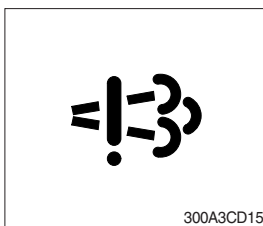

- ① This warning lamp indicates there are faults related to SCR system.
- ② The lamp lights ON when each of the below warnings is happened.
 - a. Low DEF/AdBlue® level
 - b. Poor quality of DEF/AdBlue®
 - c. Tempering or malfunction in the aftertreatment system
- ③ Once the lamp lights ON, the engine will derate shortly.
- ※ Please contact your HD Hyundai Construction Equipment service center or local dealer.

4) PILOT LAMPS

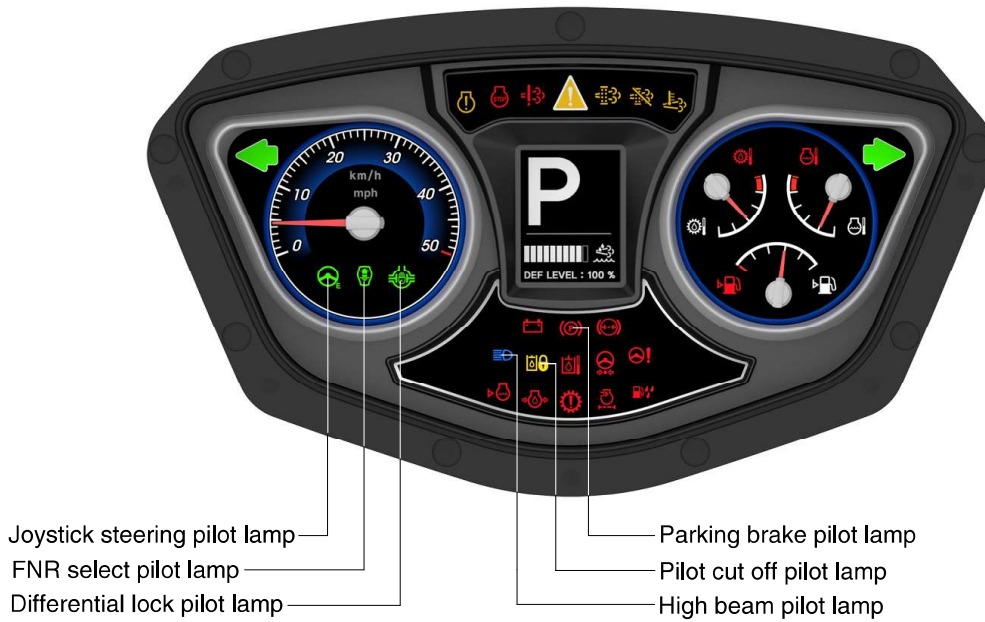

960A3CD10

(1) High beam pilot lamp

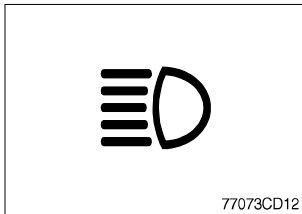

- ① This lamp works when the illuminating direction is upward.
- ② This lamp comes ON when the dimmer switch is operated, e.g., when passing another vehicle.

(2) Parking brake pilot lamp

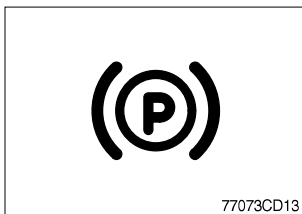

- ① When the parking brake is actuated, the lamp lights ON.
- ※ Check the lamp is OFF before driving.

(3) FNR select pilot lamp (option)

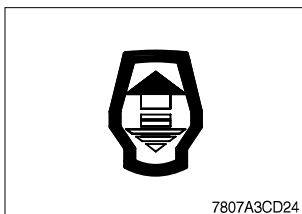

- ① The lamp comes ON when FNR select button on the optional FNR remote control lever is pressed.
- ※ Refer to page 7-70.

(4) Joystick steering pilot lamp (option)

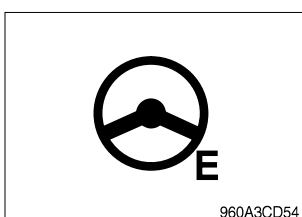

- ① This lamp lights ON when joystick steering is activated. It is then possible to steer the machine and select gears from the armrest to the left of the operator's seat.

(5) Differential lock pilot lamp (option)

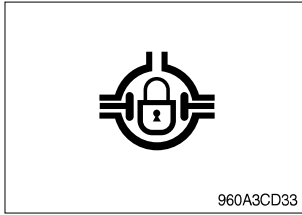

- ① This lamp lights ON when the differential lock function is operating.
 ※ Refer to page 7-68.

(6) Pilot cut off pilot lamp

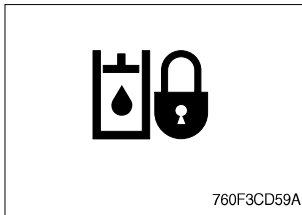

- ① This lamp lights ON when the pilot cut off switch is pressed.
 ※ Refer to page 7-68.

5) LCD

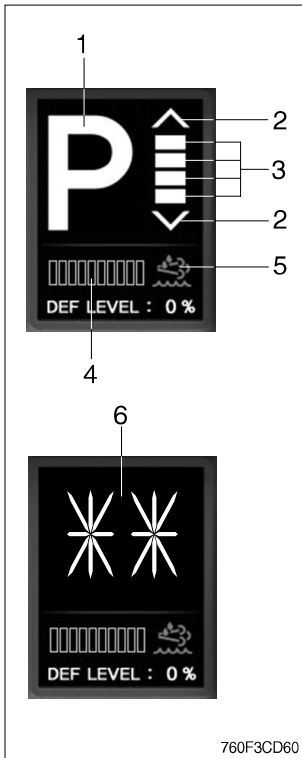

(1) The LCD can be used with the gear selector.

It indicates speed, driving direction, DEF/AdBlue® level and transmission warning.

No	Symbol	Meaning	Remark												
1	△ · ▽ · N	Actual gear display	Forward, reverse, neutral												
	1, 2, 3, 4, 5		Actual gear												
	P		Parking brake mode active												
2	^ , v	Forward, reverse	<table style="display: inline-table; vertical-align: middle;"> <tr> <td style="text-align: center;">^</td> <td>FWD 1</td> <td style="text-align: center;">v</td> <td>REV 1</td> </tr> <tr> <td style="text-align: center;">-</td> <td></td> <td style="text-align: center;">-</td> <td></td> </tr> <tr> <td style="text-align: center;">≡</td> <td>FWD 5</td> <td style="text-align: center;">≡</td> <td>REV 5</td> </tr> </table>	^	FWD 1	v	REV 1	-		-		≡	FWD 5	≡	REV 5
^	FWD 1	v	REV 1												
-		-													
≡	FWD 5	≡	REV 5												
3	≡	Gear range display													
4		DEF/AdBlue® level	Display the amount of liquid in the DEF/AdBlue® tank												
5		DEF/AdBlue® level warning lamp	Fill the DEF/AdBlue® when the lamp ON or blinks in red. - ON : DEF/AdBlue® level 5~10% - Blink : DEF/AdBlue® level below 5% ※ If the lamp ON or blinks in red even though the machine is on the normal condition, check the electric device as that can be caused by the poor connection of electricity or sensor.												
6	LF, LR	Limp home gear	-												
	**	Oil temperature too low, no gear available	Warm up engine / transmission												
	WS	Warning sump temperature	Alternate between WS and actual gear / direction while driving, in neutral only displayed WS if no fault is detected ※ Cool down transmission												
	WT	Warning torque converter temperature	Alternate between WS and actual gear / direction while driving, in neutral only displayed WS if no fault is detected ※ Cool down transmission												

2. MONITOR (7 inch touch screen)

- The monitor is adjustable.
 - Vertical : 30°
 - Horizontal : 15°



760F3CD20-1

1) MAIN DISPLAY

- ※ You can select or set the menu by the switches or touch screen.
- ※ Please refer to switch, page 7-62 for selection and change of menu and input value.
- ※ Display type can be changed by operator. See page 7-56 for details.



760F3CD11-1

- | | | | | | |
|---|---------------|----|-------------------------------|----|------------|
| 1 | Clock | 6 | Machine monitoring | 11 | Engine rpm |
| 2 | Buzzer | 7 | Fuel rate | 12 | Quick menu |
| 3 | Wiper speed | 8 | Engine mode/Operation history | 13 | 10 lamps |
| 4 | Camera screen | 9 | Transmission mode | | |
| 5 | Menu | 10 | ECO gauge | | |

(1) Menu bar

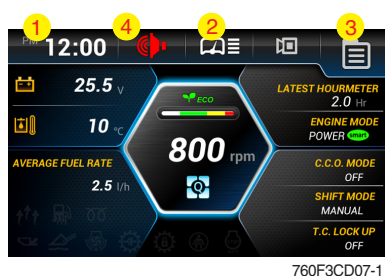

※ In main display, you can move to right side menu by touching each icon.

① Clock setting

Set the time (hour, minute and AM or PM)

② Wiper speed

Set the wiper speed (slow, normal, fast and very fast)

③ Menu

Move to main menu.

④ Buzzer stop

If you want to stop buzzer sound, just touch the



① Clock setting

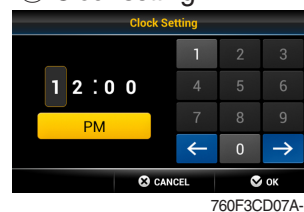

② Wiper speed

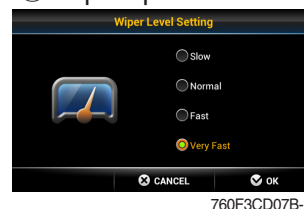

③ Menu

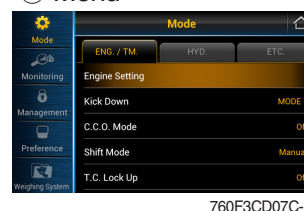

④ Buzzer stop

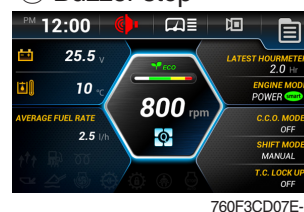

(2) Change display information

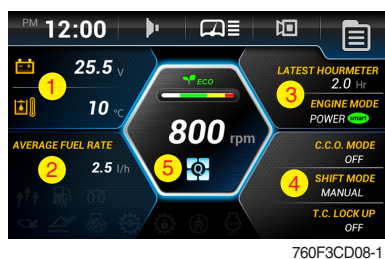

※ In main display, you can check the data and setup what you want by touching each window area or icon.

① Machine monitoring

To display the item in main display, select two items of them.

※ Priority in the machine monitoring display

The priority of the weighing system is the highest.

If the weighing system is selected, the other items are not available.

To display the other items, the weighing system should not be selected.

※ **Weighing system** : see page 7-42.

① Machine monitoring



② Fuel rate

- Set average fuel rate or a days fuel used on main display screen.
- Refer to page 7-49.

② Fuel rate

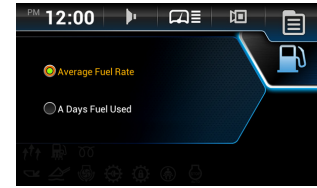

760F3CD08B-1

③ Engine mode and operation history

- Set the engine mode (A).
- Refer to page 3-19.
- Set Hour meter / ODO meter (B).
- Refer to page 7-48.

③ Engine mode

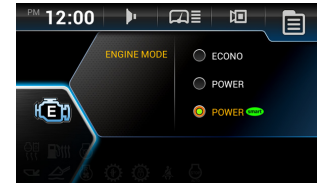

A

960A3CD08D

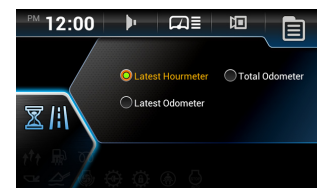

B

760F3CD08K-1

④ Transmission mode

- Set the clutch cut off (A), shift (B) and torque converter lock up mode (C).
- Refer to page 7-40.

④ Transmission mode

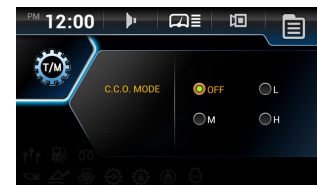

A

760F3CD08C-1

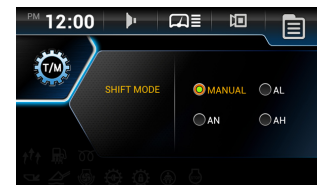

B

760F3CD08L-1

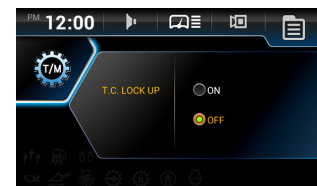

C

760F3CD08M-1

⑤ Quick menu

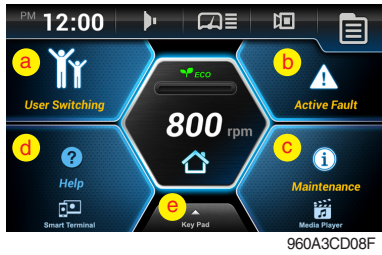

① User switching

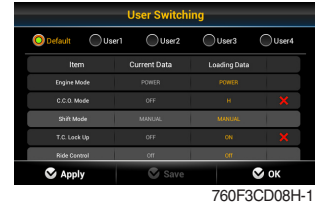

※ Move the quick menu screen by touching .

① User switching

- When multiple users share a machine, it allows users to switch user settings of machine.
- User can apply or save the setting of monitor easily.

② Active fault

- Display the fault code of MCU/ECU/TCU/EHCU.
- Refer to page 7-48.

③ Maintenance

- Elapsed time, change or replace cycle can be changed.
- Refer to page 7-52.

④ Help

- Read the monitor manual as a PDF file on the monitor.

※ Smart terminal

- The menu features a smartphone and operates the miracast.

- ▲ Operation of screen mirroring can be dangerous while driving.
Driver is responsible for accident or other damages.
Operate the screen mirroring while stopping for safety.

② Active fault

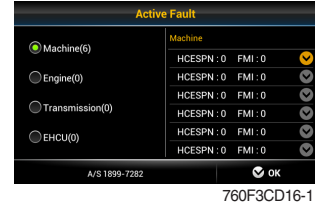

③ Maintenance



④ Help

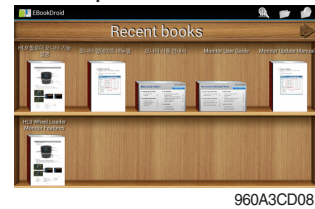

⑤ Virtual keypad

To display the virtual keypad, drag the button () to top of the screen.

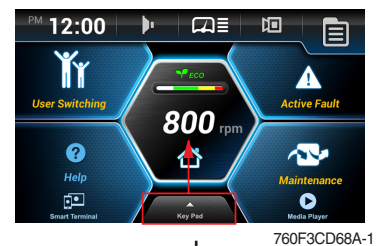

Virtual keypad

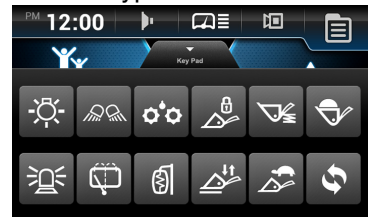

(3) Fault and maintenance warning

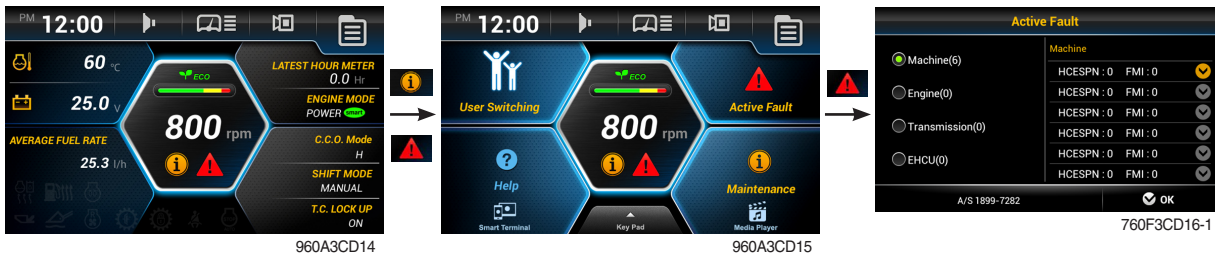

- ① If you touch the warning sign (red icon), move to the quick menu.
- ② You can check the fault message and move the maintenance screen by touching relevant area.



(4) Machine monitoring warning

- ① Warning sign (red icon) will be shown when the temperature of hydraulic oil, cooling water, transmission oil or battery voltage is not normal state.
- ② Case of warning sign

Icon	Description
	Above 106°C of hydraulic oil temperature
	Above 105°C of cooling water temperature
	Above 107°C of transmission oil temperature
	Below 24.5 voltage of battery (for 3 minutes)
	Above 100°C of axle oil temperature (option)

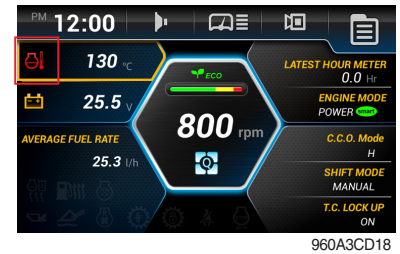

(5) Communication error

- ① MCU could not communicate with monitor over 10 seconds, error message will be show on the screen.

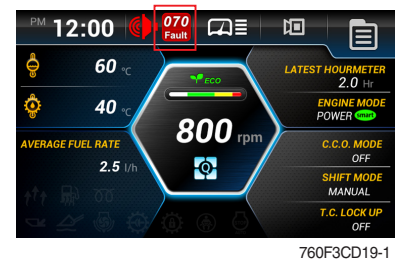

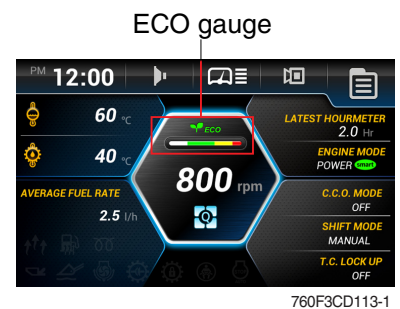

(6) Eco gauge

- ① This gauge indicates the fuel consumption rate and machine load status. So that operators can be careful with fuel economy.
- ② The fuel consumption rate or machine load is high, the segment is increased.
- ③ The color of Eco gauge indicates operation status.
 - White : Idle operation
 - Green : Economy operation
 - Yellow : Non-economy operation at a medium level.
 - Red : Non-economy operation at a high level.



2) MAIN AND SUB MENU

(1) Structure

No	Main menu	Sub menu	Description
1	<p>Mode</p>  <p>760F3CD25A</p>	<p>Engine setting Kick down C.C.O mode Shift mode T.C. lock up Work load</p> <p>Boom/bucket detent mode Bucket priority Auxiliary attach max flow level Soft end stop Speedometer frequency setting Cooling fan reverse mode Wiper level setting Calibration</p> <p>Engine auto shutdown</p>	<p>Engine mode, Engine speed Mode 1 (down/up), Mode 2 (down only) Clutch cut off mode (Off, L, M, H) Transmission shift mode (manual, AL, AN, AH) Torque converter lock up ON/OFF Weighing system, Weighing display, Error detection Boom pressure calibration, Weighing system compensation Boom/bucket detent ON/OFF, Save position Bucket priority ON/OFF Max oil flow level setting Boom up/down, Bucket in/dump ON/OFF Speedometer setting Off, Manual, Automatic Slow, Normal, Fast, Very fast Boom/bucket angle, Boom pressure, Brake pedal sensor, AEB Once, On/Always, Disable, ESL system setting</p>
2	<p>Monitoring</p>  <p>760F3CD25B</p>	<p>Machine monitoring Operation history Fault history Fuel consumption history</p> <p>Machine information</p>	<p>Hyd, Coolant, axle and TM oil temp, Battery voltage Hour meter, ODO meter Active/Logged fault (MCU, ECU, TCU, EHCUC, AAVM) General record, Hourly record, Daily record, Mode record, Operation efficiency record TCU, ECM, MCU, RMCUC, EHCUC, Monitor, Cluster</p>
3	<p>Management</p>  <p>760F3CD25C</p>	<p>Machine security Maintenance Service menu</p> <p>Change A/S phone number Software update Owner menu editing</p>	<p>ESL system setting, Change password Elapsed time, Cycle, Maintenance history Sensor monitoring, Speed limit setting, Weighing system compensation, EHCUC I/O information Check and change of contact information Update file in USB memory Owner menu editing, Menu list, Password change</p>
4	<p>Preference</p>  <p>760F3CD25D</p>	<p>Brightness setting Clock setting Unit setting</p> <p>Display style/Language Camera setting AAVM setting</p>	<p>Manual, Automatic Clock setting Temp (°F/°C), Distance (km, mile), Weight (ton, lb), Pressure (bar, Mpa, kgf/m², psi), Volume (l, gal) Type A, Type B, 14 multiple language Active camera, Display order, Reverse mode AAVM camera reverse mode</p>
5	<p>Multimedia</p>  <p>760F3CD25E</p>	<p>Media player Smart terminal</p>	<p>Play video and audio files in USB. Operation of screen mirroring</p>

(2) Mode

① Engine setting mode

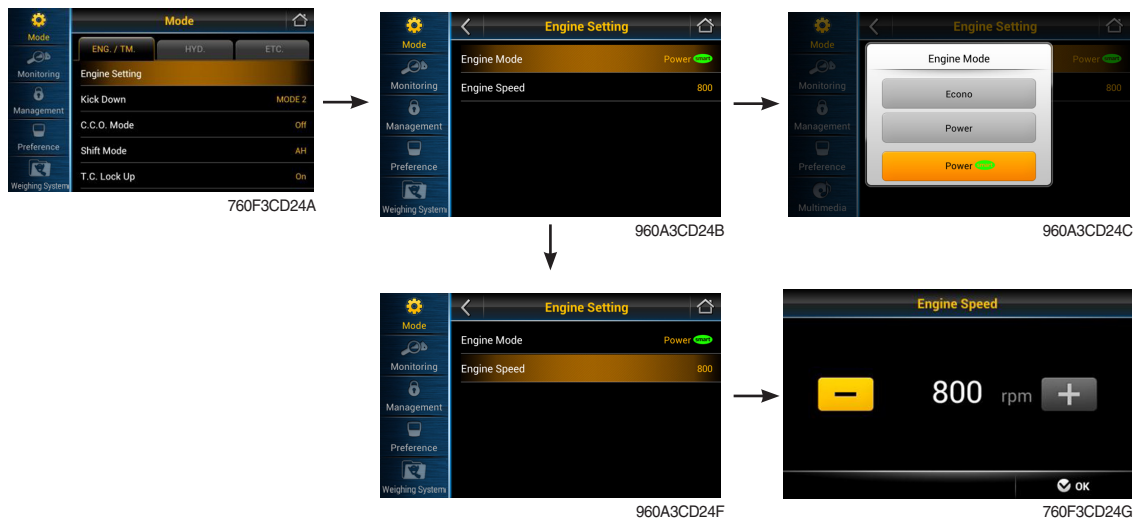

- **Engine mode**

The operator can adjust the machine's performance.

- Econo : Maximum fuel efficiency for general loading.
- Power : Maximum power output for hard digging operation or hill climb.
- Smart power : Fuel efficient operation with same performance as power mode.

- **Engine speed**

Setting engine low idle rpm.

② Kick down mode

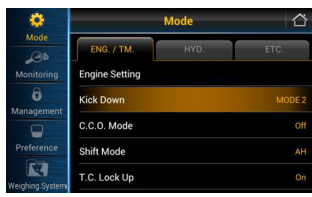

760F3CD29A

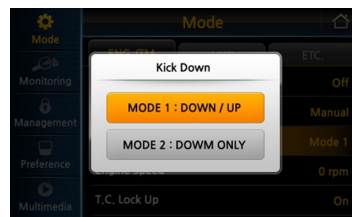

760F3CD29B

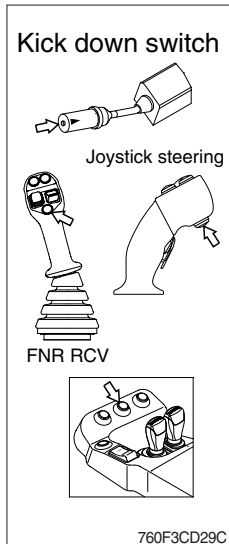

760F3CD29C

- **Manual mode** (shift mode : manual)
It is effective 2nd speed to 1st speed only and recover to 2nd speed quickly when push the switch one more time.
 - **Automatic mode** (shift mode : AL, AN, AH)
 - **Mode 1** (down/up)
It shifts down quickly from current gear to one step lower speed by pushing the switch and recover to current speed quickly when push the switch one more time.
 - **Mode 2** (down only)
It shifts down from current gear to one step lower speed when push the switch every time.
The kick down function is released in only 1st speed.
- ※ **The normal autoshift function continues after the kick down switch is released.**

③ Clutch cut off (C.C.O) mode

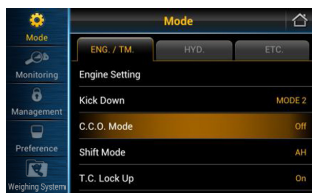

760F3CD26A

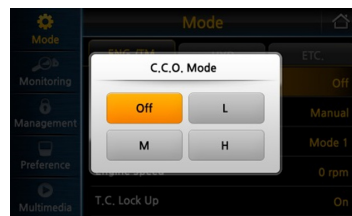

760F3CD26B

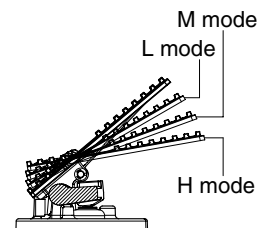

Left brake pedal

760F3CD27

- Four modes are available for operator's preference and job condition.
 - OFF : The clutch cut off function is disable.
 - L (Low) : The clutch is disengaged early for short-distance and rapid loading.
 - M (Medium) : The clutch is disengaged normally for general digging and loading operation.
 - H (High) : The clutch cut off function is automatically adjusted depending on slope angle or machine load, And inching fuction becomes possible by using the brake pedal.
- The clutch cut off functions of the left brake pedal depend on the position of the left brake pedal and the setting of the clutch cut off mode.

Positions for clutch cut off function			
Clutch cut off mode	L	M	H
Left brake pedal	L, M	M	H

④ Shift mode

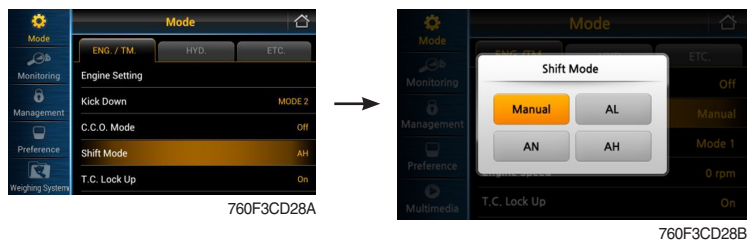

- Four modes are available for operator's preference and job condition.
 - Manual : Machine is operated by selected gear on lever.
 - AL (Auto Light) : Automatic shifting point is fast for long-distance transportation and fuel efficiency.
 - AN (Auto Normal) : Automatic shifting point is normal without automatic kick-down to 1st gear for general digging and loading operation.
 - AH (Auto Heavy) : Automatic shifting point is normal with automatic kick-down to 1st gear for more powerful operation.

⑤ Torque converter (T.C.) lock up mode (5-speed transmission)

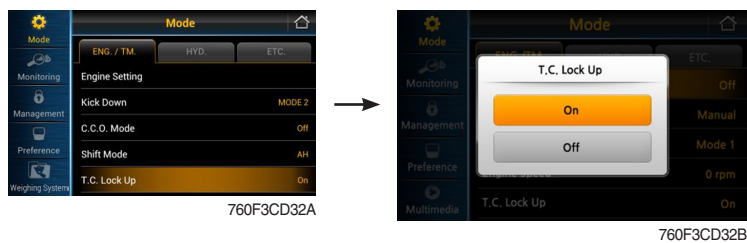

- If you select ON, the lock-up clutch on the torque converter will automatically activate according to load.
- **Lock-up clutch function (option)**
To prevent power loss in the torque converter, the pump rotor and turbine rotor on the torque converter lock together through a direct lock-up clutch.

⑥ Work load



760F3CD33A

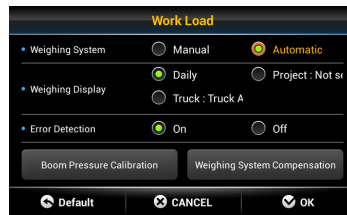

960A3CD33

- Weighing system : Set the workload measurements.
- Weighing display : Set the display on main display screen.
- Error detection : Set error detection ON/OFF.
 - OFF : Errors are not displayed.
 - ON : ①, ② and ③ are displayed on main display screen.
 - ① The boom lift was performed too fast.
 - ② The bucket was not in the fully tilted back position while bucket was in the weigh range.
 - ③ The hydraulic temperature is low (below 40 °C).

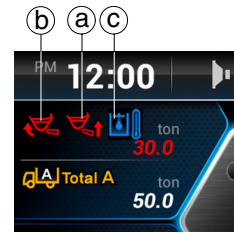

760F3CD33CK

	Work weight (today)
	Work weight (previous day)
	Total weight accumulated in memory A, B, C individually regardless of date
	Current weight

- Boom pressure calibration : See the page 7-45 for details.
- Weighing system compensation
 - Calibration workload depending on work tool.
 - ※ **Only for the service person. Do not adjust arbitrary.**
- ※ **Refer to page 7-65 for details.**

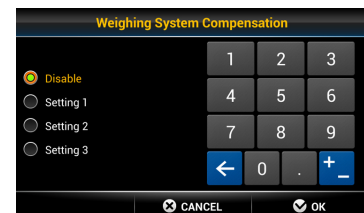

9603CD75G

※ Weighing system

- The weight indication in bucket is calculated by measuring boom position and boom pressure.
- ① The weight is '0.0 ton' when the boom is placed at below -15°.
- ② The weight is indicated when the boom is placed at the range (-5° → 15°).
- ③ The weight is calculated when the boom is placed at above -5° and boom is lowered below -15° after dumping operation.

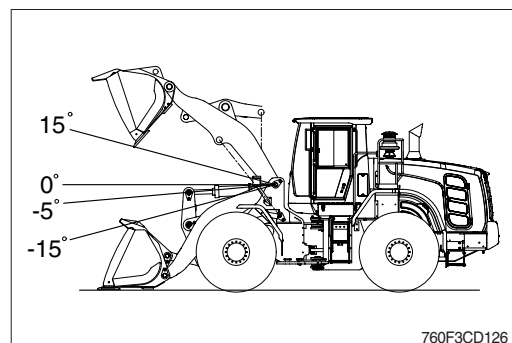

760F3CD126

In order to recheck weight, go to the ② after changing boom position (below -15°).

- Dump operation : It is checked by bucket cylinder's stroke change (below 250 mm).
- ※ The temperature for the hydraulic oil must be raised to at least 40 °C (104 °F) before operation.

⑦ Boom/bucket detent mode

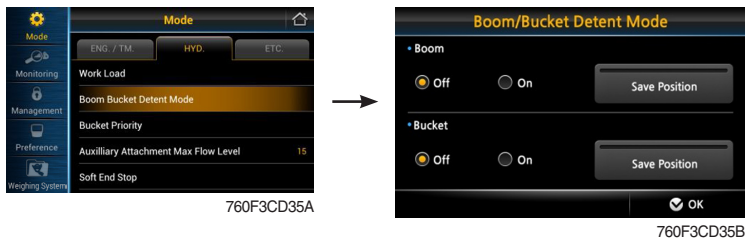

- OFF : Detent functions are not operated.
- ON : Boom or bucket detent functions are operated.
- Save position

⑧ Bucket priority mode (option)

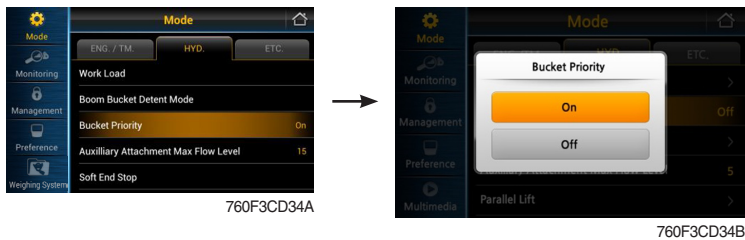

- Bucket priority function is to be more convenient for operator to load materials. Bucket-in (roll back) operation takes priority over the boom-up (raise) operation in case of using both operations at the same time and therefore boom (raise) operation is stopped and only bucket (roll back) is operated.
- Set the bucket priority function ON/OFF.

⑨ Auxiliary attachment max flow level mode (option)



- If the machine is equipped with auxiliary attachment, auxiliary attachment flow can be easily adjusted and controlled.
- Set the oil flow level from 0 to 15 level by using +/- button.

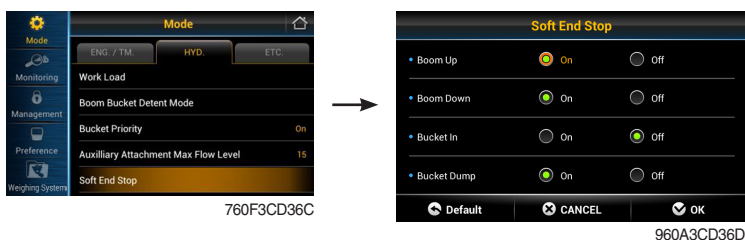

⑩ Soft end stop mode (option)



- This function gives shock free operation by reducing the speed of attachment near the end stroke.
- Set the soft end stop function ON/OFF.

⑪ Speedometer frequency setting mode



- Press speedometer setting bar (or ) for 3 seconds.
- ※ **Only for the service person. Do not adjust arbitrary.**
- ※ **Using button**
- To change the pulse value, press ◀ or ▶.
- To change the position, press .

⑫ Cooling fan reverse mode

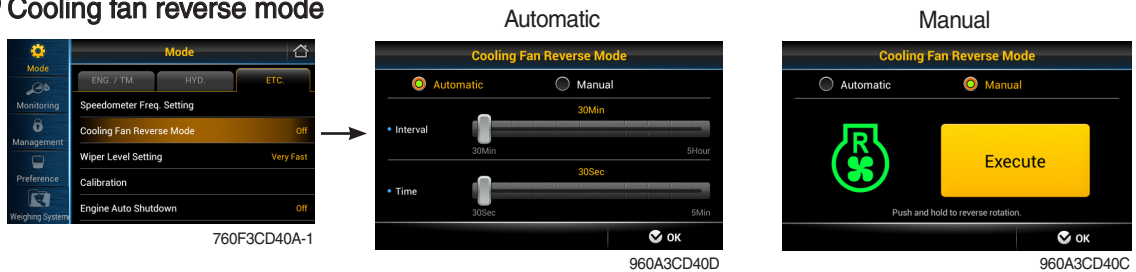

- **Manual** : Rotate the fan with reverse direction while pressing the button "Execute".
- **Automatic** : Rotate the fan with reverse direction by preset cycle.
 - Interval : 30 min ~ 5 hrs
 - Time : 30 sec ~ 5 min
- ※ **Default : Interval (60 min), time (120 sec)**

⑬ Wiper level setting (Intermittent mode)

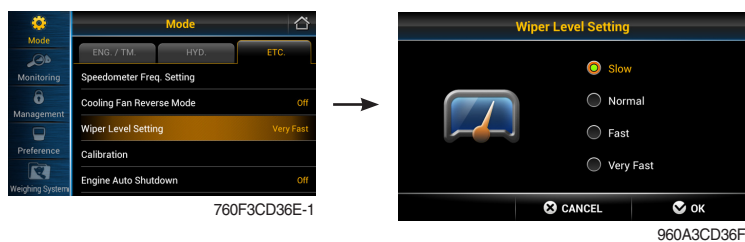

- Setting wiper speed in J position of multi function switch (slow, normal, fast and very fast)
- ※ Refer to the page 7-71.

14 Calibration

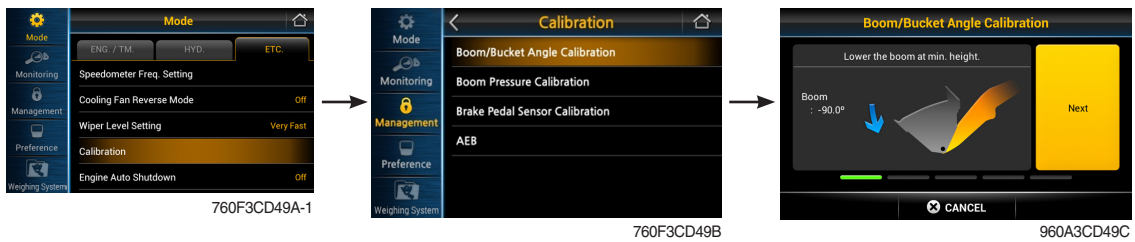

- You should turn OFF " Soft end stop " before start calibration.
- Press NEXT button after following the instruction at each step.
- If correction is right, NEXT button will be activated, then go to next stage.
- After following each step correctly, the message "Calibration completed" will be shown. Press OK button, then process be ended.

※ Using switch



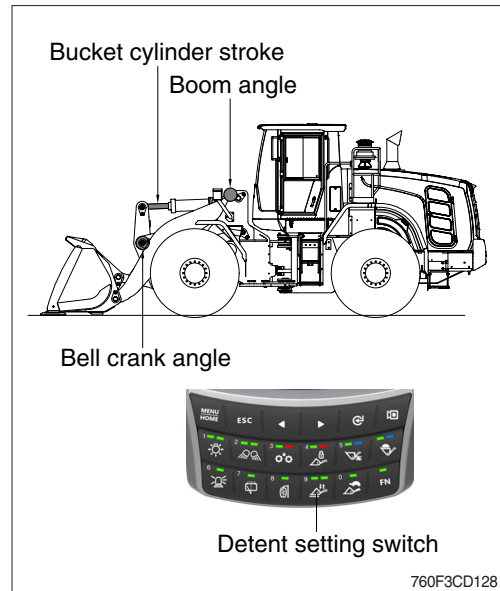

- Using  instead of NEXT, complete button.

· Boom / Bucket angle calibration

- MCU get sensing signal from boom angle and bell crank angle and calculate bucket cylinder stroke and boom link position angle from ground real time basis.
- Boom angle position and bucket cylinder stroke is set by detent setting switch on monitor.
- Individual setting position is done by lever (detent, release operation).
- Angle sensor calibration is basically carried out before delivery of the machine. When angle sensor is replaced or actual value is different compared to setting value, this function can be done.



- The calibration must be carried out as follows :

- ① Lower the boom at maximum low position and press NEXT button or  (bucket must be max tilting position).
- ② Raise boom at maximum high position and press NEXT button (or ).
- ③ Position boom at -5° and press NEXT button (or ).
- ④ Retract bucket cylinder length (to minimum position) at -5° boom position and press NEXT button (or ).
- ⑤ Extend bucket cylinder length (to maximum position) at -5° boom position and press NEXT button (or ).
- ⑥ In case above steps are carried normally, "Calibration is done" message is shown. Then angle sensor calibration is finished.

- ※ **Boom down / boom up / bucket position setting** : Refer to page 4-22 in operator's manual.

· Boom pressure calibration

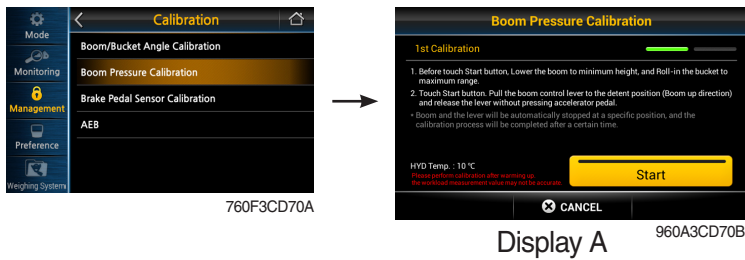

- Press START button after following the instruction.
- After a few minutes, "Calibration failed" or "Calibration completed" message will be shown. Press OK button then process be ended.

※ Using button

- Using instead of NEXT, complete button.

· Boom pressure calibration

- It is used when bucket weight is changed or measured weight is inaccurate.
- The calibration must be carried out as follows :
 - ① Increase hydraulic temperature (about 40~60°C).
 - ② Select "Boom-pressure".
 - ③ Roll-in the bucket at maximum range and lower the boom at minimum height.
 - ④ Press START button.
 - ⑤ Raise boom to maximum position. Boom up must be finished before stepping advance in "display A".
 - ⑥ If it show "Calibration success" message in a moment, press complete button (or).

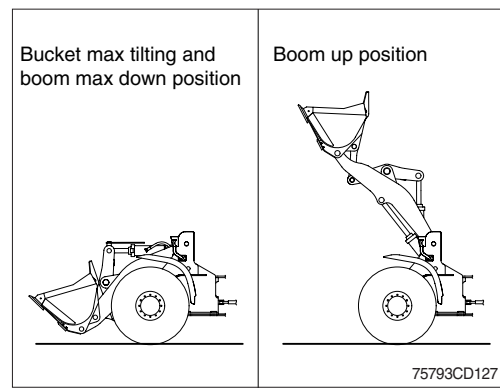

- ※ Raise hydraulic temperature enough when checking work load / boom pressure sensor calibration (recommendation : about 40 ~ 60°C).
- ※ Check if pressure sensor or angle sensor is in normal condition for accurate work load algorism or pressure sensor calibration [pressure sensors at boom cylinder head area and rod area, boom angle sensor (CD-80), bell crank angle sensor (CD-81)].
- ※ Sensor error message during pressure sensor calibration : sensor need to be checked.

· Brake pedal sensor calibration

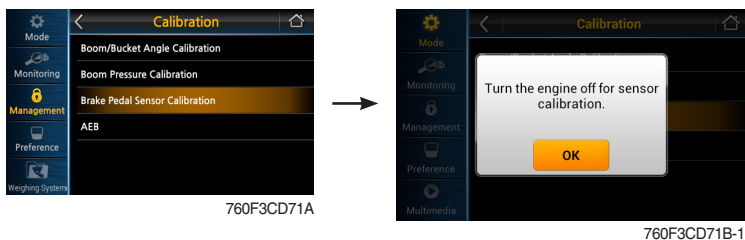



- Turn the engine OFF and turn the starting switch ON position.
- Press OK button, then calibration will be started.
- When display "IP " on main display, press slowly the brake pedal completely.
- Release the brake pedal when display "IP " on main display.
- For cancel, press MENU/HOME switch.

※ When the brake pedal or sensor is replaced, **brake pedal sensor calibration must be performed.**

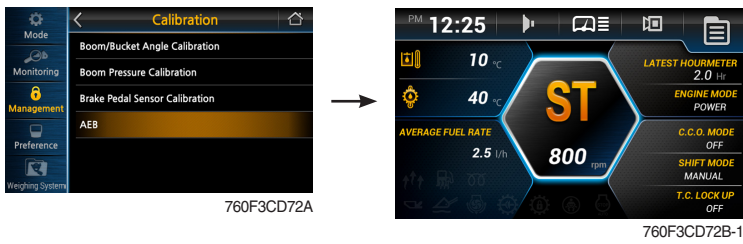
· AEB



- AEB mode controls the disk clearance of the transmission, automatically.
- To start AEB setting, press AEB bar (or ) for 3 seconds.
- If you press  or ESC, AEB setting will be canceled. Machine need to restart.
- If "OK" in actual gear window, press  to complete AEB setting.
- **Display during AEB mode**

Symbol	Meaning
ST	Start AEB
K1~K4, KV, KR	Calibrating clutch K1~K4, KV or KR respectively
OK*	Calibration for all clutches finished
Spanner and Kx*	Kx couldn't be calibrated, AEB finished
△E	Engine speed too low - Raise engine speed
▽E	Engine speed too high - Lower engine speed
△T	Transmission oil temperature too low - Heat up transmission
▽T	Transmission oil temperature too high - Cool down transmission
FO*	Output speed not zero
FN*	Shift lever not in neutral position
FP*	Parking brake not applied

* : Transmission stays in neutral, you have to restart the TCU (starting switch off/on).

⑮ Engine auto shutdown mode



- The engine auto shutdown function can be activated or cancelled.
- If machine is idling for the setting time (2~40 minutes), then engine will be shutdown automatically.

(3) Monitoring

① Machine monitoring

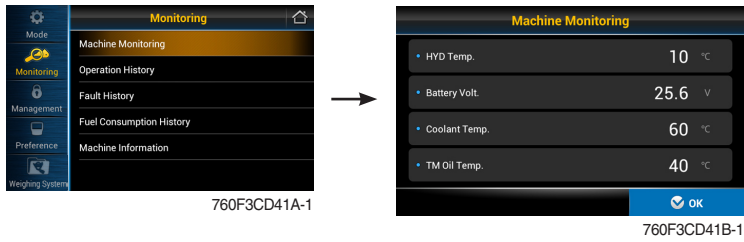

- Monitor the status of the machine.

② Operation history



- **Hour meter / ODO meter**
- **Total**
 - Total distance (this item cannot be initialized).
 - Total working hour can check on service meter. See page 3-59.
- **Latest**
 - Working hour/distance after reset.
 - If you select **Initialization**, working hour/distance start zero.
- To display the item in main display, select the item in main display. See the page 3-13.

③ Fault history

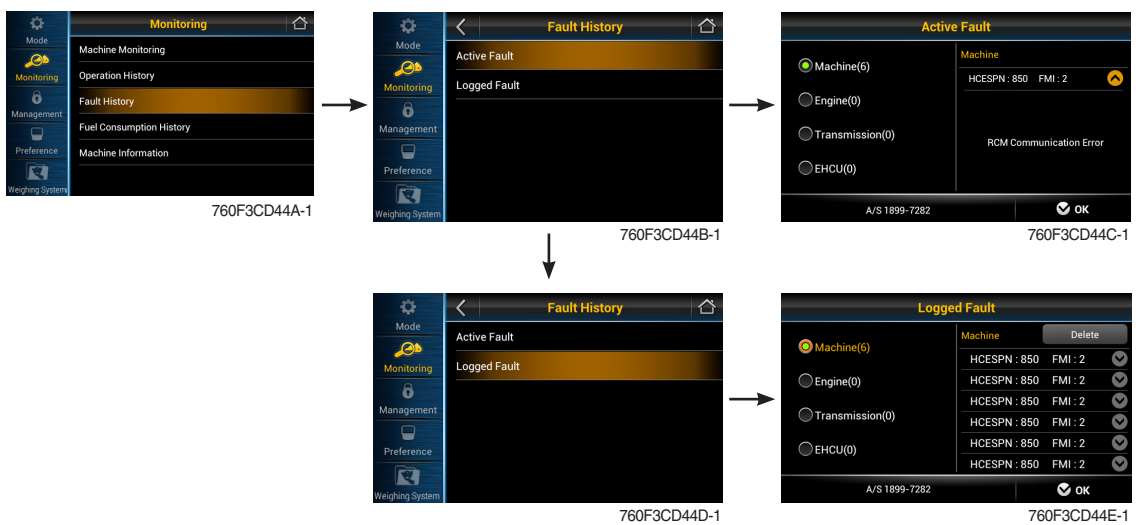

- Display the fault code of MCU/ECU/TCU/EHCU and delete logged fault.
- ※ Refer to service manual for HCESP/N/FMI of engine and transmission.
- ※ EHCUC : Electro Hydraulic Control Unit AAVM : All Around View Monitoring

④ Fuel consumption history

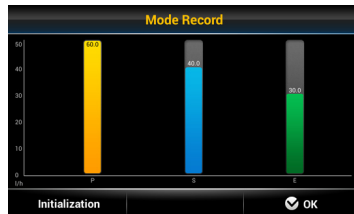
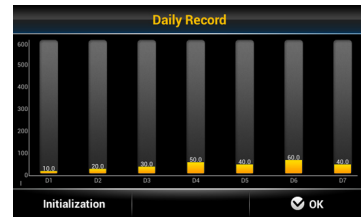
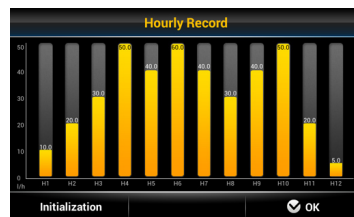
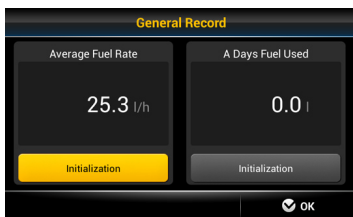
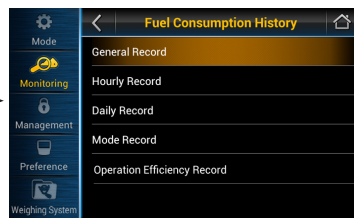
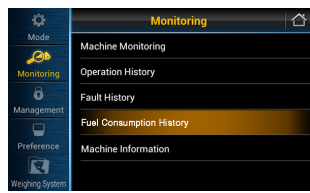

- Display the fuel consumption history.
 - General record (average fuel rate and a days fuel used)
 - Hourly record - Daily record - Mode record : P, P(smart), E mode
 - Operation efficiency record (Shuttle shift, Idle, Relief)

⑤ Machine information

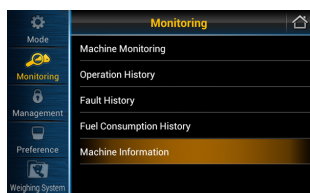

- Software versions of MCU, ECM, TCU, EHCU, RMCU, Cluster and monitor can be checked.

(4) Management

① Machine security

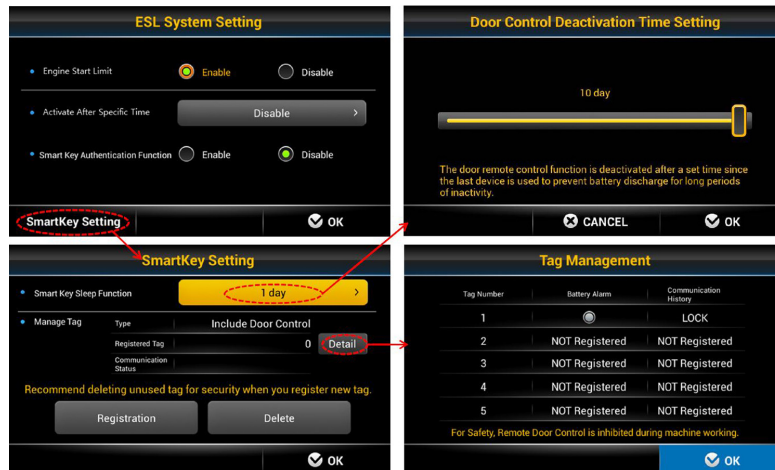
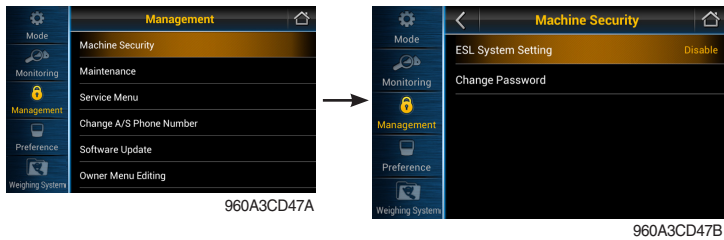

· ESL system setting

- ESL : Engine Starting Limit
- ESL mode is designed to be a theft deterrent or will prevent the unauthorized operation of the machine.
- If the ESL mode was selected ON, the password will be required when the start switch is turned ON.
- **Engine start limit**
 - . **Disable** : Not used ESL function
 - . **Enable** : The password is required whenever the operator start engine.
- **Activate after specific time**

The password is required when the operator start engine first. But the operator can restart the engine within the specific time without inputting the password.

The specific time can be set maximum 2 days.
- **Smart key authentication function (option)**
 - . **Enable** : Set the using or not of smart key. If you using smart key, ESL function always be activated.
 - . **Disable** : Register or delete user tag and display registered user tag. When delete user tag, all user tag will be deleted.

※ Using smart key

- Verification success

Green smart key icon is displayed on the main display screen.

- Verification failure

Red smart key icon and password input screen is displayed.

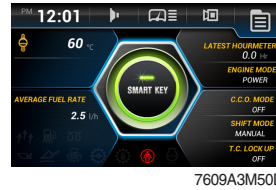

7609A3M50D Verification success

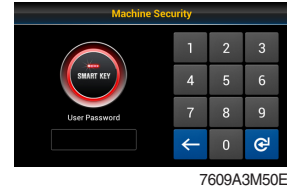

7609A3M50E Verification failure

※ Remote door control system (option)

- The machine operator can lock, unlock and open the cab door by means of the remote key tag, as long as he is within a range of 15 meters from the machine.
- Please note that the door cannot be closed using the Remote Key Tag.



- 1 Door lock
- 2 Door unlock
- 3 Door open (press and hold for 2 seconds)

⚠ Do not activate this function if there is person nearby the door and when machine work or travel.

· Door control deactivation time setting

- There is a limited period of a maximum of 10 days that can be set during which the ' Remote Door Functionality ' can be used if the machine has been parked or at a standstill.
- If the machine is parked or at a standstill for a period that exceeds the period in days set by the operator without any activity, then to prevent the machine batteries from draining, the ' Remote Door Functionality ' will be disabled.
- When this happens, the operator will be able to only use the machine Key to open the cab door, after which the ' Remote Door functionality ' can be enabled again during first start-up.
- During the first start-up after the machine was inactive for a period that exceeds the period in days set by the operator, the operator will be able to see the below pop-up on the monitor, by which the operator can then enable the ' Remote Door functionality ' again by clicking the ' Setting ' tab and confirming the settings thereafter.

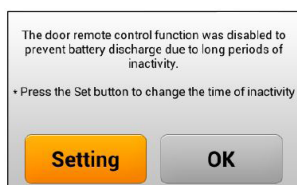

960A3CD47H

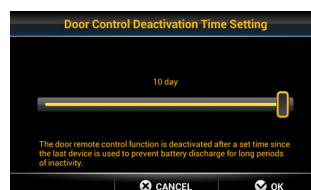

960A3CD47G

· Tag management

- Tag number
 - . Max 5 tags can be registered.
- Battery alarm
 - . Check tag's battery status. (normal or low)
- Communication history (check, lock, unlock, open)

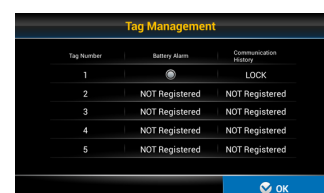

960A3CD47K

② Maintenance



- Replacement : The elapsed time will be reset to zero (0).
Change cycle : The change or replace cycle can be changed in the unit of 50 hours.
- Show the maintenance history below 10.
When history have more than 10, delete the old item.
- **Change or replace interval**

No	Item	Interval
1	Engine oil	800
2	Hydraulic oil	★ ¹ 2000 ★ ² 5000
3	Pilot line filter element	1000
4	Hydraulic oil return filter	1000
5	Engine oil filter	800
6	Fuel filter element	1000
7	Fuel pre-filter element	1000
8	Hydraulic tank air breather	1000
9	Air cleaner element	2000
10	Radiator coolant	★ ¹ 2000 ★ ² 6000
11	Transmission oil and filter	1000
12	Axle oil (front and rear)	1500
13	Aircon & heater outer filter	1000
14	Pressure filter element	1000
15	DEF/AdBlue® supply module filter	4500
16	DEF/AdBlue® Tank filter	2000
17	Aircon & heater inner filter	2000

★¹ : Conventional

★² : HD Hyundai Construction Equipment genuine long life

③ Service menu



- **Sensor monitoring** : Display information of each sensors.
- **Speed limit setting** : 20~40 km/h (5 km/h intervals)
- **EHCU I/O information**
 - Real time monitoring (joystick stroke, EPPR current).

④ Change A/S phone number

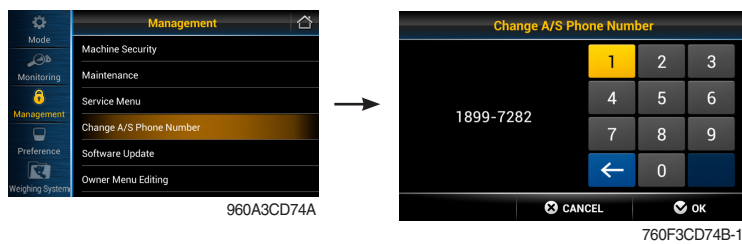

- Check and change of contact information for customer service.

Software update

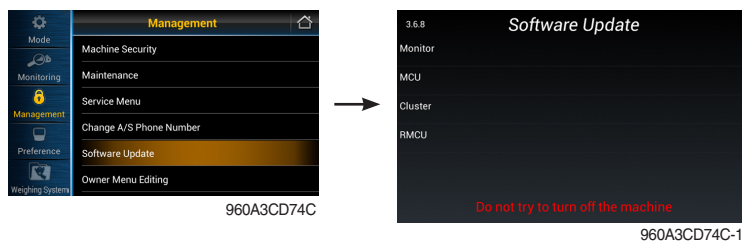

- Update file in USB memory.

⑤ Owner menu editing



- **Owner menu editing** : Owner can set the status of the function. (Enable / Disable)
- **Menu list** : In the menu, owner can set the list of the function to lock or unlock it.
- **Owner password change** (Default password : 11111)
 - Owner can manage and change the password.
 - Necessary to input the password to access the set of function.

(5) Preference

① Brightness setting

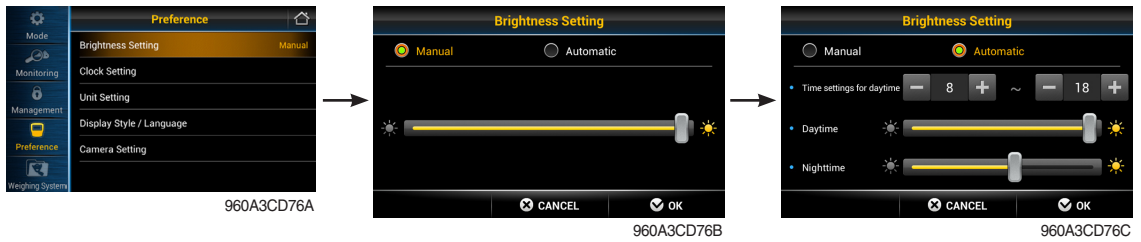

- **Manual**
 - Manual setting for LCD brightness.
- **Automatic**
 - Automatic control of LCD brightness as set level of day/night.
- **Setting day time**
 - Set the time for daylight.
 - If you set the time for daylight, the rest time will be night.

② Clock setting



- Set the time (hour, minute and AM or PM)

③ Unit setting

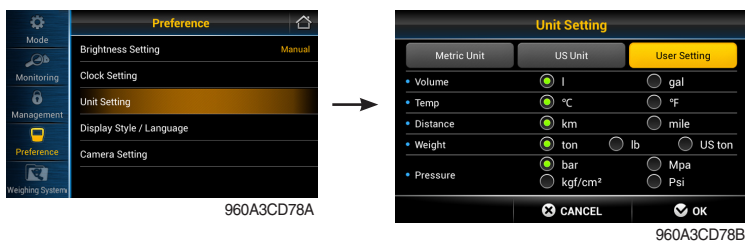

- Volume : l ↔ gal
- Temperature : °C ↔ °F
- Distance : km ↔ mile
- Weight : ton ↔ lb
- Pressure : bar ↔ Mpa ↔ kgf/m² ↔ psi

※ Using button

- Move to other item by

④ Display style/ Language

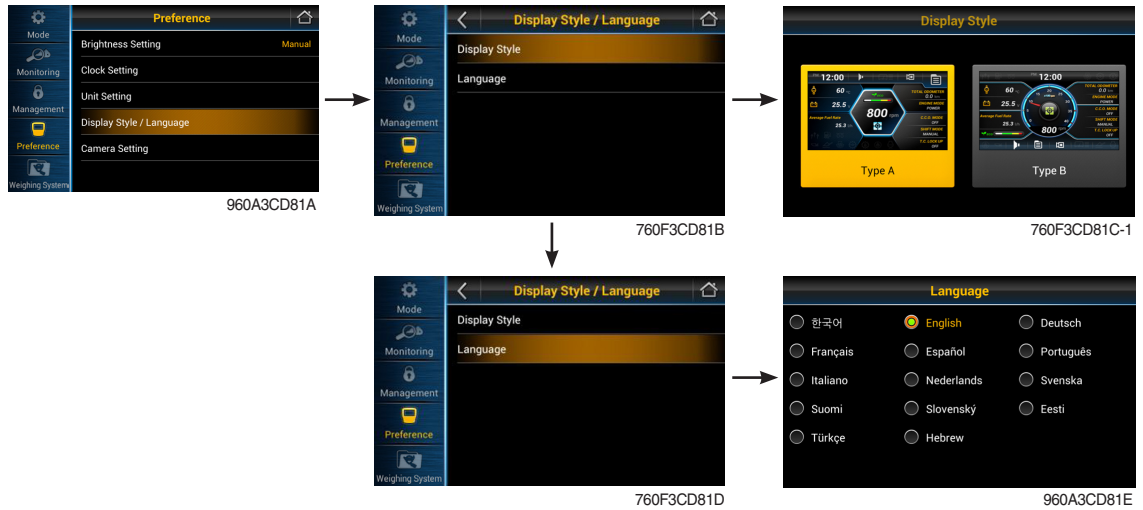

- Set the display type A or B.
- User can select preferable language and all display are changed the selected language.
- 14 multiple language available.

⑤ Camera setting

※ If the camera monitor is equipped, camera will showing on camera monitor only.

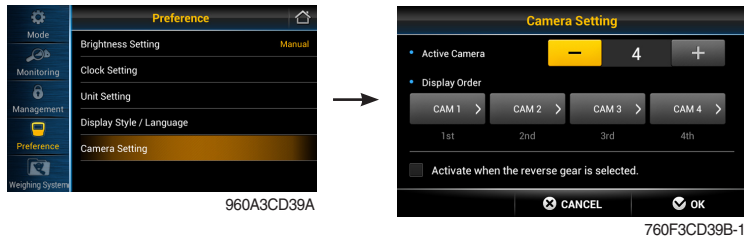

- **Active camera**
 - Four cameras can be installed on the machine.
 - **Display order**
 - Set the channel sequence of each camera.
 - **Active when the reverse gear is selected**
 - If transmission engages the reverse gear (R1~R3), the camera mode is displayed automatically in main display.
 - If the camera was not equipped, this menu is not useful.
 - If the camera monitor is equipped, camera will showing on camera monitor only. This menu is not useful.
 - In main display, if the is touched (or switch is pushed), the first ordered display camera will be viewed.
- ※ If AAVM is equipped, this menu will be changed to AAVM setting.

⑥ AAVM (Advance Around View Monitoring, option)

- ※ If the camera monitor is equipped, AAVM will showing on camera monitor only.
- The AAVM switches of the cluster consist of Camera, ESC and Buzzer stop.



- **Camera switch**
 - It will enter into the AAVM mode from the main display if the AAVM is installed.
 - If the camera monitor is equipped, AAVM will showing on camera monitor only. This menu is not useful.
 - While in the AAVM mode, select the ESC switch to return to the main display.



- **Buzzer stop switch**
 - In AAVM mode, it detects surrounding pedestrians or objects and the warning buzzer sounds.
 - User can turn OFF the warning sound by pressing buzzer stop switch.



290F3CD246

- When the worker or pedestrian go near the danger area line (green, radius 3 m), an external danger area of equipping on the main display, the warning buzzer sounds and it displays the green rectangular box for the recognition of the worker and pedestrian. At this time, the operator should stop work immediately, and stop the buzzer by pressing the buzzer stop switch. And then, please work after you check whether the danger factors are solved.



290F3CD247

- When the worker or pedestrian go inside of the danger area line (red, radius 3 m), an internal danger area of equipping on the main display, the warning buzzer sounds and it displays the red rectangular box for the recognition of the worker and pedestrian. At this time, the operator should stop work immediately, and stop the buzzer by pressing the buzzer stop switch. And then, please work after you check whether the danger factors are solved.

3) PILOT LAMPS

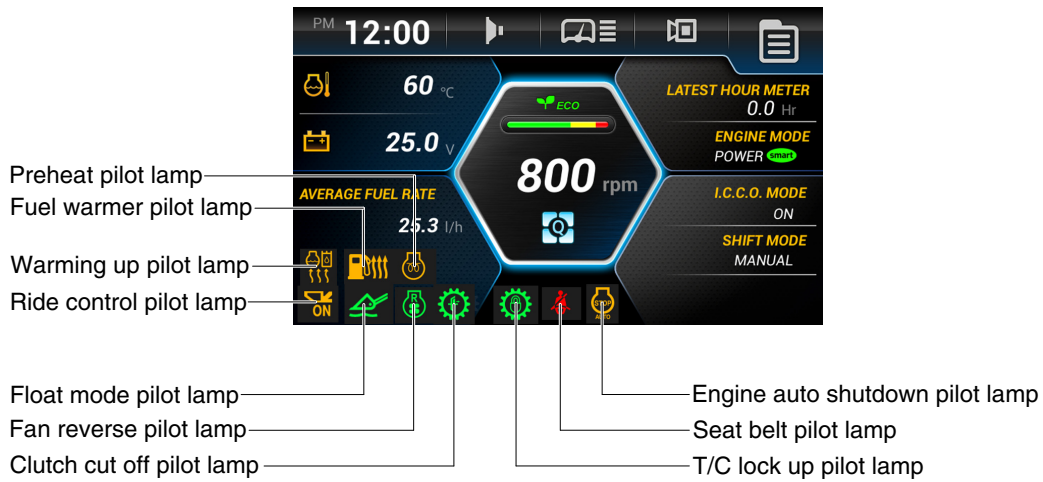

960A3CD90

(1) Warming up pilot lamp



- ① This lamp lights ON when the coolant temperature is below 30°C (86°F).
- ② The automatic warming up is cancelled when the engine coolant temperature is above 30°C, or when 10 minutes have passed since starting the engine.

(2) Seat belt pilot lamp



- ① This lamp lights ON for the first five seconds after starting the engine.

(3) Preheat pilot lamp



- ① This lamp lights ON when start switch is turned clockwise to the ON position. Light will turn off after approximately 5~45 seconds, depending on engine temperature, indicating that preheating is completed.
- ② When the lamp goes out the operator should start cranking the engine.

(4) Engine auto shutdown pilot lamp



- ① This lamp lights ON when the engine auto shutdown function is activated.

(5) Clutch cut off pilot lamp

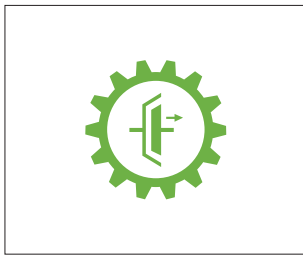

- ① This lamp lights ON when clutch cut off mode is set L, M, H.

(6) Float mode pilot lamp

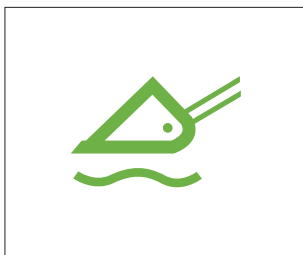

- ① This lamp lights ON when the boom float is activated.

(7) Ride control pilot lamp (option)



- ① **Auto ride control**
This lamp lights ON when the automatic ride control function is activated (**ON**, **Conditional speed** setting).



- ② **Manual ride control**
This lamp lights ON when the manual ride control function is activated (**ON**, **Always** setting).

(8) Fan reverse pilot lamp



- ① This lamp lights ON when the cooling fan reverse mode is activate

(9) Torque converter lock up pilot lamp (option)



- ① This lamp lights ON when the torque converter lock up function is operating.

(10) Fuel warmer pilot lamp

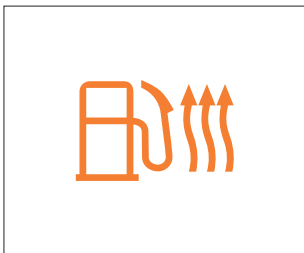

- ① This lamp is turned ON when the coolant temperature is below 10°C (50°F) or the hydraulic oil temperature 20°C (68°F).
- ② The automatic fuel warming is cancelled when the engine coolant temperature is above 60°C and the hydraulic oil temperature is above 45°C since the start switch was ON position.

3) SWITCHES

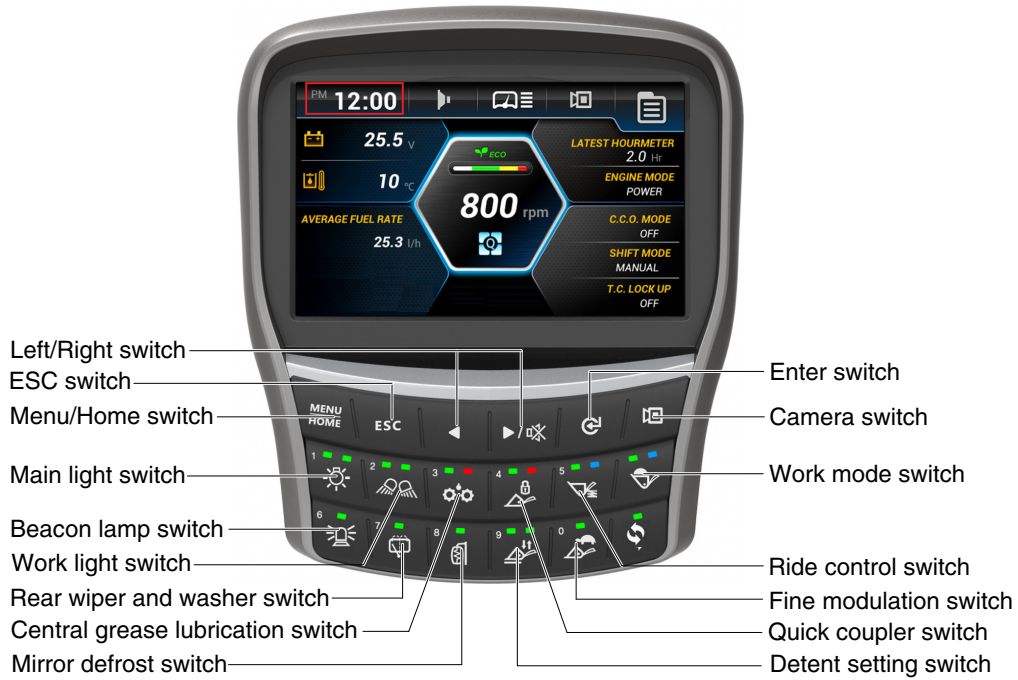

760F3CD95-1

- ※ If you push left or right switch (◀ ▶) on main display, show the select box on current time.
Move to next item in order by using left / right button.
(① Time → ② Buzzer → ③ Wiper → ④ Camera → ⑤ Menu → ⑥ Machine monitoring →
⑦ Fuel rate → ⑧ Engine mode/Operation history → ⑨ Transmission mode → ⑩ Quick menu)
- ※ Move to selected setting screen by using enter switch (⏏).
- ※ When keypad is not pressed for 3 seconds, convert screen to main display.
- ※ If you push left and right switch (◀ ▶) at the same time, move language settings.

(1) Menu / Home switch



- ① Main display to main menu, main menu to main display.

(2) ESC switch



- ① For other menu, this is used for cancellation (move to previous menu).
- ② AEB cancel or finish button in AEB.

(3) Left / Right move switch

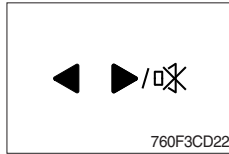

- ① Move in menu (left, up / right, down).
- ② Decrease / Increase input value.
- ③ Stop buzzer sound when sound is on.

(4) Enter switch



- ① Select menu (enter).

(5) Camera switch

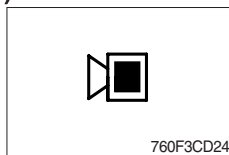

- ① Enter camera or AAVM mode in main display.
- ② If the camera monitor is equipped, camera or AAVM will showing on camera monitor only. This switch is not useful.

(6) Main light switch

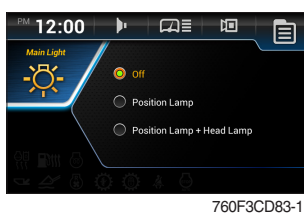

- ① This switch use to operates the clearance lamp and head light.
 - **Position lamp** : Clearance lamp and cluster illumination lamp come ON. The green pilot lamp is turned ON.
 - **Head lamp + Position lamp** : Clearance lamp, cluster illumination lamp and head light come ON. The green pilot lamp is turned ON.

(7) Work lamp switch

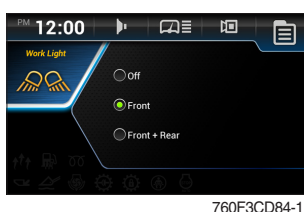

- ① This switch use to operates the front and rear work lamps.
 - **Front** : Front work lamp located on the cab comes ON. The green pilot lamp is turned ON.
 - **Front + Rear** : Front work lamp located on the cab and rear work lamp located on the cowl come ON. The green pilot lamp is turned ON.

(8) Central grease lubrication switch (option)

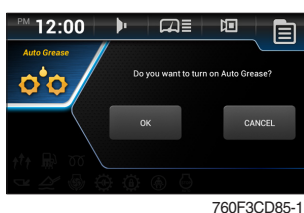

- ① This switch is used to operate the central grease lubrication system.
- ② The central grease lubrication system is operated for set period. The green pilot lamp is turned ON.
- ※ **When malfunction occur in grease lubrication system, the red pilot lamp is turned ON.**

(9) Quick coupler switch (option)

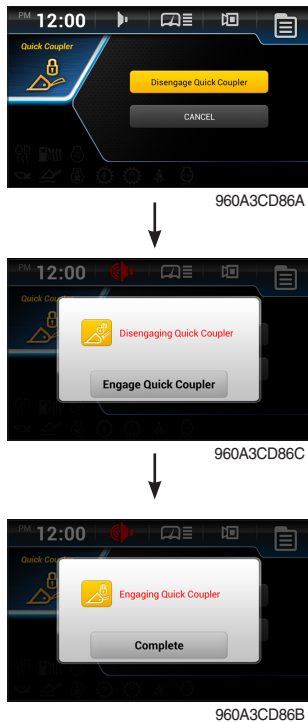

① Disengage quick coupler

- The quick coupler pins move in the disengaged position and buzzer sounds.
- The red pilot lamp is turned ON.

⚠ Always check that the attachment is properly secured to the attachment quick coupler by pressing the front part of the attachment against the ground.

⚠ Never use an attachment before you have checked its mounting.

② Engage quick coupler

- The quick coupler pins move in the engaged position and buzzer sounds.
- The green pilot lamp is turned ON.

※ Check for engagement as followings.

- a. Put down pressure on the attachment.
- b. Back up the machine and make sure that there is no movement between the quick coupler and attachment.

(10) Ride control switch (option)



① Forward / Backward 1~15 km/h

- The ride control automatically turns on when the travel speed exceeds a preset speed. (forward / backward 1~15 km/h)
- The blue pilot lamp is turned ON.

② ON, Always

- Select **ON, Always** in order to turn on the system for ride control regardless speed. The ride control will smooth the ride of the machine during travel.
- The green pilot lamp is turned ON.

③ ON/OFF

Select **ON/OFF** in order to turn on/off the system for the ride control.

(11) Work mode switch

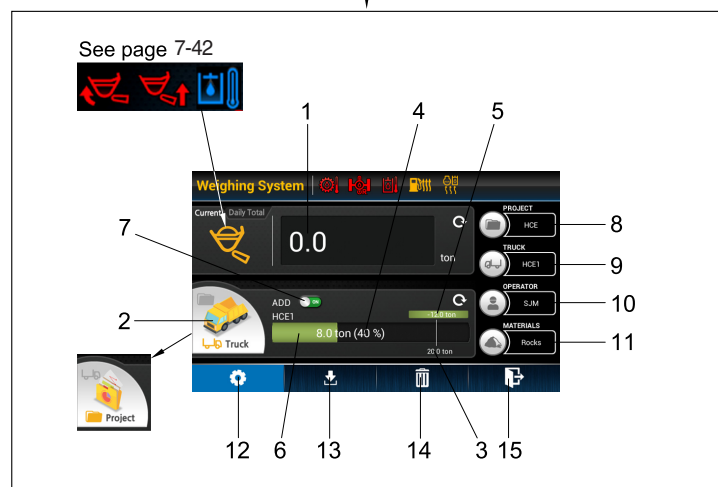
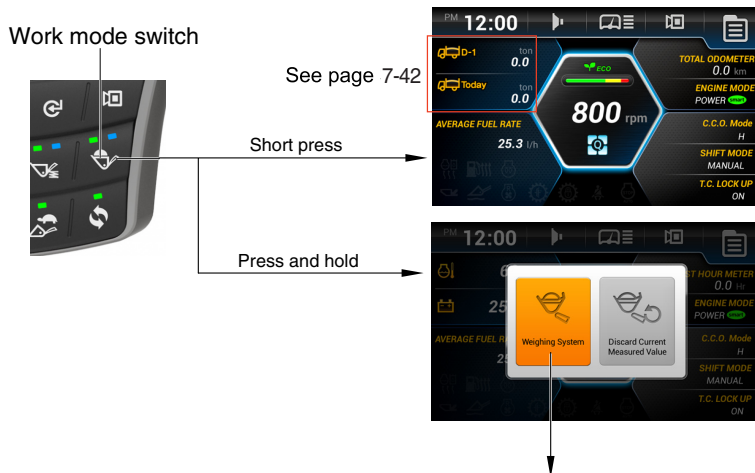

960A3CD115

- | | | | |
|---|---|----|---|
| 1 | Current weight in the bucket /
Daily total weight | 7 | Select button for mode
(Standby mode / Weigh mode) |
| 2 | Select button (Click gray icon)
for status (Project status / Truck status) | 8 | Project name |
| 3 | Target weight | 9 | Truck name |
| 4 | Loaded weight | 10 | Operator |
| 5 | Remaining weight to complete job /
Over weight to complete job | 11 | Materials |
| 6 | Progress bar / Total weight | 12 | Go to Work load setting menu |
| | | 13 | Save Work log to USB |
| | | 14 | Delete Work log |
| | | 15 | Go to Main menu |

(12) Rear wiper and washer switch

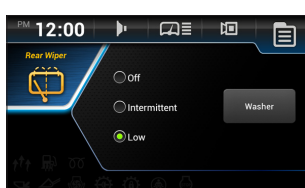

760F3CD89-1

- ① This switch use to operates the rear wiper and washer.
When pressing the switch, the mode is changed sequence base.
(OFF → intermittent → Low → OFF)
 - **Intermittent** : The rear wiper operates intermittently.
 - **Low** : The rear wiper is operated lower speed.
 - **Washer** : The washer liquid is sprayed while long pressing the button.
- ② The green pilot lamp is turned ON.

(13) Beacon lamp switch (option)

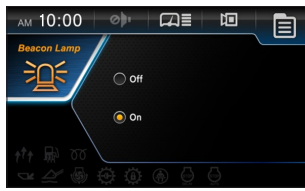

760F3CD88

- ① This switch turns ON the rotary light on the cab.
- ② The green pilot lamp is turned ON.

(14) Mirror defrost switch (option)

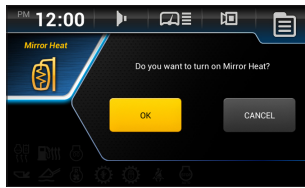

960A3CD65A

- ① **ON**
 - In condition of ON, it operates for 15 minutes. After 15 minutes, the defrost function stops automatically.
 - The green pilot lamp is turned ON.
- ② **OFF**
 - Stops defrost function.

(15) Detent setting switch



760F3CD66

- ① **Boom and bucket**
 - Set the boom and bucket detent function ON/OFF.
 - ② **Save position**
 - Set the boom kickout and bucket leveler.
 - Refer to page 4-22 in operator's manual.
- ※ **The green pilot lamps are turned ON.**

(16) Fine modulation switch

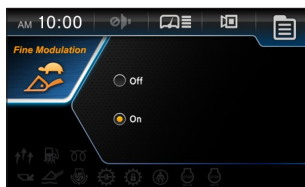

760F3CD67

- ① **ON**
 - Remote control lever provide the operator with precise control of the work equipment (bucket and boom cylinders can be controlled precisely).
 - The green pilot lamp is turned ON.
- ② **OFF**
 - Turn off the function.

4. SWITCHES

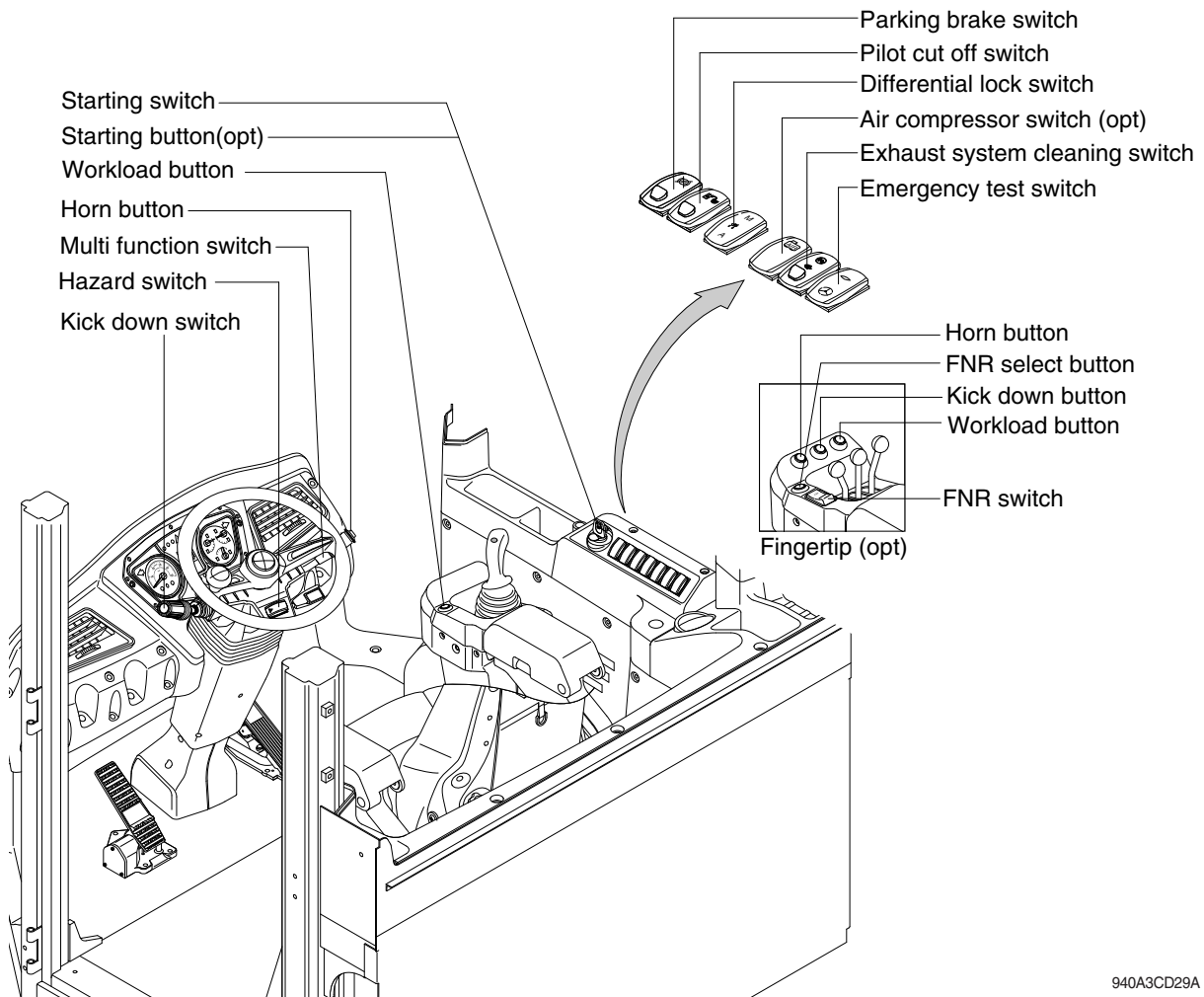

940A3CD29A

1) STARTING SWITCH & STARTING BUTTON (OPT)

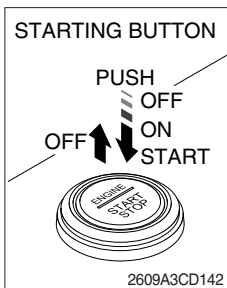
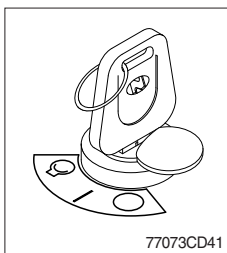

Starting button with smart key tag (opt)

(1) There are three positions, OFF, ON and START.

- ○ (OFF) : None of electrical circuits activate.
- | (ON) : All the systems of machine operate.
- Ⓞ (START) : Use when starting the engine.

Release key immediately after starting.

- ※ If you turn ON the starting switch in cold weather, the fuel warmer is automatically operated to heat the fuel by sensing the coolant temperature. Start the engine in 1~2 minutes after turning ON the starting switch. More time may take according to ambient temperature.
- ※ Key must be in the ON position with engine running maintain electrical and hydraulic function and prevent serious machine damage.

2) PILOT CUT OFF SWITCH

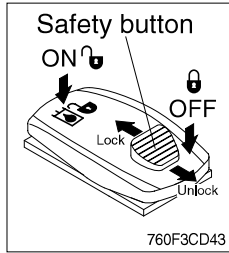

- (1) When the switch is pressed to OFF position, the hydraulic pilot line will be cut off, so the work equipment will not operate.
 - (2) Press the ON position in order to unlock the hydraulic pilot line.
- ※ **This switch can be set to ON or OFF position only when the safety button is pulled to the unlock position.**

3) PARKING BRAKE SWITCH

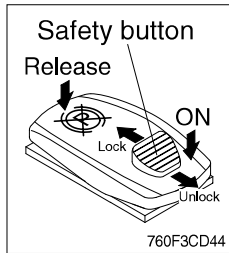

- (1) When the switch is pressed to ON position, the parking brake will start to operate and the cluster warning lamp will come ON.
 - (2) Press the release position in order to disengage the parking brake.
- ※ **When operating the gear selector lever, be sure to release the parking brake. If the machine is operated with the parking brake engaged, the brake will overheat and may cause the brake system to go out of order.**
- ※ **This switch can be set to ON or Release position only when the safety button is pulled to the unlock position.**

※ **If you turn ON the starting switch with the parking brake disengaged (release position), the parking brake will be engaged.**

To release the parking brake, press the parking brake switch to ON and Release position.

4) EMERGENCY TEST SWITCH (option)

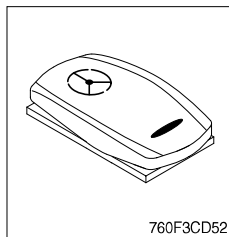

- (1) The emergency steering system can be manually tested. Push the switch in order to determine if the emergency steering and the emergency steering lamp are functional.
- (2) When the switch is pressed, the emergency steering pump motor will run. The emergency steering lamp will light. If the emergency steering lamp does not light, do not operate the machine.

5) DIFFERENTIAL LOCK SWITCH (option)

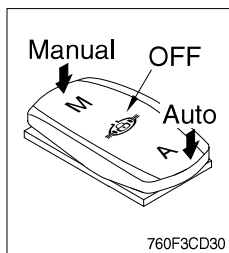

- (1) This switch is used to apply differential lock. The differential lock gives equal power to both front wheels and is used in conditions when traction is poor.
- (2) **Manual mode**
Press the **M** of the switch for the manual mode of the differential lock function. You press the switch, the differential lock will engage immediately and differential lock pilot lamp lights ON (buzzer sounds). Manual mode is temporarily engaged as long as the operator pushes the switch. When the switch is released, differential lock function is disengaged and the switch returns to OFF position.

(3) Auto mode

Press the **A** of the switch for auto mode of the differential lock function. If you press the switch, the axle differential lock will automatically engage when the differential function is used.

※ **While the axle differential lock function is operating, the differential lock pilot lamp lights ON.**

6) EXHAUST SYSTEM CLEANING SWITCH

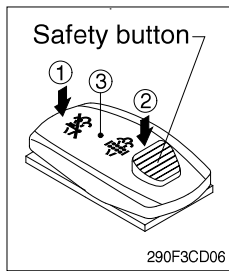

(1) This switch is used to select the exhaust system cleaning.

(2) Inhibit position (①)

- ① The inhibit position disallows any automatic or manual exhaust system cleaning.
- ② This may be used by operator to prevent exhaust system cleaning when the machine is operating in a hazardous environment is concerned about high temperature.
- ③ It is strongly recommended that this position is only activated when high temperatures may cause a hazardous condition.

(3) Auto position (③)

This position will initiate a automatic exhaust system cleaning.

(4) Manual position (②)

- ① This position will only initiate a manual exhaust system cleaning when the machine is in non-mission condition, engine must run at low idle speed and exhaust system levels are high enough to allow cleaning.
 - ② HEST lamp will be illuminated during the entire exhaust system cleaning.
- ※ Refer to the page 7-29 for details.
- ※ This switch can be move to the manual position (②) only when the safety button is pulled to backward.
- ※ Also, this switch return to the auto position when released the manual position (②).

7) HORN BUTTON

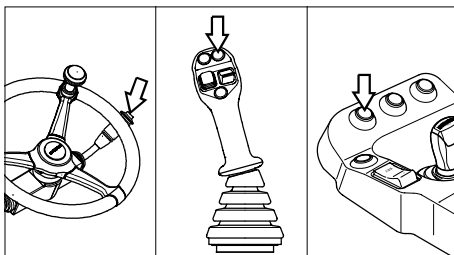

(1) If you press the button, the horn will sound.

8) CAB LAMP SWITCH

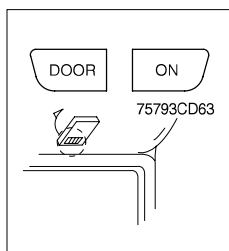

(1) This switch turns ON the cab room lamp.

① DOOR

The lamp comes ON when the door is opened.
When the door is closed the lamp is OFF.

② ON

This switch is used to turn the lamp ON or OFF.

9) KICK DOWN SWITCH

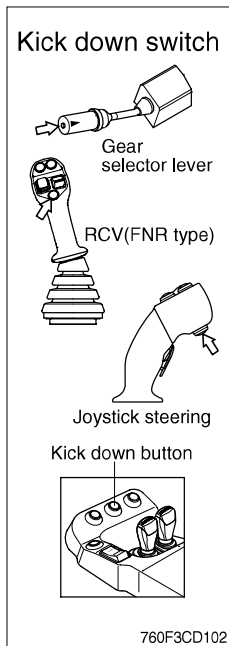

(1) Manual mode

It is effective 2nd speed to 1st speed only and recover to 2nd speed quickly when push the switch one more time.

(2) Automatic mode

① Mode 1 (down/up)

It shifts down quickly from current gear to one step lower speed by pushing the switch and recover to current speed quickly when push the switch one more time.

② Mode 2 (down)

It shifts down from current gear to one step lower speed when push the switch every time.

The kick down function is released in only 1st speed.

※ Refer to page 7-40 for the kick down mode.

※ The normal autoshift function continues after the kick down switch is released.

10) FNR SELECT BUTTON AND SWITCH

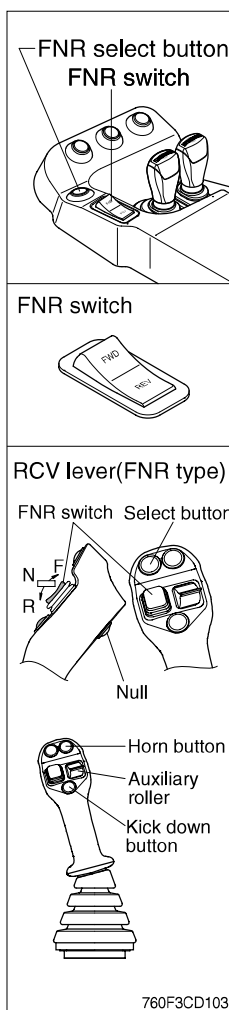

(1) These button and switch are used for forward and backward drive.

※ Gear range can be selected by gear selector lever.

(2) FNR select button

① If the select button is pressed, the indication lamp on the cluster will be ON and this FNR switch will start to operate.

※ When the engine is running, the machine is on standstill (0 speed), parking brake is released, gear selector lever is in the neutral position, you can use this function after pressing the select button.

(3) FNR switch

- F : Forward drive
- N : Neutral
- R : Reverse drive

① If the upper side (F, FWD) of this switch is pushed, the machine moves forward.

② If the down side (R, REV) of this switch is pushed, the machine moves backward.

③ This function is automatically released when the engine is stopped, parking brake is ON or gear selector lever is out of neutral.

(4) Auxiliary roller : If the machine is equipped with auxiliary hydraulics, this roller is used for the attachments.

11) WORKLOAD BUTTON

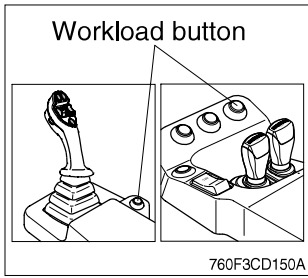

- (1) This button is used to calculate the weight manually.
If the button is not pushed, the weight of the weighing system is not calculated.
 - (2) This button is pushed for one second more, calculated weight will be accumulated.
- ※ Refer to the page 7-42, weighing system.

12) HAZARD SWITCH

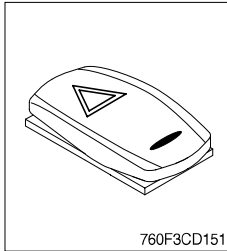

- (1) Use for parking or loading the machine.
 - (2) Both turn signal lights will flash simultaneously.
- ※ If the switch is left ON for a long time, the battery may be discharged.

13) MULTI FUNCTION SWITCH

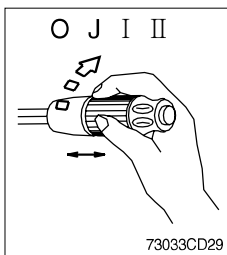

(1) Front wiper and washer switch

- ① When the switch is in J position, the wiper moves intermittently.
※ Refer to the page 7-44 (Wiper level setting).
 - ② When placed in I or II position, the wiper moves continuously.
 - ③ If you push the grip of the lever, washer liquid will be sprayed and the wiper will be activated 2-3 times.
- ※ Check the quantity of washer liquid in the tank. If the level of the washer liquid is LOW, add the washer liquid (in cold, winter days) or water. The capacity of the tank is 1 liter.
- ※ If the wiper does not operate with the switch in ON (J, I, II) position, turn the switch OFF (O) immediately and check the cause. If the switch remains ON, motor failure can result.

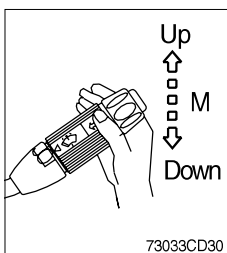

(2) Dimmer switch

- ① This switch is used to turn the head lights direction.
- ② Switch positions
 - Up : To flash for passing
 - Middle : Head lights low beam ON
 - Down : Head lights high beam ON
- ③ If you release the switch when it's in up position, the switch will return to middle.

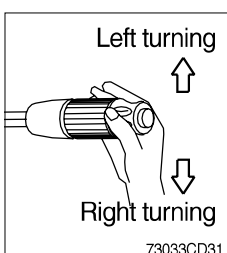

(3) Turning switch

- ① This switch is used to warn or signal the turning direction of the machine to other vehicles or equipment.
- ② Push the lever up for turning left, pull the lever down for turning right.

GROUP 4 ELECTRICAL COMPONENT SPECIFICATION

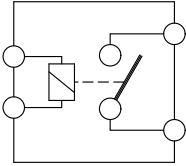
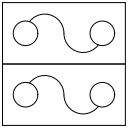
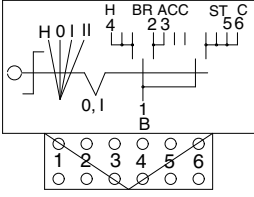
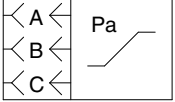
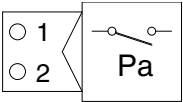
Part name	Symbol	Specifications	Check item
Battery		12V × 120Ah (2EA)	Gravity 1.280 over : over charged 1.280 ~ 1.250 : normal 1.250 below : discharged
Battery relay	 CR-1	Rated load : 24V 100A (continuity) 1000A (30seconds)	Coil resistance broken : approx 50 Ω connected : ∞ Ω
Fusible link	 CN-351 (40A), CN-352 (80A)	24V	Resistance between ring terminal and each connector pin 0 Ω : normal
Start key	 CS-2	B-BR : 24V 1A B-ACC : 24V 10A B-ST : 20V 40A	Resistance between each pin Key off : ∞ Ω (for each pin) Key on : 0 Ω (for pin 1-2 & 1-3) Start : 0 Ω (for pin 1-5)
Pressure switch	 CD-3 CD-26 CD-31 CD-39 CD-40 CD-58 CD-79 CD-80 CD-81	N.C Type	Resistance 0 Ω : normal (close)
Pressure switch	 CD-48 CD-129	N.O Type	Resistance ∞ Ω : normal (open)

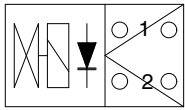
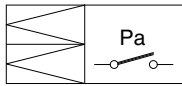
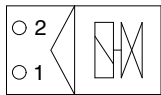
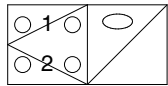
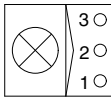
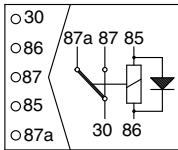
Part name	Symbol	Specifications	Check item
Pilot cut off, parking brake, diff lock, attach lock, unlock solenoid	 CN-68 CN-177 CN-71 CN-178 CN-79	24V 1A	Resistance normal : 15~25Ω
Air cleaner pressure switch	 CD-10	Max load : 6W N.O Type	Resistance ∞Ω : normal (open)
Lock-up, Ride control valve / Fan sole- noid	 CN-43 CN-136 CN-154 CN-155	24V 1.2A	※ Check LED lamp ※ Check resistance about 24Ω
Fuel sender	 CD-2	-	Resistance at fuel levels full level : 200Ω 9/12 level : 500Ω 6/12 level : 800Ω 3/12 level : 1100Ω empty : 1300Ω
Room lamp	 CL-1	24V 10W	Resistance normal : 1.2Ω
Relay (5pin)	 CR-3 CR-5 CR-7 CR-30 CR-35 CR-36 CR-38 CR-40 CR-46 CR-55 CR-56 CR-63 CR-210 CR-211 CR-381	24V 20A	Resistance normal : about 160Ω (for pin 85~86) 0Ω (for pin 30~87) ∞Ω (for pin 30~87)

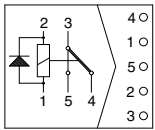
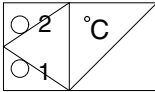
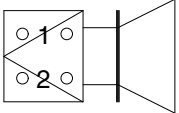
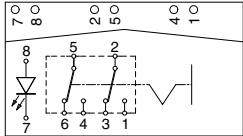
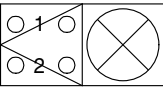
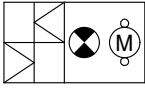
Part name	Symbol	Specifications	Check item
Relay (5 pin)	 CR-2 CR-4 CR-25 CR-26 CR-37 CR-58 CR-79 CR-115 CR-117 CR-136 CR-302 CR-303	24V 20A	Resistance normal : about 160Ω (for pin 1~2) 0Ω (for pin 3~4) ∞Ω (for pin 3~5)
Hydraulic, transmission temperature	 CD-1 CD-49	—	Resistance normal : ∞Ω 105. C over : 0Ω
Speaker	 CN-123 (LH) CN-124 (RH)	4Ω 20W	Resistance normal : 4Ω
Switch (Locking type)	 CS-4 CS-17 CS-75	24V 8A	Resistance at switch off position ∞Ω between pin 1-5 and 2-6 0Ω between pin 5-7 and 6-8
Work lamp, Number plate lamp	 CL-21 CL-32 CL-33 CL-35 CL-36 CL-42 CL-43 CL-45 CL-46	Work lamp 24V 70W Number plate lamp 24V 10W	Resistance normal : 1.2Ω
Beacon lamp	 CL-117	24V 70W (H1 TYPE)	Resistance normal : 1.1Ω

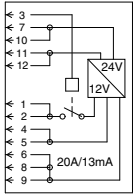
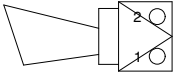
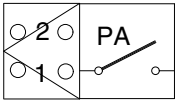
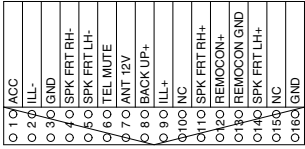
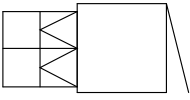
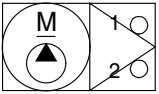
Part name	Symbol	Specifications	Check item
DC/DC Converter	 <p>CN-138</p>	12V 3A	Resistance 8.8Ω (for pin A-B) 7.7Ω (for pin B-C)
Horn	 <p>CN-120 CN-121</p>	24V 2A	Operation by external power source - connct 24V power to (+) terminal - ground the (-) terminal
Receiver dryer	 <p>CN-29</p>	24V 2.5A	Resistance 0Ω : 2.1 ± 0.3 ~ 27 ± 2kgf/cm ² ∞Ω : ~2.1 ± 0.3, 27 ± 2~kgf/cm ²
Radio & USB player	 <p>CN-27</p>	24V 20W+20W	Resistance Power ON : 4Ω+4Ω (for pin 1-6, 4-8)
Back up buzzer	 <p>CN-65</p>	24V 0.5A 110dB	Resistance normal : 5.2Ω
Washer pump	 <p>CN-102 (FR) CN-103 (RR)</p>	24V 2.5A	Resistance normal : 26.4 Ω (for pin1-2)

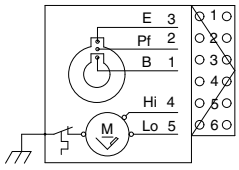
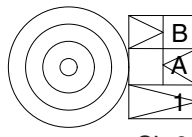
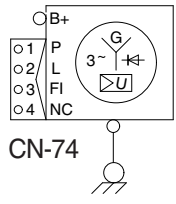
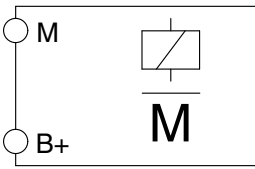
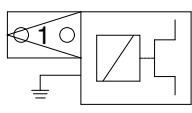
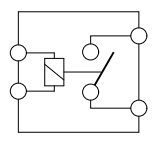
Part name	Symbol	Specifications	Check item
Wiper motor	 <p>CN-21 (FR) CN-102 (RR)</p>	<p>24V 1.5A 2-speed Auto parking</p>	-
Cigar lighter	 <p>CL-2</p>	<p>24V 5A 1.4W</p>	<p>Coil resistance normal : about 1MΩ</p>
Alternator	 <p>CN-74</p>	<p>Denso 24V 95A</p>	<p>Voltage normal : 24~28V</p>
Starter	 <p>CN-45</p>	<p>Denso PA90L (24V-7.8kW)</p>	<p>Operating or not</p>
Aircon compressor	 <p>CN-28</p>	<p>24V 79W</p>	<p>Resistance normal : 13.4Ω</p>
Start relay	 <p>CR-23</p>	<p>24V 300A</p>	<p>Coil resistance normal : 1-2Ω Switch connection ∞ Ω at normal open position 0Ω when engaged</p>

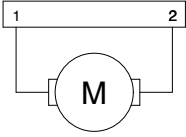
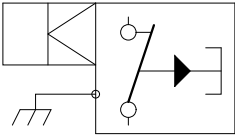
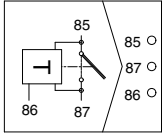
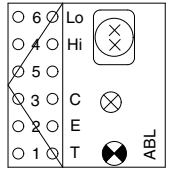
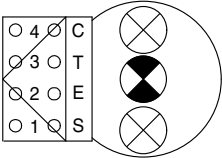
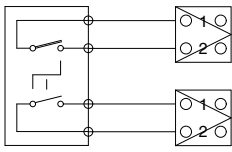
Part name	Symbol	Specifications	Check item
Blower motor		24V 9.5A	Resistance at each switch position normal : 0.5-2Ω
Door switch	 <p>CS-1 CS-55</p>	24V 2W	Resistance normal : about 5MΩ
Flasher unit	 <p>CR-11</p>	24V 85 ~ 190 C/M 50dB	-
Head lamp	 <p>CL-3 CL-4</p>	24V 75W/70W (H4 TYPE) 24V 4W (T4W)	Resistance normal : a fewΩ
Combi lamp (rear)	 <p>CL-15 CL-16</p>	24V 5W (R5W) 2×24V 21W (P21W)	-
Master switch	 <p>CS-74 CS-75</p>	Continuous capacity : 180Amp Push in capacity : 1000Amp	-

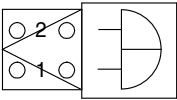
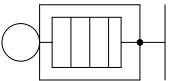
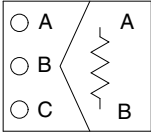
Part name	Symbol	Specifications	Check item
Warning buzzer	 <p data-bbox="517 421 593 452">CN-26</p>	<p data-bbox="836 353 979 385">24V 200mA</p> <p data-bbox="836 389 1011 421">90±5dB (ℓ m)</p>	-
Preheater	 <p data-bbox="517 725 593 757">CN-80</p>	<p data-bbox="836 658 954 689">24V 200A</p>	<p data-bbox="1064 640 1190 672">Resistance</p> <p data-bbox="1064 676 1219 707">0.25~0.12Ω</p>
Resistor	 <p data-bbox="536 1016 612 1048">CN-99</p>	<p data-bbox="836 945 884 976">4W</p>	<p data-bbox="1064 927 1190 958">Resistance</p> <p data-bbox="1064 963 1219 994">A - B : 120Ω</p>

GROUP 5 CONNECTORS

1. CONNECTOR DESTINATION

Connector number	Type	No. of pin	Destination	Connector part No.	
				Female	Male
CN-1	DEUTSCH	48	I/conn (Frame harness-Main harness)	DRB16-48SAE-L018	DRB12-48PAE-L018
CN-2	DEUTSCH	60	I/conn (Front harness-Main harness)	DRB12-60SBE-L018	DRB12-60PBE-L018
CN-4	DEUTSCH	60	I/conn (Engine harness-Main harness)	DRB16-60SAE-L018	DRB12-60PAE-L018
CN-5	DEUTSCH	60	I/conn (Front harness-Main harness)	DRB16-60SBE-L018	DRB12-60PBE-L018
CN-7	AMP	15	I/conn (Main harness-Cab harness)	2-85262-1	368301-1
CN-9	DEUTSCH	6	I/conn (Main harness-Cab harness)	174264-2	174262-2
CN-11	AMP	15	I/conn (Main harness-Aircon harness)	HDP26-24-35SN	HDP24-24-35PN
CN-12	DEUTSCH	35	I/conn (Front harness-Bottom harness)	2-85262-1	368301-1
CN-14	DEUTSCH	12	I/conn (Frame harness-Grill harness)	DT06-12S	DT04-12P
CN-15	KET	11	I/conn (RH console harness-Main harness)	MG651350	MG641353
CN-16	KET	14	I/conn (RH console harness-Main harness)	MG651110	MG641113
CN-18	DEUTSCH	12	LH seat console	DT06-12S	DT04-12P
CN-19	DEUTSCH	2	I/conn (Emer steer harness-Bottom harness)	DT04-2S	DT04-2P
CN-21	AMP	6	Front wiper motor	936257-1	-
CN-22	DEUTSCH	2	Compressor	DTP06-2S	
CN-24	DEUTSCH	12	Grill harness	DT06-12S	-
CN-26	TYCO	10	EHI unit	174655-2	174657-2
CN-26A	AMP	10	Joystick steering	-	174657-2
CN-27	MK II	16	Radio and USB player	PK145-16017	-
CN-27A	MK II	8	USB connector	174984-2	-
CN-31	DEUTSCH	3	Brake priority	DT06-3S	-
CN-36~39	-	-	Fuse box	21WD-15021	-
CN-43	AMP	2	Lock-up	282028	-
CN-45	Ring term	-	Starter	R14-12	ST 710246-2
CN-48	AMP	1	Hour meter	2-520193-2	-
CN-51	AMP	34	MCU	4-1437290-1	-
CN-52	AMP	34	MCU	2-1437285-3	-
CN-53	AMP	26	MCU	1473416-1	
CN-54	AMP	34	MCU	4-1437290-1	
CN-56	KUM	16	Cluster	KPK145-16017	-
CN-57	AMP	20	Monitor	174047-2	-
CN-64	MOLEX	4	Smart key	39012040	-
CN-65	DEUTSCH	2	Back up buzzer	DT06-2S	-
CN-68	DEUTSCH	2	Pilot cut off	DT06-2S	-
CN-71	DEUTSCH	2	Parking solenoid	DT06-2S	-
CN-72	DEUTSCH	2	Cowl open activator	DT06-2S	-

Connector number	Type	No. of pin	Destination	Connector part No.	
				Female	Male
CN-74	PACKARD	4	Alternator	1218-6568	-
CN-79	DEUTSCH	2	Differential lock solenoid	DT06-2S	-
CN-79A	DEUTSCH	2	Differential lock solenoid	DT06-2S	DT04-2D-E005
CN-83	NMWP	2	Aircon fan	PB625-02027	-
CN-100	DEUTSCH	3	Boom kick out	DT06-3S	-
CN-101	DEUTSCH	3	Bucket leveler	DT06-3S	-
CN-102	KET	2	Front washer tank	MG640605	-
CN-103	KET	2	Rear washer tank	MG640605	-
CN-112	-	16	Gear box	21L7-60290	-
CN-115	DEUTSCH	6	Auto grease	DT06-6S	DT04-6P
CN-120	MOLEX	2	Horn	26825-0211	-
CN-121	MOLEX	2	Horn	26825-0211	-
CN-123	KET	2	Speaker (LH)	7123-1520	-
CN-124	KET	2	Speaker (RH)	7123-1520	-
CN-125	DEUTSCH	12	RMCU(remote management control unit)	DT06-12S	DT04-12P
CN-126	DEUTSCH	9	Data link	HD10-9-96P	-
CN-128	NMWP	1	Aircon compressor	PB625-01027	-
CN-129	KET	2	Receiver drier	MG640795	-
CN-134	AMP	6	Diagnostic (TCU)	1-480705-0	-
CN-136	DEUTSCH	2	Ride control solenoid	DT06-2	-
CN-136A	Econoseal J	2	l/conn (Ride control harness-Front harness)	S816-002002	S816-102002
CN-137	AMP	1	12V socket	172434-2	-
CN-138	AMP	12	DC/DC Converter	1-967622-1	-
CN-139	AMP	2	12V socket	172434-2	-
CN-149	DEUTSCH	2	Mirror heat (LH)	DT06-2S	DT04-2P
CN-150	DEUTSCH	2	Mirror heat (RH)	DT06-2S	DT04-2P
CN-152	AMP	4	Proportional valve	2-967059-1	-
CN-154	DEUTSCH	2	Fan speed solenoid	DT06-2S	-
CN-155	DEUTSCH	2	Fan reverse solenoid	DT06-2S	-
CN-156	DEUTSCH	2	Seat heat (with switch)	-	DT04-2P-E005
CN-157	AMP	68	T/M control unit	963598-1	-
CN-158	PACKARD	4	Gear shift lever	1201-0974	-
CN-159	PACKARD	4	Gear shift lever	1201-5797	-
CN-160	CARLING	12	FNR joystick lever	LC3-01	-
CN-162	AMP	6	Pedal	174262-2	-
CN-163	AMP	2	ECO feeling switch	174352-2	-
CN-171	AMP	1	Service socket	172434-2	-
CN-177	DEUTSCH	2	Quick coupler unlock solenoid	DT06-2S	-

Connector number	Type	No. of pin	Destination	Connector part No.	
				Female	Male
CN-177A	Econoseal J	3	I/conn (Front harness-Quick coupler harness)	S816-003002	S816-103002
CN-178	DEUTSCH	2	Quick coupler lock solenoid	DT06-2S	-
CN-196	PACKARD	4	Fuel heater	2-967325-3	-
CN-203	AMP	6	Rear wiper motor	936257-1	-
CN-246	KET	1	PTC power	-	MG620659-5
CN-249	DEUTSCH	6	Camera	DT06-4S	DT04-6P
CN-250	DEUTSCH	2	Seat belt alarm	DT06-2S-EP06	-
CN-252	TYCO	6	Differential lock	S816-006602	S816-106602
CN-313	DEUTSCH	6	AAVM monitor service tool	DT06-4S-EP06	DT06-4S-EP06
CN-399	AMP	4	DEF sensor	1-967325-1	-
CN-431	KET	20	AAVM monitor	MG635026	-
CN-J2	DELPHI	96	ECM	13964572	-
CN-J7A	AMP	4	Nox sensor engine inlet	2-1418390-1	-
CN-J7B	AMP	4	Nox sensor turbo pipe	1-1418390-1	-
CN-J10	AMP	4	SCR temp sensor	3-1418390-1	-
CN-J17	AMP	4	DOC temp sensor	4-1418390-1	-
CN-J26	BOSCH	12	DEF supply module	2-1703639-1	-
CN-J27	AMP	2	DEF heater valve	174352-2	-
CN-J28	DEUTSCH	2	Hose heating PR line	DT06-2S	-
CN-J29	DEUTSCH	2	Hose heating back line	DT06-2S	-
CN-J30	DEUTSCH	2	Hose heating suction line	DT06-2S	-
CN-J31	DEUTSCH	2	DEF dosing inlet valve	DT06-2S	-
Relay					
CR-1	Ring term	-	Battery relay	S820-104002	-
CR-2	AMP	5	Horn relay	VCFM-1002	-
CR-3	AMP	5	Front work lamp relay	VCFM-1002	-
CR-4	AMP	5	Wiper relay (Hi)	VCFM-1002	-
CR-5	HELLA	5	Safety relay	8JA003526-001	-
CR-7	AMP	5	Aircon relay	VCFM-1002	-
CR-11	250	-	Flasher unit	S810-003702	-
CR-23	Ring term	-	Start relay	ST 710289-2	ST 710384-2
CR-24	Shur	1	Preheater relay	S822-014000	-
CR-25	AMP	5	Rear wiper relay	VCFM-1002	-
CR-26	AMP	5	Wiper relay (low)	VCFM-1002	-
CR-30	HELLA	5	ECM power relay	8JA003526-001	-
CR-36	AMP	5	Preheater relay	VCFM-1002	-
CR-39	-	2	Emergency steering pump relay	S820-104000	-
CR-40	KET	5	EHCUC power relay	MG610047-1	-

Connector number	Type	No. of pin	Destination	Connector part No.	
				Female	Male
CR-46	HELLA	5	Fuel warmer relay	8JA003526-001	-
CR-55	AMP	5	Rear work lamp relay	VCFM-1002	-
CR-56	KET	5	Mirror heat relay	MG610047-1	-
CR-58	AMP	5	Back up relay	VCFM-1002	-
CR-63	AMP	5	Stop lamp relay	VCFM-1002	-
Switch					
CS-1	AMP	1	Door switch	ST730018-3	-
CS-2	KET	6	Start key switch	MG610335-5	-
CS-4	CARLING	10	Pilot cut off switch	VC2-01	-
CS-11	KET	8	Multi function switch	MG610339-5	-
CS-12	KET	6	Multi function switch	MG610339-5	-
CS-13	KET	1	Multi function switch	ST730018-3	-
CS-17	CARLING	10	Parking switch	VC2-01	-
CS-33	AMP	6	Engine stop switch	174262-2	-
CS-41	CARLING	10	Hazard switch	VC2-01	-
CS-74	DEUTSCH	2	Master switch	DT06-2S	-
CS-75	CARLING	10	Emergency steering test switch	VC2-01	-
CS-79	CARLING	10	Differential lock switch	VC2-01	-
CS-85, 85L	KET	2	Workload switch	MG610070	MG620074
CS-86, 86L	KET	2	Kick down switch	MG610070	MG620074
CS-87, 87L	KET	2	Horn switch	MG610070	MG620074
CS-88, 88L	KET	2	FNR select switch	MG610070	MG620074
CS-105	CARLING	10	SCR switch	VC2-01	-
Light					
CL-1	KET	3	Room lamp	MG651032	-
CL-3	DEUTSCH	6	Head light (LH)	DT06-6S-EP06	-
CL-4	DEUTSCH	6	Head light (RH)	DT06-6S-EP06	-
CL-15	YAZAKI	4	Combi lamp (RR, LH)	7232-7444	-
CL-16	YAZAKI	4	Combi lamp (RR, RH)	7232-7444	-
CL-21	SWP	2	Number plate lamp	S814-002000	-
CL-22	DEUTSCH	2	Work light (LH)	DT06-2S	-
CL-23	DEUTSCH	2	Work light (RH)	DT06-2S	-
CL-32	DEUTSCH	2	Rear work light (RH)	DT06-2S	DT04-2P
CL-33	DEUTSCH	2	Rear work light (LH)	DT06-2S	DT04-2P
CL-42	DEUTSCH	2	Rear work light (opt)	DT06-2S	DT04-2P
CL-45	DEUTSCH	2	Work light (RH)	DT06-2S-EP06	-
CL-46	DEUTSCH	2	Work light (LH)	DT06-2S-EP06	-
CL-117	AMP	2	Beacon lamp	174198-2	-

Connector number	Type	No. of pin	Destination	Connector part No.	
				Female	Male
Sensor, sender					
CD-1	AMP	2	Hydraulic oil temp sensor	85202-1	-
CD-2	YAZAKI	2	Fuel sensor	7123-7424	-
CD-3	DEUTSCH	3	Brake fail pressure switch	DT06-3S	-
CD-4	DEUTSCH	3	Stop lamp pressure switch	DT06-3S	-
CD-5	PACKARD	3	Clutch cut off pressure switch	-	1215793
CD-10	AMP	2	Air cleaner switch	85202-1	-
CD-17	AMP	2	Engine pick-up sensor	85202-1	-
CD-26	DEUTSCH	3	Parking pressure switch	DT06-3S	-
CD-27	AMP	2	Turbin pick up sensor	85202-1	-
CD-31	DEUTSCH	3	Brake priority pressure switch	DT06-3S	-
CD-39	DEUTSCH	3	Main pump pressure switch	DT06-3S	-
CD-40	DEUTSCH	3	Steering pump pressure switch	DT06-3S	-
CD-43	AMP	2	Lock up proportional valve	282027	-
CD-45	DEUTSCH	2	WIF sensor	DT06-2S-EP06	-
CD-46	AMP	3	Output speed sensor	282087	-
CD-47	AMP	2	Gear chain sensor	85202-5	-
CD-48	AMP	2	Oil filter restriction sensor	282080	-
CD-49	AMP	2	Converter temp sensor	85202-1	-
CD-73	AMP	2	Speed sensor	174352-2	-
CD-79	DEUTSCH	3	Diff lock feed back sensor	DT06-3S	-
CD-80	DEUTSCH	3	Boom positioner sensor	DT06-3S	-
CD-81	DEUTSCH	3	Bucket positioner sensor	DT06-3S	-
CD-96	PACKARD	3	Coolant level sensor	12110293	-
CD-101	SUMITOMO	4	TBAP sensor	6098-0144	-

2. CONNECTION TABLE FOR CONNECTORS

1) 58-L TYPE CONNECTOR

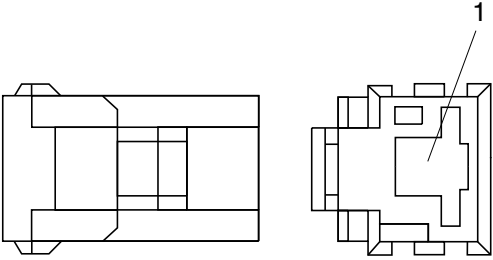
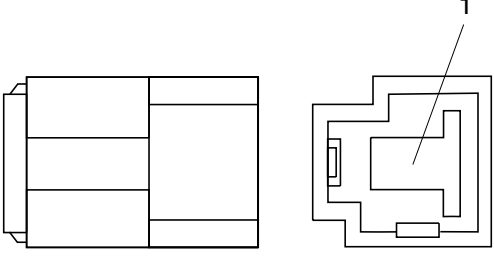
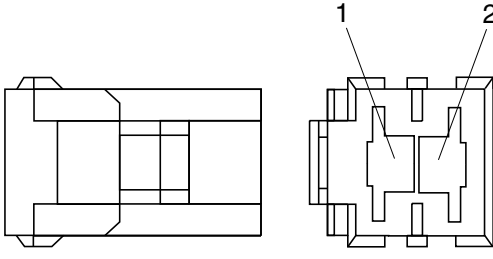
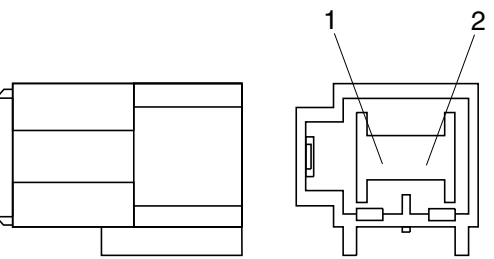
No. of pin	Receptacle connector (female)	Plug connector (male)
1	 <p data-bbox="699 728 842 757">S813-030100</p>	 <p data-bbox="1265 728 1409 757">S813-130100</p>
2	 <p data-bbox="699 1137 842 1167">S813-030200</p>	 <p data-bbox="1265 1137 1409 1167">S813-130200</p>

2) PA TYPE CONNECTOR

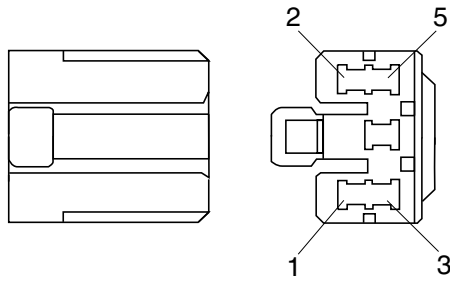
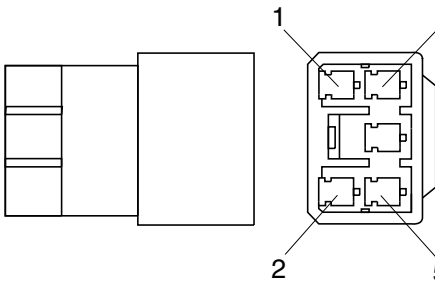
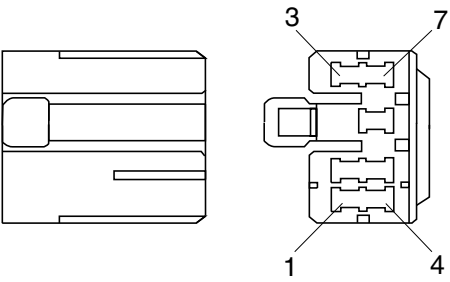
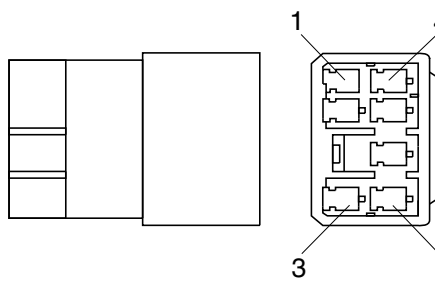
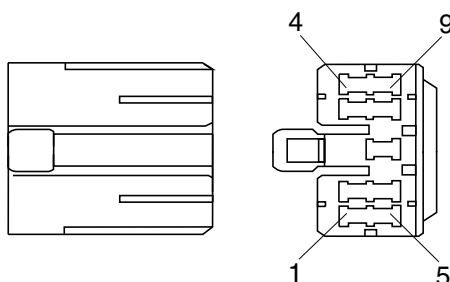
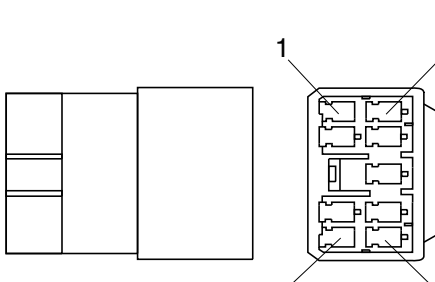
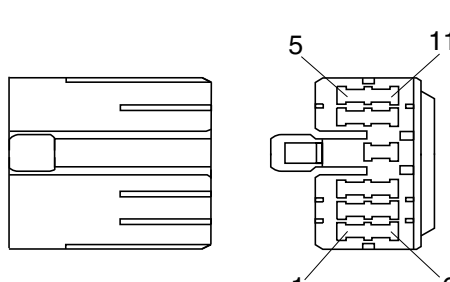
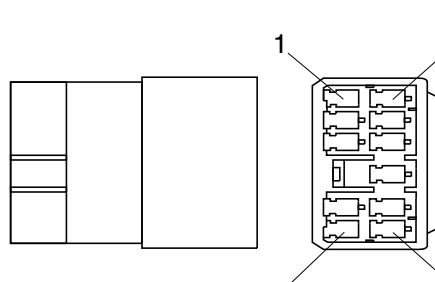
No. of pin	Receptacle connector (female)	Plug connector (male)
5	 <p data-bbox="683 674 834 703">S811-005002</p>	 <p data-bbox="1262 674 1414 703">S811-105002</p>
7	 <p data-bbox="683 1079 834 1108">S811-007002</p>	 <p data-bbox="1262 1079 1414 1108">S811-107002</p>
9	 <p data-bbox="683 1485 834 1514">S811-009002</p>	 <p data-bbox="1262 1485 1414 1514">S811-109002</p>
11	 <p data-bbox="683 1890 834 1919">S811-011002</p>	 <p data-bbox="1262 1890 1414 1919">S811-111002</p>

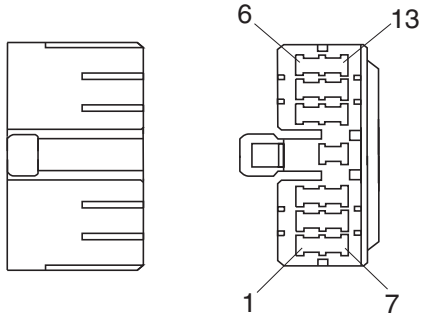
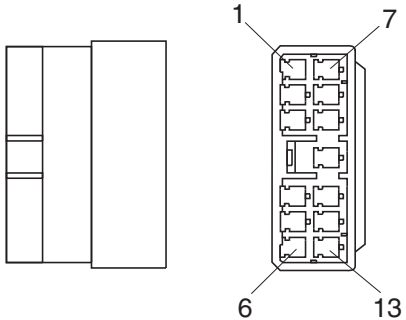
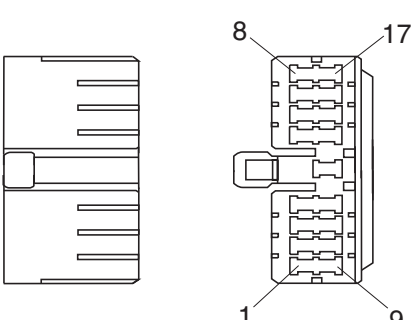
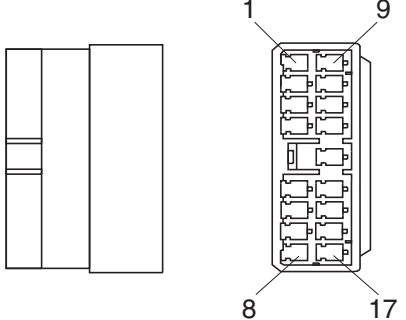
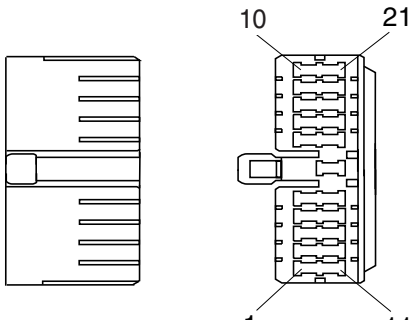
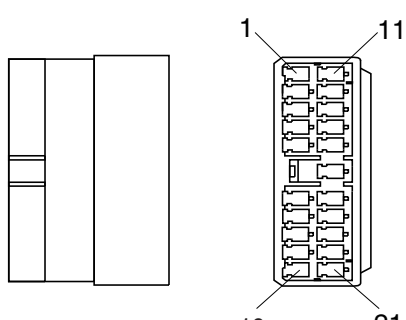
No. of pin	Receptacle connector (female)	Plug connector (male)
13	 <p data-bbox="691 633 842 663">S811-013002</p>	 <p data-bbox="1265 633 1417 663">S811-113002</p>
17	 <p data-bbox="691 1041 842 1070">S811-017002</p>	 <p data-bbox="1265 1041 1417 1070">S811-117002</p>
21	 <p data-bbox="691 1449 842 1478">S811-021002</p>	 <p data-bbox="1265 1449 1417 1478">S811-121002</p>

3) J TYPE CONNECTOR

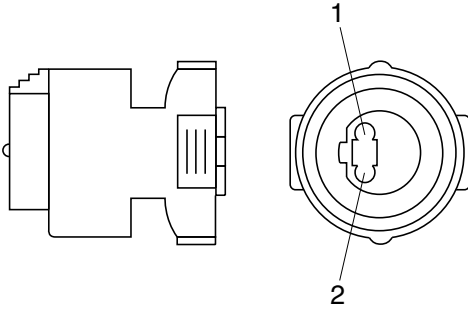
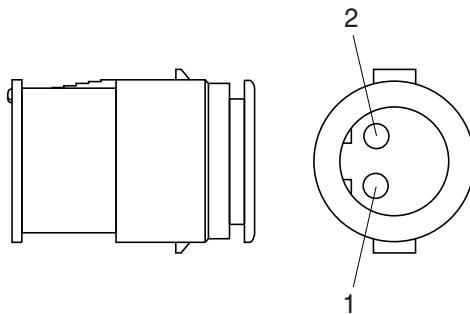
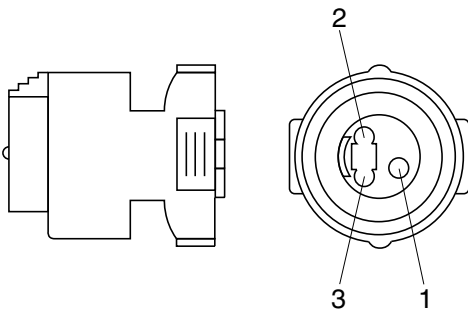
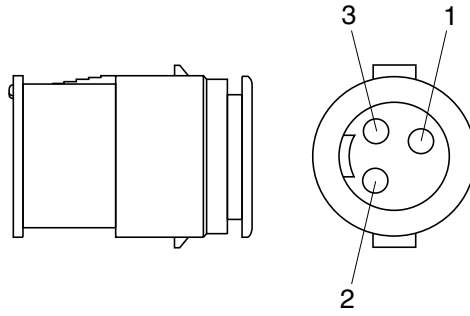
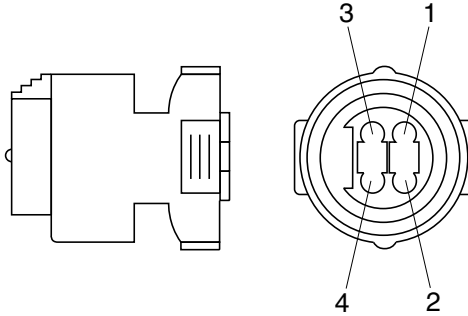
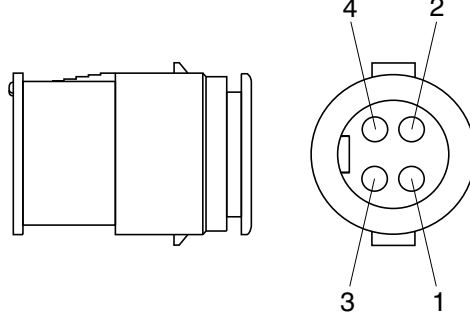
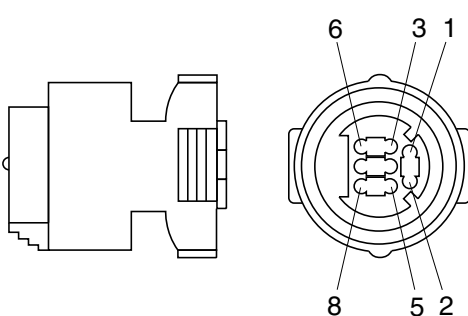
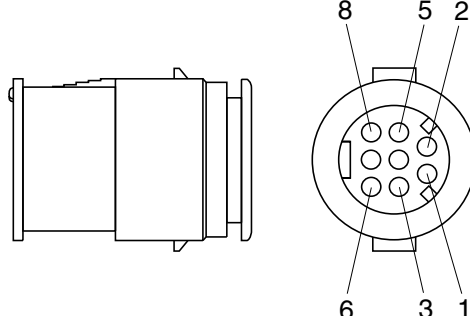
No. of pin	Receptacle connector (female)	Plug connector (male)
2	 <p style="text-align: center;">S816-002001</p>	 <p style="text-align: center;">S816-102001</p>
3	 <p style="text-align: center;">S816-003001</p>	 <p style="text-align: center;">S816-103001</p>
4	 <p style="text-align: center;">S816-004001</p>	 <p style="text-align: center;">S816-104001</p>
8	 <p style="text-align: center;">S816-008001</p>	 <p style="text-align: center;">S816-108001</p>

4) SWP TYPE CONNECTOR

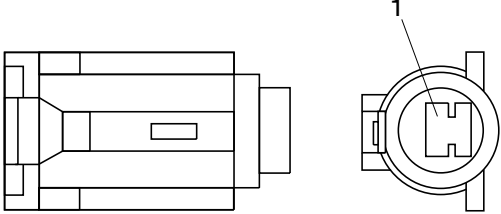
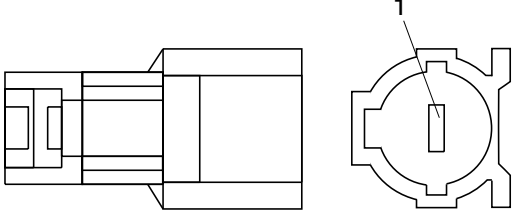
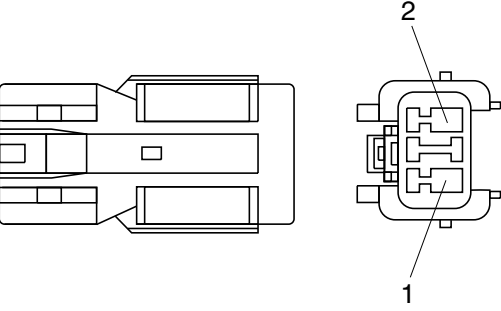
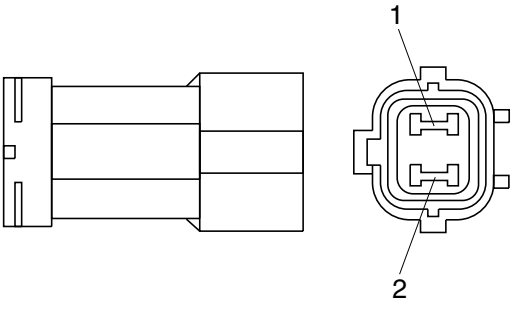
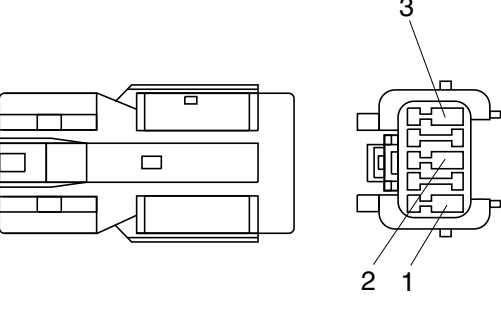
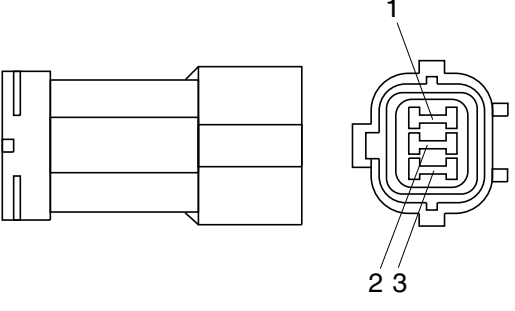
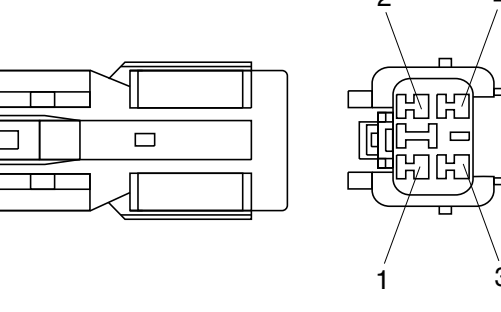
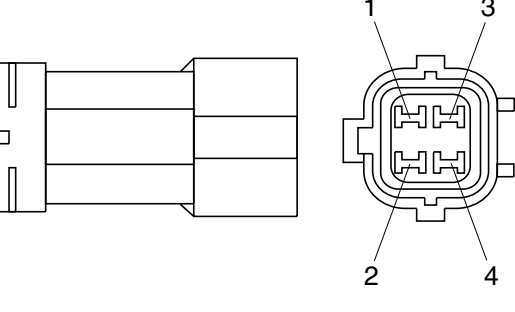
No. of pin	Receptacle connector (Female)	Plug connector (male)
1	 <p data-bbox="687 680 836 707">S814-001000</p>	 <p data-bbox="1241 680 1390 707">S814-101000</p>
2	 <p data-bbox="687 1088 836 1115">S814-002000</p>	 <p data-bbox="1241 1088 1390 1115">S814-102000</p>
3	 <p data-bbox="687 1498 836 1525">S814-003000</p>	 <p data-bbox="1241 1498 1390 1525">S814-103000</p>
4	 <p data-bbox="687 1908 836 1935">S814-004000</p>	 <p data-bbox="1241 1908 1390 1935">S814-104000</p>

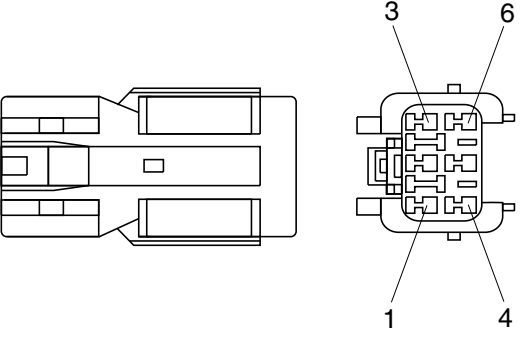
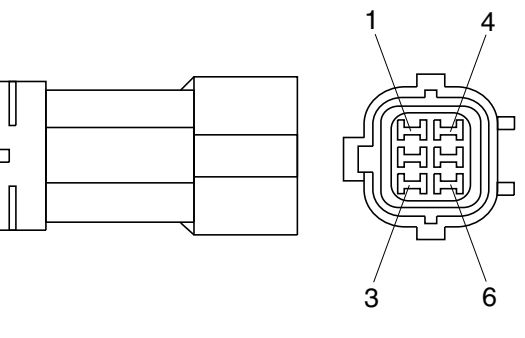
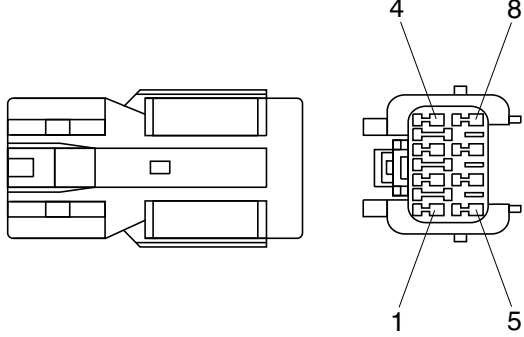
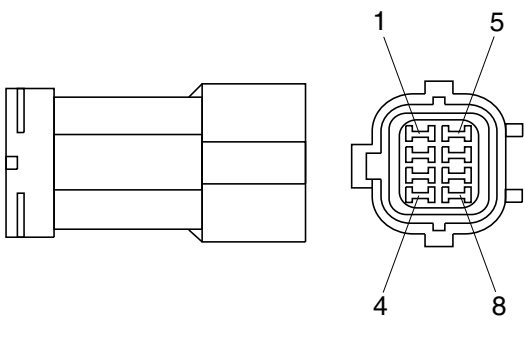
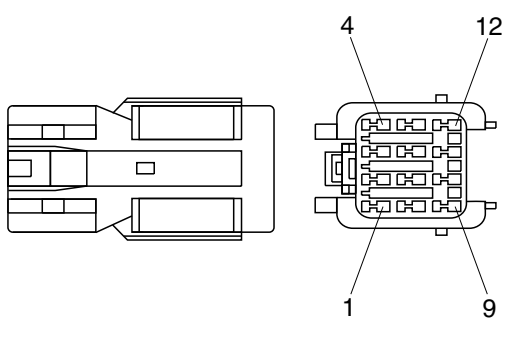
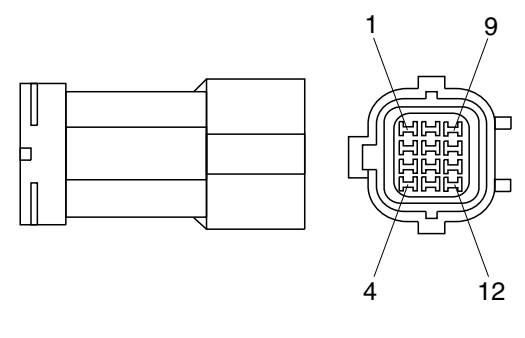
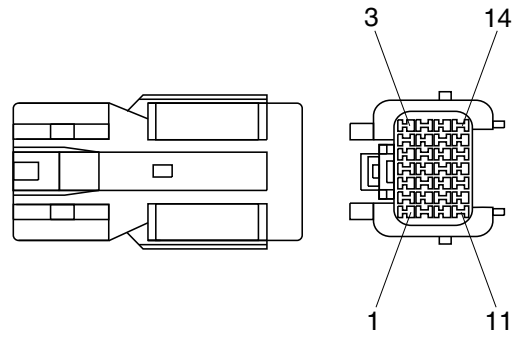
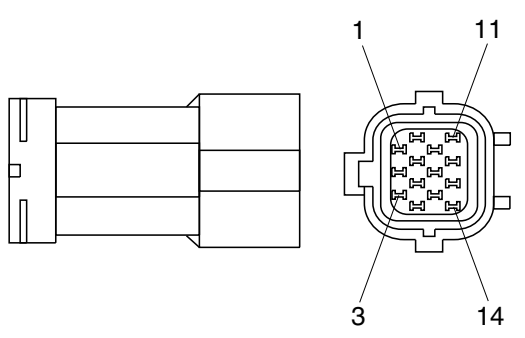
No. of pin	Receptacle connector (female)	Plug connector (male)
6	 <p data-bbox="686 627 837 660">S814-006000</p>	 <p data-bbox="1260 627 1412 660">S814-106000</p>
8	 <p data-bbox="686 1030 837 1064">S814-008000</p>	 <p data-bbox="1260 1030 1412 1064">S814-108000</p>
12	 <p data-bbox="686 1438 837 1471">S814-012000</p>	 <p data-bbox="1260 1438 1412 1471">S814-112000</p>
14	 <p data-bbox="686 1845 837 1879">S814-014000</p>	 <p data-bbox="1260 1845 1412 1879">S814-114000</p>

5) CN TYPE CONNECTOR

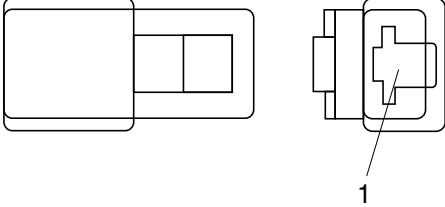
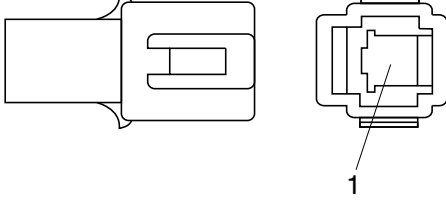
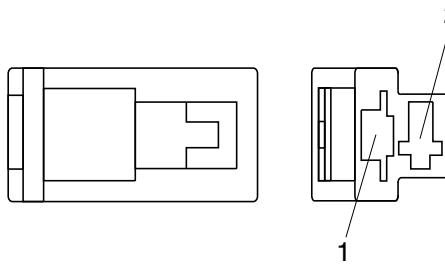
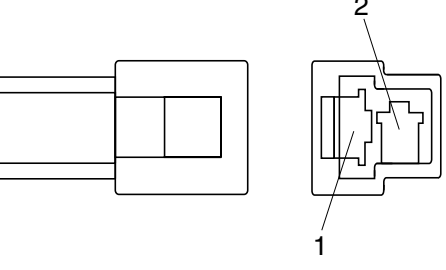
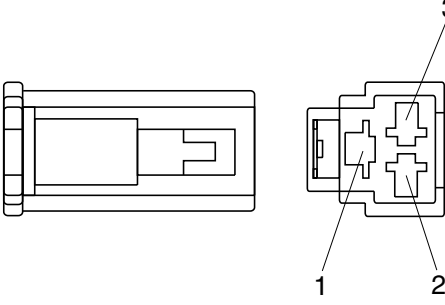
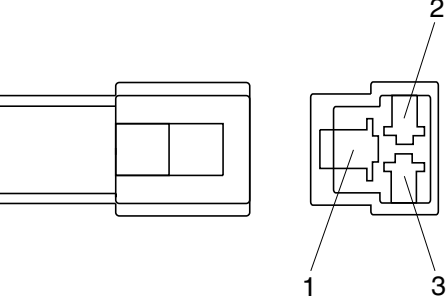
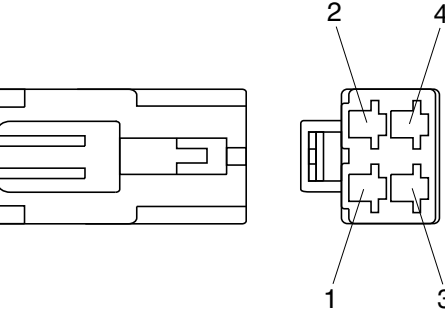
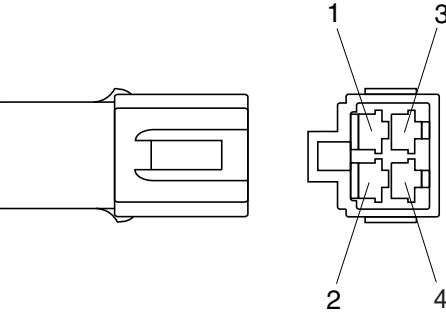
No. of pin	Receptacle connector (female)	Plug connector (male)
1	 <p data-bbox="687 678 839 707">S810-001202</p>	 <p data-bbox="1262 678 1414 707">S810-101202</p>
2	 <p data-bbox="687 1081 839 1111">S810-002202</p>	 <p data-bbox="1262 1081 1414 1111">S810-102202</p>
3	 <p data-bbox="687 1491 839 1520">S810-003202</p>	 <p data-bbox="1262 1491 1414 1520">S810-103202</p>
4	 <p data-bbox="687 1895 839 1924">S810-004202</p>	 <p data-bbox="1262 1895 1414 1924">S810-104202</p>

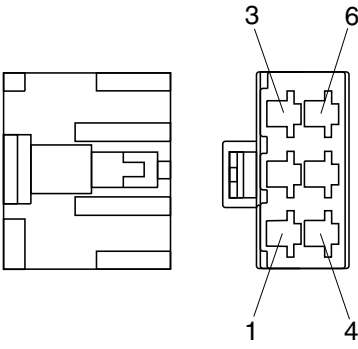
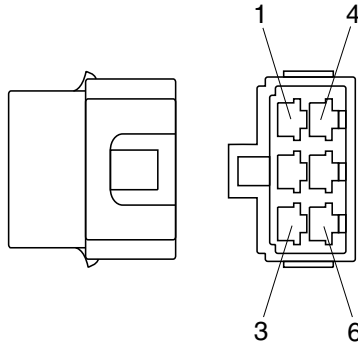
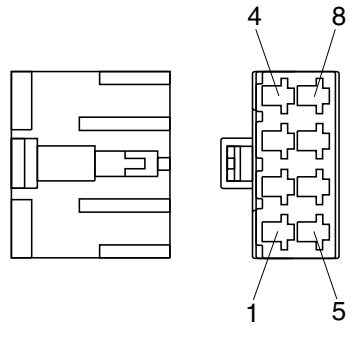
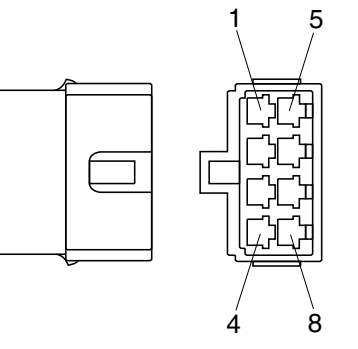
No. of pin	Receptacle connector (female)	Plug connector (male)
6	 <p data-bbox="686 638 837 672">S810-006202</p>	 <p data-bbox="1244 638 1396 672">S810-106202</p>
8	 <p data-bbox="686 1041 837 1075">S810-008202</p>	 <p data-bbox="1244 1041 1396 1075">S810-108202</p>

6) ITT SWF CONNECTOR

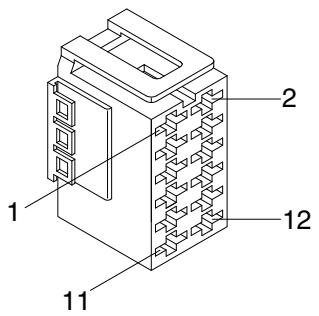
No. of pin	Receptacle connector (female)	Plug connector (male)
10	 <p style="text-align: right;">SWF589790</p>	

7) HW090 SEALED CONNECTOR

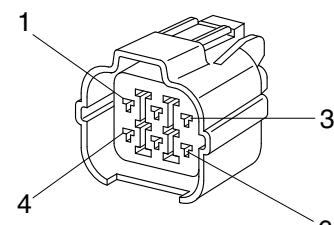
No. of pin	Receptacle connector (female)	Plug connector (male)
6	 <p style="text-align: right;">6189-0133</p>	

8) MWP02F-B CONNECTOR

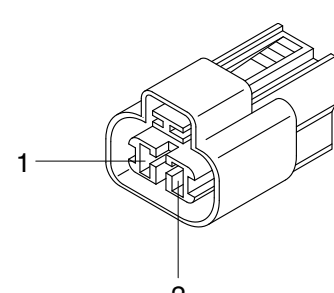
No. of pin	Receptacle connector (female)	Plug connector (male)
2	 <p style="text-align: right;">PH805-02028</p>	

9) AMP ECONOSEAL CONNECTOR

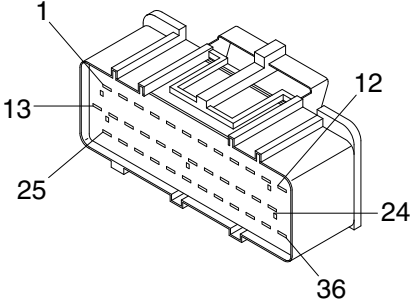
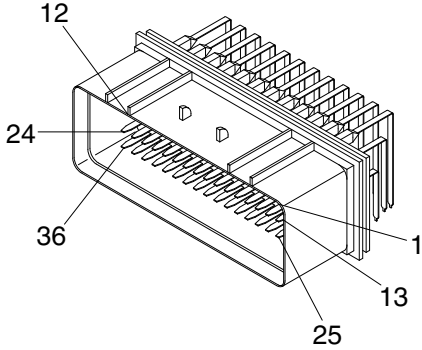
No. of pin	Receptacle connector (female)	Plug connector (male)
36	 <p style="text-align: right;">344111-1</p>	 <p style="text-align: right;">344108-1</p>

10) AMP TIMER CONNECTOR

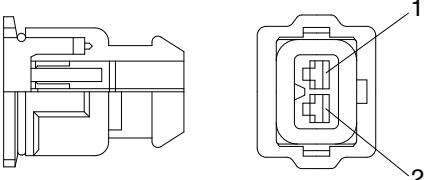
No. of pin	Receptacle connector (female)	Plug connector (male)
2	 <p style="text-align: right;">85202-1</p>	

11) AMP 040 MULTILOCK CONNECTOR

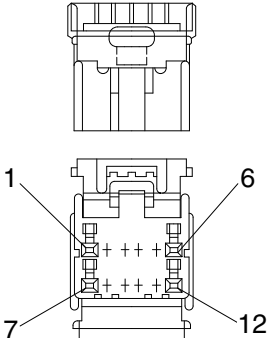
No. of pin	Receptacle connector (female)	Plug connector (male)
12	 <p style="text-align: right;">174045-2</p>	

12) KET 090 WP CONNECTORS

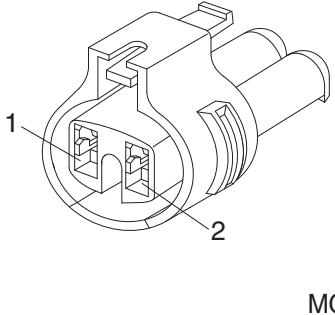
No. of pin	Receptacle connector (female)	Plug connector (male)
2	 <p style="text-align: right;">MG640795</p>	

13) ITT SWF CONNECTOR

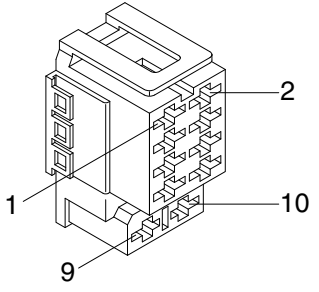
No. of pin	Receptacle connector (female)	Plug connector (male)
10	 <p style="text-align: right;">SWF593757</p>	

14) MWP NMWP CONNECTOR

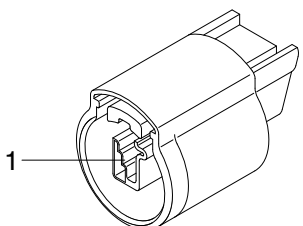
No. of pin	Receptacle connector (female)	Plug connector (male)
1	 <p style="text-align: right;">NMWP01F-B</p>	

15) DEUTSCH DT CONNECTORS

DT 06 - 3S - ★★★★

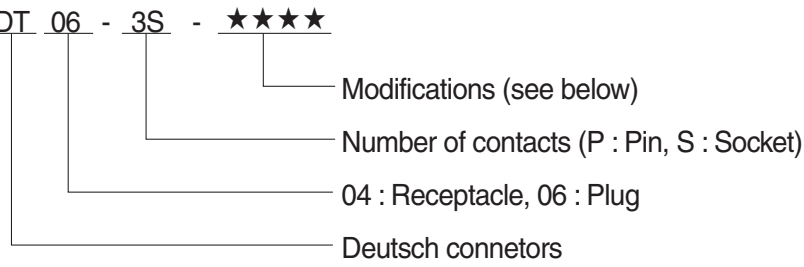

※ Modification

E003 : Standard end cap - gray

E004 : Color of connector to be black

E005 : Combination - E004 & E003

EP04 : End cap

EP06 : Combination P012 & EP04

P012 : Front seal enhancement - connectors color to black for 2, 3, 4 & 6pin

No. of pin	Receptacle connector (female)	Plug connector (male)
2	<p style="text-align: right;">DT06-2S</p>	<p style="text-align: right;">DT04-2P</p>
3	<p style="text-align: right;">DT06-3S</p>	<p style="text-align: right;">DT04-3P</p>
4	<p style="text-align: right;">DT06-4S</p>	<p style="text-align: right;">DT04-4P</p>

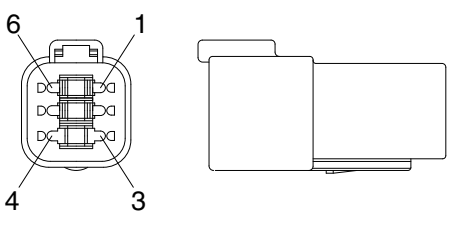
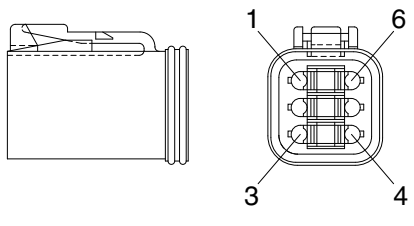
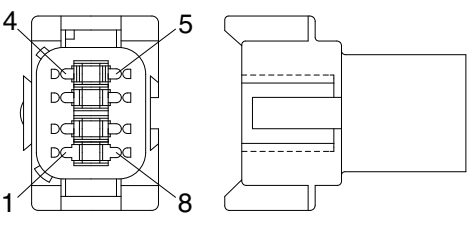
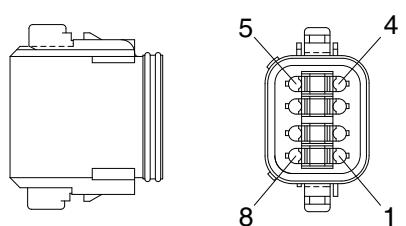
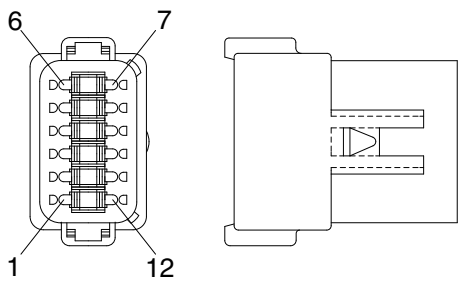
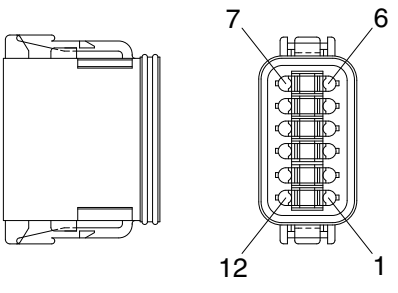
No. of pin	Receptacle connector (female)	Plug connector (male)
6	 <p style="text-align: right;">DT06-6S</p>	 <p style="text-align: right;">DT04-6P</p>
8	 <p style="text-align: right;">DT06-8S</p>	 <p style="text-align: right;">DT04-8P</p>
12	 <p style="text-align: right;">DT06-12S</p>	 <p style="text-align: right;">DT04-12P</p>

16) ECONOSEAL J TYPE CONNECTORS

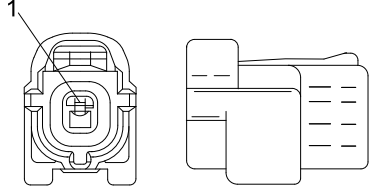
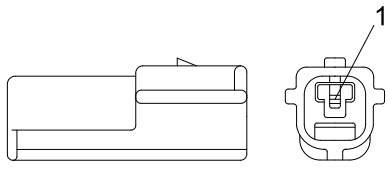
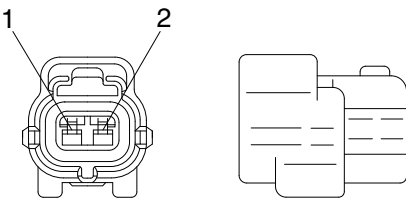
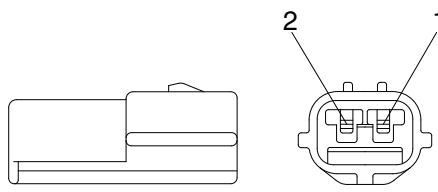
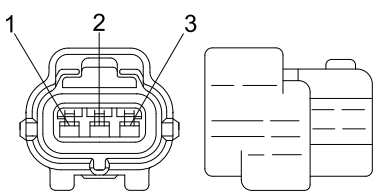
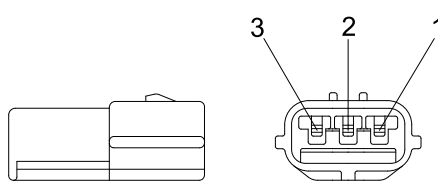
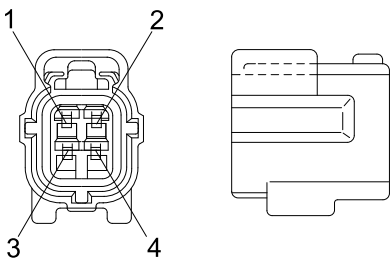
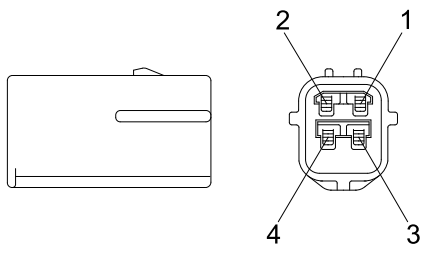
No. of pin	Receptacle connector (female)	Plug connector (male)
1	 <p style="text-align: right;">S816-001002</p>	 <p style="text-align: left;">S816-101002</p>
2	 <p style="text-align: right;">S816-002002</p>	 <p style="text-align: left;">S816-102002</p>
3	 <p style="text-align: right;">S816-003002</p>	 <p style="text-align: left;">S816-103002</p>
4	 <p style="text-align: right;">S816-004002</p>	 <p style="text-align: left;">S816-104002</p>

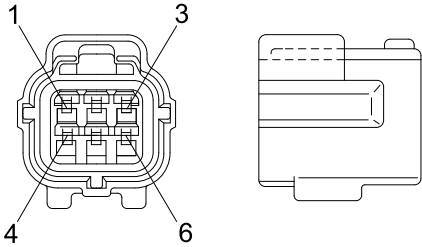
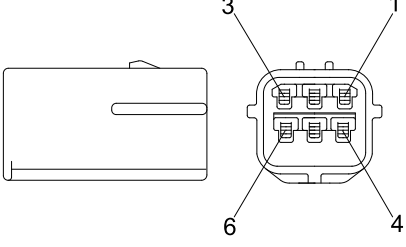
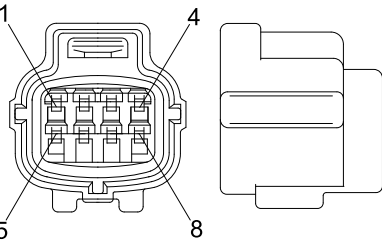
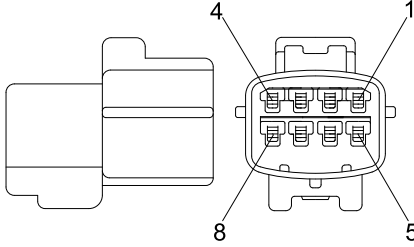
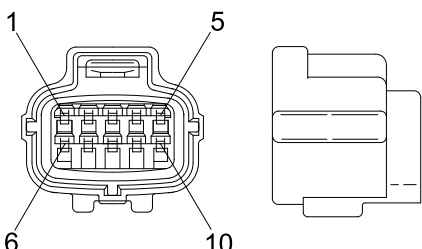
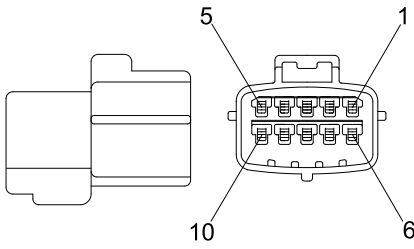
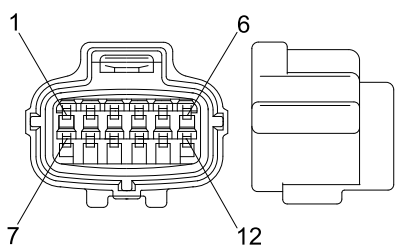
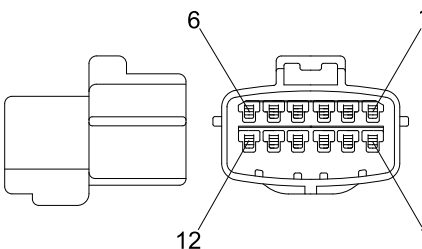
No. of pin	Receptacle connector (female)	Plug connector (male)
6	 <p data-bbox="686 638 837 672">S816-006002</p>	 <p data-bbox="1244 638 1396 672">S816-106002</p>
8	 <p data-bbox="686 1041 837 1075">S816-008002</p>	 <p data-bbox="1244 1041 1396 1075">S816-108002</p>
10	 <p data-bbox="686 1444 837 1478">S816-010002</p>	 <p data-bbox="1244 1444 1396 1478">S816-110002</p>
12	 <p data-bbox="686 1848 837 1881">S816-012002</p>	 <p data-bbox="1244 1848 1396 1881">S816-112002</p>

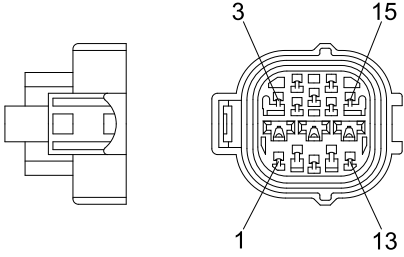
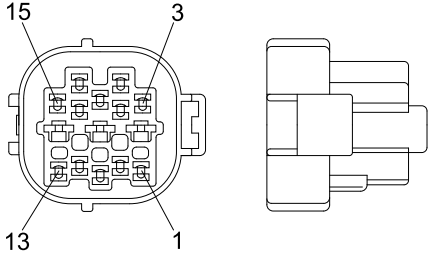
No. of pin	Receptacle connector (female)	Plug connector (male)
15	 <p data-bbox="730 636 836 663">368301-1</p>	 <p data-bbox="1276 636 1382 663">2-85262-1</p>

17) METRI-PACK TYPE CONNECTOR

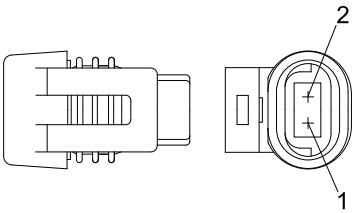
No. of pin	Receptacle connector (female)	Plug connector (male)
2	 <p data-bbox="724 1236 829 1263">12040753</p>	

18) DEUTSCH MCU CONNECTOR

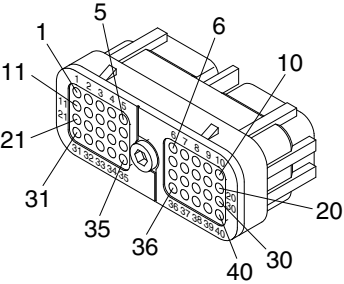
No. of pin	Receptacle connector (Female)	Plug connector (Male)
40	 <p data-bbox="667 1841 836 1868">DRC23-40PA/B</p>	

19) MONITOR CONNECTOR (21WD-11100, 21WD-11101, 21WD-11102)

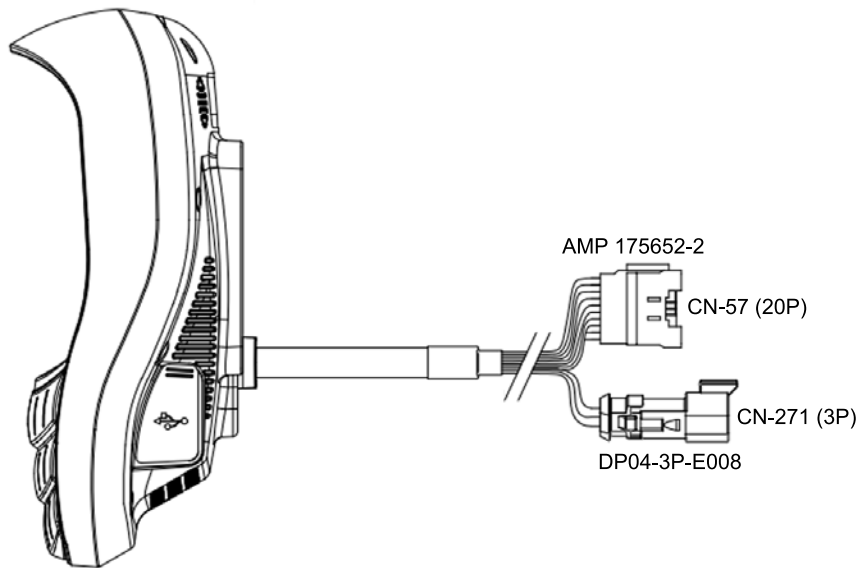

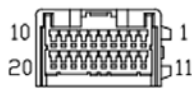
			
PART NO. : AMP 175652-2			
NO	PIN NAME	NO	PIN NAME
1	IG 24V	11	GND
2	BATTERY 24V	12	GND
3	BATTERY 24V	13	CAN1 H
4	CAMERA CH0	14	CAN2 L
5	CAMERA CH0 SIDE	15	CAN2 H
6	6.5V OUTPUT	16	CAN2 SHIELD
7	AVX LEFT	17	CAMERA SHIELD
8	AVX RIGHT	18	CAN1 LOW
9	CAMERA CH1	19	GND
10	CAMERA CH2	20	CAMERA CH3

			
PART NO. : DP04-3P-E008			
NO	PIN NAME	NO	PIN NAME
A	AUX GND	C	AUX RIGHT
B	AUX LEFT		

MONITOR CONNECTOR (21WD-11103, 21WD-11104)

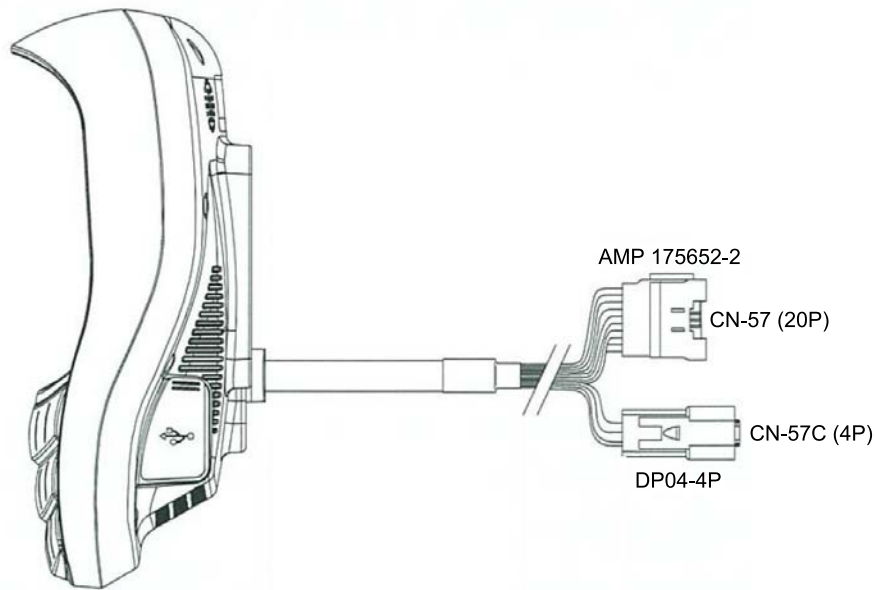

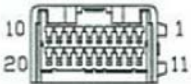
 PART NO. : AMP 175652-2			
NO	PIN NAME	NO	PIN NAME
1	IG 24V	11	GND
2	BATTERY 24V	12	GND
3	BATTERY 24V	13	CAN1 H
4	CAMERA CH0	14	CAN2 L
5	CAMERA CH3 DIFF-	15	CAN2 H
6	6.5V OUTPUT	16	CAN2 SHIELD
7	N.C	17	CAMERA SHIELD
8	N.C	18	CAN1 L
9	CAMERA CH1	19	N.C
10	CAMERA CH2	20	CAMERA CH3 DIFF+

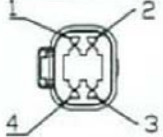
 PART NO. : DT04-4P			
NO	PIN NAME	NO	PIN NAME
1	CAM VCC	3	CAM CH3 +
2	CAM GND	4	CAM CH3 -

GROUP 6 TROUBLESHOOTING

1. WHEN STARTING SWITCH IS TURNED ON, CLUSTER AND MONITOR LAMP DOES NOT LIGHT UP

- Before carrying out below procedure, check all the related connectors are properly inserted and the fuse No.12, 17 are not blown out and ON/OFF of bulb.
- After checking, connect the disconnected connectors again immediately unless otherwise specified.

	Cause	Remedy
Check voltage between CN-56 (1), CN-57(1) and chassis	Defective cluster	Replace
	Defective monitor	Replace
	Disconnection in wiring harness or poor contact between CN-56 (1), CN-57 (1) and fuse No. 12, 17	Repair or replace (after clean)

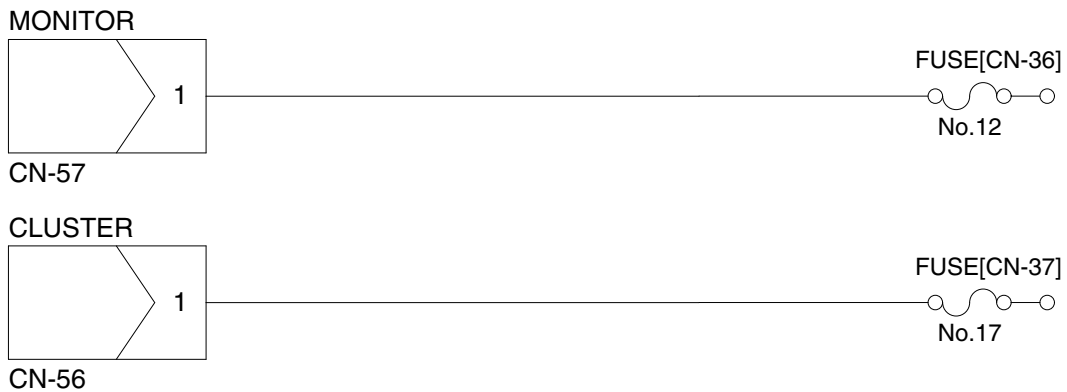

960A7EL24

Check voltage

YES	20 ~ 30 V
NO	0 V

2.  WHEN BATTERY LAMP LIGHTS UP (engine is started)

- Before carrying out below procedure, check all the related connectors are properly inserted.
- After checking, connect the disconnected connectors again immediately unless otherwise specified.

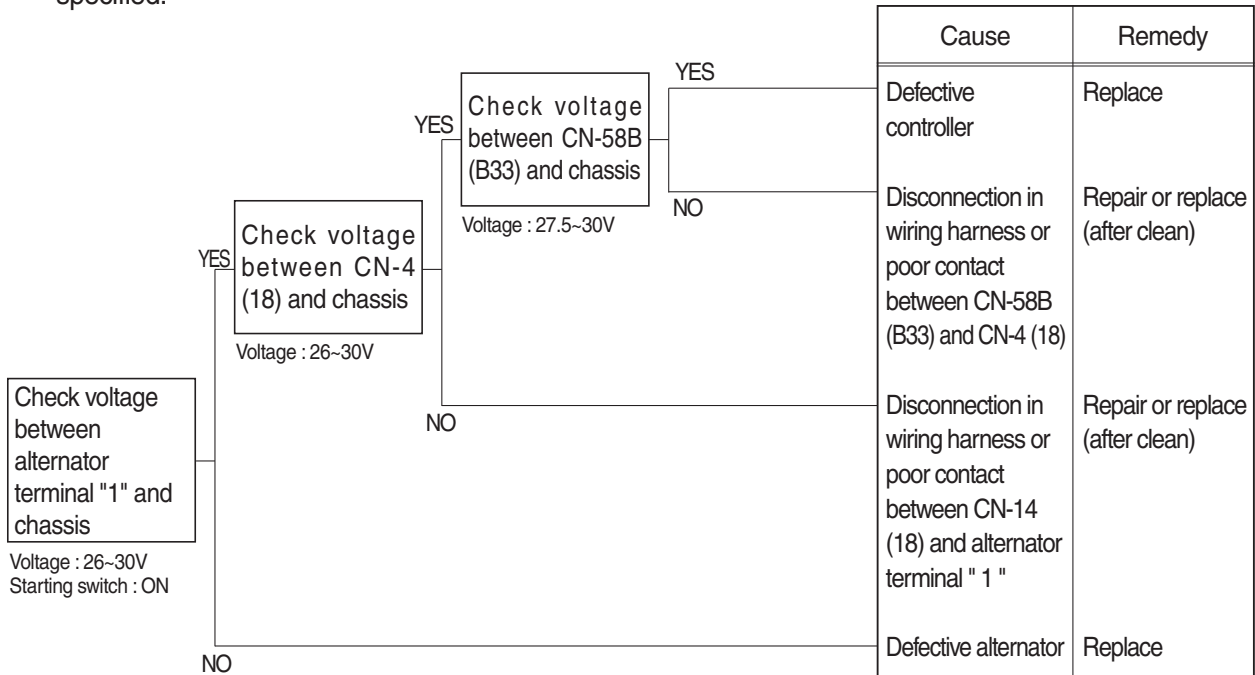

CONTROLLER(MCU)

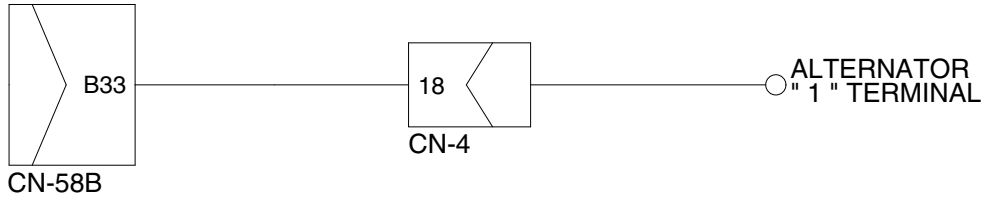

960A7EL38

Check valtage

YES	20 ~ 30 V
NO	0 V

3. WHEN PARKING SOLENOID DOES NOT WORK

- Before carrying out below procedure, check all the related connectors are properly inserted and the fuse No.41 is not blown out.
- After checking, connect the disconnected connectors again immediately unless otherwise specified.

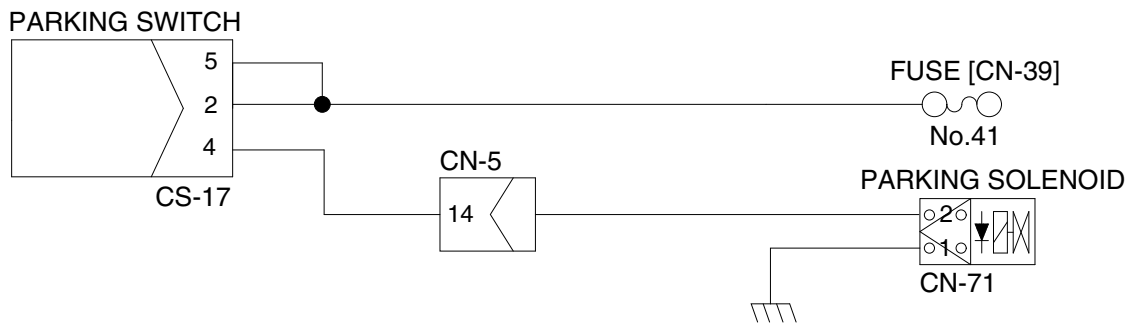
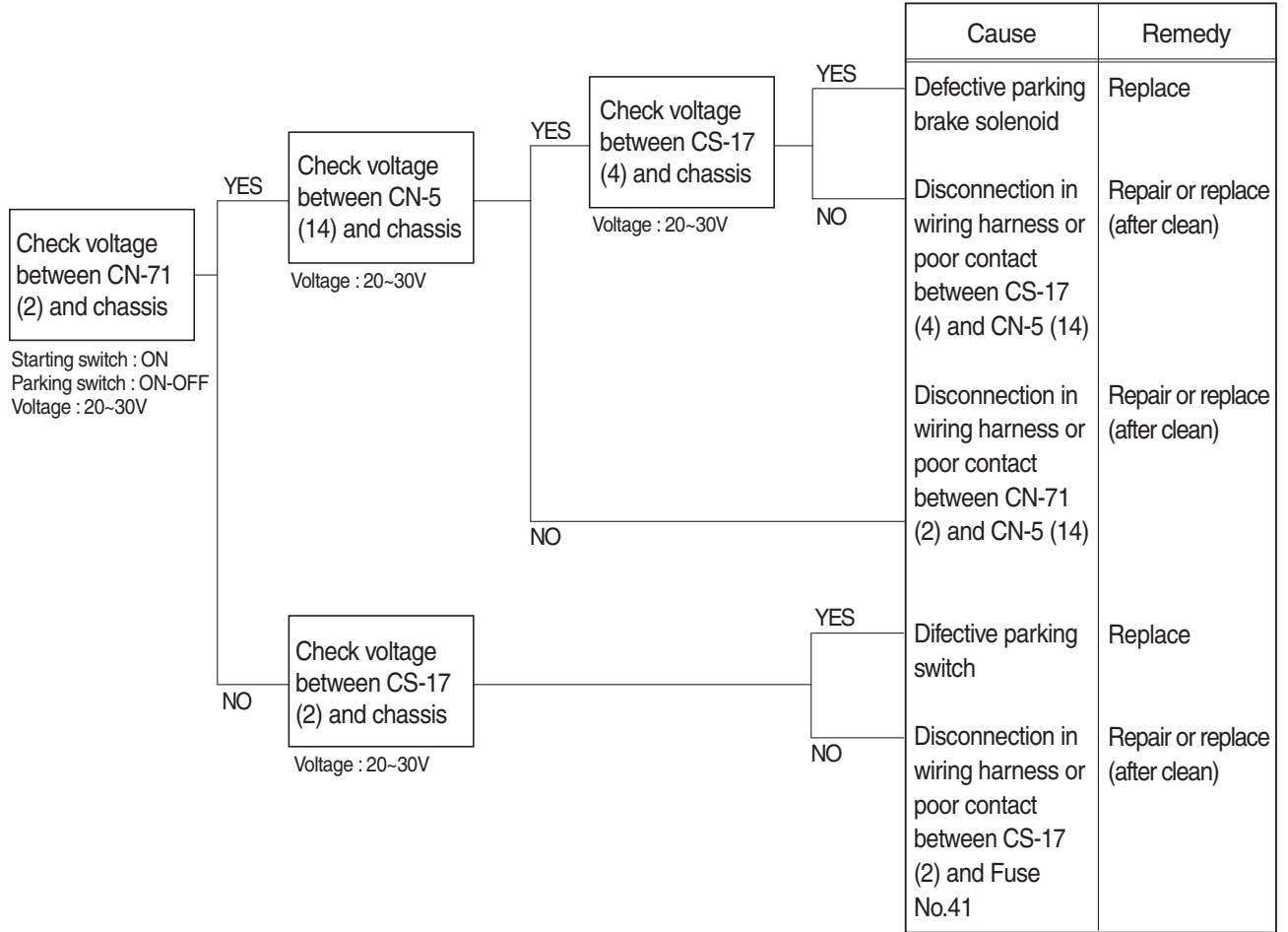

960A7EL39

4. TRANSMISSION IS NOT RETURNED TO NEUTRAL WHEN PARKING BRAKE IS APPLIED

- Before carrying out below procedure, check all the related connectors are properly inserted and the fuse No.15 (transmission control unit) and No.41 are not blown out.
- After checking, connect the disconnected connectors again immediately unless otherwise specified.

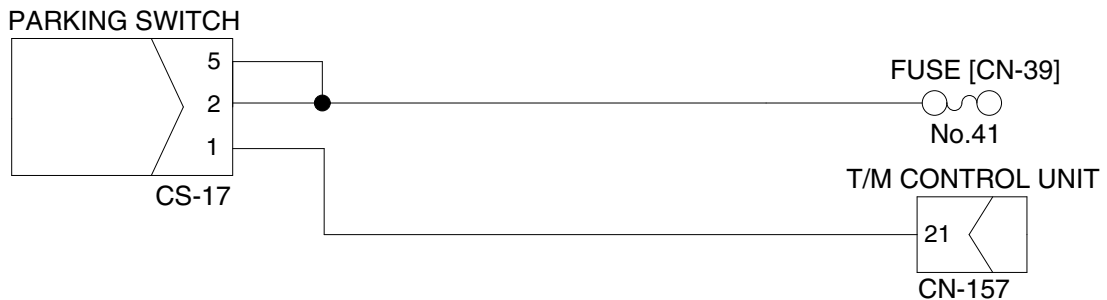
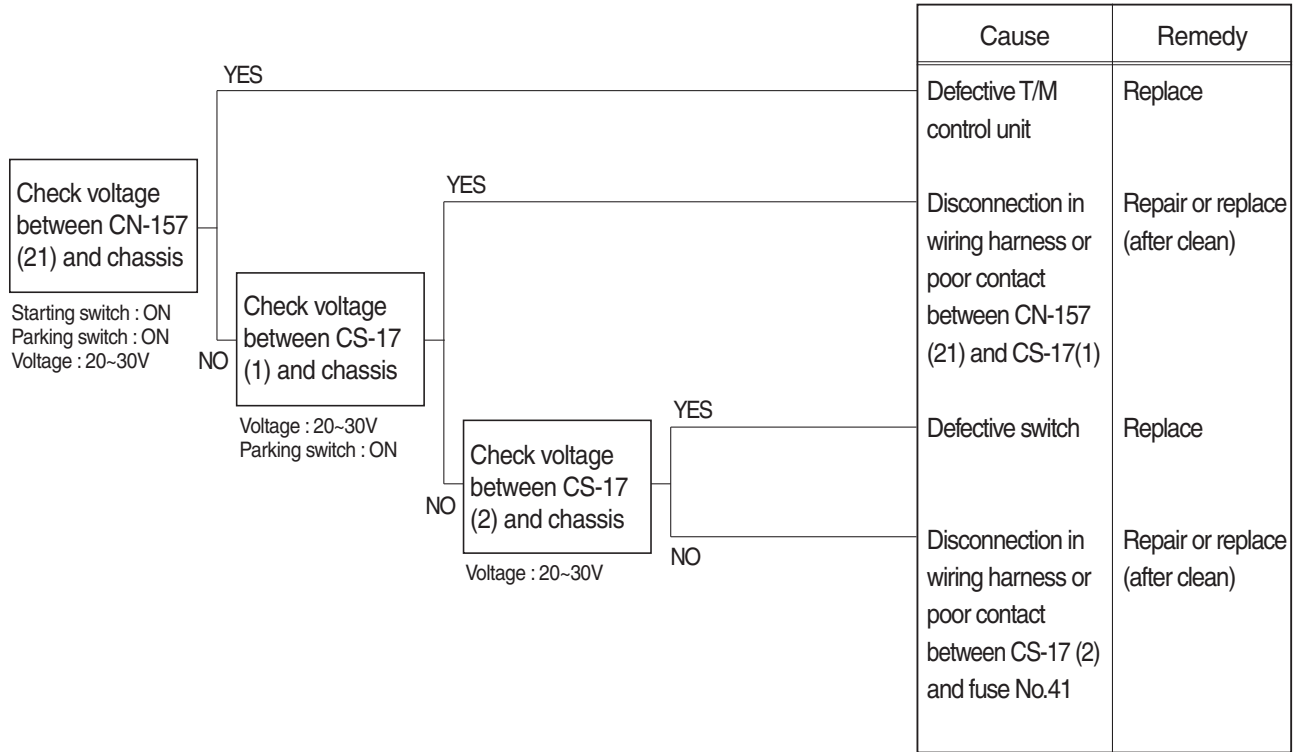

Check resistance

YES	MAX 1Ω
NO	MIN 1MΩ

760F7EL40

5. MACHINE DOES NOT TRAVEL

- Before carrying out below procedure, check all the related connectors are properly inserted and the fuse No.15 (transmission control unit) is not blown out.
- After checking, connect the disconnected connectors again immediately unless otherwise specified.
- Wiring diagram : See page 7-18.

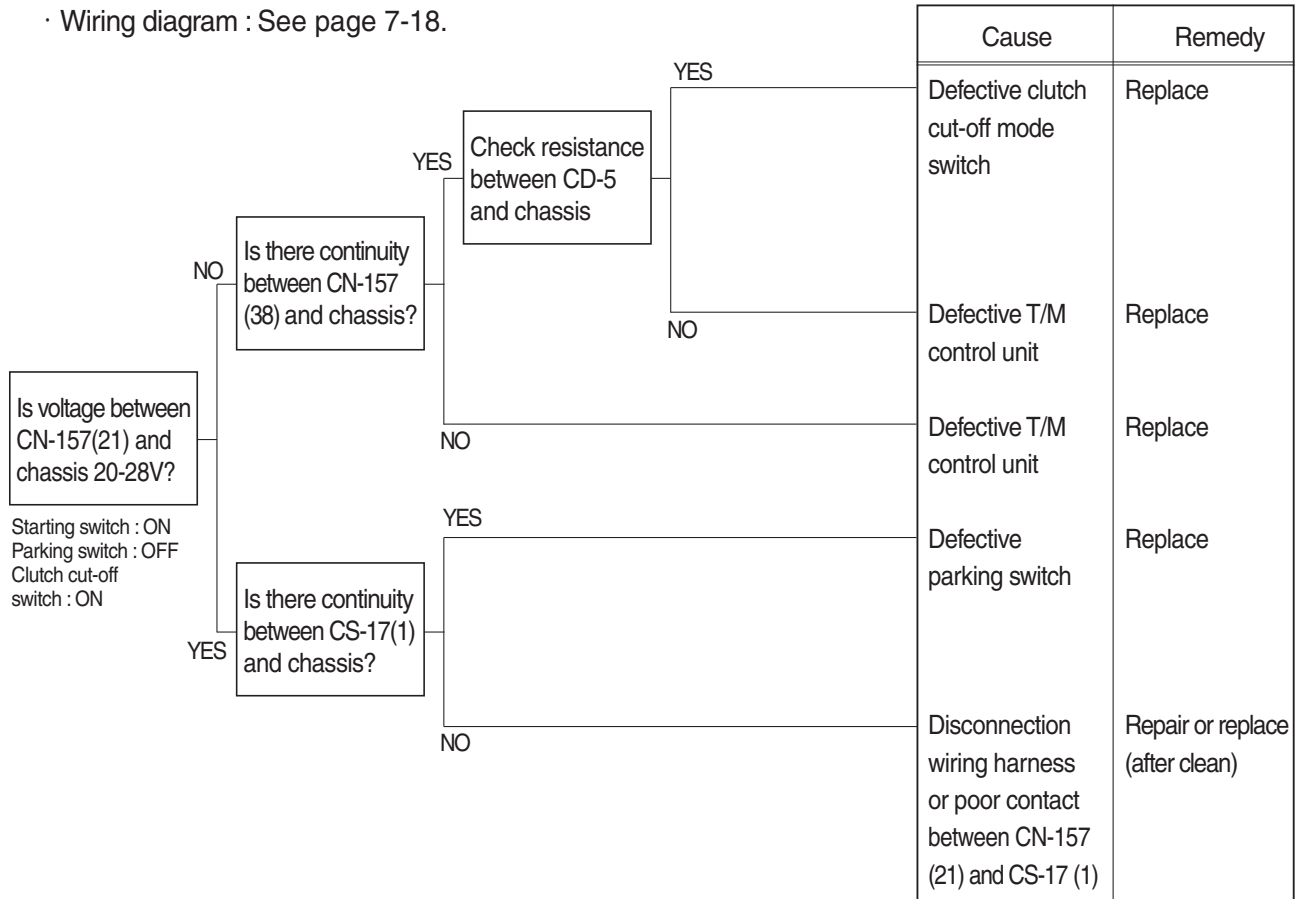

Check resistance

YES	MAX 1Ω
NO	MIN 1MΩ

6. WHEN STARTING SWITCH IS TURNED ON, WIPER MOTOR DOES NOT OPERATE

- Before carrying out below procedure, check all the related connectors are properly inserted and the fuse No.40 is not blown out.
- After checking, connect the disconnected connectors again immediately unless otherwise specified.

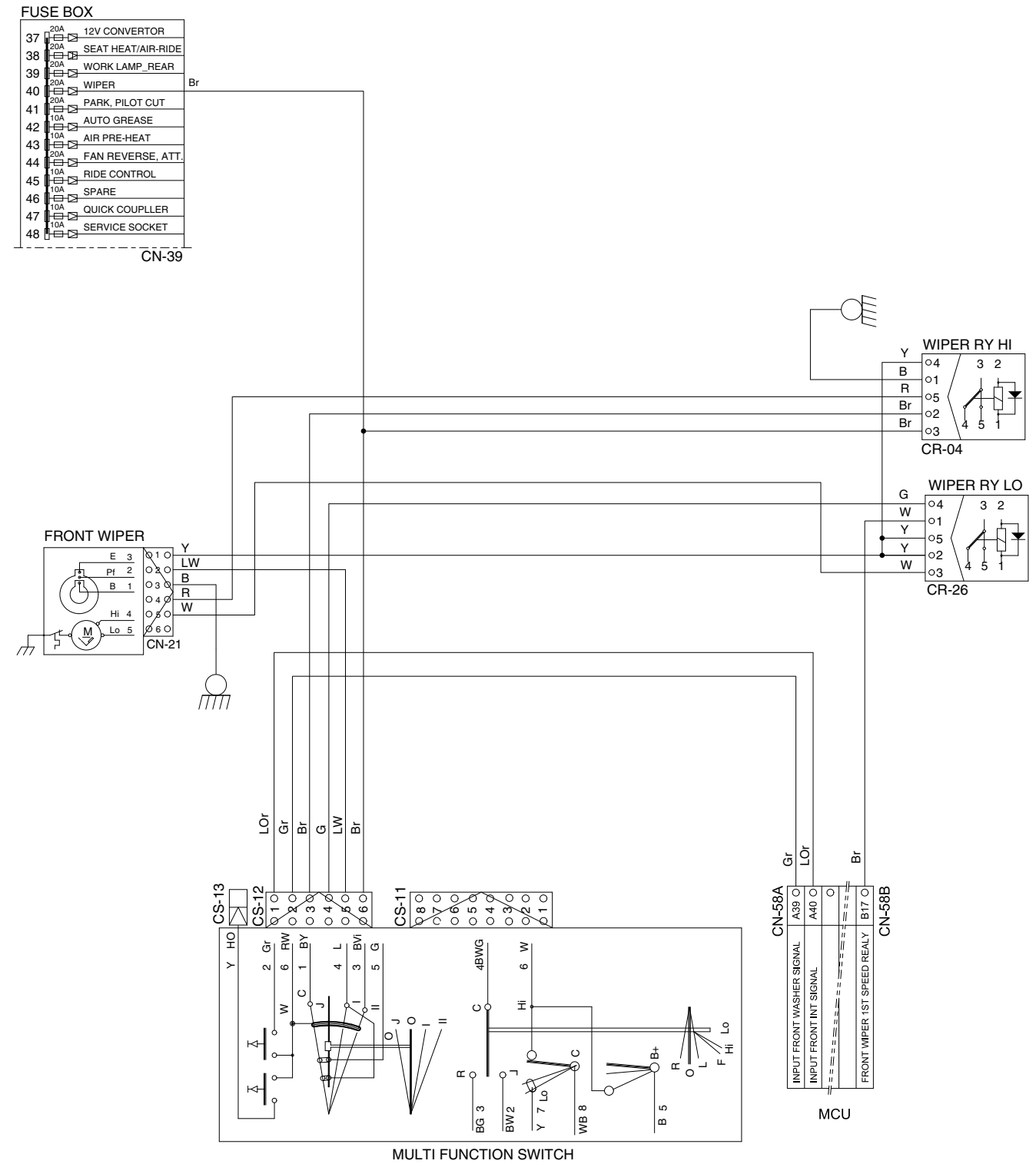
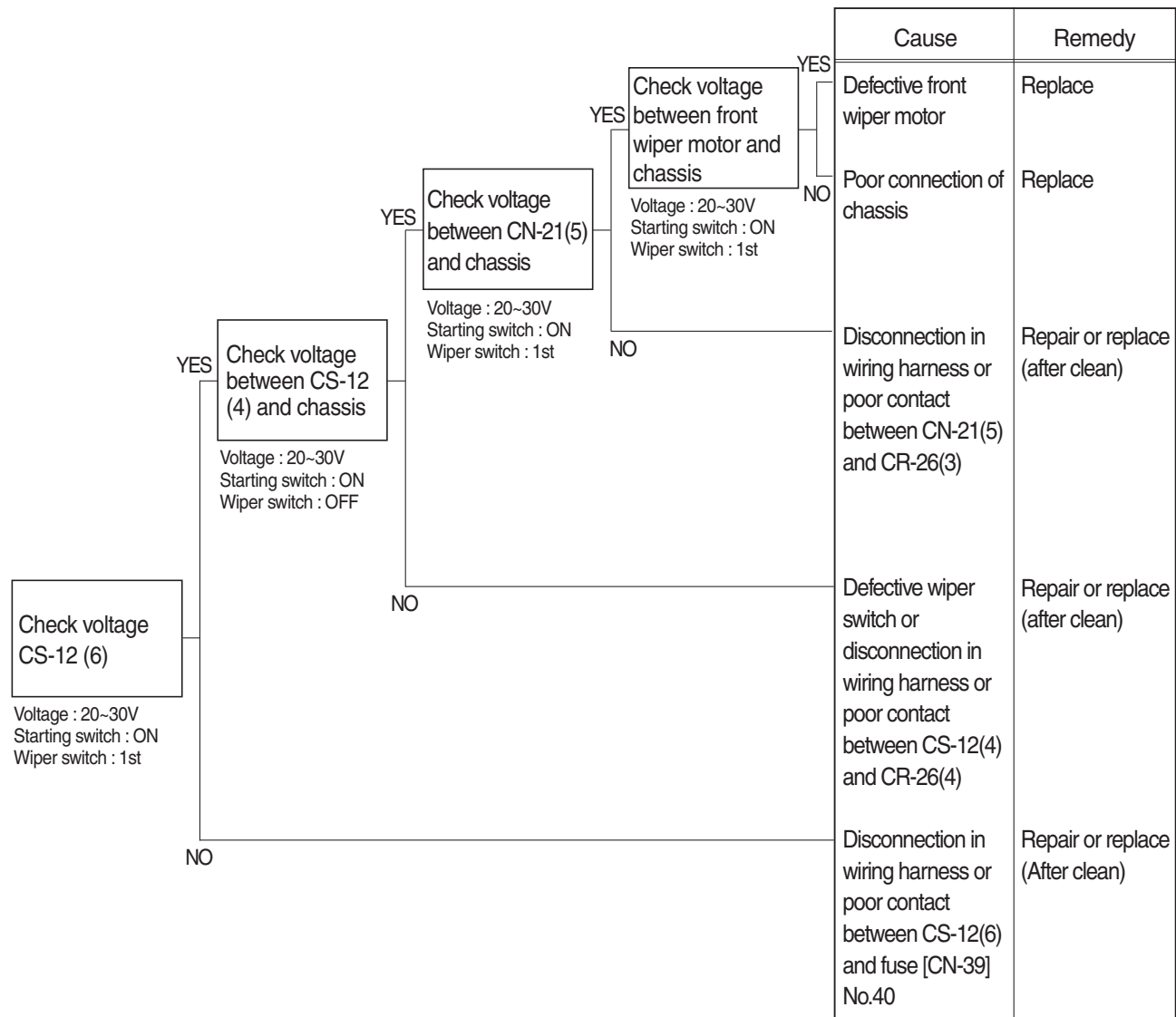

7. WHEN STARTING SWITCH "ON" DOES NOT OPERATE

- Before carrying out below procedure, check all the related connectors are properly inserted the fuse No.2 is not blown out.
- After checking, connect the disconnected connectors again immediately unless otherwise specified.

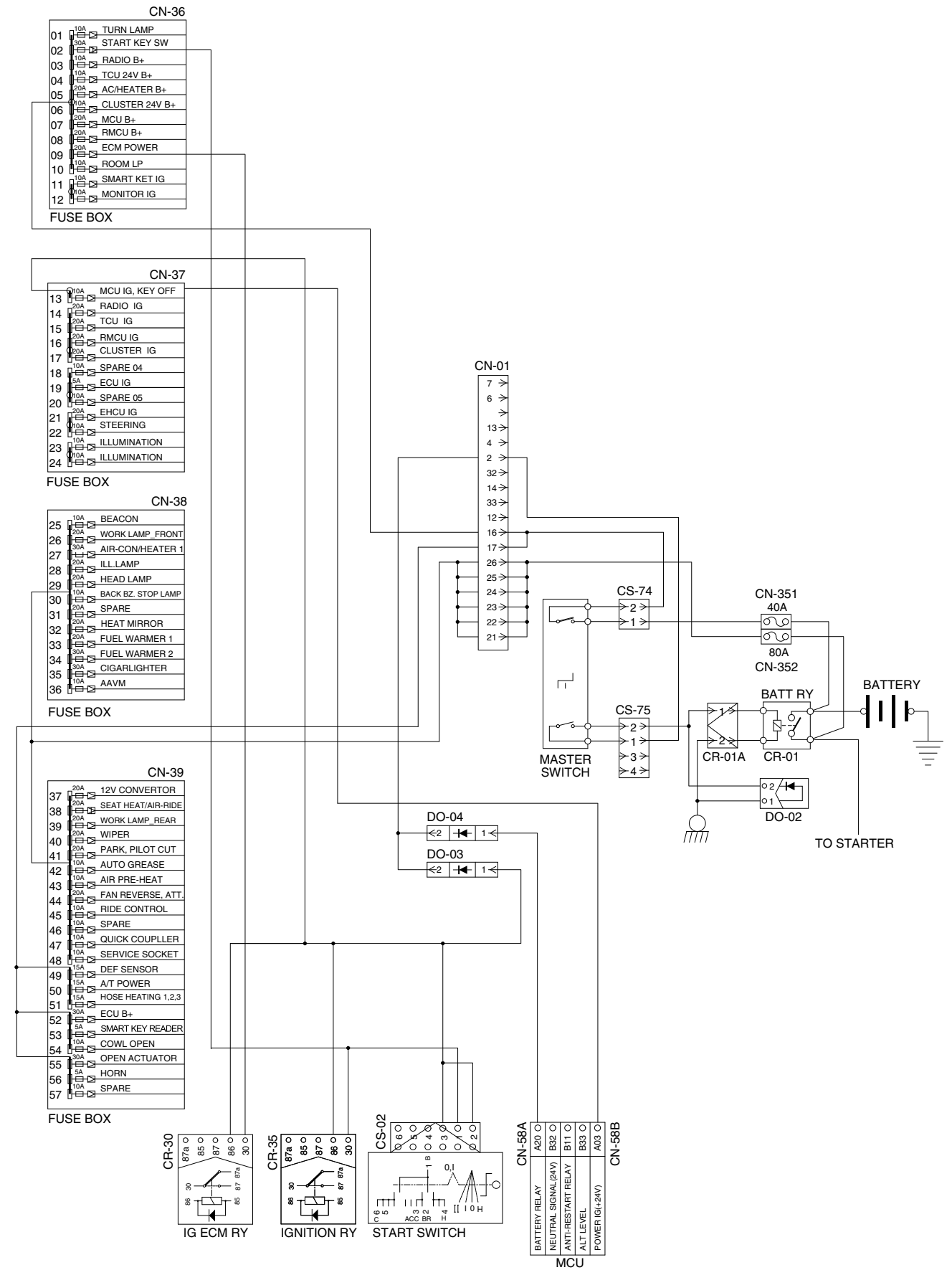
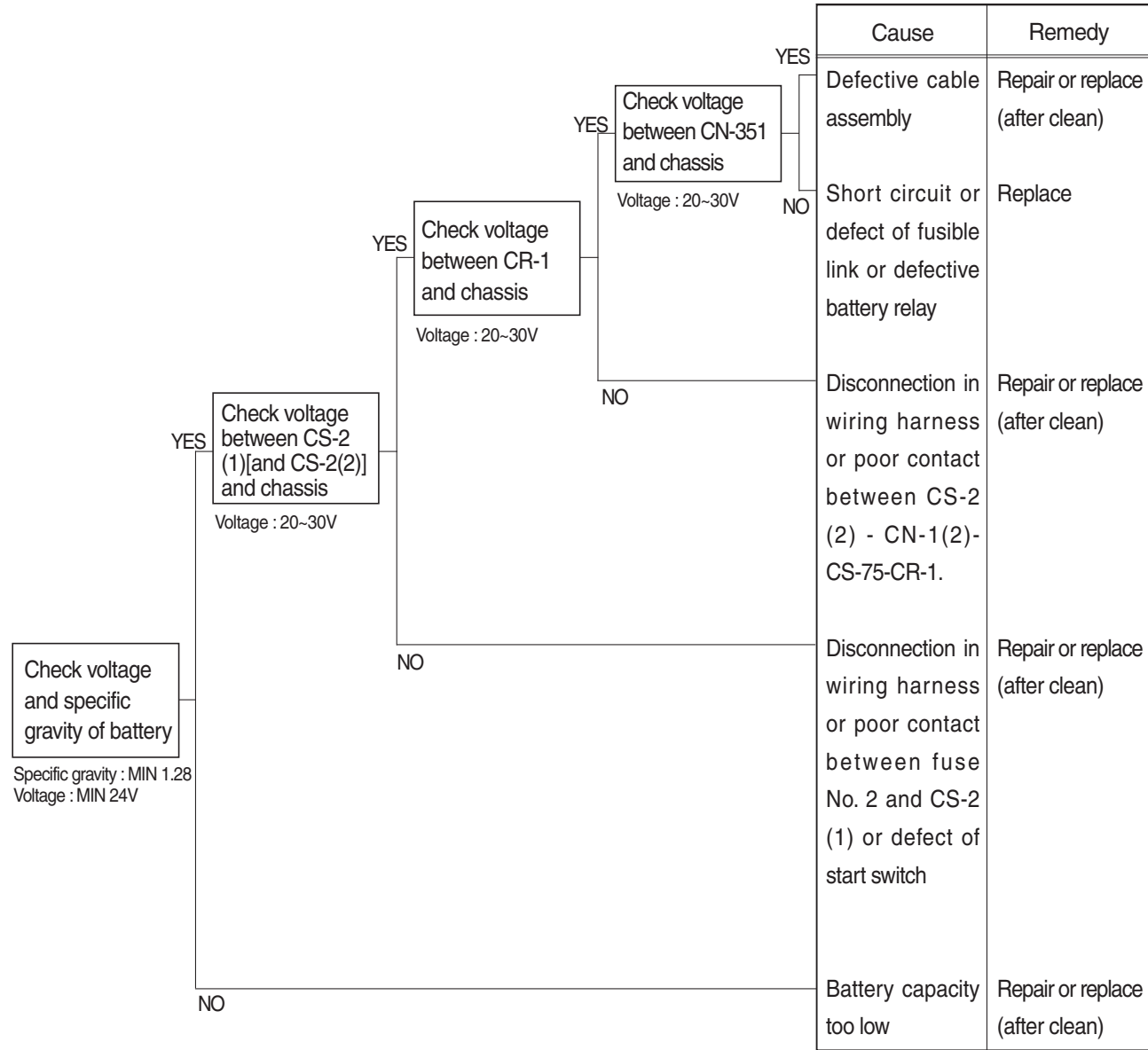

8. WHEN STARTING SWITCH IS TURNED ON, WORK LAMP DOES NOT LIGHTS UP

- Before carrying out below procedure, check all the related connectors are properly inserted, and the fuse No.26, 39 is not blown out.
- After checking, connect the disconnected connectors again immediately unless otherwise specified.

