

SECTION 6 MAIN FRAME

Quick - Tach	6.1
Illustration, Universal Type.....	pg. 6-2
Preventative Maintenance	pg. 6-3
Removal.....	pg. 6-4
Installation.....	pg. 6-4
Disassembly.....	pg. 6-5
Assembly.....	pg. 6-5
Boom Arms	6.2
Removal.....	pg. 6-6
Installation.....	pg. 6-6
Boom Support	6.3
Boom Arm Supports.....	pg. 6-7
ROPS (Cab)	6.4
Removal.....	pg. 6-8
Installation.....	pg. 6-8
Rear Door	6.5
Removal.....	pg. 6-9
Installation.....	pg. 6-9





QUICK - TACH 6.1

Universal Quick - Tach Assembly

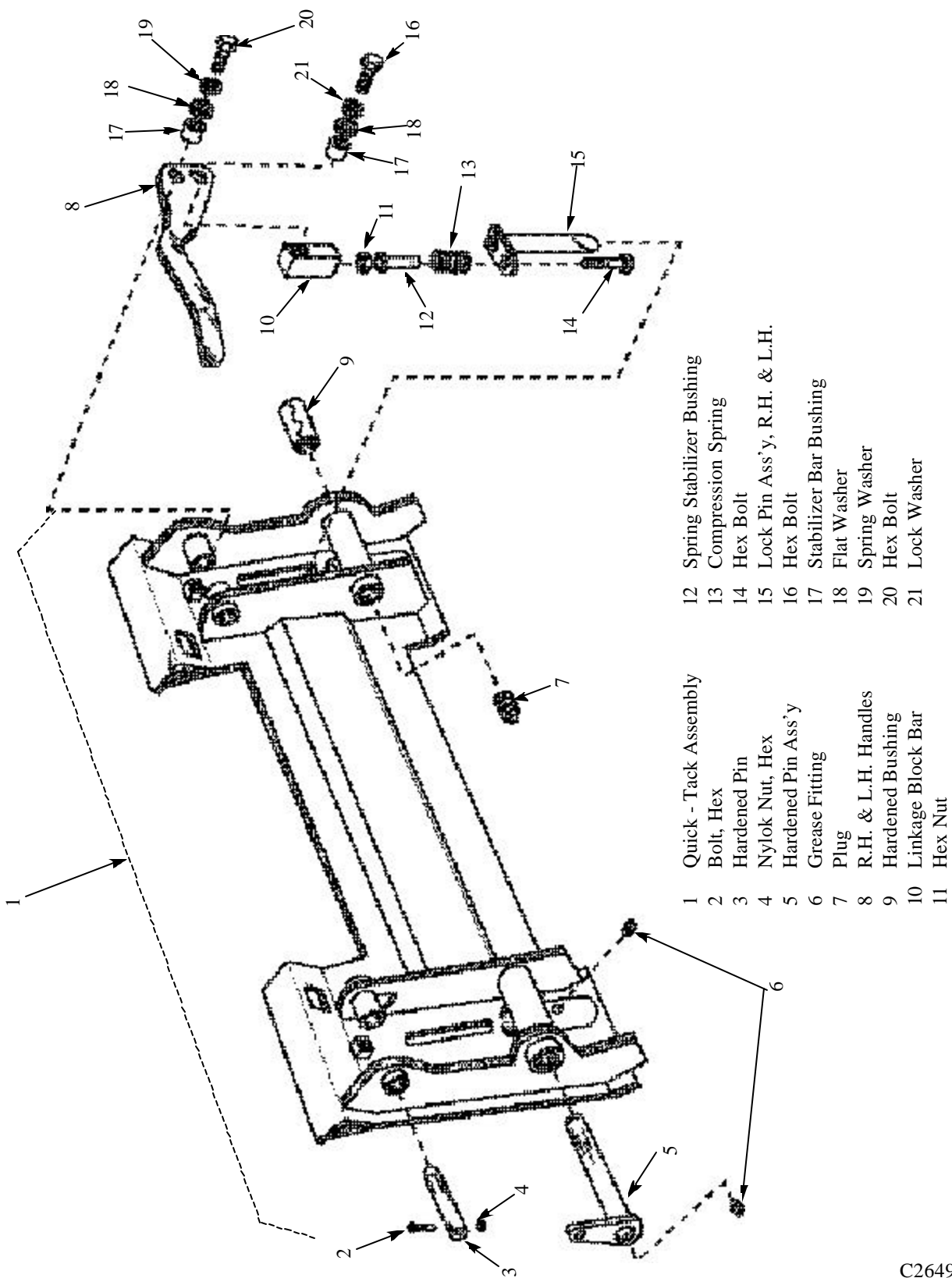

C2649

QUICK - TACH 6.1

Preventative Maintenance

To keep the quick - tach locking pins and mechanism working freely, and to prevent pin and bushing wear, the quick tach must be lubricated every 8 hours of operations. More often in dirty applications.

Lubricate the quick - tach as follows:

- 1 Remove any attachment from the loader, raise the boom arms, engage the boom supports, engage the parking brake and shut off the engine.
- 2 Clean any dirt build up around the linkages.
- 3 Lubricate the grease fittings on each of the lock pin bushings with a good quality multi purpose lithium based grease until excess shows. (fig. C3590)
- 4 Lubricate the tilt cylinder pivot pins. (fig. C3591)

- 5 Lubricate the lower boom pivot pins. (fig. C3592 and C3593)

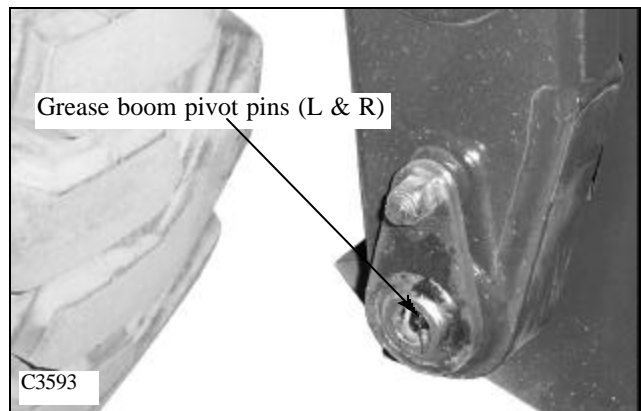
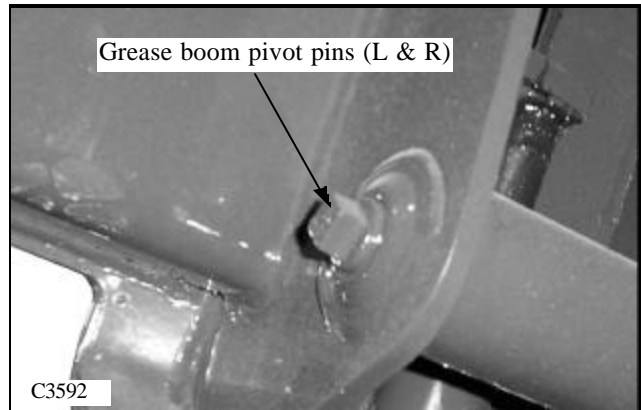
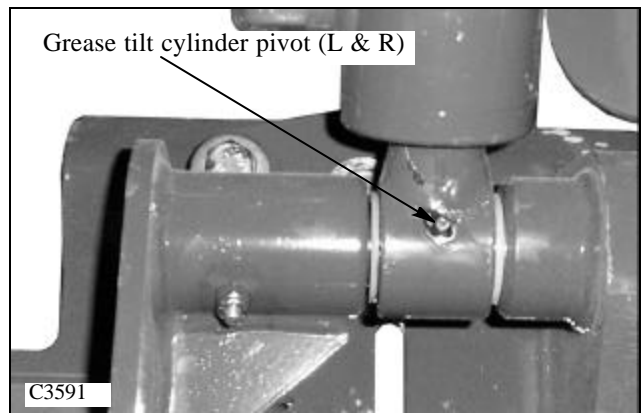
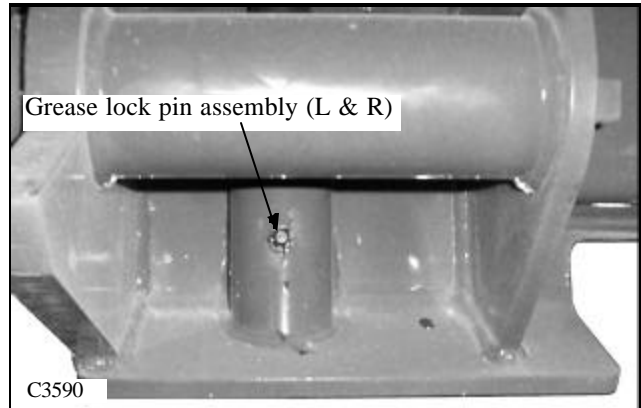

QUICK - TACH 6.1

Removal

- 1 Remove any attachment and lower the boom arms.
- 2 Start the engine and extend the hydraulic tilt cylinders approximately 12 inches. (fig. C3880)
- 3 Shut off the engine and engage the parking brake.
- 4 Remove the bolts retaining the upper pivot pins to the quick - tach frame until the quick-tach is level and the pins removed. (fig. C3880)
- 5 If this repair is being performed in a proper work shop, a portable floor jack works excellent for this next step. Place the floor jack under the quick - tach. (fig. C3881)
- 6 The floor jack is used to relieve the weight on the 2 (two) lower pivot pins. Remove the upper pivot pins.
- 7 Remove the nuts and or bolts retaining the 2 (two) lower quick - tach pivot pins to the quick - tach or boom arms. (There are two different types). (fig. C3882)
- 8 Remove the pivot pins using a brass drift punch and hammer.
- 9 Remove the quick - tach from the loader boom arms.

Installation

Upon installing the quick - tach to the loader boom arms:

- 1 Make sure all pivot pins and bushings are in good condition. Do not reuse worn parts. Replace pins and hardened bushings as required.
- 2 Use the floor jack to assist installing the quick - tach to the loader boom arms. (Or lay it down on a piece of wood. (fig. C3881)
- 3 Raise the bottom of the quick - tach up to align the boom arm pivot holes and the lower quick - tach pivot bushings. Install the 2 lower pivot pins, retaining bolts and or lock nuts.
- 4 Align the 2 tilt cylinder pivot bushings with the quick - tach bushings and install the pins and retaining bolts and lock nuts.
- 5 Lubricate all pivots until excess grease can be seen flowing out around the bushings and pins.

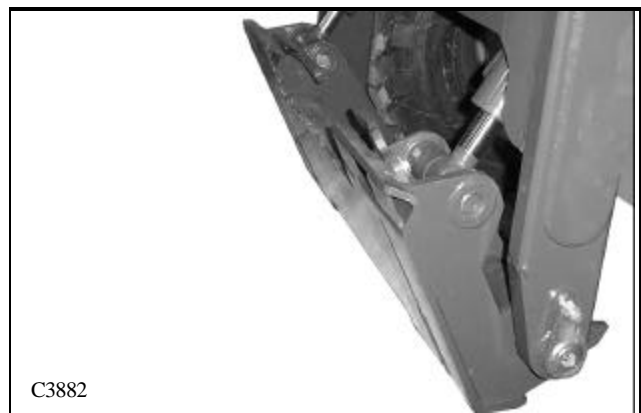
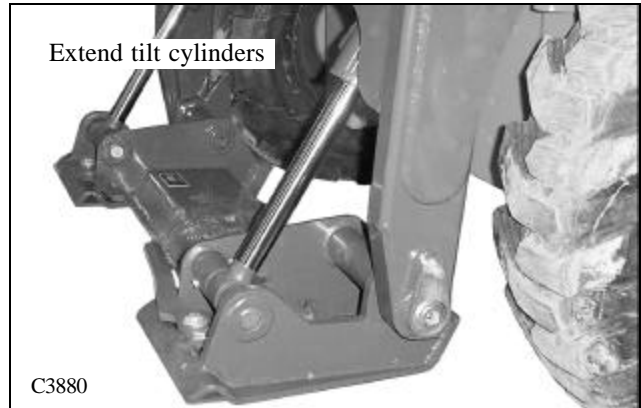

QUICK - TACH 6.1

Disassembly

Follow the exploded schematic on the 2nd page of this section to assist in taking apart the locking mechanism and to assemble the system back together. Please note that the quick - tach does not have to be removed to service or replace locking mechanism parts.

- 1 Remove the bolt retaining the lock handle to the lock linkage. (fig. C3594)
- 2 Remove the bolt retaining the lock handle to the quick - tach frame. (fig. C3594)
- 3 Pull the locking pin and linkage out of the guide bushing. (fig. C3595)
- 4 Loosen the jam nut on the linkage block. Remove the bolt holding locking pin to the lock linkage block. (fig. C3596)
- 5 Separate the parts and inspect the spring for broken or sacking (compressed) coils. (fig. C3596) Replace parts as required.
- 6 Inspect the locking pin for wear. Make sure the beveled end of the pin is not worn or broken off the opposite side of the bevel. Check the fit of the pin in the quick - tach guide bushing. If the pin or bushing is excessively worn replace the pin or complete quick - tach assembly.
- 7 Inspect the lock handle mounting holes for fit against the handle pivot bushings. Replace the handle or pivot bushings as required if the fit is sloppy. (fig. C3596)
- 8 Check the fit of the lower pivot pins in the quick - tach. Discard worn pins and replace the hardened bushings in the quick - tach if so equipped.
- 9 Check and replace any grease fittings that are damaged or defective.

Assembly

Upon assembling the locking mechanism to the quick - tach, use 242 Loctite (blue) on all the mounting nuts and bolts.

- 1 When assembling the locking pin to the spring, bushing and linkage block, adjust the length of the bolt to 4 1/16 inches. (103mm). This is measured from under the head of the bolt up to, and against the linkage block. (fig. C1818) **This is very crucial for lock pin engagement to the attachment.**
- 2 Replace the rest of the lock mechanism in the reverse order above.
- 3 Lubricate all pins and bushings.
- 4 Check the lock mechanism by cycling the lock levers to ensure correct engagement through the attachment and sufficient pressure to hold the lock system down in the over - center position. (Engages and stay in the locked position)

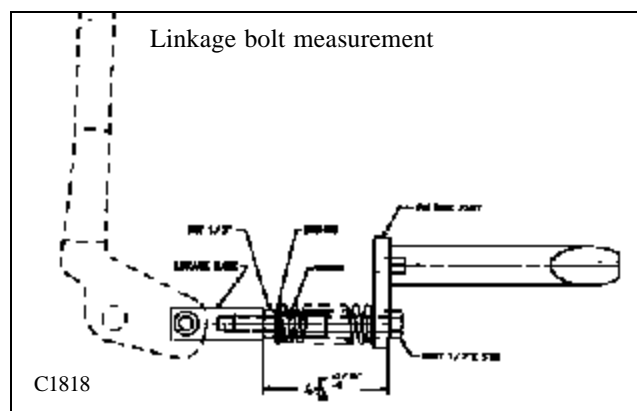
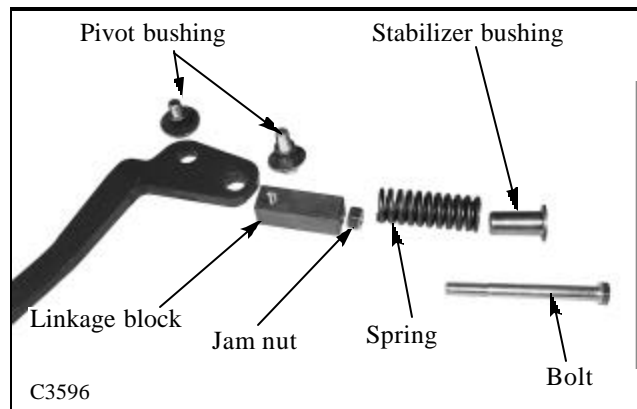
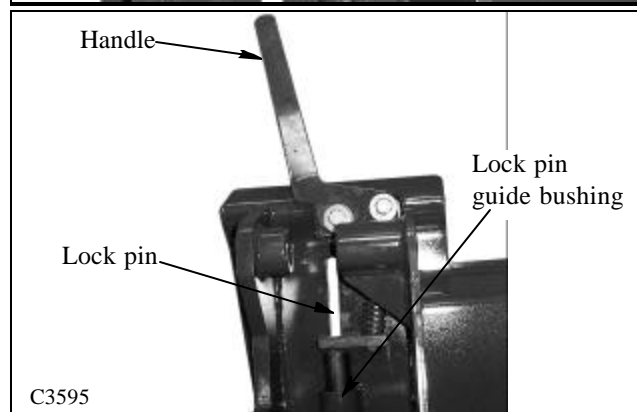
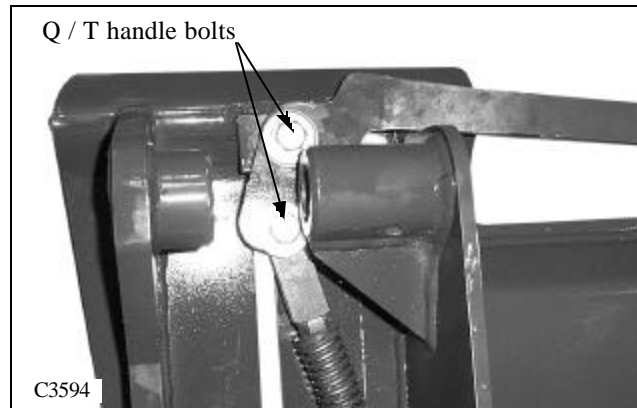

BOOM ARMS 6.2

Removal

- 1 Lower the boom arms and shut off the engine. Turn the ignition key to the "RUN" position and cycle the boom and tilt controls to relieve hydraulic backpressure. Lock the boom lift control in the float position.
- 2 Return the key to the "OFF" position and engage the parking brake (raise the restraint bar).
- 3 Remove the quick - tach assembly from the boom arms. (See Section 6.1)
- 4 Disconnect the hydraulic hoses between the boom arm and reservoir tanks. Cap the open hose ends to prevent contamination. (fig. C3601)
- 5 Fasten chains or lifting straps with an adequate capacity to sustain the weight of the boom arms. Most of the weight is at the front of the boom arms. Attach one set of straps as close as possible to the front, (fig. C1844), and the other set approximately half way toward the rear.
- 6 Using an overhead hoist, raise the boom arms enough to take the weight off of the lift cylinders. Remove the bolts from the pivot pins in the lift cylinders that are mounted in the boom arms. (fig. C3603)
- 7 Remove the pins by reaching between the ROPS and the boom arm and pushing the pin out toward you. Take care not to let the lift cylinder fall on your hand.
- 8 Remove the bolts from the upper rear boom arm pivot pins mounted through the main frame. (fig. C3604)
- 9 Remove the pivot pins using an appropriate drift punch and hammer. Use care, do not broom up the end of the pins.
- 10 Raise the boom arms enough to free from the loader and remove them.

Installation

- 1 Upon installation follow the above procedure in the reverse order.
- 2 Replace any worn or gouged pins and bushings
- 3 All stationary bushings should be coated with anti - seize compound to assist ease of future disassembly. Do not get the anti - seize compound on moving or pivoting parts. The compounds contain abrasives that may cause premature wear of pivot pins and bushings.
- 4 Torque the hydraulic hose fittings as outlined in the Section 1 Hydraulics torque chart page 1-35.

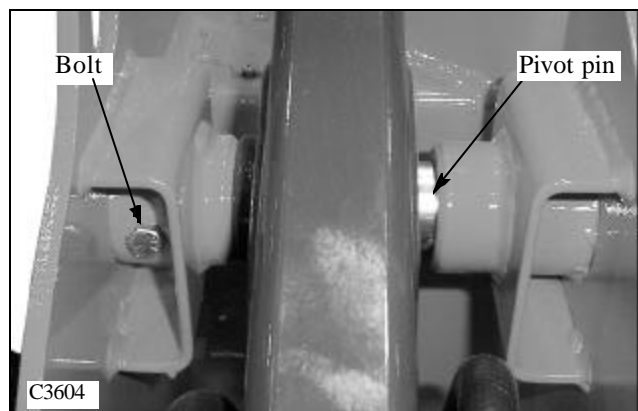
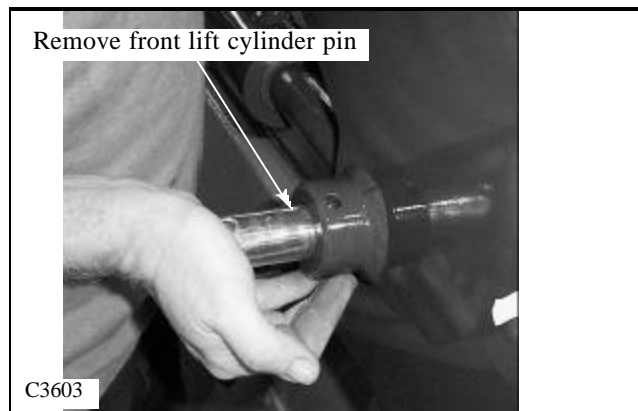
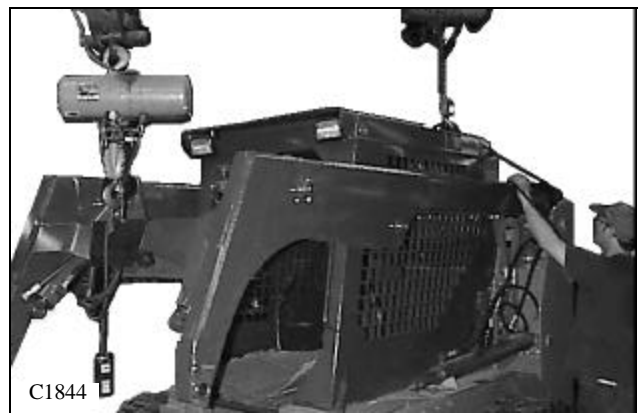
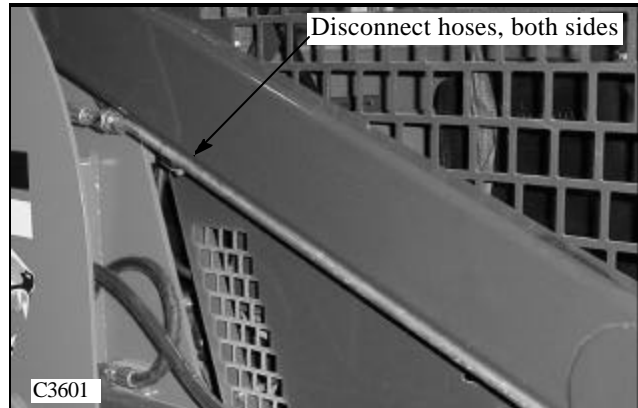

BOOM ARMS 6.2

Boom Arm Supports

For safety while performing regular service or maintenance work, the loader is equipped with boom supports. (fig. C3597) The boom supports, when extended, prevent the boom arm from lowering when servicing the hydraulic system, controls or other repair work while the engine is not operating.

The boom supports should be greased every 8 hours of use and engagement depth should be checked every time the supports are used.

- 1 Raise the boom arms, extend the boom supports and allow the boom arms to lower onto the supports. Do not pressure the hydraulic system against the boom supports.
- 2 Shut off the engine and engage the parking brake.
- 3 Measure the distance the boom support pins are protruding past the inner boom arm plate. Proper adjustment should have the support pin protruding past the inner boom arm plate by 1/4 of an inch. (6.5mm) (fig. C3597)
- 4 Adjust the engagement depth by removing the 3 screws each on the left and right dash panels to access the support pins and linkage. (fig. C3577) Only remove one side if there is only one side to be adjusted.
- 5 Loosen the jam nut on the support pin linkage. (fig. C3579) Use care to not damage the plastic center dash panel.
- 6 Screw the pin in or out the amount necessary to get the proper adjustment for support pin engagement on the boom arms.
- 7 To remove the support pins and linkage, remove both dash panels and pods to access the center boom support panel bolts. (fig. C3598)
- 8 Remove the bolts and center panel and the support pins and linkage may be removed, serviced or repaired.
- 9 Apply 242 Loctite (blue) to the nut and tighten it against the support pin when installing.
- 10 Lubricate the boom support pins and replace the dash panels.

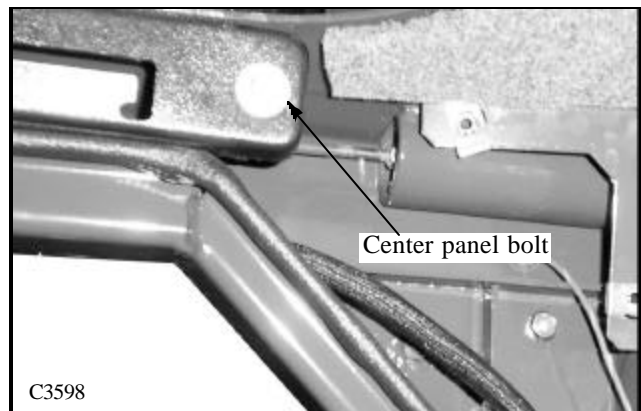
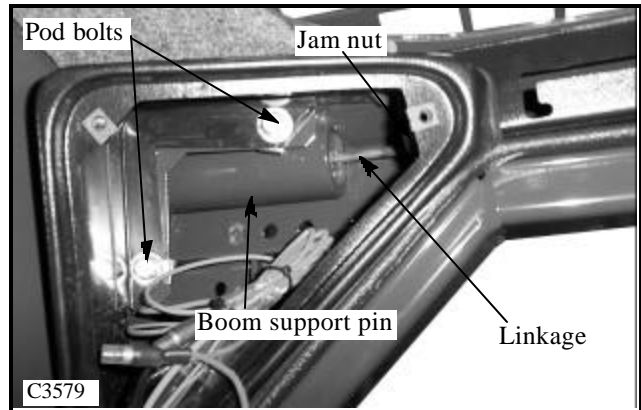
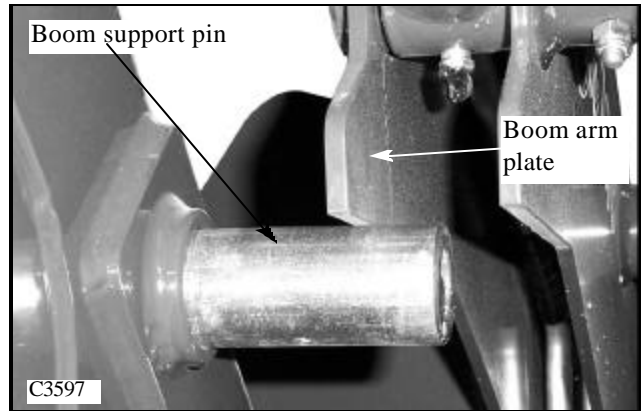

ROPS 6.4

Removal

- 1 Lower the boom arms, shut off the engine and engage the parking brake.
- 2 Remove the seat assembly and the hydrostatic shield and disconnect the battery terminals as outlined in Section 5.
- 3 Disconnect the ground cable from the mainframe and engine.
- 4 Disconnect the positive cable from the starter.
- 5 Disconnect the main wiring harness plug. (fig. C3885)
- 6 Remove any cable ties that may be used to tie wiring and hoses to the ROPS. Check the engine compartment and the hydrostatic pump area for wiring connections and ties that will need to be disconnected from accessory circuits.
- 7 Disconnect the restraint bar safety switch wiring.
- 8 Remove the nuts and washers on the ROPS isolator mounts. There are 2 in the front (fig. C3606) and 1 in the rear. (fig. C3605)
- 9 Attach chains or straps with a sufficient load rating to safely raise the ROPS from the frame. (fig. C3607)
- 10 Raise the ROPS using an over head hoist. Check for wiring that may still be connected and remove as required.

IMPORTANT

Check the ROPS mounting isolators every 150 hours for deterioration to prevent unwanted vibration and movement.

6

Installation

- 1 Upon assembling the ROPS to the loader mainframe, ensure the mounting isolators are in serviceable condition. Replace any worn, damaged or weathered isolators.
- 2 Reverse the removal procedure taking care not to pinch any wiring and connections.
- 3 Torque the ROPS mounting isolator nuts at 55 lbs / ft. (75 Nm)
- 4 See Section 4 for proper adjustment of the steering, controls and throttle.

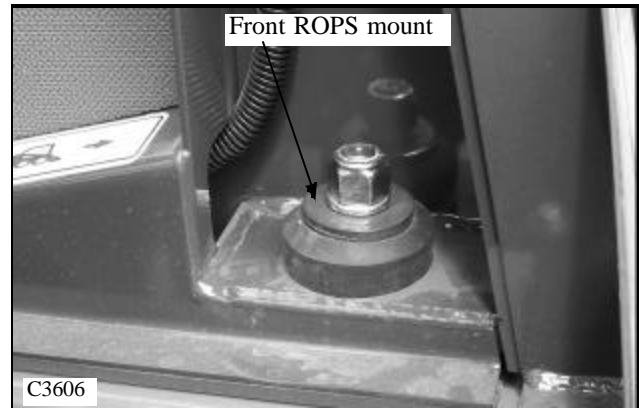
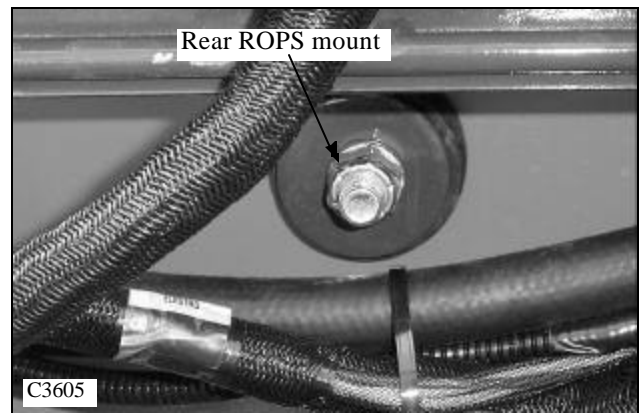
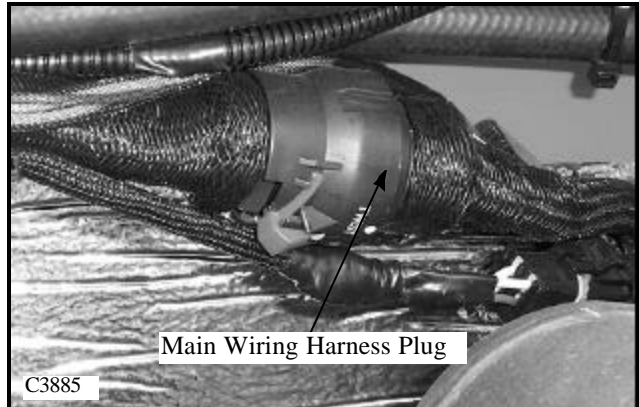

REAR DOOR 6.5

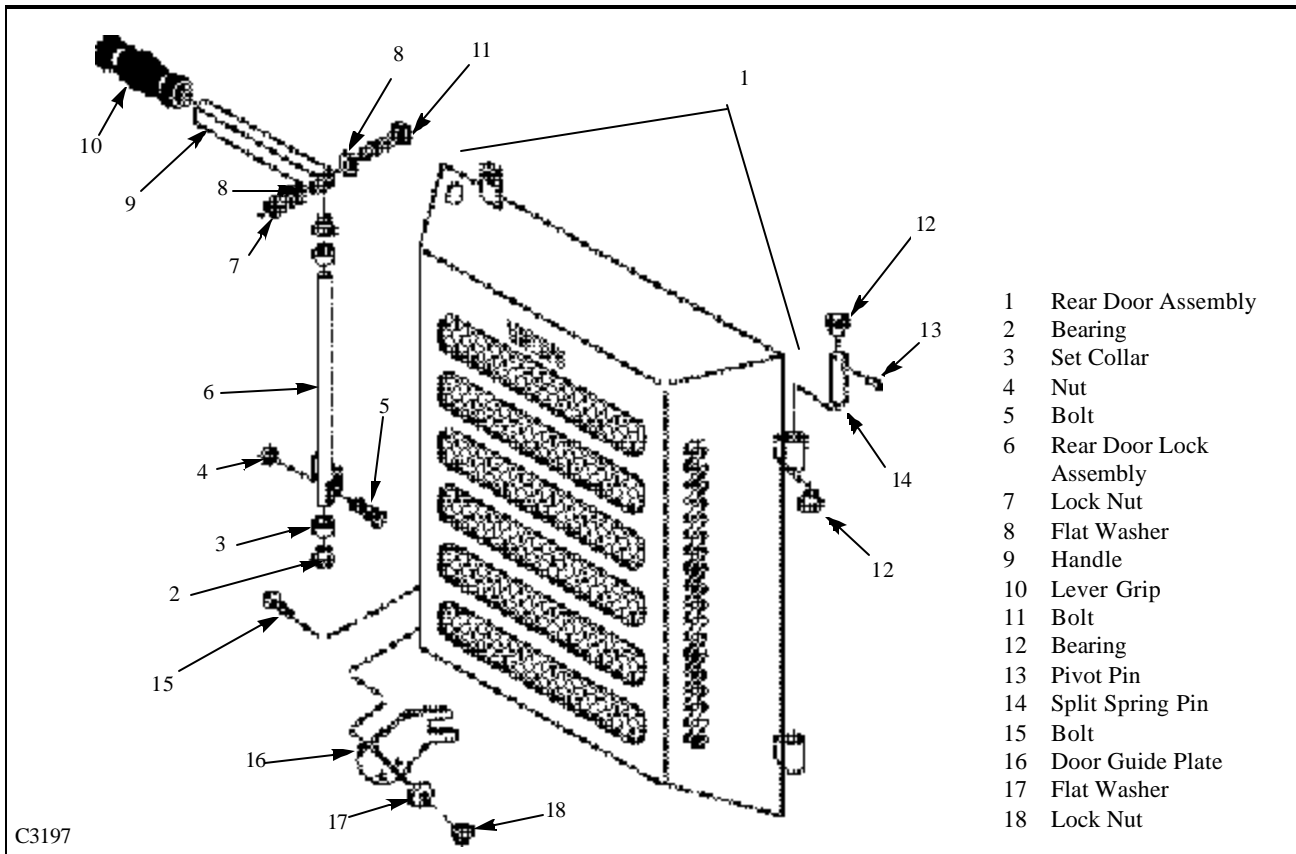

Removal

- 1 Open the rear door and remove the 4 nuts retaining the door baffle and hydraulic oil cooler to the door. (fig. C3608)
- 2 Attach chains to the rear door.
- 3 Using a hoist, raise the chains to take the weight of the door off the pivot pins.
- 4 Remove the split pins in the door pivot pins. (fig. C3609) Remove the pivot pins from the frame.
- 5 Replace any worn pivot bushings or pins as required.

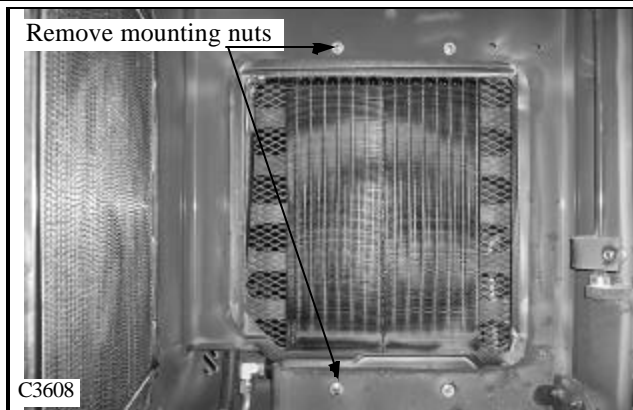

Installation

- 1 Replace the door to the frame in the reverse order above.
- 2 Adjust the door guide plate so the rear door looks level with the engine compartment cover, and the door slides freely into the closed position.
- 3 Adjust the door latch linkage bolt to provide an even fit around the outside of the door.

