



**YANMAR**<sup>®</sup>

**Electronic Control System  
Single Engine  
Installation Manual  
for BY Series Engines  
with Unlimited Controls**

***ELECTRONIC  
CONTROL  
SYSTEM  
MANINBYUM01  
REVISION 3.1***



## RECREATIONAL CRAFT DIRECTIVE 94/25/EC

Maximum performance, and compliance with the EMC Directive, can only be ensured by correct installation. It is strongly recommended that the installation conforms with the following standards:

### APPLICABLE STANDARDS

- a) ISO 8846 Small Craft-Electrical Devices  
Protection against ignition of surrounding flammable gases.
- b) ISO = International Standards Organization

### SAFE BOATING STATEMENT

This device meets or exceeds the applicable ABYC, ISO, and USCG safe boating rules, regulations, standards, and guidelines.

### SAFE BOATING ON THE WEB

U.S. Coast Guard      [www.uscg.mil](http://www.uscg.mil)  
U.S. Power Squadron   [www.usps.org](http://www.usps.org)



American Boat & Yacht Council (<http://www.abycinc.org>)

NMEA 2000® is a registered trademark of the National Marine Electronics Association.

## NOTICE TO INSTALLER

All information, illustrations and specifications in this manual are based on the latest information available at the time of publishing. The illustrations used in this manual are intended as representative reference views only. Moreover, because of our continuous product improvement policy, we may modify information, illustrations and / or specifications to explain and/or exemplify a product, service or maintenance improvement. We reserve the right to make any change at any time without notice. Yanmar and **YANMAR** are registered trademarks of Yanmar Co., Ltd. in Japan, the United States and/or other countries.

Safety alerts alone cannot eliminate the hazards that they signal. Strict compliance to these special instructions when performing installation, operation, and maintenance is the most effective accident prevention measure along with exercising care and using common sense when performing such actions.

### California Proposition 65 Warning

Diesel engine exhaust and some of its constituents are known to the state of California to cause cancer, birth defects, and other reproductive harm.

### California Proposition 65 Warning

Battery posts, terminals, and related accessories contain lead and lead compounds, chemicals known to the state of California to cause cancer and reproductive harm.  
Wash hands after handling.

### All Rights Reserved:

No part of this publication may be reproduced or used in any form by any means - graphic, electronic, or mechanical, including photocopying, recording, taping, or information storage and retrieval systems - without the written permission of Yanmar Marine International.

# Contents

<b>Components</b> .....	<b>4</b>
Engine Room .....	4
Helm .....	4
<b>Cables</b> .....	<b>6</b>
<b>NMEA 2000® CANBus Cables</b> .....	<b>7</b>
<b>Installation</b> .....	<b>8</b>
Overview .....	8
Step 1 - Install the Engine .....	8
Step 2 - Install Battery Switch and Engine Breaker .....	9
BY Unlimited SSSE - Marine Gear .....	10
BY Unlimited SSSE - Stern Drive .....	12
BY Unlimited Power Wiring Diagram .....	14
Step 3 - Route the CE504XX Boat Harness .....	15
Step 4 - Install the CE50206 Engine Harness .....	16
Step 5 - Install the Helm Components .....	17
Step 6 - Connect the Helm Components .....	18
Connect the CE50100 Helm Harness .....	18
Connect the Control Head .....	19
Stern Drive Trim Harness Connections .....	20
Step 7 - Configure the Engine .....	21
Stern Drive only - Neutral Throttle Protect .....	21
Step 8 - Install the Stern Drive Actuator .....	22
Location .....	22
Mounting .....	22
Connections .....	22
Connecting the Shift Cable .....	23
Connect to CANBUS .....	24
Step 9 - Set and Calibrate the Actuator .....	24
Templates .....	25
CH64600 Single CANBus Control Head .....	25
CH67600 Control Module .....	27
i5601E Digital Display - Front Mount .....	29
i5601E Digital Display - Rear Mount .....	31
CP19500 Key Panel Switch .....	33
3” Gauge with Key Cut .....	35
3” Gauge without Key Cut .....	37
2” Gauge with Key Cut .....	39
2” Gauge without Key Cut .....	39
Mounting Dimensions .....	40

# Contents

---

AC67002 Actuator Dimensions .....	40
i8130/40 Engine Interface .....	41
Step 10 - Check out the Installation .....	42
<b>Start Up .....</b>	<b>43</b>
Redundant (Back-up) Throttle .....	43
i5601E Digital Display .....	44
Optional Tachometer and Speedometer Menu Structures .....	45
Alarms .....	50
First Time Control Operation .....	51
Shift and Throttle Control Head Functions .....	51
<b>Operations .....</b>	<b>52</b>
Control Head Operation .....	52
Identification .....	52
Select/change Station .....	52
Indicator Dimming Feature .....	52
Split Range Throttle (SRT) .....	53
Shift Disconnect (SD) .....	53
System Alarms .....	54
Trolling Mode (Option) .....	55
i5601E Digital Display Alarms/Engine Diagnostic Codes .....	56
<b>Appendix A: i5601E Digital Display Setup .....</b>	<b>57</b>
i5601E Digital Display Setup .....	57
Display Settings .....	58
Menus .....	58
User and Factory Settings .....	59
“Unlocking” the Hot Keys .....	59
Quad Screen Parameters .....	60
<b>Appendix B: i5601E Menu Navigation .....</b>	<b>61</b>
<b>Appendix C: Network Status .....</b>	<b>62</b>
Network Status Display .....	62
Network Nodes Display .....	62
<b>Appendix D: Yanmar BY Unlimited Default Settings: Single Engine .....</b>	<b>63</b>
<b>Appendix E: Transmission Connections .....</b>	<b>64</b>
ZF80 Transmission Connections without Trolling .....	64
ZF80 Transmission Connections with Trolling .....	65
<b>Appendix F: Trolling Option .....</b>	<b>66</b>
Trolling Calibration .....	66
<b>Appendix G: Deutsch Connector: Insertion/Removal .....</b>	<b>68</b>

# Contents

---

<b>Appendix H: Miscellaneous</b> .....	<b>70</b>
Fuel Sender Connections .....	70
Paddle Wheel Connections .....	70
Tuff Torque/Kanzaki Transmissions .....	70
Power Reduction Mode .....	71
<b>Appendix I: Optional Serial Gauges</b> .....	<b>72</b>
<b>Appendix J: Emergency Shift for Stern Drive Engines</b> .....	<b>73</b>
<b>Appendix K: Station Select Protection</b> .....	<b>74</b>

# Components

---

## *Engine Room*

**i8130:** Engine Interface Module - Stern Drive  
**i8140:** Engine Interface Module - Marine Gear



**AC67002:** Actuator  
(Stern Drive ONLY)



# Components

## *Helm*

### Standard Components

#### **CH64600:**

Single Engine CANBus Control Head\*



#### **CH67600:**

Control Module



#### **CP19500:**

Ignition Switch Panel  
(for 1st Station)  
Lanyard included.



*\*other styles available*

### Optional Components

#### **i5601E:**

Digital Engine Display



*Shown with  
cable CM10504*

#### **CP67601:**

Trolling Switch



#### **780757SDFB:**

Digital Tachometer



# Cables

*Note: XX indicates cable length in feet*

**CE42306:** Transmission Harness



**CE50100:** Helm Harness



**CE50206:** Engine Harness



**CE503XX:** Engine Extension Harness  
(typically used with jack-shaft installations)



**CE504XX:** Boat Harness  
(*CE50603, CE50607 CE50610 are extension cables for CE504XX*)



**CE42100:** Control Interface



**CE10420:** Actuator Power Cable



**CM10703:** Actuator Connect to CANBus





# NMEA 2000® CANBus Cables

CM100XX: Cable



CM10051: male terminator / CM10052: female terminator / CM10055: Deutsch terminator

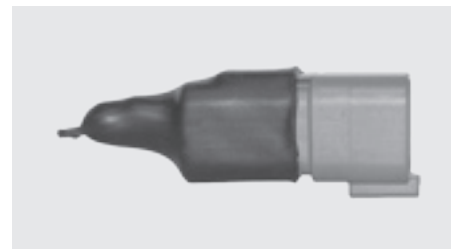

## “T” Connector:

Supplied by several vendors under part numbers CM10050 and CM10060.  
Appearance may vary - parts are interchangeable.

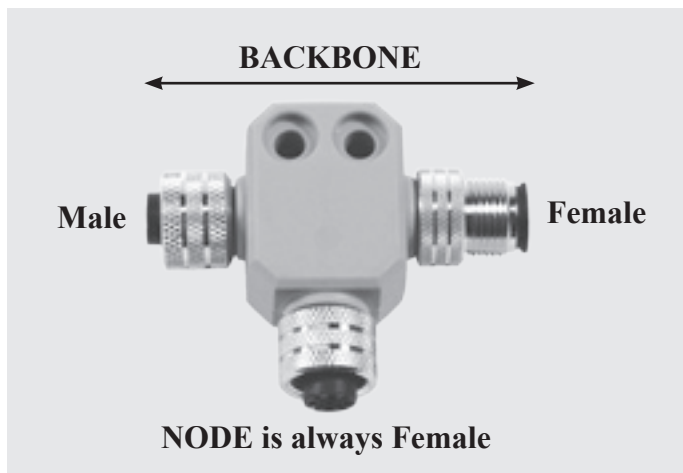

### *Note regarding connectivity of “T” Connectors:*

- When connecting a “T” connector to a component (for example, i8130 module) always install via the middle connection (“NODE”).
- When connecting a “T” connector to a CANBus cable (for example, CM10703) to connect components that are far from each other, always install via the male/female end of the connector (whichever applies).
- Hand-tighten after the connection is made.
- Do not tightly tie down the “T” connectors, as this will create stress and can cause damage.

# Installation

## *Installation Overview*

This section covers the single engine, marine gear (inboard) and stern drive installation. Power Wiring and System Diagrams are shown on pages 10 through 14.

The tasks that must be completed to hook up the BY Unlimited Control Systems are as follows (This section takes you through each task area).

1. Install the engine.
2. Install battery switch and engine breaker.
3. Route the CE504XX Boat Harness from the engine area to the helm.
4. Install the CE50206 Engine Harness and make the various connections to that harness.
5. Install the Helm Components (mount per templates on pages 25 through 41).
6. Connect the CE50100 Helm Harness.
7. Configure the Engine (if installing Marine Gear, proceed to Step 10).
8. Install the Stern Drive Actuator.
9. Calibrate the Stern Drive Shift Actuator.
10. Check out the Installation.

### **WARNING**

*Make all connections in accordance with applicable codes and standards.*

## **STEP 1 - Install the Engine.**

Install and align the engine per Yanmar's Installation Manual, Volume 3 for BY Engines. If this is a Stern Drive installation, install the Stern Drive first, followed by the engine.

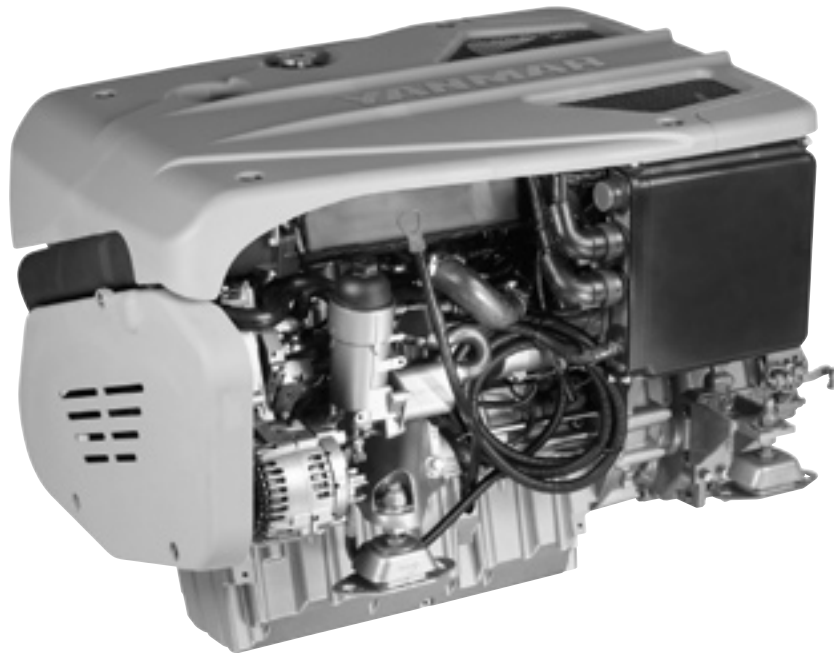

# Installation

## STEP 2 - Install Battery Switch and Engine Breaker.

Install the battery switch for the engine. Then, close to the battery switch, install a 50 amp circuit breaker (use an 80 Amp breaker when glow plugs are specified). The circuit breaker will need to be located so the 2.5 meter (8 foot) cable supplied on the engine can reach the breaker. Do not extend this cable.

The wire from the battery switch to the circuit breaker should not be longer than one meter (3 feet). The wire size should be 10mm<sup>2</sup> (AWG 6).

The wire size of the main ground cable and the cable to the starter motor should be sized based on their length. When determining the wire size add the length of the negative cable from the engine block to the battery and the length of the positive cable from the starter to the battery together.

Distance	Wire size
Up to 5 meters (16 feet)	20mm <sup>2</sup> AWG 4
Up to 9 meters (30 feet)	40mm <sup>2</sup> AWG 1

Breaker Wiring Diagram

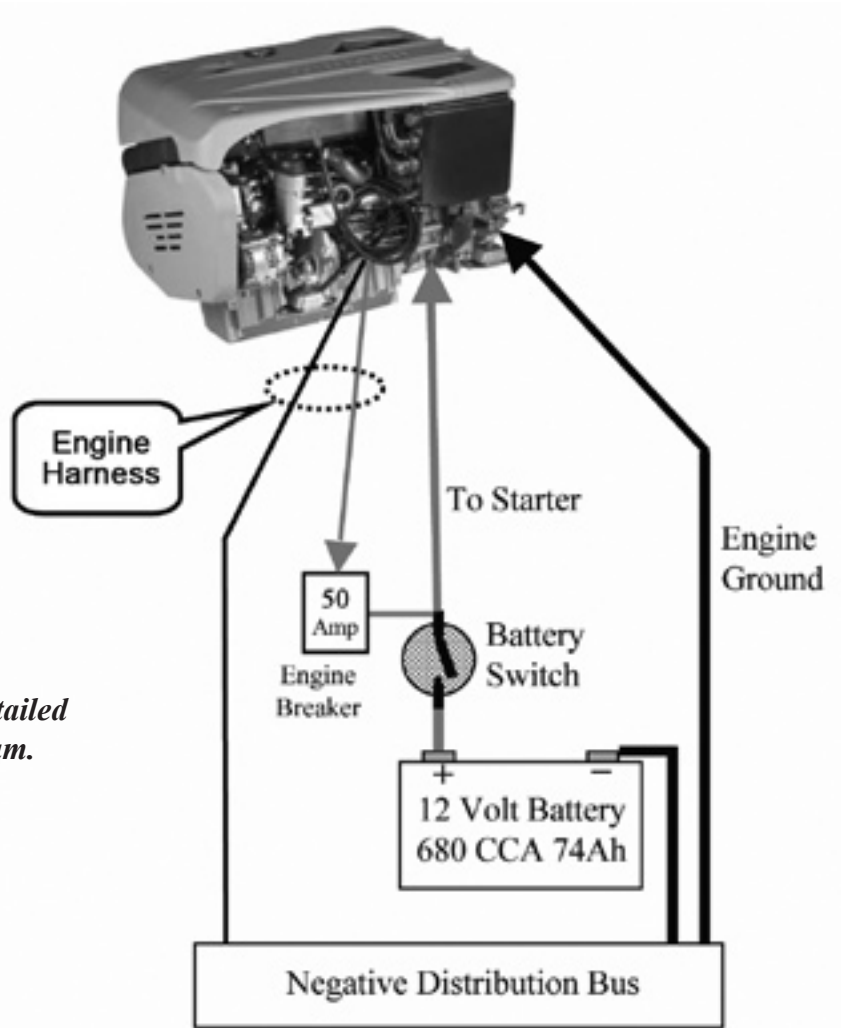

*Note:*  
See page 14 for the detailed power wiring diagram.

# Installation

## Single Station, Single Engine Diagram - Marine Gear

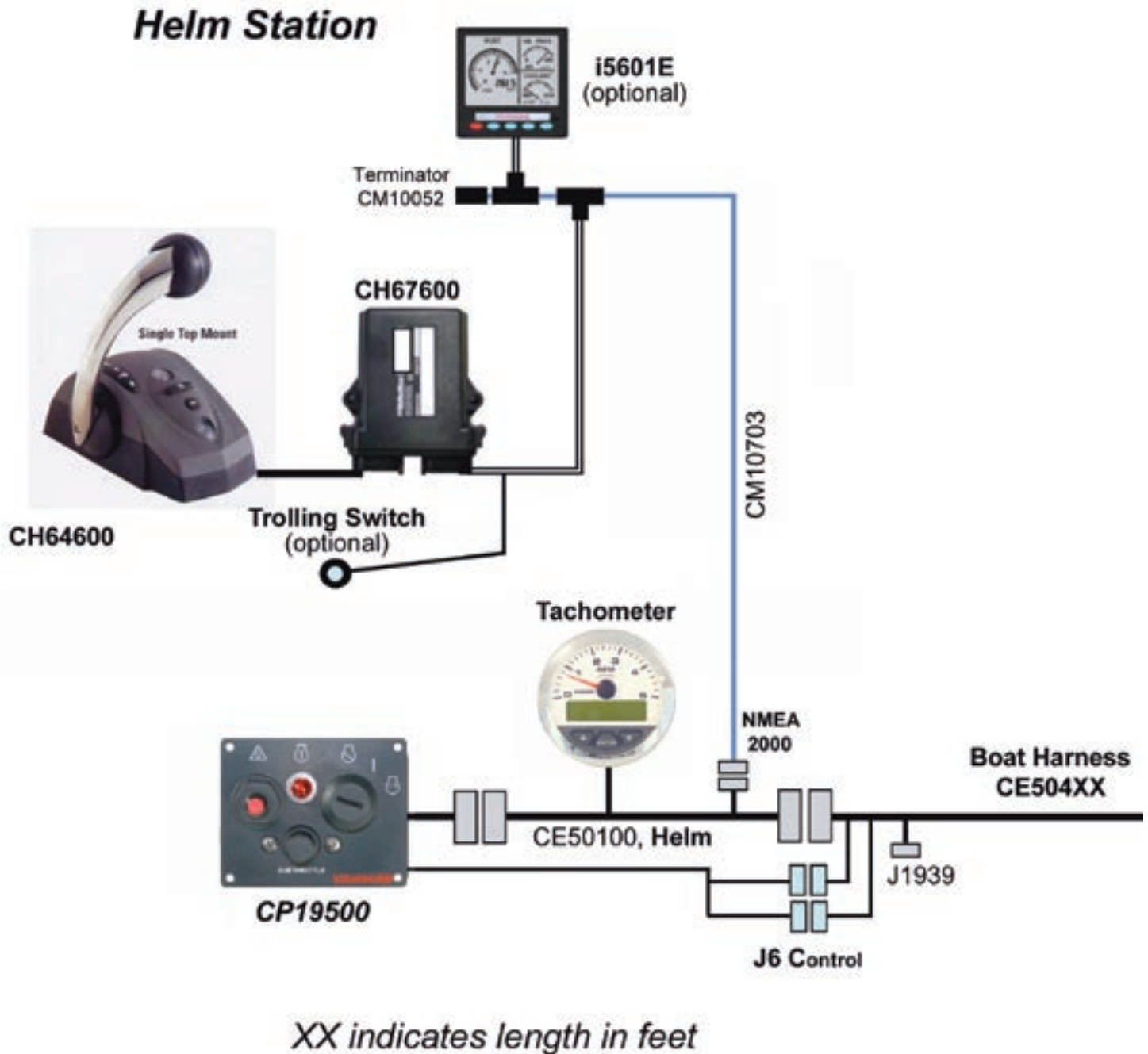

# Installation

## Single Station, Single Engine Diagram - Marine Gear

(CE50603, CE50607  
CE50610 are extension  
cables for CE504XX)

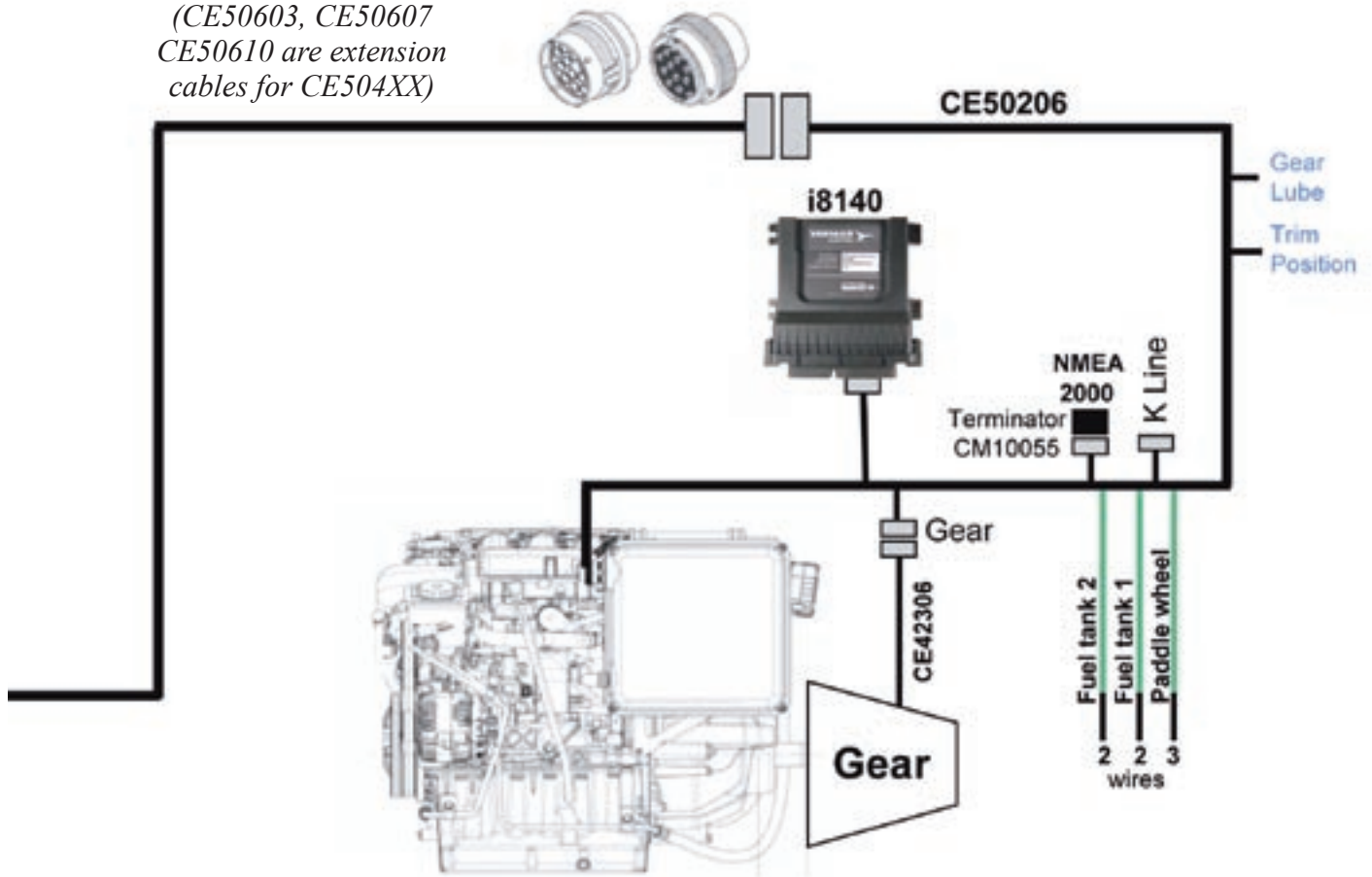

# Installation

## *Single Station, Single Engine Diagram - Stern Drive*

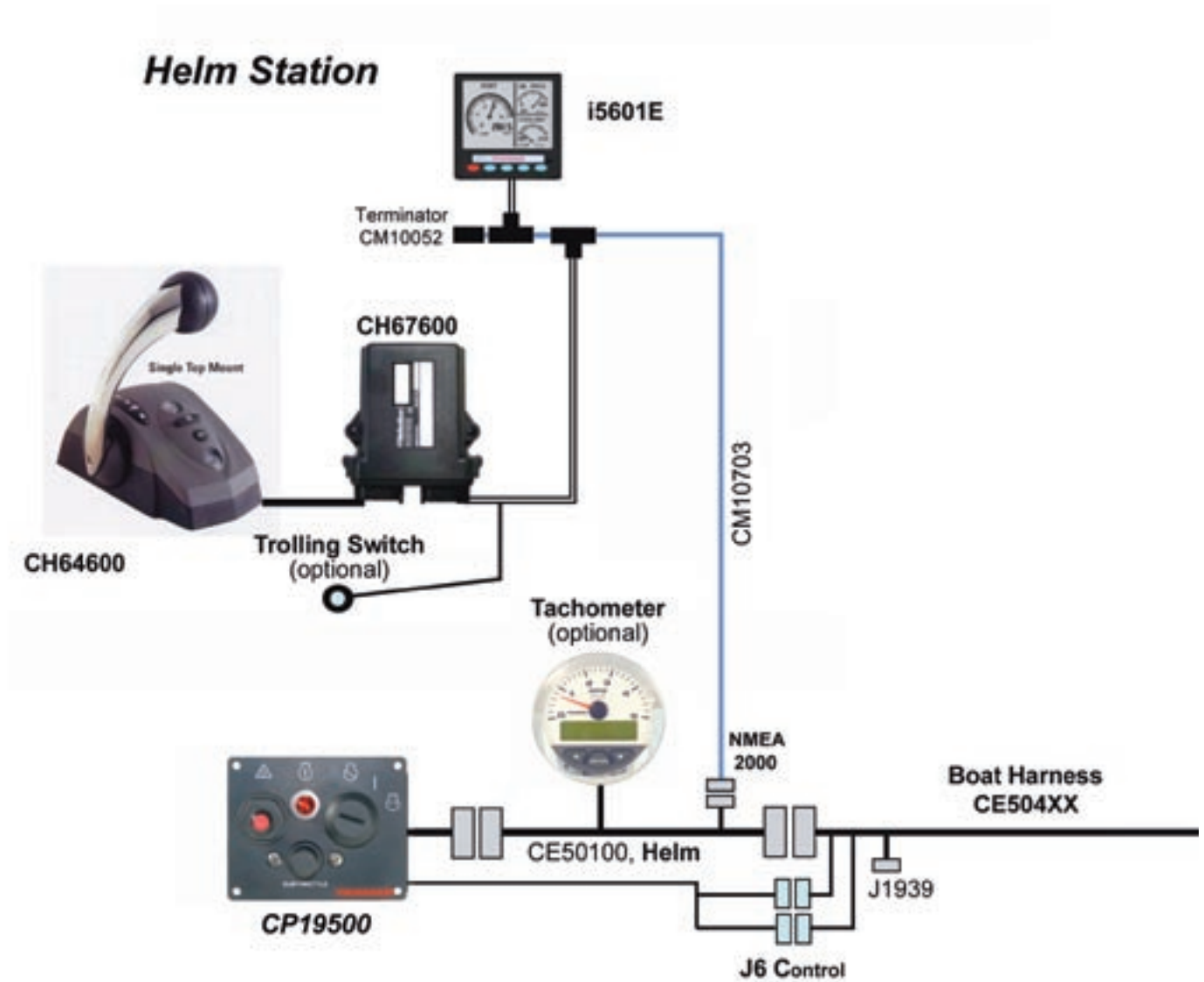

# Installation

## Single Station, Single Engine Diagram - Stern Drive

(CE50603, CE50607  
CE50610 are extension  
cables for CE504XX)

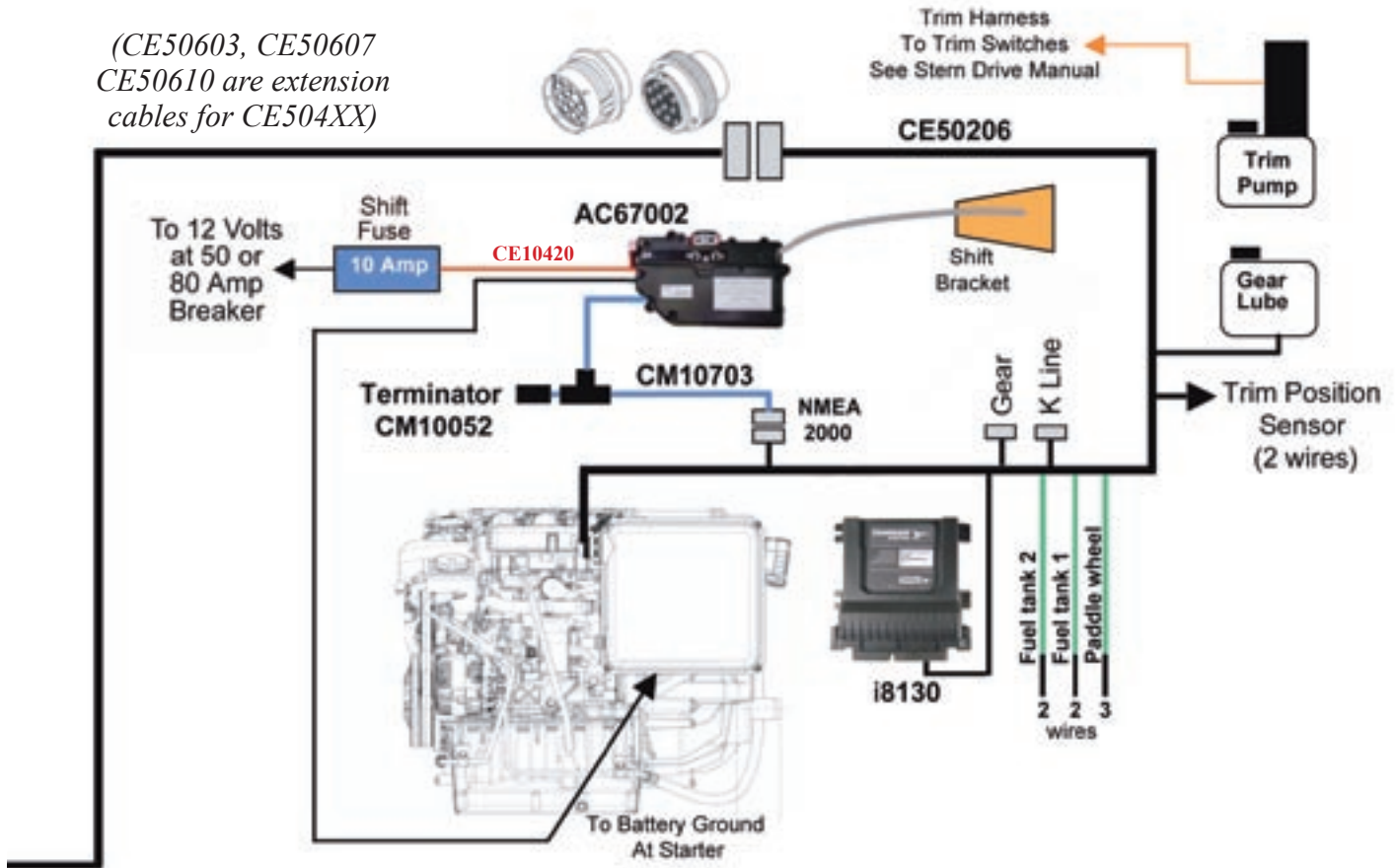

# Installation

## Power Wiring Diagram - BYU Single Engine

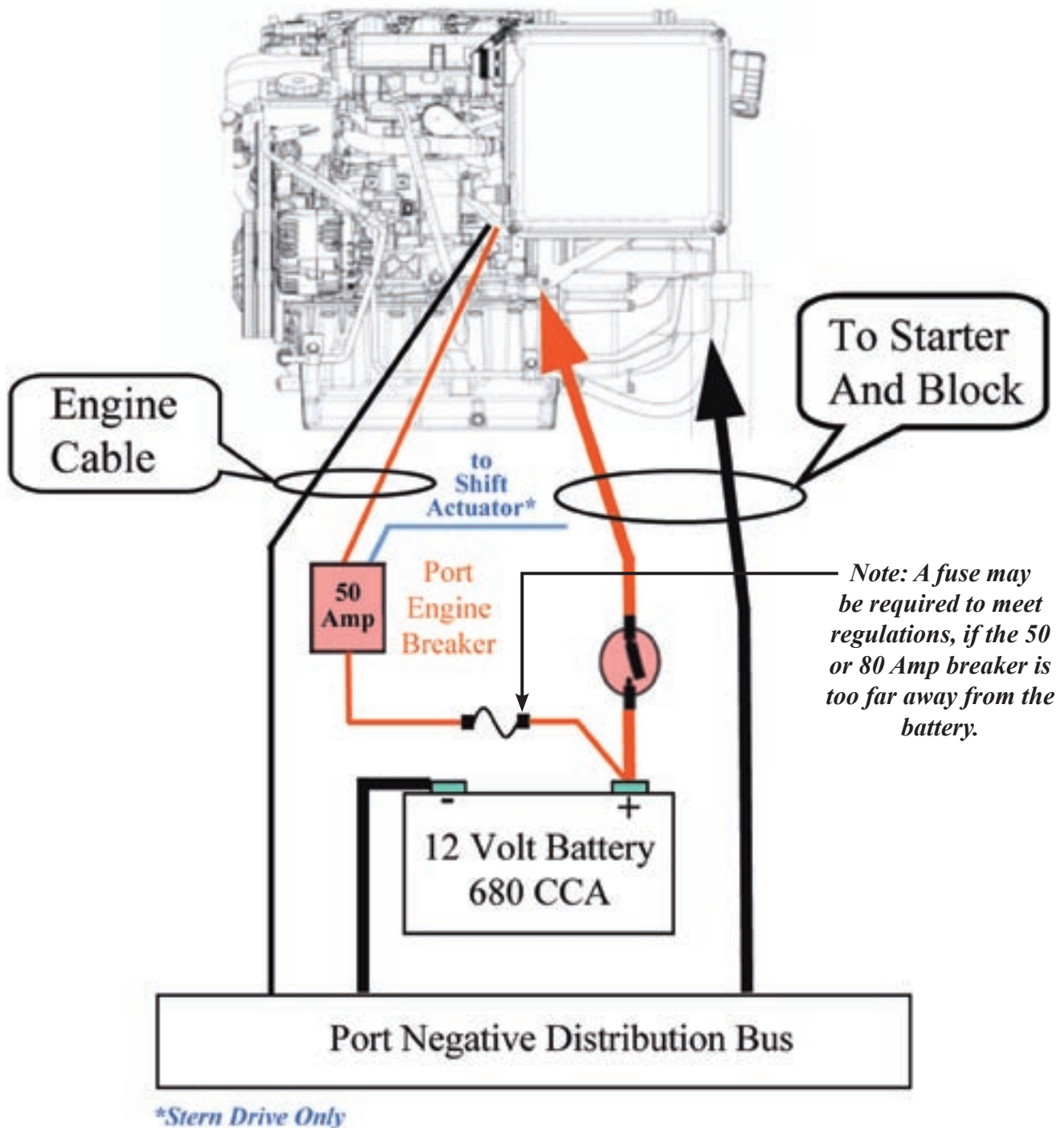



# Installation

---

## Step 3 - Route the Boat Harness.

Route the CE504XX Harness from the helm area near the control to the engine area. If the Deutsch Connectors must be removed, see Appendix G.



*Note: The J1939 connector is not normally used and should be tied back.*

# Installation

## Step 4 - Install the CE50206 Engine Harness.

### Engine Room Layout:

Mount an i8130/40 module. The six foot length of CE50206 harness determines the maximum distance between the engine/transmission and the i8130/40 module. While the i8130/40 can be mounted horizontally or vertically, the preferred mounting is vertical with the connectors facing down.

### Mounting the i8130/40 Engine Interface:

1. Always mount the i8130/40 to a solid surface, but not directly to the engine.
2. Allow 4" cable clearance at the connections.



**i8130/40  
Engine Interface**

### Connecting the CE50206 Engine Harness:

1. Connect the J1 Connector of the CE50206 Engine Harness to the Engine as shown.

**NOTE: Do NOT bend connector pins! Locate the Index Tab on the engine end connection of the CE50206 for correct orientation and be sure pins are properly in their sockets before rotating the Lock Ring.**

2. Connect the P1 plug to the CE504XX Engine Harness, installed in "Step 3."
3. Connect the J2 connector of the CE50206 to the i8130/40 Engine Interface.
4. **For Marine Gear applications:** Check to see if a CM10055 Terminator is installed in the J7 NMEA Connector. If none is present, locate one in the kit and install. For Stern Drive applications see "Step 8."

1. (also see diagram below)



5. Tie back the J8 Diagnostic Connector (K Line).
6. Connect the Fuel 1 and 2 and the Fuel 1 and 2 Returns to the appropriate senders in the fuel tanks (see Appendix H for details).
7. Connect the Paddle Wheel "REF," "SIG," and "GRD" connectors (See Appendix H for details).
8. **For Marine Gear applications:** tie back the Gear Lube and Gear Lube Return and Trim and Trim Return. **For Stern Drive applications:** connect the Gear Lube and Gear Lube Return to the Gear Lube Bottle. Connect the Trim and Trim Return to the Stern Drive.
9. **For Marine Gear applications:** connect the "Gear" to the Transmission Harness (see Appendix E or H for details).

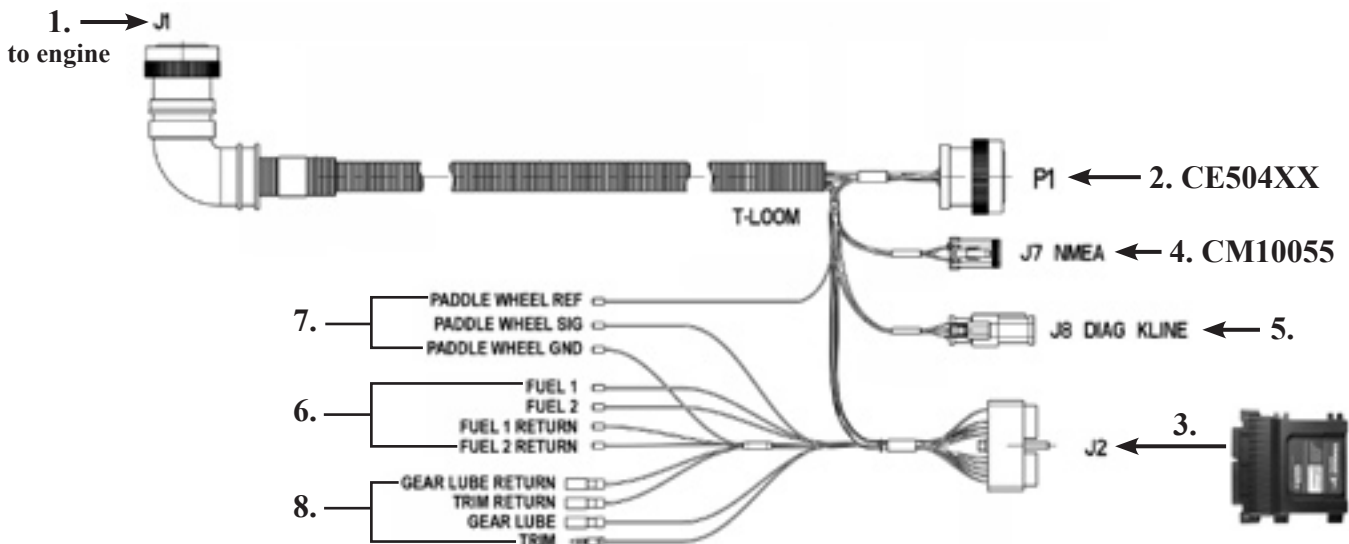

# Installation

## STEP 5 - Install the Helm Components.

1. Mount the CP19500 Key Switch Panel using the template on page 33.  
*Note: Allow 3.5 inches (88.9mm) behind the back of the CP19500 Key Switch Panel when mounting.*
2. Mount the Control Head using the template on page 25 or the template that comes with the Control.
3. Connect the CH67600 Control Module using directions on page 19. Mount per template on page 27.
4. If Trolling Option is specified, mount the CP67601 Trolling Switch using a 16 mm or 5/8 inch hole.
5. Mount the i5601E Digital Display using the template on page 29 or page 31, depending on whether a front or rear mount installation is required.
6. Mount any optional gauges that are specified, using the templates on pages 35, 37 and 39 accordingly or see Appendix I.

**1. CP19500**  
Key Switch Panel



**2. CH64600** Control Head



**3. CH67600**  
Control Module



**3. CP67601** Trolling  
Switch (optional)



**5. i5601E**  
Digital Display (optional)



**6. 780757SDFB**  
Digital Tachometer  
(optional)



# Installation

## Step 6 - Connect the Helm Components.

### Connect the CE50100 Helm Harness.

1. Plug the large grey 12 pin connector into the CE504XX Engine Harness.
2. Plug the "Key Switch" into the 4 pin CP1950 connector.
3. Connect J6A and J6B to the appropriate ends of the CP1950 cable.
4. Connect the J3 Tach to the optional gauges or tie back. See Appendix I.



(CE50603, CE50607  
CE50610 are extension  
cables for CE504XX)

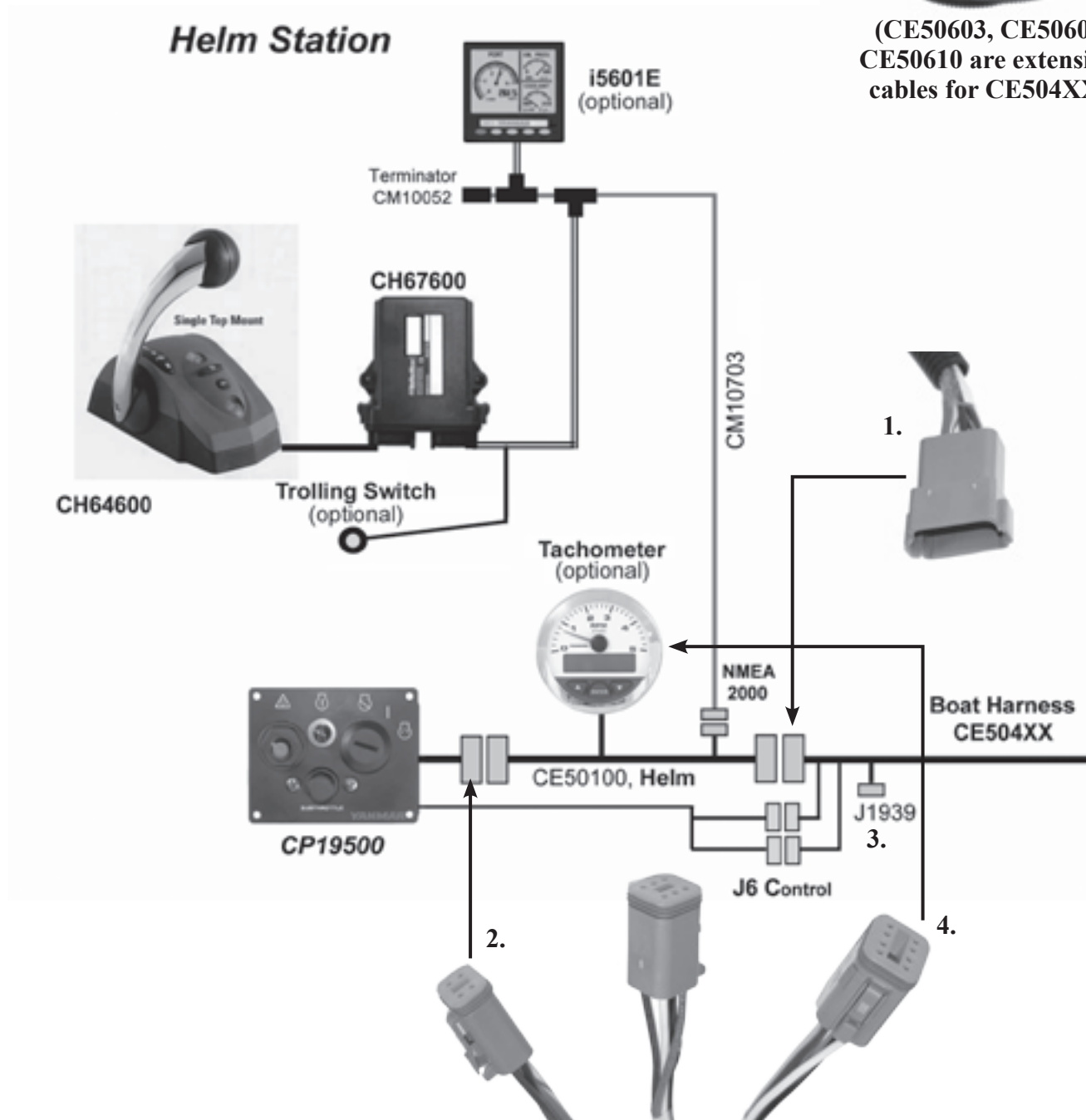

# Installation

## Connect the Control Head

1. Connect the Control Head cable to the appropriate end of cable harness CE42100 (big grey connector).
2. Connect the GREY connector on cable harness CE42100 to the GREY port on the CH67600 module.
3. Connect the BLACK connector on cable harness CE42100 to the BLACK port on the CH67600 module.
4. Install a CANBus "T" connector to the CANBus end of the CE42100 cable. Connect at the NODE.
5. Connect the "T" to the previously run CM10703 CANBus cable.
6. Terminate the "T" end with the appropriate gender CANBus Terminator.

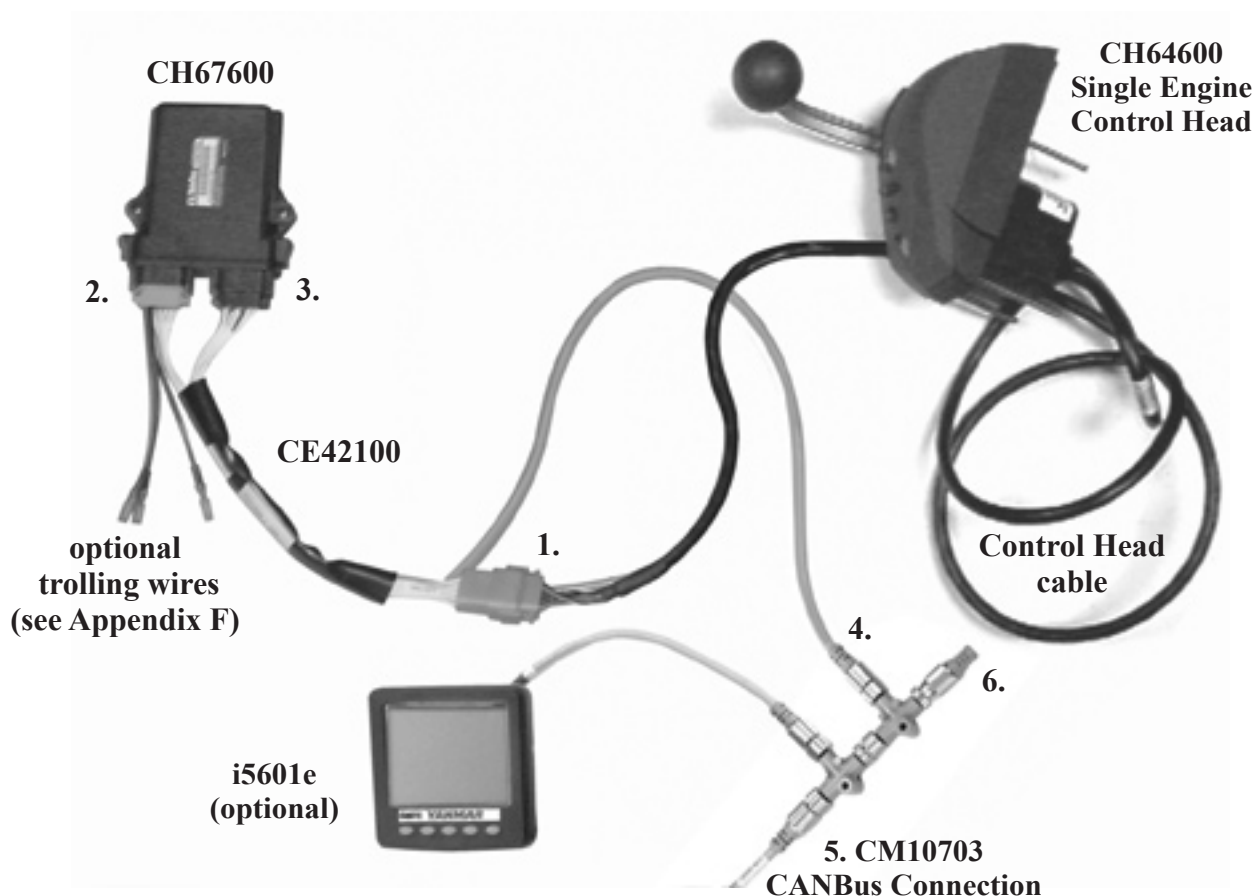

## Trolling Switch and Connection Diagram

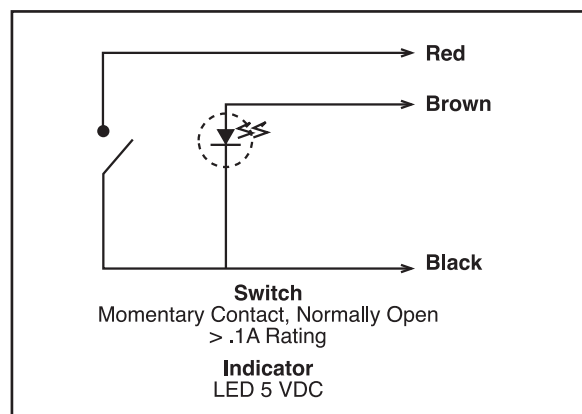
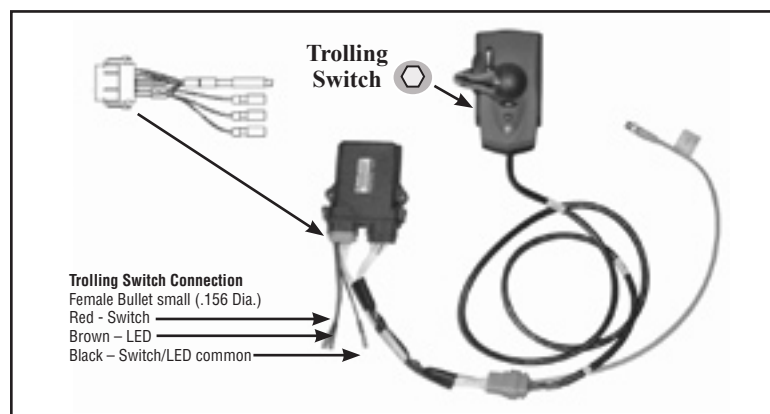

# Installation

## *Stern Drive Trim Harness Connections*



# Installation

## Step 7 - Configure the Engine for CANBus Control.

The factory defaults for a BY engine is Analog Throttle. The engine must be reconfigured for CANBus Controls.

1. Open the “E” box and go to the fuse holders.
2. Insert a 3A fuse into position F8. The engine is now configured for CANBus controls.

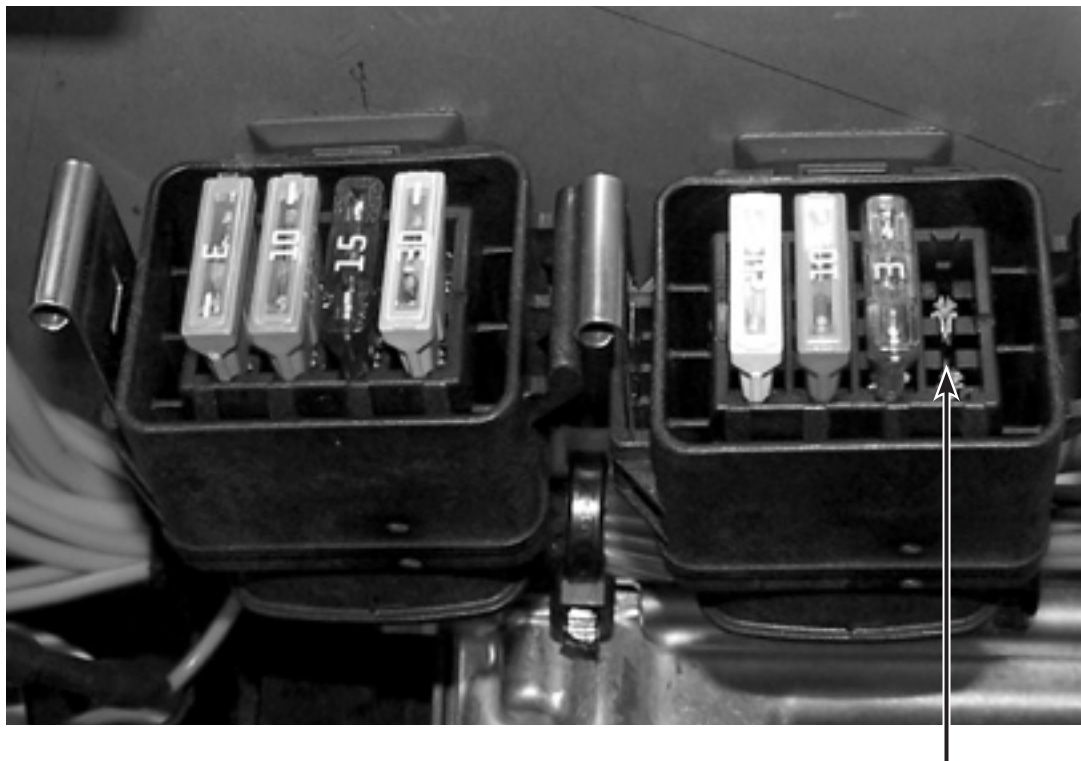

Insert 3A fuse for CANBus Controls

# Installation

## Step 8 - Install the Stern Drive Actuator.

### Location

Choose a suitable location for the Shift Actuator, considering the following requirements:

- The actuator is NOT waterproof. Choose a DRY location.
- The actuator needs 12 volt power and connects to the CANBus.
- The cable to the Stern Drive Shift Bracket requires adequate clearance and no sharp bends.
- The actuator should be mounted where it can be accessed for manual operation.

### Mounting

There are two ways to mount the actuator and hardware is supplied for both mountings.

1. Three bolts are supplied for rear mount applications (bolt heads behind the mounting panel).
2. Three screws and washers are supplied for front mount applications.

### Connections

Connect the 12 volt (3 pin) power connection of the Shift Actuator to the 50 Amp Engine Breaker using cable CE10420, cut to length. This power should be connected so it comes through the Battery Switch and has a proper fuse. See pages 13 and 14 for details.

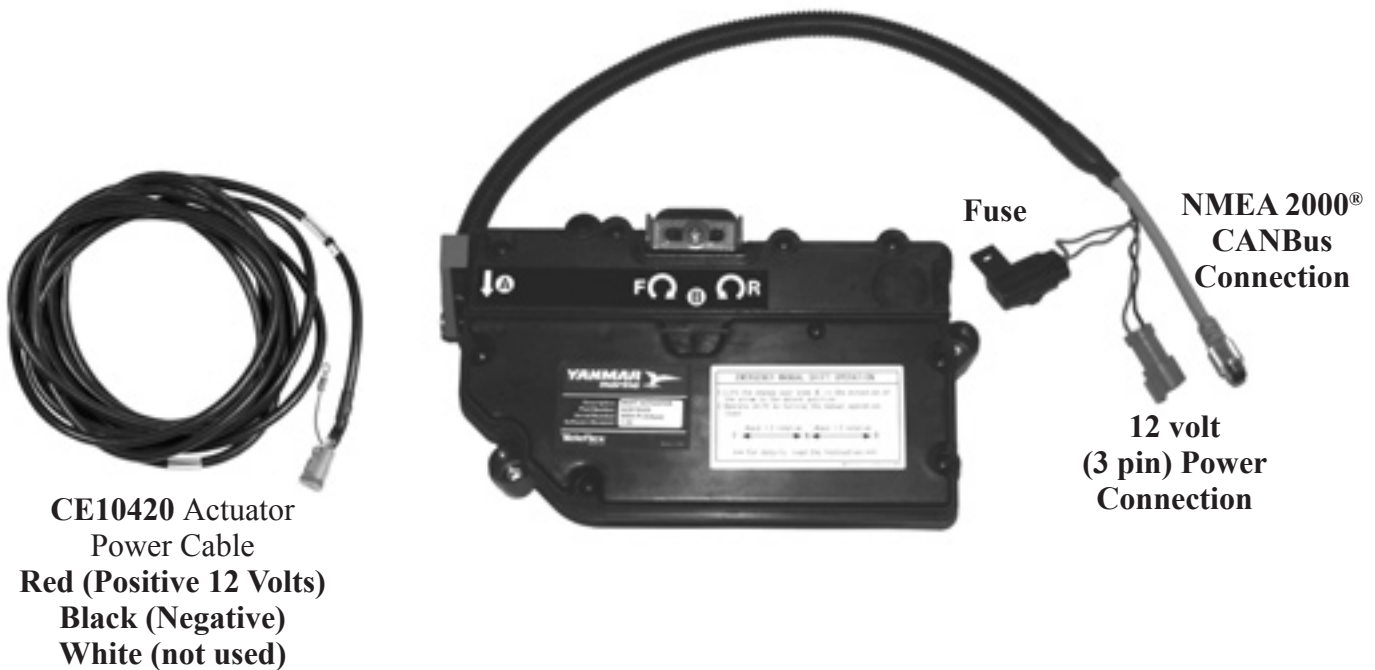



# Installation

## Connecting the Shift Cable

1. Install the Shift Bracket per the Stern Drive's installation instructions.
2. Install the Shift Cable to the Shift Bracket in "Neutral" position.
3. Set the Shift into Neutral.
4. Turn on the power to the actuator, this will set the actuator to "Neutral." Then turn off the power.
5. Connect the shift cable to the actuator:

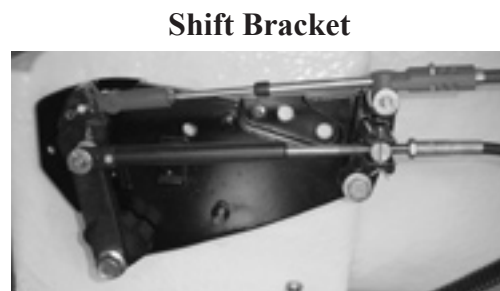

**Note: Make sure that the ends of Shift Cable are set in their respective detents with room to adjust the barrel/adjustment nuts.**

- a. Remove the cover plate (4 screws) as shown below.
- b. Position the end of the cable above the cable mount so the notch on the cable will fit into the detent in the mount.
- c. Place the rubber Grommet around the shaft of the cable, just in front of the two hex crimps. This will slide into the side edges of the housing.
- d. Screw the Brass Adjustment Barrel approximately halfway onto the end of the cable. Adjust the barrel and cable so it will fit into the slot toward the top of the cable mount. Once the proper position is found, screw on the Jam Nut (supplied with the cable) and tighten against the Adjustment Barrel.
- e. Secure the Brass Adjustment Barrel to the cable mount with the Steel Retainer.
- f. Fit the cable into the cable mount so that all previous components are seated into their respective spots.
- g. Replace the cover.

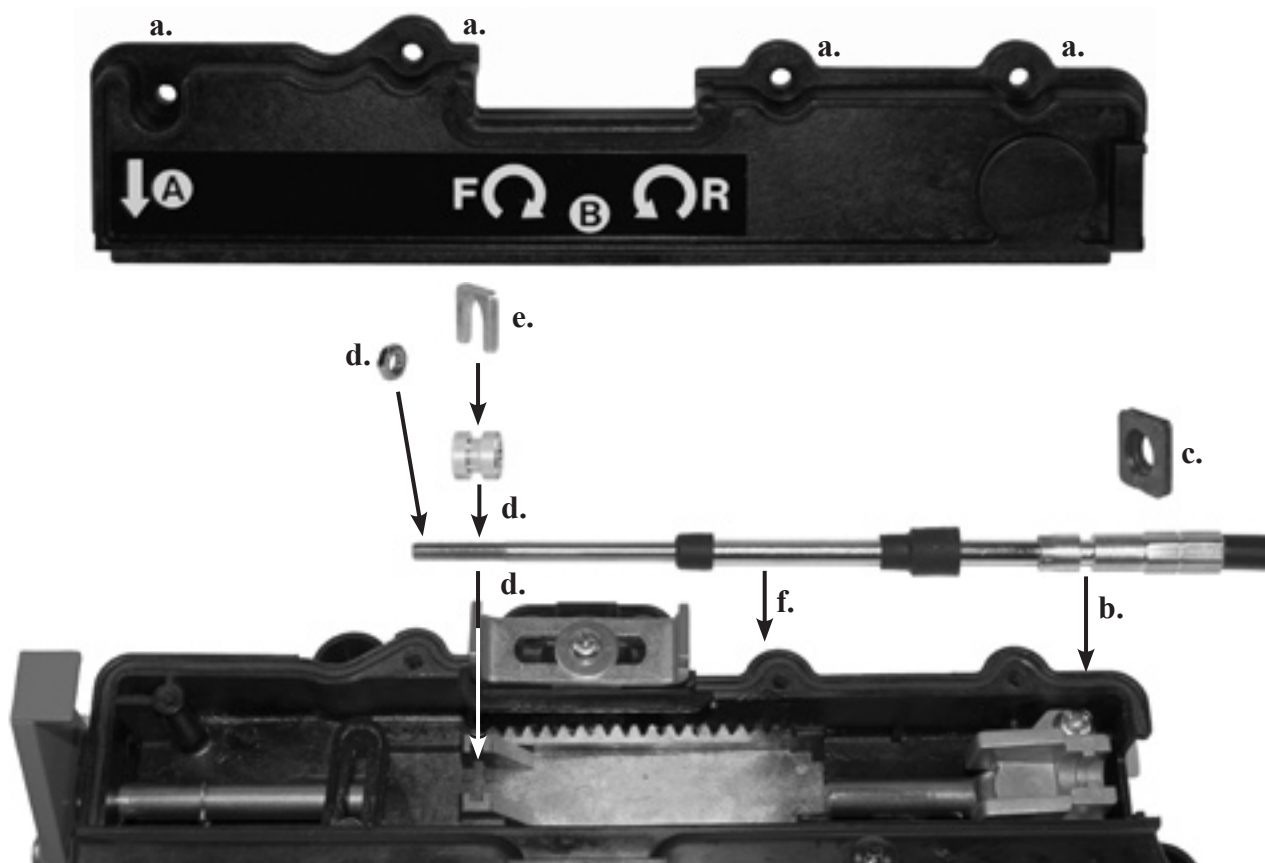

# Installation

## *Connect to the CANBus*

1. Locate the NMEA 2000® connector of the CE50206 and remove the CM10055 terminator, if one is there. Install a CM10703 cable into the NMEA 2000® connector and put a CM10050 “T” connector at the end of the CM10703 cable.
2. Put a CM10052 terminator at the end of the “T” connector.
3. Plug the Actuator cable NMEA 2000® connector into the node of the “T.”
4. The CM10703 cable can be extended using a CM100XX CANBus cable, if required.

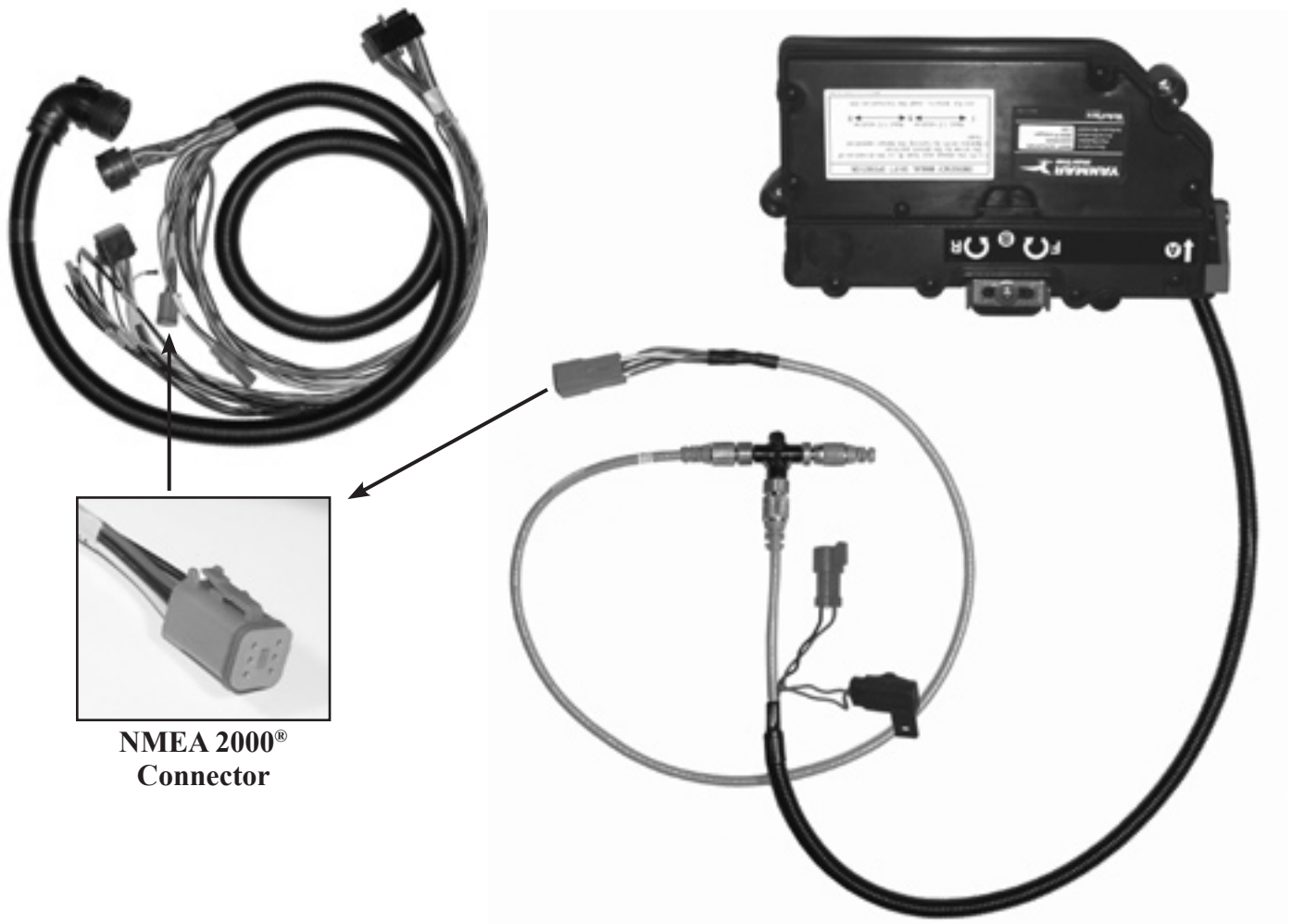

**NMEA 2000®  
Connector**

## **9. Setting and Calibrating the Actuator**

The Shift Actuator calibration is set using the i5601E display. Please refer to i5601E Menu Navigation and i5601E Menu Structure (pages 57 and 61 respectively) for directions on how to set and calibrate the actuator. Using the i5601E enter the calibration section and go to the “Shift Actuator.” Set push or pull for forward and then set the forward and reverse stroke. The stroke is set in millimeters.

Check the setting by doing several shifts and make sure the shift lever is coming to rest in the appropriate locations.

# Templates

## CH64600 Single CANBus Control Head

*If this template has been downloaded electronically or copied from another document, please verify all template dimensions prior to cutting as different printers/copiers may scale differently.*

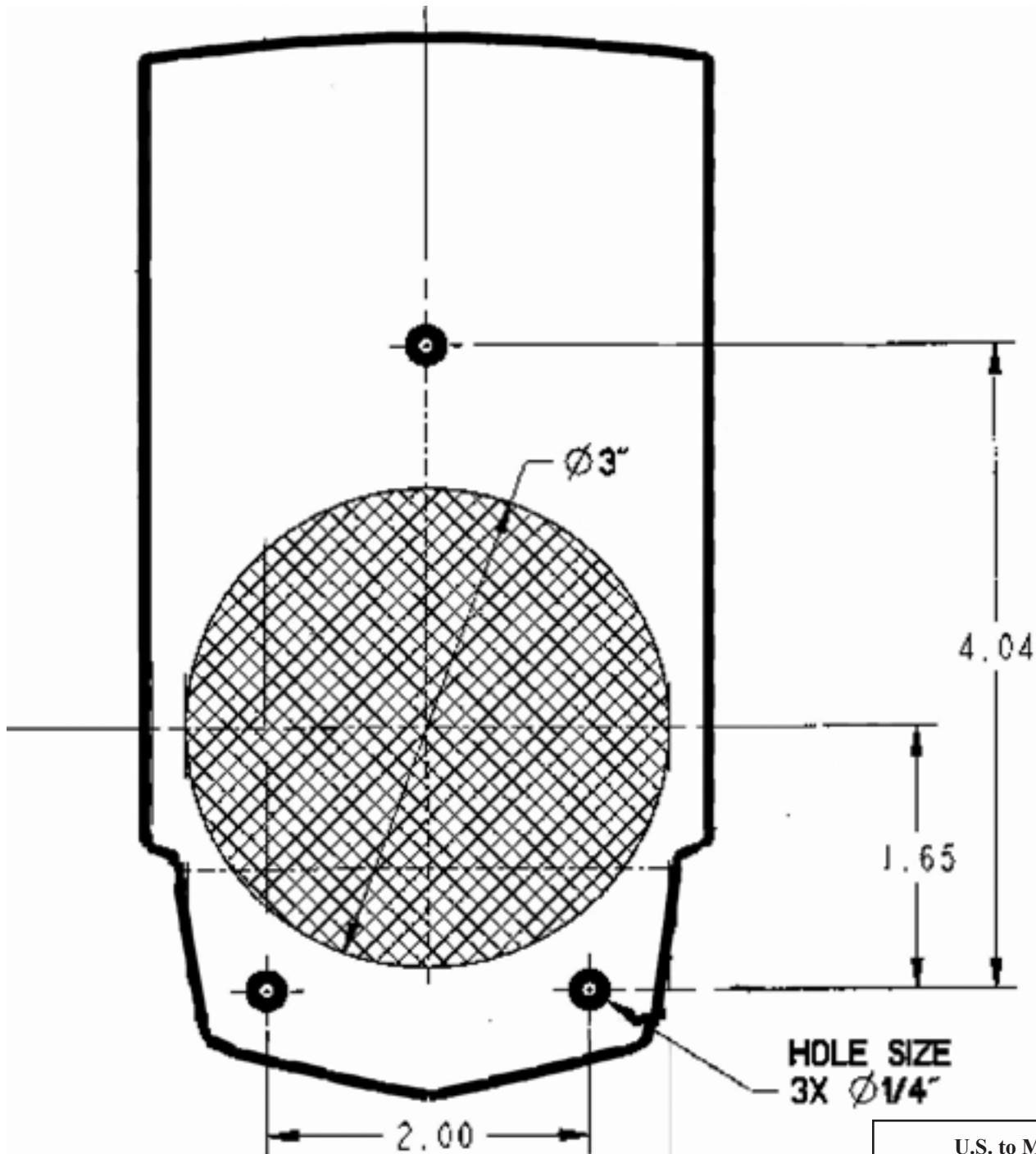

### U.S. to Metric

3.00 inches	=	76.2 mm
.25 inches	=	6.35 mm
2.00 inches	=	50.8 mm
1.65 inches	=	41.9 mm
4.05 inches	=	102.9 mm

# Templates

---

*This page has been left intentionally blank.*

# Templates

## CH67600 - Control Module

*If this template has been downloaded electronically or copied from another document, please verify all template dimensions prior to cutting as different printers/copiers may scale differently.*

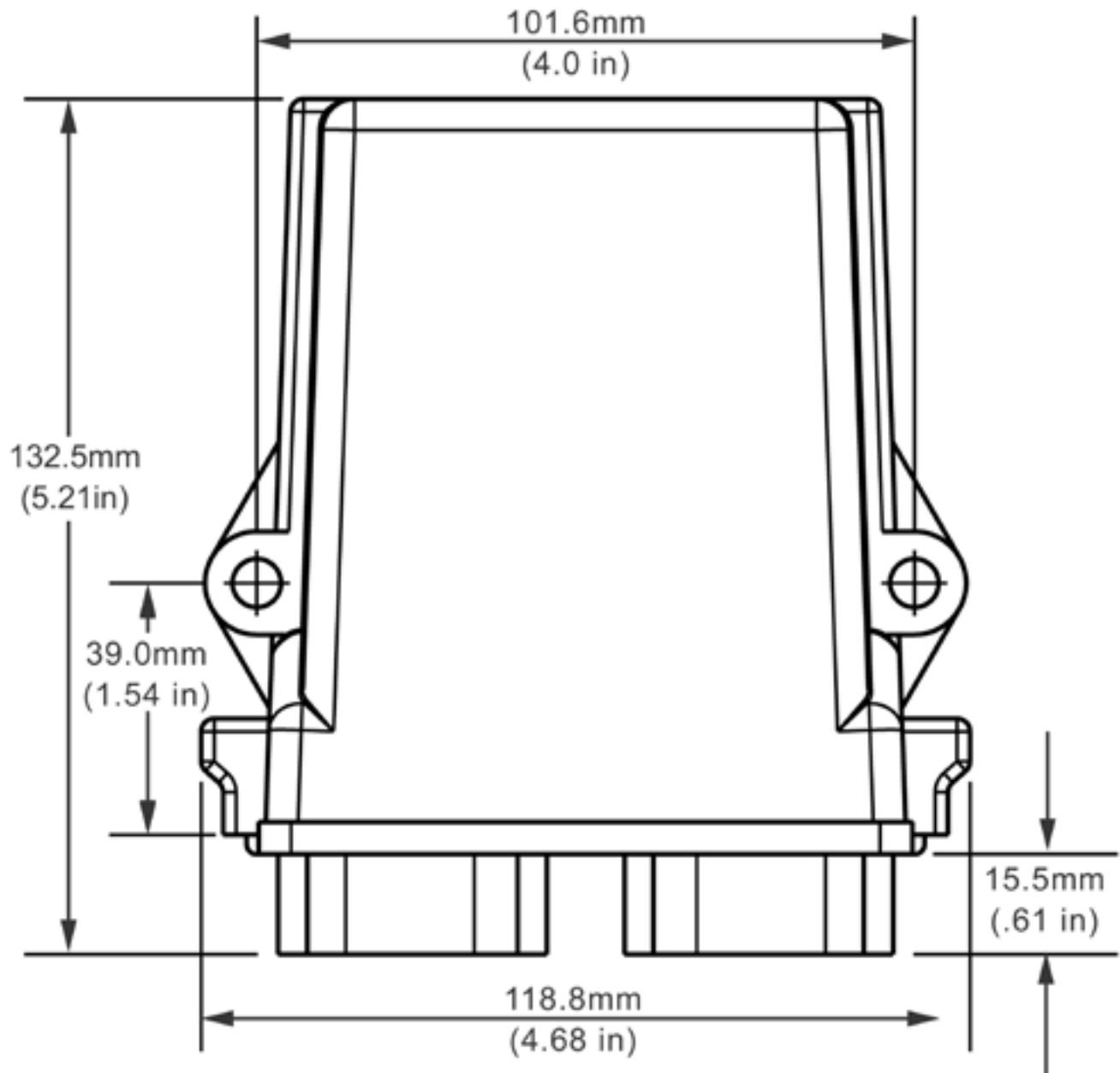

# Templates

---

*This page has been left intentionally blank.*

# Templates

## i5601E Digital Display - Front Mount

*If this template has been downloaded electronically or copied from another document, please verify all template dimensions prior to cutting as different printers/copiers may scale differently.*

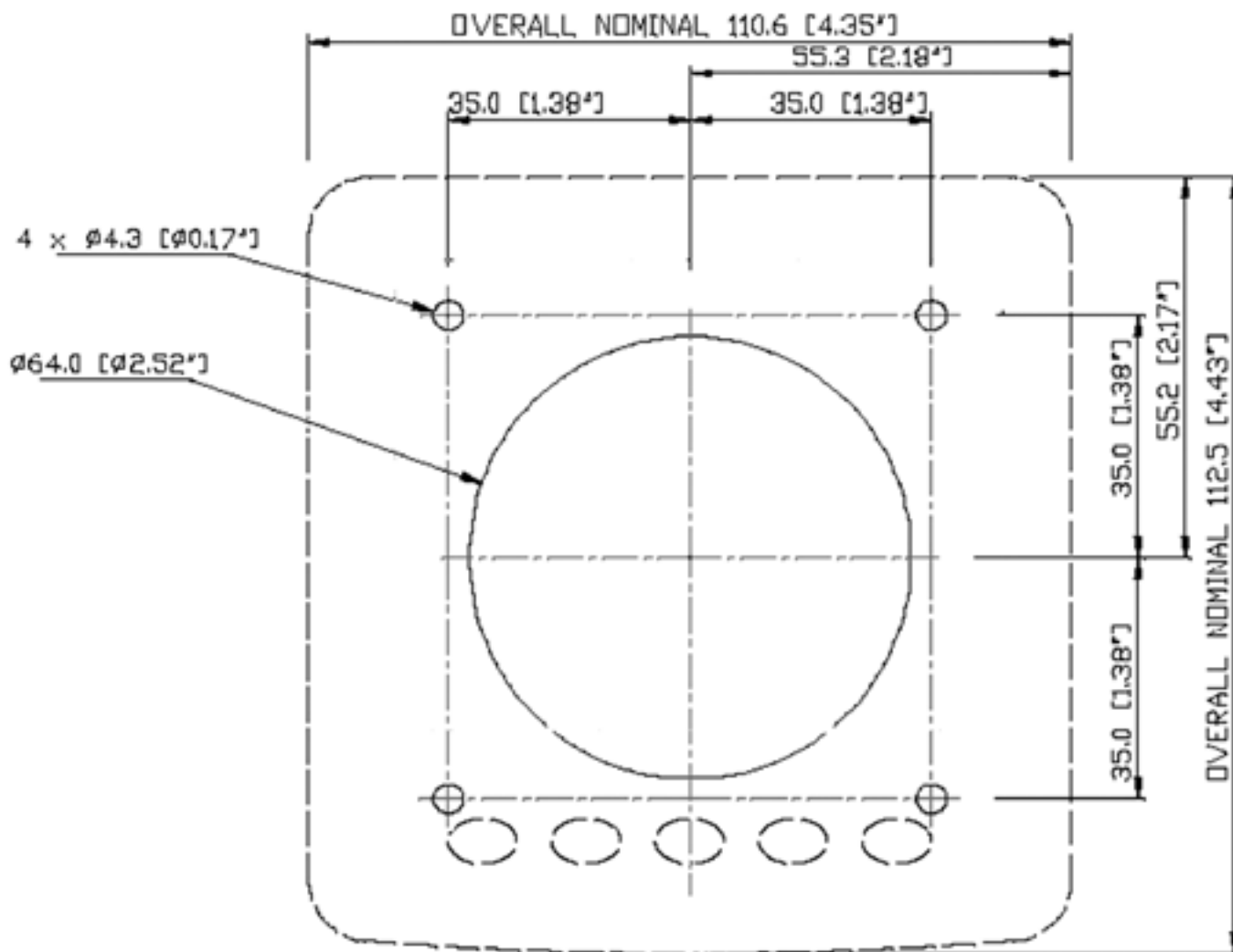

# Templates

---

*This page has been left intentionally blank.*



# Templates

## i5601E Digital Display - Rear Mount

*If this template has been downloaded electronically or copied from another document, please verify all template dimensions prior to cutting as different printers/copiers may scale differently.*

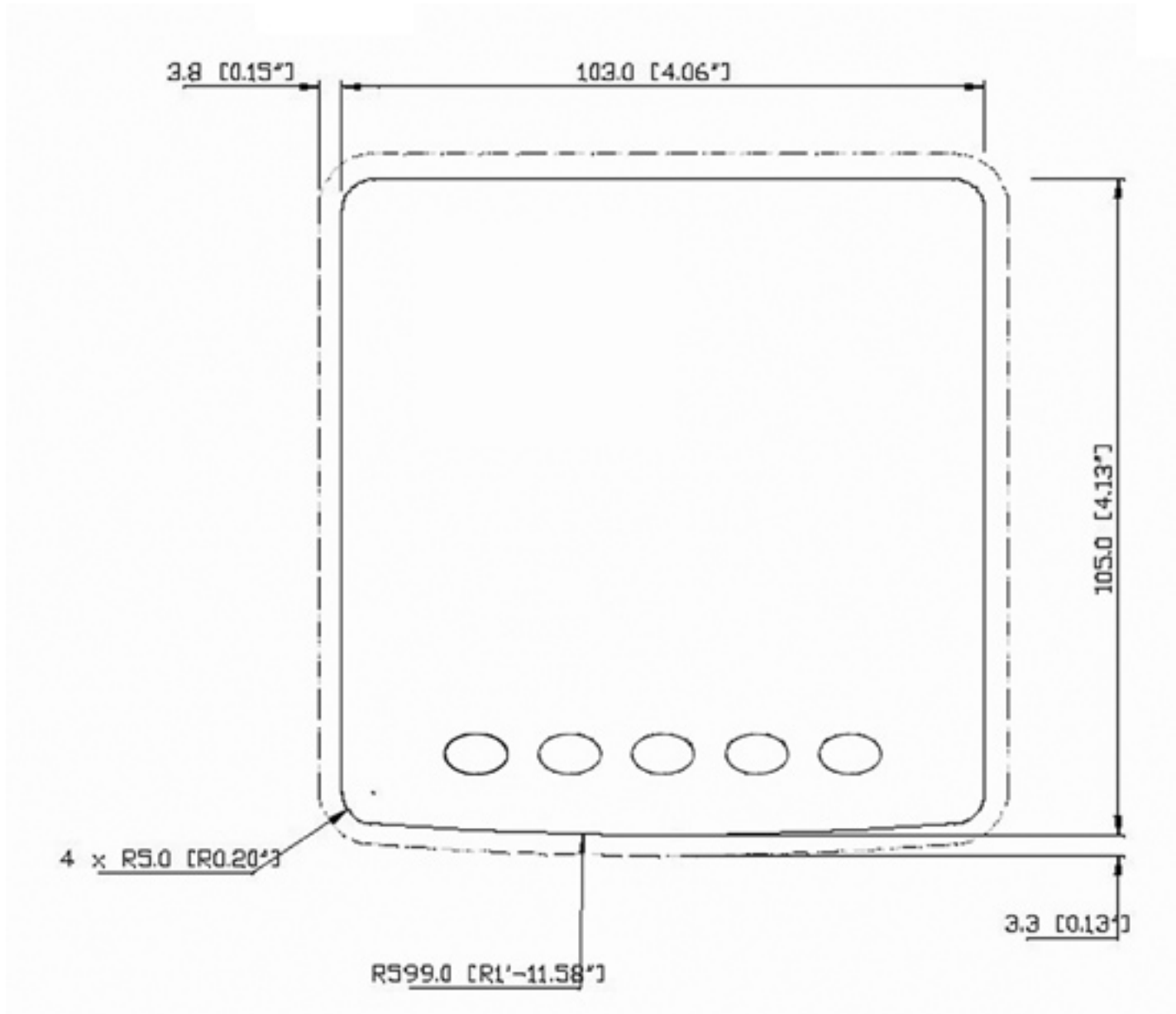

# Templates

---

*This page has been left intentionally blank.*

# Templates

## CP19500 -- Key Switch Panel

*Note: Allow 3.5 inches (88.9mm) behind the back of the CP19500 Key Switch Panel when mounting.*

*If this template has been downloaded electronically or copied from another document, please verify all template dimensions prior to cutting as different printers/copiers may scale differently.*

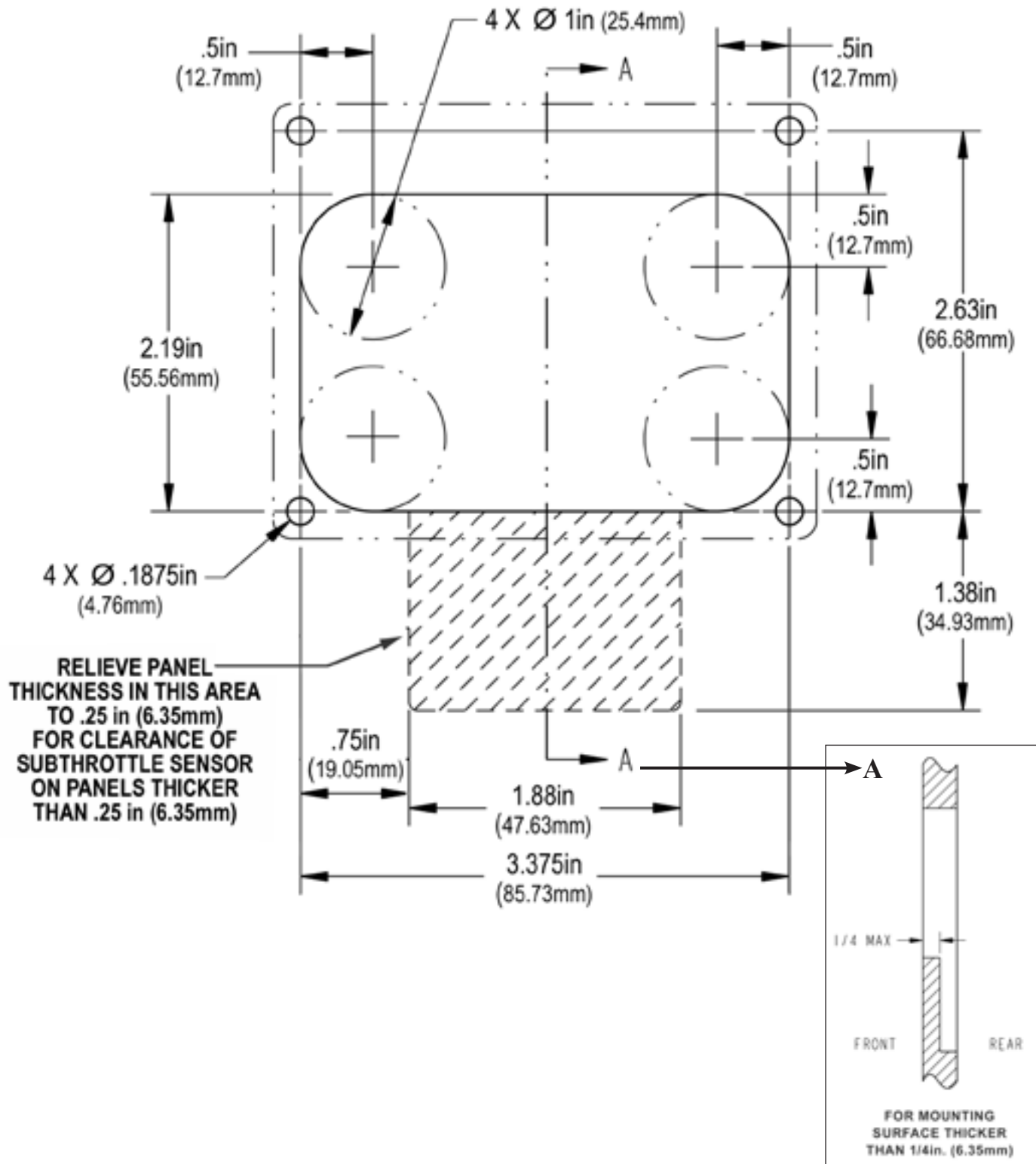

# Templates

---

*This page has been left intentionally blank.*

# Templates

## 3" Gauge with Key Cut

*Note: The 2" and 3" gauges are supplied with a locking tab and flat.*

*When installation is being done with a CNC machine, use the "with Key Cut" template. When installation is being done with a hole saw, use the "without Key Cut" templates.*

*If this template has been downloaded electronically or copied from another document, please verify all template dimensions prior to cutting as different printers/copiers may scale differently.*

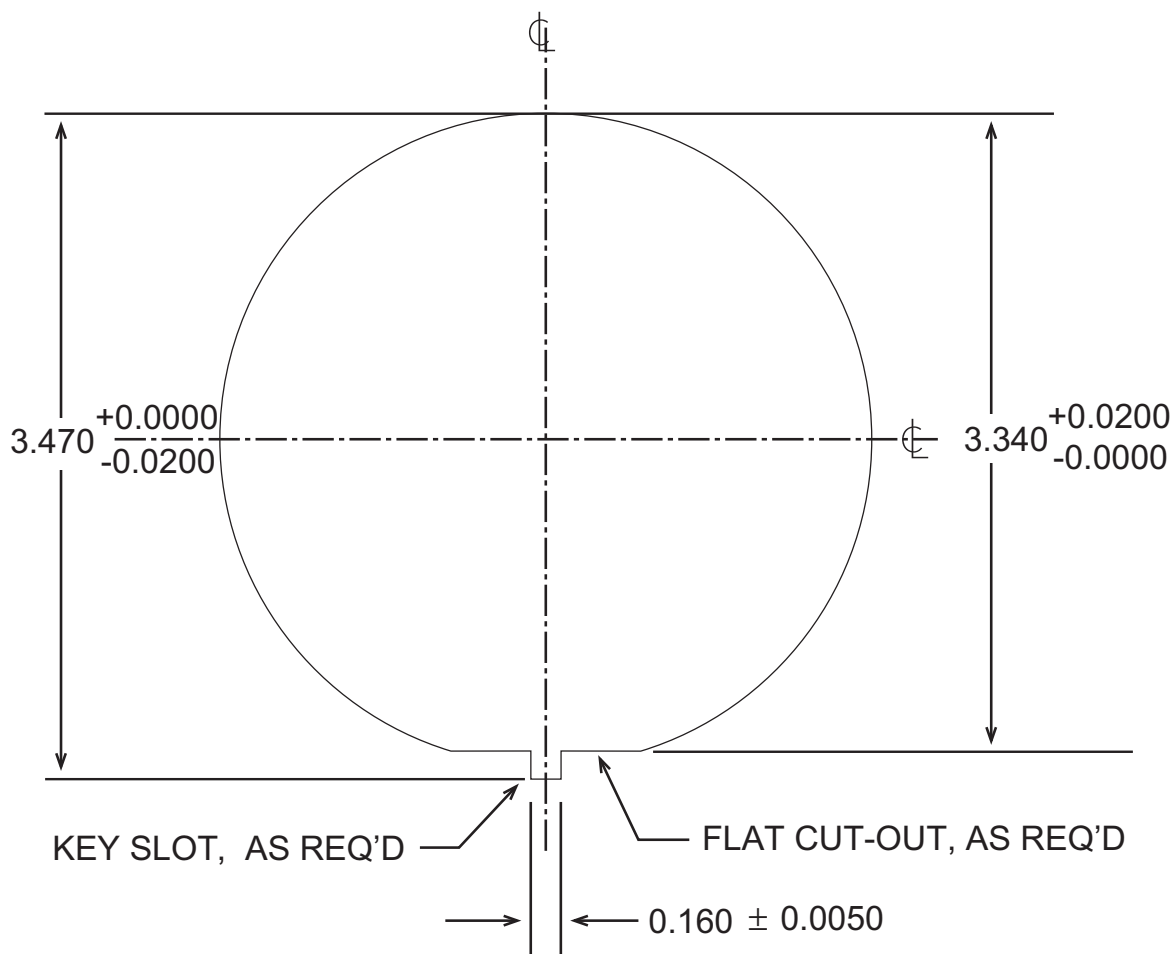

### U.S. to Metric

0.005 inches	=	0.1mm
0.02 inches	=	0.5mm
0.16 inches	=	4.1mm
3.34 inches	=	84.8mm
3.47 inches	=	88.1mm

# Templates

---

*This page has been left intentionally blank.*

# Templates

## 3" Gauge without Key Cut

*Note: The 2" and 3" gauges are supplied with a locking tab and flat.*

*When installation is being done with a CNC machine, use the "with Key Cut" template. When installation is being done with a hole saw, use the "without Key Cut" templates.*

*If this template has been downloaded electronically or copied from another document, please verify all template dimensions prior to cutting as different printers/copiers may scale differently.*

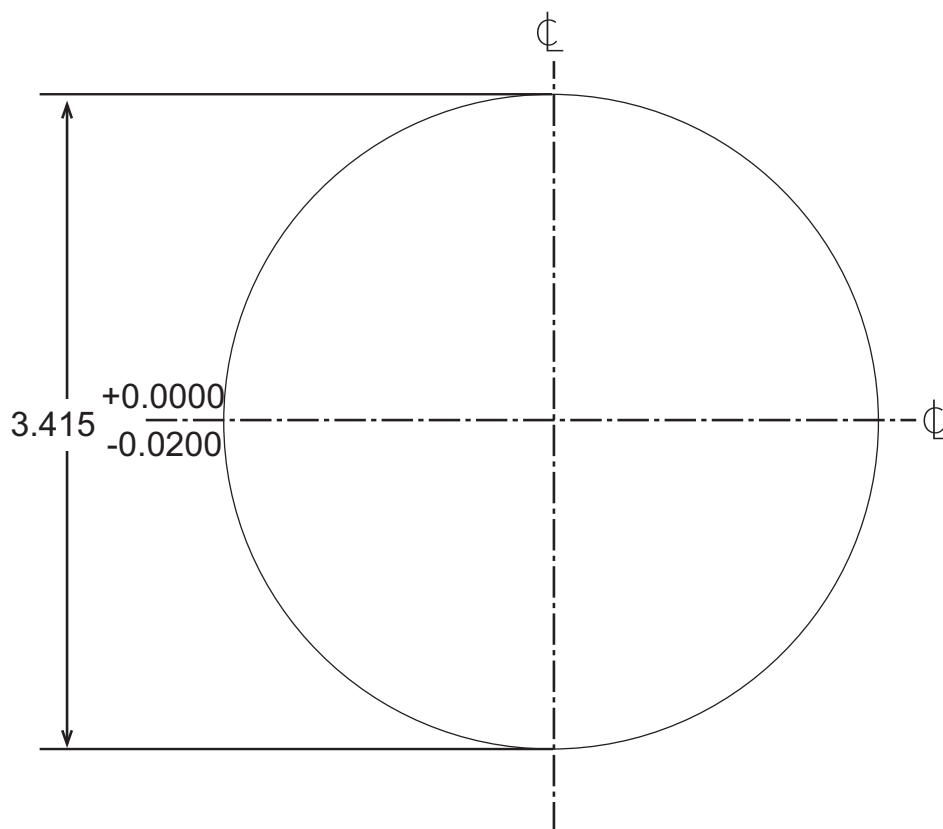

### U.S. to Metric

0.02 inches = 0.5mm

3.415 inches = 86.7mm

# Templates

---

*This page has been left intentionally blank.*



# Templates

## 2" Gauge with Key Cut

Note: The 2" and 3" gauges are supplied with a locking tab and flat.

When installation is being done with a CNC machine, use the "with Key Cut" template. When installation is being done with a hole saw, use the "without Key Cut" templates.

If this template has been downloaded electronically or copied from another document, please verify all template dimensions prior to cutting as different printers/copiers may scale differently.

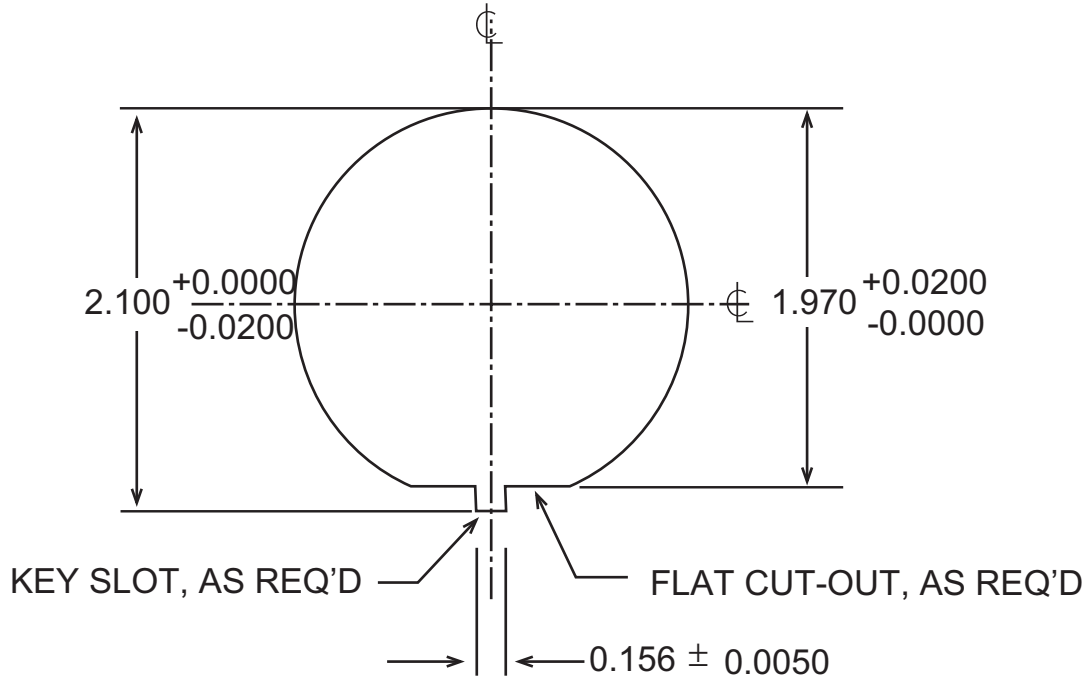

## 2" Gauge without Key Cut

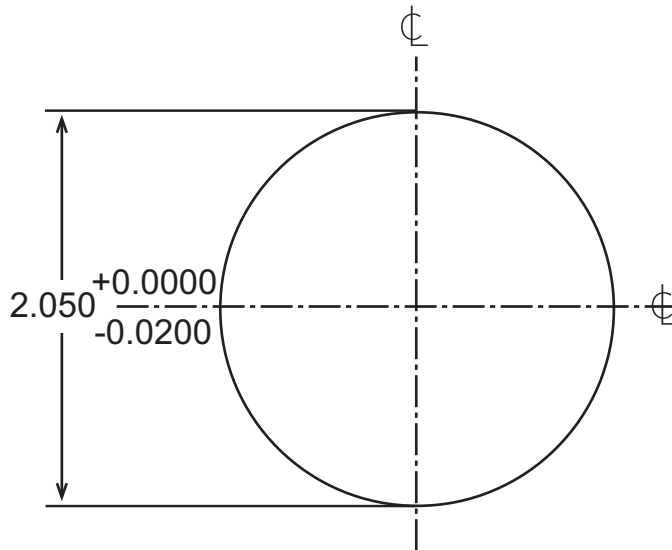

### U.S. to Metric

0.005 inches	=	0.1mm
0.02 inches	=	0.5mm
0.156 inches	=	4.0mm
1.97 inches	=	50.0mm
2.05 inches	=	52.1mm
2.1 inches	=	53.3mm

# Mounting Dimensions

AC67002 Actuator

*NOT A TEMPLATE*  
*Image NOT to scale*

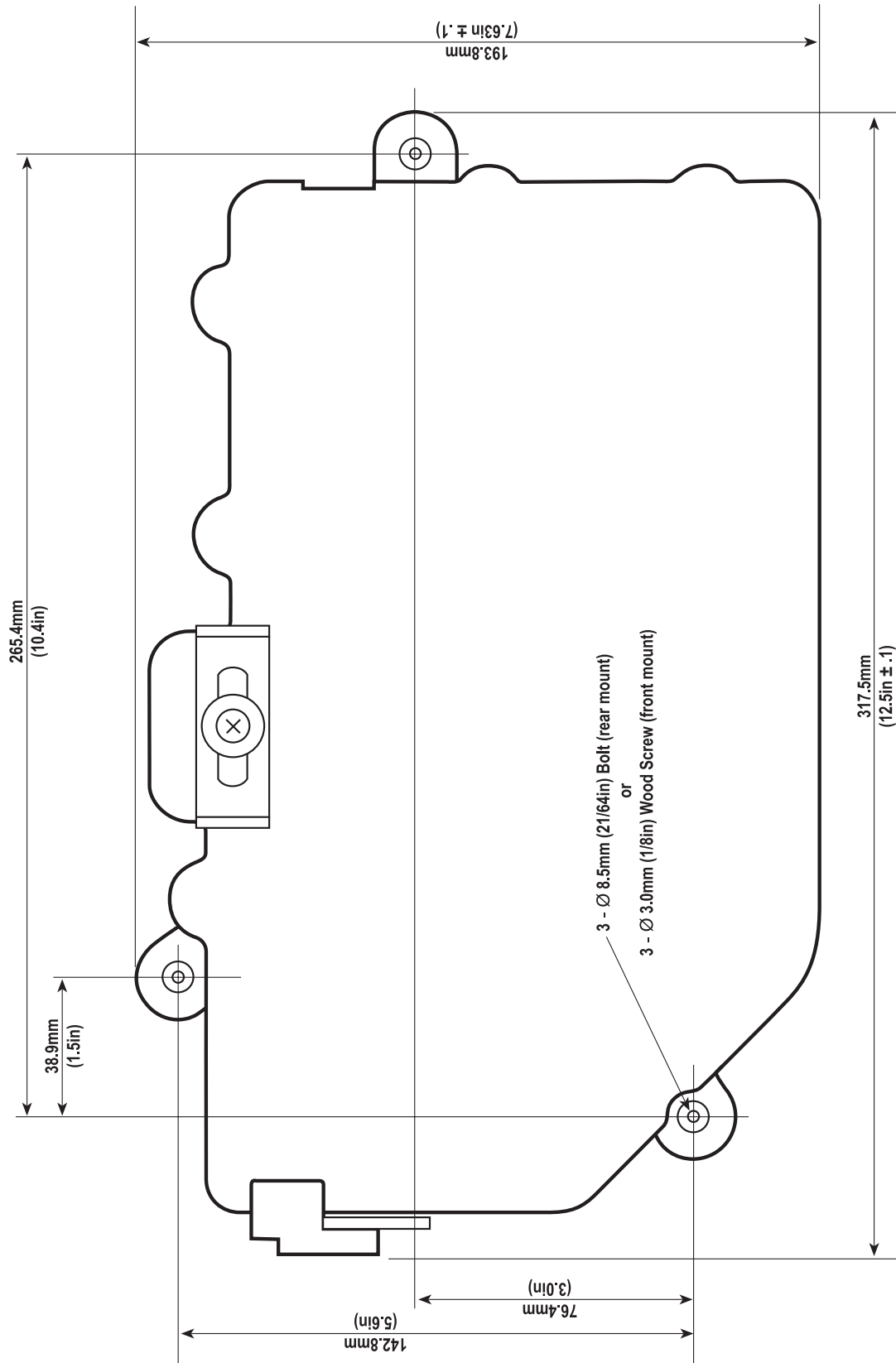

# Mounting Dimensions

## i8130/40 Engine Interface

*NOT A TEMPLATE*  
*Image NOT to scale*

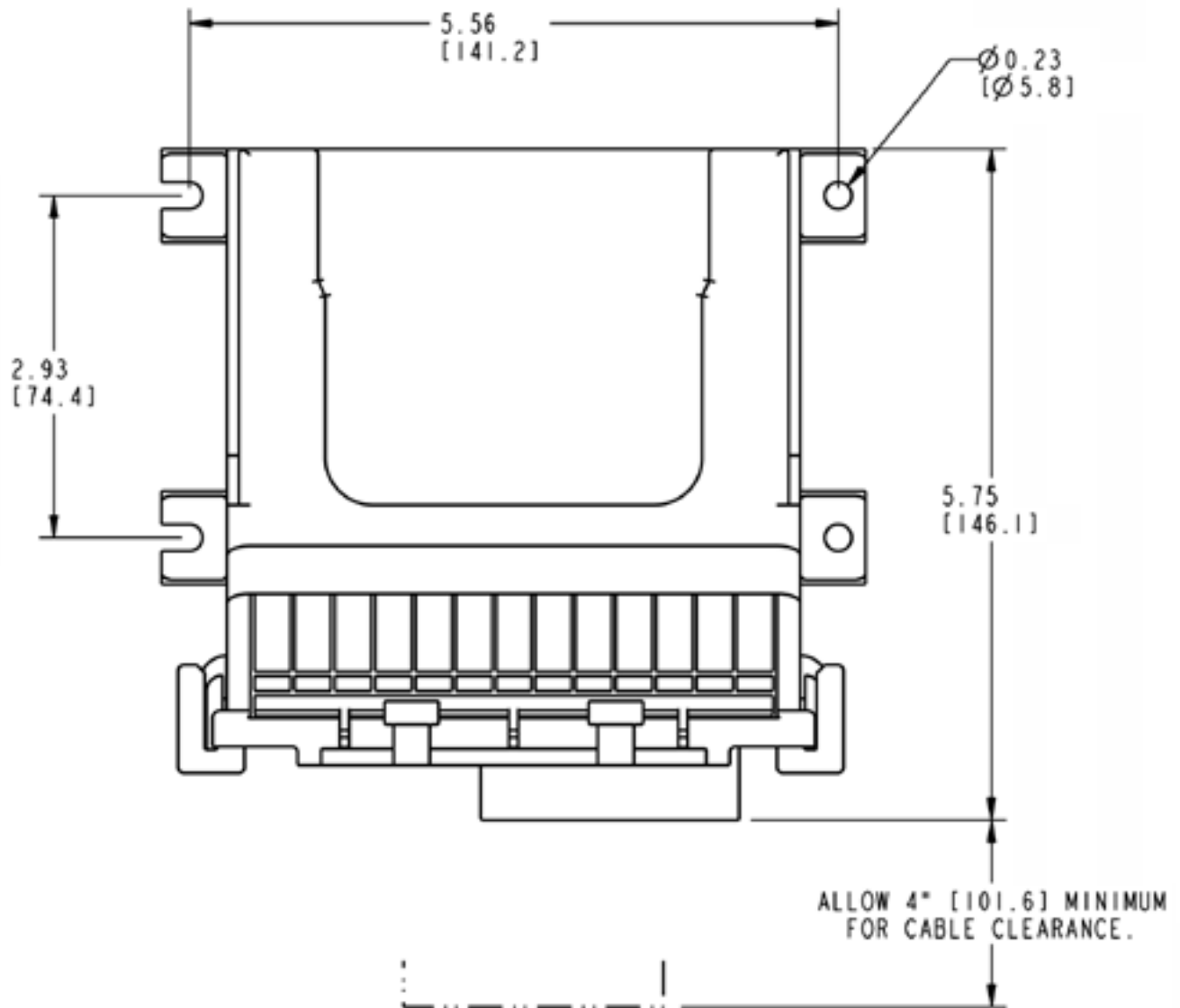

# Installation

---

## Step 10 - Check the Installation.

### *Connection Checks*

1. Ensure all connectors are plugged in and properly seated.
2. Verify that the digital display and the control head are connected to the NMEA 2000® network.
3. Make sure the CANBus “T” Connectors are not tied down too tightly, thus causing stress.
4. Check each end of the NMEA 2000® CANBus to ensure that a terminator has been properly installed.
5. Verify that the engine ignition panel is properly connected at the helm station.
6. Check Marine Gear for correct gear solenoid voltage rating. All BY Unlimited installations require 12 volt solenoid on the transmission.

### *12 Volts DC Check*

1. Turn the battery switch and the engine breaker on.
2. Test for 12 Volts DC at the starter.

### *Key Switch Check*

1. Turn the key switch to the “on” position, but do not start the engine.
2. The i5601E display comes on.

### *Module Light/Data Checks*

1. The i5601E display now shows data.
2. The Control lever should be in the neutral position; the green SEL light and yellow light should be on.

*Note: The green light will be blinking on a dual station system.*

### *i5601E Display Check*

Press the left-most key on the digital display. The data should be available.

### *Shift & Throttle Range of Motion*

Familiarize yourself with the shift and throttle control and the key switch.

### *After Checking the Installation - Boat in Operation*

After Installation and Check out is complete and with the boat operating in open water:

1. Check Neutral Start Protect to assure that the boat cannot be started in gear.
2. Check that the “Emergency Stop Switch” switch shuts off the engine when the lanyard is removed.
3. With the engine running, go to Appendix C and check the status of the CANBus.
  - The CANBus voltage should be higher than 11.5 volts.
  - The bus load should be above 0, but below 15%.
  - The error frames, per second, should be less than 5, with 0 being typical.

# Start Up

## WARNING

*In normal operating mode, the engine is started and stopped with the key switch.  
In an emergency situation, you can use the lanyard to kill all power to the engine. This will allow you to stop at once.*

Review the next pages to become familiar with the helm equipment.

Place the control lever in “neutral” and turn the ignition switch to the “on” position – *but do not start the engine.* The green control head light will illuminate.

With the control lever in “neutral,” check to see if the green light on the control head is solid or flashing. If flashing, push the “select” button to select the head. The yellow light will now come on.



## *Redundant (Back-up) Throttle*

In the unlikely event that the throttle signal is lost between the helm mounted shift/throttle control head and the engine, the system is designed to revert to the redundant or subthrottle. First, the engine would reduce RPMs to idle speed, the digital display would show “Throttle Error,” and a small red indicator light would flash at the key panel. Directly below the red light is a small potentiometer (small, knurled knob) label “subthrottle.” Turn the knob all the way to counter-clockwise in order to take control of the throttle. Then turn the knob SLOWLY to clockwise - the light will glow solid and you will have control of the throttle. When the signal loss problem has been corrected, you must shut the engine off and restart to return throttle control back to the shift/throttle control head.

For Emergency Shift of Marine Gear see Transmission Manual.

**Note:** *To use the Emergency Shift for Stern Drive, please refer to Appendix J.*

# Start Up

## *i5601E Digital Display*

When powered-up, the i5601E Digital Display will initially display an introductory screen showing the software version level. It will then display one of the following four screens:



These screens show all of the key engine data and can be accessed by pushing a single button, also called a “softkey.” The right-most softkey allows the contrast and brightness to be set (see illustration below).



# Start Up

## *Optional Tachometer and Speedometer Menu Structure*

The tachometer and speedometer menu structures (please refer to detailed diagrams on the next four pages) are set up with a Main Menu display, accompanied by their respective submenus. Successfully navigating the main and submenus depends on the familiarization and understanding of how the ENTER, UP, and DOWN buttons are pressed, and in what combination.

### *To Navigate the Menus:*

- After the “Yanmar Marine Power-on” flashes on, the screen will return to the last display viewed on shutdown. Use the up and down buttons to scroll through the Main Menu items from ENGINE DATA to SYSTEM SETUP.
- To view the submenu features under one of these Main Menu displays, press the enter button. Then use the up button to move forward and the DOWN button to move backward through the submenus.
  - Pressing the UP button at the end of the submenu scrolls directly to the first submenu item.
  - At any time you may return to the Main Menu by pressing the enter button.
  - With a bit of practice, navigating the menu should become second nature.



### *To Customize the Main Menu:*

It is possible to customize the Main Menu to better suit your boating needs.

- Scroll through the submenu until the substitute main menu item is found. Press and hold the enter button for 3 seconds. The item will be “recognized” as the new choice for the Main Menu display. You will be returned to the Main Menu with the new item displayed and the previous Main Menu item will become part of the submenu.

### *Control Button Operation*



#### *To Enter or Exit a Submenu*

- Press ENTER button at any Main Menu display to go into submenus.
- Press ENTER button at any time to exit back to the Main Menu.

#### *To Customize the Main Menu*

- Choose submenu item to replace Main Menu item, then **press and hold** ENTER button for 3 seconds. This will return you to the Main Menu, replacing the previous item with the one you just chose.

#### *To Operate the Backlight*

- Press the UP/DOWN buttons at same time (ONLY possible when in Main Menu).

# Start Up

## Tachometer Menu Structure

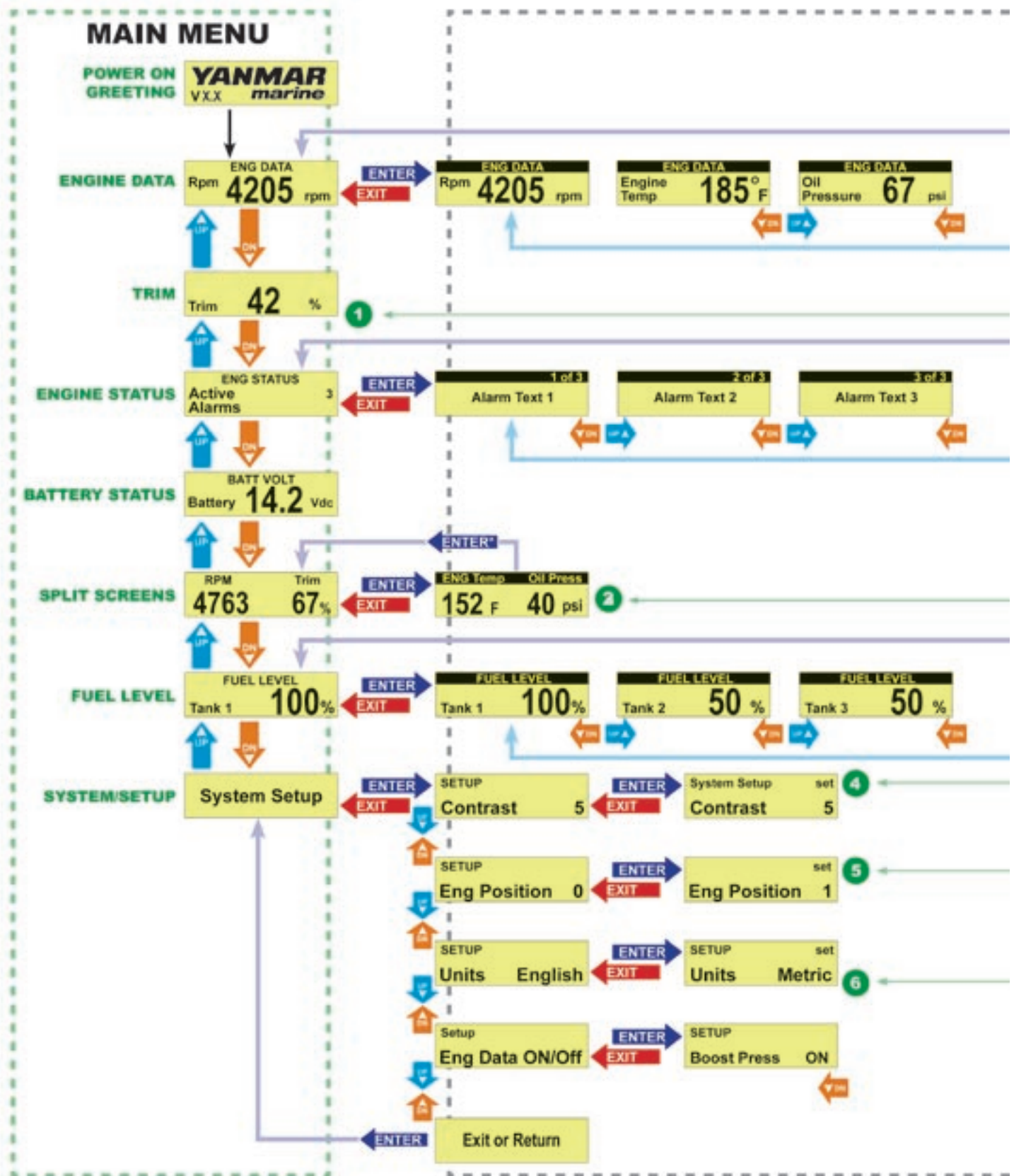



# Start Up

## Tachometer Menu Structure

### SUB MENUS

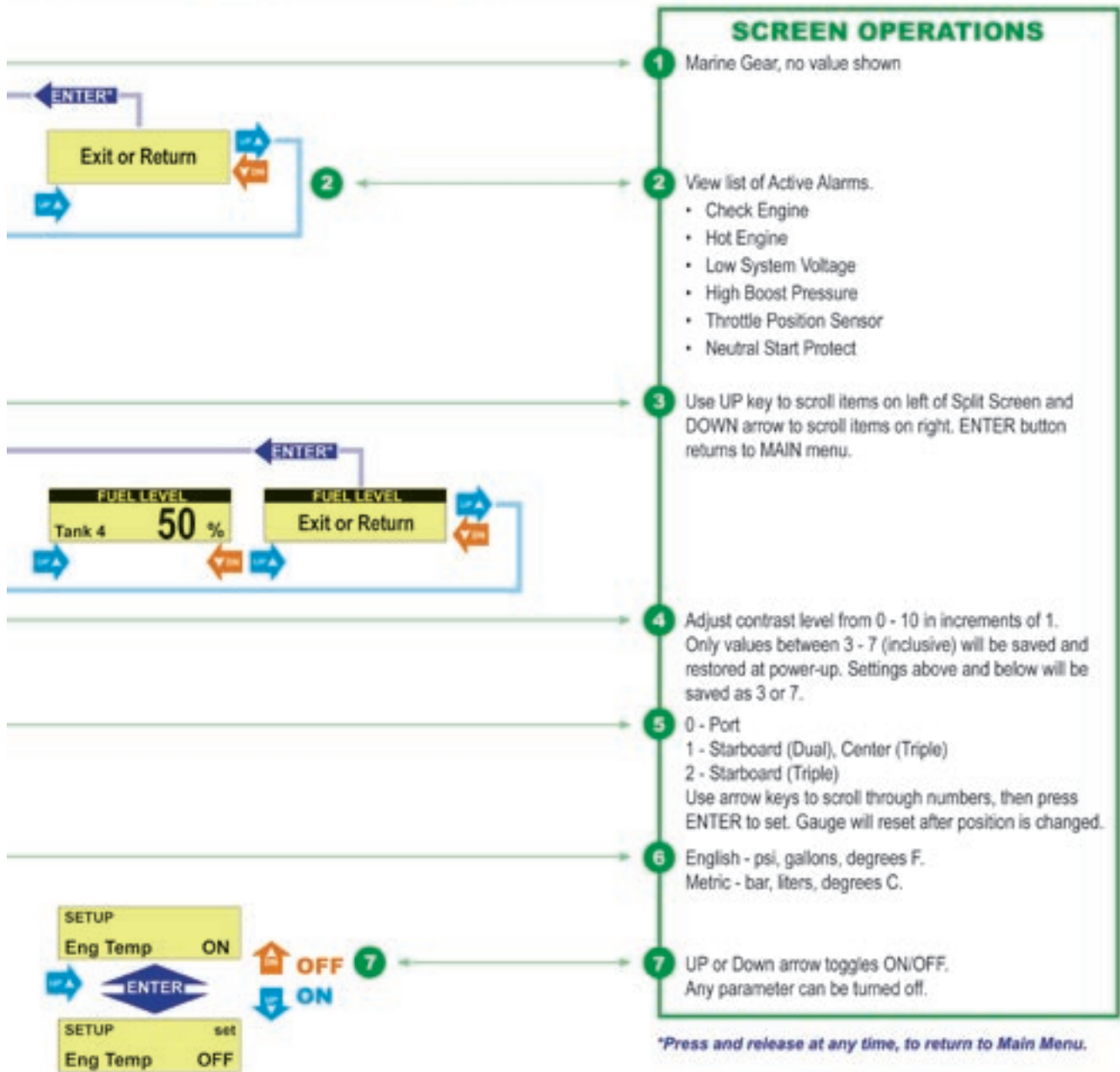
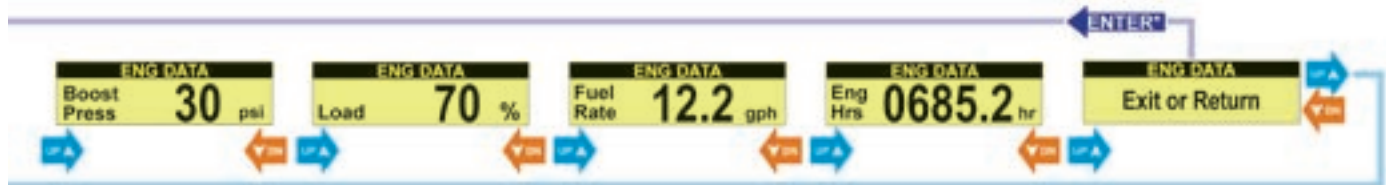

# Start Up

## Speedometer Menu Structure

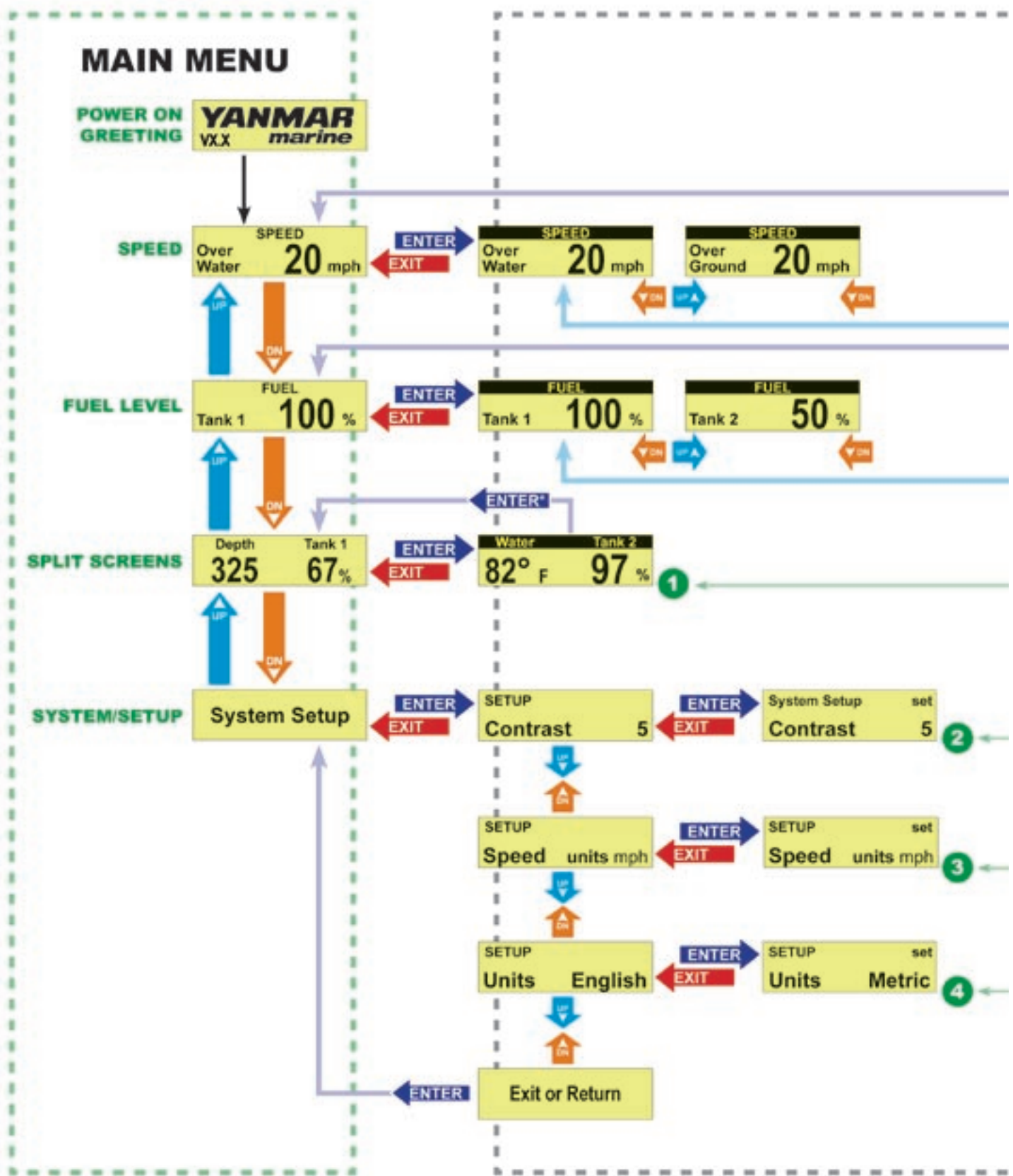

# Start Up

## Speedometer Menu Structure

### SUB MENUS

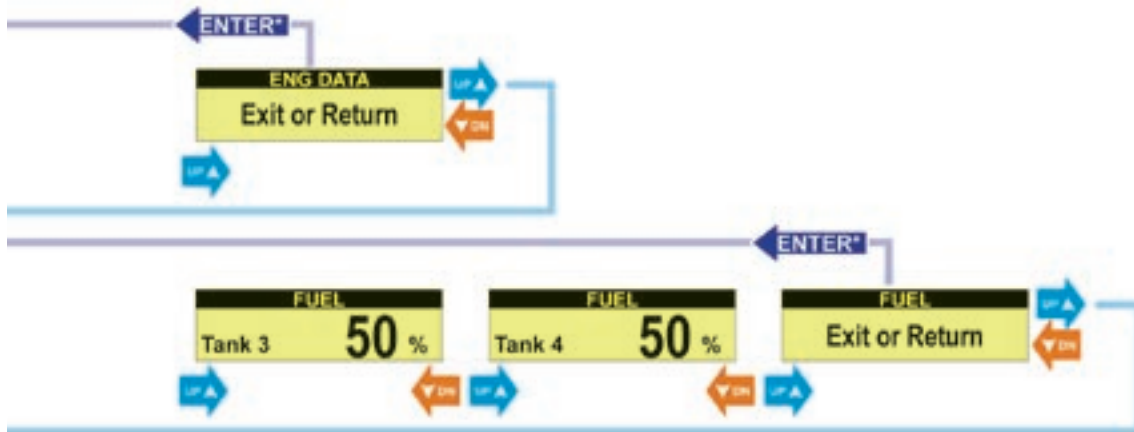

### SCREEN OPERATIONS

- 1 Use UP key to scroll items on left of Split Screen and DOWN arrow to scroll items on right. ENTER button returns to MAIN menu.
- 2 Adjust contrast level from 0 - 10 in increments of 1. Only values between 3 - 7 (inclusive) will be saved and restored at power-up. Settings above and below will be saved as 3 or 7.
- 3 kn (knots)  
mph (miles per hour)  
kph (kilometers per hour)
- 4 English - meters, degrees F.  
Metric - feet, degrees C.

*\*Press and release at any time, to return to Main Menu.*

# Start Up

## *Alarms*

In the unlikely event that an engine fault occurs, a warning box appears in the display showing the cause of the fault, and the action to take, “Press Any Key to Continue.”



Pressing any key acknowledges the alarm and immediately switches the display to the Alarms screen. The i5601E continues to beep until all alarm conditions (engine faults) have cleared. Unacknowledged alarms are shown as flashing boxes. Press any key to acknowledge alarm boxes that may still be flashing, and they will then change to a steady highlighted state.

<b>YANMAR</b> <i>marine</i>	<b>ALARMS</b>
HOT ENGINE	CHECK ENGINE
OVER REV	EMERGENCY STOP
OIL PRESSURE	LOW VOLTAGE
TURBO BOOST	ALTERNATOR
GEAR OIL	SEA WATER FLOW
ENG COM ERROR	LOW COOLANT
MAINTENANCE	WATER IN FUEL
NETWORK	MAIN THROTTLE
PWR REDUCTION	SEC THROTTLE
NEUTRAL PROTECT	SHUTTING DOWN

Alarm blocks remain highlighted as long as the alarm condition (engine fault) remains and will automatically reset to an un-highlighted state after the alarm condition has passed.

# Start Up

## *First Time Control Operation*

Various features of the electronic control system have been selected and set as part of the installation. They can be checked in Appendix D. They include:

- Max Throttle Amount in Split Range Throttle (SRT)
  - Shift Delays
  - Station Protection
1. Before starting the engines for the first time, take a moment to familiarize yourself with the shift and throttle controls. With the engines not running, move the control levers over the full range until you are familiar with the feel. Note that, on some controls, the detent pressure and drag can be adjusted using the adjusting screw on the front surface of the control head. The top screw sets the detent pressure; the lower screw sets the drag.
  2. Place the control levers in neutral and turn the ignition switches to the “On” position – *but do not start the engine*. The green control head light will illuminate.
  3. Check to see if the green light on the control head is solid or flashing. If solid, proceed to the Operations Section of this book.

## Shift & Throttle Control Head Functions

The most common Shift and Throttle Control Head comes with a dual function, single lever control. A single lever control initiates both shifting and throttle for a single engine.

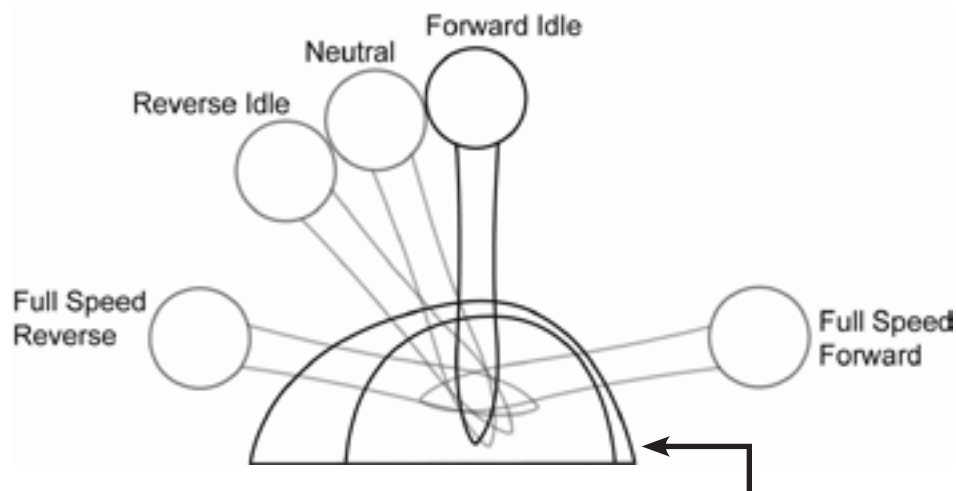

***Note that the detent pressure and drag can be adjusted using the adjusting screw on the front surface of the control head.***

# Operations

## Control Head Operation

### **WARNING**

The boat will start to move during the next steps. Be very cautious when first engaging the gears to establish that forward is truly forward and reverse is truly reverse. A quick in-and-out of gear test is recommended. Ensure that the boat is clear of all obstacles forward and aft before conducting this test.

### Identification

**Engine Trim Control**  
in the handle (optional)

**Lever Position Indicators:**

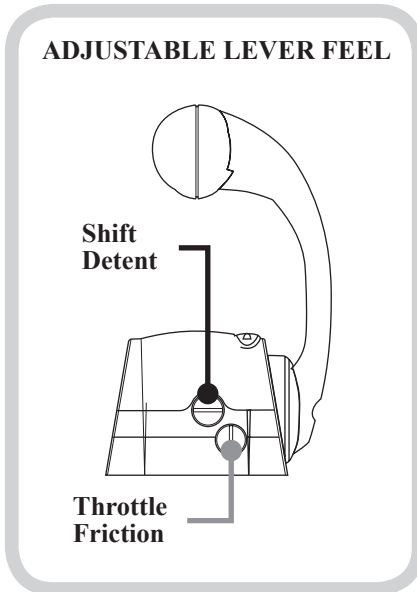

**Select/change Station:**

**NOTE:** Station Protection may be turned on. See Appendix K.

A lit **green** SELECT lamp indicates a station is active. ●

- On single station boats, station selection is automatic.
- For multi-station boats, choose a station and then press SELECT button with levers in neutral.

**to Change Stations:**

- Move to new station and press SELECT button. (**Green** lamp flashes.) ✨
- Match control handle positions with those of active station. (**Green** lamp goes steady when levers match and this station is now in control.) ●

**Indicator Dimming Feature:**

Push **SELECT** button and the lamps will dim. There are four degrees of brightness from which to choose.

**NOTE:** Indicator Dimming is only accessible from the active control station. (**Green** lamp on steady.) ●

Electronic Control System:  
Single Engine Installation Manual for BY Series Engines with Unlimited Controls

**YANMAR**

# Operations

**NOTE:** The flashing yellow N (Neutral) lamp  can indicate status of either Split Range Throttle (SRT) or Shift Disconnect (SD). Please exercise caution when engaging/disengaging either of these modes! A steady-on Neutral lamp ALWAYS indicates engine is in NEUTRAL. ●



## Split Range Throttle (SRT):

Flashing yellow N (Neutral) lamp - SRT is engaged.   
Provides greater throttle sensitivity: moving an engine's control lever to "Full Forward" will only produce the maximum percentage of WOT (Wide Open Throttle selected at set-up - typical Throttle Limit is 25%)



### TO ENGAGE SRT:

- Move engine lever to Forward Idle position.
- Press N (Neutral) button. (Yellow lamp flashes.) 

### TO DISENGAGE SRT:

- Move engine lever to Forward Idle or Reverse Idle.
- Press N (Neutral) button. The yellow N (Neutral) lamp will go out - SRT is disengaged. ○

## Shift Disconnect (SD):

Flashing yellow N (Neutral) lamp indicates SD is engaged.   
 Allows throttle without gear engagement for engine start/warm-up.

### TO ENGAGE SD:

- Move engine lever to the "Neutral" position.
- Press the N (Neutral) button. (Yellow lamp flashes.) 

### TO DISENGAGE SD:

- Return engine's lever to the "Neutral" position.
- Press N (Neutral) button. The yellow N (Neutral) lamp will go steady - SD is disengaged and the engine/transmission will now respond to lever commands. ●

# Operations

---

## System Alarms

### *Critical Alarms*

**Continuous flashing** lights on the control indicates a **Critical Alarm**. System will do a “Safe Shut Down,” and **must be serviced before further use**.

When a critical alarm occurs, the system will automatically go to the selected “Fail Safe Response” mode. The system **MUST** be shut down and restarted for most critical alarms. Some functions may operate for a time after restart. See display on Control Unit to determine cause of alarm.

If the alarm is caused by the Throttle Actuator hitting “Stop” - Wide Open Throttle (WOT) - the alarm will go away when the throttle is pulled back. **However, as with ALL Critical Alarms, the system must be serviced before further use.**

### *Non-Critical Alarms*

**Intermittent flashing** of lights on the control (five seconds flash, normal for fifteen seconds, then repeating), indicates a **Non-Critical Alarm**. Acknowledge by a power up cycle. Continue to operate and **have the system checked as soon as possible**.





# Operations

## Optional Trolling Mode

**Note: The Trolling Mode must be calibrated before trolling will operate properly. See Appendix F.**

The Trolling mode option allows the boat operator to slow the forward and aft speed of the boat for fishing. Trolling mode is achieved by the ECU electronically adjusting pressure bypass valves in the gearbox, allowing the clutches to slip.

When trolling is selected (by pressing the separate trolling switch) and the control lever is moved forward, the boat will start to move at the slowest speed. As the lever approaches 60% throttle, the boat will be close to its non-trolling idle speed. Moving the lever further forward will cause the transmission to lock out trolling and advance the throttle. The factory set defaults will limit throttle to 40%.

The trolling defaults -- as shown in Appendix D -- can be set to a variety of operating modes. Contact your dealer for details, or see technical manual.

### How to Enter Trolling Mode:

1. Move the Control Head lever to the Neutral position.
2. Start the engine if necessary. The system must see RPM in order to permit trolling mode to be entered.
3. Press the separate trolling switch. This places the system in trolling mode.
4. When you move the Control Head lever in either the forward or reverse direction, the engine RPM will remain steady, but the boat should move in the selected direction.
5. To take the boat out of the trolling mode, return the Control Head lever to the "Neutral" position and press the Trolling Switch.

**Control Lever Range of Operation**

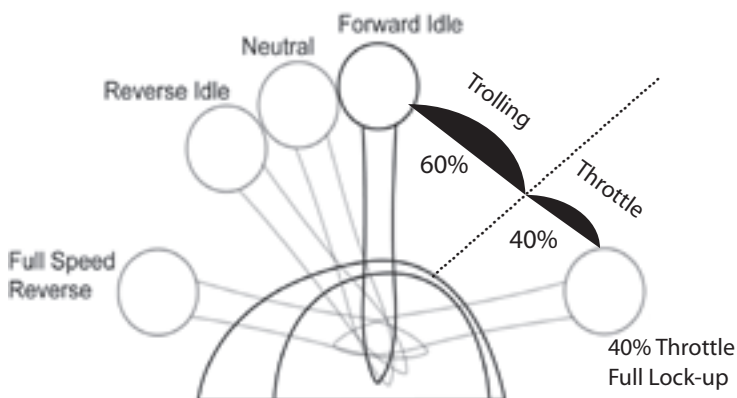

**Trolling Switch**



# Operations

## *i5601E Digital Display Alarms/Engine Diagnostic Codes*

Basic i5601E operation uses the keys shown on page 44. This page and Appendix A show more advanced operation.



Performs the function indicated by a pop-up menu, if present.

With no pop-up menu showing, briefly press to display the "Lighting & Contrast" menu.

With no pop-up menu showing, press and HOLD to display the MAIN MENU.

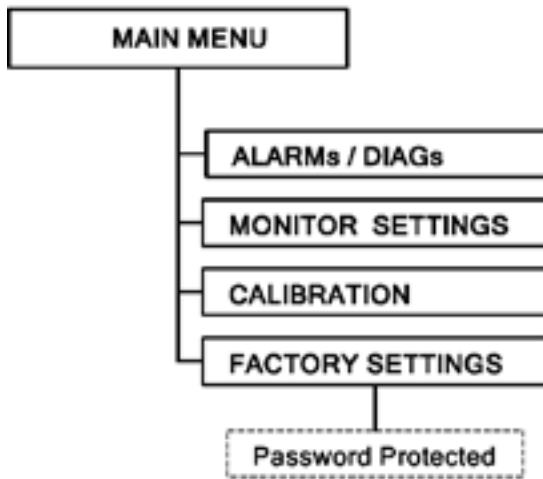

### **Buttons:**

 "Down" Arrow moves menu selection down.

 "Up" Arrow moves menu selection up.

 "Right" Arrow acts on current menu item.

 "Back" moves back to previous menu.

### **Engine Alarms/Diagnostic Codes**

The ALARMS / DIAGs Screen Menu allows the user to go to the Alarm or Diag Code Screen. This is very useful in the HOT KEY Mode (see page 59), as a dedicated hot key is not required to view these screens. The User can hold the right-most key down to go into the menu, and then via this menu, access the desired screen.

# Appendix A

## *i5601E Digital Display Setup*

The i5601E was set up at the factory with the keys assigned and locked as shown on page 44 of this manual. This mode is the default mode and allows start up and operation of the engine. It serves many applications quite well. The i5601E Digital Display unit has many additional features and capabilities. This section of the book shows the use of some of these features.

Changing the basic set up is typically accomplished in one of two ways.

1. Go to the systems menu and alter basic selections
2. Enable the right arrow key (5) on the basic screens to allow changing of the data shown in the default displays.









To enter the Main Menu press and hold key 5 until the menu appears.

To move around the menus use the softkeys at the bottom of the screen. The function of a particular softkey changes from screen to screen to whatever is most appropriate for the given screen.



Keys 1 2 3 4 5

**NOTE:** Any changes to the setup menus may require reconfiguring the i5601E HOT KEY SETUP.

-  **BACK** Returns you to the previous menu or screen.
-  **-** Decreases the setting of a selected menu item.
-  **↓** Moves the cursor arrow down to select the next menu item in a list.
-  **EXIT** Exits the current menu and returns you to the prior screen.
-  **+** Increases the setting of a selected menu item.
-  **MORE** Reveals additional keys and swaps them with those currently shown.
-  **ON OFF** Toggles the operational status of a currently selected menu item.
-  **↑** Moves the cursor arrow up to select the previous menu item in a list.

# Appendix A

## Display Settings



The Monitor Settings Menu allows setting of parameters that are specific to the display unit. Some settings such as Language and Lighting will be communicated to the other displays.

### *Display Description*

### *Function*

MENU HOT KEYS LOCK	Controls the actions of the keys
UNITS	Sets a variety of units to suit the operator
LANGUAGE	Sets the language the unit will display
TACH RNG 0-5000	Sets the tach range
SPEED	Allows adjustments to speed readings if available
DEPTH OFFSET	Allows adjustments to depth readings if available
DEFAULT MONITOR	Returns the unit to the default settings
BEEPER ON	Turns the key beeper on and off
ABOUT	Supplies information about the display

## Menus

This menu controls the key functions. There are three choices.

1. When the Pop-Up Menu feature is selected (drawing at right), the unit functions like a typical computer. A key push brings up a menu and you then use the keys to make a series of selections. This is the mode that allows new screen set ups to be selected and any screen to be accessed.
2. The Hot Key Locked selection allows keys 1, 2, 3, and 4 to be assigned as favorite screens. Pushing the key immediately brings up the selected screen. This mode will not display the right arrow over key 5. Thus the screens are locked when this is selected. This is the factory default setting.
3. The Hot Key selection allows keys 1, 2, 3, and 4 to be assigned as favorite screens. Pushing the key immediately brings up the selected screen. This mode will display the right arrow above key 5. That arrow allows the user to select various data inputs in the various sections of the screen.

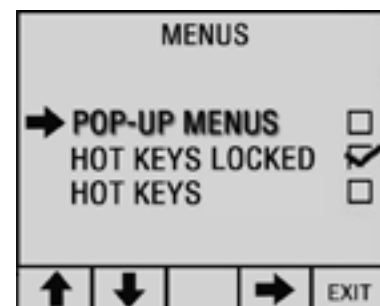

# Appendix A

## User Settings and Factory Settings

- The factory settings require a password to change.

### “Unlocking” the Hot Keys

This is a popular way to expand the use of the i5601E. To unlock the hot keys and allow for additional data selections go to the Main menu, as described on page 57. Select MONITOR SETTINGS, then select HOT KEYS. Exit the menu back to the normal operating screens. You will see a right hand arrow above key 5 when any key is pressed.

The Right Arrow button changes the menu to allow selection of each block. Pressing a block key will cycle through the choices listed on the next page. The choices are presented in alphabetical order. Bold items are the default settings and will appear initially unless replaced by another listed item.

Example using a quad screen:

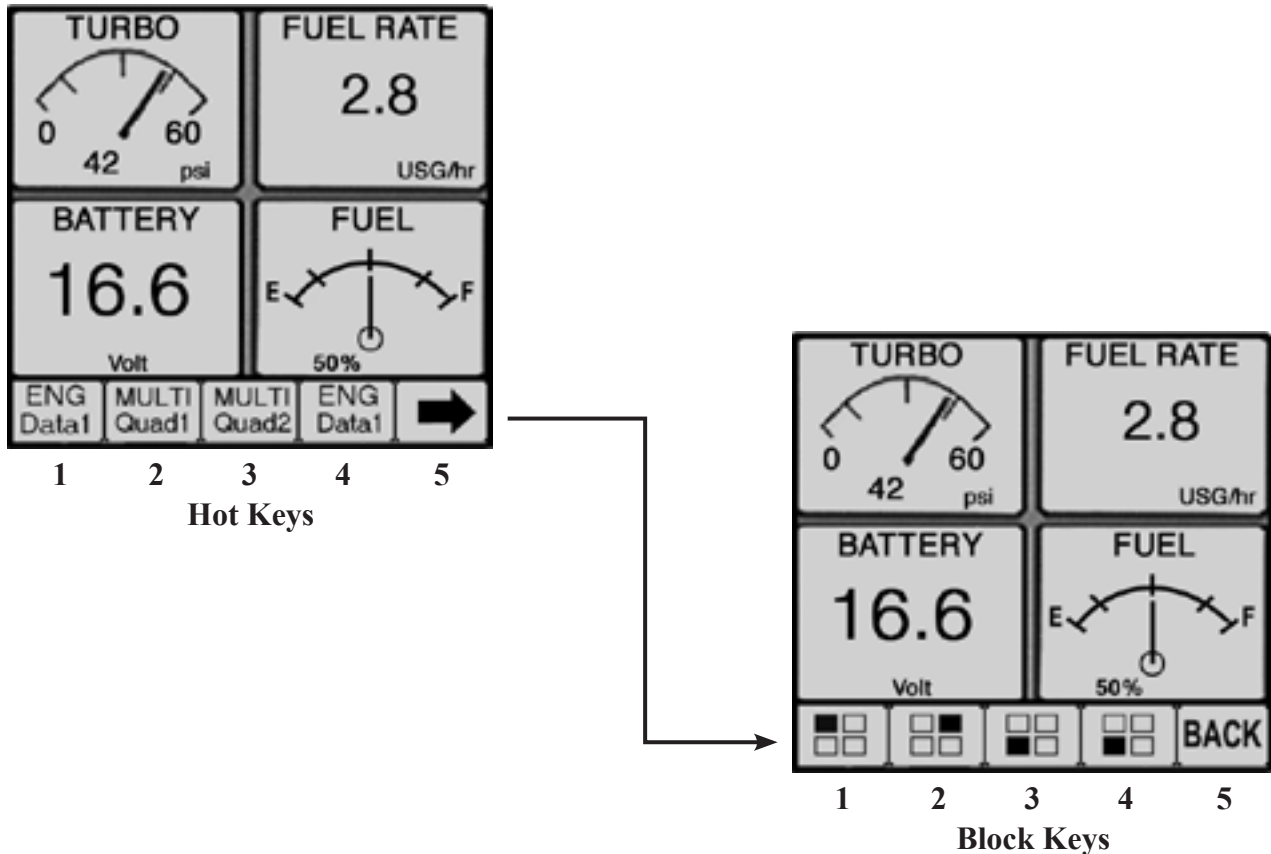

Each button cycles the related block through the list on the next page.

**Note:** Data in NMEA 2000® format may be added to the CANBus system from a compatible device which feeds the optional parameters listed above. The i5601E display has the capability of displaying additional information as other devices with NMEA 2000® communication capabilities are added to the vessel.

# Appendix A

## *Quad Screen Parameters*

These data choices can be placed in any box of a quad screen or in the two small boxes of an engine data screen: The screen headings that are included in a standard (default) set-up are noted in **bold**.

<i>Screen Heading</i>	<i>Function</i>	<i>Typical Data Source</i>
<b>Battery</b>	Battery Voltage	Engine
Bearing	Bearing to Waypoint	GPS
COG	Course Over Ground	GPS
<b>Coolant</b>	Engine Coolant Temperature	Engine
Depth	Depth of the water	Sonar
<b>Fuel Rate</b>	Fuel level if single engine	Sender
<b>Fuel Tank 1</b>	Fuel level in Tank 1	Sender
Fuel Tank 2	Fuel level in Tank 2	Sender
Fuel Tank 3	Fuel level in Tank 3	Sender
Fuel Tank 4	Fuel level in Tank 4	Sender
Gear	Indicates the selected gear	Engine
Heading	Current vessel heading	Compass
<b>Hours</b>	Actual Engine Hours	Engine
<b>Load</b>	Percent load on engine	Engine
Network	Network voltage	Engine
<b>Oil Pressure</b>	Engine Oil Pressure	Engine
Oil Temperature	Engine Oil Temperature	Engine
<b>RPM</b>	Engine Revolutions Per Minute	Engine
Rudder	Rudder Angle	Sender
Sea Temp	Sea Water Temperature	Sender
SOG	Speed Over Ground	GPS
<b>Speed (SOW)</b>	Speed through the water	Sender
Tab Port	Position of the Port Trim Tab	Sender
Tab Stbd	Position of the Starboard Trim Tab	Sender
Trim Port	Port Engine Trim	Sender
Trim Stbd	Starboard Engine Trim	Sender
<b>Throttle</b>	The percent of throttle currently selected	Engine
Torque	The percent torque the engine is developing	Engine
<b>Turbo</b>	The amount of turbo boost pressure	Engine
Waste	The amount of waste in the holding tank	Sender
Water	The amount of water in the water tank	Sender
WP Dist	The distance to the selected waypoint	GPS
XTE graph	The cross track error from a best source	GPS
XTE value	The cross track error from a best source	GPS

# Appendix B

## i5601E Menu Navigation

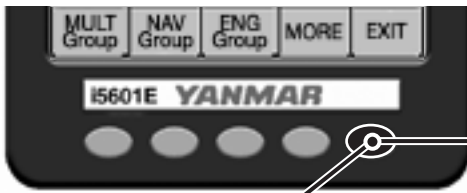

Performs the function indicated by a pop-up menu, if present.

With no pop-up menu showing, briefly press to display the “Lighting & Contrast” menu.

With no pop-up menu showing, press and **HOLD** to display the MAIN MENU.

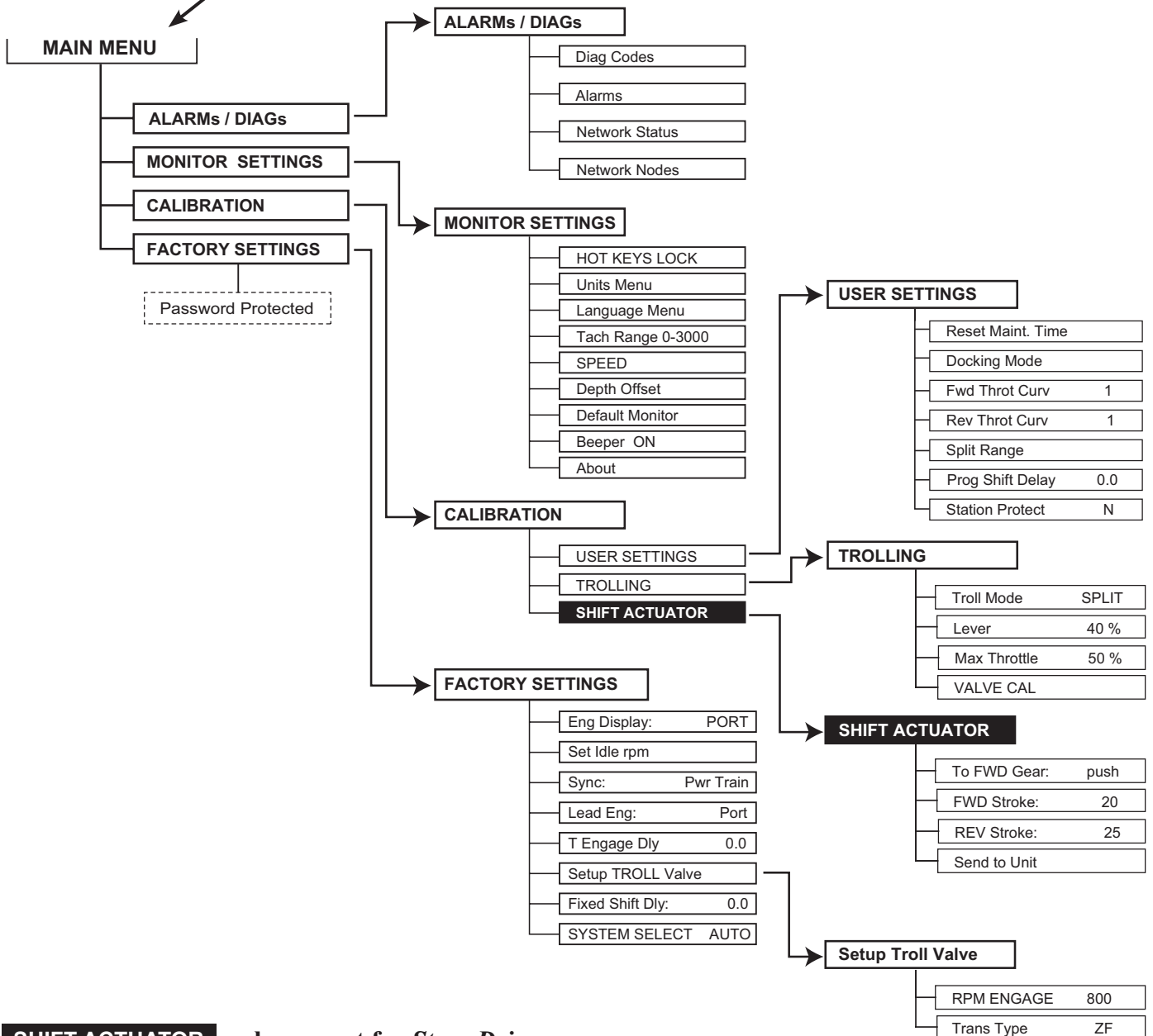

**SHIFT ACTUATOR** only present for *Stern Drives*

# Appendix C

## Network Status

The i5601E has several screens to help technicians diagnose errors on the NMEA 2000® Data Bus. See i5601E Operation on pages 57 and 58 and Menu Navigation on page 61 to locate this screen.

### Network Status Display

Accesses the Network Status Display Screen. The purpose of the display is to show details of the Network and allow determination of Network Problems. (The values are constantly monitored and do not rely on the screen being displayed.)

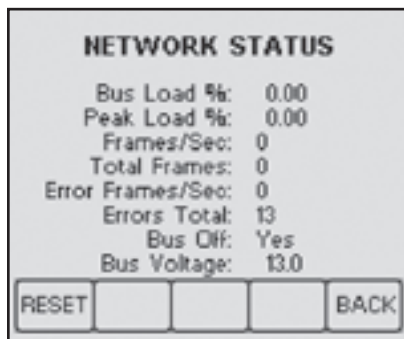

Bus Load:	Current bus load over 1 sec
Peak Load:	Peak Load since last Reset
Frames/Sec:	Current frames transferred over 1 sec
Total Frames:	Total number of frames received since last Reset
Error Frames/Sec:	Error frames over 1 sec
Errors Total:	Total Number of errors received since last Reset
Bus Off	If YES, indicates unit is not Transmitting on Bus
Bus Voltage:	Measured Value of Bus Supply

#### Buttons:



“Reset” - Resets the various parameters that have accumulated values



“Back” - Moves back to previous menu

### Network Nodes Display

The Network Units Display shows Yanmar and Teleflex units that have claimed an address on the bus. From the information in the claimed message name (Device Class, Function, and Instance Fields) the type of model number of the unit will be determined. (The specific model may not be indicated, but it will give a general model of the type of the unit.) i.e. i813x.

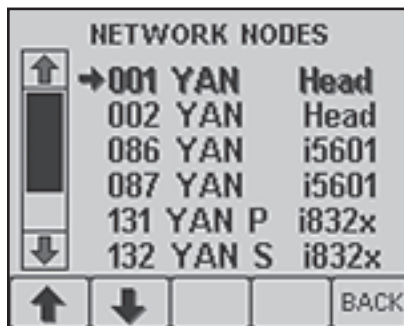

The information displayed consists of:

- Node Address
- Manufacturer's Code - (All mfg's codes will be shown, but only Yanmar and Teleflex units will show the mfg's name)
- Manufacturers Model Info - On some units the ending letter signifies the following: P - Port  
S - Starboard  
C - Center Engine

#### Buttons:



“Down” Arrow moves menu selection down.



“Up” Arrow moves menu selection up.



“Back” moves back to previous menu.



# Appendix D

## *Yanmar BY Unlimited Default Settings: Single Engine*

For stern drive configuration, the engine interface part number is i8130. For marine gear the part number is i8140.

### *Stern Drive*

<i>Engine Interface part number</i>	<i>i8130</i>
Idle RPM	not adjustable
Split Range Throttle	25%
Forward Throttle Curve	F1
Reverse Throttle Curve	R1
Programmable Shift Delay	4.8
Fixed Shift Delay	0
Station Select Protection	Off

### *Marine Gear*

<i>Engine Interface part number</i>	<i>i8140</i>
Idle RPM	not adjustable
Troll Trans Type	ZF80
Troll Engage RPM	800
Split Range Throttle	25%
Forward Throttle Curve	F1
Reverse Throttle Curve	R1
Programmable Shift Delay	4.8
Fixed Shift Delay	0
Station Select Protection	Off
Troll Mode*	Full
Troll Lever Travel	60%
Maximum Throttle in Troll Mode	40%
Troll Throttle Engage Delay	0.2

**Note:** *A system reset may be needed for some changes to take effect.*

*\*Troll Mode functions are not displayed until Troll Mode is selected.*

# Appendix E

## Transmission Connections

### ZF80 Transmission Connections without Trolling

See Appendix H for connection details.

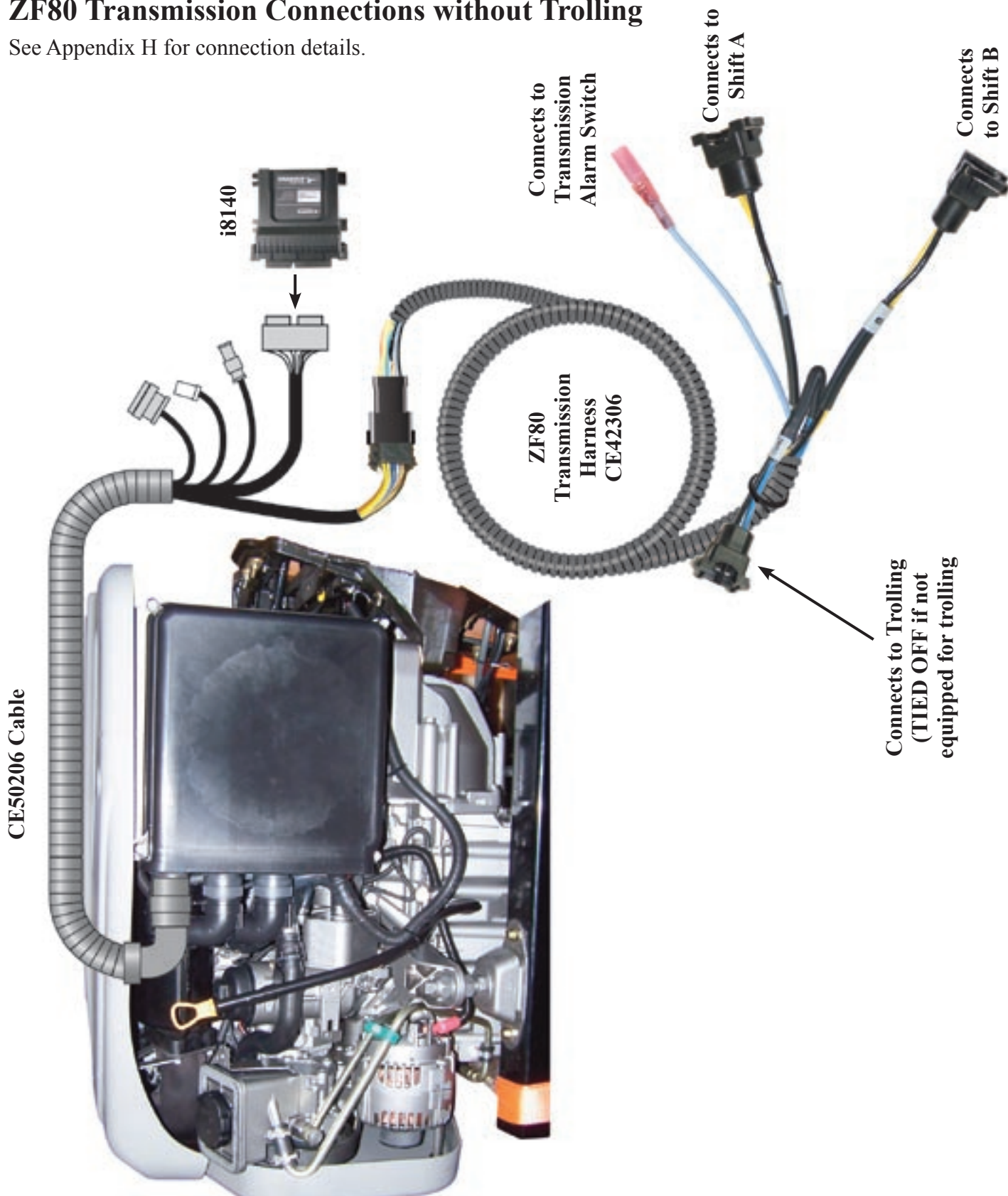

# Appendix E

## Transmission Connections

### ZF80 Transmission Connections with Trolling

See Appendix H for connection details.

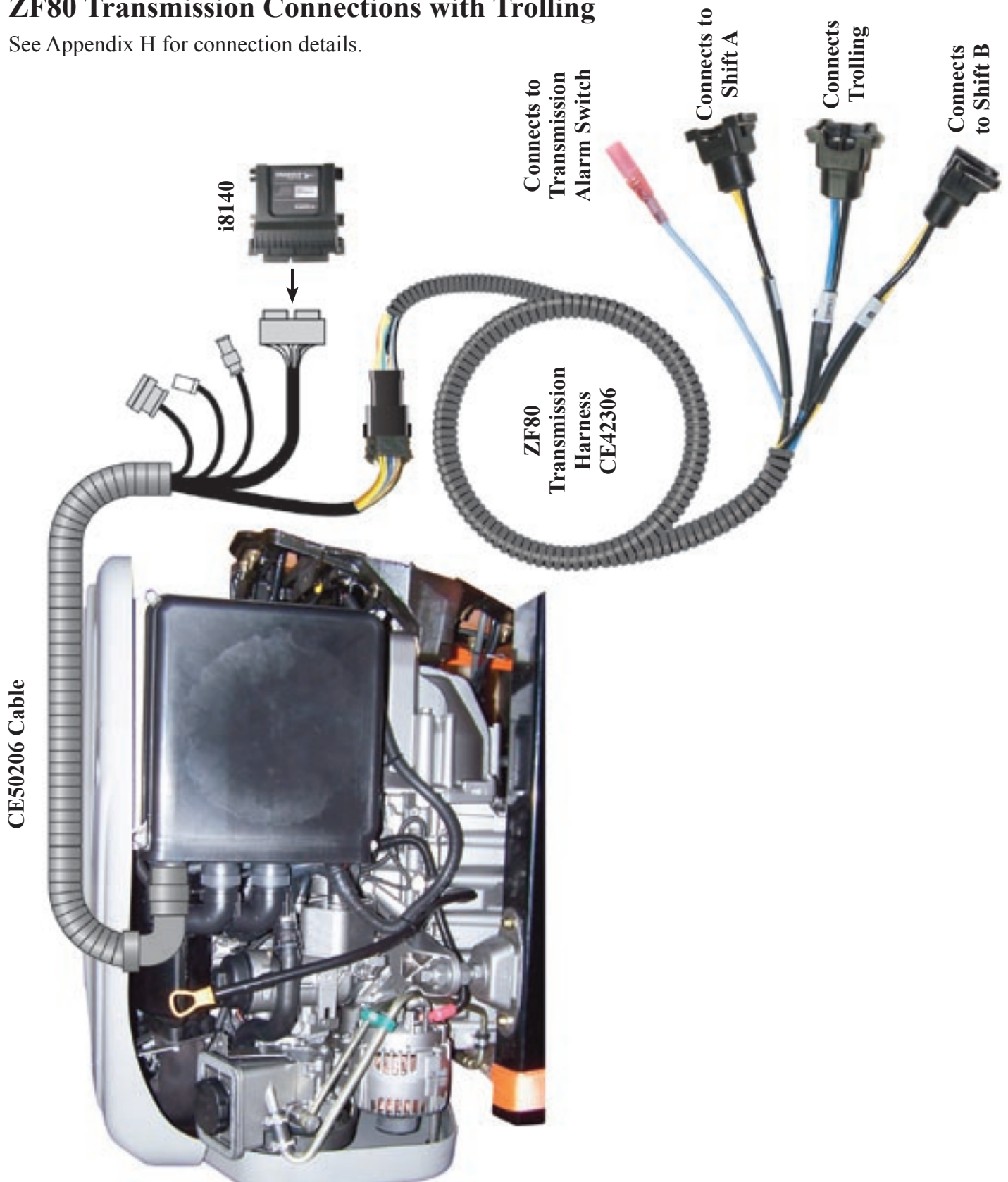

# Appendix F

## Trolling Option

### Trolling Calibration

All Trolling systems require set-up prior to initial use.

*The transmission **MUST** be fully warmed up and at normal operating temperature prior to calibration.  
Proper set-up calibration can only be achieved when the boat maneuvers  
are caused by the action of the propeller.  
Setting calibration during windy, strong current or rough water conditions  
may not result in the most favorable calibration.  
**CAUTION:** Trolling engagement should be performed only during safe conditions.*

### Calibrating Trolling

Go to the Digital Display and hold the right most key down until the Main Menu appears (about 5 seconds). Using the below information navigate the menu down to Trolling Calibration.

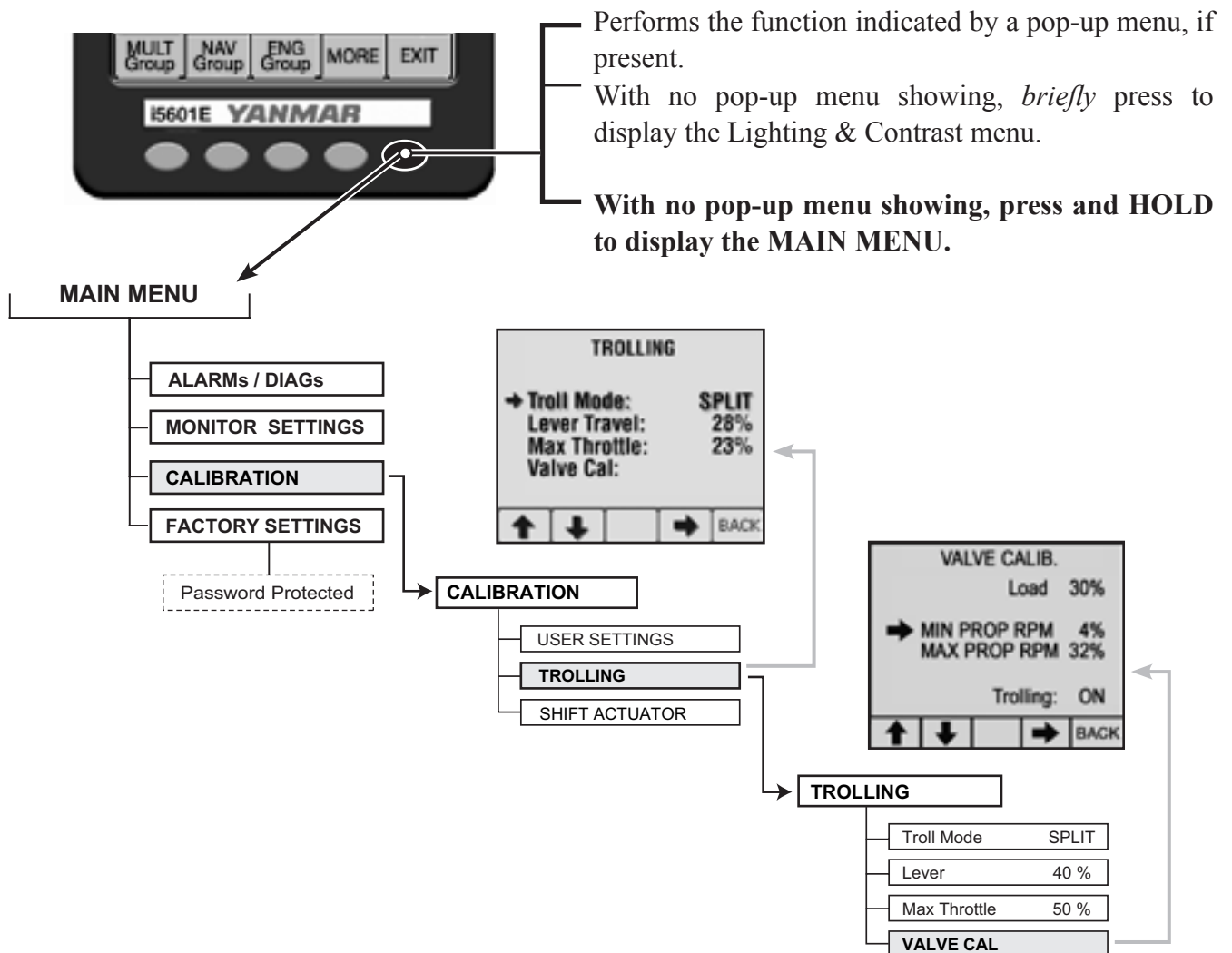

# Appendix F

## Trolling Option

With the engine and transmission fully warmed up and in neutral idle record the LOAD value. This will typically be a number around 0%. Then put the boat in forward idle and record the LOAD value. A number between 5% and 15% is typical - however the numbers may vary quite a bit at the lower values. Record the SOG speed as well. Retain these numbers for later use. Return to neutral.

**Note: When making changes to the settings, allow sufficient time for the boat to respond.**

1. Enter Troll Mode by placing the control lever at Neutral and pressing the separate trolling switch.

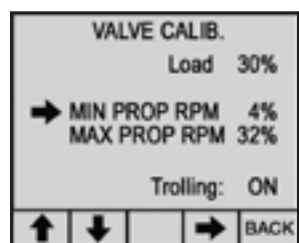

- “Down” Arrow moves menu selection down.
- “Up” Arrow moves menu selection up.
- “Back” to previous menu.
- “Right” Arrow acts on current menu item. It will change the 3rd and 4th buttons to Plus and Minus keys to allow incremental 1% changes to the value.

**Caution: The boat will respond IMMEDIATELY as soon as a value is sent to the controller for each change.**

2. Place the control lever in the forward idle position. The transmission will enter forward gear and the boat will move at “Forward Idle” speed. Select the Min Prop RPM on the digital display and using the “+” and “-” keys to adjust the value until the boat slows to minimum trolling speed. This resulting Min Prop RPM number varies by quite a bit so no typical number can be offered. A 30-to-50% number is common on some transmissions.
3. Select the Max Prop RPM on the digital display and use the “+” and “-” keys to set the value such that the LOAD reading is about 2% lower than it was in the earlier recorded forward idle position. You want the boat to move forward just below normal idle speed.

### Calibration Notes

If, after using troll, you determine that when you first enter forward idle in the troll mode the shaft is spinning too fast, you can go into the trolling calibration on the digital display menu and lower the Min Prop RPM value. If the shaft is spinning too slowly or not at all you can increase the Min Prop RPM value.

If, after using troll, you determine that the maximum trolling speed is too low, you can go into the trolling calibration on the digital display and raise the Max Prop RPM value. If the trolling max speed is too high, reduce the value of the Max Prop RPM.

On some occasions the minimum value may be too low for the valve to operate. If lowering the value does not slow down the prop speed, try increasing the value until the prop responds and then adjust accordingly.

# Appendix G

A kit that contains many of the Deutsch connectors and pins used on the Yanmar Electronic Control System is available from LADD\*. The kit number is 7005-111.

## Deutsch “How-To” Instructions for DT Series Style Connectors

### Step 1: Contact Removal



1. Remove wedgelock using needlenose pliers or removal tool. Pull wedgelock straight out.



2. To remove the contacts, gently pull wire backwards, while at the same time releasing the locking finger by moving it away from the contact with a screwdriver.



3. Hold the rear seal in place when pulling contact/wire out, as removing the contact may displace the seal.

### Step 2: Wire Stripping

**Solid Contacts**

Contact Part Number	Wire Gauge Range	Strip Length (inches)
0460-202-20141 0462-201-20141	20 AWG	.156-.218
0460-202-16141 0462-201-16141	16, 18 & 20 AWG	.250-.312
0460-215-16141 0462-209-16141	14 AWG	.250-.312
0460-204-12141 0462-203-12141	12 & 14 AWG	.222-.284
0460-204-08141 0462-203-08141	8 & 10 AWG	.430-.492
0460-204-0490 0462-203-04141	6 AWG	.430-.492

### Step 3: Contact Crimping

Use Crimp Tool #HDT48-00



1. Strip insulation from wire. (See Step 2).



2. Raise selector knob and rotate until arrow is aligned with wire size to be crimped.



3. Loosen locknut, turn adjusting screw in until it stops.



4. Insert contact with barrel up. Turn adjusting screw counter-clockwise until contact is flush with indenter cover. Tighten locknut.

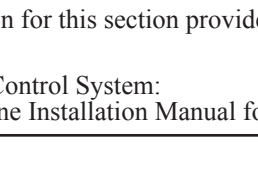

5. Insert wire into contact. Contact must be centered between indicators. Close handles until crimp cycle is completed.



6. Release handles and remove crimped contact.



7. Inspect terminal to ensure that all strands are in crimp barrel. **NOTE:** Tool must be readjusted for each type/size of contact. Use HDT04-08 for size 8 and 4 contacts.

### Step 4: Contact Insertion



1. Grasp crimped contact approximately one inch behind the contact barrel.



2. Hold connector with rear grommet facing you.



3. Push contact straight into connector grommet until a click is felt. A slight tug will confirm that contact is properly locked in place.



4. Once all contacts are in place, insert wedgelock. The wedgelock will snap into place. **NOTE:** The receptacle is shown. Use the same procedure for plug.



LADD Industries, Inc.  
4800 International Station Dr.  
Columbus, OH 43260  
LADD 700-111  
Authorized U.S. Distributor/Supplier of Yanmar Industrial Products

\*Information for this section provided courteously by LADD Industries, Inc.

# Appendix G

## Deutsch “How-To” Instructions for HD Series Style Connectors

### Step 1: Contact Removal



1. With rear insert toward you, snap appropriate size extractor tool over the wire of contact to be removed.



2. Slide tool along wire into the insert cavity until it engages contact and resistance is felt.



3. Pull contact/wire assembly out of connector.  
**NOTE:** Do not twist tool or insert at an angle.

### Step 2: Wire Stripping

Solid Contacts

Contact Part Number	Wire Gauge Range	Strip Length (inches)
0460-202-20141 0462-201-20141	20 AWG	.156-.218
0460-202-16141 0462-201-16141	16, 18 & 20 AWG	.250-.312
0460-215-16141 0462-209-16141	14 AWG	.250-.312
0460-204-12141 0462-203-12141	12 & 14 AWG	.222-.284
0460-204-08141 0462-203-08141	8 & 10 AWG	.430-.492
0460-204-0490 0462-203-04141	6 AWG	.430-.492

### Step 3: Contact Crimping

Use Crimp Tool #HDT48-00



1. Strip insulation from wire. (See Step 2).  
2. Raise selector knob and rotate until arrow is aligned with wire size to be crimped.  
3. Loosen locknut, turn adjusting screw in until it stops.



4. Insert contact with barrel up. Turn adjusting screw counter-clockwise until contact is flush with indenter cover. Tighten locknut.



5. Insert wire into contact. Contact must be centered between indicators. Close handles until crimp cycle is completed.  
6. Release handles and remove crimped contact.



7. Inspect terminal to ensure that all strands are in crimp barrel. **NOTE:** Tool must be readjusted for each type/size of contact. Use HDT04-08 for size 8 and 4 contacts.

### Step 4: Contact Insertion



1. Grasp contact approximately one inch behind the contact crimp barrel.



2. Hold connector with rear grommet facing you.



3. Push contact straight into connector grommet until a click is felt. A slight tug will confirm that contact is properly locked in place. **NOTE:** For unused wire cavities, insert sealing plugs for full environmental sealing.



LADD Industries, Inc.  
4849 Hempstead Station Drive  
Kettering, OH 45429  
9376 0001 0000  
©2008 LADD Industries, Inc.

[WWW.LADDINC.COM](http://WWW.LADDINC.COM) • 1-800-223-1236

LADD Industries Inc. • 4849 Hempstead Station Drive • Kettering, OH 45429

# Appendix H

## Miscellaneous

### i8130/40 Fuel Sender Connections

The i8130/40 Engine Interface box can handle two fuel senders. The sender inputs are both two wire inputs and may be used for single or double pole fuel sender applications. When used for single pole application the return line is connected to ground, preferably at the tank.

When set for US calibration the range of both senders is 33 (full) to 240 (empty) ohms. When set for European calibration the range of both senders is 10 (empty) to 180 (full) ohms. The units are shipped set for European Calibration. To change to US calibration, cut the black wire going into pin G1 of the J2 connector on the i8130/40 module.

The fuel sender wires are available in CE50206 Harness near the i8130/40 module connector. The Fuel 1 Sender wire is pink with a white tracer. The Fuel 2 Sender wire is pink. Both Fuel Return wires are black.

### i8130/40 Paddle Wheel Connections

The i8130/40 Engine Interface box has three wires to connect the paddle wheel. The Paddle Wheel Reference wire is violet. The Paddle Wheel Signal wire is violet with a white tracer. And the Ground wire is black. These wires are found in the CE50206 cable near the connector to the i8130/40.

### i8130/40 Transmission Connections

WIRING CONNECTIONS					
Teleflex ECU J1 DT04-12PA-E005	TROLL	SOL A	SOL B	OTHER	WIRE COLOR
1		POSITIVE			YELLOW
2			POSITIVE		YELLOW/WHT
3	POSITIVE				BLUE/WHT
4				OIL PRESS	LT BLUE
5				NSP LOOP	YELLOW/RED
6	NEGATIVE				BLACK
				NSP LOOP	YELLOW/RED
11		NEGATIVE			BLACK
			NEGATIVE		BLACK
7, 8, 9, 10, 12				SEAL PLUG	

*Note: Unlimited Control Systems energize Solenoid "A" in "Forward" Gear.*

### Tuff Torque / Kanzaki Transmission

Red (positive) and black (negative) are solenoid "A" (CCW). Blue (positive) and white (negative) are solenoid "B" (CW).



# Appendix H

---

## *Miscellaneous*

### **Power Reduction Mode**

An automatic protection mode called Power Reduction is included in the electronic control system to help protect the engine from major failure.

On multi-station boats, if one engine goes into power reduction, the engines will act independently.

# Appendix I

## Optional Serial Gauges Using *BYU* Tachometer

Connections for an individual engine are shown below. Repeat connections for multi-engine systems.



**780757SDFB:**  
Digital Tachometer

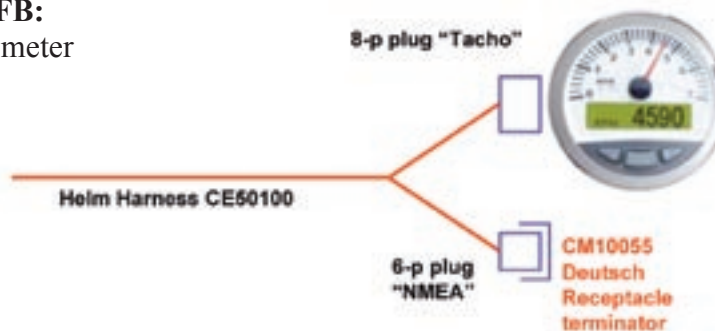

### Connections using 67322 Harness



## *i2200 CANBus Gauges*

Standard *i2200* NMEA 2000® gauges may be used with the *BY* Unlimited System. This requires the use of *i5601E* Digital Engine Display. The *i2200* Tachometer must be used, as it handles the CANBus interface. Below is a typical Single Engine system connection diagram.

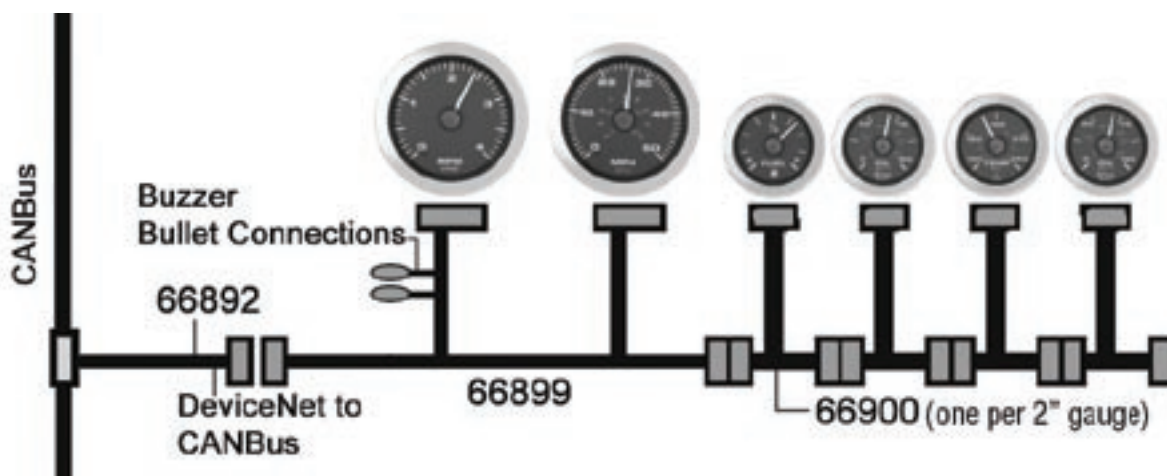

# Appendix J

## *Emergency Shift for Stern Drive Engines*

### Manual Shift Operation

In case of loss of shift at the Control Head, go to the Actuator and switch it into Manual Shift Operation:

1. Unplug the power connector. This will keep the servo from driving the motor and the unit from flashing an “error” on the Control Head.
2. Push lever “A” in the direction of the arrow; this will place the Actuator in “Manual” mode.
3. Turn the bracket style lever “B” clockwise to put the shift into “Forward” or turn it counter-clockwise to shift it into “Reverse.”

**Warning:**

*Engage lever “B” instructions with caution - they are sometimes reverse of the label.*

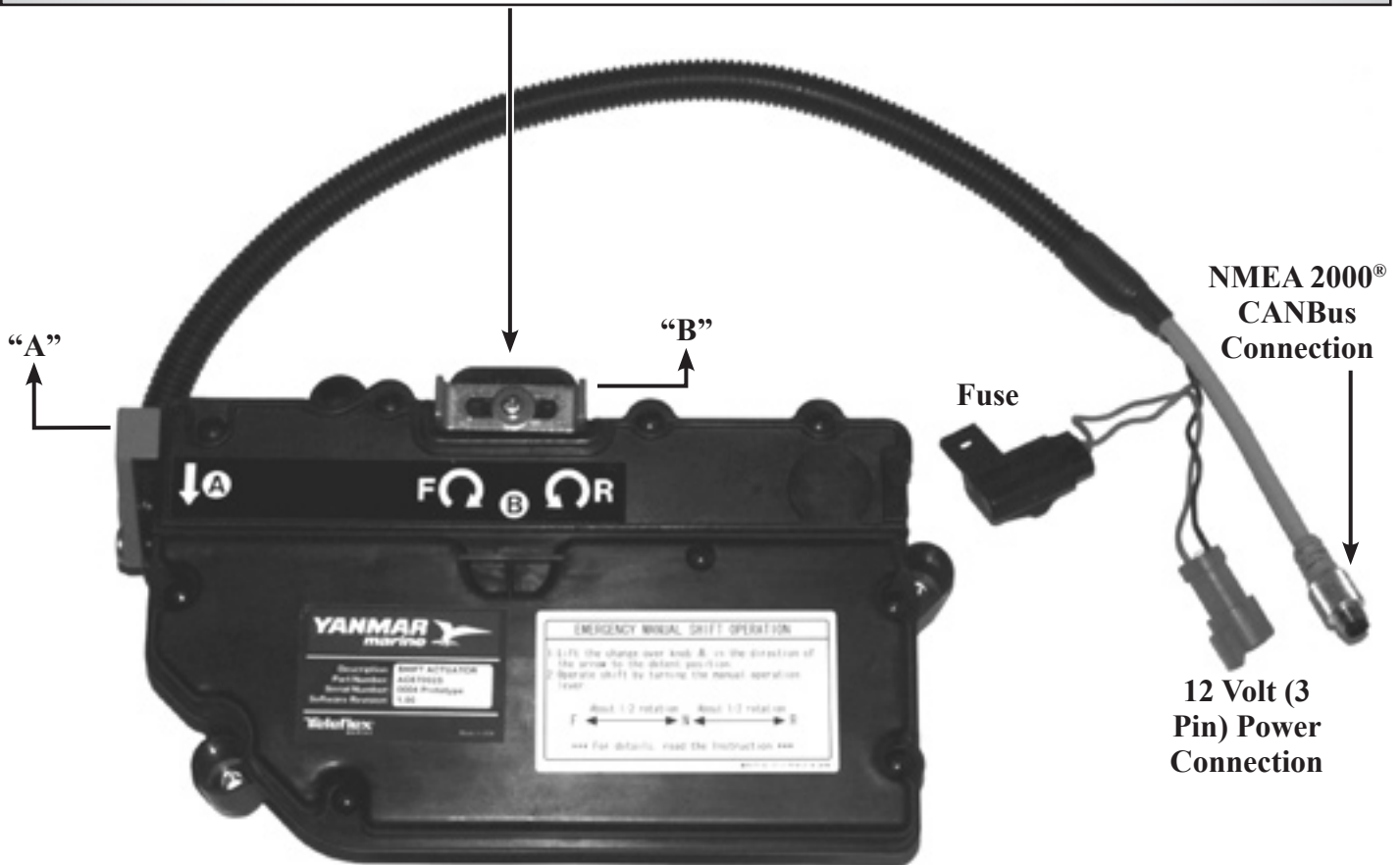

# Appendix K

## Station Select Protection

Station Select Protection prevents accidental switching between control stations on multi-stationed boats. If turned on, a change of control stations requires that control head buttons be pressed in a specific sequence - SELECT, SELECT, NEUTRAL, SELECT to change stations.

The menu options are:

- Station Select Protection Off (N) (Default Setting).
- Station Select Protection On (Y).

**NOTE:** *If the status of Station Protection is in question, it may be checked through the i5601E Digital Display. Sequence: “Main Menu - Calibration,” “Calibration,” “User Settings.” “Station Protect” is the last option under “User Settings.” OR try to set the second station - if Station Protection is on (Y) Station Select will not engage.*

### Operation

To change stations this is the button sequence:

- Go to the station you wish to make active
- Press the SELECT button.
- Press the SELECT button again.
- Press the NEUTRAL or ‘N’ button.
- Press the SELECT button.
- The station will go active (green light on solid) if the handles are matched with the originally active station. ●
- If the green light flashes ☼, match the handles with the originally active station and the green light will go solid. ●



#### **Warning:**

***Until the green light is on solid, the original active station retains controls of the boat.***



**Yanmar Marine International B.V.**

P.O. Box 30112, 1303AC Almere, The Netherlands  
Brugplein 11, 1332 BS Almere-De Vaart, The Netherlands  
Phone: +31 36-5493200  
Fax: +31 36-5493209

**Yanmar Co., Ltd  
Head Office**

1-32, Chayamachi, Kita-Ku, Osaka 530-8311, Japan

**Yanmar Marine USA Corporation**

101 International Parkway, Adairsville, GA 30103, USA  
Phone: +1 770-877-9894  
Fax: +1 770-877-7565

**Yanmar Asia (Singapore) Corporation Pte Ltd.**

4 Tuas Lane. Singapore 638613  
Phone: +65 6861-3855  
Fax: +65 6862-5195

**Dealer Network: [www.yanmarmarine.com](http://www.yanmarmarine.com)**

