

GENUINE PARTS & ACCESSORIES

ATV 2009





Go for it!

We have a full line of Yamaha Genuine Accessories designed specially for your Utility and/or Leisure ATV to enhance its aggressive style and leading edge performance. It has never been easier to outfit your ATV for whatever you want to do. What is more, we have exclusive Yamaha Riding Gear and casual wear, so you'll be well dressed for your four-wheel adventure.

Yamaha is dedicated to helping you get the most from your ATV's. Just turn the pages to see all that's available through your local Yamaha ATV dealer.



***ATV
2009***

***Genuine parts &
Accessories***



Contents

UTILITY ATV ACCESSORIES

PROTECTION	6
FAIRINGS, FENDERS & WINDSHIELDS	9
RACKS & LUGGAGE	10
HUNTING	12
GENERIC:	
LIGHTING & METERS	14
LEISURE	16
WARN PLOWS	17
WARN WINCHES	18

LEISURE ATV ACCESSORIES

WOLVERINE 350 / 450	24
YFZ 450	26
YFM 250R	40
YFM 350R	44
YFM 660R	48
YFM 700R	54

APPAREL

RIDING GEAR	62
-------------	----

YAMALUBE

	70
--	----

INTERNET

	71
--	----



Utility



Utility Protection

1 Front Brush Guard

Help protect the headlights and front fenders.

Black powder-coated steel for durability.

'02-'08 GRIZZLY 660

ABA-5KM58-00-00

'03-'06 KODIAK, >'07 GRIZZLY 450

ABA-5ND58-W0-00

2 Front Bumper

Super heavy-duty protection for your front end. Powder-coated steel construction. Trail lights sold separately.

'02-'08 GRIZZLY 660

ABA-5KM58-2W-00

3 Front Skid Plate

'03-'04 KODIAK, '03-'06 BRUIN

ABA-5ND34-40-00

4 Engine Skid Plate

'03-'05 KODIAK, '03-'05 BRUIN

ABA-5ND34-20-00

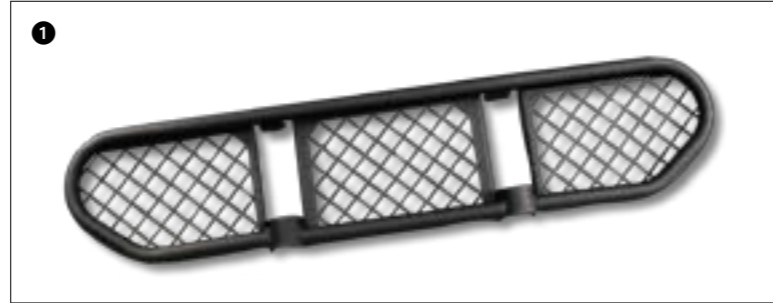

6

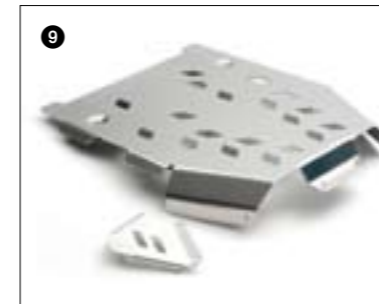
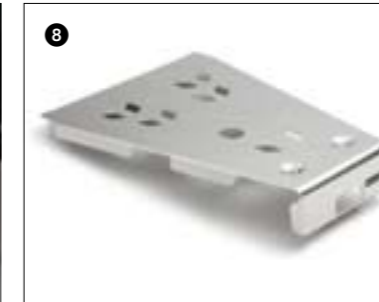
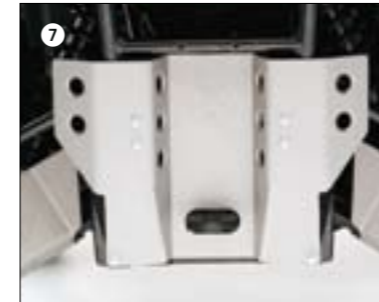

7

Utility Protection

Bash Plate Front

5 '02-'08 GRIZZLY 660

ABA-5KM34-40-00

6 GRIZZLY 700/550

ATV-3B400-00-03

Bash Plate Rear

7 '02-'06 GRIZZLY 660

ABA-5KM34-50-00

8 GRIZZLY 700/550

ATV-3B400-00-04

9 Aluminium Frame Skid Plate

Cannot be mounted in combination with plow.

GRIZZLY 700

ATV-3B400-00-05



Utility Protection

A-Arm Guards

This lightweight, heavy-duty brushed silver aluminium plate provides added protection

Front

- ❶ '02-'08 GRIZZLY 660
ABA-5KM34-10-00
- ❷ GRIZZLY 700/550
ATV-3B400-00-00

Rear

- ❸ '02-'08 GRIZZLY 660
ABA-5KM34-20-00
- ❹ GRIZZLY 700
ATV-3B400-00-02

❺ Kevlar Boot Guard (4 Pcs)

Reinforced with extra tough, Para-Aramid fibers. Installs over the rubber CV boots for extra protection. Fits all 4WD models.

ABA-2HR95-00-00

❻ Front A-Arm Skid Plate

Constructed of special brushed-finish silver 5052 H32 aluminium plate for appearance, durability and light weight. Includes a stamped in Yamaha Bear Logo for added distinction.

'03-'06 KODIAK, '03-'07 GRIZZLY 450

ABA-5ND34-10-00

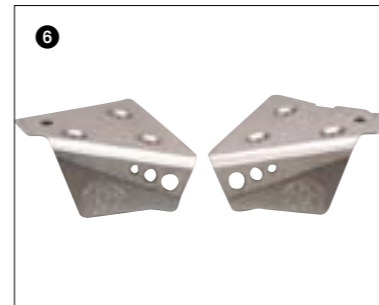

8

Utility Fairing, Fenders & Windshields

❷ Overfenders

Custom-formed design helps to deflect trail debris.

Set of front and rear overfenders.

- GRIZZLY 700/550
ATV-3B466-00-00
- '02-'08 GRIZZLY 660
ABB-5KM66-00-00
- '04 KODIAK
ABA-5GH66-00-00
- '05-'06 KODIAK IRS-1D9,
'05-'08 GRIZZLY 450
ATV-1D966-00-00
- '09 GRIZZLY 450
ATV-1D966-01-00
- '06 BRUIN,
GRIZZLY 350 FAN/FWAN
ATV-5UH04-FN-DR



❸ ATV Fairing Black

Helps deflect wind, flying objects and brush. Universal "break-away" mounts allow you to remove and store fairing when not in use.

ABA-FAIRN-00-BK

❹ ATV Cover

Helps protect your ATV while in storage. Storage bag included.

ALL EXCEPT GRIZZLY 660 / 700

ATV-COVER-01-00

GRIZZLY 660 / 700

ATV-COVER-02-00

9

Utility Racks & Luggage

Front Rack Extension, Wrinkle Finish

Powder-coated steel construction for durability, with special wrinkle finish to match stock rack. Helps keep rack loads in place.

- ❶ '02-'08 GRIZZLY 660
ABA-5KM53-10-00
- ❷ GRIZZLY 700/550
ATV-3B400-00-08

Rear Rack Extension, Wrinkle Finish

Powder-coated steel construction for durability, with special wrinkle finish to match stock rack. Helps keep rack loads in place.

- ❸ GRIZZLY 700
ATV-3B400-00-07
- ❹ '02-'08 GRIZZLY 660
ABA-5KM51-10-00
'03-'04 KODIAK, '08 GRIZZLY 450
(NOT SHOWN)
ABA-5ND51-1W-00

❺ Anti Skid Rubber Packs

Special aluminium and rubber construction. Fits front or rear rack (one pair per rack).

- GRIZZLY 660
ABA-5KM34-90-00

❻ Standard Front Rack Bag

Soft-sided design includes a full-length zipper for easy access, and outside straps for additional attachments. Fits all ATV's with racks.

- ABB-4SH53-30-00

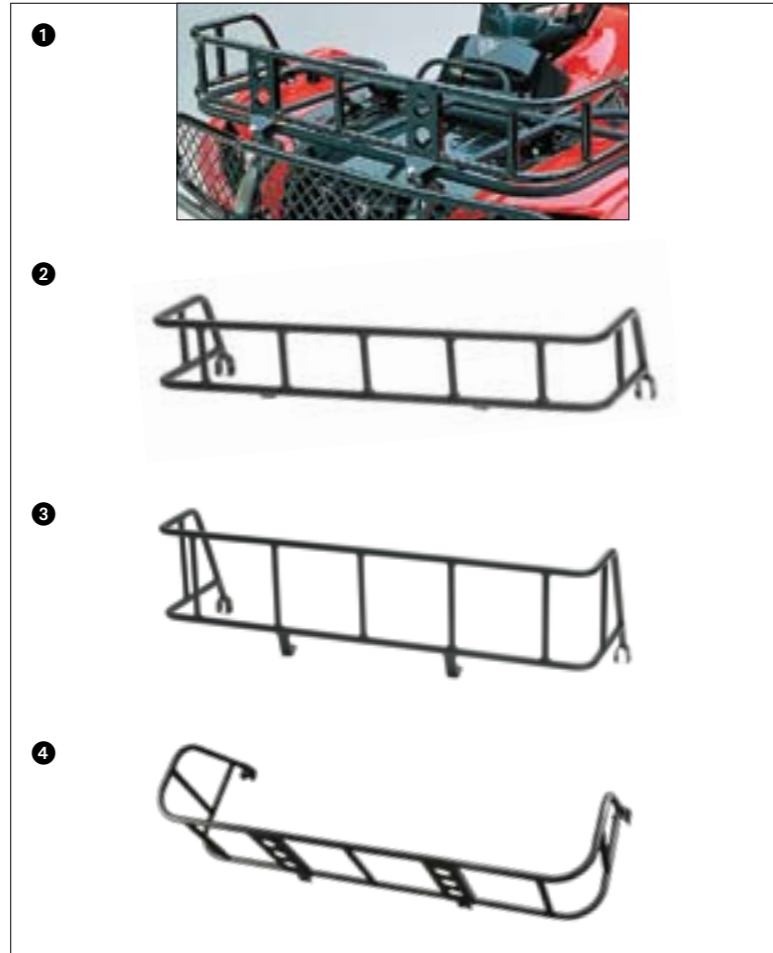

10

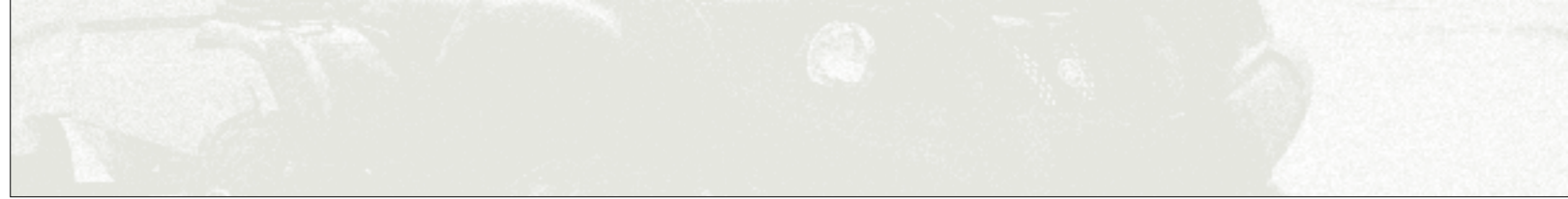

Utility Racks & Luggage

❷ Deluxe Rear Rack Bag

Content 60 Liters
ABA-4SH51-30-BK

❸ Standard Rear Rack Bag

ABA-4SH51-30-00

❹ Front Rack Bag

Features: Shoulder carrying strap. Snap-on pocket. Rubber carry handle. Inside cargo dividers. Heavy-duty zipper and zipper flap. Approx. 40 litres storage capacity. Approx. 74cm wide bag.

ABA-30W53-30-BK

❽ Fender Bag

Soft-sided design includes a full-length zipper for easy access, and outside straps for additional attachments. Fits all ATV's.

ABA-FENDB-AG-BK

❾ ATV Front Box

Sturdy PE ATV box with quick release/ fastening system. Storage space for chain saw.

- GREEN
ATV-W0754-00-00
- BLACK
ATV-W0754-03-00

● Mounting Kit ATV Front Box (NOT SHOWN)

Needed for front installation of ATV Box on Big Bear, Kodiak, Grizzly and Bruin
ATV-W0754-BR-01



11

Utility Hunting

1 Gun Boot

Includes a heavy-duty, impact resistant Yamaha gun boot with thick pile lining.

ABB-4SH67-10-00

2 Deluxe Gun Boot

Includes a heavy-duty, impact resistant Yamaha gun boot shell, and a convenient transport bag for your rifle.

ABA-UXX67-10-00

3 Gun Boot Cover

Realtree® Hardwoods™ Camouflage.

installs easily over Yamaha's gun boots.

ATV-COVER-GN-HD

Universele Gun Boot Mount

Heavy-duty steel construction for durability. Special powder-coated paint adds corrosion resistance and durability, and is finished to match the rear rack of the ATV.

4 GRIZZLY 700/550

ABA-3B462-00-00

5 GRIZZLY 660

ABA-UXX67-40-00



12



13

Utility Hunting

6 Front Rack Bag Realtree® Hardwoods Camouflage

- Shoulder carrying strap.
- Snap-on pocket.
- Rubber carry handle.
- Inside cargo dividers.
- Heavy-duty zipper and zipper flap.

GRIZZLY, BIG BEAR

Approx. 80cm wide bag.

ABA-UXX53-30-HD

7 Rear Rack Bag Realtree® Hardwoods™ Camouflage

- Shoulder carrying strap.
- Snap-on pocket.
- Rubber carry handle.
- Inside cargo dividers.
- Heavy-duty zipper and zipper flap.
- Approx. 3.0 cubic feet storage capacity.

Fits all ATV's with racks

ABA-UXX51-30-HD

8 Fender Cover Realtree® Hardwoods™ Camouflage

Form-fitting design fits tightly over the fenders.

GRIZZLY 660

ABA-5KMCM-CV-HD

9 ATV Cover Realtree® Hardwoods™ Camouflage

Helps protect your ATV during storage.

ALL EXCEPT GRIZZLY 660 / 700

ABA-5ND43-00-HD

GRIZZLY 660 / 700 / 550

ABA-5KM43-00-HD

Generic

Lighting & Meters

1 Light Kit Halogen

Back-Up, Warn
YMD-62017-00-00

2 Light Kit trail

FEATURES: two Warn halogen lamps, a universal mounting bracket, high-grade mounting hardware, full electrical wiring system, and a water-resistant control switch.
YMD-62018-00-00

3 Spot Light Kit

FEATURES: 70,000-candlepower sealed-beam bulb, durable and weather-resistant rubber housing, a deluxe RAM® mounting system, 10' coiled cable, and a 12V-plug/receptacle system.
ABA-2HR35-10-00

4 Hour Meter

Includes pre-programmed service intervals for 4-cycle ATVs.
ENG-METER-4C-01

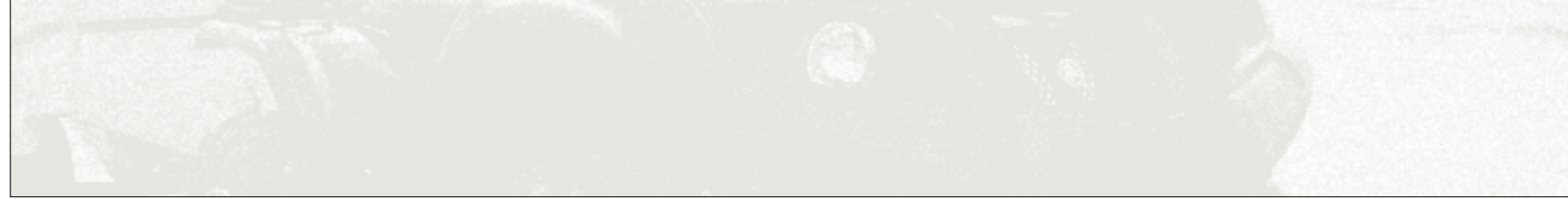

Generic

Lighting & Meters

5 PIAA 004X Series 35W=60W

FEATURES: High-performance 60mm (2.4") Diameter round light kit. Includes lamps, wiring, and switch.
LONG RANGE BEAM
ABA-73462-00-00

Mounting Brackets

ATV
ABA-74100-00-00

RHINO

SSV-5UG12-00-00

6 PIAA 510 Series 35W=60W

FEATURES: High-performance 100mm (3.9") Diameter round light kit. Includes lamps, wiring, and switch.

LONG RANGE BEAM
ABA-73514-00-00
WIDE BEAM
ABA-73510-00-00



Generic Leisure

1 Pop-It Whip Antenna

Snaps together easily. Includes, flag, pole and leash.

ABA-POPIT-WP-00

2 ATV Shock Adjuster Tool

ATV-SHK19-73-01

3 Front Shock Covers

Helps protect against rocks and debris. Heat-venting holes included for maximum performance. Easy to install and remove. (Sold in pairs.)

'04-'05 YFM 350,
'87-'04 WARRIOR; '88-'05 BLASTER

BLACK

ABA-SCVRF-BK-02

BLUE

ABA-SCVRF-BL-02

RED

ABA-SCVRF-RD-02

SILVER

ABA-SCVRF-SL-02

4 Rear Shock Covers

Helps protect against rocks and debris. Heat-venting holes included for maximum performance.

Easy to install and remove. (Sold individually.)

'04-'05 YFM 350,
'87-'05 BANSHEE;

'87-'04 WARRIOR,

'88-'05 BLASTER

BLACK

ABA-SCVRR-BK-01

BLUE

ABA-SCVRR-BL-01

RED

ABA-SCVRR-RD-01

SILVER

ABA-SCVRR-SL-01

5 Metric Tool Kit

Contains combo wrenches (8/ 10/ 12/ 14mm). 8" adjustable wrench, locking wrench. 4-way Phillips/ standard screw driver. Allen wrenches (3/ 4/ 5/ 6). Spark plug wrench. Spark plug gap gauge. Black electrical tape. WD-40. Tire pressure gauge. Zip ties. Wire, rag, and a handy zippered storage case.

ABA-METRC-00-00

6 ATV Cover Leisure

ABA-COVER-SP-RT



16

Utility Warn Plows



7 Plow Blade Kit 54"

8 Additional Plastic Wear Bar dedicated for 54" plow

(NOT SHOWN)

Ultra high modular weight plastic.

Saves wear on plow blade and replaceable when worn out.

YMD-67861-00-00

Plow SPARE PART:

8 ATV Plow Actuator

Set; including Plow Actuator Cable

9 Plow Actuator Cable

YMD-68135-00-00

Configuration Options

Step 1:

- Order Plow Blade (YMD-70954-00-00) and Base (YMD-62100-00-00)

Step 2:

- Order Mounting Kit for your ATV (column E)

Step 3:

- Plow operated by Winch - No further items needed
- Plow operated by Manual Lift - Order Manual Lift (YMD-65510-00-00)
- Plow operated by Actuator - Order Actuator (YMD-67650-00-00)

YAMAHA - WARN PLOW CONFIGURATION LIST



Configuration Steps			Step 1		Step 2	Step 3		
Model	Model Code	Year	Plow Blade	Base	Plow Mounting Kit	Plow Manual Lift	ATV Plow Actuator	Actuator Pully Bracket
Big Bear Professional 4X4	4SH	'00-'06	YMD-70954-00-00	YMD-62100-00-00	YMD-37840-00-00	YMD-65510-00-00	YMD-67650-00-00	YMD-60113-00-00
Bruin 2 x 4	5WH	'04-'06			YMD-64670-00-00	YMD-65510-00-00	YMD-67650-00-00	Not Needed
Bruin 4 x 4	5UH	'04-'06			YMD-64670-00-00	YMD-65510-00-00	YMD-67650-00-00	Not Needed
Kodiak 400 Automatic 4X4	5GA	'00-'02			YMD-60013-00-00	YMD-65510-00-00	YMD-67650-00-00	Not Needed
Kodiak 400 Automatic 2X4	5ND	'03-'04			YMD-64670-00-00	YMD-65510-00-00	YMD-67650-00-00	Not Needed
Kodiak 400 Automatic 4X4	5ND	'03-'04			YMD-64670-00-00	YMD-65510-00-00	YMD-67650-00-00	Not Needed
Kodiak 450 Automatic 4X4	5ND	'03-'04			YMD-64670-00-00	YMD-65510-00-00	YMD-67650-00-00	Not Needed
Kodiak 450 Auto/IRS 4X4	1D9	'05-'06			YMD-64670-00-00	YMD-65510-00-00	YMD-67650-00-00	Not Needed
Grizzly 600 4X4	5KM	'98			YMD-37841-00-00	YMD-65510-00-00	YMD-67650-00-00	YMD-60117-00-00
Grizzly 600 4X4	5KM	'99-'01			YMD-39553-00-00	YMD-65510-00-00	YMD-67650-00-00	YMD-60118-00-00
Grizzly 660 Automatic 4X4	5KM	'02-'06	YMD-64669-00-00	YMD-65510-00-00	YMD-67650-00-00	Not Needed		
Grizzly 700	3B4	'06-'07	YMD-73655-00-00	YMD-65510-00-00	YMD-67650-00-00	Not Needed		

17

Utility Warn Winches

- Dedicated 2009 Mounting Kit reduces installation time up to 2 hours.
- 1134kg (2500 lb) of pulling force with best-in-class line speed.
- Durable black powder-coated wrinkle finish - Gives a customized look and industry-leading corrosion resistance.
- Fully sealed all-metal drive train - Provides the ultimate in performance and durability.
- Patented disc brake - Provides enhanced control in any situation.
- 15m of 5mm (50' of 3/16") aircraft-grade wire rope and a roller fairlead - Makes easy work of any job you choose to tackle.



			2009 Yamaha-Warn Winch 2.5 Rt		
			YMD-78650-00-00		
			INCLUDES: Yamaha winch, Wire rope and hook, Yamaha hook safety strap, Fairlead roller, Contactor, Nuts/bolts fitting package, Product manual, Guide to safe winching, CE Certificate		
Model	Code	Year	Dedicated 2009 Mounting Kit		
Grizzly 700		'07-09	INCLUDES: Mounting plate, model dedicated wiring kit, Remote control switch, Switch hardware kit		
Grizzly 550		'07-09			
Grizzly 450		'07-09			
Grizzly 400		'07-08			
Grizzly 350		'07-09			
Grizzly 350 IRS		'07-09	YMD-78654-00-00	YMD-79160-00-00	
			Yamaha-Warn Winch 1.5 Rt		
			YMD-70245-00-00		
			INCLUDES: Winch, cables, Universal long wiring, contactor, etc. Note: Fairlead should be ordered separately		
			Yamaha-Warn Winch 2.5 Rt		Yamaha-Warn Winch 3.0 Rt
			YMD-74111-00-00		YMD-74679-00-00
			INCLUDES: Winch, cables, fairlead Universal long wiring, contactor, etc.		
Model	Code	Year	Mounting Kit	Mounting Kit	Mounting Kit
Beartracker 2X4	5XG	'98-04	4XE-W0769-20-BT	4XE-W0769-20-BT	4XE-W0769-20-BT
Bruin 2 x 4	5WH	'04-'06	YMD-68366-00-00	YMD-68366-00-00	YMD-68366-00-00
Bruin 4 x 4	5UH	'04-'06	YMD-68366-00-00	YMD-68366-00-00	YMD-68366-00-00
Big Bear Professional 4X4	4SH	'00-'06	N/A	5GH-W0769-20-KO	5GH-W0769-20-KO
Kodiak 400 Automatic 4X4	5GA	'00-'02	5GH-W0769-20-KO	5GH-W0769-20-KO	5GH-W0769-20-KO
Kodiak 400 Automatic 2X4	5ND	'03-'04	YMD-63945-00-00	YMD-63945-00-00	YMD-63945-00-00
Kodiak 400 Automatic 4X4	5ND	'03-'04	YMD-63945-00-00	YMD-63945-00-00	YMD-63945-00-00
Kodiak 450 Automatic 4X4	5ND	'03-'04	YMD-63945-00-00	YMD-63945-00-00	YMD-63945-00-00
Grizzly 450 Auto/IRS 4X4	1D9	'05-'06	N/A	YMD-69480-00-00	N/A
Grizzly 600 4X4	5KM	'98-'01	5GT-W0769-00-GR	5GT-W0769-00-GR	5GT-W0769-00-GR
Grizzly 660 Automatic 4X4	5KM	'02-'08	YMD-65098-01-00	YMD-65098-01-00	YMD-65098-01-00
YFM 660R	5LP	'05	YMD-69062-00-00	N/A	N/A
Grizzly 700	3B4	'06-'08	YMD-73985-00-00	2009 model available	N/A

Utility Warn Winches



- 1 Winching Accessory Kit**
INCLUDES: Snatch block: assists in double lined and angled pulls. Shackle for rigging attachments. Tree trunk protector: load strap to protect a tree trunk and other objects from the damage a wire rope might cause.
 YMD-63350-00-00
- 2 Roller Fairlead all models**
 Helps "guide" the cable into and out of the winch
 YMD-W0769-10-00
- 3 Syntetic rope (not shown)**
 Note: When replacing a wire rope with synthetic, it is necessary to replace the fairlead to avoid damage and wear to the new synthetic rope from the rough surface of the old fairlead.
 For 1.5 winch, 12 meter
 YMD-72495-00-00
 For 2.5 and 3.0 winch, 12 meter
 YMD-72128-00-00
- 4 Winching Gloves**
 Essential for safe handling of wire rope. Material: leather & cotton.
 YMD-14042-00-00
- 4 Remote Control**
 Remote control upgrade for CE 2.5 Ci winch and new 2.5 CE winch 2.5
 YMD-64259-00-00

Utility Warn Winches

1 Wireless remote control

The system is quick and easy to install, thanks to an integrated antenna and the included mounting hardware. The system allows you to operate your winch from anywhere within a 50' radius, increasing your recovery options.

Works with any WARN Powersports winch with a contactor and a mini-rocker control switch.

Operates your winch from anywhere within a 50' radius.

Built-in antenna and included hardware allows for quick and easy installation

Activation process and recessed buttons prevent accidental winch activation

Two color LED indicates when the system has powered on (green) and when the system has begun winching (red). Blinking red LED indicates low battery life.

System automatically powers off to conserve battery life.

Waterproof and rugged receiver ignores interference from other signals.

Ergonomically designed handheld remote has large buttons for easy use - even when wearing gloves.

Works at all vehicle voltage levels that allow winch operation.

All components are weatherproof.

YMD-74500-00-00

2 Flexi Winch

Now you can add a recovery system with 1,500 lb. of pulling power to your ATV. Kit includes integrated mounting plate with fairlead and handle, remote control with 10' lead, two D-shackles, 8' and 25' recovery straps and 40' of 5/32" synthetic rope. Quick-connect wiring plug. Custom bag for off-season storage.

YMD-70170-00-00



WINCH SPECIFICATION TABLE

	1.5 RT Yamaha	2.5 RT Yamaha	3.0 RT Yamaha
Part Number:	YMD-70245-00-00	YMD-74111-00-00	YMD-74679-00-00
Rated Line Pull:	680kgs (1500 lbs.) single line	1133 kgs. (2500 lbs) single line	1360 kgs. (3000 lbs.) single-line
Wire Rope	15m, 4mm diameter	15m, 5mm diameter	15m, 5mm diameter
Weight	5.2 kgs.	7.1 Kgs	7.1 Kgs
Motor:	12V DC, .04hp permanent magnet sealed	Motor: 12V DC, .9hp (.7kW) sealed permanent magnet	12V DC, .9 hp (.7 kW) permanent magnet, Sealed
Control	Handlebar mounted Mini-rocker switch	Handlebar mounted Mini-rocker switch	Handlebar mounted Mini-rocker switch
Geartrain	3-Stage Planetary	3-Stage Planetary	All-metal 3-stage planetary
Gear ratio	103:01	154:01	154:01
Brake	patent-pending disc brake	patent-pending disc brake	patent-pending disc brake
Drum Diameter/Length:	38mm/76mm	52mm/74mm	52mm/74mm
Fairlead	Hawse	Roller	Roller
Battery leads	10 gauge	8 gauge	6 gauge
Finish	Grey	Grey/Red	Grey/Red
Use for	Sports ATV's	> 400 cc ATV's	Heavy Utility / mud and water environment

Utility Warn Winches



GYTR

We have a full line of accessories for our Leisure range to raise comfort, performance or appearance. These accessories are designed and tested especially for your Yamaha.

Those who use their Yamaha intensively for sports and only want the best of the best should ask for Genuine Yamaha Technology Racing (GYTR™) accessories. Yamaha has developed GYTR accessories especially for racing and performance enthusiasts. A long history of engineering advances, knowledge earned in the pursuit of racetrack victories, and a reputation for quality workmanship have given Yamaha the technological advantage to produce GYTR accessories.

GYTR provides that edge racers need to seal victory. GYTR accessories are precision-made to Yamaha's exacting standards so they fit right and give a level of performance previously unavailable.

What sets GYTR apart from the competition? It's the winning combination of advanced technology, high-quality materials, and superior design. Yamaha's rigorous testing ensures superior durability and performance. Race inspired accessories designed to perform and please.

That's why people who know insist on the best and ask for GYTR by name.



Leisure



Leisure

Wolverine 350-450

1 Rear Carrier Rack

Heavy-duty aluminium tube-and-plate construction. Accommodates smaller size coolers.

WOLVERINE 350/450
ABA-3C251-00-00

2 A-Arm Skid Plates

WOLVERINE 350/450
ABA-3C234-10-00

3 Rear Differential Skid Plate

Constructed of heavy-duty aluminium plate with rubber dampers.

WOLVERINE 350
ABB-4KB34-10-00

4 Front Skid Plate

Made of high-quality aluminium. Features drain holes for mud and water.

WOLVERINE 350
ABA-5ND34-40-00

5 Aluminium Skid Plate

WOLVERINE 350
ABB-4KB34-20-00

6 Radiator Guard

Made of perforated aluminium for added protection against dents.

WOLVERINE 450
ABA-3C226-40-00

7 Frame Skid Plate

Made of high-quality aluminium. Features drain holes for mud and water.

WOLVERINE 450
ABA-3C234-00-00



24

Leisure

Wolverine 350-450

8 Aluminium Oval Muffler *

FEATURES: 6061-T6 aluminium two-piece aluminium end cap. Hard-anodized aluminium shell. New fixed rubber mounting system. Removable screen-type USFS-approved spark arrester. Passes the 96 dBA 20" stationary test. Completely rebuildable 10% horsepower increase in the usable power band. 1,5 Kg. lighter than stock. This accessory is restricted to closed-course use. This component affects exhaust emissions; installation on EPA-regulated 2006 or later models constitutes unlawful tampering except when used solely for closed-course competition.

WOLVERINE 450
GYT-3C293-01-AL
* For Racing Use Only

Graphic Kit

WOLVERINE 450
9 Blue
ABA-3C225-30-BL
10 White
ABA-3C225-30-WH



25



Leisure

YFZ450 - Protection

❶ Front Bumper Open

Special ball-burnished, aluminum tube construction. Functional and stylish design.

'04-'06

GYT-5TG14-00-00

❷ Sport Bumper with Shield

Special ball-burnished, aluminum tube construction. Functional and sporty design.

'04-'06

GYT-5TG14-10-00

❸ Front Brake Joint Protector

'04-'06

ATV-5TG80-01-00

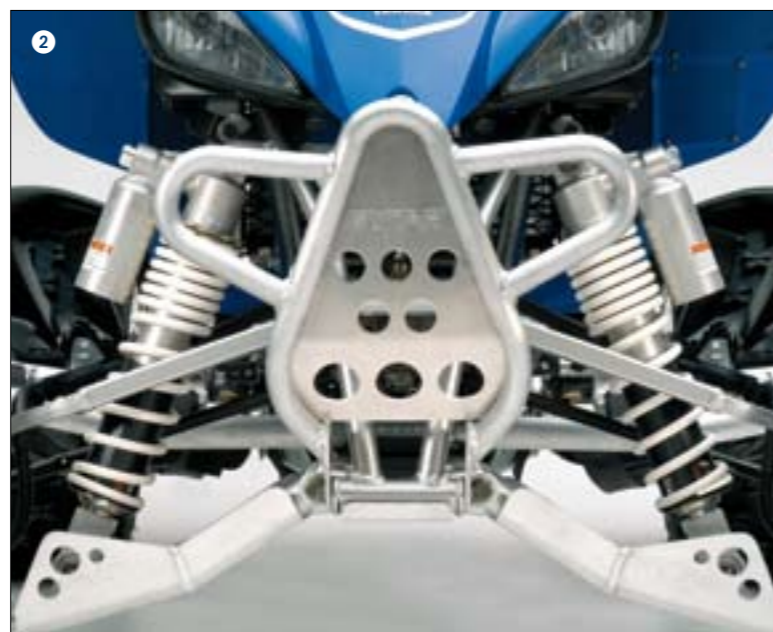
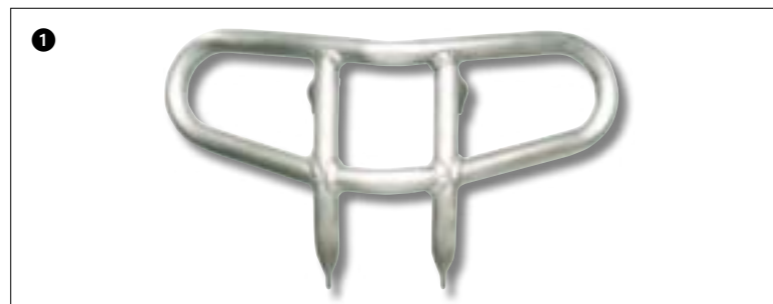

26

Leisure

YFZ450 - Protection

❹ Aluminium Swing Arm Skid Plate

U-shape chain guard for improved chain guidance. Strong bridge construction. Surface treatment matches the swing arm look.

'06

ATV-5TG33-10-00

'04-'05

ATV-5TG33-01-00

❺ Disk and Chain Protection

Add on to swingarm protection

ATV-5TG33-10-01

❻ Aluminium Engine / Frame Skid Plate

Satin polished aluminium AL-MG3 with dewatering slits and service holes for oil drain.

ATV-5TG34-01-00

❼ Aluminium A-Arm Skids

Satin polished aluminium AL-MG3 with slits for dewatering and shock adjustment.

'04-'06

ATV-5TG34-11-00



27

Leisure

YFZ450 - Protection

1 Aluminum Footwells
'06-'07
ATV-5TG57-10-00

2 Billet Rear Brake Pedal
'04-'07
GYT-5TG37-23-00

3 Billet Shift Pedal
'04-'07
GYT-5TG38-00-00



1



2



3

28



Leisure

YFZ450 - Graphics



4



5



6



7

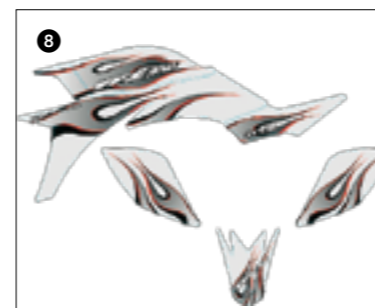

8



7

29

4 Sticker Kit
'06
YMF-45720-R4-50

5 Universal stickerkit
Universal stickerkit fitting YFM450. Kit includes tank, fenders & front body graphics
BLUE
ATV-W0740-10-00
BLACK, RED/GOLD
ATV-W0740-20-00

● Universal, graphic protection kit (NOT SHOWN)
Universal, transparent stikerkit to protect your graphics. Kit includes tank, fenders & front body protector film.
ATV-W0740-00-00

6 Seat Cover
'06
YMF-45710-R4-50

7 Graphic Kit Speedblock
Kit includes a gripper seat cover with a rear sponsor patch. Kits designed to enhance the look of the YFZ450.
GYT-5TGK1-BL-ST

8 Graphic Kit with Seat Cover Flame
Kit contains gripper seat cover with sponsor section at rear.
GYT-5TGK1-WH-FL

Leisure

YFZ450 - Performance

1 Kick Shaft Kit

Includes all internal components necessary to adapt a kick start lever.
'04-'06
GYT-5TG07-20-00

2 Kick Crank Kit

Kick start lever is made of 2024-T3 billet aluminum, and attaches to a stock YZ450F kick boss which is supplied in the kit. This lever has been precisely designed to give you the leverage needed to start the motor yet also gives you enough clearance for your foot.
'04-'06
GYT-5TG07-35-00

3 Foot Wells Kick Start

Includes a pair of aluminum footwells. The right side has been designed to give you clearance for your foot when the kick start lever is installed. The rear fender must be cut to mount the footwells and to allow access for the kick start lever.
'04-'06
GYT-5TG57-30-00

4 Starter Block Off Plug

Required if the started motor is removed.
Uses stock starter O-ring.
'04-'06
GYT-5TG07-50-00

5 Öhlins Front Shock Absorbers (set)

'04-'05
5TG-W0702-FR-00

6 Extended A-Arms

Lightweight and durable made of 4130 Chromoly with a hard chrome finish. Extends a-arms 1" per side and fully camber adjustable for fine tuning. Includes ball joints, bushings, and zerk fittings.
<'05
GYT-5TG70-00-00

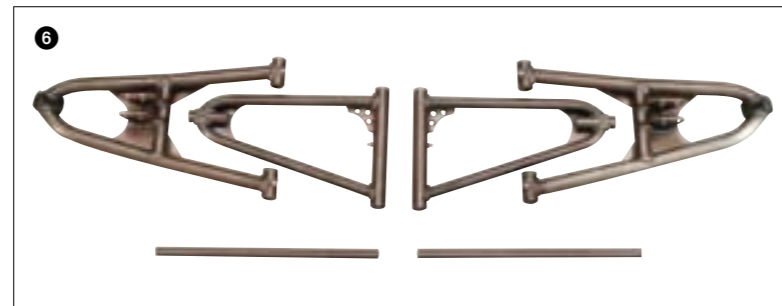

30

Leisure

YFZ450 - Performance

7 Nerf Bars

Aluminum frame construction, utilizing Nylon webbing.
'04-'07
GYT-5TG31-00-00

8 GYT-R Billet Clutch Basket

Precision machined from the highest grade of aluminum and then hard anodized to achieve an exceptionally hard, wear-resistant surface. This clutch basket provides amazing durability that has been thoroughly tested and race-proven.
'04-'07
GYT-5TG56-10-00

9 GYT-R Billet Clutch Pressure Plate

Precision machined from the highest grade of aluminum and then hard anodized to achieve an exceptionally hard, wear-resistant surface. Additional oil passages help improve clutch performance as well as reducing weight by 30% to reduce rotational mass for improved acceleration. This clutch pressure plate also provides amazing durability that has been thoroughly tested and race-proven.
'04-'07
GYT-5TG56-20-00

10 GYT-R Billet Clutch Inner Hub

Precision machined from the highest grade of aluminum and then hard anodized to achieve an exceptionally hard, wear-resistant surface. Additional oil passages to help improve clutch performance as well as reducing weight by 20% to reduce rotational mass for improved acceleration. This clutch inner hub also provides amazing durability that has been thoroughly tested and race-proven.
'04-'07
GYT-5TG56-40-00

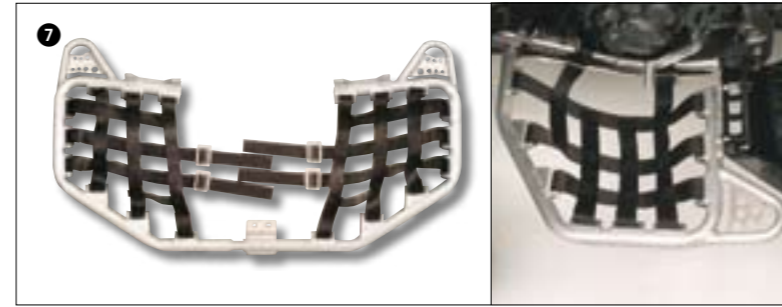

31

Leisure

YFZ450 - Performance

1 GYT-R Exhaust Mounting Strap and Spacer
'04-'07
GYT-5SF93-08-K0

2 GYT-R Exhaust Can Packing
'04-'07
GYT-5TA93-33-KT

3 GYT-R Quiet Muffler Insert
This end cap lets your GYT-R™ competition muffler pass the 96 dBa per the 20" stationary sound test. Fits GYT-R™ oval mufflers.
'04-'07
GYT-5XD93-75-00

4 GYT-R Aluminum Oval Muffler
Ball burnished oval aluminum shell with a stainless steel inlet pipe, 1.25 kgs lighter than stock. Design based on our Factory YZ team pipes. Offers improved power throughout the powerband: 25% increase in low-end horsepower, 20% increase in midrange horsepower and a whopping 5.5 peak horsepower gain. For closed-course competition only unless GYT-R Quiet Muffler Insert is installed.
'04-'07
GYT-5TG93-02-AL

5 GYT-R Stainless Steel Header Pipe
Stainless steel construction with a billet aluminum flange. Includes brackets to mount stock heat-shield. A must have for the ultimate performance with the GYT-R muffler.
'04-'07
GYT-5TG93-50-00

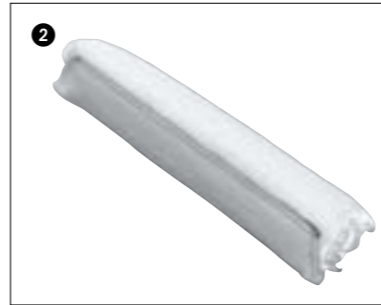

Leisure

YFZ450 - Performance

6 Top End Gasket Kit
Required for installation of the GYT-R High Compression Piston Kit.
'04-'05
GYT-5TG04-10-00

7 Carburetor Jet Kit
Developed to improve throttle response, drivability and power when used in conjunction with GYT-R exhaust systems and removal of airbox lid. Includes new needle, main jets, and pilot jets. For closed-course competition only.
'04-'07
GYT-5TG98-10-00

8 Multi Stage Air Filter
Special two-stage design for maximum airflow and superior filtration for greater engine protection.
GYT-5TG95-00-00

9 Number Plate Backing
Contains 1 front and 2 rear backgrounds
'04-'06
BLUE
GYT-5TG25-BG-BL
BLACK
GYT-5TG25-BG-BK
WHITE
GYT-5TG25-BG-WH

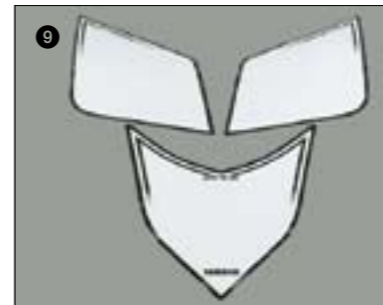
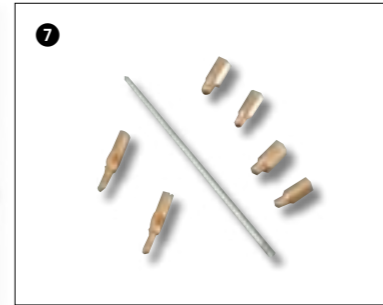
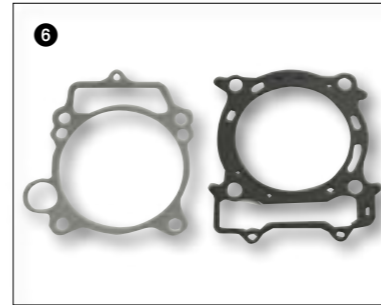

1 Bumper with shield

Made of strong yet light weight 5052 and 6063 aluminum alloy tubing and sheet metal for the ultimate in protection and performance. "Bull Horn" design provides protection to the shocks and radiator while offering a large hand hold to man over the machine in sticky situations. Wrap under design provides a smooth transition from the front grab bar to the glide plate while not effecting the stock approach angles. Ball Burnished finish resists scratches for long lasting good looks.

18P-F84LO-U0-00

2 Alumium Bumper Tubing

Made of high quality yet aluminum 6063 alloy construction for the ultimate in protection and performance. 25.4mm tubing provides protection to the shocks and radiator while offering a large hand hold to manover the machine in sticky situations. Wrap under design provides a smooth transition form the bar to the glide plate while not effecting the stock approach angles. Ball Burnished finish for long lasting good looks

18P-F84LO-V0-00

3 Black Bumper Tubing

Similar to the Aluminium Bumper Tubing (18P-F84LO-V0-00) but with durable black powder coating for long lasting good looks

18P-F84LO-T0-00

4 High end Nerf bars including adjustable footwells

This accessory combines the nerfbar, footwell and footpeg into one accessory. Features 31.7 mm 6063 brushed aluminum alloy tubing construction for the ultimate in light weight, strength and performance with a extruded joint clamp that makes alignment and installation a snap. Features a 5 degree sweep that allows the ultimate in leverage, comfort and clearance. The integrated footpeg is 63.5mm wide and 19mm longer than stock with two height positions (19mm lower than stock or 31.7mm lower than stock) that allow the rider to adjust to their personal preference. Durable 38mm black nylon webbing, in both the nerf bar and footwell area so mud will flow through better. For racing use only.

GYT-18P64-KT-07



5 Nerf Bars, Black Webbing

30.5mm 6063 brushed aluminum alloy tubing construction for the ultimate in light weight, strength and performance. Features a extruded joint clamp that makes alignment and installation a snap.

FOR RACING USE ONLY

GYT-18P31-KT-01

6 Black Nerf Bars, Black Webbing

High quality yet weight 6063 aluminum alloy 30.5mm tubing construction with durable black powder coating finish for the ultimate in light weight, strength and performance. Features a extruded joint clamp that makes alignment and installation a snap. For those who only want the best.

FOR RACING USE ONLY

GYT-18P31-KT-04

7 Plastic Frame skidplate White

Lightweight 6.4mm polyurethane construction is much lighter than aluminum plates that provides a smooth and slick surface so the unit can "glide" over track obstacles. Mounting holes are recessed to help protect mounting hardware. Protects the frame, engine, and chassis components. Drain holes located in key areas that allow mud and water to drain that reduces mud and dirt weight and provides easier unit clean-up.

18P-F84N0-S0-00

8 Plastic Frame skidplate Black

Similar specifications to the White plastic frame skid plate. Perfect match to both red/white and blue/black machines.

18P-F1471-U0-00

1 Alu Frame Skid Plate

Protects the frame and steering stem sleeve, engine, and chassis components. The mounting holes are dimpled, preventing hardware damage and is easy to install (no loose spacers to lose or align). Strong yet lightweight 5052 4mm thick aluminum alloy sheet metal for the ultimate in protection and performance. Smart design has oil drain holes located in key areas that allow oil, mud and water to drain, reducing mud and dirt weight and providing easier unit clean-up and maintenance. Rubber pads in key areas help prevent stock component damage and minimal vibration noise.

18P-F84N0-V0-00

2 A-Arm Skid Plates

Strong yet lightweight 3.2mm thick 5052 aluminum alloy sheet metal for the ultimate in protection and performance has drain holes located in key areas that allow mud and water to drain, reducing mud and dirt weight and provide easier unit clean-up. Rubber pads in key areas help prevent stock component damage and reduce vibration noise. protects A-arms, steering and suspension componets. mounting holes are dimpled to prevent mounting hardware damage and provide easy installation.

18P-F31A0-V0-00

3 Swing arm skid plate

Improved smart and lightweight design compared to the YFZ450 '08 model whilst the chain and disk are optimal protected

18P-W0746-00-00

4 Chain and Disk protection

Offers protection for human and machine and required for race-use. Must be fitted on the Swing-arm protection (sold separately)

18P-W0746-10-00

5 Aluminum Footwells

Good looking aluminium footwells to protect your feet.

18P-F16G0-V0-00

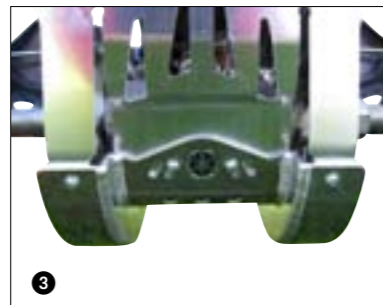

36

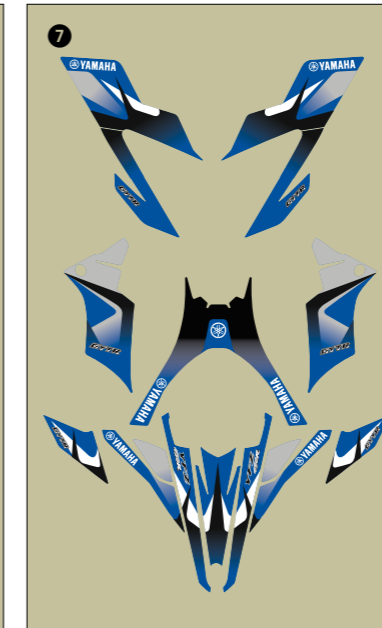
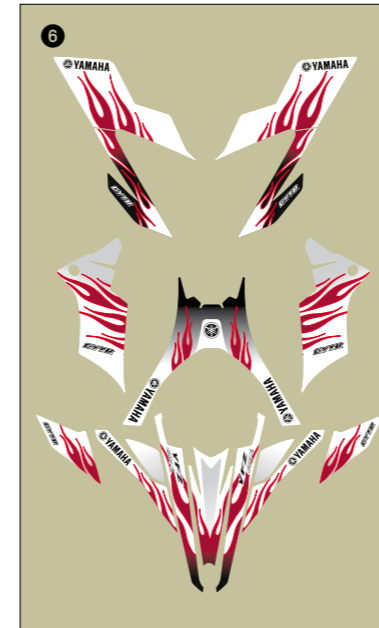
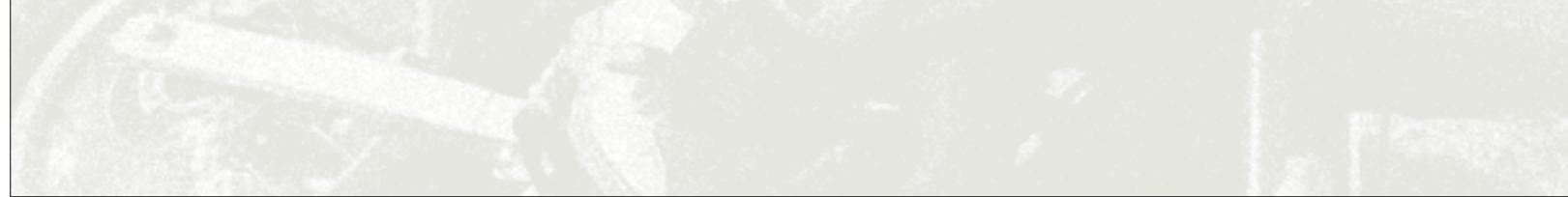

37

Stickers kit

6 Red/ White

Perfect combination with your Red/white coloured YFZ450R. Offers protection and a good looking machine

18P-F17C0-U0-00

7 Black/ Blue

Perfect combination with your blue coloured YFZ450R. Offers protection and a good looking machine

18P-F17C0-V0-00

8 GYTR high flow air filter

High flow gauze filter offers optimal airflow while the engine is still protected. Re-usable after cleaning. Must be used in combination with GYT-R Air Filter Adaptor Plate (4D3-W0727-02-00). For racing use only!

GYT-5TG95-01-10

9 GYTR air filter adaptor

Billet aluminium adaptor allows installation of GYT-R High Flow Air Filter (4D3-W0727-01-00) onto the stock airbox. For racing use only!

18P-E41E0-V0-00

● Racing Mufflers (NOT SHOWN)

This slip-on muffler is designed to offer a boost in mid and top-end power. Hard-anodized oval aluminum muffler shell. Cone-style end cap, Completely rebuildable, Uses stock heat shield, Noise level is 99bBA. For closed circuit use only.

18P-E47A0-T0-00

● Shut-off Lanyard (NOT SHOWN)

Engine shut-off lanyard. Easy fitting to all ATV units. Waterproof.

YMD-W0720-00-00

Leisure

YFZ450R

1 Front Shock Covers

Helps protect against rocks and debris. Heat-venting holes included for maximum performance. Easy to install and remove. (Sold in pairs)

18P-F33A0-V0-00

2 Rear Shock Covers

Helps protect against rocks and debris. Heat-venting holes included for maximum performance. Easy to install and remove. (Sold in pairs)

18P-F22A0-V0-00

Braded Brake Lines

These top-quality brake lines are designed to not fatigue under extreme conditons, improving brake feel. Feature black oxide banjo fittings and smoked clear coated stainless steel braided lines.

3 Front

18P-F58E0-V0-00

4 Rear

18P-F58A0-V0-01

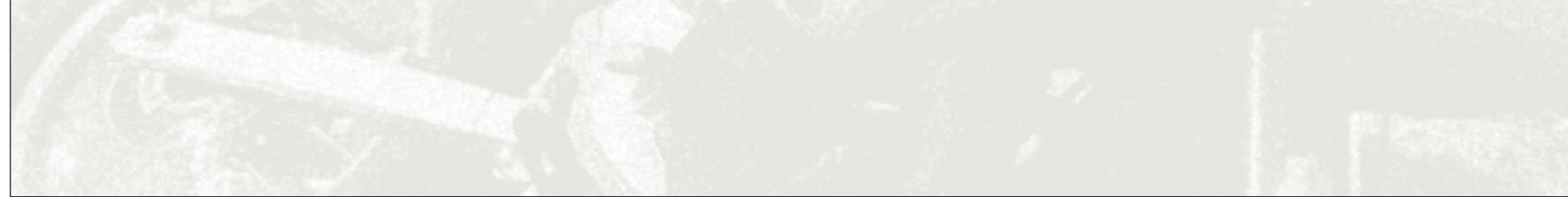

Leisure

YFZ450R



1 Aluminium Nerf Bars

Aluminium tubing (30x3mm) Nerf Bar with integrated heel protector. Original heel protector will be replaced. For racing use only.
4D3-W0747-00-00

2 Graphic Kit

4D3-W0790-00-00

Universal stickerkit

Universal stickerkit fitting YFZ250R. Kit includes tank, fenders & front body graphics.

3 Blue

ATV-W0740-10-00

4 Black, red/gold

ATV-W0740-20-00

Universal, graphic protection kit

Universal, transparent stickerkit to protect your graphics. Kit includes tank, fenders & front body protector film.

ATV-W0740-00-00



40



41

5 Front Grab Bar with Integrated Shield

Special ball-burnished, aluminium tube construction (25x3mm). Functional and stylish design with integrated aluminium shield (2mm) for additional radiator protection.
4D3-W0735-00-00

6 Aluminium Disk and Chain Protection

Add on to swingarm protection
4D3-W0746-01-00

7 Aluminium Swingarm Skidplate

U-shape chain guard for improved chain guidance. Strong bridge construction. Surface treatment matches the swing arm look.
4D3-W0746-02-00

8 Aluminium A-arm Skidplates

Satin polished, 4mm thick aluminium with holes for dewatering and to avoid dust accumulation.
4D3-W0746-03-00

9 Nylon Frame Skidplate

Black Nylon frame skidplate (5mm) with holes for dewatering and to avoid dust accumulation.
4D3-W0746-00-10

10 Aluminium Frame Guards

Light aluminium (2mm) frame guards. Protect the frame from abrasion caused by boots.
4D3-W0740-00-00

Engine Shut-off Lanyard*

(NOT SHOWN)

Engine shut-off lanyard. Easy fitting to all ATV units. Waterproof.
YMD-W0720-00-00

* For Racing Use Only

1 GYT-R Aluminium Racing Muffler

Hard anodized aluminum shell with a stainless steel inlet pipe, 1.25 kgs lighter than stock. Offers improved mid range and top power. Noise level = 96DB. Should be installed with carburator jetkit (4D3-W0727-00-00). For closed-circuit competition only.
4D3-W0724-00-00

2 Front Shock Covers (set)

Helps protect against rocks and debris. Heat-venting holes included for maximum performance. Easy to install and remove. (Sold in pairs)
BLACK
YMD-W0749-00-00

3 Carburator Jet Kit

Designed to improve throttle response, drivability, and power when the accessory air filter is used on the stock engine. Compatible with GYT-R Aluminium Racing Muffler (4D3-W0724-00-00).
4D3-W0727-00-00

4 GYT-R High Flow Air Filter

High flow gauze filter offers superior engine protection, reusable. Must be used in combination with GYT-R Air Filter Adaptor Plate (4D3-W0727-02-00).
4D3-W0727-01-00

5 GYT-R Air Filter Adapter Plate

Billet aluminium adaptor allows installation of GYT-R High Flow Air Filter (4D3-W0727-01-00) onto the stock airbox.
4D3-W0727-02-00

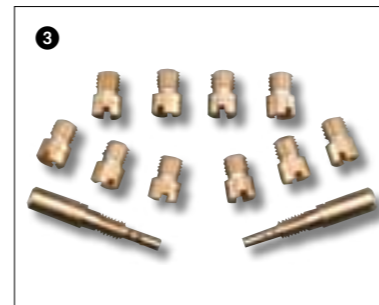

Leisure

yfm350R - Performance

1 GYT-R Carburetor Jet kit

Designed to improve throttle response, drivability, and power when the accessory air filter is used on the stock engine. Tunable for the GYT-RTM Muffler.

GYT-5YT98-00-00

2 GYT-R Aluminum Muffler

Passes the 96 dBA 20" stationary test used by authorities in some public riding areas. Provides over 25% increase in mid range horsepower and a 2 peak horsepower gain. Features include: Ball-burnished aluminium shell with stainless steel inlet pipe. Ball-burnished 6061-T6 aluminium end caps. Silent Sport™ Pillow packing. Removable screen-type U.S.F.S.-approved spark arrestor. Completely rebuildable. This accessory may be restricted to closed-course use.

GYT-5YT93-01-AL

3 GYT-R Air Filter Adaptor

Adaptor allows use of the high flow air filter in the stock airbox.

GYT-5YT95-10-00

4 GYT-R High Flow Air Filter

High flow gauze filter offers superior engine protection, reusable. Must use billet air filter adaptor plate (GYT-5YT95-10-00).

GYT-5YT95-01-00

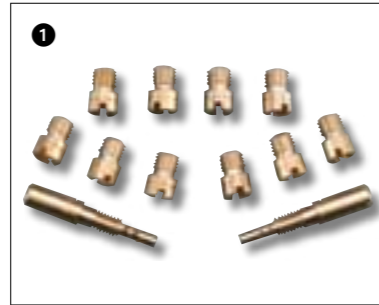

44

Leisure

yfm350R - Protection

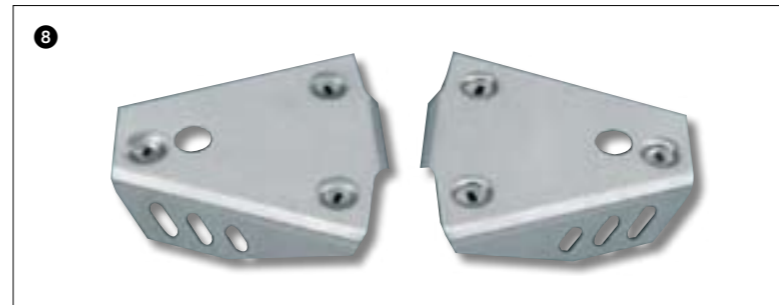
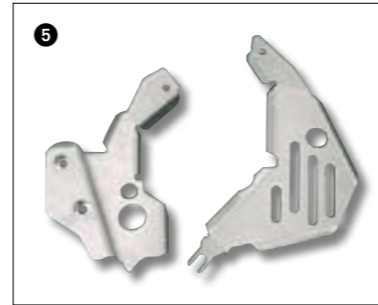

5 Aluminium Frame Guards

Protect against boot wear on your frame.

GYT-5YT33-10-00

6 Swing Arm Skid Plate

High-tech design with brushed-aluminum finish. Helps protect and complement the look of the factory aluminum swing arm.

ATV-5YT33-00-10

7 Frame Skid Plate

Brushed-finished aluminum plate construction.

ATV-5YT34-00-10

8 A-Arm Skid Plates

Aluminum plate construction designed to wrap in front to protect A-Arms. Brushed finish.

ATV-3GD34-10-10

9 Aluminum Front Sprocket Cover

Made from 6061-T6 Billet aluminum, special ball-burnished finish.

GYT-5YT09-40-AL

10 Aluminum Generator Cover

Made from 6061-T6 billet aluminum, special ball-burnished finish.

GYT-5YT09-20-AL

45

Leisure

YFM350R - Protection/Graphics

Leisure

YFM350R

1 Front Grab Bar

Special ball-burnished, aluminum tube construction. Functional and stylish design.

GYT-5YT14-00-00

Graphics

Universal stickerkit

Universal stickerkit fitting YFM350R. Kit includes tank, fenders & front body graphics

2 Blue

ATV-W0740-10-00

3 Black, red/gold

ATV-W0740-20-00

● Universal, graphic protection kit

(NOT SHOWN)

Universal, transparent stikerkit to protect your graphics. Kit includes tank, fenders & front body protector film.

ATV-W0740-00-00



Leisure

yfm660R - Protection

❶ A-Arm Skid Plates

Special ball-burnished, surface-hardened finish. Helps protect the upper and lower A-arms from damage. Matches the look of the front and rear grab bars, heel plate, and wheels (sold in pairs).

ABA-5LP34-11-00

❷ Swing Arm Skid Plates

High-tech design with a brushed aluminium finish. Helps protect and complement the look of the factory aluminium swing arm.

ABA-5LP33-01-00

❸ Engine Frame Skid Plate

Brushed finish aluminium plate construction includes a unique design for added cooling hose protection.

ABA-5LP34-01-00



48



49

Leisure

yfm660R - Protection

❹ Aluminium Frame Guard

Protects against boot wear on your frame (sold in pairs).

ABA-5LP33-10-00

❺ Aluminium Radiator Guard

Made from high-quality expanded aluminium. Offers increased protection for radiator against flying objects.

ABA-5LP26-40-00

❻ Rear Brake Reservoir Guard

Made from the same quality aluminium as our skid plates.

ABA-5LP19-00-00

Leisure

YFM660R - Protection

1 Aluminium Footwells

Special ball-burnished, surface-hardened aluminium is used in this tube-and-plate construction. Replaces factory footwell assembly (sold in pairs).
ABA-5LP57-00-00

2 Aluminium Grab Bar Front

Special ball-burnished, surface-hardened aluminium tube construction.
ABA-5LP14-00-00

3 Front Shock Covers Blue

Helps protect against rocks and debris. Heat-venting holes included for maximum performance. Easy to install and remove. (Sold in pairs.)
ABA-SCVRF-BL-04

4 Rear Shock Cover Blue

Helps protect against rocks and debris. Heat-venting holes included for maximum performance. Easy to install and remove. (Sold individually.)
ABA-SCVRR-BL-04



50

Leisure

YFM660R - Protection

5 Light Guards Carbon Look (Pair)

For a uniquely customised look. These durable, thermal-formed plastic covers will enhance the look of your YFM 660R (sold in pairs).
ABA-5LP35-00-CF

6 Side Cover Carbon Look (Pair)

ABA-5LP09-10-CF

7 Hand Deflectors Carbon Look (Pair)

Helps in protecting your hands and knuckles from weather and trail brush (sold in pairs).
Suitable until model year '04.
< '04
ABA-5LP26-20-CF

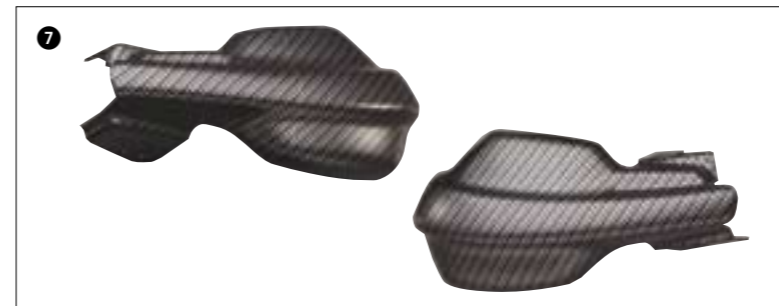

51



Leisure

YFM660R - Performance

1 Billet Throttle Housing Cover

Add a serious performance look with this high-quality billet cover.
ABA-5LP27-33-00

2 Billet Brake Pedal

Add unique styling to your YFM 660R with this high-quality accessory.
ABA-5LP37-23-00

3 Billet Oil Filter Cover

ABA-5LP27-62-00

4 GYT-R Aluminium Oval Muffler

GYT-5LP93-02-AL

5 GYT-R Performance Header

GYT-5LP93-50-00

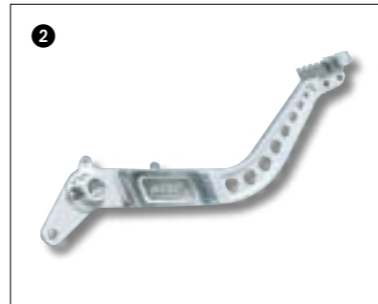

6 GYT-R Multi Stage Air Filter

GYT-5LP95-00-00

7 Billet Air Filter Adapter Plate

GYT-5LP95-10-00



Leisure

YFM700R - Protection

1 Swing Arm Skid Plate

Complete swing arm protection with riveted chain guide.
ATV-1S333-01-00

2 Chain Guide

ATV-1S333-01-01

3 A-Arm Skid Plates

ATV-1S334-11-00

4 Aluminium Footwells

Aluminium tube and plate constructions. Utilizes a unique, punch-through design that enhances the complete styling of the YFM 700R.
ATV-1S357-01-00

5 Engine Frame Skid Plate

Features side guards to reduce intrusion from foreign objects. Covers complete lower frame tubes
ATV-1S334-01-00

6 Front Bumper

Aluminium tube construction with lower bash plate. Functional and sporty design.
ATV-1S314-00-00

7 Radiator guard

Made from high-quality expanded aluminium.
Offers increased protection for radiator against flying objects.
GYT-1S340-00-AL



54

Leisure

YFM700R - Protection

8 Front Brake Joint Protector

ATV-5TG80-01-00

9 Billet Shift Pedal
Strong, yet lightweight billet aluminum construction. Ball-burnished finish with GYT-RTM® logo.
GYT-1S338-10-AL

10 Billet Brake Pedal
(NOT SHOWN)
Add unique styling to your YFM 700R with this high-quality GYT-R performance accessory.
GYT-1S327-10-AL

11 Aluminium Slip on Muffler *

Offers 16% increase in low-to-midrange horsepower, a 3.8 peak horsepower gain and up to 30% more power after peak when used with the GYTR™ High Flow Air Filter (GYT-1S395-01-00). 1,1 Kg. lighter than stock.

FEATURES INCLUDE:

- Hard anodized extruded 6061-T6 aluminium shell.
- Two piece billet aluminium end cap; ball-burnished outer and hard-anodized inner.
- New fixed rubber mounting system.
- 304 Stainless Steel inlet and inlet cap.
- Removable new screen-type U.S.F.S.-approved spark arrestor with welded joints.
- Completely rebuildable
GYT-1S393-01-AL

11 Head Pipe *

This stainless steel performance header, combined with the GYTR™ Performance Oval Muffler, will add 20% increase to mid-range horsepower and a 4.3 peak horsepower gain when used with the GYTR™ High Flow Air Filter (GYT-1S395-01-00).

FEATURES:

- 304 Stainless Steel stepped head pipe.
- Incorporates heat shield mounts for the stock heat shield.
- Uses gasket and clamp when mating to the muffler.
GYT-1S393-50-00

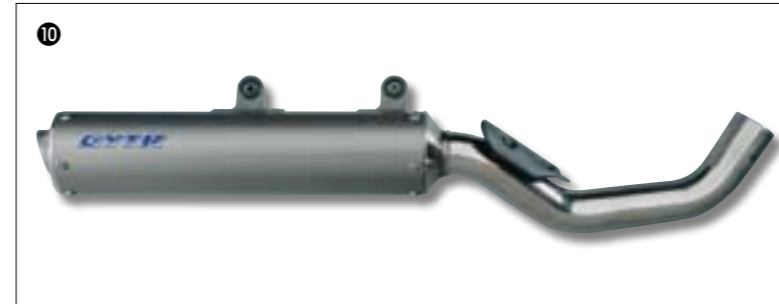

55

*This accessory is restricted to closed-course use. This component affects exhaust emissions; installation on EPA-regulated 2006 or later models constitutes unlawful tampering except when used solely for closed-course competition.

Leisure

YFM700R - Graphics

1 Graphic Kit

BLUE STROBE
GYT-1S325-20-BS
BLUE DRIP
GYT-1S325-30-BD

2 Graphic Kit '07

BLUE / GREY / BLACK / ORANGE
1S3-W0790-00-00

3 Seat Cover

YMF-45710-R7-00

Universal stickerkit

Universal stickerkit fitting YFM700R. Kit includes tank, fenders & front body graphics.

4 Blue

ATV-W0740-10-00

5 Black, red/gold

ATV-W0740-20-00

Universal, graphic protection kit

(NOT SHOWN)

Universal, transparent stickerkit to protect your graphics. Kit includes tank, fenders & front body protector film.

ATV-W0740-00-00



56

Leisure

YFM700R - Protection

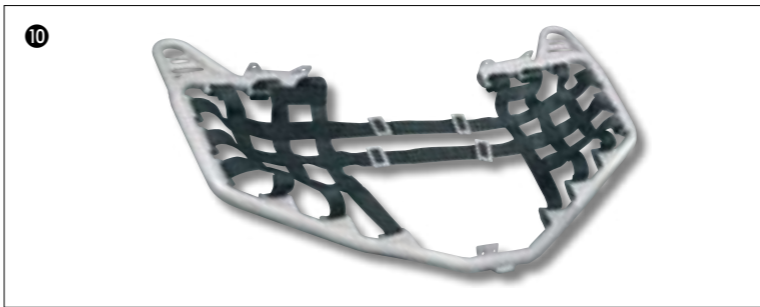

57

6 Air Filter Adapter Plate

Designed to be used in conjunction with the high flow air filters
GYT-1S395-10-00

7 Gauze Performance Filter

High-flow gauze filter offers superior engine protection. Reusable. Must use Billet Air Filter. Adaptor Plate
GYT-1S395-01-00

8 Replacement Element

GYTR™ High Flow Air Filter High-flow, oiled gauze filter offers a unique 'D'-shaped design for optimal airflow and superior engine protection. Reusable. Must use Billet Air Filter Adaptor Plate (GYT-1S395-10-00), sold separately. Service with Genuine Yamaha Gauze Filter Cleaner and Filter Oil, both available from your Yamaha dealer
GYT-1S395-00-00

9 Outerwear Pre Filter

Less maintenance in dusty conditions. Pre-filters dirt with no critical airflow or power loss.
GYT-1S395-11-BL

10 CYT-R Nerfbar

Aluminum frame construction, utilizing 1.5" Nylon webbing.
GYT-1S331-00-AL

11 Nerf Bars Basic

ATV-1S331-00-00

❶ Öhlins Front Shock Absorbers (set)
1S3-W0702-FR-00

❷ Öhlins Rear Shock Absorber
1S3-W0702-RR-00





Apparel



Apparel

Riding Gear



AVAILABLE COLOURS:



MX-Pro Gloves
MALE
SIZE: 7-12



AVAILABLE COLOURS:



Paddock Cap
UNISEX
SIZE: ONE SIZE FITS ALL



AVAILABLE COLOURS:



Mx-Pro Jersey
MALE
SIZE: L-XXL



AVAILABLE COLOURS:



MX-Pro Pants
MALE
SIZE: 30-40



AVAILABLE COLOURS:



MX Start Jersey
MALE
SIZE: M-XXL



AVAILABLE COLOURS:



MX Start Pants
MALE
SIZE: 7-12



AVAILABLE COLOURS:



MX Start Youth Jersey
KIDS
SIZE: XXS-S

AVAILABLE COLOURS:



MX Start Youth Pants
KIDS
SIZE: 24-28

Apparel

Riding Gear



Apparel

Riding Gear



AVAILABLE COLOURS:



MX Start Gloves
MALE
SIZE: 7-12

AVAILABLE COLOURS:



MX Start Youth Gloves
KIDS
SIZE: 4-6

AVAILABLE COLOURS:



ATV/Enduro Soft Protection Gloves
MALE
SIZE: 7-12

AVAILABLE COLOURS:



Freeride Jersey
MALE
SIZE: L-XXL



AVAILABLE COLOURS:



MX Start Cap
UNISEX
SIZE: ONE SIZE FITS ALL

AVAILABLE COLOURS:



MX Start Cap
UNISEX
SIZE: ONE SIZE FITS ALL

AVAILABLE COLOURS:



MX Start Cap
UNISEX
SIZE: ONE SIZE FITS ALL

AVAILABLE COLOURS:



Freeride Jacket
MALE
SIZE: S-XXL

AVAILABLE COLOURS:



Freeride Pants
MALE
SIZE: S-XXL



Apparel

Riding Gear



AVAILABLE COLOURS:

ATV/Enduro Jacket
MALE
SIZE: S-XXL

AVAILABLE COLOURS:

ATV/Enduro Trousers
MALE
SIZE: 30-40

AVAILABLE COLOURS:

ATV/Enduro Jersey
MALE
SIZE: L-XXL



AVAILABLE COLOURS:

ATV/Enduro Hard Protection Gloves
MALE
SIZE: 7-12



More details on page 69

Apparel

Riding Gear



1 MX boots

These high quality MX boots in the basic colours of grey and black are ideal to match any Yamaha of road clothing. For an even better match, we have in our assortment various coloured straps. An injected contoured shin plate and wide calf plate give superior protection, and the four adjustable aluminium buckles and soles are all available as spare parts

BLACK/WHITE		BLUE/WHITE	
40	A09-HF003-40-W4	40	A09-HF003-40-E2
41	A09-HF003-41-W4	41	A09-HF003-41-E2
42	A09-HF003-42-W4	42	A09-HF003-42-E2
43	A09-HF003-43-W4	43	A09-HF003-43-E2
44	A09-HF003-44-W4	44	A09-HF003-44-E2
45	A09-HF003-45-W4	45	A09-HF003-45-E2
46	A09-HF003-46-W4	46	A09-HF003-46-E2
47	A09-HF003-47-W4	47	A09-HF003-47-E2

2 Toe Cup - in pairs

Aluminium toe cap
YMF-62520-96-00

3 Buckle (Aluminium in sets of 2)

boot buckle
YMF-62520-96-02

4 Soles - in pairs

SIZE
39-42 = YMF-62520-96-04
43-45 = YMF-62520-96-05
46-48 = YMF-62520-96-01

5 MX Boot strap (bootstrap - 1 set =4)

black boot strap, 4 straps in a packet
YMF-62520-96-03

Apparel

Riding Gear













Apparel

Riding Gear

	Page 62		Page 62		Page 62		Page 62		Page 63	Page 63
	MX-Pro Gloves - male		Paddock Cap - unisex		Mx-Pro Jersey - male		MX-Pro Trouser - male		MX Start Jersey - male	MX Start Jersey - male
										
Size	Blue	Size	Blue	Size	Blue	Size	Blue	Size	Black/Red	Chilli/Vanilla
7	A09-RG104-07-E8	one size	B08-0A130-00-4A	L	A09-RT112-L0-E0	30	A09-RP107-30-E0	M	A09-GT112-M0-E8	A09-GT112-M0-C2
8	A09-RG104-08-E8			XL	A09-RT112-1L-E0	32	A09-RP107-32-E0	L	A09-GT112-L0-E8	A09-GT112-L0-C2
9	A09-RG104-09-E8			XXL	A09-RT112-2L-E0	34	A09-RP107-34-E0	XL	A09-GT112-1L-E8	A09-GT112-1L-C2
10	A09-RG104-10-E8					36	A09-RP107-36-E0	XXL	A09-GT112-2L-E8	A09-GT112-2L-C2
11	A09-RG104-11-E8					38	A09-RP107-38-E0			
12	A09-RG104-12-E8					40	A09-RP107-40-E0			

	Page 64		Page 64		Page 64		Page 64		Page 64		Page 65	Page 65
	MX Start Gloves - kids/male		MX StartGloves -kids/male		Mx Start Cap - Unisex		Mx Start Cap - Unisex		Mx Start Cap - Unisex		Freeride Jacket - male	Freeride Pants - male
												
Size	Black/Red	Size	Chilli/Vanilla	Size	Black/Red	Size	Chilli/Vanilla	Size	Black/Red		Black/Gray	Black/Gray
4 kid	A09-GG404-04-B0	one size	A09-GG404-04-C2	N09-GH000-00-B0	N09-GH000-00-C2	B08-0A103-00-9C	S	A07-0K120-S0-9B	A07-1B120-S0-9B			
5 kid	A09-GG404-05-B0		A09-GG404-05-C2				M	A07-0K120-M0-9B	A07-1B120-M0-9B			
6 kid	A09-GG404-06-B0		A09-GG404-06-C2				L	A07-0K120-L0-9B	A07-1B120-L0-9B			
7	A09-GG104-07-B0		A09-GG104-07-C2				XL	A07-0K120-1L-9B	A07-1B120-1L-9B			
8	A09-GG104-08-B0		A09-GG104-08-C2				XXL	A07-0K120-2L-9B	A07-1B120-2L-9B			
9	A09-GG104-09-B0		A09-GG104-09-C2									
10	A09-GG104-10-B0		A09-GG104-10-C2									
11	A09-GG104-11-B0		A09-GG104-11-C2									
12	A09-GG104-12-B0		A09-GG104-12-C2									

	Page 63		Page 63		Page 63		Page 63		Page 63	Page 63
	MX Start Pants - male		MX Start Pants - male		MX Start Jersey - kids		MX Start Jersey - kids		MX Start Youth Pants - kids	MX Start Youth Pants - kids
										
Size	Black/Red	Size	Chilli/Vanilla	Size	Black/Red	Size	Chilli/Vanilla	Size	Black/Red	Chilli/Vanilla
30	A09-GP107-30-B0	XXS	A09-GP107-30-C2	A09-GT412-2S-B0	A09-GT412-2S-C2	24	A09-GP407-24-B0	A09-GP407-24-C2		
32	A09-GP107-32-B0	XS	A09-GP107-32-C2	A09-GT412-1S-B0	A09-GT412-1S-C2	26	A09-GP407-26-B0	A09-GP407-26-C2		
34	A09-GP107-34-B0	S	A09-GP107-34-C2	A09-GT412-S0-B0	A09-GT412-S0-C2	28	A09-GP407-28-B0	A09-GP407-28-C2		
36	A09-GP107-36-B0		A09-GP107-36-C2							
38	A09-GP107-38-B0		A09-GP107-38-C2							
40	A09-GP107-40-B0		A09-GP107-40-C2							

	Page 65		Page 65		Page 66		Page 66		Page 66		Page 66
	ATV/Enduro soft protection gloves - male		Freeride Jersey - male		ATV/Enduro jacket - male		ATV/Enduro Trouser - male		ATV/Enduro Jersey - male		ATV/Enduro hard protection gloves - male
											
Size	Black	Size	Black/Gray	Size	Black	Size	Black	Size	Black	Size	Black
7	A09-SG107-07-B1	L	A07-0E120-L0-9B	S	A09-SJ101-S0-B0	30	A09-SP106-30-B0	L	A09-ST112-L0-B0	7	A09-SG105-07-B0
8	A09-SG107-08-B1	XL	A07-0E120-1L-9B	M	A09-SJ101-M0-B0	32	A09-SP106-32-B0	XL	A09-ST112-1L-B0	8	A09-SG105-08-B0
9	A09-SG107-09-B1	XXL	A07-0E120-2L-9B	L	A09-SJ101-L0-B0	34	A09-SP106-34-B0	XXL	A09-ST112-2L-B0	9	A09-SG105-09-B0
10	A09-SG107-10-B1			XL	A09-SJ101-1L-B0	36	A09-SP106-36-B0			10	A09-SG105-10-B0
11	A09-SG107-11-B1			XXL	A09-SJ101-2L-B0	38	A09-SP106-38-B0			11	A09-SG105-11-B0
12	A09-SG107-12-B1					40	A09-SP106-40-B0			12	A09-SG105-12-B0



The Yamalube® difference

At Yamaha, we believe the oil is as integral a part of the engine as any other. So critical, in fact, that we design our engines' design and performance specification based on the oil they will use. By synchronising the development of Yamalube® with the machines it's engineered for, we've delivered high-quality genuine oils recognised by many of today's riders as the perfect match for the power of their Yamaha. We carefully select the base oil and additives best suited for purpose, then rigorously test our oils to ensure a good affinity with the

Yamaha unit to bring out its fullest potential. Our dedication to the Yamalube® Product Range ensures we can give full support to the differing technical specifications and performance demands of each individual country – matching engine and oil for maximum performance every time.

THE OIL OF CHAMPIONS
With a legendary reputation built on countless racing victories, you can trust Yamaha to deliver 'Quality Before Anything'. And our oils are no different. Our

commitment to providing the finest oil for your Yamaha has created Yamalube® – a range of oils precisely formulated to suit the unique conditions facing your engine, from the very same team who engineered it. Extensively tested and proven in the lab and the field, Yamalube® performance oils safeguard your engine while keeping it performing to its peak. Truly the oil of champions, it's the only choice for your Yamaha. Why trust your engine to anything less?

www.yamaha-motor-acc.com

For the latest information on Yamaha genuine accessories please check out our website:

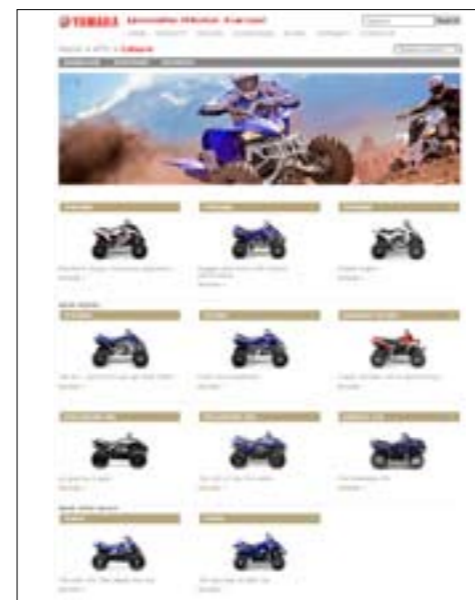

Yamalube Products

Yamalube FS 4

- Type: Fully Synthetic
- Oil name: 4 Stroke Motor Oil
- Specifications: API SG/ JASO MA

10W40

AVAILABLE PACKAGING

1L bottle	YMD-65011-01-02	DOQ*=12L
4L bottle	YMD-65011-04-02	DOQ=16L
60L barrel	YMD-65011-60-01	DOQ=60L
208L barrel	YMD-65011-20-81	DOQ=208L

15W50

AVAILABLE PACKAGING

1L bottle	YMD-65012-01-02	DOQ=12L
-----------	-----------------	---------

Yamalube S 4

- Type: Semi Synthetic
- Oil name: 4 Stroke Motor Oil
- Specifications: API SG/ JASO MA

10W40

AVAILABLE PACKAGING

1L bottle	YMD-65021-01-02	DOQ=12L
4L bottle	YMD-65021-04-02	DOQ=16L
60L barrel	YMD-65021-60-01	DOQ=60L
208L barrel	YMD-65021-20-81	DOQ=208L

20W-50

AVAILABLE PACKAGING

1L bottle	YMD-65022-01-02	DOQ=12L
60L barrel	YMD-65022-60-01	DOQ=60L

Yamalube M 4

- Type: Mineral
- Oil name: 4 Stroke Motor Oil
- Specifications: API SG

10W40

AVAILABLE PACKAGING

1L bottle	YMD-65031-01-02	DOQ=12L
4L bottle	YMD-65031-04-02	DOQ=16L
60L barrel	YMD-65031-60-01	DOQ=60L
208L barrel	YMD-65031-20-81	DOQ=208L

20W-50

AVAILABLE PACKAGING

1L bottle	YMD-65032-01-01	DOQ=12L
-----------	-----------------	---------

Yamalube S 2

- Type: Semi Synthetic
- Oil name: 2 Stroke Motor Oil
- Specifications: 81 YMC 525

10W40

AVAILABLE PACKAGING

1L bottle	YMD-65042-01-02	DOQ=12L
60L barrel	YMD-65042-60-01	DOQ=60L
208L barrel	YMD-65042-20-81	DOQ=208L**

* DOQ= Dealer Order Qty.

** Availability subject to confirmation

Nothing else.

2009
ATV

www.yamaha-motor-europe.com



Disclaimer:

Always wear a helmet, eye protection and protective clothing. Yamaha encourage you to ride safely and respect fellow riders and the environment. Images shown in this brochure depict professional riders performing under controlled conditions. Specifications and appearance of Yamaha products as shown here are subject to change without notice and may vary according to requirements and conditions. For further details, please consult your Yamaha dealer.



Yamaha highly recommend to you the use of genuine Yamaha accessories and clothing. Contact your local dealer or visit our website: www.yamaha-motor-acc.com

DEALER: