

Page	Description
1	Audio, Premium
2	Body Controller Front J1, J2
3	Body Controller Front J3, Cables
4	Body Controller Front J4
5	Body Controller Left J1
6	Body Controller Left J2, OHC
7	Body Controller Right J1
8	Body Controller Right J2, J5
9	Body Controllerer Dashboard
10	Brake Controls
11	CAN Chassis
12	CAN Party
13	CAN Vehicle
14	Charge Port Inlet
15	Door Front Left
16	Door Front Right
17	Door Rear
18	Drive Inverters
19	Driver Assistance
20	eCall
21	HV Battery & HVIL
22	HV Penthouse
23	HVAC Case Subassembly
24	HVAC Thermal Subassembly
25	Power Distribution, E-Fuse VCfront, J1-J4
26	Power Distribution, E-Fuse VCfront, J5-J12
27	Power Distribution, E-Fuse VLeft, J1-J3
28	Power Distribution, E-Fuse VLeft, J4-J9
29	Power Distribution, E-Fuse VCRight, J1-J3
30	Power Distribution, E-Fuse VCRight, J4-J9
31	Power Distribution, Grounding A,B,C Pillars
32	Power Distribution, Grounding Frunk
33	Power Distribution, Grounding Trunk
34	Restraints Airbags
35	RF/Special Cables
36	Seats Front Left
37	Seats Front Right
38	Security Controls
39	Steering
40	Ultrasonics

Table 1: Abbreviations

LF	Left Front	RF	Right Front
LR	Left Rear	RR	Right Rear
LHS	Left-Hand Side	RHS	Right-Hand Side

Table 2: Harness Designators

A	LH BODY	Q	PARCEL SHELF
B	RH BODY	R	LH RR DOOR
C	CENTER CONSOLE	S	RH RR DOOR
D	LH FR DOOR	T	LIFT GATE
F	FR FASCIA	U	THERMAL
G	RR FASCIA	V	GLASS
H	HV PENTHOUSE	W	FRUNK
J	IP	X	REAR SUBFRAME
K	HEADLINER	Y	FRONT SEATS
L	FRONT END MODULE		
N	FRONT SUBFRAME		
P	RH FR DOOR		

Table 3: Wire Color Designators

BK	Black	OG	Orange
BN	Brown	RD	Red
BU	Blue	VT	Violet (Purple)
GN	Green	WH	White
GY	Gray	YE	Yellow

Table 4: Wire Type Designators

FLRY	Thin wall 105C rated, regular stranded PVC insulated [FLRY-A]
FLRB	Thin wall 105C rated, bunched conductor PVC insulated [FLRY-B]
MCIV	Thin wall 105C rated, compressed conductor PVC (halogen free) insulated
XR15	Thin wall 150C rated, cross-linked polyolefin, high flexible
FLXB	Thin wall 125C rated, cross-linked polyolefin, high flexible, halogen free insulated
3TBL	Thick wall 105C rated, aluminum conductor PVC insulated

Table 5: Option Codes

DRIVR	Driver Seat
PASSN	Passenger Seat
LHST	Left side Seat
RHST	Right Side Seat
FOG	Fog Light
PCOLM	Power Steering Column
PAUDIO	Premium Audio
COLDW	Cold Weather Package
LHD	Left Hand Drive
RHD	Right Hand Drive
AWD	All Wheel Drive
RWD	Rear Wheel Drive
PINLT	Premium Interior Lights
PMIRROR	Premium Mirror with Powerfold
REEU	Region Europe
RENA	Region North America
CSUSP	Coil Suspension
PREMST	Premium Seat

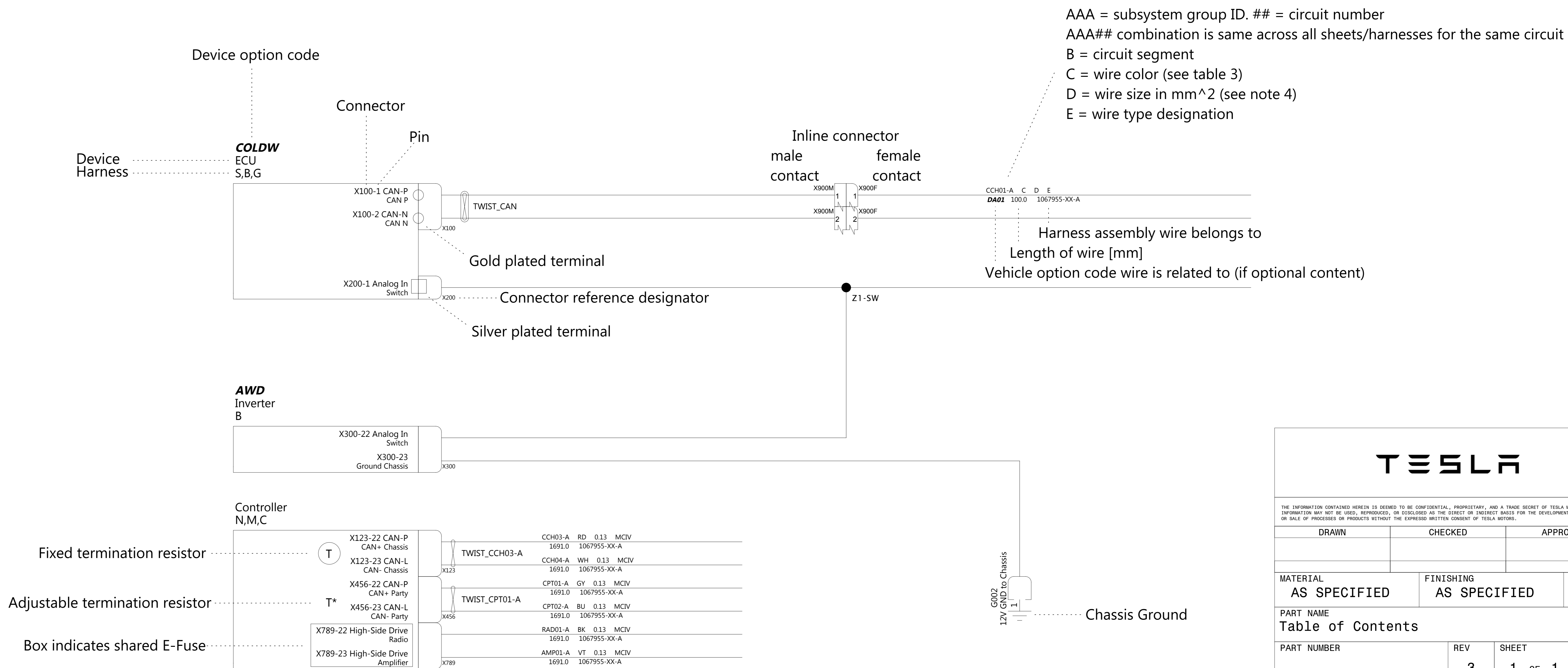

General Notes:

- Switches [Relays] are shown in their inactive [de-energized] state.
- Splices may be split across pages for visual clarity with respect to the function displayed on the particular page.
- Some connectors are split across multiple pages for clarity. There is no overall reference in this document for the signals routed to a specific connector.
- Wire sizes are specified in mm² cross-sectional area (CSA) per SAE 1127/8
- Wire Specification: 60V, thin-wall PVC (ISO type or equivalent). Default wire type to be rated 60VDC/25VAC and -40C to 105C operating temperature. See DIN 13602 or ISO 6722 for detailed specifications.
- Unless otherwise specified at the device pins, terminal plating is to be Tin or Pre-Tin

TERMINAL PLATING

- GOLD TERMINAL NECESSARY
- SILVER PLATING NECESSARY

- Inline connector gender specification is based on the terminal type. Inline connectors with "M" suffix have male, tab or pin terminals. Inline connectors with "F" suffix have female, receptacle or socket terminals

TESLA

THE INFORMATION CONTAINED HEREIN IS DEEMED TO BE CONFIDENTIAL, PROPRIETARY, AND A TRADE SECRET OF TESLA MOTORS. THIS INFORMATION MAY NOT BE USED, REPRODUCED, OR DISCLOSED AS THE DIRECT OR INDIRECT BASIS FOR THE DEVELOPMENT, MANUFACTURE, OR SALE OF PROCESSES OR PRODUCTS WITHOUT THE EXPRESS WRITTEN CONSENT OF TESLA MOTORS.

DRAWN	CHECKED	APPROVED

MATERIAL AS SPECIFIED	FINISHING AS SPECIFIED	SCALE NONE

PART NAME Table of Contents			
PART NUMBER	REV	SHEET	SIZE
	3	1 OF 1	A0

MCU
W,B

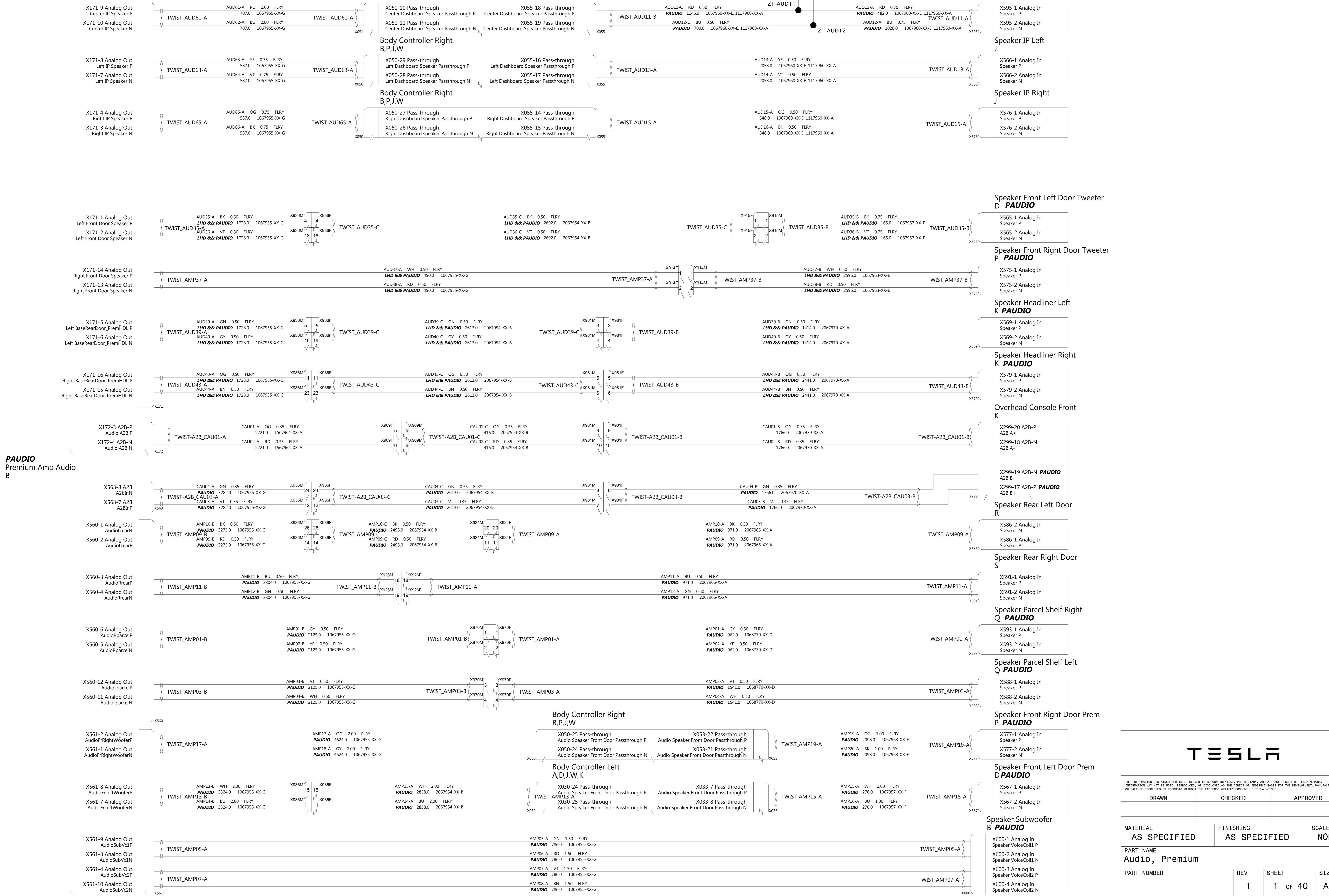

TESLA			
THE INFORMATION CONTAINED HEREIN IS DEEMED TO BE CONFIDENTIAL, PROPRIETARY, AND A TRADE SECRET OF TESLA MOTORS. THIS INFORMATION MAY NOT BE USED, REPRODUCED, OR DISCLOSED AS THE DIRECT OR INDIRECT BASIS FOR THE DEVELOPMENT, MANUFACTURE, OR SALE OF PROCESSES OR PRODUCTS WITHOUT THE EXPRESS WRITTEN CONSENT OF TESLA MOTORS.			
DRAWN	CHECKED	APPROVED	
MATERIAL AS SPECIFIED		FINISHING AS SPECIFIED	SCALE NONE
PART NAME Audio, Premium			
PART NUMBER	REV	SHEET	SIZE
	1	1 OF 40	A0

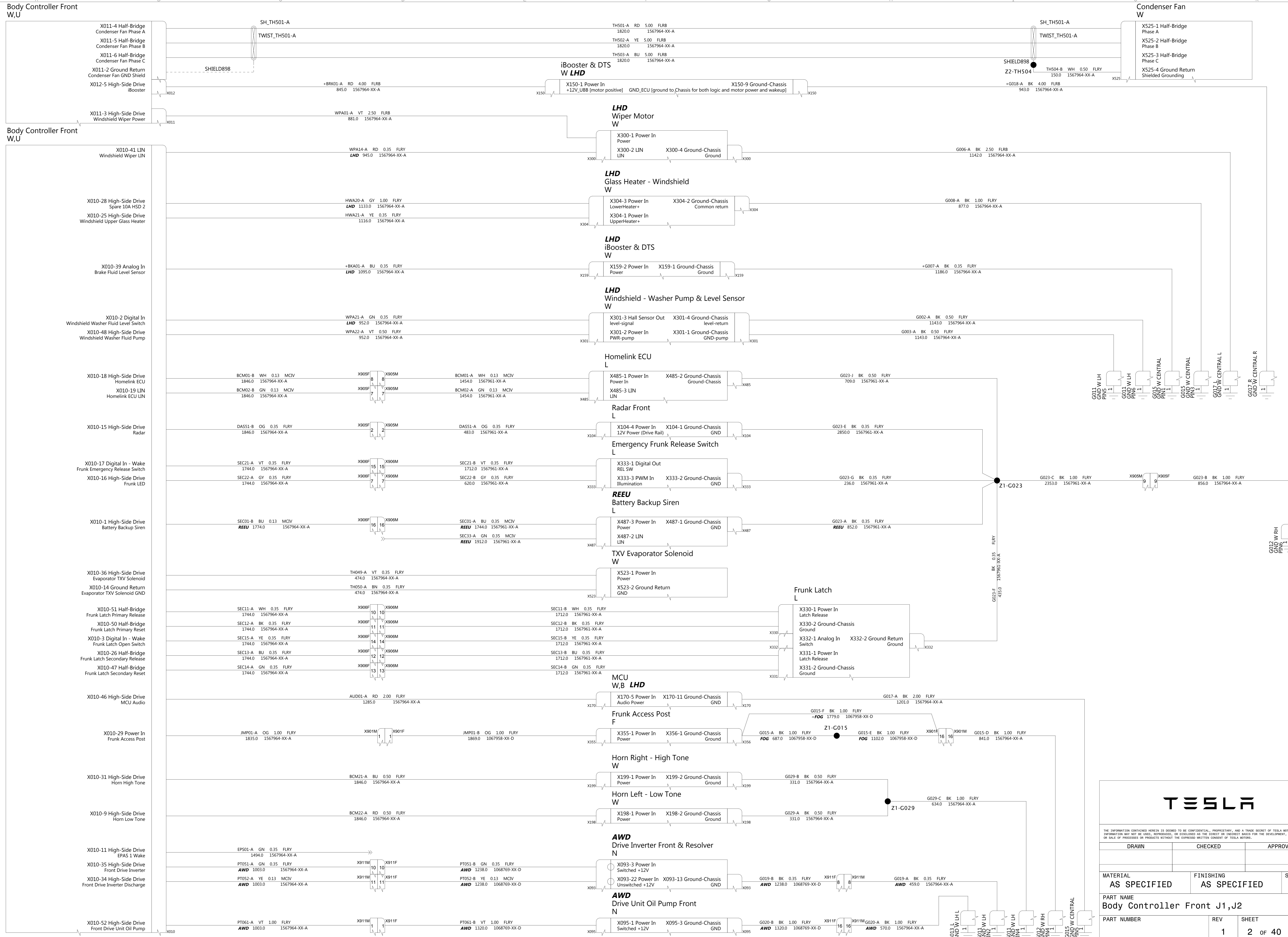

THE INFORMATION CONTAINED HEREIN IS DEEMED TO BE CONFIDENTIAL, PROPRIETARY, AND A TRADE SECRET OF TESLA MOTORS. THIS INFORMATION MAY NOT BE USED, REPRODUCED, OR DISCLOSED AS THE DIRECT OR INDIRECT BASIS FOR THE DEVELOPMENT, MANUFACTURE, OR SALE OF PROCESSES OR PRODUCTS WITHOUT THE EXPRESSED WRITTEN CONSENT OF TESLA MOTORS.

DRAWN	CHECKED	APPROVED
MATERIAL AS SPECIFIED	FINISHING AS SPECIFIED	SCALE NONE
PART NAME Body Controller Front J1,J2		
PART NUMBER	REV	SHEET
	1	2 OF 40
		SIZE A0

Body Controller Front
W,U

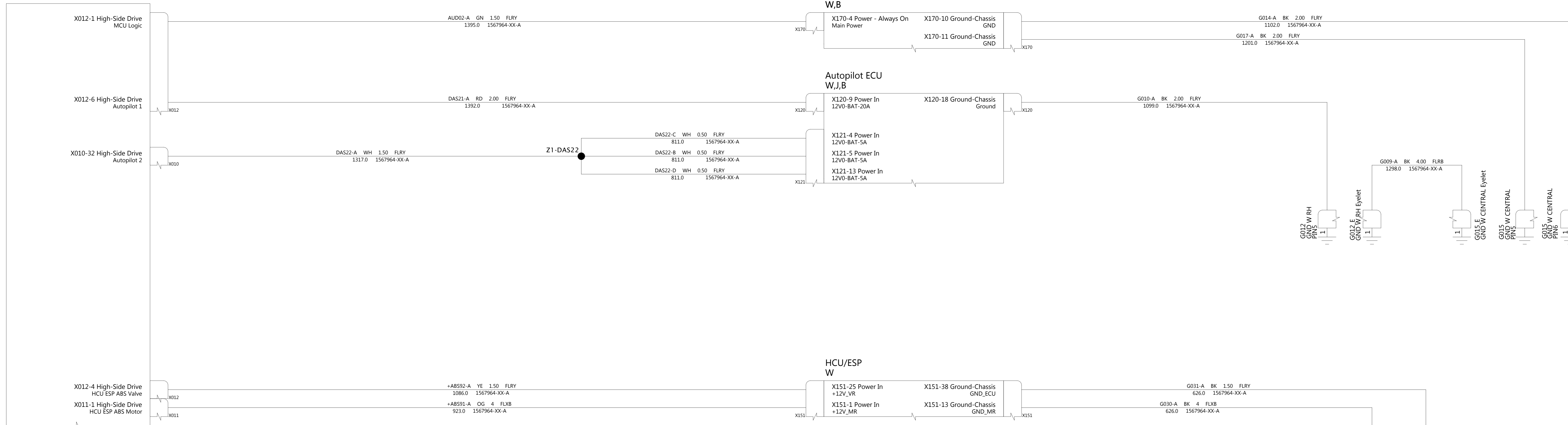

HV Battery
B

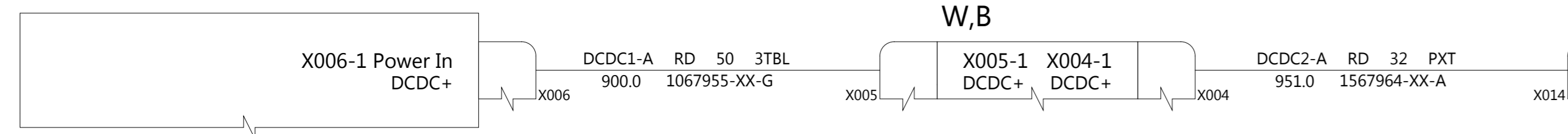

12V Battery
W

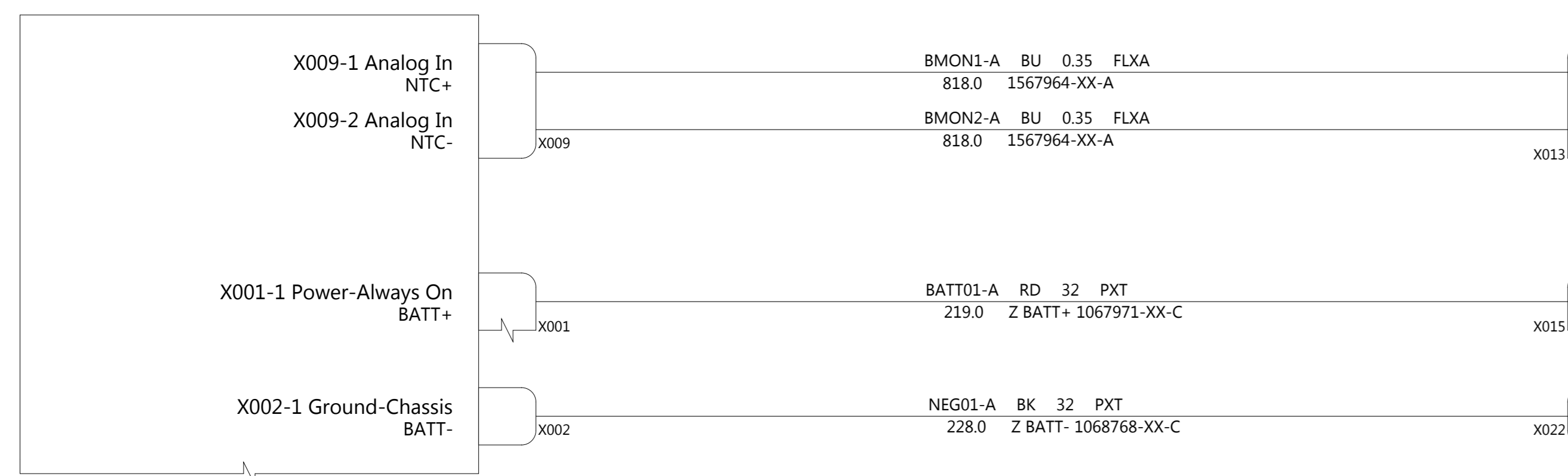

Body Controller Front
W,U

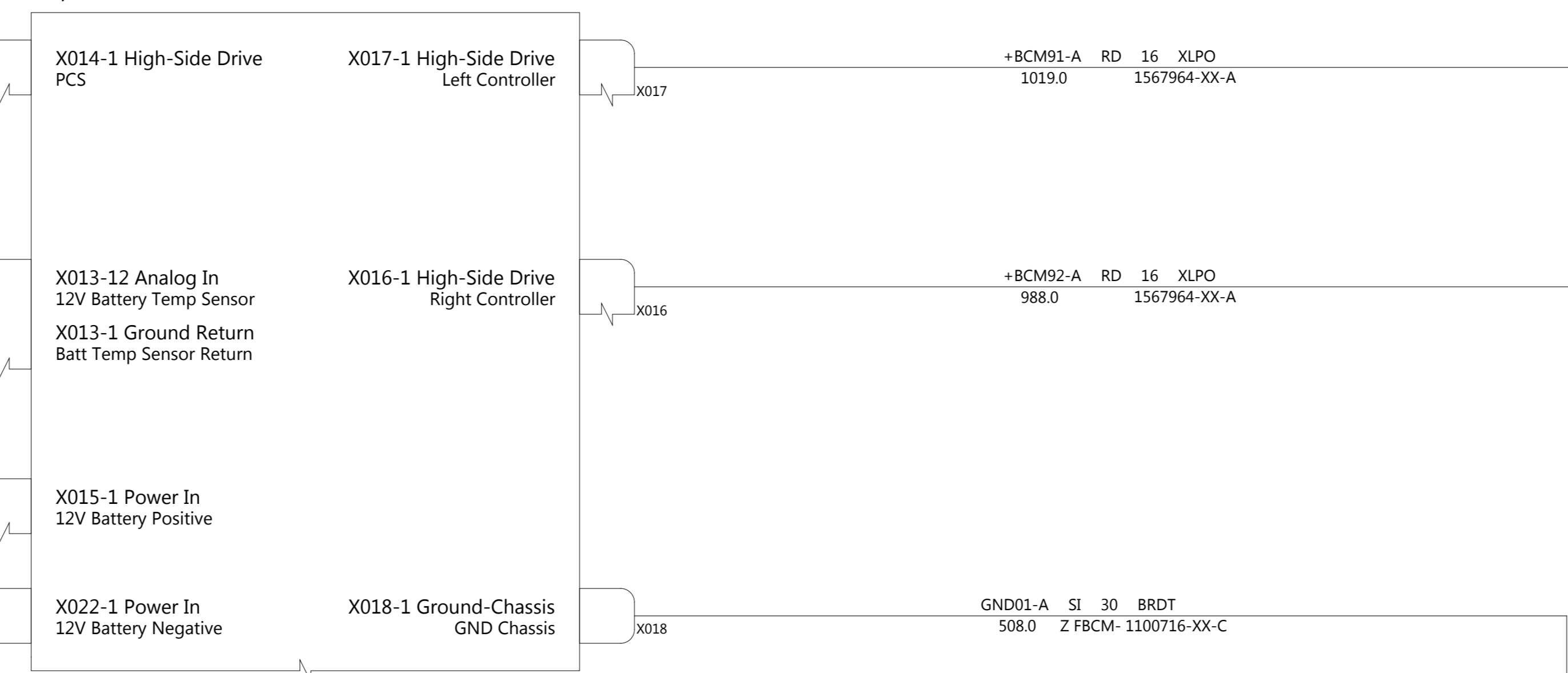

Body Controller Left
A,D,J,W,K

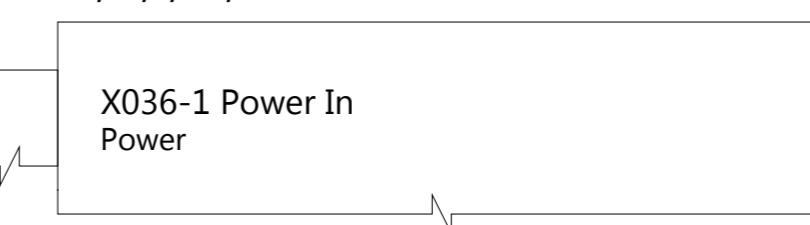

Body Controller Right
B,P,J,W

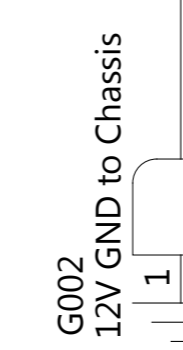
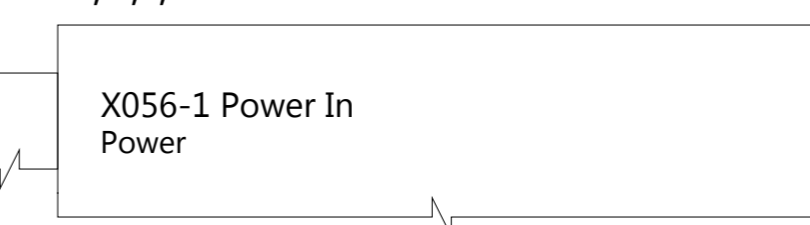

THE INFORMATION CONTAINED HEREIN IS DEEMED TO BE CONFIDENTIAL, PROPRIETARY, AND A TRADE SECRET OF TESLA MOTORS. THIS INFORMATION MAY NOT BE USED, REPRODUCED, OR DISCLOSED AS THE DIRECT OR INDIRECT BASIS FOR THE DEVELOPMENT, MANUFACTURE, OR SALE OF PROCESSES OR PRODUCTS WITHOUT THE EXPRESSED WRITTEN CONSENT OF TESLA MOTORS.

DRAWN	CHECKED	APPROVED
MATERIAL AS SPECIFIED	FINISHING AS SPECIFIED	SCALE NONE
PART NAME Body Controller Front J3, Cables		
PART NUMBER	REV 1	SHEET 3 OF 40
		SIZE A0

Body Controller Front
W,U

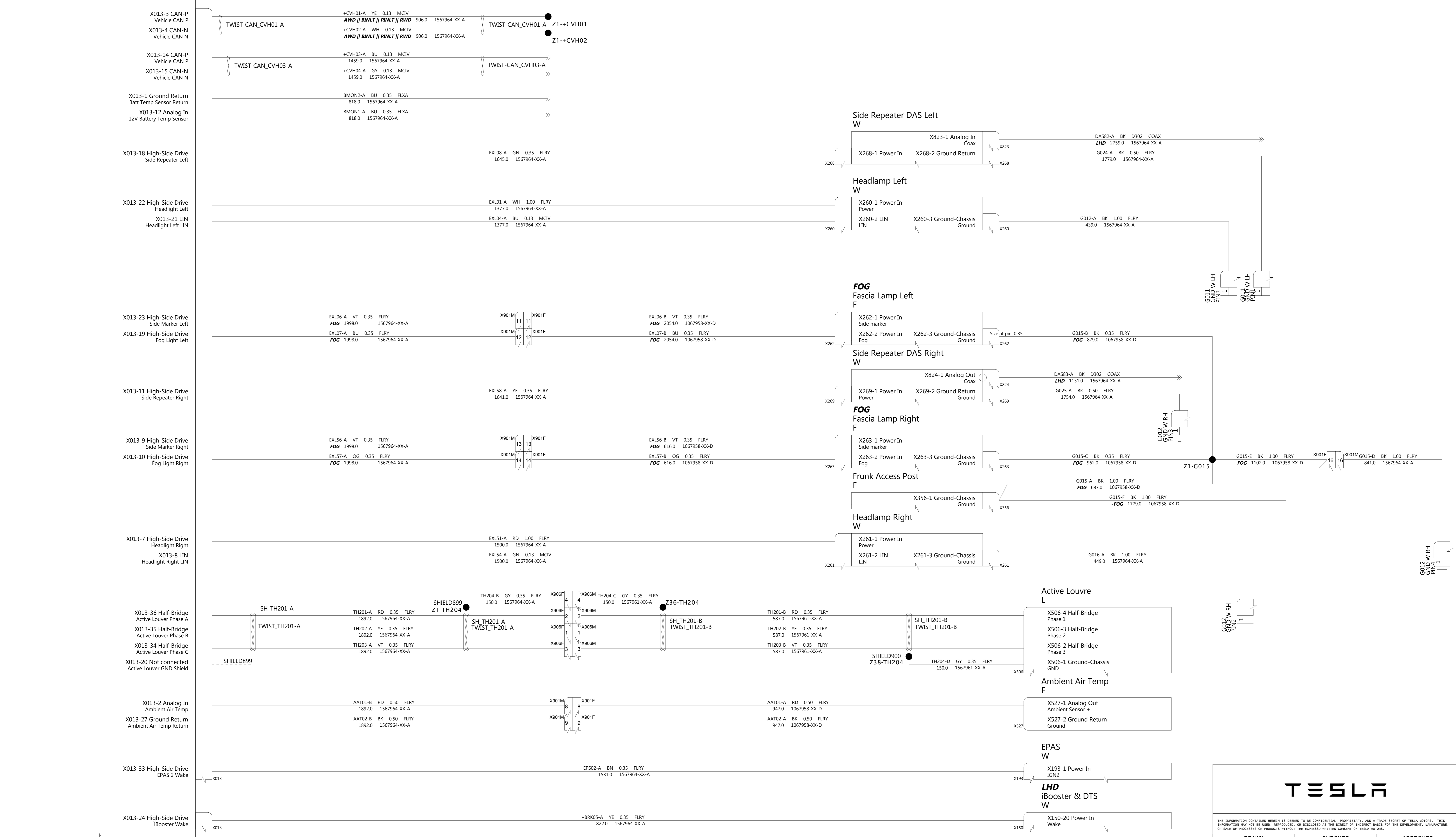

THE INFORMATION CONTAINED HEREIN IS DEEMED TO BE CONFIDENTIAL, PROPRIETARY, AND A TRADE SECRET OF TESLA MOTORS. THIS INFORMATION MAY NOT BE USED, REPRODUCED, OR DISCLOSED AS THE DIRECT OR INDIRECT BASIS FOR THE DEVELOPMENT, MANUFACTURE, OR SALE OF PROCESSES OR PRODUCTS WITHOUT THE EXPRESS WRITTEN CONSENT OF TESLA MOTORS.

DRAWN	CHECKED	APPROVED
MATERIAL AS SPECIFIED	FINISHING AS SPECIFIED	SCALE NONE
PART NAME Body Controller Front J4		
PART NUMBER	REV 1	SHEET 4 OF 40
		SIZE A0

Body Controller Left
A,D,J,W,K

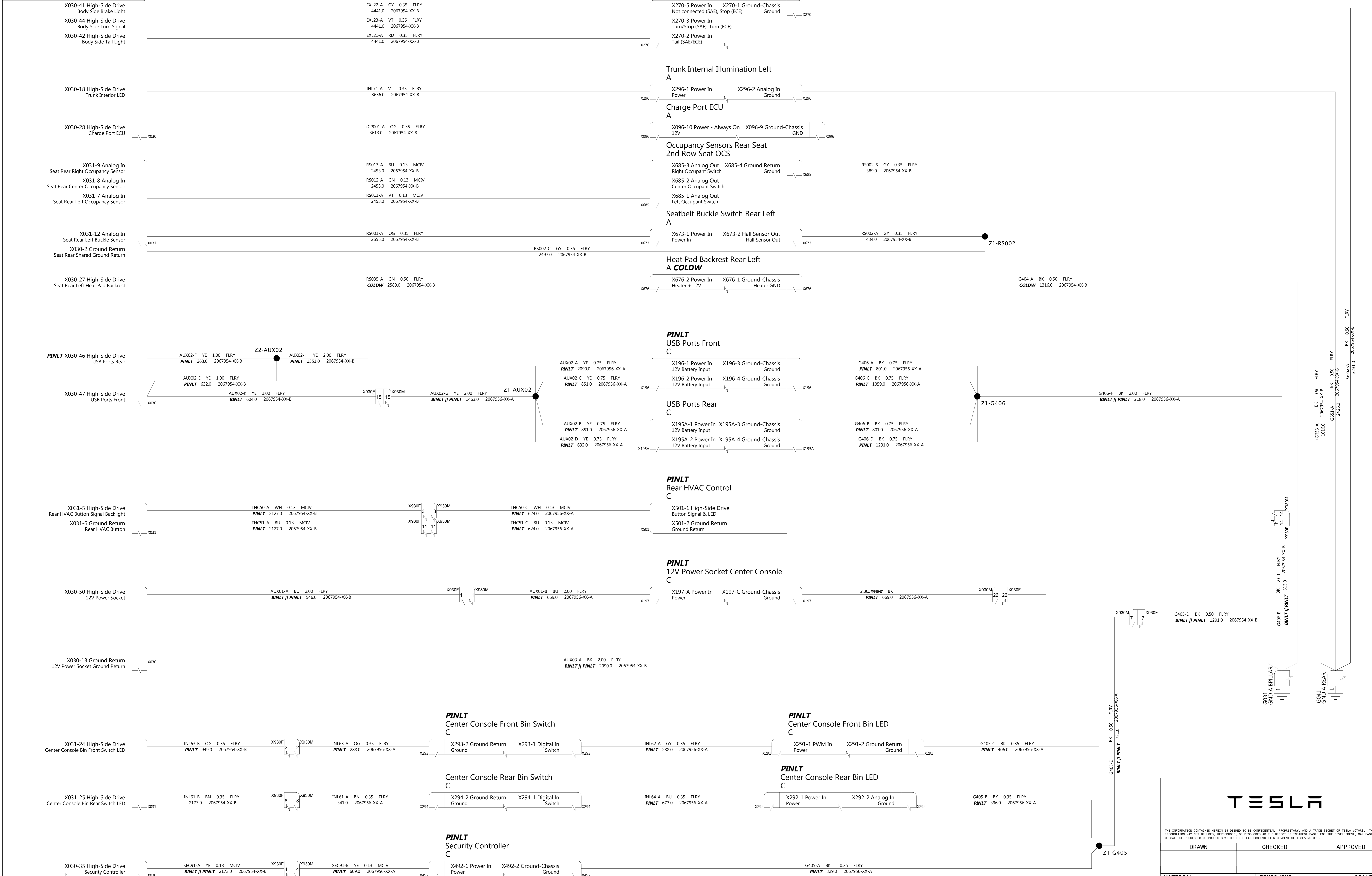

THE INFORMATION CONTAINED HEREIN IS DEEMED TO BE CONFIDENTIAL, PROPRIETARY, AND A TRADE SECRET OF TESLA MOTORS. THIS INFORMATION MAY NOT BE USED, REPRODUCED, OR DISCLOSED AS THE DIRECT OR INDIRECT BASIS FOR THE DEVELOPMENT, MANUFACTURE, OR SALE OF PROCESSES OR PRODUCTS WITHOUT THE EXPRESSED WRITTEN CONSENT OF TESLA MOTORS.

DRAWN	CHECKED	APPROVED
-------	---------	----------

MATERIAL AS SPECIFIED	FINISHING AS SPECIFIED	SCALE NONE
--------------------------	---------------------------	---------------

PART NAME
Body Controller Left J1, Center Console

PART NUMBER	REV	SHEET	SIZE
	1	5 OF 40	A0

Body Controller Left
A,D,J,W,K

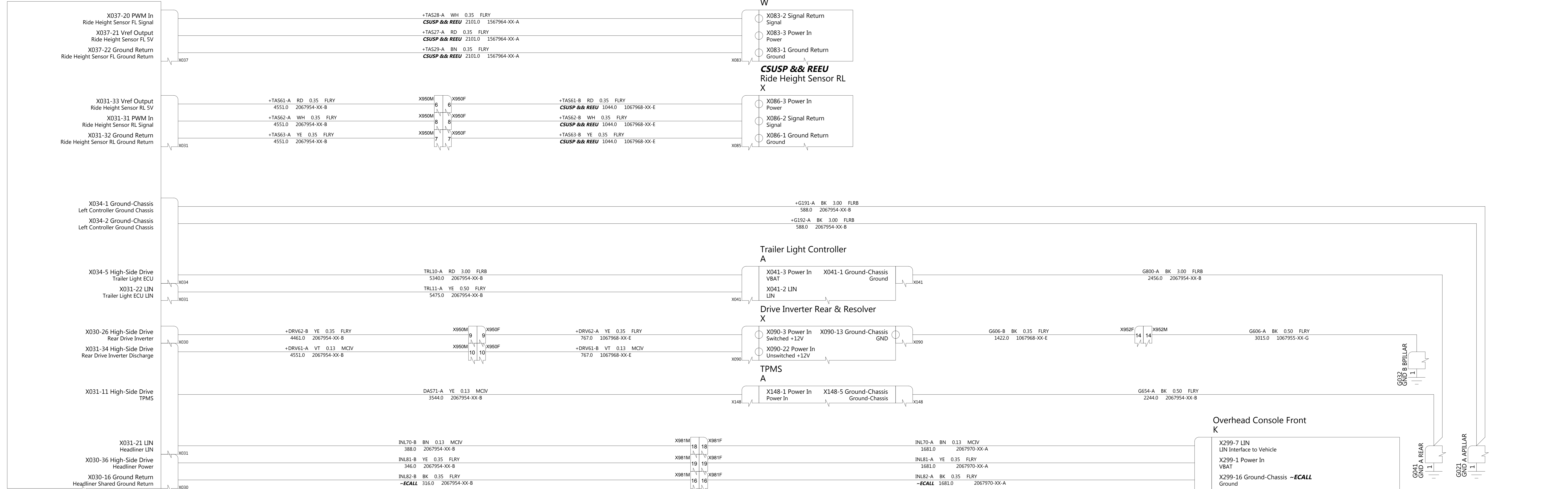

Vanity LED Right
K

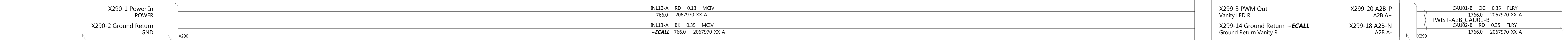

Vanity LED Left
K

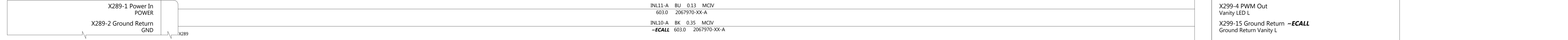

Overhead Console Rear
K



Body Controller Left
A,D,J,W,K

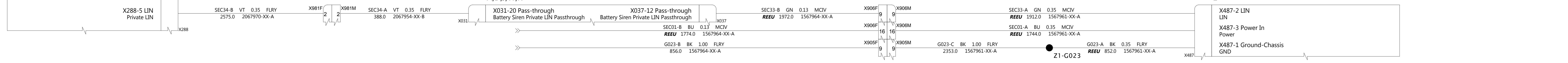

Overhead Console Front
K

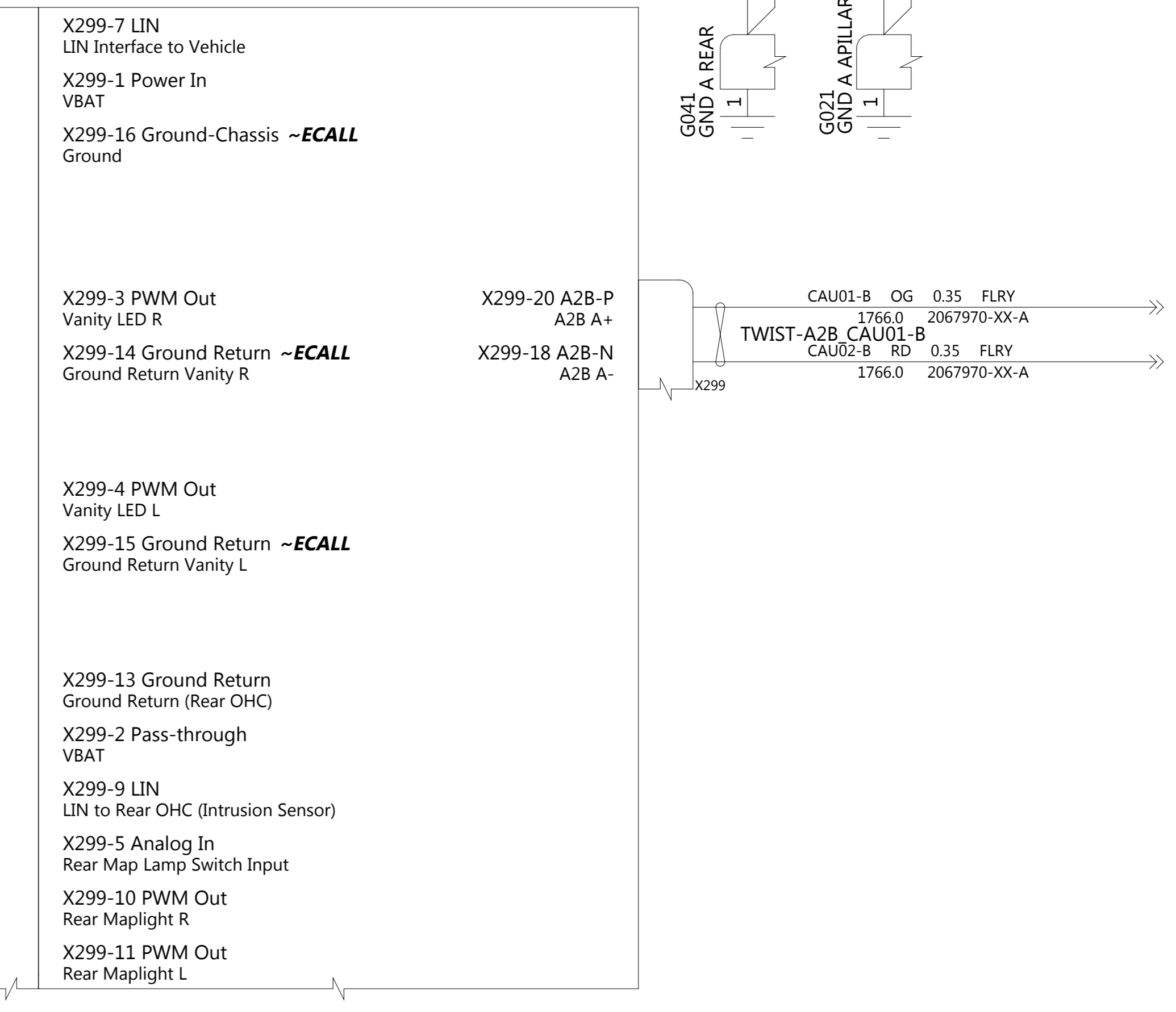

REEU
Battery Backup Siren
L



THE INFORMATION CONTAINED HEREIN IS DEEMED TO BE CONFIDENTIAL, PROPRIETARY, AND A TRADE SECRET OF TESLA MOTORS. THIS INFORMATION MAY NOT BE USED, REPRODUCED, OR DISCLOSED AS THE DIRECT OR INDIRECT BASIS FOR THE DEVELOPMENT, MANUFACTURE, OR SALE OF PRODUCTS OR SERVICES WITHOUT THE EXPRESS WRITTEN CONSENT OF TESLA MOTORS.

DRAWN	CHECKED	APPROVED
-------	---------	----------

MATERIAL AS SPECIFIED	FINISHING AS SPECIFIED	SCALE NONE
--------------------------	---------------------------	---------------

PART NAME
Body Controller Left J2, OHC

PART NUMBER	REV	SHEET	SIZE
	1	6 OF 40	A0

Body Controller Right
B,P,J,W

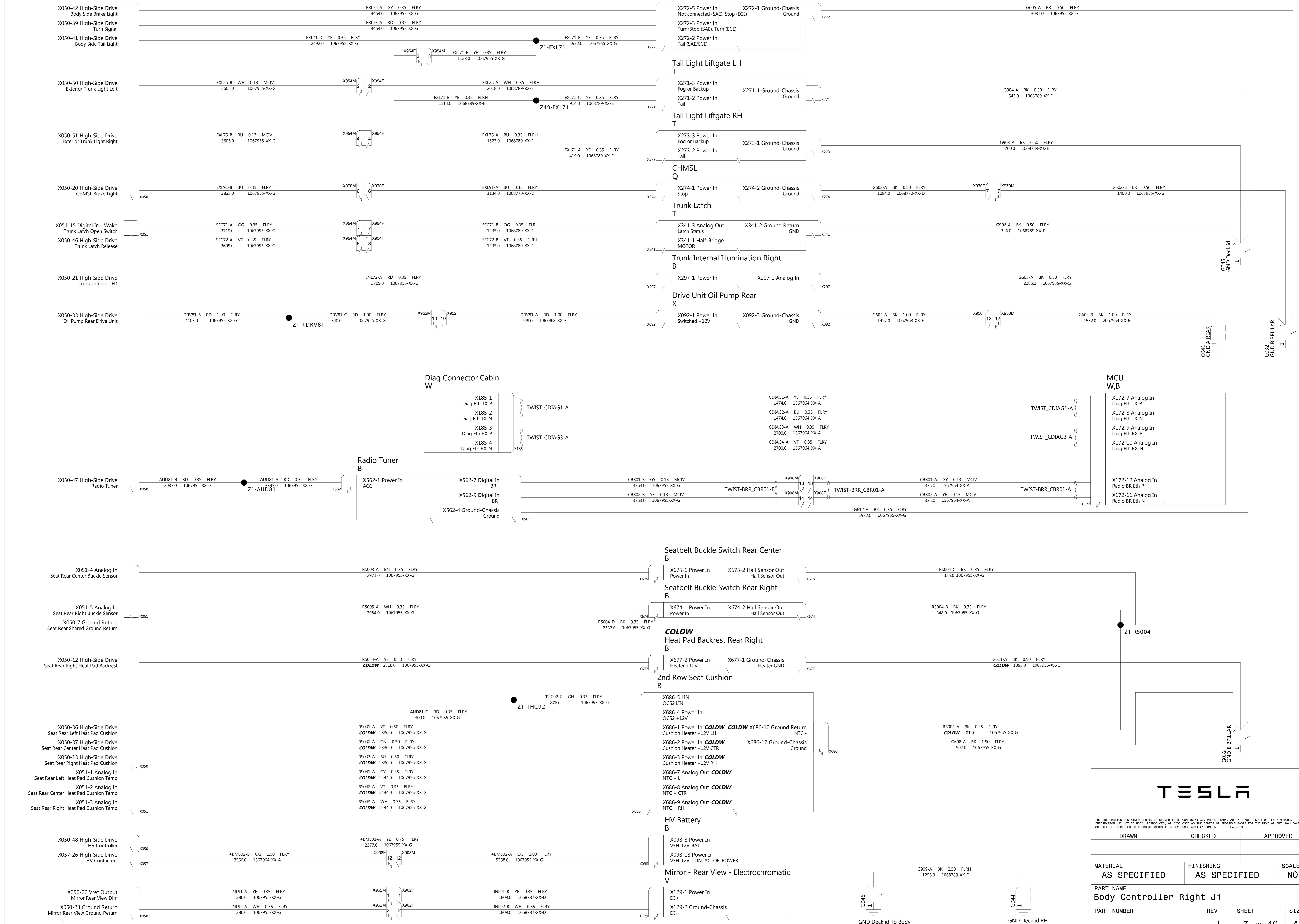

THE INFORMATION CONTAINED HEREIN IS DEEMED TO BE CONFIDENTIAL, PROPRIETARY, AND A TRADE SECRET OF TESLA MOTORS. THIS INFORMATION MAY NOT BE USED, REPRODUCED, OR DISCLOSED AS THE DIRECT OR INDIRECT BASIS FOR THE DEVELOPMENT, MANUFACTURE, OR SALE OF PROCESSES OR PRODUCTS WITHOUT THE EXPRESSED WRITTEN CONSENT OF TESLA MOTORS.

DRAWN	CHECKED	APPROVED
MATERIAL AS SPECIFIED	FINISHING AS SPECIFIED	SCALE NONE
PART NAME Body Controller Right J1		
PART NUMBER	REV	SHEET
	1	7 OF 40
		SIZE A0

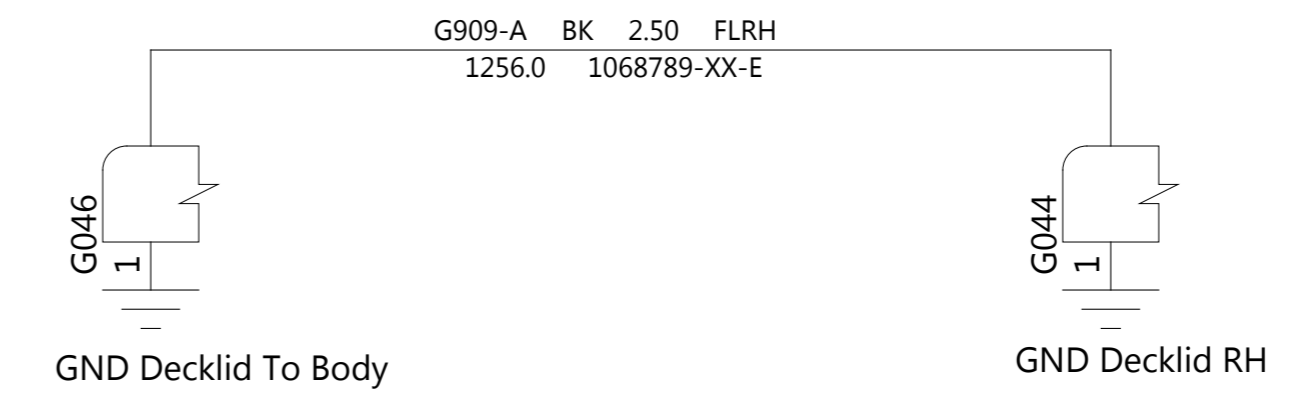

Body Controller Right
B,P,J,W

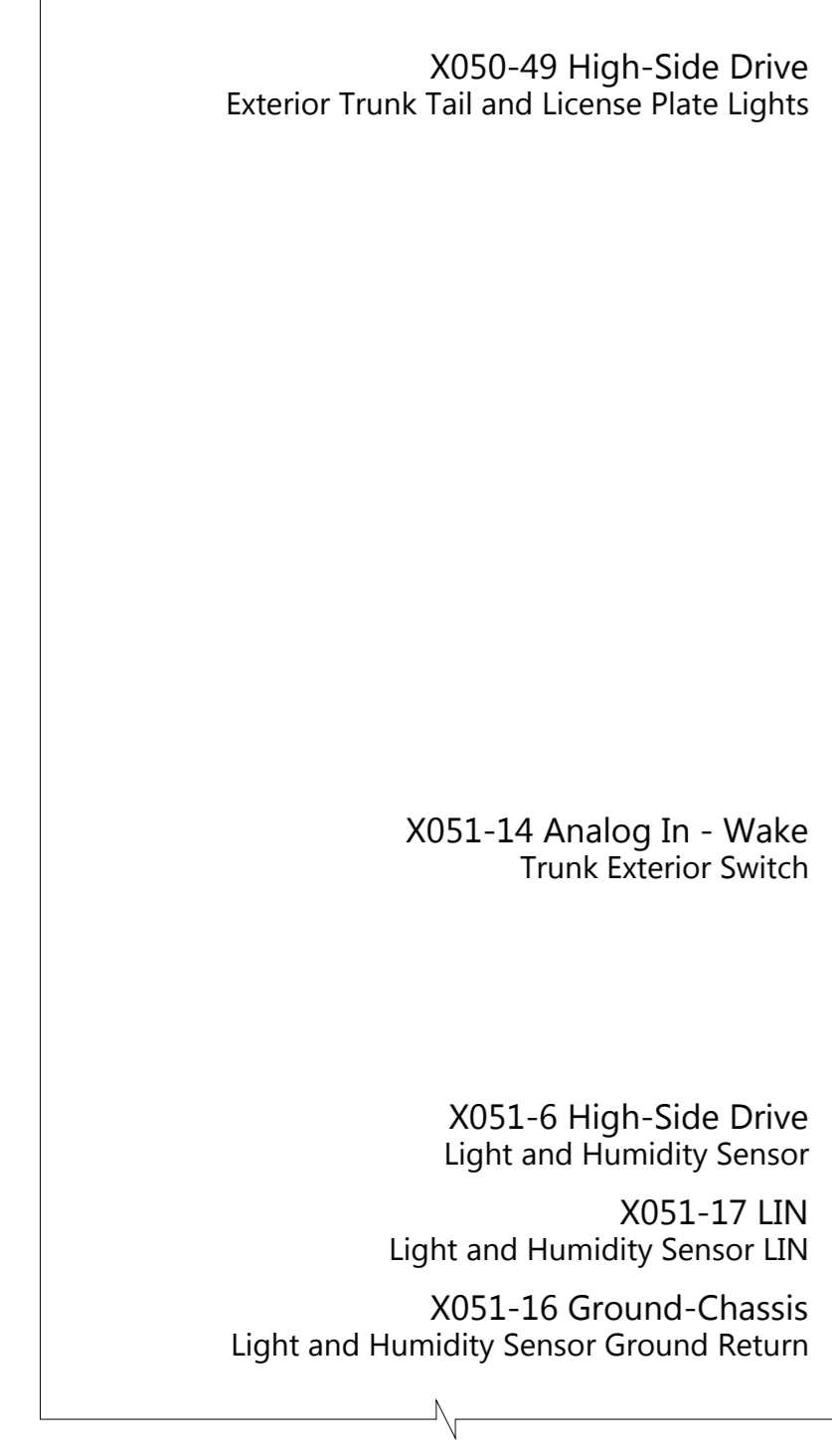

Body Controller Right
B,P,J,W

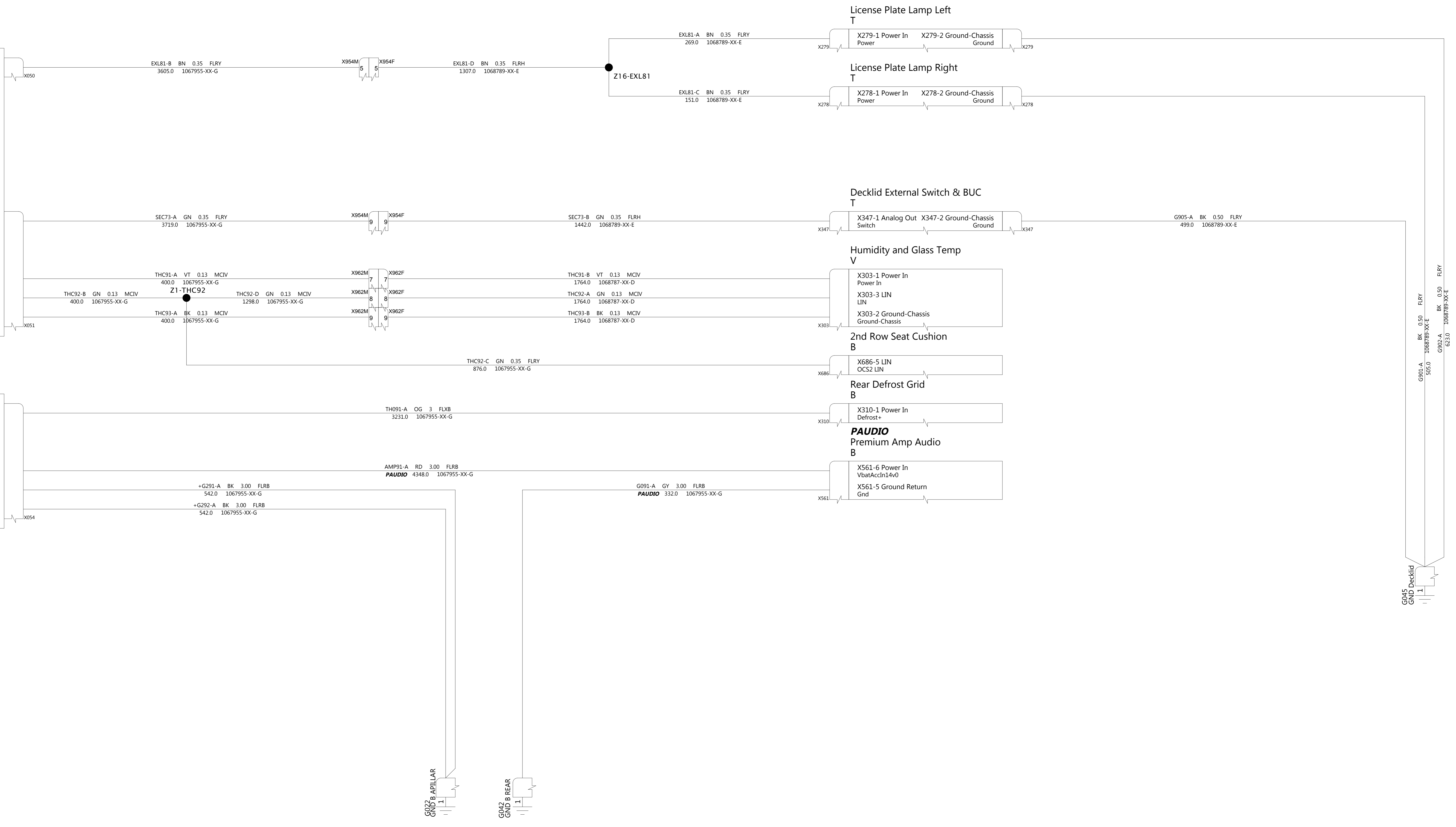
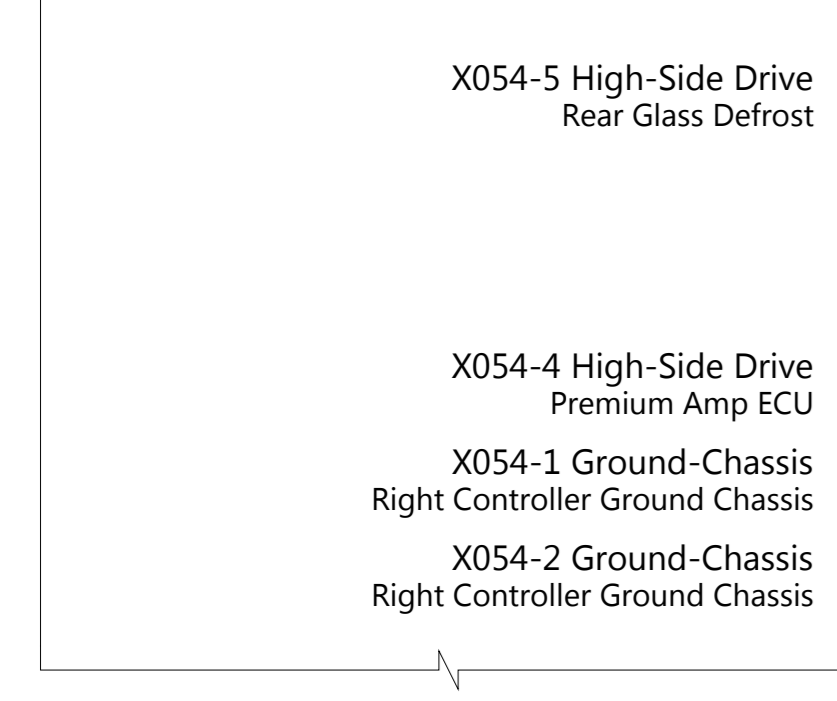

THE INFORMATION CONTAINED HEREIN IS DEEMED TO BE CONFIDENTIAL, PROPRIETARY, AND A TRADE SECRET OF TESLA MOTORS. THIS INFORMATION MAY NOT BE USED, REPRODUCED, OR DISCLOSED AS THE DIRECT OR INDIRECT BASIS FOR THE DEVELOPMENT, MANUFACTURE, OR SALE OF PROCESSES OR PRODUCTS WITHOUT THE EXPRESSED WRITTEN CONSENT OF TESLA MOTORS.

DRAWN	CHECKED	APPROVED
MATERIAL AS SPECIFIED	FINISHING AS SPECIFIED	SCALE NONE
PART NAME Body Controller Right J2, J5		
PART NUMBER	REV 1	SHEET 8 OF 40
		SIZE A0

Body Controller Left
A,D,J,W,K

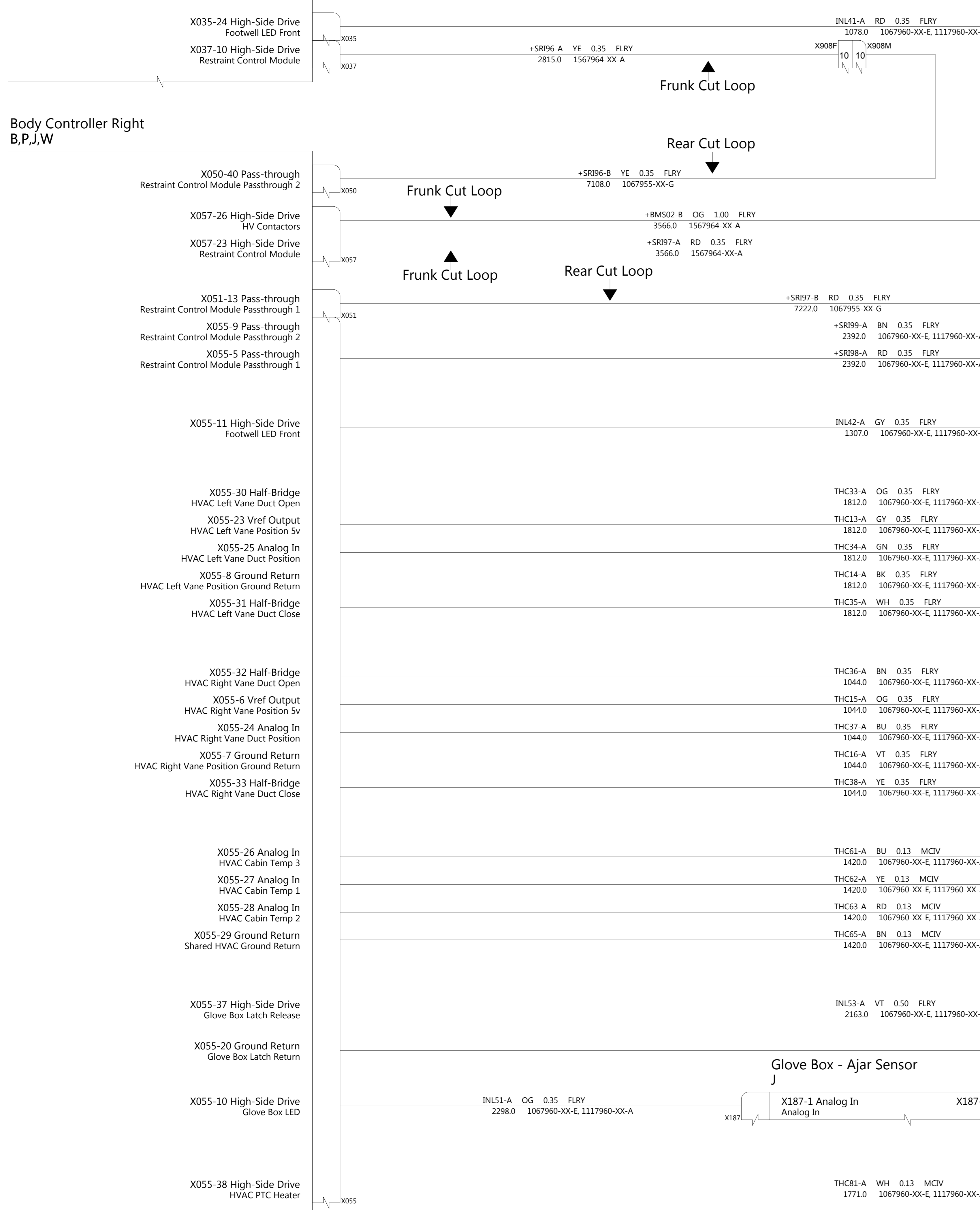

Body Controller Right
B,P,J,W

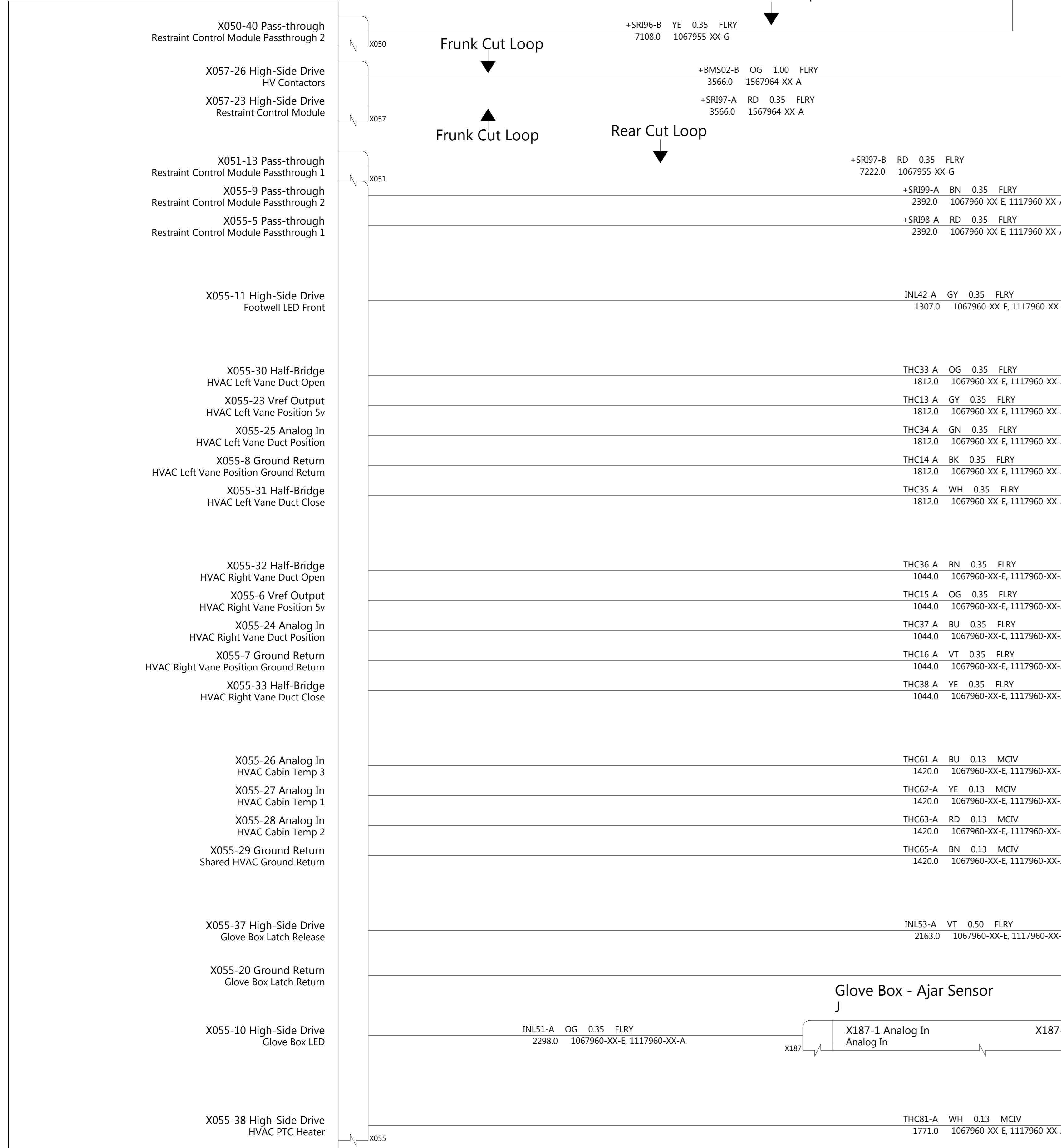

Body Controller Left
A,D,J,W,K

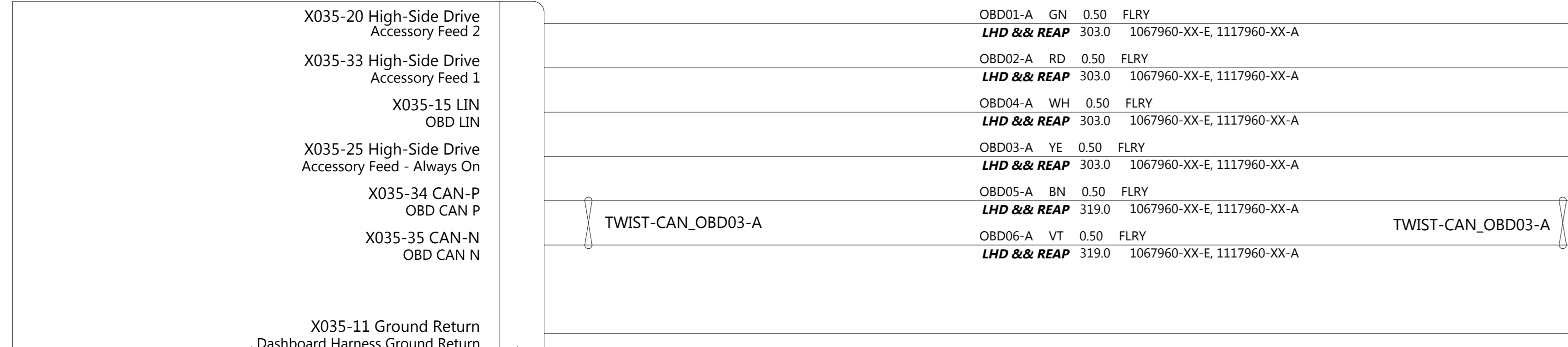

LHD & REAP
OBD-II
J

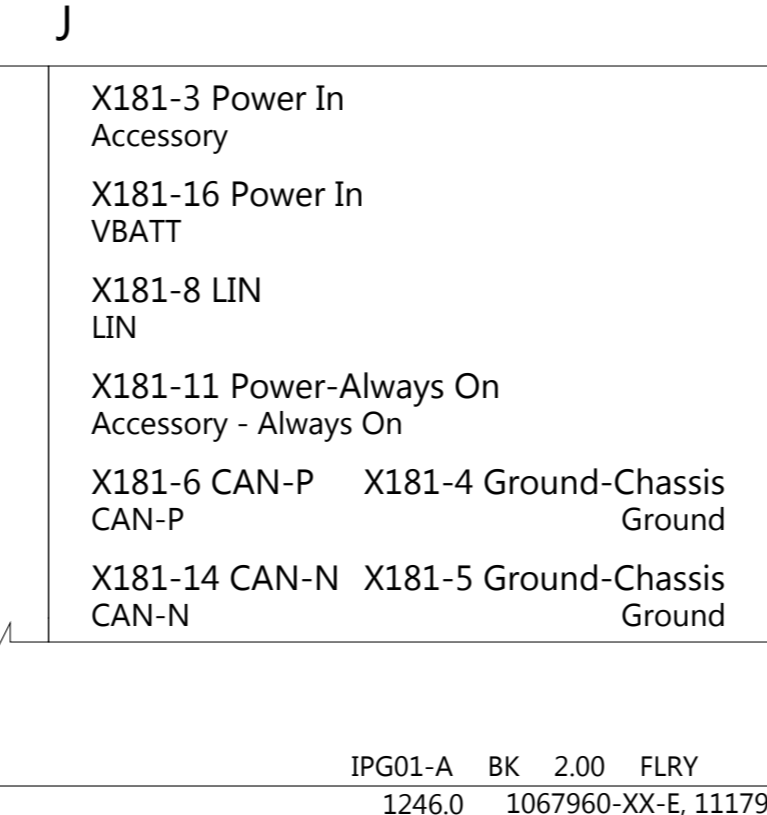

Footwell LED Front Left
J



HV Battery
B



Restraints Controller
A,J



Footwell LED Front Right
J

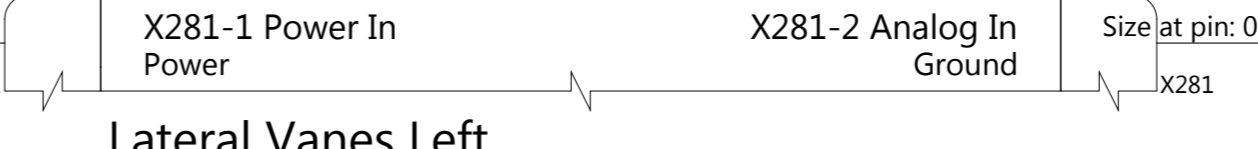

Lateral Vanes Left
J

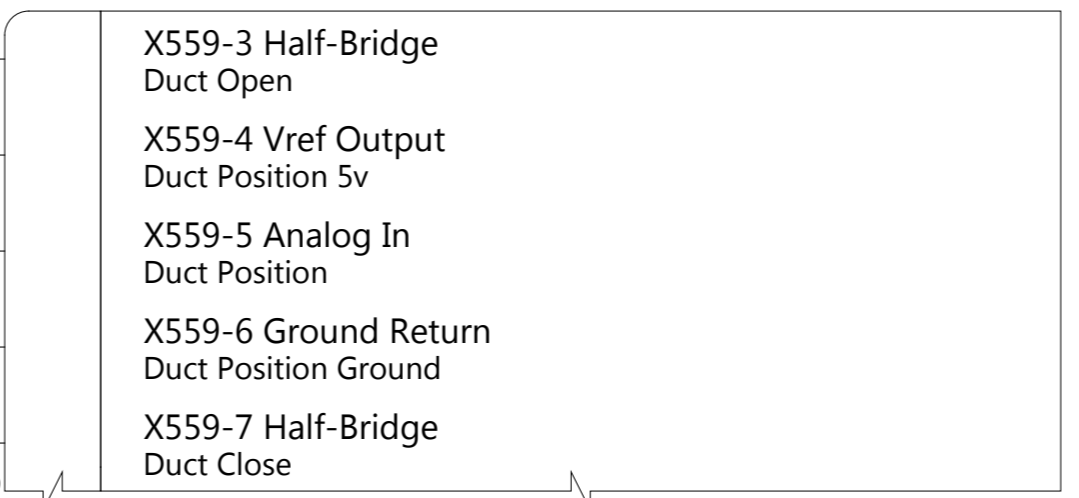

Lateral Vanes Right
J

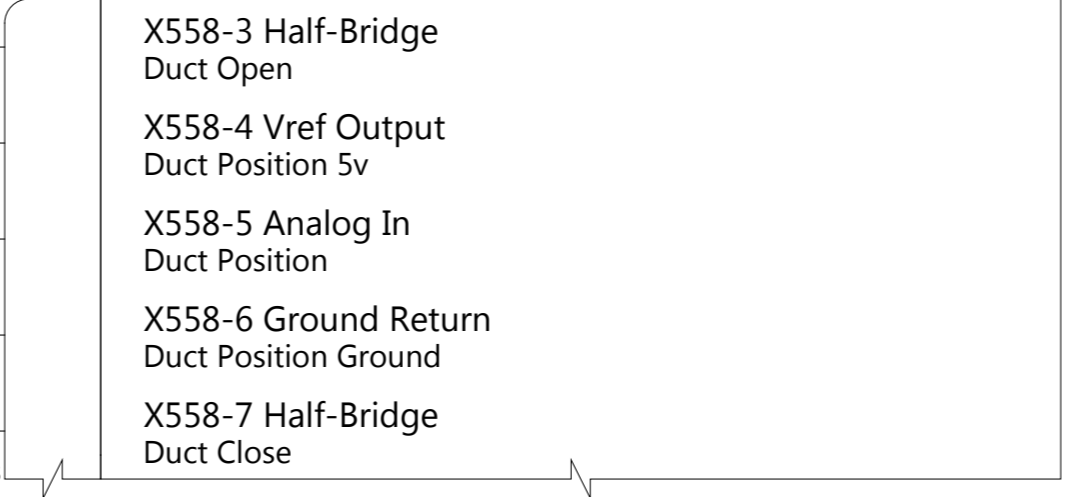

Cabin Thermistors
J

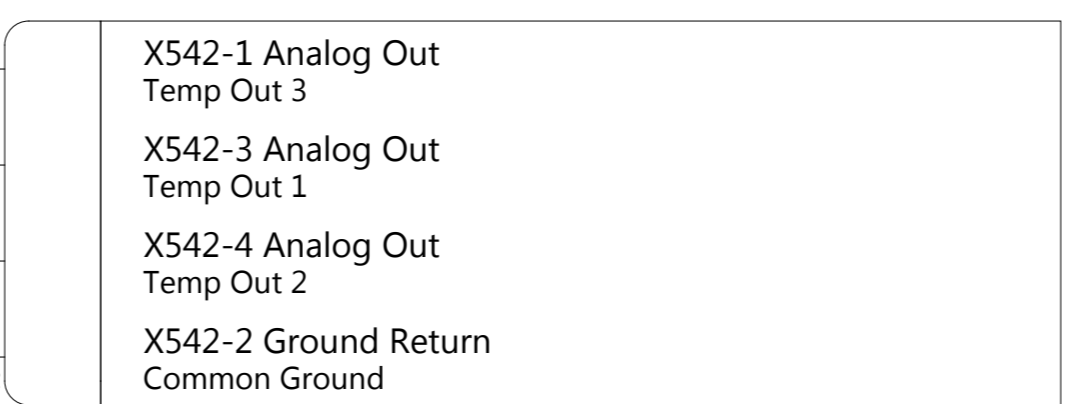

Glove Box - Latch
J

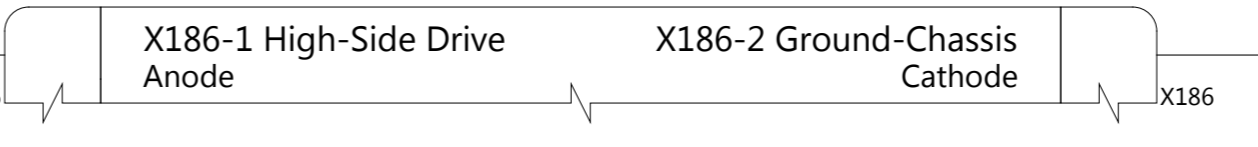

Glove Box - LED
J



PTC Heater
J,W



Steering Angle and Stalk ECU
J

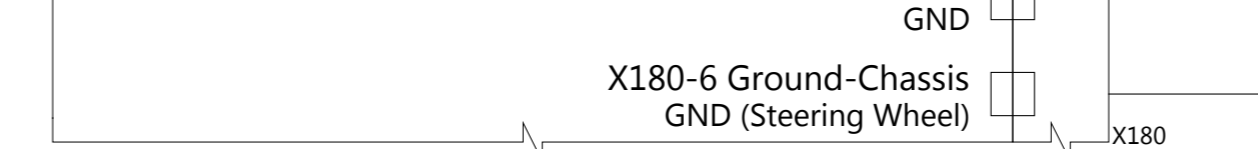

THE INFORMATION CONTAINED HEREIN IS DEEMED TO BE CONFIDENTIAL, PROPRIETARY, AND A TRADE SECRET OF TESLA MOTORS. THIS INFORMATION MAY NOT BE USED, REPRODUCED, OR DISCLOSED AS THE DIRECT OR INDIRECT BASIS FOR THE DEVELOPMENT, MANUFACTURE, OR SALE OF PROCESSES OR PRODUCTS WITHOUT THE EXPRESSED WRITTEN CONSENT OF TESLA MOTORS.

DRAWN	CHECKED	APPROVED
MATERIAL AS SPECIFIED	FINISHING AS SPECIFIED	SCALE NONE
PART NAME Body Controllers Dashboard		
PART NUMBER	REV	SHEET
	1	9 OF 40
		SIZE A0

HCU/ESP W

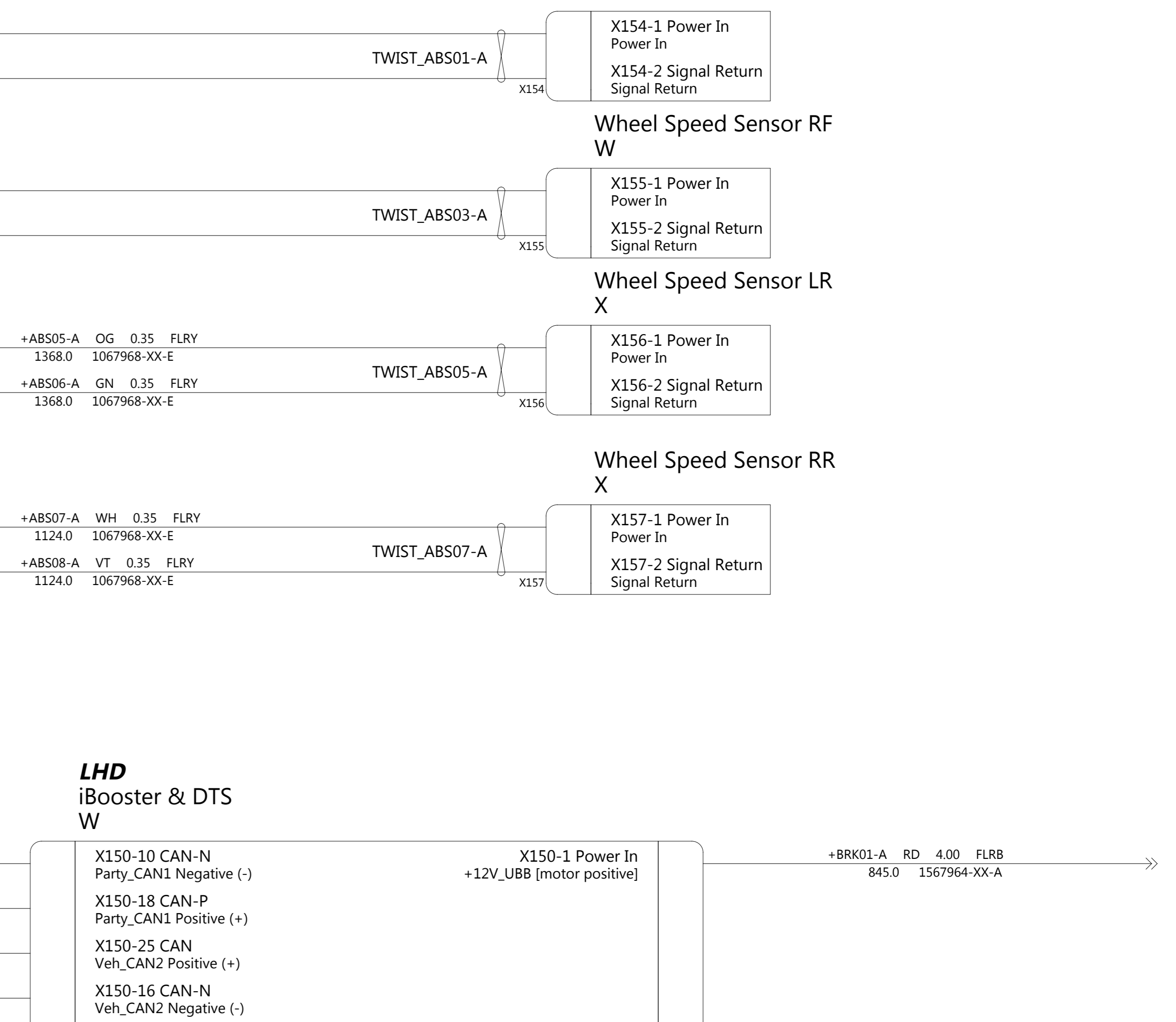
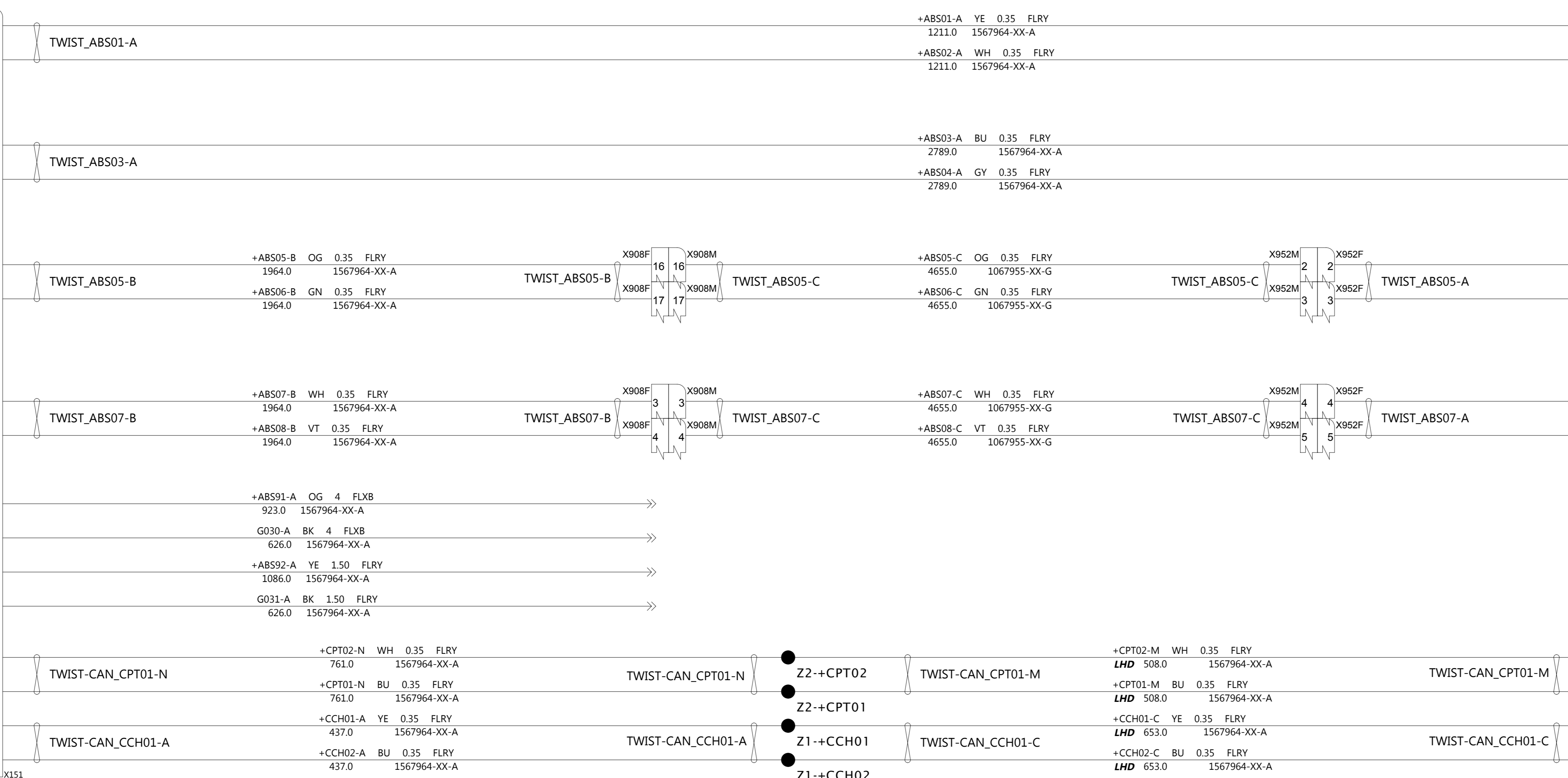
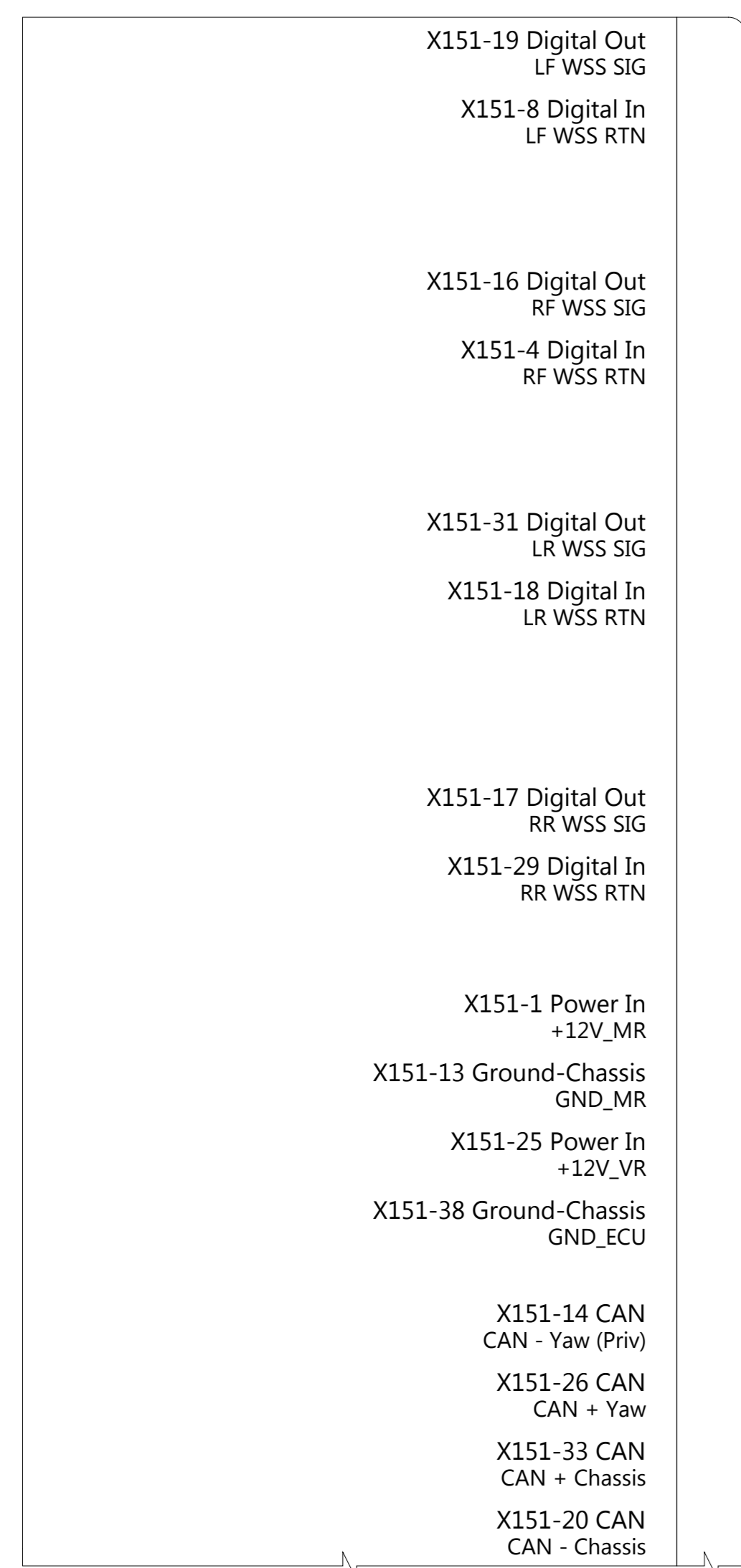

LHD iBooster & DTS W

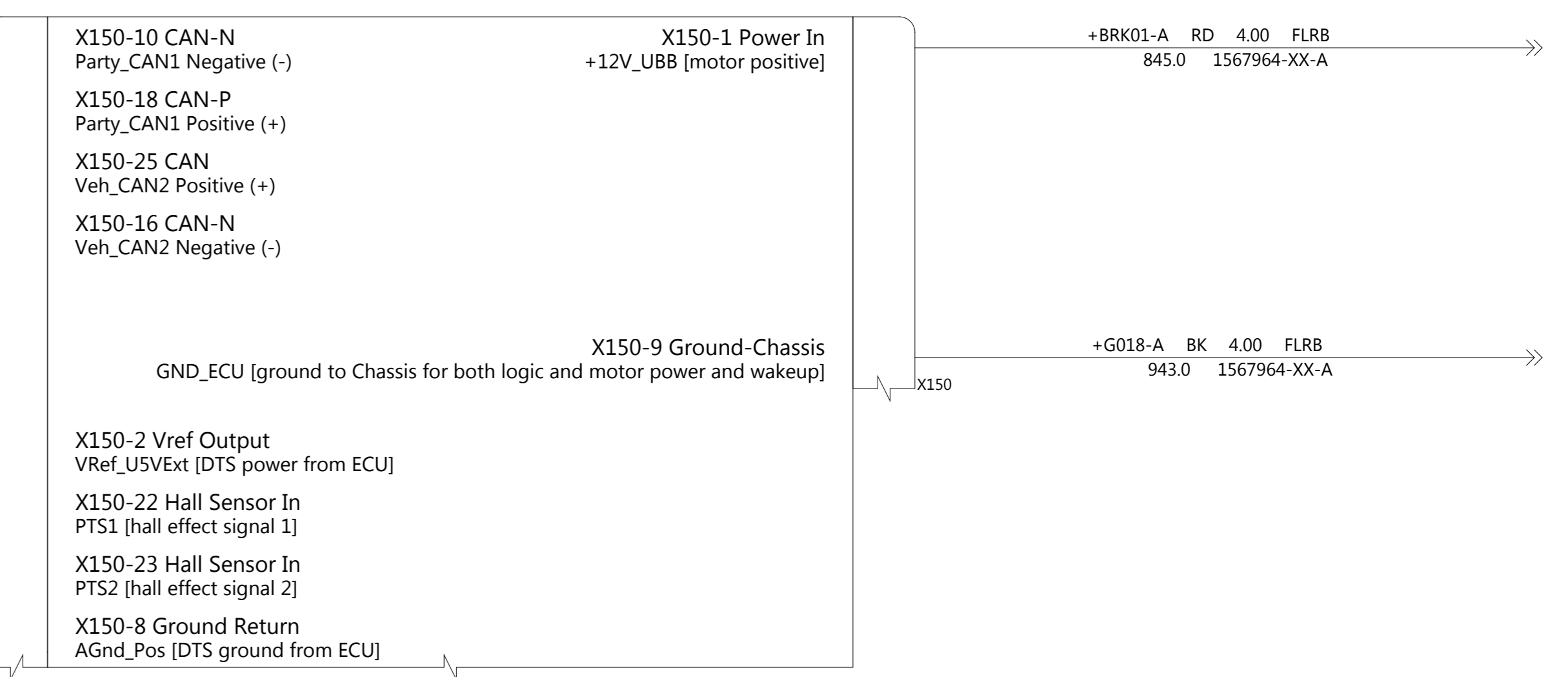

LHD iBooster & DTS W

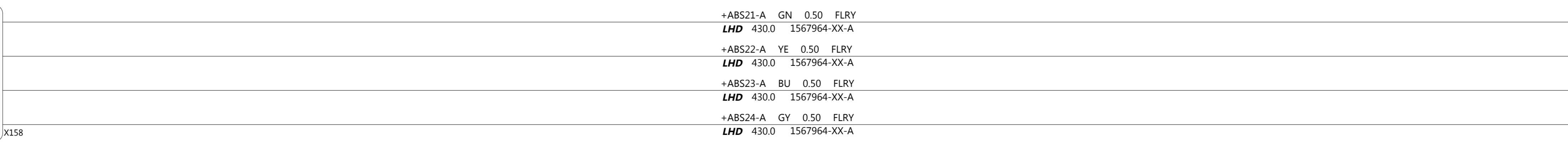
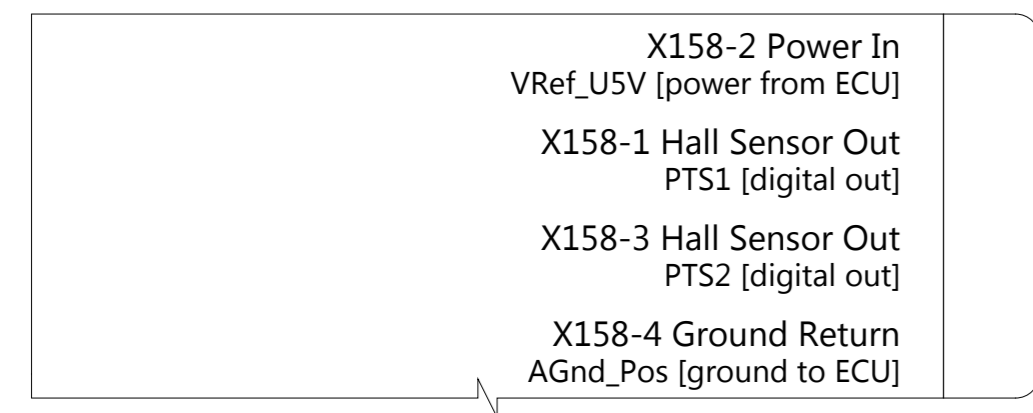

Body Controller Left A,D,J,W,K

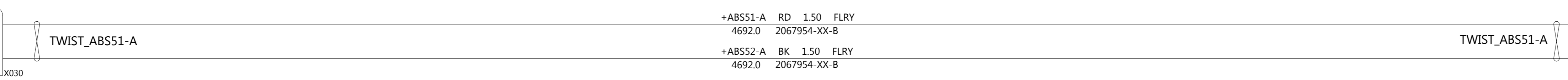
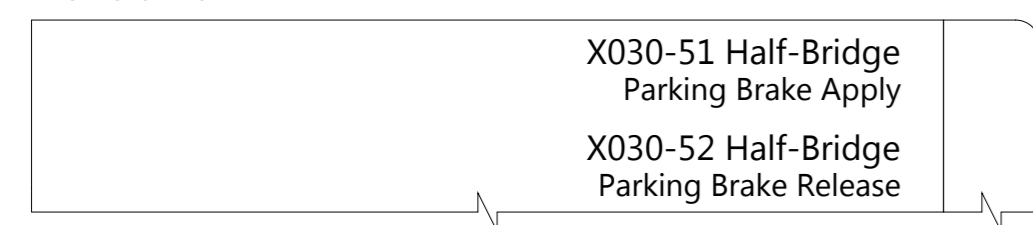

EPB Left A

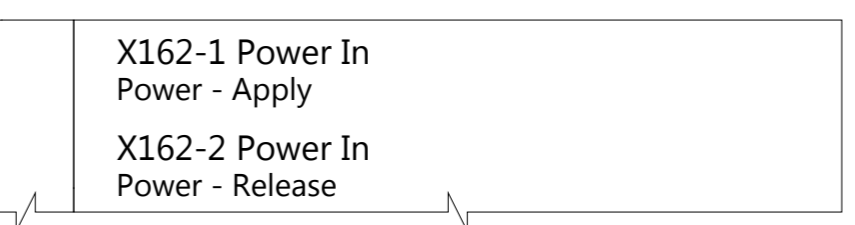

Body Controller Right B,P,J,W

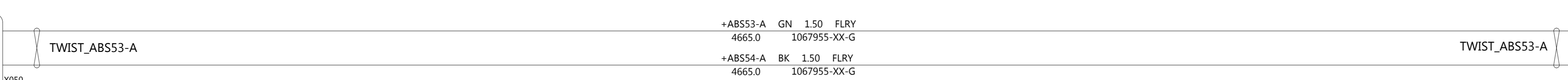
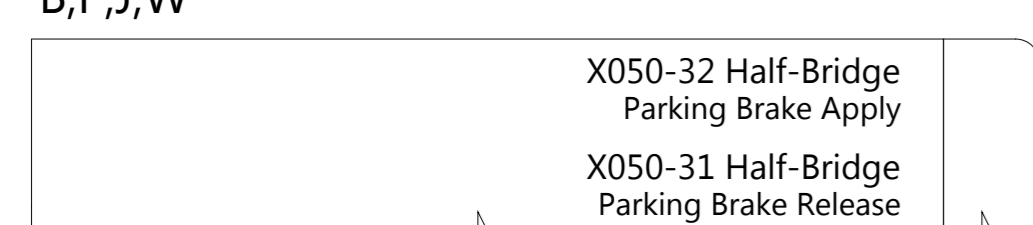

EPB Right B

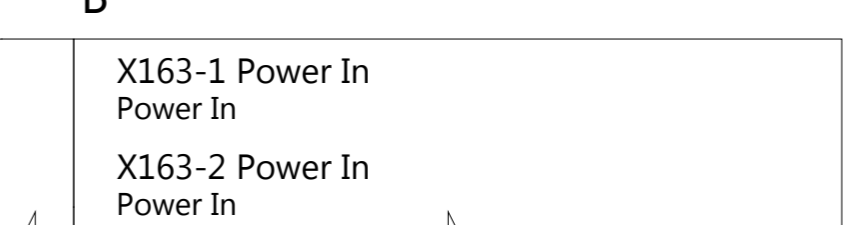

THE INFORMATION CONTAINED HEREIN IS DEEMED TO BE CONFIDENTIAL, PROPRIETARY, AND A TRADE SECRET OF TESLA MOTORS. THIS INFORMATION MAY NOT BE USED, REPRODUCED, OR DISCLOSED AS THE DIRECT OR INDIRECT BASIS FOR THE DEVELOPMENT, MANUFACTURE, OR SALE OF PROCESSES OR PRODUCTS WITHOUT THE EXPRESSED WRITTEN CONSENT OF TESLA MOTORS.

DRAWN	CHECKED	APPROVED
MATERIAL AS SPECIFIED	FINISHING AS SPECIFIED	SCALE NONE
PART NAME Brake Controls		
PART NUMBER	REV	SHEET
	1	10 of 40
		SCALE
		A0

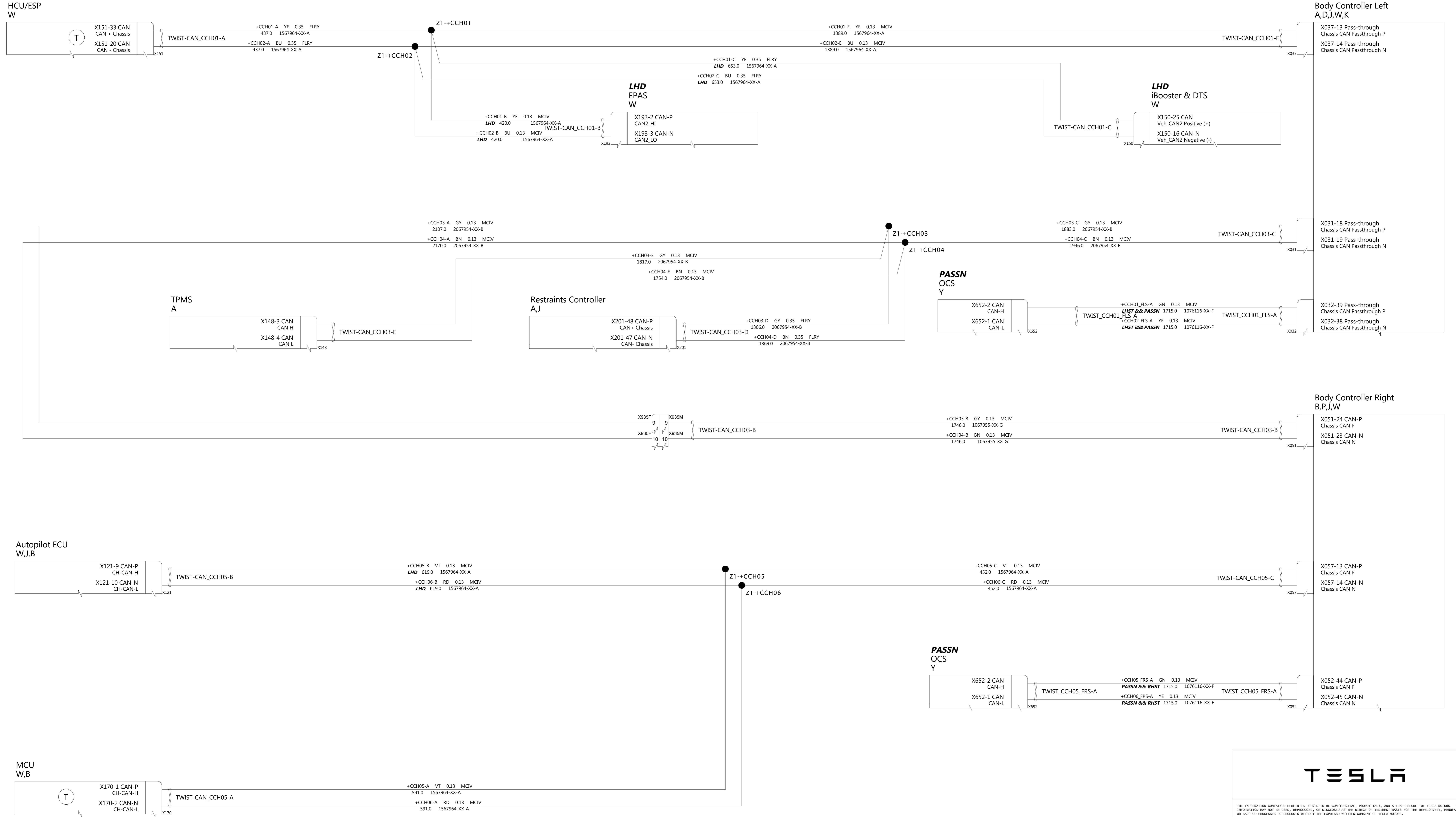

THE INFORMATION CONTAINED HEREIN IS DEEMED TO BE CONFIDENTIAL, PROPRIETARY, AND A TRADE SECRET OF TESLA MOTORS. THIS INFORMATION MAY NOT BE USED, REPRODUCED, OR DISCLOSED AS THE DIRECT OR INDIRECT BASIS FOR THE DEVELOPMENT, MANUFACTURE, OR SALE OF PROCESSES OR PRODUCTS WITHOUT THE EXPRESSED WRITTEN CONSENT OF TESLA MOTORS.

DRAWN	CHECKED	APPROVED
MATERIAL AS SPECIFIED	FINISHING AS SPECIFIED	SCALE NONE
PART NAME CAN Chassis		
PART NUMBER	REV	SHEET
	1	11 OF 40
		SIZE A0

AWD
Drive Inverter Front & Resolver
N

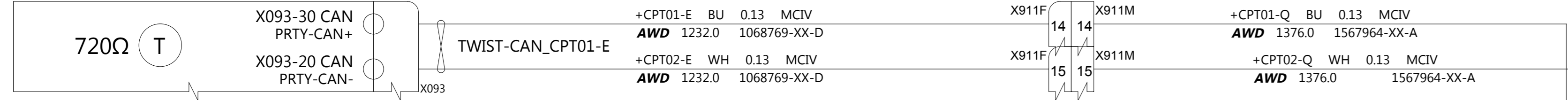

Body Controller Front
W,U

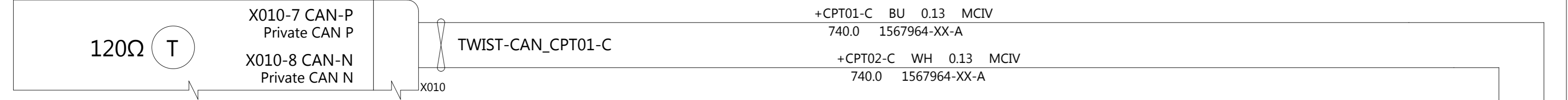

Autopilot ECU
W,J,B

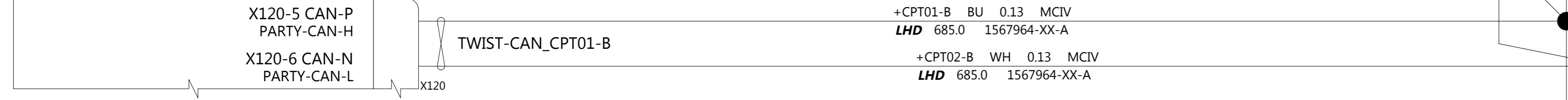

HCU/ESP
W

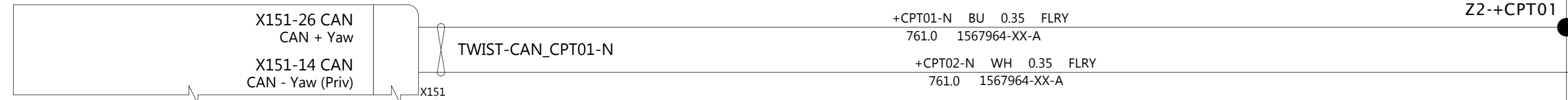

Body Controller Left
A,D,J,W,K

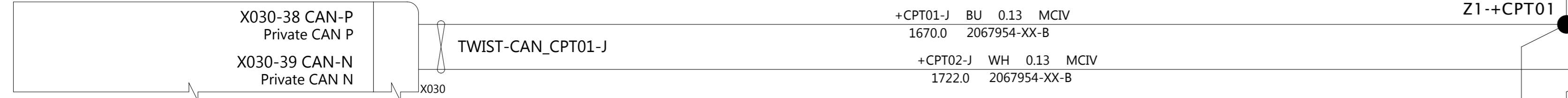

Drive Inverter Rear & Resolver
X

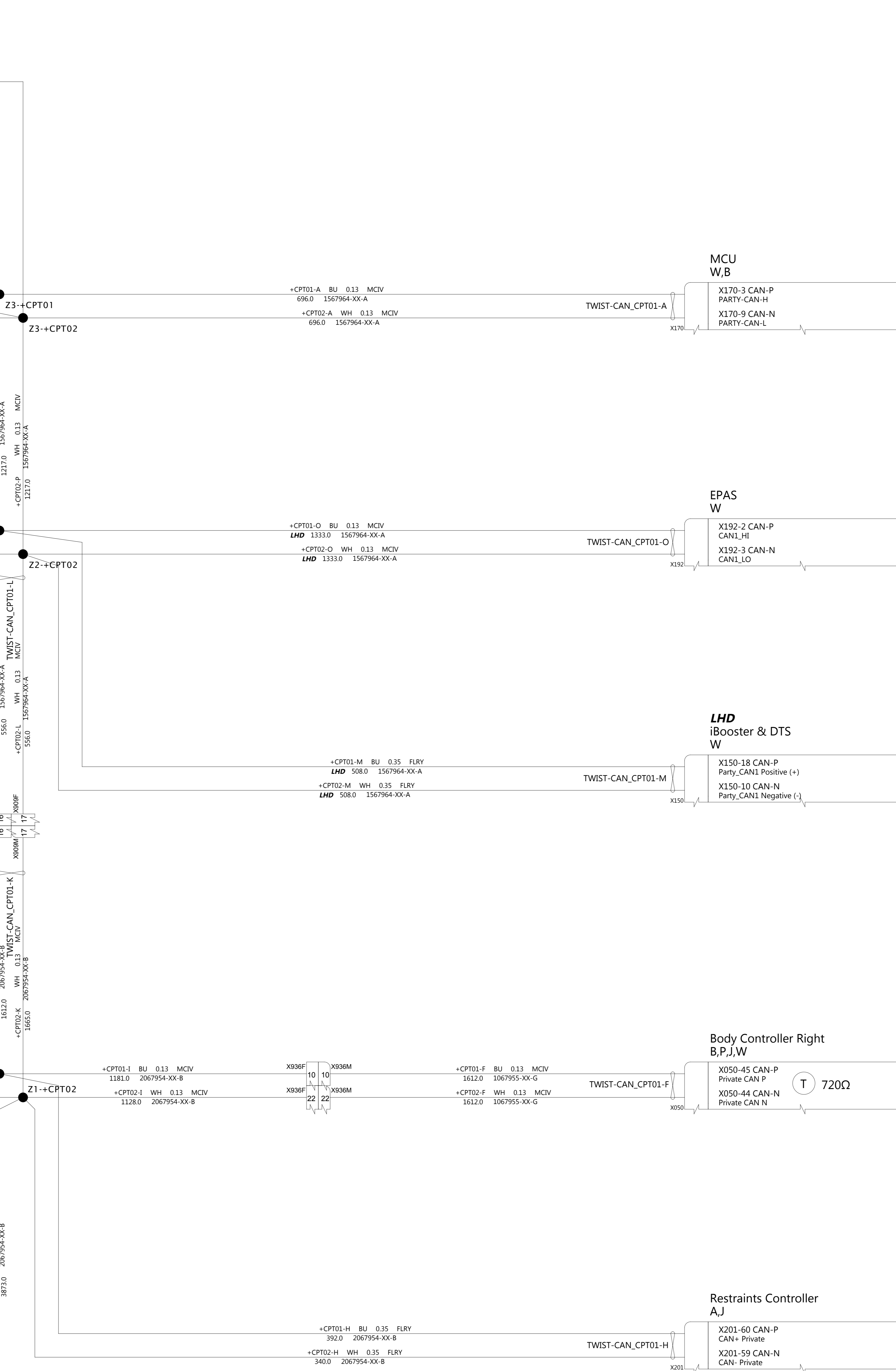
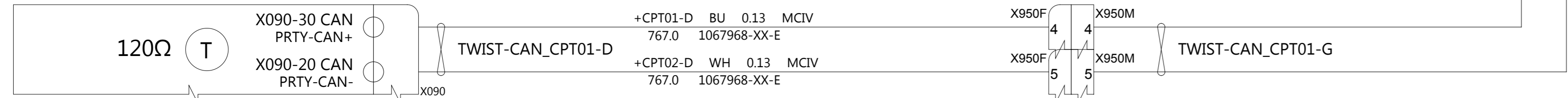

MCU
W,B

EPAS
W

LHD
iBooster & DTS
W

Body Controller Right
B,P,J,W

Restraints Controller
A,J



THE INFORMATION CONTAINED HEREIN IS DEEMED TO BE CONFIDENTIAL, PROPRIETARY, AND A TRADE SECRET OF TESLA MOTORS. THIS INFORMATION MAY NOT BE USED, REPRODUCED, OR DISCLOSED AS THE DIRECT OR INDIRECT BASIS FOR THE DEVELOPMENT, MANUFACTURE, OR SALE OF PROCESSES OR PRODUCTS WITHOUT THE EXPRESS WRITTEN CONSENT OF TESLA MOTORS.

DRAWN	CHECKED	APPROVED
MATERIAL AS SPECIFIED		SCALE NONE
PART NAME CAN Party		
PART NUMBER	REV	SHEET
	1	12 OF 40
		SIZE A0

AWD
Drive Inverter Front & Resolver
N

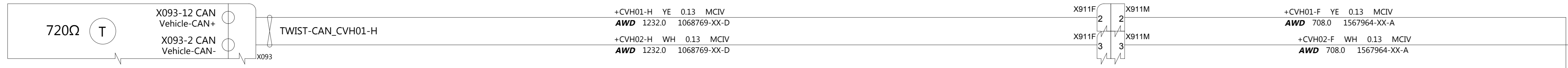

PINLT
Security Controller
C

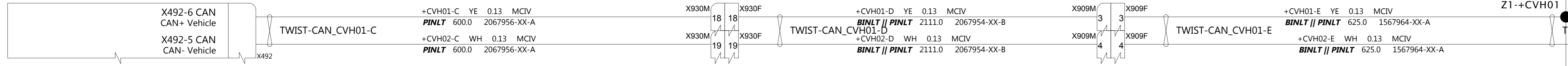

Body Controller Front
W,U

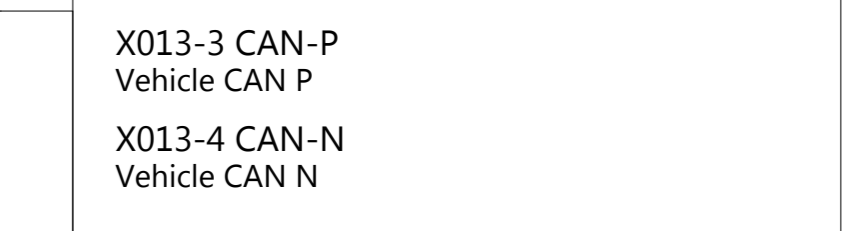

Body Controller Left
A,D,J,W,K

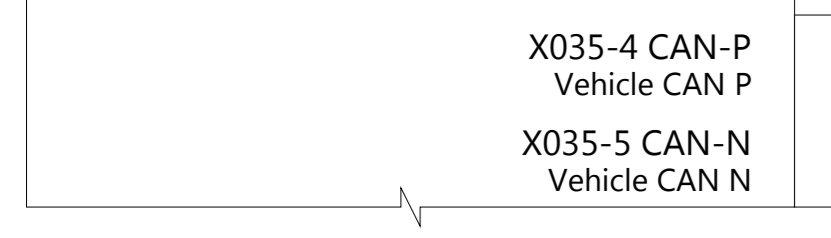
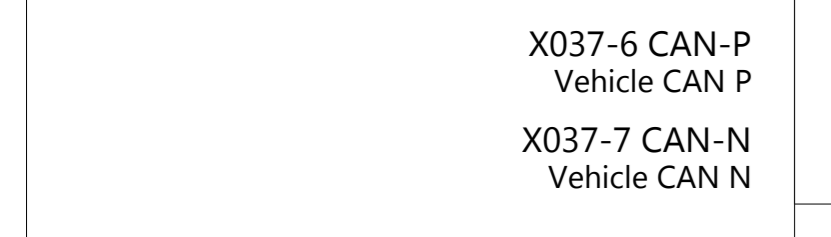
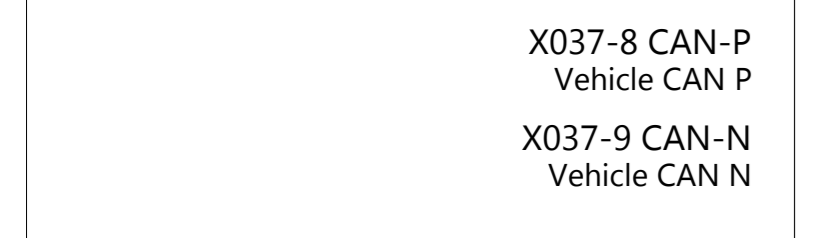
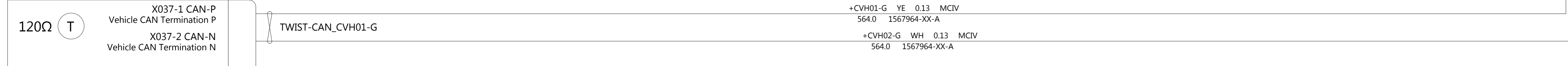

Steering Angle and Stalk ECU
J



HV Compressor
U,W

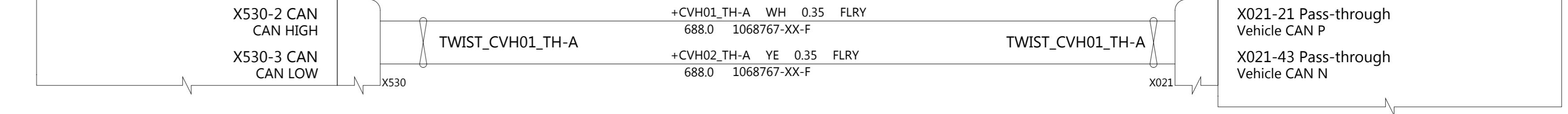

Body Controller Right
B,P,J,W

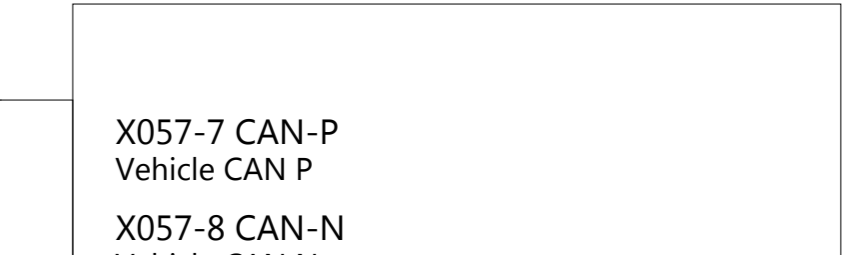

MCU
W,B

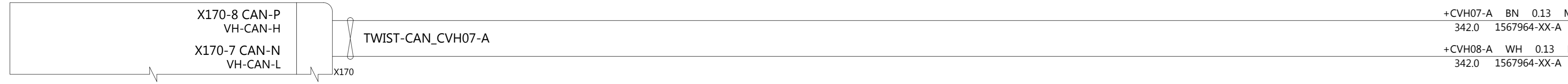

Autopilot ECU
W,J,B

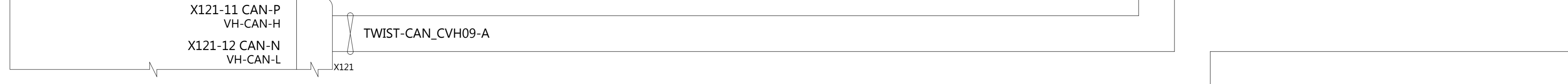

PTC Heater
J,W

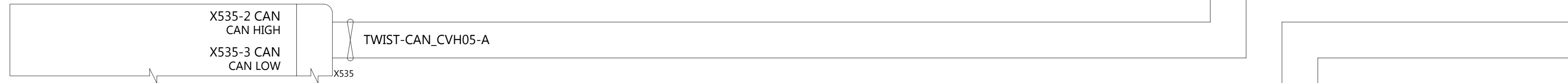

Drive Inverter Rear & Resolver
X

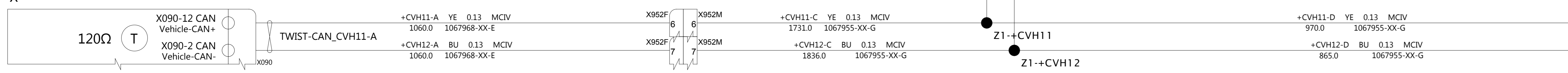

HV Battery
B

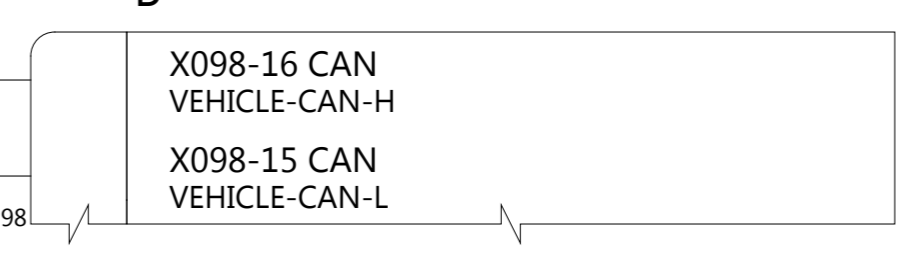

THE INFORMATION CONTAINED HEREIN IS DEEMED TO BE CONFIDENTIAL, PROPRIETARY, AND A TRADE SECRET OF TESLA MOTORS. THIS INFORMATION MAY NOT BE USED, REPRODUCED, OR DISCLOSED AS THE DIRECT OR INDIRECT BASIS FOR THE DEVELOPMENT, MANUFACTURE, OR SALE OF PROCESSES OR PRODUCTS WITHOUT THE EXPRESS WRITTEN CONSENT OF TESLA MOTORS.

DRAWN	CHECKED	APPROVED
MATERIAL AS SPECIFIED	FINISHING AS SPECIFIED	SCALE NONE
PART NAME CAN Vehicle		
PART NUMBER	REV	SHEET
	1	13 OF 40
		SIZE A0

CPSAE
Charge Port Inlet, SAE
E

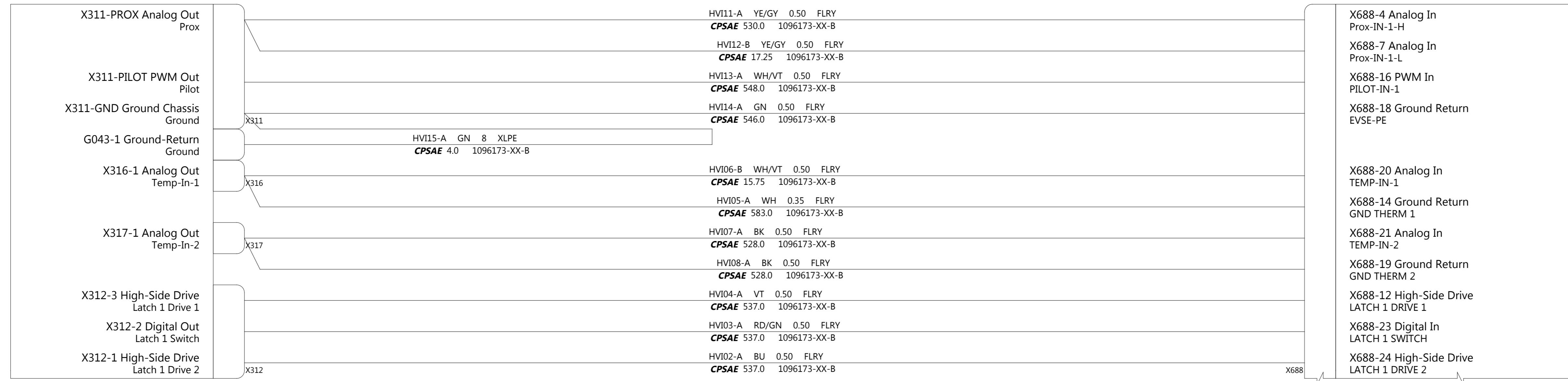

CPIEC
Charge Port, IEC
E



THE INFORMATION CONTAINED HEREIN IS DEEMED TO BE CONFIDENTIAL, PROPRIETARY, AND A TRADE SECRET OF TESLA MOTORS. THIS INFORMATION MAY NOT BE USED, REPRODUCED, OR DISCLOSED AS THE DIRECT OR INDIRECT BASIS FOR THE DEVELOPMENT, MANUFACTURE, OR SALE OF PROCESSES OR PRODUCTS WITHOUT THE EXPRESSED WRITTEN CONSENT OF TESLA MOTORS.

DRAWN	CHECKED	APPROVED

MATERIAL AS SPECIFIED	FINISHING AS SPECIFIED	SCALE NONE
--------------------------	---------------------------	---------------

PART NAME
Charge Port Inlet

PART NUMBER	REV	SHEET	SIZE
	1	14 OF 40	A0

Body Controller Left
A,D,J,W,K

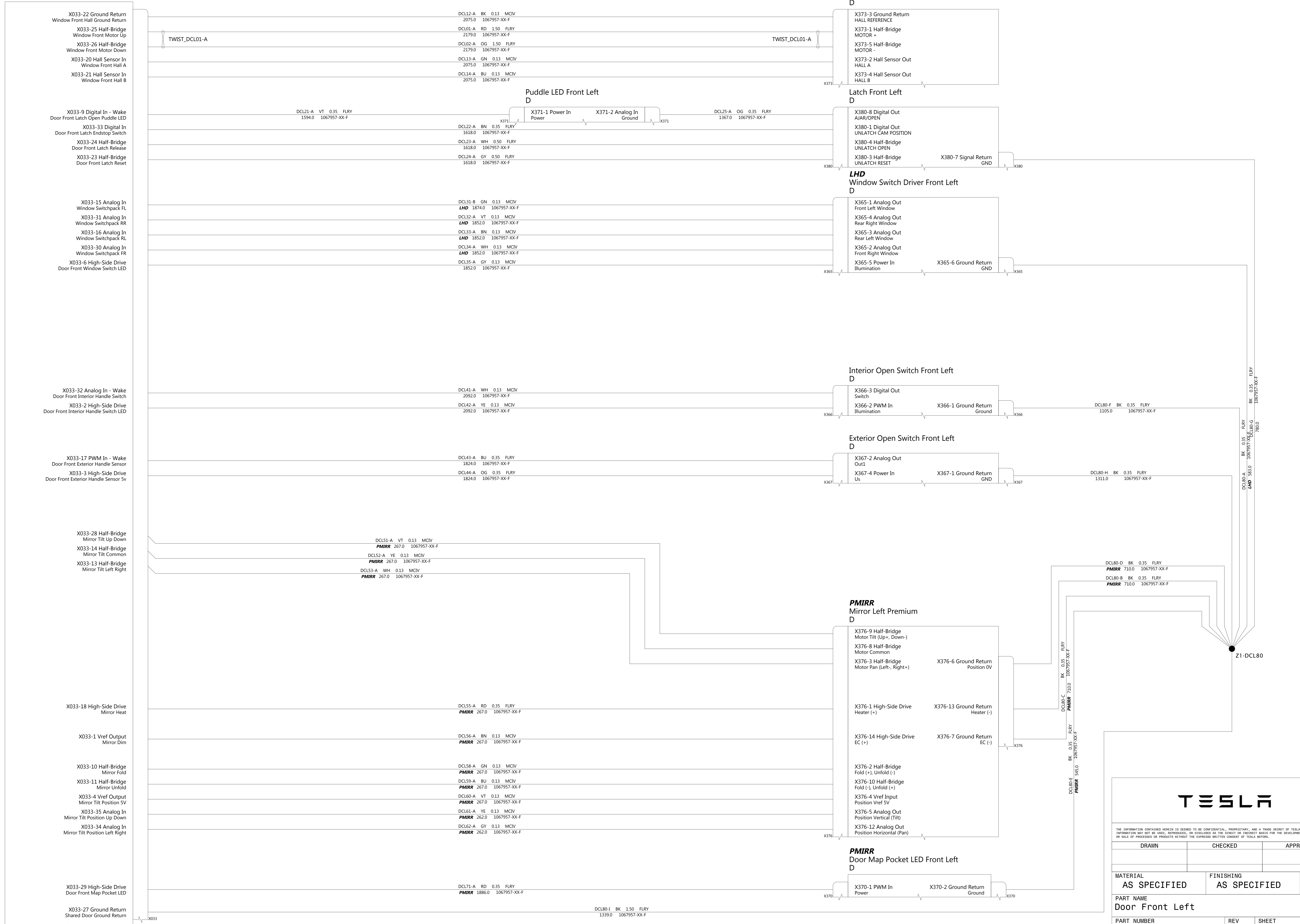

THE INFORMATION CONTAINED HEREIN IS DEEMED TO BE CONFIDENTIAL, PROPRIETARY, AND A TRADE SECRET OF TESLA MOTORS. THIS INFORMATION MAY NOT BE USED, REPRODUCED, OR DISCLOSED AS THE DIRECT OR INDIRECT BASIS FOR THE DEVELOPMENT, MANUFACTURE, OR SALE OF PROCESSES OR PRODUCTS WITHOUT THE EXPRESSED WRITTEN CONSENT OF TESLA MOTORS.

DRAWN	CHECKED	APPROVED
MATERIAL AS SPECIFIED	FINISHING AS SPECIFIED	SCALE NONE
PART NAME Door Front Left		
PART NUMBER	REV	SHEET
	1	15 OF 40
		SCALE A0

Body Controller Right
B,P,J,W

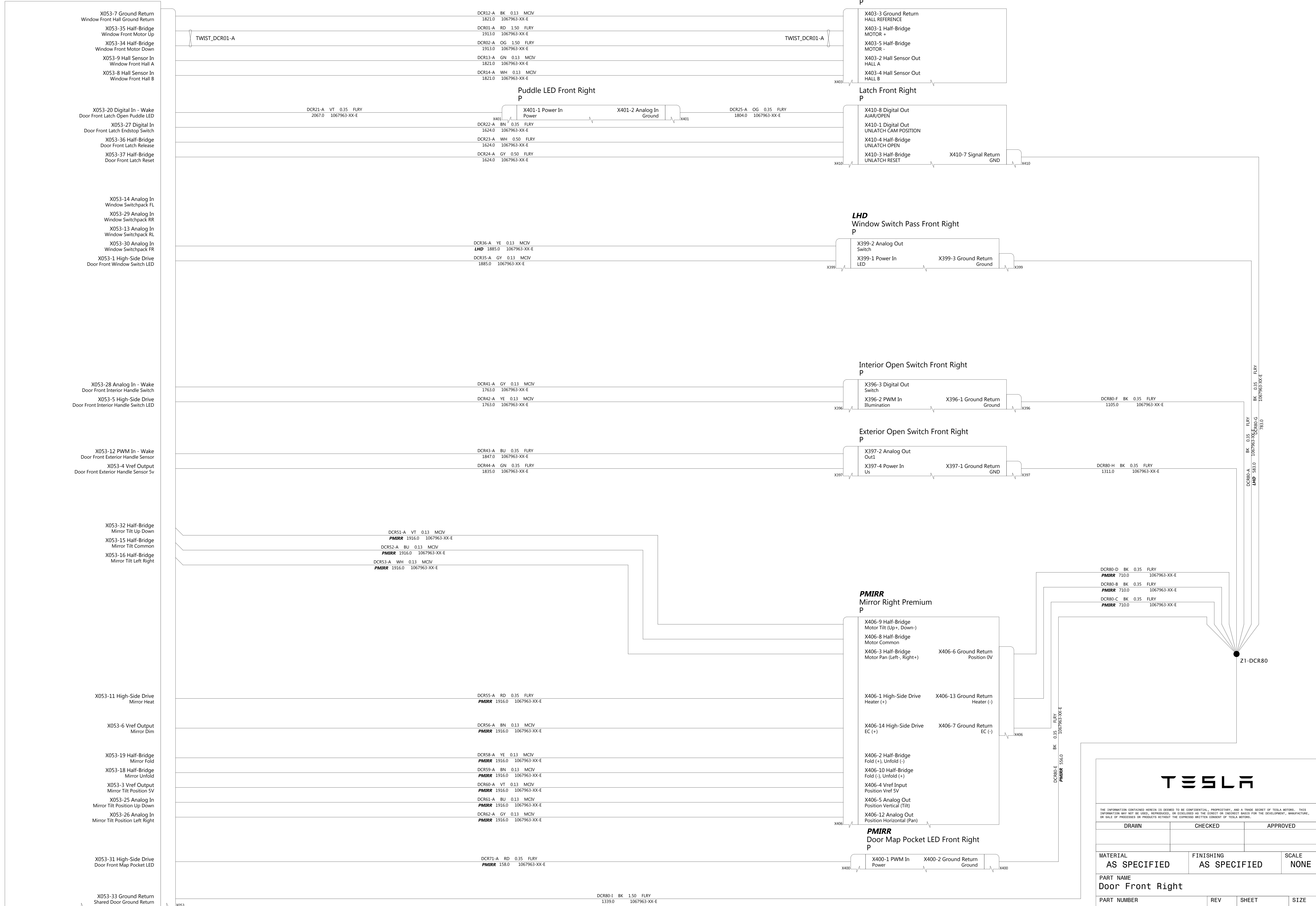

THE INFORMATION CONTAINED HEREIN IS DEEMED TO BE CONFIDENTIAL, PROPRIETARY, AND A TRADE SECRET OF TESLA MOTORS. THIS INFORMATION MAY NOT BE USED, REPRODUCED, OR DISCLOSED AS THE DIRECT OR INDIRECT BASIS FOR THE DEVELOPMENT, MANUFACTURE, OR SALE OF PROCESSES OR PRODUCTS WITHOUT THE EXPRESSED WRITTEN CONSENT OF TESLA MOTORS.

DRAWN	CHECKED	APPROVED
MATERIAL AS SPECIFIED	FINISHING AS SPECIFIED	SCALE NONE
PART NAME Door Front Right		
PART NUMBER	REV	SHEET
	1	16 OF 40
		SIZE A0

Body Controller Left
A,D,J,W,K

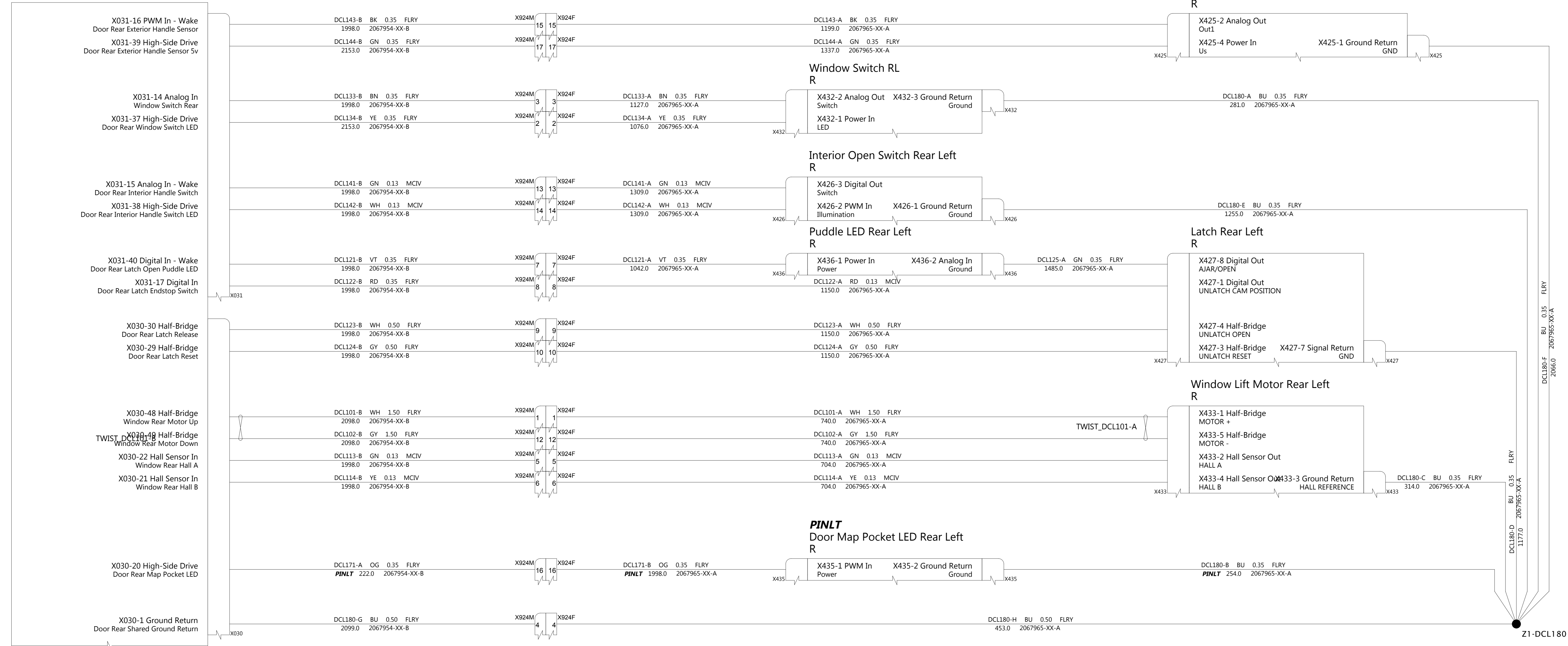

Body Controller Right
B,P,J,W

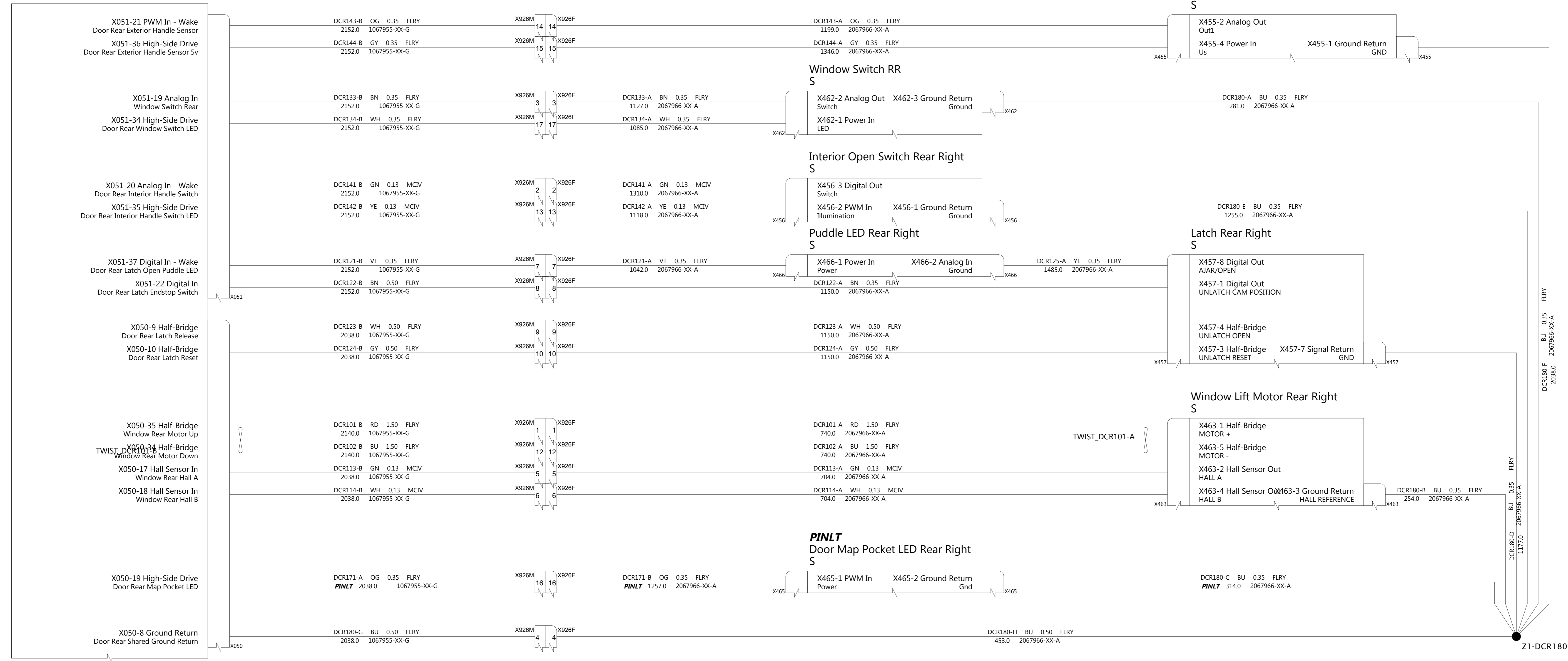

THE INFORMATION CONTAINED HEREIN IS DEEMED TO BE CONFIDENTIAL, PROPRIETARY, AND A TRADE SECRET OF TESLA MOTORS. THIS INFORMATION MAY NOT BE USED, REPRODUCED, OR DISCLOSED AS THE DIRECT OR INDIRECT BASIS FOR THE DEVELOPMENT, MANUFACTURE, OR SALE OF PROCESSES OR PRODUCTS WITHOUT THE EXPRESSED WRITTEN CONSENT OF TESLA MOTORS.

DRAWN	CHECKED	APPROVED
MATERIAL AS SPECIFIED	FINISHING AS SPECIFIED	SCALE NONE
PART NAME Doors Rear		
PART NUMBER	REV	SHEET
	1	17 OF 40
		SIZE A0

AWD
Drive Inverter Front & Resolver
N

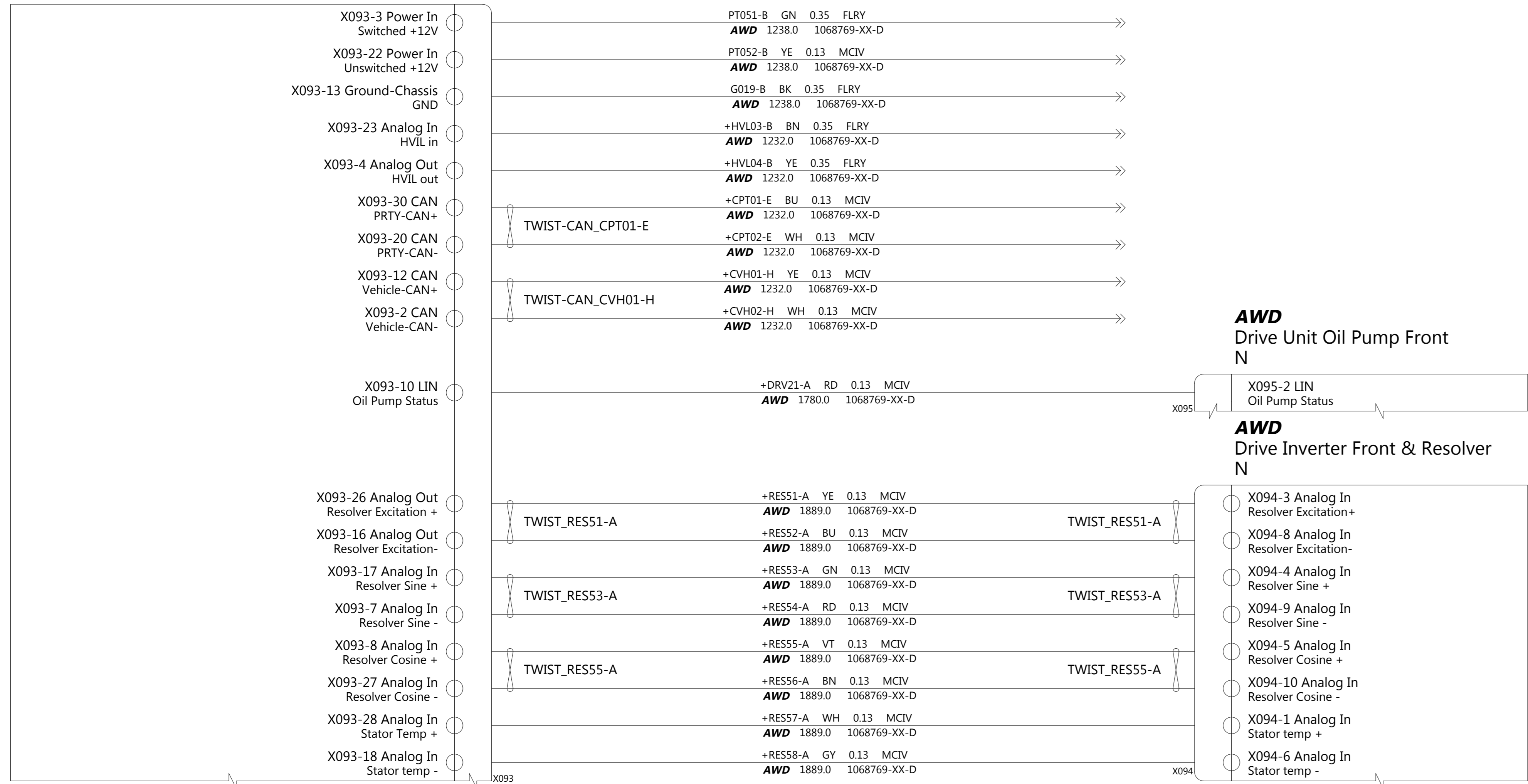

AWD
Drive Inverter Rear & Resolver
X

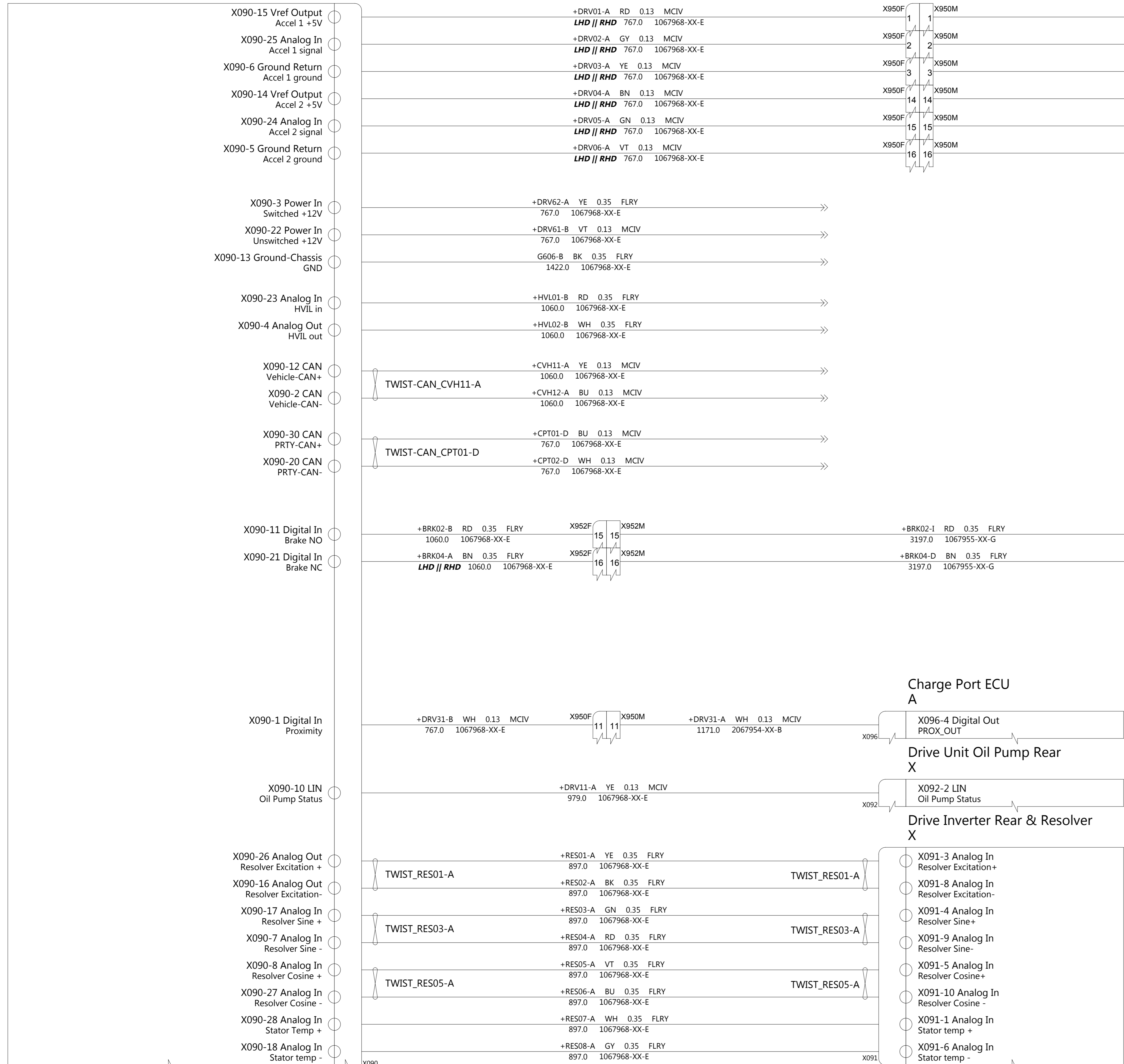

Accel Pedal Sensor
A

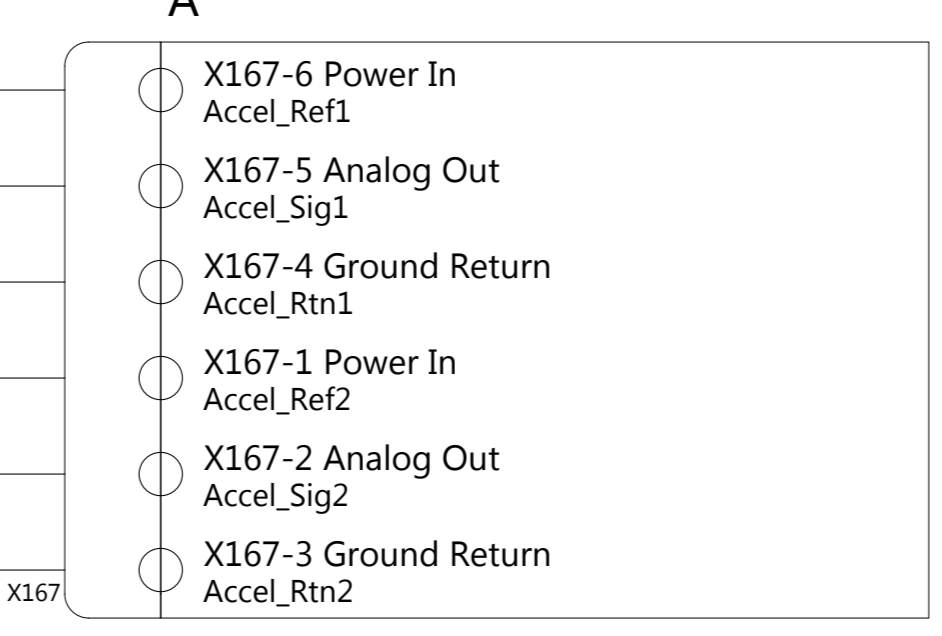

Body Controller Left
A,D,J,W,K

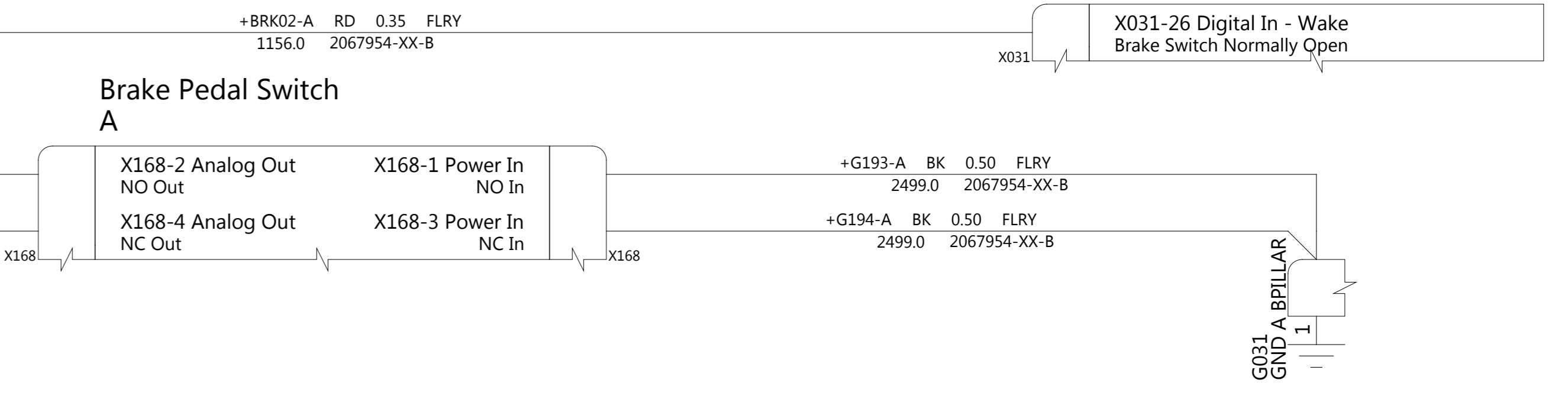

THE INFORMATION CONTAINED HEREIN IS DEEMED TO BE CONFIDENTIAL, PROPRIETARY, AND A TRADE SECRET OF TESLA MOTORS. THIS INFORMATION MAY NOT BE USED, REPRODUCED, OR DISCLOSED AS THE DIRECT OR INDIRECT BASIS FOR THE DEVELOPMENT, MANUFACTURE, OR SALE OF PROCESSES OR PRODUCTS WITHOUT THE EXPRESSED WRITTEN CONSENT OF TESLA MOTORS.

DRAWN	CHECKED	APPROVED
MATERIAL AS SPECIFIED	FINISHING AS SPECIFIED	SCALE NONE
PART NAME Drive Inverters		
PART NUMBER	REV	SHEET
	1	18 OF 40
		SIZE A0

**Body Controller Front
W,U**



**Body Controller Right
B,P,J,W**

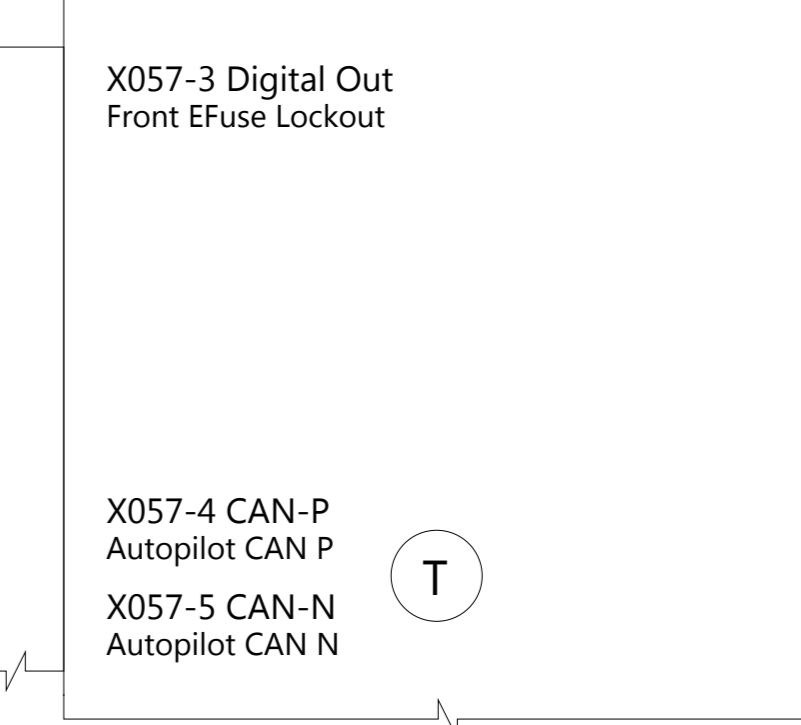

**LHD
Autopilot ECU
W,J,B**

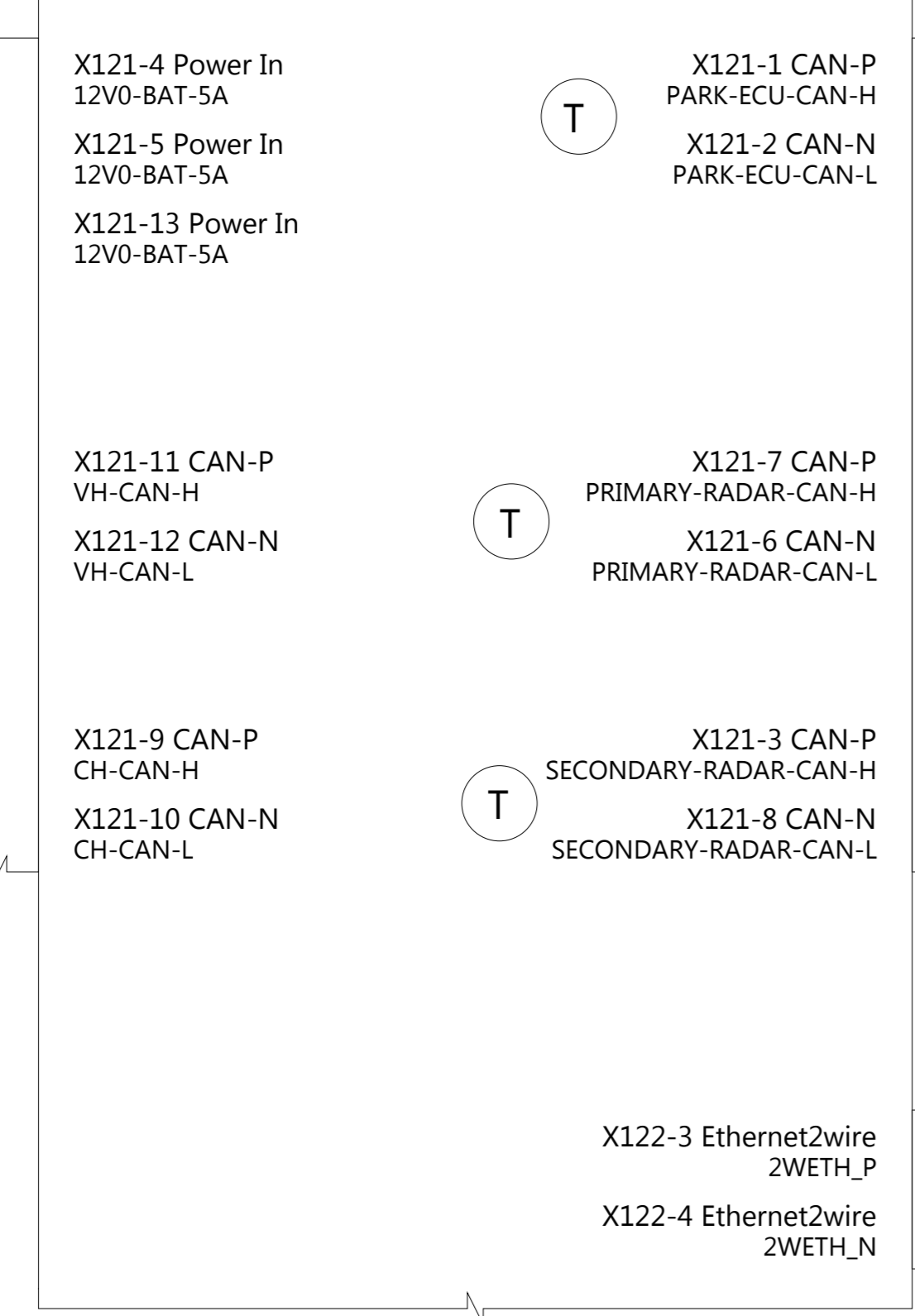

**Radar Front
L**

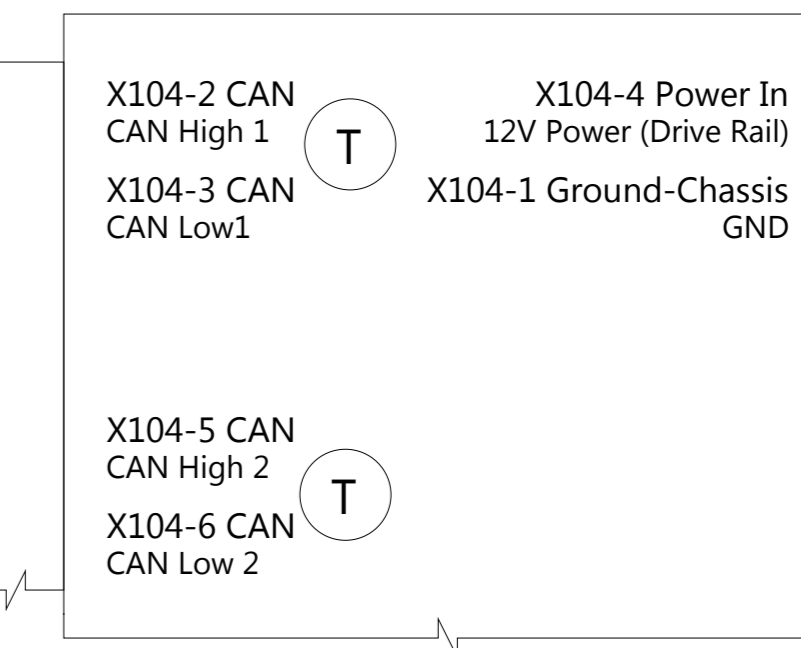

**LHD
MCU
W,B**

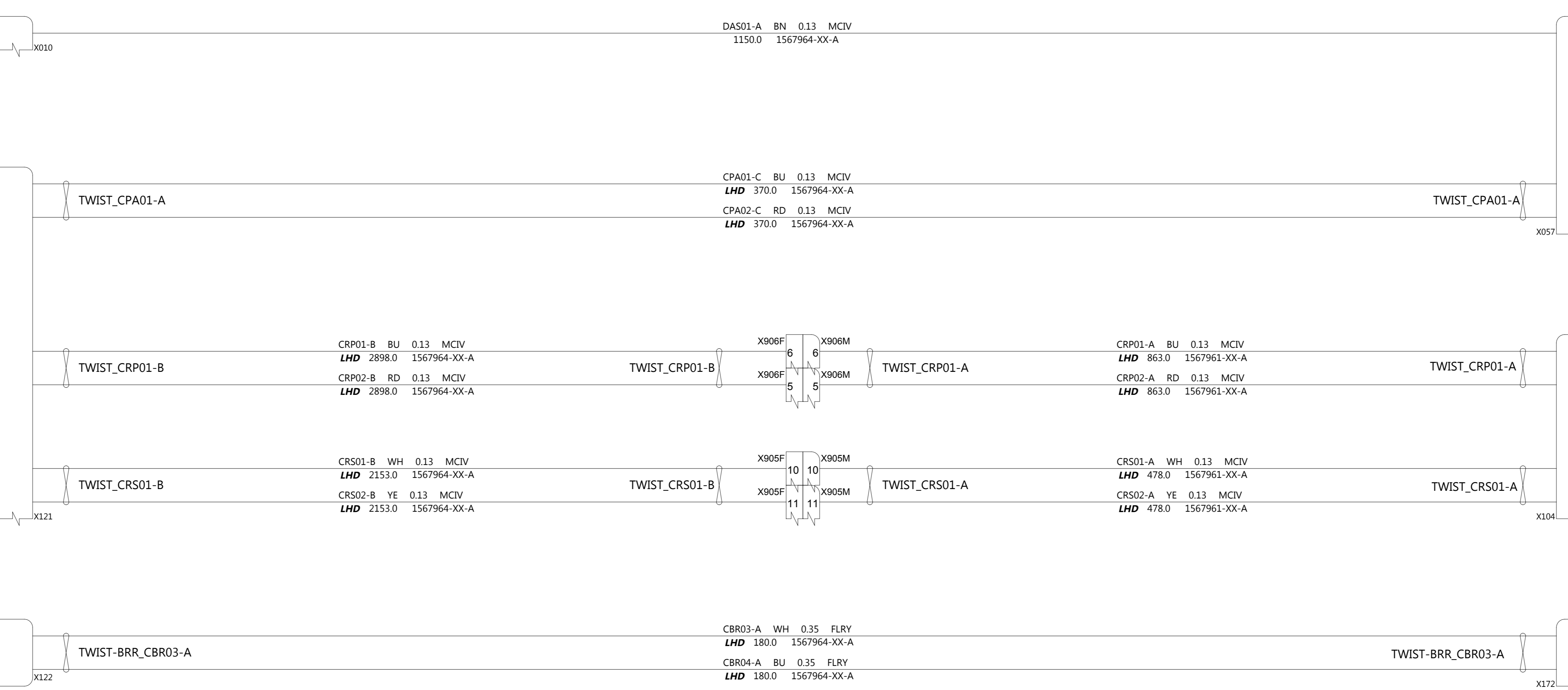
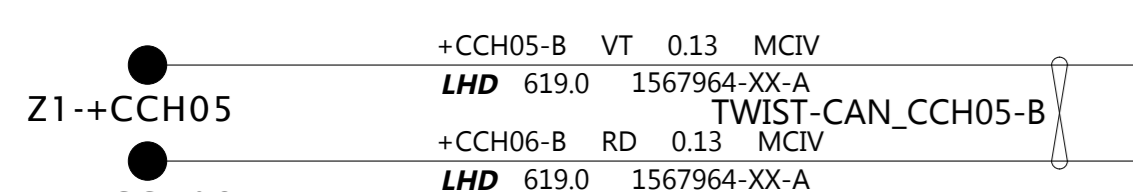
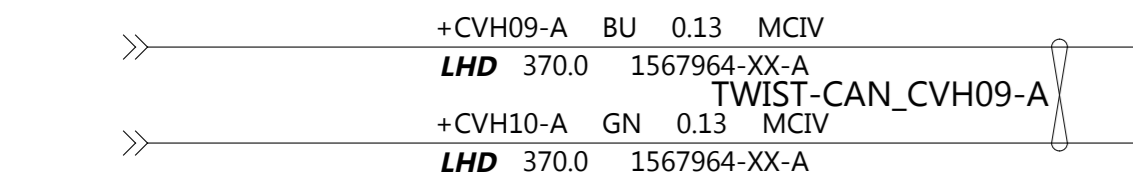
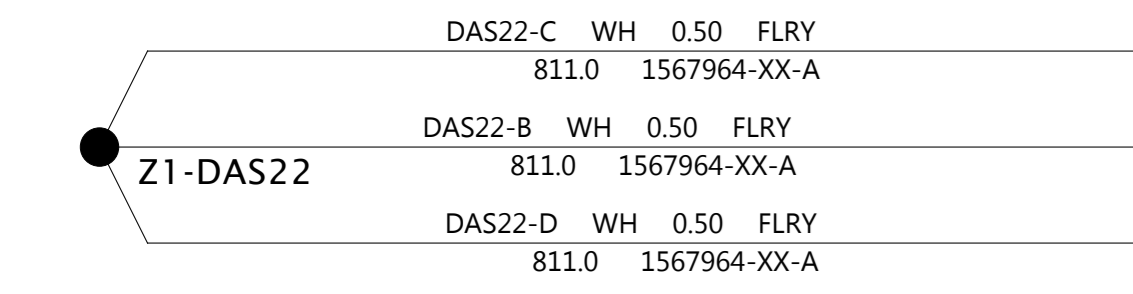
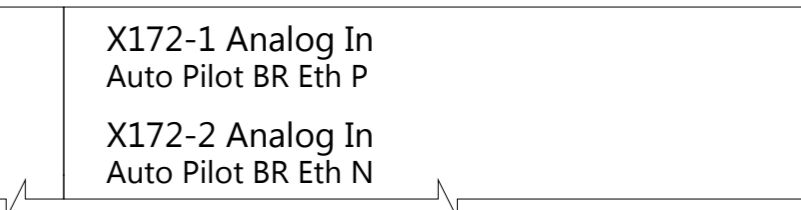

THE INFORMATION CONTAINED HEREIN IS DEEMED TO BE CONFIDENTIAL, PROPRIETARY, AND A TRADE SECRET OF TESLA MOTORS. THIS INFORMATION MAY NOT BE USED, REPRODUCED, OR DISCLOSED AS THE OBJECT OR INDIRECT BASIS FOR THE DEVELOPMENT, MANUFACTURE, OR SALE OF PROCESSES OR PRODUCTS WITHOUT THE EXPRESS WRITTEN CONSENT OF TESLA MOTORS.

DRAWN	CHECKED	APPROVED
-------	---------	----------

MATERIAL AS SPECIFIED	FINISHING AS SPECIFIED	SCALE NONE
--------------------------	---------------------------	---------------

PART NAME
Driver Assistance

PART NUMBER	REV	SHEET	SIZE
	1	19 of 40	A0

Body Controller Left
A,D,J,W,K



Vanity LED Right
K

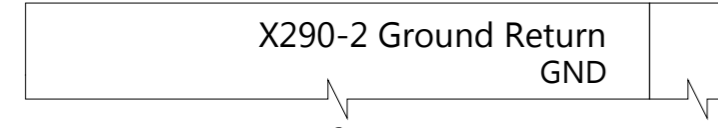

Vanity LED Left
K

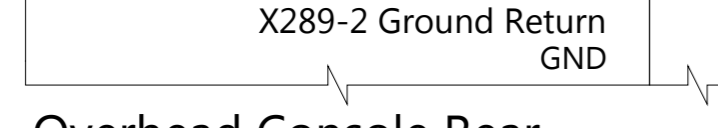

Overhead Console Rear
K

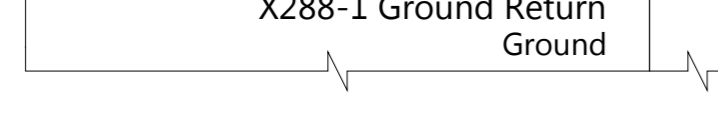

Overhead Console Front eCall
K

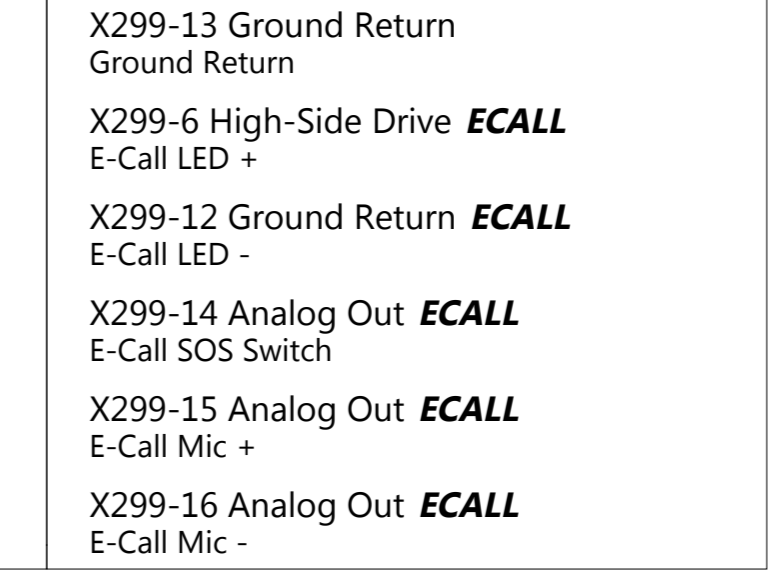

MCU
W,B

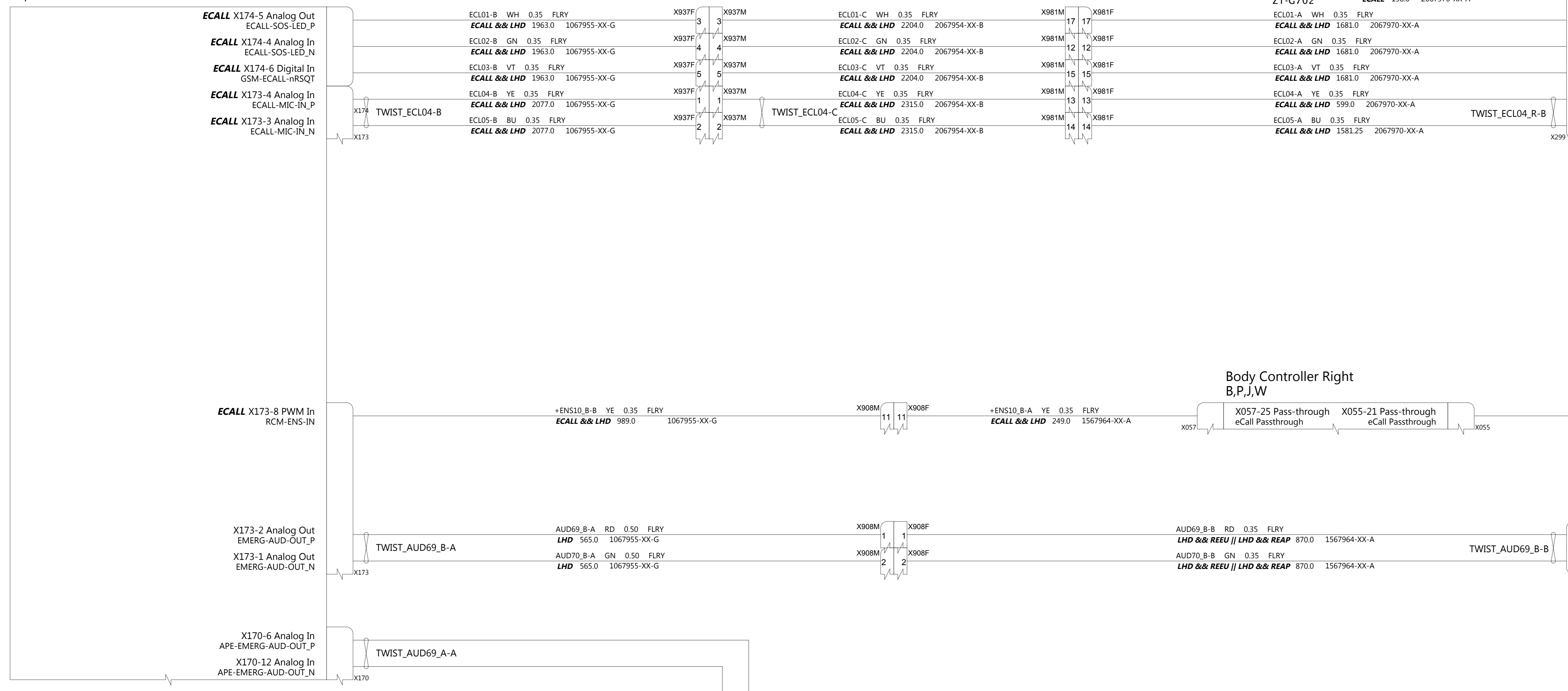

Body Controller Right
B,P,J,W

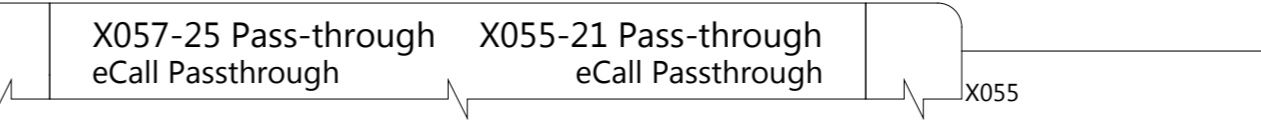

Restraints Controller
A,J



Speaker Emergency Audio
W

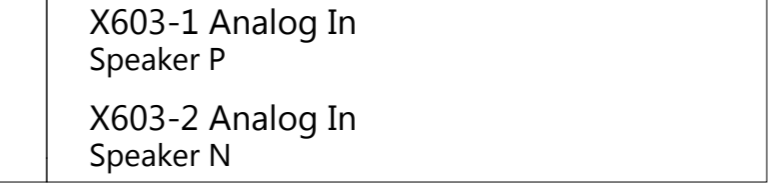

Autopilot ECU
W,J,B

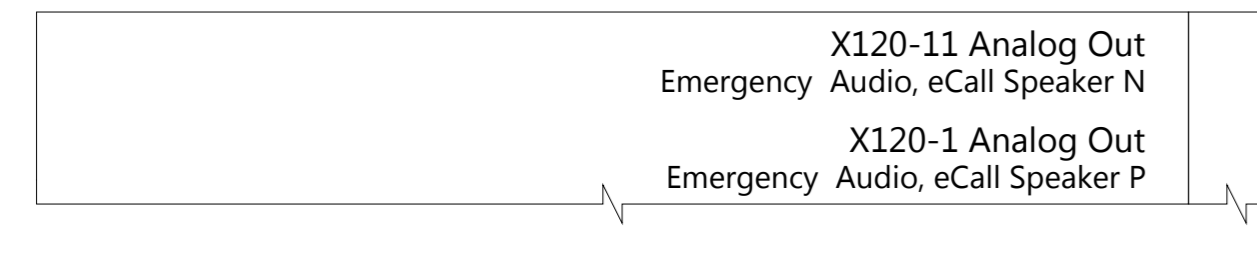

THE INFORMATION CONTAINED HEREIN IS DEEMED TO BE CONFIDENTIAL, PROPRIETARY, AND A TRADE SECRET OF TESLA MOTORS. THIS INFORMATION MAY NOT BE USED, REPRODUCED, OR DISCLOSED AS THE DIRECT OR INDIRECT BASIS FOR THE DEVELOPMENT, MANUFACTURE, OR SALE OF PROCESSES OR PRODUCTS WITHOUT THE EXPRESSED WRITTEN CONSENT OF TESLA MOTORS.

DRAWN	CHECKED	APPROVED
MATERIAL AS SPECIFIED	FINISHING AS SPECIFIED	SCALE NONE
PART NAME eCall		
PART NUMBER	REV 1	SHEET 20 OF 40
		SIZE A0

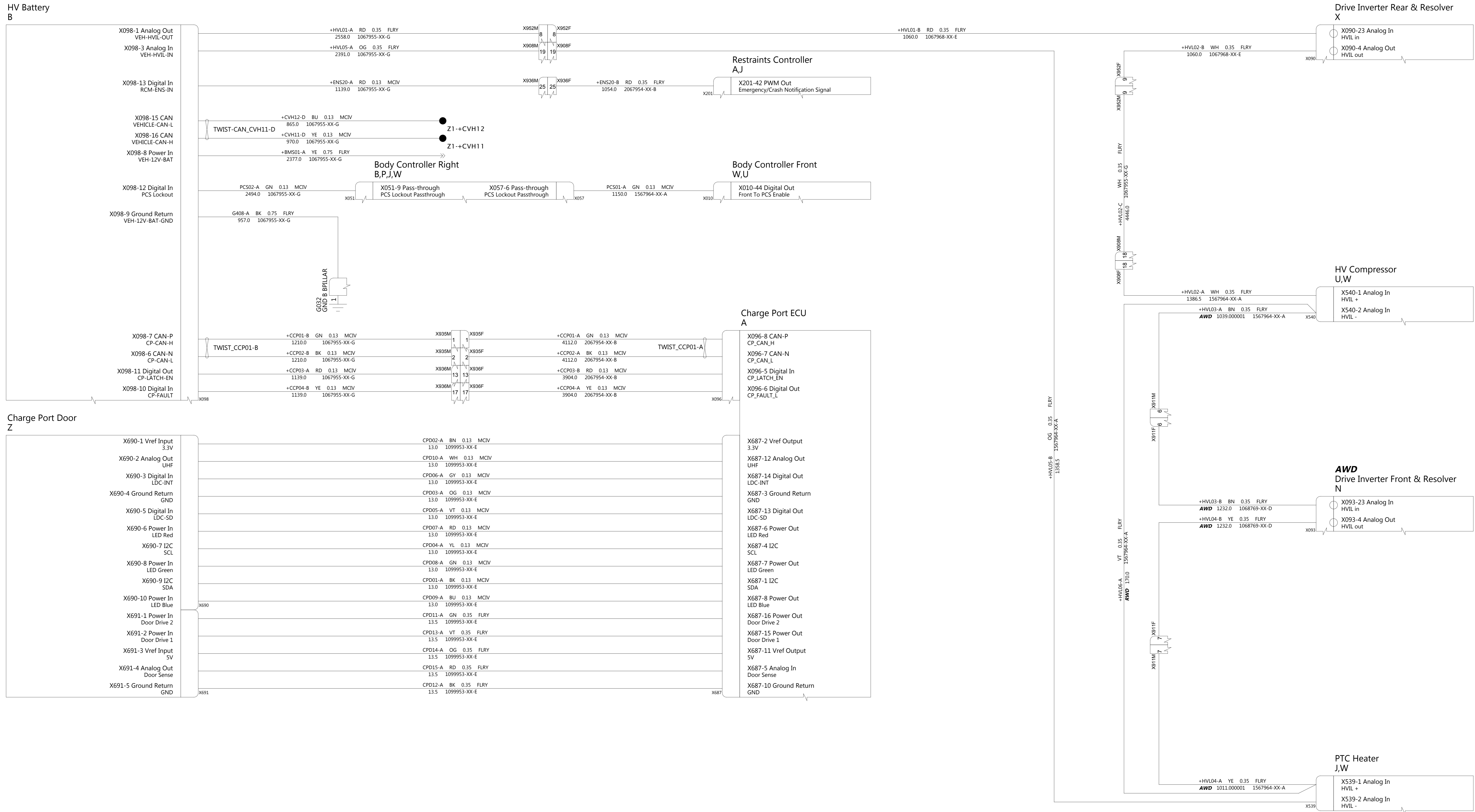

TESLA

THE INFORMATION CONTAINED HEREIN IS DEEMED TO BE CONFIDENTIAL, PROPRIETARY, AND A TRADE SECRET OF TESLA MOTORS. THIS INFORMATION MAY NOT BE USED, REPRODUCED, OR DISCLOSED AS THE OBJECT OR INDIRECT BASIS FOR THE DEVELOPMENT, MANUFACTURE, OR SALE OF PROCESSES OR PRODUCTS WITHOUT THE EXPRESSED WRITTEN CONSENT OF TESLA MOTORS.

DRAWN	CHECKED	APPROVED
-------	---------	----------

MATERIAL AS SPECIFIED	FINISHING AS SPECIFIED	SCALE NONE
--------------------------	---------------------------	---------------

PART NAME
HV Battery and HVIL

PART NUMBER	REV	SHEET	SIZE
	1	21 OF 40	A0

PCS
H

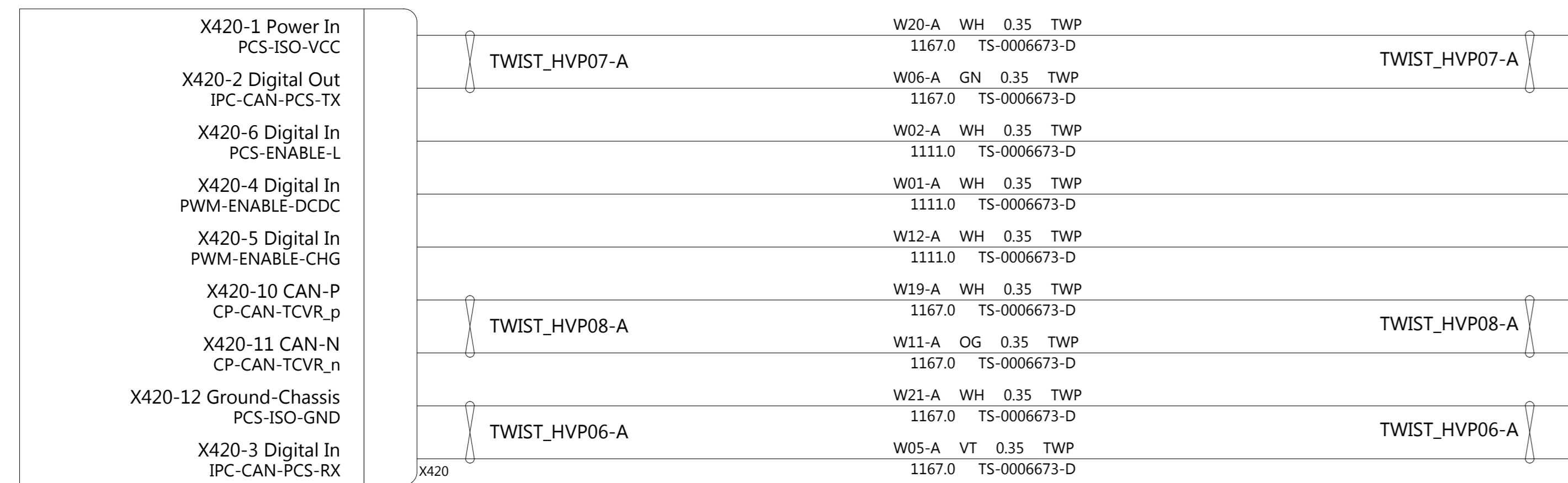

AWD
HV-FDU
H

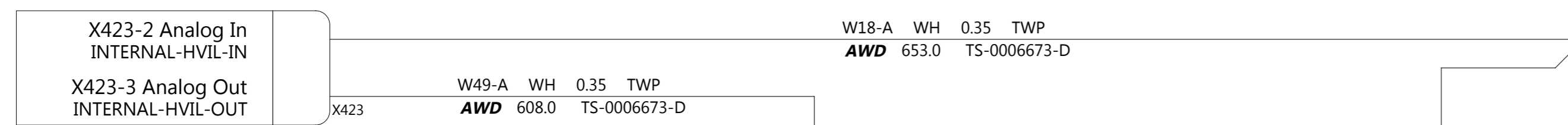

HV-RDU
H

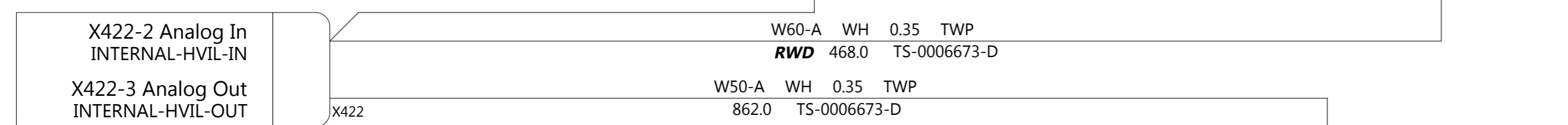

HV-ANCIL
H

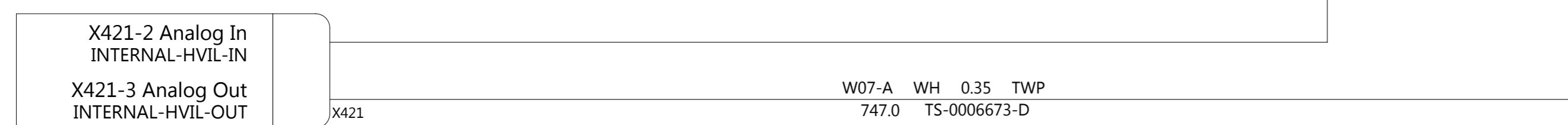

CHARGER-INLET
H

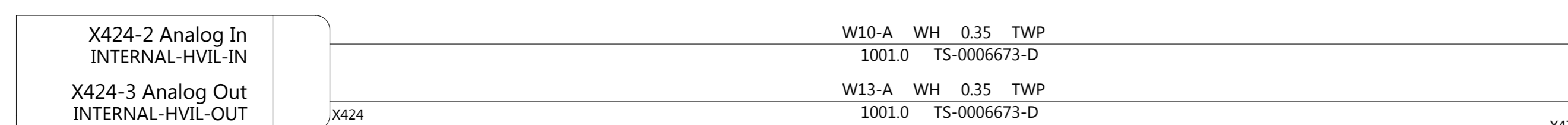

BMB-DAISY-A
H



BMB-DAISY-B
H



HV Controller
H

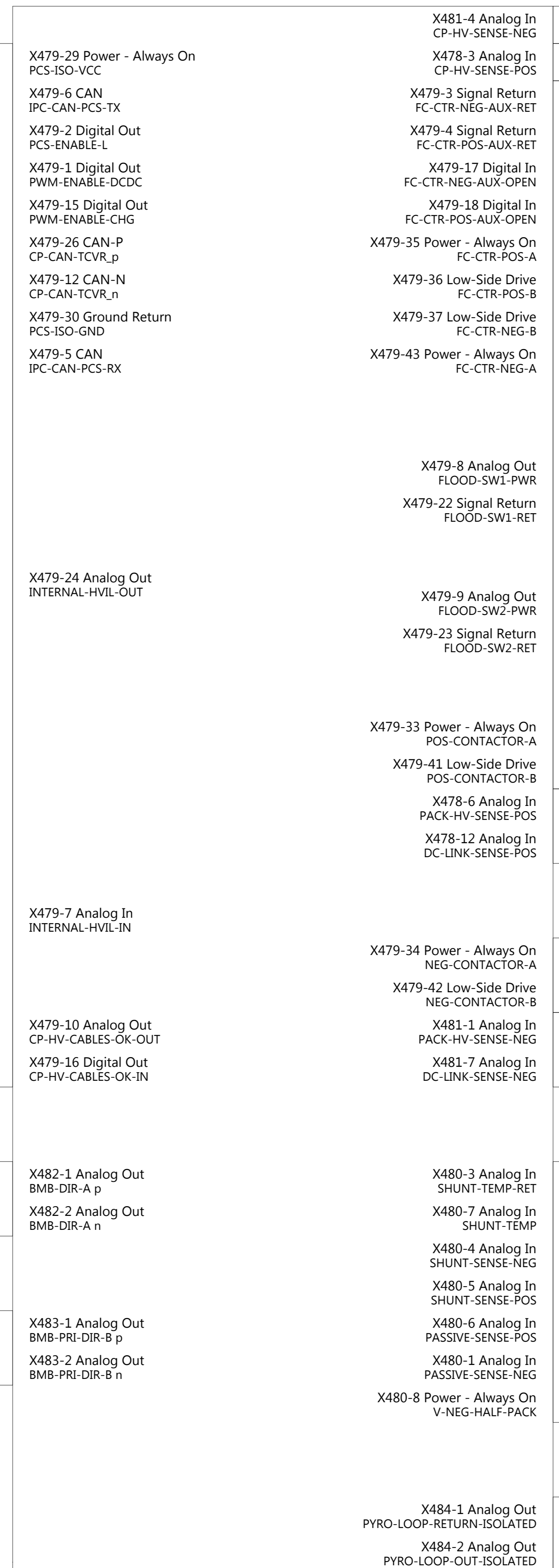

FAS-CHR-CONTACT-P1
H

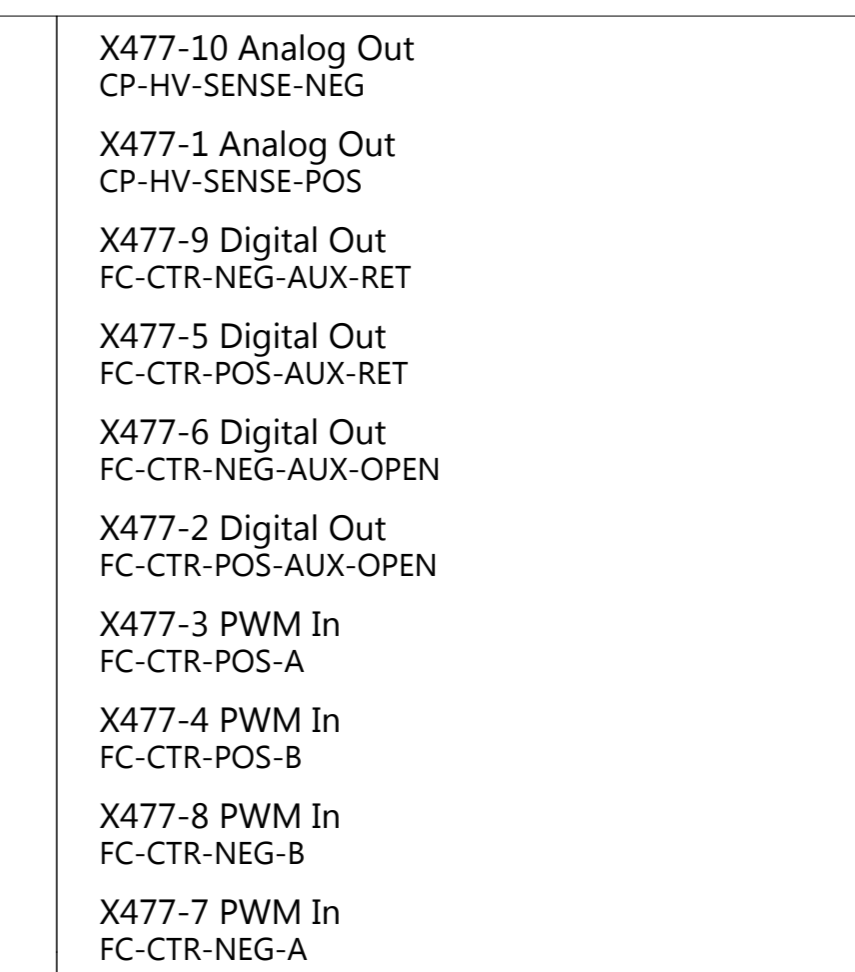

COOLANT-V1
H

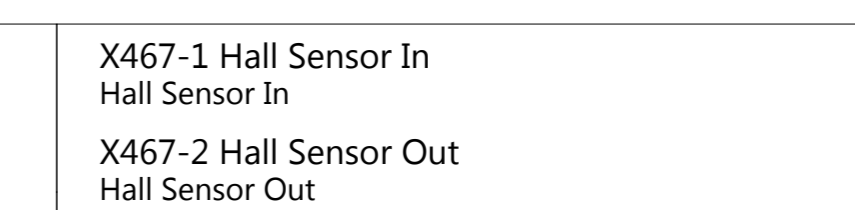

COOLANT-V2
H

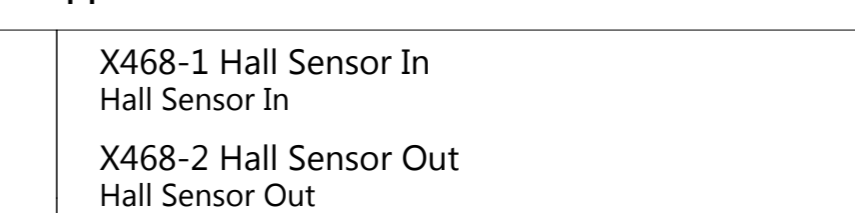

POS-SWITCH
H

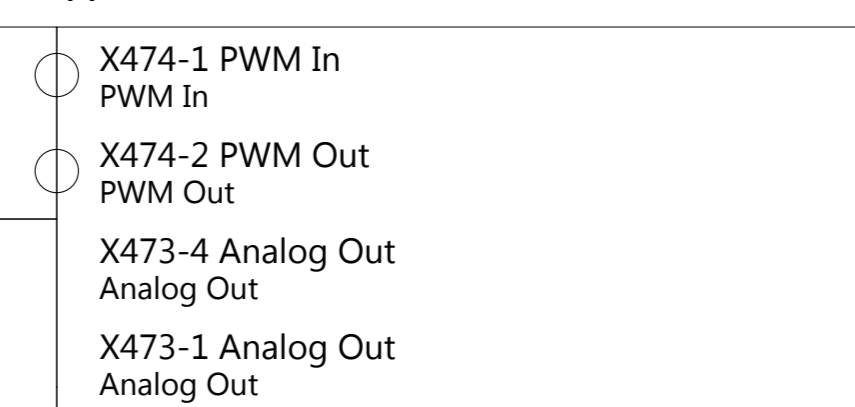

NEG-SWITCH
H

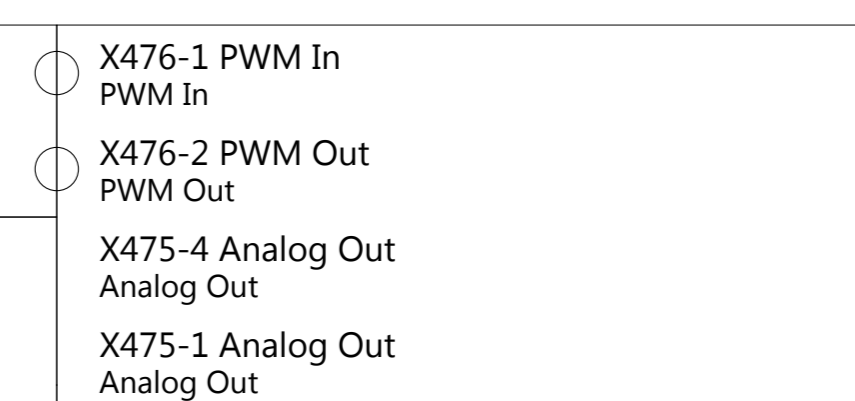

SHUNT-P1
H

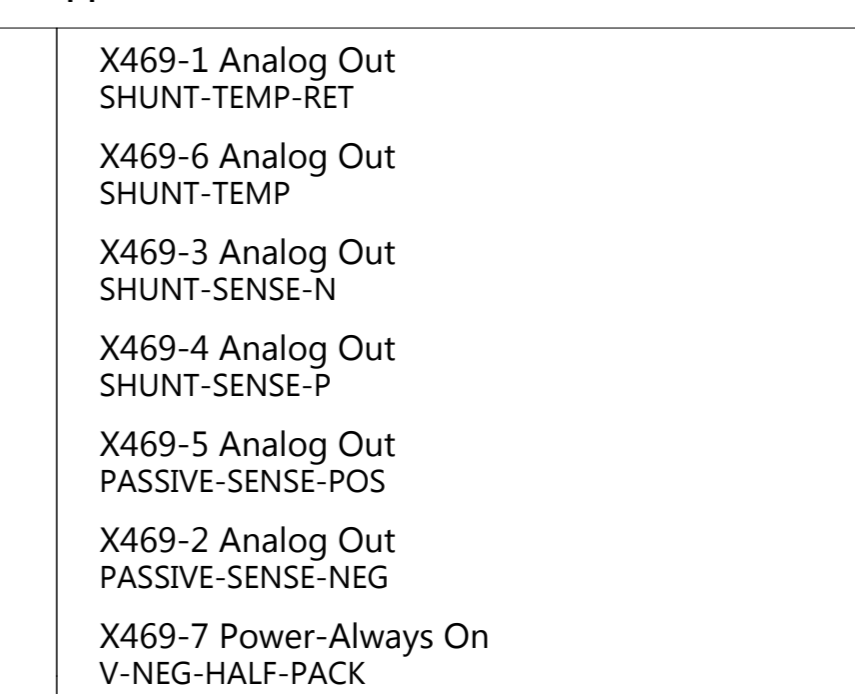

PYRO-DISC-P1
H



THE INFORMATION CONTAINED HEREIN IS DEEMED TO BE CONFIDENTIAL, PROPRIETARY, AND A TRADE SECRET OF TESLA MOTORS. THIS INFORMATION MAY NOT BE USED, REPRODUCED, OR DISCLOSED AS THE DIRECT OR INDIRECT BASIS FOR THE DEVELOPMENT, MANUFACTURE, OR SALE OF PROCESSES OR PRODUCTS WITHOUT THE EXPRESSED WRITTEN CONSENT OF TESLA MOTORS.

DRAWN	CHECKED	APPROVED
MATERIAL AS SPECIFIED	FINISHING AS SPECIFIED	SCALE NONE
PART NAME HV Penthouse		
PART NUMBER	REV	SHEET
	1	22 OF 40
		SCALE A0

**Body Controller Right
B,P,J,W**

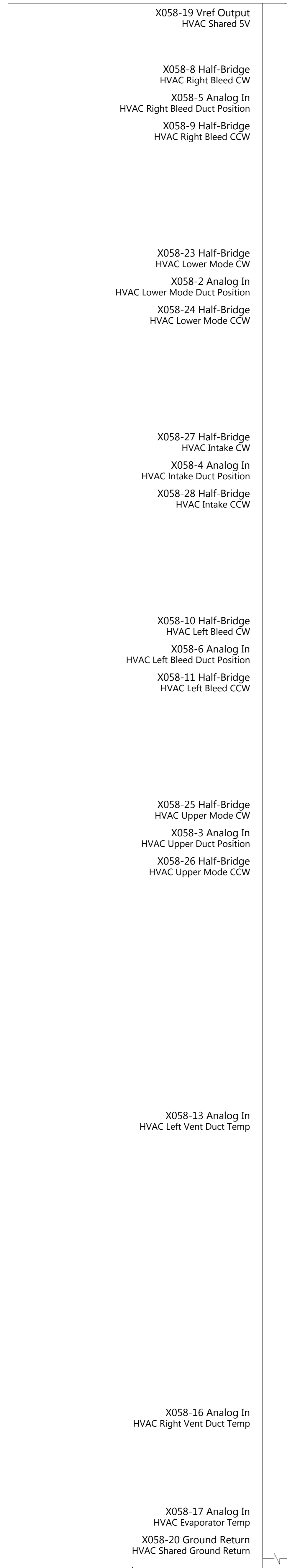

**Body Controller Left
A,D,J,W,K**

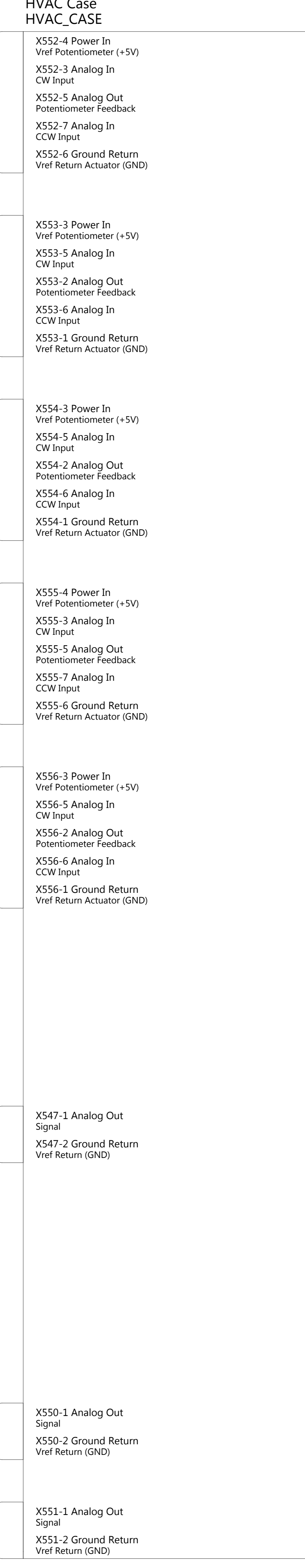
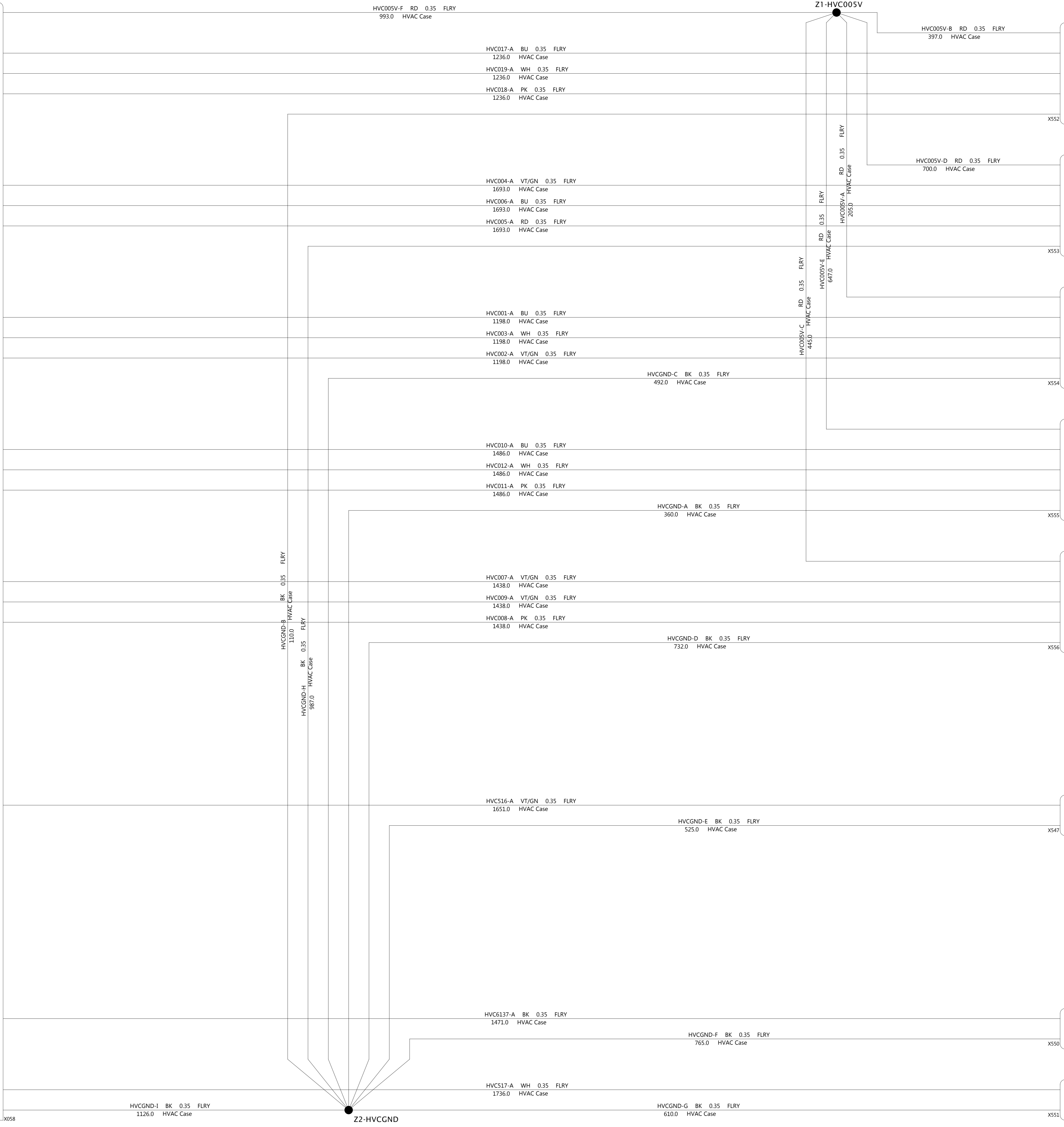
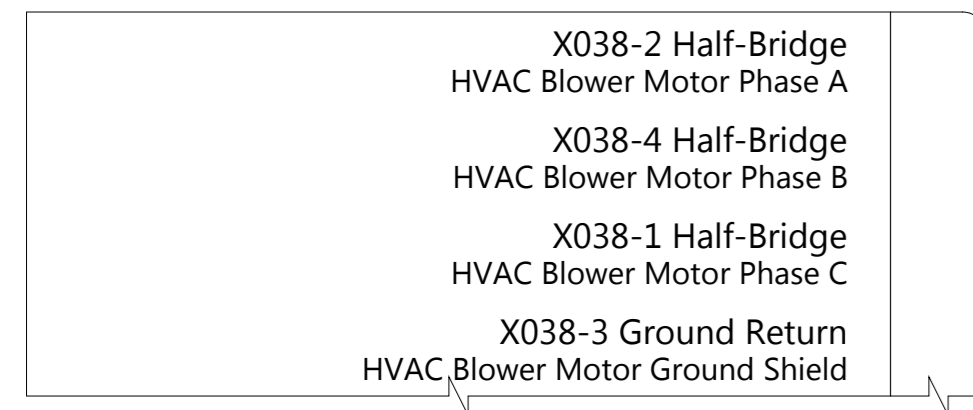

**Blower Motor
J**

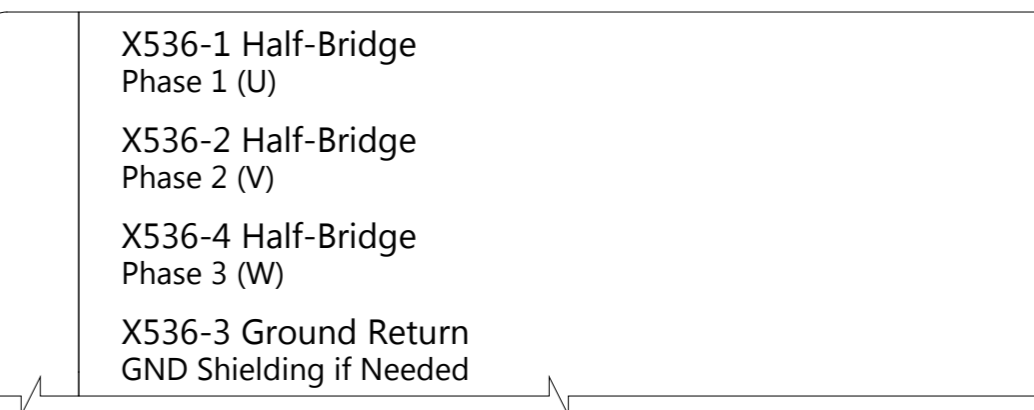

THE INFORMATION CONTAINED HEREIN IS DEEMED TO BE CONFIDENTIAL, PROPRIETARY, AND A TRADE SECRET OF TESLA MOTORS. THIS INFORMATION MAY NOT BE USED, REPRODUCED, OR DISCLOSED AS THE DIRECT OR INDIRECT BASIS FOR THE DEVELOPMENT, MANUFACTURE, OR SALE OF PROCESSES OR PRODUCTS WITHOUT THE EXPRESSED WRITTEN CONSENT OF TESLA MOTORS.			
DRAWN	CHECKED	APPROVED	
MATERIAL AS SPECIFIED	FINISHING AS SPECIFIED	SCALE NONE	
PART NAME HVAC Case Subassembly			
PART NUMBER	REV	SHEET	SIZE
	1	23 OF 40	A0

Body Controller Front
W,U

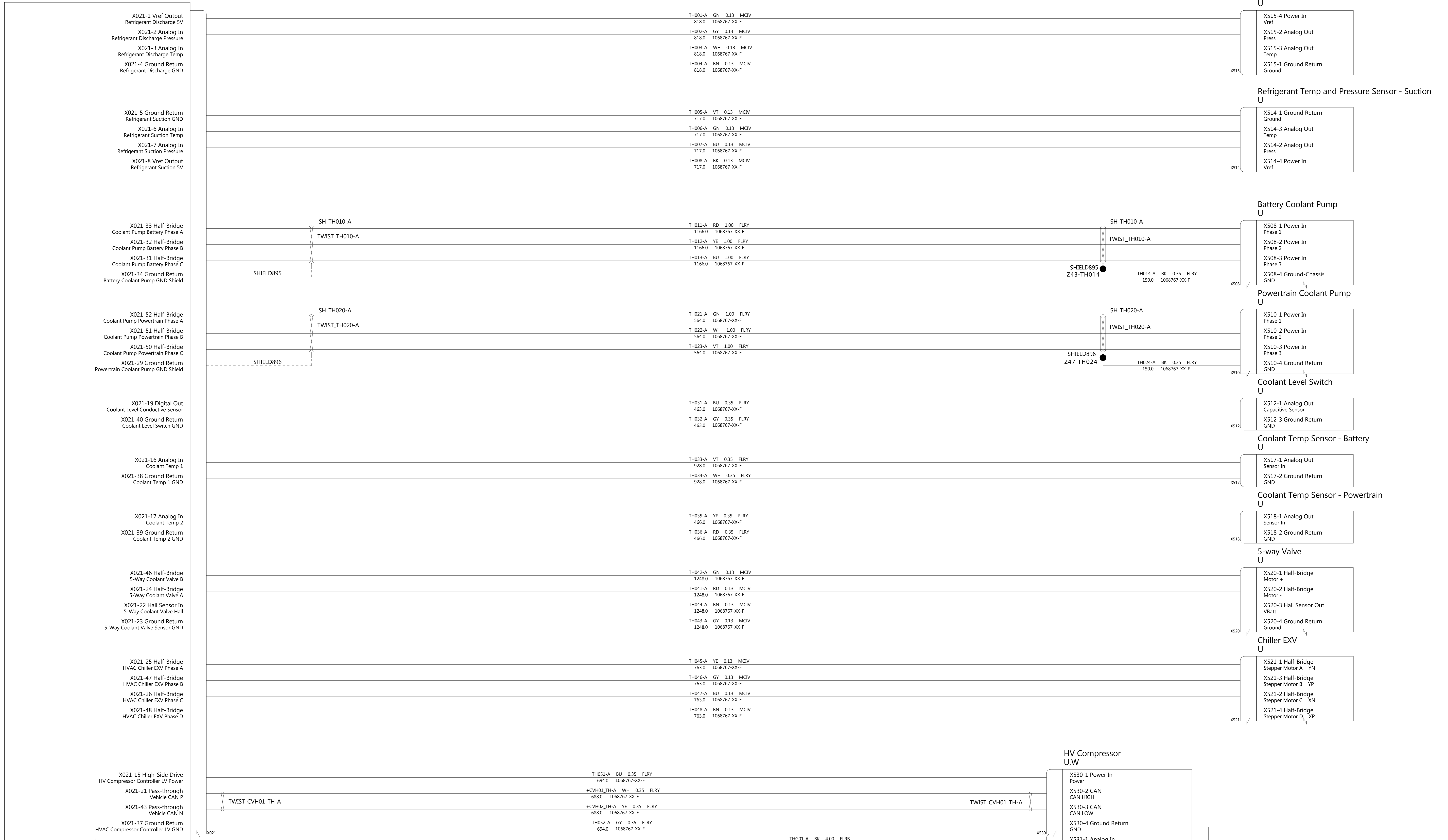

Refrigerant Temp and Pressure Sensor - Discharge
U

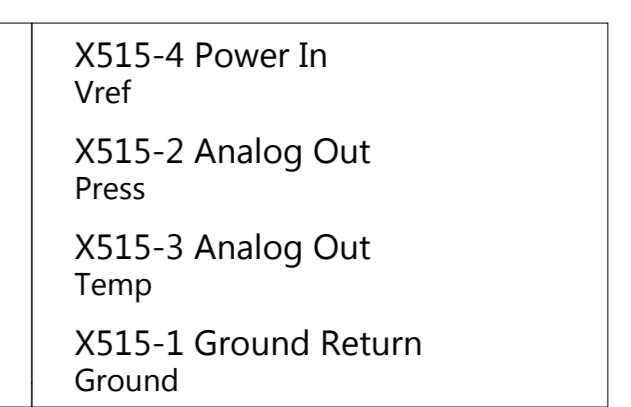

Refrigerant Temp and Pressure Sensor - Suction
U

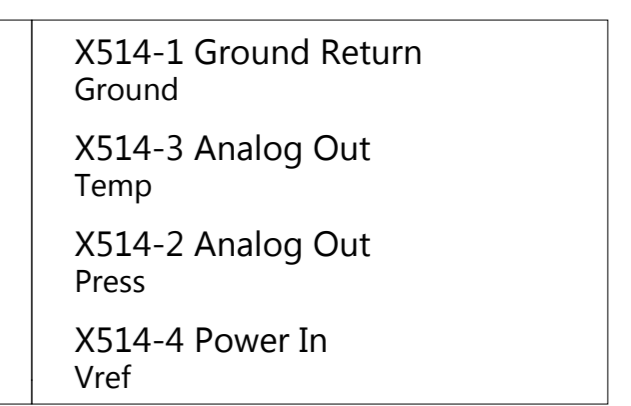

Battery Coolant Pump
U

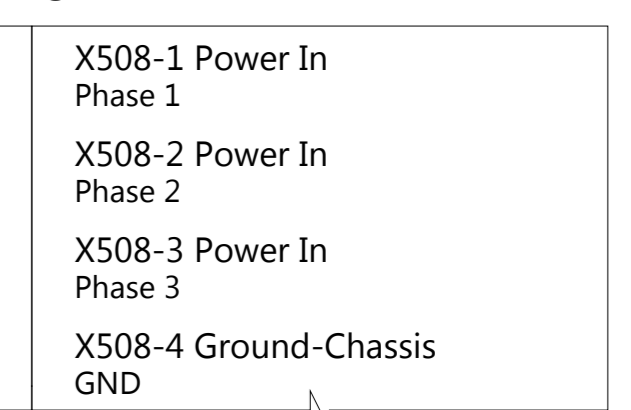

Powertrain Coolant Pump
U

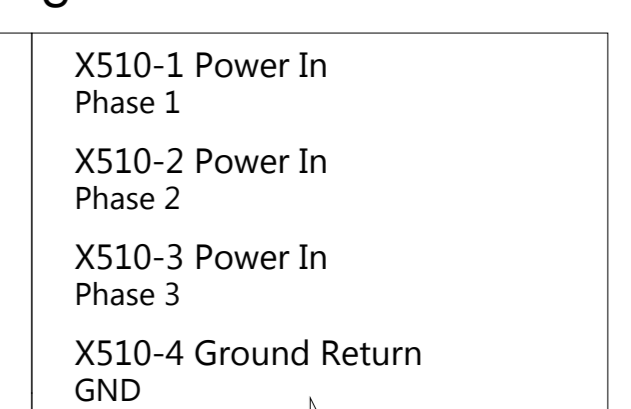

Coolant Level Switch
U

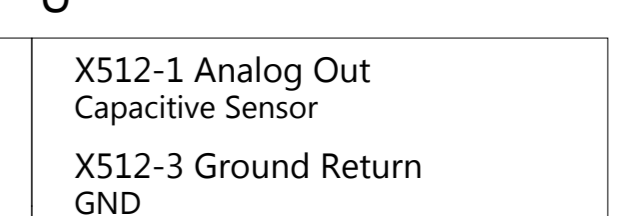

Coolant Temp Sensor - Battery
U

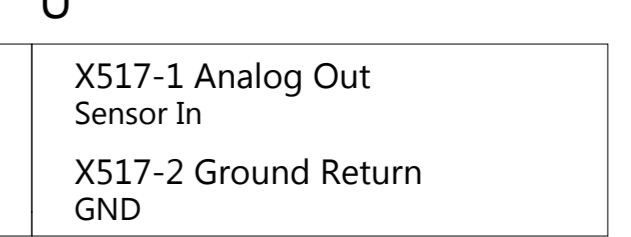

Coolant Temp Sensor - Powertrain
U

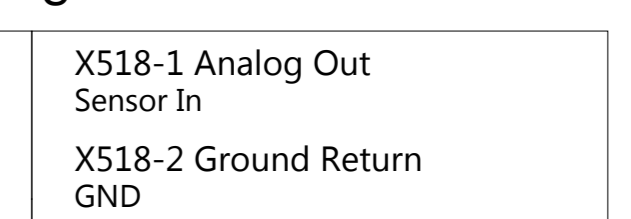

5-way Valve
U

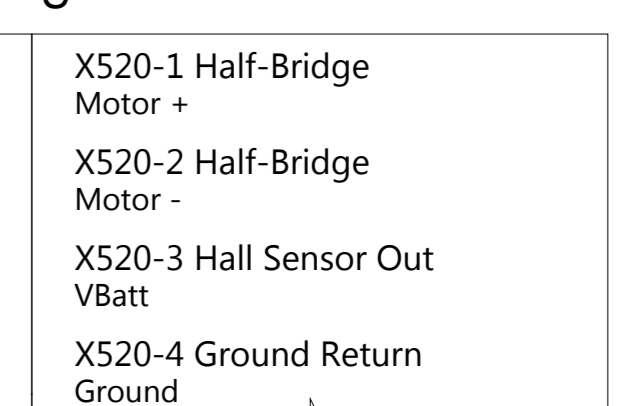

Chiller EXV
U

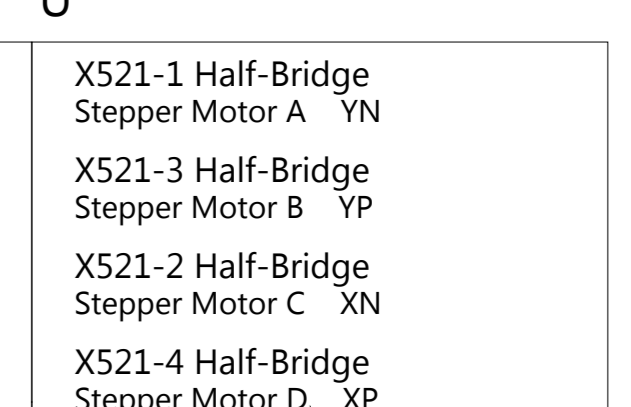

HV Compressor
U,W

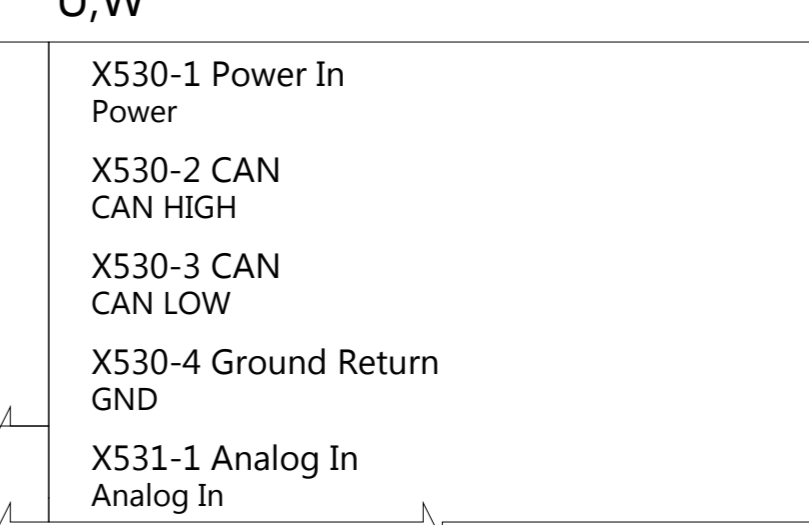

THE INFORMATION CONTAINED HEREIN IS DEEMED TO BE CONFIDENTIAL, PROPRIETARY, AND A TRADE SECRET OF TESLA MOTORS. THIS INFORMATION MAY NOT BE USED, REPRODUCED, OR DISCLOSED AS THE DIRECT OR INDIRECT BASIS FOR THE DEVELOPMENT, MANUFACTURE, OR SALE OF PROCESSES OR PRODUCTS WITHOUT THE EXPRESSED WRITTEN CONSENT OF TESLA MOTORS.

DRAWN	CHECKED	APPROVED
-------	---------	----------

MATERIAL AS SPECIFIED	FINISHING AS SPECIFIED	SCALE NONE
--------------------------	---------------------------	---------------

PART NAME
HVAC Thermal Subassembly

PART NUMBER	REV	SHEET	SIZE
	1	24 OF 40	A0

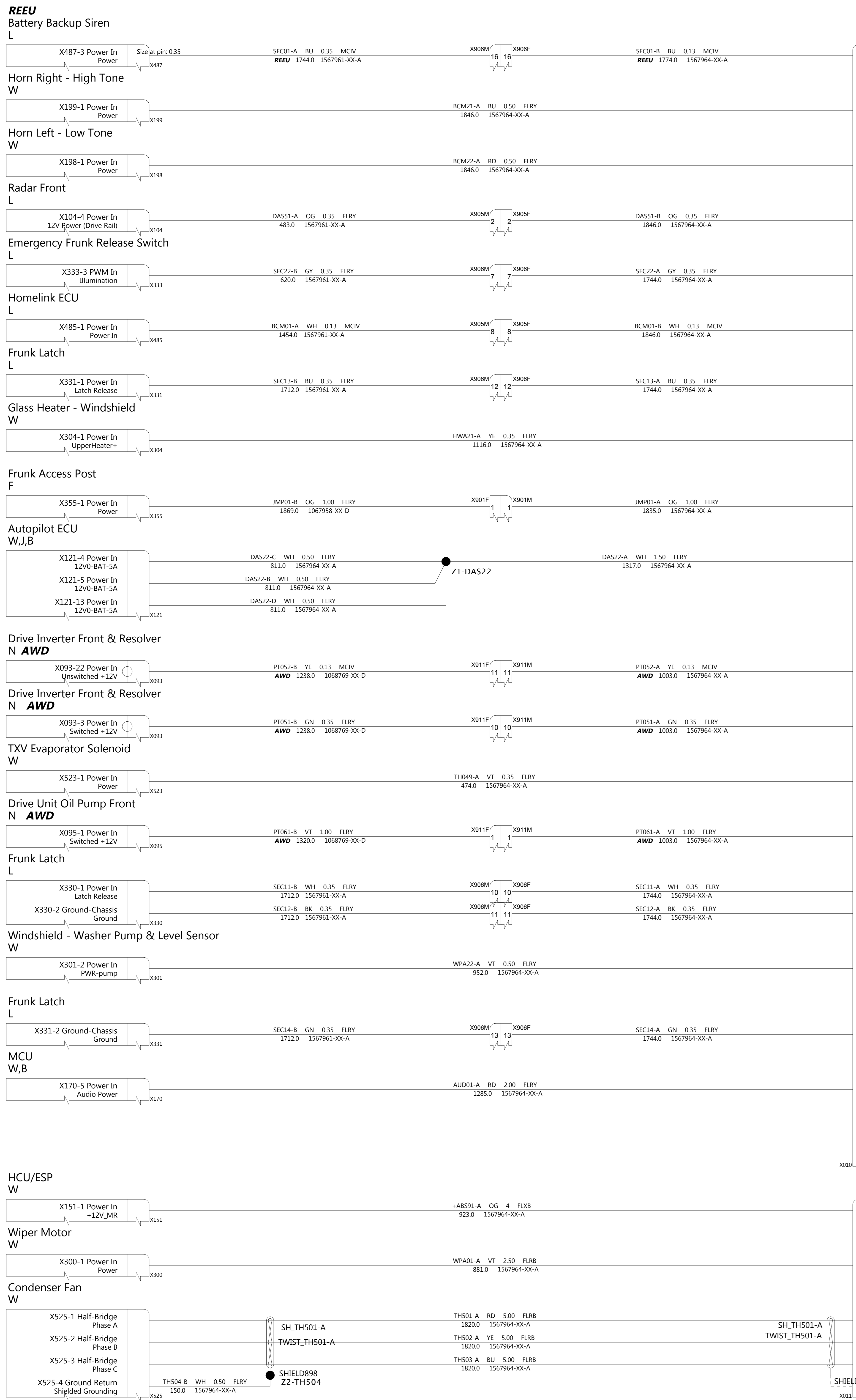

Body Controller Front
W,U

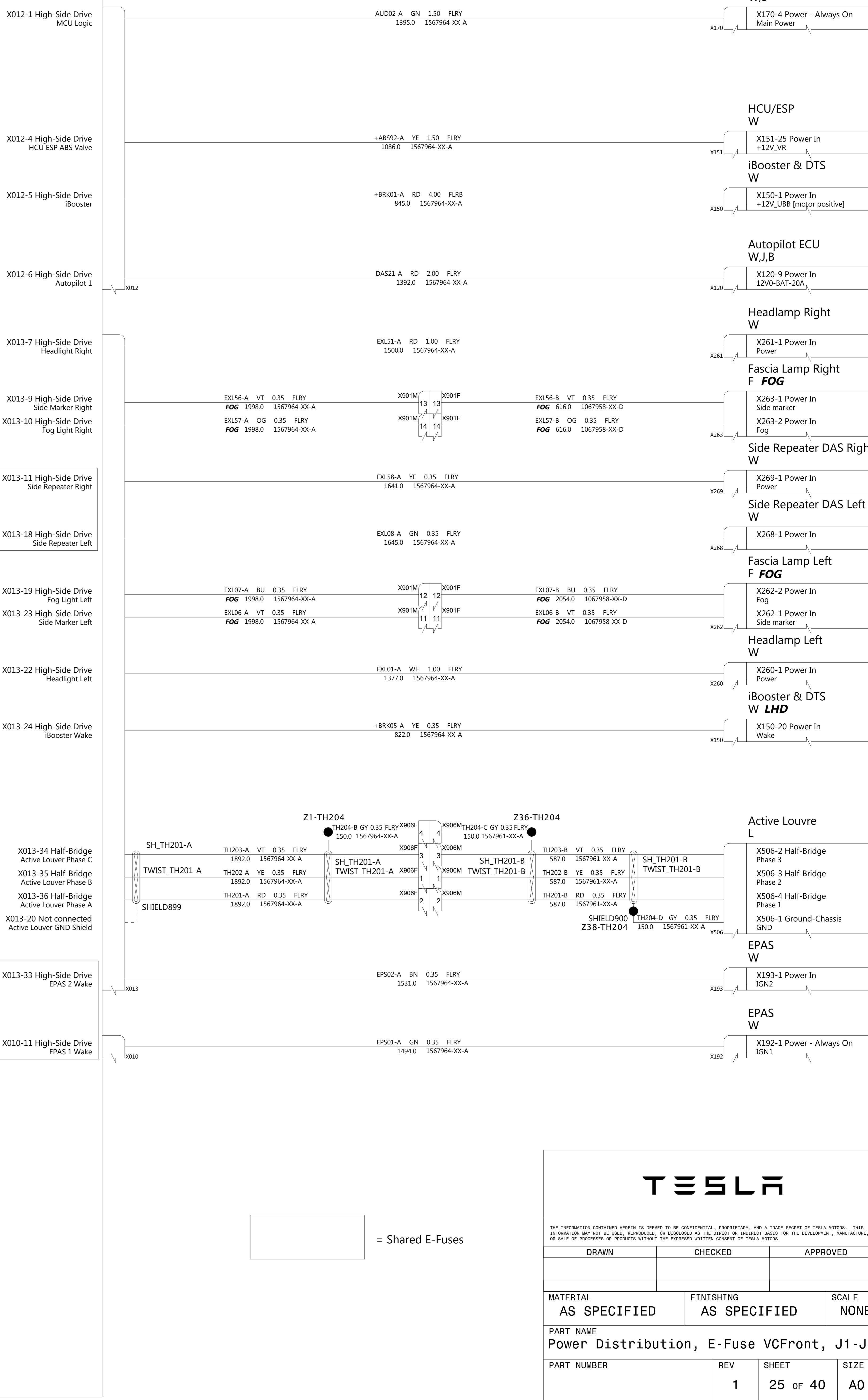
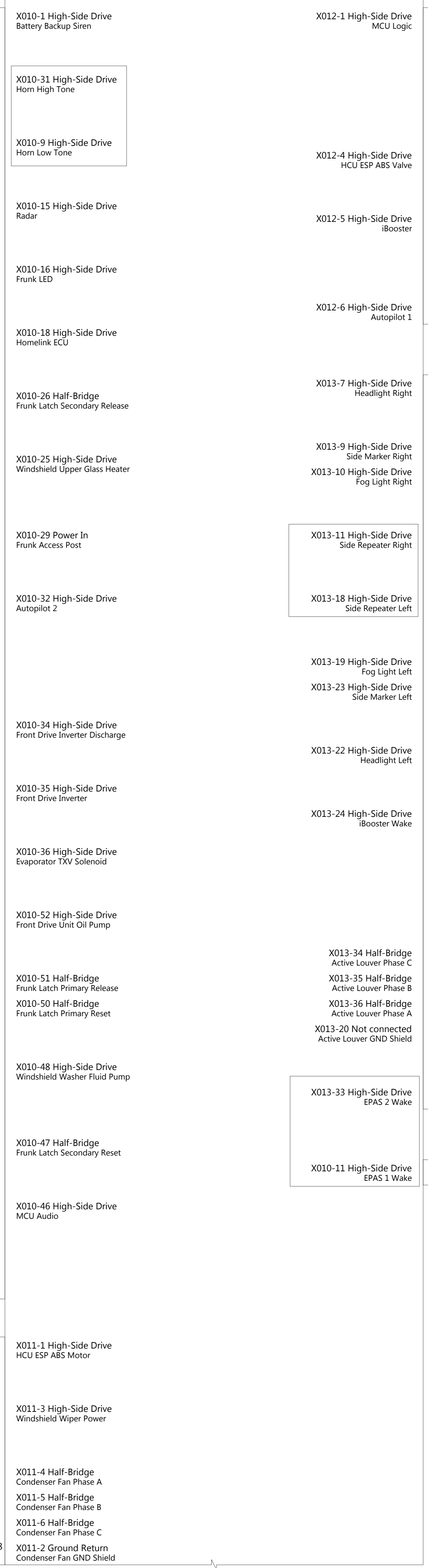

= Shared E-Fuses



THE INFORMATION CONTAINED HEREIN IS DEEMED TO BE CONFIDENTIAL, PROPRIETARY, AND A TRADE SECRET OF TESLA MOTORS. THIS INFORMATION MAY NOT BE USED, REPRODUCED, OR DISCLOSED AS THE DIRECT OR INDIRECT BASIS FOR THE DEVELOPMENT, MANUFACTURE, OR SALE OF PROCESSES OR PRODUCTS WITHOUT THE EXPRESSED WRITTEN CONSENT OF TESLA MOTORS.

DRAWN	CHECKED	APPROVED
MATERIAL AS SPECIFIED	FINISHING AS SPECIFIED	SCALE NONE
PART NAME Power Distribution, E-Fuse VCFront, J1-J4		
PART NUMBER	REV	SHEET
	1	25 OF 40
		SIZE A0

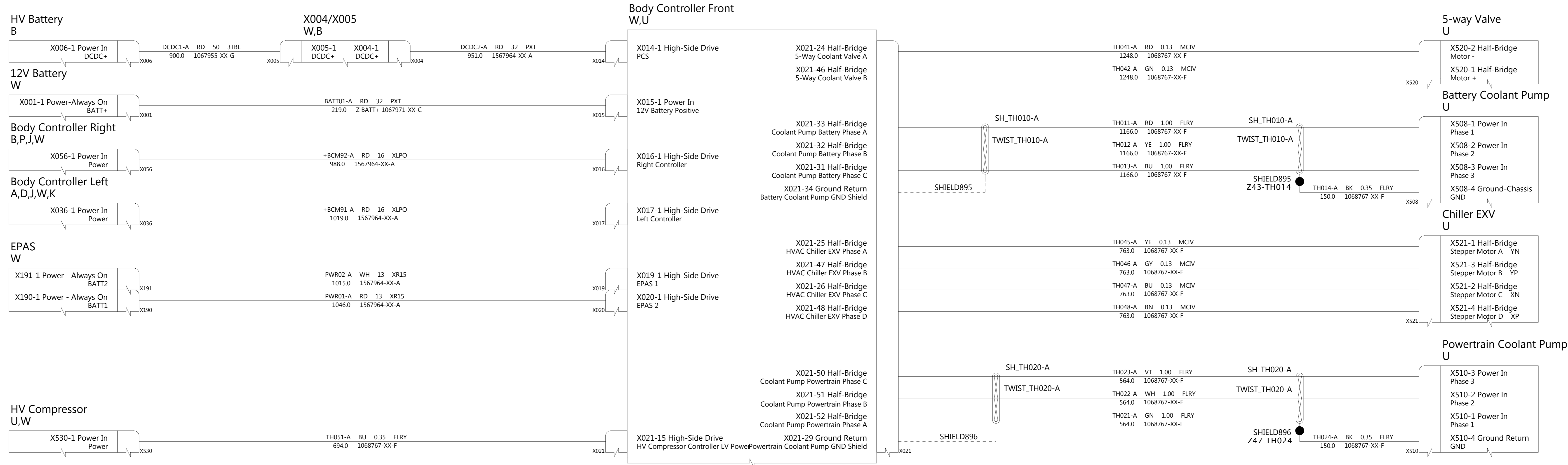

TESLA

THE INFORMATION CONTAINED HEREIN IS DEEMED TO BE CONFIDENTIAL, PROPRIETARY, AND A TRADE SECRET OF TESLA MOTORS. THIS INFORMATION MAY NOT BE USED, REPRODUCED, OR DISCLOSED AS THE DIRECT OR INDIRECT BASIS FOR THE DEVELOPMENT, MANUFACTURE, OR SALE OF PROCESSES OR PRODUCTS WITHOUT THE EXPRESSED WRITTEN CONSENT OF TESLA MOTORS.

DRAWN	CHECKED	APPROVED
MATERIAL AS SPECIFIED	FINISHING AS SPECIFIED	SCALE NONE
PART NAME Power Distribution, E-Fuse VCFront, J5-J12		
PART NUMBER	REV	SHEET
	1	26 OF 40
		SIZE A0



THE INFORMATION CONTAINED HEREIN IS DEEMED TO BE CONFIDENTIAL, PROPRIETARY, AND A TRADE SECRET OF TESLA MOTORS. THIS INFORMATION MAY NOT BE USED, REPRODUCED, OR DISCLOSED AS THE DIRECT OR INDIRECT BASIS FOR THE DEVELOPMENT, MANUFACTURE, OR SALE OF PROCESSES OR PRODUCTS WITHOUT THE EXPRESSED WRITTEN CONSENT OF TESLA MOTORS.

DRAWN	CHECKED	APPROVED
MATERIAL AS SPECIFIED	FINISHING AS SPECIFIED	SCALE NONE

PART NAME
Power Distribution, E-Fuse VLeft, J1-J3

PART NUMBER	REV	SHEET	SIZE
	1	27 OF 40	A0

PMIRR
Mirror Left Premium
D



Exterior Open Switch Front Left
D

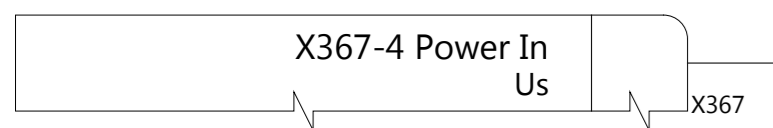

PMIRR
Mirror Left Premium
D

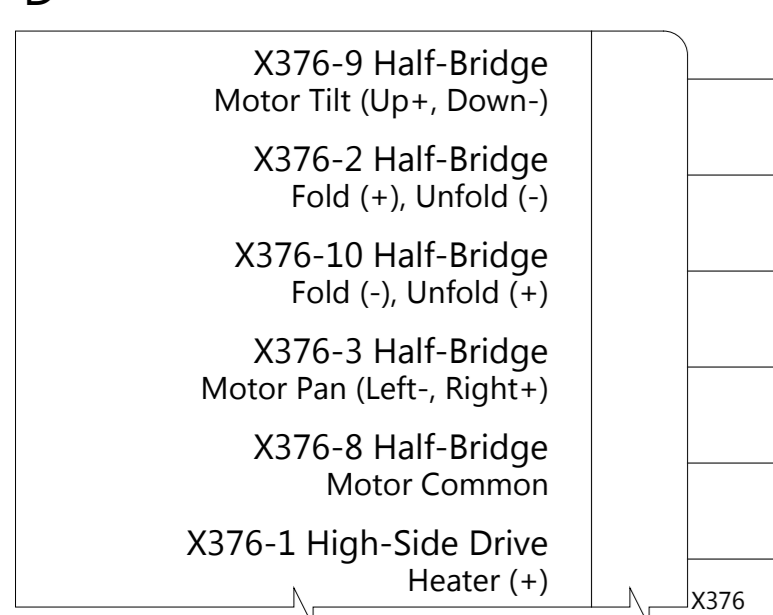

Latch Front Left
D

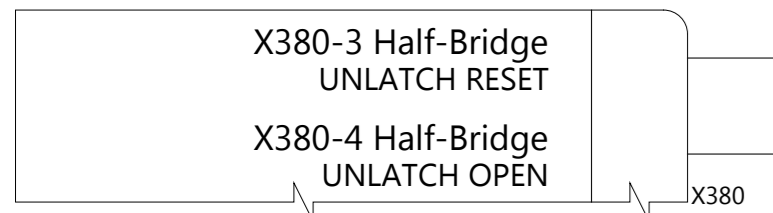

Window Lift Motor Front Left
D

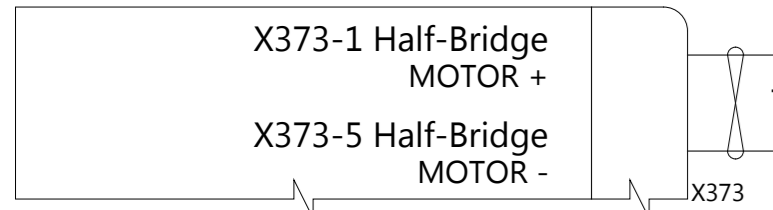

Trailer Light Controller
B

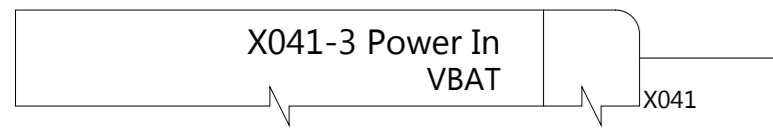

Steering Angle and Stalk ECU
J

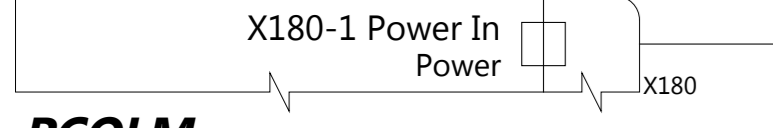

PCOLM
Steering Column Adjust
J



Body Controller Left
A,D,J,W,K

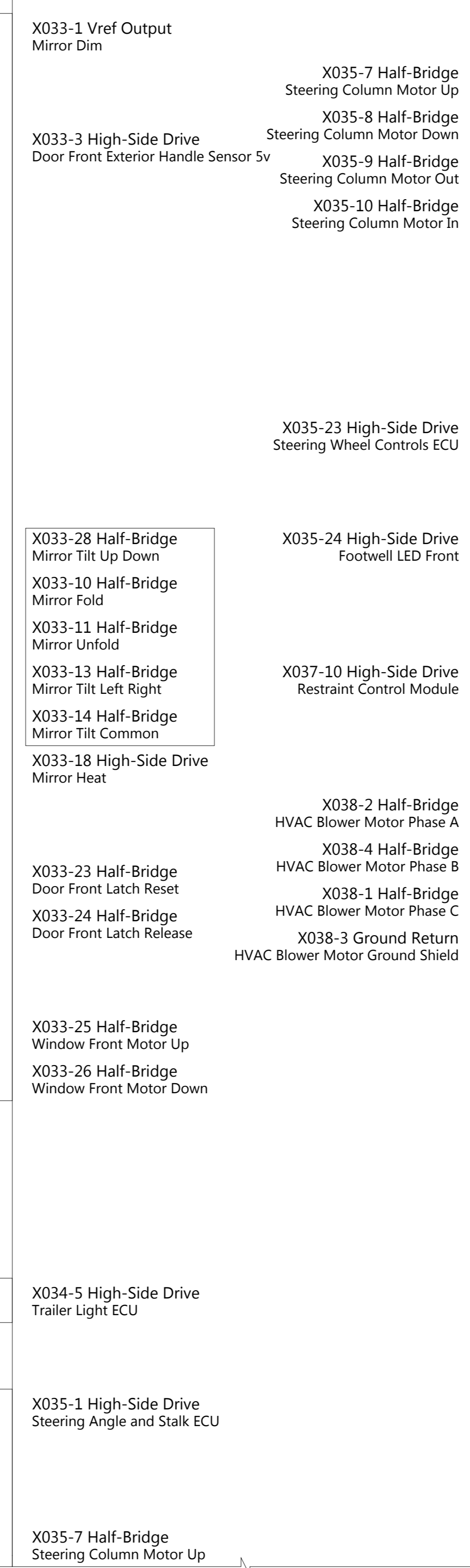

PCOLM
Steering Column Adjust
J

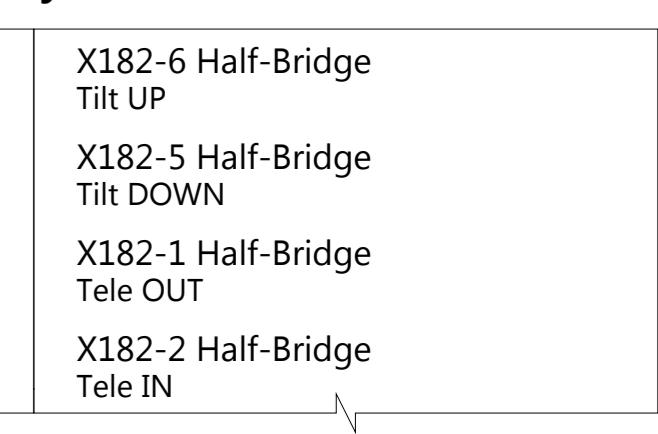

Steering Angle and Stalk ECU
J

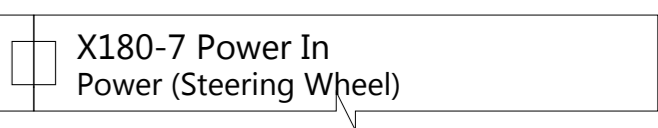

Footwell LED Front Left
J

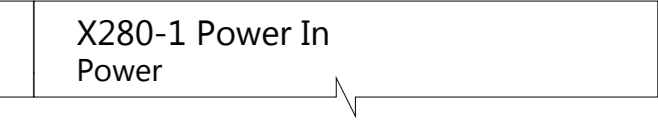

Restraints Controller
A,J

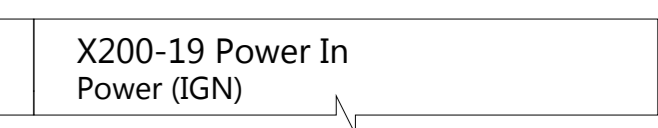

Blower Motor
J

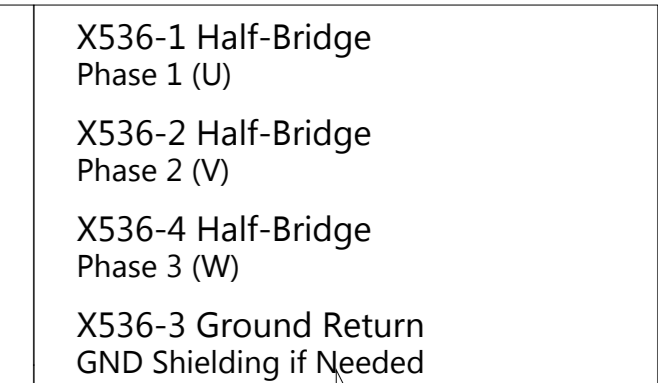

Body Controller Right
B,P,J,W

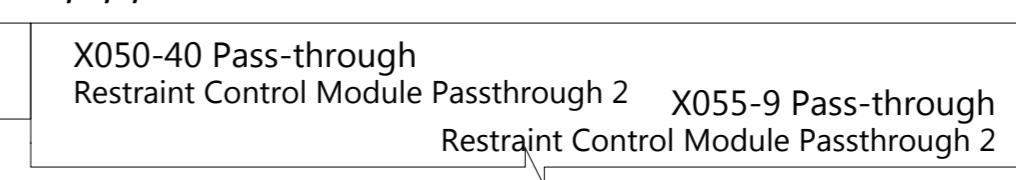

THE INFORMATION CONTAINED HEREIN IS DEEMED TO BE CONFIDENTIAL, PROPRIETARY, AND A TRADE SECRET OF TESLA MOTORS. THIS INFORMATION MAY NOT BE USED, REPRODUCED, OR DISCLOSED AS THE DIRECT OR INDIRECT BASIS FOR THE DEVELOPMENT, MANUFACTURE, OR SALE OF PROCESSES OR PRODUCTS WITHOUT THE EXPRESSED WRITTEN CONSENT OF TESLA MOTORS.

DRAWN	CHECKED	APPROVED
-------	---------	----------

MATERIAL AS SPECIFIED	FINISHING AS SPECIFIED	SCALE NONE
--------------------------	---------------------------	---------------

PART NAME
Power Distribution, E-Fuse VLeft, J4-J9

PART NUMBER	REV	SHEET	SIZE
	1	28 OF 40	A0

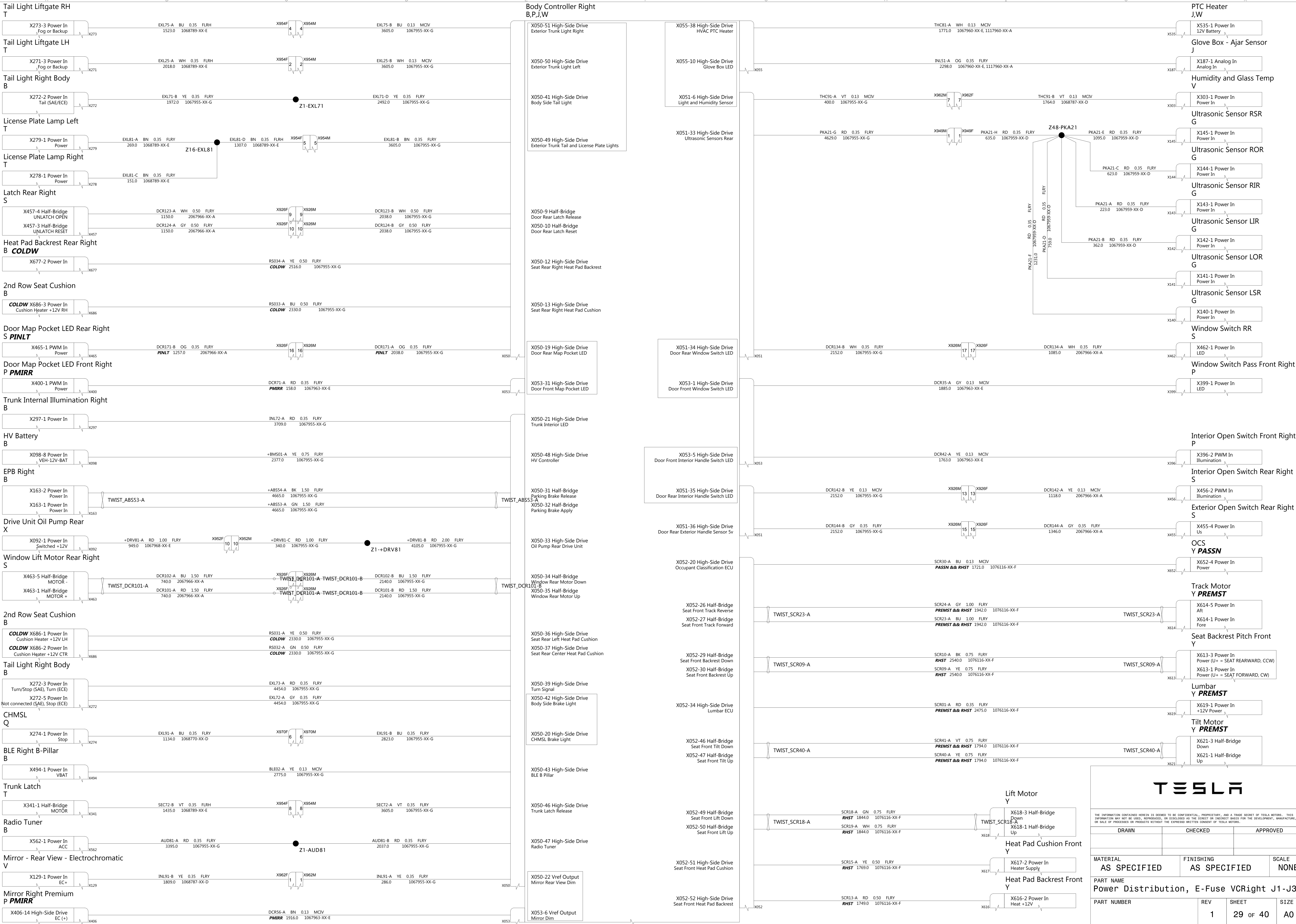

TESLA			
THE INFORMATION CONTAINED HEREIN IS DEEMED TO BE CONFIDENTIAL, PROPRIETARY, AND A TRADE SECRET OF TESLA MOTORS. THIS INFORMATION MAY NOT BE USED, REPRODUCED, OR DISCLOSED AS THE DIRECT OR INDIRECT BASIS FOR THE DEVELOPMENT, MANUFACTURE, OR SALE OF PROCESSES OR PRODUCTS WITHOUT THE EXPRESS WRITTEN CONSENT OF TESLA MOTORS.			
DRAWN	CHECKED	APPROVED	
MATERIAL AS SPECIFIED	FINISHING AS SPECIFIED	SCALE NONE	
PART NAME Power Distribution, E-Fuse VCRight J1-J3			
PART NUMBER	REV	SHEET	SIZE
	1	29 OF 40	A0

Exterior Open Switch Front Right
P



PMIRR
Mirror Right Premium
P

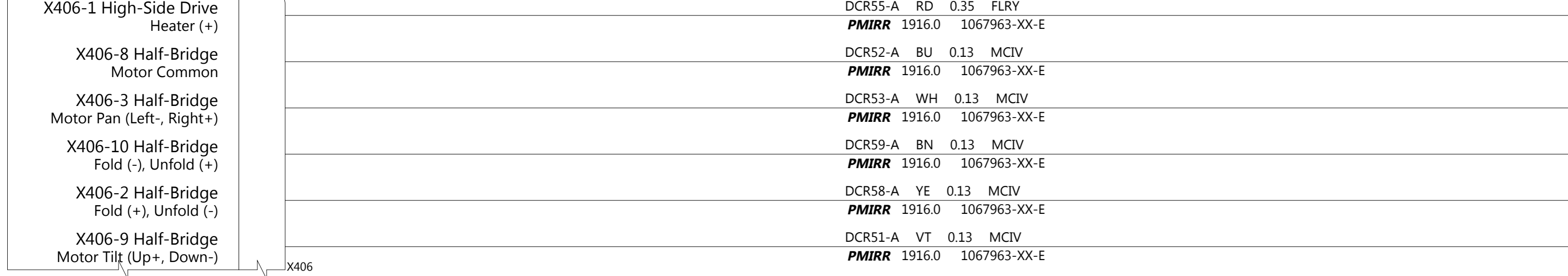

Window Lift Motor Front Right
P

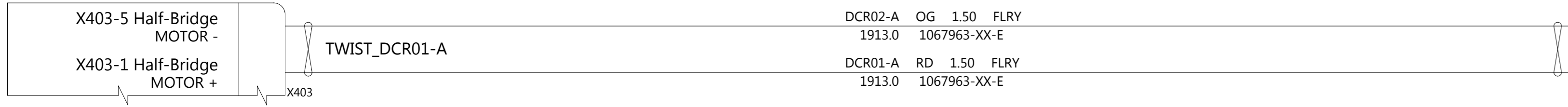

Latch Front Right
P

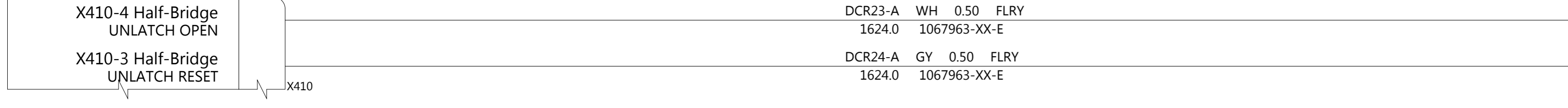

PMIRR
Mirror Right Premium
P



Puddle LED Front Right
P



Puddle LED Rear Right
S



Body Controller Right
B,P,J,W

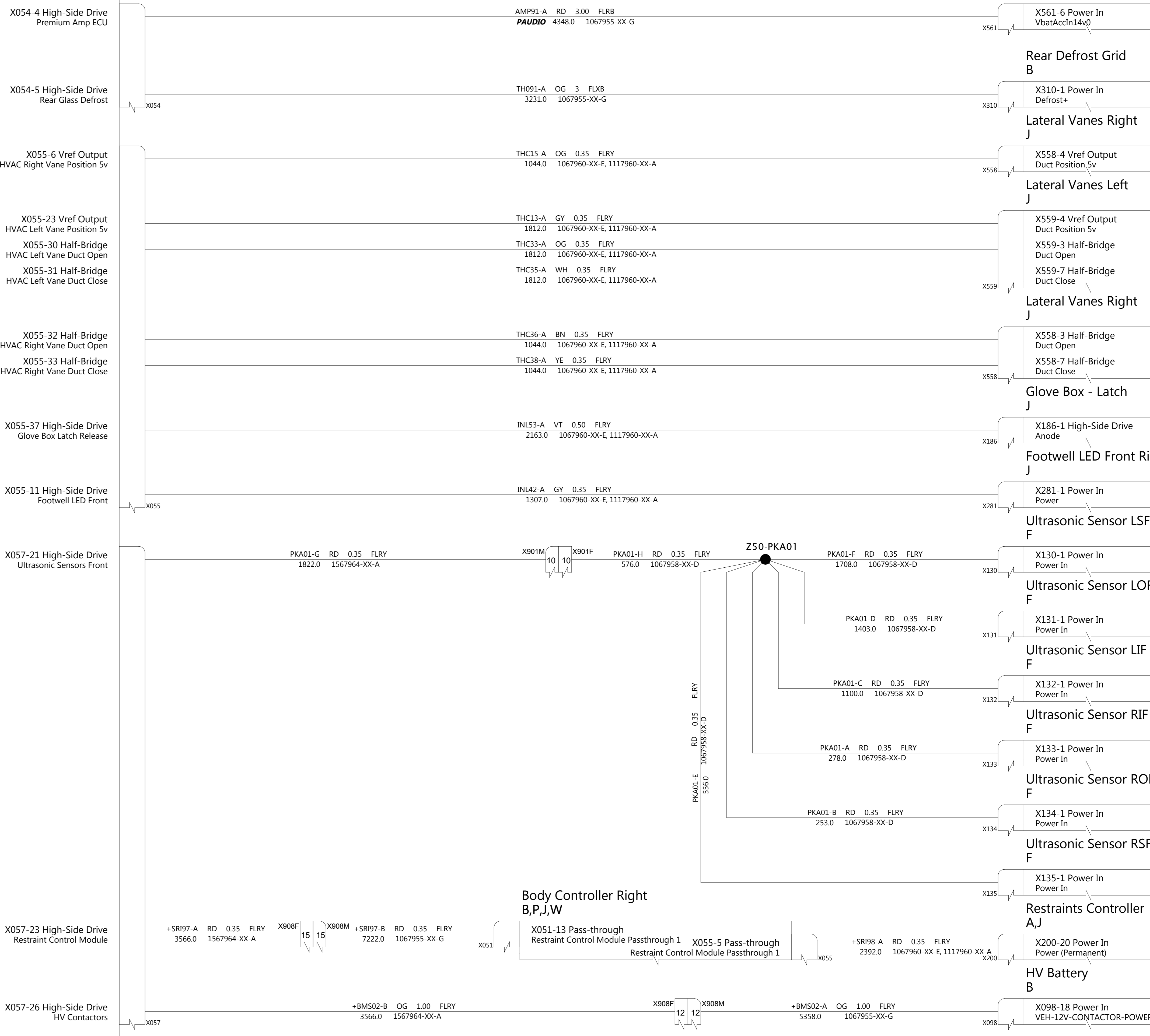
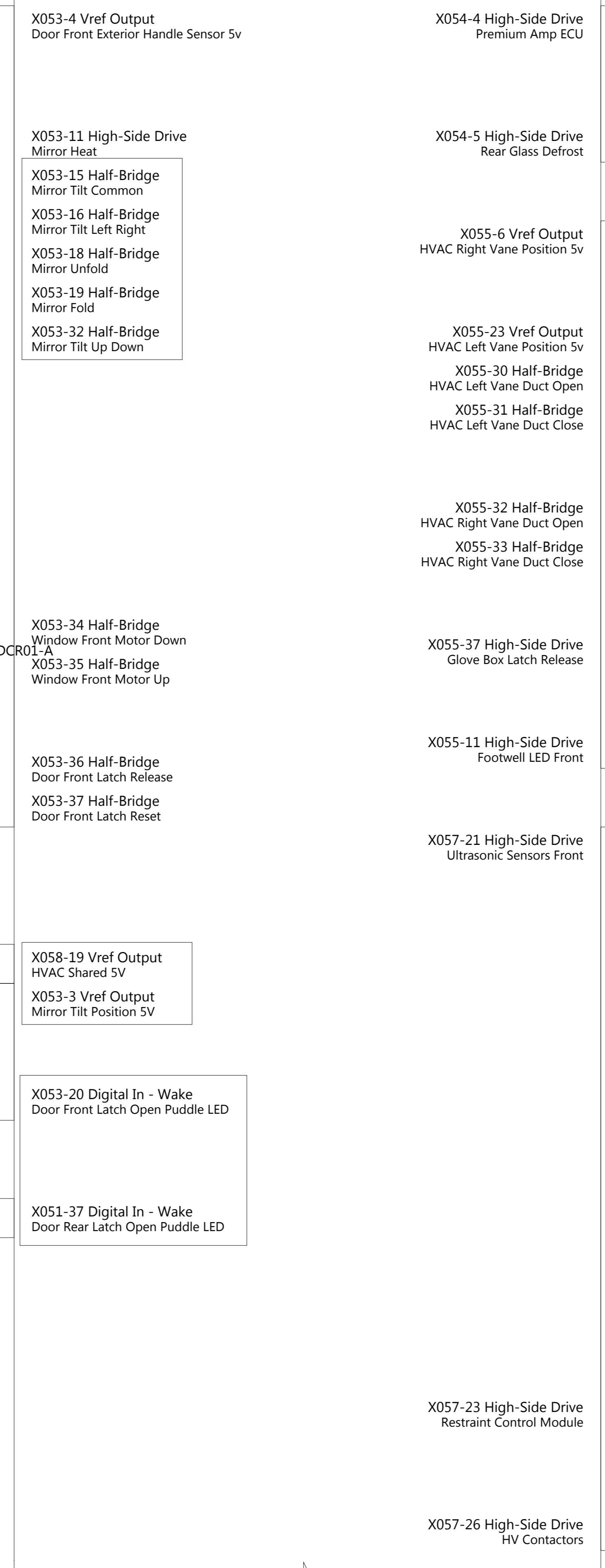

THE INFORMATION CONTAINED HEREIN IS DEEMED TO BE CONFIDENTIAL, PROPRIETARY, AND A TRADE SECRET OF TESLA MOTORS. THIS INFORMATION MAY NOT BE USED, REPRODUCED, OR DISCLOSED AS THE DIRECT OR INDIRECT BASIS FOR THE DEVELOPMENT, MANUFACTURE, OR SALE OF PROCESSES OR PRODUCTS WITHOUT THE EXPRESSED WRITTEN CONSENT OF TESLA MOTORS.

DRAWN	CHECKED	APPROVED
-------	---------	----------

MATERIAL AS SPECIFIED	FINISHING AS SPECIFIED	SCALE NONE
--------------------------	---------------------------	---------------

PART NAME
Power Distribution, E-Fuse VCRight J4-J9

PART NUMBER	REV	SHEET	SIZE
	1	30 OF 40	A0

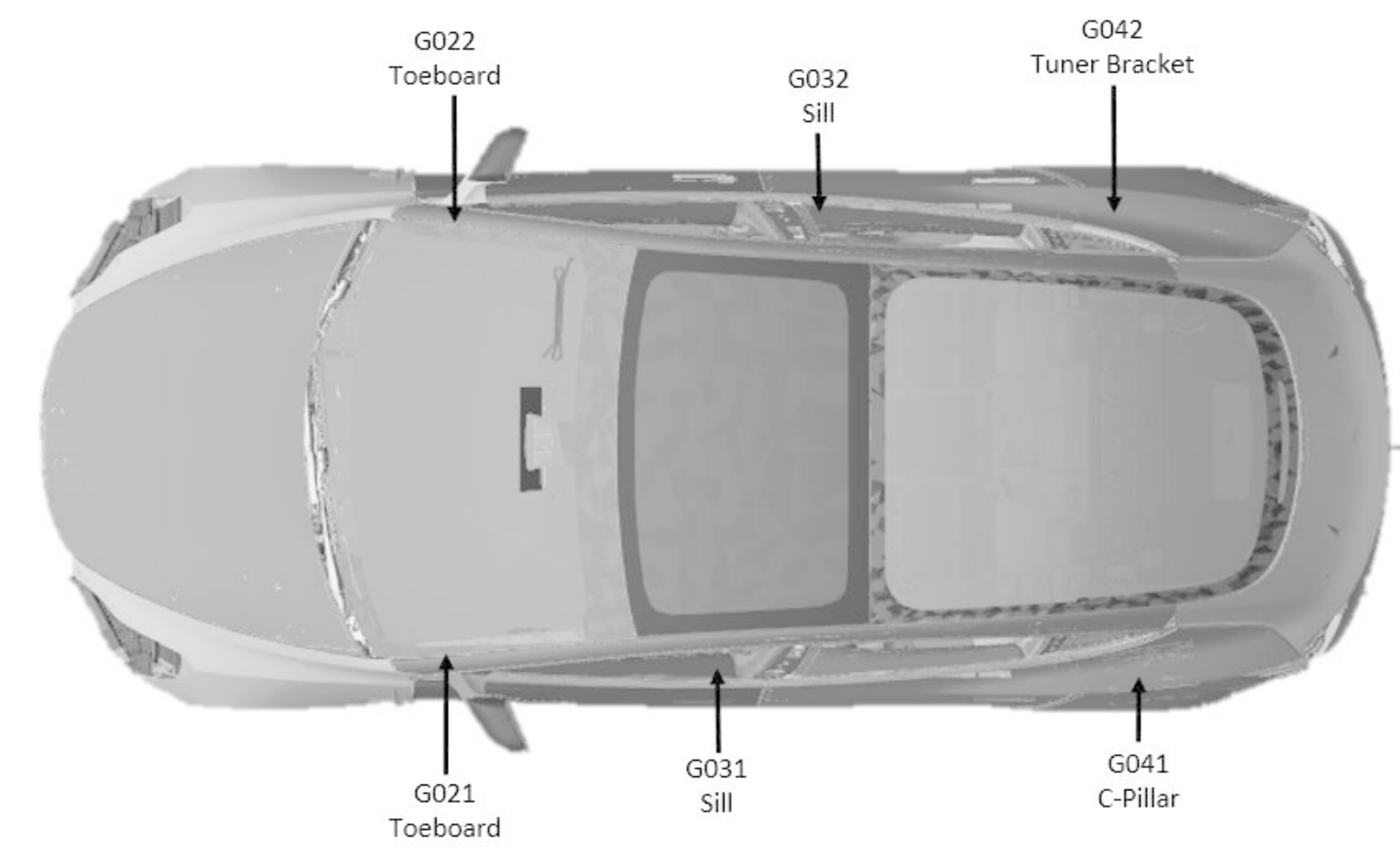
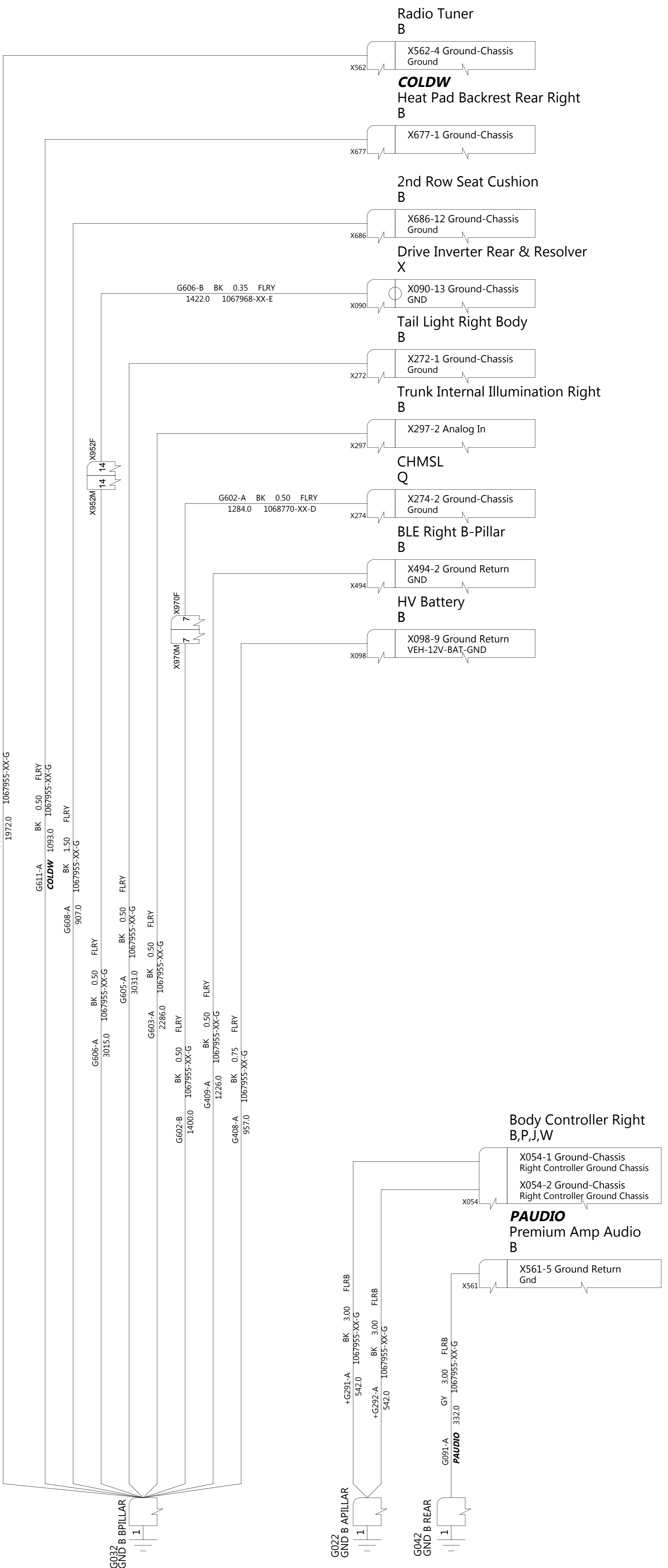
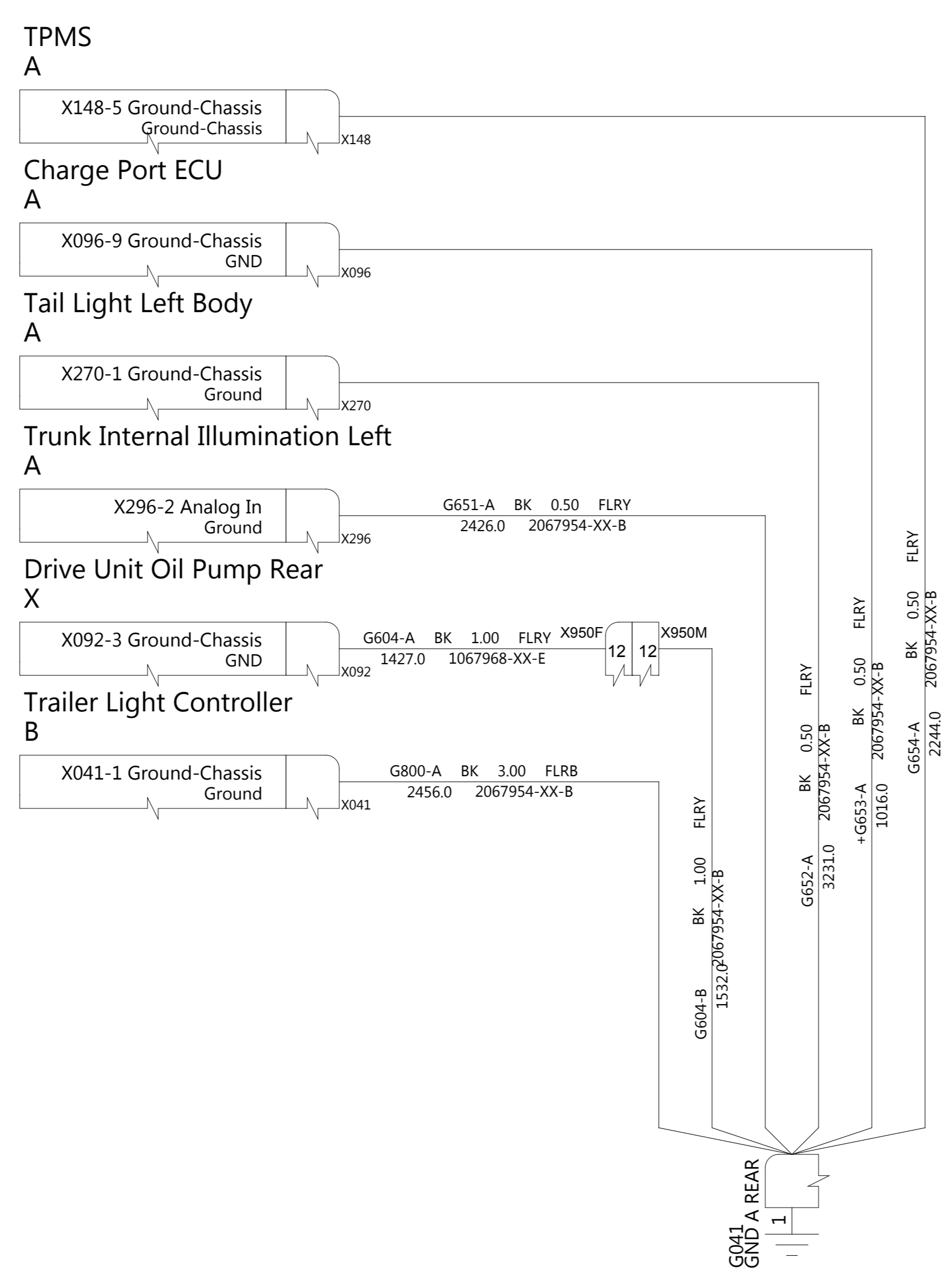
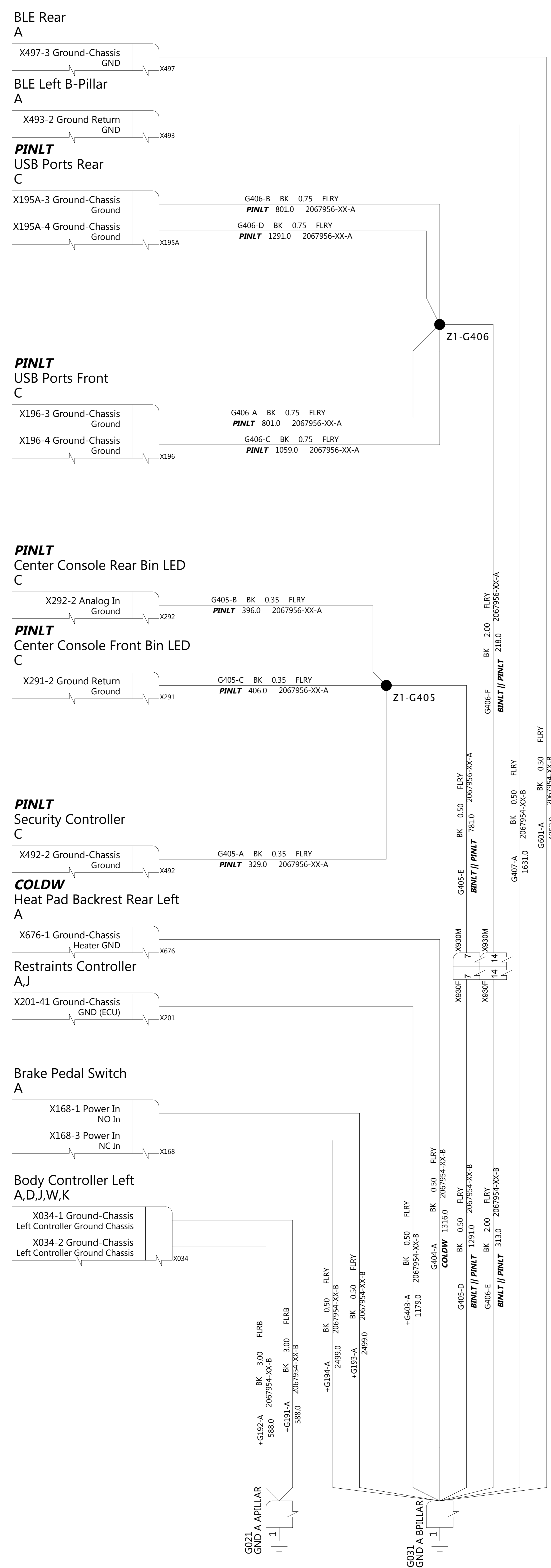

TESLA

THE INFORMATION CONTAINED HEREIN IS DEEMED TO BE CONFIDENTIAL, PROPRIETARY, AND A TRADE SECRET OF TESLA MOTORS. THIS INFORMATION MAY NOT BE USED, REPRODUCED, OR DISCLOSED AS THE DIRECT OR INDIRECT BASIS FOR THE DEVELOPMENT, MANUFACTURE, OR SALE OF PROCESSES OR PRODUCTS WITHOUT THE EXPRESS WRITTEN CONSENT OF TESLA MOTORS.

DRAWN	CHECKED	APPROVED
MATERIAL AS SPECIFIED	FINISHING AS SPECIFIED	SCALE NONE
PART NAME Power Distribution, Grounding A, B, C Pillars		
PART NUMBER	REV	SHEET
	1	31 OF 40
		SIZE A0

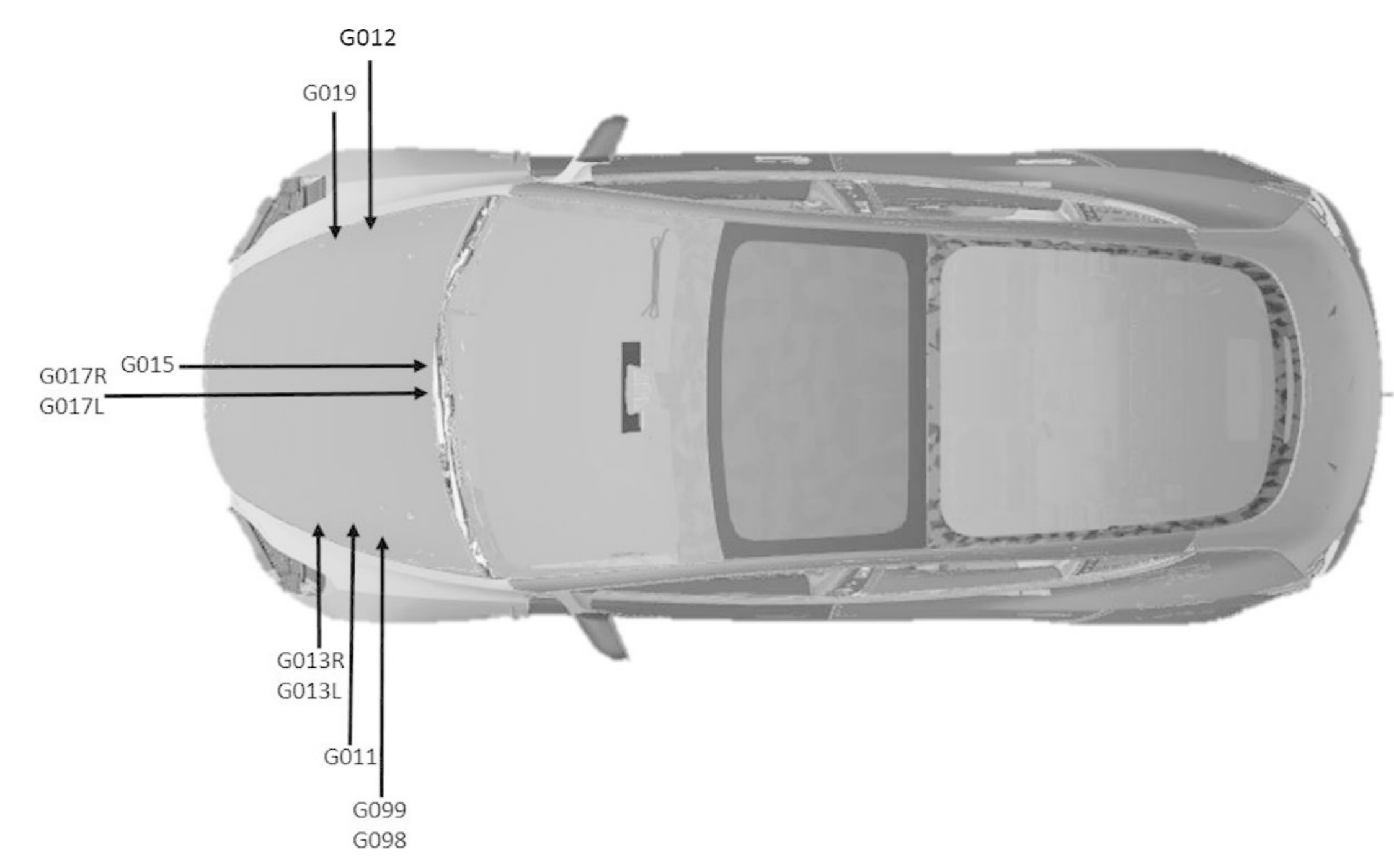
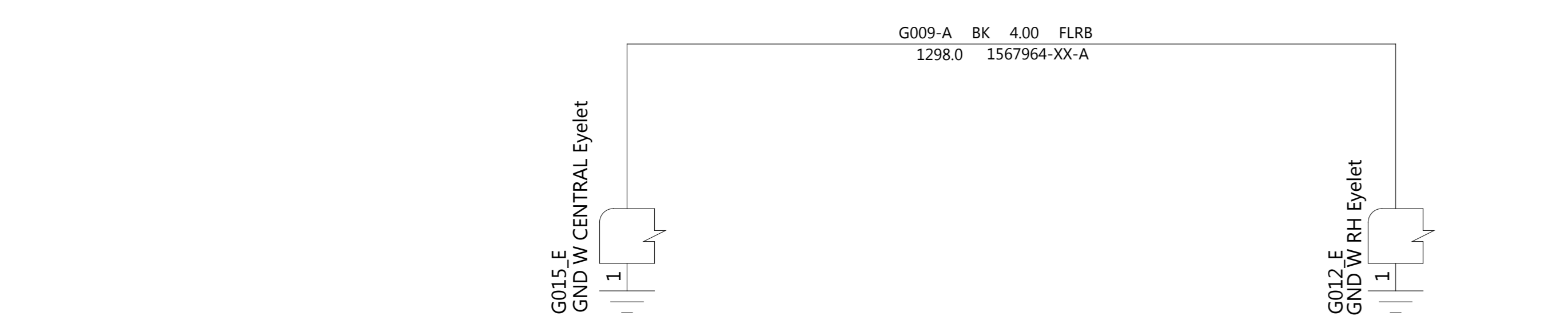
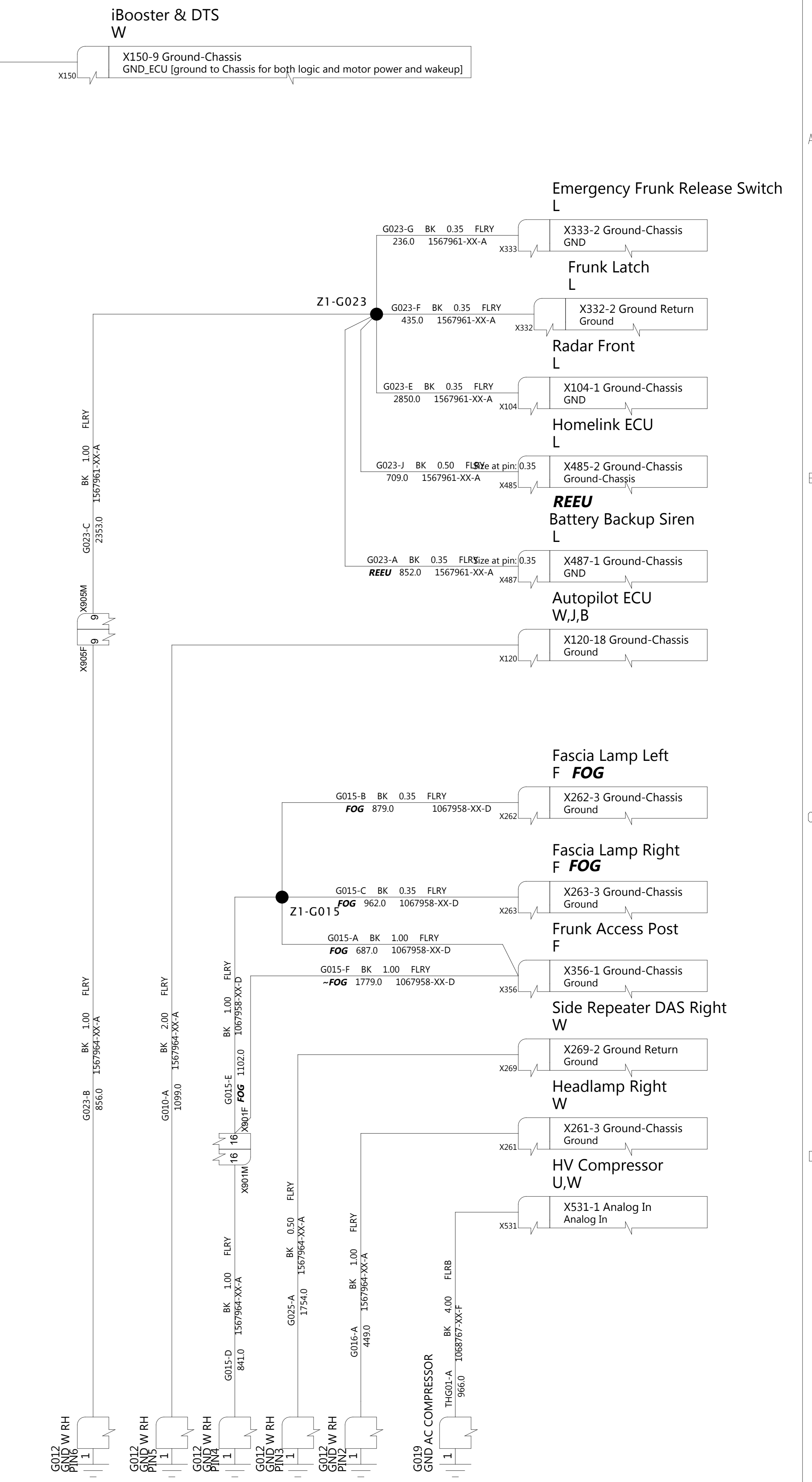
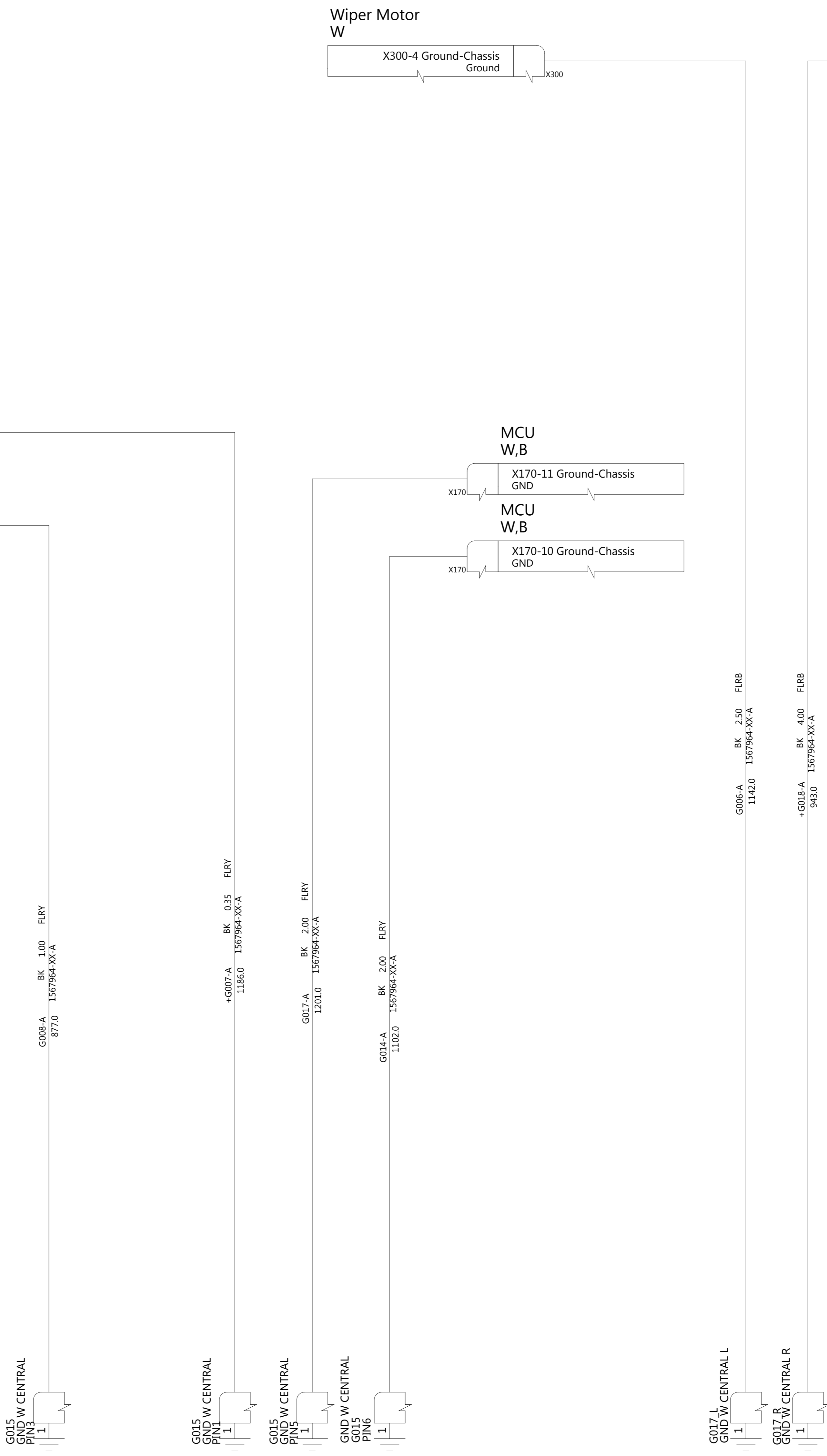
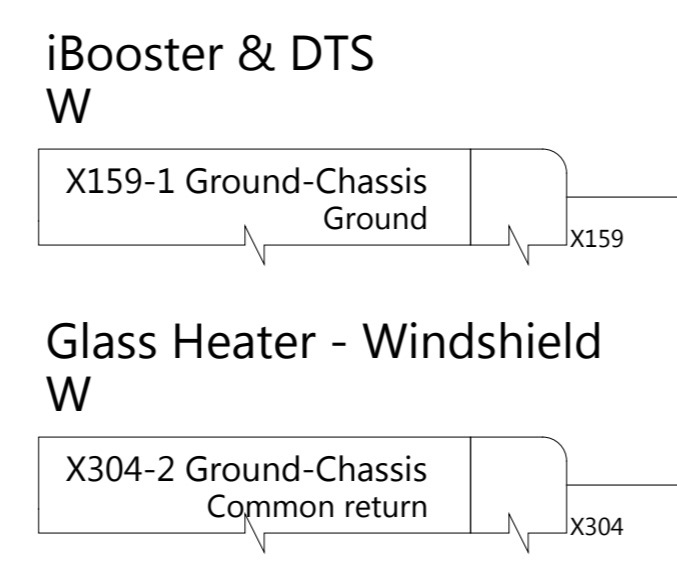
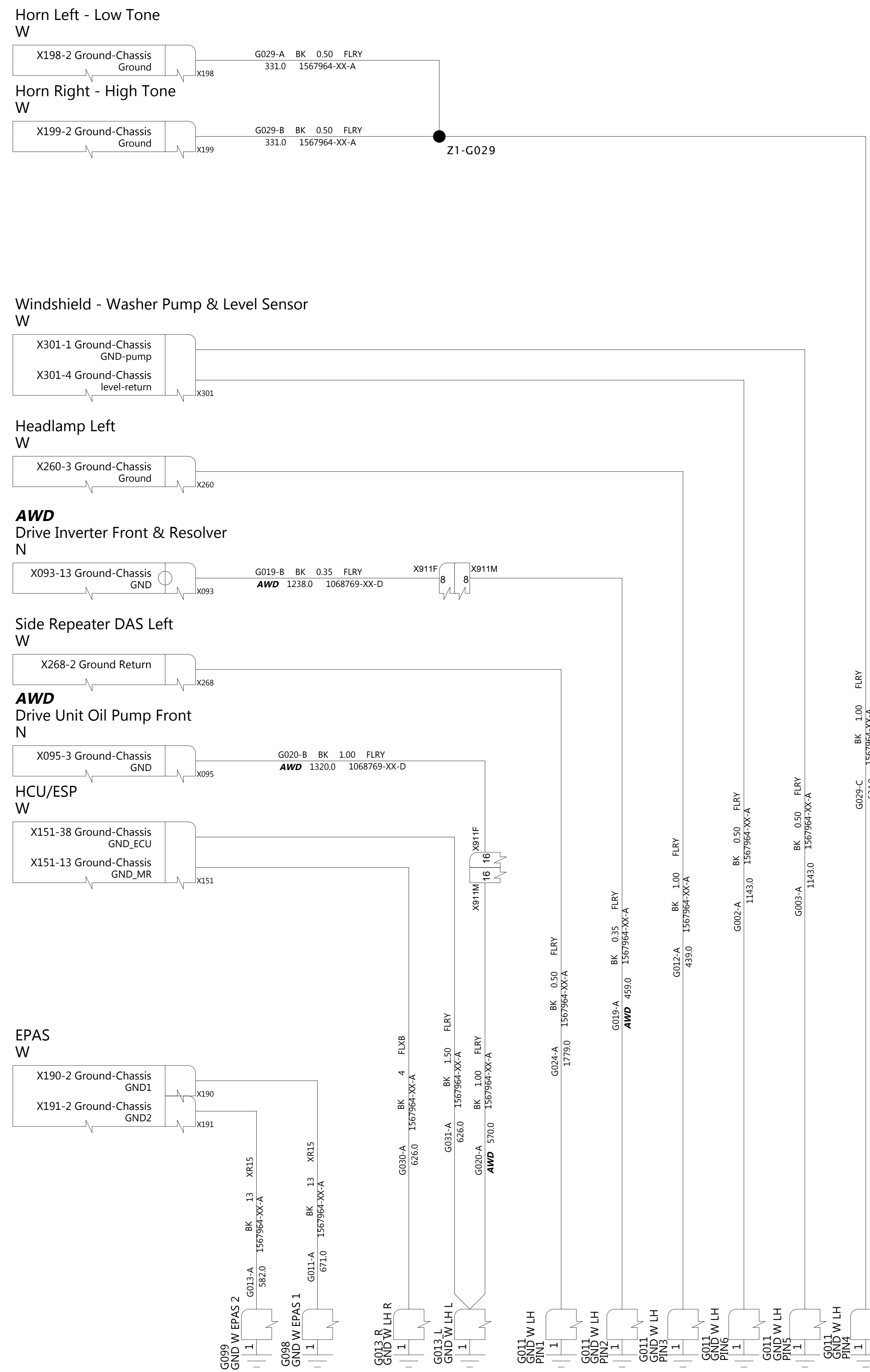

TESLA			
THE INFORMATION CONTAINED HEREIN IS DEEMED TO BE CONFIDENTIAL, PROPRIETARY, AND A TRADE SECRET OF TESLA MOTORS. THIS INFORMATION MAY NOT BE USED, REPRODUCED, OR DISCLOSED AS THE DIRECT OR INDIRECT BASIS FOR THE DEVELOPMENT, MANUFACTURE, OR SALE OF PROCESSES OR PRODUCTS WITHOUT THE EXPRESSED WRITTEN CONSENT OF TESLA MOTORS.			
DRAWN	CHECKED	APPROVED	
MATERIAL AS SPECIFIED		FINISHING AS SPECIFIED	
PART NAME Power Distribution, Grounding Frunk		SCALE NONE	
PART NUMBER	REV	SHEET	SIZE
	1	32 OF 40	A0

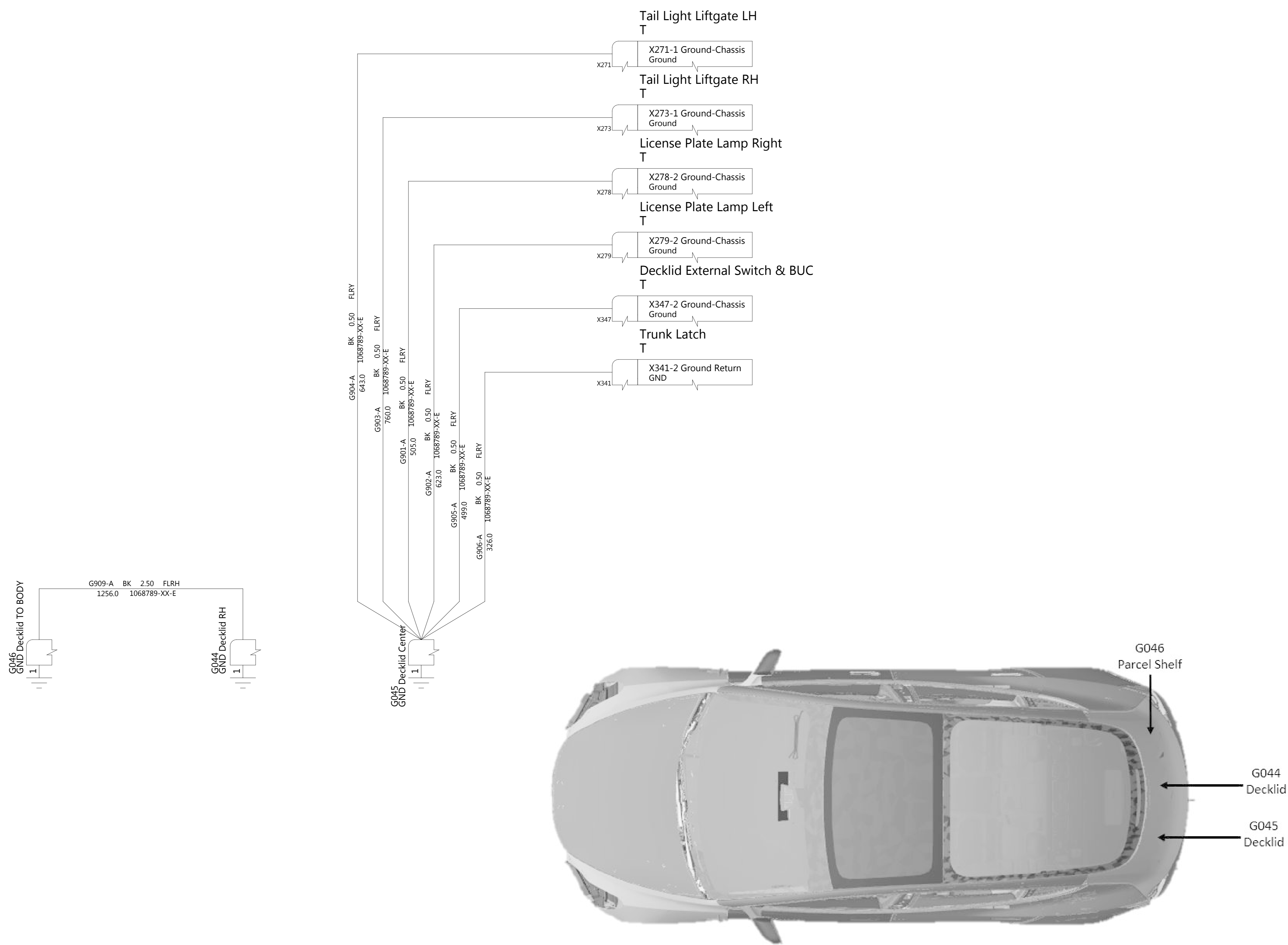

TESLA

THE INFORMATION CONTAINED HEREIN IS DEEMED TO BE CONFIDENTIAL, PROPRIETARY, AND A TRADE SECRET OF TESLA MOTORS. THIS INFORMATION MAY NOT BE USED, REPRODUCED, OR DISCLOSED AS THE DIRECT OR INDIRECT BASIS FOR THE DEVELOPMENT, MANUFACTURE, OR SALE OF PRODUCTS OR SERVICES WITHOUT THE EXPRESSED WRITTEN CONSENT OF TESLA MOTORS.

DRAWN	CHECKED	APPROVED

MATERIAL AS SPECIFIED	FINISHING AS SPECIFIED	SCALE NONE
--------------------------	---------------------------	---------------

PART NAME
Power Distribution, Grounding Trunk

PART NUMBER	REV	SHEET	SIZE
	1	33 OF 40	A0

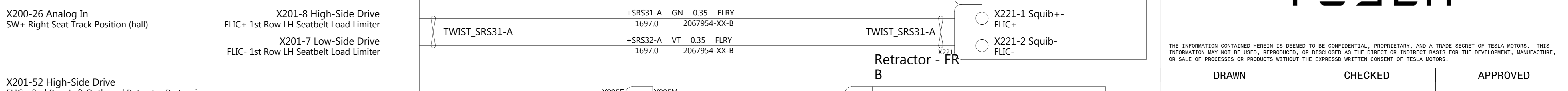
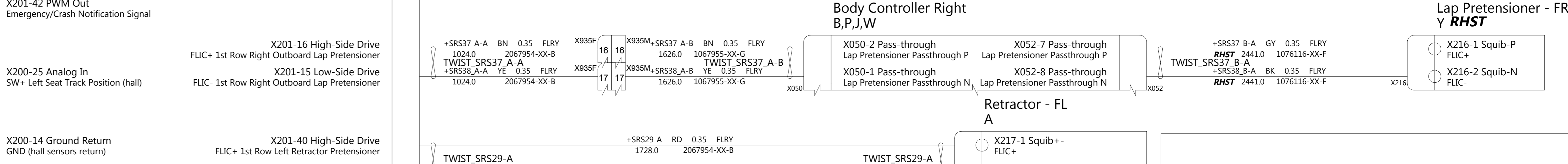
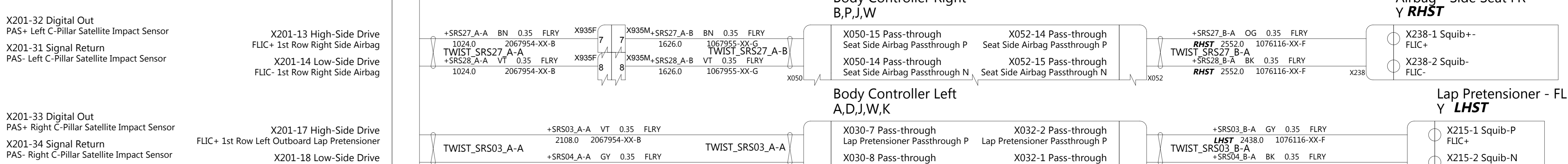
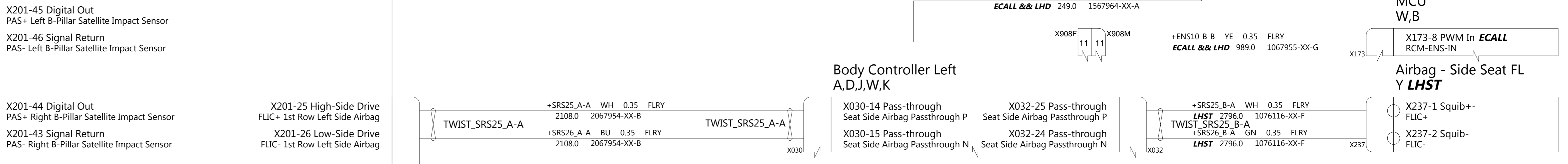
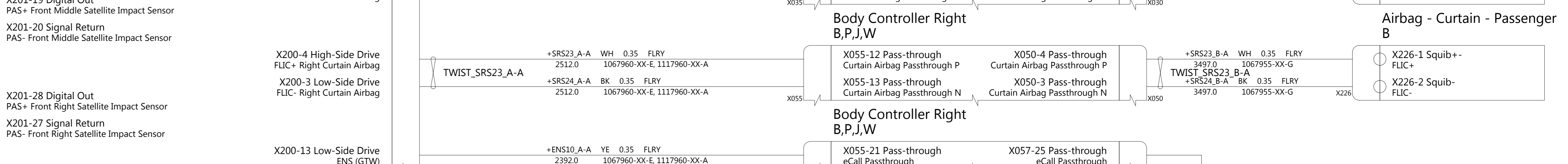
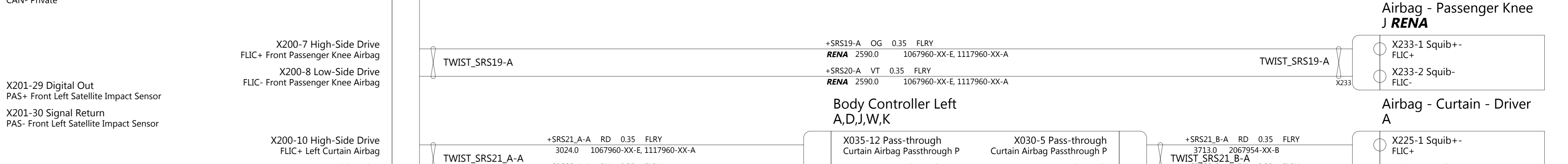
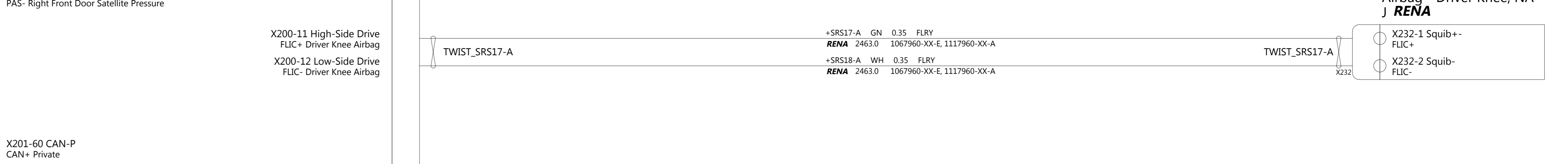
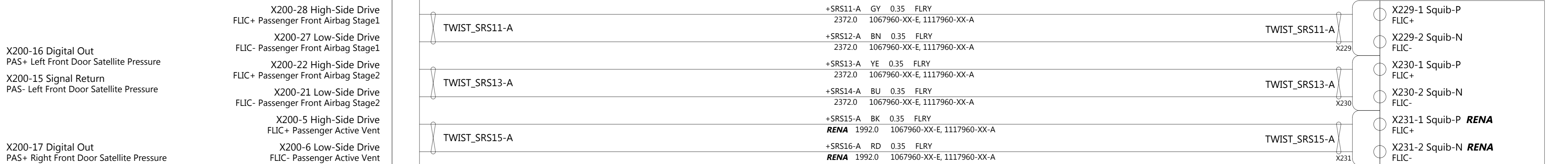
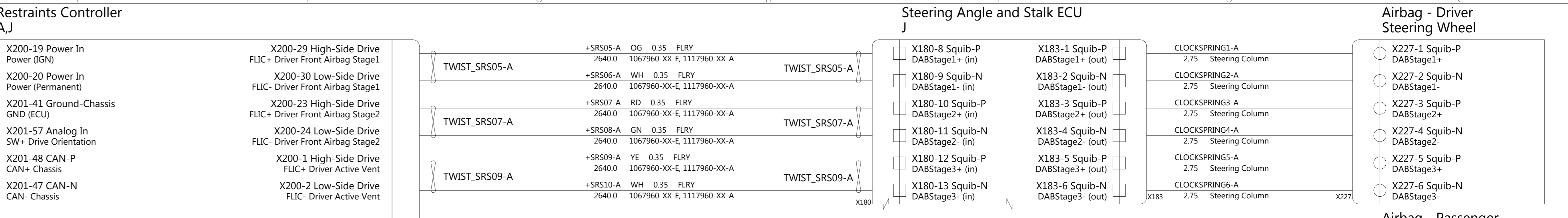
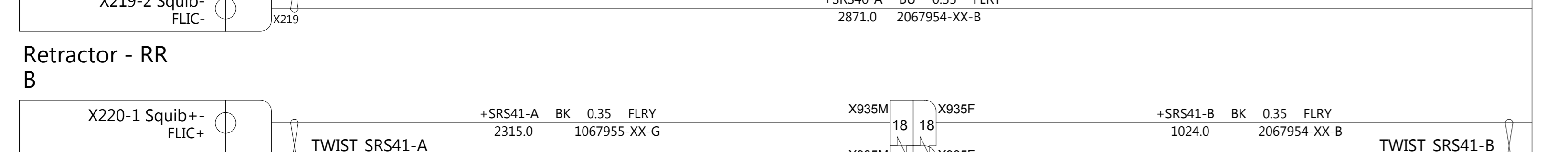
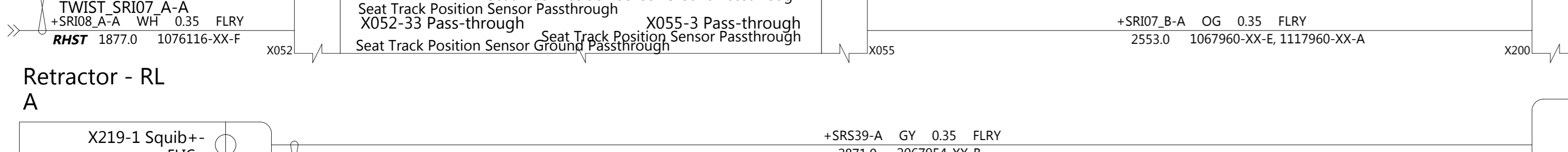
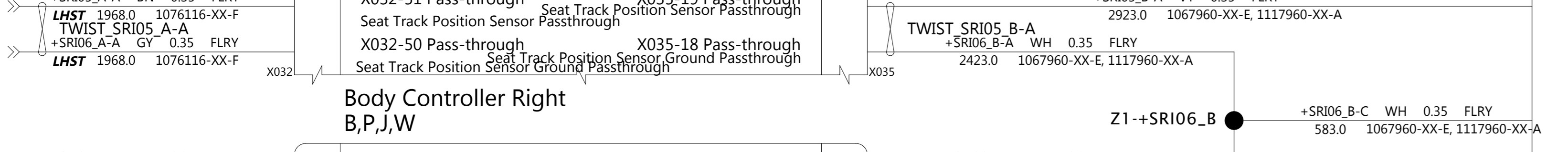
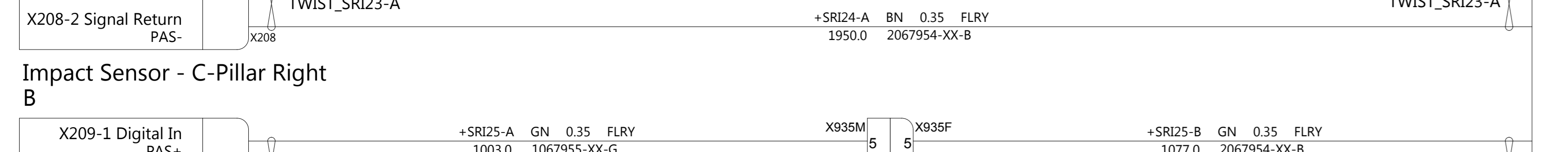
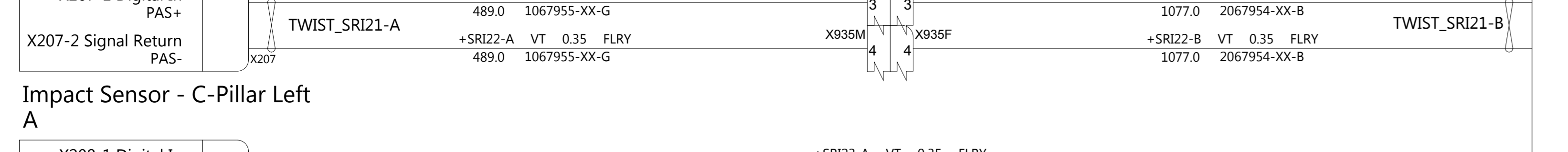
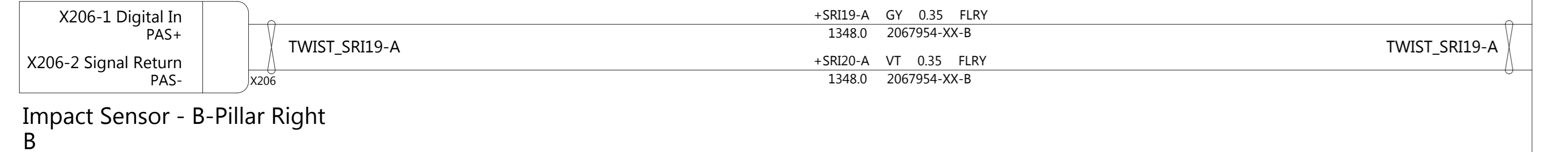
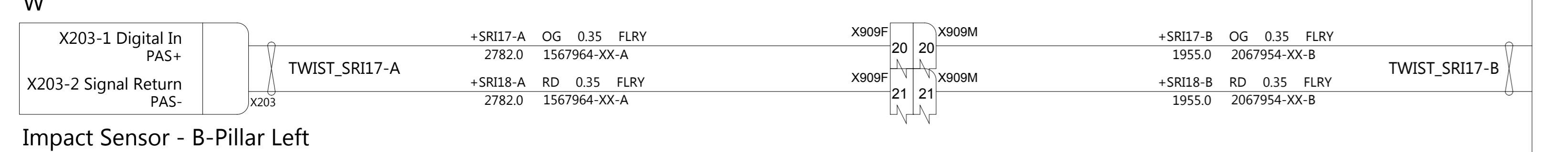
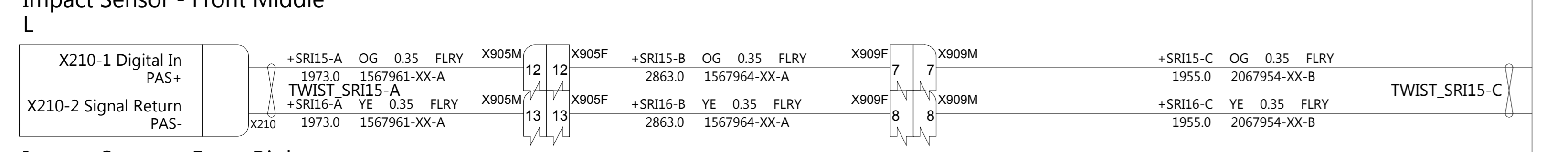
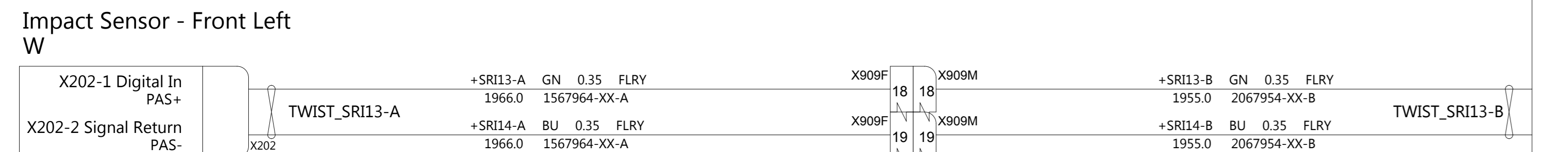
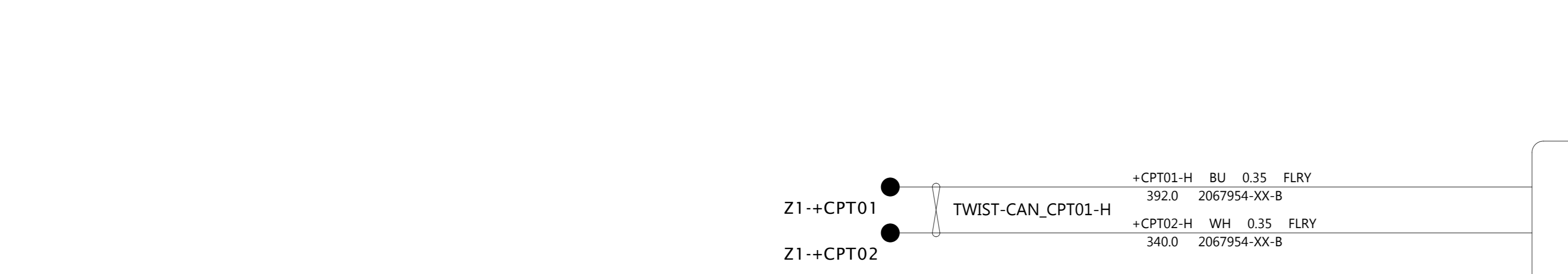
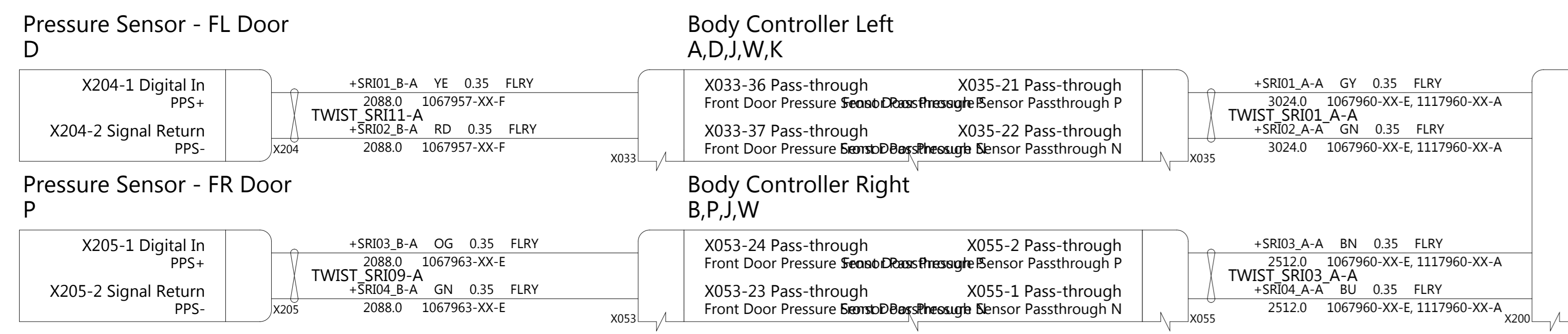
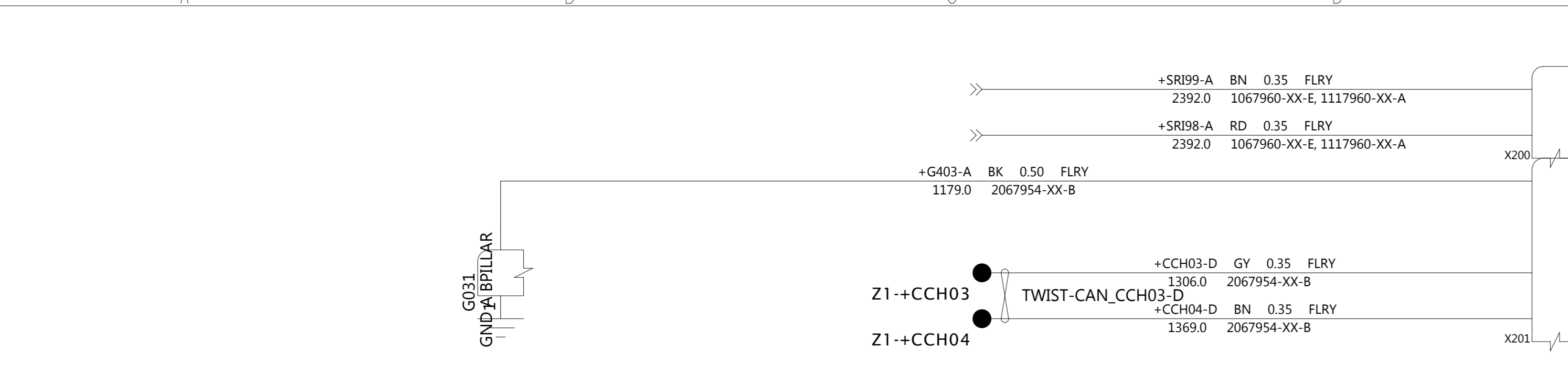

TESLA

THE INFORMATION CONTAINED HEREIN IS DEEMED TO BE CONFIDENTIAL, PROPRIETARY, AND A TRADE SECRET OF TESLA MOTORS. THIS INFORMATION MAY NOT BE USED, REPRODUCED, OR DISCLOSED AS THE DIRECT OR INDIRECT BASIS FOR THE DEVELOPMENT, MANUFACTURE, OR SALE OF PRODUCTS OR PROCESSES WITHOUT THE EXPRESSED WRITTEN CONSENT OF TESLA MOTORS.

DRAWN	CHECKED	APPROVED
MATERIAL AS SPECIFIED	FINISHING AS SPECIFIED	SCALE NONE
PART NAME	Restraints Airbags	
PART NUMBER	REV	SHEET
	1	34 of 40
SIZE	A0	

LHD
MCU
W,B

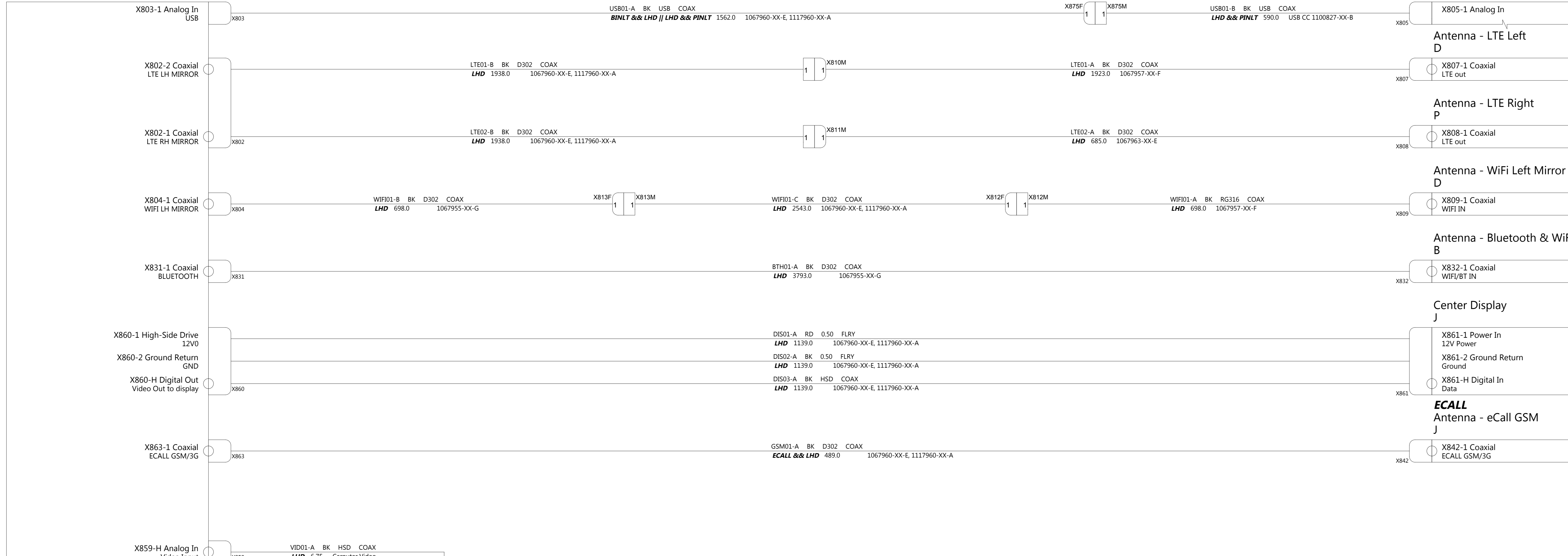

Autopilot ECU
W,J,B LHD

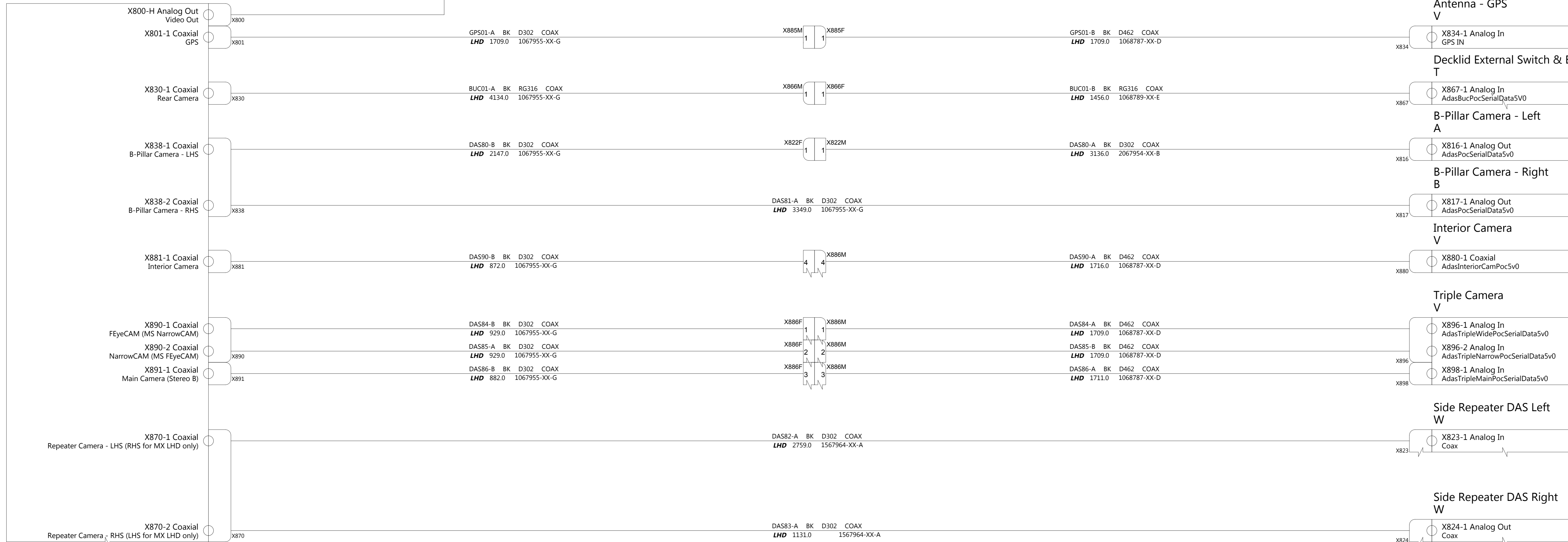

Radio Tuner
B

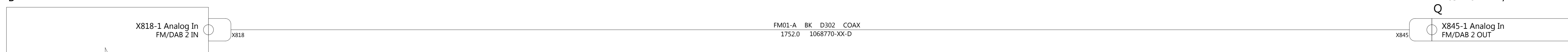

- USB Ports Front C
- Antenna - LTE Left D
- Antenna - LTE Right P
- Antenna - WiFi Left Mirror D
- Antenna - Bluetooth & WiFi B
- Center Display J
- Antenna - eCall GSM J
- Antenna - GPS V
- Decklid External Switch & BUC T
- B-Pillar Camera - Left A
- B-Pillar Camera - Right B
- Interior Camera V
- Triple Camera V
- Side Repeater DAS Left W
- Side Repeater DAS Right W
- Antenna - FM/DAB Q



THE INFORMATION CONTAINED HEREIN IS DEEMED TO BE CONFIDENTIAL, PROPRIETARY, AND A TRADE SECRET OF TESLA MOTORS. THIS INFORMATION MAY NOT BE USED, REPRODUCED, OR DISCLOSED AS THE DIRECT OR INDIRECT BASIS FOR THE DEVELOPMENT, MANUFACTURE, OR SALE OF PROCESSES OR PRODUCTS WITHOUT THE EXPRESSED WRITTEN CONSENT OF TESLA MOTORS.

DRAWN	CHECKED	APPROVED
-------	---------	----------

MATERIAL AS SPECIFIED	FINISHING AS SPECIFIED	SCALE NONE
--------------------------	---------------------------	---------------

PART NAME
RF/Special Cables

PART NUMBER	REV	SHEET	SIZE
	1	35 OF 40	A0

Body Controller Left
A,D,J,W,K

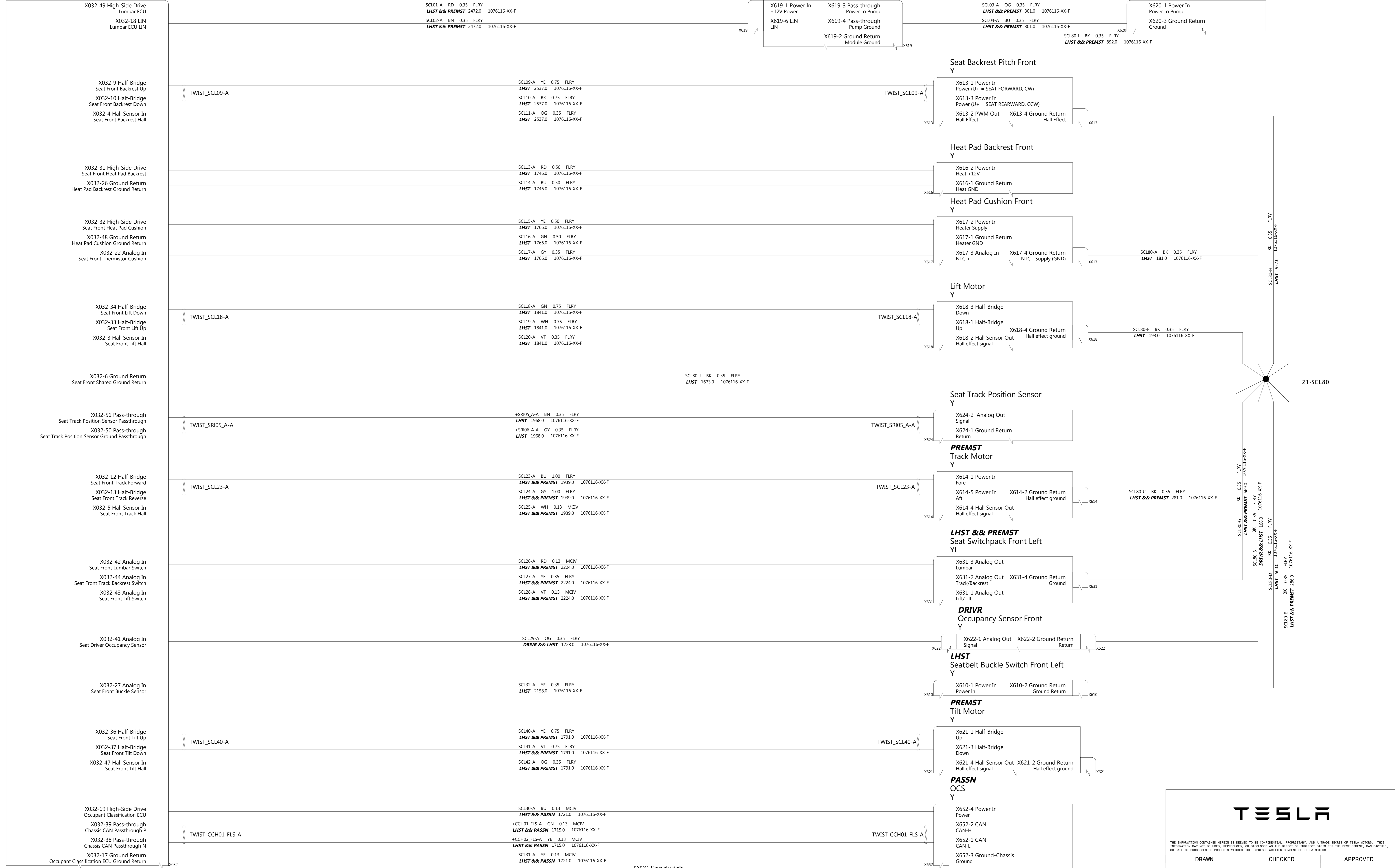

DRAWN				CHECKED		APPROVED	
MATERIAL AS SPECIFIED		FINISHING AS SPECIFIED		SCALE NONE			
PART NAME Seats Front Left							
PART NUMBER		REV 1	SHEET 36 OF 40	SIZE A0			

Body Controller Right
B,P,J,W



THE INFORMATION CONTAINED HEREIN IS DEEMED TO BE CONFIDENTIAL, PROPRIETARY, AND A TRADE SECRET OF TESLA MOTORS. THIS INFORMATION MAY NOT BE USED, REPRODUCED, OR DISCLOSED AS THE DIRECT OR INDIRECT BASIS FOR THE DEVELOPMENT, MANUFACTURE, OR SALE OF PROCESSES OR PRODUCTS WITHOUT THE EXPRESSED WRITTEN CONSENT OF TESLA MOTORS.

DRAWN	CHECKED	APPROVED
-------	---------	----------

MATERIAL AS SPECIFIED	FINISHING AS SPECIFIED	SCALE NONE
--------------------------	---------------------------	---------------

PART NAME
Seats Front Right

PART NUMBER	REV	SHEET	SIZE
	1	37 OF 40	A0

PINLT
Security Controller
C

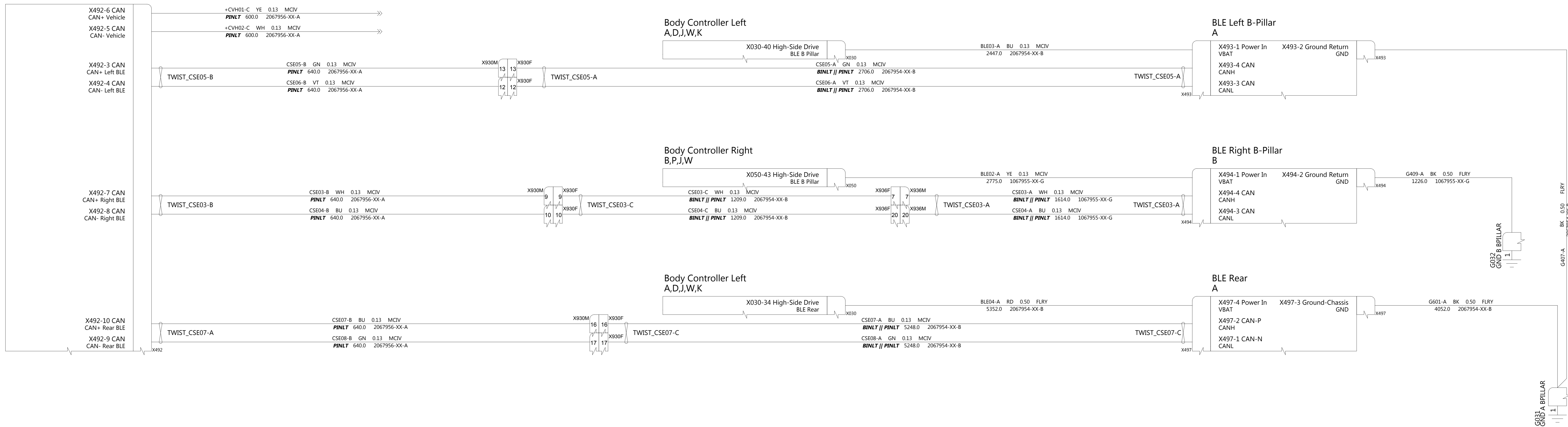

THE INFORMATION CONTAINED HEREIN IS DEEMED TO BE CONFIDENTIAL, PROPRIETARY, AND A TRADE SECRET OF TESLA MOTORS. THIS INFORMATION MAY NOT BE USED, REPRODUCED, OR DISCLOSED AS THE DIRECT OR INDIRECT BASIS FOR THE DEVELOPMENT, MANUFACTURE, OR SALE OF PROCESSES OR PRODUCTS WITHOUT THE EXPRESSED WRITTEN CONSENT OF TESLA MOTORS.

DRAWN	CHECKED	APPROVED
MATERIAL AS SPECIFIED	FINISHING AS SPECIFIED	SCALE NONE
PART NAME Security Controls		
PART NUMBER	REV 1	SHEET 38 OF 40
		SIZE A0

Body Controller Front
W,U

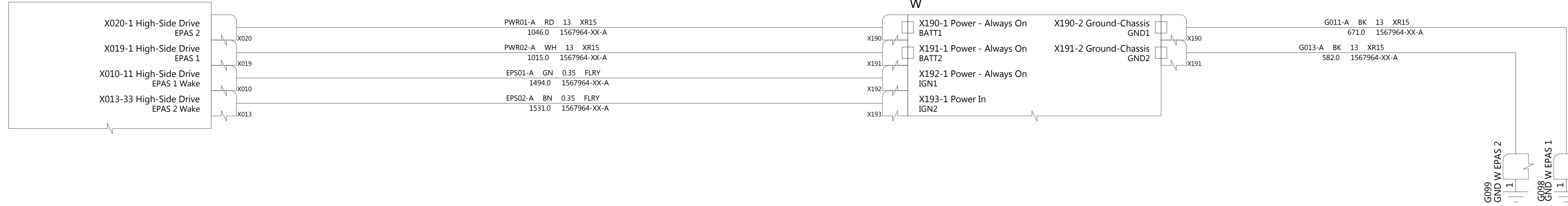

Body Controller Left
A,D,J,W,K

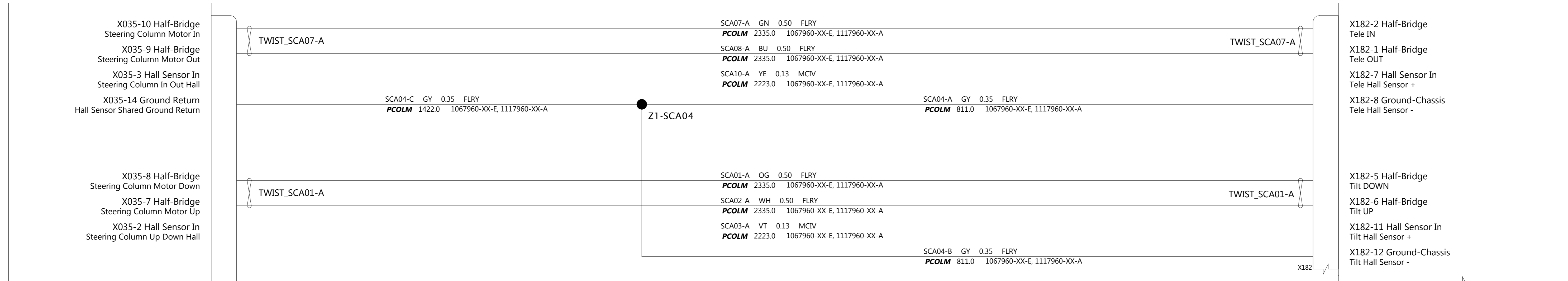

Steering Angle and Stalk ECU
J

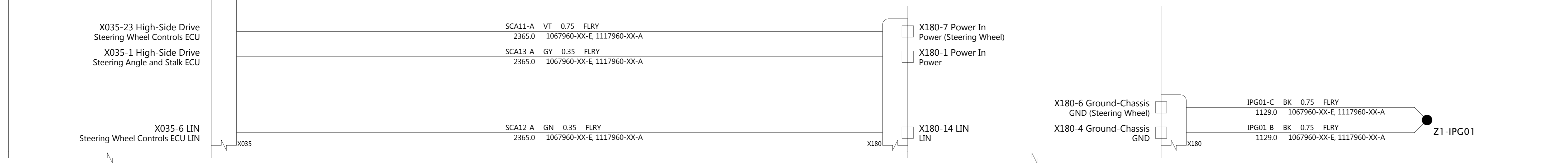

THE INFORMATION CONTAINED HEREIN IS DEEMED TO BE CONFIDENTIAL, PROPRIETARY, AND A TRADE SECRET OF TESLA MOTORS. THIS INFORMATION MAY NOT BE USED, REPRODUCED, OR DISCLOSED AS THE DIRECT OR INDIRECT BASIS FOR THE DEVELOPMENT, MANUFACTURE, OR SALE OF PROCESSES OR PRODUCTS WITHOUT THE EXPRESSED WRITTEN CONSENT OF TESLA MOTORS.

DRAWN	CHECKED	APPROVED
MATERIAL AS SPECIFIED	FINISHING AS SPECIFIED	SCALE NONE
PART NAME Steering		
PART NUMBER	REV	SHEET
	1	39 OF 40
		SIZE A0

Body Controller Right
B,P,J,W

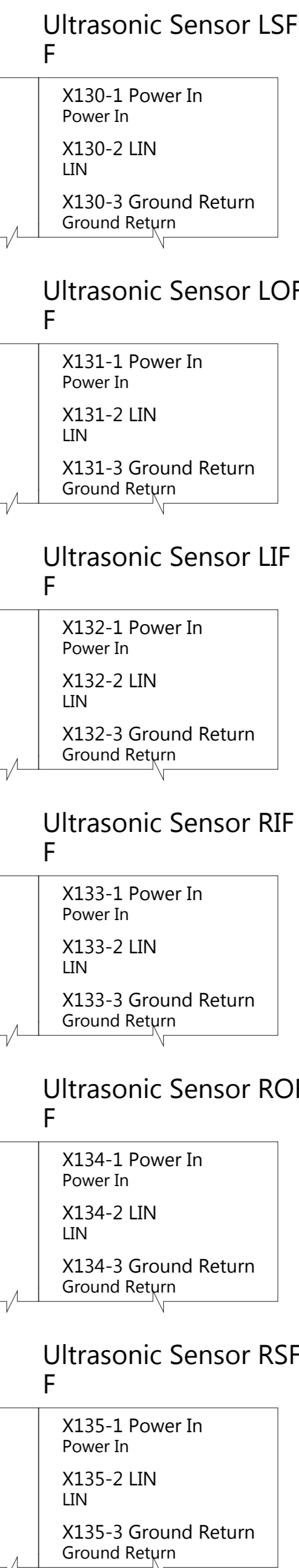
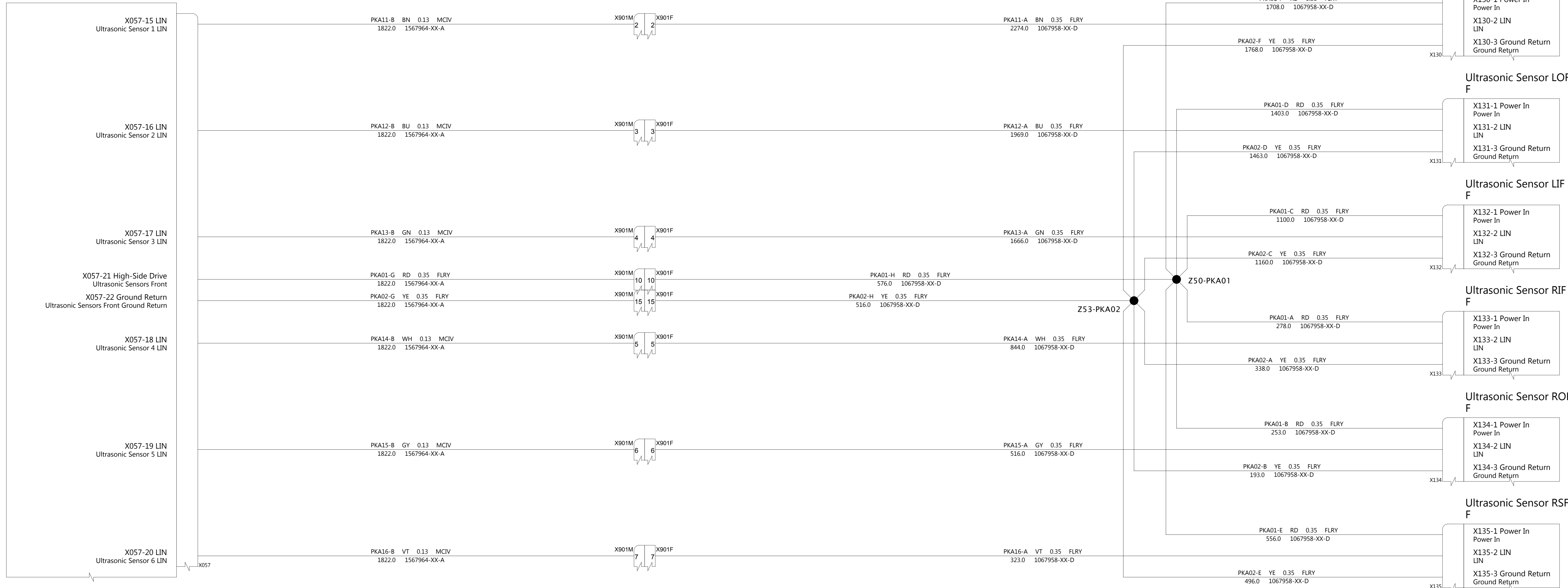

Body Controller Right
B,P,J,W

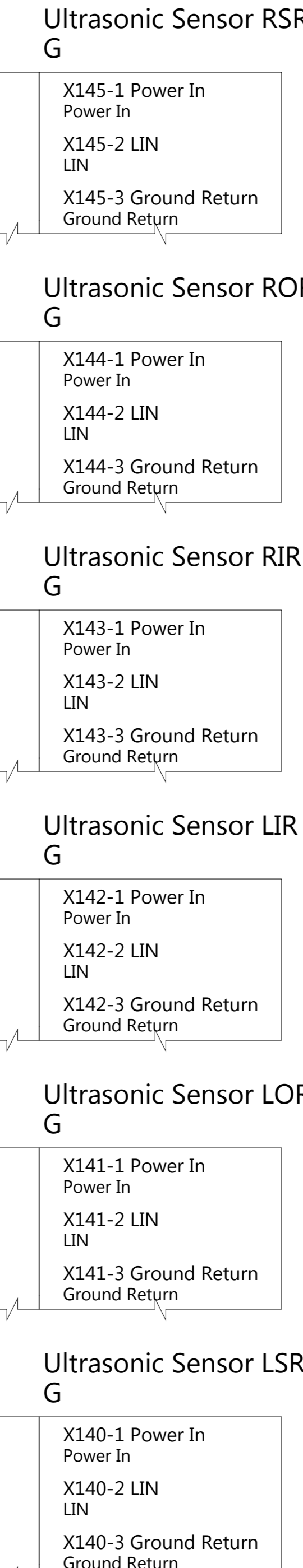
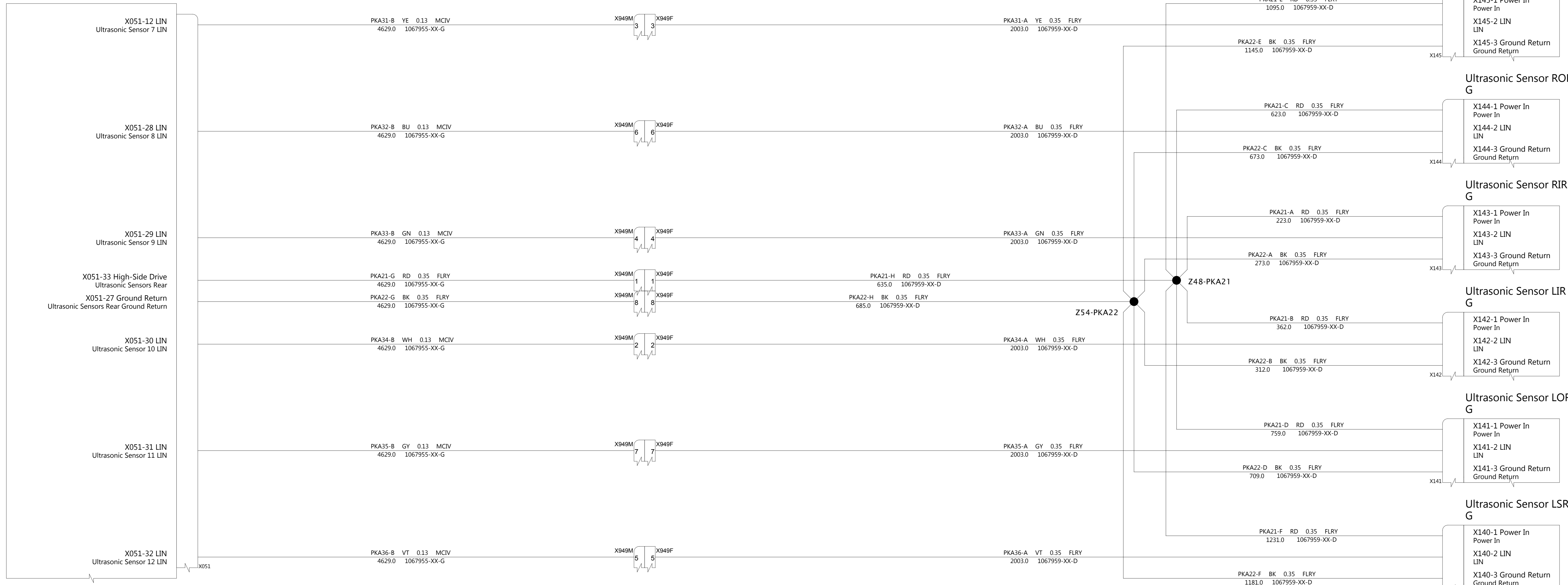

THE INFORMATION CONTAINED HEREIN IS DEEMED TO BE CONFIDENTIAL, PROPRIETARY, AND A TRADE SECRET OF TESLA MOTORS. THIS INFORMATION MAY NOT BE USED, REPRODUCED, OR DISCLOSED AS THE DIRECT OR INDIRECT BASIS FOR THE DEVELOPMENT, MANUFACTURE, OR SALE OF PROCESSES OR PRODUCTS WITHOUT THE EXPRESSED WRITTEN CONSENT OF TESLA MOTORS.

DRAWN	CHECKED	APPROVED
MATERIAL AS SPECIFIED	FINISHING AS SPECIFIED	SCALE NONE
PART NAME Ultrasonics		
PART NUMBER	REV	SHEET
	1	40 OF 40
		SIZE A0