

# Operation & Maintenance Manual

SEAM051900T

## PC400,400LC-6 PC450,450LC-6 HYDRAULIC EXCAVATOR

SERIAL NUMBERS PC400,400LC-32488 and up  
PC450,450LC-12629

### WARNING

Unsafe use of this machine may cause serious injury or death. Operators and maintenance personnel must read this manual before operating or maintaining this machine. This manual should be kept near the machine for reference and periodically reviewed by all personnel who will come into contact with it.

### NOTICE

Komatsu has Operation & Maintenance Manuals written in some other languages. If a foreign language manual is necessary, contact your local distributor for availability.

# KOMATSU

# 1. FOREWORD

---

This manual provides rules and guidelines which will help you use this machine safely and effectively. Keep this manual handy and have all personnel read it periodically. If this manual has been lost or has become dirty and can not be read, request a replacement manual from Komatsu or your Komatsu distributor.

If you sell the machine, be sure to give this manual to the new owners.

Continuing improvements in the design of this machine can lead to changes in detail which may not be reflected in this manual. Consult Komatsu or your Komatsu distributor for the latest available information of your machine or for questions regarding information in this manual.

This manual may contain attachments and optional equipment that are not available in your area. Consult Komatsu or your Komatsu distributor for those items you may require.

## WARNING

- **Improper operation and maintenance of this machine can be hazardous and could result in serious injury or death.**
- **Operators and maintenance personnel should read this manual thoroughly before beginning operation or maintenance.**  
**Keep this manual in the luggage box to the rear of the operator's seat, and have all personnel involved in working on the machine read the manual periodically.**
- **Some actions involved in operation and maintenance of the machine can cause a serious accident, if they are not done in a manner described in this manual.**
- **The procedures and precautions given in this manual apply only to intended uses of the machine. If you use your machine for any unintended uses that are not specifically prohibited, you must be sure that it is safe for you and others. In no event should you or others engage in prohibited uses or actions as described in this manual.**
- **Komatsu delivers machines that comply with all applicable regulations and standards of the country to which it has been shipped. If this machine has been purchased in another country or purchased from someone in another country, it may lack certain safety devices and specifications that are necessary for use in your country. If there is any question about whether your product complies with the applicable standards and regulations of your country, consult Komatsu or your Komatsu distributor before operating the machine.**
- **The description of safety is given in SAFETY INFORMATION on page 0-4 and in SAFETY from page 1-1.**

### **CALIFORNIA**

#### **Proposition 65 Warning**

**Diesel engine exhaust and some of its constituents are known to the State of California to cause cancer, birth defects, and other reproductive harm.**

### **CALIFORNIA**

#### **Proposition 65 Warning**

**Battery posts, terminals and related accessories contain lead and lead compounds, chemicals known to the State of California to cause cancer and birth defects or other reproductive harm.**

**Wash hands after handling.**

## EMISSION CONTROL WARRANTY

### EMISSION CONTROL WARRANTY STATEMENT (APPLIES TO CANADA ONLY)

#### 1. Products Warranted

Komatsu America International Company, Komatsu Mining Systems Inc. and Komatsu Utility Corporation (collectively "Komatsu") produce and/or market products under brand names of Komatsu, Dresser, Dressta, Haulpak and Galion. This emissions warranty applies to new engines bearing the Komatsu name installed in these products and used in Canada in machines designed for industrial off-highway use. This warranty applies only to these engines produced on or after January 1, 2000. This warranty will be administered by Komatsu distribution in Canada.

#### 2. Coverage

Komatsu warrants to the ultimate purchaser and each subsequent purchaser that the engine is designed, built and equipped so as to conform, at the time of sale by Komatsu, with all U.S. Federal emission regulations applicable at the time of manufacture and that it is free from defects in workmanship or material which would cause it not to meet these regulations within five years or 3,000 hours of operation, whichever occurs first, as measured from the date of delivery of the engine to the ultimate purchaser.

#### 3. Limitations

Failures, other than those resulting from defects in materials or workmanship, are not covered by this warranty. Komatsu is not responsible for failures or damage resulting from what Komatsu determines to be abuse or neglect, including, but not limited to: operation without adequate coolant or lubricants; over fueling; over speeding; lack of maintenance of lubricating, cooling or intake systems; improper storage, starting, warm-up, run-in or shutdown practices; unauthorized modifications of the engine. Komatsu is also not responsible for failures caused by incorrect fuel or by water, dirt or other contaminants in the fuel. Komatsu is not responsible for non-engine repairs, "downtime" expense, related damage, fines, all business costs or other losses resulting from a warrantable failure.

### KOMATSU IS NOT RESPONSIBLE FOR INCIDENTAL OR CONSEQUENTIAL DAMAGES.

This warranty, together with the express commercial warranties, are the sole warranties of Komatsu. **THERE ARE NO OTHER WARRANTIES, EXPRESS OR IMPLIED, OR OF MERCHANTABILITY OR FITNESS FOR A PARTICULAR PURPOSE.**

## GARANTIE SUR LE CONTRÔLE DES ÉMISSIONS

### ÉNONCÉ DE GARANTIE SUR LE CONTRÔLE DES ÉMISSIONS (APPLICABLE AU CANADA SEULEMENT):

#### 1. Produits garantis:

Komatsu America International Company, Komatsu Mining Systems Inc. et Komatsu Utility Corporation (collectivement Komatsu) produisent et/ou font la mise en marché de produits portant les noms de marque Komatsu, Dresser, Dressta, Haulpak et Galion. Cette garantie sur les émissions s'applique à tous les nouveaux moteurs portant le nom Komatsu, installés dans ces produits et utilisés au Canada dans des machines conçues pour utilisation industrielle non-routière. Cette garantie s'applique seulement sur les moteurs produits à partir du 1er Janvier 2000. Cette garantie sera administrée par la distribution de Komatsu au Canada.

#### 2. Couverture:

Komatsu garantit à l'acheteur ultime et chaque acheteur subséquent que le moteur est conçu, construit et équipé en toute conformité, au moment de la vente par Komatsu, avec toutes les Réglementations fédérales américaines sur les émissions applicables au moment de la fabrication et qu'il est exempt de défauts de construction ou de matériaux qui auraient pour effet de contrevenir à ces réglementations en dedans de 5 ans ou 3000 heures d'opération, mesuré à partir de la date de livraison du moteur au client ultime.

#### 3. Limitations:

Les bris, autres que ceux résultant de défauts de matériaux ou de construction, ne sont pas couverts par cette Garantie. Komatsu n'est pas responsable pour bris ou dommages résultant de ce que Komatsu détermine comme étant de l'abus ou négligence, incluant mais ne se limitant pas à: l'opération sans lubrifiants ou agent refroidissants adéquats; la suralimentation d'essence; la survitesse; le manque d'entretien des systèmes de lubrification, de refroidissement ou d'entrée; de pratiques non-propices d'entreposage, de mise en marche, de réchauffement, de conditionnement ou d'arrêt; les modifications non-autorisées du moteur. De plus, Komatsu n'est pas responsable de bris causés par de l'essence inadéquate ou de l'eau, des saletés ou autres contaminants dans l'essence. Komatsu n'est pas responsable des réparations non-relées au moteur, des dépenses encourues suite aux temps d'arrêts, des dommages relatifs, amendes, et de tout autre coût d'affaires ou autres pertes résultant d'un bris couvert par la garantie.

### KOMATSU N'EST PAS RESPONSABLE DES INCIDENTS OU DOMMAGES CONSÉQUENTS.

Cette garantie, ainsi que les garanties expresses commerciales, sont les seules garanties de Komatsu. **IL N'Y A AUCUNE AUTRE GARANTIE, EXPRESSE OU SOUS-ENTENDUE, MARCHANDABLE OU PROPICE A UNE UTILISATION PARTICULIÈRE.**

**AVERTISSEMENT**  
 DES BLESSURES PEUVENT RÉSULTER ET LA GARANTIE S'ANNULER SI LES RPM DU TAUX D'ESSENCE OU L'ALTITUDE EXCÈDENT LES VALEURS MAXIMALES PUBLIÉES POUR CE MODÈLE ET SON APPLICATION.

**INFORMATION IMPORTANTE SUR LE MOTEUR**  
 CE MOTEUR EST CONFORME AUX NORMES AMÉRICAINES DE L'EPA (ANNÉE DU MODÈLE) ET DE LA CALIFORNIE POUR LES MOTEURS LARGES NON-ROUTIERS À IGNITION PAR COMPRESSION. CE MOTEUR EST CERTIFIÉ POUR OPERATION À ESSENCE DIESEL.

**IMPORTANT ENGINE INFORMATION**

THIS ENGINE CONFORMS TO YYYY MODEL YEAR U.S. EPA REGULATION AND THE CALIFORNIA REGULATIONS LARGE NON ROAD COMPRESSION IGNITION ENGINES. THIS ENGINE IS CERTIFIED TO OPERATE ON DIESEL FUEL.

**WARNING**  
 INJURY MAY RESULT AND WARRANTY IS VOIDED IF FUEL RATE RPM OR ALTITUDES EXCEED PUBLISHED MAXIMUM VALUES FOR THIS MODEL AND APPLICATION.

ENGINE MODEL	SERIAL NO.	DISPLACEMENT	LITERS
ENGINE FAMILY		FIRING ORDER	1-5-3-6-2-4
EXHAUST EMISSION CONTROL SYSTEM		ADV. LOAD OUTPUT	Kw ( HP) RPM
VALVE LASH COLD (mm)	IN.	FUEL RATE AT ADV.	mm <sup>3</sup> /STROKE
IDLE SPEED	RPM	FAMILY EMISSION LIMIT	
INITIAL INJECTION TIMING	DEG. BTDC	DATE OF MANUFACTURE	
		KOMATSU LTD. MADE IN JAPAN	

- MODÈLE DU MOTEUR
- FAMILLE DU MOTEUR
- SYSTÈME DE CONTRÔLE DES ÉMISSIONS D'ÉCHAPPEMENT
- CHARGE DE SORTIE ADV.
- PORTÉE DE VALVE À FROID (mm)
- VITESSE STATIQUE
- RÉGLAGE DE L'ALLUMAGE - INJECTION INITIALE
- DEG. BTDC

- NO. SÉRIE
- DÉPLACEMENT
- LITRES
- SÉQUENCE DE MISE À FEU
- mm<sup>3</sup>/BATTEMENT
- TAUX D'ESSENCE À ADV.
- LIMITÉ D'ÉMISSION DE LA FAMILLE
- DATE DE FABRICATION

KOMATSU LTD.  
FABRIQUÉ AU JAPON

ENGINE DATAPLATE - ENGLISH / FRENCH





## 2. SAFETY INFORMATION

---

Most accidents are caused by the failure to follow fundamental safety rules for the operation and maintenance of machines. To avoid accidents, read, understand and follow all precautions and warnings in this manual and on the machine before performing operation and maintenance.

To identify safety messages in this manual and on machine labels, the following signal words are used.

-  **DANGER** – This word is used on safety messages and safety labels where there is a high probability of serious injury or death if the hazard is not avoided. These safety messages or labels usually describe precautions that must be taken to avoid the hazard. Failure to avoid this hazard may also result in serious damage to the machine.
  
-  **WARNING** – This word is used on safety messages and safety labels where there is a potentially dangerous situation which could result in serious injury or death if the hazard is not avoided. These safety messages or labels usually describe precautions that must be taken to avoid the hazard. Failure to avoid this hazard may also result in serious damage to the machine.
  
-  **CAUTION** – This word is used on safety messages and safety labels for hazards which could result in minor or moderate injury if the hazard is not avoided. This word might also be word for hazards where the only result could be damage to the machine.
  
- NOTICE** – This word is used for precautions that must be taken to avoid actions which could shorten the life of the machine.

Safety precautions are described in SAFETY from page 1-1.

Komatsu cannot predict every circumstance that might involve a potential hazard in operation and maintenance. Therefore the safety messages in this manual and on the machine may not include all possible safety precautions. If any procedures or actions not specifically recommended or allowed in this manual are used, you must be sure that you and others can do such procedures and actions safely and without damaging the machine. If you are unsure about the safety of some procedures, contact Komatsu distributor.

## 3. INTRODUCTION

---

### 3.1 INTENDED USE

This Komatsu HYDRAULIC EXCAVATOR is designed to be used mainly for the following work:

- Digging work
- Smoothing work
- Ditching work
- Loading work

See the section "12.14 WORK POSSIBLE USING HYDRAULIC EXCAVATOR" for further details.

### 3.2 FEATURES

- This Komatsu HYDRAULIC EXCAVATOR is equipped with various controls based on an advanced electronics system.
  - The monitor panel greatly facilitates daily maintenance and self-diagnosis.
  - Working mode, travel speed and swing priority are selectable.
  - Digging and lifting force can be increased by light-touch control.  
(For details, see operation section.)
- Adjustable wrist control levers make operations smooth and easy.
- Air-conditioned operator's cab assures comfortable operation.
- Low noise level and smart urban-style design and coloring.
- Superb operating performance provided by powerful engine and high-performance hydraulic pumps.
- Low fuel consumption controlled by an electronic control system provides an environment-friendly machine.

### 3.3 BREAKING IN THE MACHINE

Your Komatsu machine has been thoroughly adjusted and tested before shipment.

However, operating the machine under severe conditions at the beginning can adversely affect the performance and shorten the machine life.

Be sure to break in the machine for the initial 100 hours (as indicated by the service meter.)

During breaking in:

- Idle the engine for 5 minutes after starting it up.
- Avoid operation with heavy loads or at high speeds.
- Avoid sudden starts, sudden acceleration, sudden steering and sudden stops except in cases of emergency.

The precautions given in this manual for operating, maintenance, and safety procedures are only those that apply when this product is used for the specified purpose. If the machine is used for a purpose that is not listed in this manual, Komatsu cannot bear any responsibility for safety. All consideration of safety in such operations is the responsibility of the user.

Operations that are prohibited in this manual must never be carried out under any circumstances.

## 4. LOCATION OF PLATES, TABLE TO ENTER SERIAL NO. AND DISTRIBUTOR

### 4.1 MACHINE SERIAL NO. PLATE POSITION

On the bottom right of the operator's cab

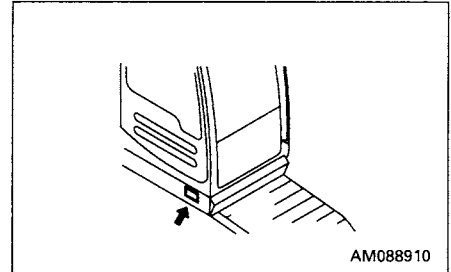

### 4.2 ENGINE SERIAL NO. PLATE POSITION

On the upper side of the engine cylinder head cover  
(The EPA auxiliary nameplate is on the top of the No. 5 cylinder head cover.)

EPA: Environmental Protection Agency, U.S.A.

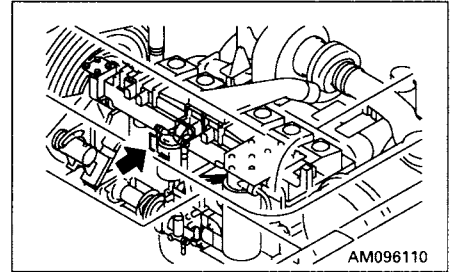

### 4.3 TABLE TO ENTER SERIAL NO. AND DISTRIBUTOR

Machine serial No.:	
Engine serial No.:	
Distributor name:	
Address:	Phone:
Service personnel for your machine:	

REMARKS

# 5. CONTENTS

---

1. Foreword .....	0- 1
2. Safety information .....	0- 4
3. Introduction .....	0- 5
4. Location of plates, table to enter serial No. and distributor .....	0- 6

## SAFETY

6. General precautions .....	1- 2
7. Precautions during operation .....	1-11
7.1 Before starting engine .....	1-11
7.2 After starting engine .....	1-13
7.3 Transportation .....	1-21
7.4 Battery .....	1-23
7.5 Towing .....	1-25
7.6 Bucket with hook .....	1-26
8. Precautions for maintenance .....	1-27
8.1 Before carrying out maintenance .....	1-27
8.2 During maintenance .....	1-32
9. Position for attaching safety labels .....	1-39

## OPERATION

10. General view .....	2- 2
10.1 General view of machine .....	2- 2
10.2 General view of controls and gauges .....	2- 3
11. Explanation of components .....	2- 4
11.1 Machine monitor .....	2- 4
11.2 Switches .....	2-15
11.3 Control levers, pedals .....	2-19
11.4 Ceiling window .....	2-24
11.5 Front window .....	2-25
11.6 Door lock .....	2-27
11.7 Cap, cover with lock .....	2-28
11.8 Hot and cool box .....	2-29
11.9 Luggage box .....	2-29
11.10 Ashtray .....	2-29
11.11 Handling air conditioner .....	2-30
11.12 Car radio .....	2-33
11.13 Electric power take-out adapter .....	2-37
11.14 Fuse .....	2-38
11.15 Fusible link .....	2-39
11.16 Controllers .....	2-39
11.17 Tool box .....	2-39
11.18 Greas gun holder .....	2-39
11.19 Handling accumulator .....	2-40

## 5. CONTENTS

---

<b>12. Operation</b> .....	2-41
12.1 Check before starting engine .....	2-41
12.2 Starting engine .....	2-52
12.3 Operations and checks after starting engine .....	2-55
12.4 Moving machine off .....	2-61
12.5 Steering machine .....	2-64
12.6 Stopping machine .....	2-66
12.7 Swinging .....	2-67
12.8 Operation of work equipment .....	2-68
12.9 Handling active mode .....	2-69
12.10 Handling working mode .....	2-70
12.11 Prohibitions for operation .....	2-72
12.12 Precautions for operation .....	2-74
12.13 Precautions when traveling up or down hills .....	2-75
12.14 How to escape from mud .....	2-77
12.15 Work possible using hydraulic excavator .....	2-78
12.16 Replacement and inversion of bucket .....	2-79
12.17 Parking machine .....	2-81
12.18 Check after finishing work .....	2-82
12.19 Stopping engine .....	2-83
12.20 Check after stopping engine .....	2-84
12.21 Locking .....	2-84
<b>13. Transportation</b> .....	2-85
13.1 Transportation procedure .....	2-85
13.2 Loading, unloading work with trailers .....	2-86
13.3 Method of lifting machine .....	2-92
<b>14. Cold weather operation</b> .....	2-93
14.1 Precautions for low temperature .....	2-93
14.2 Precautions after completion of work .....	2-95
14.3 After cold weather .....	2-95
<b>15. Long-term storage</b> .....	2-96
15.1 Before storage .....	2-96
15.2 During storage .....	2-97
15.3 After storage .....	2-97
15.4 Starting machine after long-term storage .....	2-97
<b>16. Troubleshooting</b> .....	2-98
16.1 Phenomena that are not failures .....	2-98
16.2 Method of towing machine .....	2-98
16.3 Using method for light-weight towing hole .....	2-98
16.4 Precautions on particular jobsites .....	2-99
16.5 If battery is discharged .....	2-99
16.6 Other trouble .....	2-104

## MAINTENANCE

<b>17. Guides to maintenance</b> .....	3- 2
<b>18. Outlines of service</b> .....	3- 5
18.1 Outline of oil, fuel, coolant .....	3- 5
18.2 Outline of electric system .....	3- 8
18.3 Outline of hydraulic system .....	3- 9
<b>19. Wear parts list</b> .....	3-10
<b>20. Use of fuel, coolant and lubricants according to ambient temperature</b> .....	3-12
<b>21. Standard tightening torques for bolts and nuts</b> .....	3-16
21.1 Introduction of necessary tools .....	3-16
21.2 Torque list .....	3-17
<b>22. Periodic replacement of safety critical parts</b> .....	3-18
<b>23. Maintenance schedule chart</b> .....	3-20
23.1 Maintenance schedule chart .....	3-20
23.2 Maintenance interval when using hydraulic breaker .....	3-22
<b>24. Service Procedure</b> .....	3-23
24.1 Initial 250 hours service .....	3-23
24.2 When required .....	3-24
24.3 Check before starting .....	3-42
24.4 Every 50 hours service .....	3-46
24.5 Every 100 hours service .....	3-48
24.6 Every 250 hours service .....	3-50
24.7 Every 500 hours service .....	3-56
24.8 Every 1000 hours service .....	3-64
24.9 Every 2000 hours service .....	3-67
24.10 Every 4000 hours service .....	3-70
24.11 Every 5000 hours service .....	3-71

## SPECIFICATIONS

<b>25. Specifications</b> .....	4- 2
---------------------------------	------

## OPTIONS, ATTACHMENTS

<b>26. General precautions</b> .....	5- 2
26.1 Precautions related to safety .....	5- 2
26.2 Precautions when installing attachments .....	5- 3
<b>27. Handling bucket with hook</b> .....	5- 4
27.1 Checking for damage to bucket with hook .....	5- 4
27.2 Prohibited operations .....	5- 4
27.3 Precautions during operations .....	5- 4
<b>28. Using seat belt</b> .....	5- 5
28.1 Seat belt .....	5- 5
<b>29. Handling car heater</b> .....	5- 7
29.1 General locations .....	5- 7
29.2 Precaution for car heater .....	5- 8
<b>30. Machines ready for attachment</b> .....	5- 9
30.1 General locations .....	5- 9
30.2 Hydraulic circuit .....	5-11
30.3 Procedure for removal and installation of attachment .....	5-13
30.4 Operation .....	5-15
30.5 Long term storage .....	5-16
30.6 Specifications .....	5-16
<b>31. Introduction of attachments</b> .....	5-17
31.1 Specification, use .....	5-17
31.2 Attachment installation combination table .....	5-19
31.3 Selection of track shoes .....	5-21
31.4 Selection of bucket teeth .....	5-22
<b>32. Extending machine service life</b> .....	5-23
32.1 Hydraulic breaker .....	5-23
32.2 Power ripper .....	5-27
32.3 Fork grab .....	5-28
32.4 Grapple bucket .....	5-29
32.5 Scrap grapple .....	5-30
32.6 Crusher and cutter .....	5-31
32.7 Hydraulic pile driver .....	5-32
32.8 Hydraulic excavator with multi-purpose crane .....	5-33
<b>33. Auto-greasing system</b> .....	5-34
33.1 Auto greasing controller .....	5-34
33.2 Action when abnormality occurs .....	5-35
33.3 Check before starting .....	5-36
33.4 Every 50 hours service .....	5-38

# SAFETY



## WARNING

**Read and follow all safety precautions. Failure to do so may result in serious injury or death.**

This safety section also contains precautions for optional equipment and attachments.



## 6. GENERAL PRECAUTIONS

**⚠ WARNING:** For reasons of safety, always follow these safety precautions.

### SAFETY RULES

- Only trained and authorized personnel can operate and maintain the machine.
- Follow all safety rules, precautions and instructions when operating or performing maintenance on the machine.
- Do not operate the machine if you are feeling unwell, if you are taking medication that makes you feel sleepy, if you have been drinking, or if you are suffering from emotional problems. These problems will interfere with your sense of judgement in emergencies and may cause accidents.
- When working with another operator or with a person on worksite traffic duty, be sure that all personnel know the nature of the work and understand all hand signals that are to be used.
- Always observe strictly any other rules related to safety.

### SAFETY FEATURES

- Be sure that all guards and covers are installed in their proper position. Have guards and covers repaired immediately if damaged.
- Be sure that you understand the method of use of safety features such as safety lock lever (1) and the seat belt, and use them properly.
- Never remove any safety features. Always keep them in good operating condition.  
**Safety lock lever** → See "12.17 PARKING MACHINE".  
**Seat belt (option)** → See "28. USING SEAT BELT".
- Failure to use safety features according to the instructions in the Operation and Maintenance Manual could result in serious bodily injury.

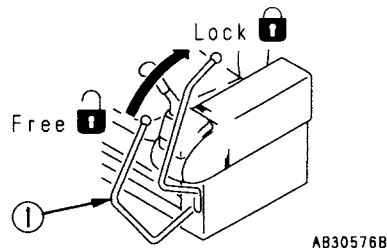

### INSIDE OPERATOR'S COMPARTMENT

- When entering the operator's compartment, always remove all mud and oil from the soles of your shoes.  
If you operate the brake pedal with mud or oil stuck to your shoes, your foot may slip and this may cause a serious accident.
- After using the ashtray, make sure that any matches or cigarettes are properly extinguished, and be sure to close the lid.  
If the ashtray is left open, there is danger of fire.
- Do not stick suction pads to the window glass. Suction pads act as a lens and may cause fire.
- Do not leave lighters lying around the operator's compartment. If the temperature inside the operator's compartment become high, there is danger that the lighter may explode.
- Do not use cellular telephones inside the operator's compartment when driving or operating the machine.  
There is danger that this may lead to an unexpected accident.
- Never bring any dangerous objects such as flammable or explosive items into the operator's cab.
- To ensure safety, do not use the radio or music headphones when operating the machine. There is danger that this may lead to a serious accident.
- When operating the machine, do not put your hands or head out of the window.

**CLOTHING AND PERSONAL PROTECTIVE ITEMS**

- Avoid loose clothing and jewelry. They can catch on controls or in protruding parts and cause serious injury or death.
- Do not wear oily clothes. They are highly flammable.
- Wear a hard hat, safety glasses, safety shoes, mask, or gloves when operating or maintaining the machine.

Always wear safety goggles, hard hat, gloves, and other protective equipment if your job involves scattering metal chips or minute materials - particularly when driving in pins with a hammer and when cleaning the air cleaner element with compressed air.

Check also that there is no one near the machine.

- Check that all protective equipment works properly before using it.

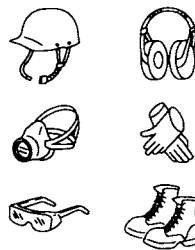

AW513200

**UNAUTHORIZED MODIFICATION**

Any modification made without authorization from Komatsu can create hazards. Before making a modification, consult your Komatsu distributor.

Komatsu will not be responsible for any injury or damage caused by any unauthorized modification.

**ALWAYS APPLY LOCK WHEN LEAVING OPERATOR'S SEAT**

- When standing up from the operator's seat, always place safety lock lever ① securely in the LOCK position. If you accidentally touch the work equipment levers when they are not locked, the machine may suddenly move and cause serious injury or damage.
- When leaving the machine, lower the work equipment completely to the ground, set safety lock lever ① to the LOCK position, then stop the engine and use the key to lock all the equipment. Always remove the key and take it with you.

**Work equipment posture → See "12.17 PARKING MACHINE".**

**Locks → See "12.21 LOCKING".**

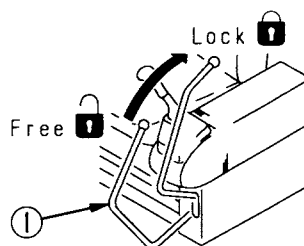

AB30576B

**MOUNTING AND DISMOUNTING**

- Before getting on or off the machine, if there is any oil, grease, or mud on the handrails, steps, or track shoes, wipe it off immediately. Always keep these parts clean. Repair any damage and tighten any loose bolts.
- Never jump on or off the machine. In particular, never get on or off a moving machine. These actions may lead to serious injury.
- When getting on or off the machine, always face the machine, and maintain three-point contact (both feet and one hand or one foot and both hands) with the handrails, steps, and track shoes to ensure that you support yourself securely.
- Never hold any control levers when getting on or off the machine.
- Apply the door lock securely. If you grip the handrail inside the door when moving on top of the track shoes, and the door lock is not applied securely, the door may move and cause you to fall.
- Use the points marked by arrows in the diagram when getting on or off the machine.  
**Method of locking door → See "11.6 DOOR LOCK".**

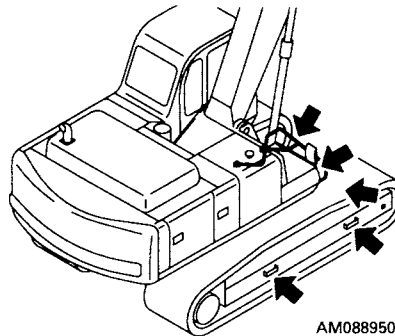
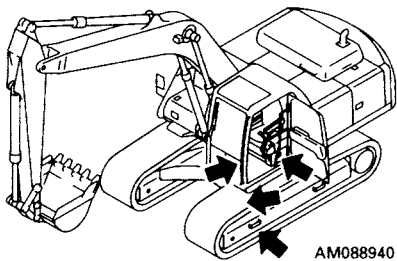

**FIRE PREVENTION FOR FUEL, OIL, AND ANTIFREEZE**

Fuel, oil, and antifreeze will catch fire if it is brought close to a flame. Fuel is particularly flammable and can be hazardous.

Always strictly observe the following.

- Keep any lighted matches or cigarettes away from flammable materials.
- Stop the engine and do not smoke when refueling.
- Tighten all fuel and oil caps securely.
- Use well-ventilated areas for adding or storing oil and fuel.
- Keep oil and fuel in the determined place and do not allow unauthorized persons to enter.
- Do not leave the area when supplying fuel or oil.



A0055020



A0055040

**PRECAUTIONS WHEN HANDLING AT HIGH TEMPERATURE**

Immediately after operations are stopped, the coolant, engine oil, and hydraulic oil are at high temperature and the radiator and hydraulic tank are still under pressure. Attempting to remove the cap, drain the oil or coolant, or replace the filters may lead to serious burns. Always wait for the temperature to go down, and follow the specified procedures when carrying out these operations.

- To prevent hot water from spurting out, stop the engine, wait for the water to cool, then loosen the cap slowly to relieve the pressure before removing the cap.  
(When checking how much the water temperature has gone down, bring your hand close to the surface of the radiator without touching it, and check the temperature of the air at the radiator surface.)
- To prevent hot oil from spurting out, stop the engine, wait for the oil to cool, then loosen the cap slowly to relieve the pressure before removing the cap.  
(When checking how much the oil temperature has gone down, bring your hand close to the surface of the hydraulic tank without touching it, and check the temperature of the air at the hydraulic tank surface.)



A0055050

### ASBESTOS DUST HAZARD PREVENTION

Asbestos dust can be hazardous to your health if it is inhaled. Komatsu does not use asbestos in its products, but if you handle materials containing asbestos fibers during demolition operations, always do as follows.

- Never use compressed air for cleaning.
- Use water to keep down the asbestos dust when cleaning.
- If there is danger that there may be asbestos dust in the air, operate the machine with the wind to your back whenever possible.
- Use an approved respirator if necessary.  
Do not allow any other person into the area during the operation.
- There is danger that non-genuine parts may contain asbestos, so use only Komatsu genuine parts.
- Always observe any rules and regulations related to the jobsite and working environment.



A0055060

### INJURY FROM WORK EQUIPMENT

Do not enter or put your hand or arm or any other part of your body between movable parts, such as between the work equipment and cylinders, or between the machine and work equipment.

If the control levers are operated, the clearance between the machine and the work equipment will change and this may lead to serious damage or personal injury.

If it is necessary to go between movable parts, always fix the work equipment so that it cannot move.



A0066090

### FIRE EXTINGUISHER AND FIRST AID KIT

As a precaution if any injury or fire should occur, always do as follows.

- Be sure that fire extinguishers have been provided and read the labels to ensure that you know how to use them.
- Provide a first aid kit at the storage point. Check the kit periodically and make any additions if necessary.
- Know what to do in the event of injury or fire.
- Make a list of the phone numbers of persons you should contact in case of an emergency (doctor, ambulance, fire station), and post the list at specified places to ensure that all workers can carry out the emergency contact.

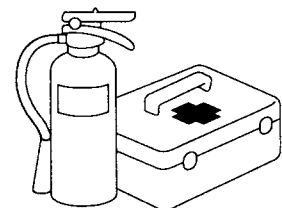

A0055070

**⚠ WARNING:** Failure to follow these safety precautions may lead to a serious accident.

**ESCAPE FROM FIRE**

If the machine catches fire, it may lead to serious personal injury or death.

If a fire occurs during operation, escape from the machine as follows.

- Turn the starting switch OFF and stop the engine.
- If there is time, use the fire extinguisher to extinguish as much of the fire as possible.
- Use the handrails and steps to escape from the machine.

The above is the basic method for escaping from the machine, but it may be necessary to change the method according to the conditions, so carry out practice drills at the jobsite.

**WINDOW WASHER FLUID**

Use an ethyl alcohol type washer fluid.

Do not use a methyl alcohol type washer fluid because it may irritate your eyes.

**PROTECTION FROM FALLING OR FLYING OBJECTS**

On jobsites where there is danger that falling objects or flying objects may hit the operator's cab, select a guard to match the operating conditions in order to protect the operator.

- For breaker operations, install a front guard and stick a laminated coating sheet to the front glass.
- When carrying out demolition or cutting operations, install a front guard and top guard, and stick a laminated coating sheet to the front glass.
- When working in mines or quarries where there is danger of falling rock, install FOPS (Falling Objects Protective Structure) and stick a laminated coating sheet to the front glass.
- When carrying out the above operations, always close the front window. In addition, always ensure that everyone apart from the operator is a safe distance away and is not in danger from falling or flying objects. Be particularly careful to keep people at a good distance during cutting operations.
- The above recommendations assume that the conditions are for standard operations, but it may be necessary to add additional guards according to the operating conditions on the jobsite. Always contact your Komatsu distributor for advice before starting operations.
- If the glass on the work equipment side is broken, replace it with new glass immediately. If you put your hand out, it may get caught in the work equipment and this may lead to serious personal injury.
- The Komatsu FOPS fulfills the standards and regulations of all countries, but if it is damaged or deformed by falling objects or by the machine rolling over, its strength will be reduced and it will be unable to ensure its basic function. If such problems occur, please contact your Komatsu distributor for advice about repairs.

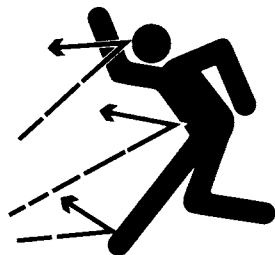

A0055200



A0084311

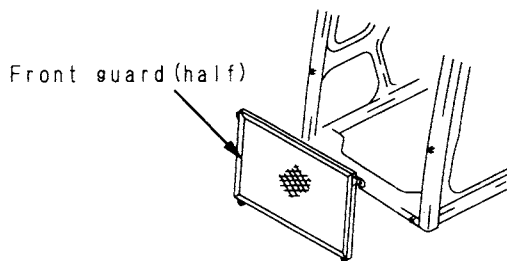

Front guard (half)

AB30050B

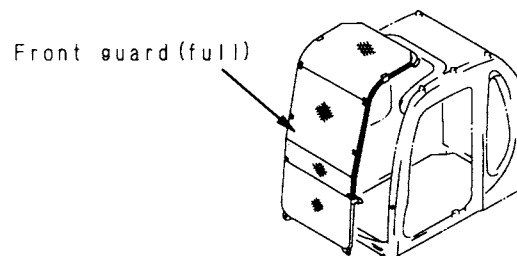

Front guard (full)

AB30051B

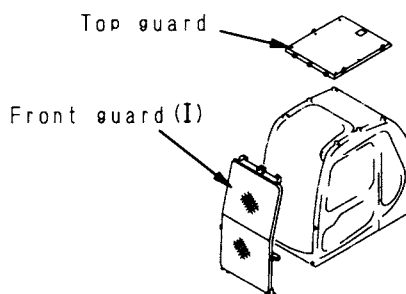

Top guard

Front guard (I)

AB30052B

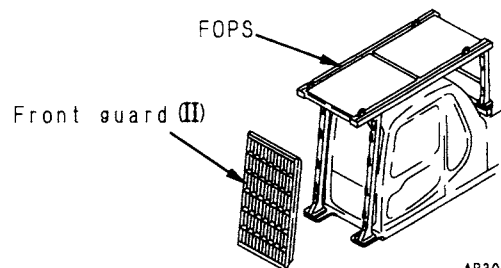

FOPS

Front guard (II)

AB30053B

### PRECAUTIONS FOR ATTACHMENTS

- When installing and using optional parts or attachments, read the instruction manual for the attachment and the information related to attachments in this manual.
- Do not use attachments that are not authorized by Komatsu or your Komatsu distributor. Use of unauthorized attachments could create a safety problem and adversely affect the proper operation and useful life of the machine.
- Any injury, accidents, or product failures resulting from the use of unauthorized attachments will not be the responsibility of Komatsu.

### ACCUMULATOR

- When leaving the machine, lower the work equipment (including any attachment) completely to the ground, set safety lock lever ① to the LOCK position, and lock attachment control pedal with lock pin.
- When releasing the pressure from the control circuit of machines equipped with an accumulator, or when releasing the pressure of the charge gas, carry out the operation according to the instructions in the instruction manual for the accumulator. See METHOD OF RELEASING PRESSURE, CHARGING GAS, 11.19 HANDLING ACCUMULATOR.
- The accumulator is charged with high-pressure nitrogen gas, so it is extremely dangerous if it is handled mistakenly. Always observe the following precautions.
  - Do not make any hole in the accumulator or bring any flame close.
  - Do not weld any boss to the accumulator.
  - When scrapping the accumulator, the charged gas must be released, so please contact your Komatsu distributor.

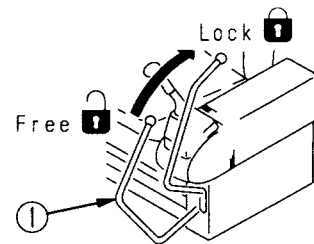

### INDOOR VENTILATION

- When starting the engine, or using fuel, flushing oil, or paint indoors or in areas with poor ventilation, always open the windows and doors to improve the ventilation and prevent the danger of gas poisoning.
- If the ventilation is still insufficient even when the windows and doors are opened, use a ventilation fan.



### CAB GLASS

- If the cab glass on the work equipment side should be broken, there is serious danger that you may come into direct contact with the work equipment. If the glass breaks, stop operations immediately and replace the glass.



**EMERGENCY EXIT FROM OPERATOR'S CAB**

- If it should become impossible to open the cab door for any reason, open the rear window and use it as an emergency escape.
- Remove the rear window as follows.
  1. Pull ring ① and completely remove seal ② from the window frame rubber.
  2. Push the corner of the rear window glass strongly to remove it to the outside.
- Remove the rear window only when it is used as an emergency exit.

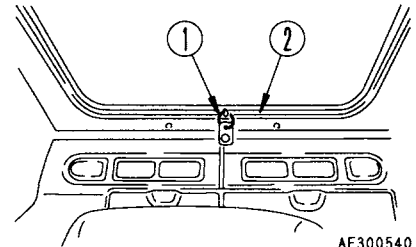

AE300540

## 7. PRECAUTIONS DURING OPERATION

**⚠ WARNING:** Failure to follow these safety precautions may lead to a serious accident.

### 7.1 BEFORE STARTING ENGINE

#### SAFETY AT WORKSITE

- Before starting operations, thoroughly check the area for any unusual conditions that could be dangerous.
- Check the terrain and condition of the ground at the worksite, and determine the best and safest method of operation.
- Make the ground surface as hard and horizontal as possible before carrying out operations. If there is a lot of dust and sand on the jobsite, spray water before starting operations.
- If you need to operate on a street, protect pedestrians and cars by designating a person for worksite traffic duty or by erecting fences and posting "No Entry" signs around the worksite.
- If water lines, gas lines, and high-voltage electrical lines may be buried under the worksite, contact each utility and identify their locations. Be careful not to damage or cut any of these lines.
- Erect fences, post "No Entry" signs, and take other steps to prevent people from coming close to or entering the jobsite. If people come close to a moving machine, they may be hit or caught by the machine, and this may lead to serious personal injury or death.
- Check the condition of the river bed, and the depth and flow of the water before operating in water or crossing a river. **NEVER** be in water which is in excess of the permissible water depth. **Permissible water depth → See "12.12 PRECAUTIONS FOR OPERATION".**

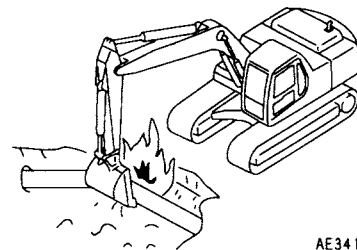

AE341030

### CHECKS BEFORE STARTING ENGINE

Every day before starting the engine for the first time, carry out the following checks. If these checks are not carried out properly, there is danger of serious injury.

- Completely remove all wood chips, leaves, grass, paper and other flammable materials accumulated in the engine compartment and around the battery. They could cause a fire. Remove any dirt from the window glass, mirrors, handrails, and steps.
- Do not leave tools or spare parts lying around in the operator's compartment. The vibration of the machine when traveling or during operations may cause them to fall and damage or break the control levers or switches. They may also get caught in the gap of the control levers and cause the work equipment to malfunction or move dangerously. This may lead to unexpected accidents.  
**Walk-around check → See "12.1.1 WALK AROUND CHECK".**
- Check the coolant level, fuel level, and hydraulic tank oil level, and check for clogging of the air cleaner and damage to the electrical wiring.  
**Check before starting → See "12.1.2 CHECK BEFORE STARTING".**
- Adjust the operator's seat to a position where it is easy to operate the machine, and check the seat belt and mounts for damage and wear.  
**Adjusting operator's seat → See "12.1.3 ADJUST BEFORE OPERATION".**  
**Seat belt → See "28. USING SEAT BELT".**
- Check the operation of the gauges and the angle of the mirrors, and check that the control levers are at the LOCK position.  
**Method of checking actuation of gauges → See "12.1.4 OPERATIONS AND CHECKS BEFORE STARTING ENGINE".**

If any abnormalities are found in the above checks, carry out repairs immediately.



A0055020

### WHEN STARTING ENGINE

- Walk around your machine again just before mounting it, and check for people and objects that might be in the way.
- Never start the engine if a warning tag has been attached to the control levers.
- When starting the engine, sound the horn as an alert.
- Start and operate the machine only while seated.
- If another person is allowed on the machine, that person may sit only in the assistant's seat.
- Do not short circuit the starting motor to start the engine. This is not only dangerous, but may also damage the machine.

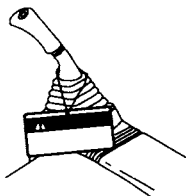

AE305910

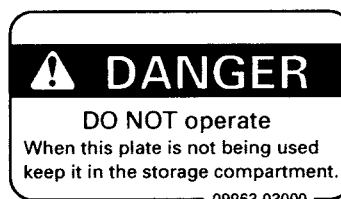

## 7.2 AFTER STARTING ENGINE

### CHECKS AFTER STARTING ENGINE

If checks are not carried out properly after starting the engine, it may result in a delay in discovering abnormalities in the machine, and this may lead to personal injury or damage to the machine. Carry out the checks in an open area where there are no obstructions. Do not let any one near the machine when carrying out the checks.

- Check the operating condition of the equipment, and the actuation of the bucket, arm, boom, travel, and swing systems.
- Check the machine for any abnormal noise, vibration, heat, smell, or abnormality with the gauges. Check also for leakage of air, oil, and fuel.
- If any abnormality is found, repair the problem immediately.  
If the machine is used without repairing the problems, it may lead to unexpected injury or failure.

### CHECK DIRECTION BEFORE STARTING MACHINE

Before operating the travel lever, check the direction of the track frame.

- If the sprocket is at the front, the travel lever must be operated in the opposite direction.  
**Travel operations → See "12.4 MOVING MACHINE OFF".**
- Before moving the machine off, check again that there is no person or obstacle in the surrounding area.
- Before operating the machine or work equipment, sound the horn to warn people in the area.
- Always set in the operator's seat when operating the machine.
- Fasten the seat belt securely.
- If another person is allowed on the machine, that person may sit only in the assistant's seat.
- Check that the travel alarm and other alarms work properly.
- Always close the door of the operator's compartment and check that the door lock is applied.

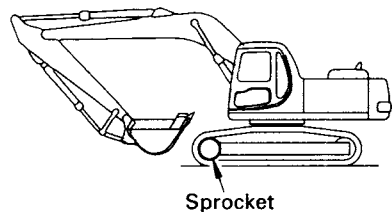

AN112970

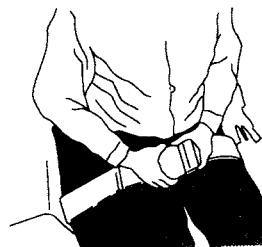

AE305800

**PRECAUTIONS WHEN SWINGING OR CHANGING DIRECTION OF TRAVEL**

Before operating the machine or the work equipment, always observe the following precautions in order to prevent serious injury or death.

- When changing the direction of travel from forward to reverse or from reverse to forward, reduce speed early and stop the machine before changing the direction of travel.
- Sound the horn to warn people in the area.
- Check that there is no one in the area around the machine. There are blind spots behind the machine, so if necessary, swing the upper structure to check that there is no one behind the machine before traveling in reverse.
- When operating in areas that may be hazardous or have poor visibility, designate a person to direct worksite traffic.
- Ensure that no unauthorized person can come within the turning radius or direction of travel.

Be sure to observe the above precautions even if a travel alarm or mirrors are installed.

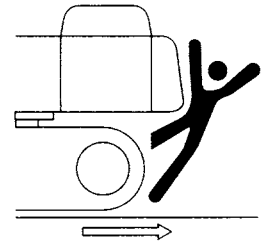

A0067190

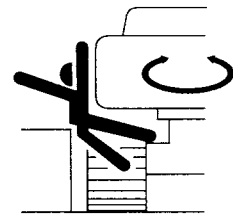

A0067200

**PRECAUTIONS WHEN TRAVELING**

- Never turn the starting switch to the OFF position when traveling. It is dangerous if the engine stops when the machine is traveling. It will be impossible to operate the steering.
- It is dangerous to look at other things when operating. Always concentrate on your work.
- It is dangerous to drive too fast, start suddenly, stop suddenly, turn suddenly, or snake when driving the machine.
- If any abnormality in the machine (noise, vibration, smell, abnormality in gauges, leakage of air or oil, etc.) is seen during operations, stop the machine immediately at a safe place and look for the cause.
- Keep the work equipment at a height of 40 – 50 cm (16 – 20 in) from the ground level.
- When traveling, do not operate the work equipment control levers. If the work equipment control levers have to be operated, stop the machine before operating them.
- Do not operate the steering suddenly. The work equipment may hit the ground and cause the machine to lose its balance, and this may damage the machine or structures in the area.
- When traveling on rough ground, travel at low speed, and avoid sudden changes in direction.
- Avoid traveling over obstacles as far as possible. If the machine has to travel over an obstacle, keep the work equipment as close to the ground as possible and travel at low speed. Never travel over obstacles which make the machine tilt strongly (10° or more). When traveling and during operations, always keep a good distance to prevent contact with other machines and structures.
- Always keep to the permissible water depth.  
**Permissible water depth → See “12.12 PRECAUTIONS FOR OPERATION”.**
- When traveling over bridges or structures on private land, check first that the bridge or structure can withstand the weight of the machine. When traveling on public roads, check with the local authorities and follow their instructions.

Travel posture

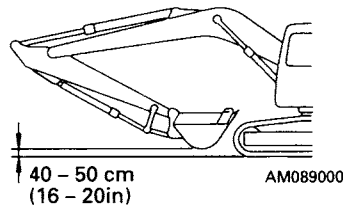

**INCORRECT**

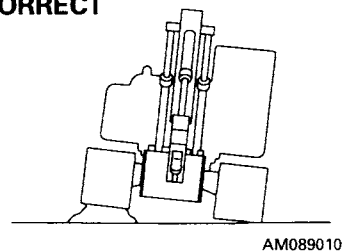

### TRAVELING ON SLOPES

- Never jump on to a machine that is running away in order to stop it. There is danger of serious injury.
- Traveling on slopes could result in the machine tipping over or slipping.
- On hills, banks or slopes, carry the bucket approximately 20 to 30 cm (8 – 12 in) above the ground. In case of emergency, quickly lower the bucket to the ground to help stop the machine.
- Do not turn on slopes or travel across slopes. Always go down to a flat place to perform these operations.

**Method of traveling on slopes → See "12.13 PRECAUTIONS WHEN TRAVELING UP OR DOWN HILLS".**

- Do not travel on grass, fallen leaves, or wet steel plates. Even slight slopes may cause the machine to slip to the side, so travel at low speed and make sure that the machine is always traveling directly up or down the slope.
- When traveling downhill, travel slowly at low speed. If necessary, use the brakes (shift the travel lever to neutral) and use the braking force of the engine.
- If the engine stops on a slope, shift the travel lever to the neutral position and start the engine again.

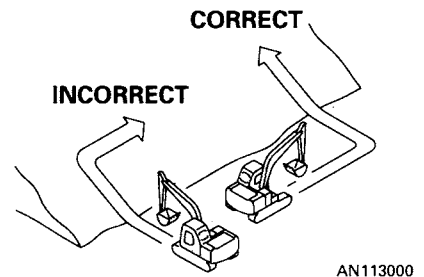
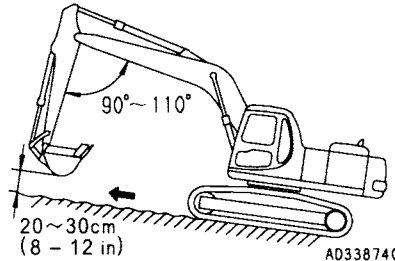
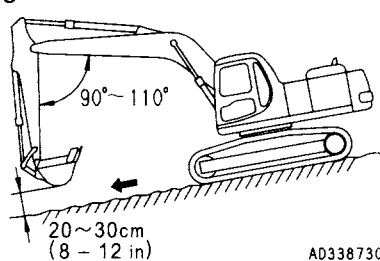

### PROHIBITED OPERATIONS

- Do not dig the work face under an overhang. This may cause the overhang to collapse and fall on top of the machine.
- Do not carry out deep digging under the front of the machine. The ground under the machine may collapse and cause the machine to fall. To make it easier to escape if there is any problem, set the crawlers at right angles to the road shoulder with the travel motor at the rear when carrying out digging operations. If the ground under the machine collapses and there is no time to drive out in reverse, do not panic and raise the arm and boom. It may actually be safer to lower the arm and boom.
- Do not swing the upper structure to the side when it is carrying a heavy load. Generally speaking, the machine is more liable to overturn when the work equipment is at the side than when it is at the front or rear.

**For details → See "12.12 PRECAUTIONS FOR OPERATION".**

- Limit of use

When using the machine, to prevent accidents caused by damage to the work equipment and overturning because of excessive load, do not use the machine in excess of its ability (in terms of the maximum load and stability determined by the structure of the machine).

**INCORRECT**

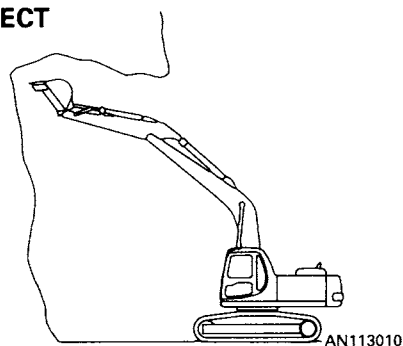

**INCORRECT**

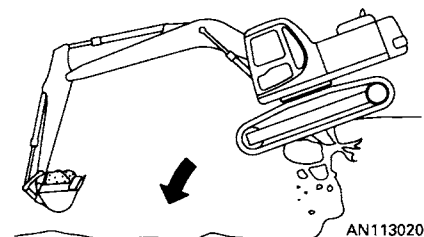

**⚠ WARNING:** Failure to follow these safety precautions may lead to a serious accident.

**PRECAUTIONS FOR OPERATION**

- Be careful not to go close to the edge of a cliff by mistake.
- Use the machine only for its main purpose. Using it for other purposes will cause failures. Specified work → See "12.15 WORK POSSIBLE USING HYDRAULIC EXCAVATOR".
- To ensure an ample view, do as follows.
  - When working in dark areas, fit working lamps and front lamps to the machine. If necessary, set up lighting at the jobsite.
  - Stop operations when the visibility is poor, such as in fog, mist, snow, and rain. Wait for the visibility to improve to a level which causes no problems for the operation.
- To avoid hitting the work equipment, always do as follows.
  - When working in tunnels, on bridges, under electric wires, or when parking the machine or carrying out other operations in places with limited height, be extremely careful not to hit the bucket or other parts.
  - To prevent collisions, operate the machine at a safe speed when working in confined spaces, indoors, or in crowded areas.
  - Do not pass the bucket over the heads of workers or over the operator's compartment of dump truck.

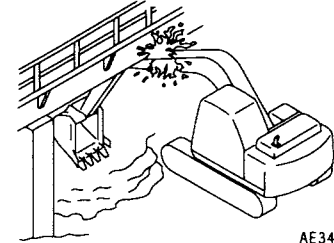

**DO NOT GO CLOSE TO HIGH-VOLTAGE CABLES**

- Do not let the machine touch overhead electric wires. In the case of high-voltage cables, even going close can cause electric shock.
- To prevent accidents, always do the following.
  - On jobsites where there is danger of the machine contacting electric wires, consult with the electric power company and check that the actions required by law are being taken before starting operations.
  - Wear shoes with rubber soles and rubber gloves, spread a rubber sheet on the seat and be careful not to let any part of your body not protected by rubber touch the machine.
  - Use a signalman to give warning if the machine approaches too close to the electric cables.
  - Check with the electricity company about the voltage of the cables before starting operations.

	Voltage	Min. safety distance
Low voltage	100 - 200 V	2 m
	6,600 V	2 m
Very high voltage	22,000 V	3 m
	66,000 V	4 m
	154,000 V	5 m
	187,000 V	6 m
	275,000 V	7 m
	500,000 V	11 m

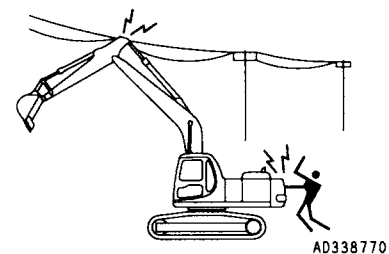



### OPERATE CAREFULLY ON SNOW

- When working on snow or icy roads, even a slight slope may cause the machine to slip to the side, so always travel at low speed and avoid sudden starting, stopping, or turning. There is particular danger of the machine slipping to the side when traveling up or down hills.
- When the temperature rises, frozen road surfaces become soft, so the machine travel becomes unstable.
- When there has been heavy snow, the road shoulder and objects placed beside the road are buried in the snow and cannot be seen, so always carry out snow-clearing operations carefully.

### WORKING ON LOOSE GROUND

- Avoid entering soft ground. It will be difficult for the machine to escape.
- Avoid operating your machine too close to the edge of cliffs, overhangs, and deep ditches. The ground may be weak in such areas. If the ground should collapse, the machine could fall or tip over and this could result in serious injury or death. Remember that the soil after heavy rain or blasting or after earthquakes is weakened in these areas.
- Earth laid on the ground and the soil near ditches is loose. It can collapse under the weight or vibration of your machine and cause your machine to tip over.
- Install the head guard (FOPS) if working in areas where there is danger of falling rocks.

### OPERATIONS ON SLOPES

- When working on slopes, there is danger that the machine may lose its balance and turn over when the swing or work equipment are operated. Always carry out these operations carefully.
- Do not swing the work equipment from the uphill side to the downhill side when the bucket is loaded. This operation is dangerous.
- If the machine has to be used on a slope, pile the soil to make a platform that will keep the machine as horizontal as possible. In addition, lower the bucket as far as possible, keep it pulled in to the front, and keep the swing speed as low as possible.  
**Piled soil on slope → See "12.13 PRECAUTIONS WHEN TRAVELING UP OR DOWN HILLS".**

#### CORRECT

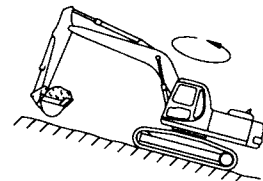

AN113040

#### INCORRECT

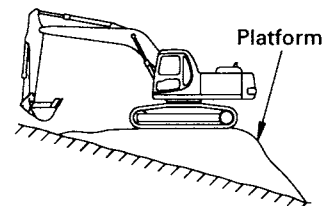

AN113050

**⚠ WARNING:** Failure to follow these safety precautions may lead to a serious accident.

**PARKING MACHINE**

- Park on level ground where there is no danger of falling rocks or landslides. When parking on low ground, park in a place where there is no problem of flooding. When parking the machine, lower the work equipment to the ground.
- If the machine must be parked on a slope, block the tracks, lower the work equipment and thrust the bucket into the ground.
- After stopping the engine, operate the right work equipment control lever to the RAISE and LOWER positions 2 or 3 times to release the pressure remaining in the hydraulic circuit.
- When parking on public roads, provide fences, signs, flags, or lights, and put up any other necessary signs to ensure that passing traffic can see the machine clearly, and park the machine so that the machine, flags, and fences do not obstruct traffic.  
**Parking procedure → See "12.17 PARKING MACHINE".**
- When leaving the machine, lower the work equipment completely to the ground, set safety lock lever ① to the LOCK position, then stop the engine and use the key to lock all the equipment. Always remove the key and take it with you.  
**Work equipment posture → See "12.17 PARKING MACHINE".**  
**Locks → See "12.21 LOCKING".**
- Always close the door of the operator's compartment.

**CORRECT**

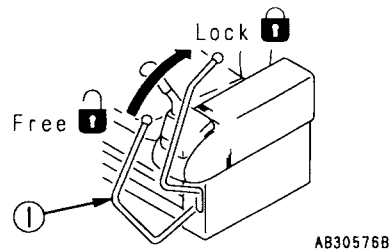
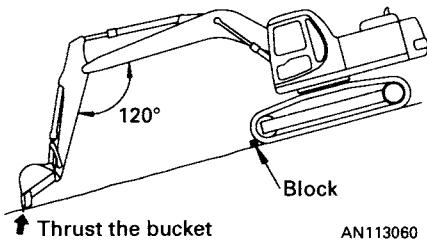

**PRECAUTIONS IN COLD WEATHER**

- After completing operations, remove any drops of water, snow, or mud stuck to the wiring harnesses, connector ①, switches, or sensors, and cover these parts.  
If drops of water get in and freeze, the machine may malfunction when it is next used, and this may lead to an unexpected accident.
- Carry out the warming-up operations thoroughly. If the control levers are operated before the machine is fully warmed up, the response of the machine will be slow, and this may lead to an unexpected accident.
- Operate the control levers to relieve the hydraulic pressure (raise the pressure to above the set pressure of the hydraulic circuit and relieve the pressure oil to the hydraulic tank) to warm up the oil in the hydraulic circuit.  
This improves the response of the machine and prevents mistaken operation.
- If the battery electrolyte is frozen, do not charge the battery or start the engine with power from another source. There is danger that the battery may catch fire.  
When charging the battery or starting with power from another source, let the battery electrolyte melt and check that there is no leakage of battery electrolyte before starting the operation.  
**Battery charge ratio → See "14.1.3 BATTERY".**
- In cold weather, do not touch metal surfaces with your bare hands. If you touch a metal surface in extremely cold weather, your skin may freeze to the metal surface.

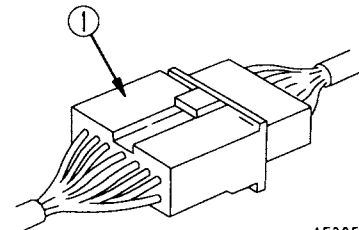

AE305820

**NEVER LET ANYONE RIDE ON ATTACHMENT**

Never let anyone ride on any work attachment, such as the bucket, crusher, grapple, or clamshell (grab bucket). There is danger of the person falling and suffering serious injury.

## 7.3 TRANSPORTATION

### LOADING AND UNLOADING

- Loading and unloading the machine always involves potential hazards. **EXTREME CAUTION SHOULD BE USED.**
- When loading or unloading the machine, run the engine at low idling and travel at low speed.
- Perform loading and unloading on firm, level ground only. Maintain a safe distance from the edge of the road.
- **ALWAYS** use ramps of adequate strength. Be sure that the ramps are wide, long, and thick enough to provide a safe loading slope. If there is excessive deflection of the ramps, strengthen the ramp with blocks.
- When loading or unloading the machine on piled soil or temporarily structure, be careful to ensure that the width, strength, and angle of the slope fulfill the limits.
- To prevent the machine from slipping, remove all oil, grease, or other material from the surface of the ramps. Remove all mud from the undercarriage of the machine. Be particularly careful on rainy days because the machine is more likely to slip.
- **NEVER** correct your steering on the ramps. If necessary, drive away from the ramps and climb again.
- The center of gravity of the machine will change suddenly at the joint between the ramps and the track or trailer, and there is danger of the machine losing its balance. Travel slowly over this point.
- After loading, block the machine tracks and secure the machine with wire rope.  
**Loading and unloading → See "13. TRANSPORTATION".**  
**Tie-downs → See "13.2.3 SECURING MACHINE".**

#### CORRECT

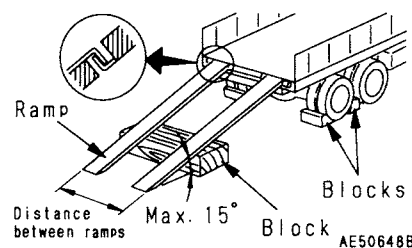

### SHIPPING

- When shipping the machine on a hauling vehicle, obey all state and local laws governing the weight, width, and length of a load. Also obey all applicable traffic regulations.
- Take into account the width, height and weight of the load when determining the shipping route.  
**Height, width, weight limits → See "13. TRANSPORTATION".**
- When traveling over bridges or structures on private land, check first that the bridge or structure can withstand the weight of the machine. When traveling on public roads, check with the local authorities and follow their instructions.
- For machines equipped with a cab, always lock the door securely.

**PRECAUTIONS WHEN LIFTING MACHINE**

When lifting the machine, always do as follows.

- Carry out the lifting operation on flat ground.
- Do not carry out the lifting operation with any person on the machine.
- Use wire rope that has ample strength to lift the weight of the machine.
- For details of the machine weight: See "25. SPECIFICATIONS".  
The specifications are the standard specifications, so the method of lifting may differ according to the attachments and options actually installed. When lifting machines with different attachment, please contact your Komatsu distributor for advice.
- Swing the upper structure so that it is at the sprocket end and set the upper structure parallel to the undercarriage when lifting.  
**Work equipment position → See "13.3 METHOD OF LIFTING MACHINE".**
- When lifting the machine, pay careful attention to the center of gravity to maintain the balance.
- Do not go under the machine when it is raised.

Travel in reverse direction

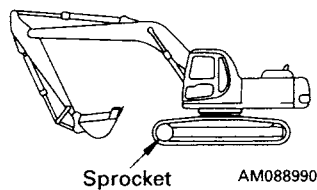

**⚠ WARNING:** Failure to follow these safety precautions may lead to a serious accident.

## 7. PRECAUTIONS DURING OPERATION

### 7.4 BATTERY

#### BATTERY HAZARD PREVENTION

Battery electrolyte contains dilute sulfuric acid and batteries generate hydrogen gas. Hydrogen gas is highly explosive, and mistakes in handling can cause serious injury or fire. To prevent problems, always do as follows.

- Do not smoke or bring any flame near the battery.
- When working with batteries, **ALWAYS** wear safety glasses and rubber gloves.
- If you spill battery electrolyte on yourself or your clothes, immediately flush the area with water.
- If battery electrolyte gets into your eyes, flush them immediately with large quantities of water and see a doctor at once.
- If you accidentally drink battery electrolyte, drink a large quantity of water or milk, raw egg or vegetable oil. Call a doctor or poison prevention center immediately.
- When cleaning the top surface of the battery, wipe it with a clean, damp cloth. Never use gasoline, thinner, or any other organic solvent or detergent.
- Tighten the battery caps securely.
- If the battery electrolyte is frozen, do not charge the battery or start the engine with power from another source. There is danger that the battery may catch fire.  
When charging the battery or starting with power from another source, let the battery electrolyte melt and check that there is no leakage of battery electrolyte before starting the operation.
- Always remove the battery from the machine before charging.

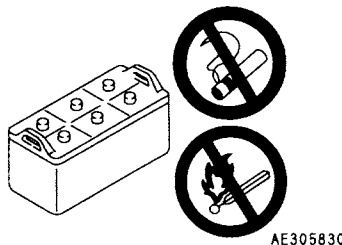
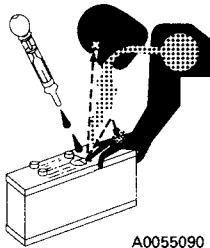

#### STARTING WITH BOOSTER CABLES

If any mistake is made in the method of connecting the booster cables, it may cause fire. Always do as follows.

- Use two workers for the starting operation: one of these sits in the operator's seat.
- When using another machine to start a problem machine, be careful not to let the normal machine and problem machine touch each other.
- When connecting the booster cables, turn the starting switches OFF on both the normal machine and the problem machine.
- Be sure to connect the positive  $\oplus$  cable first when installing the booster cables. Disconnect the ground or negative  $\ominus$  cable first when removing them.
- Finally, when connecting the ground cable to the frame of the upper structure, sparks will be caused, so be sure to connect it as far as possible from the battery.

**Starting with booster cables → See "16.5 IF BATTERY IS DISCHARGED".**

- When removing the booster cable, be careful not to let the booster cable clips contact each other or let the clip contact the machine.

#### INCORRECT

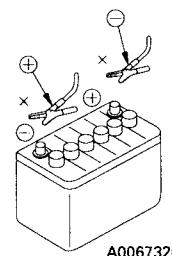

**CHARGING BATTERY**

When charging the battery, if the battery is not handled correctly, there is danger that the battery may explode. Always follow the instructions for use of the battery and the instruction manual accompanying the charger, and do as follows.

- Take the charger to a well-ventilated place and remove the battery caps.  
This is to disperse the hydrogen gas and prevent explosion.
- Set the voltage of the charger to match the voltage of the battery to be charged. If the voltage is not selected correctly, the charger may overheat and cause an explosion.
- Connect the positive ⊕ charger clip of the charger to the positive ⊕ terminal of the battery, then connect the negative ⊖ charger clip of the charger to the negative ⊖ terminal of the battery. Be sure to fix the clips securely.
- Set the charging current to 1/10 of the value of the rated battery capacity; when carrying out rapid charging, set it to less than the rated battery capacity.  
If the charger current is too high, the electrolyte will leak or dry up, and this may cause the battery to catch fire and explode.



A0055110

## 7.5 TOWING

### PRECAUTIONS WHEN TOWING

If any mistake is made in the method of selecting or inspecting the towing wire or in the method of towing, it may lead to serious personal injury. Always do as follows.

- Always use the method of towing given in this Operation and Maintenance Manual. Do not use any other method.

**Method of towing → See "16.2 METHOD OF TOWING MACHINE".**

- Use leather gloves when handling the wire rope.
- When carrying out the preparation work for towing with two or more workers, determine the signals to use and follow these signals correctly.
- Always fit the towing rope to the left and right hooks and secure in position.
- If the engine on the problem machine will not start or there is a failure in the brake system, always contact your Komatsu distributor.
- Never go between the towing machine and the towed machine during the towing operation.
- It is dangerous to carry out towing on slopes, so select a place where the slope is gradual. If there is no place where the slope is gradual, carry out operations to reduce the angle of the slope before starting the towing operation.
- When towing a problem machine, always use a wire rope with a sufficient towing capacity.
- Do not use a frayed (A), kinked (B) rope or a rope with any loss of diameter (C).
- Do not use the light-weight towing hook for towing another machine.

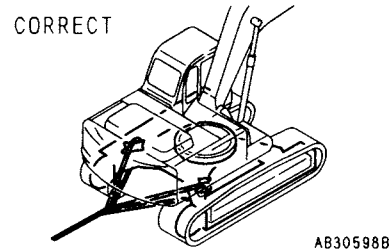
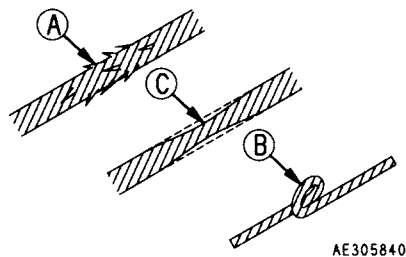



## 7.6 BUCKET WITH HOOK

### PROHIBITED OPERATIONS

This machine is not designed to be used as a crane, so crane operations are prohibited. However, the following work is possible using the bucket with hook.

- Trench timbering work
- Cases where the nature of work requires it or when it is necessary for ensuring safe operation.

### PRECAUTIONS WHEN INSTALLING AND OPERATING BUCKET WITH HOOK

The swing speed of a hydraulic excavator is 3 – 4 times that of a mobile crane. When swinging with a raised load, adjust the swing speed so that the machine does not tip over.

Lifting operations with a hydraulic excavator are permitted if they fulfill the following special conditions. Always follow these conditions.

- The specified special hook is installed to the bucket. For details, please contact your Komatsu distributor.
- If the special hook is installed, there are extra items for the check before starting and periodic inspection, and the recording and storage of the periodic self-inspection is required.
- When carrying out work with a lifted load, set the machine on firm, flat ground and install the wire rope securely to the special lifting hook.
- Lifting operations are prohibited except for the main purpose. Never use the work equipment to lift people.
- People are not allowed within the operating radius.
- When carrying out lifting operations, decide a leader for the operation and the method of operation, procedure, and signs, and follow the directions from the leader.
- Wear leather gloves when handling the wire rope, and do not use any wire rope that does not fulfill the specified standards.
- When carrying out lifting operations, reduce the engine speed and operate slowly.
- Do not leave the operator's seat when there is a raised load.
- It is dangerous to carry out operations that exceed the performance of the machine or to pull the load to the side or in towards the machine.
- Do not travel with a raised load.
- Depending on the operating posture of the machine, there is danger that the wire rope or lifting ring may come off, so be extremely careful to maintain the hook at an angle where the wire rope or ring do not come off.

**INCORRECT**

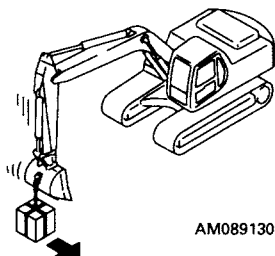

**INCORRECT**

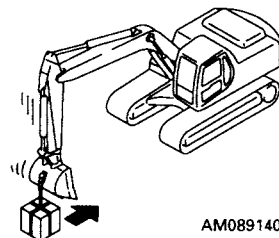

## 8. PRECAUTIONS FOR MAINTENANCE

**⚠ WARNING:** Failure to follow these safety precautions may lead to a serious accident.

### 8.1 BEFORE CARRYING OUT MAINTENANCE

#### CONTACT WHEN THERE IS FAILURE

Carrying out maintenance that is not listed in the Komatsu Operation and Maintenance Manual may cause unexpected failure. Please contact your Komatsu distributor for repairs.

#### WARNING TAG

ALWAYS attach the "DO NOT OPERATE" warning tag to the gearshift lever in the operator's cab to alert others that you are working on the machine. Attach additional warning tags around the machine if necessary.

If others start the engine or operate the controls while you are performing inspection or maintenance, you could suffer serious injury.

Warning tag part No. 09963-03000

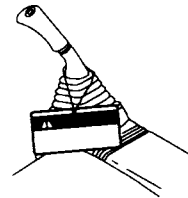
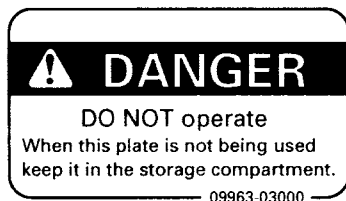

AE305910

#### CLEAN BEFORE INSPECTION OR MAINTENANCE

- Clean the machine before carrying out inspection and maintenance. This prevents dirt from getting into the machine and also ensures safety during maintenance.
- If inspection and maintenance are carried out when the machine is dirty, it will become more difficult to locate the problems, and also there is danger that you may get dirt or mud in your eyes or that you may slip and injure yourself.
- When washing the machine, do as follows.
  - Wear shoes with non-slip pads to prevent yourself from slipping and falling on wet places.
  - Wear protective clothing when washing the machine with high-pressure steam.
  - Take action to prevent touching high-pressure water and cutting your skin or having mud fly into your eyes.
  - Do not spray water directly on electrical components (sensors, connector) ①. If water gets into the electrical system, there is danger that it will cause defective operation and malfunction.

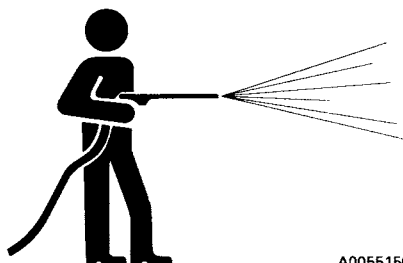

A0055150

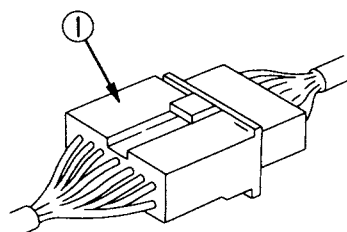

AE305820

### NEAT CLEAN WORK PLACE

Tidy any tools or hammers that are lying in the work place, wipe up any grease or oil or any other slippery substances, and clean the area to make it possible to carry out the operation in safety. If the work place is left untidy, you may trip or slip and suffer injury.

### FOLLOW LEADER IN OPERATIONS WITH OTHER WORKERS

When carrying out repairs of the machine or removal and installation of components, decide a leader and follow the instructions of the leader.

There is danger that differences of opinion between workers when working together may lead to misunderstandings and cause an expected accident.

### RADIATOR WATER LEVEL

- When checking the radiator water level, stop the engine, let the engine and radiator cool down, then check the sub tank. If the water level in the sub tank is near the upper limit, there is enough water in the radiator.
- If the water level in the sub tank is below the lower limit, add water.
- There is no need to remove the radiator cap unless the coolant is being changed, but if there is no sub tank, or if it is necessary to remove the radiator cap, do as follows.
  - Wait for the radiator water temperature to go down, then check the water level. (When checking how much the water temperature has gone down, bring your hand close to the surface of the engine or radiator without touching it, and check the temperature of the air at the engine or radiator surface.)
  - Loosen the radiator cap gradually to release the internal pressure before removing the radiator cap.



A0055050

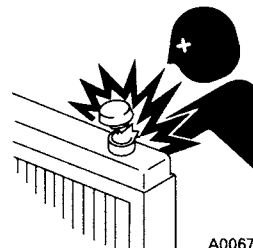

A0067380

### DO NOT DISASSEMBLE RECOIL SPRING

The recoil spring assembly used to cushion the idler has a powerful spring built in, so if it is disassembled by mistake, the spring and other parts may fly out and cause serious injury or death. Never try to disassemble the recoil spring assembly.

**⚠ WARNING:** Failure to follow these safety precautions may lead to a serious accident.

**STOP THE ENGINE BEFORE CARRYING OUT INSPECTION AND MAINTENANCE**

- When carrying out inspection and maintenance, always stop the machine on firm, level ground where there is no danger of falling rocks and landslides, and where there is no danger of floods. Lower the work equipment to the ground and stop the engine.
- Operate the work equipment control lever to the RAISE and LOWER positions 2 or 3 times to release the remaining pressure in the hydraulic circuit, then set safety lock lever ① to the LOCK position.
- Put blocks under the shoes to prevent the track from moving. The worker carrying out the maintenance should be extremely careful not to touch or get caught in the moving parts.

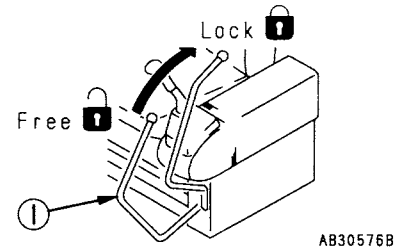
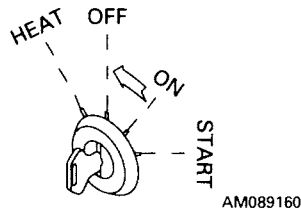
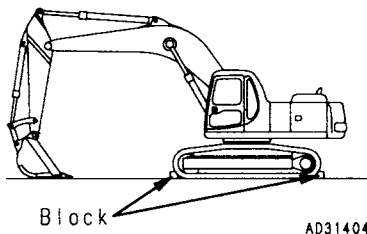

**SUPPORT FOR WORK EQUIPMENT**

When carrying out inspection and maintenance with the work equipment raised, fit stand ② under the boom to prevent the work equipment from moving down. In addition, set the work equipment control levers to HOLD, then set safety lock lever ① to the LOCK position.

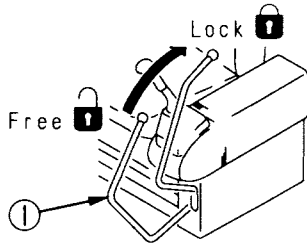

AB30576B



A0055140

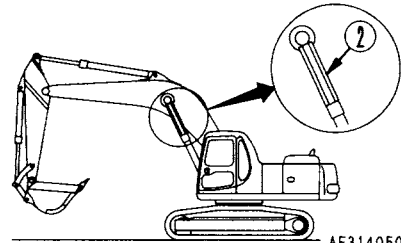

AE314050

**PROPER TOOLS**

Use only tools suited to the task. Using damaged, low quality, faulty, or makeshift tools could cause personal injury. There is danger that pieces from chisels with crushed heads or hammers may get into your eyes and cause blindness.

**Tools → See "21.1 INTRODUCTION OF NECESSARY TOOLS".**



A0055120

**PERIODIC REPLACEMENT OF SAFETY CRITICAL PARTS**

Hoses in the fuel system, hydraulic system, and brake system are important parts for safety, so they must be replaced at periodic intervals.

The replacement of such safety critical parts requires skill and experience, so please contact your Komatsu distributor for replacement.

- Replace these components periodically with new ones, regardless of whether or not they appear to be defective. These components deteriorate over time, and leakage of oil may cause fire or failure of the work equipment system.
- Replace or repair any such components if any defect is found, even though they have not reached the time specified.

**Replacement of safety critical parts → See "22. PERIODIC REPLACEMENT OF SAFETY CRITICAL PARTS".**

### USE OF LIGHTING

- When checking fuel, oil, battery electrolyte, or window washing fluid, always use lighting with anti-explosion specifications. If such lighting equipment is not used, there is danger of explosion.
- If work is carried out in dark places without using lighting, it may lead to injury, so always use lighting.
- Even if the place is dark, never use a lighter or flame instead of lighting. There is danger of fire. There is also danger that the battery gas may catch fire and cause an explosion.
- When taking the power for the lighting from the machine itself, follow the instructions in this Operation and Maintenance Manual.

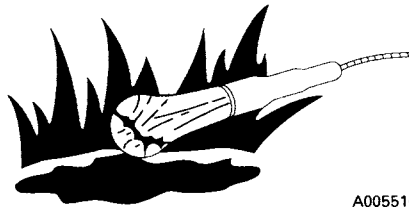

A0055160

### FIRE PREVENTION

During maintenance, fuel, batteries, and other materials which may catch fire are handled, so always do as follows.

- Store flammable materials such as fuel, oil, and grease away from frame.
- Do not leave the area when adding fuel or oil.
- Use non flammable oil as the oil for washing parts. Diesel oil and gasoline may catch fire, so do not use them.
- Do not smoke when carrying out inspection and maintenance. Always smoke in the specified smoking areas.
- When carrying out inspection of fuel, oil, or battery electrolyte, use lighting with anti-explosion specifications. Never use lighters or matches as lighting. Loose or damaged electrical connections may cause short circuits which may lead to fire. Always check during check before starting.
- Check that there is a fire extinguisher close to the location for carrying out inspection and maintenance.



A0055020

## 8.2 DURING MAINTENANCE

### PERSONNEL

Only authorized personnel can enter the area during the maintenance operation. If necessary, have a guard supervise the area.  
Extra precaution should be used when grinding, welding, and using a sledge-hammer.

### PRECAUTIONS FOR REMOVAL, INSTALLATION, AND STORAGE OF ATTACHMENTS

- Before starting removal and installation of attachments, decide the team leader.
- Do not allow anyone except the authorized workers close to the machine or attachment. Place attachments that have been removed from the machine in a safe place so that they do not fall. Put up a fence around the attachments and take other measures to prevent unauthorized persons from entering.



A0055130

### WORK UNDER MACHINE

- Stop the machine on firm, flat ground and lower the work equipment to the ground.
- Always block the track shoes of the machine securely.
- It is extremely dangerous to work with the track shoes jacked up from the ground using the work equipment. Never work with the machine raised in this way.



A0055140

### NOISE

If the surrounding noise is loud it may cause hearing problems or even loss of hearing.

- When carrying out maintenance of the engine or other operations with long exposure to noise, wear ear muffs or ear plugs.

**PRECAUTIONS WHEN WORKING ON MACHINE**

- When carrying out maintenance operations on the machine, keep the area around your feet clean and tidy to prevent you from falling. Always do as follows.
  - Do not spill oil or grease.
  - Do not leave tools lying about.
  - Watch your step when walking.
- Never jump down from the machine. When getting on or off the machine, use the steps and handrails, and maintain three-point contact (both feet and one hand or both hands and one foot) to support yourself securely.
- If the job requires it, wear protective clothing.
- To prevent injury from slipping or falling, when working on the hood or covers, never use any part except the inspection passage fitted with non-slip pads.



A0305870

**LOCK INSPECTION COVERS**

When carrying out maintenance with the inspection cover open, lock the cover securely in position with the lock bar.  
If maintenance work is carried out with the inspection cover open but not locked, there is danger that it may suddenly close and cause injury if there is a gust of wind.



### TWO WORKERS FOR MAINTENANCE WHEN ENGINE IS RUNNING

To prevent accidents, do not carry out maintenance with the engine running. If it is necessary to carry out maintenance with the engine running, always do as follows.

- One worker sits in the operator's seat so that it is possible to stop the engine immediately whenever necessary. The workers confirm their actions with each other.
- When working near rotating parts, be particularly careful. There is danger of getting caught.
- When cleaning the inside of the radiator, set safety lock lever ① to the LOCK position to make sure that the work equipment does not move.
- Be careful not to touch the control levers. If a control lever has to be operated, always signal your partner to move to a safe place.
- Never touch the fan blade or fan belt with your body or tools. There is danger of losing fingers or limbs.

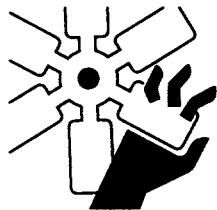

A0055210

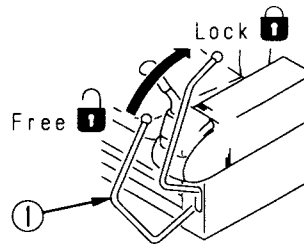

AB30576B

### DO NOT DROP TOOLS OR PARTS INSIDE MACHINE

- When carrying out inspection with the inspection window or tank oil filler open, be careful not to drop bolts, nuts, or tools inside the machine. If any part is dropped inside the machine, it will cause breakage or malfunctioning of the machine, which may lead to a serious accident. If you drop anything, always be sure to remove it.
- When carrying out inspection, put only the things necessary for inspection in your pockets.

### FLYING PIECES WITH HAMMER WORK

- When working with hammers, wear protective glasses, helmet, and other protective clothing. Put a brass rod between the hammer and the object when hitting with the hammer.
- If hard metal parts such as pins, edges, teeth, and bearings are hit with a hammer, there is danger that small pieces will fly off and get into your eyes.

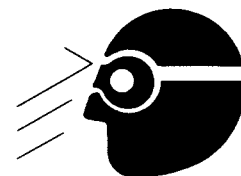

AE305880

### WELDING REPAIRS

When carrying out welding repairs, carry out the welding in a properly equipped place. The welding should be performed by a qualified worker. During welding operations, there is the danger of generation of gas, fire, or electric shock, so never let an unqualified worker do welding.

The qualified welder must do as follows.

- To prevent explosion of the battery, remove the battery terminals.
- To prevent generation of gas, remove the paint from the location of the weld.
- If hydraulic equipment or piping or places close to them are heated, a flammable gas or mist will be generated and there is danger of it catching fire. To avoid this, never subject these places to heat.
- If heat is applied directly to rubber hoses or piping under pressure, they may suddenly break, so cover them with a fireproof covering.
- Wear protective clothing.
- Make sure there is good ventilation.
- Remove all flammable objects and provide a fire extinguisher.

### REMOVE BATTERY TERMINALS

When repairing the electrical system or when carrying out electric welding, remove the negative ⊖ terminal of the battery to stop the flow of electricity.

**Handling battery → See "16.5 IF BATTERY IS DISCHARGED".**

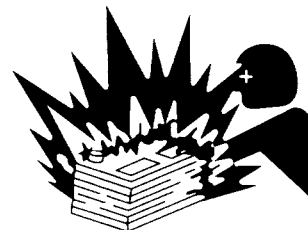

A0055170

### ACTION WHEN ABNORMALITY IS FOUND DURING INSPECTION

- If any abnormality is found during inspection, always carry out repairs. In particular, if the machine is used when there are still problems with the brake or work equipment systems, it may lead to serious injury.
- If necessary depending on the type of failure, please contact your Komatsu distributor for repairs.

### RULES TO FOLLOW WHEN ADDING FUEL OR OIL

If flame is brought close to fuel or oil, there is danger that it will catch fire. Always do as follows.

- Stop the engine when adding fuel or oil.
  - Do not smoke.
  - Wipe up spilled fuel and oil immediately.
  - Always tighten the caps of the fuel and oil fillers securely.
  - Always add fuel and oil in a well-ventilated place.
- Do not leave the work place when adding fuel or oil.



A0055020

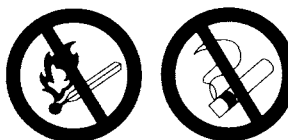

A0055040

### PRECAUTIONS WITH HIGH-PRESSURE GREASE WHEN ADJUSTING TRACK SHOE TENSION

- The track shoe adjustment device is filled with high- pressure grease. If maintenance is not carried out in the correct order, valve ① may fly off and cause serious injury.
- When loosening grease discharge valve ①, never loosen it more than one turn.
- Do not put your face, hands, feet, or body in the direction of mounting of the grease discharge valve.  
**Adjusting track shoe tension → See “24.2 WHEN REQUIRED”.**

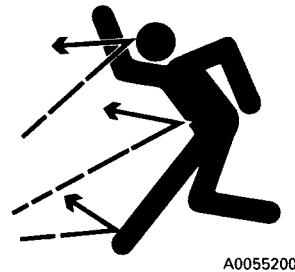
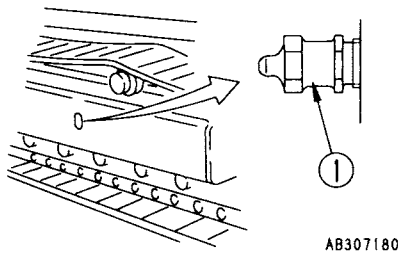

### HANDLING HIGH-PRESSURE HOSES

- If oil or fuel leaks from high-pressure hoses, it will cause serious injury through fire or defective actuation. If any damage to the hoses or loose bolts are found, stop operations immediately and contact your Komatsu distributor.
- Experience and skill is required when replacing high pressure hoses. The tightening torque is determined according to the type and size of the hose, so please contact your Komatsu distributor.
- If any of the following conditions are found, replace the part.
  - Damage or leakage from hose mouthpiece.
  - Wear, damage, cutting of covering, or exposure of strengthening wire layer.
  - Cover portion is swollen in places.
  - There is twisting or crushing at movable parts of hose.
  - Foreign material is embedded in the covering.
  - Hose mouthpiece is deformed.

**PRECAUTIONS WITH HIGH-PRESSURE OIL**

When inspecting or replacing high-pressure piping or hoses, check that the pressure has been released from the circuit. Failure to release the pressure may lead to serious injury. Always do as follows.

- For details of the method of releasing the pressure: see "INSPECTION AND MAINTENANCE WITH ENGINE STOPPED". Do not carry out any inspection or replacement operation before the pressure has been completely removed.
- Wear protective glasses and leather gloves.
- If there is any leakage from the piping or hoses, the piping and hoses and the area around them will be wet, so check for cracks in the piping or cracks or swelling in the hoses. If it is difficult to find the location, please contact your Komatsu distributor.
- If oil is leaking under high pressure from small holes, it is dangerous if it hits your skin or enters your eyes. It may make holes in your skin or cause blindness. If you are hit by a jet of high-pressure oil and suffer serious injury to your skin or eyes, wash off the oil with large amounts of water, then consult a doctor immediately for medical attention.

**INCORRECT**



**CORRECT**

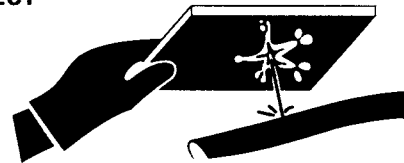

**PRECAUTIONS WHEN CARRYING OUT MAINTENANCE AT HIGH TEMPERATURE**

- Immediately after stopping operations, the engine coolant, oil at all parts, and the exhaust manifold and muffler are at high temperature. In this condition, if the cap is removed, or the oil or water is drained, or the filters are replaced, it may result in burns or other injury. Wait for the temperature to go down, then carry out the inspection and maintenance in accordance with the procedures given in this manual.

**Cleaning inside of cooling system → See "24.2 WHEN REQUIRED".**

**Checking coolant, hydraulic tank oil level → See "24.3 CHECK BEFORE STARTING".**

**Checking lubricating oil level, adding oil → See "24.3 CHECK BEFORE STARTING". - "24.7 EVERY 500 HOURS SERVICE".**

**Changing oil, replacing filters → See "24.5 EVERY 100 HOURS SERVICE". - "24.8 EVERY 1000 HOURS SERVICE".**

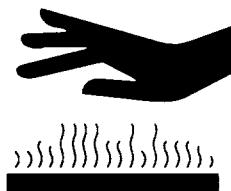

**CHECKS AFTER INSPECTION AND MAINTENANCE**

If inspection and maintenance items are forgotten or the function of the maintenance locations is not checked properly, unexpected problems may occur and this may lead to serious personal injury. Always do as follows.

- Checks after stopping engine
  - Has any inspection or maintenance location been forgotten?
  - Have any tools or parts been dropped? This is particularly dangerous if they get caught in the link mechanism for the levers.
  - Is there any leakage of water or oil? Have all the bolts been tightened properly?
- Checks when engine is running
  - For details of the checks when the engine is running: see "TWO WORKERS FOR MAINTENANCE WHEN ENGINE IS RUNNING", and pay full attention to safety.
  - Is the actuation of the inspection and maintenance locations correct?
  - Is there any oil leakage when the engine speed is raised and load is applied to the hydraulic system?

**WASTE MATERIALS**

To prevent pollution of the environment, always do as follows.

- Never dump waste oil in a sewer system, rivers, etc.
- Always put oil drained from your machine in containers. Never drain oil directly onto the ground.
- Obey appropriate laws and regulations when disposing of harmful materials such as oil, fuel, solvent, filters, and batteries.

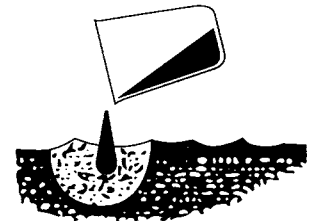
**INCORRECT**

A0055220

**MAINTENANCE OF AIR CONDITIONER**

If the air conditioner refrigerant gets into your eyes or touches your skin, it may cause blindness or frostbite.

- When handling the refrigerant, follow the precautions given on the container.
- To prevent the refrigerant from leaking into the atmosphere, use a recovery recycling system.
- Never touch the refrigerant.

## 9. POSITION FOR ATTACHING SAFETY LABELS

Always keep these labels clean. If they are lost or damaged, attach them again or replace them with a new label.

There are other labels in addition to the safety labels listed as follows, so handle them in the same way.

Safety labels may be available in languages other than English. To find out what labels are available, contact your Komatsu distributor.

### POSITION FOR ATTACHING SAFETY LABELS

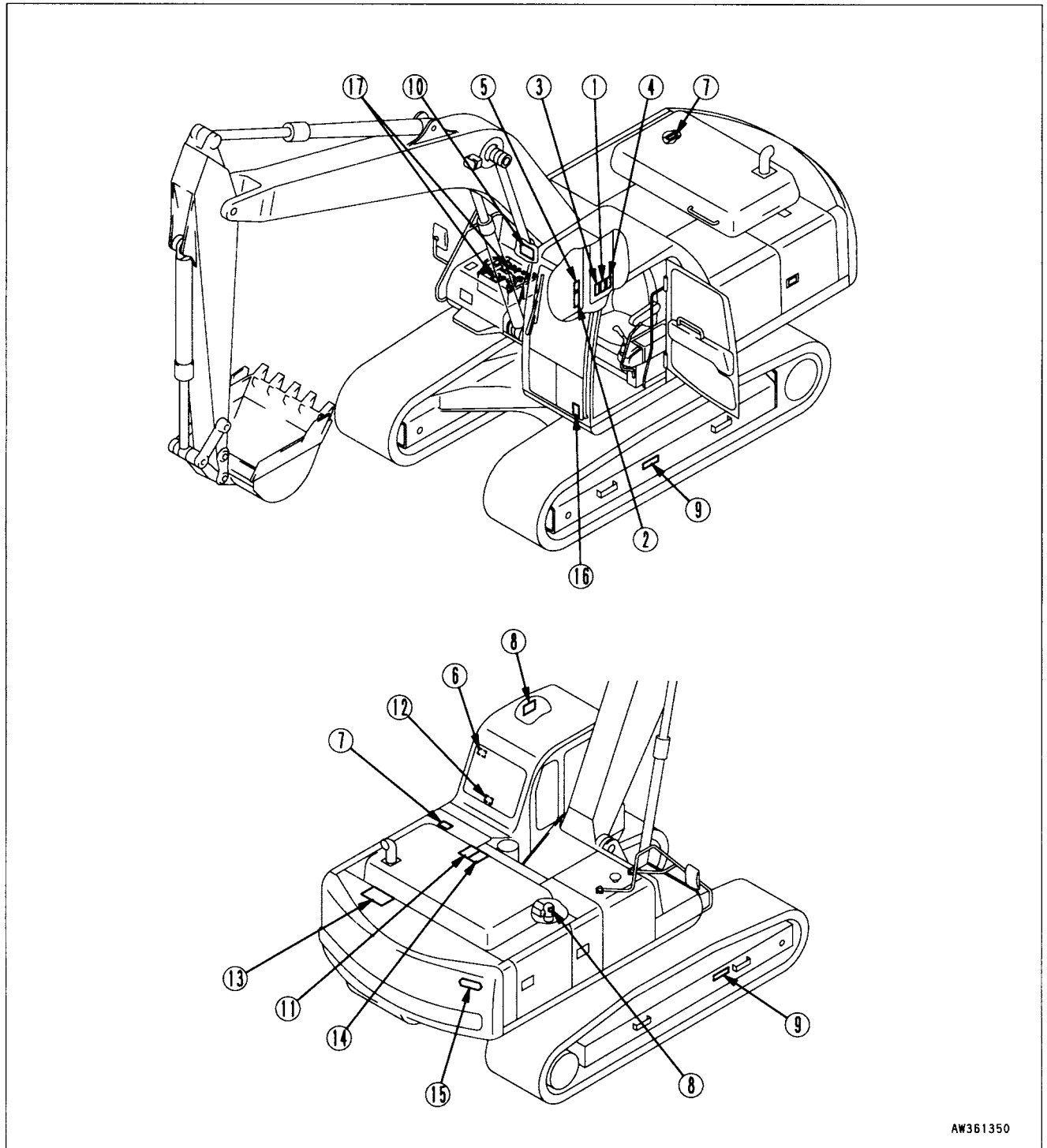

AW361350

9. POSITION FOR ATTACHING SAFETY LABELS

1. Warnings for operation, inspection and maintenance (09651-03001)

**⚠ WARNING**

Improper operation and maintenance can cause serious injury or death.

Read manual and labels before operation and maintenance.  
Follow instructions and warnings in manual and in labels on machine.

Keep manual in machine cab near operator.  
Contact Komatsu distributor for a replacement manual.

09651-03001

2. Warnings before operating machine (09802-03000)

**⚠ WARNING**

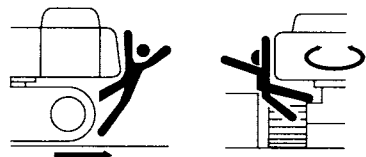

To prevent SEVERE INJURY or DEATH. Do the following before moving machine or its attachments:

- Honk horn to alert people nearby.
- Be sure no one is on or near machine or in swing area.
- Rotate cab for full view of travel path if it can be done safely.
- Use spotter if view is obstructed.

Follow above even if machine equipped with travel alarm and mirrors.

09802-03000

3. Warnings for leaving operator's seat (09654-03001)

**⚠ WARNING**

To avoid hitting unlocked operation levers, lower equipment to ground and move SAFETY LOCK LEVER (located near seat) to LOCK position before standing up from operator's seat.

Sudden and unwanted machine movement can cause serious injury or death.

09654-03001

4. Warnings for high voltage (09801-03001)

**⚠ DANGER**



Hazardous voltage hazard. Serious injury or death can occur if machine or attachments are not kept safe distance away from electric lines.

Line voltage	Safe Disatnce
6.6 kv	At least 10 ft (3 m)
66.0 kv	At least 16 ft (5 m)
275.0 kv	At least 33 ft (10 m)

09801-03001

5. Precautions for opening the window (09839-03000)

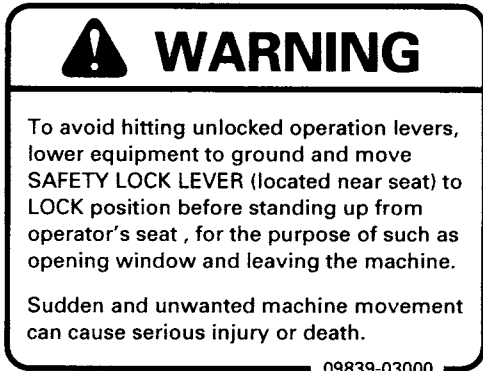

6. Warnings when opening front window (09803-03000)

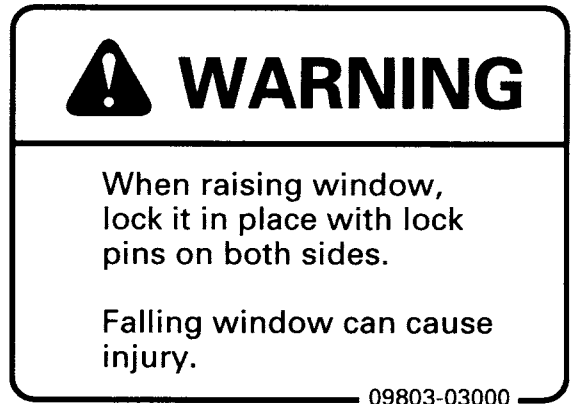

7. Warnings for hot water (09668-03001)



8. Warnings for handling accumulator (09659-53000)





9. POSITION FOR ATTACHING SAFETY LABELS

9. Warning for adjusting track tension  
(09657-03003)

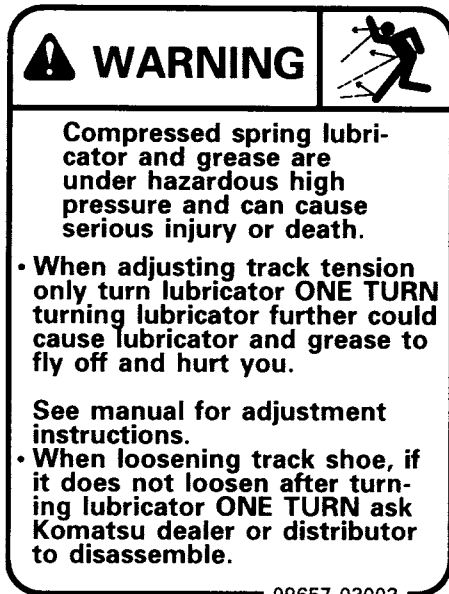

10. Warning for battery cable  
(09808-03000)

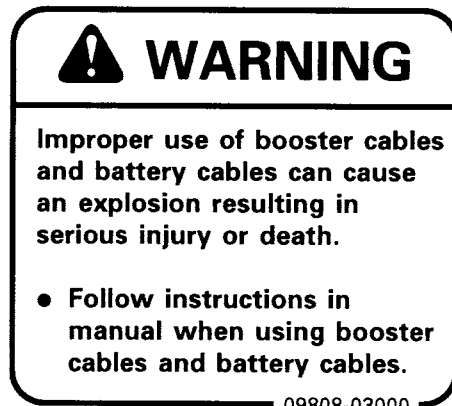

11. Caution for engine running  
(09667-03001)

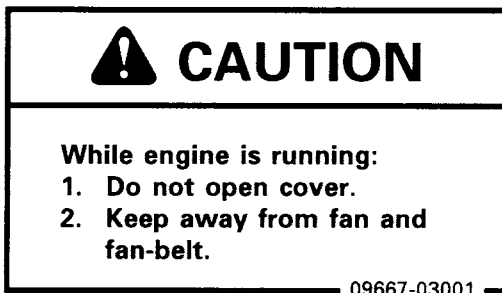

12. Explanation of escape method in emergency  
(20Y-00-22880)

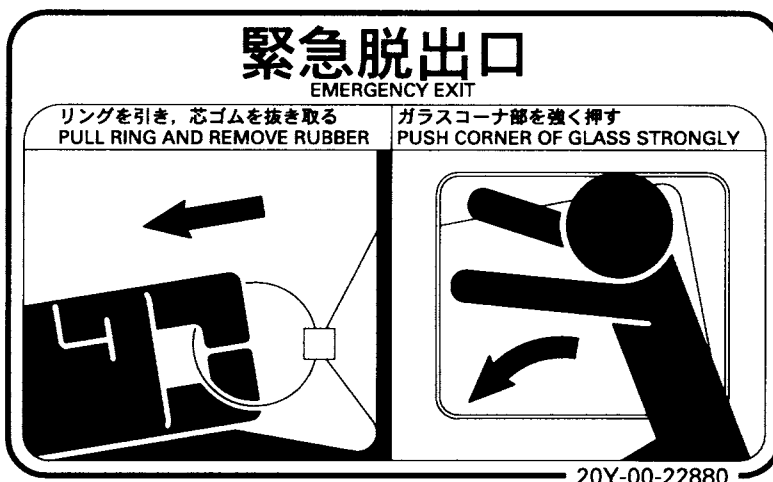

13. Precautions for avoiding falling down  
(09805-23000)

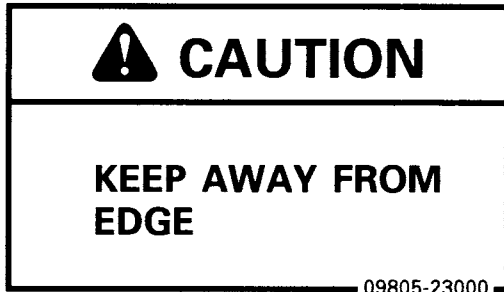

14. Caution for food  
(09805-13000)

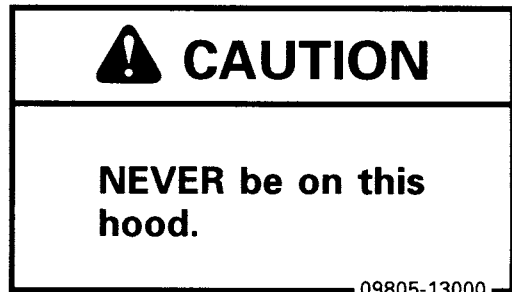

15. Keep off swing area  
(09133-23000)



16. Caution with bucket when operating work equipment (machine equipped with FOPS)  
(205-00-71710)

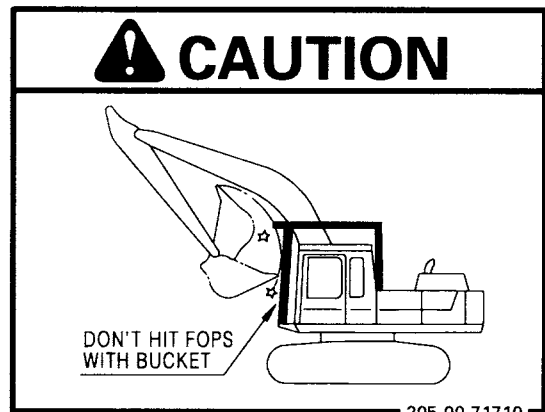

17. Precautions when handling battery  
(14X-98-11370)

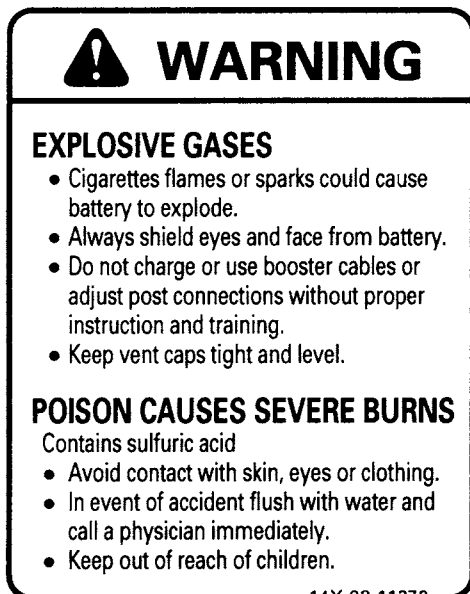

# OPERATION

# 10. GENERAL VIEW

## 10.1 GENERAL VIEW OF MACHINE

If directions are indicated in this section, they refer to the directions shown by the arrows in the diagram below.

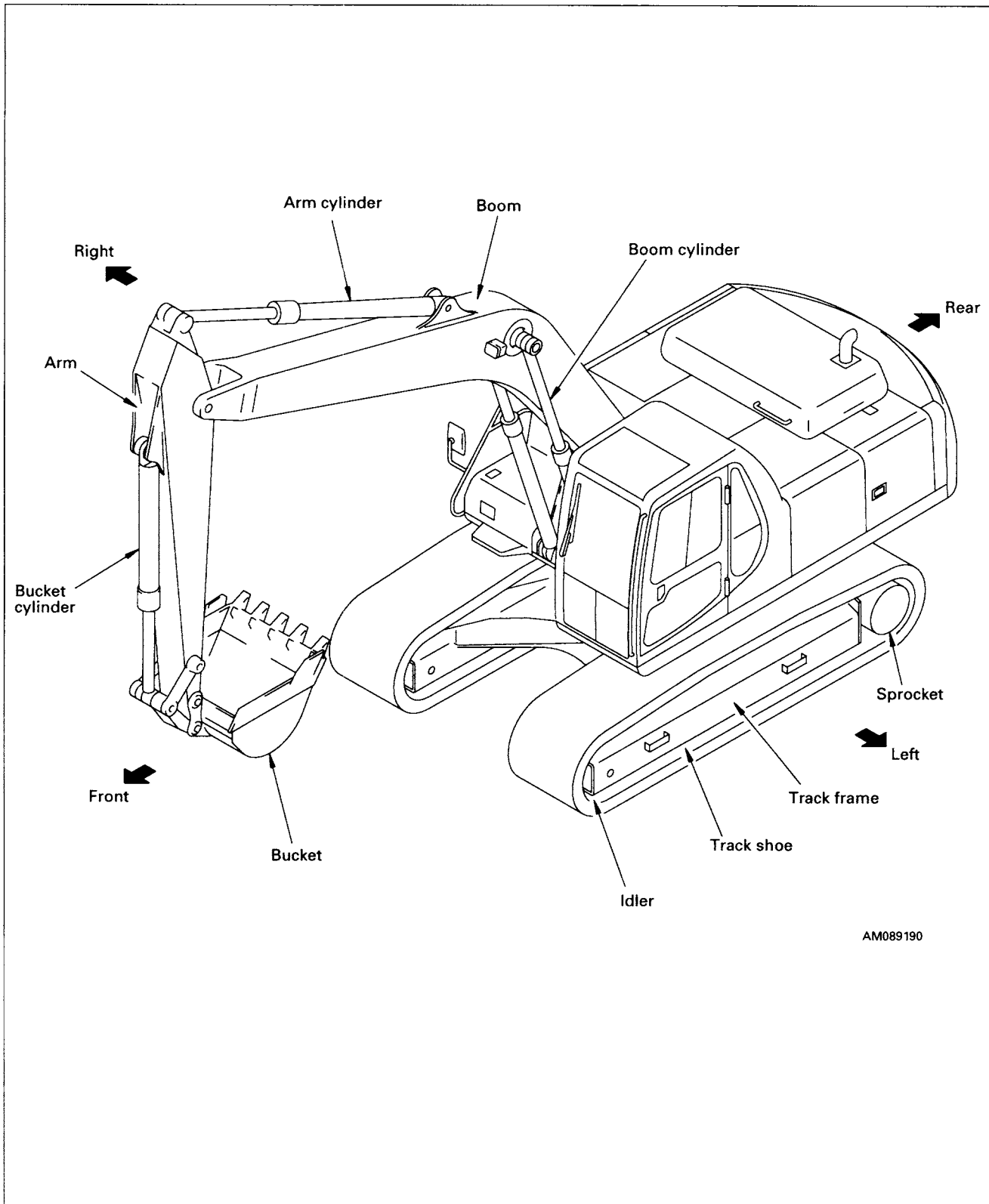

10.2 GENERAL VIEW OF CONTROLS AND GAUGES

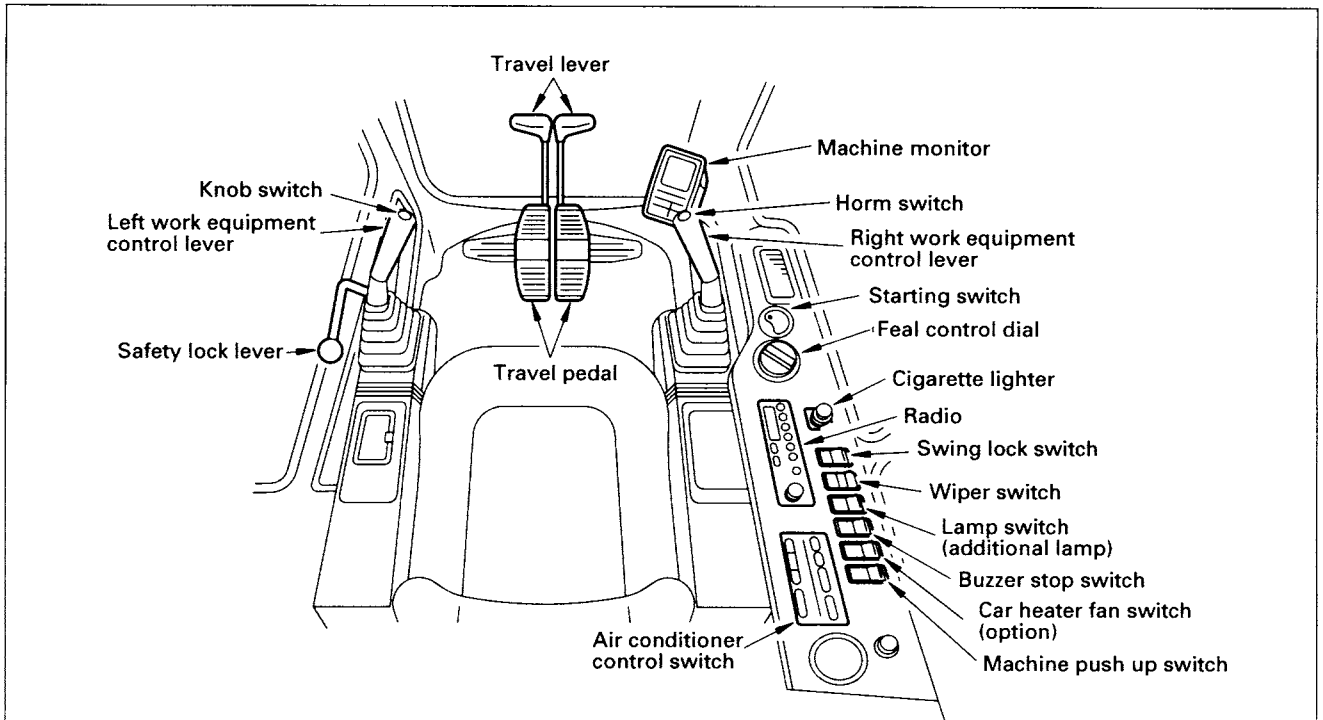

AM162500

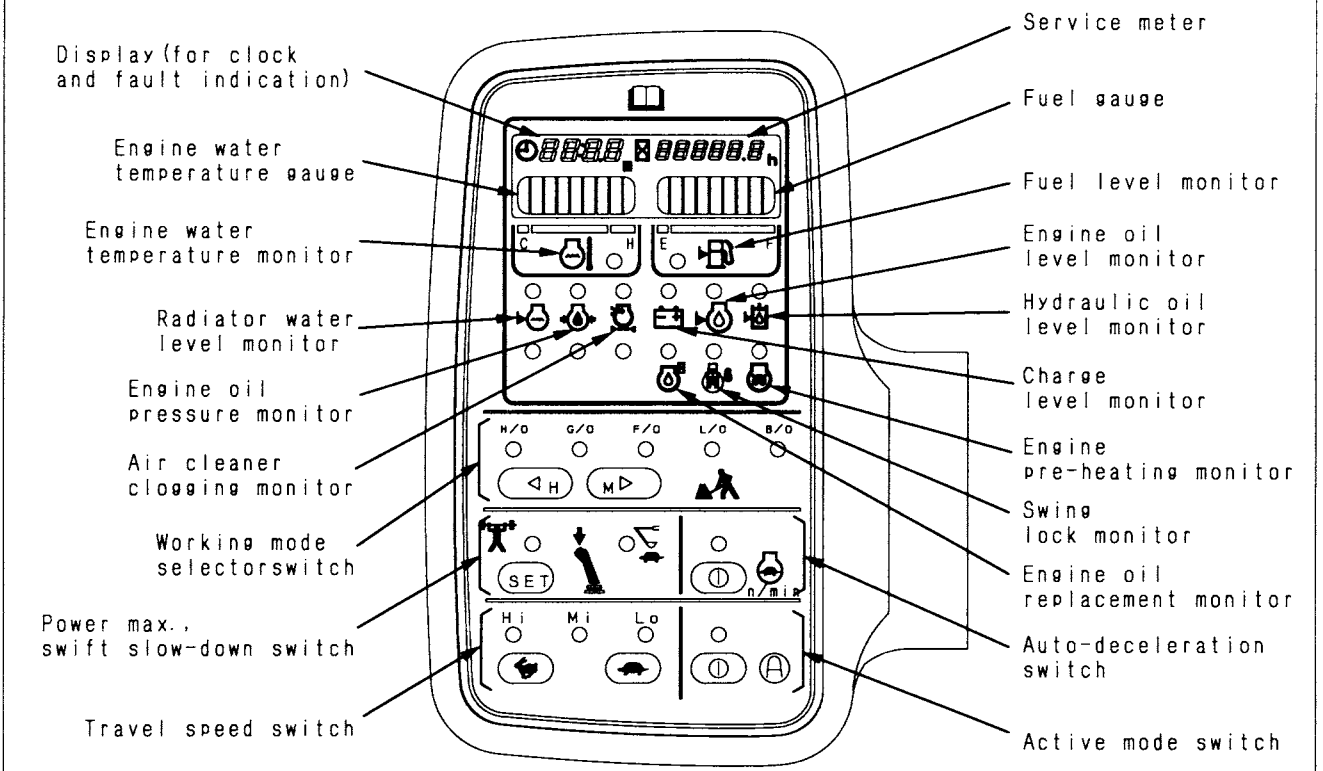

A032421B

# 11. EXPLANATION OF COMPONENTS

The following is an explanation of the devices needed for operating the machine.

To carry out suitable operations correctly and safely, it is important to understand fully the methods of operating the equipment and the meanings of the displays.

## 11.1 MACHINE MONITOR

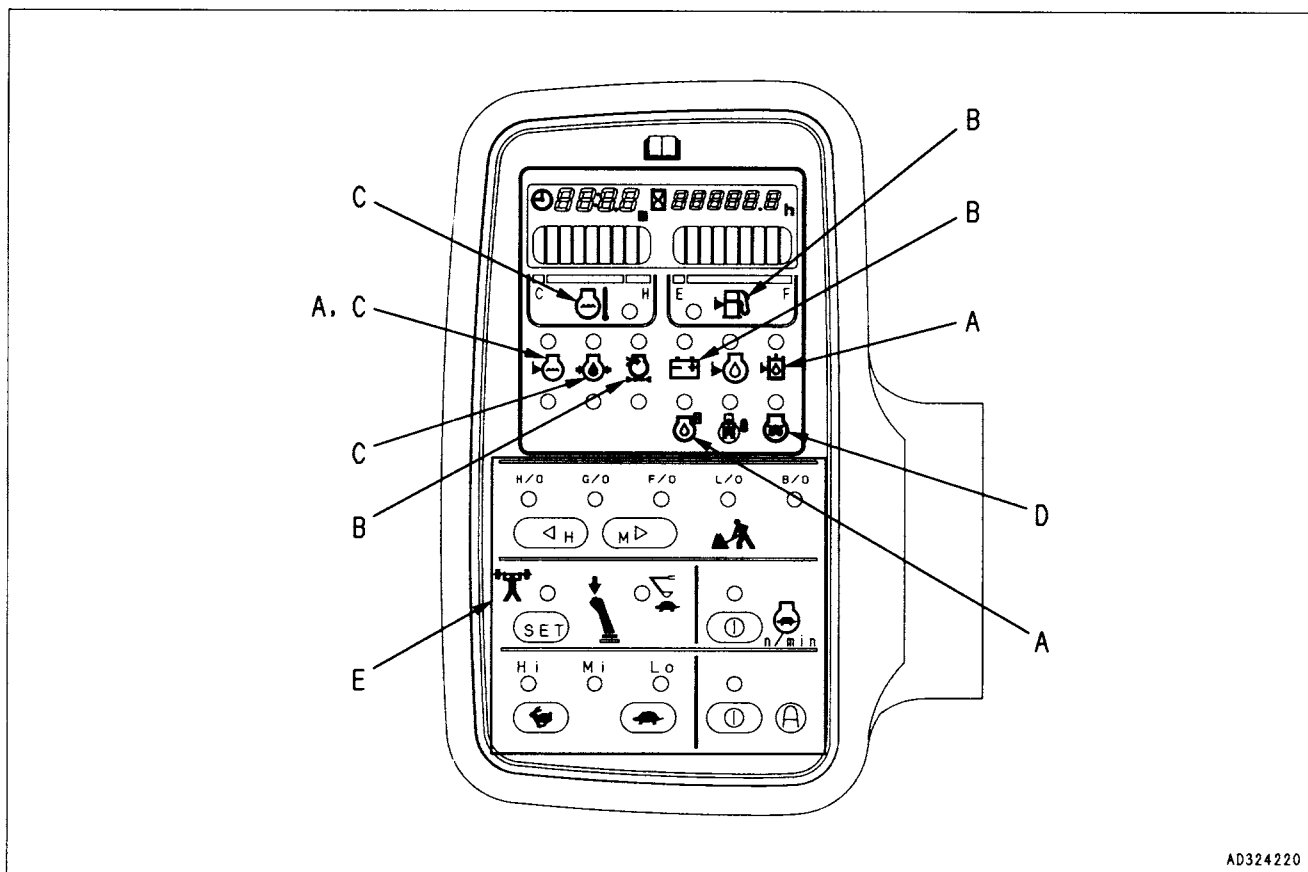

AD324220

### A. BASIC CHECK ITEMS (11.1.1)

This displays the basic items that should be checked before starting the engine.

If there is any abnormality, the appropriate monitor lamp will flash.

### NOTICE

**When carrying out checks before starting, do not simply rely on the monitor. Always refer to the periodic maintenance items or "12. OPERATION" to carry out the checks.**

**B. CAUTION ITEMS (11.1.2)**** CAUTION**

**If these monitor items flash, check and repair the appropriate location as soon as possible.**

These are items which need to be observed while the engine is running. If any abnormality occurs, items which need to be repaired as soon as possible are displayed.

If there is any abnormality, the appropriate monitor lamp will flash to indicate the location of the abnormality.

**C. EMERGENCY STOP ITEMS (11.1.3)**** CAUTION**

**If these monitor items flash, stop operations immediately, then check and repair the appropriate location.**

These are items which need to be observed while the engine is running. If any abnormality occurs, items which need to be repaired immediately are displayed.

**D. METER DISPLAY PORTION (11.1.4)**

This portion consists of pre-heating monitor, swing lock monitor, engine water temperature gauge, fuel gauge, service meter and display.

**E. SWITCHES (11.1.5)**

This select working mode, travel speed and time setting of clock.

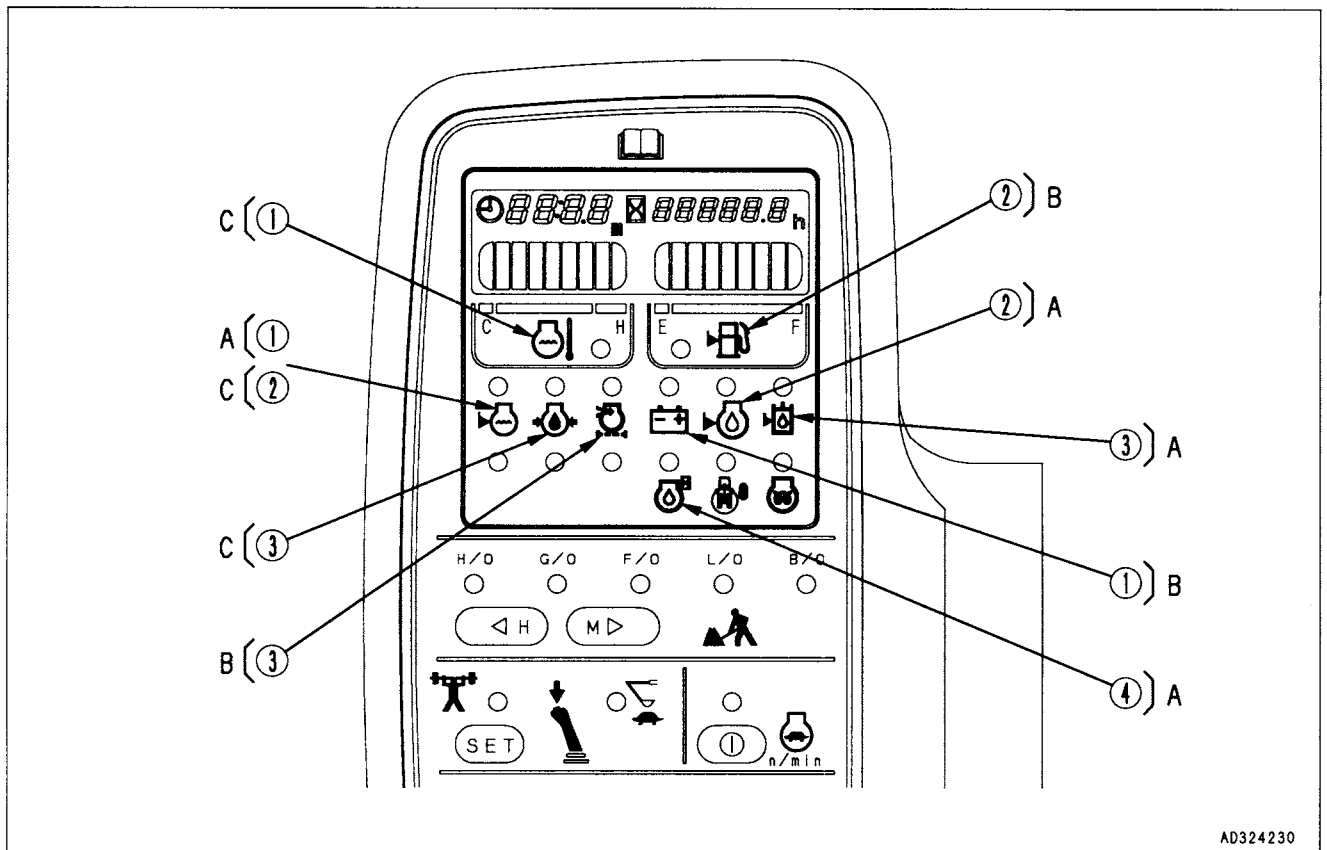

AD324230

### 11.1.1 A: BASIC CHECK ITEMS

#### NOTICE

Do not rely on the "BASIC CHECK ITEMS" only for the check before starting

Always refer to the periodic maintenance items or "12. OPERATION" to carry out the checks.

#### 1. RADIATOR WATER LEVEL

This warns that the radiator cooling water level is too low. If the monitor lamp flashes, check the cooling water level in the radiator and reserve-tank, and add water.

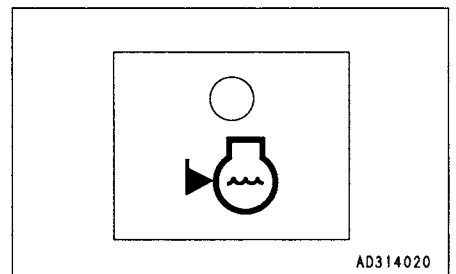

AD314020

#### 2. ENGINE OIL LEVEL

This warns that the oil level in the engine oil pan is too low. If the monitor lamp flashes, check the oil level in the engine oil pan, and add oil.

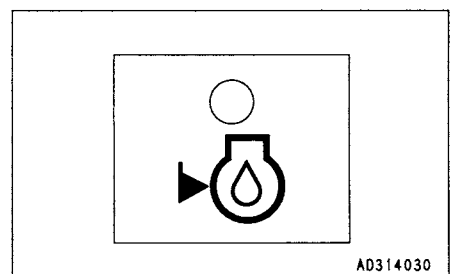

AD314030



**3. HYDRAULIC OIL LEVEL**

This warns that the hydraulic oil level is too low.  
If the monitor lamp flashes, check the hydraulic oil level, and add oil.

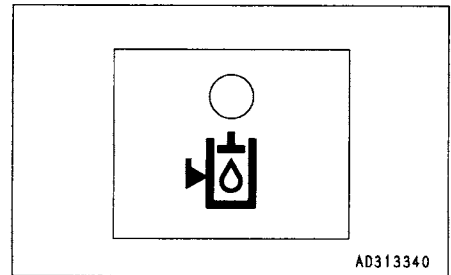
**4. REPLACEMENT OF ENGINE OIL (For only set machines)**

If the set time (125, 250, 500H) passes after the engine oil is replaced, this lamp lights up. At this time, replace the engine oil.

If you want to change the set time for replacement of oil, please consult your Komatsu distributor.

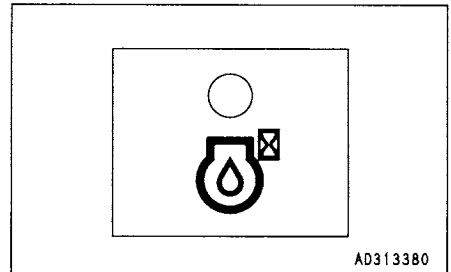
**11.1.2 B: CAUTION ITEMS**

—  **CAUTION** —

**If the caution monitor lamp flashes, repair the problem as soon as possible.**

**1. CHARGE LEVEL**

This monitor indicates an abnormality in the charging system while the engine is running.

If the monitor lamp flashes, check the V-belt tension. If any abnormality is found, see "16.6 OTHER TROUBLE".

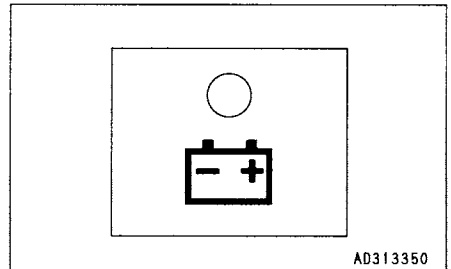
**REMARK**

While the starting switch is ON, the lamp will remain lit and will go off once the engine is started.

**2. FUEL LEVEL**

If the fuel drops below 55 liters (14.5 US gal, 12.2 UK gal), the lamp will flash. Top up the fuel before this.

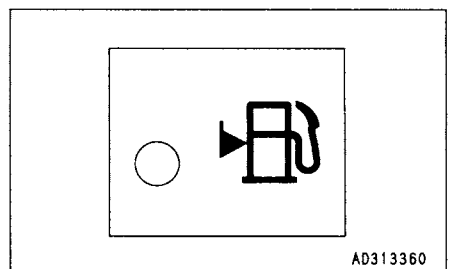

**3. AIR CLEANER CLOGGING**

This warns that the air cleaner is clogged.  
If the monitor lamp flashes, stop the engine, then inspect and clean the air cleaner.

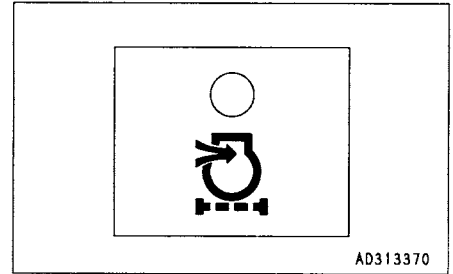

**11.1.3 C: EMERGENCY STOP ITEMS**

**CAUTION**

If any monitor lamp flashes, stop the engine or run it at low idling, and take the following action.

**1. ENGINE WATER TEMPERATURE**

If the temperature of the engine cooling water becomes abnormally high, the monitor lamp flashes, and the overheat prevention system is automatically actuated to reduce the engine speed.  
Stop operations and run the engine at low idling until the engine water temperature gauge enters the green range.

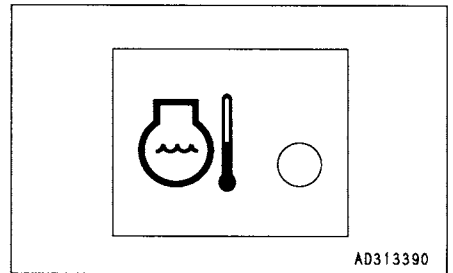

**2. RADIATOR WATER LEVEL**

If the radiator water level drops, the monitor lamp flashes. Stop the engine, check the radiator water level, and add water if necessary.

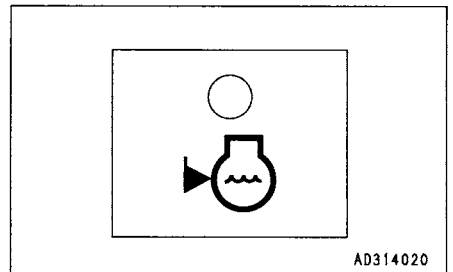

**3. ENGINE OIL PRESSURE**

If the engine oil pressure drops below the normal pressure, the monitor lamp flashes. At this item, stop the engine and inspect it according to "16.6 OTHER TROUBLE."

**REMARK**

While the starting switch is ON, the lamp remains lit and goes off once the engine is started. When the engine starts, the buzzer may sound for a short time, however, this does not indicate a fault.

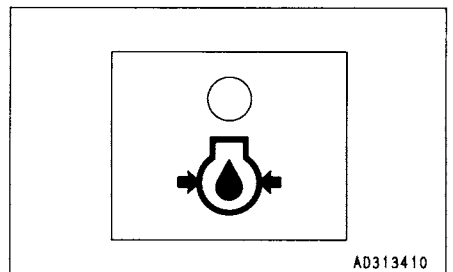

11.1.4 D: METER DISPLAY PORTION

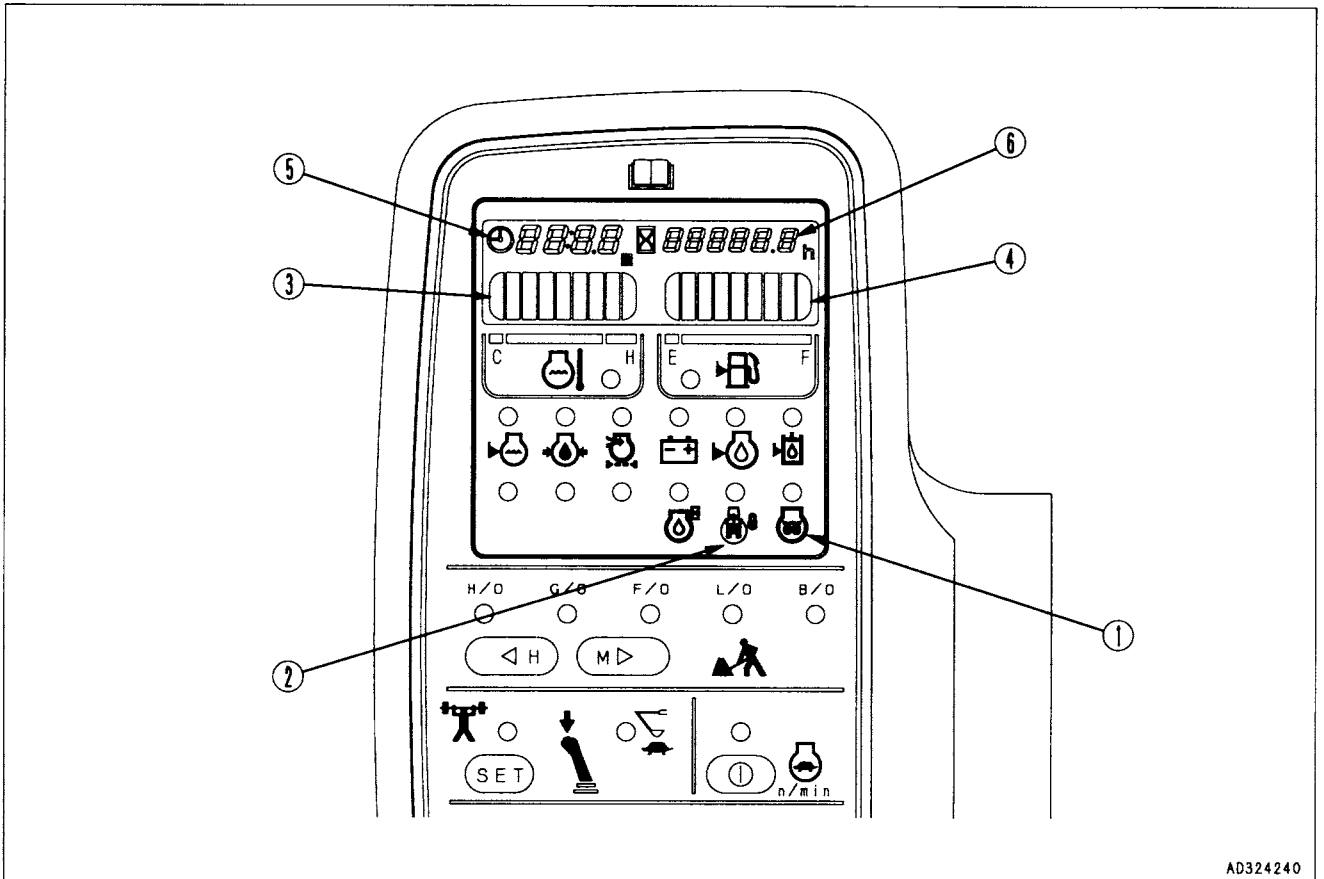

AD324240

**PILOT DISPLAY**

When the starting switch is ON, the pilot display lights up when the display items are functioning.

**1. ENGINE PRE-HEATING MONITOR**

This monitor lamp indicates the pre-heating time required when starting the engine at an ambient temperature below 0°C.

The monitor lamp lights when the starting switch is turned to HEAT position and flashes after about 30 seconds to show that the pre-heating is completed. (The monitor lamp will go off after about 10 seconds.)

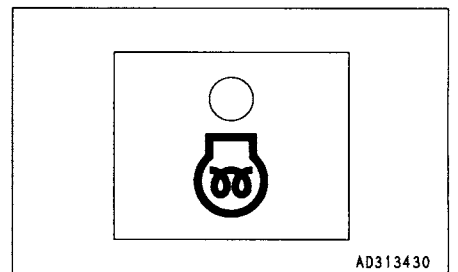

AD313430

**2. SWING LOCK MONITOR**

This informs the operator that the swing lock is being actuated.

Actuated: Lights up

When the swing lock switch is turned ON (ACTUATED), the monitor lamp lights up.

When the swing lock override switch is turned on, this monitor lamp flashes.

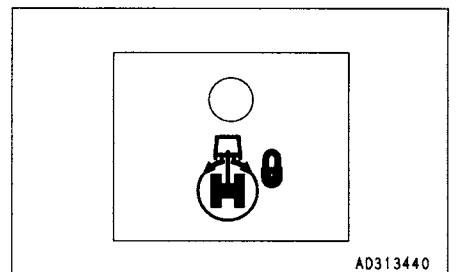

AD313440

**REMARK**

A disc brake is installed in the swing motor to mechanically stop motor rotation.

The brake is always applied while the swing lock is actuated.

**METERS**

**3. ENGINE WATER TEMPERATURE GAUGE**

This gauge indicates the engine cooling water temperature. If the temperature is normal during operation, the green range will light up. If the red range lights up during operation, the overheat prevention system will be actuated.

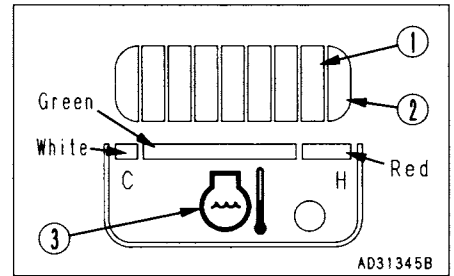

The overheat prevention system acts as follows.

When red range ① lights up:

Engine water temperature monitor ③ flashes.

When red range ② lights up:

Engine speed is lowered further to low idling, engine water temperature monitor ③ flashes, and alarm buzzer sounds at the same time.

The overheat prevention system is actuated until the temperature enters the green range.

When red range ② lights, if the engine water temperature is reduced and the fuel control dial is turned to the low idling position, the display will be canceled.

**4. FUEL GAUGE**

This gauge indicates the amount of fuel in the fuel tank.

If the fuel level is normal during operation, the green range will light up.

If only the red range lights up during operation, there is less than 70 liters (18.5 US gal, 15.4 UK gal) of fuel remaining in the tank, so check and add fuel.

Red range ① ON: Fuel gauge monitor lamp (LED) ② flashes

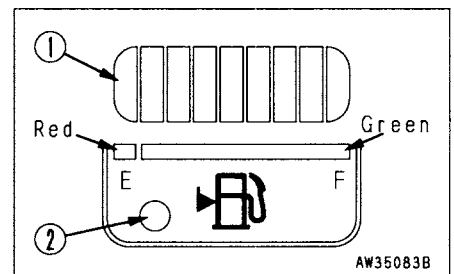

After the starting switch is turned ON, the correct level may not be displayed for a moment, but this does not indicate any abnormality.

When stopping the engine, turn the starting switch ON and check that the monitor lamps on items A, B, C and D and the meters light up.

**5. DISPLAY**

When the starting switch is ON, the time and service meter reading is displayed if the condition is normal. If the condition is abnormal, the content of the failure is displayed.

When setting the time, the (⌚) symbol flashes.

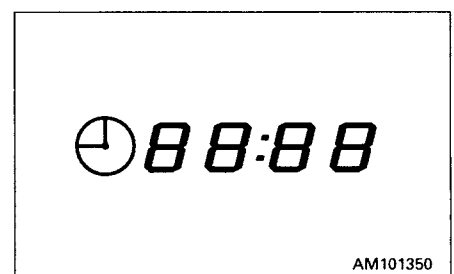

**Manual setting**

1. When the time is displayed, depress clock switch ① for 2.5 sec or more.
2. "⌚" flashes.
3. Pressing H switch ② increases hours and pressing M switch ③ increases minutes. If switch ② or ③ is pressed for 2.5 seconds or more, hours or minutes increase continuously.
4. When the correct time is reached, press clock switch ①. This completes clock setting.

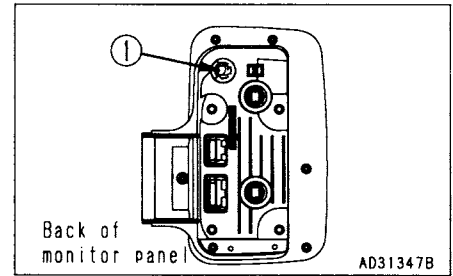

**Correct time setting**

1. When the time is displayed, depress the clock switch for 2.5 sec or more.
2. "⌚" flashes.
3. When SET switch ④ is pressed, the hour is rounded off for 0 to 14 minutes and rounded up for 45 to 59 minutes.  
 [Examples] 10:14 becomes 10:00 (rounded off)  
 10:45 becomes 11:00 (rounded up)  
 When SET switch ④ is pressed at the time signal or standard clock, the correct time is obtained.
4. When the correct time is reached, press clock switch ①. This completes clock setting.

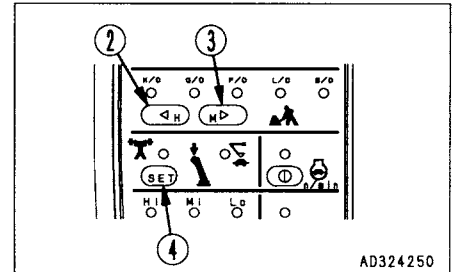

If the machine has a fault, error information appears while the starting switch is ON. The monitor flashes and displays all error informations sequentially.

Monitor indications	Error mode
E02	TVC valve system error
E03	Swing brake system error
E05	Governor system error
CALL	Non-operating error

If any of these monitors flashes, see "16.6.4 ELECTRONIC CONTROL SYSTEM".

**6. SERVICE METER**

This meter shows the total operation hours of the machine. Set the periodic maintenance intervals using this display. The service meter advances while the engine is running - even if the machine is not traveling.

The meter will advance by 1 for each hour of operation regardless of the engine speed.

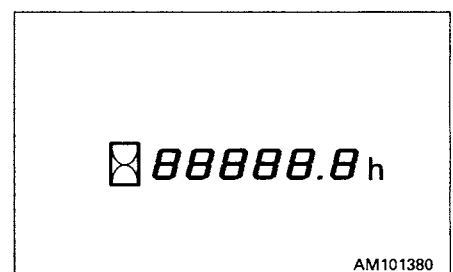

11.1.5 E: SWITCHES

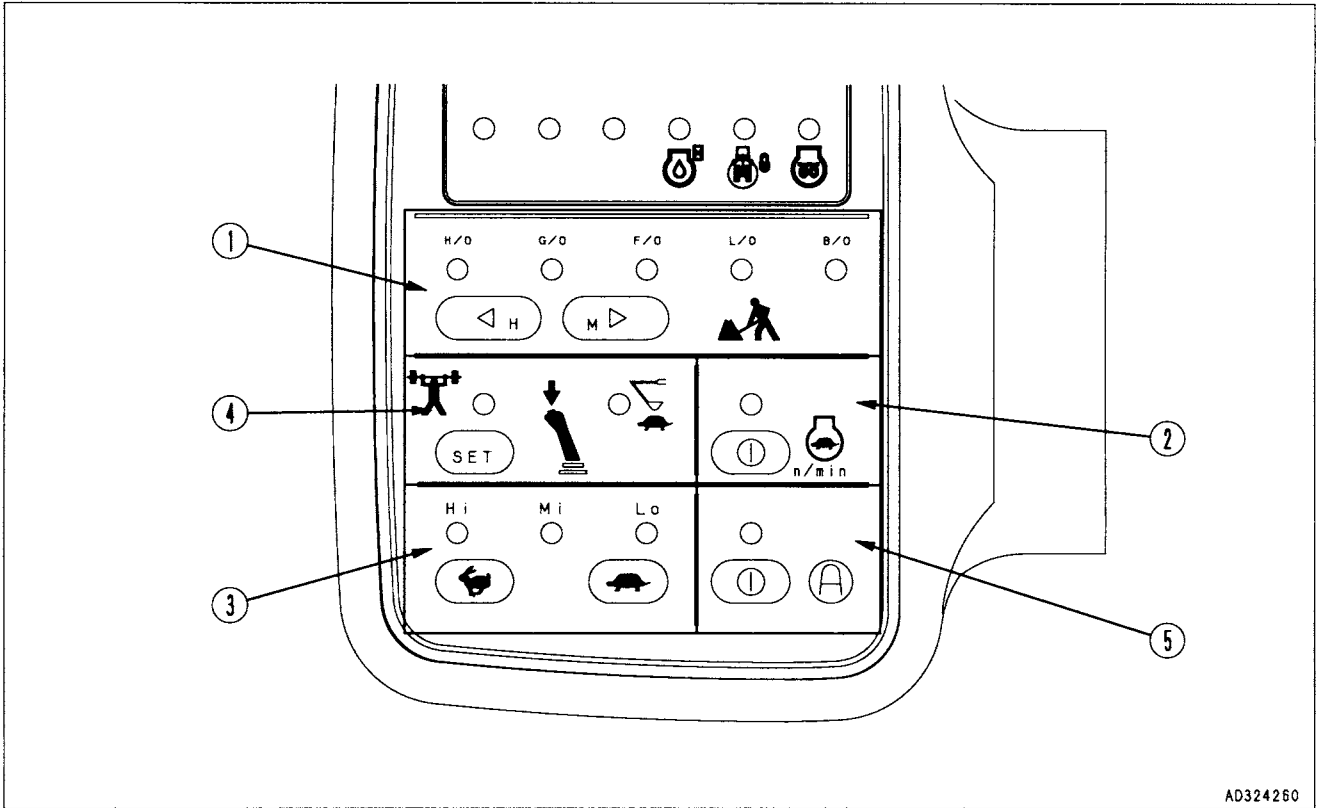

AD324260

**1. WORKING MODE SELECTOR SWITCH (Basic mode)**

This switch is used to set the movement or power for the work equipment. By selecting the mode to match the working conditions, it is possible to carry out operations more easily.

H.O. (heavy-duty operation mode) lights up:

This is used for heavy-duty work.

G.O. (general operation mode) lights up:

This is used for ordinary work.

F.O. (finishing operation mode) lights up:

This is used for leveling or grading work.

L.O. (lifting operation mode) lights up:

This is used for fine control operations.

B.O. (breaker operation mode) lights up:

This is used for breaker operations.

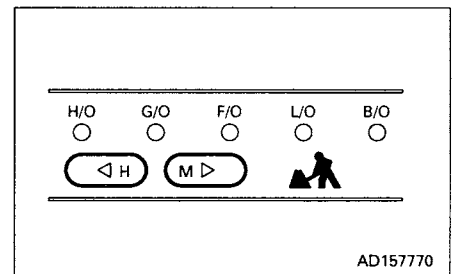

AD157770

When starting the engine, G.O. (general operation) mode is automatically selected. Each time the switch is pressed, the mode selection changes.

If it is desired to set to automatic setting (optional default setting) of the H.O. mode when the engine is started, please contact your Komatsu distributor to have the setting changed.

**NOTICE**

**When using the breaker, do not set to the H/O mode.**

**REMARK**

The H switch is used for changing the hour when setting the time. The M switch is used for changing the minute when setting the time. For details, see "11.1.4 5. DISPLAY".

## 2. AUTO-DECELERATION SWITCH (Selection switch)

This switch acts to activate the function that automatically lowers the engine speed and reduces fuel consumption when the control lever is at neutral.

ON lights up: Auto-deceleration is actuated.

OFF: Auto-deceleration is canceled.

Each time the switch is pressed, the auto-deceleration is actuated or canceled.

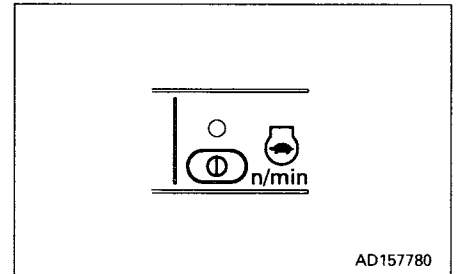

## 3. TRAVEL SPEED SWITCH

### WARNING

If the Hi-Lo switch is operated when the machine is traveling, the machine may deviate even when traveling in a straight line. To prevent this, always stop the machine before operating the travel speed switch.

This is used to select the three travel speeds.

Lo lights up: Low speed travel

Mi lights up: Middle speed travel

Hi lights up: High speed travel

When the engine is started, the travel speed is automatically set to Lo.

When traveling in high speed travel (Hi) or middle speed travel (Mi), the travel speed is automatically switched to low speed travel (Lo) to match the travel surface on soft ground or when traveling uphill, so there is no need to operate this switch.

Monitor lamp remain the light up (Hi or Mi).

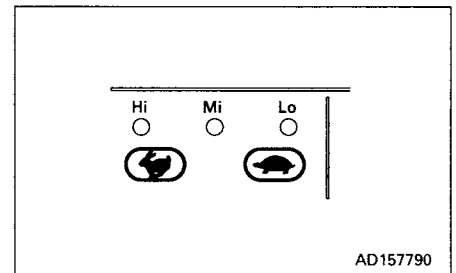

#### 4. POWER MAX./SWIFT SLOW-DOWN SWITCH

During operations, the digging power can be increased and the speed reduced by a one-touch operation of the knob button (single click while pushing).

Power max. (power up) lights up:

When the working mode is heavy-duty and general operation mode only, the power can be increased while the knob button is being pressed. Even if the knob button continues to be pressed, the increase in power finishes after approx. 8.5 sec.

Swift slow-down (speed down) lights up:

When the working mode is heavy-duty operation and general operation mode only, the speed can be reduced while the knob button is being pressed.

When the engine is started, the power max. lamp lights up. Each time the SET switch is pressed, the mode is switched.

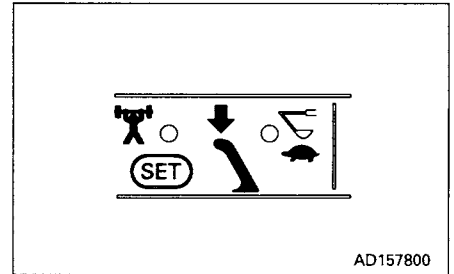

#### 5. ACTIVE MODE SWITCH (SELECTOR SWITCH)

The active mode is effective for quick leveling operations or deep digging and loading operations.

Lamp lights up: Active mode is actuated.

Lamp goes out: Active mode is cancelled.

The lamp is off when the engine is started.

If it is turned lamp (lights up), it is possible to enter the active mode from any working mode.

Even when it is turned lamp (lights up), the working mode display does not change. When the lamp goes out, the system returns to the original working mode.

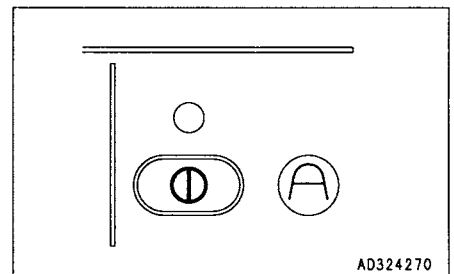



## 11.2 SWITCHES

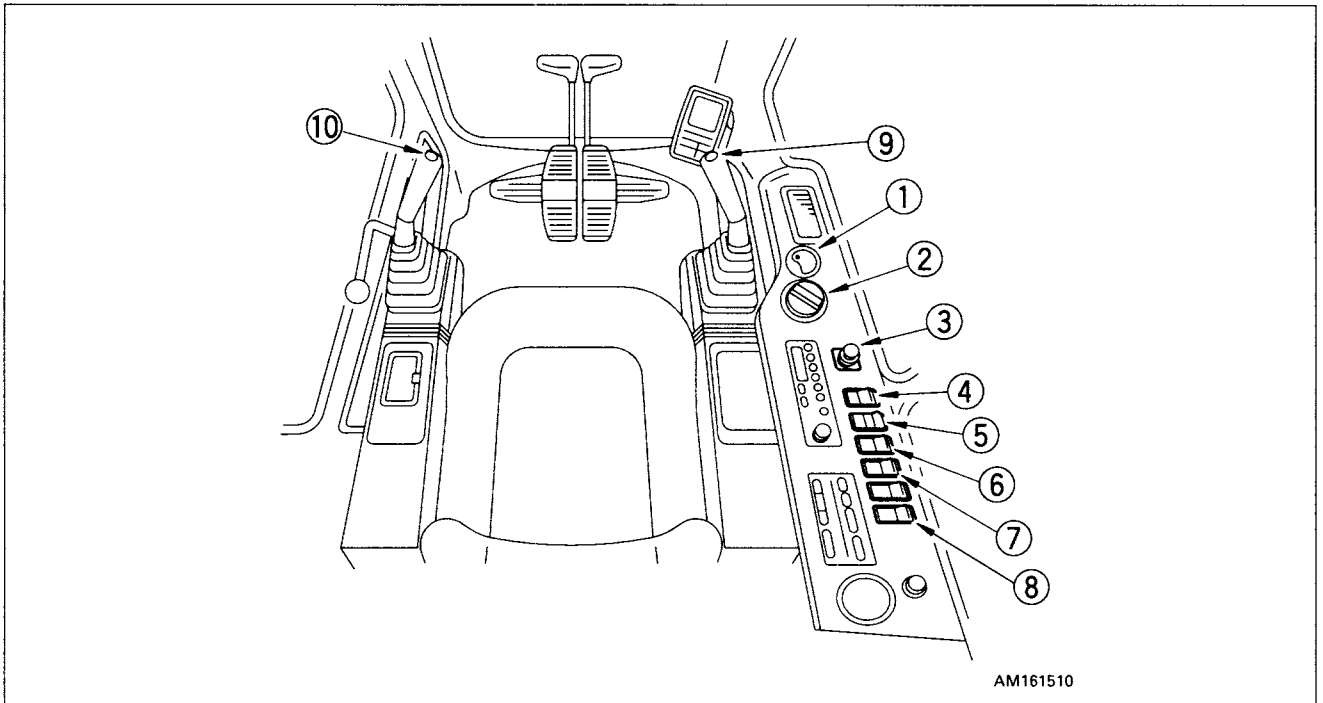

### 1. STARTING SWITCH

This switch is used to start or stop the engine.

#### OFF position

The key can be inserted or withdrawn. The switches for the electric system except the cab lamp and clock, are all turned off and the engine is stopped.

#### ON position

Electric current flows in the charging and lamp circuits.

Keep the starting switch key at the ON position while the engine is running.

Electricity flows to all electrical circuits except the START and HEAT circuit.

#### START position

This is the engine-start position. Keep the key at this position during cranking. Immediately after starting the engine, release the key which will automatically return to the ON position.

#### HEAT (preheat) position

When starting the engine in winter, set the key to this position. When the key is set to the HEAT position, the pre-heating monitor lights up. Keep the key at this position until the monitor lamp goes off. Immediately after the pre-heating monitor goes off, release the key. The key automatically returns to the OFF position. Then, start the engine by turning the key to the START position.

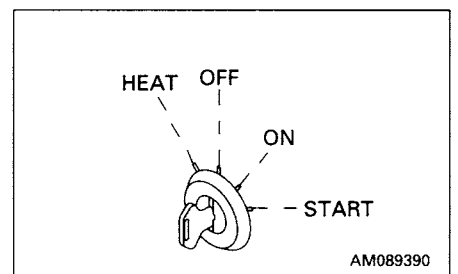

**2. FUEL CONTROL DIAL  
(WITH AUTO-DECELERATION MECHANISM)**

This adjusts the engine speed and output.

- ① Low idling (MIN): Turned fully to the left
- ② Full speed (MAX): Turned fully to the right

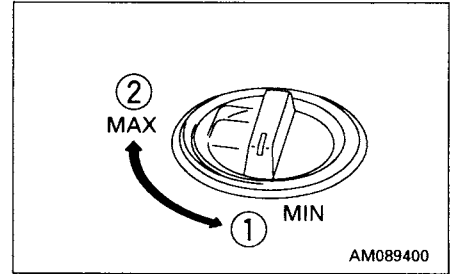

**3. CIGARETTE LIGHTER**

This is used to light cigarettes. To use, push the lighter in. After a few seconds it will spring back.

Pull out the lighter and light your cigarette.

By removing the cigarette lighter, the socket is available as a power source for the yellow flashing lamp. Max. current is 3.5 A (85 W).

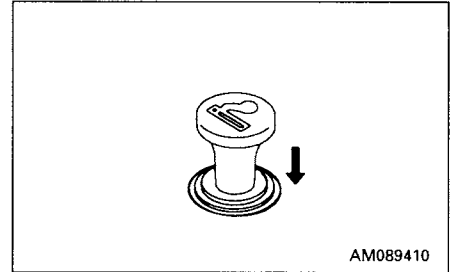

**4. SWING LOCK SWITCH**

**⚠ WARNING**

- When the machine is traveling under its own power, or when the swing is not being operated, always set the switch to the ON (ACTUATED) position.
- On a slope, the work equipment may swing to the down side even if the swing lock switch is located at the ON position. Be careful concerning this point.

This switch is used to lock the upper structure so that it cannot swing.

ON position (actuated):

The swing lock is always applied, and the upper structure will not swing even if the swing is operated. In this condition, the swing lock lamp lights up.

OFF position (canceled):

The swing lock is applied only when all work equipment control levers are at neutral; when any work equipment control lever is operated, it is canceled.

The swing lock is actuated approx. 4 seconds after all work equipment control lever is placed in neutral.

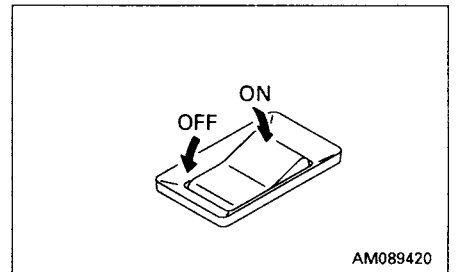

**5. WIPER SWITCH**

This actuates the wiper for the front glass.

- ① OFF: Wiper stops
- ② ON: Wiper moves continuously
- ③ Window washer fluid is sprayed out. When switch is released it returns to position ②.
- ④ ON: Wiper moves intermittently
- ⑤ Window washer fluid is sprayed out. When switch is released it returns to position ④.

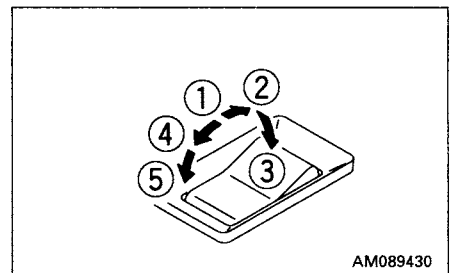

**6. LAMP SWITCH**

This switch is used to turn on the front lamps, working lamps, additional lamp at the top front of the cab, rear lamps, and monitor lighting.

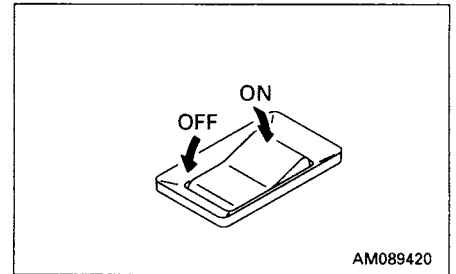

AM089420

**7. ALARM BUZZER STOP SWITCH**

This is used to stop the alarm buzzer if it sounds to warn of an abnormality during operation.

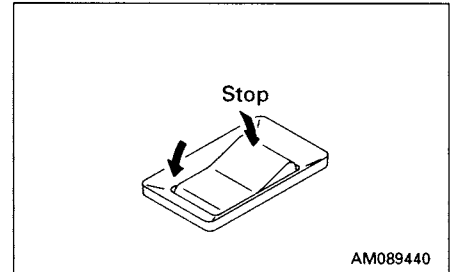

AM089440

**8. MACHINE PUSH-UP SWITCH**

This switch is used to switch the safety valve set pressure at the head end of the boom cylinder to two levels.

- ① Low pressure setting: The boom thrust force is weak, so the swaying of the chassis is small during digging operations, and digging operations can be carried out smoothly. This is used for general digging operations on normal ground, soft rock, or blasted rock.
- ② High pressure setting: The thrusting force of the boom becomes more powerful, so it is easy to twist and swing or escape from soft ground. It is effective in carrying out digging operations using the bucket and the weight of the machine in confined areas.

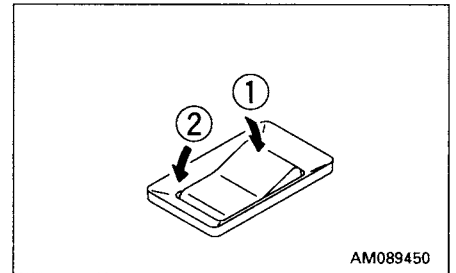

AM089450

**9. HORN SWITCH**

Press the switch on the right work equipment control lever to sound the horn.

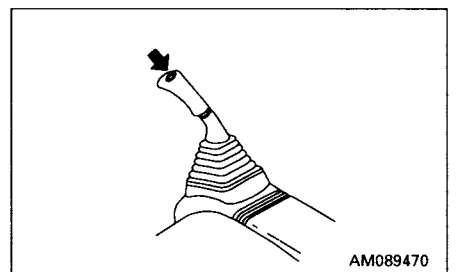

AM089470

**10. KNOB SWITCH**

The knob switch on the left work equipment control lever is used to actuate the power max. or swift slow-down functions.

Keep the switch pressed. The power max. function can be used for a maximum of 8.5 seconds in H/O or G/O mode. The swift slow-down function can be used for as long as the switch is kept pressed.

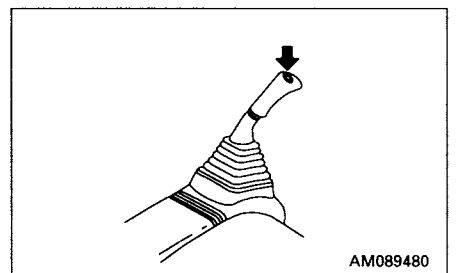

AM089480

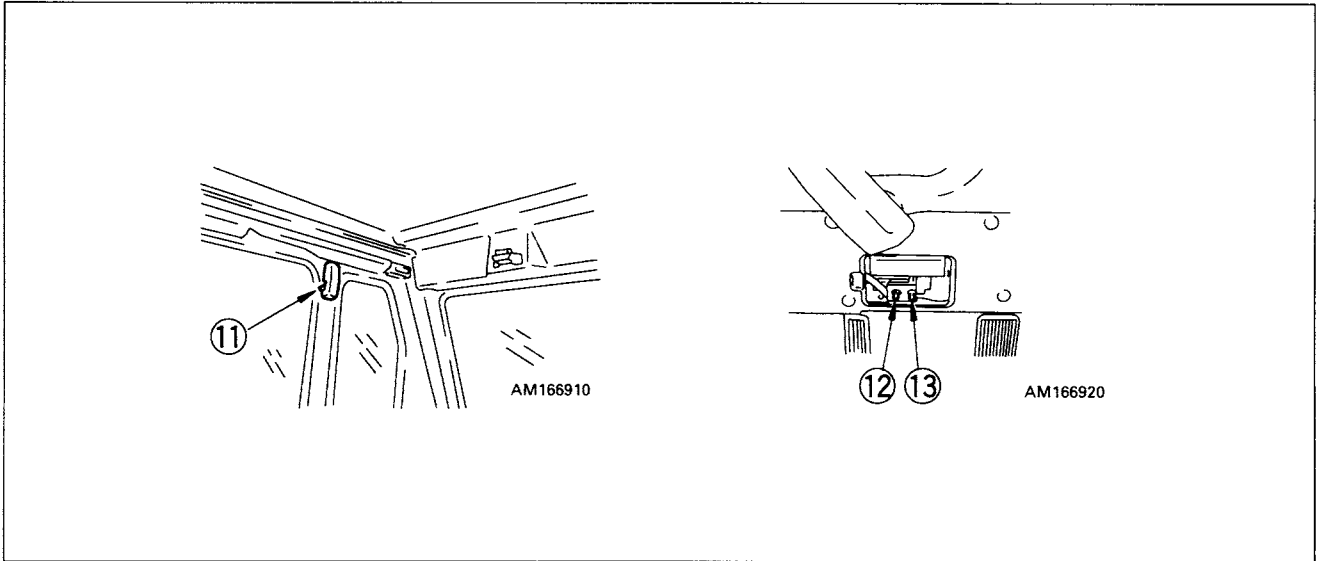

**11. ROOM LAMP SWITCH**

This is used to turn on the room lamp.

ON: Lights up

It is possible to turn on the room lamp even when the starting switch is at the OFF position, so be careful not to forget to turn it off.

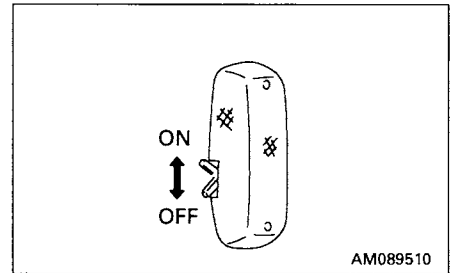

**12. PUMP PROLIX SWITCH**

When normal: Switch is pushed down

When abnormal: When the monitor display shows E02 (TVC valve system error), move the switch up to make it possible to carry out work.

The pump prolix switch is provided to make it possible to carry out work for a short time when there is a failure in the pump control system (TVC valve system error). It is necessary to repair the abnormal location as soon as possible.

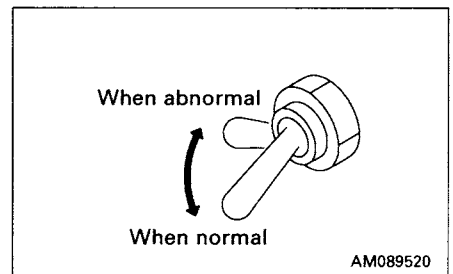

**13. SWING PROLIX SWITCH**

When normal: Switch is pushed down

When abnormal: When the monitor display shows E03 (Swing brake system error), the brake is canceled, and it becomes possible to actuate the swing and carry out normal operations. However, the swing brake remains released.

The swing prolix switch is provided to make it possible to carry out swing operations for a short time even when there is an abnormality in the swing brake electric system. It is necessary to repair the abnormality as soon as possible.

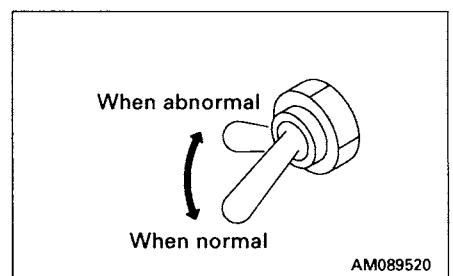

### 11.3 CONTROL LEVERS, PEDALS

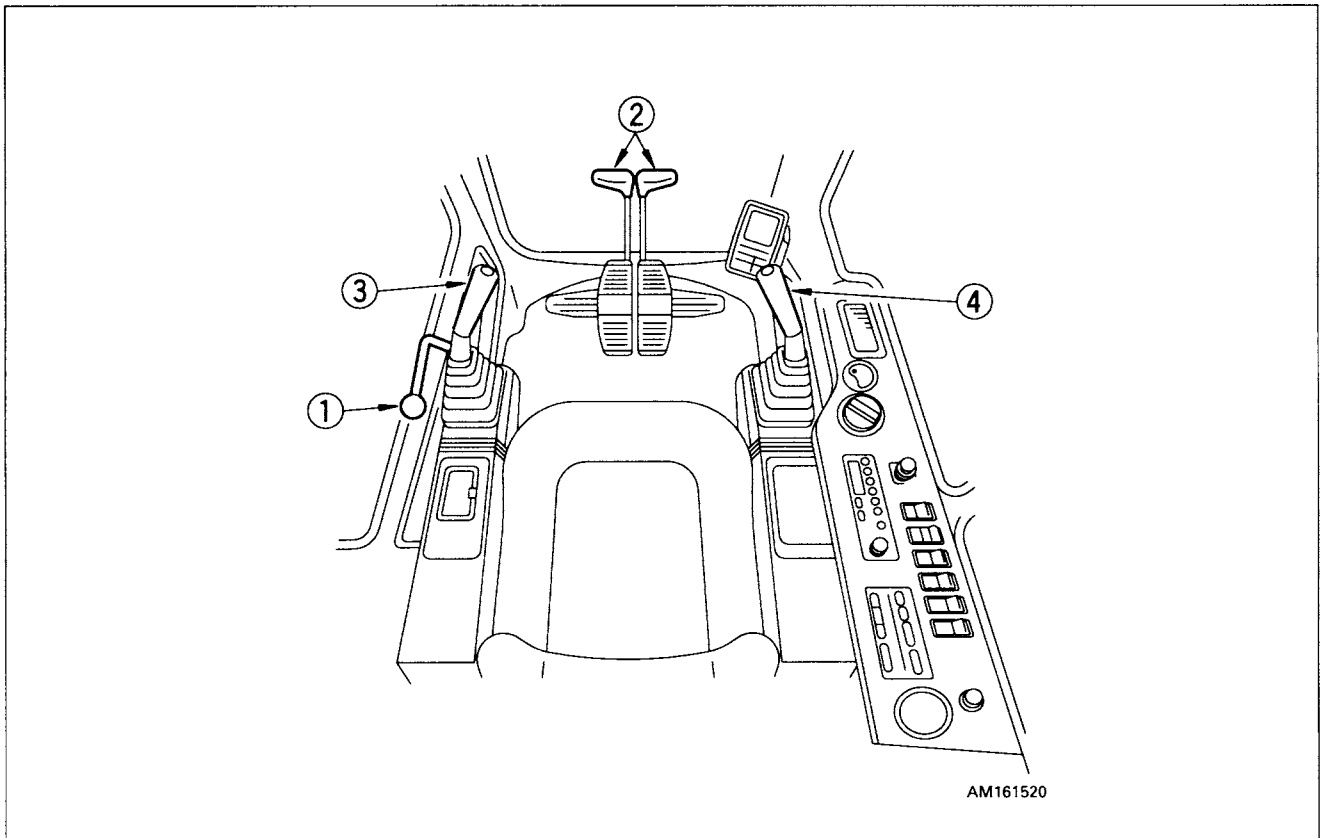

#### 1. SAFETY LOCK LEVER

#### WARNING

- When leaving the operator's compartment, set the safety lock lever securely to the LOCK position. If the control levers are not locked, and they are touched by mistake, this may lead to a serious accident.  
If the safety lock lever is not placed securely in the LOCK position, the control levers may not be properly locked. Check that the situation is as shown in the diagram.
- When the safety lock lever is raised, take care not to touch the work equipment control lever. If the safety lock lever is not properly locked at the up position, the work equipment and swing will move, creating a potentially dangerous situation.
- When the safety lock lever is lowered, take care not to touch the work equipment control lever.

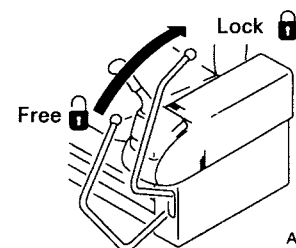

This lever locks the controls for the work equipment, swing, travel, and optional attachments.

Pull the lever up to apply the lock.

## 11. EXPLANATION OF COMPONENTS

This lock lever is a hydraulic lock, so even if it is in the lock position, the work equipment control lever and travel lever will move, but the work equipment, travel motor, and swing motor will not work.

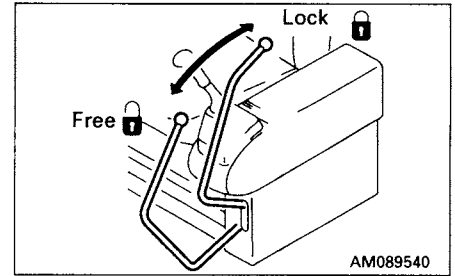

## 2. TRAVEL LEVERS (WITH PEDAL, AUTO-DECELERATION MECHANISM)

### WARNING

- Do not put your foot on the pedal unless the machine is traveling. If you leave your foot on the pedal and press it by mistake, the machine will move suddenly, and this may lead to a serious accident.
- With the track frame facing to the rear, the machine will move in the reverse direction by forward traveling and in the forward direction by reverse traveling. When the travel lever is used, check to see if the track frame is facing forward or backward. (If the sprocket is located to the rear, the track frame is facing forward.)

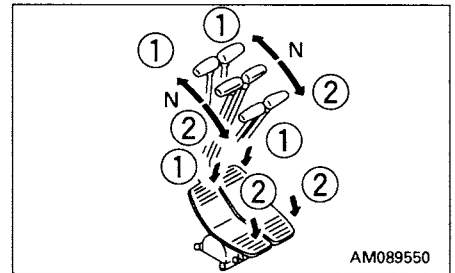

- ① FORWARD:  
The lever is pushed forward  
(The pedal is angled forward)
- ② REVERSE:  
The lever is pulled back  
(The pedal is angled back)
- N (Neutral): The machine stops

( ): This indicates operation of the pedal.

### REMARK

#### Machines equipped with travel alarm (Option)

If the lever is shifted to the advance or reverse position from the neutral position, the alarm sounds to warn that the machine is starting to advance.

### 3. LEFT WORK EQUIPMENT CONTROL LEVER (with auto-deceleration device)

**WARNING**

If any lever is operated when in the deceleration range, the engine speed will suddenly increase, so be careful when operating the levers.

This lever is used to operate the arm and upper structure.

Arm operation

Ⓐ Arm OUT

Ⓑ Arm IN

N (Neutral)

Swing operation

Ⓒ Swing to right

Ⓓ Swing to left

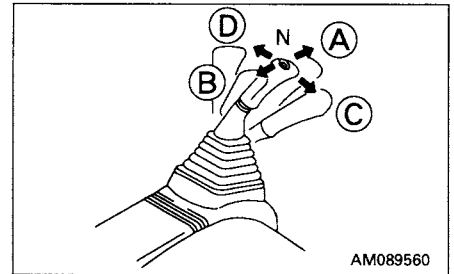

AM089560

When the lever in this position, the upper structure and the arm will be retained in the position in which they stop.

### 4. RIGHT WORK EQUIPMENT CONTROL LEVER (with auto-deceleration device)

**WARNING**

If any lever is operated when in the deceleration range, the engine speed will suddenly increase, so be careful when operating the levers.

This lever is used to operate the boom and bucket.

Boom operation

① RAISE

② LOWER

N (Neutral)

Bucket operation

③ DUMP

④ CURL

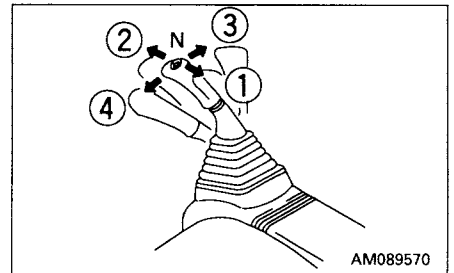

AM089570

When the lever in this position, the boom and the bucket will be retained in the position in which they stop.

For levers 2, 3 and 4, the engine speed changes as follows because of the auto-deceleration mechanism.

- When the travel lever and work equipment control levers are at neutral, even if the fuel control dial is above the mid-range position, the engine speed will drop to a mid-range speed. If any of the levers are operated, the engine speed will rise to the speed set by the fuel control dial.
- If all control levers are set to neutral, the engine speed will drop by approx. 100 rpm, and after approx. 4 seconds, the engine speed will drop to the deceleration speed (approx. 1400 rpm).

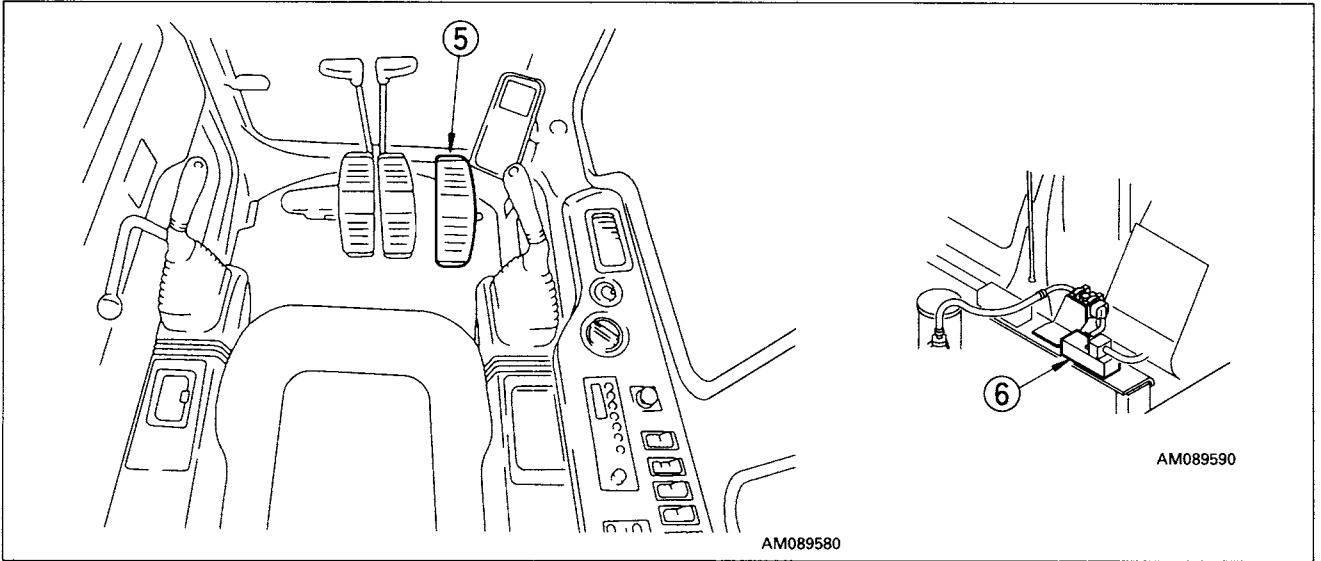

**5. ATTACHMENT CONTROL PEDAL (OPTION)**

**⚠ WARNING**

Do not put your foot on the pedal except when operating it. If you rest your foot on the pedal during operations, and you depress the pedal by mistake, the attachment may move suddenly and cause serious damage or injury.

**When breaker is installed**

- When the front of the pedal is depressed, the breaker is actuated.
- The positions of the lock pin are as follows: ① lock, ② pedal half stroke position, ③ pedal full stroke position
- Set the working mode to the breaker mode and set the lock pin to position ③.

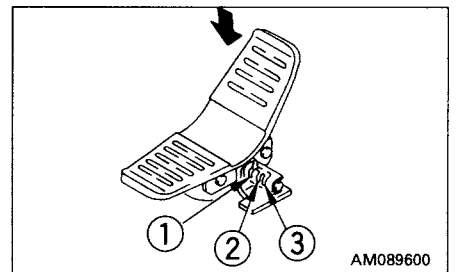

**When general attachment is installed**

- When the front of the pedal is depressed, the attachment is actuated.
- The positions of the lock pin are as follows: ① lock, ② pedal half stroke position, ③ pedal full stroke position

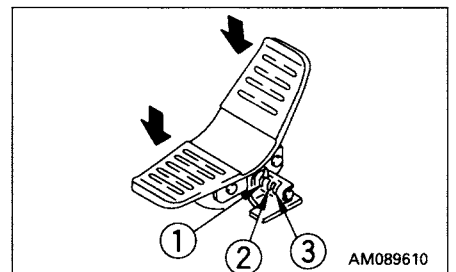



**Path of hydraulic oil**

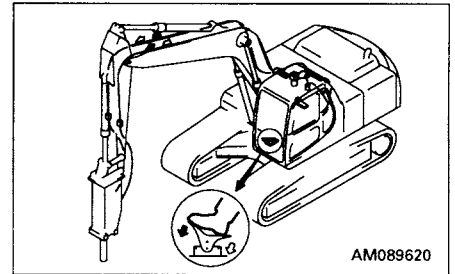

When the front of the pedal is depressed, the oil flows to the left piping for the work equipment; when the rear of the pedal is depressed, the oil flows to the right piping for the work equipment. (When the breaker is installed, only the front of the pedal is used.)



**6. BREAKER, GENERAL ATTACHMENT (CRUSHER, ETC.) SELECTOR VALVE (OPTION)**

When a breaker or general attachment (such as a crusher) are used, turn the rotor of the 3-way valve to switch selector valve ① as shown in the table below.

(The arrow showing the direction of the port is stamped on the head of the 3-way valve.)

Attachment	Right 3-way valve ①
Breaker, etc.	Right side of machine 
Crusher, etc.	Right side of machine 
When not using	Right side of machine 

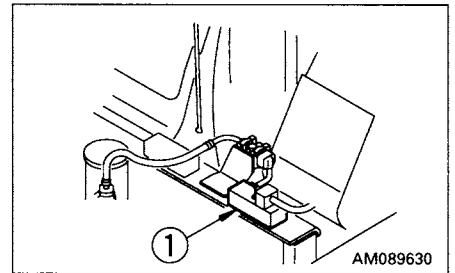

**NOTICE**

Stop the engine and lower the work equipment and chassis to the ground to set in a stable position before carrying out the operation.

**REMARK**

For details, see "30. MACHINES READY FOR ATTACHMENTS".

## 11.4 CEILING WINDOW

### WARNING

When leaving the operator's compartment, set the safety lock lever securely to the LOCK position. If the control levers are not locked, and they are touched by mistake, this may lead to a serious accident.

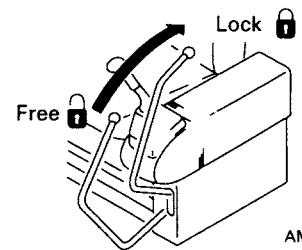

#### When opening

1. Lock the safety lock lever securely.
2. Check for any ceiling window movement by pulling lock knob ② located on front side, then push up and open the ceiling window grasping grip ①.

#### When closing

Close the ceiling window grasping grip ① and lock it with lock knob ②. If the lock cannot be applied, open and close the ceiling window again.

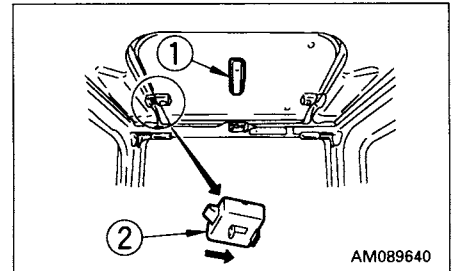

## 11.5 FRONT WINDOW

### WARNING

When opening the front window, always hold the grip firmly with both hands and pull up. If you use only one hand, your hand may slip and get caught.

It is possible to store (pull up) the front window (top) in the roof of the operator's compartment.

### When opening

### WARNING

When the front window is open, there is danger that it will fall, so always lock it with left and right lock pins .

1. Place the work equipment on flat ground and stop the engine.
2. Securely lock the safety lock lever.

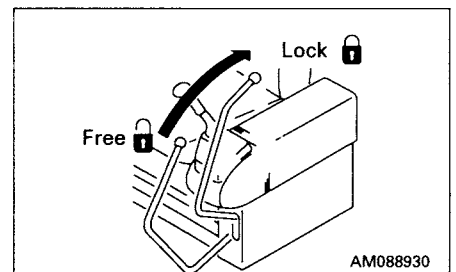
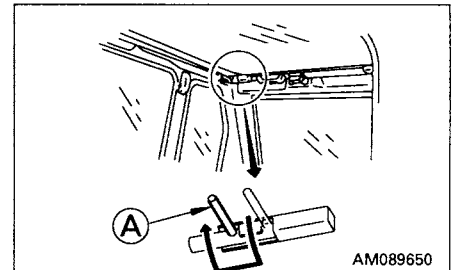

3. Check that the wiper is stowed in the right stay.

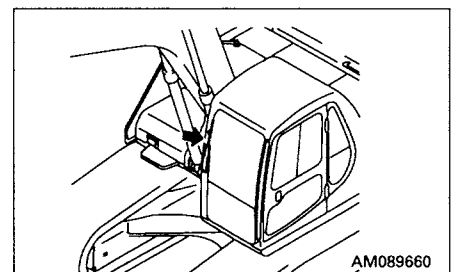

4. Pull lock pins  at the top left and right sides of the front window to the inside to release the lock.

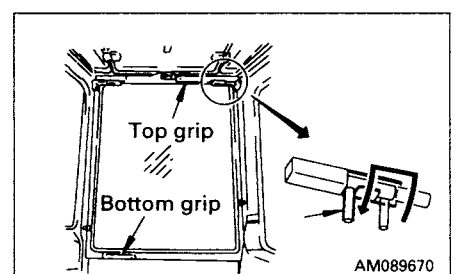

## 11. EXPLANATION OF COMPONENTS

- From the inside of the operator's cab, hold the bottom grip with the left hand and the top grip with the right hand, pull up the window, and push it in fully until it is locked by catch ③.

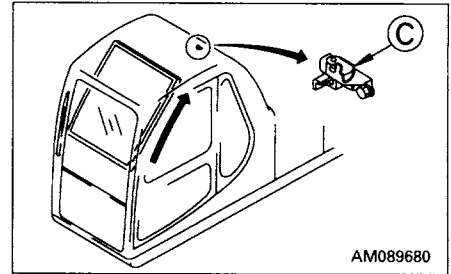

- Lock with lock pins ① on the left and right sides.

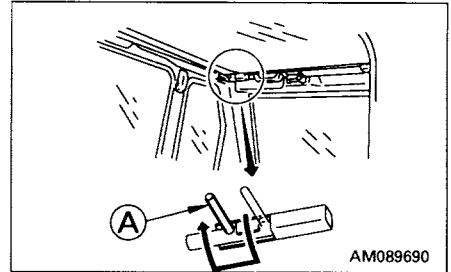

### When closing

#### WARNING

When closing the window, lower it slowly and be careful not to get your hand caught.

- Place the work equipment on flat ground and stop the engine.
- Securely lock the safety lock lever.

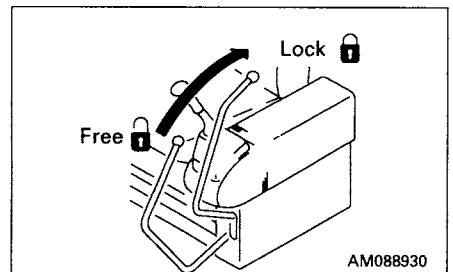

- Release the lock pin ①.

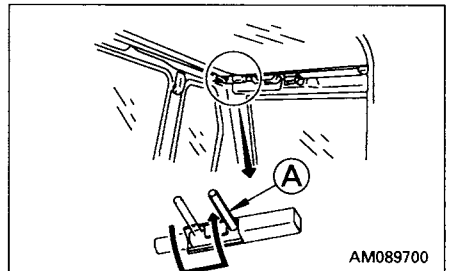

- Hold the grip at the bottom of the front window with your left hand and the grip at the top with your right hand, release the lock of catch ③ with your right thumb, then pull the top grip slowly and lower the front window. When releasing the lock of catch ③, push release lever ④ in the direction of the arrow to release the lock.

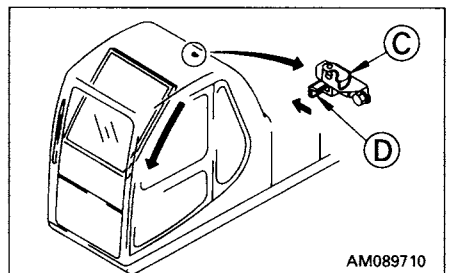

5. Lock securely with lock pins (A) at the left and right sides.

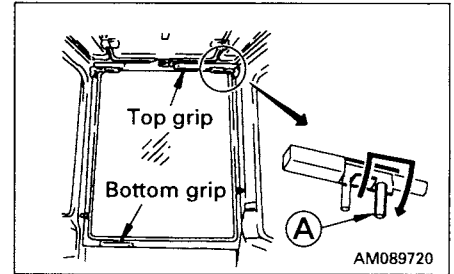

**Removing front window (bottom)**

With the front window open, remove lock pins (E), and the bottom part of the front window can be removed.

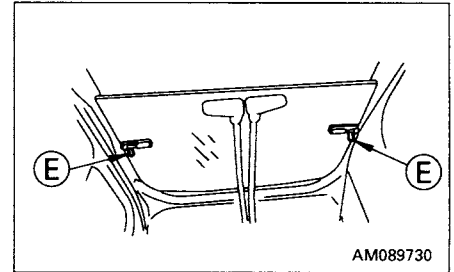

Store the removed bottom part of the front window at the rear of the operator's cab and lock with lock pins (E).

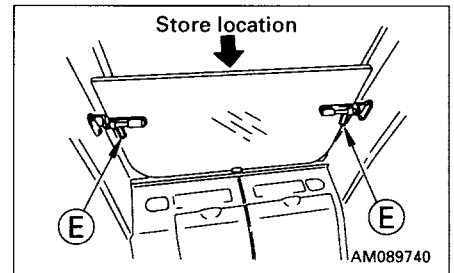

**11.6 DOOR LOCK**

Use the door lock to fix the door in position after opening it.

1. The door will become fixed in place when it is pressed against catch (1).
2. To release the lock, press knob (2) down at the left side of the operator's seat to release the catch.  
When fixing the door, fix it firmly to the catch.

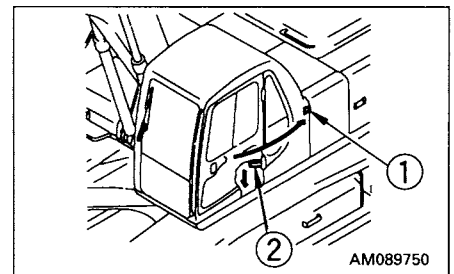

## 11.7 CAP, COVER WITH LOCK

The fuel filler, operator's cab, engine hood, tool box cover, pump room door (right side of the machine body) and battery room door (left side of the machine body) are fitted with locks.

Use the starting key to lock or unlock these places.

Insert the key as far as it will go. If the key is turned before it is inserted all the way, it may break.

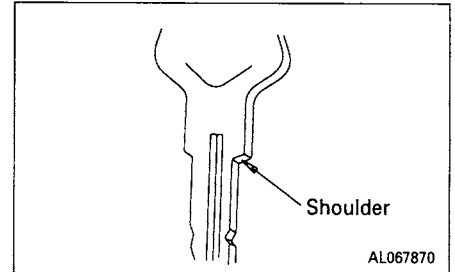

### 11.7.1 METHOD OF OPENING AND CLOSING CAP WITH LOCK

#### To open the cap

1. Insert the key into the key slot.
2. Turn the key clockwise (but, for the B type, turn counterclockwise), align the key slot with the match mark on the cap, then open the cap.

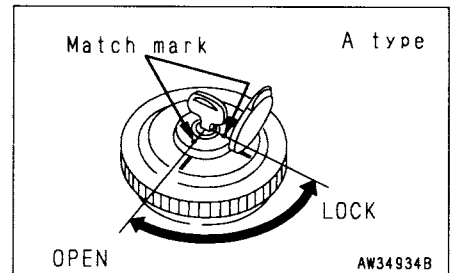

#### To lock the cap

1. Turn the cap into place and insert the key into the key slot.
2. Turn the key counterclockwise (but, for the B type, turn clockwise) and take the key out.

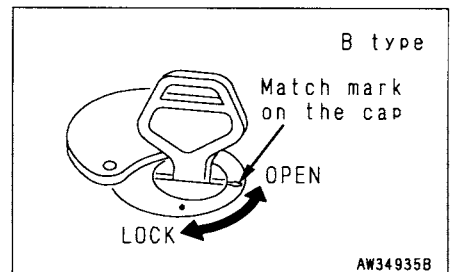

### 11.7.2 METHOD OF OPENING AND CLOSING COVER WITH LOCK

#### To open the cover (locked cover)

1. Insert the key into the key slot.
2. Turn the key counterclockwise and open the cover by pulling the cover grip.

#### To lock the cover

1. Close the cover and insert the key into the key slot.
2. Turn the key clockwise and take the key out.

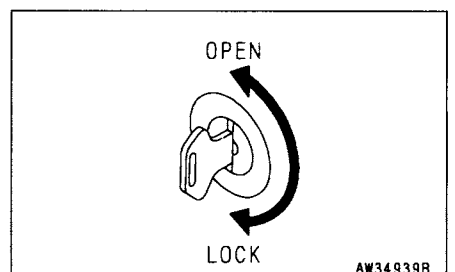

### 11.8 HOT AND COOL BOX

This is on the right side at the rear of the operator's seat. It is interconnected with the air conditioner: it stays warm when the heating is used, and stays cool when the cooling is used.

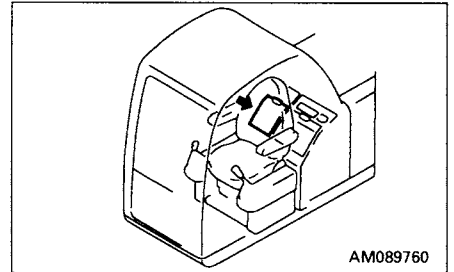

### 11.9 LUGGAGE BOX

This is on the left side at the rear of the operator's seat.

Keep the Operation and Maintenance Manual in this box so that it can be taken out and read whenever necessary.

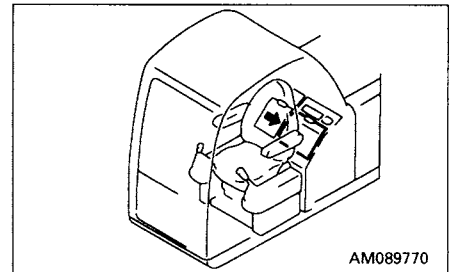

### 11.10 ASHTRAY

This is on the left side of the operator's seat.

Always make sure that you extinguish the cigarette before closing the lid.

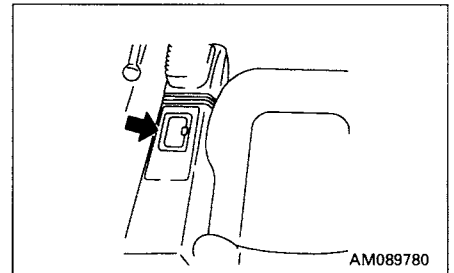

## 11.11 HANDLING AIR CONDITIONER

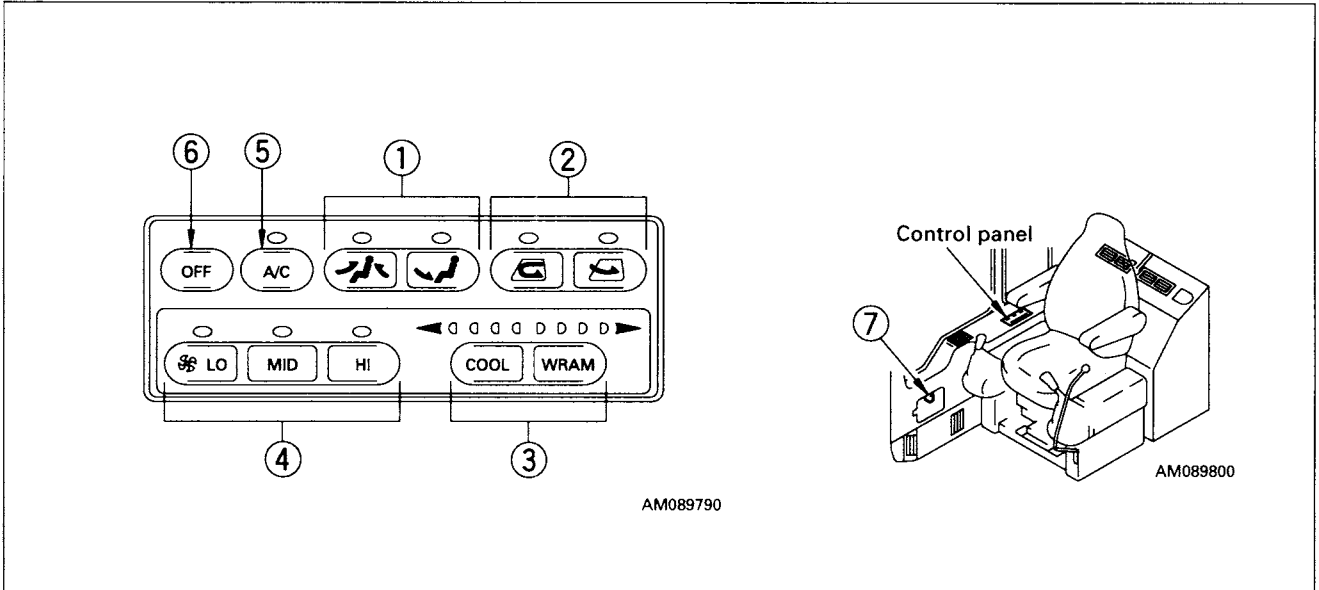

### 11.11.1 GENERAL LOCATIONS ON CONTROL PANEL



The pilot lamp for the switches light up to indicate that the switch is functioning.

#### 1. VENT SELECTOR SWITCH

This is used to select the vents which match the purpose of use.

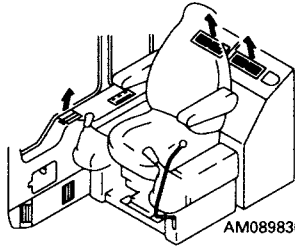
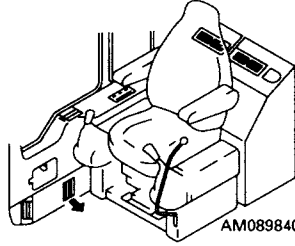
Purpose of use	Sending breeze to upper part of body	Sending breeze to feet
Switch	 <p>AM089810</p>	 <p>AM089820</p>
Vent	 <p>AM089830</p>	 <p>AM089840</p>



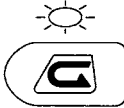
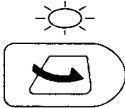

**2. FRESH/RECIRC SELECTOR SWITCH**

This switch is used to intake fresh air or recirculate the internal air.

Purpose of use	Recirculating internal air Use this position to heat or cool the operator's cab quickly or when the outside air is dirty.	Taking in fresh air Use this position when taking in clean, fresh air or when demisting.
Switch	 AM089850	 AM089860

**3. TEMPERATURE CONTROL SWITCH**

This switch is used to adjust the temperature steplessly between low and high.

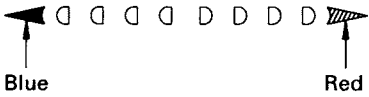
Purpose of use	Cooling	Heating
	 AM089870	 AM089880
Switch	 AM089890 <p>The more lamps in the blue range light up, the lower the temperature becomes; the more lamps in the red range light up, the higher the temperature becomes. The range is divided into 7 levels, and each range is divided further steplessly.</p>	

**4. WIND FLOW SELECTOR SWITCH**

The wind flow can be adjusted to 3 levels.

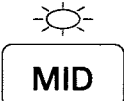
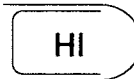
Purpose of use	Low wind flow	Medium wind flow	High wind flow
Switch	 AM089900	 AM089910	 AM089920

## 11. EXPLANATION OF COMPONENTS

---

### 5. AIR CONDITIONER SWITCH

This is used to switch the air conditioner ON/OFF.

### 6. OFF SWITCH

This switch is use to stop the fan.

### 7. DEFROSTER SELECTOR LEVER

This is used to clear the mist from the front glass in cold or rainy conditions.

Selector lever forward: Defroster

Selector lever back: Foot

The defroster can be used when the vent selector panel is at the position.

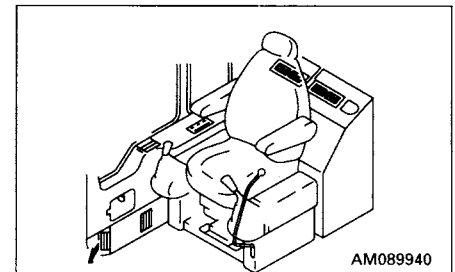
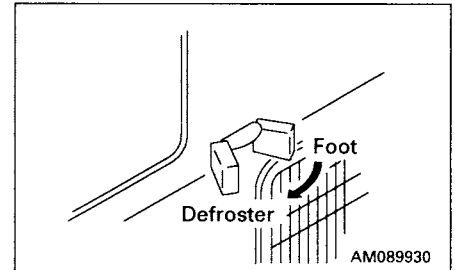

### 11.11.2 PRECAUTIONS WHEN USING AIR CONDITIONER

**Carry out ventilation from time to time when using the cooler.**

- If you smoke when the cooler is on, the smoke may start to hurt your eyes, so turn the lever to FRESH to remove the smoke while continuing the cooling.
- When running the air conditioner for a long time, turn the lever to the FRESH position once an hour to carry out ventilation and cooling.

**Be careful not to make the temperature in the cab too low.**

- When the cooler is on, set the temperature so that it feels slightly cool when entering the cab (5 – 6°C lower than the outside temperature). This temperature difference is considered to be the most suitable for your health, so always be careful to adjust the temperature properly.

### 11.11.3 CHECK, MAINTAIN MACHINE EQUIPPED WITH AIR CONDITIONER

When carrying out inspection and maintenance of a machine equipped with air conditioner, see "23.1 MAINTENANCE SCHEDULE CHART".

## 11.12 CAR RADIO

### 11.12.1 EXPLANATION OF COMPONENTS

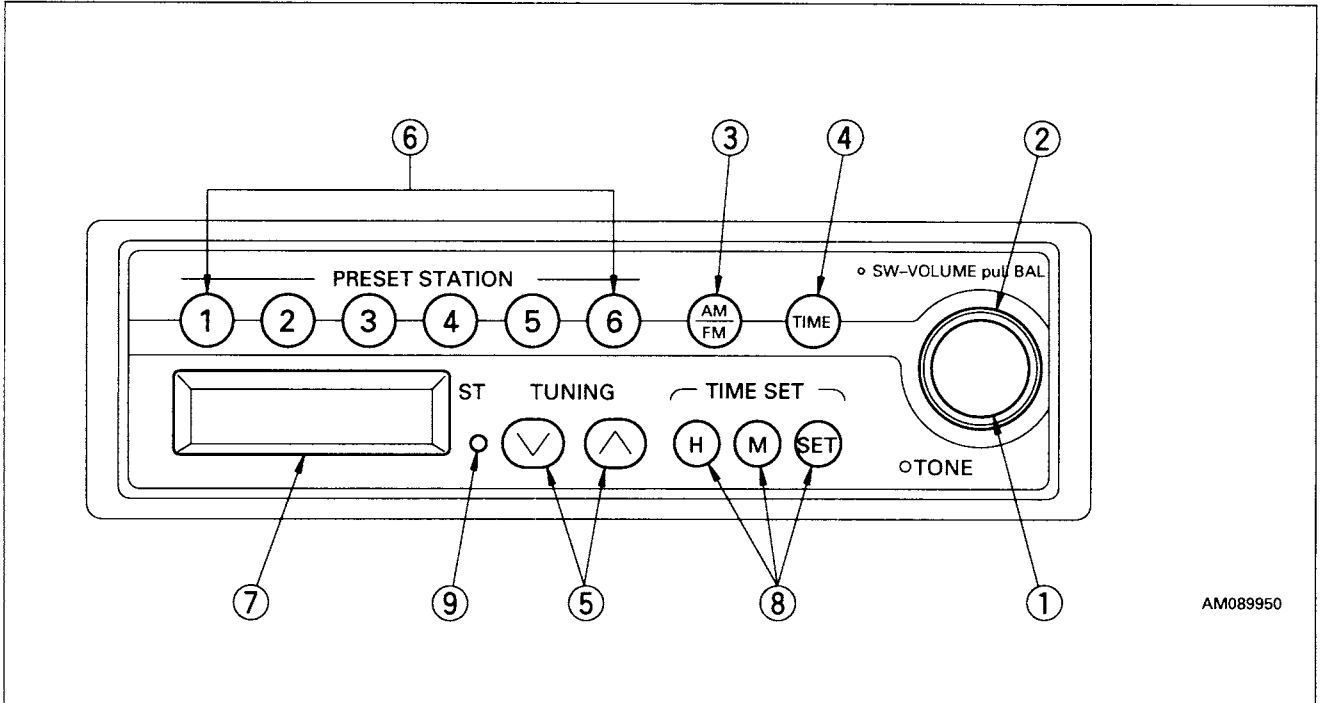

#### 1. POWER SWITCH/VOLUME CONTROL KNOB (SW-VOLUME) BALANCE (Pull BAL)

Press this knob to turn the power for the radio on. The frequency is displayed on display ⑦. Press again to turn the power off.

Turn the knob to adjust the volume as follows.

Turn CLOCKWISE to INCREASE volume

Turn COUNTERCLOCKWISE to REDUCE volume

If the knob is pulled until it locks, it can be turned to the left or right to adjust the balance of the left and right speakers.

Turn CLOCKWISE to increase volume from RIGHT speaker

Turn COUNTERCLOCKWISE to increase volume from LEFT speaker

After adjusting the left and right balance, press lightly to return the knob to its original position. (If it is left pulled out, the overall volume cannot be adjusted.)

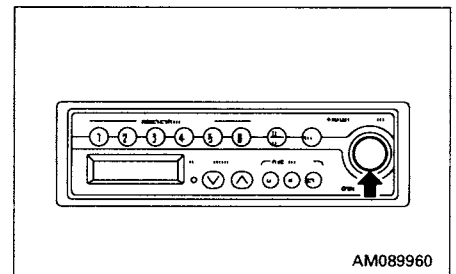

#### 2. TONE CONTROL KNOB

Turn the knob to adjust the tone as follows.

Turn CLOCKWISE to emphasize the high sounds

Turn COUNTERCLOCKWISE to suppress the high sounds

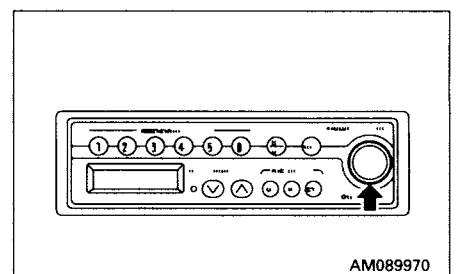

**3. FM/AM SELECTOR BUTTON (AM/FM)**

Press this button and select the desired band.  
Each time the button is pressed, it switches AM → FM → AM ...

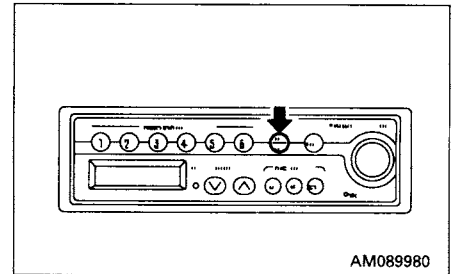

**4. DISPLAY SELECTOR BUTTON (TIME)**

This equipment gives priority to the frequency display. If the button is pressed when the frequency is displayed, display will give the present time for 5 seconds. After 5 seconds pass, the display will automatically return to the frequency display. If any button other than TIME SET (H, M, SET) is pressed within the 5 seconds, the display will return to the frequency display.

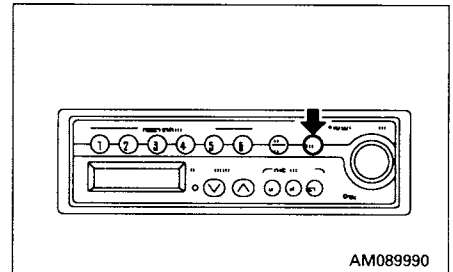

**5. TUNING BUTTONS (TUNING)  
MANUAL TUNING (MANUAL)**

Use the buttons to change the frequency.

Up button (∧): Each time the button is pressed, the frequency will go up in steps (FM: 0.1 MHz, AM: 9 kHz).

Down button (∨): Each time the button is pressed, the frequency will go down in steps (FM: 0.1 MHz, AM: 9 kHz).

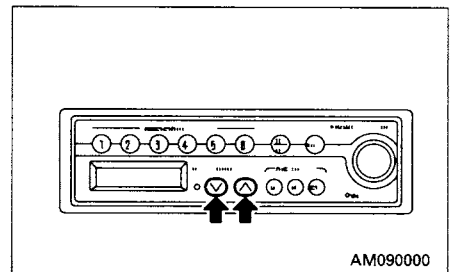

**6. PRESET BUTTONS (1, 2, 3, 4, 5, 6) (PRESET STATION)**

If these buttons are set to the frequency of the desired broadcasting station, the station can be selected at a touch.

For details of the method of presetting, see "11.12.2 METHOD OF OPERATION".

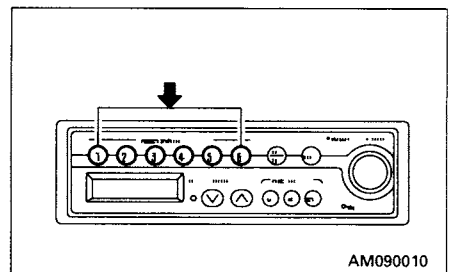

**7. DISPLAY**

The reception band, frequency, preset number, and time are displayed.

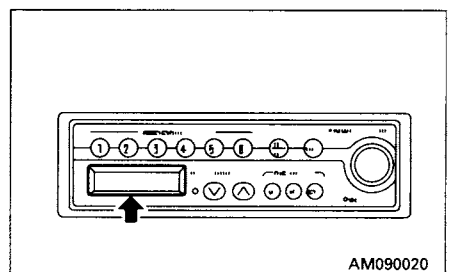

**8. TIME CORRECTION BUTTON**

This is used to correct the time.

H : Hour

M : Minute

SET: Sets to start of hour (00 minutes)

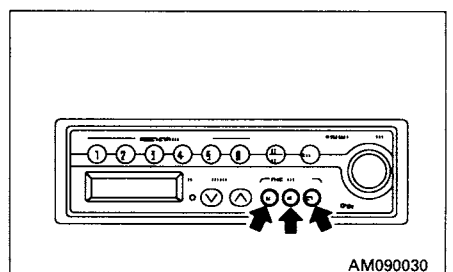

### 9. STEREO INDICATOR (ST)

This lamp lights up when a stereo broadcasting is picked up when receiving an FM broadcasting station.

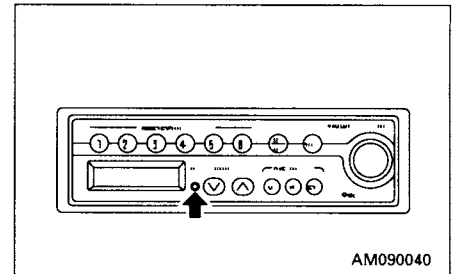

### 11.12.2 METHOD OF OPERATION METHOD OF SETTING PRESET BUTTONS

1. Press power switch ① and display the frequency on display ⑦.
2. Turn the tuning button (manual, auto) to adjust to the desired frequency.
3. Select a preset button to use for recording the frequency setting, and keep that button pressed for at least 1.5 seconds. The sound will disappear, but when the setting is recorded, the sound will appear and the preset number will appear on display ⑦ to show that the station has been preset.

After completion of presetting, press preset button ⑥, and release it within approx. 1.5 seconds. The setting will change to the frequency of the broadcasting station recorded for that button. One AM station and one FM station can be recorded for each preset button.

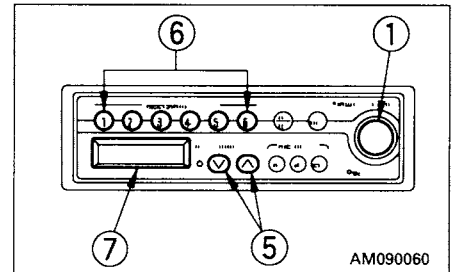

### MANUAL TUNING

Press tuning button ⑤ and set to the desired frequency.

Each time the button is pressed, the frequency will move up or down in steps of 9 kHz (AM) or 0.1 MHz (FM).

∨ button: Move to a higher frequency station

∧ button: Move to a lower frequency station

- If the frequency reaches the top or bottom limit, it will automatically change as follows: top limit → bottom limit, or bottom limit → top limit

### AUTOMATIC TUNING

Keep tuning button ⑤ pressed for at least 0.5 seconds. When a broadcasting station is picked up, it will automatically stop. To search for the next station, press tuning button ⑤ again for at least 0.5 seconds.

∨ button: Move to a higher frequency station

∧ button: Move to a lower frequency station

- If tuning button ⑤ is pressed during auto tuning, the auto tuning will be canceled and the frequency at the point where it is canceled will be picked up.

### SETTING CORRECT TIME

1. Press display selector button ④ to display the time.  
After 5 seconds, the display will return to the frequency display and the time cannot be corrected. If this happens, press display selector button ④ again.
2. Press time adjustment button ⑧ and adjust the hour and minute.  
H button: Adjusts hour (advances one hour each time it is pressed)  
M button: Adjusts minute (advances one minute each time it is pressed)  
If the H or M button are kept pressed, the time will advance continuously until the button is released.  
SET button: Sets to start of hour (when it is pressed, the minute returns to 00)  
If the minute display is between 0 and 29, and the SET button is pressed, the minute reading will return to 00. If it is pressed when the minute display is between 30 and 59, the minute display will return to 00 and the hour will advance by 1.  
Example 10:29 → 10:00  
          10:30 → 11:00  
Press the H, M, and SET buttons to set to the correct time.

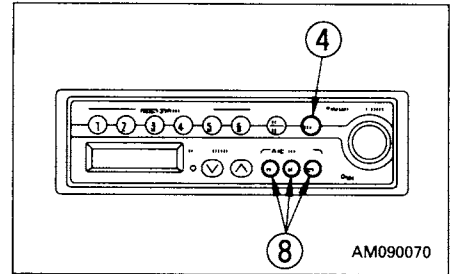

### ANTENNA

In areas where the reception is weak or there is interference, extend the antenna. If the radio is set to a station with strong radio waves, retract the antenna to set to a weaker input.

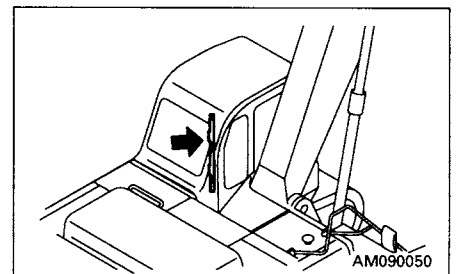

### NOTICE

**Always retract the antenna before transporting the machine or driving the machine into a work shop or garage.**

### 11.12.3 PRECAUTIONS WHEN USING

- To ensure safety, always keep the sound to a level where it is possible to hear outside sounds during operation.
- If water gets into the speaker case or car radio (auto tuning), it may lead to an unexpected failure, so be careful not to get water on the equipment.
- Do not wipe the scales or buttons with benzene, thinner, or any other solvent. Wipe with a soft dry cloth. Use a cloth soaked in alcohol if the equipment is extremely dirty.
- When the battery is replaced, the settings for the preset buttons are all cleared, so set again.

### 11.12.4 SPECIFICATIONS

Tuning method:	PLL synthesizer method
Reception frequency:	AM 522 kHz – 1629 kHz (in 9 kHz steps) FM 76.0 MHz – 90.0 MHz (in 0.1 MHz steps)
Actual max. sensitivity:	AM 30 dB FM 15 dB
Actual max. output:	10 W x 2
Current consumption:	Max. 2 A
External dimensions:	Width 184 mm, Height 56 mm, Depth 116 mm
Weight:	0.65 kg

### 11.13 ELECTRIC POWER TAKE-OUT ADAPTER

Pull out the connector plug for taking out electric power from the rear side of the panel.

Maximum usable electric power is 85 W (24 V x 3.5 A).

#### NOTICE

**Do not use as a 12 V power supply. It will cause machine failure.**

### 11.14 FUSE

**NOTICE**

**Before replacing a fuse, be sure to turn off the starting switch.**

The fuses protect the electrical equipment and wiring from burning out.

If the fuse becomes corroded, or white powder can be seen, or the fuse is loose in the fuse holder, replace the fuse.

Replace a fuse with another of the same capacity.

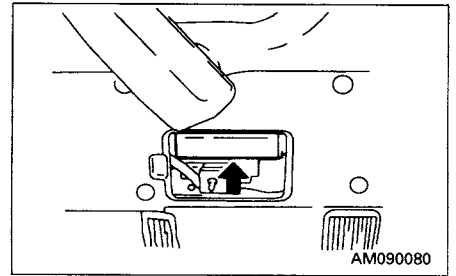

**Fuse capacity and name of circuit**

No.	Fuse capacity	Circuit
①	10 A	Pump governor controller
②	10 A	Solenoid
③	20 A	Air conditioner (motor)
④	10 A	Right head lamp, working lamp
⑤	10 A	Radio, cigarette lighter, Air conditioner panel, heater, window washer, left knob switch, auto-lubrication (option)
⑥	10 A	Horn
⑦	15 A	Wiper controller, auto-pull up controller (option)
⑧	15 A	Head lamp (option), rear working lamp (option)
⑨	10 A	Travel alarm (option), spare
⑩	10 A	Key switch signal
⑪	10 A	Spare
⑫	10 A	Spare
⑬	10 A	Buzzer, monitor
⑭	10 A	Battery relay, electric heater relay, start signal
⑮	10 A	Room lamp, car radio (back-up)
⑯	10 A	Spare fuse
⑰	10 A	Spare fuse
⑱	15 A	Spare fuse
⑲	20 A	Spare fuse

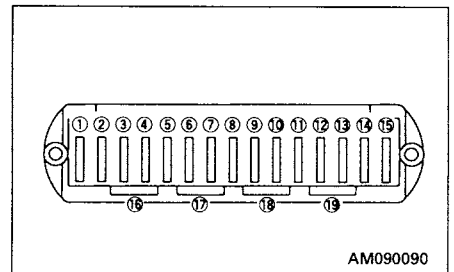



### 11.15 FUSIBLE LINK

If the starting motor will not rotate when the starting switch is turned ON, a possible cause is disconnection of wire-type fusible link ①. Inspect the fusible link in battery box cover at right side of machine and, if necessary, replace it.

#### REMARK

A fusible link refers to the large-sized fuse wiring installed in the high current flow portion of the circuit to protect electrical components and wiring from burning, similarly to an ordinary fuse.

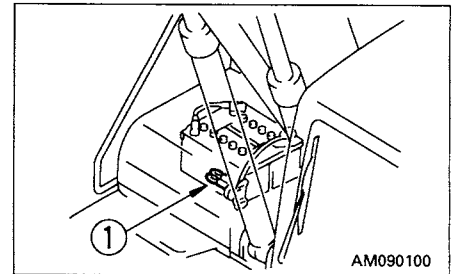

### 11.16 CONTROLLERS

A pump controller and electronic governor controller are provided.

#### NOTICE

- Never splash or spill water, mud or drink over the controllers as this may cause a fault.
- If a fault occurs in the controller, do not attempt repair, but consult your Komatsu distributor.

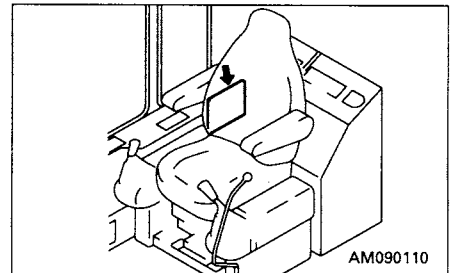

### 11.17 TOOL BOX

This is used for keeping the tools.

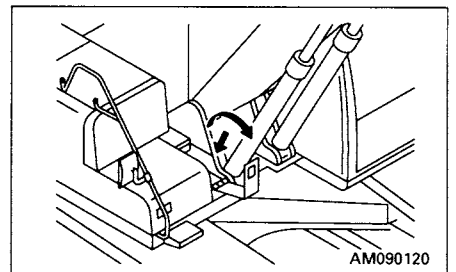

### 11.18 GREASE GUN HOLDER

This is inside the front door on the right side of the machine. Fit the grease gun to the holder when it is not being used.

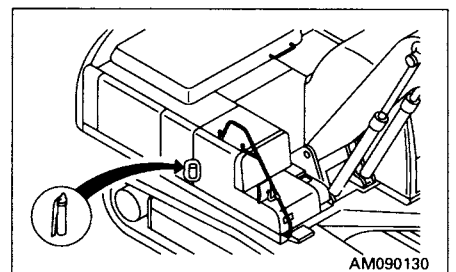

## 11.19 HANDLING ACCUMULATOR

### WARNING

On machines equipped with an accumulator, for a short time after the engine is stopped, if the work equipment control lever is moved to the LOWER position, the work equipment will move down under its own weight.

After stopping the engine, always place the safety lock lever in the LOCK position and lock the attachment control pedal with the lock pin.

The accumulator is filled with high-pressure nitrogen gas, and it is extremely dangerous if it is handled in the wrong way. Always observe the following precautions.

- Never make any hole in the accumulator or expose it to flame or fire.
- Do not weld any boss to the accumulator.
- When disposing of the accumulator, it is necessary to release the gas from the accumulator, so please contact your Komatsu distributor.

This machine is equipped with the accumulator in the control circuit. The accumulator is a device to store the pressure in the control circuit, and when it is installed, the control circuit can be operated for a short time even after the engine is stopped. Therefore, if the control lever is moved in the direction to lower the work equipment, it is possible for the work equipment to move under its own weight.

The accumulator is installed to the position shown in the diagram on the right.

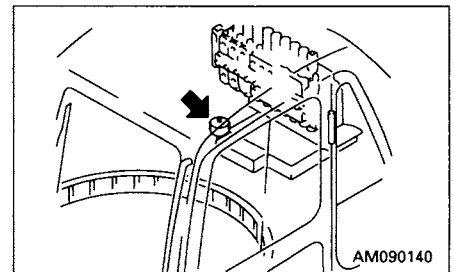

### 11.19.1 METHOD OF RELEASING PRESSURE IN CONTROL CIRCUIT ON MACHINE EQUIPPED WITH ACCUMULATOR

1. Place the work equipment on the ground. Close the crusher attachment jaws, etc.
2. Stop the engine.
3. Move the safety lock lever to the free position. Move the work equipment control lever and the attachment control pedal to full stroke back and forth, right and left so as to release the pressure in the control circuit.
4. Move the safety lock lever to the lock position. Lock the control lever and attachment control pedal. The pressure, however, will not be completely released, so when the accumulator is removed in the control circuit, gradually loosen the screws. Never stand in the oil ejection direction.

## 12. OPERATION

### 12.1 CHECK BEFORE STARTING ENGINE

Perform following check for operator safety and maintenance of machine performance.

#### 12.1.1 WALK-AROUND CHECK

**WARNING**

- Leakage of oil or fuel, or accumulation of flammable material around high temperature parts, such as the engine muffler or turbocharger, may cause fire. Check carefully, and if any abnormality is found, repair it or contact your Komatsu distributor.

Before starting the engine, look around the machine and under the machine to check for loose nut or bolts, or leakage of oil, fuel, or coolant, and check the condition of the work equipment and hydraulic system. Check also for loose wiring, play, and collection of dust at places which reach high temperatures.

Always carry out the items in this section before starting the engine each day.

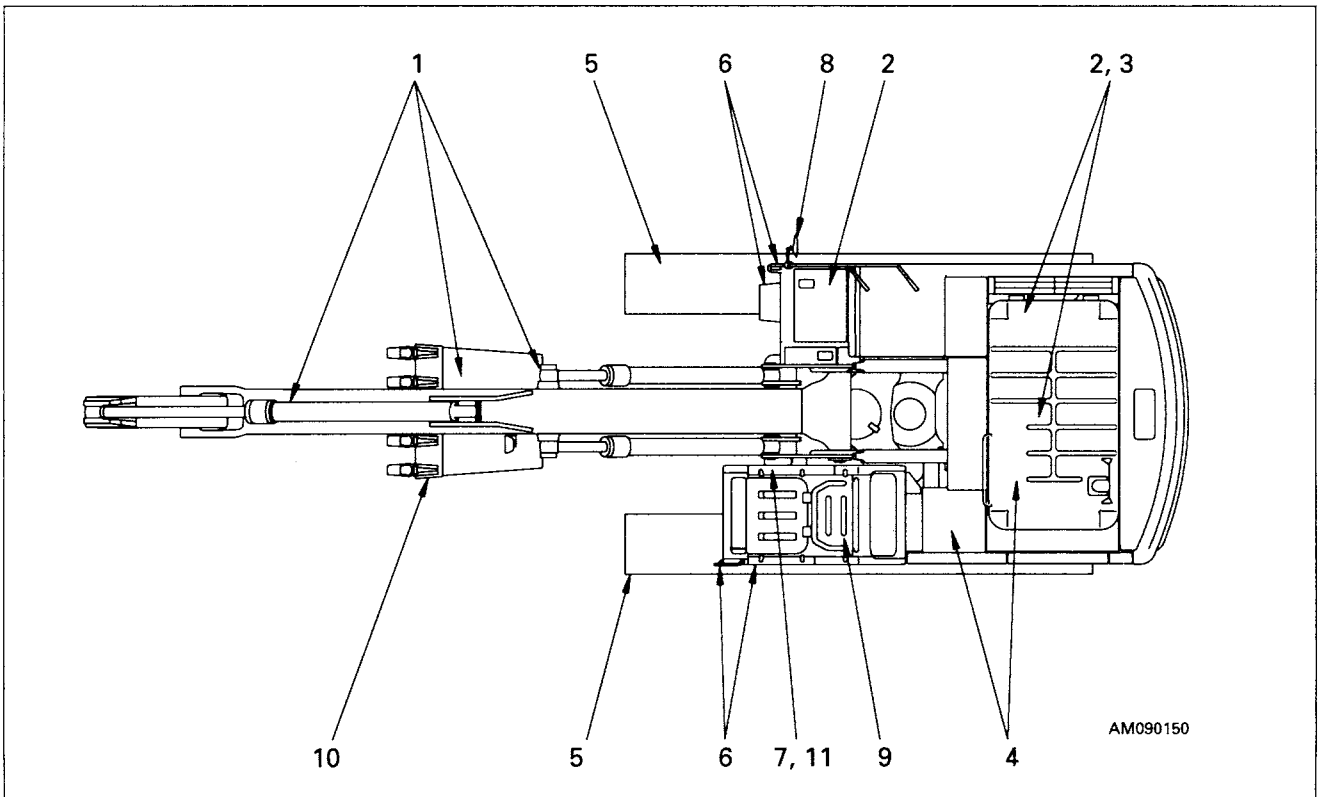

**1. Check for damage, wear, play in work equipment, cylinders, linkage, hoses**

Check that there are no cracks, excessive wear, or play in the work equipment, cylinders, linkage, or hoses. If any abnormality is found, repair it.

- 2. Remove dirt and dust from around engine, battery, radiator**  
Check if there is any dirt or dust accumulated around the engine or radiator. Check also if there is any flammable material (dead leaves, twigs, grass, etc.) accumulated around the battery or high temperature engine parts, such as the engine muffler or turbocharger. Remove all such dirt or flammable material.
- 3. Check for leakage of water or oil around engine**  
Check that there is no leakage of oil from the engine or leakage of water from the cooling system. If any abnormality is found, repair it.
- 4. Check for oil leakage from hydraulic equipment, hydraulic tank, hoses, joints**  
Check that there is no oil leakage. If any abnormality is found, repair the place where the oil is leaking.
- 5. Check the undercarriage (track, sprocket, idler, guard) for damage, wear, loose bolts, or leakage of oil from rollers**
- 6. Check for damage to handrail, loose bolts**  
Repair any damage and tighten any loose.
- 7. Check for damage to gauges, monitor, loose bolts**  
Check that there is no damage to the gauges and monitor in the operator's cab. If any abnormality is found, replace the parts. Clean off any dirt on the surface.
- 8. Clean rear view mirror, check for damage**  
Check that there is no damage to the rear view mirror. If it is damaged, replace it with a new mirror. Clean the surface of the mirror and adjust the angle so that the view to the rear can be seen from the operator's seat.
- 9. Seat belt option and mounting clamps**  
Check that there is no abnormality in the seat belt or mounting clamps. If there is any damage, replace with new parts.
- 10. Check bucket with hook (option) for damage.**  
Check the hook, catcher and hook foot for damage. If damage is found, contact your Komatsu distributor for repair.

### 12.1.2 CHECK BEFORE STARTING

Always carry out the items in this section before starting the engine each day.

#### CHECK COOLANT LEVEL, ADD WATER

##### WARNING

**Do not open the radiator cap unless necessary. When checking the coolant, always check the radiator reserve tank when the engine is cold.**

1. Open the right rear cover on the machine and check that the cooling water level is between the FULL and LOW marks on radiator reserve tank ① (shown in the diagram on the right). If the water level is low, add water through the water filler of reserve tank ① to the FULL level.
2. After adding water, tighten the caps securely.
3. If the reserve tank becomes empty, first inspect for water leaks and then fill the radiator and the reserve tank with water.

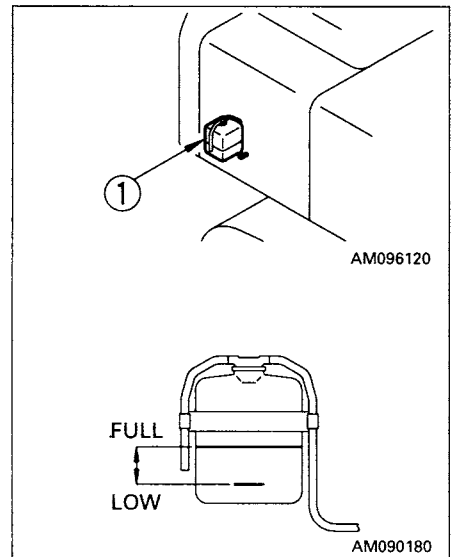

#### CHECK OIL LEVEL IN ENGINE OIL PAN, ADD OIL

##### WARNING

**The turbocharger (with safety cover) exhaust manifold is near dipstick ⑥, so be careful not to touch it.**

1. Open the engine hood on the machine.
2. Remove dipstick ⑥ and wipe the oil off with a cloth.
3. Insert dipstick ⑥ fully in the oil filler pipe, then take it out again.
4. The oil level should be between the H and L marks on dipstick ⑥.  
If the oil level is below the L mark, add engine oil through oil filler ⑦.

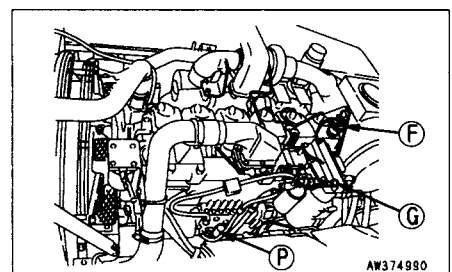

#### NOTICE

For details of the oil to use, see "20. USE OF FUEL, COOLANT AND LUBRICANTS ACCORDING TO AMBIENT TEMPERATURE".

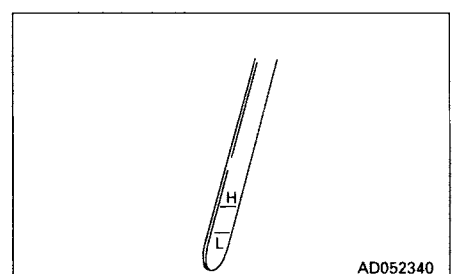

5. If the oil is above the H mark, drain the excess engine oil from drain plug (P), and check the oil level again.
6. If the oil level is correct, tighten the oil filler cap securely and close the engine hood.

**REMARK**

When checking the oil level after the engine has been operated, wait for at least 15 minutes after stopping the engine before checking.

If the machine is at an angle, make it horizontal before checking.

**CHECK FUEL LEVEL, ADD FUEL**

**WARNING**

**When adding fuel, never let the fuel overflow. This may cause a fire. If you spill fuel, thoroughly clean up any spillage.**

1. Open fuel filler cap (F) of the fuel tank.
2. When fuel filler cap (F) is opened, float gauge (G) will rise according to the fuel level.  
Check that the fuel tank is full. Check by looking into the tank and by using float gauge (G).
3. If the tank is not full, add fuel through the fuel filler until float gauge (G) rises to the maximum position.

Fuel capacity: 605 l (159.8 US gal, 133.1 UK gal)

**NOTICE**

For details of the fuel to use, see "20. USE OF FUEL, COOLANT AND LUBRICANTS ACCORDING TO AMBIENT TEMPERATURE".

4. After adding fuel, push float gauge (G) straight down with fuel filler cap (F). Be careful not to get float gauge (G) caught in the tab (2) of fuel filler cap (F), and tighten fuel filler cap (F) securely.

**REMARK**

If breather hole (1) on the cap is clogged, the pressure in the tank will drop and fuel will not flow.  
Clean the hole from time to time.

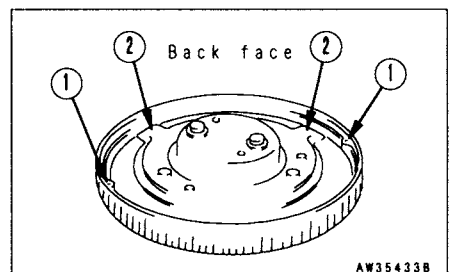
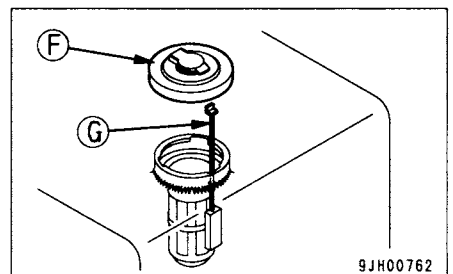
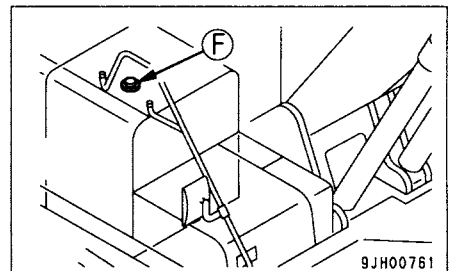

## CHECK OIL LEVEL IN HYDRAULIC TANK, ADD OIL

**WARNING**

- When removing the oil filler cap, oil may spurt out, so turn the cap slowly to release the internal pressure before removing the cap.
- If oil has been added to above the H mark, stop the engine and wait for the hydraulic oil to cool down, then drain the excess oil from the drain plug.

1. If the work equipment is not in the condition shown in the diagram on the right, start the engine, run the engine at low speed, retract the arm and bucket cylinders, then lower the boom, set the bucket teeth in contact with the ground, and stop the engine.
2. Within 15 seconds after stopping the engine, move each control lever (for work equipment and travel) to the full stroke in all directions to release the internal pressure.
3. Check sight gauge ③. The oil level is normal if between the H and L marks.

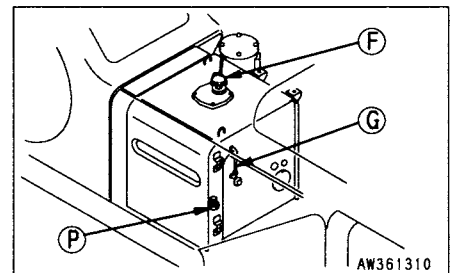
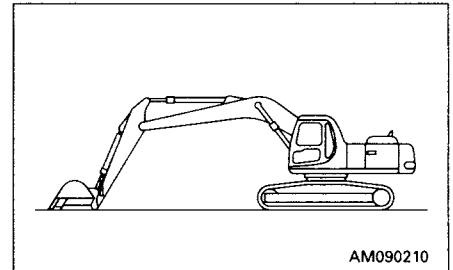
**NOTICE**

Do not add oil if the level is above the H line. This will damage the hydraulic equipment and cause the oil to spurt out.

4. If the level is below the L mark, remove the upper cover of the hydraulic tank and add oil through oil filler ④.

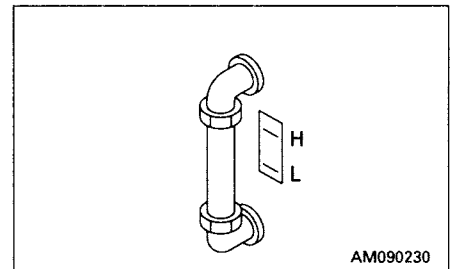
**NOTICE**

For details of the oil to use, see "20. USE OF FUEL, COOLANT AND LUBRICANTS ACCORDING TO AMBIENT TEMPERATURE".

**REMARK**

The oil level will vary depending upon the oil temperature. Accordingly, use the following as a guide:

- Before operation: around L level (Oil temperature 10 to 30°C (50 to 86°F))
- Normal operation: around H level (Oil temperature 50 to 80°C (122 to 176°F))

**CHECK AIR CLEANER FOR CLOGGING**

1. Confirm that the air cleaner clogging monitor does not flash.
2. If it flashes, immediately clean or replace the element.

For details of method of cleaning the element, see "24.2.1 CHECK, CLEAN AND REPLACE AIR CLEANER ELEMENT".

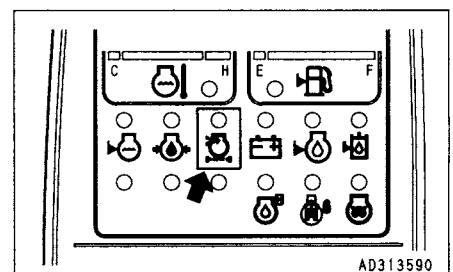

### CHECK ELECTRIC WIRINGS

**⚠ WARNING**

- If fuses are frequently blown or if there are traces of short circuit on the electrical wiring, locate the cause and carry out repair.
- Accumulation of flammable material (dead leaves, twigs, grass, etc.) around the battery may cause fire, so always check and remove such material.
- Keep the top surface of the battery clean and check the breather hole in the battery cap. If it is clogged with dirt or dust, wash the battery cap to clean the breather hole.

Check for damage and wrong capacity of the fuse and any sign of disconnection or short circuit in the electric wiring. Check also for loose terminals and tighten any loose parts.

Check the wiring of the "battery", "starting motor" and "alternator" carefully in particular.

When carrying out walk-around checks or checks before starting, always check if there is any accumulation of flammable material around the battery, and remove such flammable material.

Please contact your Komatsu distributor for investigation and correction of the cause.

### CHECK FUNCTION OF HORN

1. Turn the starting switch to the ON position.
2. Confirm that the horn sounds without delay when the horn button is pressed. If the horn does not sound, ask your Komatsu distributor for repair.

### CHECK FOR WATER AND SEDIMENT IN WATER SEPARATOR, DRAIN WATER (OPTION)

The water separator separates water mixed in the fuel. If float ② is at or above red line ①, drain the water according to the following procedure:

1. Loosen drain plug ③ and drain the accumulated water until the float reaches the bottom.
2. Tighten drain plug ③.
3. If the air is sucked into fuel line when draining the water, be sure to bleed air in the same manner as for the fuel filter. See "24.7 EVERY 500 HOURS SERVICE".

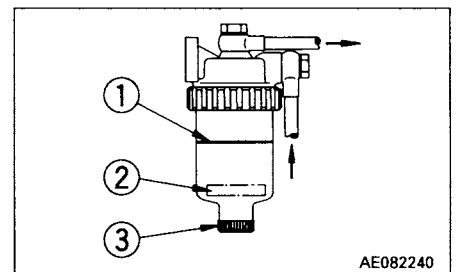



### 12.1.3 ADJUST BEFORE OPERATION

#### **⚠ WARNING**

- Adjust the seat position before starting operations or after changing the operator.
- Adjust the seat so that the brake pedal can be depressed fully with the operator's back against the backrest.

#### **A: Fore-and-aft adjustment**

Move lever ① to right. After the seat is set to the desired position, release the lever.

Adjustable distance: 100 mm (3.3 in) in 10 steps

#### **B: Adjusting reclining**

#### **NOTICE**

The seat can be reclined to a large angle when the seat is pushed fully forward, but the reclining angle is reduced when the seat is moved back, so when moving the seat to the rear, return the seat back to its original position.

Pull lever ② and set the seat back to a position which is comfortable for operation, then release the lever.

Sit with your back against the seat back when adjusting. If your back is not touching the seat back, the seat back may suddenly move forward.

#### **C: Adjusting seat tilt**

##### 1. Forward tilt (↕)

Push lever ③ down to adjust the angle of the front of the seat. (4 stages)

1. To raise the angle at the front of the seat, keep the lever pushed down and apply your weight to the rear of the seat.
2. To lower the angle at the front of the seat, keep the lever pushed down and apply your weight to the front of the seat.

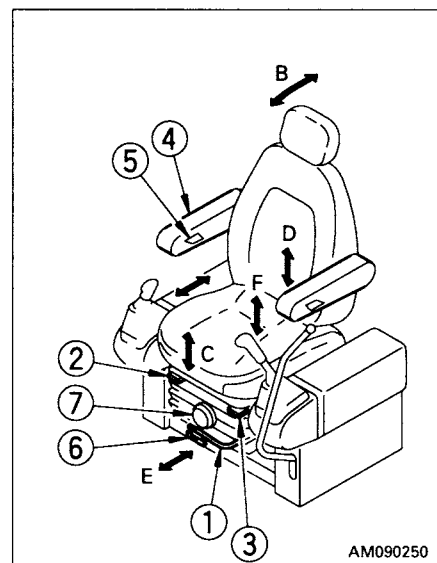

### 2. Rear tilt (↕)

Pull lever ③ up to adjust the angle of the rear of the seat. (4 stages)

1. To raise the angle at the rear of the seat, keep the lever pulled up and stand up slightly to remove your weight from the seat.
2. To lower the angle at the rear of the seat, keep the lever pulled up and apply your weight to the rear of the seat.

Amount of tilt: Up 13°, down 13°

### 3. Adjusting seat height

It is possible to move the seat up or down by combining adjustments 1 and 2.

After setting the forward tilt or rear tilt to the desired height, operate the opposite part to set the seat horizontal then secure in position.

Height adjustment: 60 mm (2.4 in)

### D: Adjusting armrest angle

Armrest ④ can be made to spring up by hand approx. 90°.

In addition, by turning the bottom ⑤ of the armrest by hand it is possible to make fine vertical adjustments of the armrest angle.

Armrest adjustment angle: 25°

### REMARK

If the seat back is tipped to the front without raising the armrest, the armrest will rise automatically.

### E: Overall fore-and-aft adjustment of seat

Pull up lever ⑥, set to the desired position, then release the lever. In this case, the operator's seat, left and right control levers, and safety lock lever all slide together.

Fore-and-aft adjustment: 120 mm (4.8 in)

**F: Adjusting suspension**

Turn knob ⑦ to the right to make the suspension harder, or to the left to make the suspension softer. Adjust the reading of the dial to match the operator's weight and select the optimum suspension.

**REMARK**

To obtain the optimum adjustment, turn the knob so that the indicator of the weight display (kg) in the transparent portion of knob ⑦ is the same as the operator's weight.

**ADJUSTMENT OF MONITOR PANEL ANGLE**

Turn the monitor panel so that the operator can view the monitor with ease. When adjusting the angle, the panel should be set to the desired position using both hands. The panel is automatically locked at that position. Amount of adjustment: 30° (stepless)

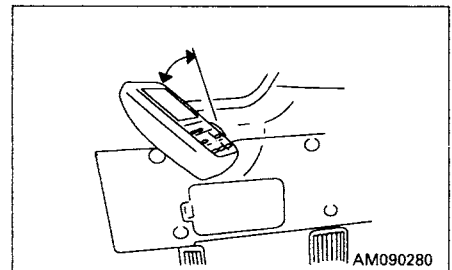

**ADJUSTMENT OF MIRRORS**

Loosen nut ① and bolt ② of the mirror and adjust the mirror so that it gives the optimum view from the operator's seat.

- Adjust the mirror mount so that any person on the left and right side at the rear of the machine (or any object approx. 1 m (39.4 in) high and 30 cm (11.8 in) in diameter) is clearly visible.
- Install so that the mounting position of the mirror is the dimensions shown in the chart. The field of visibility is given in the chart below for reference.

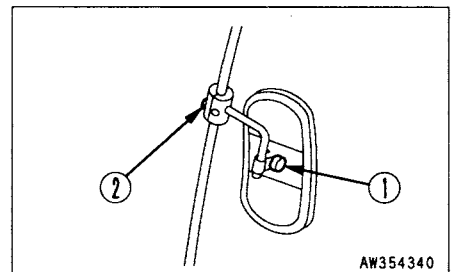

Mounting position X: 150 mm (5.9 in)  
 Field of visibility Y (right): 2800 mm (110.3 in)  
 Field of visibility Z (left): 2400 mm (94.6 in)

- Mirror A: Hatched area ① to be visible
- Mirror B: Hatched area ② to be visible
- Mirror C: Hatched area ③ (option) to be visible

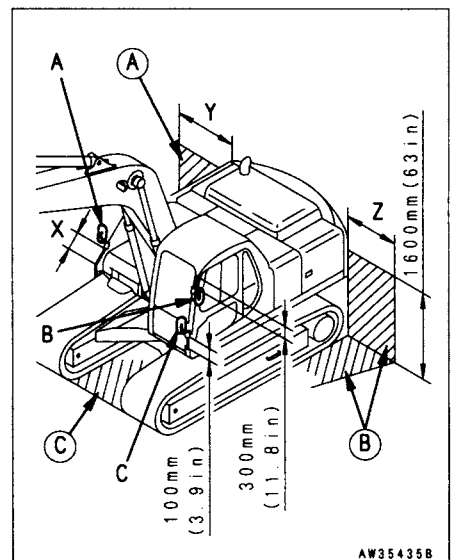

### 12.1.4 OPERATIONS AND CHECKS BEFORE STARTING ENGINE

**⚠ WARNING**

If the control lever is touched by accident, the work equipment or the machine may move suddenly. When leaving the operator's compartment, always set the safety lock lever securely to the LOCK position.

1. Check that safety lock lever ① is at the LOCK position.
2. Check the position of each lever.

Set the control lever to the neutral position.  
When starting the engine, never touch the knob button.

3. Insert the key in starting switch ②, turn the key to the ON position, then carry out the following checks.

(1) The buzzer will sound for approx. 1 sec, and the following monitors and gauges will light up for approx. 3 sec.

- Radiator water level monitor ③
- Engine oil level monitor ④
- Hydraulic oil level monitor ⑤
- Charge level monitor ⑥
- Fuel level monitor ⑦
- Engine water temperature monitor ⑧
- Engine oil pressure monitor ⑨
- Engine water temperature gauge ⑩
- Fuel gauge ⑪
- Engine pre-heating lamp ⑫
- Air cleaner clogging ⑬
- Swing lock lamp ⑭
- Replacement monitor of engine oil ⑮

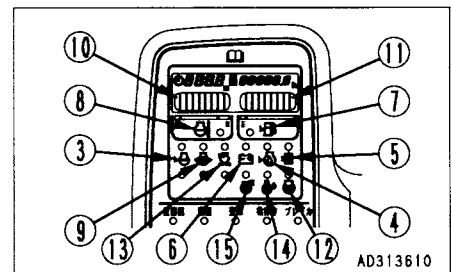
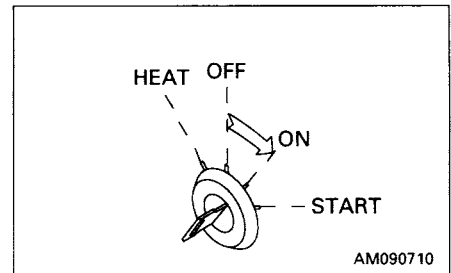
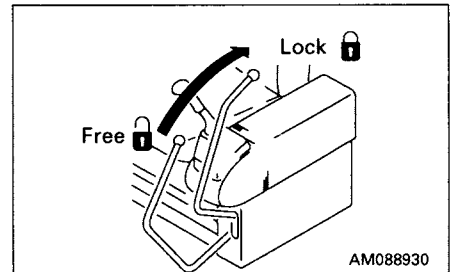
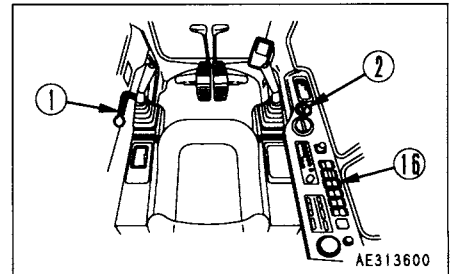

If the monitors or gauges do not light up or the buzzer does not sound, there is probably a broken bulb or disconnection in the monitor wiring, so contact your Komatsu distributor for repairs.

After approx. 3 sec, the following gauges will remain on and the other monitors will go out.

- Engine water temperature gauge ⑩
- Fuel gauge ⑪

- (2) Press lamp switch ⑯ to turn on the head lamps.  
If the lamps do not light up, there is probably a broken bulb or disconnection in the wiring, so contact your Komatsu distributor for repairs.

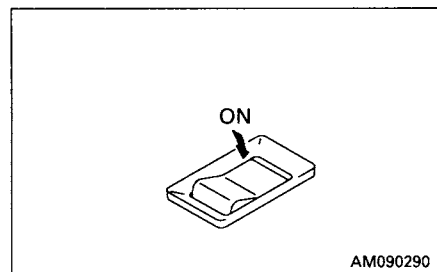

## 12.2 STARTING ENGINE

### 12.12.1 NORMAL STARTING

**WARNING**

Check that there are no persons or obstacles in the surrounding area, then sound the horn and start the engine.

**NOTICE**

Do not keep the starting motor rotating continuously for more than 20 seconds.

If the engine will not start, wait for at least 2 minutes before trying to start the engine again.

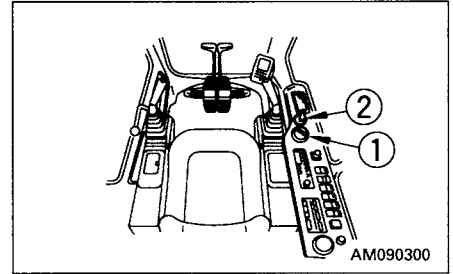

1. Set fuel control dial ① at the low idling (MIN) position.

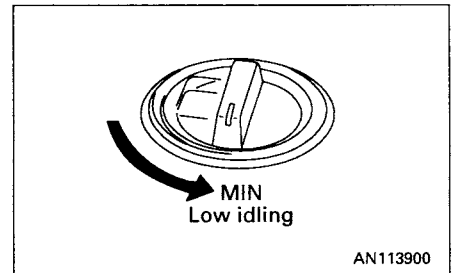

2. Turn the key in starting switch ② to the START position. The engine will start.

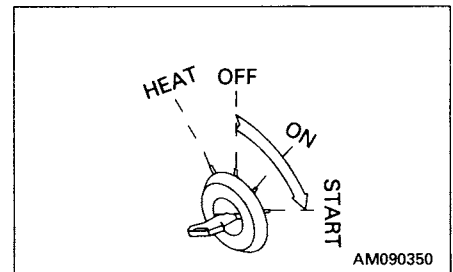

3. When the engine starts, release the key in starting switch ②. The key will return automatically to the ON position.

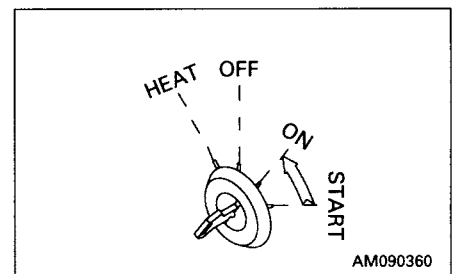

## 12.2.2 STARTING IN COLD WEATHER

**WARNING**

- Check that there are no persons or obstacles in the surrounding area, then sound the horn and start the engine.
- Never use starting aid fluids as they may cause explosions.

**NOTICE**

Do not keep the starting motor rotating continuously for more than 20 seconds.

If the engine fails to start, repeat from step 2 and after waiting for about 2 minutes.

When starting in low temperatures, do as follows.

1. Set fuel control dial ① at 3 notch from the low idling (MIN) position.

**REMARK**

There are 10 notches for the dial rotation, and the click can be felt by hand.

2. Hold the key in starting switch ② at the HEAT position, and check that preheating monitor ③ lights up. After about 30 seconds, preheating monitor lamp ③ will flash for about 10 seconds to indicate that preheating is finished.

**REMARK**

The monitor and gauge also light up when the key is at the HEAT position, but this does not indicate any abnormality.

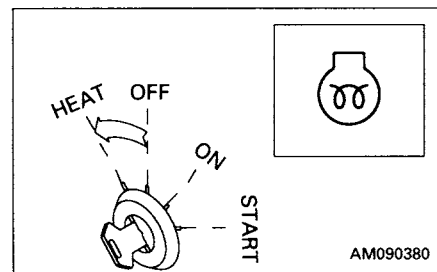
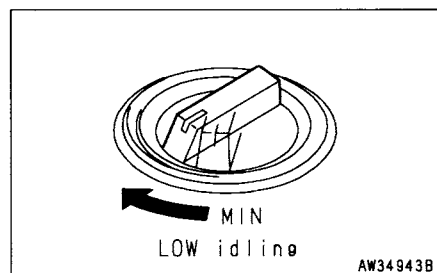
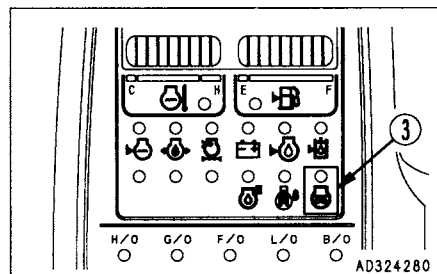
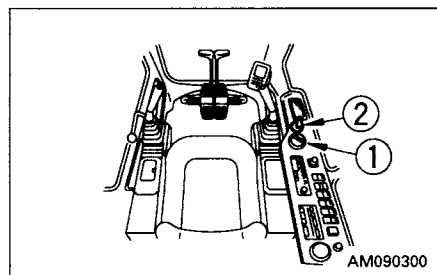

## 12. OPERATION

---

3. When preheating monitor ③ flashes, turn the key in starting switch ② to the START position to start the engine.

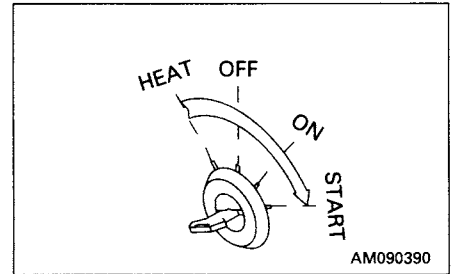

4. When the engine starts, release the key in starting switch ②. The key will return automatically to the ON position.

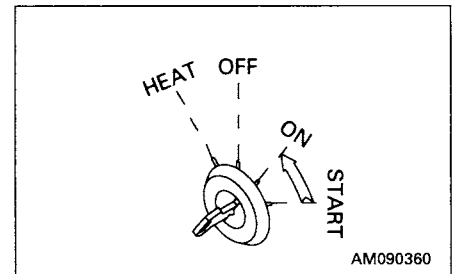



## 12.3 OPERATIONS AND CHECKS AFTER STARTING ENGINE

### WARNING

- **Emergency stop**  
If there has been any abnormal actuation or trouble, turn the starting switch key to the OFF position.
- If the work equipment is operated without warming the machine up sufficiently, the response of the work equipment to the movement of the control lever will be slow, and the work equipment may not move as the operator desires, so always carry out the warming-up operation. Particularly in cold areas, be sure to carry out the warming-up operation fully.

### 12.3.1 WHEN NORMAL

#### NOTICE

- When the hydraulic oil is at a low temperature, do not carry out operations or move the levers suddenly. Always carry out the warming-up operation. This will help to extend the machine life.
- Do not suddenly accelerate the engine before the warming-up operation is completed.

Do not run the engine at low idling or high idling continuously for more than 20 minutes. This will cause leakage of oil from the turbocharger oil supply piping. If it is necessary to run the engine at idling, apply a load from time to time or run the engine at a mid-range speed.

After starting the engine, do not immediately start operations. First, carry out the following operations and checks.

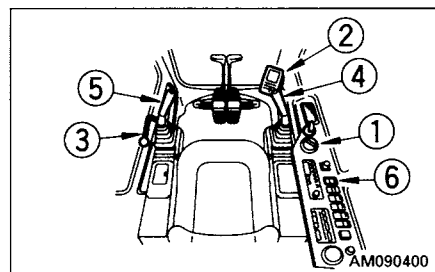

1. Turn fuel control dial ① to the center position between LOW IDLING (MIN) and HIGH IDLING (MAX) and run the engine at medium speed for about 5 minutes with no load.

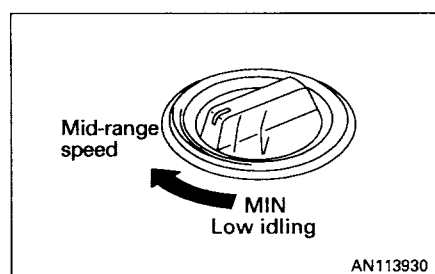

2. While running the engine at medium speed, press working mode switch ② until the heavy-duty operation mode lamp is turned on.

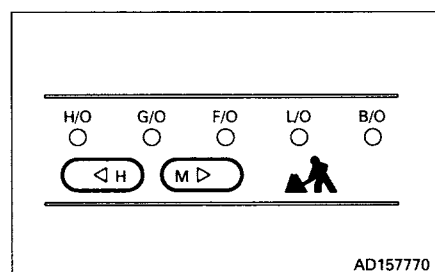

## 12. OPERATION

3. Set the safety lock lever ③ to the FREE position, and raise the bucket from the ground.

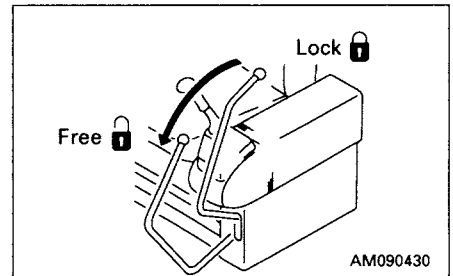

4. Operate bucket control lever ④ and arm control lever ⑤ slowly to move the bucket cylinder and arm cylinder to the end of the stroke.

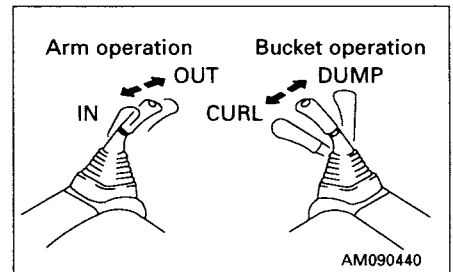

5. Carry out bucket and arm operation for 5 minutes at full stroke, alternating between bucket operation and arm operation at 30 second intervals.

If the swing lock switch ⑥ is set to the ON (actuated) position and swing control lever ⑤ is operated at full stroke, oil temperature-rise can be increased earlier.

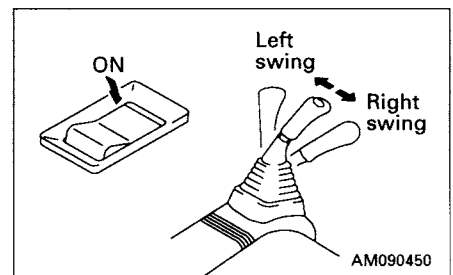

### NOTICE

When the work equipment is retracted, take care that it does not interfere with the machine body or ground.

6. After carrying out the warming-up operation, check that each gauge and monitor lamp is in the following condition.

- Engine water temperature gauge ⑦: Inside green range
- Fuel gauge ⑧: Inside green range
- Engine water temperature monitor ⑨: OUT
- Radiator water level monitor ⑩: OUT
- Engine oil pressure monitor ⑪: OUT
- Charge level monitor ⑫: OUT
- Fuel level monitor ⑬: OUT
- Air cleaner clogging monitor ⑭: OUT
- Engine pre-heating lamp ⑮: OUT
- Engine oil level monitor ⑯: OUT
- Hydraulic oil level monitor ⑰: OUT
- Replacement monitor of engine oil ⑱: OUT

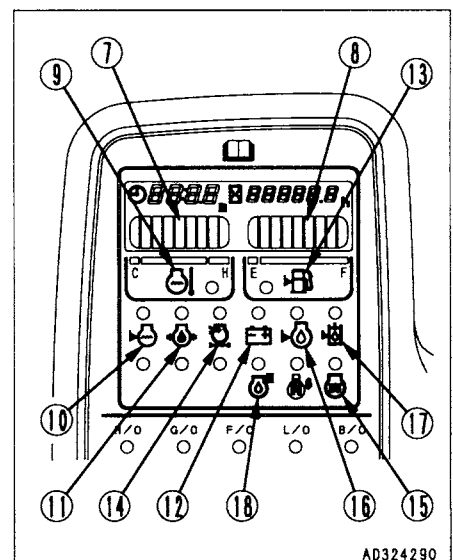

7. Check that there is no abnormal exhaust gas color, noise, or vibration. If any abnormality is found, repair it.

8. Press mode switch ② until required operation mode lamp is turned on.

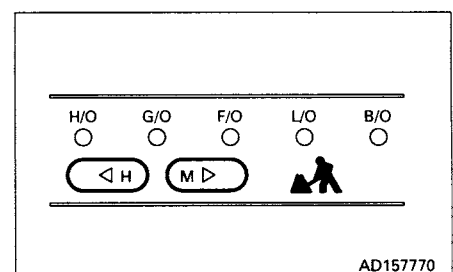

### 12.3.2 IN COLD AREAS (AUTOMATIC WARMING-UP OPERATION)

When starting the engine in cold areas, carry out the automatic warming-up operation after starting the engine.

When the engine is started, if the engine water temperature is low (below 30°C), the warming-up operation is carried out automatically.

The automatic warming-up operation is canceled if the engine water temperature reaches the specified temperature (30°C) or if the warming-up operation is continued for 10 minutes. If the engine water temperature or hydraulic oil temperature are low after the automatic warming-up operation, warm the engine up further as follows.

#### NOTICE

- When the hydraulic oil is at a low temperature, do not carry out operations or move the levers suddenly. Always carry out the warming-up operation. This will help to extend the machine life.
- Do not suddenly accelerate the engine before the warming-up operation is completed.

Do not run the engine at low idling or high idling continuously for more than 20 minutes. This will cause leakage of oil from the turbocharger oil supply piping. If it is necessary to run the engine at idling, apply a load from time to time or run the engine at a mid-range speed.

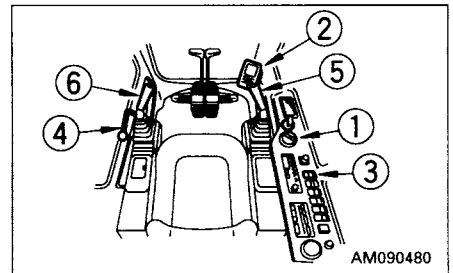

1. Set fuel control dial ① to the low idling (MIN) position and run the engine for about 5 minutes without load.

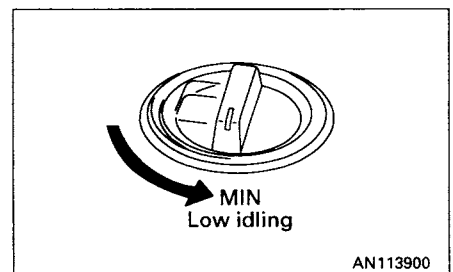

## 12. OPERATION

2. Press working mode switch ② on the monitor panel until the H.O (heavy-duty operation) mode lamp lights up.

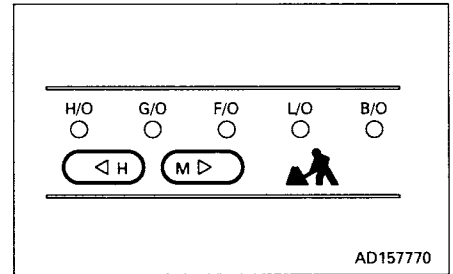

3. Turn fuel control dial ① to the medium speed position.

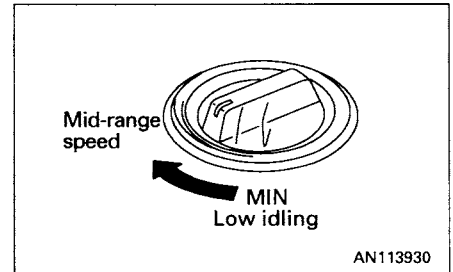

4. Set safety lock lever ④ to the FREE position and raise the bucket from the ground.

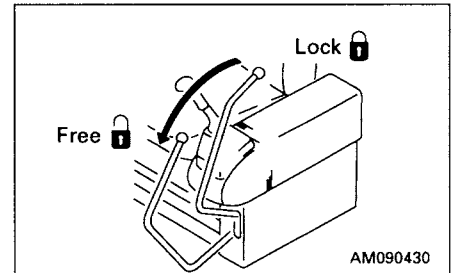

5. Operate bucket control lever ⑤ and arm control lever ⑥ slowly to move the bucket cylinder and arm cylinder to the end of their stroke.

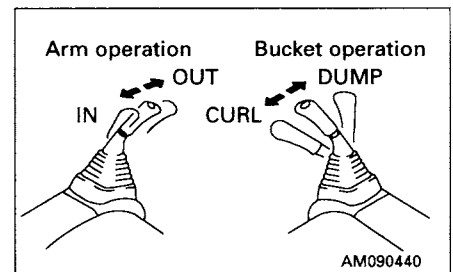

6. Operate the bucket for 30 seconds and the arm for 30 seconds in turn fully for 5 minutes.

### REMARK

Turn swing lock switch ③ ON (ACTUATED) and operate the lever to make the oil temperature rise more quickly.

### NOTICE

When the work equipment is retracted, take care that it does not interfere with the machine body or ground.

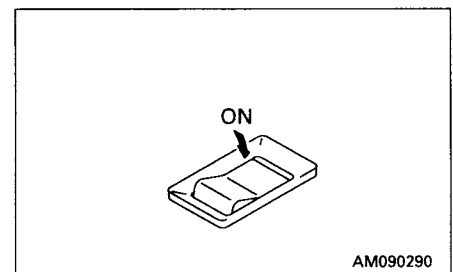

7. Turn fuel control dial ① to the full speed (MAX) position and carry out the operation in Step 6 for 3 – 5 minutes.
8. Repeat the following operation 3 – 5 times and operate slowly.
- Boom operation                      RAISE ↔ LOWER
  - Arm operation                        IN ↔ OUT
  - Bucket operation                    CURL ↔ DUMP
  - Swing operation                    LEFT ↔ RIGHT
  - Travel (Lo) operation      FORWARD ↔ REVERSE

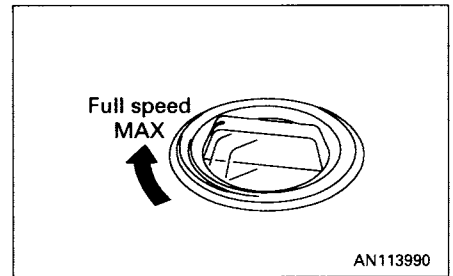

#### REMARK

In the above operation is not carried out, there may be a delay in response when starting or stopping each actuator, so continue the operation until it becomes normal.

9. Use working mode switch ② on the monitor panel to select the working mode to be used.

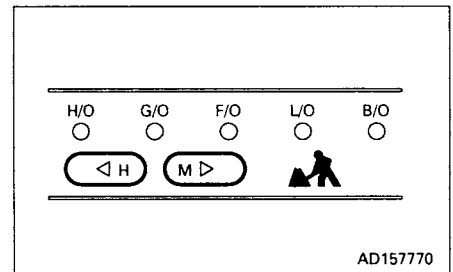

**NOTICE**

**Canceling automatic warming-up operation**

If it becomes necessary in an emergency to lower the engine speed to low idling, cancel the automatic warming-up operation as follows.

1. Turn fuel control dial ① to the full speed (MAX) position and hold it for 3 seconds.

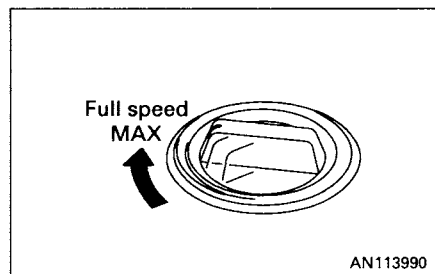

2. When fuel control dial ① is returned to the low idling (MIN) position, the engine speed will drop.

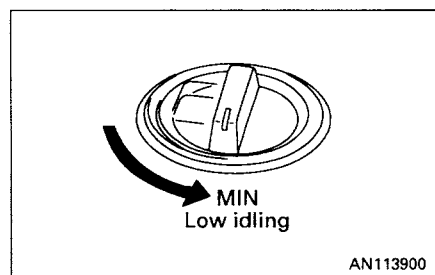

## 12.4 MOVING MACHINE OFF

### 12.4.1 MOVING MACHINE FORWARD

#### WARNING

- Before operating the travel levers, check the direction of the track frame. If the sprocket is at the front, the operation of the travel levers is reversed.
- When moving off, check that the area around the machine is safe, and sound the horn before moving.
- Clear all personnel from the machine and the area.
- Clear all obstacles from the path of the machine.
- If the lever is moved inside the deceleration range, engine speed will rise suddenly. Operate the levers carefully.
- For machines equipped with the travel alarm (option), check that the alarm works properly.

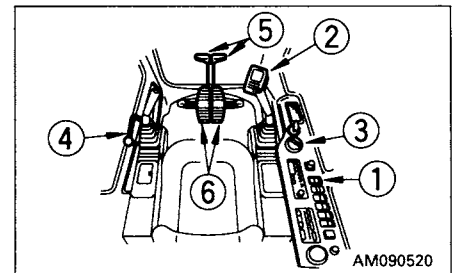

1. Set swing lock switch ① to the ON (actuated) position and confirm that swing lock monitor lamp ② lights up.

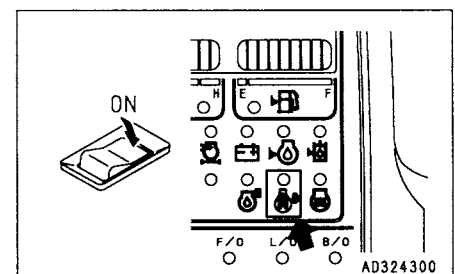

2. Turn fuel control dial ③ towards the full speed position to increase the engine speed.

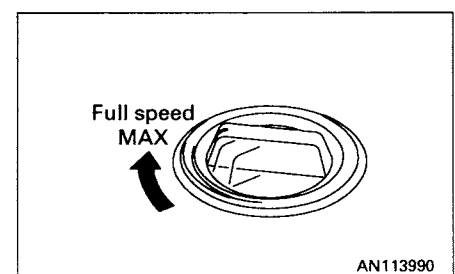

3. Set safety lock lever ④ in the FREE position, fold the work equipment, and raise it 40 – 50 cm (16 to 20 in) from the ground.

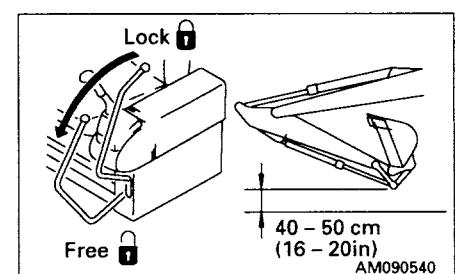

4. Operate right and left travel levers ⑤ or right and left travel pedals ⑥ as follows.

- **When the sprocket is at the rear of the machine**  
Push levers ⑤ forward slowly or depress the front part of pedals ⑥ slowly to move the machine off.

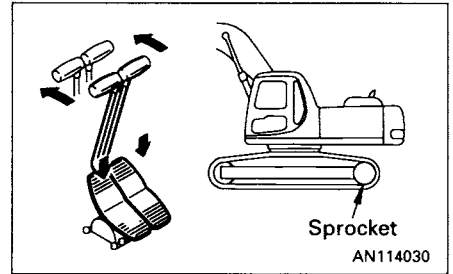

- **When the sprocket is at the front of the machine**  
Pull levers ⑤ backward slowly or depress the rear part of pedals ⑥ slowly to move the machine off.

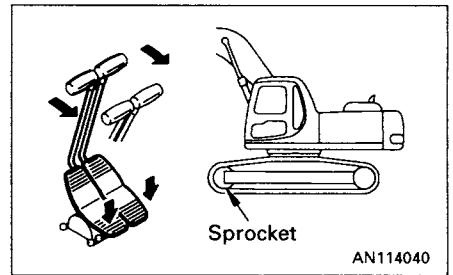

**REMARK**

Each time the travel levers are operated on machines equipped with the travel alarm, the alarm sounds to warn people in the machine vicinity.

**12.4.2 MOVING MACHINE BACKWARD**

**⚠ WARNING**

- Before operating the travel levers, check the direction of the track frame. If the sprocket is at the front, the operation of the travel levers is reversed.
- When moving off, check that the area around the machine is safe, and sound the horn before moving.
- Clear all personnel from the machine and the area.
- Clear all obstacles from the path of the machine.
- Use extreme care when reversing the machine. Note there is an blind spot behind the machine.
- If the lever is moved inside the deceleration range, engine speed will suddenly rise. Operate the levers carefully.
- For machines equipped with the travel alarm (option), check that the alarm works properly.

1. Set swing lock switch ① to the ON (actuated) position and confirm that swing lock monitor lamp ② lights up.

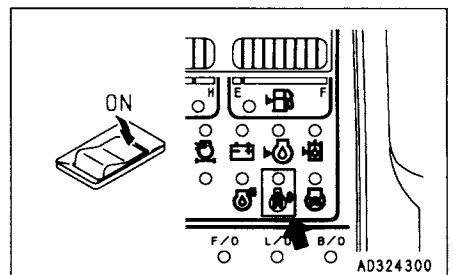
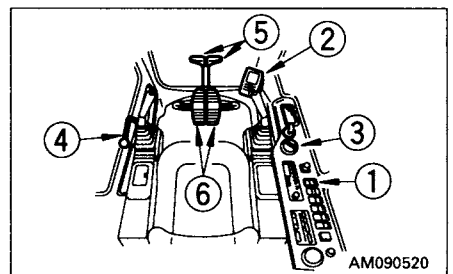



2. Turn fuel control dial ③ towards the full speed (MAX) position to increase the engine speed.

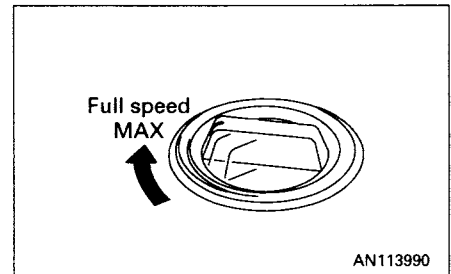

3. Set safety lock lever ④ in the FREE position, fold the work equipment, and raise it 40 – 50 cm (16 to 20 in) from the ground.

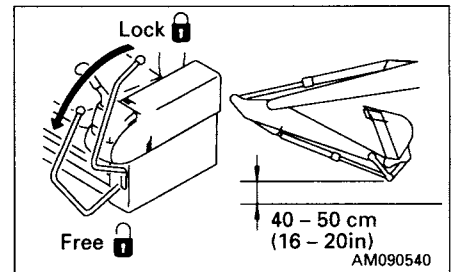

4. Operate right and left travel levers ⑤ or right and left travel pedals ⑥ as follows.

- **When the sprocket is at the rear of the machine**  
Pull levers ⑤ backward slowly or depress the rear part of pedals ⑥ to move the machine off.
- **When the sprocket is at the front of the machine**  
Push levers ⑤ forward slowly or depress the front part of pedals ⑥ to move the machine off.

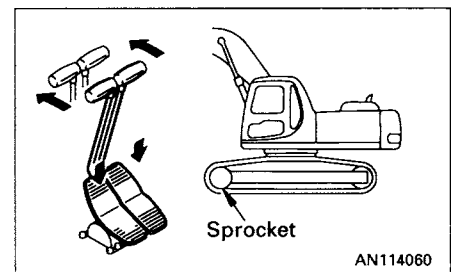
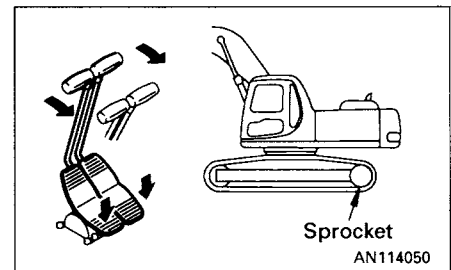

## 12.5 STEERING MACHINE

### 12.5.1 STEERING (CHANGING DIRECTION)

**WARNING**

Before operating the travel levers, check the position of the sprocket. If the sprocket is at the front, the operation of the travel levers is reversed.

Use the travel levers to change direction.

Avoid sudden changes of direction as far as possible. In particular, when carrying out counter-rotation (spin turn), stop the machine first before turning.

Operate two travel levers ① as follows.

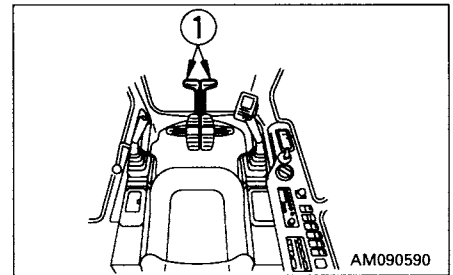

#### Changing direction of machine when stopped

When turning to the left:

Push the right travel lever forward to travel left when traveling forward; and pull it back to turn left when traveling in reverse.

**REMARK**

When turning to the right, operate the left travel lever in the same way.

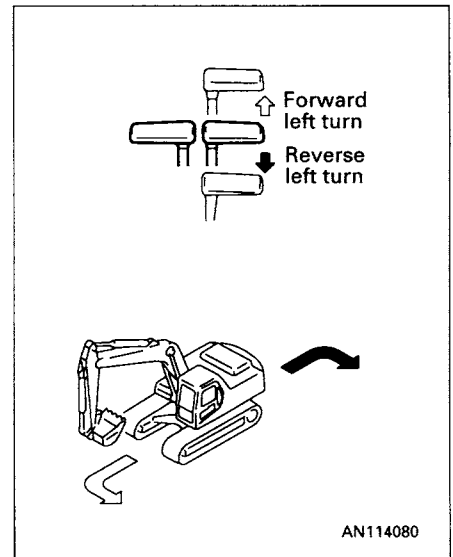

#### Steering when traveling (left and right travel levers both operated in same direction)

When turning to the left:

If the left travel lever is returned to the neutral position, the machine will turn to the left.

**REMARK**

When turning to the right, operate the right travel lever in the same way.

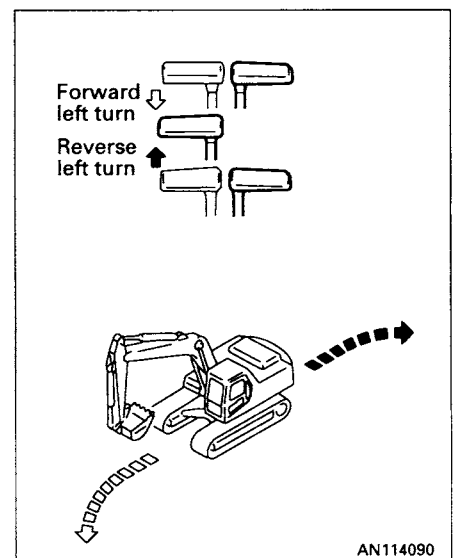

**When making counter-rotation turn (spin turn)**

When turning left using counter-rotation, pull the left travel lever back and push the right travel lever forward.

**REMARK**

When turning right using counter-rotation, pull the right travel lever back and push the left travel lever forward.

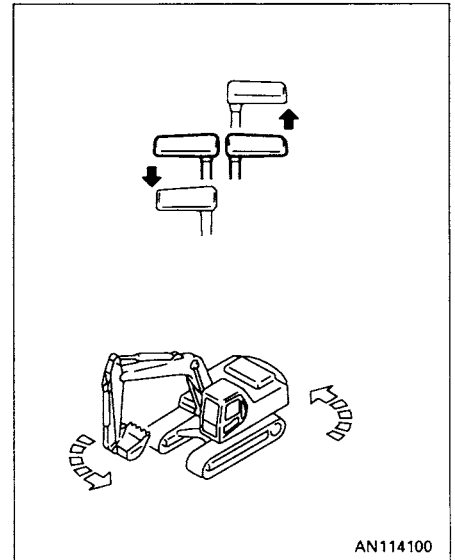

## 12.6 STOPPING MACHINE

**⚠ WARNING**

- Avoid stopping suddenly. Give yourself ample room when stopping.
- When stopping the machine, select flat hard ground and avoid dangerous places. If it is unavoidably necessary to park the machine on a slope, insert blocks underneath the track shoes. As an additional safety measure, thrust the bucket into the ground.
- If the control lever is touched by accident, the work equipment or the machine may move suddenly, and this may lead to a serious accident. Before leaving the operator's compartment, always set the safety lock lever securely to the LOCK position.

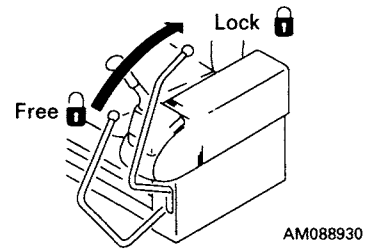
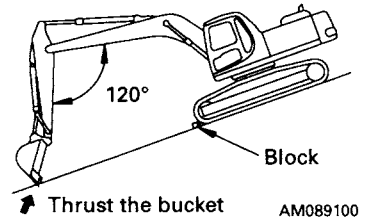

1. Put the left and right travel levers ① in the neutral position, then stop the machine.

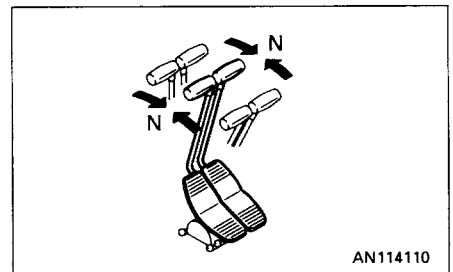
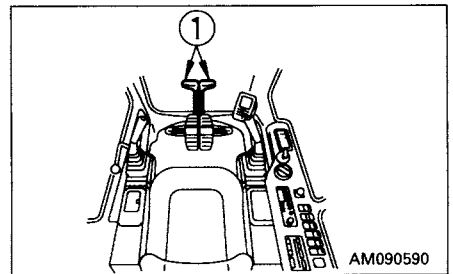

## 12.7 SWINGING

**WARNING**

When operating the swing, check that the area around the machine is safe.

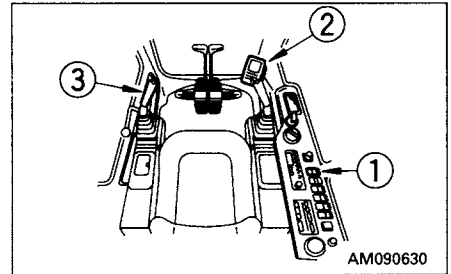

1. Before operating the swing, turn swing lock switch ① OFF (CANCELED).

**NOTICE**

Check that swing lock monitor ② goes out at the same time.

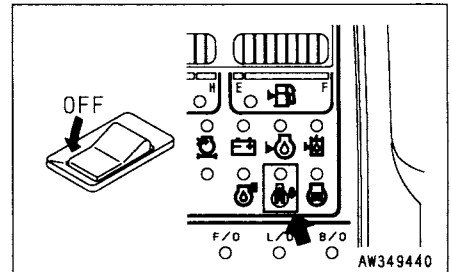

2. Operate left work equipment control lever ③ to swing the upper structure.

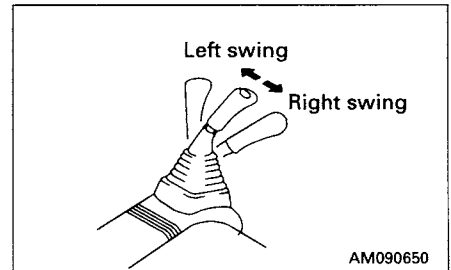

3. When not operating the swing, turn swing lock switch ① ON (ACTUATED).

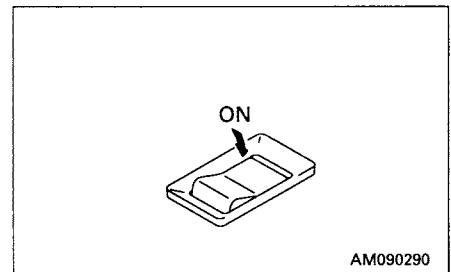

## 12.8 OPERATION OF WORK EQUIPMENT

### WARNING

If any lever is operated when in the deceleration range, the engine speed will suddenly increase, so be careful when operating the levers.

The work equipment is operated by the left and right work equipment control levers. The left work equipment control lever operates the arm and swing, and the right work equipment control lever operates the boom and bucket.

The movements of the lever and work equipment are as shown in the diagrams on the right. When the levers are released, they automatically return to the neutral position and the work equipment is held in place.

- If the work equipment control lever is returned to the neutral position when the machine is stopped, even if the fuel control dial is set to FULL, the auto-deceleration mechanism will act to reduce the engine speed to a mid-range speed.

### REMARK

If the levers are operated within 15 seconds after stopping the engine, it is possible to lower the work equipment to the ground. In addition, the levers can also be operated to release any remaining pressure inside the hydraulic cylinder circuit and to lower the boom after loading the machine on a trailer.

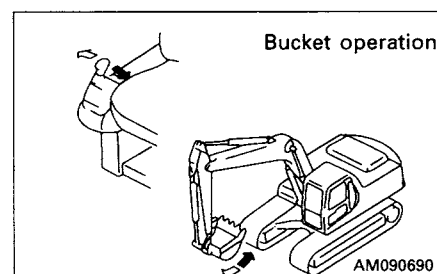
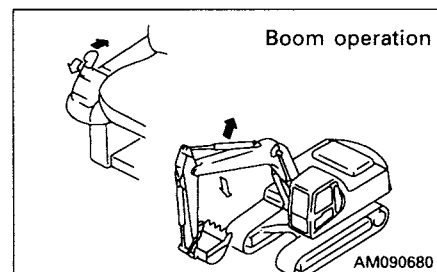
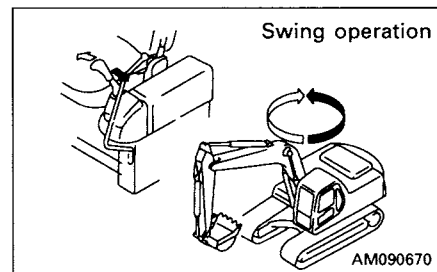
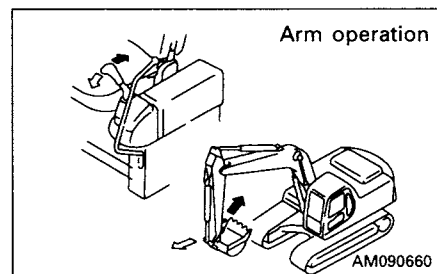

## 12.9 HANDLING ACTIVE MODE

Make full use of the active mode to match the purpose and conditions of the operation in order to carry out operations effectively and efficiently.

The active mode selector switch can be turned ON (lights up) in order to provide quick leveling operations and effective deep digging and loading operations.

ON lights up: Active mode ON

ON goes out: Active mode cancelled

The ON lamp is off when the engine is started.

If it is turned ON (lights up), it is possible to enter the active mode from any working mode.

Even when it is turned ON (lights up), the working mode display does not change. When the lamp goes out, the system returns to the original working mode.

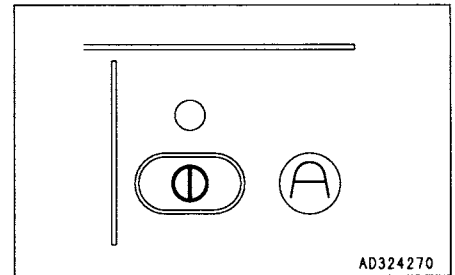

Mode	Effective operation	Advantages for operation
Active mode	Digging and loading	By increasing the boom lowering speed and increasing the work equipment lift for boom RAISE + swing, the cycle time for deep digging operations is reduced.
	Leveling	By increasing the arm IN speed and the pump response, the speed of rough leveling (light loads) is increased.

### REMARK

- Use the active mode with the fuel control dial turned to the MAX position. If it is not at the MAX position, it will be impossible to achieve a suitable increase in the work equipment speed.

## 12.10 HANDLING WORKING MODE

### WORKING MODE

The mode selector switch can be used to switch the mode to match the operating conditions and purpose, thereby enabling work to be carried out efficiently.

Make effective use of each mode as follows.

When the starting switch is turned ON, the working mode is set to the most commonly used general operation mode, so normal operations can be carried out without setting the mode.

Use the working mode switch to set the mode to the most efficient mode to match the type of work.

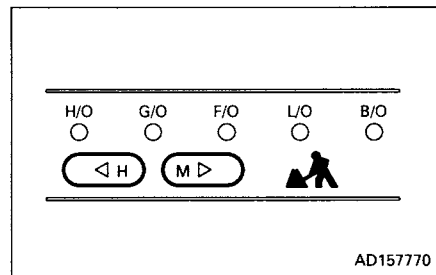

Working mode	Applicable operation	Power max.	Swift slow-down
		Power	Speed
Heavy-duty operation operation mode	Large volume digging and loading in a short time	5% up	30% down
General operation mode	Normal digging and loading operations	10% up	20% down
Finishing operation mode	Leveling operations, hauling operations	-	-
Lifting operation mode	Aligning position	-	-
Breaker mode	Breaker operations	-	-

#### NOTICE

**Do not use the heavy-duty operation mode for breaker operations. If breaker operations are carried out in the heavy-duty operation mode, there is danger that the hydraulic equipment may be damaged or broken.**



**POWER MAX., SWIFT SLOW-DOWN**

The power max. and swift slow-down for the work equipment can be carried out at a touch during operations. This can be used effectively in combination with the working mode when necessary.

1. When the starting switch is turned ON, the power max. lamp lights up. Each time the set switch is pressed, the system switches between power max. and swift slow-down.

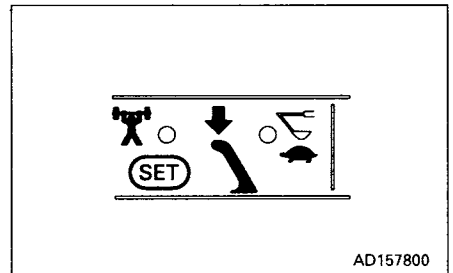
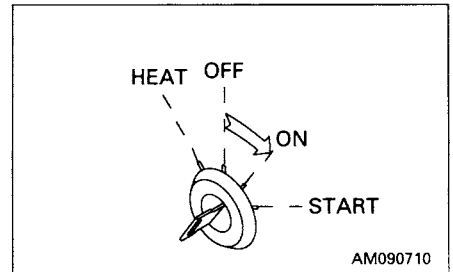

2. If the left knob switch is kept pressed, the function is actuated as long as the switch is pressed. However, for the power max. function, the function is automatically finished after 8.5 seconds.

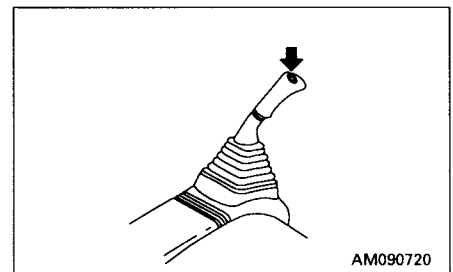

## 12.12 PROHIBITIONS FOR OPERATION

### WARNING

- If it is necessary to operate the work equipment control lever when the machine is traveling, stop the machine before operating the work equipment control lever.
- If the lever is moved inside the deceleration range, engine speed will suddenly rise. Operate the levers carefully.
- Never operate the machine on a rock bed (hard or soft rock).

#### Prohibited operations using swing force

Do not use the swing force to compact soil or break earth mounds or walls.

When swinging, do not dig the bucket teeth into the soil. These operations will damage the work equipment.

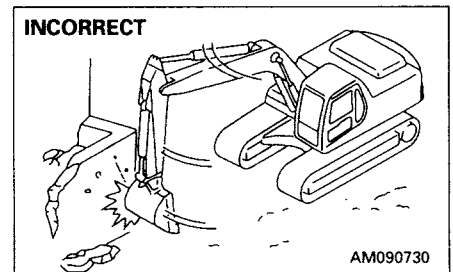

#### Prohibited operations using travel force

Do not leave the bucket dug into the ground and use the travel force to excavate. This will bring excessive force to bear on the machine and the work equipment.

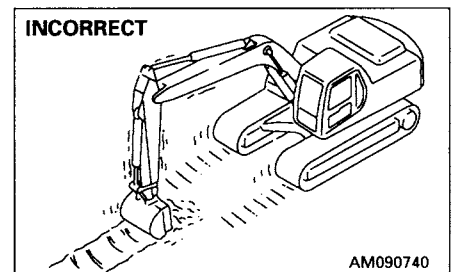

#### Precautions when operating hydraulic cylinders to end of stroke

If the cylinder is operated to the end of its stroke during operations, force will be brought to bear on the stopper inside the cylinder, and this will reduce the life of the machine. To prevent this, always leave a small safety margin when operating the cylinders.

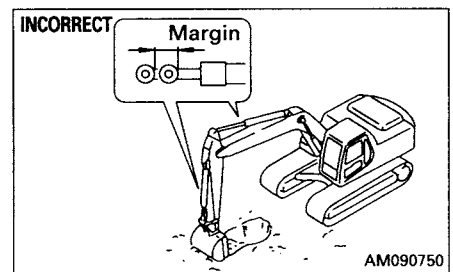

#### Prohibited operations using dropping force of bucket

Do not use the dropping force of the bucket as a pickaxe, breaker, or pile driver. This will bring excessive force to bear on the rear of the machine, and will not only damage the machine, but is also dangerous.

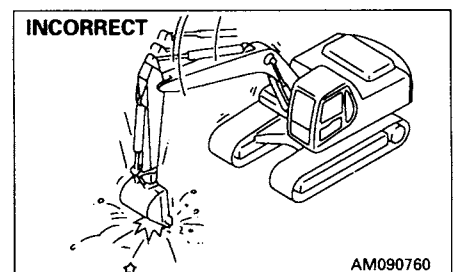

**Prohibited operations using dropping force of machine**

Do not use the dropping force of the machine for digging.

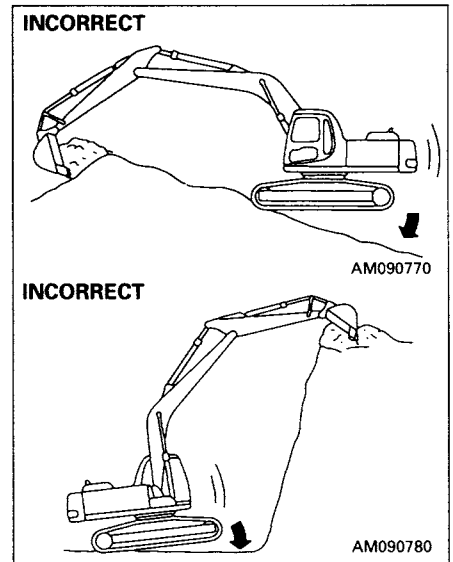
**Digging rocky ground**

It is better to excavate hard rocky ground after breaking it up by some other means. This will not only reduce damage to the machine but make for better economy.

**Sudden lever shifting during Hi-speed travel prohibited**

- ① Never carry out sudden lever shifting as this may cause sudden starting.
- ② Avoid sudden lever shifting from forward to reverse (or vice versa).
- ③ Avoid sudden lever shifting change such as sudden stopping from near top speed (lever release operation).

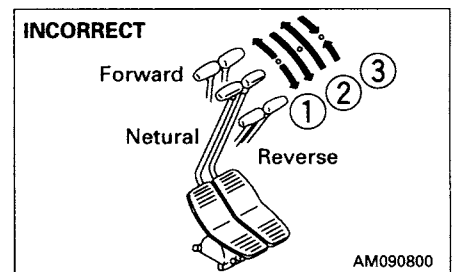

## 12.12 PRECAUTIONS FOR OPERATION

### PRECAUTIONS WHEN TRAVELING

When traveling over obstacles such as boulders or tree stumps, the machine (in particular, the undercarriage) is subjected to a large shock, so reduce the travel speed and travel over the obstacle at the center of the tracks. As far as possible, remove such obstacles or avoid traveling over them.

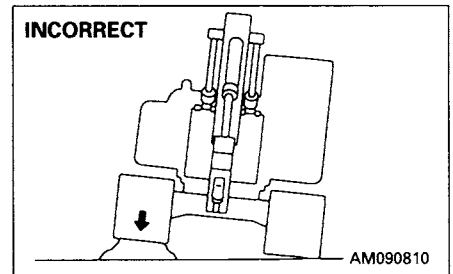

### PRECAUTIONS AT HI-SPEED TRAVEL

On uneven roadbeds such as rock beds or uneven roads with large locks, travel at Lo speed. When Hi-speed traveling, set the idler in the forward direction.

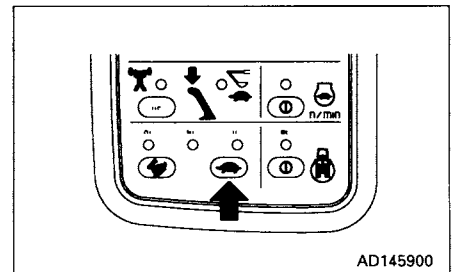

### PERMISSIBLE WATER DEPTH NOTICE

When driving the machine out of water, if the angle of the machine exceeds 15°, the rear of the upper structure will go under water, and water will be thrown up by the radiator fan. This may cause the fan to break.

**Be extremely careful when driving the machine out of water.**

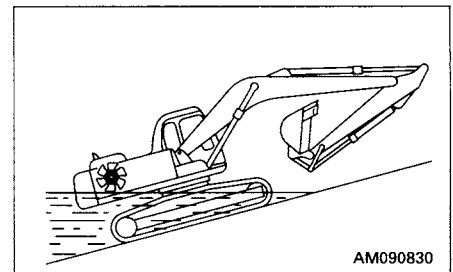

Do not immerse the machine in water by more than the permissible depth (under center of carrier roller ①).

In addition, for parts that have been immersed in water for a long time, pump in grease until the old grease comes out from the bearings. (Around the bucket pins)

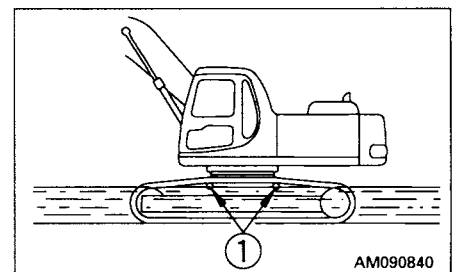

## 12.13 PRECAUTIONS WHEN TRAVELING UP OR DOWN HILLS

### WARNING

- When traveling, raise the bucket approx. 20 – 30 cm (8 – 12 in) from the ground.  
Do not travel downhill in reverse.
- When traveling over ridges or other obstacles, keep the work equipment close to the ground and travel slowly.
- It is dangerous to turn on slopes or to travel across slopes. Always go down to a flat place to perform these operations. It may be longer, but it will ensure safety.
- If the machine starts to slide or loses stability, lower the bucket immediately and brake the machine.
- Turning or operating the work equipment when working on slopes may cause the machine to lose its balance and turn over, so avoid such operations. It is particularly dangerous to swing downhill when the bucket is loaded. If such operations have to be carried out, pile soil to make platform on the slope so that the machine can be kept horizontal when operating.
- Do not travel on slopes of over 30° as there is danger that the machine may overturn.

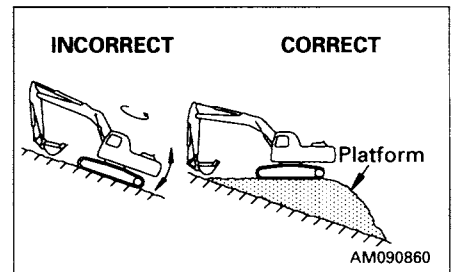
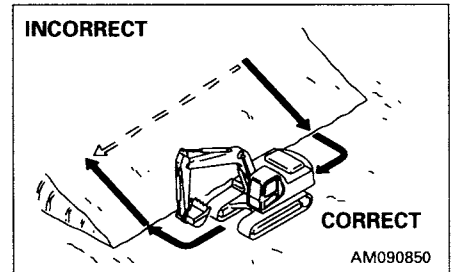

- 1) When traveling down steep hills, use the travel lever and fuel control lever to keep the travel speed low. When traveling down slopes of more than 15°, set the work equipment in the posture shown in the figure on the right, and lower the engine speed.

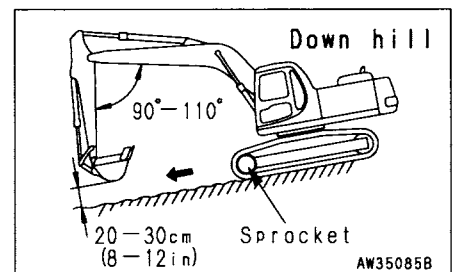

- 2) When traveling up a steep hill of more than 15°, set the work equipment in the posture shown in the diagram on the right.

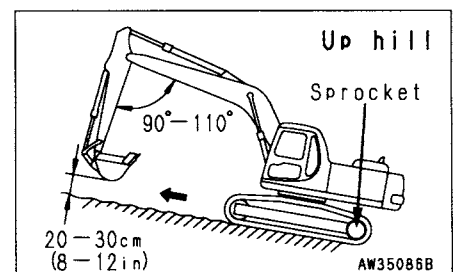

### **Braking when traveling downhill**

To brake the machine during downhill runs, put the travel lever in the neutral position. This will cause the brake to be automatically applied.

### **If shoes slip**

When traveling uphill, if the shoes slip or it is impossible to travel uphill using the force of the track only, it is possible to use the pulling force of the arm to help the machine travel uphill.

### **If engine stops**

If the engine stops when traveling uphill, move the travel levers to the neutral position, lower the bucket to the ground, stop the machine, then start the engine again.

### **Precautions on slopes**

- If the engine stops when the machine is on a slope, never use the left work equipment control lever to carry out swing operations. The upper structure will swing under its own weight.
- Do not open or close the door on the cab if the machine is on a slope. This may cause a sudden change in the operating force. Always keep the door locked.

## 12.14 HOW TO ESCAPE FROM MUD

Always operate carefully to avoid getting stuck in mud. If the machine does get stuck in mud, use the following procedures to get the machine out.

Be careful not to get stuck in mud when operating. If you do get stuck in mud, do as follows to escape.

- Place the machine push-up switch at position ①. This will increase the pushing power of the boom and make it easier to escape.

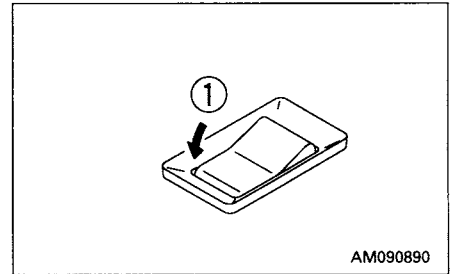

AM090890

### 12.14.1 WHEN ONE SIDE IS STUCK

When only one side is stuck in mud, use the bucket to raise the track, then lay boards or logs and drive the machine out. If necessary, put a board under the bucket also.

#### NOTICE

When using the boom or arm to raise the machine, always have the bottom of the bucket in contact with the ground. (Never push with the teeth). The angle between the boom and arm should be 90° to 110°.

The same applies when using the inverting bucket.

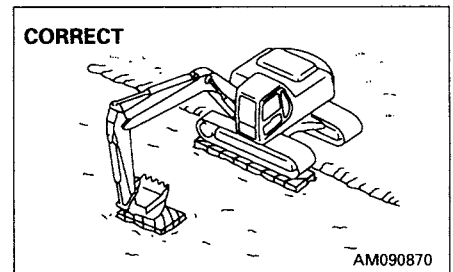

AM090870

### 12.14.2 WHEN BOTH SIDES ARE STUCK

When the tracks on both sides are stuck in mud and the machine will not move, lay boards as explained above, and dig the bucket into the ground in front. Then pull in the arm as in normal digging operations and put the travel levers in the FORWARD position to pull the machine out.

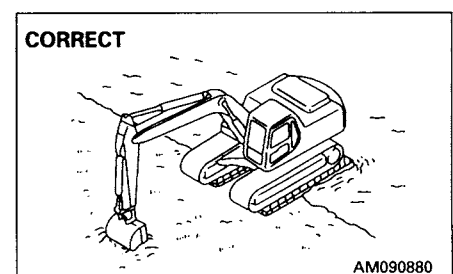

AM090880

## 12.15 WORK POSSIBLE USING HYDRAULIC EXCAVATOR

In addition to the following, it is possible to further increase the range of applications by using various attachments.

### 12.15.1 BACKHOE WORK

When condition of the machine is as shown in the diagram at right, each cylinders maximum pushing excavation force is obtained when the bucket cylinder and link, arm cylinder and arm are at 90°.

When excavating, use this angle effectively to optimize your work efficiency.

The range for excavating with the arm is from a 45° angle away from the machine to a 30° toward the machine.

There may be some differences depending on the excavation depth, but try to use within the above range rather than going all the way to the extreme end of the cylinder stroke.

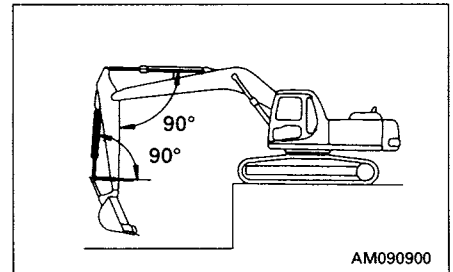

AM090900

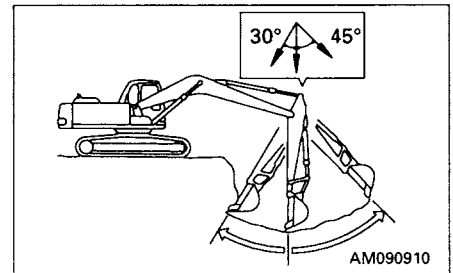

AM090910

### 12.15.2 SHOVEL WORK

A shovel is suitable for excavating at a position higher than the machine. Shovel work is performed by attaching the bucket in the reverse direction.

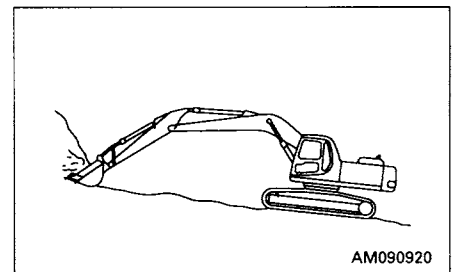

AM090920

### 12.15.3 DITCHING WORK

Ditching work can be performed efficiently by attaching a bucket to match the width of the ditch and then setting the tracks parallel to the line of the ditch to be excavated.

To excavate a wide ditch, first dig out both sides and then finally remove the center portion.

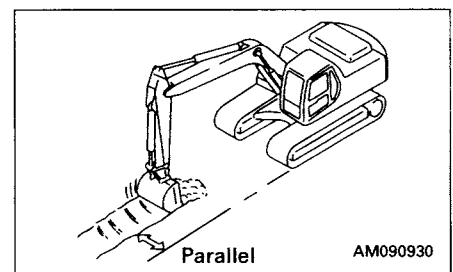

AM090930

### 12.15.4 LOADING WORK

In places where the swing angle is small, work efficiency can be enhanced by locating the dump truck in a place easily visible to the operator.

Loading is easier and capacity greater if you begin from the front of the dump truck body than if loading is done from the side.

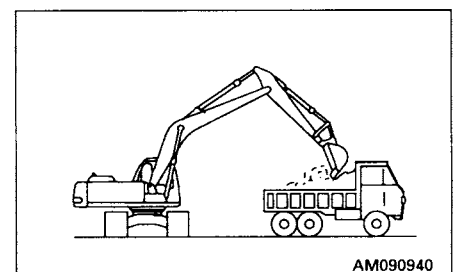

AM090940



## 12.16 REPLACEMENT AND INVERSION OF BUCKET

### ⚠ WARNING

- When knocking the pin in with a hammer, metal particles may fly and cause serious injury, particularly if they get into your eyes. When carrying out this operation, always wear goggles, helmet, gloves, and other protective equipment.
- When the bucket is removed, place it in a stable condition.

Stop the machine on a firm, flat surface. When performing joint work, make clear signals to each other and work carefully for safety's sake.

### 12.16.1 REPLACEMENT

1. Place the bucket in contact with a flat surface.

#### REMARK

When removing the pins, place the bucket so that it is in light contact with the ground.

If the bucket is lowered strongly to the ground, the resistance will be increased and it will be difficult to remove the pins.

2. Remove the stopper bolts and nuts, then remove pins (A) and (B), and remove the bucket.

#### NOTICE

After removing the pins, make sure that they do not become contaminated with sand or mud and that the seals of bushing on both sides do not become damaged.

3. Align the arm with holes (1) and the link with holes (2), then coat with grease and install pins (A) and (B).

#### REMARK

When installing the bucket, the O-rings are easily damaged, so fit the O-rings on the boss of the arm end as shown in the diagram. When knocking in the pins, move the O-ring down to the regular groove.

4. Install the stopper bolts and nuts for each pin, then grease the pin.

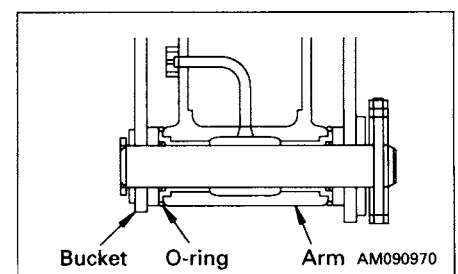
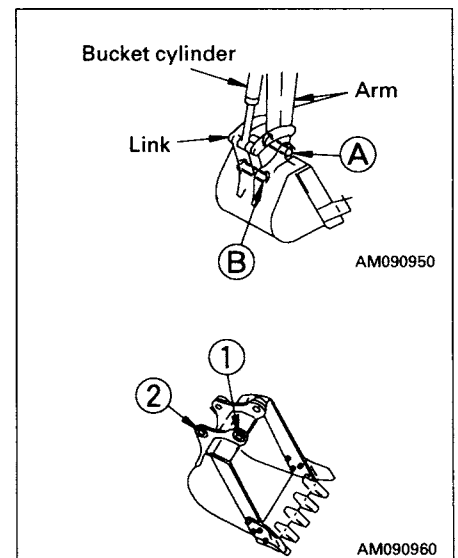

### 12.16.2 INVERSION

**REMARK**

The rock bucket (PC300: option, PC350: standard) interferes with the arm, so it cannot be turned and used for shovel operations.

1. Place the bucket in contact with a flat surface.

**REMARK**

When removing the pins, place the bucket so that it is in light contact with the ground.

If the bucket is lowered strongly to the ground, the resistance will be increased and it will be difficult to remove the pins.

2. Remove the stopper bolts and nuts, then remove pins ① and ②, and remove the bucket.

**NOTICE**

After removing the pins, make sure that they do not become contaminated with sand or mud and that the seals of bushing on both sides do not become damaged.

3. Install the bucket inversely.  
After the bucket is inverted, correct the inclination and direction of the retaining pin holes ① and ② and stabilize the bucket securely.
4. Align the arm with holes ① and the link with holes ②, then coat with grease and install pins ① and ②.

**REMARK**

When installing the bucket, the O-rings are easily damaged, so fit the O-rings on the boss of the arm end as shown in the diagram. When knocking in the pins, move the O-ring down to the regular groove.

5. Install the stopper bolts and nuts for each pin, then grease the pin.

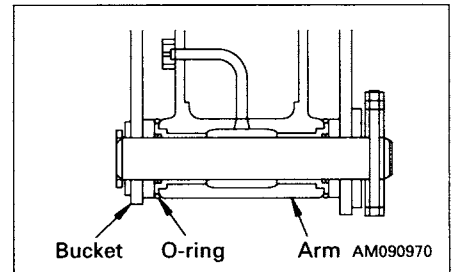
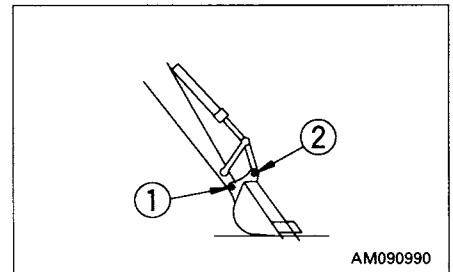
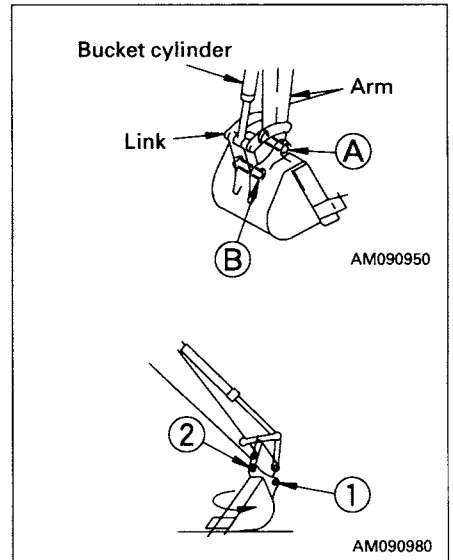

## 12.17 PARKING MACHINE

 **WARNING**

- Avoid stopping suddenly. Give yourself ample room when stopping.
- When stopping the machine, select flat hard ground and avoid dangerous places. If it is unavoidably necessary to park the machine on a slope, insert blocks underneath the track shoes. As an additional safety measure, thrust the bucket into the ground.
- If the control lever is touched by accident, the work equipment or the machine may move suddenly, and this may lead to a serious accident. Before leaving the operator's compartment, always set the safety lock lever securely to LOCK position.

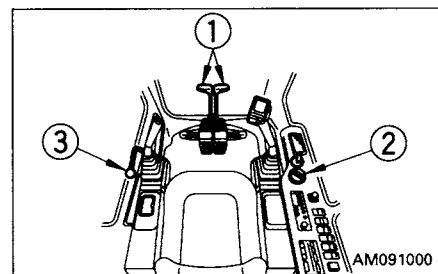
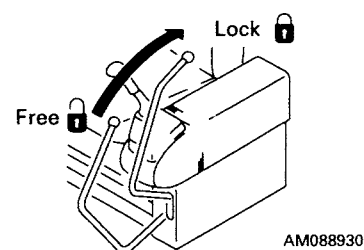
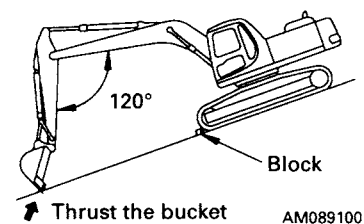

1. Put left and right travel levers ① in the neutral position. The machine stops.

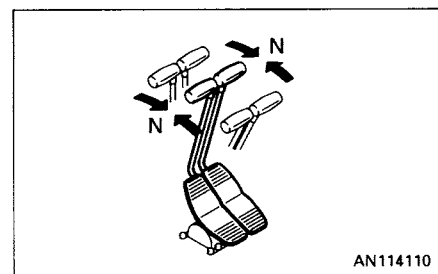

2. Turn fuel control dial ② to lower the engine speed to low idling.

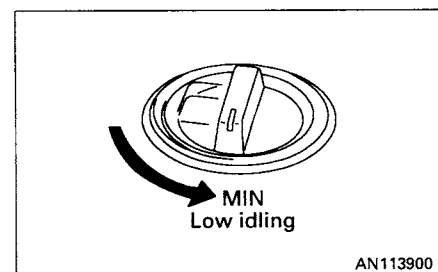

## 12. OPERATION

---

3. Lower the bucket horizontally until the bottom touches the ground.

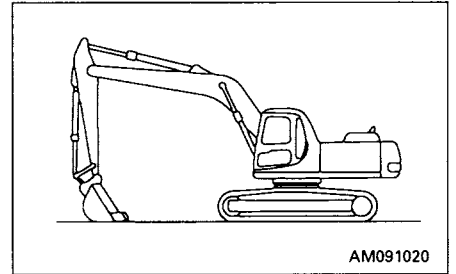

4. Set safety lock lever ③ in the LOCK position.

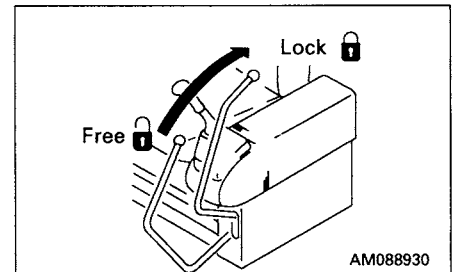

### 12.18 CHECK AFTER FINISHING WORK

Check the engine water temperature, engine oil pressure and fuel level on the monitor.

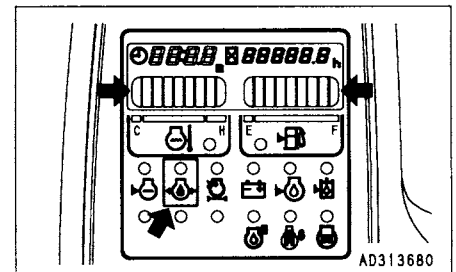

## 12.19 STOPPING ENGINE

### NOTICE

If the engine is abruptly stopped before it has cooled down, engine life may be greatly shortened. Consequently, do not abruptly stop the engine apart from an emergency.

In particular, if the engine has overheated, do not abruptly stop it but run it at medium speed to allow it to cool gradually, then stop it.

1. Run the engine at low idling speed for about 5 minutes to allow it go gradually cool down.

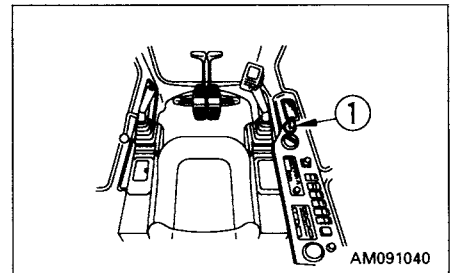

2. Turn the key in starting switch ① to the OFF position and stop the engine.
3. Remove the key from starting switch ①.

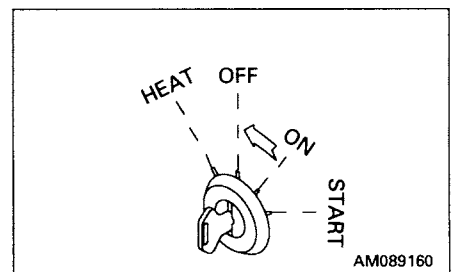

## 12.20 CHECK AFTER STOPPING ENGINE

1. Walk around the machine and check the work equipment, paint-work, and undercarriage, and check also for leakage of oil or water. If any abnormalities are found, repair them.
2. Fill the fuel tank.
3. Check the engine compartment for paper and debris. Clean out any paper and debris to avoid a fire hazard.
4. Remove any mud stuck to the undercarriage.

## 12.21 LOCKING

Always lock the following places.

- ① Door of operator's cab  
Always remember to close the window.
- ② Fuel tank filler port
- ③ Engine hood
- ④ Battery box cover
- ⑤ Left side door of the machine
- ⑥ Right side door of the machine (2 places)
- ⑦ Tool box
- ⑧ Hydraulic tank filler port

### REMARK

Use the starting switch key to open and close all these places.

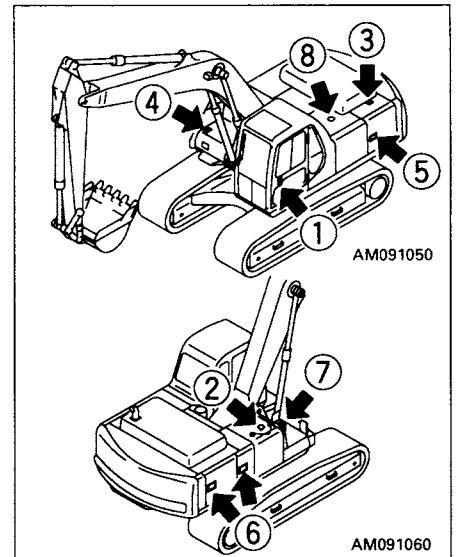

## **13. TRANSPORTATION**

---

When transporting the machine, observe all related laws and regulations, and be careful to assure safety.

### **13.1 TRANSPORTATION PROCEDURE**

As a basic rule, transport the machine by trailer.

Select the trailer to match the weight and dimensions given in "25. SPECIFICATIONS".

Note that the value for the weight and transportation dimensions given in SPECIFICATIONS may differ according to the type of shoe or type of arm or other attachments.

## 13.2 LOADING, UNLOADING WORK WITH TRAILERS

### WARNING

- Always turn the auto-deceleration switch OFF (cancel) during loading and unloading operations.  
If the auto-deceleration switch is left ON, the machine may suddenly start moving.
- Run the engine at low idling, set to low speed, and operate the machine slowly when loading or unloading.
- Do not carry out loading or unloading operations during the automatic warming-up operation.  
If the automatic warming-up operation is canceled before completion, the travel speed may suddenly change.
- Select firm, level ground when loading or unloading the machine.  
Maintain a safe distance from the edge of the road.
- Use ramps with ample width, length, thickness, and strength and install them at a maximum slope of 15°.  
When using piled soil, compact the piled soil fully and prevent the slope face from collapsing.
- Remove all mud and dirt from the machine tracks before starting in order to prevent the machine from slipping on the ramps.  
Be sure that the ramp surface is clean and free of water, snow, grease, oil, or ice.
- Never correct your steering on the ramps. There is danger that the machine may turn over.  
If necessary, drive off the ramps, correct the direction, then enter the ramps again.
- It is dangerous to use the work equipment for loading and unloading operations.
- When on the ramps, do not operate any lever except the travel lever.
- The center of gravity of the machine will change suddenly at the joint between the ramps and the track or trailer, and there is danger of the machine losing its balance. Travel slowly over this point.
- When swinging the upper structure on the trailer, the trailer is unstable, so pull in the work equipment and swing slowly.

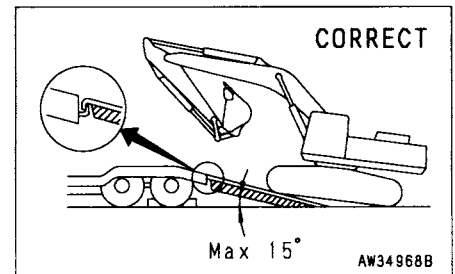
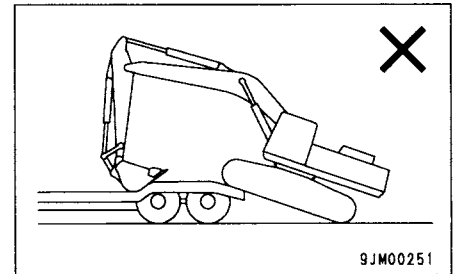

When loading or unloading, always use ramps or a platform and carry out the operation as follows.



**13.2.1 LOADING**

1. Perform loading and unloading on firm, level ground only. Maintain a safe distance from the edge of a road.
2. Properly apply the brakes on the trailer and put blocks under the tires to ensure that the trailer does not move. Then fix the ramps in line with the centers of the trailer and the machine.  
Be sure that the two sides are at the same level as one another. Make the slope of the ramps a maximum of 15°. Set the distance between the ramps to match the center of the tracks.
3. Set the travel speed switch to Lo.
4. Turn the auto-deceleration switch OFF and turn the fuel control dial to lower the engine speed.
5. Turn the swing lock switch ON to apply the swing lock.
6. If the machine is equipped with work equipment, set the work equipment at the front, and travel forward to load it; if it has no work equipment, travel in reverse to load it.
7. Align the direction of travel with the ramps and travel slowly. Lower the work equipment as far as possible without causing interference. When on the ramps, operate only the travel lever. Do not operate any other lever or pedal.

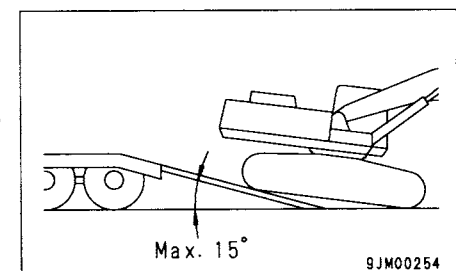
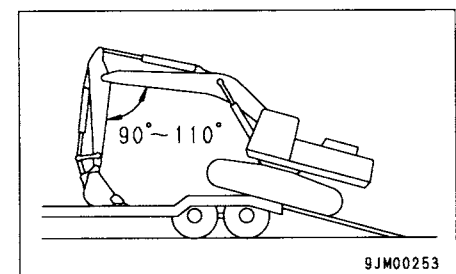
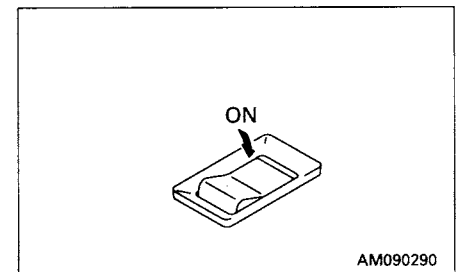
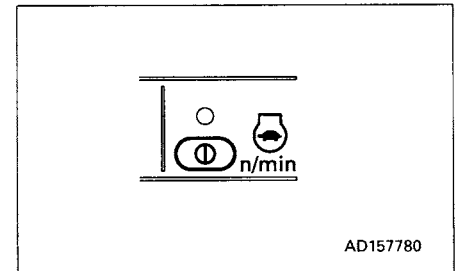
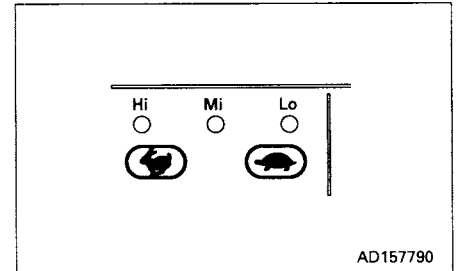
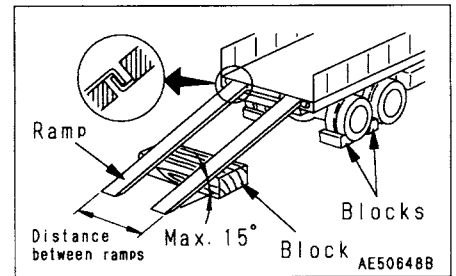

## 13. TRANSPORTATION

### 13.2.2 UNLOADING

1. Perform loading and unloading on firm, level ground only. Maintain a safe distance from the edge of a road.
2. Properly apply the brakes on the trailer and put blocks under the tires to ensure that the trailer does not move. Then fix the ramps in line with the centers of the trailer and the machine.  
Be sure that the two sides are at the same level as one another. Make the slope of the ramps a maximum of 15°. Set the distance between the ramps to match the center of the tracks.

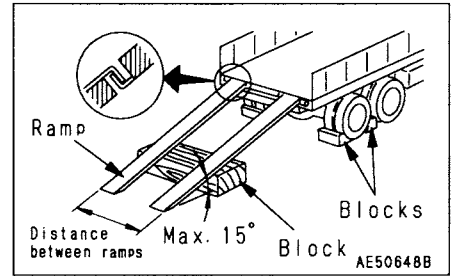

3. Remove the chains or wire rope holding the machine.
4. Start the engine.  
Warm the engine up fully.
5. Set the safety lock lever to the FREE position.

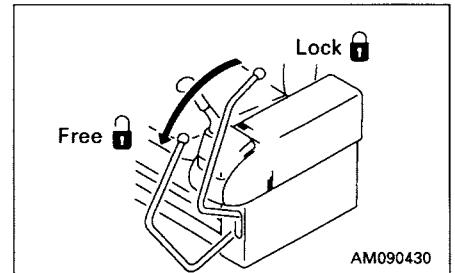

6. Set the travel speed switch to Lo.

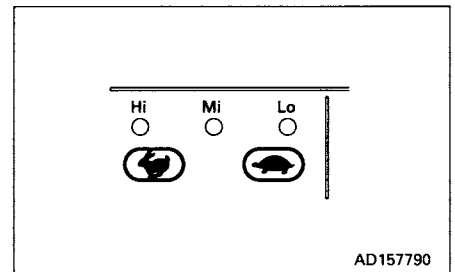

7. Turn the auto-deceleration switch OFF and turn the fuel control dial to lower the engine speed.

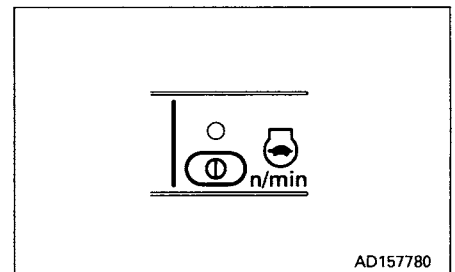

8. Turn the swing lock switch OFF to release the swing lock.

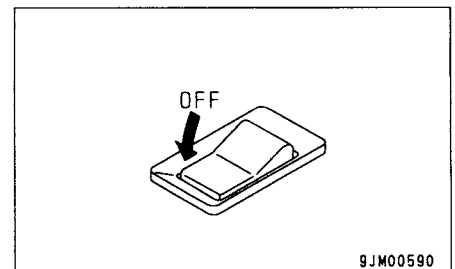

9. Raise the work equipment, pull in the arm under the boom, then move the machine slowly.
10. When the machine is horizontal on top of the rear wheels of the trailer, stop the machine.

**NOTICE**

- If the machine is unloaded with the arm pulled in, the work equipment will be damaged.
- When moving on to the ramps, to prevent damage to the hydraulic cylinders, do not let the bucket hit the ground.

11. When moving from the rear of the trailer on to the ramps, set the angle of the arm and boom to  $90^{\circ}$  –  $110^{\circ}$ , lower the bucket to the ground, then move the machine slowly.

12. When moving down the ramps, operate the boom and arm slowly to lower the machine carefully until it is completely off the ramps.

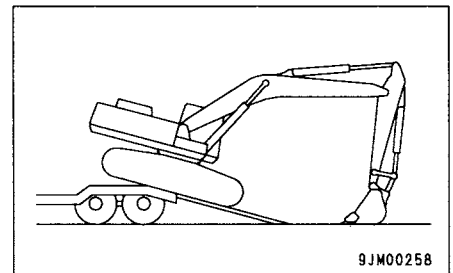
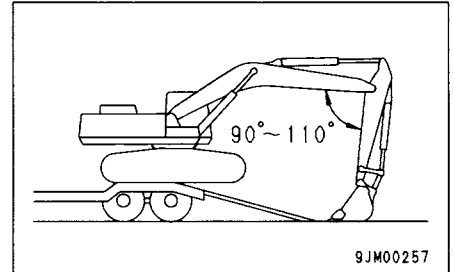
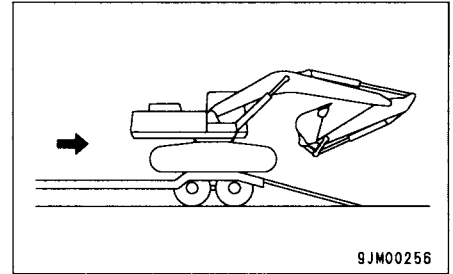

### 13.2.3 SECURING MACHINE

#### NOTICE

- Retract the car radio antenna and remove the mirrors. Tie the removed parts securely to the trailer.
- To prevent damage to the bucket cylinder during transportation, fit a wooden block at one end the bucket cylinder to prevent it from touching the floor.

After loading the machine on to a trailer, tie the machine down as follows.

1. When the machine becomes horizontal over the rear wheels of the trailer, stop the machine.
2. Swing the upper structure slowly 180°, then move the machine slowly to the front of the trailer. (If the machine is not equipped with work equipment, load it as it is.)
3. Stop the machine at the specified position on the trailer.

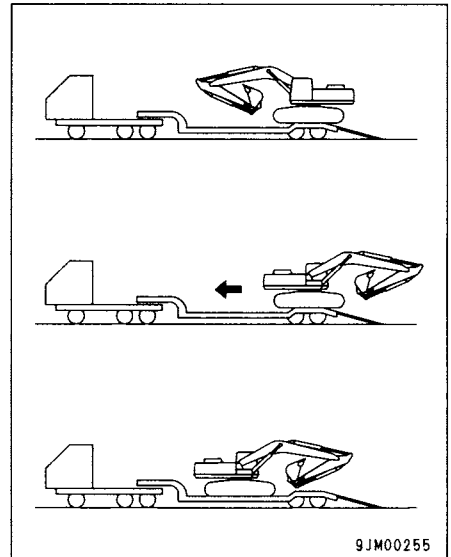

4. Extend the bucket cylinders and arm cylinders fully, then lower the boom slowly.
5. Stop the engine, then remove the key from the starting switch.

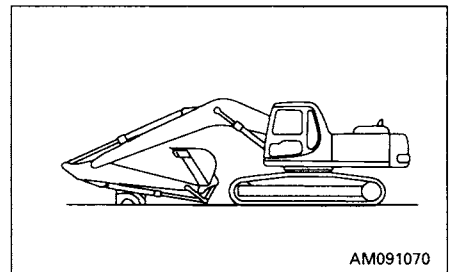

6. Lock the control levers securely with the safety lock lever.
7. Lock the operator's cab, side cover, and engine hood.

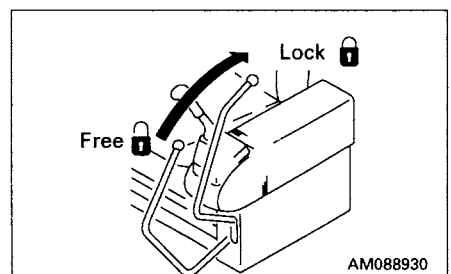

8. Put blocks under both ends of the tracks to prevent the machine from moving during transportation, and tie the machine down securely with chains or wire rope of suitable strength. Be particularly careful to fix the machine in position securely so that it does not slip to the side.

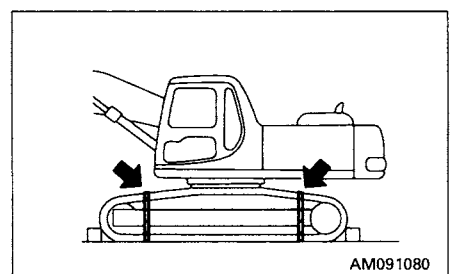

### 13.2.4 REMOVAL, INSTALLATION OF MIRRORS

There are mirrors in the positions shown in the diagram on the right. (\*: if required)

If they are damaged, or when removing and installing them for transportation, do as follows.

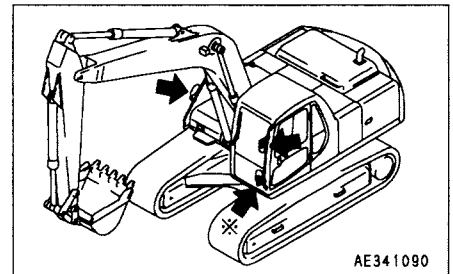

#### REMOVAL

1. Loosen locknut ② of mirror ①, then remove mirror ① from support ③.
2. Loosen bolt ④ and remove support ③ and clamp ⑤ from the handrail.

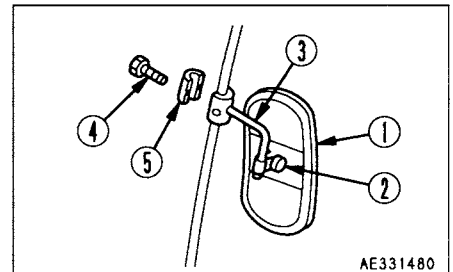

#### INSTALLATION

1. Install support ③ and clamp ⑤ to the handrail, then tighten with bolt ④.
2. Install mirror ① to support ③, then tighten locknut ②.

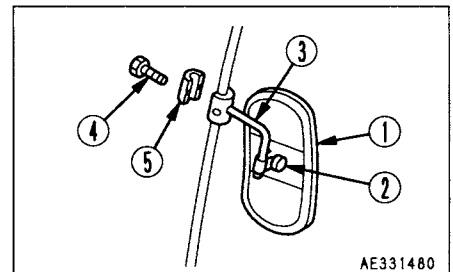

### 13.3 METHOD OF LIFTING MACHINE

#### WARNING

- Never raise the machine with any worker on it.
- Always make sure that the wire rope used for lifting the machine is of ample strength for the weight of the machine.
- Never try to lift the machine in any posture other than the posture given in the procedure below.  
There is danger that the machine may lose its balance.
- Never lift the machine with the upper structure swung to the side. Swing the work equipment so that it is at the sprocket end and set the undercarriage and upper structure parallel before lifting.
- When lifting, be careful of the center of gravity and be sure to maintain the balance.

#### NOTICE

The lifting procedure given below applies to machines with standard specifications.

The method of lifting differs according to the attachments and options actually installed. In such cases, please contact your Komatsu distributor.

For details of the weight, see "25. SPECIFICATIONS".

When lifting the machine, carry out the operation on flat ground as follows.

1. Start the engine, then swing the upper structure so that the work equipment is at the rear of the machine.
2. Extend the bucket cylinder and arm cylinder fully, then lower the work equipment to the ground as shown in the diagram on the right using the boom cylinder.
3. Stop the engine, check that there is nothing around the operator's compartment, then get off the machine.  
Close the cab door and front glass securely.
4. Pass the wire rope between the 1st and 2nd track rollers from the front of the machine and the 1st and 2nd track rollers from the rear of the machine.  
Note: For machines equipped with a full roller guard for the track roller, pass the wire rope from under the track shoe.
5. Set the lifting angle of the wire rope to 30 – 40°, then lift the machine slowly.
6. After the machine comes off the ground, check carefully that the machine is balanced, then lift slowly.

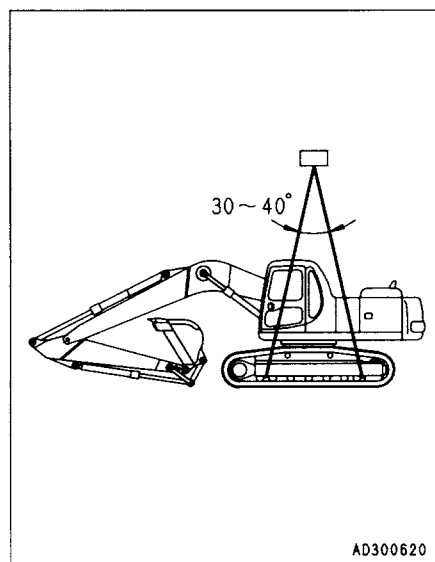
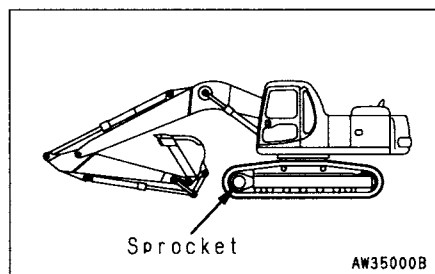

# 14. COLD WEATHER OPERATION

---

## 14.1 PRECAUTIONS FOR LOW TEMPERATURE

If the temperature becomes low, it becomes difficult to start the engine, and the coolant may freeze, so do as follows.

### 14.1.1 FUEL AND LUBRICANTS

Change to fuel and oil with low viscosity for all components. For details of the specified viscosity, see "20. USE OF FUEL, COOLANT AND LUBRICANTS ACCORDING TO AMBIENT TEMPERATURE".

### 14.1.2 COOLANT

 **WARNING**

**Keep antifreeze fluid away from an open flame. Never smoke when using antifreeze.**

#### NOTICE

- Never use methanol, ethanol or propanol based antifreeze.
- Absolutely avoid using any water leak preventing agent irrespective of whether it is used independently or mixed with an antifreeze.
- Do not mix one antifreeze with a different brand.

For details of the antifreeze mixture when changing the coolant, see "24.2 WHEN REQUIRED".

Use a Permanent Antifreeze (ethylene glycol mixed with corrosion inhibitor, antifoam agent, etc.) meeting the standard requirements as shown below. With permanent antifreeze, no change of coolant is required for a year. If it is doubtful that an available antifreeze meets the standard requirements, ask the supplier of that antifreeze for information.

Standard requirements for permanent antifreeze

- SAE ..... J1034
- FEDERAL STANDARD ..... O-A-548D

#### REMARK

Where no permanent antifreeze is available, an ethylene glycol antifreeze without corrosion inhibitor may be used only for the cold season. In this case, clean the cooling system twice a year (in spring and autumn). When refilling the cooling system, add antifreeze in autumn, but do not add any in spring.

### 14.1.3 BATTERY

 **WARNING**

- To avoid gas explosions, do not bring fire or sparks near the battery.
- Battery electrolyte is dangerous. If it gets in your eyes or on your skin, wash it off with large amounts of water, and consult a doctor.

When the ambient temperature drops, the capacity of the battery will also drop. If the battery charge ratio is low, the battery electrolyte may freeze. Maintain the battery charge as close as possible to 100%, and insulate it against cold temperature so that the machine can be started easily the next morning.

**REMARK**

Measure the specific gravity and calculate the rate of charge from the following conversion table.

Temp. of fluid	20°C	0°C	-10°C	-20°C
Rate of charge				
100%	1.28	1.29	1.30	1.31
90%	1.26	1.27	1.28	1.29
80%	1.24	1.25	1.26	1.27
75%	1.23	1.24	1.25	1.26



## 14.2 PRECAUTIONS AFTER COMPLETION OF WORK

To prevent mud, water, or the undercarriage from freezing and making it impossible for the machine to move on the following morning, always observe the following precautions.

- Mud and water on the machine body should be completely removed. This is to prevent damage to the seal caused by mud or dirt getting inside the seal with frozen drops of water.
- Park the machine on hard, dry ground. If this is impossible, park the machine on wooden boards. The boards help protect the tracks from being frozen in soil and the machine can start next morning.
- Open the drain valve and drain any water collected in the fuel system to prevent it from freezing.
- After operation in water or mud, remove water from undercarriage as described below, to extend undercarriage service life.

### WARNING

**Performing idle-running of tracks is potentially dangerous so stay well away from tracks at this time.**

1. Swing by 90° with engine at low idle and bring work equipment beside track.
  2. Slightly float track by slowly pushing the ground and cause track to idle-run. Perform this for the opposite track, too.
- As the battery capacity drops markedly in low temperatures, cover the battery or remove it from the machine, keep it in a warm place, and install it again the next morning.
  - If electrolyte level is found low, add distilled water in the morning before beginning work. Do not add the water after the day's work so as to prevent fluid in the battery from freezing in the night.

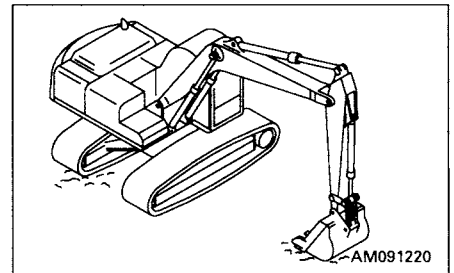

## 14.3 AFTER COLD WEATHER

When season changes and the weather becomes warmer, do as follows.

- Replace the fuel and oil for all parts with oil of the viscosity specified.

### NOTICE

For details, see "20. USE OF FUEL, COOLANT AND LUBRICANTS ACCORDING TO AMBIENT TEMPERATURE".

- If for any reason permanent antifreeze cannot be used, and an ethyl glycol base antifreeze (winter, one season type) is used instead, or if no antifreeze is used, drain the cooling system completely, then clean out the inside of the cooling system thoroughly, and fill with fresh water.

# 15. LONG-TERM STORAGE

---

## 15.1 BEFORE STORAGE

### NOTICE

To protect the cylinder rod when the machine is not being used, set the work equipment in the posture shown in the diagram. (This prevents rusting of the cylinder rod)

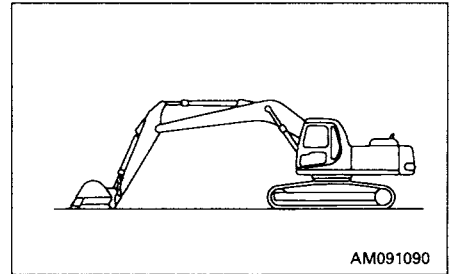

When putting the machine in storage for a long time, do as follows.

- After every part is washed and dried, the machine shall be housed in a dry building. Never leave it outdoors. In case it is indispensable to leave it outdoors, park the machine on flat ground free from flooding or other danger and cover it with canvas etc.
- Completely fill the fuel tank, lubricate and change the oil before storage.
- Apply a thin coat of grease to metal surface of the hydraulic piston rods.
- Disconnect the negative terminals of the battery and cover it, or remove it from the machine and store it separately.
- If the ambient temperature is expected to drop below 0°C, always add antifreeze to the cooling water.
- Lock each control lever and pedal with the lock lever and pedal lock.
- Set the stop valve to the "lock" position on machines ready for attachments. Install the blind plugs to the elbows.
- Set the selector valve to the "When not use" position on machines ready for attachments.

## 15.2 DURING STORAGE

 **WARNING**

**If it is unavoidably necessary to carry out the rustpreventive operation while the machine is indoors, open the doors and windows to improve ventilation and prevent gas poisoning.**

Operate the engine and move the machine for a short distance once a month so that a new film of oil will be coated over movable parts and component surfaces. At the same time, also charge the battery.

Also carry out cooler operation in the case of machines equipped with an air conditioner.

## 15.3 AFTER STORAGE

### NOTICE

**If the machine is stored without carrying out the monthly rust prevention operation, request your Komatsu distributor for service.**

Carry out the following procedure when taking the machine out of long-term storage.

- Wipe off the grease from the hydraulic cylinder rods.
- Add oil and grease to all places.

## 15.4 STARTING MACHINE AFTER LONG-TERM STORAGE

When starting the machine after a long-term storage, first cancel the automatic warming-up function as follows.

1. Turn the starting switch key to the ON position.
2. Turn the fuel control dial from the low idling (MIN) position to the full (MAX) position, hold it there for 3 seconds, then return it to the low idling (MIN) position and start the engine.

## 16. TROUBLESHOOTING

### 16.1 PHENOMENA THAT ARE NOT FAILURES

Note that the following phenomena are not failures:

1. When the arm is pulled in, the speed of movement will drop momentarily when the arm is more or less vertical.
2. The arm speed will drop momentarily when the bucket teeth are more or less horizontal.
3. When starting or stopping the swing, noise will be emitted from the brake valve.
4. When going down a steep slope at low speed, a noise will be emitted from the travel motor.

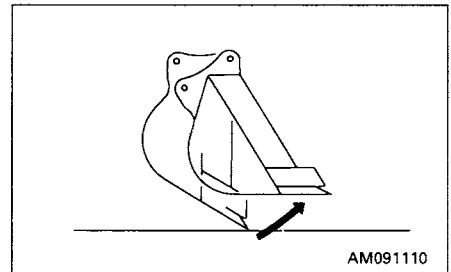
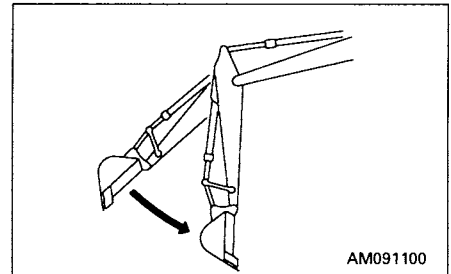

### 16.2 METHOD OF TOWING MACHINE

#### ⚠ WARNING

When towing the machine, use a wire rope that has ample strength for the weight of the machine that is being towed.

If the machine sinks in mud and cannot get out under its own power, or if the drawbar pull of the excavator is being used to tow a heavy object, use a wire rope as shown in the diagram on the right. Place pieces of wood between wire ropes and body to prevent damage to ropes and body.

At this time, never use the hole for light-weight towing.

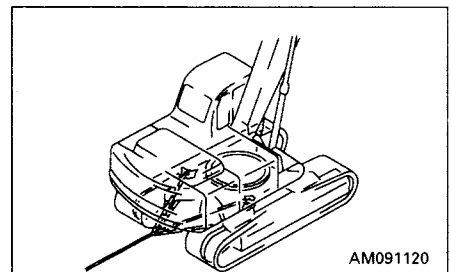

### 16.3 USING METHOD FOR LIGHT-WEIGHT TOWING HOLE

#### ⚠ WARNING

- The shackle must always be used.
- Hold the rope level and direct it straight to the track frame.
- Move the machine slowly in the Lo mode.

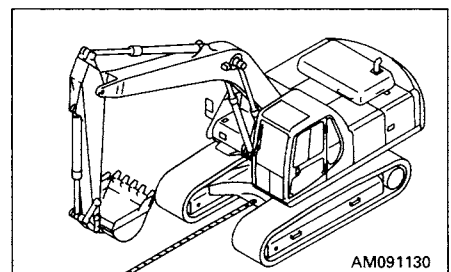

There is a hole in the track frame to fit the shackle when towing light objects.

#### NOTICE

The maximum towing capacity for this machine is 15,400 N (16,000 kg·f).

Always carry out towing operations within the maximum towing capacity.

## 16.4 PRECAUTIONS ON PARTICULAR JOBSITES

1. When carrying out digging operations in water, if the work equipment mounting pin goes into the water, carry out greasing every time the operation is carried out.
2. For heavy-duty operations and deep digging, carry out greasing of the work equipment mounting pins every time before operation.

After greasing, operate the boom, arm and bucket several times, then grease again.

## 16.5 IF BATTERY IS DISCHARGED

### WARNING

- When checking or handling the battery, stop the engine and turn the starting switch key to the OFF position before starting.
- The battery generates hydrogen gas, so there is danger of explosion. Do not bring lighted cigarettes near the battery, or do anything that will cause sparks.
- Battery electrolyte is dilute sulphuric acid, and it will attack your clothes and skin. If it gets on your clothes or on your skin, wash it immediately off with large amounts of water. If it gets in your eyes, wash it out with fresh water, and consult a doctor.
- When handling battery, always wear protective goggles.
- When removing the battery, first disconnect the cable from the ground (normally, from the negative  $\ominus$  terminal). When installing, install the positive  $\oplus$  terminal first. If a tool touches the cable connecting the positive terminal and the chassis, there is danger that it will cause sparks.
- If the terminals are loose, there is danger that the defective contact may generate sparks that will cause an explosion. When installing the terminals, install them tightly.
- When removing or installing, check which is the positive  $\oplus$  terminal and negative  $\ominus$  terminal.

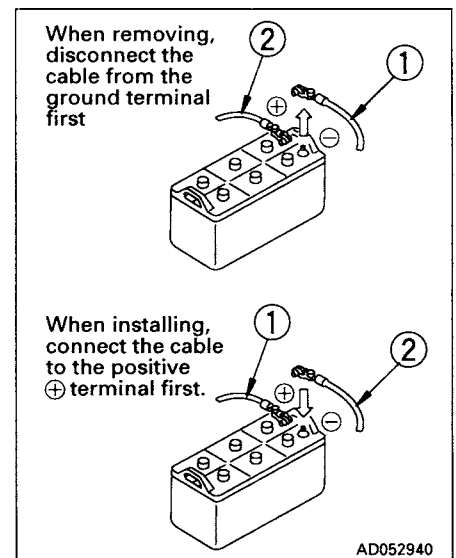

### 16.5.1 REMOVING AND INSTALLING BATTERY

- Before removing the battery, remove the ground cable (normally connected to the negative  $\ominus$  terminal). If any tool touches between the positive terminal and the chassis, there is danger of sparks being generated. Loosen the nut of the terminal and remove the wires from the battery.
- When installing the battery, connected the ground cable last. Insert the hole of the terminal on the battery and tighten the nut.
- Tightening torque:  
Tightening battery terminal: 9.8 – 14.7 N·m  
(1.0 – 1.5 kgf·m, 7.2 – 10.9 lb·ft)

### 16.5.2 PRECAUTIONS FOR CHARGING BATTERY CHARGING BATTERY WHEN MOUNTED ON MACHINE

- Before charging, disconnect the cable from the negative  $\ominus$  terminal of the battery. Otherwise, an unusually high voltage will damage the alternator.
- While charging the battery, remove all battery plugs for satisfactory ventilation.  
To avoid gas explosions, do not bring fire or sparks near the battery.
- If the electrolyte temperature exceeds 45°C, stop charging for a while.
- Turn off the charging as soon as the battery is charging.  
Overcharging the battery may cause the following:
  - 1) Overcharging the battery
  - 2) Decreasing the quantity of electrolyte.
  - 3) Damaging the electrode plate.
- Do not mix the cables (positive  $\oplus$  to negative  $\ominus$  or negative  $\ominus$  to positive  $\oplus$ ), as it will damage the alternator.
- When performing any service to the battery besides checking the electrolyte level or measuring the specific gravity, disconnect cables from the battery.

### 16.5.3 STARTING ENGINE WITH BOOSTER CABLE

When starting the engine with a booster cable, do as follows:

#### Precautions when connecting and disconnecting booster cable

#### **⚠ WARNING**

- When connecting the cables, never contact the positive  $\oplus$  and negative  $\ominus$  terminals.
- When starting the engine with a booster cable, always wear safety glasses.
- Be careful not to let the normal machine and problem machine contact each other. This prevents sparks from generating near the battery which could ignite the hydrogen gas given off by the battery. If hydrogen gas explodes, it could cause serious injury.
- Make sure that there is no mistake in the booster cable connections. The final connection is to the revolving frame, but sparks will be generated when this is done, so connect to a place as far as possible from the battery. (However, avoid connecting the cable to the work equipment, as conduction is poor.)
- Use care when removing the cables from the machine that has been started. Do not allow the cable ends to contact each other or the machine, to avoid hydrogen explosion.

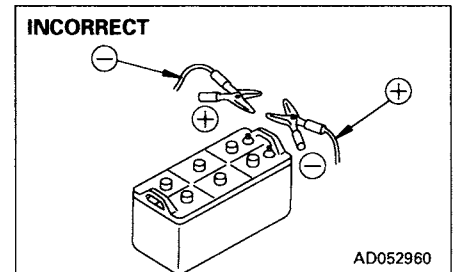

#### NOTICE

- The size of the booster cable and clip should be suitable for the battery size.
- The battery of the normal machine must be the same capacity as that of the engine to be started.
- Check the cables and clips for damage or corrosion.
- Make sure that the cables and clips are firmly connected.

**Connecting the booster cables**

Keep the starting switch at the OFF position.

Connect the booster cable as follows, in the order of the numbers marked in the diagram.

1. Make sure that the starting switches of the normal machine and problem machine are both at the OFF position.
2. Connect one clip of booster cable (A) to the positive  $\oplus$  terminal of the problem machine.
3. Connect the other clip of booster cable (A) to the positive  $\oplus$  terminal of the normal machine.
4. Connect one clip of booster cable (B) to the negative  $\ominus$  terminal of the normal machine.
5. Connect the other clip of booster cable (B) to the engine block of the problem machine.

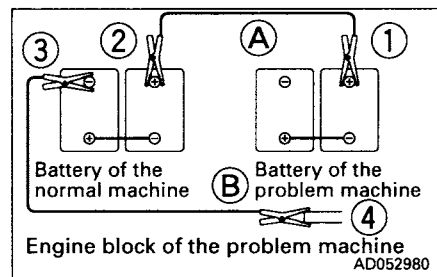
**Starting the engine**

1. Make sure the clips are firmly connected to the battery terminals.
2. Start the engine of the normal machine and keep it to run at high idling speed.
3. Turn the starting switch of the problem machine to the START position and start the engine. If the engine doesn't start at first, try again after 2 minutes or so.



**Disconnecting the booster cables**

After the engine has started, disconnect the booster cables in the reverse of the order in which they were connected.

1. Remove one clip of booster cable **(B)** from the engine block of the problem machine.
2. Remove the other clip of booster cable **(B)** from the negative  $\ominus$  terminal of the normal machine.
3. Remove one clip of booster cable **(A)** from the positive  $\oplus$  terminal of the normal machine.
4. Remove the other clip of booster cable **(A)** from the positive  $\oplus$  terminal of the problem machine.

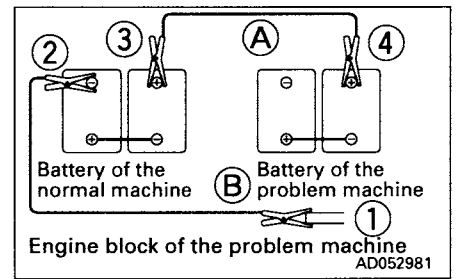

**16.6 OTHER TROUBLE****16.6.1 ELECTRICAL SYSTEM**

- ( ): Always contact your Komatsu distributor when dealing with these items.
- In cases of abnormalities or causes which are not listed below, please contact your Komatsu distributor for repairs.

<b>Problem</b>	<b>Main causes</b>	<b>Remedy</b>
Lamp does not glow brightly even when the engine runs at high speed	<ul style="list-style-type: none"> <li>● Defective wiring</li> <li>● Defective adjustment of fan belt tension</li> </ul>	<ul style="list-style-type: none"> <li>● Check, repair loose terminals, disconnections</li> <li>● Adjust fan belt tension For details, see EVERY 250 HOURS SERVICE</li> </ul>
Lamp flickers while engine is running		
Charge level monitor does not go out even when engine is running	<ul style="list-style-type: none"> <li>● Defective alternator</li> <li>● Defective wiring</li> </ul>	<ul style="list-style-type: none"> <li>● Replace</li> <li>● Check, repair</li> </ul>
Abnormal noise is generated from alternator	<ul style="list-style-type: none"> <li>● Defective alternator</li> </ul>	<ul style="list-style-type: none"> <li>● Replace</li> </ul>
Starting motor does not turn when starting switch is turned to ON	<ul style="list-style-type: none"> <li>● Defective wiring</li> <li>● Insufficient battery charge</li> <li>● Defective starting motor</li> </ul>	<ul style="list-style-type: none"> <li>● Check, repair</li> <li>● Charge</li> <li>● Replace</li> </ul>
Pinion of starting motor keeps going in and out	<ul style="list-style-type: none"> <li>● Insufficient battery charge</li> <li>● Defective safety relay</li> </ul>	<ul style="list-style-type: none"> <li>● Charge</li> <li>● Replace</li> </ul>
Starting motor turns engine sluggishly	<ul style="list-style-type: none"> <li>● Insufficient battery charge</li> <li>● Defective starting motor</li> </ul>	<ul style="list-style-type: none"> <li>● Charge</li> <li>● Replace</li> </ul>
Starting motor disengages before engine starts	<ul style="list-style-type: none"> <li>● Defective wiring</li> <li>● Insufficient battery charge</li> </ul>	<ul style="list-style-type: none"> <li>● Check, repair</li> <li>● Charge</li> </ul>
Pre-heating monitor does not light	<ul style="list-style-type: none"> <li>● Defective wiring</li> <li>● Defective heater relay</li> <li>● Defective monitor</li> </ul>	<ul style="list-style-type: none"> <li>● Check, repair</li> <li>● Replace</li> <li>● Replace</li> </ul>
Oil pressure monitor does not light up when engine is stopped (starting switch at ON position)	<ul style="list-style-type: none"> <li>● Defective monitor</li> <li>● Defective caution lamp switch</li> </ul>	<ul style="list-style-type: none"> <li>● Replace</li> <li>● Replace</li> </ul>
Outside of electrical heater is not warm when touched by hand	<ul style="list-style-type: none"> <li>● Defective wiring</li> <li>● Disconnection in electric heater</li> <li>● Defective operation of heater relay switch</li> </ul>	<ul style="list-style-type: none"> <li>● Check, repair</li> <li>● Replace</li> <li>● Replace</li> </ul>

**16.6.2 CHASSIS**

- ( ): Always contact your Komatsu distributor when dealing with these items.
- In cases of abnormalities or causes which are not listed below, please contact your Komatsu distributor for repairs.

<b>Problem</b>	<b>Main causes</b>	<b>Remedy</b>
Speed of travel, swing, boom, arm, bucket is slow	<ul style="list-style-type: none"> <li>● Lack of hydraulic oil</li> </ul>	<ul style="list-style-type: none"> <li>● Add oil to specified level, see CHECK BEFORE STARTING</li> </ul>
Pump generates abnormal noise	<ul style="list-style-type: none"> <li>● Clogged element in hydraulic tank strainer</li> </ul>	<ul style="list-style-type: none"> <li>● Clean, see EVERY 2000 HOURS SERVICE</li> </ul>
Excessive rise in hydraulic oil temperature	<ul style="list-style-type: none"> <li>● Loose fan belt</li> <li>● Dirty oil cooler</li> <li>● Lack of hydraulic oil</li> </ul>	<ul style="list-style-type: none"> <li>● Adjust fan belt tension, see EVERY 250 HOURS SERVICE</li> <li>● Clean, see EVERY 500 HOURS SERVICE</li> <li>● Add oil to specified level, see CHECK BEFORE STARTING</li> </ul>
Track comes off	<ul style="list-style-type: none"> <li>● Track too loose</li> </ul>	<ul style="list-style-type: none"> <li>● Adjust track tension, see WHEN REQUIRED</li> </ul>
Abnormal wear of sprocket		
Bucket rises slowly, does not rise	<ul style="list-style-type: none"> <li>● Lack of hydraulic oil</li> </ul>	<ul style="list-style-type: none"> <li>● Add oil to specified level, see CHECK BEFORE STARTING</li> </ul>
Does not swing	<ul style="list-style-type: none"> <li>● Swing lock switch still applied</li> </ul>	<ul style="list-style-type: none"> <li>● Turn swing lock switch OFF</li> </ul>

**16.6.3 ENGINE**

- ( ): Always contact your Komatsu distributor when dealing with these items.
- In cases of abnormalities or causes which are not listed below, please contact your Komatsu distributor for repairs.

Problem	Main causes	Remedy
Engine oil pressure monitor lights up	<ul style="list-style-type: none"> <li>● Engine oil pan oil level is low (sucking in air)</li> <li>● Clogged oil filter cartridge</li> <li>● Defective tightening of oil pipe joint, oil leakage from damaged part</li> <li>● Defective engine oil pressure sensor</li> <li>● Defective monitor</li> </ul>	<ul style="list-style-type: none"> <li>● Add oil to specified level, see CHECK BEFORE STARTING</li> <li>● Replace cartridge, see EVERY 250 HOURS SERVICE</li> <li>(● Check, repair)</li> <li>(● Replace sensor)</li> <li>(● Replace monitor)</li> </ul>
Steam is emitted from top part of radiator (pressure valve)	<ul style="list-style-type: none"> <li>● Cooling water level low, water leakage</li> <li>● Loosen fan belt</li> <li>● Dirt or scale accumulated in cooling system</li> <li>● Clogged radiator fin or damaged fin</li> </ul>	<ul style="list-style-type: none"> <li>● Add cooling water, repair, see CHECK BEFORE STARTING</li> <li>● Adjust fan belt tension, see EVERY 250 HOURS SERVICE</li> <li>● Change cooling water, clean inside of cooling system, see WHEN REQUIRED</li> <li>● Clean or repair, see EVERY 500 HOURS SERVICE</li> </ul>
Radiator water level monitor lights up	<ul style="list-style-type: none"> <li>● Defective thermostat</li> <li>● Loose radiator filler cap (high altitude operation)</li> <li>● Defective water level sensor</li> <li>● Defective monitor</li> </ul>	<ul style="list-style-type: none"> <li>(● Replace thermostat)</li> <li>● Tighten cap or replace packing</li> <li>(● Replace sensor)</li> <li>(● Replace monitor)</li> </ul>
Engine does not start when starting motor is turned	<ul style="list-style-type: none"> <li>● Lack of fuel</li> <li>● Air in fuel system</li> <li>● Defective fuel injection pump or nozzle</li> <li>● Starting motor cranks engine sluggishly</li> <li>● Preheating monitor does not light up</li> <li>● Defective compression                             <ul style="list-style-type: none"> <li>○ Defective valve clearance</li> </ul> </li> </ul>	<ul style="list-style-type: none"> <li>● Add fuel, see CHECK BEFORE STARTING</li> <li>● Repair place where air is sucked in, see EVERY 500 HOURS SERVICE</li> <li>(● Replace pump or nozzle)</li> <li>See ELECTRICAL SYSTEM</li> <li>(○ Adjust valve clearance)</li> </ul>

**ENGINE (cont'd) (16.6.3)**

<b>Problem</b>	<b>Main causes</b>	<b>Remedy</b>
Exhaust gas is white or blue	<ul style="list-style-type: none"> <li>● Too much oil in oil pan</li> <li>● Improper fuel</li> </ul>	<ul style="list-style-type: none"> <li>● Add oil to specified level, see CHECK BEFORE STARTING</li> <li>● Change to specified fuel</li> </ul>
Exhaust gas occasionally turns black	<ul style="list-style-type: none"> <li>● Clogged air cleaner element</li> <li>● Defective nozzle</li> <li>● Defective compression</li> <li>● Defective turbocharger</li> </ul>	<ul style="list-style-type: none"> <li>● Clean or replace, see WHEN REQUIRED</li> <li>(● Replace nozzle)</li> <li>(● See defective compression above)</li> <li>● Clean or replace turbocharger</li> </ul>
Combustion noise occasionally makes breathing sound	<ul style="list-style-type: none"> <li>● Defective nozzle</li> </ul>	<ul style="list-style-type: none"> <li>(● Replace nozzle)</li> </ul>
Abnormal noise generated (combustion or mechanical)	<ul style="list-style-type: none"> <li>● Low grade fuel being used</li> <li>● Overheating</li> <li>● Damage inside muffler</li> <li>● Excessive valve clearance</li> </ul>	<ul style="list-style-type: none"> <li>● Change to specified fuel</li> <li>● Refer to "Radiator water level monitor lights up" as above</li> <li>(● Replace muffler)</li> <li>(● Adjust valve clearance)</li> </ul>

### 16.6.4 ELECTRONIC CONTROL SYSTEM

If an error code is displayed on the machine monitor display (normally this displays the time), follow the self-diagnostic remedy table below.

#### Machine monitor failure display

Monitor display	Failure mode	Remedy
E02	TVC valve system error	When pump prolix switch is turned ON, normal operations become normal, but carry out inspection immediately. (※)
E03	Swing brake system error	Turn swing prolix switch ON and release brake. When applying swing brake, operate swing lock switch manually. In this case, carry out inspection immediately. (※)
E05	Governor system error	The governor cannot carry out control. Operate the governor lever manually. To secure at the full position, there is a mounting hole for the lock bolts in the bracket. In this case, carry out inspection immediately.
CALL	Operation cannot be continued	Move machine to a safe posture, and carry out inspection immediately.
If no error code is displayed but work equipment or swing cannot be operated		Carry out inspection immediately.

※: For details of handling the pump prolix switch and swing prolix switch, see "11.2 SWITCHES".

# MAINTENANCE



## WARNING

Before carrying out maintenance, always attach the **WARNING TAG** to the control lever in the operator's cab.

## 17. GUIDES TO MAINTENANCE

---

Do not carry out any inspection and maintenance operation that is not given in this manual. Perform maintenance work on hard, flat ground.

**Check service meter:**

Check the service meter reading every day to see if the time has come for any necessary maintenance to be carried out.

**Komatsu genuine replacement parts:**

Use Komatsu genuine parts specified in the Parts Book as replacement parts.

**Komatsu genuine oils:**

Use Komatsu genuine oils and grease. Choose oils and grease with proper viscosities specified for ambient temperature.

**Always use clean washer fluid:**

Use automobile window washer fluid and be careful not to let any dirt get into it.

**Always use clean oil and grease:**

Use clean oil and grease. Also, keep containers of the oil and grease clean. Keep foreign materials away from oil and grease.

**Keeping the machine clean:**

Always keep the machine clean. This makes it easier to find parts causing problems. Keep in particular grease fittings, breathers and oil level gauges clean and avoid foreign matters from getting in them.

**Be careful of hot water and oil:**

Draining hot oils and coolants and removing their filters immediately after the engine stops are hazardous. Allow the engine to cool.

If the oil has to be drained when it is cold, warm up the oil to a suitable temperature (approx. 20 – 40°C) before draining it.

**Checking foreign materials in drained oil and on filter:**

After oil is changed or filters are replaced, check the oil and filters for metallic particles and foreign materials. If large quantities of metallic particles or foreign materials are found, consult your Komatsu distributor.

**Fuel strainer:**

If your machine is equipped with a fuel strainer, do not remove it while fueling.

**Oil change:**

Check or change oils in the places where dust is scarce to keep foreign materials away from oils.



**Warning tag:**

Attach the warning tag to the starting switch or other appropriate control lever to avoid someone who is not aware of the circumstances from starting the engine.

**Obey precautions:**

During the operation, always obey the precautions on the safety label attached to the machine.

**Welding instructions:**

- Turn off the engine starting switch.
- Do not apply more than 200 V continuously.
- Connect grounding the cable within 1 m from the area to be welded.
- Avoid seals or bearings from being between the area to be welded and the position of grounding point.
- Do not use the area around the work equipment pins or the hydraulic cylinders as the grounding point.

**Fire prevention:**

Use nonflammable cleaner or light oil for cleaning parts. Keep flame or cigarette light away from light oil.

**Clamp faces:**

When O-rings or gaskets are removed, clean the clamp faces and replace the O-rings and gaskets with new ones. Be sure to fit O-rings and gaskets when assembling.

**Objects in your pockets:**

Keep your pockets free of loose objects which can fall out and drop into the machinery; especially when you work on the machinery while bending over it.

**Checking undercarriage:**

When working in rocky areas, check for damage to the undercarriage and for looseness, flaws, wear and damage in bolts and nuts. Loosen the track tension a little when working in such areas.

**Precautions when washing machine:**

- Never spray steam or water directly on the connectors and mechatronics parts.
- Do not allow water to get on the monitors and controllers inside the operator's cab.
- Never spray steam or water directly at the radiator or oil cooler portions.

**Pre-and post-work checks:**

Before starting work in mud, rain, snow or at seashore, check plugs and valves for tightness.

Wash the machine immediately after the work to protect components from rusting.

Lubricate components more frequently than usual. Be sure to lubricate work equipment pins daily if they are submerged in water.

**Dusty worksites:**

When working at dusty worksites, do as follows:

- Inspect the air cleaner clogging monitor to see whether the air cleaner is blocked up.
- Clean the radiator core frequently to avoid clogging.
- Clean and replace the fuel filter frequently.
- Clean electrical components, especially the starting motor and alternator, to avoid accumulation of dust.

**Avoid mixing oils:**

Never mix oils of different brands. If you have only oil which is a different brand from the one that is used in the machine, do not add it but replace all the oil.

## 18. OUTLINES OF SERVICE

---

- Use Komatsu genuine parts for replacement.
- When changing or adding oil, do not use a different type of oil.
- Unless otherwise specified, the oil and coolant used at the time of shipment from the factory are as shown in the table below.

Item	Kind of fluid
Engine oil pan	SAE 10W-30 API classification CD
Swing machinery case Final drive case Damper case	SAE 30 API classification CD
Hydraulic tank	SAE 10W API classification CD
Fuel tank	ASTM D975 No. 2 (However, ASTM D975 No. 1 is used for the winter season (October to March))
Radiator	Komatsu Super Coolant (AF-ACL) 41% added to water

### 18.1 OUTLINE OF OIL, FUEL, COOLANT

#### 18.1.1 OIL

- Oil is used in the engine and work equipment under extremely severe conditions (high temperature, high pressure), and it deteriorates with use.  
Always use oil that matches the grade and temperature for use given in the Operation and Maintenance Manual. Even if the oil is not dirty, always replace the oil after the specified interval.
- Oil corresponds to blood in the human body, so always be careful when handling it to prevent any impurities (water, metal particles, dirt, etc.) from getting in.  
The majority of problems with machine are caused by the entry of such impurities.  
Take particular care not to let any impurities get in when storing or adding oil.
- Never mix oils of different grades or brands.
- Always add the specified amount of oil.  
Having too much oil or too little oil are both causes of problems.
- If the oil in the work equipment is not clear, there is probably water or air getting into the circuit.  
In such cases, please contact your Komatsu distributor.
- When changing the oil, always replace the related filters at the same time.
- We recommend you to have an analysis made of the oil periodically to check the condition of the machine. For those who wish to use this service, please contact your Komatsu distributor.

### 18.1.2 FUEL

- The fuel pump is a precision instrument, and if fuel containing water or dirt is used, it cannot work properly.
- Be extremely careful not to let impurities get in when storing or adding fuel.
- Always use the fuel specified in the Operation and Maintenance Manual.  
Fuel may congeal depending on the temperature when it is used (particularly in low temperature below-15°C), so it is necessary to change to a fuel that matches the temperature.
- To prevent the moisture in the air from condensing and forming water inside the fuel tank, always fill the fuel tank after completing the day's work.
- Before starting the engine, or when 10 minutes have passed after adding fuel, drain the sediment and water from the fuel tank.
- If the engine runs out of fuel, or if the filters have been replaced, it is necessary to bleed the air from the circuit.

### 18.1.3 COOLANT

- River water contains large amounts of calcium and other impurities, so if it is used, scale will stick to the engine and radiator, and this will cause defective heat exchange and overheating.  
Do not use water that is not suitable for drinking.
- When using anti-freeze, always observe the precautions given in the Operation and Maintenance Manual.
- Komatsu machines are supplied with Komatsu original anti-freeze in the coolant when the machine is shipped.  
This anti-freeze is effective in preventing corrosion of the cooling system.  
The anti-freeze can be used continuously for two years or 4000 hours. Therefore, it can be used as it is even in hot areas.
- Anti-freeze is inflammable, so be extremely careful not to expose it to flame or fire.
- The proportion of anti-freeze to water differs according to the ambient temperature.  
For details of the mixing proportions, see "24.2.2 CLEAN INSIDE OF COOLING SYSTEM".
- If the engine overheats, wait for the engine to cool before adding coolant.
- If the coolant level is low, it will cause overheating and will also cause problems with corrosion from the air in the coolant.

#### **18.1.4 GREASE**

- Grease is used to prevent twisting and noise at the joints.
- The nipples not included in the maintenance section are nipples for overhaul, so they do not need grease.  
If any part becomes stiff after being used for long time, add grease.
- Always wipe off all of the old grease that is pushed out when greasing. Be particularly careful to wipe off the old grease in places. Where sand or dirt sticking in the grease would cause wear of the rotating parts.

#### **18.1.5 STORING OIL AND FUEL**

- Keep indoors to prevent any water, dirt, or other impurities from getting in.
- When keeping drum cans for a long period, put the drum on its side so that the filler port of the drum can is at the side. (To prevent moisture from being sucked in)  
If drum cans have to be stored outside, cover them with a waterproof sheet or take other measures to protect them.
- To prevent any change in quality during long-term storage, be sure to use in the order of first in - first out (use the oldest oil or fuel first).

#### **18.1.6 FILTERS**

- Filters are extremely important safety parts. They prevent impurities in the fuel and air circuits from entering important equipment and causing problems.  
Replace all filters periodically. For details, see the Operation and Maintenance Manual.  
However, when working in severe conditions, it is necessary to consider replacing the filters at shorter intervals according to the oil and fuel (sulfur content) being used.
- Never try to clean the filters (cartridge type) and use them again. Always replace with new filters.
- When replacing oil filters, check if any metal particles are stuck to the old filter. If any metal particles are found, please contact your Komatsu distributor.
- Do not open packs of spare filters until just before they are to be used.
- Always use Komatsu genuine filters.

## 18.2 OUTLINE OF ELECTRIC SYSTEM

- If the wiring gets wet or the insulation is damaged, the electric system leaks and this could result in hazardous malfunction of the machine.
- Services relating to the electric system are (1) check of fan belt tension, (2) check of damage or wear in the fan belt and (3) check of battery fluid level.
- Never remove or disassemble any electric components installed in the machine.
- Never install any electric components other than these specified by Komatsu.
- Be careful to keep the electric system free of water when washing the machine or when it rains.
- Since the controller for the control system may cause malfunction due to external wave interference, before installing a radio receiver and a walkie-talkie or citizen band, consult your Komatsu distributor.
- When working on the seashore, carefully clean the electric system to prevent corrosion.
- When installing a car cooler or any other electrical equipment, connect it to an independent power source connector. The optional power source must never be connected to the fuse, starting switch, or battery relay.

### 18.3 OUTLINE OF HYDRAULIC SYSTEM

- During operation and immediately after operation is ended, the temperature of the hydraulic system still remains high.  
In addition, high hydraulic pressure is applied to the system. Take care when inspecting and maintaining the hydraulic system.
  - Stop the machine on level ground, lower the bucket to the ground, then set so that there is no pressure applied to the cylinder circuit.
  - Always stop the engine.
  - Immediately after operations, the hydraulic oil and lubricating oil are at high temperature and high pressure, so wait for the oil temperature to go down before starting maintenance.  
Even when the temperature goes down, the circuit may still be under internal pressure, so when loosening the plug or screw, or the hose joint, do not stand in front of the part. Loosen it slowly to release the internal pressure before removing it.
  - When carrying out inspection or maintenance of the hydraulic circuit, always bleed the air from the hydraulic tank to remove the internal pressure.
- Periodic maintenance includes the inspection of the hydraulic oil level, replacement of the filter and refilling of hydraulic oil.
- When the high pressure hose, etc. is removed, check the O-ring for damage. If necessary, replace it.
- After the hydraulic filter element and strainer are cleaned or replaced, or after the hydraulic system is repaired or replaced or the hydraulic piping is removed, bleed air from the hydraulic circuit.
- The accumulator is charged with high-pressure nitrogen gas. Incorrect handling may be dangerous. For the handling procedure, see "11.19 HANDLING ACCUMULATOR".

## 19. WEAR PARTS LIST

Wear parts such as the filter element, bucket tooth, etc. are to be replaced at the time of periodic maintenance or before their abrasion limits.

The wear parts should be changed correctly in order to use the machine economically.

For part change, Komatsu genuine parts of excellent quality should be used.

When ordering parts, please check the part number in the parts book.

**The parts in parentheses are to be replaced at the same time.**

Item	Part No.	Part Name	Q'ty	Replacement frequency
Engine oil filter	600-21-1231	Cartridge	1	Every 250 hours service
Hydraulic oil filter	208-60-61180 (07000-05210)	Element (O-ring)	1 (1)	Every 250 hours service
Fuel filter	600-311-8293	Cartridge	1	Every 500 hours service
Hydraulic tank breather	20Y-60-21470	Element	1	Every 500 hours service
Additional hydraulic oil filter	285-62-17320	Element	1	Every 1000 hours service
Corrosion resistor	600-411-1151	Cartridge	1	Every 1000 hours service
Air cleaner	6125-81-7032	Element assembly	1	–
Additional breaker filter (option)	207-970-5120 (07000-12011) (07000-02125)	Element (O-ring) (O-ring)	1 (1) (1)	–
Electrical intake air heater	6150-13-4810	Gasket	12	–
Line filter	07063-21200 (07000-12055) (07001-02055)	Element (O-ring) (Ring)	2 (2) (2)	–



Item	Part No.	Part Name	Q'ty	Replacement frequency
Bucket	208-70-34211 (208-70-34220) (208-70-74191)	Vertical pin type Tooth (Pin) (Lock)	5 (5) (5)	—
	208-70-14152 (09244-03036)	Horizontal pin type Tooth (Pin)	5 (5)	
	208-70-34160 208-70-34170 (198-32-14210) (198-32-11221)	Side cutter type Cutter (left) Cutter (right) (Bolt) (Nut)	1 1 (10) (10)	
	209-70-54610 01011-83005 01580-13024 01643-33080	Shroud type Shroud Bolt Nut Washer	4 (12) (12) (24)	

If bypass filter equipped, replace the filter cartridge at every 500 hours service.

Item	Part No.	Part Name	Q'ty	Replacement frequency
Engine bypass filter	600-212-1511	Cartridge	1	Every 500 hours service
Engine oil filter	6136-51-1231	Cartridge	1	Every 500 hours service

# 20. USE OF FUEL, COOLANT AND LUBRICANTS ACCORDING TO AMBIENT TEMPERATURE

## PROPER SELECTION OF FUEL, COOLANT AND LUBRICANTS

RESERVOIR	KIND OF FLUID	AMBIENT TEMPERATURE										CAPACITY			
		-22 -30	-4 -20	14 -10	32 0	50 10	68 20	86 30	104 40	122°F 50°C	Specified	Refill			
Engine oil pan	Engine oil											<b>SAE 30</b>		38 ℓ 10.0 US gal 8.4 UK gal	34 ℓ 9.0 US gal 7.5 UK gal
												<b>SAE 10W</b>		41 ℓ 10.8 US gal 9.0 UK gal	37 ℓ 9.8 US gal 8.1 UK gal
												<b>SAE 10W-30</b>		(For machines equipped with bypass filter)	(For machines equipped with bypass filter)
												<b>SAE 15W-40</b>			
Swing machinery case												21.5 ℓ 5.7 US gal 4.7 UK gal	21.5 ℓ 5.7 US gal 4.7 UK gal		
Final drive case (each)												12 ℓ 3.2 US gal 2.6 UK gal	11.5 ℓ 3.0 US gal 2.5 UK gal		
Damper case												0.75 ℓ 0.20 US gal 0.17 UK gal	-		
Hydraulic system												<b>SAE 10W</b>		490 ℓ 129.4 US gal 107.8 UK gal	270 ℓ 71.3 US gal 59.4 UK gal
												<b>SAE 10W-30</b>			
												<b>SAE 15W-40</b>			
Fuel tank	Diesel fuel										<b>ASTM D975 No.2</b>		605 ℓ 159.8 US gal 133.1 UK gal	-	
											※				
Grease fitting	Grease										<b>NLGI No.2</b>		-	-	
Cooling system	Water	<b>Add antifreeze</b>										43.9 ℓ 11.6 US gal 9.7 UK gal	-		

※ ASTM D975 No. 1

**REMARK**

- When fuel sulphur content is less than 0.5%, change oil in the oil pan every periodic maintenance hours described in this manual.

Change oil according to the following table if fuel sulphur content is above 0.5%.

Fuel sulphur content	Change interval of oil in engine oil pan
0.5 to 1.0%	1/2 of regular interval
Above 1.0%	1/4 of regular interval

- When starting the engine in an atmospheric temperature of lower than 0°C, be sure to use engine oil of SAE10W, SAE10W-30 and SAE15W-40, even though an atmospheric temperature goes up to 10°C more or less in the day time.
- Use API classification CD as engine oil and if API classification CC, reduce the engine oil change interval to half.
- There is no problem if single grade oil is mixed with multigrade oil (SAE10W-30, 15W-40), but be sure to add single grade oil that matches the temperature in the table.
- We recommend Komatsu genuine oil which has been specifically formulated and approved for use in engine and hydraulic work equipment applications.

Specified capacity: Total amount of oil including oil for components and oil in piping.

Refill capacity: Amount of oil needed to refill system during normal inspection and maintenance.

ASTM: American Society of Testing and Material

SAE: Society of Automotive Engineers

API: American Petroleum Institute

20. USE OF FUEL, COOLANT AND LUBRICANTS ACCORDING TO AMBIENT TEMPERATURE

No.	Supplier	Engine Oil [CD or CE] SAE10W, 30, 40 10W30, 15W40 (The 15W40 oil marked * is CE.)	Gear Oil [GL-4 or GL-5] SAE80, 90, 140	Grease [Lithium-Base] NLGI No. 2	Anti-freeze Coolant [Ethylene Glycol Base] Permanent Type
1	KOMATSU	EO10-CD EO30-CD EO10-30CD EO15-40CD	GO90 GO140	G2-LI G2-LI-S	AF-ACL AF-PTL AF-PT (Winter, one season type)
2	AGIP	Diesel sigma S Super dieselmulti- grade *Sigma turbo	Rotra MP	GR MU/EP	-
3	AMOCO	*Amoco 300	Multi-purpose gear oil	RYKON premium grease	-
4	ARCO	*Arcofleet S3 plus	Arco HD gear oil	Litholine HEP 2 Arco EP moly D	-
5	BP	Vanellus C3	Gear oil EP Hypogear EP	Energrease LS-EP2	Antifreeze
6	CALTEX	*RPM delo 400 RPM delo 450	Universal thuban Universal thuban EP	Marfak all purpose 2 Ultra-duty grease 2	AF engine coolant
7	CASTROL	*Turbomax *RX super CRD	EP EPX Hypoy Hypoy B Hypoy C	MS3 Spheerol EPL2	Anti-freeze
8	CHEVRON	*Delo 400	Universal gear	Ultra-duty grease 2	-
9	CONOCO	*Fleet motor oil	Universal gear lubricant	Super-sta grease	-
10	ELF	Multiperformance 3C Performance 3C	-	Tranself EP Tranself EP type 2	Glacelf
11	EXXON (ESSO)	Essolube D3 *Essolube XD-3 *Essolube XD-3 Extra *Esso heavy duty Exxon heavy duty	Gear oil GP Gear oil GX	Beacon EP2	All season coolant
12	GULF	Super duty motor oil *Super duty plus	Multi-purpose gear lubricant	Gulfcrown EP2 Gulfcrown EP special	Antifreeze and coolant
13	MOBIL	Delvac 1300 *Delvac super 10W-30, 15W-40	Mobilube GX Mobilube HD	Mobilux EP2 Mobilgrease 77 Mobilgrease special	-

**20. USE OF FUEL, COOLANT AND LUBRICANTS ACCORDING TO AMBIENT TEMPERATURE**

No.	Supplier	<b>Engine Oil [CD or CE]</b> SAE10W, 30, 40 10W30, 15W40 (The 15W40 oil marked * is CE.)	<b>Gear Oil [GL-4 or GL-5]</b> SAE80, 90, 140	<b>Grease [Lithium-Base]</b> NLGI No. 2	<b>Anti-freeze Coolant [Ethylene Glycol Base] Permanent Type</b>
14	PENNZOIL	*Supreme duty fleet motor oil	Multi-purpose 4092 Multi-purpose 4140	Multi-purpose white grease 705 707L White – bearing grease	Anti-freeze and summer coolant
15	PETROFINA	FINA kappa TD	FINA potonic N FINA potonic NE	FINA marson EPL2	FINA tamidor
16	SHELL	Rimula X	Spirax EP Spirax heavy duty	Albania EP grease	–
17	SUN	–	Sunoco GL5 gear oil	Sunoco ultra prestige 2EP Sun prestige 742	Sunoco antifreeze and summer coolant
18	TEXACO	*Ursa super plus Ursa premium	Multigear	Multifak EP2 Starplex 2	Code 2055 startex antifreeze coolant
19	TOTAL	Rubia S *Rubia X	Total EP Total transmission TM	Multis EP2	Antigel/antifreeze
20	UNION	*Guardol	MP gear lube LS	Unoba EP	–
21	VEEDOL	*Turbostar *Diesel star MDC	Multigear Multigear B Multigear C	–	Antifreeze

# 21. STANDARD TIGHTENING TORQUES FOR BOLTS AND NUTS

## 21.1 INTRODUCTION OF NECESSARY TOOLS

The following tools are needed when carrying out maintenance.

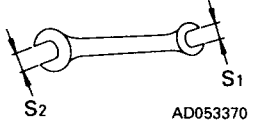
No.	Name of tool	Part No.	Remarks
1	Wrench	09002-01317 09002-01922	Applicable width across flats ( $S_1$ - $S_2$ ) 13mm – 17mm 19mm – 22mm  AD053370
2	Wrench	09002-03641	Applicable width across flats 36 mm – 41 mm
3	Screwdriver	09033-00190	Interchangeable flat-head and cross-head type
4	Socket wrench set	09020-10286 207-98-61130	Applicable width across flats 12 mm, 14 mm, 17 mm, 19 mm, 24 mm, 36 mm Extension, Handle
5	Hexagon wrench	09007-00836	Applicable width across flats 8 mm
6	Filter wrench	09019-08035	
7	Grease pump	07950-10450	For greasing work
8	Nozzle	07951-31400	
9	Grease cartridge	07950-90403	(Lithium base grease, 400 g)
10	Hammer	09039-00150	
11	Pinch bar	09055-10390	

If any of the above tools are broken, please order them from your Komatsu distributor.

## 21.2 TORQUE LIST

Unless otherwise specified, tighten the metric bolts and nuts to the torque shown in the table.

The tightening torque is determined by the width across the flats (b) of the nut and bolt.

If it is necessary to replace any nut or bolt, always use a Komatsu genuine part of the same size as the part that was replaced.

Nm (newton meter):  $1\text{Nm} \approx 0.1 \text{ kgm}$   
 $\approx 0.74 \text{ lbft}$

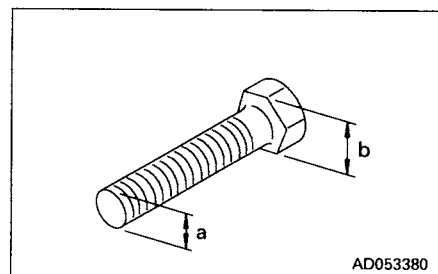

Thread diameter of bolt (mm) (a)	Width across flat (mm) (b)	AD054300		
		Nm	kgm	lbft
6	10	13.2 ± 1.4	1.35 ± 0.15	9.73 ± 1.03
8	13	31.4 ± 2.9	3.2 ± 0.3	23.2 ± 2.1
10	17	65.7 ± 6.8	6.7 ± 0.7	48.5 ± 5.0
12	19	112 ± 9.8	11.5 ± 1.0	82.6 ± 7.2
14	22	177 ± 19	18.0 ± 2.0	131 ± 14
16	24	279 ± 29	28.5 ± 3	206 ± 21
18	27	383 ± 39	39 ± 3	282 ± 29
20	30	549 ± 58	56 ± 6	405 ± 43
22	32	745 ± 78	76 ± 8	549 ± 58
24	36	927 ± 98	94.5 ± 10	684 ± 72
27	41	1320 ± 140	135 ± 15	973 ± 100
30	46	1720 ± 190	175 ± 20	1270 ± 140
33	50	2210 ± 240	225 ± 25	1630 ± 180
36	55	2750 ± 290	280 ± 30	2030 ± 210
39	60	3280 ± 340	335 ± 35	2420 ± 250
*1-7/16-12UN-2B	41	205 ± 29	21 ± 3	150 ± 20

### NOTICE

When tightening panels or other parts having tightening fixtures made of plastic, be careful not to use excessive tightening torque: doing so will damage the plastic parts.

\* The torque marked with \* is the tightening torque for the hose at the top of the swivel.

## **22. PERIODIC REPLACEMENT OF SAFETY CRITICAL PARTS**

To ensure safety at all times when operating or driving the machine, the user of the machine must always carry out periodic maintenance. In addition, to further improve safety, the user should also carry out periodic replacement of the parts given in the table. These parts are particularly closely connected to safety and fire prevention.

With these parts, the material changes as time passed, or they easily wear or deteriorate. However, it is difficult to judge the condition of the parts simply by periodic maintenance, so they should always be replaced after a fixed time has passed, regardless of their condition. This is necessary to ensure that they always maintain their function completely.

However, if these parts show any abnormality before the replacement interval has passed, they should be repaired or replaced immediately.

If the hose clamps show any deterioration, such as deformation or cracking, replace the clamps at the same as the hoses.

When replacing the hoses, always replace the O-rings, gaskets, and other such parts at the same time.

Ask your Komatsu distributor to replace the safety critical parts.



**SAFETY CRITICAL PARTS**

No.	Safety critical parts for periodic replacement	Q'ty	Replacement interval
1	Fuel hose (fuel tank – engine)	2	Every 2 years or 4000 hours, whichever comes sooner
2	Spill hose (nozzle – fuel tank)	1	
3	Spill hose (between nozzles)	2	
4	Fuel hose (fuel filter – injection pump)	2	
5	Pump output hose	2	
6	Work equipment hose (boom cylinder inlet port)	4	
7	Work equipment hose (bucket cylinder line, boom foot)	2	
8	Work equipment hose (bucket cylinder inlet port)	2	
9	Work equipment hose (bucket cylinder inlet port, 4.0 m arm)	2	
10	Work equipment hose (arm cylinder line, boom foot)	2	
11	Work equipment hose (arm cylinder inlet port)	2	
12	Attachment additional line hose (boom foot)	2	
13	Attachment additional line hose (boom intermediate)	2	
14	Attachment additional line hose (boom top)	2	
15	Swing line hose (swing motor inlet port)	2	
16	Main suction hose	1	
17	Gear pump suction hose	1	
18	Heater hose	2	
19	Seat belt	1	Replace every 3 years

## 23. MAINTENANCE SCHEDULE CHART

### 23.1 MAINTENANCE SCHEDULE CHART

SERVICE ITEM	PAGE
<b>INITIAL 250 HOURS SERVICE (only after the first 250 hours)</b>	
Replace fuel filter cartridge	3-56
Change oil in engine oil pan, replace engine oil filter cartridge and bypass filter cartridge (only for machines equipped with bypass filter)	3-58
Check engine valve clearance, adjust	3-69
<b>WHEN REQUIRED</b>	
Check, clean and replace air cleaner element	3-24
Clean inside of cooling system	3-26
Check and tighten track shoe bolts	3-30
Check and adjust track tension	3-31
Check electrical intake air heater	3-33
Replace bucket teeth (vertical pin type)	3-34
Replace bucket teeth (horizontal pin type)	3-37
Adjust bucket clearance	3-38
Check window washer fluid, add fluid	3-39
Check, maintain air conditioner (only machines equipped with air conditioner)	3-40
Replace additional breaker filter element (option)	3-41
<b>CHECK BEFORE STARTING</b>	
Check coolant level, add water	3-42
Check oil level in engine oil pan, add oil	3-42
Check fuel level, add fuel	3-43
Check oil level in hydraulic tank, add oil	3-44
Check air cleaner for clogging	3-44
Check electric wirings	3-45
Check function of horn	3-45
Check for water and sediment in water separator, drain water (option)	3-45
<b>EVERY 50 HOURS SERVICE</b>	
Lubricating	3-46
● Boom cylinder foot pin (2 points)	3-46
● Boom foot pin (2 points)	3-47
● Arm-Link coupling pin (1 point)	3-47

SERVICE ITEM	PAGE
<b>(EVERY 50 HOURS SERVICE)</b>	
● Arm-Bucket coupling pin (1 point)	3-47
● Link coupling pin (2 points)	3-47
● Bucket cylinder rod end (1 point)	3-47
● Bucket-Link coupling pin (1 point)	3-47
<b>EVERY 100 HOURS SERVICE</b>	
Lubricating	3-48
● Boom cylinder rod pin (2 points)	3-48
● Arm cylinder foot pin (1 point)	3-48
● Boom-Arm coupling pin (1 point)	3-48
● Arm cylinder rod end (1 point)	3-48
● Bucket cylinder foot pin (1 point)	3-48
Check oil level in swing machinery case, add oil	3-49
Drain water and sediment from fuel tank	3-49
<b>EVERY 250 HOURS SERVICE</b>	
Check oil level in final drive case, add oil	3-50
Check level of battery electrolyte	3-51
Change oil in engine oil pan, replace engine oil filter cartridge	3-52
Lubricate swing circle (2 points)	3-53
Check fan belt tension, adjust	3-54
Check, adjust tension of air conditioner compressor belt	3-55
<b>EVERY 500 HOURS SERVICE</b>	
Replace fuel filter cartridge	3-56
Check swing pinion grease level, add grease	3-57
Change oil in engine oil pan, replace engine oil filter cartridge and bypass filter cartridge (for machines equipped with bypass filter)	3-58
Clean and inspect radiator fins, oil cooler fins, after cooler fins, condenser fins (only for machines equipped with air conditioner)	3-60
Clean FRESH/RECIRC air filters of air conditioner (only for machines equipped with air conditioner)	3-61
Replace hydraulic tank breather element	3-62
Replace hydraulic filter element	3-63

23. MAINTENANCE SCHEDULE CHART

SERVICE ITEM	PAGE
<b>EVERY 1000 HOURS SERVICE</b>	
Change oil in swing machinery case	3-64
Check oil level in damper case, add oil	3-65
Check all tightening parts of turbocharger	3-65
Check play of turbocharger rotor	3-65
Replace corrosion resistor cartridge (option)	3-66
<b>EVERY 2000 HOURS SERVICE</b>	
Change oil in final drive case	3-67
Clean hydraulic tank strainer	3-68
Clean engine breather	3-69
Clean, check turbocharger	3-69
Check alternator, starting motor	3-69
Check engine valve clearance, adjust	3-69
Check vibration damper	3-69
<b>EVERY 4000 HOURS SERVICE</b>	
Check water pump	3-70
<b>EVERY 5000 HOURS SERVICE</b>	
Change oil in hydraulic tank	3-71

**23.2 MAINTENANCE INTERVAL WHEN USING HYDRAULIC BREAKER**

For machines equipped with a hydraulic breaker, the hydraulic oil deteriorates faster than for normal bucket digging operations, so set the maintenance intervals as follows.

- Replacing hydraulic element  
On new machines, replace the element after the first 100 to 150 hours, then carry out further replacement of the element according to the table on the right.
- Changing oil in hydraulic tank  
Change the oil according to the table on the right.
- Replacing additional filter element for breaker  
Use a guideline of 250 hours for use of the breaker (operating ratio for the breaker: 50 % or more), and replace the element according to the table on the right.

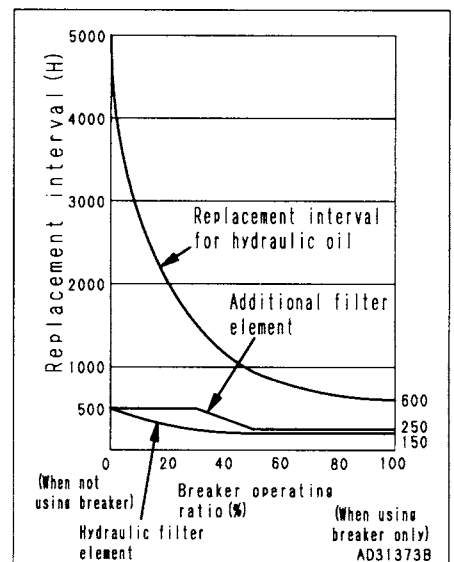

## **24. SERVICE PROCEDURE**

---

### **24.1 INITIAL 250 HOURS SERVICE**

Carry out the following maintenance only after the first 250 hours.

- **REPLACE FUEL FILTER CARTRIDGE**
- **CHANGE OIL IN ENGINE OIL PAN, REPLACE ENGINE OIL FILTER CARTRIDGE AND BYPASS FILTER CARTRIDGE (ONLY FOR MACHINES EQUIPPED WITH BYPASS FILTER)**
- **CHECK ENGINE VALVE CLEARANCE, ADJUST**

As special tool is required for removing and adjusting the parts, you shall request Komatsu distributor for service.

For details of the method of replacing or maintaining, see the section on EVERY 500 HOURS and 2000 HOURS SERVICE.

## 24.2 WHEN REQUIRED

### 24.2.1 CHECK, CLEAN AND REPLACE AIR CLEANER ELEMENT

**WARNING**

- Never clean or replace the air cleaner element with the engine running.
- When using pressure air to clean the element wear safety glasses or goggles to protect the eyes.

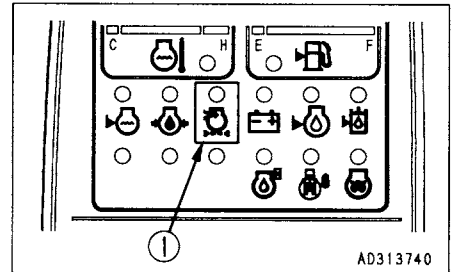

#### Checking

If air cleaner clogging monitor ① flashes, clean the air cleaner element.

#### NOTICE

Do not clean the air cleaner element until the air cleaner clogging monitor on the monitor panel flashes.

If the element is cleaned frequently before the clogging monitor flashes, the air cleaner will not be able to display its performance fully, and the cleaning efficiency will also go down.

In addition, during the cleaning operation, more dirt stuck to the element will fall inside the inner element.

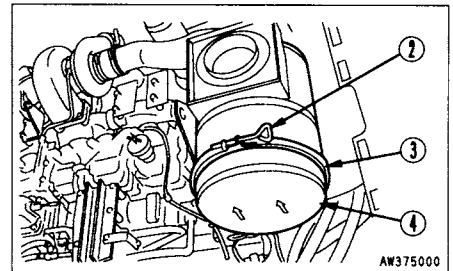

#### Cleaning the outer element

1. Open the engine hood, loosen wing nut ②, then loosen band ③ and remove cover ④. Remove wing nut ⑤, then take out element ⑥.

To prevent dirt or dust from entering, use tape or a clean cloth to cover the air connector end of the air cleaner body.

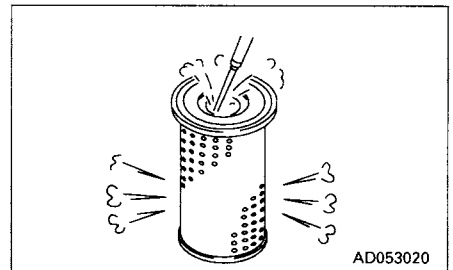

2. Clean the air cleaner body interior and the cover ④.
3. Direct dry compressed air (less than 700 kPa (7 kg/cm<sup>2</sup>, 100 psi)) to element ⑥ from inside along its folds, then direct it from outside along its folds and again from inside.
  - 1) Remove one seal from the outer element whenever the outer element has been cleaned.
  - 2) Replace the outer element which has been cleaned 6 times repeatedly or used throughout a year. Replace the inner element at the same time.
  - 3) Replace both inner and outer elements when the monitor lamp ① flashed soon after installing the cleaned outer element even though it has not been cleaned 6 times.
  - 4) Check inner element mounting nuts for looseness and, if necessary, retighten.
  - 5) If seal washer ⑦ is damaged or the thread of wing nut ⑤ is broken, replace with a new part.
  - 6) Remove vacuator valve ⑧ and clean with compressed air. After cleaning, install again.

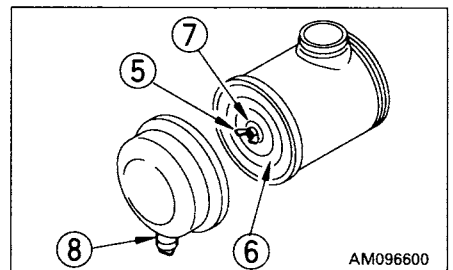

4. If small holes or thinner parts are found on the element when it is checked by shining a light through it after cleaning, replace the element.

**NOTICE**

Do not use an element whose folds or gasket or seal are damaged.

When cleaning the element, do not hit or beat it against anything.  
Wrap up unused elements and store them in a dry area.

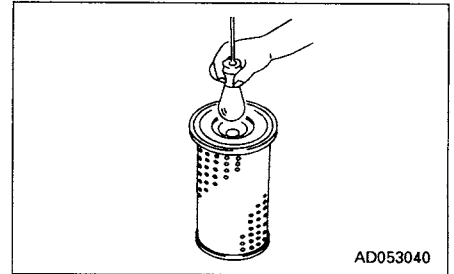

5. Remove the cloth and tape used for cover in Step 1.
6. Install the cleaned element ⑥ and fix it with the wing nut ⑤.

**Replacing inner element**

1. First remove the outer element, and then remove the inner element.
2. Place the cover over the air intake part to prevent dust entering.
3. Clean the air cleaner body interior, then remove the cover from the air intake port in Step 2.
4. Fit a new inner element and tighten it with nuts.  
The inner element must not be cleaned and used again.
5. Set the new outer element in position and secure it with the wing nut.
6. Remove vacuator valve ⑧, then clean with compressed air.  
After cleaning, install again.

**REMARK**

When securing wing bolt ②, to avoid interference with the engine hood, set and tighten so that the head of the bolt does not protrude from the top of cover ④.

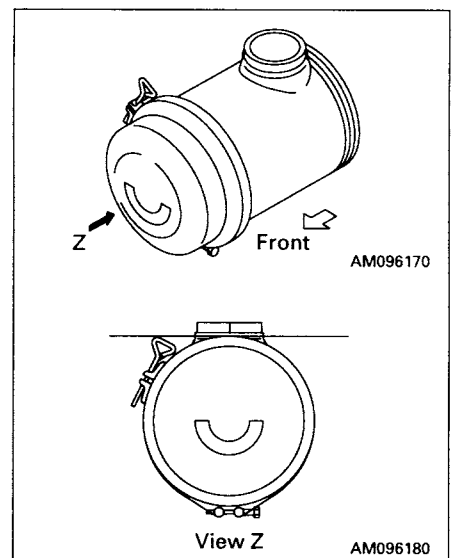

**24.2.2 CLEAN INSIDE OF COOLING SYSTEM**

**⚠ WARNING**

- **Soon after the engine has been stopped, the coolant is hot and can cause personal injury. Allow the engine to cool before draining water.**
- **Since cleaning is performed while the engine is running, it is very dangerous to enter the rear side of the machine as the machine may suddenly start moving. If the under cover is left removed, it may interfere with the fan. While the engine is running, never enter the rear side of the machine.**
- **Never remove the radiator cap when the engine is at operating temperature. At operating temperature, the coolant is under pressure. Steam blowing up from the radiator could cause personal injury. Allow the engine to cool until the radiator filler cap is cool enough to touch with your hand. Remove the filler cap slowly to allow pressure to be relieved.**

- Clean the inside of the cooling system change the coolant and replace the corrosion resistor according to the table below.

Kind of coolant	Cleaning inside of cooling system and changing coolant	Replacing corrosion resistor
Permanent type antifreeze (All season type)	Every year (autumn) or every 2000 hours whichever comes first	Every 1000 hours and when cleaning the inside of the cooling system and when changing coolant.
Non permanent type antifreeze containing ethylene glycol (Winter, one season type)	Every 6 months (spring, autumn) (Drain antifreeze in spring, add antifreeze in autumn)	
When not using antifreeze	Every 6 months or every 1000 hours whichever comes first	

- Stop the machine on level ground when cleaning or changing the coolant.
- Use a permanent type of antifreeze. If, for some reason, it is impossible to use permanent type antifreeze, use an antifreeze containing ethylene glycol.
- Super Coolant (AF-ACL) has an anti-corrosion effect as well as an antifreeze effect. The ratio of antifreeze to water depends on the ambient temperature, but to obtain the corrosion resistance effect, a minimum ratio of 30% by volume is necessary.



- When deciding the ratio of antifreeze to water, check the lowest temperature in the past, and decide from the mixing rate table given below.

It is actually better to estimate a temperature about 10°C lower when deciding the mixing rate.

#### Mixing rate of water and antifreeze

Min. atmospheric temperature	°C	-5	-10	-15	-20	-25	-30
	°F	23	14	5	-4	-13	-22
Amount of antifreeze	ℓ	10.1	13.2	15.8	18.0	20.2	21.85
	US gal	2.67	3.48	4.17	4.75	5.33	5.8
	UK gal	2.22	2.90	3.48	3.96	4.44	4.85
Amount of water	ℓ	33.8	30.7	28.1	25.9	23.7	21.85
	US gal	8.93	8.12	7.43	6.85	6.27	5.8
	UK gal	7.48	6.80	6.22	5.74	5.26	4.85

#### WARNING

**Antifreeze is flammable, so keep it away from any flame.**

- Use city water for the cooling water.  
If river water, well water or other such water supply must be used, contact your Komatsu distributor.
- We recommend use of an antifreeze density gauge to control the mixing proportions.

#### WARNING

**When removing drain plug, avoid pouring coolant on yourself.**

## 24. SERVICE PROCEDURE

---

- Prepare a container to catch drained coolant: Min 43.9 ℓ (11.6 US gal, 9.7 UK gal) capacity.

1. If a corrosion resistor cartridge is installed, close valves ①.
2. Turn radiator cap ② slowly to remove it.
3. Remove the undercover, then set a container to catch the coolant under drain valves ③ and ④. Open drain valve ③ at the bottom of the radiator and open drain valve ④ of cylinder block to drain the water.
4. After draining the water, close drain valves ③ and ④ and add water. When the radiator is full, start the engine and run at low idling.
5. Open drain valves ③ and ④, run the engine at low idling, and flush water through the system for 10 minutes.

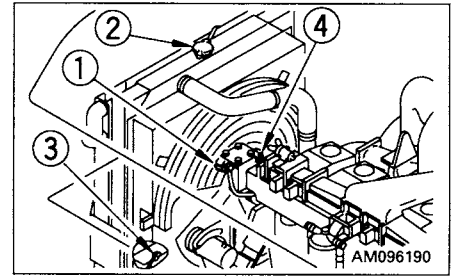

When doing this, adjust the speed of filling and draining the water so that the radiator is always full.

While flushing water through the system, watch carefully that the water inlet hose does not come out of the radiator water filler.

6. After flushing, stop the engine, open drain valves ③ and ④, then close it again after all the water has drained out.
7. After draining the water, clean with a flushing agent. We recommend use of a Komatsu genuine cleaning agent. For details of the cleaning method, see the instructions given with the cleaning agent.
8. After cleaning, open drain valves ③ and ④ to drain all the cooling water, then close them and fill slowly with clean water.
9. When the water comes up to near the water filler port, open drain valves ③ and ④, run the engine at low idling, and continue to run water through the system until clean colorless water comes out.

When doing this, adjust the speed of filling and draining the water so that the radiator is always full.

10. When the water is completely clean, stop the engine, close drain valve ③, then wrap with sealing tape and close drain valve ④.
11. Replace the corrosion resistor cartridge and open valves ①.  
For details of replacement of the corrosion resistor, see "24.8 EVERY 1000 HOURS SERVICE".
12. Install the undercover.
13. Open air bleed valve ④ of the aftercooler and add coolant (antifreeze) and tap water from the water filler port to the edge of the port. When water comes out from air bleed valve ④, tighten the valve.
14. To remove the air in the cooling water, run for five minutes at low idling, then for another five minutes at high idling.  
When doing this, leave radiator cap ② off.
15. After draining off the cooling water of reserve tank ⑤, clean the inside of the reserve tank and refill the water between FULL and LOW level.
16. Stop the engine, wait for about three minutes, add cooling water up to near the radiator water filler port, then tighten cap ②.

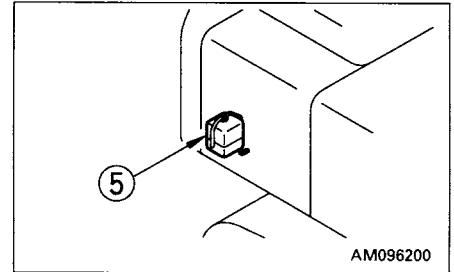

### 24.2.3 CHECK AND TIGHTEN TRACK SHOE BOLTS

If the machine is used with track shoe bolts ① loose, they will break, so tighten any loose bolts immediately.

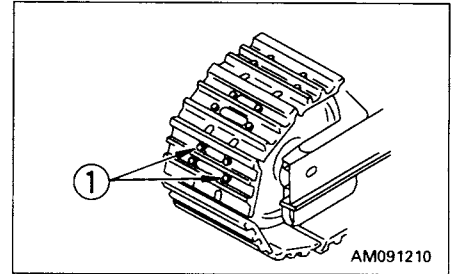

#### Method for tightening

- 1 First tighten to a tightening torque of  $390 \pm 40$  Nm ( $40 \pm 4$  kgm,  $290 \pm 30$  lbft) then check that the nut and shoe are in close contact with the link contact surface.
- 2 After checking, tighten a further  $120^\circ \pm 10^\circ$ .

#### Order for tightening

Tighten the bolts in the order shown in the diagram on the right. After tightening, check that the nut and shoe are in close contact with the link mating surface.

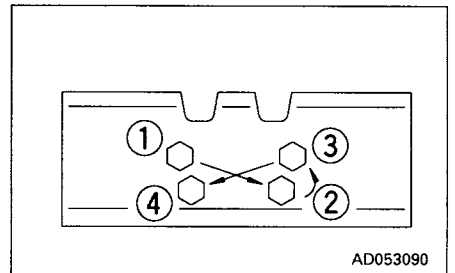

### 24.2.4 CHECK AND ADJUST TRACK TENSION

#### **WARNING**

Carry out this operation with two workers. The operator must move the machine in accordance with the signals from the other worker. The track tension is checked with the chassis raised, so it is extremely dangerous if the machine is lowered by mistake during the inspection. Never move the machine while anyone is carrying out measurements.

The wear of pins and bushings on the undercarriage will vary with the working conditions and soil properties. It is thus necessary to continually inspect the track tension so as to maintain the standard tension.

Carry out the check and adjustment under the same conditions as when operating (on jobsites where the track becomes clogged with mud, measure with the track clogged with mud).

#### Inspection

1. Raise the chassis with the boom and arm.  
When doing this, operate the levers slowly.
2. Measure the clearance between the bottom of the track frame and the top of the track shoe at a position that is safe even if the chassis should come down.

Standard clearance:  $365 \pm 13$  mm ( $14.4 \pm 0.8$  in)

#### Measurement position

PC400, 450: 4th track roller from sprocket

PC400LC, 450LC: Midway between 4th and 5th track rollers from sprocket

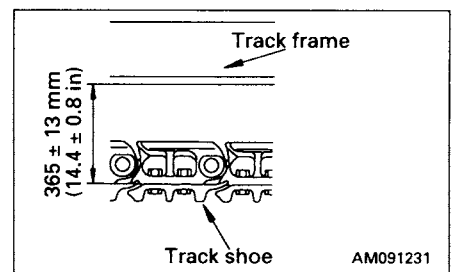
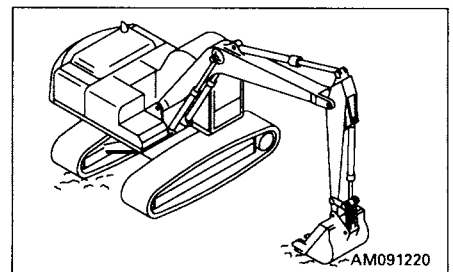

If the track tension is not at the standard value, adjust it in the following manner.

**Adjustment**

**⚠ WARNING**

**Grease inside the adjusting mechanism is under high pressure. Grease coming from plug ① under pressure can penetrate the body causing injury or death. For this reason, do not loosen plug ① more than one turn. Do not loosen any part other than plug ①. Furthermore, do not bring your face in front of the plug ①. If the track tension is not relieved by this procedure, please contact your Komatsu distributor.**

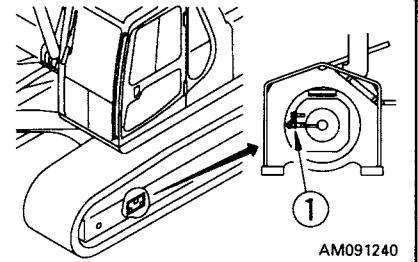

**When increasing tension**

Prepare a grease gun.

1. Pump in grease through grease fitting ② with a grease gun.
2. To check that the tension is correct, move the machine slowly forward (7 – 8 m).
3. Check the track tension again, and if the tension is not correct, adjust it again.
4. Continue to pump in grease until S becomes 0 mm. If the tension is still loose, the pin and bushing are excessively worn, so they must be either turned or replaced. Please contact your Komatsu distributor.

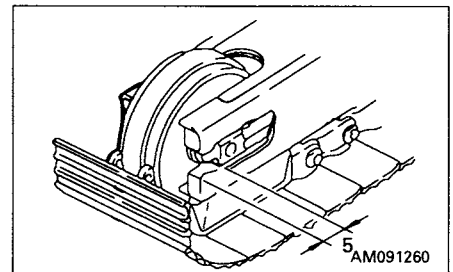
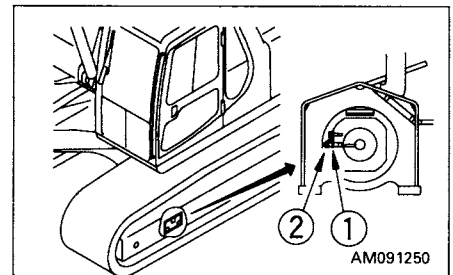

**When loosening tension****⚠ WARNING**

It is extremely dangerous to release the grease by any method except the procedure given below. If the track tension is not relieved by this procedure, please contact your Komatsu distributor.

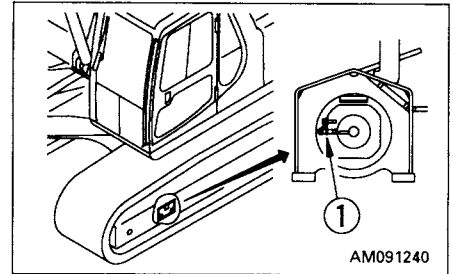

1. Loosen plug ① gradually to release the grease.
2. Turn plug ① a maximum of one turn.
3. If the grease does not come out smoothly, move the machine backwards and forwards a short distance.
4. Tighten plug ①.
5. To check that the correct tension has been achieved, move the machine backwards and forwards.
6. Check the track tension again, and if the tension is not correct, adjust it again.

**24.2.5 CHECK ELECTRICAL INTAKE AIR HEATER**

Before the start of the cold season (once a year), contact your Komatsu distributor to have the electrical intake air heater repaired or checked for dirt or disconnections.

**24.2.6 REPLACE BUCKET TEETH (VERTICAL PIN TYPE)**

Replace the point before the adapter starts to wear.

**⚠ WARNING**

It is dangerous if the work equipment moves by mistake when the teeth are being replaced. Set the work equipment in a stable condition, then stop the engine and apply the locks securely to the levers.

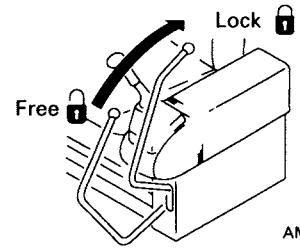

AM088930

1. Place a block under the bucket bottom to allow the pin of tooth ① to be knocked out with a hammer. Carry out full stroke operation of the control levers within 15 seconds after stopping the engine. After confirming that the work equipment is in a stable condition, lock the safety lock lever. Set so that the bottom face of the bucket is horizontal.
2. Use a hammer and drift to knock out lock pin ②. (If the drift is set against rubber pin lock ③ when it is hit, the rubber pin lock may break. Set it against the back of the pin.)
3. After removing lock pin ② and rubber pin lock ③, check them.

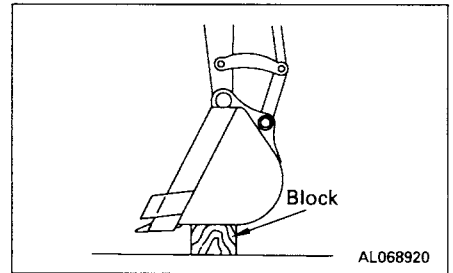

AL068920

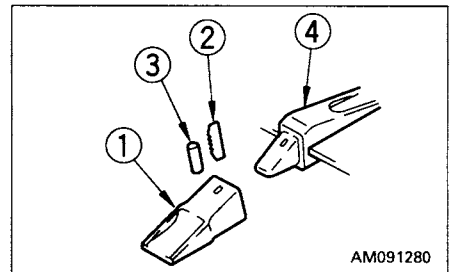

AM091280

If lock pins and rubber pin locks with the following defects are used, the point may come off the bucket. Replace them with new ones.

- The lock pin is too short.

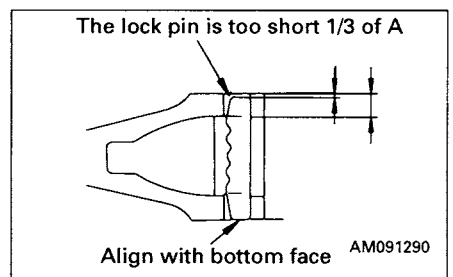

AM091290



- The rubber of the rubber pin lock is torn, and the steel balls may come out.

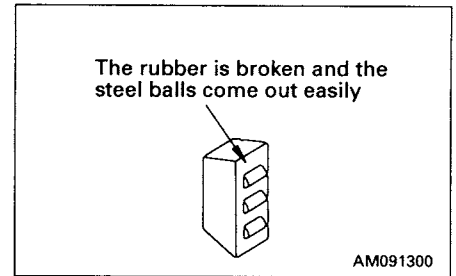

- The steel balls are buried when they are pressed by hand.

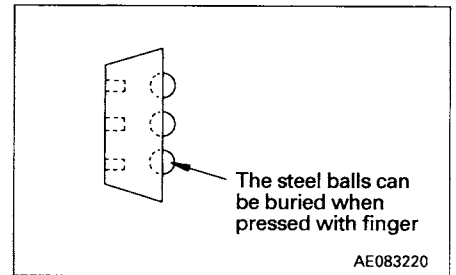

4. Clean the surface of adapter ④ and remove the soil from it with a knife.

5. Use your hand or a hammer to push rubber pin lock ③ into the hole of the adapter.  
When doing this, be careful that the rubber pin lock does not fly out from the adapter surface.

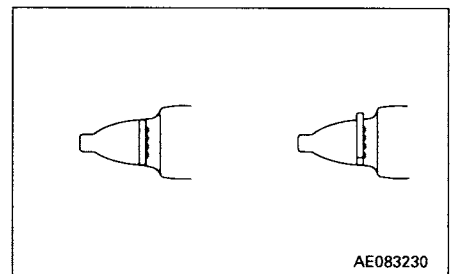

6. Clean the inside of point ①, then install it to adapter ④. If there is mud stuck to it or if there are protrusions, the point will not enter the adapter properly, and there will not be proper contact at the mating portion.

7. Fit point ① to adapter ④, and confirm that when the pointer is pressed strongly, the rear face of the hole for the pin of the point is at the same level as the rear face of the hole for the pin of the adapter.

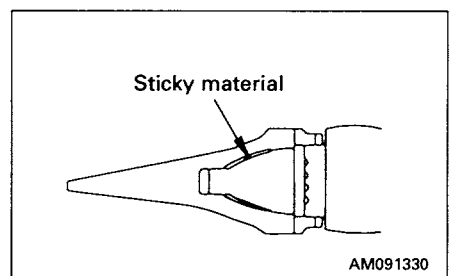

## 24. SERVICE PROCEDURE

---

If the rear face of the hole for the pin of point ① is protruding to the front from the rear face of the pin hole for adapter ④, do not try to knock the pin in. There is something preventing point ① from entering adapter ④ fully, so remove the obstruction. When point ① enters adapter ④ fully, knock in lock pin ②.

8. Insert lock pin ② in the hole of the point and hit it until its top is the same level as the surface of point ①.

9. After replacing a bucket tooth, always check the following.

- 1) After the lock pin has been knocked in completely, check that it is being secured by the point and surface.
- 2) Lightly hit lock pin ② in the reverse direction from which it was hit in.
- 3) Lightly hit the tip of the point from above and below, and hit its sides from right and left.

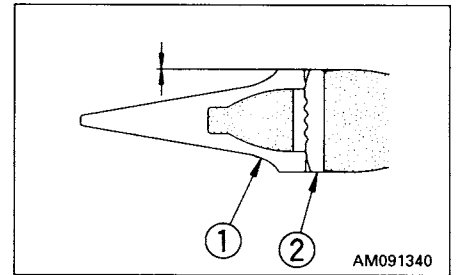

- 4) Confirm that rubber pin lock ③ and lock pin ② are set as shown in the figure.

The life of the point can be lengthened and the frequency of its replacement can be reduced by turning it upside down so that it will wear evenly.

Replace the rubber pin and locking pin with new pins at the same time as replacing the point to prevent the point from falling.

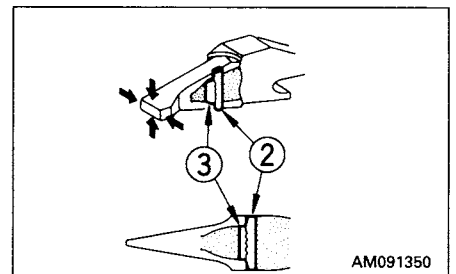

### 24.2.7 REPLACE BUCKET TEETH (HORIZONTAL PIN TYPE)

Replace the teeth before the wear reaches the adapter.

**⚠ WARNING**

It is dangerous if the work equipment moves by mistake when the teeth are being replaced. Set the work equipment in a stable condition, then stop the engine and apply the locks securely to the levers.

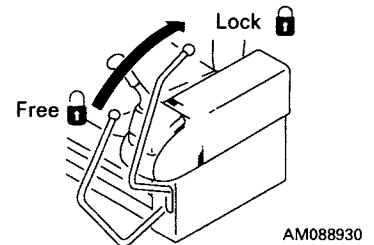

1. Place a block under the bucket bottom so that the pin of tooth ① can be knocked out with a hammer. Carry out full stroke operation of the control levers within 15 seconds after the engine has stopped. After confirming that the work equipment is in a stable condition, lock the safety lock lever. Set so that the bottom face of the bucket is horizontal.

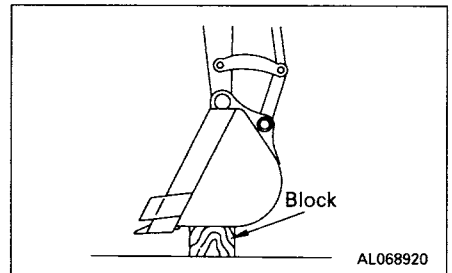

2. Place a bar on the pin head and strike the bar with a hammer to knock out pin ①. Remove tooth ②.

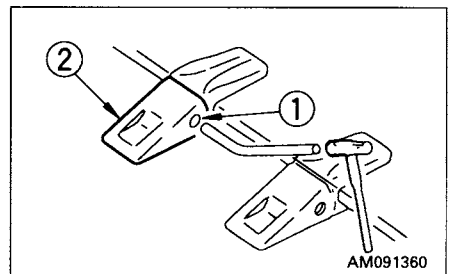

**REMARK**

Use a round bar with a smaller diameter than that of the pin.

3. Clean the mounting face. Fit a new tooth ② in the adapter, push in pin ① partially by hand, then lock it with a hammer to install the tooth to the bucket.

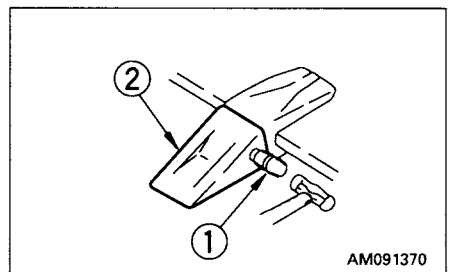

### 24.2.8 ADJUST BUCKET CLEARANCE

**⚠ WARNING**

It is dangerous if the work equipment moves by mistake when the clearance is being adjusted.  
Set the work equipment in a stable condition, then stop the engine and lock the lever securely.

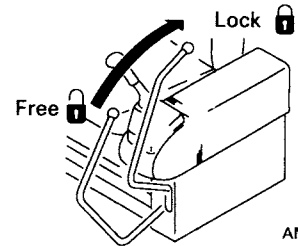

1. Set the work equipment to the position shown in the diagram at right, stop the engine and set the lock lever to the locked position.
2. Measure the amount of play "a".  
Measurement is easier if you move the bucket to one side or the other so all the play can be measured in one place.  
Use a gap (clearance) gauge for easy and accurate measurement.
3. Loosen 4 plate mounting bolts ②, and loosen plate ③.  
The shim is a split type, so the operation can be carried out without removing the bolts.
4. Remove shim ④ corresponding to the amount of play "a" measured above.

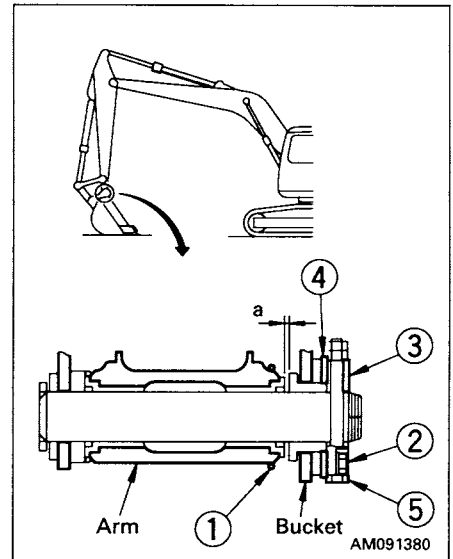

[Example]

In the case of play of 3 mm, remove two 1.0 mm shims and one 0.5 mm shim. Play becomes 0.5 mm. For shim ④, two types of 1.0 mm and 0.5 mm are used.

When play *a* is smaller than one shim, do not carry out any maintenance.

5. Tighten the four bolts ②.  
If the bolts ② are too stiff to tighten, pull out pin stopper bolt ⑤ for easier tightening.

### 24.2.9 CHECK WINDOW WASHER FLUID, ADD FLUID

If there is air in the window washer fluid, check the level of the fluid in window washer tank ①. Add automobile window washer fluid if necessary.

When adding fluid, be careful not to let any dust get in.

- Proportion for mixing washer fluid with water

The proportion differs according to the ambient temperature, so dilute the washer fluid with water to the following proportions before adding.

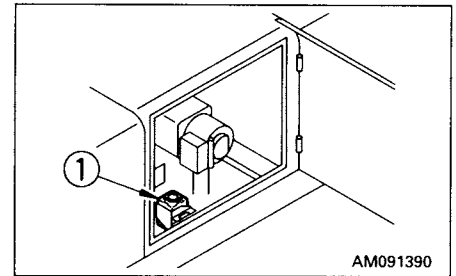

Area, season	Proportions	Freezing temperature
Normal	Washer fluid 1/3: water 2/3	-10°C (14°F)
Winter in cold area	Washer fluid 1/2: water 1/2	-20°C (-4°F)
Winter in extremely cold area	Pure washer fluid	-30°C (-22°F)

There are two types depending on the freezing temperature: -10°C (14°F) (general use) and -30°C (-22°F) (cold area use), so select according to the area and season.

**24.2.10 CHECK, MAINTAIN AIR CONDITIONER (ONLY MACHINES WITH AIR CONDITIONER)**  
**CHECK LEVEL OF REFRIGERANT (GAS)**

**⚠ WARNING**

If the refrigerant used in the cooler gets into your eyes or on your hands, it may cause loss of sight or frostbite, so never loosen any part of the refrigerant circuit.

If the level of the refrigerant (gas) is low, the cooling effect will be reduced. Run the engine at high idling, and check the flow of the refrigerant gas (freon 134a) in the refrigerant circuit through the sight glass of the receiver when the cooler is running at high speed.

- No bubbles in refrigerant flow: Suitable
- Some bubbles in flow (bubbles pass continuously): Lack of refrigerant
- Colorless, transparent: No refrigerant

**REMARK**

When there are bubbles, the refrigerant gas level is low, so contact your refrigerant dealer to have refrigerant added. If the air conditioner is run with the refrigerant gas level low, it will cause damage to the compressor.

**INSPECTION DURING OFF-SEASON**

Even during the off-season, run the compressor at low speed for 3 – 5 minutes once a month to prevent the loss of the oil film at the lubricated parts of the compressor.

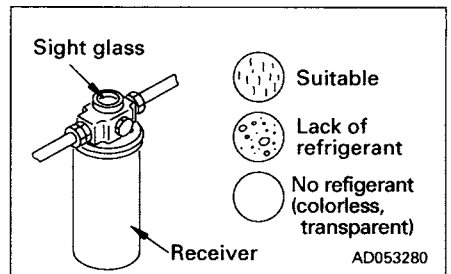
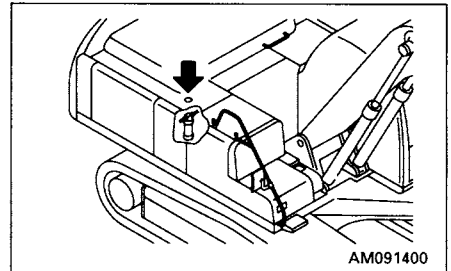

**Table of cooler check and maintenance items**

Check, maintenance items	Content of check, maintenance	Guideline for maintenance interval
Refrigerant (gas)	Charge amount	Twice a year (spring, autumn)
Condenser	Clogged fins	Every 500 hours
Compressor	Operating condition	Every 4000 hours
V-belt	Damage, tension	Every 250 hours
Blower motor, fan	Operating condition (does it make abnormal noise?)	When required
Control mechanism	Operating condition (does it function normally?)	When required
Piping mounts	Mounting condition, looseness at tightening or connecting portions, leakage of gas, damage	When required

**24.2.11 REPLACE ADDITIONAL BREAKER FILTER ELEMENT (OPTION)**

**⚠ WARNING**

The oil is at high temperature after the engine has been operated, so never replace the filter immediately after finishing operations. Wait for the parts to cool down before changing the filter.

- Prepare a container to catch the oil.
1. Place a container under the filter element to catch the oil.
  2. Turn filter case ① to the left to remove it, then take out element ②.
  3. Remove plug ③ from filter case ①.
  4. Clean the removed parts, then install new element ② and O-ring ④.
  5. When installing, bring the case into contact with the filter holder, then tighten a further 1/2 turns.

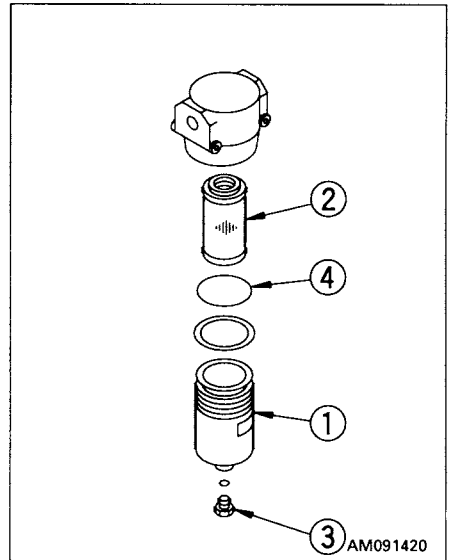
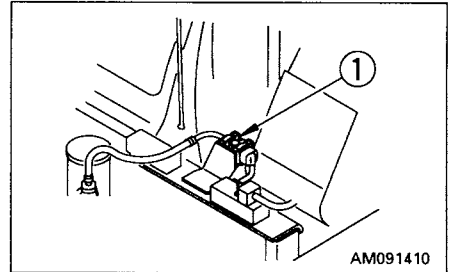

**NOTICE**

When the breaker is used, replace the element every 250 hours (when the breaker operating ration is more than 50%) as shown in the table on the right.

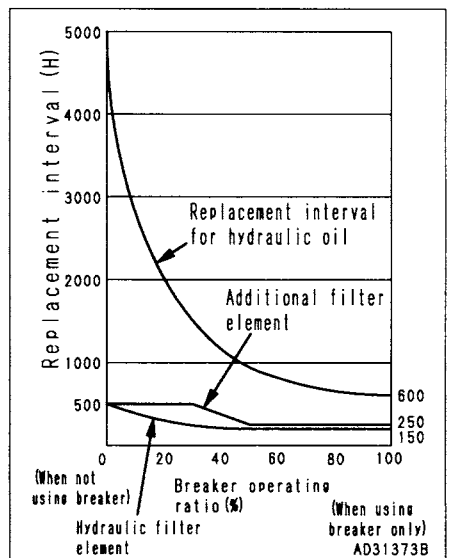

## 24.3 CHECK BEFORE STARTING

### 24.3.1 CHECK COOLANT LEVEL, ADD WATER

**⚠ WARNING**

Do not open the radiator cap unless necessary. When checking the coolant, always check the radiator reserve tank when the engine is cold.

1. Open the right rear cover on the machine and check that the cooling water level is between the FULL and LOW marks on radiator reserve tank ① (shown in the diagram on the right). If the water level is low, add water through the water filler of reserve tank ① to the FULL level.
2. After adding water, tighten the caps securely.
3. If the reserve tank becomes empty, first inspect for water leaks and then fill the radiator and the reserve tank with water.

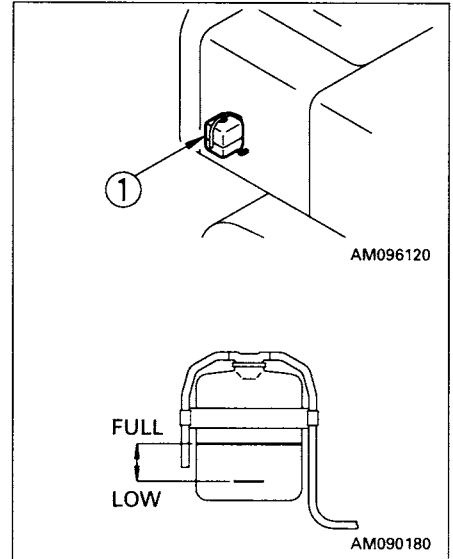

### 24.3.2 CHECK OIL LEVEL IN ENGINE OIL PAN, ADD OIL

**⚠ WARNING**

The turbocharger (with safety cover) exhaust manifold is near dipstick ⑥, so be careful not to touch it.

1. Open the engine hood on the machine.
2. Remove dipstick ⑥ and wipe the oil off with a cloth.
3. Insert dipstick ⑥ fully in the oil filler pipe, then take it out again.
4. The oil level should be between the H and L marks on dipstick ⑥.  
If the oil level is below the L mark, add engine oil through oil filler ⑦.

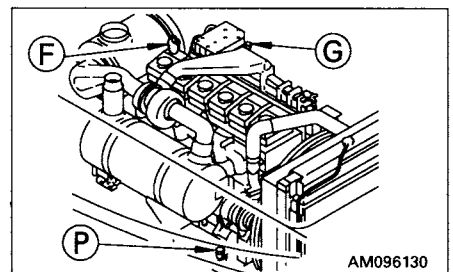

**NOTICE**

For details of the oil to use, see "20. USE OF FUEL, COOLANT AND LUBRICANTS ACCORDING TO AMBIENT TEMPERATURE".

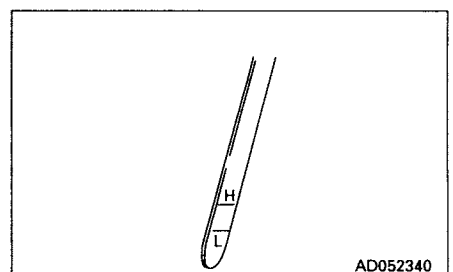



5. If the oil is above the H mark, drain the excess engine oil from drain valve (P), and check the oil level again.
6. If the oil level is correct, tighten the oil filler cap securely and close the engine hood.

**REMARK**

When checking the oil level after the engine has been operated, wait for at least 15 minutes after stopping the engine before checking.

If the machine is at an angle, make it horizontal before checking.

**24.3.3 CHECK FUEL LEVEL, ADD FUEL****⚠ WARNING**

**When adding fuel, never let the fuel overflow. This may cause a fire. If you spill fuel, thoroughly clean up any spillage.**

1. Open fuel filler cap (F) of the fuel tank.
2. When fuel filler cap (F) is opened, float gauge (G) will rise according to the fuel level.  
Check that the fuel tank is full. Check by looking into the tank and by using float gauge (G).
3. If the tank is not full, add fuel through the fuel filler until float gauge (G) rises to the maximum position.

Fuel capacity: 605 ℓ (159.8 US gal, 133.1 UK gal)

**NOTICE**

**For details of the fuel to use, see "20. USE OF FUEL, COOLANT AND LUBRICANTS ACCORDING TO AMBIENT TEMPERATURE".**

4. After adding fuel, push float gauge (G) straight down with fuel filler cap (F). Be careful not to get float gauge (G) caught in the tab (2) of fuel filler cap (F), and tighten fuel filler cap (F) securely.

**REMARK**

If breather hole (1) on the cap is clogged, the pressure in the tank will drop and fuel will not flow.  
Clean the hole from time to time.

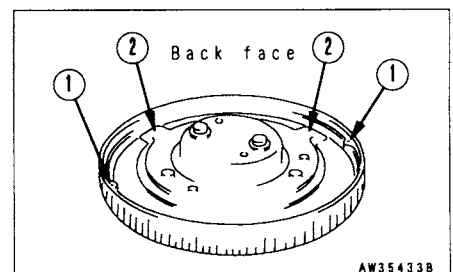
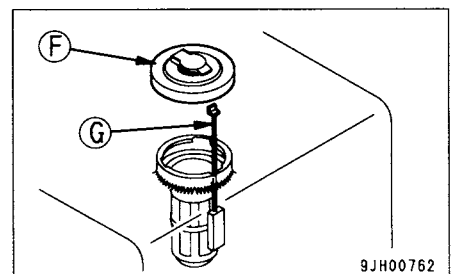
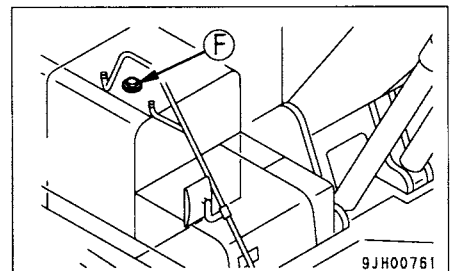

### 24.3.4 CHECK OIL LEVEL IN HYDRAULIC TANK, ADD OIL

**⚠ WARNING**

- When removing the oil filler cap, oil may spurt out, so turn the cap slowly to release the internal pressure before removing the cap.
- If oil has been added to above the H mark, stop the engine and wait for the hydraulic oil to cool down, then drain the excess oil from the drain plug.

1. If the work equipment is not in the condition shown in the diagram on the right, start the engine, run the engine at low speed, retract the arm and bucket cylinders, then lower the boom, set the bucket teeth in contact with the ground, and stop the engine.
2. Within 15 seconds after stopping the engine, move each control lever (for work equipment and travel) to the full stroke in all directions to release the internal pressure.
3. Check sight gauge ③. The oil level is normal if between the H and L marks.

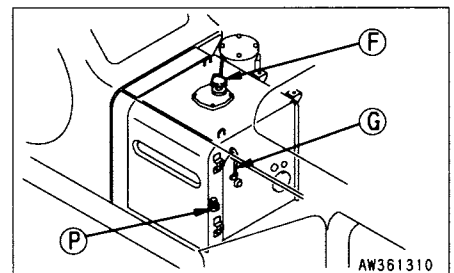
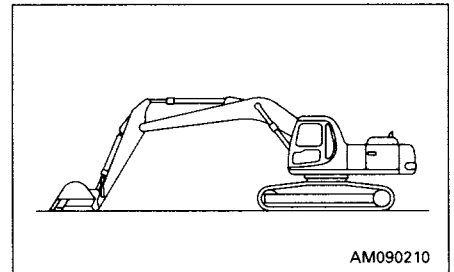

**NOTICE**

Do not add oil if the level is above the H line. This will damage the hydraulic equipment and cause the oil to spurt out.

4. If the level is below the L mark, remove the upper cover of the hydraulic tank and add oil through oil filler ⑤.

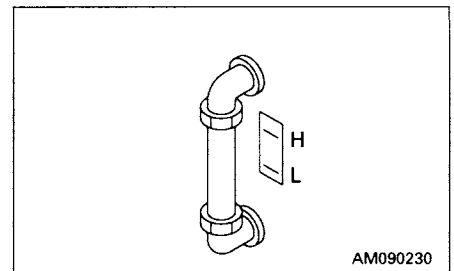

**NOTICE**

For details of the oil to use, see "20. USE OF FUEL, COOLANT AND LUBRICANTS ACCORDING TO AMBIENT TEMPERATURE".

**REMARK**

The oil level will vary depending upon the oil temperature. Accordingly, use the following as a guide:

- Before operation: around L level (Oil temperature 10 to 30°C (50 to 86°F))
- Normal operation: around H level (Oil temperature 50 to 80°C (122 to 176°F))

### 24.3.5 CHECK AIR CLEANER FOR CLOGGING

1. Confirm that the air cleaner clogging monitor does not flash.
2. If it flashes, immediately clean or replace the element.

For details of method of cleaning the element, see "24.2.1 CHECK, CLEAN AND REPLACE AIR CLEANER ELEMENT".

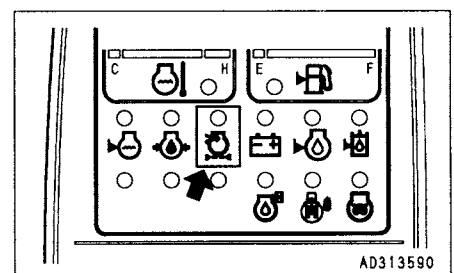

### 24.3.6 CHECK ELECTRIC WIRINGS

#### WARNING

- If fuses are frequently blown or if there are traces of short circuit on the electrical wiring, locate the cause and carry out repair.
- Accumulation of flammable material (dead leaves, twigs, grass, etc.) around the battery may cause fire, so always check and remove such material.
- Keep the top surface of the battery clean and check the breather hole in the battery cap. If it is clogged with dirt or dust, wash the battery cap to clean the breather hole.

Check for damage and wrong capacity of the fuse and any sign of disconnection or short circuit in the electric wiring. Check also for loose terminals and tighten any loose parts.

Check the wiring of the "battery", "starting motor" and "alternator" carefully in particular.

When carrying out walk-around checks or checks before starting, always check if there is any accumulation of flammable material around the battery, and remove such flammable material.

Please contact your Komatsu distributor for investigation and correction of the cause.

### 24.3.7 CHECK FUNCTION OF HORN

1. Turn the starting switch to the ON position.
2. Confirm that the horn sounds without delay when the horn button is pressed. If the horn does not sound, ask your Komatsu distributor for repair.

### 24.3.8 CHECK FOR WATER AND SEDIMENT IN WATER SEPARATOR, DRAIN WATER (OPTION)

The water separator separates water mixed in the fuel. If float ② is at or above red line ①, drain the water according to the following procedure:

1. Loosen drain plug ③ and drain the accumulated water until the float reaches the bottom.
2. Tighten drain plug ③.
3. If the air is sucked into fuel line when draining the water, be sure to bleed air in the same manner as for the fuel filter. See "24.7 EVERY 500 HOURS SERVICE".

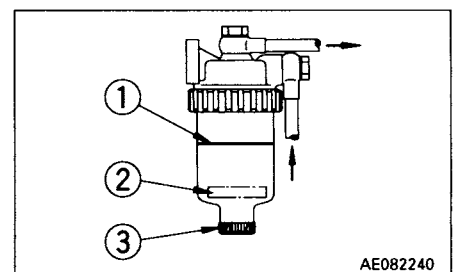

## 24.4 EVERY 50 HOURS SERVICE

### 24.4.1 LUBRICATING

#### NOTICE

For the first 100 hours on new machines where the parts are settling in, carry out greasing every 10 hours.

1. Set the work equipment in the greasing posture below, then lower the work equipment to the ground and stop the engine.
2. Using a grease pump, pump in grease through the grease fittings shown by arrows.
3. After greasing, wipe off any old grease that was pushed out.

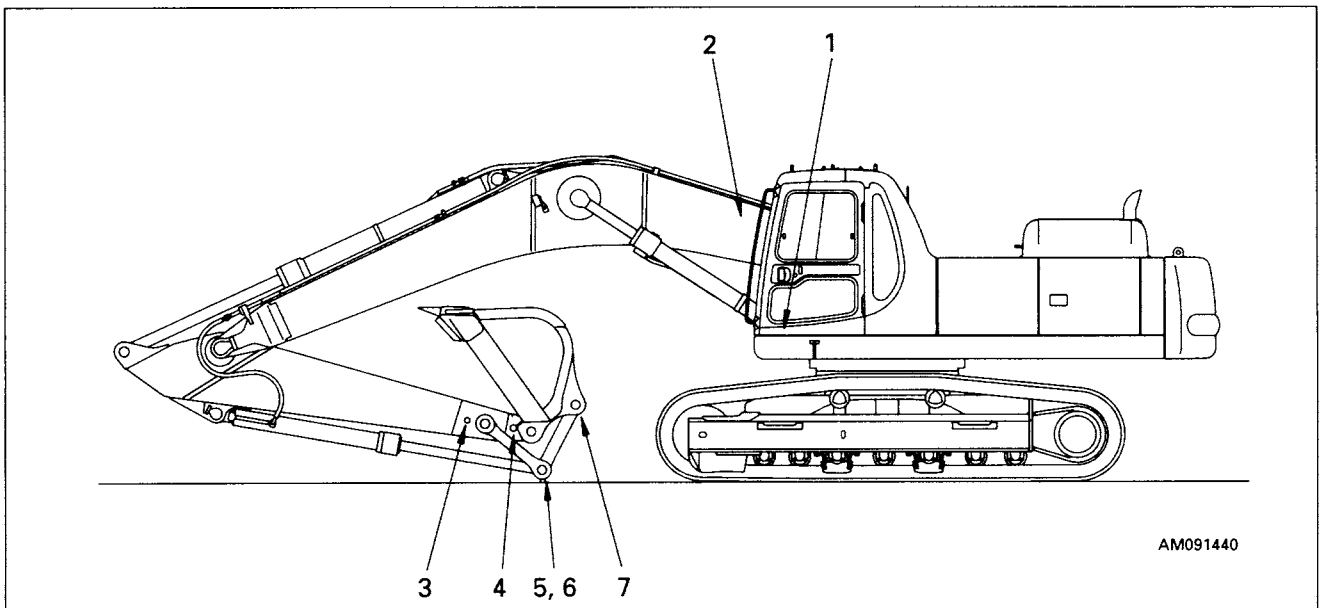

1. Boom cylinder foot pin (2 points)

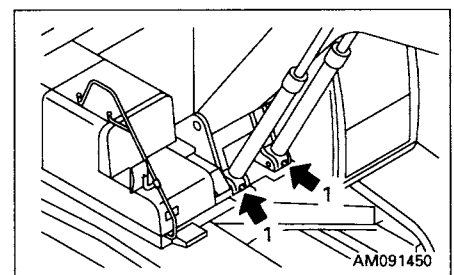

- 2. Boom foot pin (2 points)

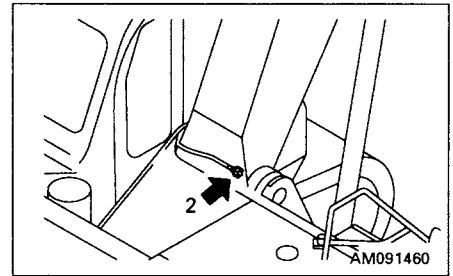

- 3. Arm-Link coupling pin (1 point)
- 4. Arm-Bucket coupling pin (1 point)

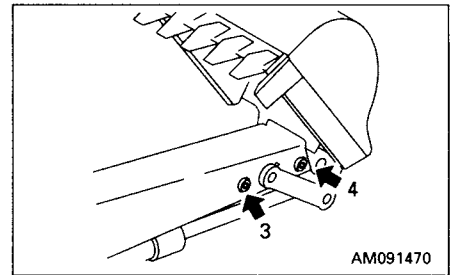

- 5. Link coupling pin (2 points)
- 6. Bucket cylinder rod end (1 point)
- 7. Bucket-Link coupling pin (1 point)

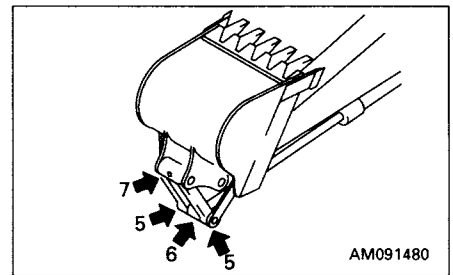

## 24.5 EVERY 100 HOURS SERVICE

Maintenance for every 50 hours service should be carried out at the same time.

### 24.5.1 LUBRICATING NOTICE

- For the first 100 hours on new machines where the parts are setting in, carry out greasing every 10 hours.
- After digging under water, be sure to supply grease to the pins which were submerged.

1. Set the work equipment in the greasing posture below, then lower the work equipment to the ground and stop the engine.
2. Using a grease pump, pump in grease through the grease fittings shown by arrows.
3. After greasing, wipe off any old grease that was pushed out.

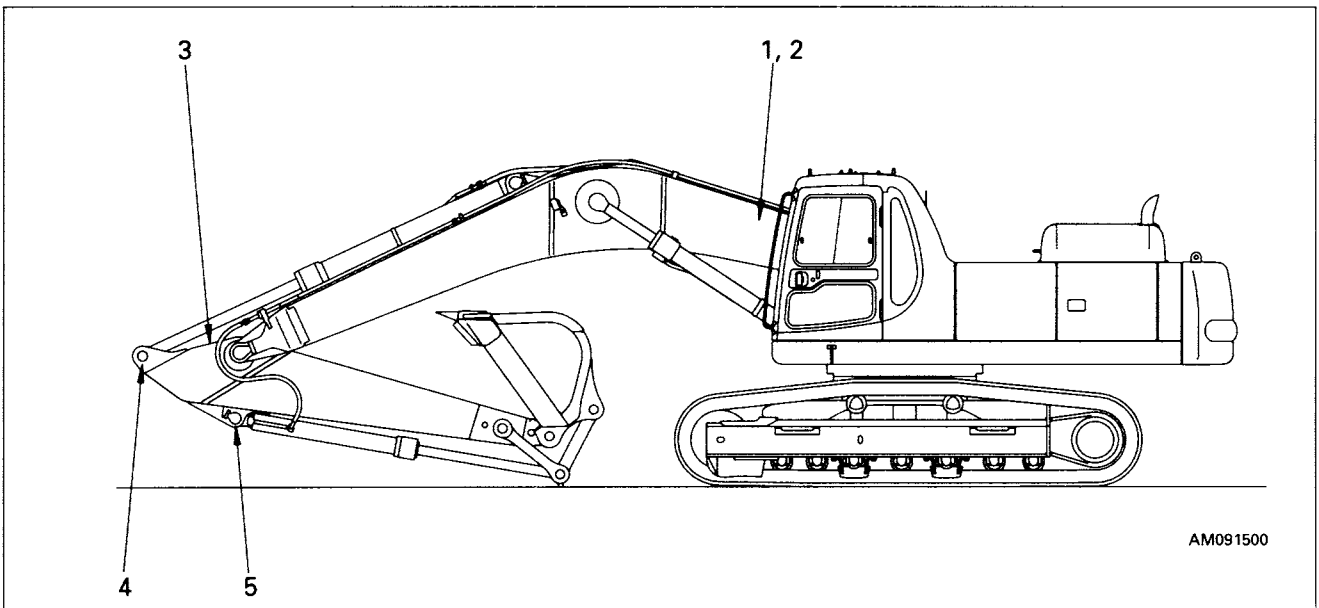

1. Boom cylinder rod pin (2 points)
2. Arm cylinder foot pin (1 point)

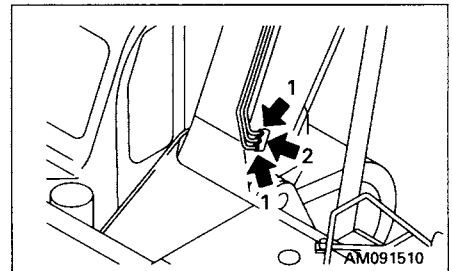

3. Boom-Arm coupling pin (1 point)
4. Arm cylinder rod end (1 point)
5. Bucket cylinder foot pin (1 point)

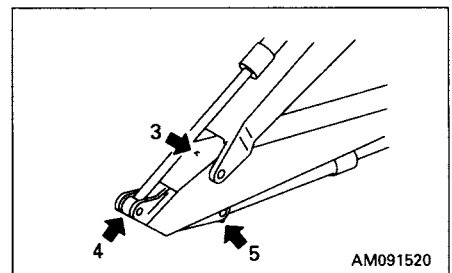

### 24.5.2 CHECK OIL LEVEL IN SWING MACHINERY CASE, ADD OIL

#### **⚠ WARNING**

The oil is at high temperature immediately after the machine has been operated. Wait for the oil to cool down before carrying out this check.

1. Remove dipstick ⑥ and wipe the oil from the dipstick with a cloth.
2. Insert dipstick ⑥ fully in the guide.
3. When dipstick ⑥ is pulled out, if the oil level is between the H and L marks of the gauge, oil level is proper.
4. If the oil does not reach the L mark on dipstick ⑥, add engine oil through dipstick insertion hole ⑦.  
When refilling, remove bleeding plug ①.

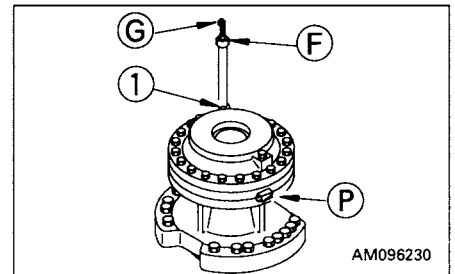

#### **NOTICE**

For details of the oil to use, see "20. USE OF FUEL, COOLANT AND LUBRICANTS ACCORDING TO AMBIENT TEMPERATURE".

5. If the oil level exceeds the H mark on the dipstick, loosen drain valve ② to drain the excess oil.
6. After checking oil level or adding oil, insert the dipstick into the hole and install air bleeding plug ①.

### 24.5.3 DRAIN WATER AND SEDIMENT FROM FUEL TANK

1. Carry out this procedure before operating the machine.
2. Prepare a container to catch the fuel that is drained.
3. Open valve ① at the bottom of the tank and drain the sediment and water that has accumulated at the bottom together with fuel. When doing this, be careful not to get fuel on yourself.
4. When only clean fuel comes out, close drain valve ①.

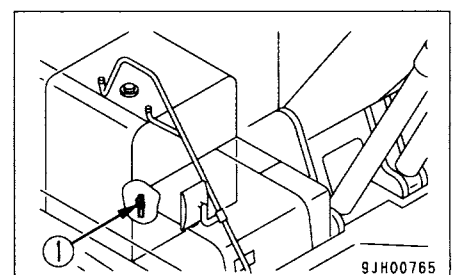

#### **NOTICE**

Never use trichlene for washing the inside of the tank.

## 24.6 EVERY 250 HOURS SERVICE

Maintenance for every 50 hours service should be carried out at the same time.

### 24.6.1 CHECK OIL LEVEL IN FINAL DRIVE CASE, ADD OIL

**⚠ WARNING**

- The oil is at high temperature immediately after the machine has been operated. Wait for the oil to cool down before starting the operation.
- If there is still pressure remaining inside the case, the oil or plug may fly out.  
Loosen the plug slowly to release the pressure.

- Prepare a handle.
1. Set the TOP mark at the top, with the UP mark and plug (P) perpendicular to the ground surface.
  2. Remove plug (F) using the handle. When the oil level reaches a point 10 mm below the bottom of the plug hole, the correct amount of oil has been added.
  3. If the oil level is too low, install plug (F), operate the travel levers, and drive forward or in reverse to rotate the sprocket one turn. Then repeat Step 2 to check again.
  4. If the oil level is still too low, add engine oil through the hole in plug (F) until the oil overflows.

#### NOTICE

For details of the oil to use, see "20. USE OF FUEL, COOLANT AND LUBRICANTS ACCORDING TO AMBIENT TEMPERATURE".

5. After checking, install plug (F).

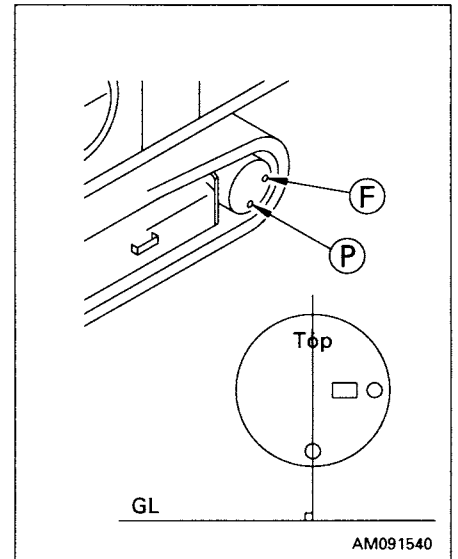



## 24.6.2 CHECK LEVEL OF BATTERY ELECTROLYTE

### WARNING

- To avoid gas explosions, do not bring fire or sparks near the battery.
- Battery electrolyte is dangerous. If it gets in your eyes or on your skin, wash it off with large amounts of water, and consult a doctor.

Carry out this check before operating the machine.

1. Open the battery box cover on the right side of the machine.
2. Remove cap ①, and check that the electrolyte is at the specified level (10 to 12 mm (0.40 to 0.47 in) above the plate). If the electrolyte level is low, add distilled water to the specified level.

If the battery electrolyte is spilled, have dilute sulphuric acid added.

3. Clean the air hole in the battery cap, then tighten the cap securely.

When adding distilled water in cold weather, add it before starting operations in the morning to prevent the electrolyte from freezing.

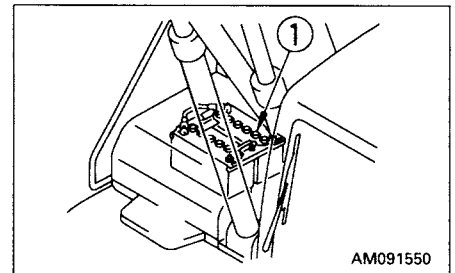

### 24.6.3 CHANGE OIL IN ENGINE OIL PAN, REPLACE ENGINE OIL FILTER CARTRIDGE

Perform this maintenance every 500 hours on machines equipped with bypass filter.

**WARNING**

The oil is at high temperature after the engine has been operated, so never change the oil immediately after finishing operations. Wait for the oil to cool down before changing it.

Prepare the following

- Container to catch drained oil: Min 34 l capacity
- Refill capacity: 34 l (9.0 US gal, 7.5 UK gal)
- Filter wrench

1. Remove the inspection cover of the undercover directly under drain plug (P) under the machine, then place a container to catch the oil.
2. Lower the lever of drain valve (P) slowly to prevent getting oil on yourself, and drain the oil. After draining the oil, raise the lever to close the valve.
3. Check the drained oil, and if there are excessive metal particles or foreign material, please contact your Komatsu distributor.
4. Tighten drain valve (P).
5. Open the engine hood. Using the filter wrench from the upper side of the engine, turn filter cartridge (1) counterclockwise to remove it.  
In particular, if this operation is carried out immediately after stopping the engine, a large amount of oil will come out, so wait for 10 minutes before starting the operation.
6. Clean the filter holder, coat the packing surface of a new filter cartridge with engine oil (or coat it thinly with grease), then install it to the filter holder.

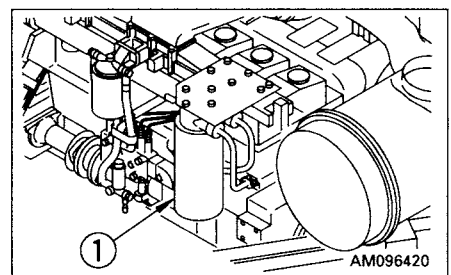
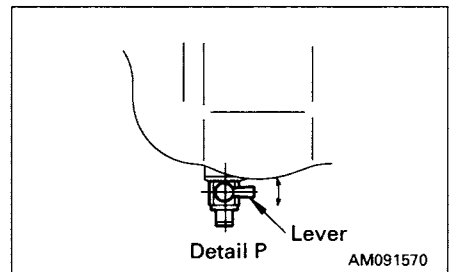
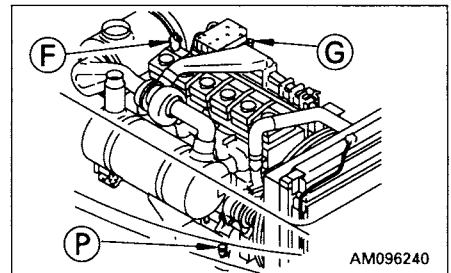

**REMARK**

Confirm that no remnants of old packing still adhere to the filter holder as this may result in oil leakage.

7. When installing, tighten until the packing surface contacts the seal surface of the filter holder, then tighten it up further 3/4 to 1 of a turn.

8. After replacing the filter cartridge, add engine oil through oil filler ⑤ until the oil level is between the H and L marks on dipstick ⑥.

**NOTICE**

For details of the oil to use, see "20. USE OF FUEL, COOLANT AND LUBRICANTS ACCORDING TO AMBIENT TEMPERATURE".

9. Run the engine at idling for a short time, then stop the engine, and check that the oil level is between the H and L marks on the dipstick. For details, see "24.3 CHECK BEFORE STARTING".

Even if the machine has not been operated for 250 hours, the oil and filter cartridge must be replaced when the machine has been operated for 6 months.

In the same way, even if the machine has not been operated for 6 months, the oil and filter cartridge must be replaced when the machine has been operated for 250 hours.

**24.6.4 LUBRICATE SWING CIRCLE (2 POINTS)**

1. Lower the work equipment to the ground.
2. Using a grease gun, pump in grease through the grease fittings shown by arrows.
3. After greasing, wipe off all the old grease that was pushed out.

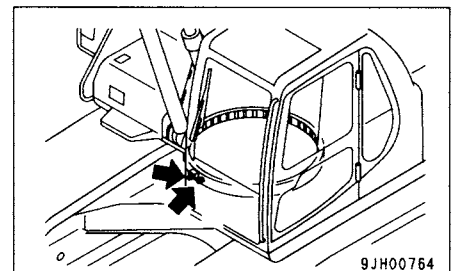

### 24.6.5 CHECK FAN BELT TENSION, ADJUST

#### Checking

The standard deflection for the drive belt is 13 mm (0.51 in) when pressed with a thumb (at approx. 58.80 N (approx. 6 kg·f)) at a point midway between the fan pulley and alternator pulley.

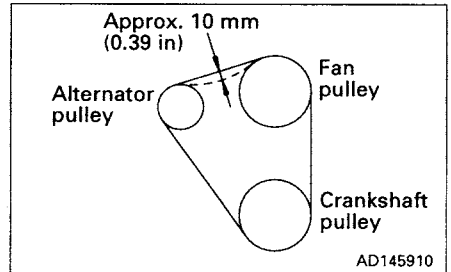
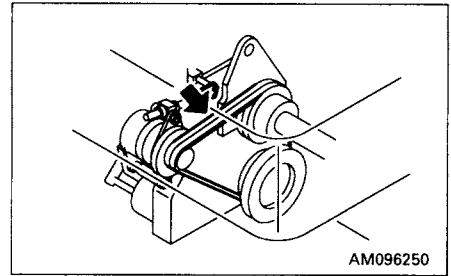

#### Adjusting

1. Loosen nuts and bolts ①, ②, and ③.
2. Turn nut ④ clockwise and move alternator ⑤ so that the deflection of the belt is approx. 10 mm (at approx. 6 kg (13 lb)).
3. Tighten nuts and bolts ①, ②, and ③ to secure alternator ⑤ in position.

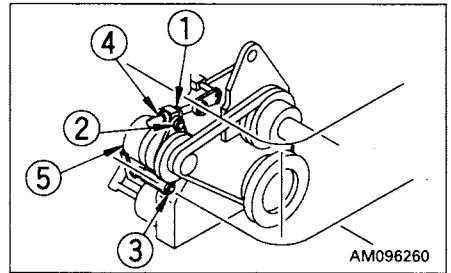

#### Tightening torque

Lock nuts ①, ②:  $137.2 \pm 53.9$  N·m { $14 \pm 5.5$  kgf·m}

Bolts ③:  $33.3 \pm 4.9$  N·m { $3.4 \pm 0.5$  kgf·m}

Bolts ④:  $127.4 \pm 19.6$  N·m { $13 \pm 2$  kgf·m}

4. Check each pulley for breakage, wear of the groove, and wear of the belt. Check in particular that the belt does not contact the bottom of the groove.
5. Replace the belt if it is elongated and can no longer be adjusted, or if it is cut or cracked.
6. When the belt has been replaced, operate the machine for one hour, then adjust the belt tension again.

### 24.6.6 CHECK, ADJUST TENSION OF AIR CONDITIONER COMPRESSOR BELT

#### Checking

The belt should deflect 10 – 12 mm (0.39 – 0.47 in) when pressed with a finger force of approx. 6 kg (13 lb) at a point midway between the crankshaft pulley and the compressor pulley.

The standard deflection for the drive belt is 14 – 16 mm (0.552 – 0.630 in) when pressed with a thumb (at approx. 58.80 N (approx. 6 kg-f)) at a point midway between the crankshaft pulley and compressor pulley.

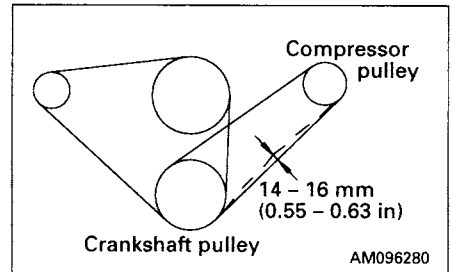
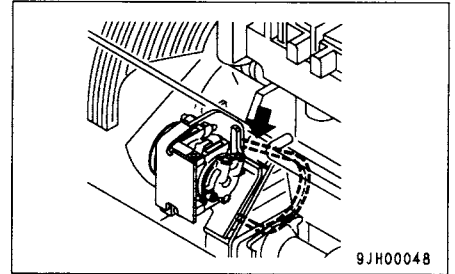

#### Adjusting

1. Loosen bolt ① and bolt ②, and move compressor ③ to adjust.
2. When the deflection is correct, tighten bolts ① and ② to hold the compressor in position.
3. Check each pulley for damage, and check the V-groove and V-belt for wear. In particular, check that the V-belt is not contacting the bottom of the V-groove.
4. If the V-belt is stretched and cannot be adjusted any further, or if there are any cuts or cracks, replace the V-belt.
5. After replacing the V-belt, adjust again after one hour of operation.

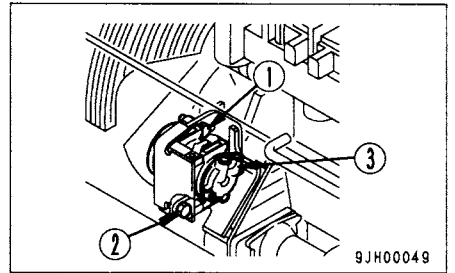

## 24.7 EVERY 500 HOURS SERVICE

Maintenance for every 50, 100 and 250 hours service should be carried out at the same time.

### 24.7.1 REPLACE FUEL FILTER CARTRIDGE

**⚠ WARNING**

- Engine is at high temperature immediately after the machine has been operated. Wait for engine to cool down before replacing the filter.
- Do not bring fire or sparks near the fuel.

Prepare a filter wrench and a container to catch the fuel.

1. Set the container to catch the fuel under the filter cartridge.
2. Using a filter wrench, turn filter cartridge ① counterclockwise to remove it.
3. Clean the filter holder, fill a new filter cartridge with clean fuel, coat the packing surface with engine oil, then install it to the filter holder.

4. When installing, tighten until the packing surface contacts the seal surface of the filter holder, then tighten it up 1/2 to 3/4 of a turn.

If the filter cartridge is tightened too far, the packing will be damaged and this will lead to leakage of fuel. If the filter cartridge is too loose, fuel will also leak from the packing, so always tighten to the correct amount.

5. After replacing the fuel filter cartridge, bleed the air from the system.

Bleed the air as follows.

6. Fill the fuel tank with fuel (to the position where the Float is at the maximum position).

7. After replacing filter cartridge ①, loosen air bleed plug ②.

8. Loosen the knob of feed pump ③, operate it up and down, and continue until no more bubbles come out with the fuel from air bleed plug ②.

9. Tighten air bleed plug ②.

Use a genuine Komatsu filter cartridge.

After replacing the filter cartridge, start the engine, and check that there is no leakage of fuel from the filter seal surface.

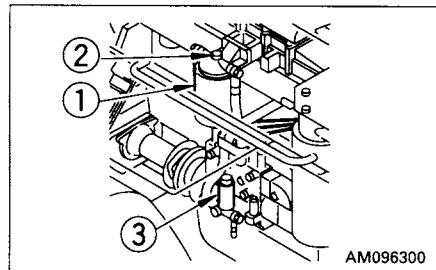

### 24.7.2 CHECK SWING PINION GREASE LEVEL, ADD GREASE

Prepare a scale.

1. Remove bolts ① (2 bolts) on the top of the revolving frame and remove cover ②.
2. Insert a scale into the grease and check that the height of the grease in the portion where the pinion passes is at least 24 mm (0.9 in). Add more grease if necessary.
3. Check if the grease is milky white. If it is milky white, it is necessary to change the grease. Please contact your Komatsu distributor.

The total amount of grease is 33 ℓ (29.7 kg) (8.7 US gal, 7.3 UK gal [65.5 lb]).

4. Install cover ② with bolts ①.

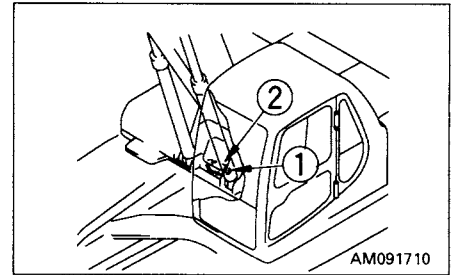

### 24.7.3 CHANGE OIL IN ENGINE OIL PAN, REPLACE ENGINE OIL FILTER CARTRIDGE AND BYPASS FILTER CARTRIDGE (FOR MACHINES EQUIPPED WITH BYPASS FILTER)

**⚠ WARNING**

The oil is at high temperature after the machine has been operated. Always wait for the temperature to go down before starting this operation.

Prepare the following.

- Container to catch drained oil: Min. 37 ℓ capacity
  - Refill capacity of oil pan: 37 ℓ (9.8 US gal, 8.1 UK gal)
  - Filter wrench
1. Set the container immediately under drain plug (P) under the chassis to catch the oil.
  2. Lower the lever of drain plug (P) slowly to avoid getting oil on yourself, and drain the oil. After draining the oil, raise the lever.
  3. Inspect the drained oil, and if there is a large amount of metal particles or foreign material, please contact your Komatsu distributor.
  4. Open the engine hood, and using the filter wrench from above the engine, turn engine oil filter cartridge (1) and bypass filter cartridge (2) counterclockwise to remove them.
  5. Clean the engine oil filter holder, fill the new filter cartridge with clean engine oil, coat the packing and thread of new filter cartridge (1) with engine oil (or coat thinly with grease), then install.

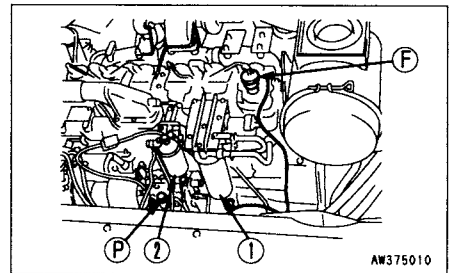

**REMARK**

Check that there is no old packing stuck to the filter holder. If there is any old packing stuck to the filter, it will cause leakage of oil.



6. When installing, tighten until the packing surface of the cartridge contacts the seal surface of the filter holder, then tighten a further  $3/4 - 1$  turn.
7. Clean the bypass filter holder, fill new bypass filter cartridge ② with clean engine oil, coat the packing and thread of the filter cartridge with engine oil (or coat thinly with grease), then install.
8. When installing, tighten until the packing surface of the cartridge contacts the seal surface of the filter holder, then tighten a further  $3/4 - 1$  turn.
9. After replacing the filter cartridge, add engine oil through oil filler port ⑤ so that the oil level is between the H and L marks on dipstick ⑥.
10. Run the engine at idling for a short time, then stop the engine and check again that the oil level is between the H and L marks on the level gauge. For details, see "24.3 CHECK BEFORE STARTING".

Replace the filter at least once every 6 months, even if the machine has been operated for less than 500 hours.

Replace the filter at least once every 500 hours, even if the machine has been operated for less than 6 months.

**24.7.4 CLEAN AND INSPECT RADIATOR FINS, OIL COOLER FINS, AFTER COOLER FINS, CONDENSER FINS (ONLY FOR MACHINES EQUIPPED WITH AIR CONDITIONER)**

**⚠ WARNING**

If compressed air, high-pressure water, or steam hit your body directly, or they cause dirt or dust to be blown up, there is a hazard of serious injury. Always use safety glasses, dust mask, or other protective equipment.

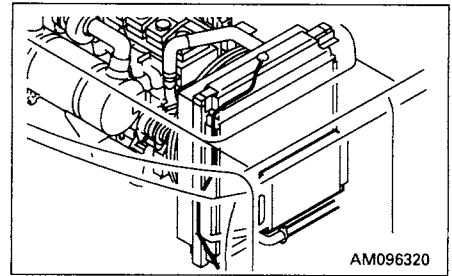

**NOTICE**

When using compressed air, keep the air nozzle at a distance to prevent damage to the fins. Especially for the aftercooler, blow the air from 300mm (11.8 in) or more, and at a 45 degree angle.

To prevent damage to the fins, apply compressed air from an appropriate distance. Damaged fins may cause water leakage or overheating. On dusty sites, check the fins daily, regardless of the maintenance interval.

1. Open the engine hood and rear door on the right side of the machine.
2. Use compressed to blow off mud, dust, or leaves clogging the radiator fins and oil cooler fins. At the same time, clean the net in front of the oil cooler. On machines equipped with an air conditioner, clean the condenser fins also.  
Steam or water can be used in place of compressed air.
3. Check the rubber hose. Replace with a new one if the hose is found to have cracks or to be hardened by ageing.  
Further, check hose clamps for looseness.

### 24.7.5 CLEAN FRESH/RECIRC AIR FILTERS OF AIR CONDITIONER (ONLY FOR MACHINES EQUIPPED WITH AIR CONDITIONER)

1. Remove 4 bolts at the top of the luggage box, then remove bracket ①.
2. Remove the 2 bolts at the bottom of the luggage box, then pull up box ② to remove.
3. Loosen wing bolt ③, move stopper ④ aside, then pull recirculation air filter ⑤ up to remove it. Pull fresh air filter ⑥ to the side (left side of the machine) to remove it.
4. Clean filters ⑤ and ⑥ with compressed air. If there is oil on the filter or it is extremely dirty, wash it in a neutral washing agent. After washing it, dry it completely before using it again.

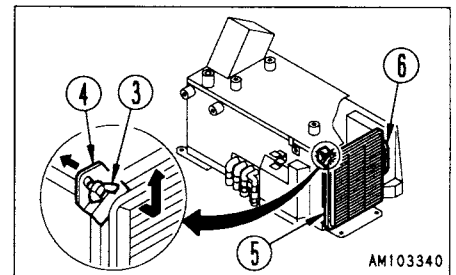
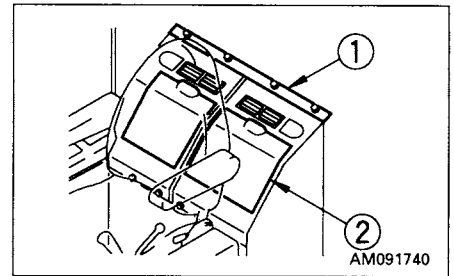

If the dirt clogging the filter cannot be removed by blowing it with air or washing it in water, replace the filter with a new part.

#### REMARK

If the filter becomes clogged, the air flow will be reduced, and there will be an abnormal noise from the air conditioner unit.

#### NOTICE

**As a guideline, the filters should be cleaned every 500 hours, but on dusty jobsites, clean the filters more frequently.**

### 24.7.6 REPLACE HYDRAULIC TANK BREATHER ELEMENT

**⚠ WARNING**

Replace the element when the oil is cold.  
When removing the oil filler cap, turn it slowly to release the internal pressure before removing it.

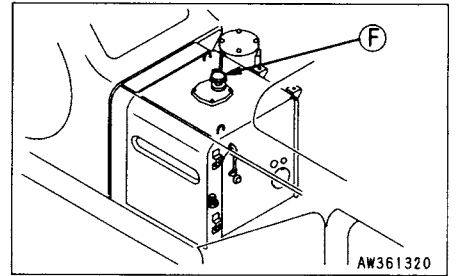

1. Remove the cap of oil filler ⑥ at the top of the hydraulic tank.
2. Replace element ① inside the cap.

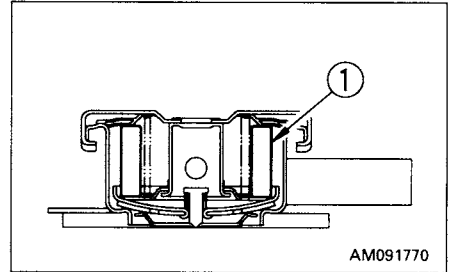

### 24.7.7 REPLACE HYDRAULIC FILTER ELEMENT

#### ⚠ WARNING

When removing the oil filler cap, turn it slowly to release the internal pressure before removing it.

1. Remove the cap from oil filler (F), and release the internal pressure.
2. Loosen 4 bolts, then remove cover (1).  
When doing this, the cover may fly out under the force of spring (2), so hold the cover down when removing the bolts.
3. After removing spring (2) and valve (3), take out element (4).
4. Clean the removed parts in diesel oil.
5. Install a new element in the place where old element (4) was installed.
6. Set valve (3) and spring (2) on top of the element.
7. Set cover (1) in position, push it down by hand, and install the cover with the mousing bolts.
9. Screw in the oil filler cap and install the cover.
10. To bleed the air, start the engine according to "12.2 STARTING ENGINE" and run the engine at low idling for 10 minutes.
11. Stop the engine.

#### REMARK

Operate the machine after halting for more than 5 minutes to eliminate bubbles in the oil inside the tank.

12. Check for oil leakage and wipe off any spilled oil.

When the hydraulic breaker is installed, the hydraulic oil deteriorates earlier than in normal bucket digging work.

The first element replacement should be at 100 to 150 hours for new machines. Thereafter, replace the element according to the table on the right.

Replace the additional filter element for the breaker every approx. 250 hours (when breaker operating ratio is more than 50%) according to the table on the right. (See "23.2 MAINTENANCE INTERVAL WHEN HYDRAULIC BREAKER".)

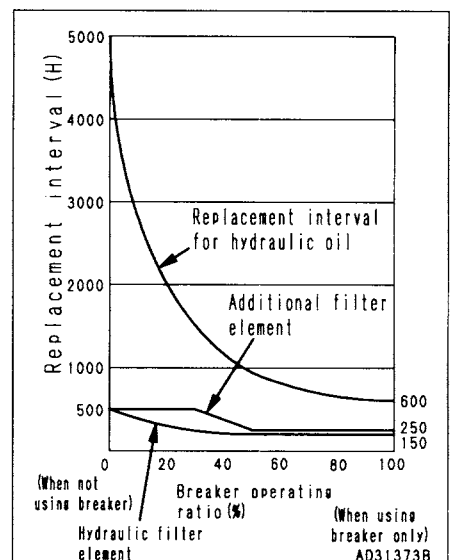
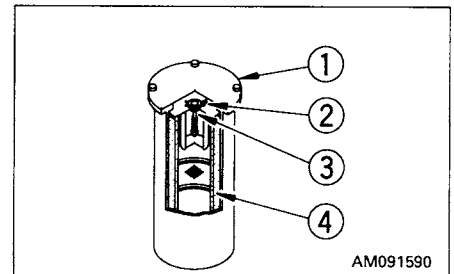
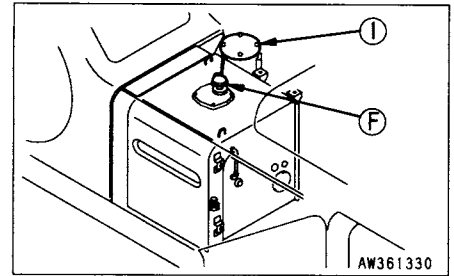

## 24.8 EVERY 1000 HOURS SERVICE

Maintenance for every 50, 100, 250 and 500 hours service should be carried out at the same time.

### 24.8.1 CHANGE OIL IN SWING MACHINERY CASE

**⚠ WARNING**

The oil is at high temperature immediately after the machine has been operated. Wait for the oil to cool down before carrying out maintenance.

- Container to catch drained oil: Min. 21.5 ℓ capacity
  - Refill capacity: 21.5 ℓ (5.7 US gal, 4.7 UK gal)
1. Set a container under drain valve (P) under the machine body to catch the oil.
  2. Loosen drain valve (P) under the machine body, drain the oil, then tighten the drain plug again.
  3. Remove dipstick (G) and air bleed plug (1), then add the specified amount of engine oil through filler port (F) of the dipstick guide.

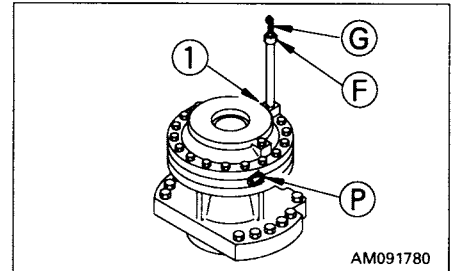

#### NOTICE

For details of the oil to use, see "20. USE OF FUEL, COOLANT AND LUBRICANTS ACCORDING TO AMBIENT TEMPERATURE".

4. After adding oil, install air bleed plug (1).
5. Wipe off the oil on the dipstick with a cloth.
6. Insert dipstick (G) fully into the dipstick guide, and then pull it out again.
7. The oil level should be between H and L marks on the dipstick (G). If the oil does not reach the L mark, add engine oil through oil filler port (F).
8. If the oil is above the H mark, drain the excess engine oil from drain valve (P), and check the oil level again.

### 24.8.2 CHECK OIL LEVEL IN DAMPER CASE, ADD OIL

#### **⚠ WARNING**

The oil is at high temperature immediately after the machine has been operated. Wait for the oil to cool down before carrying out maintenance.

#### NOTICE

Park the machine on flat ground and stop the engine. After waiting for more than 30 minutes after stopping the engine, check the oil level.

1. Open the door on the left side of the machine.
2. Remove plug **Ⓒ** and check the oil level. If the oil is up to near the bottom of the plug hole, it is normal.  
If insufficient, remove plug **Ⓕ** and add oil through the hole of plug **Ⓕ** up to the bottom of the plug hole **Ⓒ**.

#### NOTICE

For details of the oil to use, see "20. USE OF FUEL, COOLANT AND LUBRICANTS ACCORDING TO AMBIENT TEMPERATURE".

#### NOTICE

If excess oil is supplied, drain it to the specified amount to avoid overheating.

3. Install plugs **Ⓒ** and **Ⓕ**.
4. Close the door.

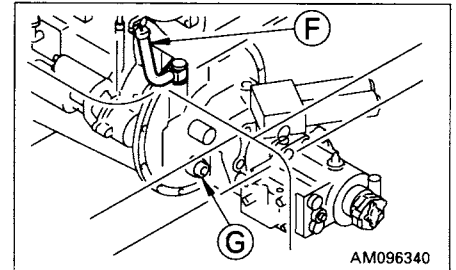

### 24.8.3 CHECK ALL TIGHTENING PARTS OF TURBOCHARGER

Contact your Komatsu distributor to have the tightening portions checked.

### 24.8.4 CHECK PLAY OF TURBOCHARGER ROTOR

Ask Komatsu distributor to check the play of the turbocharger rotor.

### 24.8.5 REPLACE CORROSION RESISTOR CARTRIDGE (OPTION)

1. Screw in valve ① at the top of the corrosion resistor.
2. Using a filter wrench, turn cartridge ② to the left to remove it.
3. Coat the seal surface of the new filter cartridge with engine oil, then install it.  
When installing, bring the packing surface into contact with the seal surface of the filter holder, then tighten a further 2/3 turn.  
Always use a genuine Komatsu cartridge.
4. Open valve ①.
5. Run the engine and check that there is no leakage of water from the seal surface.

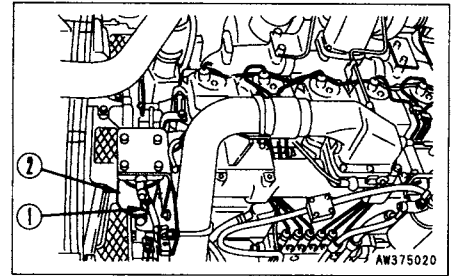



## 24.9 EVERY 2000 HOURS SERVICE

Maintenance for every 50, 100, 250, 500 and 1000 hours service should be carried out at the same time.

### 24.9.1 CHANGE OIL IN FINAL DRIVE CASE

#### ⚠ WARNING

- The oil is at high temperature immediately after the machine has been operated. Wait for the oil to cool down before carrying out maintenance.
- If there is still pressure remaining inside the case, the oil or plug may fly out.  
Loosen the plug slowly to release the pressure.

Prepare the following.

- Container to catch drained oil: Min. 11.5 ℓ capacity
  - Refill capacity: 11.5 ℓ (3.0 US gal, 2.5 UK gal)
  - Handle
1. Set the TOP mark at the top, with the TOP mark and plug ① perpendicular to the ground surface.
  2. Set a container under plug ① to catch the oil.
  3. Remove plugs ① and ② with the handle and drain the oil.

#### REMARK

Check the O-rings in the plugs for damage. If necessary, replace with new ones.

4. Screw in plug ①.
5. Add engine oil through the hole of plug ②.

#### NOTICE

For details of the oil to use, see "20. USE OF FUEL, COOLANT AND LUBRICANTS ACCORDING TO AMBIENT TEMPERATURE".

6. When the oil overflows from the hole of plug ②, install plug ②.  
Tightening torque of plugs ① and ②:  $70 \pm 10$  Nm ( $7 \pm 1$  kgm,  $50 \pm 7$  lbft)

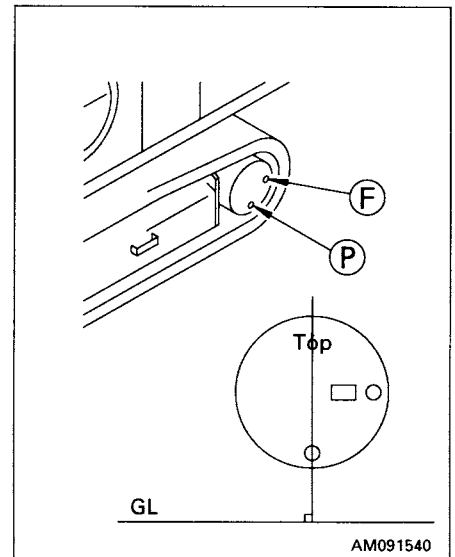

### 24.9.2 CLEAN HYDRAULIC TANK STRAINER

**⚠ WARNING**

The oil is at high temperature immediately after the machine has been operated. Wait for the oil to cool down before changing the oil. When removing the oil filler cap, turn it slowly to release the internal pressure, then remove it carefully.

1. Remove 4 bolts, then remove cover ①. When doing this, cover ① may fly off because of the force of spring ②, so keep the cover pushed down when removing the bolts.
2. Hold the top of rod ③ and pull up to remove spring ② and strainer ④.
3. Remove any dirt stuck to strainer ④, then wash in clean diesel oil or flushing oil. If strainer ④ is broken, replace it with a new part.
4. When installing, insert strainer ④ into protruding part ⑤ of the tank, and assemble.
5. Tighten the bolts to install cover ①.

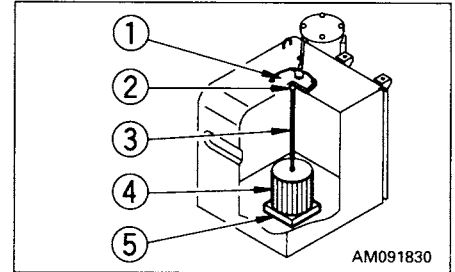

### 24.9.3 CLEAN ENGINE BREATHER

#### **⚠ WARNING**

- The parts and oil are at high temperature after the engine is stopped, and may cause serious burns. Wait for the temperature to go down before cleaning the engine breather.
- When using compressed air, there is a hazard that dirt may be blown up and cause serious injury. Always use safety glasses, dust mask, or other protective equipment.

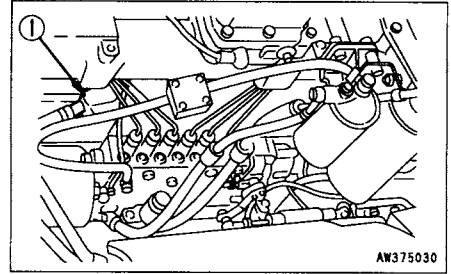

1. Wipe away dust around the breather.
2. Loosen the clamp and remove the hose. Remove breather ①.
3. Clean the breather body with light oil or cleaning oil.
4. Replace O-ring with new one. Coat a new O-ring with engine oil, set it, then install breather ①.
5. Check the breather hose. If caked oil (sludge) adheres to the inside, replace the hose with a new one.

### 24.9.4 CLEAN, CHECK TURBOCHARGER

Contact your Komatsu distributor for cleaning or inspection.

### 24.9.5 CHECK ALTERNATOR, STARTING MOTOR

The brush may be worn, or the bearing may have run out of grease, so contact your Komatsu distributor for inspection or repair. If the engine is started frequently, carry out inspection every 1000 hours.

### 24.9.6 CHECK ENGINE VALVE CLEARANCE, ADJUST

As special tool is required for removing and adjusting the parts, you shall request Komatsu distributor for service.

### 24.9.7 CHECK VIBRATION DAMPER

Check that there are no cracks or peeling in the outside surface of the rubber ①.

If any cracks or peeling are found, contact your Komatsu distributor to have the parts replaced.

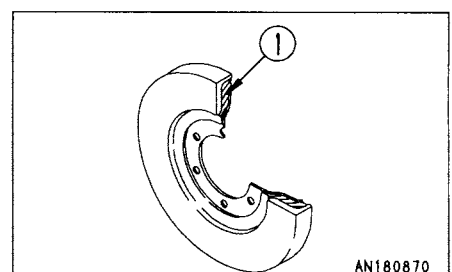

## **24.10 EVERY 4000 HOURS SERVICE**

**Maintenance for every 50, 100, 250, 500, 1000 and 2000 hours service should be carried out at the same time.**

### **24.10.1 CHECK WATER PUMP**

Check that there is oil leakage, water leakage, or clogging of the drain hole. If any abnormality is found, contact your Komatsu distributor for disassembly and repair or replacement.

## 24.11 EVERY 5000 HOURS SERVICE

Maintenance for every 50, 100, 250, 500 and 1000 hours service should be carried out at the same time.

### 24.11.1 CHANGE OIL IN HYDRAULIC TANK

#### WARNING

The oil is at high temperature immediately after the machine has been operated. Wait for the oil to cool down before changing the oil. When removing the oil filler cap, turn it slowly to release the internal pressure, then remove it carefully.

Prepare the following.

- Container to catch drained oil: min. 270 ℓ capacity
- Refill, capacity: 270 ℓ (71.3 US gal, 59.4 UK gal)
- Handle for socket wrench set

1. Swing so that the drain plug at the bottom of the hydraulic tank is in the middle between the left and right tracks.
2. Retract the arm and bucket cylinders to the end of the stroke, then lower the boom and put the teeth in contact with the ground.
3. Set the safety lock lever to the LOCK position and stop the engine.
4. Remove the cap of oil filler port (F) at the top of the hydraulic tank.
5. Set a container immediately under the drain plug under the machine body to catch the oil that is drained. Using the handle, remove drain plug (P) and drain the oil. Check the O-ring installed to plug (P), and if it is scratched or damaged, replace the O-ring. After draining the oil, tighten drain plug (P).  
Tightening torque:  $70 \pm 10$  Nm ( $7 \pm 1$  kgm,  $50 \pm 7$  lbft)

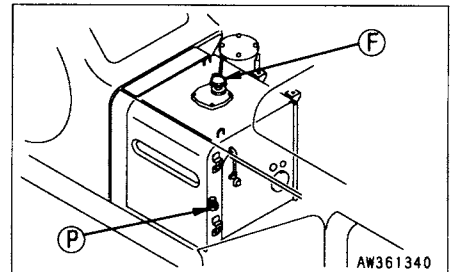
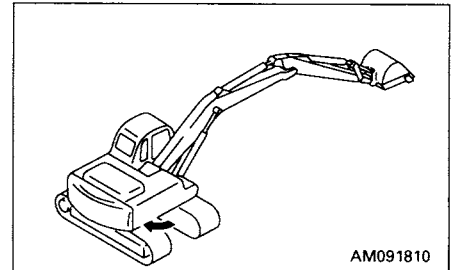

Take care not to get oil on yourself when you remove drain plug (P).

6. Add the specified amount of engine oil through oil filler port ⑥.  
Check that the oil level is between H and L on the sight gauge.

**NOTICE**

For details of the oil to use, see "20. USE OF FUEL, COOLANT AND LUBRICANTS ACCORDING TO AMBIENT TEMPERATURE".

**NOTICE**

When the hydraulic breaker is installed, the hydraulic oil deteriorates earlier than in normal bucket digging work. Therefore, replace the hydraulic oil according to the chart at the right.

7. After replacing hydraulic oil and cleaning or replacing filter element and strainer, bleed air from the circuit according to the following procedure.

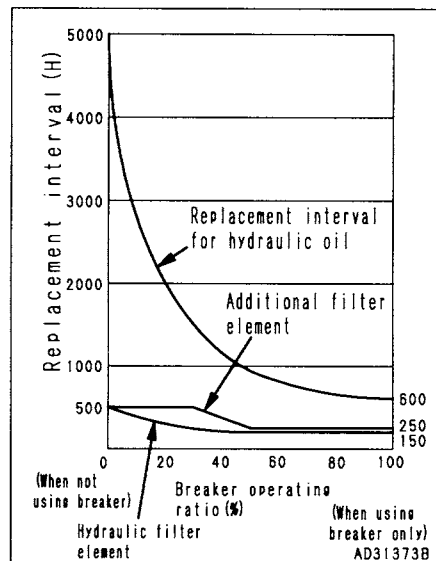

**Procedure for bleeding air**

Bleed the air from the various components in the order below (1 - 7).

**1. Bleeding air from pump**

- 1) Loosen air bleed plug ① and check that oil oozes out from the air bleeder.
- 2) If no oil oozes out, remove the drain hoses from the pump case, and add hydraulic oil through drain port ② to fill the pump case. Oil will come out when the drain hose is removed, so secure the hose mouthpiece at a position higher than the level of the oil in the hydraulic tank.
- 3) After completing the air bleed operation, tighten air bleed plug ① and install the drain hose.

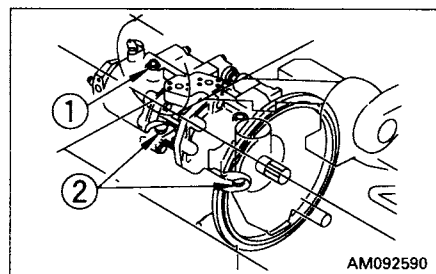

**NOTICE**

If the drain hose is installed first, oil will spurt out from plug hole ①. If the pump is operated without filling the pump case with hydraulic oil, abnormal heat will be generated and this may cause premature damage to the pump.

**2. Starting engine**

Start the engine. For details, see "12.2 STARTING ENGINE". Run the engine for 10 minutes at low idling, then go on to the next operation.

**3. Bleeding air from cylinders**

- 1) Run the engine at low idling, and extend and retract each cylinder 4 – 5 times. Do not operate the cylinder to the end of its stroke. Stop at a point approx. 100 mm before the end of the stroke.
- 2) Next, operate each cylinder 3 – 4 times to the end of its stroke.
- 3) Finally, operate each cylinder 4 – 5 times to the end of its stroke to completely remove the air.

**NOTICE**

If the engine is run immediately at high speed or the cylinder is operated to the end of its stroke, the air inside the cylinder may cause damage to the piston packing.

**4. Bleeding air from swing motor**

(Carry out this operation only when the oil in the swing motor case has been drained.)

- 1) Run the engine at low idling, loosen air bleed plug ① and check that oil oozes out from air bleed plug ①.

**NOTICE**

When doing this, do not operate the swing.

- 2) If no oil oozes out, stop the engine, remove air bleed plug ①, then fill the motor case with hydraulic oil.
- 3) After completing the air bleed operation, tighten air bleed plug ①.
- 4) Run the engine at low idling, and swing the upper structure at least 2 times uniformly to the left and right.

**NOTICE**

If the air is not bled from the swing motor, the motor bearings may be damaged.

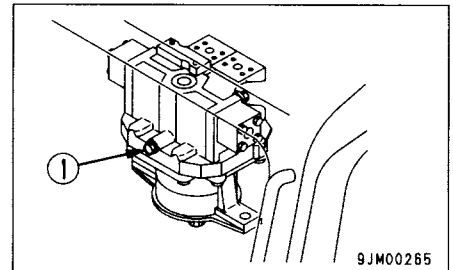

9JM00265

**5. Bleeding air from travel motor**

**(Carry out this operation only when the oil in the travel motor case has been drained.)**

- 1) Run the engine at low idling, loosen air bleed plug ① and check that oil flows out. If oil flows out, tighten the air bleed plug.
- 2) Keep the engine running at low idling, and swing the upper structure 90° to bring the work equipment to the side of the track.

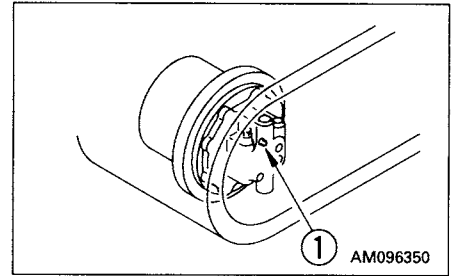

- 3) Use the work equipment to jack up the chassis so that the track comes slightly off the ground, then run the track under no load for 2 minutes. Carry out this operation on the left and right sides.

When rotating the track under no load, rotate the track uniformly in forward and reverse.

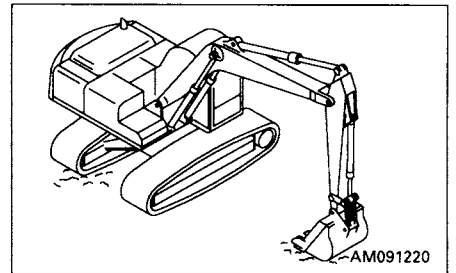

**6. Bleeding air from attachment (hydraulic breaker, etc.)**

If a hydraulic breaker or any other attachment has been newly installed, run the engine at low idling and operate the equipment repeatedly (approx. 10 times) until the air has been bled from the attachment and circuit.

**NOTICE**

**If the method of bleeding the air from the attachment itself is specified by the manufacturer, bleed the air according to those specifications.**

**7. Operation**

- 1) After completing the air bleed operation, stop the engine and wait for at least 5 minutes before starting operations. This will allow the bubbles in the oil inside the tank to escape.
- 2) Check that there is no leakage of oil, and wipe up any oil that has been spilled.



# **SPECIFICATIONS**

## 25. SPECIFICATIONS

### PC400-6 AVANCE PC400LC-6 AVANCE

		PC400-6 AVANCE	PC400LC-6 AVANCE
<b>WEIGHT</b>			
● Operating weight (without operator)		41400 kg (91290 lb)	42600 kg (93930 lb)
<b>PERFORMANCE</b>			
● Bucket capacity (standard bucket) SAE/CECE		1.8 m <sup>3</sup> (2.08 cu.yd)/1.6 m <sup>3</sup>	
● Width of opening	(Standard bucket)	1424 mm (56.1 in)	
	(With side cutter)	1574 mm (62.0 in)	
● Travel speed	Low speed	3.2 km/h (2.0 MPH)	
	Middle speed	4.5 km/h (2.8 MPH)	
	High speed	5.5 km/h (3.4 MPH)	
● Swing speed		9.1 rpm	
<b>TRACK SHOE</b>			
● Triple grouser shoe (standard)		600 mm (23.6 in) width	700 mm (27.6 in) width
<b>ENGINE</b>			
● Model		Komatsu SAA6D125E-2 diesel engine	
● Flywheel horsepower		228.01 kW (306 HP)/2050 rpm	
● Starting motor		24 V 11 kW	
● Alternator		24 V 33 A	
● Battery		12 V 150 Ah x 2 pieces	

**PC400, PC400LC-6**

The values given are the values for PC400-6 AVANCE

[     ]: Values for PC400LC-6 AVANCE

In cases where there are no values given in [     ], the values are the same as for PC400-6 AVANCE.

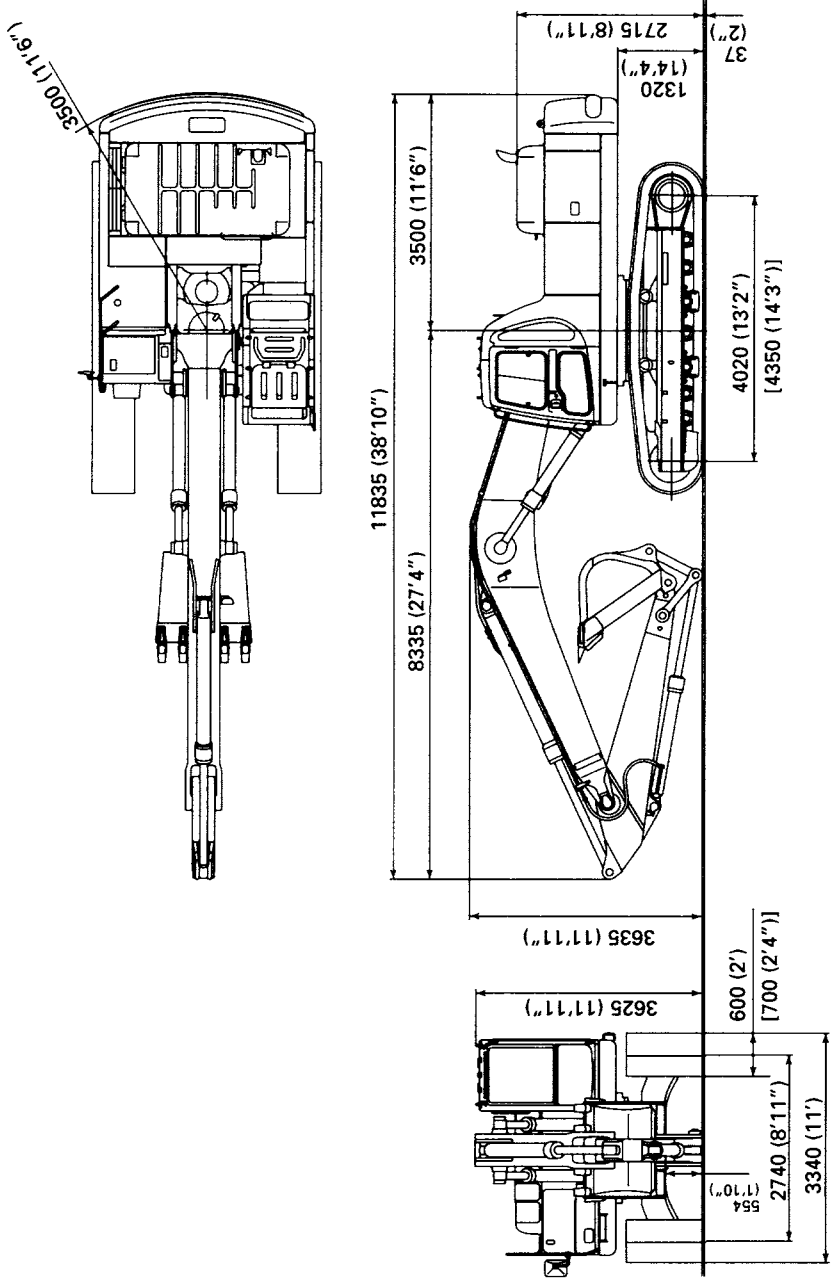

AM096370

25. SPECIFICATIONS

**PC400-6 AVANCE, PC400LC-6 AVANCE**

1. The mark ※ indicates the dimensions for shovel operation.
2. Never allow other person than the operator to enter the swing range (Max. swing range, Max. digging radius).

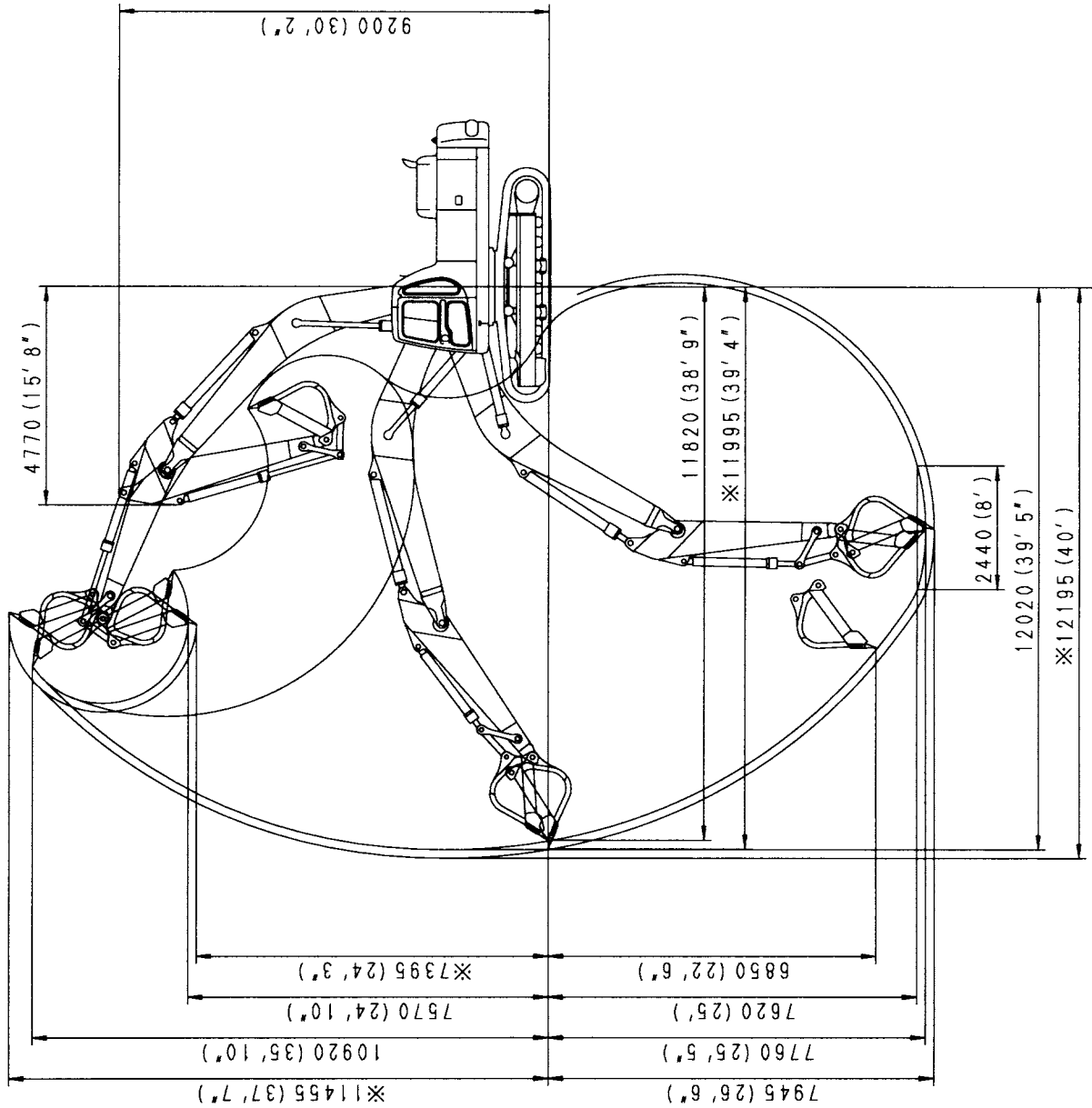

AW35084B

**PC450-6 AVANCE**  
**PC450LC-6 AVANCE**

		PC450-6 AVANCE	PC450LC-6 AVANCE
<b>WEIGHT</b>			
● Operating weight (without operator)		42240 kg (93140 lb)	43500 kg (95920 lb)
<b>PERFORMANCE</b>			
● Bucket capacity (standard bucket) SAE/CECE		1.8 m <sup>3</sup> (2.08 cu.yd)/1.6 m <sup>3</sup>	
● Width of opening	(Standard bucket)	1424 mm (56.1 in)	
	(With side cutter)	1574 mm (62.0 in)	
● Travel speed	Low speed	3.2 km/h (2.0 MPH)	
	Middle speed	4.5 km/h (2.8 MPH)	
	High speed	5.5 km/h (3.4 MPH)	
● Swing speed		9.1 rpm	
<b>TRACK SHOE</b>			
● Triple grouser shoe (standard)		600 mm (23.6 in) width	600 mm (23.6 in) width
<b>ENGINE</b>			
● Model		Komatsu SAA6D125E-2 diesel engine	
● Flywheel horsepower		228.01 kW (306 HP)/2050 rpm	
● Starting motor		24 V 11 kW	
● Alternator		24 V 33 A	
● Battery		12 V 150 Ah x 2 pieces	

25. SPECIFICATIONS

**PC450, PC450LC-6**

The values given are the values for PC450-6 AVANCE

[     ]: Values for PC450LC-6 AVANCE

In cases where there are no values given in [     ], the values are the same as for PC450-6 AVANCE.

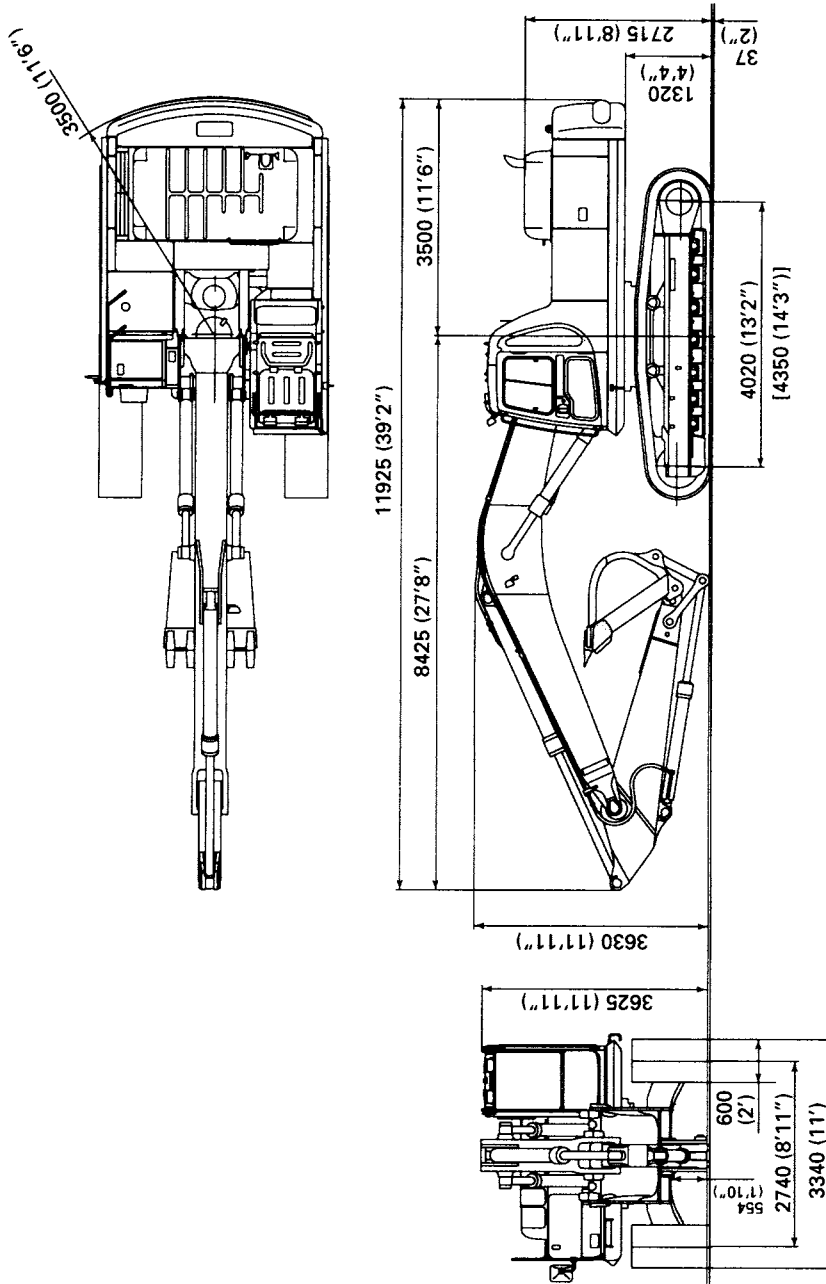

AM096390

**PC450-6 AVANCE, PC450LC-6 AVANCE**

- 1. The mark ※ indicates the dimensions for shovel operation.
- 2. Never allow other person than the operator to enter the swing range (Max. swing range, Max. digging radius).

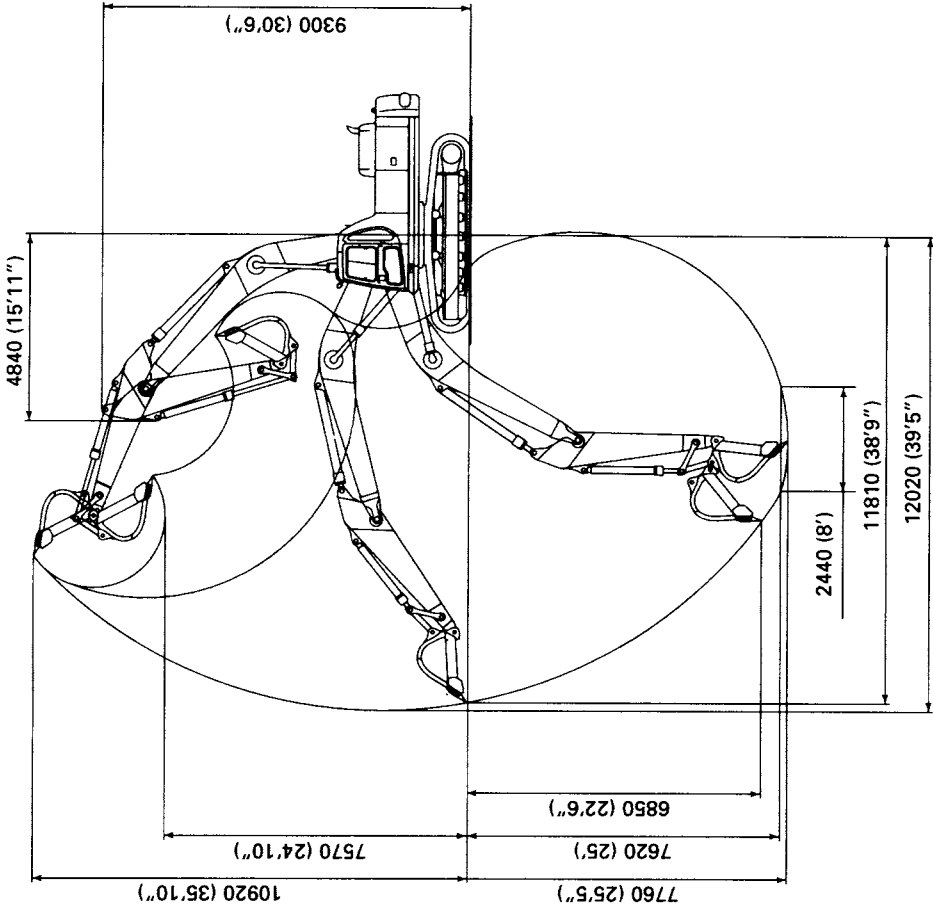

AM096400

# **OPTIONS, ATTACHMENTS**



## 26. GENERAL PRECAUTIONS

---

### 26.1 PRECAUTIONS RELATED TO SAFETY

If attachments or options other than those authorized by Komatsu are installed, this will not only affect the life of the machine, but will also cause problems with safety.

When installing attachments not listed in this Operation and Maintenance Manual, please contact your Komatsu distributor first.

If you do not contact Komatsu, we cannot accept any responsibility for any accident or failure.

#### WARNING

##### **Precautions for removal and installation operations**

**When removing or installing attachments, obey the following precautions and take care to ensure safety during the operation.**

- **Carry out the removal and installation operations on a flat, firm ground surface.**
- **When the operation is carried out by two or more workers, determine signals and follow these during the operation.**
- **When carrying heavy objects (more than 25 kg (55 lb)), use a crane.**
- **When removing heavy parts, always support the part before removing it.  
When lifting such heavy parts with a crane, always pay careful attention to the position of the center of gravity.**
- **It is dangerous to carry out operations with the load kept suspended. Always set the load on a stand, and check that it is safe.**
- **When removing or installing attachments, make sure that they are in a stable condition and will not fall over.**
- **Never go under a load suspended from a crane.  
Always stand in a position that is safe even if the load should fall.**

#### NOTICE

Qualifications are required to operate a crane. Never allow the crane to be operated by an unqualified person.

For details of the removal and installation operations, please contact your Komatsu distributor.

## 26.2 PRECAUTIONS WHEN INSTALLING ATTACHMENTS

### ⚠ WARNING

Long work equipment reduces the stability of the chassis, so if the swing is operated on a slope, or when going down a steep hill, the machine may lose its balance and overturn. The following operations are particularly dangerous, so never operate the machine in these ways.

- Going downhill with the work equipment raised

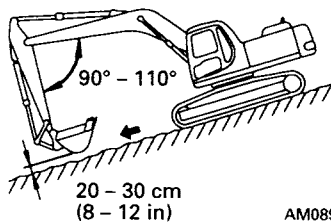

- Traveling across slopes

INCORRECT

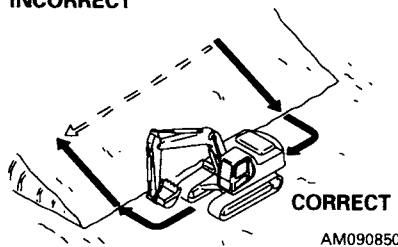

CORRECT

- Swinging the upper structure on slopes

INCORRECT

CORRECT

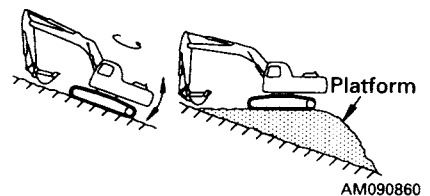

- If heavy work equipment is installed, the overrun of the swing becomes greater (the distance from the point where the operator operates the control levers to stop the swing to the point where the upper structure stops completely), so there is danger of mistaking the distance and hitting something.

Always operate so that there is an ample margin to the stopping point.

Furthermore, the hydraulic drift also becomes larger (when the work equipment is stopped in mid-air, it will gradually move down under its own weight).

- Always follow the correct procedure when installing the boom and arm. If the correct procedure is not followed, this may lead to serious damage or injury, so please consult your Komatsu distributor before carrying out installation.

If long work equipment is installed, the working range will suddenly become larger, so there is danger of mistaking the distance and hitting something.

Always operate the work equipment so that there is ample space from any obstacles in the area.

## 27. HANDLING BUCKET WITH HOOK

### 27.1 CHECKING FOR DAMAGE TO BUCKET WITH HOOK

Check that there is no damage to the hook, stopper, or hook mount. If any abnormality is found, please contact your Komatsu distributor.

### 27.2 PROHIBITED OPERATIONS

The standard work equipment must not be used for lifting loads. If this machine is to be used for lifting loads, it is necessary to install the specified bucket with hook.

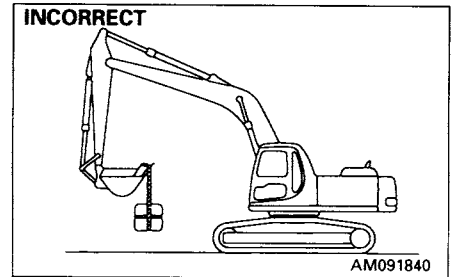

### 27.3 PRECAUTIONS DURING OPERATIONS

- When carrying out lifting operations, reduce the engine speed and use the lifting operation mode.
- Depending on the posture of the work equipment, there is danger that the wire or load may slip off the hook. Always be careful to maintain the correct hook angle to prevent this from happening.
- Never steer the machine while lifting a load.
- If the bucket with hook is turned and used for operations, it will hit the arm during dumping operations, so be careful when using it.
- Loads suspended must not exceed the limit indicated in the "LIFTING CAPACITY TABLE" stuck on the right-side lower portion of the driver's seat.
- If you wish to install a hook in the future, please contact your Komatsu distributor.

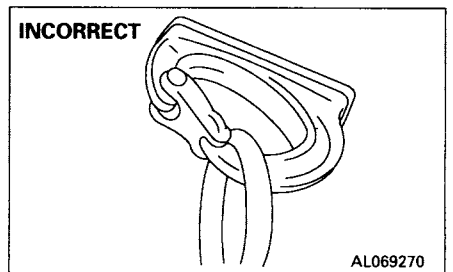
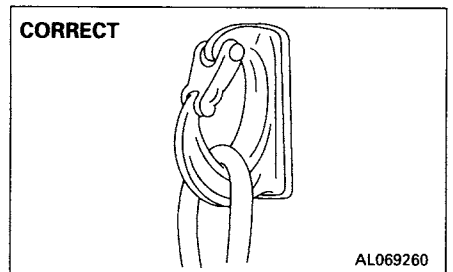

## 28. USING SEAT BELT

### 28.1 SEAT BELT

**⚠ WARNING**

- Before fastening the seat belt, inspect the securing brackets and belt for abnormal conditions. Replace any worn or damaged seat belt or the securing brackets.
- Adjust and fasten the seat belt before operating the machine.
- Always use seat belt when operating the machine.
- Do not use seat belt with either half of the belt kinked.

#### 28.1.1 FASTEN THE BELT AND REMOVE IT

1. Adjust the seat so that the operator still feels that there is sufficient knee room when fully depressing the pedal while seated, with operator's back against the backrest.
2. For suspension-type seat, adjust tether belt ①, after adjusting the seat position.
3. After adjusting the seat position, sit in the seat. Grip buckle ② and tongue ③ in each hand and insert tongue ③ into buckle ②. Confirm by pulling the belt that the tongue is securely locked to the buckle.
4. When removing the belt, raise the tip of buckle ② lever to release it.

Fasten belt along your body without kinking it. Adjust the lengths of the belt on both the buckle and the tongue sides so that the buckle is located at the mid-point of your body front.

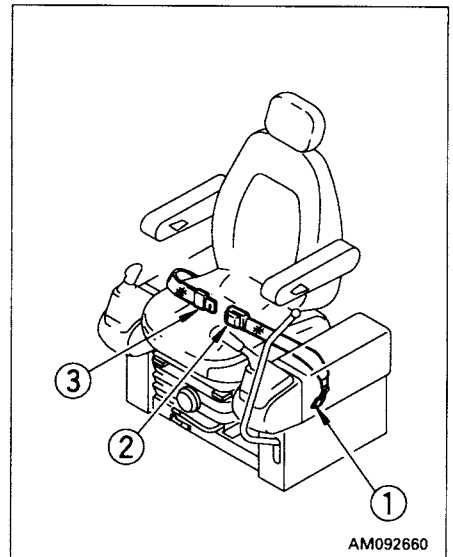

### 28.1.2 ADJUST THE BELT LENGTH

#### To shorten the belt

Pull the free end of the belt on either the buckle body or tongue side.

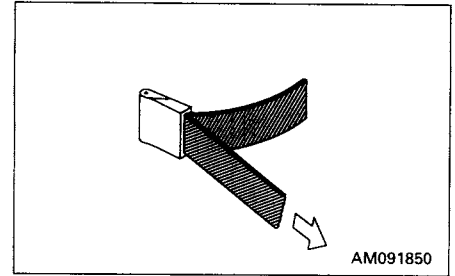

#### To lengthen the belt

Pull the belt while holding it at a right angle to buckle or tongue.

Inspect bolts and fittings on the chassis for tightness. Retighten any loose bolts to 20 – 29 Nm (2 – 3 kgm, 15 – 20 lbft) torque.

If the seat is scratched or frayed or if any of the fittings are broken or deformed from long service, replace the seat belt immediately.

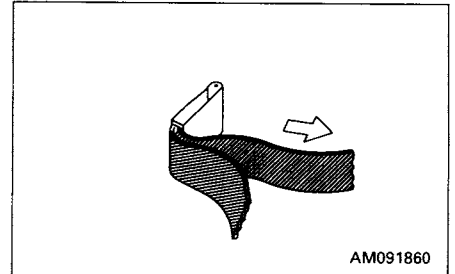

# 29. HANDLING CAR HEATER

## 29.1 GENERAL LOCATIONS

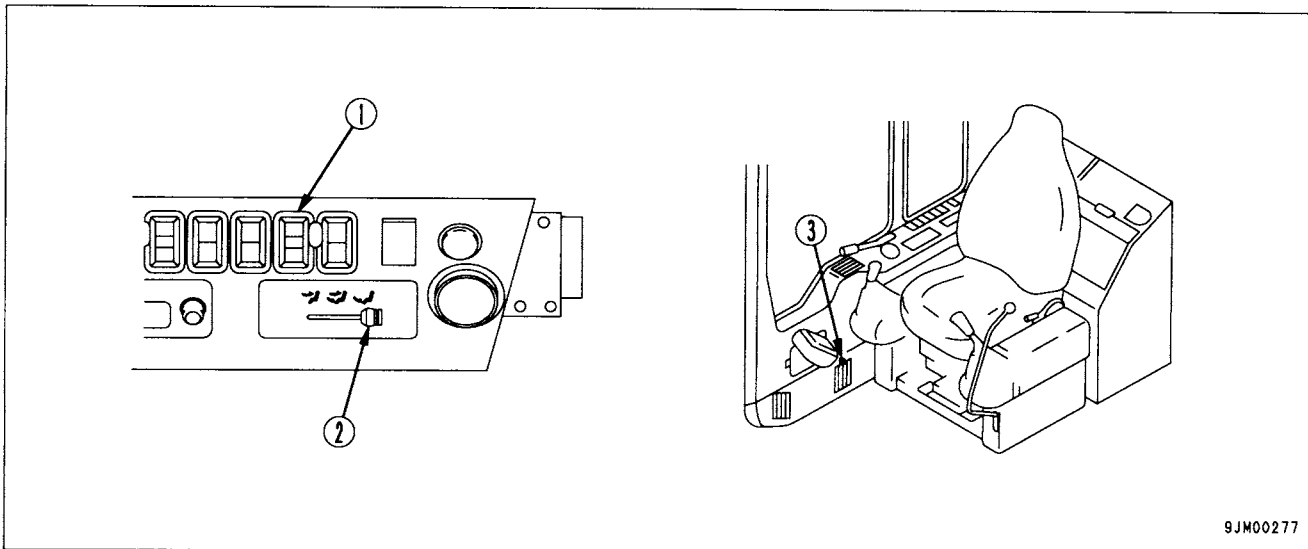

9JM00277

This car heater uses the hot water from the engine to carry out heating, so allow the engine to warm up before using the heater.

### 1. CAR HEATER FAN SWITCH

This adjusts the wind flow in two stages.

Hi: High

Lo: Low

OFF: Car heater is switched off

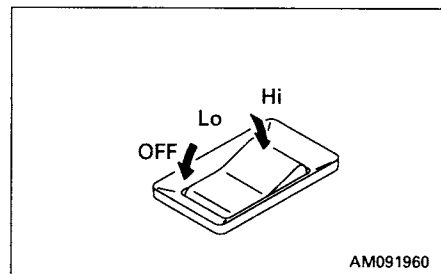

AM091960

### 2. VENT SELECTOR SWITCH

This is used to select the vents which match the purpose of use.



Purpose of use	Sending breeze to upper part of body	Sending breeze to upper part of body and feet	Sending breeze to feet
Lever			
Vent			

**3. DEFROSTER SELECTOR LEVER**

This is used to clear the mist from the front glass in cold or rainy conditions.

Selector lever forward : Defroster

Selector lever back : Feet

The defroster can be used when the vent selector panel is at the  or  position.

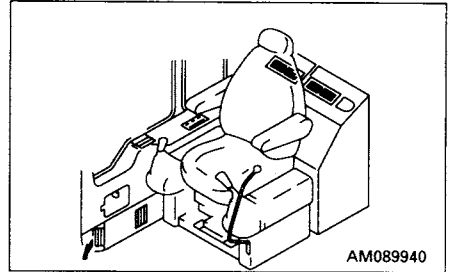
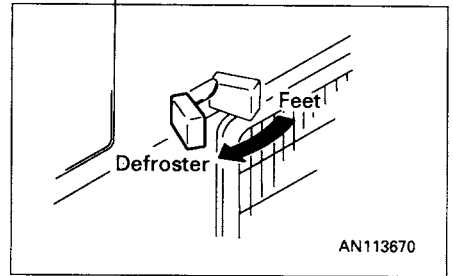

**29.2 PREPARATION FOR CAR HEATER**

Use the car heater when the temperature drops. When using the car heater, turn valve ① on the water pump to the left to open it.

When the warm season returns and the car heater is not to be used for a long period, turn valve ① to the right to close it.

**REMARK**

For machines equipped with an air conditioner, keep valve ① open at all times.

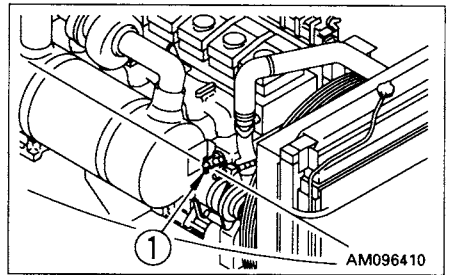

## 30. MACHINES READY FOR ATTACHMENT

### 30.1 GENERAL LOCATIONS

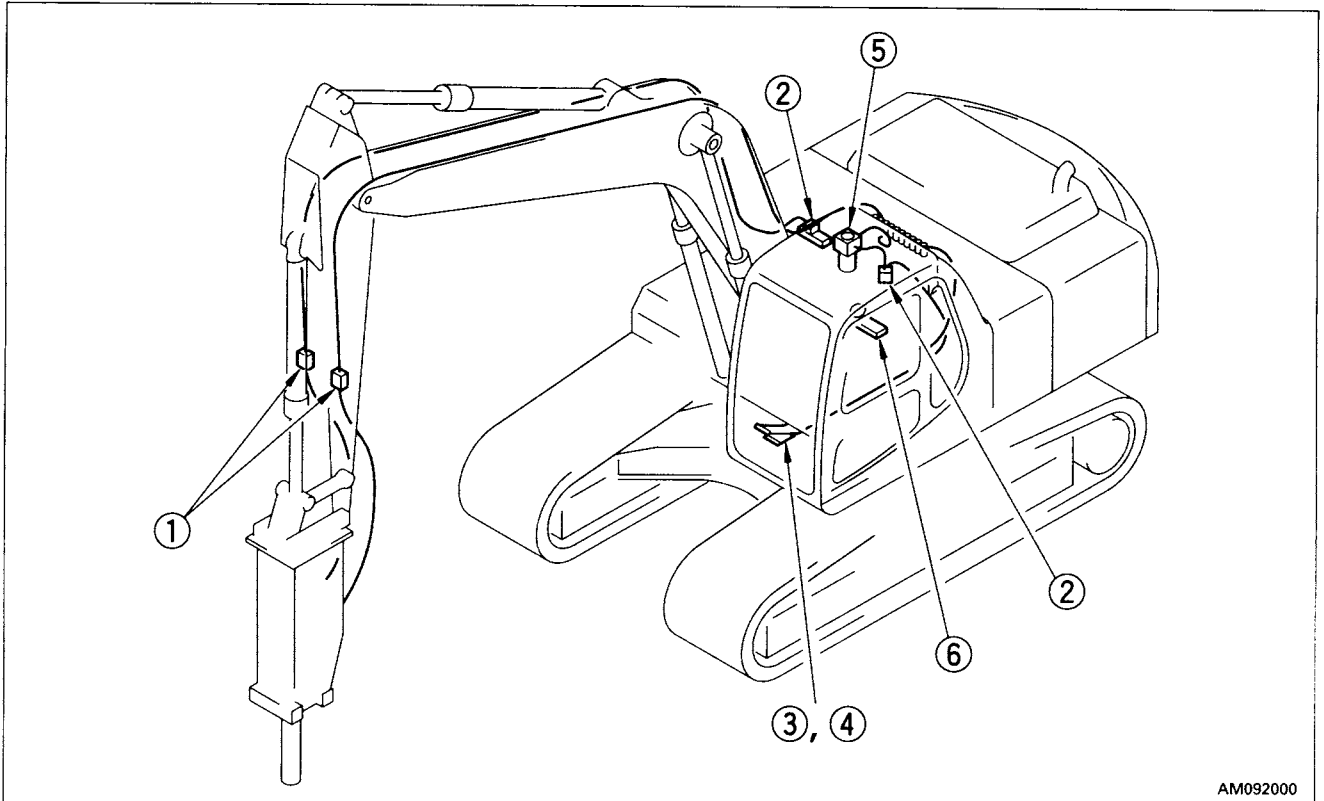

#### 1. STOP VALVE

This valve stops the flow of the hydraulic oil.

- ① FREE : Hydraulic oil flows.
- ② LOCK: Hydraulic oil stops.

When removing or installing attachments, set this valve to the LOCK position.

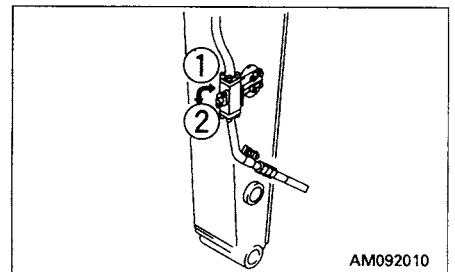

#### 2. SELECTOR VALVE

This switches the flow of the hydraulic oil.

For details of the attachment to install and the direction of right 3-way valve ①, see "30.2 HYDRAULIC CIRCUIT".

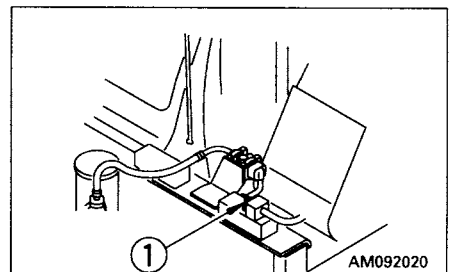



### 3. CONTROL PEDAL

This is used to operate the attachment.

The pedal can be depressed to the front, neutral, and rear to operate the attachment as follows.

#### Hydraulic breaker

Front of pedal ① : Actuate

Pedal neutral (N) : Stop

Rear of pedal ② : Stop

For use of the pedals with other attachments, consult with the attachment manufacturer at the time of installation to determine the operation of the attachment and pedals.

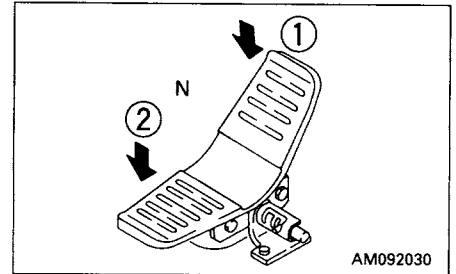

### 4. LOCK PIN

This locks the control pedal.

Position ①: Lock

Position ②: Pedal half-stroke position (oil flow 50%)

Position ③: Pedal full-stroke position (oil flow 100%)

- When using the breaker, select the breaker mode on the monitor, and use position ③.
- The oil flow at position ② is smaller, so select it when using other attachments.

Keep the lock pin in the LOCK position except when using the attachment.

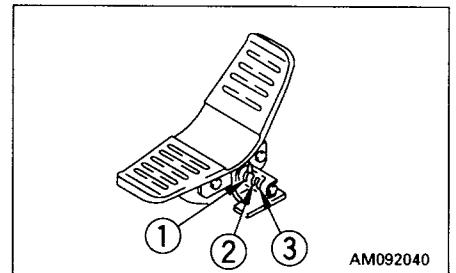

### 5. ADDITIONAL FILTER FOR BREAKER

This is used to prevent deterioration of the hydraulic oil when using the breaker.

The oil flows through this only when the selector valve is at the breaker position.

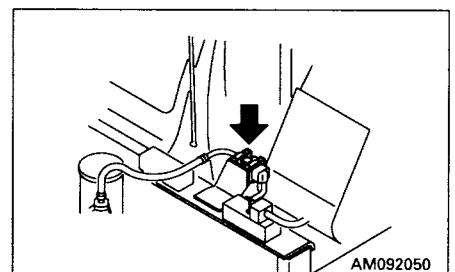

### 6. ACCUMULATOR (FOR CONTROL CIRCUIT)

#### ⚠ WARNING

The accumulator is charged with high-pressure nitrogen gas, and it is extremely dangerous if it is handled mistakenly. For details of handling, see "11.19 HANDLING ACCUMULATOR".

This is installed to release any remaining pressure in the attachment circuit after the engine is stopped. Normally, do not touch it.

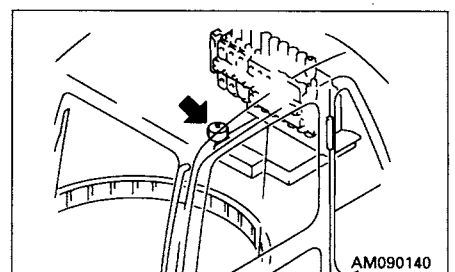



## 30.2 HYDRAULIC CIRCUIT

### SWITCHING HYDRAULIC CIRCUIT

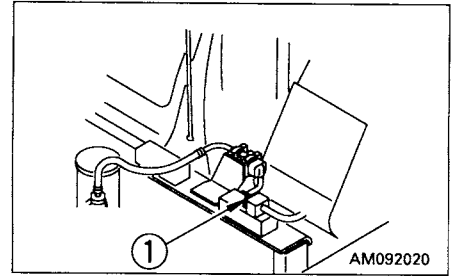
When installing an attachment or installing a bucket, set right 3-way valve ① installed to the hydraulic circuit as follows.



Use a wrench to rotate the rotor and match the attachment and the direction of right 3-way valve ① as shown in the table below. (The arrow showing the direction of the port is stamped on the head of the 3-way valve.)

Attachment	Right 3-way valve
Breaker, etc.	Right of machine 
Crusher, etc.	Right of machine 
When not using	Right of machine 

#### NOTICE

- When installing a breaker, connect the return circuit directly to the return filter.
- The standard set pressure for the low-pressure safety valve is set at 20600 kPa (210 kg/cm<sup>2</sup>, 2990 psi) when shipping from the plant.  
 When installing breakers made by other manufacturers, it is necessary to adjust the pressure, so please contact your Komatsu distributor.

### CONNECTING HYDRAULIC CIRCUIT

When connecting the attachment, connect the hydraulic circuit as follows.

1. Remove blind plug ① at the tip of the stop valve piping. (Left and right, 2 places)

Be careful not to lose or damage the removed parts.

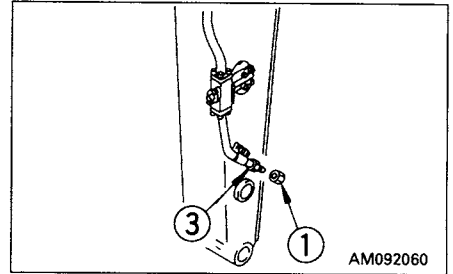

2. Connect attachment piping ② provided by the attachment maker to the part from which the plug was removed.

When it is shipped from the plant, tube ③ is fitted with an Okada compatible part.

In other cases, a Nippon Pneumatic compatible part is also used, but when adding an accumulator, the action to take differs according to the attachment maker, so please contact your Komatsu distributor.

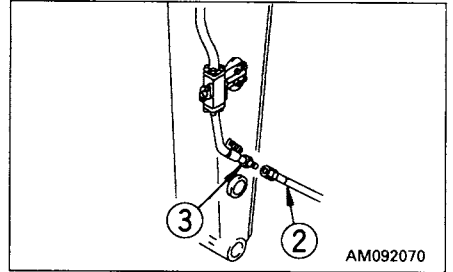

### PATH OF OIL FLOW

The direction of operation of the pedal and the path of the oil flow is as shown in the diagram below.

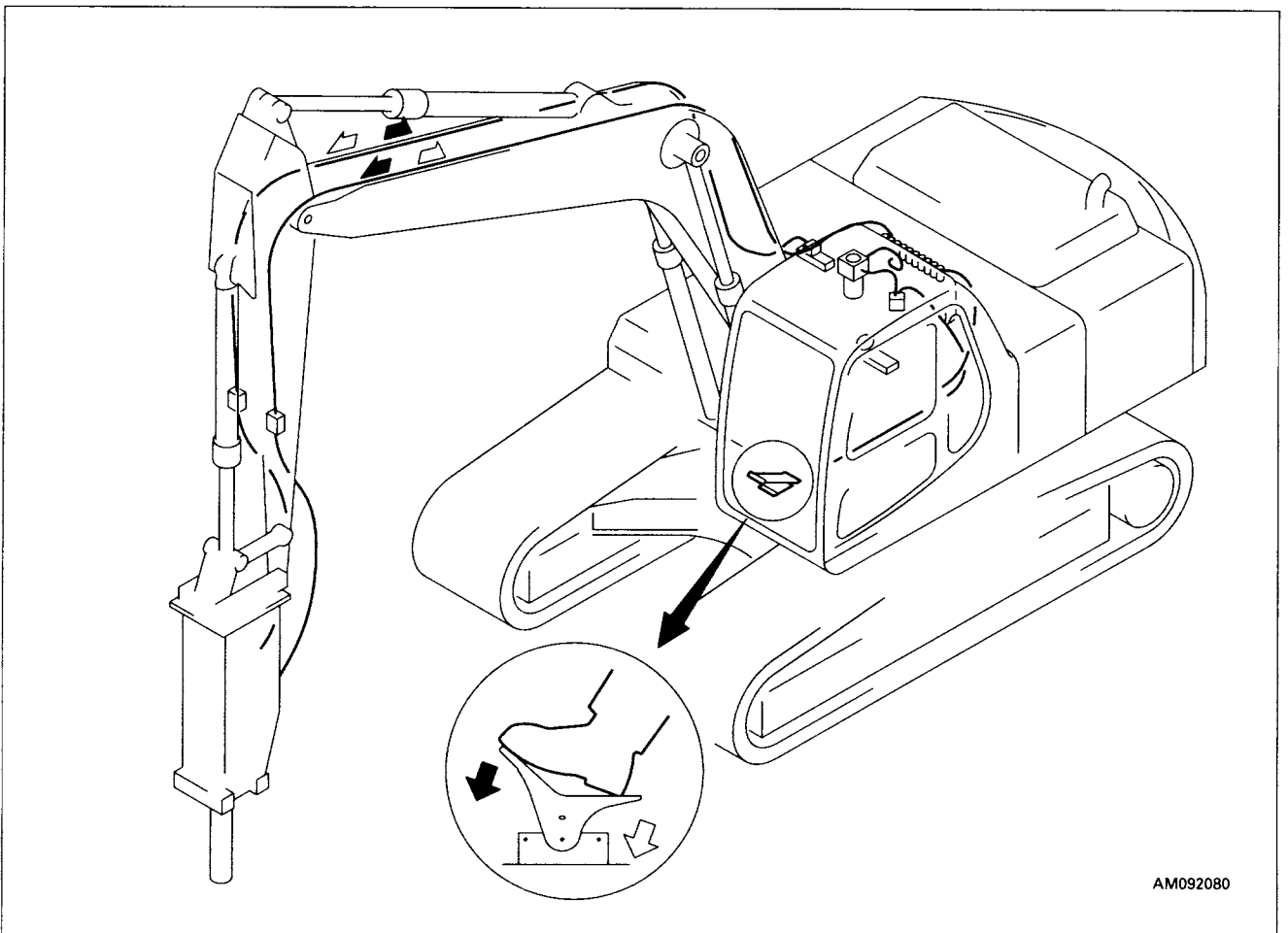

### 30.3 PROCEDURE FOR REMOVAL AND INSTALLATION OF ATTACHMENT

#### PROCEDURE FOR REMOVAL

1. Lower the attachment to the ground and stop the engine.
2. After stopping the engine, operate each control lever and attachment control pedal to the front and rear, and left and right 2 or 3 times to the end of its stroke to release the remaining pressure inside the hydraulic circuit.
3. After checking that the oil temperature is low, turn the rotor of the stop valves installed to the inlet and outlet piping at the side of the arm to the OFF position.

4. Remove the hose from the attachment, then install blind covers to the inlet port and outlet port (2 places).

The blind covers are to prevent defective actuation of the attachment caused by the entry of dirt or dust, so fit them securely before storing the parts away.

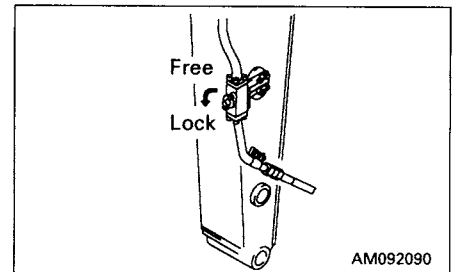

5. Pull out the mounting pins (2 places), remove the attachment, then install the bucket.

For details of the procedure for installing the bucket, see "12.16 REPLACING AND INVERSION OF BUCKET".

6. After installing the bucket, check the oil level in the hydraulic tank.

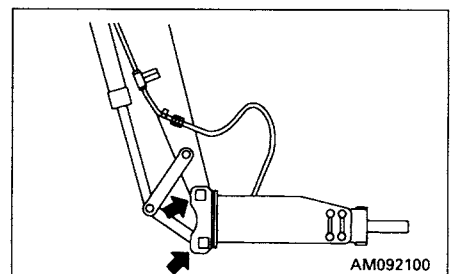

**Procedure for installation**

1. Remove the bucket.

For details of the procedure for removing the bucket, see "12.15 REPLACING AND INVERSION OF BUCKET".

2. Place the attachment in a horizontal position, then install to the arm with pin (A) and then pin (B).
3. After installing the attachment, stop the engine. Then operate each control lever and attachment control pedal to the front and rear, and left and right 2 or 3 times to the end of its stroke to release the remaining pressure inside the hydraulic circuit.
4. After checking that the oil temperature is low, remove the blind covers from the inlet port and outlet port (2 places).

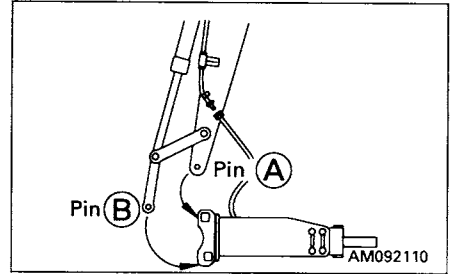

Be careful that no dirt or mud is stuck to the hose mouthpiece. If the O-ring is damaged, replace it with a new part.

5. Turn the rotor of the stop valves installed to the inlet and outlet piping at the side of the arm to the FREE position.
6. After installing the attachment, check the oil level in the hydraulic tank.

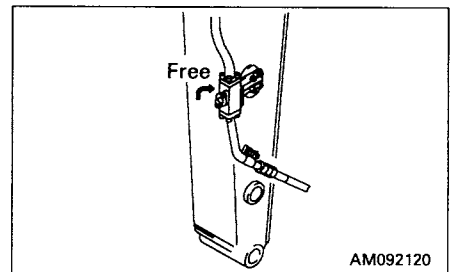

## 30.4 OPERATION

### WARNING

- Be careful when operating the pedal in the deceleration range. The engine speed will rise suddenly.
- Do not put your foot on the pedal except when operating the pedal. If rest your foot on the pedal during operations, and it is depressed by accident, the attachment may move suddenly and cause serious damage or injury.

Operate the attachment as follows.

### WHEN USING BREAKER

Set the lock pin at the FREE position, and depress the front of the pedal to operate the breaker.

Set the working mode to the BREAKER position.

### Precautions when using

- Check that the stopper valve is in the FREE position.
  - Check that the selector valve is in the position for using the breaker.
- For details of the path followed by the oil, see "30.2 HYDRAULIC CIRCUIT".
- Consult with the attachment maker to decide whether it is necessary to install an accumulator for the attachment circuit.
  - For details of other precautions when handling the breaker, read and use correctly the instruction manual provided by the breaker manufacturer.
  - When using the breaker, the hydraulic oil deteriorates more rapidly than for normal operations, so change the hydraulic oil and replace the element at a shorter interval.

For details, see "23.2 MAINTENANCE INTERVAL WHEN USING HYDRAULIC BREAKER".

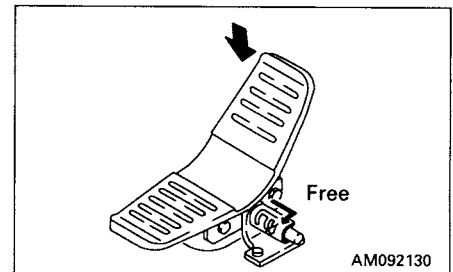

### WHEN USING GENERAL ATTACHMENT SUCH AS CRUSHER

When the lock pin is set at the FREE position and the front or rear of the pedal is depressed, the attachment is actuated.

#### Precautions when using

- Check that the stopper valve is in the FREE position.
- Check that the selector valve is in the position for using the general attachment such as crusher.  
For details of the path followed by the oil, see "30.2 HYDRAULIC CIRCUIT".
- For details of other precautions when handling the breaker, read and use correctly the instruction manual provided by the breaker manufacturer.

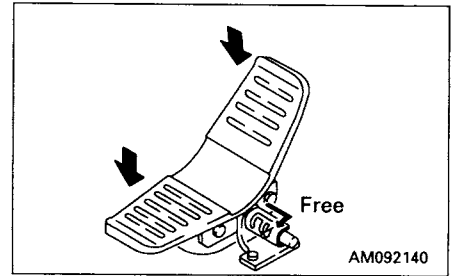

### 30.5 LONG TERM STORAGE

If the machine is not to be used for a long time, do as follows.

- Set the stop valve in the LOCK condition.
- Install a blind plug to the valve.
- Set the selector valve to the "when not using" position.
- Set the lock pin at the LOCK position.

If there is no breaker or general attachment installed, operating the pedal may cause overheating.

### 30.6 SPECIFICATIONS

#### Hydraulic specifications

- Max. oil flow when merged: 600 l/min
- Relief set pressure of service valve safety valve: 27400 kPa (280 kg/cm<sup>2</sup>, 3980 psi)
- Cracking pressure of service valve safety valve: 24500 kPa (250 kg/cm<sup>2</sup>, 3560 psi)

In addition, valves with a safety valve relief set pressure of 24500 kPa (250 kg/cm<sup>2</sup>, 3560 psi) and safety valve cracking pressure of 20000 kPa (205 kg/cm<sup>2</sup>, 2920 psi) are also available, so please contact your Komatsu distributor.

# 31. INTRODUCTION OF ATTACHMENTS

## 31.1 SPECIFICATION, USE PC400, 400LC

Name	Specifications, use	
Narrow bucket	Capacity	1.30 m <sup>3</sup>
	Outside width	1,120 mm
Narrow bucket	Capacity	1.59 m <sup>3</sup>
	Outside width	1,270 mm
Light duty bucket	Capacity	2.06 m <sup>3</sup>
	Outside width	1,565 mm
Light duty bucket	Capacity	2.20 m <sup>3</sup>
	Outside width	1,715 mm
Rock bucket	Capacity	1.8 m <sup>3</sup>
	Outside width	1,425 mm
Ripper bucket	Capacity	1.16 m <sup>3</sup>
	Outside width	1,250 mm
One tooth ripper bucket	Shank width	118 mm
	Crushing depth	1,130 mm

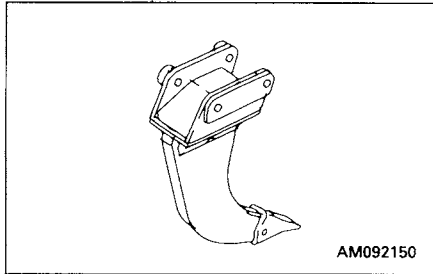

Name	Specifications, use	
Track shoes (PC400)	Triple grouser shoe width	700 mm
	Triple grouser shoe width	800 mm
Track shoes (PC400LC)	Triple grouser shoe width	600 mm
	Triple grouser shoe width	800 mm
Short arm	Arm length	2,900 mm
	Max. digging depth	7,285 mm
Short arm	Arm length	2,400 mm
	Max. digging depth	6,785 mm
Extension arm	Arm length	4,000 mm
	Max. digging depth	8,385 mm
Extension arm	Arm length	4,800 mm
	Max. digging depth	9,195 mm



### 31. INTRODUCTION OF ATTACHMENTS

#### PC450, 450LC

Name	Specifications, use
Ripper bucket	Capacity CECE 1.16 m <sup>3</sup>
	Outside width 1,250 mm
One tooth ripper bucket	Shank width 118 mm
	Crushing depth 1,130 mm

Name	Specifications, use
Track shoes (PC450)	Triple grouser shoe width 700 mm
Track shoes (PC450LC)	Triple grouser shoe width 700 mm

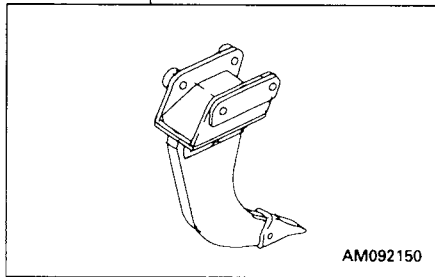

- Long life teeth, self-sharpening teeth, track frame center guard, arm holding valve, auto pull-up front window, additional front lamp, rear lamp, and travel alarm are also available, so please contact your Komatsu distributor.

## 31.2 ATTACHMENT INSTALLATION COMBINATION TABLE

### PC400, 400LC

This table lists the combination of attachments which can be installed to the long arm (standard), short arm and extension arm.

○: Can be used

△: Can be used only for light-duty work

x: Cannot be used

#### NOTICE

- When the extension arm is equipped, if the bucket is drawn to the machine body, the arm interferes with the body. Operate the extension arm carefully.
- When the boom is fully lowered during oblique digging, the boom interferes with the undercarriage. Operate the boom carefully.

#### Categories of use

For general digging: digging or loading sand, gravel, clay etc.

For light duty digging: digging or loading dry, uncaked earth and sand, mud etc.

For loading work: loading dry, loose earth and sand

- For digging or loading hard soil or soft rock, it is recommended that the strengthened bucket with high durability and high wear resistance be employed.

\*: Equipped with side cutter

Name of bucket	Capacity (m <sup>3</sup> )	Outside width (mm)	Use	Standard Boom (7000 mm)					HD Boom (7000 mm)
				Standard arm (3.4 m)	Short arm (2.9 m)	Short arm (2.4 m)	Long arm (4.0 m)	Long arm (7.8 m)	HD arm (3.4 m)
* Narrow bucket	1.30	1120	Narrow digging	○	○	○	○	○	x
* Narrow bucket	1.59	1270	Narrow digging	○	○	○	△	△	x
* Standard bucket	1.80	1425	General digging	○	○	○	x	x	x
* Light duty bucket	2.06	1565	Loading	△	△	△	x	x	x
Light duty bucket	2.20	1715	Loading	△	△	△	x	x	x
* Rock bucket	1.80	1425	Loading	○	○	○	x	x	○
Ripper bucket	1.16	1250	Digging rocks	○	○	○	x	x	○
One tooth ripper	–	–	Digging, removing rocks	○	○	○	x	x	○

## 31. INTRODUCTION OF ATTACHMENTS

---

### PC450, 450LC

This table lists the combination of attachments which can be installed to the HD arm (standard).

### NOTICE

**When the boom is fully lowered during oblique digging, the boom interferes with the undercarriage. Operate the boom carefully.**

\*: Equipped with side cutter

Name of bucket	Capacity (m <sup>3</sup> )	Outside width (mm)	Use	Standard HD arm (3.4 m)
*Rock bucket (standard)	1.8	1425	Loading	○
Ripper bucket	1.0	1250	Digging rocks	○
One tooth ripper	-	-	Digging, removing rocks	○

### 31.3 SELECTION OF TRACK SHOES

Select suitable track shoes to match the operating conditions.

#### METHOD OF SELECTING SHOES

Confirm the category from the list of uses in Table 1, then use Table 2 to select the shoe.

Categories B and C are wide shoes, so there are limitations on their use. When using these shoes, check the precautions, then investigate and study fully the conditions of use to confirm that these shoes are suitable.

When selecting the shoe width, select the narrowest shoe possible that will give the required flotation and ground pressure. If a wider shoe than necessary is used, the load on the track will increase, and this will cause the shoes to bend, links to crack, pins to break, shoe bolts to come loose, and various other problems.

**Table 1**

Category	Use	Precautions when using
A	Rocky ground, riverbeds, normal soil	<ul style="list-style-type: none"> <li>On rough ground with large obstacles such as boulders or fallen trees, travel at low speed.</li> </ul>
B	Normal soil, soft ground	<ul style="list-style-type: none"> <li>These shoes cannot be used on rough ground where there are large obstacles such as boulders or fallen trees.</li> <li>Travel at Hi or Mi speed only on flat ground, and if it is impossible to avoid going over obstacles, shift down and travel at half speed in Lo.</li> </ul>
C	Extremely soft ground (swampy ground)	<ul style="list-style-type: none"> <li>Use the shoes only in places where the machine sinks and it is impossible to use A or B shoes.</li> <li>These shoes cannot be used on rough ground where there are large obstacles such as boulders or fallen trees.</li> <li>Travel at Hi or Mi speed only on flat ground, and if it is impossible to avoid going over obstacles, shift down and travel at half speed in Lo.</li> </ul>

**Table 2**

	PC400		PC400LC		PC450		PC450LC	
	Specifications	Category	Specifications	Category	Specifications	Category	Specifications	Category
Standard	600 triple grouser	A	700 triple grouser	B	600 triple grouser	A	700 triple grouser	B
Option	700 triple grouser	B	600 triple grouser	A	700 triple grouser	B	600 triple grouser	A
Option	800 triple grouser	C	800 triple grouser	C	800 triple grouser	C	-	-

### 31.4 SELECTION OF BUCKET TEETH

Depending on the working conditions, there is danger that the adapter and teeth may break, so select from the vertical pin teeth and horizontal pin teeth to give teeth that are suitable for the purpose.

#### METHOD OF SELECTING TEETH

##### Use of vertical pin tooth

General digging: Digging, loading normal soil, such as sand, gravel, clay

Light-duty digging: Digging, loading loose dry sandy soil or muddy soil.

Loading: Loading dry loosened soil

##### Use of horizontal pin tooth

Heavy-duty digging: Compacting, digging hard soil, soil mixed with rocks, heavy-duty work such as scraping

- The heavy-duty bucket is a horizontal pin tooth type, so use it for heavy-duty digging.

##### Long-life teeth

- Jobsites where wear life is demanded, such as when loading hard rocks.
- Jobsites where no penetration is needed, such as when working with crushed rock after blasting or ripping.
- Jobsites where heavy-duty operations are carried out, such as hitting or pulling up rocks with the tips of the teeth.

##### Self-sharpening teeth (horizontal pin type, vertical pin type)

- Jobsites demanding penetration such as digging and loading sandy or clayey soil.

#### Standards for selecting horizontal pin type and vertical pin type teeth

		Appropriate work site			
		Rock	Crushed stone	Clay, spread earth	Sand
Work contents	Heavy	Ground breaking excavation	Lateral pin-type teeth		Lateral pin-type teeth
	↕				Vertical pin-type teeth
		Scraping down	Lateral pin-type teeth		Lateral pin-type teeth
		Vertical pin-type teeth			
Light	General excavation	Lateral pin-type teeth			Vertical pin-type teeth
	Loading	Lateral pin-type teeth			Vertical pin-type teeth

## 32. EXTENDING MACHINE SERVICE LIFE

This section describes the necessary precautions to be observed when operating a hydraulic excavator equipped with an attachment.

### NOTICE

Select the attachment most suited to the machine body.

- The machine models to which attachments can be mounted vary. For selection of attachment and machine model, consult your Komatsu distributor.

### 32.1 HYDRAULIC BREAKER

#### MAIN FIELDS OF APPLICATION

- Crushed rock
- Demolition work
- Road construction

This attachment can be used for a wide range of work including demolition of buildings, breaking up of road surfaces, tunnel work, breaking up slag, rock crushing, and breaking operations in quarries.

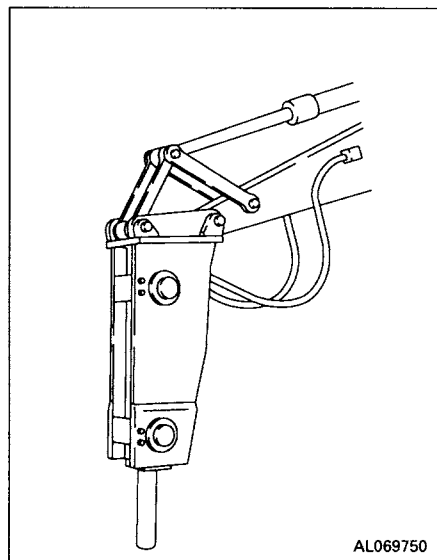

Keep the chisel pushed perpendicularly against the impact surface when carrying out breaking operations.

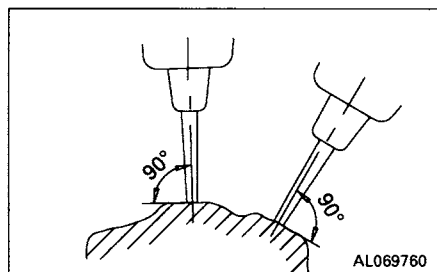

When applying impact, push the chisel against the impact surface and operate so that the chassis rises approx. 5 cm (2 in) off the ground. Do not let the machine come further off the ground than is necessary.

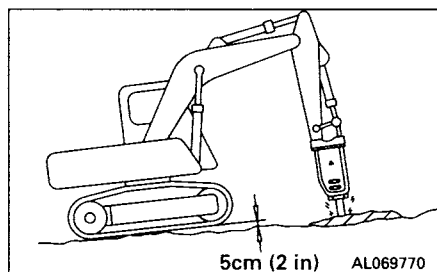

When applying continuous impact to the same impact surface, if the chisel does not penetrate or break the surface within 1 minute, change the point of impact and carry out breaking operations closer to the edge.

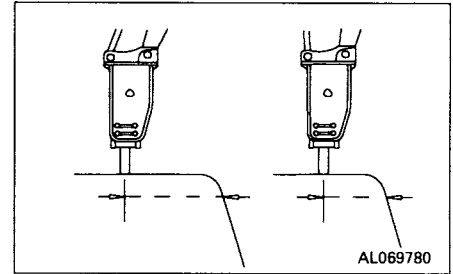

The direction of penetration of the chisel and the direction of the breaker body will gradually move out of line with each other, so always adjust the bucket cylinder to keep them aligned.

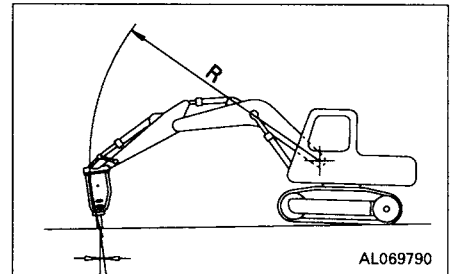

Always keep the chisel pressed against the impact surface properly to prevent using the impact force when there is no resistance.

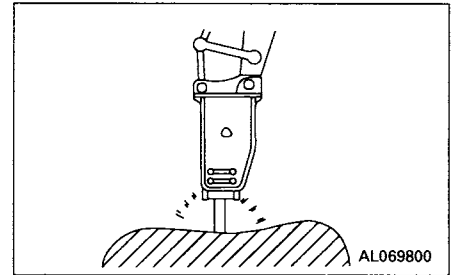

#### MISTAKEN METHODS OF USE

To ensure that the machine has a long life, and to ensure that operations are carried out in safety, do not operate the machine in any of the following ways.

- Do not operate the cylinder to the end of its stroke. Always leave approx. 5 cm (2 in) to spare.

Using the mount to gather in pieces of rock

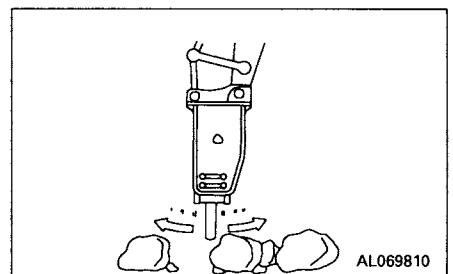

Operations using the swing force

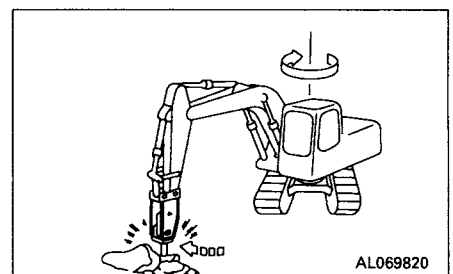

Moving the chisel while carrying out impacting operations

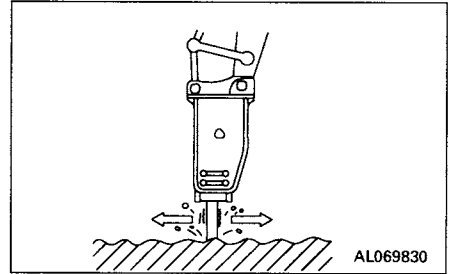

Holding the chisel horizontal or pointed up when carrying out impacting operations

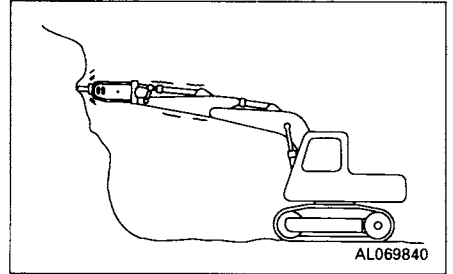

Twisting the chisel when it has penetrated the rock

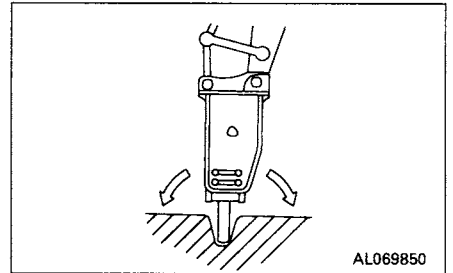

Pecking operations

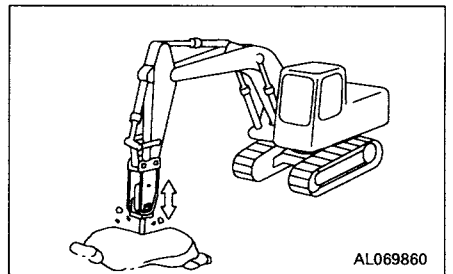

Extending the bucket cylinder fully and thrusting to raise the machine off the ground

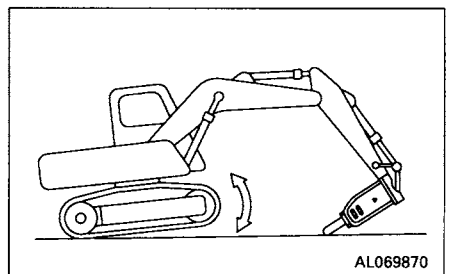



### GREASING POSITION FOR HYDRAULIC BREAKER

Supply grease in the correct position.

#### NOTICE

If grease is supplied in an incorrect position, the breaker is filled with more grease than necessary. As a result, soil and sand will enter the hydraulic circuit and can damage the hydraulic devices while the breaker is used. Accordingly, be sure to supply grease in the correct position.

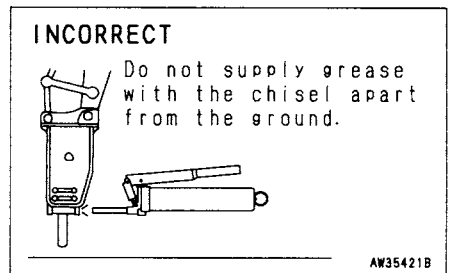
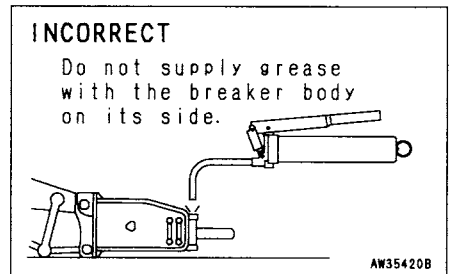
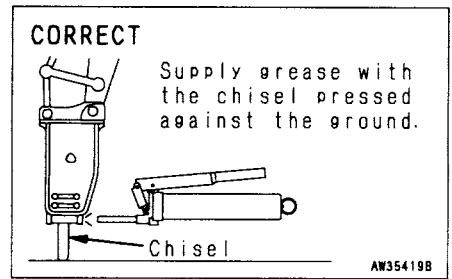

## 32.2 POWER RIPPER

### MAIN FIELDS OF APPLICATION

- Road repair work
- Demolition work

This attachment can be used for a wide range of work including peeling off and crushing pavement roads, demolishing wooden houses and buildings, and crushing foundation and roadbeds.

### MISTAKEN METHODS OF USE

To ensure that the machine has a long life, and to ensure that operations are carried out in safety, do not operate the machine in any of the following ways.

- Do not operate the cylinder to the end of its stroke.  
Always leave approx. 5 cm (2 in) to spare.

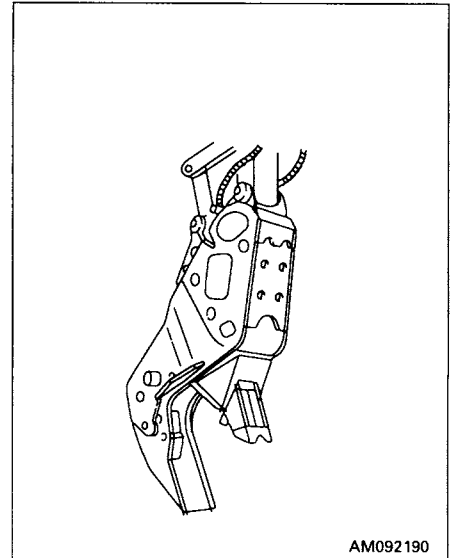

Impact operations using attachment

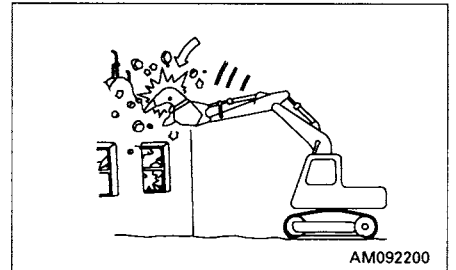

Impact operations using swing force

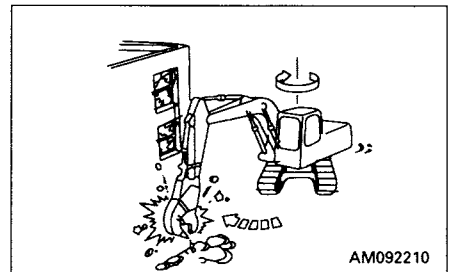

Overloading work equipment during lifting and loading operations

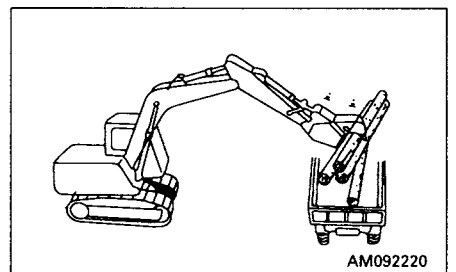

Operations using attachment to grip at an angle

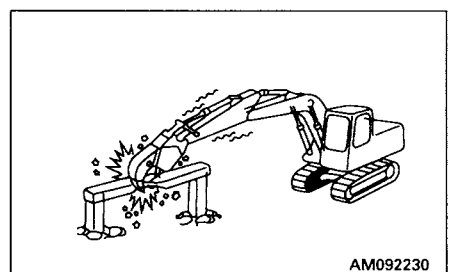

### 32.3 FORK GRAB

#### MAIN FIELDS OF APPLICATION

- Disposing of industrial waste
- Disposing of demolition waste

This can be used for a wide range of work including collecting or loading demolition waste materials and debris, timber, grass etc.

#### MISTAKEN METHODS OF USE

To ensure that the machine has a long life, and to ensure that operations are carried out in safety, do not operate the machine in any of the following ways.

- Do not operate the cylinder to the end of its stroke.  
Always leave approx. 5 cm (2 in) to spare.

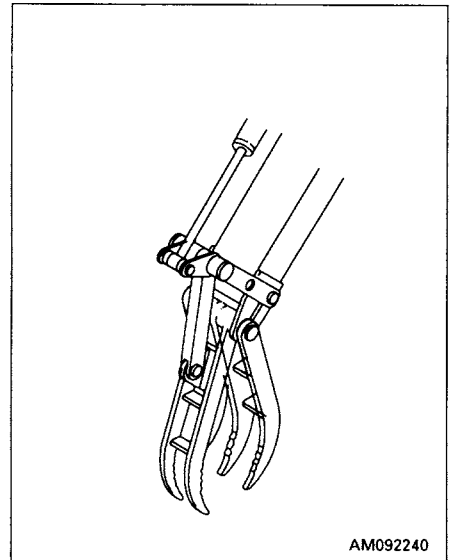

Operations using the swing force

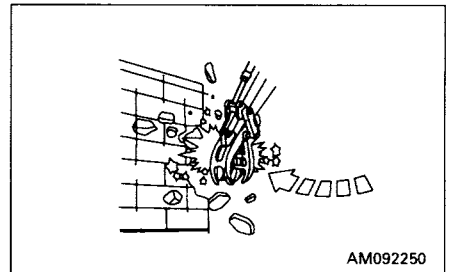

Operations using one side of work equipment

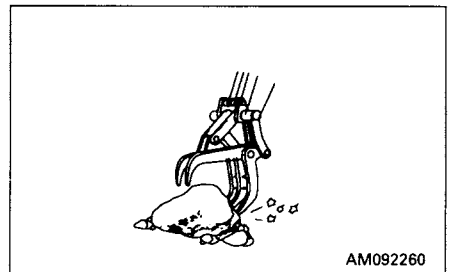

Pushing fork into ground surface to jack up and change direction of machine

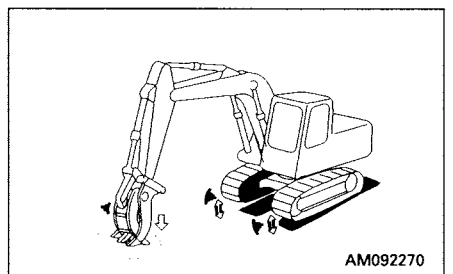

Impact operation with no load

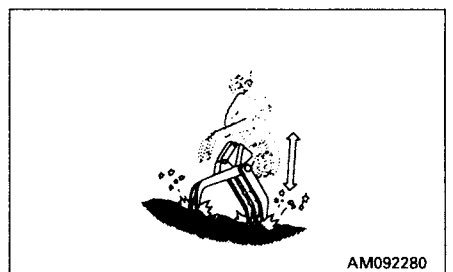

### 32.4 GRAPPLE BUCKET

#### MAIN FIELDS OF APPLICATION

- Demolition
- Disposing of industrial waste
- Forestry

This bucket is widely used for demolition including breaking-up work, grading and digging, clean-up work after natural disasters, dumping industrial waste, and forestry work, etc.

#### MISTAKEN METHODS OF USE

To ensure that the machine has a long life, and to ensure that operations are carried out in safety, do not operate the machine in any of the following ways.

- Do not operate the cylinder to the end of its stroke.  
Always leave approx. 5 cm (2 in) to spare.

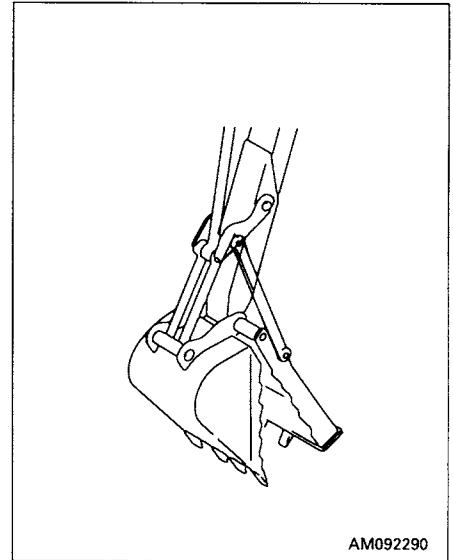

Operations using the swing force

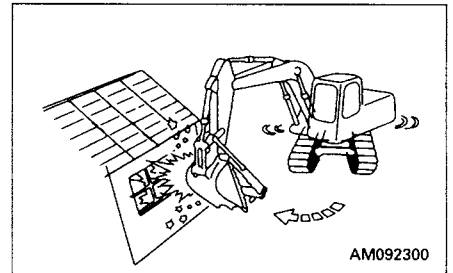

Grabbing a object using buckets on only one side

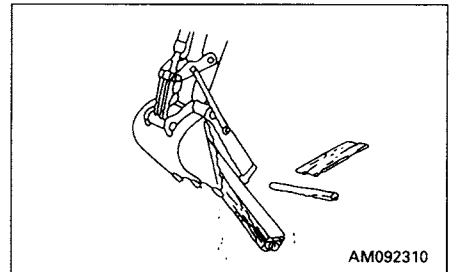

Closing the sub-bucket with the boom and arm fully extended.

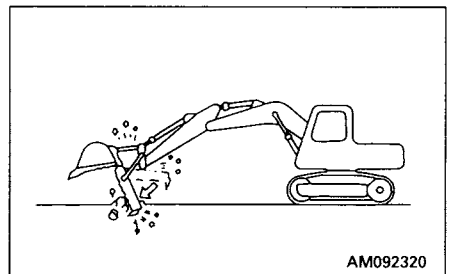

Impact operation with no load

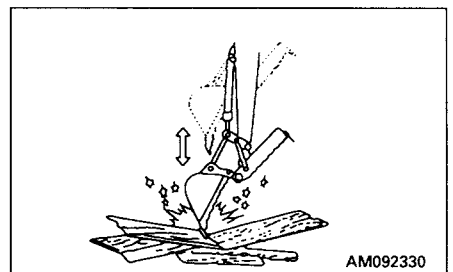

### 32.5 SCRAP GRAPPLE

#### MAIN FIELDS OF APPLICATION

- Disposal of rock or debris

This attachment is mounted to the arm end and used to grasp rock, debris etc. by opening and closing the claws (3 to 5) corresponding to the extension and retraction of the hydraulic cylinder.

#### MISTAKEN METHODS OF USE

To ensure that the machine has a long life, and to ensure that operations are carried out in safety, do not operate the machine in any of the following ways.

- Do not operate the cylinder to the end of its stroke.  
Always leave approx. 5 cm (2 in) to spare.

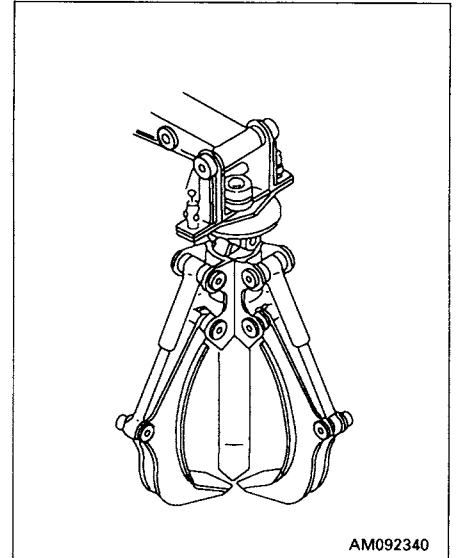

Operations using the swing force

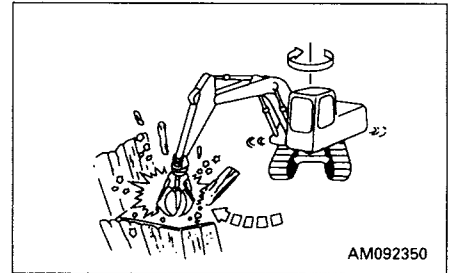

Operations using one side of work equipment

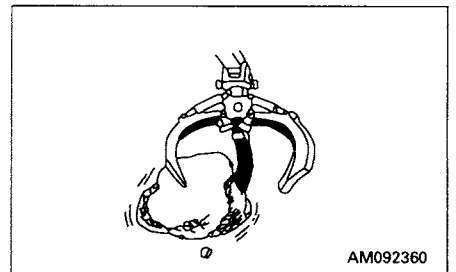

Catching and dragging with claw end

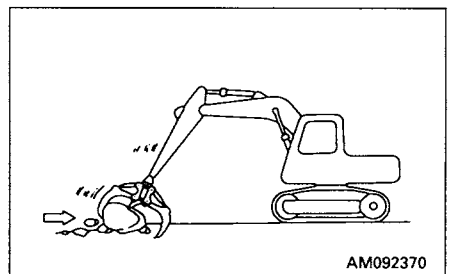

Gouging

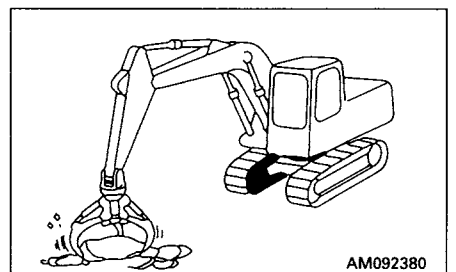

## 32.6 CRUSHER AND CUTTER

### MAIN FIELDS OF APPLICATION

- Demolition
- Road repair work

This is the optimum attachment for demolition of steel frame reinforced structures, and for crushing of concrete blocks and rock, etc. The unique blade shape provides heavy crushing power.

### MISTAKEN METHODS OF USE

To ensure that the machine has a long life, and to ensure that operations are carried out in safety, do not operate the machine in any of the following ways.

- Do not operate the cylinder to the end of its stroke.  
Always leave approx. 5 cm (2 in) to spare.

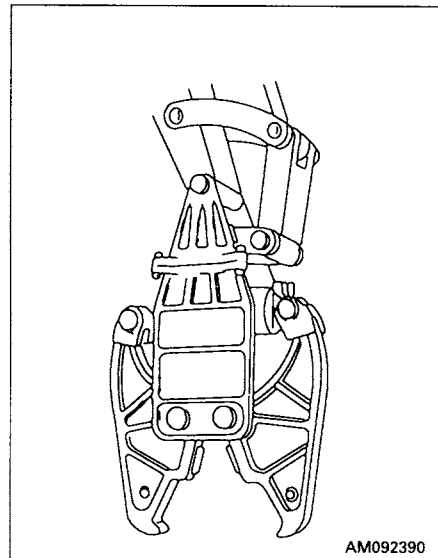

Operations using cutting tip on one side only

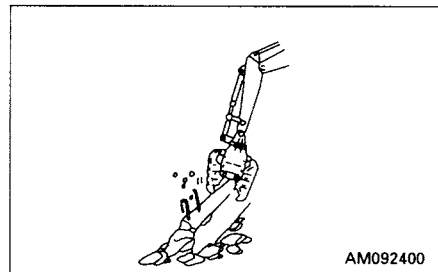

Impact operation with no load

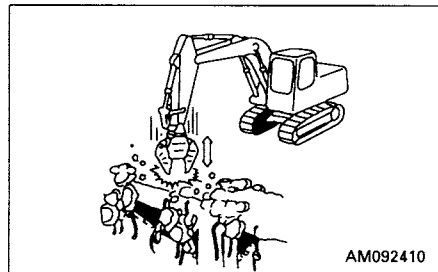

Twisting operations at end of cylinder stroke

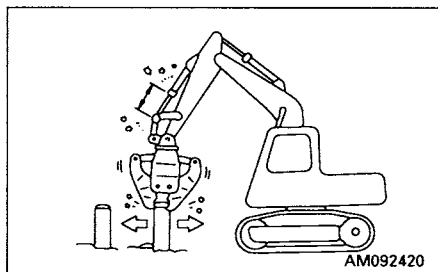

Sudden gripping and breaking operations

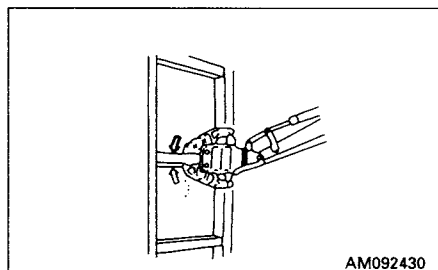

### 32.7 HYDRAULIC PILE DRIVER

#### MAIN FIELDS OF APPLICATION

- Foundation work
- River work
- Water supply and sewerage

This is a piling machine employing the hydraulic power source of the excavator. The machine features a long arm and a chuck unit movable by 360°. This facilitates operations such as driving and removing long piles, driving in piles at corners, vertical driving etc.

#### MISTAKEN METHODS OF USE

To ensure that the machine has a long life, and to ensure that operations are carried out in safety, do not operate the machine in any of the following ways.

- Do not operate the cylinder to the end of its stroke.  
Always leave approx. 5 cm (2 in) to spare.

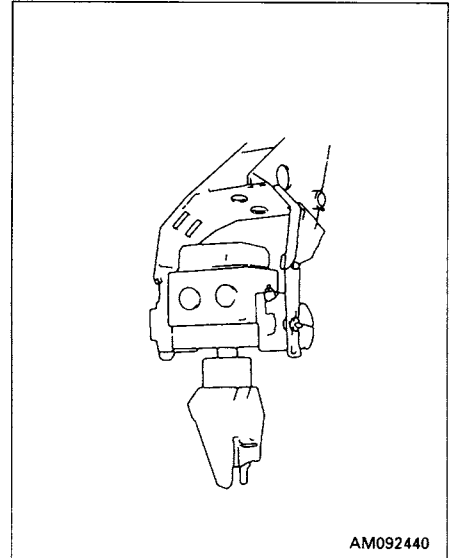

Forward or swing motion while grasping a pile

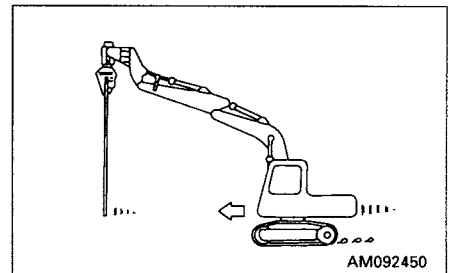

Lifting more than two piles at the same time

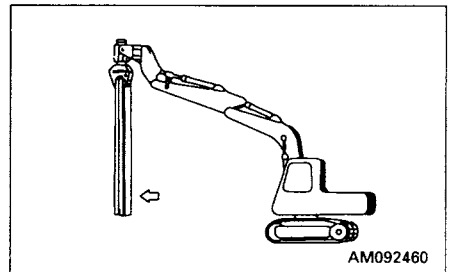

Work other than standard works

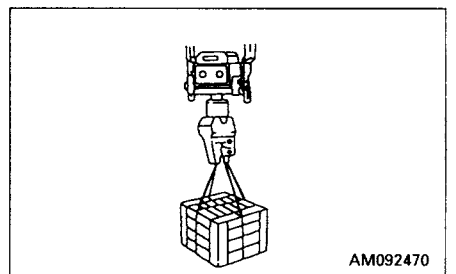

Loading or unloading a machine equipped with hydraulic pile driver

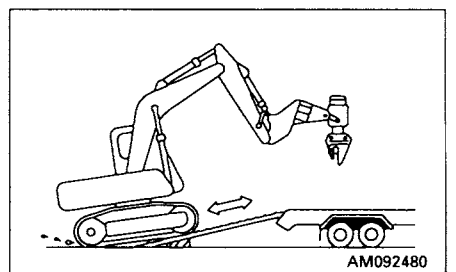

## 32.8 HYDRAULIC EXCAVATOR WITH MULTI-PURPOSE CRANE

### MAIN FIELDS OF APPLICATION

- Site preparation
- Water supply and sewerage
- River work
- Agricultural, civil engineering work

Crane operation can be carried out without removing the bucket.

This machine is used for laying U section gutters and hume pipes for water supply and sewerage as well as river and canal work, agricultural, civil engineering work and site preparation.

### MISTAKEN METHODS OF USE

To ensure that the machine has a long life, and to ensure that operations are carried out in safety, do not operate the machine in any of the following ways.

- Do not operate the cylinder to the end of its stroke.  
Always leave approx. 5 cm (2 in) to spare.

Abrupt lever operation

Traveling with a suspended load

Operating other work equipment during crane operation

Excessive lengthening of wire rope

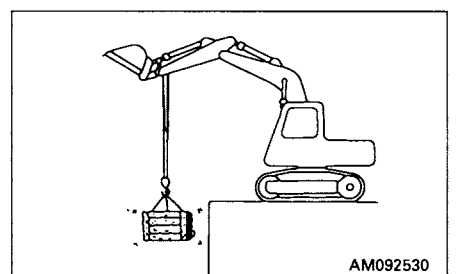
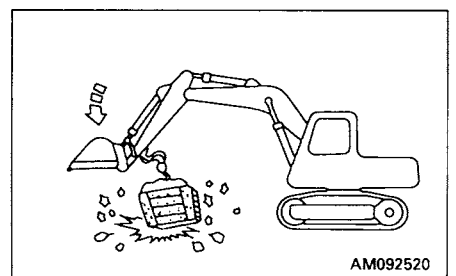
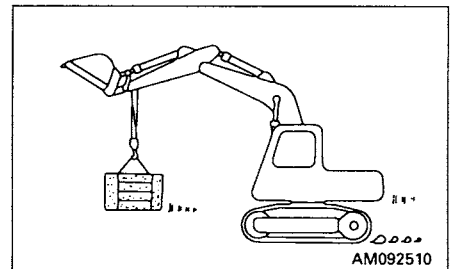
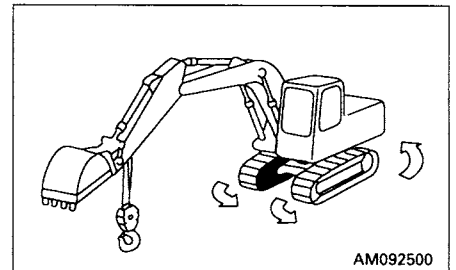
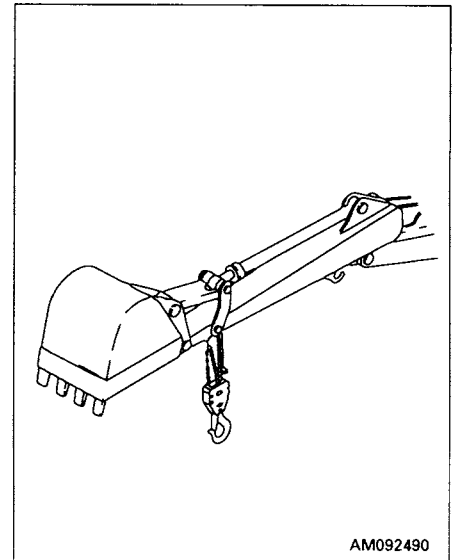



## 33. AUTO-GREASING SYSTEM

### 33.1 AUTO-GREASING CONTROLLER

**WARNING**

- If any abnormality occurs in the controller, see "34.2 ACTION WHEN ABNORMALITY OCCURS", and please report the information to your Komatsu distributor and ask for repairs.
- When operating the controller, please consult your Komatsu distributor for advice.

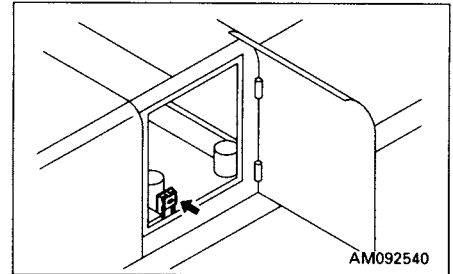

The auto-greasing controller is inside the door at the rear of the fuel tank.

This controller carries out control of the auto-greasing system.

#### REMARK

Even if the greasing controller or greasing pump suffers any damage and its function stops, greasing can be carried out from the divider valve (3 places) using a grease gun.

- The greasing points for the auto-greasing controller are as shown in the diagram on the right.

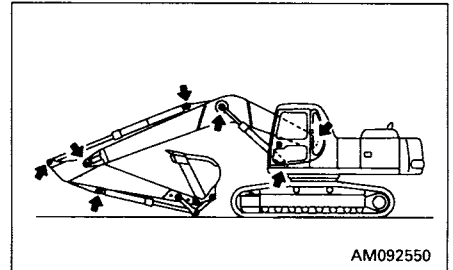

- Carry out greasing with the grease gun every 50 hours for the arm-link connection pin (1 point), arm-bucket connection pin (1 point), link connection pin (2 points), bucket cylinder rod end (1 point), bucket link connection pin (1 point). For details, see "33.4.1 GREASING".

### 33.2 ACTION WHEN ABNORMALITY OCCURS

If auto-greasing pilot lamp (green) ① on top of the side cover at the right side of the machine monitor goes out and the buzzer sounds, open the door at the rear of the fuel tank and note the display on display portion A of greasing controller ②. Inform your Komatsu distributor of the content of the display.

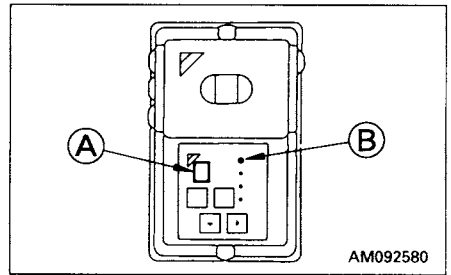
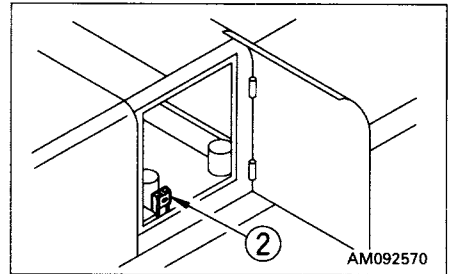
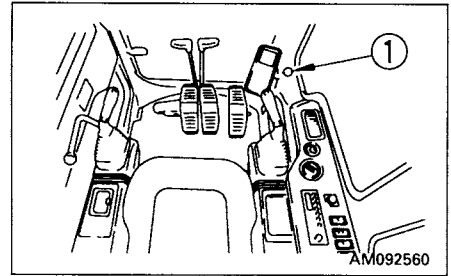

Display	Failure mode	Main causes	Remedy
<ul style="list-style-type: none"> <li>● <b>E</b> and <b>b</b> flash in turn</li> </ul>	Abnormally high pressure	<ul style="list-style-type: none"> <li>● Grease cartridge is being operated empty</li> <li>● Grease leaking from main grease piping (piping from pump to divider valve)</li> <li>● Grease leaking from divider valve</li> <li>● Defective pump</li> </ul>	<ul style="list-style-type: none"> <li>(● Bleed air from grease pump)</li> <li>● Replace grease cartridge</li> <li>(● Inspect, repair)</li> <li>(● Replace)</li> <li>(● Replace)</li> <li>(● Replace)</li> </ul>
<ul style="list-style-type: none"> <li>● <b>E</b> and <b>b</b> flash in turn</li> </ul>	Abnormal loss of pressure	<ul style="list-style-type: none"> <li>● Defective pump</li> </ul>	<ul style="list-style-type: none"> <li>(● Replace)</li> </ul>
<ul style="list-style-type: none"> <li>● <b>E</b> and <b>c</b> flash in turn</li> </ul>	Abnormal pressure detection		
<ul style="list-style-type: none"> <li>● No display <input type="checkbox"/> Power source LED <b>B</b> is off</li> </ul>	Abnormal flow of electricity	<ul style="list-style-type: none"> <li>● Blown fuse</li> </ul>	<ul style="list-style-type: none"> <li>(● Replace)</li> </ul>

### 33.3 CHECK BEFORE STARTING

#### 33.3.1 CHECK AMOUNT OF GREASE IN GREASE CARTRIDGE FOR AUTOMATIC GREASING, REPLACE GREASE CARTRIDGE

**⚠ WARNING**

The tank has a built-in compressed spring, so be careful when installing or removing tank cover ①.

1. Open the door at the rear of the operator's cab, and check the height of grease cartridge ② inside tank cover ①.
2. If the height of grease cartridge ② is lower than mark A on tank cover ①, replace grease cartridge ② with a new cartridge.

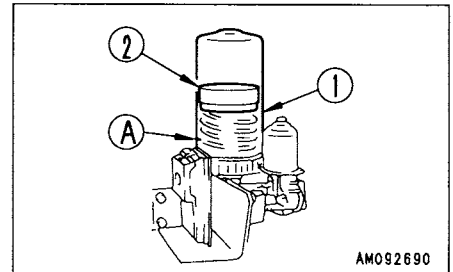

#### METHOD OF REPLACING GREASE CARTRIDGE

1. Turn tank cover ① to the left to remove it.
2. Turn empty grease cartridge ② to the left to remove it.
3. Remove cap ③ and plug ④ from the new grease cartridge.

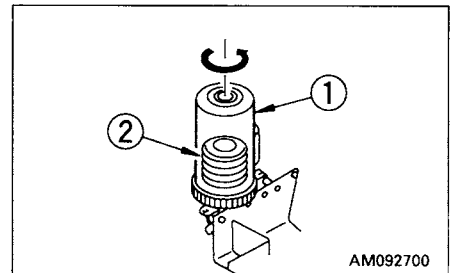

3. Remove cap ③ and plug ④ from the new grease cartridge.

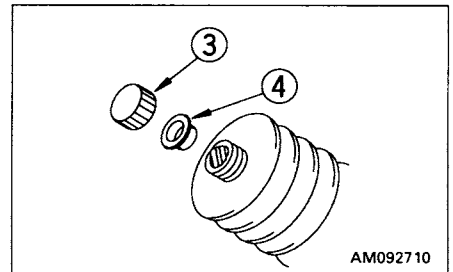

4. Press the grease cartridge slightly so that grease comes out from the mouth, then screw the cartridge (approx. 5 turns) securely into suction port mouthpiece ⑤.
5. Tighten tank cover ① (approx. 1/3 turns) securely until the lock is engaged.

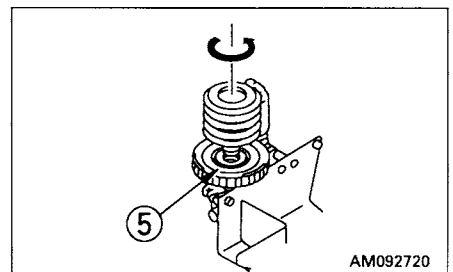

#### NOTICE

When changing the grease cartridge from the standard type to the cold area type, or from the cold area type to the standard type, please contact your Komatsu distributor.

Select the grease from the following table according to the ambient temperature.

Greasing point	Type of lubricant	Ambient temperature								Capacity (ℓ)
		-22 -30	-4 -20	14 -10	32 0	50 10	68 20	86 30	122°F 40°C	
Cartridge for auto- matic greasing Inside grease piping	Grease	NLGI No.2 (※1)								1 cartridge 1.0 + inside grease piping 1.5
		NLGI No.0 (※1)				(※2)				

※1: There are two types of automatic greasing cartridges available: the standard type (NLGI No. 2) and the cold area type (NLGI No. 0).

When changing the automatic greasing cartridge from the standard type to the cold area type, or from the cold area type to the standard type, please contact your Komatsu distributor.

Unless otherwise specified, a standard cartridge (NLGI No. 2) is installed when the machine is shipped from the factory.

The part numbers are as follows.

Standard cartridge: 20Y-70-25480

Cold area cartridge: 20Y-70-25490

When ordering the cartridge, check the part number in the parts book.

※2: If the cold area type grease (NLGI No. 0) is used in warm areas, some grease will drip from the ends of the work equipment pins, but there is no problem in the lubricating performance.

### 33.4 EVERY 50 HOURS SERVICE

#### NOTICE

For the first 100 hours of operation on new machines, carry out greasing every 10 hours.

#### 33.4.1 GREASING

1. Set the machine to the greasing posture shown below, lower the work equipment to the ground, then stop the engine.
2. Using a grease gun, pump in grease through the grease fittings marked by arrows.
3. Wipe off any old grease that is pushed out.

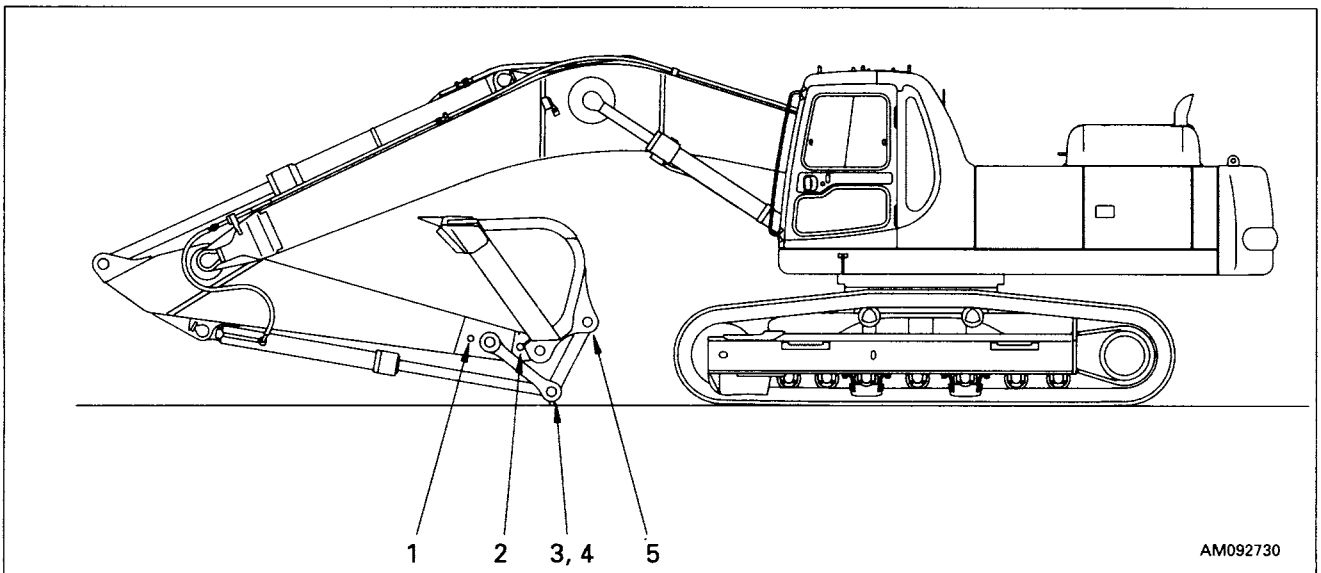

1. Arm-link connection pin (1 point)
2. Arm-bucket connection pin (1 point)

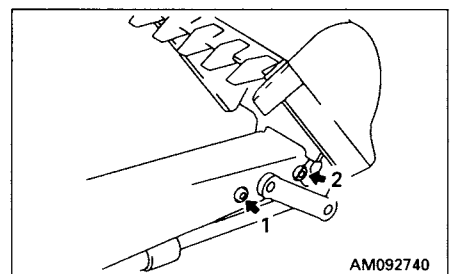

3. Link connection pin (2 points)
4. Bucket cylinder rod end (1 point)
5. Bucket-link connection pin (1 point)

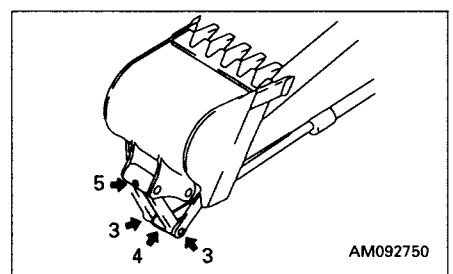

**PC400, 400LC, 450, 450LC-6 HYDRAULIC EXCAVATOR**

---

Form No. SEAM051900T