

SEAM05660503

Operation & Maintenance Manual

KOMATSU

HD352-5

WHEEL LOADER

SERIAL NUMBER
HD325-12264 and up

FOREWORD

This manual describes procedures for operation, handling, lubrication, maintenance, checking, and adjustment. It will help the operator or anyone realize peak performance through effective, economical and safe machine operation and maintenance.

- Please read this manual carefully BEFORE operating the machine.
- Please continue studying this manual until proper operation is completely reinforced into personal habit.
- This manual describes the basic techniques. Skill is performed as the operator or anyone get the correct knowledge and performance of the machine.
- Operation, inspection, and maintenance should be carefully carried out, and the safety must be given the first priority. Safety precautions are indicated with  marks and technical precautions with ★ marks in this manual. The safety information contained in this manual is intended only to supplement safety codes, insurance requirements, local laws, rules and regulations.
- Some photographs and illustration pictures are different from your machine as technical improvement is continuously reflected on it. Revision to up-to-date manual's content is performed in later editions.
- This operation & maintenance manual may contain attachments and optional equipment that are not available in your area. Please consult your local Komatsu distributor for those items you may require.
Materials and specifications are subject to change without notice.

BREAKING IN YOUR NEW MACHINE

Operate your dump truck gently for the first *100 hours (refer to service meter) or so to break in all moving parts. The machine has been fully inspected and adjusted before shipment.

If you operate it up to the limit of its capacity during the break-in period, its potential of performance will be prematurely reduced. Use special care for the following points.

- After starting, idle the engine, until the water temperature and oil pressure gauges indicate to the green range. An engine which is not fully broken in will have its operating life reduced if it is operated under load while the oil temperature is low. Warm-up is also important after the break-in period.
 - Avoid heavy-duty works and high-speed traveling.
 - Avoid sudden starts and stops, abrupt acceleration and turning.
 - During the first *250 hours, the services noted below are required together with periodical maintenance.
Change all oils and replace hydraulic oil filter, transmission oil filter and fuel filter, and check engine valve clearance.
(Refer to EVERY 500 HOURS SERVICE, EVERY 1000 HOURS SERVICE and EVERY 2000 HOURS SERVICE.)
- * Hours of operation are indicated by the service meter.

CONTENTS

OPERATION		MAINTENANCE	
GENERAL LOCATIONS AND SPECIFICATIONS . . .	5	PERIODIC MAINTENANCE	71
INSTRUMENTS AND CONTROLS	6	PERIODICAL REPLACEMENT OF	
CHECK BEFORE STARTING	30	SAFETY PARTS	72
OPERATING YOUR MACHINE	40	MAINTENANCE TABLE	73
METHOD OF RELEASING PARKING BRAKE		OIL FILLER AND LEVEL GAUGE POSITIONS	77
AND EMERGENCY BRAKE WHEN		EVERY 50 HOURS SERVICE	78
ACTUATED IN A EMERGENCY	59	INITIAL 250 HOURS SERVICE	81
INSTRUCTIONS FOR TOWING		EVERY 250 HOURS SERVICE	81
THE MACHINE	61	EVERY 500 HOURS SERVICE	87
DUMP BODY OPERATION	62	EVERY 1000 HOURS SERVICE	91
HANDLING THE TIRES	64	EVERY 2000 HOURS SERVICE	97
COLD WEATHER OPERATION	67	EVERY 4000 HOURS SERVICE	99
		WHEN REQUIRED	100
		ADJUSTMENT	107
		TROUBLE SHOOTING GUIDE	113
		SERVICE METER	118
		MACHINE AND ENGINE SERIAL NUMBERS	119
		FUEL, COOLANT AND LUBRICANTS	120
		OPERATION AND MAINTENANCE	
		(EQUIPPED WITH A ELECTRONIC	
		INSTRUMENT PANEL)	123

GENERAL LOCATIONS AND SPECIFICATIONS

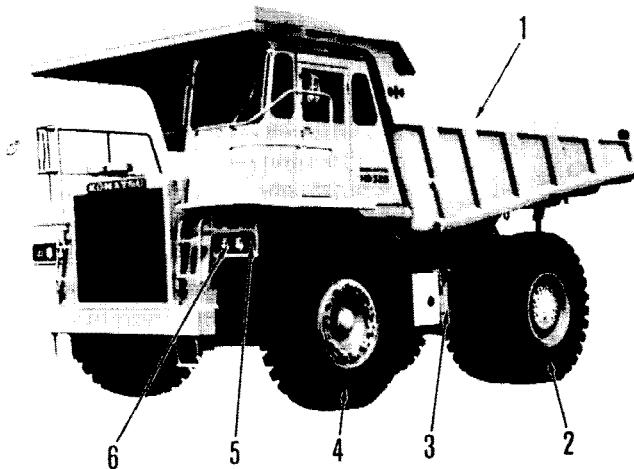

- 1. Dump body
- 2. Rear wheel
- 3. Hydraulic tank
- 4. Front wheel

- 5. Turn signal lamp,
clearance lamp
- 6. Head lamps

WEIGHT

- Gross weight (empty-truck weight + maximum payload + 1 operator): 59255 kg
- Distribution of gross weight
 - Front (32%): 18960 kg
 - Rear (68%): 40295 kg
- Empty-truck weight: 27200 kg
- Operator: 1 (55 kg)

PERFORMANCE

- Traveling speed
 - Forward: Max. 70 km/h
 - Reverse: Max. 11 km/h
- Maximum payload: 32000 kg
- Dump body capacity: 24 m³
- Dumping speed (at 2100 rpm): 10 seconds
- Minimum turning radius: 7200 mm

ENGINE

- Model: Komatsu SA6D140 diesel engine
- Flywheel horsepower (at 2100 rpm): 463 HP

NOTE:

Specifications are subject to change without notice.

INSTRUMENTS AND CONTROLS

1. Emergency brake valve lever
2. Windshield wiper and washer switches

3. Lamp switch
4. Service meter
5. Engine oil pressure gauge

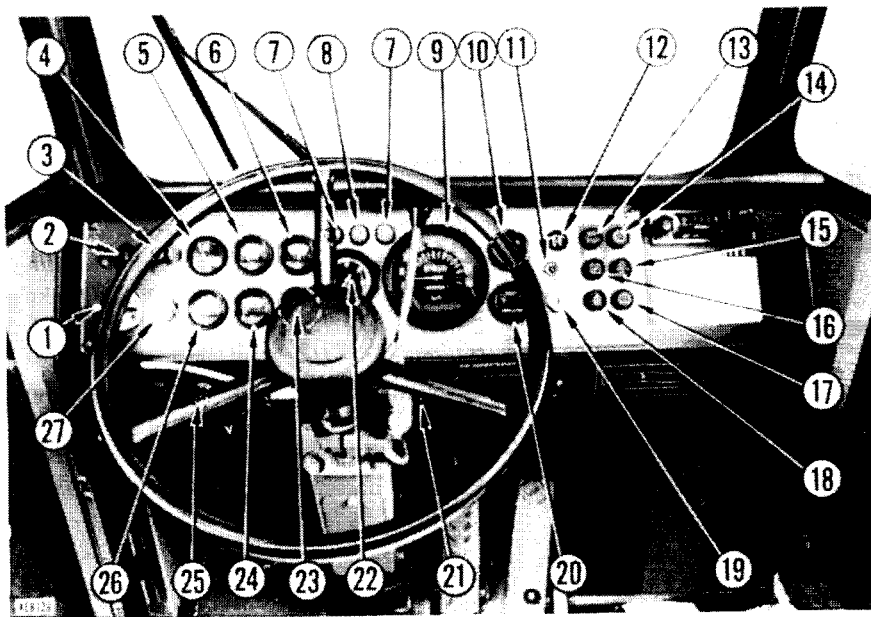

6. Air pressure gauge
7. Pilot lamp for turn signal
8. Pilot lamp for head lamp
9. Speedometer
10. Ammeter
11. Preheater switch
12. Preheating pilot lamp
13. Pilot lamp for kick-down
14. Pilot lamp for retarder
15. Coolant level warning lamp
16. Pilot lamp for parking brake
17. Transmission filter warning lamp
18. Hydraulic filter warning lamp
19. Starting switch
20. Shift indicator
21. Air conditioner switch
22. Tachometer
23. Retarder oil temperature gauge
24. Engine water temperature gauge
25. Cigarette lighter
26. Torque converter oil temperature gauge
27. Emergency steering switch

SERVICE METER

Indicates the total machine operation hours. When the engine is running, a current flows to advance the meter reading even if the machine is not moving.

- ★ When the engine is running, the meter indicator turns to show that the meter is operating.

TORQUE CONVERTER OIL TEMPERATURE GAUGE

- When the pointer of the temperature gauge shows the green range, the oil temperature is normal.
- When the pointer enters the red range, stop the truck immediately, and then keep the gear shift lever at neutral position, and run the engine at medium speed with no load until the oil temperature drops to the normal value.

ENGINE OIL PRESSURE GAUGE

- Oil pressure is normal if the gauge pointer stays in the green range during engine running.
- Immediately after the engine starts, the pointer may deflect beyond the green range. In this case, extend the warm-up running of the engine until the pointer comes into the green range.

ENGINE WATER TEMPERATURE GAUGE

- Water temperature is normal if the pointer stays in the green range during running of the engine.
- After starting the engine, warm up the engine sufficiently until the pointer comes into the green range.
- If the pointer deflects beyond the green range to red range during driving of the truck, reduce the engine speed to medium speed and maintain this until the pointer returns to the green range.

AIR PRESSURE GAUGE

During operation, this should normally register in the green range.

If the green range is not reached, the central warning lamp will light red and a buzzer will sound. When this happens, stop operation and keep the engine speed raised until the pointer enters the green range.

PILOT LAMP FOR TURN SIGNAL (GREEN)

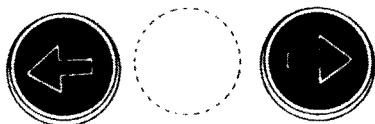

This pilot lamp flashes when the turn signal switch is operated.

RETARDER OIL TEMPERATURE GAUGE

The pointer staying in the green range indicates a normal oil temperature.

When the pointer goes beyond the green range into the red range during operation of the engine, stop the machine (with the engine held running) and hold the engine to revolve at 2000 rpm until the pointer goes back to the green range.

TACHOMETER

The tachometer indicates the engine speed in revolutions per minute. When the pointer enters the red range, it indicates that the engine is over running. The tachometer should not be allowed to enter the red range by braking the running speed.

- ★ When the engine speed reaches 2500 rpm, the retarder brake works automatically to reduce engine speed and slow down the machine. Do not use this function unless absolutely necessary.

SPEEDOMETER

The speedometer indicates the truck running speed in kilometer per hour. An odometer is built in the speedometer.

AMMETER

- The pointer in the green range indicates battery charging.
- The pointer in the red range indicates battery discharging.
- The battery charging circuit is normal, if the pointer shows the green range during engine operation.

PILOT LAMP FOR HEAD LAMP (BLUE)



This pilot lamp comes on when the head lamp is on high beam.

PILOT LAMP FOR KICK-DOWN



This pilot lamp comes on when the machine is in kickdown.

This machine is provided with kick-down memory. When the accelerator pedal is fully depressed, the kickdown operates and this pilot lamp comes on. Because of the kickdown memory, the lamp stays on even after the pedal returns. The lamp will go off after the pedal returns much further.

(Refer to section "OPERATING YOUR MACHINE.")

PILOT LAMP FOR RETARDER (ORANGE)



This pilot lamp lights up when the retarder brake is on.

PILOT LAMP FOR PARKING BRAKE (RED)



This pilot lamp lights up when the parking brake is applied by operation of the parking brake valve lever.

COOLANT LEVEL WARNING LAMP (RED)



This lamp lights up to warn of an abnormal drop of the coolant level in the radiator.

When this lamp lights up, stop the engine, correct the problem, and add water.

HYDRAULIC FILTER WARNING LAMP (RED)



This lamp lights up to warn of a clogged element in the hydraulic oil filter.

If this lamp lights (when the oil is warm in high idle), stop the engine. Replace the hydraulic oil filter element.

- ★ The lamp may light when oil temperature is low or dump body is lowering. No abnormality. If the lamp lights up at high idle, stop the engine and replace oil filter element.

TRANSMISSION FILTER WARNING LAMP (RED)



This lamp lights up when the torque converter or transmission filter elements are clogged.

If this lamp lights up (when the oil is warm in high idle), stop the engine. Replace the two transmission filter elements.

The lamp may light when oil temperature is low. No abnormality.

PREHEATING PILOT LAMP

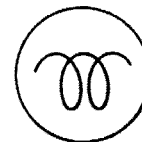

This lamp lights up when electrical heating circuit activates.

SHIFT INDICATOR

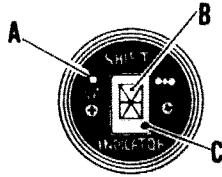

Indicates

- A: Lock up lamp "ON" (Green)
 B: Indicates speed range (Red)
 C: Indicates speed sensor condition (Red)

Indicates what gear the transmission is in. When the lock-up clutch is applied, the lock-up lamp (green) in the meter lights up to show direct drive travel. The lamp on the lower right side indicates the operation of the speed sensor.

CENTRAL WARNING LAMP (RED)

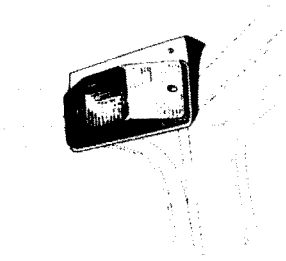

In case any abnormality occurs, this warning lamp lights and warning buzzer sounds. Then, immediately stop machine and check the causes.

- i) **Air pressure is lower than the specified value;**
 Check the air leakage point.
 After the repair, wait for the rise of air pressure.

- ii) **Retarder oil temperature exceeds the allowable limit;**
 Stop machine and wait for the lowering of the temperature under idling the engine at 2000 rpm.
- iii) **Gear shift lever is placed in any speed range other than NEUTRAL position during parking brake or emergency brake is applied;**
 Release parking brake or emergency brake.
- iv) **Gear shift lever is placed in any speed range other than NEUTRAL and the dump lever in a position other than FLOAT;**
 Shift the dump lever to the FLOAT position.
- v) **When the coolant level in the radiator drops because of leakage or some other reason;**
 Correct the trouble which caused the level drop and add water.

EMERGENCY BRAKE VALVE LEVER

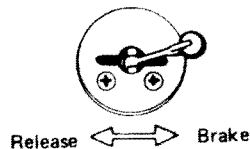

When this lever is placed in the brake position, the emergency brake is applied.

When it is placed in the release position, the emergency brake is released to allow the machine to travel.

- ★ If the pressure in the main air reservoir drops below 2.2 kg/cm^2 because of air leakage or other compressor or air circuit trouble, the emergency relay valve operates the emergency brake to automatically stop the machine.
- ★ The central warning lamp lights up and the warning buzzer sounds while the emergency brake is applied.
- ★ If some trouble in the air system causes the emergency brake to be applied, see the section "RELEASE OF EMERGENCY BRAKE".

WINDSHIELD WIPER AND WASHER SWITCHES

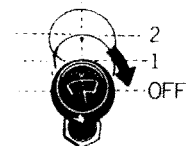

The windshield wiper starts to operate at low speed, when the switch is put in the "1" position.

The wiper moves quickly when the switch is moved to the "2" position.

When the switch is turned clockwise until it stops, the switch changes its function to the windshield washer switch and causes solvent to be sprayed on the front windshield.

LAMP SWITCH

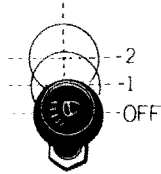

When the lamp switch is put in the “1” position, the side clearance lamp, instrument lamps and tail lamps are lighted.

In the “2” position, the head lamps are lighted, with the aforementioned lamps kept lighted.

EMERGENCY STEERING SWITCH



This switch serves to actuate the emergency steering pump. Depressing the switch causes the emergency pump to operate, and makes it possible to steer the machine. Depressing the switch further causes the pump to stop.

- ★ When the switch is ON, a pilot lamp in the switch lights.
- ★ Press this switch to turn off immediately after stopping the machine.

! Do not use emergency steering continuously for more than 3 minutes.

- ★ The travel speed shall be 5 km/h or less.
- ★ At emergency steering operation, it is able to raise the body with dump control lever. (Also it is able to do this at loaded condition.)

INSTRUMENTS AND CONTROLS

TURN SIGNAL SWITCH

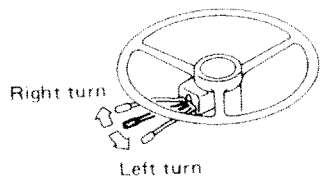

The turn signal switch lever, which is also used as the dimmer switch lever, is used when the truck changes its travelling direction.

When turning to the left, the switch lever is moved toward the operator. When turning to the right, the lever is moved forward. With the aforementioned operation, the respective turn signal lamp starts to blink. Simultaneously, the signal pilot lamp on the instrument panel starts to blink.

DIMMER SWITCH

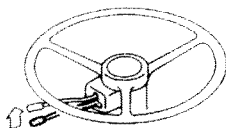

The dimmer switch lever is also used as the turn signal switch lever.

This switch chooses beam direction of the head lamp, either for high beam or low beam.

When the lever is pulled up, high and low beams appear alternately.

★ When the head lamp is switched to high beam, the pilot lamp for the head lamp lights up.

CIGARETTE LIGHTER



Depress the knob and wait for several seconds until it is returned automatically to its original position. Then the lighter is ready to use.

HORN BUTTON

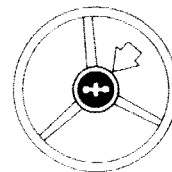

Depress the center of the steering wheel to actuate the horn.

PREHEATER SWITCH

This switch is used to warm the intake air in cold weather.

When switch is released:

When the ambient air temperature drops below approx. -5°C , automatic preheating is carried out according to the ambient temperature.

When switch is pressed in:

When the preheater switch is pressed, preheating starts. In cold conditions, this is used for post-heating after starting the engine or if the engine will not start with only AUTO preheating.

- ★ When the switch is released at the ON position, it returns to the AUTO position.

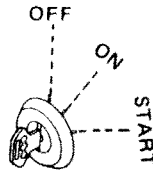
STARTING SWITCH**OFF**

The key can be inserted and pulled out at this position, the switches of all the electric systems are turned off, and the engine is stopped.

ON

In this position power is supplied to the charging circuit and the lamp circuit.

This position will be held after the engine is started.

START

The starting motor starts by turning the switch clockwise further, and the engine is started.

The key will be automatically restored to the ON position by releasing the key.

INSTRUMENTS AND CONTROLS

1. Gear shift lever
2. Retarder control lever
3. Brake pedal
4. Accelerator pedal

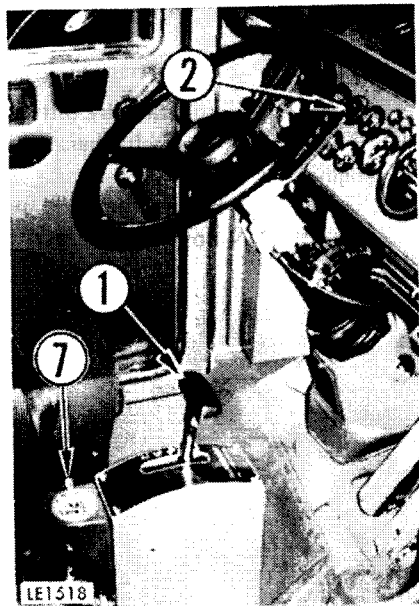

5. Dump lever
6. Safety lock
7. Parking brake valve lever

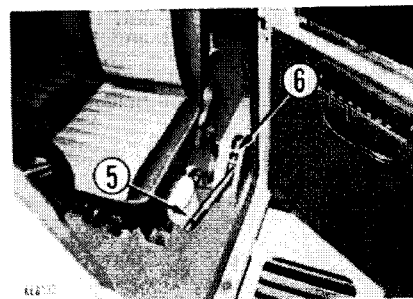
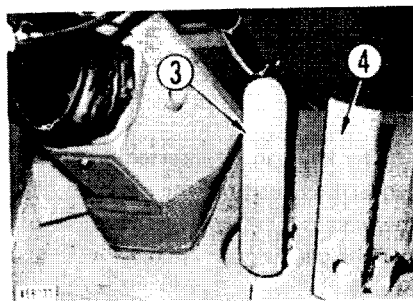

MANUAL GEAR SHIFT LEVER

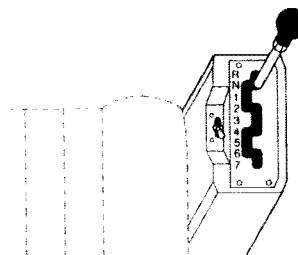

The lever allows the operator most optimum selection of the seven forward and one reverse speeds.

The optimum machine performance is insured in all forward speeds with the aid of the auto-lockup system.

AUTO-LOCK-UP SYSTEM

The revolutions of the transmission input shaft are detected electrically, and the torque converter lock-up clutch works automatically to enable efficient direct drive at 1500 rpm or more. The lock-up lamp lights up when the lock-up clutch operates.

When the speed drops below 1100 rpm, the torque converter lock-up clutch disconnects automatically to enable the torque converter to function, and the lock-up lamp goes off.

- ★ If the gear shift lever is placed at a position other than N with the parking brake locked, the central warning lamp lights up and the alarm buzzer sounds.
- ★ Placing the gear shift lever at a position other than N with the dump lever at a position other than float lights up the central warning lamp and sounds the alarm buzzer.
- ★ Stop the machine completely before reversing the direction of travel.

- ★ When parking the machine on a slope, the parking brake should be applied, since the engine cannot be utilized as a brake. This is due to the fact that the engine is not connected directly to the propeller shaft, no matter which position the gear shift lever is in.
- ★ The engine can not start unless the gear shift lever is in N.

AUTOMATIC GEAR SHIFT LEVER

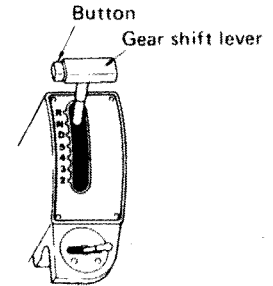

This lever shifts the transmission according to traveling conditions.

Position D:

This position is used for ordinary traveling. The TORQFLOW transmission will automatically adjust the traveling speed, shifting gears from second speed to seventh as necessary.

- ★ The maximum traveling speed is 70 km/h at this setting.

INSTRUMENTS AND CONTROLS

Positions 5 - 2

These positions are used when road conditions are not suitable for high-speed traveling, when traveling on the soft ground or starting up a slope with load and these positions are also used on downhill slopes when it is necessary to use the engine as a brake.

In these positions, the transmission is automatically shifted to give a speed range which matches the travel speed of the machine. The range of shifting for each position is as shown in the table below.

Position	Transmission range	Max. speed (km/h)
5	1st torque converter ~ 5th direct	38
4	1st torque converter ~ 4th direct	28
3	1st torque converter ~ 3rd direct	21
2	1st torque converter ~ 2nd direct	15

- ★ When using the skip shift (for details, see OPERATING YOUR MACHINE), these positions are used to select a speed range to match the slope.

Position R:

Set the lever at this position to back up the truck.

Push in the gear shift lever button to shift the lever to this position.

The torque converter intervenes to adjust the power flow.

Position N:

This is neutral. When starting the engine, be sure to shift the lever to this position.

- ★ Stop the truck completely before reversing the direction of travel.
- ★ If the engine is started with this lever at a position other than N, the engine does not start.
- ★ If the gear shift lever is placed at a position other than N with the parking brake or emergency brake locked, the central warning lamp lights up and the alarm buzzer sounds.
- ★ Placing the gear shift lever at a position other than N with the dump lever at a position other than float lights up the central warning lamp and sounds the alarm buzzer.
- ★ Never move back the gear shift lever to N while traveling.

RETARDER CONTROL LEVER

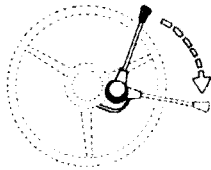

The lever controls the retarder that is used in combination with the rear brake when driving the machine downhill.

The further the lever is pulled, the greater the braking force obtained.

- ★ When the retarder is actuated, the retarder pilot lamp lights.
- ★ For details, refer to section on "DOWNHILL TRAVELING".

⚠ Do not use retarder as for parking brake.

BRAKE PEDAL

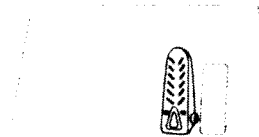

This pedal is used to apply the wheel brakes.

ACCELERATOR PEDAL



This pedal is used to control the engine speed and output over the whole speed range from low idling to full speed.

- ★ For the kickdown control, refer to the section in kickdown under "OPERATING YOUR MACHINE".

DUMP LEVER

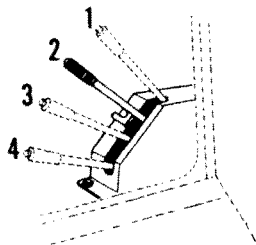

The dump lever is provided to shift the dump body position.

Lever position:

1. RAISE

2. HOLD

The dump body is kept held where it is.

3. LOWER

4. FLOAT

The dump body move freely according to external force.

- ★ Push the button at the tip end of the lever to move the dump lever from the float position.
- ★ Lever should be set in FLOAT position whenever driving.
- ★ See the section on DUMP BODY OPERATION for details.

SAFETY LOCK

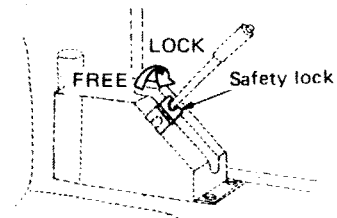

This safety lock serves to lock the dump lever.

- ⚠** When checking machine with dump body kept raised, always lock the dump lever at HOLD position with safety lock.

PARKING BRAKE VALVE LEVER

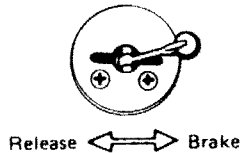

When the parking brake valve lever is put in the "BRAKE" position, the parking brake will be applied to the wheels. Simultaneously, the parking brake pilot lamp is lighted in red.

- ★ In case the gear shift lever is placed in any position other than NEUTRAL while the parking brake is applied, the central warning lamp lights and the buzzer sounds.

- ★ If the brake air pressure drops to 2.2 kg/cm^2 or less, the emergency brake and the parking brake are automatically applied. For the releasing method of the braking force after this emergency application, refer to the section RELEASE OF PARKING BRAKE.

⚠ Apply the parking brake whenever parking machine.

⚠ During loading operations, do not apply the parking brake. Pull the retarder control lever to apply the brake.

DUST INDICATOR

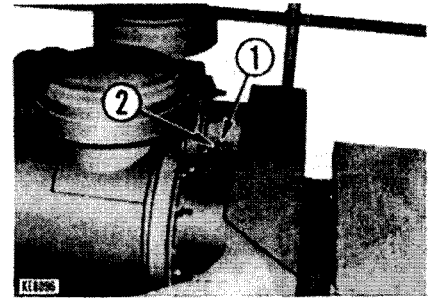

This device indicates clogging of air cleaner elements. When red piston appears in the transparent part of indicator (1), the elements are clogged.

Immediately clean the elements. After cleaning, push indicator button (2) to return the red piston to the original position.

SHIFT CONTROLLER

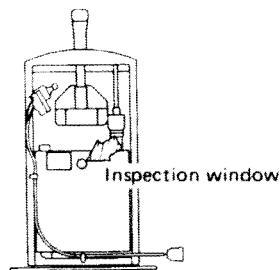

This informs the location of any abnormality in the electronic control equipment for automatic shift.

Inside the inspection window in the cover of the control box, there are one green and one red LED (light emitting diode). The combination of OFF, flashing, ON shows the location of the abnormality.

When the electronic control equipment is normal, red LED goes off and green LED lights.

- ★ For details of LED display when the condition is abnormal, see "TROUBLE SHOOTING GUIDE".

STEERING WHEEL TILT LEVER

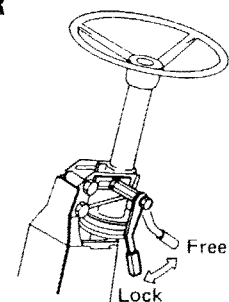

The steering wheel is adjustable within an angle of 5° back and forth and 30 mm up and 20 mm down to allow the operator to select the best posture for operation. Loosen the lever and determine the best position by moving the wheel then tighten the lever.

- ⚠ Fix the handle surely at the best posture for operation.**

SAFETY PIN



The safety pins are used to ensure safety while inspecting and servicing a raised dump body.

- ★ The pins are inserted on both sides of the body when it is raised all the way up.

⚠ When checking machine with dump body kept raised, always lock the dump lever at HOLD position with safety lock, and insert these safety pins.

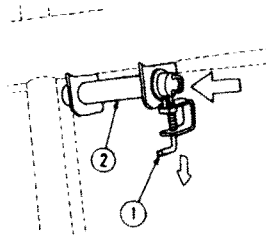

Storage of the safety pins

The pins are stored on the rear underside of the body.

1. Pull rod (1) and insert safety pin (2).
2. Release and set rod (1) into the hole for the safety pin to lock the pin for safe storage.

OPERATING THE RADIO

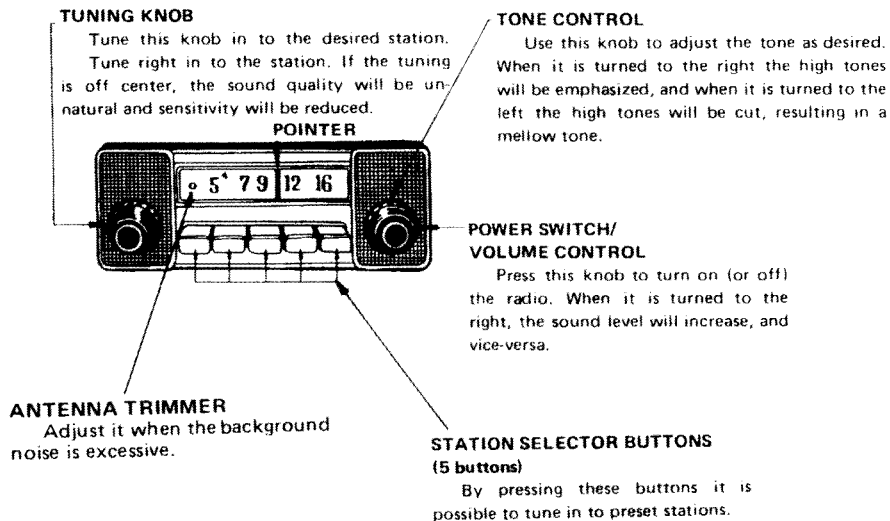

How to set station selector buttons

Set the station selector buttons to the desired stations as shown in the following figure.



1. Pull back the button corresponding to the station to be preselected.

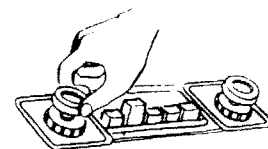

2. Turn the station selector knob until the pointer is in front of the desired station. (Carefully tune in so that noise disappears and the broadcast is heard plainly.)

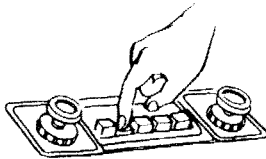

3. Carefully push back the button with the fingertip until it clicks into place.

★ When setting the tuning selector to a strong station, shorten the antenna to reduce the input as far as possible before carrying out alignment.

ADJUSTMENT OF ANTENNA TRIMMER

The antenna trimmer is pre-adjusted, but adjust it as required to reduce the background noise.

Adjustment procedure

1. Fully extend the antenna and pick up a weak radio broadcast having a frequency of 1400 to 1500 KHz.
2. Adjust the trimmer by turning it with a screwdriver until the volume is maximized.

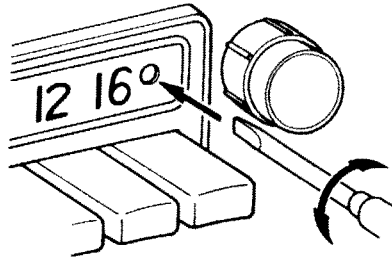

Precautions when using radio

- To prevent possible breakdown, keep water well away from the speaker case and interior of the radio. In particular, close the window during rain or when washing the machine.
- Do not wipe the dial plate or knobs with benzine or paint thinners, etc. Always use a dry, soft cloth (if the radio is particularly dirty, soak the cloth in alcohol).
- Do not disassemble the radio.

FUSE BOX

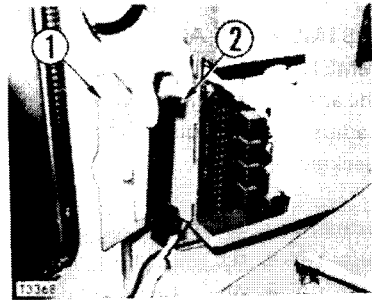

Trouble shooting guide

No sound

- Turn the SW/VOL knob to the right and press it two or three times.

Sound quality is poor

Reception is noisy

- Return using the station selector knob. If the problem disappears, reset the tuning button.
- Try lengthening the antenna to its fullest extent.

The fuses protect the electric devices and wiring from burning out. If any fuse is rusted or coated with white powder, replace it.

Open cover (1) on the fuse box and remove cover (2).

Its fuse can be taken out of place.

- ★ Replace a fuse with another of the same capacity.

⚠ Before replacing a fuse, be sure to turn off the starting switch.

Fuse arrangement and circuit

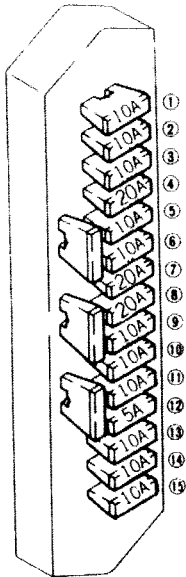

Fuse box

No.	Fuse capacity	Circuit
①	10A	Room lamp, Wiper
②	10A	Radio, Car stereo
③	10A	Turn signal lamp, Cigarette lighter
④	20A	Airconditioner, Engine water temperature gauge
⑤	10A	Torque converter oil temperature gauge, Fog lamp
⑥	10A	Engine stop motor
⑦	20A	Head lamp, Horn valve
⑧	20A	Head lamp, Horn valve
⑨	10A	Parking switch, Emergency steering, Low pressure switch
⑩	10A	Brake switch
⑪	10A	Retarder switch
⑫	5A	Shift controller
⑬	10A	Back up switch
⑭	10A	Retarder oil temperature
⑮	10A	Relay switch (Radiator water level, Retarder oil temperature, Low pressure)

OPERATOR'S SEAT

Set operator's seat as follows for maximum comfort.

Backward-and-Forward Adjustment

Set the seat in the desired position by moving lever (1) to right, then release the lever.

The seat can be adjusted forward or backward 140 mm in 8 steps.

Seat Up and Down Adjustment

Turn knob (2). Match the scale (50 to 100 kg) to operator's weight for optimum seat adjustment.

Reclining Adjustment

Move lever (3) upward, set the back of the seat at the desired position, and release the lever. The seat can be adjusted backward at 32 positions in a range of 62° , and forward at a single position at a 62° angle. A pocket is provided on the rear side of the back of the seat.

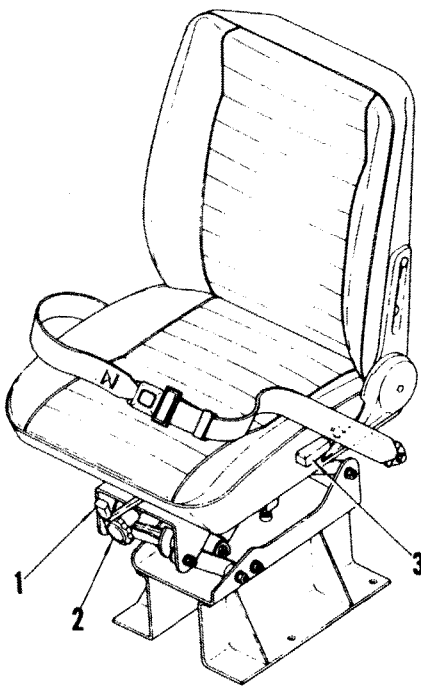

SEAT BELT

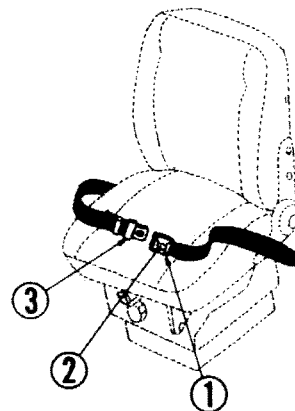

⚠ Before using seat belt, make sure that no unusual conditions are observed in the belt fittings and the belt itself.

FASTENING THE SEAT BELT

1. Sit in the seat and adjust the seat so that your back will be against the backrest when the brake pedal is fully depressed.
 2. Sit in the seat. Holding buckle (1) with your left hand and tongue (3) with your right hand, put the tongue into the buckle. Make sure that the belt is securely locked by pulling the belt.
 3. To remove the belt, press button (2) on the buckle to unlock the belt.
- ★ Make sure the belt is not twisted when fastened. Adjust the belt length on both sides so that the buckle will be positioned in the front center of your body.

ADJUSTMENT OF BELT LENGTH

To shorten the belt:

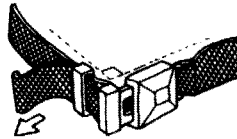

Pull the free end of the belt on the buckle side or tongue side.

To lengthen the belt:

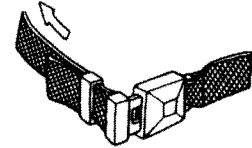

Bend the belt at a right angle to the buckle or the tongue and pull the belt on the fixed side with the buckle or with the tongue.

- ★ Check the belt fixtures on the machine body for loose bolts and retighten the bolts if necessary.
- ★ When the belt gets shabby or worn out, or when the metal parts get damaged or deformed, replace the entire seat belt.

CHECK BEFORE STARTING

The check before starting shall never be neglected as troubles and prevented beforehand by the check.

a. WALK-AROUND CHECK

Look around the machine and under the machine to check for loose nut or bolts, collection of dirt, or leakage of oil, fuel, or coolant, and check the condition of the work equipment and hydraulic system. Check also for loose wiring, play, and collection of dust at places which reach high temperatures.

1. Check for loose battery terminals
2. Check for loose air cleaner mounting bolts
3. Check for leakage of oil from axle
4. Check for leakage of oil from transmission piping
5. Check for leakage of oil and water around engine
6. Check for leakage of water from radiator

b. CHECK COOLING WATER LEVEL

Part the machine on the flat ground, remove cap (1) and confirm that radiator is filled with cooling water up to the depth indicated by shadow portion. If insufficient, refill with water.

- ★ If the volume of cooling water added is more than usual, check for possible water leakage.

- ★ After replenishing the radiator, run the engine at low-idling for 4 or 5 minutes. Then, check the water level again.

! When the water temperature is high, do not remove the cap. When remove the cap, push the button on the cap to release the internal pressure before removing the cap.

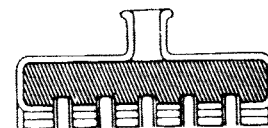
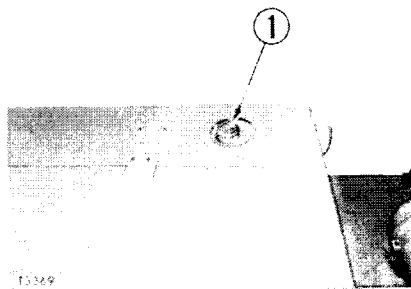

CHECK BEFORE STARTING

c. CHECK FUEL LEVEL

Check the fuel level with sight gauge (G). At the end of a day's job, be sure to refill with fuel from filler (F).

A clogged fuel tank cap breather (1) may lead to interruption of fuel feeding. It is recommended to clean it periodically.

- ★ When adding fuel, never let the fuel overflow. This may cause a fire.
- ★ Fuel capacity: 500ℓ

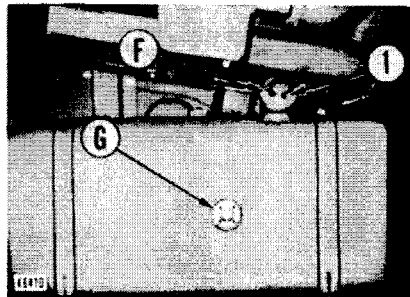

Detail (G)

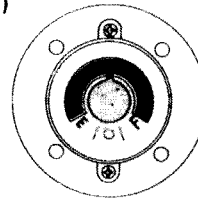

d. CHECK OIL LEVEL IN THE ENGINE OIL PAN

Use dipstick (G) to check the oil level. If necessary, add oil from oil filler (F).

- ★ The type of lubricant used depends on the ambient temperature. Select according to the table "FUEL, COOLANT AND LUBRICANTS".

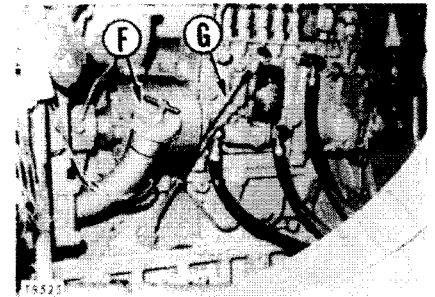

CHECK BEFORE STARTING

- ★ When checking the oil level, park the machine on a level surface, stop the engine and wait for 15 minutes before checking.

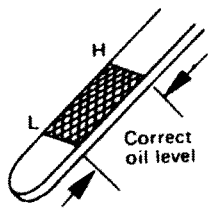

e. DRAIN WATER AND SEDIMENT FROM THE FUEL TANK

Open drain valve (1) of fuel tank to drain accumulated water and sediment.

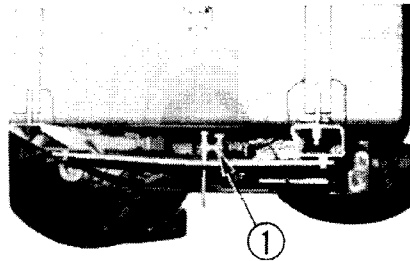

T8528

f. CHECK OIL LEVEL IN THE TRANSMISSION CASE

Check the oil level with sight gauge (G). If the oil level is low, open cover (1) and add engine oil through oil filler (F).

- ★ The type of lubricant used depends on the ambient temperature. Select according to the table "FUEL, COOLANT AND LUBRICANTS".
- ★ Normally, the oil level should be checked before starting the engine. If the check is made after the engine is started, wait for at least an hour after the engine is stopped.

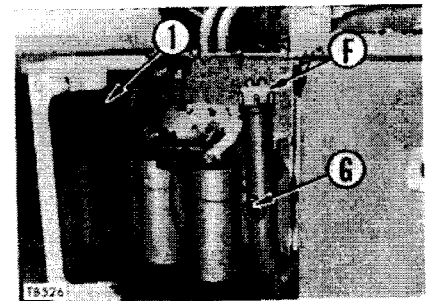

T8526

g. CHECK THE OIL LEVEL IN HYDRAULIC TANK

Lower the dump body before checking the oil level. If the oil level is not between the top and bottom of the red circle on sight gauge (G), add engine oil through oil filler (F).

★ The type of lubricant used depends on the ambient temperature. Select according to the table "FUEL, COOLANT AND LUBRICANTS".

 When removing cap, turn it slowly to relieve the internal pressure.

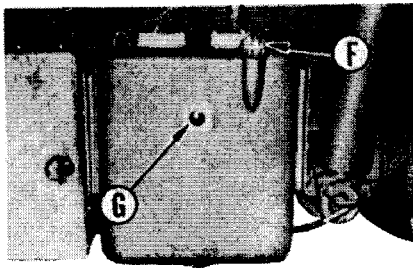

T8524

h. DRAIN WATER FROM THE AIR RESERVOIR

After starting the engine, drain the water from the air reservoir by opening drain valves. Repeat this after completion of the work.

★ Drain water just after the end of work in the cold weather.

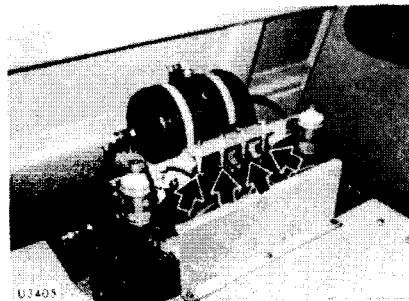

U3405

i. CHECK SUSPENSION CYLINDER LENGTH

See if the bottom end of the suspension covers of front and rear are within the proper range on the label (1) when the machine is on level ground without load.

If out of the proper range, contact your Komatsu distributor for repair.

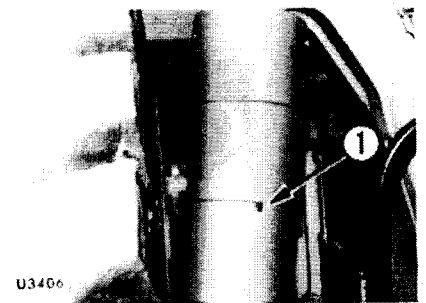
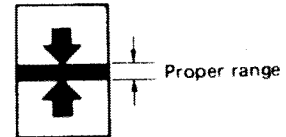

U3406

CHECK BEFORE STARTING

j. CHECK EMERGENCY STEERING

1. Keep the starting switch to "OFF".
2. Turn the emergency steering switch to "ON" and operate the steering wheel for 20 seconds for checking.

★ If the steering wheel does not control, contact your Komatsu distributor for servicing.



k. CHECK HUB NUTS FOR TIGHTNESS

Tighten any loose hub nuts 3 to 4 times in the order illustrated below, to a torque of 55 to 60 kgm. A tightening force of 60 kg applied at one meter on a box wrench away from the center of box produces a torque of 60 kgm. For rear wheels, tighten carrier mounting bolts (three, marked with ※) at a torque of 55 to 60 kgm after tightening hub nuts.

- ★ When a wheel has been remounted, as after tire replacement, tighten hub nuts once again after running for 5 or 6 kilometers.

Compared with front wheels, rear wheels take longer for the contact surfaces to fit well with each other. Repeat retightening hub nuts until about 50 hours after replacing wheels.

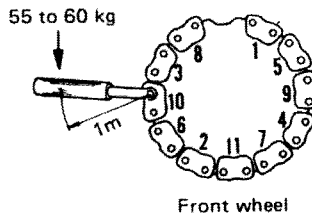

Tightening order

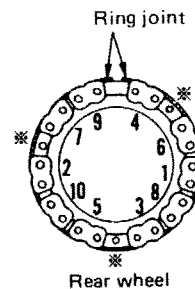

I. CHECK TIRES FOR PROPER INFLATION PRESSURE AND DAMAGE

Check for tire inflation pressure before daily operation while the tires are still cold. At the same time, carefully check the tires for slight wounds and abrasion, and remove sticking nails or pieces of metal.

The tire has some damages as shown in section HANDLING THE TIRES, replace with new tire.

Standard inflation pressure

18.00-33-28PR	5.0 kg/cm ²
18.00-33-32PR	5.75 kg/cm ²
18.00-25-32PR	5.75 kg/cm ²

m. CHECK DUST INDICATOR

When the red-colored piston of dust indicator (1) is shown, clean or replace the air cleaner elements immediately.

Refer to the section WHEN REQUIRED for how to clean the elements.

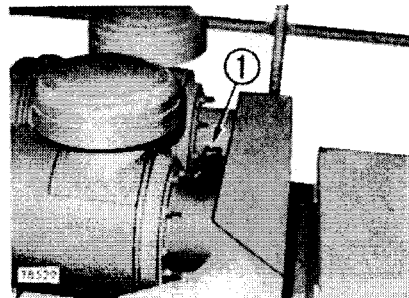

n. CHECK CENTRAL WARNING LAMP

Perform following checks to find the mal-function of buzzer or bulb.

- Stop the engine, place the starting switch ON and the parking brake valve lever in BRAKE, and the gear shift lever in any position other than NEUTRAL.

If the lamp lights, it is normal.

- Place the starting switch key in ON when air pressure is below the specified value.

If the lamp lights and the buzzer sounds, they are normal.

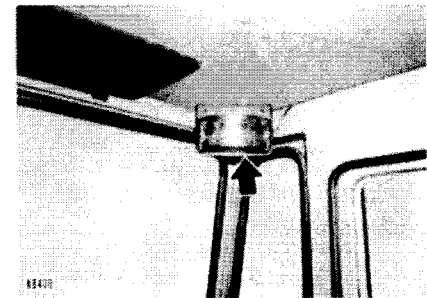

CHECK BEFORE STARTING

o. CHECK OIL LEVEL IN FRONT BRAKE OIL RESERVOIR

If the oil is not between the FULL and LOW marks of the oil reservoir, add engine oil (CD class SAE10W regardless of ambient temperature) through oil filler (F).

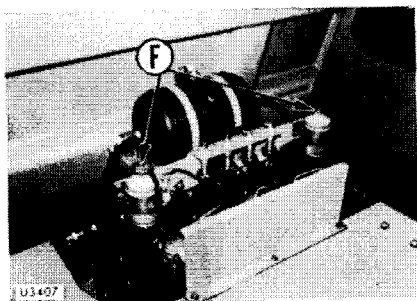

p. CHECK BRAKING ACTION OF FOOT BRAKE

Carry out checks before starting, and if the effect of the brakes is poor, adjust the brakes.

For details, see "Adjustment of parts".

Check braking capacity of foot brake

Check the capacity of the foot brake as follows.

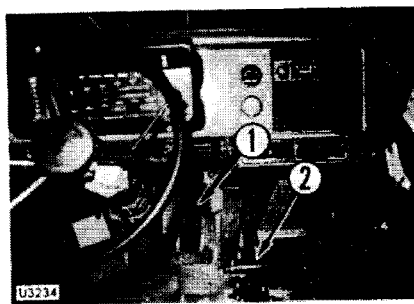

Automatic transmission

1. Raise the air pressure to the maximum, stop the machine on level ground and depress foot brake (1) on level ground.
2. Place gear shift lever (2) in the "D" position, gradually increase the engine speed, and check that the machine does not move even when the engine speed reaches 1450 rpm.

Manual transmission

1. Raise the air pressure to the maximum, stop the machine on level ground and depress foot brake on level ground.
2. Place gear shift lever in the "3" position, gradually increase the engine speed, and check that the machine does not move even when the engine speed reaches 1700 rpm.

q. CHECK BRAKING ACTION OF RETARDER BRAKE

Carry out checks before starting.

Check braking capacity of retarder brake

Check the capacity of the retarder brake as follows.

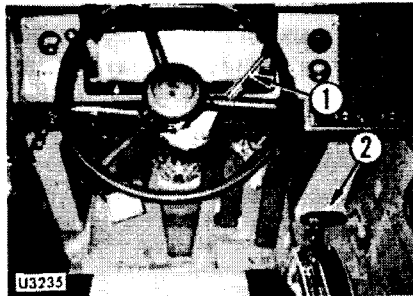

Automatic transmission

1. Raise the air pressure to the maximum, stop the machine on level ground and pull retarder lever (1) fully.
2. Place gear shift lever (2) in the "D" position, gradually increase the engine speed, and check that the machine does not move even when the engine speed reaches 1250 rpm.

Manual transmission

1. Raise the air pressure to the maximum, stop the machine on level ground and pull retarder lever fully.
2. Place gear shift lever in the "4" position, gradually increase the engine speed, and check that the machine does not move even when the engine speed reaches 1700 rpm.

r. CHECK BRAKING ACTION OF PARKING BRAKE

Check after completing work.

Check braking capacity of parking brake

Check the capacity of the parking brake as follows.

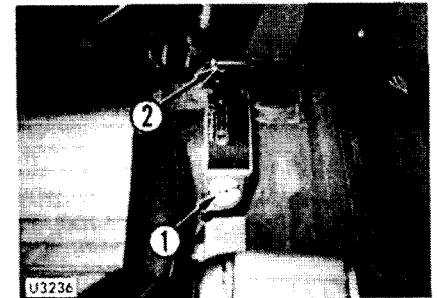

CHECK BEFORE STARTING

Automatic transmission

1. Raise the air pressure to the maximum, stop the machine on level ground and place parking brake lever (1) in the PARKING position.
2. Place gear shift lever (2) in the "D" position, gradually increase the engine speed, and check that the machine does not move even when the engine speed reaches 1100 rpm.

Manual transmission

1. Raise the air pressure to the maximum, stop the machine on level ground and place parking brake lever in the PARKING position.
2. Place gear shift lever in the "5" position, gradually increase the engine speed, and check that the machine does not move even when the engine speed reaches 1700 rpm.

s. CHECK BRAKING ACTION OF EMERGENCY BRAKE

Carry out checks before starting.

Check braking capacity of emergency brake

Check the capacity of the emergency brake as follows.

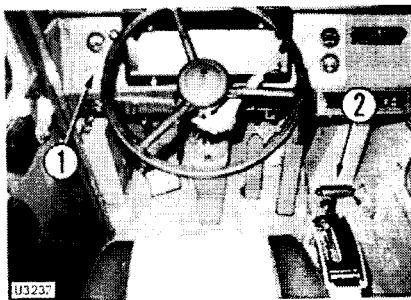

Automatic transmission

1. Raise the air pressure to the maximum, stop the machine on level ground and place emergency brake lever (1) in the braking position.
2. Place gear shift lever (2) in the "D" position, gradually increase the engine speed, and check that the machine does not move even when the engine is at full throttle.

Manual transmission

1. Raise the air pressure to the maximum, stop the machine on level ground and place emergency brake lever in the braking position.
2. Place gear shift lever in the "2" position, gradually increase the engine speed, and check that the machine does not move even when the engine speed reaches 1700 rpm.

- t. CHECK THAT THE STEERING SYSTEM WORKS PROPERLY
- u. CHECK THAT THE REAR AND UNDER-VIEW MIRRORS ARE WELL ADJUSTED
- v. CHECK THAT ALL LAMPS WORK PROPERLY
- w. CHECK THE HORN AND TURN SIGNAL LAMPS
- x. CHECK THAT THE INSTRUMENTS FUNCTION PROPERLY IN OPERATION
- y. CHECK EXHAUST EMISSION AND NOISE
- z. CHECK BODY MOUNT RUBBER

Check cracks, biting unexpected materials, or tightening of bolts.

a'. CHECK ELECTRICAL WIRING

Check for any sign of disconnection or short circuit in the electric wiring. Check also for loose terminals and tighten any loose parts.

Check the following points carefully.

- Battery
- Starting motor
- Alternator

b'. CHECK FOR SEDIMENT AND WATER IN THE WATER SEPARATOR

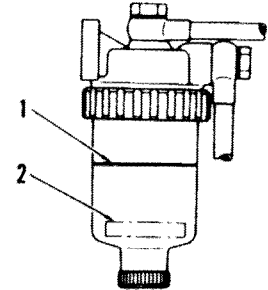

The water separator separates water mixed in the fuel. If float (2) is at or above red line (1), drain the water. For the draining procedure, see section "WHEN REQUIRED".

- ★ Even if a water separator is installed, be sure to check the fuel tank to remove water and sediment in the fuel.

OPERATING YOUR MACHINE

BEFORE STARTING THE ENGINE

Carry out an initial inspection. (For details of the inspection see CHECK BEFORE STARTING.)

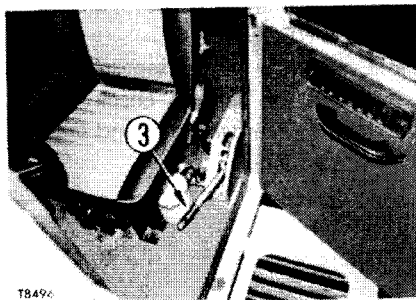
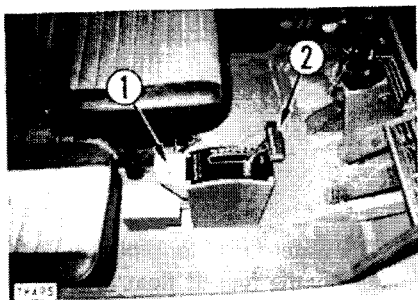

T849c

1. With your back against the back rest of the operator's seat, adjust the seat position so that the brake pedal can be easily depressed.
2. Parking brake valve lever (1) should be placed in "BRAKE" position.

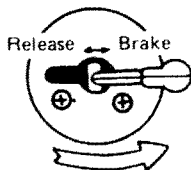

3. Gear shift lever (2) should be put in "NEUTRAL" position.
★ When the shift lever is in any speed position other than "NEUTRAL", the engine will not start.

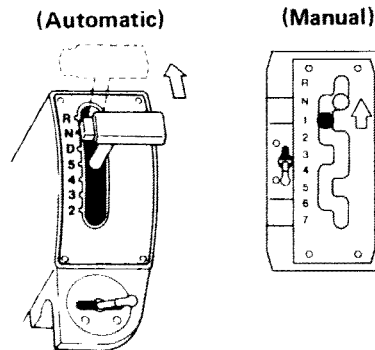

4. Dump lever (3) should be put in "FLOAT" position.

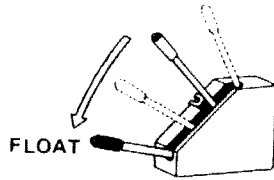

5. Retarder control lever should be in the brake release position.

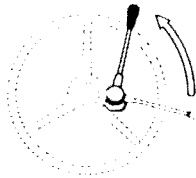

TO START THE ENGINE

1. Slightly depress the accelerator pedal.
2. Turn the starting switch ON, check that the preheating pilot lamp is OFF, then turn the starting switch key to the START position to start the engine.

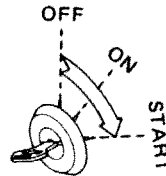

3. Release the switch key, and it returns to ON automatically. Keep the key in this position.

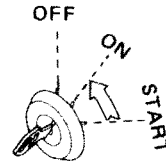

- ★ Do not keep the starting switch key at START for more than 20 seconds.

When the engine fails to start, leave a 2-minute interval before attempting to start engine again.

- ★ To start engine in cold weather, refer to the section "COLD WEATHER OPERATION".

Special starting

When starting after running out of fuel, fill with fuel, then fill the fuel filter cartridge with fuel and bleed the air from the fuel system before starting.

Refer to FUEL FILTER in EVERY 500 HOURS SERVICE.

OPERATING YOUR MACHINE

CHECKS AFTER STARTING

After the engine starts, do not attempt to operate machine immediately, but be careful to observe the followings:

1. Lightly depress the accelerator pedal to run the engine at medium speed for about 5 minutes under no-load condition.
2. Run the engine under light load until the engine oil pressure gauge and engine water temperature gauge indicate the green range.

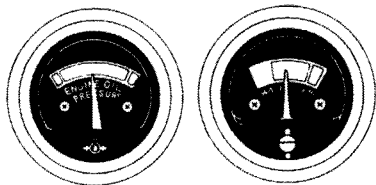

3. Confirm that air pressure gauge indicates the green range, that the central warning lamp is off, and that the warning buzzer has stopped sounding.

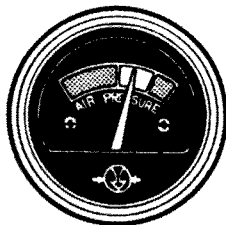

4. After warm-up run is completed, check gauges, warning lamps for proper operation.
5. Check if the exhaust color is normal or whether there is any abnormal noise or vibration.
 - ★ Avoid abruptly accelerating the engine until the completion of warm-up.
 - ★ Do not run the engine for more than 20 minutes at low idling or at high idling.

TO START THE MACHINE

1. Fasten the seat belt.
2. Confirm that the dump lever is in the "FLOAT" position.

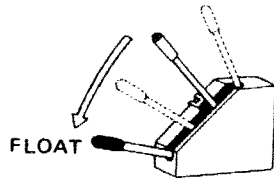

3. Confirm that the pointer of the air pressure gauge is in the green range. Then, put the parking brake valve lever in the "RELEASE" position.

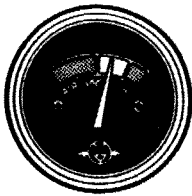

4. Make sure that retarder pilot lamp is off and place the gear shift lever in the desired speed position.

(Automatic)

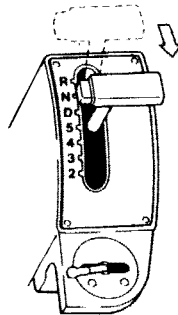

(Manual)

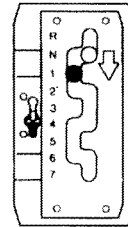

5. Depress the accelerator pedal, and the machine will start moving.

- ★ If the gear shift lever is placed at a position other than N with the parking brake locked, the central warning lamp lights up and the alarm buzzer sounds.
- ★ Placing the gear shift lever at a position other than N with the dump lever at a position other than float causes the central warning lamp to light up and the alarm buzzer to sound.

OPERATING YOUR MACHINE

GEAR SHIFTING MANUAL TRANSMISSION

Shift up (Increasing the traveling speed.)

- ★ Gear shift lever should be shifted up so as to keep up with traveling speed, with accelerator pedal kept depressed.
- ★ High efficiency driving is obtained by keeping machine in direct drive with indicator of tachometer kept in green range.

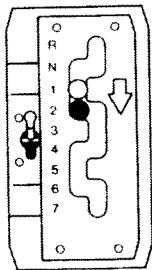

Shift-down (Decelerating the traveling speed.)

- If the machine slows down so much that the engine speed goes below 1500 rpm, shift down gear shift lever.
- ★ Be sure to shift down machine stage by stage. Shifting down by two stages or more must be avoided.

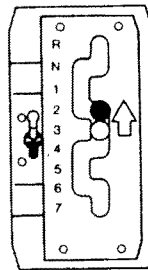

- When shifting down the machine while traveling downhill, slow down the machine by depressing brake pedal. When the engine speed goes below 1500 rpm, shift down gear shift lever.
- ★ Be sure to shift down the gear shift lever if the engine speed goes below 1500 rpm.

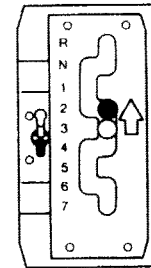

AUTOMATIC TRANSMISSION

Because of the automatic transmission, the gears will shift automatically according to the travel speed when gear shift lever is placed in the desired position.

- ★ Depress the button at the head of the lever to shift the lever (except between N and 5).
- ★ When reversing the direction of travel, stop the machine completely, then proceed in the opposite direction.

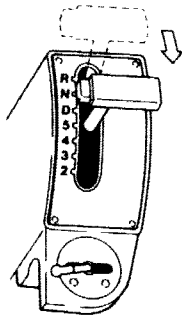

Shift up (Increasing the traveling speed.)

When the travel speed is accelerated by stepping on accelerator pedal, the lockup clutch will engage to form direct drive.

Further acceleration will cause the transmission to shift up automatically.

Shift down (Decelerating the traveling speed.)

As you remove your foot from the accelerator pedal, the machine begins decelerating and the transmission automatically shifts down.

Down shift inhibit

This prevents engine overrun caused by mistaken operation of the gear-shift lever.

KICK-DOWN

In order to reduce the travel speed at a greater rate than ordinary deceleration or to travel downhill without upshifting, depress accelerator pedal with a lot of foot pressure. The kick-down pilot lamp will light.

The relationship between the kick-down control and the accelerator pedal is described below.

S₁ : This position is used for downhill travel, coasting, and for releasing the transmission from kicked-down condition.

If the pedal is released while traveling downhill or coasting, the engine speed will shift down by one speed gear at 1550 rpm.

Downshifting at 1550 rpm

Upshifting at 2450 rpm

Kick-down memory range
Engine full speed S₁ S₂ S₃ Engine idling

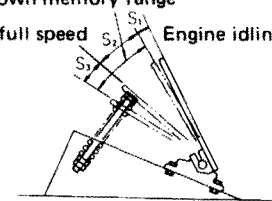

OPERATING YOUR MACHINE

S₂: This position is used for ordinary travel on a level road.

Downshifting at 1500 rpm
Upshifting at 2200 rpm

S₃: This position is used for uphill travel.

This position is used to reduce the travel speed at a greater rate than ordinary deceleration or to travel uphill without upshifting.

Downshifting at 1550 rpm
Upshifting at 2450 rpm

- ★ The accelerator pedal need not be kept down firmly under a lot of foot pressure, because the pedal is provided with a kick-down memory. To release the pedal from the kicked-down condition, move the pedal back to S₁ range, or depress the accelerator pedal with a lot of foot pressure again.

SKIP SHIFT

This is used when traveling at high speed and starting to go up a slope. The operator uses it when he wishes to travel smoothly and shift down in one step to a speed range which matches the slope.

1. Skip shift operation

Keep the accelerator pedal pressed down and move the gear shift lever to a position to match the slope. (Use the positions in the following table as a guide.)

- Guide for selection of positions when traveling uphill loaded.

Grade	Position
2 – 3%	5
3 – 5%	4
5 – 6%	3
Over 6%	2

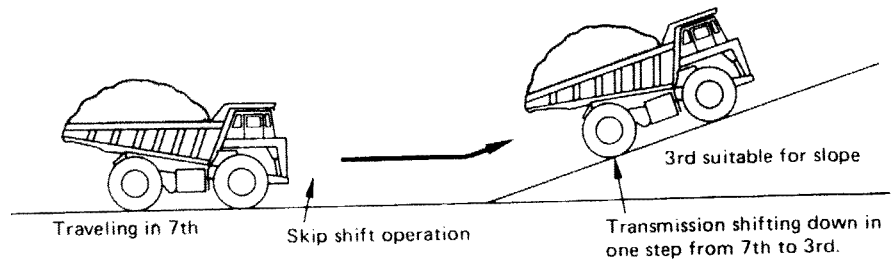

- ★ After the gear shift lever is operated, the shift controller drives the machine distinguishing between direct range and torque converter range until it reaches a travel speed which matches the set position. When the travel speed matches the speed range, the shift controller shifts down in one step.
- ★ If the gear shift lever is operated with the accelerator pedal depressed, this operation can be repeated several times. The shift controller will shift down to the final set gear speed, so there is no need to worry if you make a mistake. Simply move the gear shift lever to the correct position

2. After traveling uphill with skip shift
 - Return the gear shift lever to the position before it was set, or to position D.
- ★ If the brake is operated during skip shift operation, the transmission will be automatically locked at the speed range which matches the actual speed of the machine at that moment.

- ★ If the gear shift lever is set to an unsuitable position, the shift controller will lock the gear at a suitable range, so the final position may not be the same as the set position
- ★ When traveling, the skip shift may not function directly after shifting gear or when the engine speed is low. This does not indicate a failure.

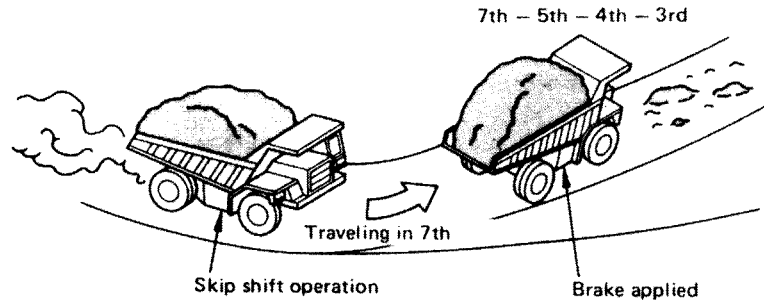

BACKING-UP

Place gear shift lever in R position and depress accelerator pedal little by little until the machine starts moving.

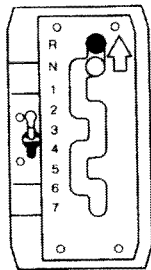

DOWNHILL TRAVELING

When traveling downhill, maintain a safe speed according to road conditions: consider the road grade, the grade of the path, the road surface, degree of curves and road width.

1. Before starting downhill, release accelerator pedal and operate retarder control lever to slow the machine down to a safe speed for the downhill slope.
2. Move the gear shift lever to a position (5, 4, 3, or 2) which matches the maximum permissible speed for the capacity of the retarder brake.

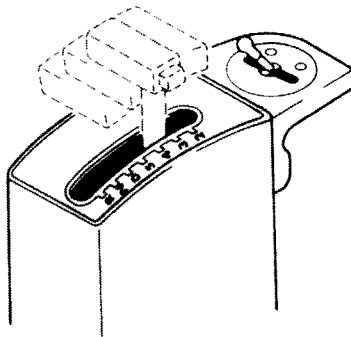

3. When traveling downhill, operate the retarder control lever to keep the engine above 1800 rpm, and travel at a speed which keeps the retarder oil temperature gauge pointer in the green range.

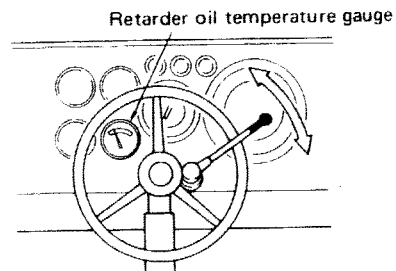

- ★ Do not use the brake pedal except in an emergency while traveling downhill.
- ★ Apply the retarder brake lever slowly to avoid large impact or tire slippage.

PRECAUTIONS FOR DOWNHILL TRAVEL

- ★ The maximum allowable travel speed when going downhill with the retarder applied depends on the downhill travel distance and the hill gradient. (Refer to the brake performance graph.)
- ★ If the machine continues traveling downhill at a speed exceeding the maximum allowable value indicated in the brake performance graph, it may damage the retarder brake, resulting in a serious accident.
- ★ If the retarder oil temperature gauge pointer enters the red range of the scale while the retarder is applied, shift down the gear shift lever. (At this time, the central warning lamp will light and the warning buzzer will sound.) If the gauge pointer does not yet move into the green range, stop the machine immediately, put the gear shift lever in Neutral position, and keep the engine speed at 2000 rpm until the gauge pointer moves into the green range.
- ★ If the retarder control lever is applied while traveling downhill, the machine can be shifted down faster than in ordinary deceleration and without the necessity of shifting up the gear shift lever.
- ★ If the retarder should stop working while traveling downhill, do the following:
 1. Completely release the retarder control lever once and then operate the lever again.
 2. If the repeated operation of the retarder control lever fails to actuate the retarder, return the lever to RELEASE position and stop the machine by depressing the brake pedal. Then, ask your Komatsu distributor to make the repair.

OVERRUN PREVENTIVE MECHANISM

If the machine is accelerated beyond the maximum speed for any gear position while going downhill, the overrun preventive mechanism actuates, causing the retarder to work to slow down the machine.

CHECKING THE BRAKING CAPACITY OF THE RETARDER BRAKE

The retarder brake capacity can be checked in the following manner.

Manual transmission

1. With the machine on flat ground, raise the air pressure to the maximum and pull retarder control lever all the way.

2. Place the gear shift lever in the 2nd speed position and gradually increase the engine speed. If the machine does not move while the torque converter is stalling at 1150 rpm, it indicates that the retarder brake capacity is normal.

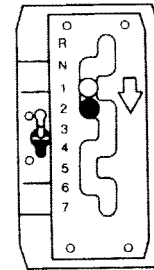
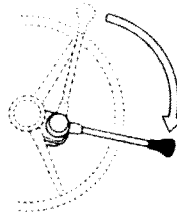

Automatic transmission

1. With the machine on flat ground, raise the air pressure to the maximum and pull retarder control lever all the way.
2. Place gear shift lever in the position D and gradually increase the engine speed. If the machine does not move while the torque converter is stalling at 1150 rpm, it indicates that the retarder brake capacity is normal.

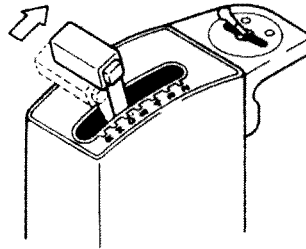
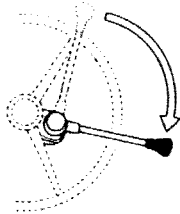

OPERATING YOUR MACHINE

HOW TO USE THE GRAPH

The maximum allowable travel speed and the speed range can be determined from the brake performance curve as shown in the following example where the downhill distance is 1500 m, the travel resistance is minus 12% (gradient resistance is minus 14% and rolling resistance 2%) and the haul load is 32 tons.

1. Use the brake performance curve for a downhill distance of 1500 m. (See the graph at left on the next page.)
2. Plot machine gross weight **A** in the graph and draw a line straight down from point **A**.
3. Find point **B** where the vertical line intersects the minus 12% travel resistance line, and draw a horizontal line from point **B**.
4. Find point **C** where the horizontal line intersects the performance curve. Draw a line straight down from point **C**, and find point **D** where the vertical line intersects the travel speed scale line.
5. Through the above process, the following values can be obtained.
From point **D**, the maximum permissible speed is 29 km/h and from point **C**, the gear speed should be F-4.

- ★ This value for the maximum permissible speed is only a rough target value based on the retarder brake performance. At the actual jobsite, however, the safe driving speed will almost always be lower than the maximum permissible speed because of the road conditions and other factors. Therefore, select a speed at which the retarder brake oil temperature gauge will be kept in the green range.

● Brake performance (length of slope: 1500m)

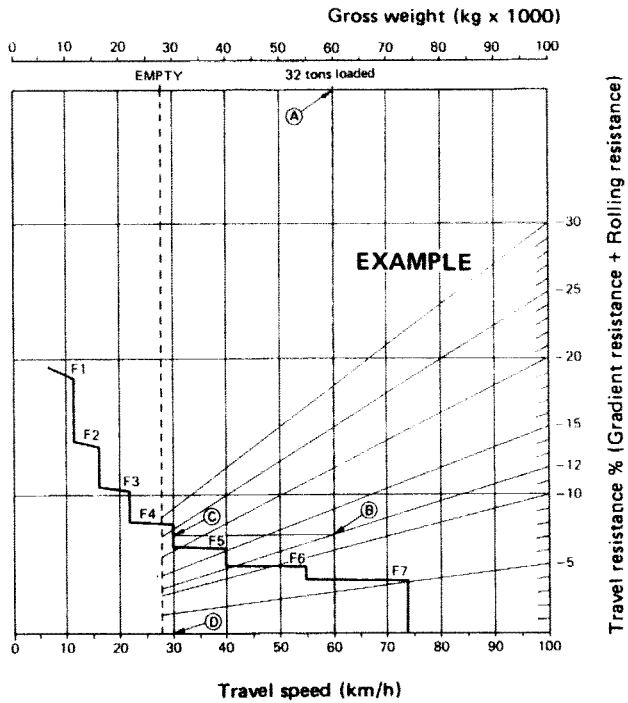

● Brake performance (length of slope: 450 m)

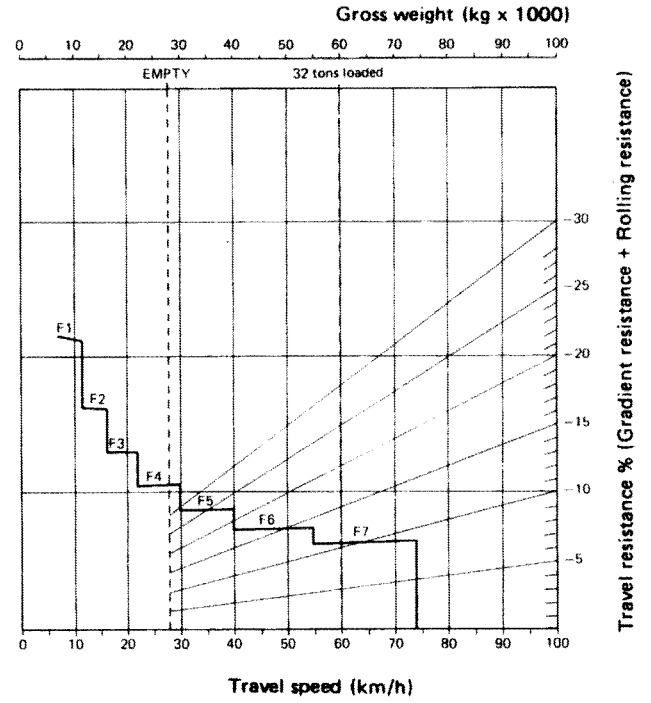

OPERATING YOUR MACHINE

● Brake performance (length of slope: 600 m)

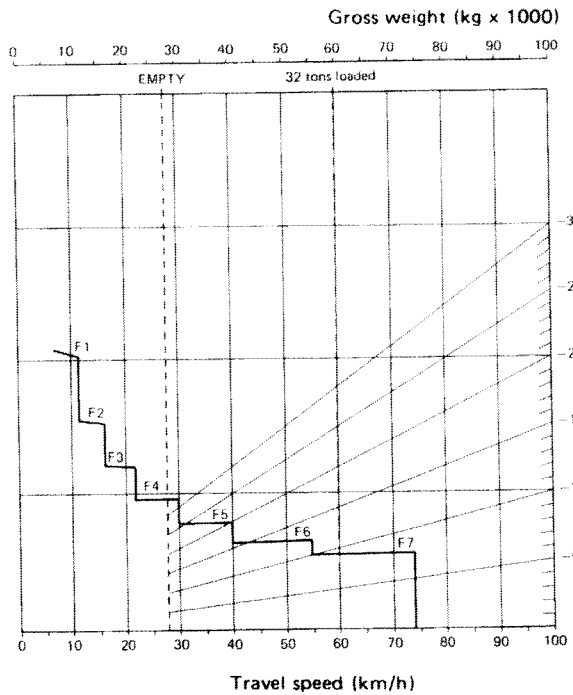

● Brake performance (length of slope: 900 m)

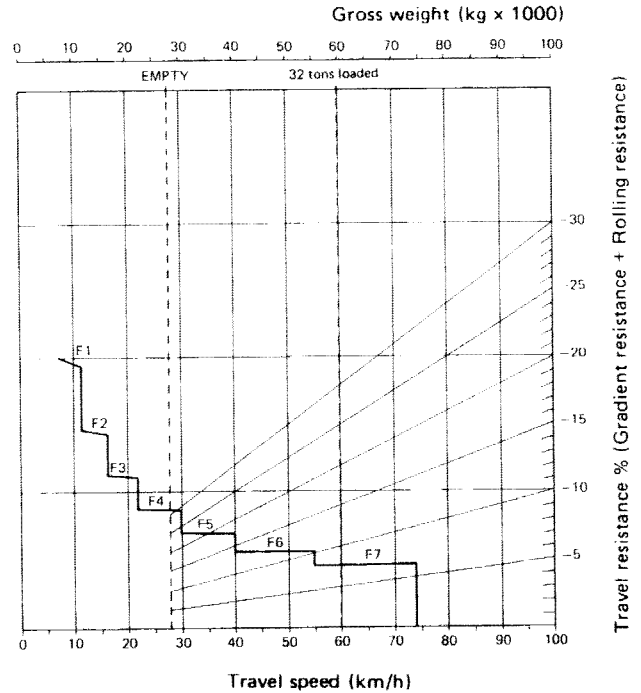

● Brake performance (length of slope: 1500 m)

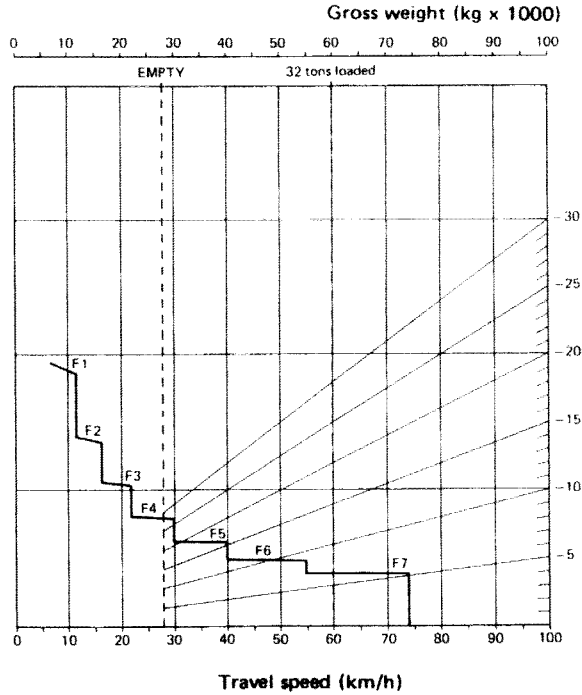

● Brake performance (length of slope: continuous)

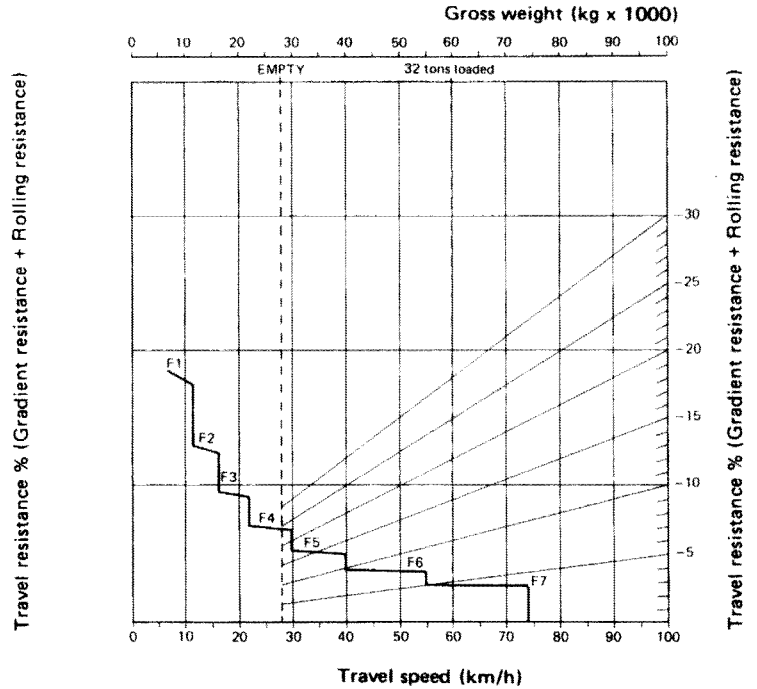

OPERATING YOUR MACHINE

TO STOP THE MACHINE

1. Release your foot from the accelerator pedal and depress the brake pedal to stop the machine.
- ★ When coasting and reducing speed, it is possible to reduce speed slowly by moving the gear shift lever to position "2" and using the skip shift.
2. Move the gear shift lever to the "NEUTRAL" position. Then put the parking brake switch in the "BRAKE" position.
3. When staying in the operator's compartment, pull the retarder lever fully to apply the retarder.

- !** When leaving the operator's compartment, apply the parking brake.

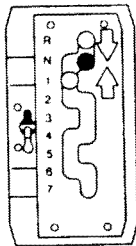

EMERGENCY STOP

In an emergency, such as fault of the foot brake, stop the machine as described below:

1. Fully pull the retarder control lever to apply the retarder.

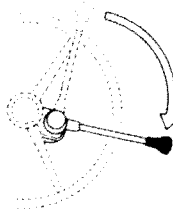

2. Put the emergency brake valve lever to the "BRAKE" position.

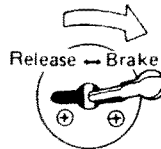

3. Put the parking brake valve lever to the "BRAKE" position.

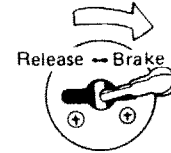

- !** Immediately place chocks under tires when the machine stops.

- ★ Determine the cause and repair on the spot as much as possible.

TO STOP THE ENGINE

1. Run the engine at low idling speed for about 5 minutes to allow it to gradually cool down.
2. Return the starting switch key to the OFF position and remove the key.

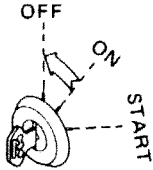

- ★ If the engine is abruptly stopped before it has cooled down, engine life may be greatly shortened. Consequently, do not abruptly stop the engine apart from an emergency.
- ★ In particular, if the engine has overheated, do not abruptly stop it but run it at medium speed to allow it to cool gradually, then stop it.

⚠ Be sure to apply parking brake when leaving the machine.

OPERATION INSTRUCTIONS

- ★ When traveling in rain or snow or on muddy or silty road, pay special attention to prevent the truck from slipping or being mired in mud. It should be kept in mind that the truck should be operated in consideration of the loaded conditions when traveling on such roads.
- ★ When there is a curve in the road, release the accelerator pedal before reaching the curve and let the gears shift down to the lowest possible gear speed, then step on the accelerator pedal again to keep on driving. Do not let the machine coast at high speed.
- ★ When loading the machine, take care to distribute the load evenly over the entire dump body. Do not overload the front section of the dump body.

- ★ If the engine comes to a stop while driving the machine, stop the machine as soon as possible, return the gear shift lever to N position, then restart the engine.
- ★ When the pointer of the torque converter oil temperature gauge is in the red range, stop the truck immediately. In so doing, the engine should be kept operated at a speed of 2000 rpm, with the gear shift lever put in the "NEUTRAL" position, until the pointer returns to the green range. (Refer to TROUBLE SHOOTING GUIDE)

⚠ The load should be dumped in accordance with the instructions of the signal man.

OPERATING YOUR MACHINE

- ★ When driving, the direction of the steering wheel may change (the position of the spokes moves slightly), but this is not a failure.
- ★ If force is applied to the steering wheel when the tires are turned fully to the right or left, the steering wheel will turn a little at a time, but this is not a failure.
- ★ When the steering wheel is turned to the full lock on the right or left side, do not continue to apply force to it. This will cause the temperature of the oil inside the circuit to rise, resulting in overheating.

METHOD OF RELEASING PARKING BRAKE AND EMERGENCY BRAKE WHEN ACTUATED IN A EMERGENCY

If the pressure inside the air tank drops abnormally due to some problem, such as leakage of air from the air circuit, the parking brake and emergency brake are automatically actuated.

RELEASE OF PARKING BRAKE

If the parking brake can not be released after its emergency application even if the parking brake valve lever is put in **RELEASE** position, take the following actions to release the parking brake.

- 1) Remove the air charge socket (1) from the dry reservoir.
- 2) Install the socket (1) on the parking brake chamber (2) after removing the air hose connected to the parking brake chamber (2).
- 3) Connect one end of the wheel air charge hose (3) to the air charge socket (1).
(They can be installed at a touch.)
- 4) Press the other end of hose (3) to the wheel's valve (4) and the brake will be released as air is supplied to the brake chamber.

5) When the parking brake is released, immediately move the machine to a safe place by traction.

- ★ When the pneumatic system has trouble, the brake does not operate. This is very dangerous. Be sure to tow the machine at low speed, keeping the engine running and always being ready to steer.
- ★ Refer to **INSTRUCTIONS FOR TOWING THE TRUCK.**

! When releasing the parking brake, confirm safety in the surrounding area.

If it is absolutely necessary to release the parking brake on a slope, put chocks against the tires.

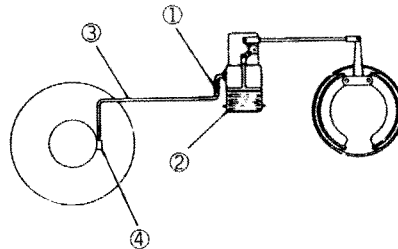
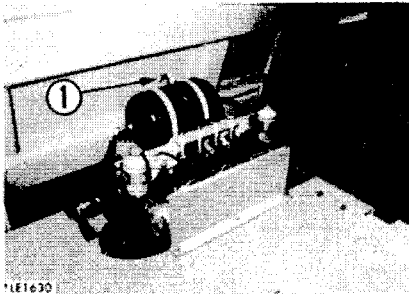

METHOD OF RELEASING PARKING BRAKE AND EMERGENCY BRAKE WHEN ACTUATED AN A EMERGENCY

RELEASE OF EMERGENCY BRAKE

If the emergency brake can not be released after its emergency application even if the emergency brake valve lever is put in **RELEASE** position, release the emergency brake in the following manner.

1. After making preparations to tow the machine, open the 4 drain valves on the air reservoir to release the air pressure so that the emergency brake can be released.
2. After releasing the emergency brake, close the drain valves.

! Before releasing the air pressure from the emergency brake reservoir, confirm safety in the surrounding area and put chocks against the tires.

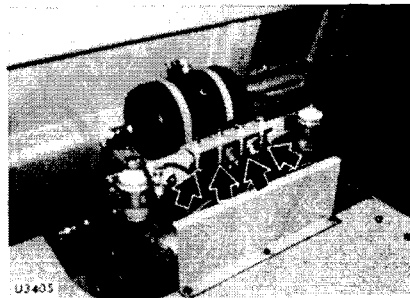

INSTRUCTIONS FOR TOWING THE MACHINE

This machine must not be towed except in emergencies. When towing the machine, take the following precautions.

1) When the engine is in operation;

Always keep the engine running when towing the machine, so that the steering and braking can be used.

⚠ If there is a failure in the air circuit, the brakes cannot be used, so be extremely careful when towing.

2) When the engine is out of operation;

Never haul the machine over 800 m.

★ If the towing distance surpasses that limit, be sure to remove the drive shaft between the transmission and the differential case.

★ The towing speed must be within 8 km/h.

★ The hook for towing a machine is installed under the front frame.

★ When air pressure in air reservoir abnormally drops due to leakage from air circuit, parking brake and emergency brake are actuated. When towing machine, release both brakes.

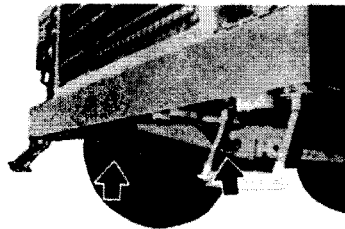

T8.523

DUMP BODY OPERATION

Operate the dump body in the following way:

- 1) Move the gear shift lever to neutral and the parking brake valve lever to BRAKE.

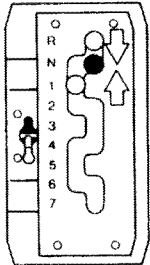

- 2) Move the dump lever to RAISE position and depress the accelerator pedal, then dump body will begin tipping.

- ★ If you remove your hand from the lever at that time, the lever remains at RAISE and the dump body continues moving.
- ★ The tipping speed varies proportionally with the speed of engine revolution.

- 3) As the dump body reaches a pre-determined "positioner" position, the dump lever automatically returns to HOLD and the dump body remains stationary there.

(For details on adjusting the positioner, see the section on ADJUSTMENT.)

- ★ To tip the dump body even more, move the dump lever to RAISE (the lever is not locked at raise.) If you remove your hand from the lever, it again returns to HOLD and the dump body remains stationary.

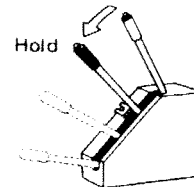
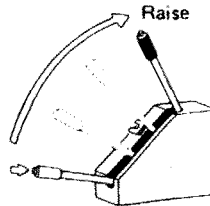

- 4) As you move the dump lever to **LOWER**, the dump body begins to descend.

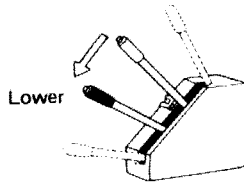

- 5) If you reset the dump lever to **FLOAT** while the dump body is coming down, it will fall by its own weight. (The lever is locked at **FLOAT**.)

- ★ While traveling, keep the dump lever in **FLOAT** position whether the machine is carrying a load or not.

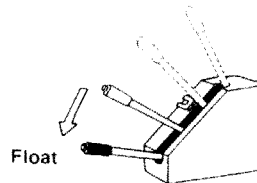

- ★ If the gear shift lever is placed in any position other than N while the dump lever is in a position other than **FLOAT**, the central warning lamp will light and the warning buzzer will sound.
- ★ When raising the dump body, ease up on the accelerator pedal in the vicinity of the maximum tilt position to avoid giving an impact to the hydraulic circuit and the hoist cylinder.

- ⚠ Reduce the dumping speed when dumping large rocks.
- ⚠ Do not load material while the dump body is tipped.
- ⚠ When making inspections with the dump body raised, be sure to use a safety pin and lock the dump lever in **HOLD** position.

HANDLING THE TIRES

Ton-Km-Per-Hour Rating

Tires of construction machinery are used under conditions incomparably more severe than those of passenger cars, buses and trucks. They are specially designed to survive such working conditions.

OR tires generate much more heat in the rubber layer during operation than ordinary tires. If they are used continuously in excess of their load and speed limits, the inside temperature might exceed the permissible limit, leading to softening of rubber and separation of layers.

The ton-km-per-hour rating serves as a standard to use tires safely and prevent such trouble.

If a tire is forced to work beyond its ton-km-per-hour rating, troubles will occur frequently.

In such cases, take the following measures:

- 1) Ease the working conditions: reduce the ton-km-per-hour rating of the work.
- 2) Replace the tires with those having a higher ton-km-per-hour rating.

Calculation method of actual

T. Km.P.H. value:

A = Actual T.Km.P.H.

B = Average load per tire

C = Average traveling speed per day

D = Tire load on the empty truck

E = Tire load on the loaded truck

F = Turnaround distance

G = Turnaround frequencies for one day

H = Total operating hours for one day

$$A = B \times C$$

$$B = \frac{D + E}{2}$$

$$C = \frac{F \times G}{H}$$

- ★ The total operating hours for one day include the operator's break time and the time during which the truck is not in operation.

Ton-km-per-hour tire rating and maximum continuous traveling speed

Tire	Tire ton-km-per-hour rating with ambient temperature				Maximum continuous traveling speed (km/h) with ambient temperature				
	16°C	27°C	38°C	49°C	16°C	27°C	38°C	49°C	
Sizes: 18.00-33-28PR Construction: CR Code No. (TRA): E3	226	212	197	182	Empty (Front wheel basis)	30	28	26	24
					Laden (Rear wheel basis)	22	21	18	17
Sizes: 18.00-33-32PR Construction: CR Code No. (TRA): E4	200	188	175	165	Empty (Front wheel basis)	27	26	24	22
					Laden (Rear wheel basis)	20	19	17	16
Sizes: 18.00-33-32PR Construction: CR Code No. (TRA): E3	226	212	197	182	Empty (Front wheel basis)	30	28	26	24
					Laden (Rear wheel basis)	22	21	18	17

As T. Km. P. H values in the above table vary more or less with tire manufacturers, if machine is driven at around speed of the above table, consult your Komatsu distributor.

! Defective tires as shown in 1) to 6) below should be replaced with new tires for safe operations:

- 1) Tires with cuts, broken or excessively deformed bead wire.
- 2) Excessively worn tires in which the carcass ply (excluding breaker) is exposed along 1/4 the circumference.
- 3) Tires whose carcass is damaged more than 1/3 the tire width.
- 4) Tires with ply separation.
- 5) Tires with radial cracks which reach the carcass.
- 6) Aged, deformed or abnormally damaged tires.

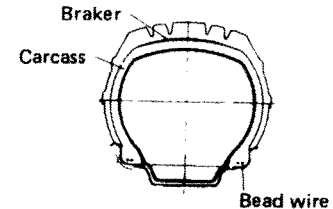

★ When replacing the tires, please contact your Komatsu distributor. It is dangerous to jack up the machine without taking due care.

INSTRUCTIONS WHEN TRAVELING OVER A LONG DISTANCE

When the truck travels continuously over a long distance at high speed, the tires produce extreme heat. This may cause the tires to be worn. To prevent this, the following instructions should be observed:

- The truck should be operated without load.
- The tire inflation pressure should be checked and adjusted, when the tires are still cold before operation.

Correct inflation pressure:

18.00-33-28PR: 5.0 kg/cm²

18.00-33-32PR: 5.75 kg/cm²

18.00-25-32PR: 5.75 kg/cm²

- The tire inflation pressure should not be reduced during operation.
- The truck should be operated in either one of the following two traveling conditions:
 - 1) When the maximum traveling speed is 30 km/h, the truck should be stopped for at least 60 minutes after every 50 km. to cool the tires.
 - 2) When the maximum traveling speed is 40 km/h, the truck should be stopped for at least 70 minutes after every 50 km.
- The machine should not be operated with the tires filled with water or dry-ballast.

COLD WEATHER OPERATION

PREPARATION FOR LOW TEMPERATURE

If the temperature becomes low, it becomes difficult to start the engine, and the coolant may freeze, so do as follows.

FUEL AND LUBRICANTS

Change to fuel and oil with low viscosity for all components. For details of the specified viscosity, see the TABLE OF FUEL, COOLANT AND LUBRICANTS.

COOLANT

After cleaning inside of the cooling system, add antifreeze to the coolant to prevent the coolant from freezing when the machine is not being used.

★ For details of the antifreeze mixture when changing the coolant, see WHEN REQUIRED.

Care in using antifreeze

Use a Permanent Antifreeze (ethylene glycol mixed with corrosion inhibitor, antifoam agent, etc.) meeting the standard requirements as shown below. With permanent antifreeze, no change of coolant is required for a year. If it is doubtful that an available antifreeze meets the standard requirements, ask the supplier of that antifreeze for information.

Standard requirements for permanent antifreeze

- SAE J1034
- FEDERAL STANDARD
..... O-A-548D

COLD WEATHER OPERATION

- ★ Never use methanol, ethanol or propanol based antifreeze.
- ★ Where no permanent antifreeze is available, an ethylene glycol antifreeze without corrosion inhibitor may be used only for the cold season. In this case, clean the cooling system twice a year (in spring and autumn).

When refilling the cooling system, add antifreeze in autumn, but do not add any in spring.

- ★ Absolutely avoid using any water-leak preventing agent irrespective of whether it is used independently or mixed with an antifreeze.
- ★ Do not mix an antifreeze with one of different brand.

 Antifreeze is flammable, so keep it away from any flame.

BATTERY

As ambient temperature drops, battery capacity will drop, and electrolyte may sometimes freeze if battery charge is low. Maintain battery at a charge level of approx. 100% and insulate it against cold temperature so that machine can be readily started the next morning.

- ★ Measure specific gravity of fluid and obtain rate of charge from the following conversion table:

Temp. of fluid Rate of charge	20°C	0°C	-10°C	-20°C
100%	1.28	1.29	1.30	1.31
90%	1.26	1.27	1.28	1.29
80%	1.24	1.25	1.26	1.27
75%	1.23	1.24	1.25	1.26

- ★ When electrolyte level is low, add distilled water in the morning before work instead of after the day's work. This is to prevent fluid from freezing at night.

 To avoid gas explosions, do not bring fire or sparks near the battery.

 If the electrolyte gets on your skin or clothes, immediately wash with plenty of clean water.

STARTING IN COLD WEATHER

For the pre- and post-starting inspection, refer to the section OPERATING YOUR MACHINE.

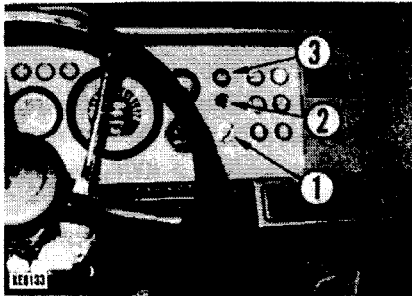

1. Turn the key of starting switch (1) to ON.

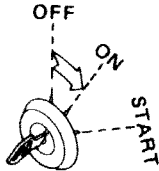

2. Preheating is automatically started, and preheating pilot lamp (3) lights up.
3. Depress accelerator pedal half-way.
4. When preheating is finished, the pilot lamp will go out. Turn the key of starting switch (1) to the START position to start the engine.

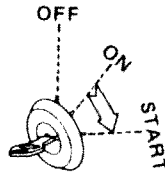

5. Release the key of starting switch (1), and the key will return automatically to ON.

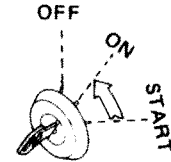

- ★ If the engine does not start after following this procedure, push the preheater switch (2) and preheat fully before trying to start.

The table below gives a guide to preheating times.

Temperature	Preheating time
Above 0°C	—
0°C to -10°C	20 sec.
-10°C to -20°C	30 sec.

- ⚠ Never use starting aid fluids as they may cause explosions.**

INSTALLATION OF RADIATOR CURTAIN

If the engine water temperature gauge does not move into the green range, install a radiator curtain.

The radiator curtain can be adjusted to three modes; totally closed, one window open, and both windows open. Select the curtain mode according to the ambient air temperature so that the engine water temperature gauge will indicate the green range.

CAUTIONS AFTER COMPLETION OF WORK

Observe the following cautions so that it won't be difficult to start the machine the next morning because frozen mud and water.

1. Remove the mud and water attached to the machine body.
2. Park the machine on hard, dry ground.
If this is impossible, park the machine on wooden boards.
3. Drain the water from the air tank and the fuel system to prevent the water from freezing at night.
4. As battery capacity drops at low ambient temperature, cover the battery or remove it from the machine to be kept warm at night.

WHEN THE COLD SEASON IS OVER

When the season draws to an end and the weather starts to warm up,

- Replace the lubricating oil in the various units with oil having the recommended viscosity.
- If for any reason permanent antifreeze cannot be used, and an ethyl glycol base antifreeze (winter, one season type) is used instead, or if no antifreeze is used, drain the cooling system completely, then clean out the inside of the cooling system thoroughly, and fill with fresh water.

PERIODIC MAINTENANCE

Proper lubrication and maintenance assure trouble-free operation and long machine life. Time and money spent for scheduled periodic maintenance will be amply compensated by prolonged machine operation and reduced operating cost.

All hourly figures given in the following descriptions are based on service meter readings. In practice, however, it is recommended to rearrange all of them into units of days, weeks and months to make the maintenance schedule more convenient. Under rough job site or operating conditions, it is necessary to somewhat shorten the maintenance intervals stated in this manual.

PERIODICAL REPLACEMENT OF SAFETY PARTS

The users of our machine should carry out periodical maintenance in order to ensure the working and operation safety. Those parts, as listed on the right, which are closely connected with safety, must be replaced periodically so that the highest safety standard can be maintained.

These parts with the passage of time have a great tendency to deteriorate in quality and to wear or deform. Furthermore, their defective condition is difficult to detect during periodical maintenance. These parts must, therefore, be replaced with new ones after a predetermined service period even though there is no apparent abnormality.

It goes without saying that if any abnormality should be found, these parts must be replaced or repaired even before the predetermined period expires.

The periodical replacement is completely different from the replacement due to the claim against the guarantee by the manufacturer, so they must be treated separately.

	Parts to be regularly replaced	Replacement interval	Remarks
1	Air governor parts	Every 2000 hours, or every one year, whichever comes first.	Replace with service kit
2	Brake valve parts		Replace with service kit
3	Retarder control valve parts		Replace with service kit
4	Parking brake valve parts		Replace with service kit
5	Emergency brake valve parts		Replace with service kit
6	Relay valve parts		Replace with service kit
7	Emergency relay valve parts		Replace with service kit
8	Quick release valve parts		Replace with service kit
9	Parking brake chamber parts		Replace with service kit
10	Brake chamber parts (front, rear)		Replace with service kit
11	Rubber hoses of brake	Every 4000 hours, or every two years, whichever comes first.	Replace assembly
12	Rubber hoses of steering (Pump → demand valve → steering valve → steering cylinder)		Replace assembly

MAINTENANCE TABLE

No.	ITEM	SERVICE	PAGE
CHECK BEFORE STARTING			
a	Walk-around check		30
b	Cooling water	Check and supply	30
c	Fuel	Check and supply	31
d	Engine oil pan	Check and supply oil	31
e	Fuel tank	Drain water and sediments	32
f	Transmission case	Check and supply oil	32
g	Hydraulic tank	Check and supply oil	33
h	Air reservoir	Drain water	33
i	Suspension cylinder	Check and adjust	33
j	Emergency steering	Check	34
k	Hub nuts	Check and retighten	34
l	Tires	Check inflation pressure and damage	35
m	Dust indicator	Check	35
n	Central warning lamp	Check	35

No.	ITEM	SERVICE	PAGE
o	Front brake oil reservoir	Check and supply oil	36
p	Foot brake	Check function	36
q	Retarder brake	Check function	37
r	Parking brake	Check function	37
s	Emergency brake	Check function	38
t	Steering	Check function	39
u	Rear view and under mirror	Check	39
v	Lamps	Check	39
w	Horn and turn signal lamp	Check	39
x	Instruments	Check	39
y	Exhaust emission and noise	Check	39
z	Body mount rubber	Check	39
a'	Electrical wiring	Check	39
b'	Water separator	Inspect float position	39

MAINTENANCE TABLE

No.	ITEM	SERVICE	PAGE
EVERY 50 HOURS SERVICE			
a	Lubricating		78
-1	Dump body hinge pin	Lubricate 2 points	78
-2	Rear suspension cylinder	Lubricate 4 points	78
-3	Rear axle support	Lubricate 8 points	78
-4	Front suspension	Lubricate 4 points	78
-5	Steering linkage	Lubricate 13 points	79
-6	Hoist cylinder pin	Lubricate 4 points	79
b	Battery	Check electrolyte level	80
INITIAL 250 HOURS SERVICE			
a	Hydraulic filter	Replace element	81
b	Transmission filter	Replace element	81
c	Fuel filter	Replace cartridge	81
d	Transmission case	Change oil	81
e	Differential case	Change oil	81
f	Final drive case	Change oil	81

No.	ITEM	SERVICE	PAGE
g	Hydraulic tank	Change oil	81
h	Engine valve clearance	Check	81
EVERY 250 HOURS SERVICE			
a	Lubricating		81
-1	Output shaft	Lubricate 2 points	81
-2	Drive shaft	Lubricate 5 points	81
b.	Check the oil level		82
-1	Differential case	Check and supply	82
-2	Final drive case	Check and supply	82
c	Engine oil pan and filter	Change oil and replace cartridge	82
d	Alternator belt	Check and adjust	84
e	Parking brake	Check clearance	84
f	Radiator fins	Clean	85
g	Drive shaft	Check	85
h	Breathers		86
-1	Transmission case	Clean	86

MAINTENANCE TABLE

No.	ITEM	SERVICE	PAGE
-2	Differential case	Clean	86
-3	Hydraulic tank	Clean	86
EVERY 500 HOURS SERVICE			
a	Lubricating		87
-1	Tension pulley	Lubricate	87
b	Fan belt	Check	87
c	Fuel filter	Replace cartridge	87
d	Hydraulic filter	Replace element	88
e	Transmission filter	Replace element	89
f	Front disc brake pad	Check and replace	89
EVERY 1000 HOURS SERVICE			
a	Lubricating		91
-1	Transmission mount	Lubricate 1 point	91

No.	ITEM	SERVICE	PAGE
-2	Steering column	Lubricate 3 points	91
-3	Accelerator control linkage	Lubricate 2 points	91
-4	Dump control linkage	Lubricate 3 points	91
b	Transmission case	Change oil and clean strainer	92
c	Differential case	Change oil	93
d	Final drive cases	Change oil	93
e	Hydraulic tank	Change oil	94
f	Transmission valve	Clean strainer	94
g	Rear brake disc	Check wear	95
h	Turbocharger various fasteners	Check and retighten	96
i	Corrosion resistor	Replace cartridge	96
EVERY 2000 HOURS SERVICE			
a	Engine breather	Clean element	97
b	Turbocharger	Check and clean	97
c	Turbocharger	Check rotor play	98
d	Alternator and starting motor	Check	98

MAINTENANCE TABLE

No.	ITEM	SERVICE	PAGE
(EVERY 2000 HOURS SERVICE)			
e	Engine valve clearance	Check	98
f	Vibration damper	Check	99
g	Safety parts	Replace	99
EVERY 4000 HOURS SERVICE			
a	Water pump	Check and lubricate	99
b	Air compressor	Check and adjust	99
c	Fan pulley and tension pulley	Check	99
WHEN REQUIRED			
a	Cooling system	Clean	100
b	Air cleaner inner and outer elements	Check, clean and re-place when required	102
c	Electrical intake air heater	Check	105
d	Fan belt	Replace	106
e	Water separator	Drain water	106

OIL FILLER AND LEVEL GAUGE POSITIONS

1. Radiator inlet
2. Hydraulic tank oil filler
3. Engine oil pan oil filler
4. Engine oil level gauge
5. Radiator drain valve
6. Transmission case oil filler
7. Final drive case level plug and oil filler
8. Hydraulic tank level gauge
9. Transmission case level gauge

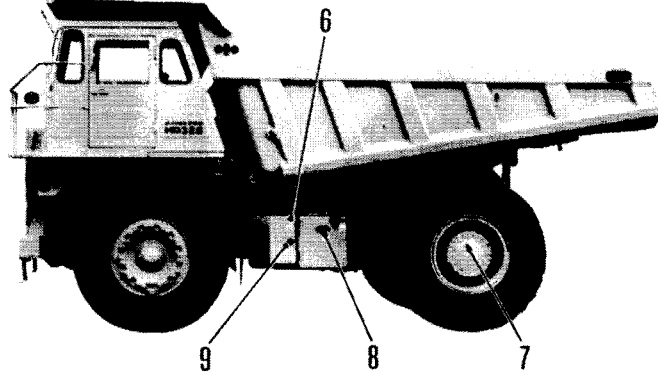

EVERY 50 HOURS SERVICE

EVERY 50 HOURS SERVICE

a. LUBRICATING PARTS

Apply grease to the grease fittings shown by arrows:

1. Dump body hinge pin (2 points)

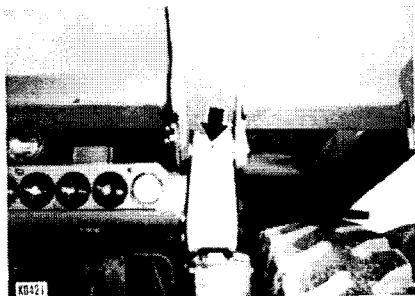

2. Rear suspension cylinder (4 points)

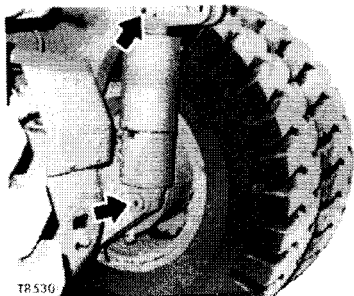

3. Rear axle support (8 points)

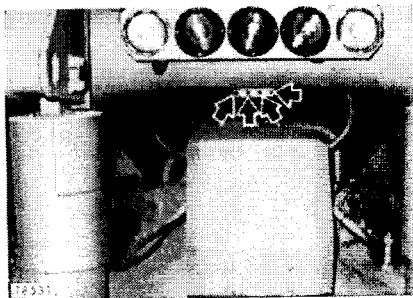

4. Front suspension (4 points)

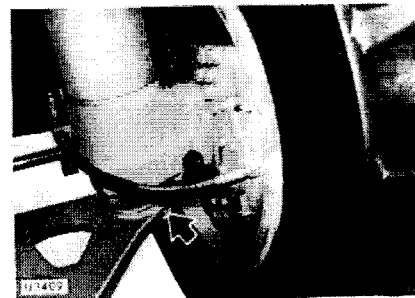
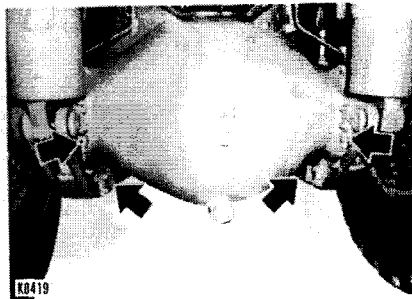
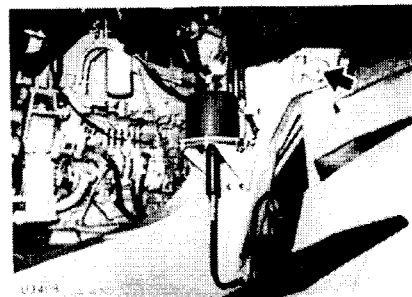

5. Steering linkage (13 points)

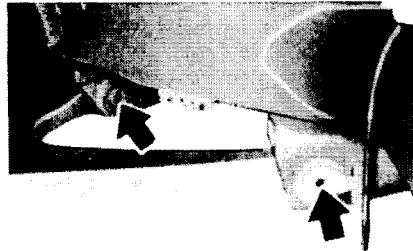
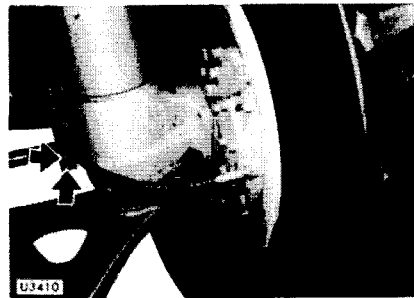

6. Hoist cylinder pin (4 points)

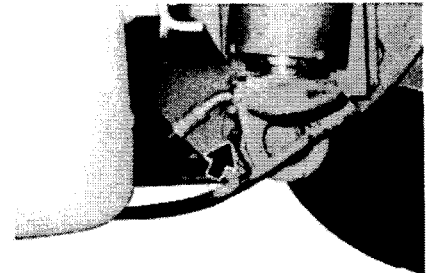
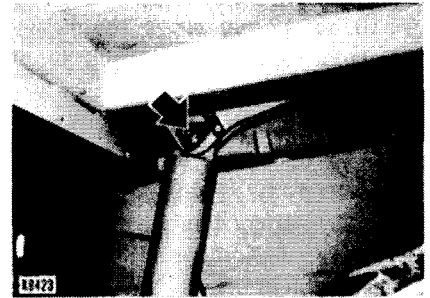

EVERY 50 HOURS SERVICE

b. BATTERY ELECTROLYTE LEVEL AND TERMINALS

1. Open battery cover (1) in front of the air tank.
2. Remove cap and check the electrolyte level.

If the electrolyte level is less than 10 to 12 mm above the battery plates, add distilled water to the battery.

- ★ Clean up the vent holes on the battery caps and check the battery terminals for looseness.
- ★ If the battery fluid has spilled out, ask your Komatsu distributor to replenish it.

! If the electrolyte gets on your skin or clothes, immediately wash with plenty of clean water.

! To avoid gas explosions, do not bring fire or sparks near the battery.

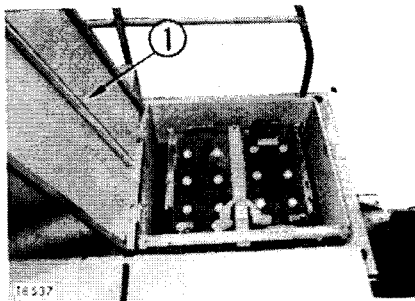

INITIAL 250 HOURS SERVICE

Perform the following maintenance after running the machine for the first 250 hours.

- a. HYDRAULIC FILTER, REPLACE ELEMENT
- b. TRANSMISSION OIL FILTER, REPLACE ELEMENT
- c. FUEL FILTER, REPLACE CARTRIDGE
- d. TRANSMISSION CASE, CHANGE OIL
- e. DIFFERENTIAL CASE, CHANGE OIL
- f. FINAL DRIVE CASE, CHANGE OIL
- g. HYDRAULIC TANK, CHANGE OIL
- h. ENGINE VALVE CLEARANCE, CHECK

For details of method of replacing or maintaining, see the section on EVERY 500 HOURS, 1000 HOURS AND 2000 HOURS SERVICE.

EVERY 250 HOURS SERVICE

a. LUBRICATING

Apply grease to the grease fittings shown by arrows.

1. Output shaft (2 points)

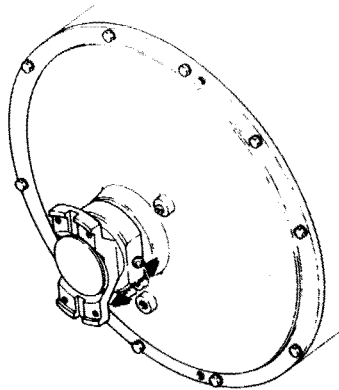

- INITIAL 250 HOURS SERVICE
EVERY 250 HOURS SERVICE
- ★ Maintenance for every 50 hours should be carried out at the same time.

2. Drive shaft (5 points)

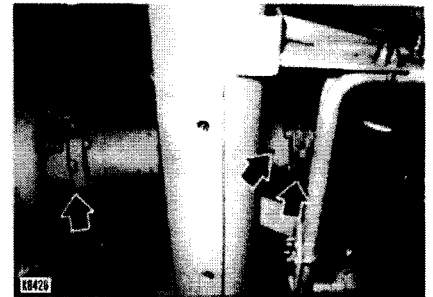
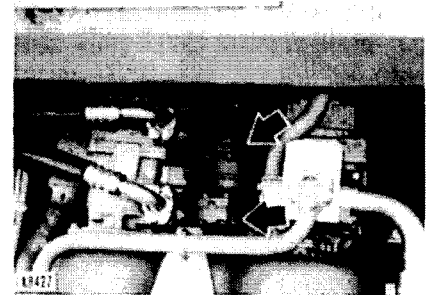

EVERY 250 HOURS SERVICE

b. CHECK THE OIL LEVEL

1. Differential case

Remove the plug (G) and check the oil level. If the oil level is not at or near the lower end of the plug hole, refill engine oil through the plug hole.

- ★ The type of lubricant used depends on the ambient temperature. Select according to the table "FUEL, COOLANT AND LUBRICANTS".

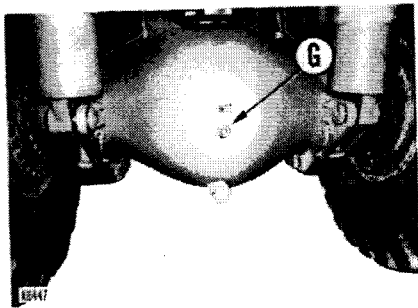

2. Final drive case

- 1) Stop the truck so that the cast line (1) comes into horizontal.
 - 2) Remove the plug (G) and check for the oil level. If the oil level is not near the lower edge of the plug hole, add engine oil through the same plug hole.
- ★ The type of lubricant used depends on the ambient temperature. Select according to the table "FUEL, COOLANT AND LUBRICANTS".

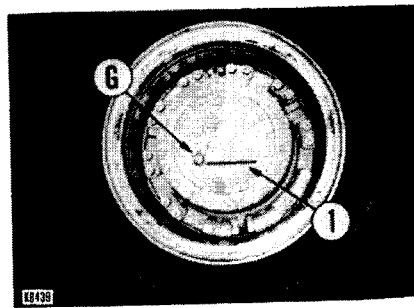

c. ENGINE OIL PAN AND FILTER

1. Open oil filter (F), remove drain plug (1) and loosen drain valve (2) to drain oil. After draining, tighten drain valve (2) and drain plug (1).
- ★ Take care not to rotate drain valve (2) so much that the stopper pin in the valve is distorted.

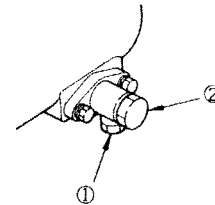

EVERY 250 HOURS SERVICE

- Using a filter wrench, remove cartridge (3) of the engine oil filter by turning it counterclockwise.
- Clean the filter head, fill a new filter cartridge with engine oil, and apply a thin coat of engine oil to the seal and threaded portion.
- After bringing the seal face of the filter cartridge into contact with the filter head, tighten the filter cartridge by rotating it about 2/3 turn by hand.

- Add engine oil to the specified level through oil filler (F).
- Idle the engine for a while and stop the engine. Check the oil level, for details, see CHECK BEFORE STARTING.

- ★ The type of lubricant used depends on the ambient temperature. Select according to the table "FUEL, COOLANT AND LUBRICANTS".
- ★ Refill capacity: 30 ℓ
- ★ Use a genuine Komatsu cartridge.
- ★ Replace these parts once every six months regardless of the hours of service.
- ★ If filter cartridge is removed immediately after stopping the engine, oil will spill. Wait at least 10 minutes after stopping the engine before replacing the filter cartridge.



EVERY 250 HOURS SERVICE

d. ALTERNATOR BELT

Checking

The belt tension should normally deflect by about 15 mm when pressed with the finger at a point midway between the alternator pulley and the drive pulley (approx. 6 kg).

Adjustment

Loosen bolts (1) and (2) and displace the alternator (3) as required.

- ★ Check for pulley damage, wear of the V-groove and V-belt, and especially that the V-belt is not in contact with the bottom of the V-groove.

Alternator pulley

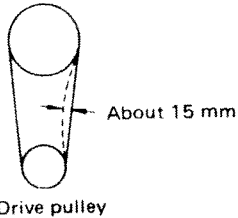

- ★ Replace the belt if it has stretched beyond the point of adjustment or if it has cuts or fissures.
- ★ When adjusting the V-belt, do not attempt to push alternator (3) directly with a bar or the like, but use a wood pad to prevent damage to the core.
- ★ When the belt is replaced, readjust its tension after running for an hour.

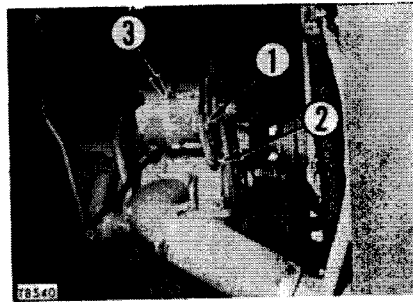

e. PARKING BRAKE

Check the lever of parking brake chamber for proper travel "S".

If any travel exceeding 30 mm is found, adjust the brake.

- ★ Refer to the section ADJUSTMENT.

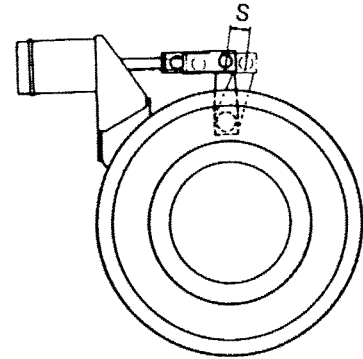

f. RADIATOR FIN

Blow off mud, dust or leaves blocking radiator fins with compressed air. Steam or water can be substituted for compressed air.

Air pressure should be less than 10 kg/cm^2 and steam pressure is less than 4 kg/cm^2 .

Never touch the nozzle of the air or steam to the radiator fins.

- ★ When washing the radiator, always direct air or steam at 90° to the radiator.
- ★ Also check rubber hose connections to radiator. If they have cracks or become fragile, replace with a new one. In addition, check hose clamp for loosening.

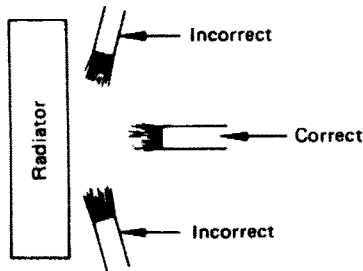

g. DRIVE SHAFT

Check the drive shaft for any abnormality such as loose joints, worn splines or bearing, unusual vibration of the shaft, etc. If any, have the shaft serviced by a Komatsu distributor.

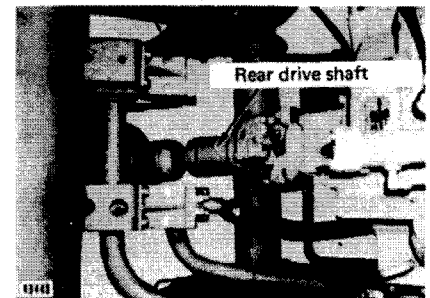

EVERY 250 HOURS SERVICE

h. BREATHERS

1. Transmission case breather

Remove mud and dirt from the vicinity of the breather, remove the breather, and rinse the dirt out of the breather with diesel fuel or cleaning solvent.

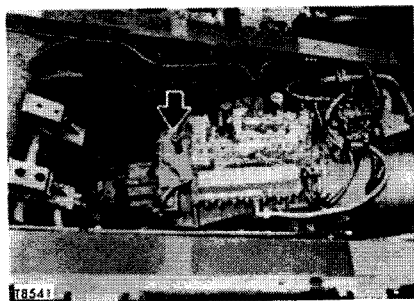

2. Differential case breather

Remove mud and dirt from the vicinity of the breather, remove the breather, and rinse the dirt out of the breather with diesel fuel or cleaning solvent.

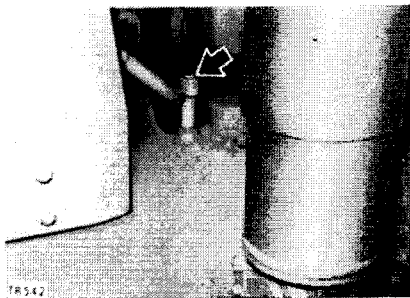

3. Hydraulic tank breather

- 1) Remove snap ring (1) and cover (2), then clean element (3).
- 2) Install element (3), cover (2), and snap ring (1).

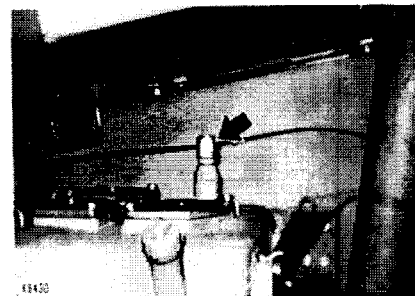
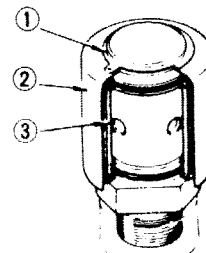

EVERY 500 HOURS SERVICE

a. LUBRICATING

Apply grease to the grease fitting shown by arrow.

1. Tension pulley

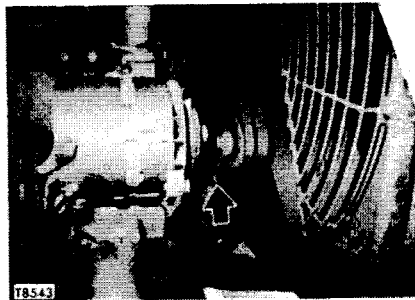

b. FAN BELT

1. Check the V-belt. Replace the V-belt with a new V-belt if the condition is as follows.
 - The V-belt touches the bottom of the pulley groove.
 - The belt is worn, and is below the outside edge of the pulley.
 - The belt is cracked or peeling.
- ★ The machine is fitted with an auto-tensioner, so there is no need to adjust the fan belt tension.
2. For details of replacing the fan belt, see **WHEN REQUIRED**. Replacing fan belt and adjusting auto tensioner.

EVERY 500 HOURS SERVICE

- ★ Maintenance for every 50 and 250 hours should be carried out at the same time.

c. FUEL FILTER CARTRIDGE

1. Close supply valve (1) of fuel tank.
2. Using a filter wrench, remove cartridge (2) by turning it counter-clockwise.

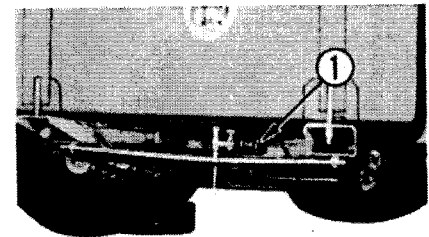

18545

EVERY 500 HOURS SERVICE

3. Clean head of filter and new cartridge filling with fuel.
Then apply a dab of oil to the gasket of the new cartridge.
 4. To install cartridge, bring their heads into contact with sealing surface and then tighten cartridge 1/2 to 3/4 turn by hand.
 5. Open supply valve (1) of fuel tank.
- ★ Use genuine Komatsu cartridge.

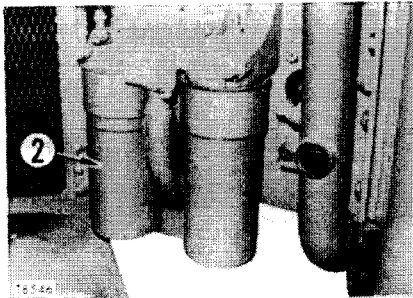

d. HYDRAULIC FILTER ELEMENT

1. Gradually unscrew the cap of oil filler (F) and leave it for several minutes to relieve the inner pressure in the tank.
2. Remove bolts (1) and cover (2).
3. Take out element.
Then, clean the inside of the filter housing together with the other removed parts.
4. Replace with a new element.
Then install cover (2) with bolt (1).

⚠ When removing the cap, turn it slowly to relieve inner pressure.

- ★ When hydraulic oil filter warning lamp goes on during the engine idling or warming up oil, replace the filter element.
- ★ Use genuine Komatsu element.

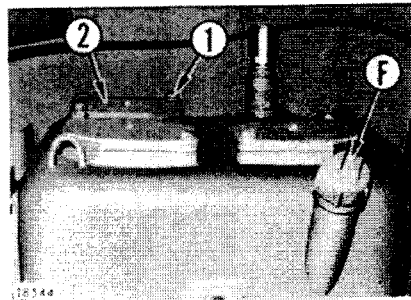

e. TRANSMISSION FILTER ELEMENT

1. Remove bolts (1) and cover (2).
Then, clean the inside of the filter housing together with the other removed parts.
2. Take out element.
3. Replace with a new element.
Then install cover (2) with bolt (1).

- ★ When transmission oil filter warning lamp goes on during the engine idling or warming up oil, replace the filter element.
- ★ Use genuine Komatsu element.

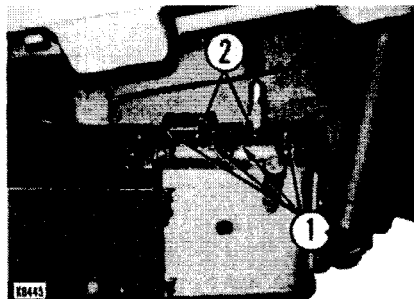

f. FRONT DISC BRAKE PAD

1. Check the disc brake pad for wear by inserting pad gauge in standard tools through check holes (1).
2. Replace the disc brake pads when the bigger diameter portion of the gauge touches the brake calipers. Replace the disc brake pads when the remaining thickness of the brake pads reach to 3 mm.

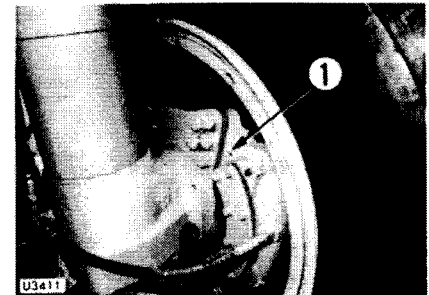

EVERY 500 HOURS SERVICE

! If the pads are used beyond max. wear limit, poor braking will be caused which is very dangerous. As pads reaches to wear limit, more frequent checks may be required.

★ If the pads are worn to the limit, ask your Komatsu distributor to replace the pads.

★ Since the pads in the wheels do not always wear evenly, all the pads must be checked. If any pad is worn to the limit, replace the four pads at the same time.

★ After working in water or in muddy areas, wash the mud off the surrounding of the brake disc with water. If leaving the caliper disc muddy, the pad will wear out in a short time.

! In places there is a lot of soil or where the foot brakes are used frequently, carry out this check every 250 hours.

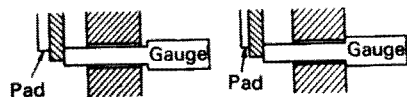

Near Wear Limit Wear Limit Replace Pads

EVERY 1000 HOURS SERVICE

a. LUBRICATING

Apply grease to the grease fittings shown by arrows.

1. Transmission mount (1 point)

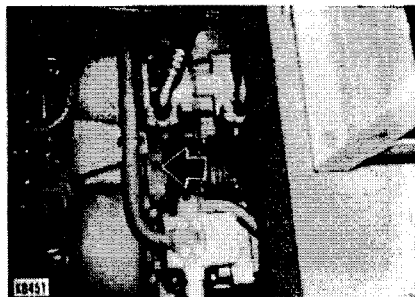

2. Steering column (3 points)
Loosen wing nut, remove cover (1) and apply grease to the three grease fittings.

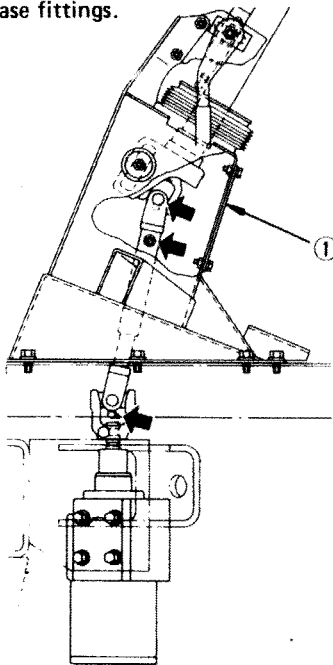

EVERY 1000 HOURS SERVICE
★ Maintenance for every 50, 250 and 500 hours should be carried out at the same time.

3. Accelerator control linkage (2 points)

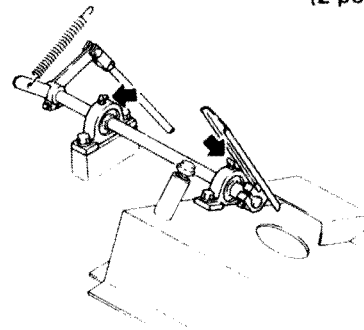

4. Dump control linkage (3 points)

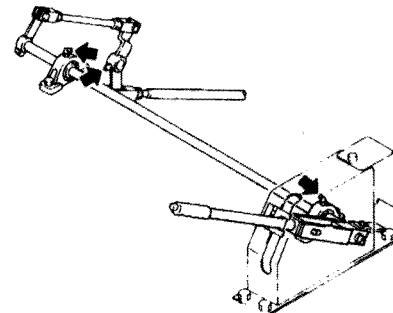

EVERY 1000 HOURS SERVICE

b. TRANSMISSION CASE

1. Remove drain plug (P), drain the oil, and tighten the plug.

2. Remove bolt (1) and cover (2), then take out the strainer.

3. Remove the dust and dirt from the strainer and wash it with diesel fuel or cleaning solvent. If the strainer is damaged, replace it.

4. After the strainer is installed, add engine oil to the specified level through oil filler (F).

5. Confirm that the oil is added to the specified level. For details, see CHECK BEFORE STARTING.

★ The type of lubricant used depends on the ambient temperature. Select according to the table "FUEL, COOLANT AND LUBRICANTS".

★ Refill capacity: 95 ℓ

★ Change oil every 1000 hours or 10000km whichever comes earlier.

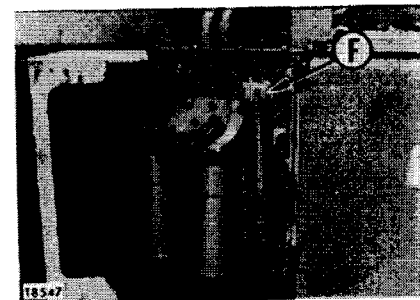
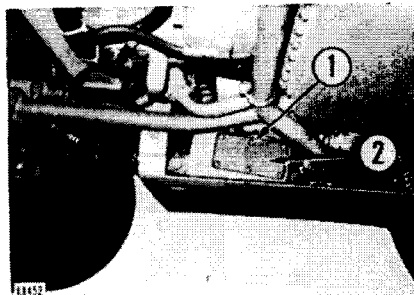
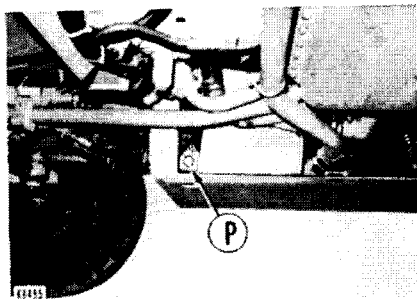

c. DIFFERENTIAL CASE

- 1) Remove the drain plug (P), then drain oil through the plug hole.
 - 2) Fill the differential case with the specified oil through the plug hole (G).
- ★ See "EVERY 250 HOURS SERVICE" for the refilling procedure.
 - ★ Change oil every 1000 hours or 10000km whichever comes earlier.
 - ★ The type of lubricant used depends on the ambient temperature. Select according to the table "FUEL, COOLANT AND LUBRICANTS".
 - ★ Refill capacity: 45ℓ

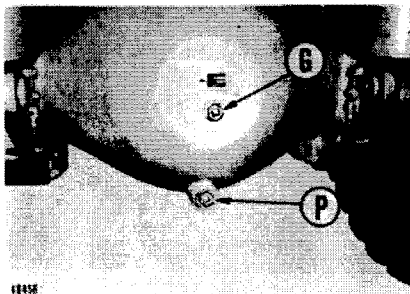

d. FINAL DRIVE CASE

1. Park the truck so that cast line (1) becomes horizontal.
 2. Remove drain plug (P) to drain the oil.
 3. Refill the case with fresh engine oil through oil filler (G).
- ★ The type of lubricant used depends on the ambient temperature. Select according to the table "FUEL, COOLANT AND LUBRICANTS".

- ★ Refill capacity: 13ℓ for each case.
- ★ See "EVERY 250 HOURS SERVICE" for the refilling procedure.
- ★ Change oil every 1000 hours or 10000 km whichever comes earlier.

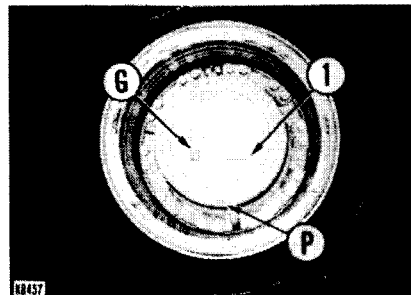

EVERY 1000 HOURS SERVICE

e. HYDRAULIC TANK

- 1) Lower the dump body and stop the engine.
- 2) After releasing the internal pressure by slowly turning the cap on oil filler (F), remove the cap.
- 3) Remove drain plug (P) from the lower part of the tank, drain the oil, and tighten the plug.
- 4) Add engine oil to the specified level through oil filler (F).
- 5) After adding the oil, check the oil level. For details, see CHECK BEFORE STARTING.

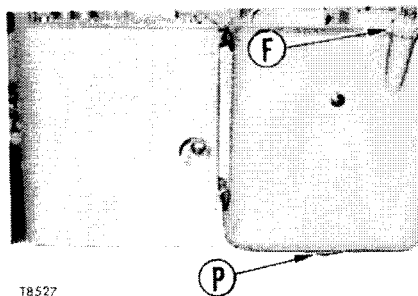

T8527

- ★ The type of lubricant used depends on the ambient temperature. Select according to the table "FUEL, COOLANT AND LUBRICANTS".
- ★ Refill capacity: 129 ℓ

⚠ When removing cap, turn it slowly to relieve the internal pressure.

- ★ Change oil every 1000 hours or 10000km whichever comes earlier.

f. TRANSMISSION VALVE STRAINER

1. Raise the dump body and insert the safety pin.
2. Remove strainer body (1).
3. Remove the dust and dirt from the strainer and wash it with diesel fuel or cleaning solvent. If the strainer is damaged, replace it.
4. Install the strainer to the original position.

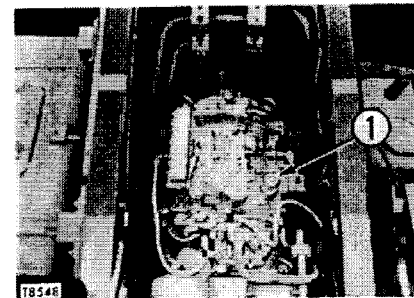

g. REAR BRAKE DISC

1. Shift parking brake valve lever to "BRAKE" position and secure the other brakes do not work.
2. Remove air bleeding plug (1) of rear brake and insert disc wear gauge in to the air bleeding valve.
3. Turn starting switch to "ON", check air pressure gauge pointer indicates in green range.
4. When air pressure is low, turn the engine as to keep 2000 rpm till the air pressure gauge indicates in the green range, then, turn off the starting key to "OFF".

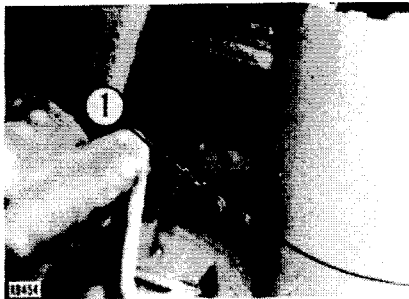

5. Pull retarder control lever to full stroke and push the wear gauge till it contact to top face of piston.
- ★ When the retarder control lever is pulled, the rod will fly out under hydraulic pressure, so hold it by hand when doing this.
6. When mark (A) shown on the gauge passes through in the valve case, this means wear of disc is in the limit of wear.
In such a case, contact to your Komatsu distributor for maintenance.

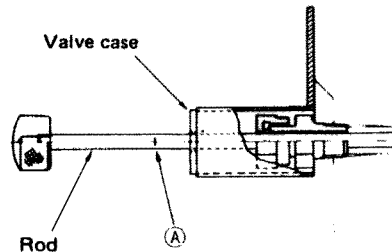

7. Install air bleeding plug (1).
8. Depress the brake pedal, loosen air bleeding plug (1), tighten the plug, and release the brake pedal.
9. Repeat the air bleeding until no air bubbles come out of air bleeding plug (1).
10. After completing the air bleeding, firmly tighten plug (1).

⚠ Check rear brake for wear when the brake oil temperature is below 60°C.

⚠ When the discs have reached the wear limit, carry out inspection carefully regardless of the maintenance interval. Check the retarder capacity also.

EVERY 1000 HOURS SERVICE

h. TURBOCHARGER VARIOUS FASTENERS

Contact your Komatsu distributor for checking, or proceed as follows:

Periodically inspect all joints for looseness. Tighten when necessary.

1. Mounting bolt for turbine housing:
6.0 to 7.5 kgm
2. V-clamp bolt for blower housing:
0.8 to 1.0 kgm
3. Exhaust manifold and turbine housing connection bolt:
6.0 to 7.5 kgm

i. CORROSION RESISTOR

1. After screwing in valve (1) on the corrosion resistor (2) remove the cartridge by turning it counter-clockwise and replace it with new one.
2. Turn the cartridge in until its sealing surface comes into contact with the head. Then, retighten the cartridge 1/2 to 3/4 turn by hand.
3. After replacement, open valve (1).

- ★ It is recommended genuine Komatsu cartridge are used.
- ★ Be careful not to screw in more than required.
- ★ When installing a new cartridge, coat the sealing surface with lubricating oil.

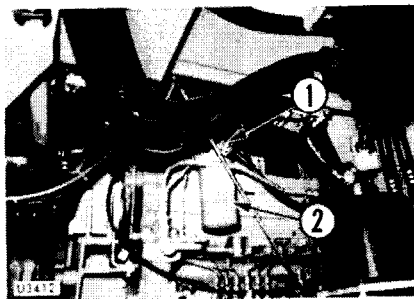

EVERY 2000 HOURS SERVICE

EVERY 2000 HOURS SERVICE

a. ENGINE BREATHER

1. Remove breather (1).
 2. Rinse the breather in diesel oil or flushing oil, dry with compressed air, then install again.
- ★ Before removing the breather, clean all the dirt from around the breather.
 - ★ Replace the breather O-ring with a new part, and coat it with engine oil before installing.

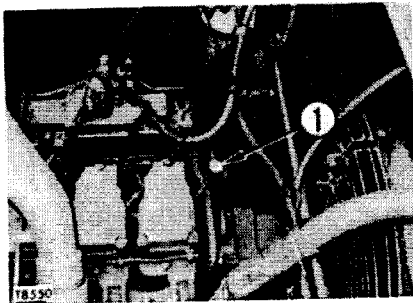

b. TURBOCHARGER

Ask Komatsu distributor to clean the turbocharger and check rotation of the rotor impeller, or perform the following.

1. Remove the intake pipe connector and the lubrication pipe from the turbocharger.
2. Remove the blower housing so that the blower impeller can be seen.
3. When cleaning the blower impeller, do not use a wire brush or other device which may scratch the impeller. Clean it with light oil. If it is very dirty, use a soft brush made of animal hair.

- ★ Maintenance for every 50, 250, 500 and 1000 hours should be carried out at the same time.

4. Pour the light oil through the oil filler of the turbocharger and rotate the impeller several turns to wash out the sludge.
 5. Rotate the impeller with your fingers at high speed to check the rotation.
- ★ If the impeller rotates at least one turn and no sound of hitting comes from inside, it is normal. If any abnormality is found, call Komatsu distributor.
6. After cleaning and checking, blow off the light oil with air and add engine oil.

EVERY 2000 HOURS SERVICE

c. TURBOCHARGER ROTOR

Ask Komatsu distributor to check the play of the turbocharger rotor, or perform the following steps after cleaning and checking it.

Play in the axial direction of rotor assembly.

- Move the rotor assembly in the axial direction. Measure the play in the direction of the shaft with a dial gauge.

Standard: 0.08 – 0.18 mm

- Play in the radial direction of rotor assembly.
- Move both sides of the rotor assembly in the radial direction with your finger, and measure the play with a dial gauge.
Standard: 0.25 – 0.60 mm
- ★ If the play exceeds the allowable limit, ask Komatsu distributor for repair or replacement.
- ★ If the rotor is excessively soiled with dust or carbon or if any oil leakage caused by turbocharger trouble is noted, have the turbocharger repaired by your Komatsu distributor.

d. ALTERNATOR AND STARTING MOTOR

Brushes should be worn by this time. Request Komatsu distributor to repair.

- ★ If the machine is required to operate at night and to consume large amount of electricity for the lighting system, request your Komatsu distributor to accomplish the maintenance at intervals of 1000 hours.

e. ENGINE VALVE CLEARANCE

Ask Komatsu distributor to check engine valve clearance because special tools should be used.

EVERY 2000 HOURS SERVICE
EVERY 4000 HOURS SERVICE

EVERY 4000 HOURS SERVICE

f. VIBRATION DAMPER

Check the vibration damper for cracks or separation on rubber surface.

If there are cracks or separation, contact your Komatsu distributor for replacement.

g. SAFETY PARTS

Replace component parts for safety. (Refer to section PERIODICAL REPLACEMENT OF SAFETY PARTS.)

a. WATER PUMP

Check the water pump for play in the pulley, grease leakage and water leakage. If a fault is detected, ask Komatsu distributor to disassemble and repair or replace.

b. AIR COMPRESSOR

Since all works above-mentioned requires special tools, contact your Komatsu distributor for repair.

★ Maintenance for every 50, 250, 500, 1000 and 2000 hours should be carried out at the same time.

c. FAN PULLEY AND TENSION PULLEY

Check the pulley for play and grease leakage. If any abnormality is found, ask your Komatsu distributor to repair or replace it.

WHEN REQUIRED

WHEN REQUIRED

a. CLEAN INSIDE OF COOLING SYSTEM

Clean the inside of the cooling system, change the coolant, and replace the corrosion resistor, according to the table.

★ Stop the machine on level ground when cleaning or changing the coolant.

★ Use a permanent type of antifreeze.

If, for some reason, it is impossible to use permanent type antifreeze, use an antifreeze containing ethylene glycol.

★ Be sure to replace the corrosion resistor cartridge.

★ Use city water for the cooling water.

If river water, well water or other such water supply must be used, contact your Komatsu distributor.



Antifreeze is flammable, so keep it away from any flame.

● Add antifreeze in the cooling water

When deciding the ratio of antifreeze to water, check the lowest temperature in the past, and decide from the mixing rate table given below.

It is actually better to estimate a temperature about 10°C lower when deciding the mixing rate.

Mixing rate of water and antifreeze

Min. atmospheric temperature (°C)	-5	-10	-15	-20
Amount of antifreeze (ℓ)	29	37.5	45	50
Amount of water (ℓ)	96	87.5	80	75

★ We recommend use of an antifreeze density gauge to control the mixing proportions.

Type of antifreeze solution	Cleaning inside of cooling system and changing coolant	Replacing corrosion resistor
Permanent type antifreeze (All season type)	Every year (autumn) or every 2000 hours whichever comes first	Every 1000 hours and when cleaning the inside of the cooling system and when changing coolant
Non permanent type antifreeze containing ethylene glycol (Winter, one season type)	Every 6 months (spring, autumn) (Drain antifreeze in spring, add antifreeze in autumn)	
When not using antifreeze	Every 6 months or every 1000 hours whichever comes first	

WHEN REQUIRED

1. Stop the engine, close corrosion resistor valve (1).
2. Turn radiator cap (2) slowly until it comes off.
3. Open drain valve (3) at the bottom of radiator and drain valve (4) at the side of cylinder block, and drain off the cooling water.
4. Close up drain valves (3) and (4) and pour in clean water (e.g., city water) up to the vicinity of the water filler.
5. When the water reaches the vicinity of the water filler, put the engine at low idling, open the drain valves, then pass water through the cooling system until clean water comes out from the drain valves for 10 minutes.
 - ★ When doing this, adjust the amount of water supplied and drained to keep the radiator full at all time.
6. When the water becomes completely clean, stop the engine and close drain valves (3) and (4).
7. After draining off the cooling water, wash out the cooling system using commercially available detergent. Follow the instructions on the detergent container.
8. After washing the cooling system, drain off all the water, then close up drain valves and pour in clean water (e.g., city water) slowly up to the vicinity of the water filler.

Corrosion resistor

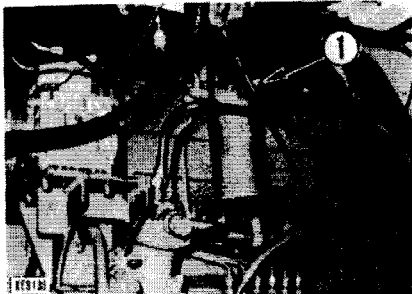

Water filler

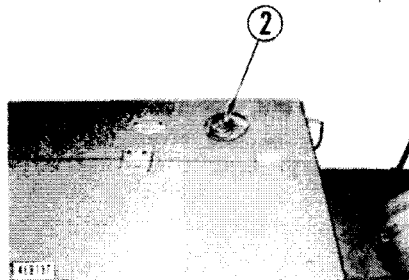

Drain valve (radiator)

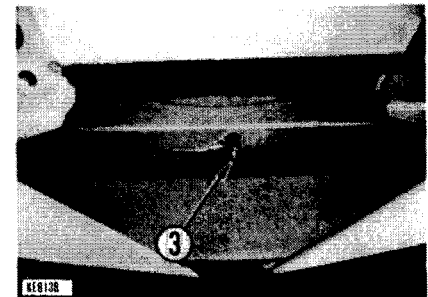

WHEN REQUIRED

9. When the water reaches the vicinity of the water filler, put the engine at low idling, open the drain valves, then pass water through the cooling system until clean water comes out from the drain valves.
- ★ When doing this, adjust the amount of water supplied and drained to keep the radiator full at all times.
10. When the water becomes completely clean, stop the engine and close the all drain valves.
11. Replace the corrosion resistor cartridge and open valve (1).

Drain valve (cylinder block)

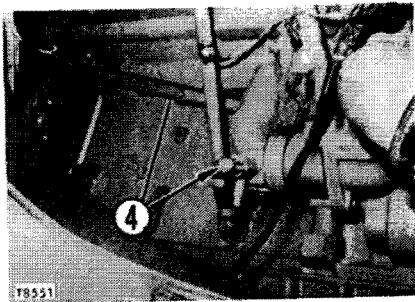

- ★ For details of replacement of the corrosion resistor, see **EVERY 1000 HOURS SERVICE**.
12. Supply water until it overflows from water filler (2).
13. Run the engine for 5 minutes at low idling and then for another 5 minutes at high idling to eliminate air trapped in the cooling system (leave radiator cap off during this operation).
14. Stop the engine, and after letting it stand for about 3 minutes pour in water up to the vicinity of the water filler, then screw up the cap.

⚠ If the water temperature is high, do not remove the cap. This is because of the possibility of scalding water spurting out. Remove the cap after raising the cap lever to relieve internal pressure.

b. CHECK, CLEAN AND REPLACE AIR CLEANER ELEMENT

Checking

Whenever the red piston in the dust indicator (1) appears, clean the air cleaner element. Stop the engine when cleaning the element.

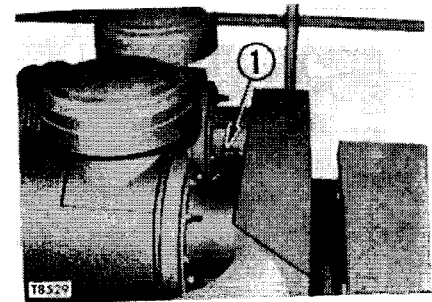

Cleaning or replacing outer element

1. Loosen bolt (2) and remove band (3) and cover (4).
2. Remove wing nut and outer element.
3. Clean the air cleaner body interior and the removed cover.
4. Clean and inspect the element. (See the next page for cleaning procedure.)
5. Install the cleaned element.
6. Push the dust indicator reset button to return the red piston to the original position.

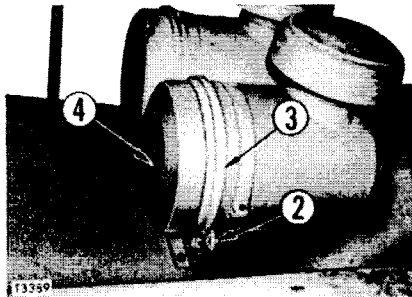

- ★ Remove one seal from the outer element. The number of times the outer element has been cleaned can be seen by the number of removed seals.
- ★ If the outer element has been used for more than a year, replace both the inner and outer elements even if the outer element has been cleaned less than 6 times.
- ★ When the dust indicator red piston appears soon even after installing the cleaned outer element less than 6 times, replace both the inner and outer elements.
- ★ Check inner element mounting nuts for looseness and, if necessary, re-tighten.

- ★ Replace seal washer (6) or wing nut (5) if they are broken.

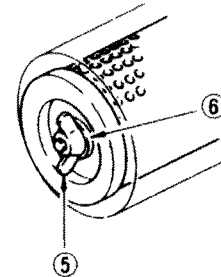

WHEN REQUIRED

Replacing inner element

1. First remove the cover and the outer element, and then remove the inner element.
 2. Cover the air outlet port.
 3. Clean the air cleaner body interior. Remove the cover from the air outlet port.
 4. Fit a new inner element to the connector and tighten it with nuts.
 5. Install the outer element and the cover. Push the dust indicator reset button.
- ★ Always replace the inner element. Do not attempt to reuse by cleaning.
 - ★ When cleaning or replacing the air cleaner element, do not start the engine.

Cleaning outer element

With compressed air

Direct dry compressed air (less than 7kg/cm^2) to element from inside along its folds, then direct it from outside along its folds and again from inside, and check element.

! When using compressed air, wear safety glasses and other things required to maintain safety.



The following methods require spare parts.

With water

Dash city water (less than 3kg/cm^2) on element from inside along folds, then from outside and again from inside. Dry and check it.

If heavily contaminated, carry out the following steps:

- 1) Dissolve 300 g of the detergent into 20l of water (full capacity of an oil can).
- 2) Immerse the element for 15 minutes.
- 3) After rinsing, wash dirt off with clean water.
- 4) Inspect the element after drying it. Dry with a fan or in shade.

With cleaning agent

For removing oils and fats as well as carbon etc. attached on the element, the element may be cleaned in lukewarm solution of mild detergent, then rinsed in clean water and left to drip dry.

- ★ Drying can be speeded up by blowing dried compressed air (less than $7\text{kg}/\text{cm}^2$) from the inside to the outside of the element.

Never attempt to heat the element.

- ★ Using warm water (about 40°C) instead of soapy water may also be effective.

- ★ If small holes or thinner parts are found on element when it is checked with an electric bulb after cleaning and drying, replace the element.
- ★ If element is usable, wrap it and store it in dry place.
- ★ Do not use element whose folds or gasket or seal are damaged.
- ★ When cleaning element, do not hit it or beat it against something.



c. CHECK ELECTRICAL INTAKE AIR HEATER

Check electrical intake air heater (1) once a year before commencing work in the cold season.

Remove electrical intake air heater from the engine intake manifold, and check it for possible defective and dirt.

When inspecting and replacing electrical intake air heater, replace the gasket with new one.

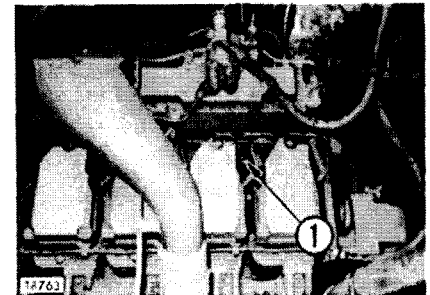

WHEN REQUIRED

d. REPLACING THE FAN BELT

An auto-tensioner is installed, so there is no need to adjust the belt tension until the belt is replaced.

Replacement procedure

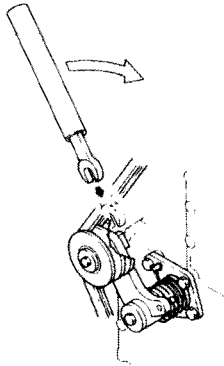

Fit a wrench to the tension pulley, and push in the direction of the arrow until the V-belts can be removed, then replace the V-belts.

★ Replace the V-belts as a set.

e. DRAIN WATER FROM THE WATER SEPARATOR

When float (2) is at or above red line (1), drain the water according to the following procedure:

1. Loosen drain plug (3) and drain the accumulated water until the float reaches the bottom.
2. Tighten drain plug (3).

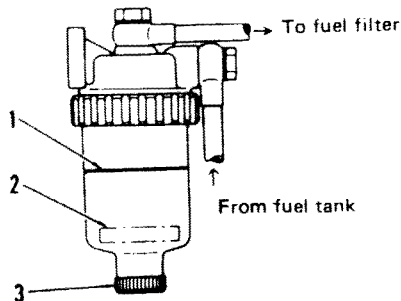

3. If the air is sucked into the fuel line when draining the water, be sure to bleed the air in the same manner as for the fuel filter.

(See Fuel Filter Cartridge in EVERY 500 HOURS SERVICE section.)

ADJUSTMENT

PARKING BRAKE

To Adjust, proceed as follows:

1. Rotate the drum (1) so that the adjustment hole (3) of the drum (1) positions on the adjuster wheel (2).
2. Next turn the adjuster wheel (2) with a screwdriver through the adjustment hole (3) so that the lining comes close to the drum (1); then return the adjuster wheel by 15 teeth to get the standard clearance.

In this case the stroke S of the brake lever is below 30 mm.

- ★ After adjusting, if stroke S of the brake lever exceeds 30 mm, the lining must be replaced or the parking brake linkage must be inspected and adjusted. Please contact your Komatsu distributor.

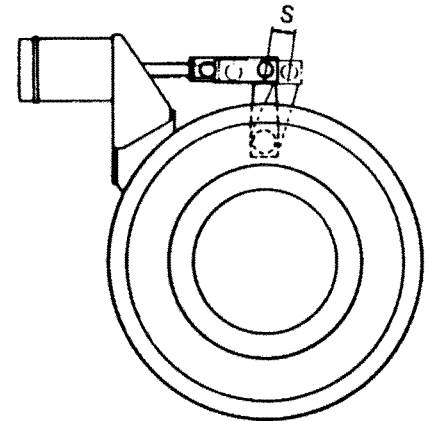
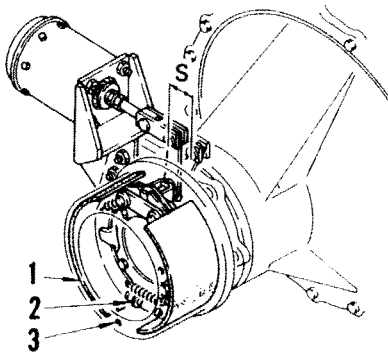

ADJUSTMENT

BLEEDING AIR FROM FRONT BRAKE

1. Start the engine and raise the pressure until it reaches the maximum position inside the green range on the air pressure gauge.
2. Fill oil reservoir (1) with brake oil. (CD class SAE10W)

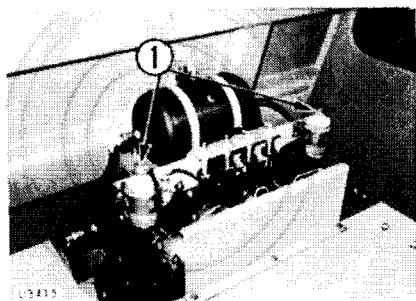

3. Remove the cap of bleeder screw (2), insert a vinyl hose (inside diameter: 8 mm), then loosen the bleeder screw approx. 3/4 turns and depress the brake pedal slowly. Tighten bleeder screw, then release the brake pedal.

Repeat this procedure until no more bubbles come out from the vinyl hose.

- ★ Do not keep the pedal fully depressed. Depress it slowly each time.
- ★ After bleeding the air, tighten bleeder screw (2) securely and fit the cap.

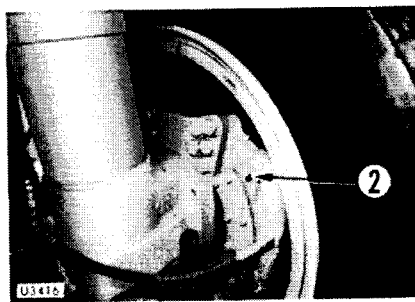

4. After completing the air bleeding, add oil so that the oil level in the oil reservoir is at the specified level (MAX).
- ★ Carry out the same procedure on both the left and right sides.
 - ★ When bleeding air from the front brakes and rear brakes at the same time, bleed the air from the rear brakes first.

SUSPENSION CYLINDER LENGTH AND OIL LEVEL

During operation, the following abnormalities may be noticed: the machine bounces greatly, the suspension cylinder is shortened and hits against the stopper, or the operator senses an excessive bouncing caused by unlevel ground surfaces. When these troubles are noticed, stop the machine immediately, and check.

1. Check for cylinder length

See if the bottom end of the suspension cover of front and rear are within the proper range on the label when the machine is on level ground without load.

- ★ After checking front and rear, if there is any abnormality, contact your Komatsu distributor.

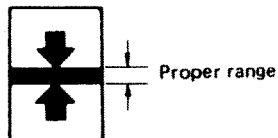

Front

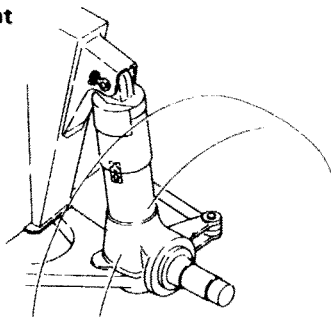

Rear

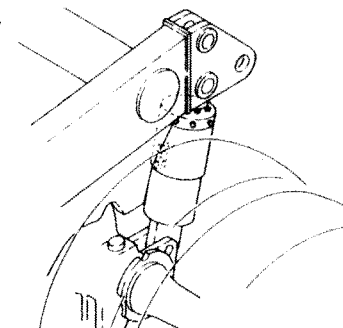

ADJUSTMENT

2. Check for cylinder oil amount

a. Front

If oil is short, the distance from the top of the sliding trace (glossy surface) of plated surface of rod to rod head shoulder becomes less than 65 mm.

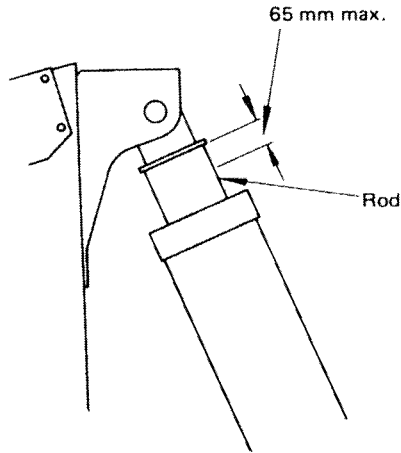

b. Rear

If oil is short, signs of being hit are found on differential case and stopper.

★ After checking front and rear, if there is any abnormality, contact your Komatsu distributor.

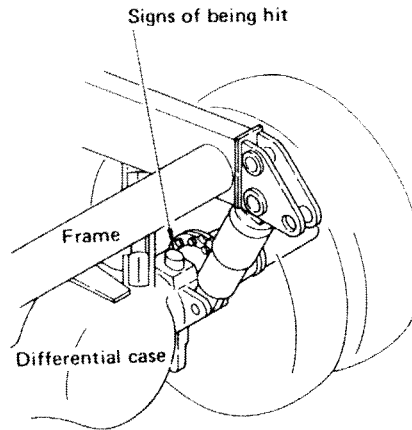

ADJUSTMENT OF DUMP BODY POSITIONER

The positioner is provided for automatic and shock-free stopping of the dump body when the dump body reaches any preset height (or turning angle).

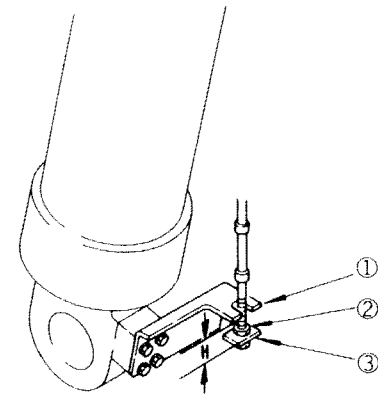

To adjust, proceed as follows:

1. Stop the engine when the dump body has reached the desired angle.
2. Loosen lock nut (2) and adjust plate (3) until plate (3) comes into contact with bracket (1), then tighten lock nut (2).
3. After adjustment, run the engine and make sure that the dump lever returns automatically to HOLD when the dump body has reached the determined angle.

- ★ If the clearance "H" shown in the figure exceeds 26 mm when the dump body is lowered, the hoist cylinder piston rod reaches its stroke end before the positioner works.

BACK-UP ALARM VOLUME

Three degrees of back-up alarm volume can be selected according to the work area.

Changing method

Loosen screw (1), remove cover (2), and you can find variable bridge. Three screws (3) indicate H, L and M respectively.

H: Maximum, $112 \pm 4\text{dB}$

Connect the bridge (4) to L and H.

L: Minimum, $97 \pm 4\text{dB}$

Connect one end of bridge (4) to L and the other end is set free.

M: Medium, $107 \pm 4\text{dB}$

Connect the bridge (4) to L and M.

Back-up alarm block circuit

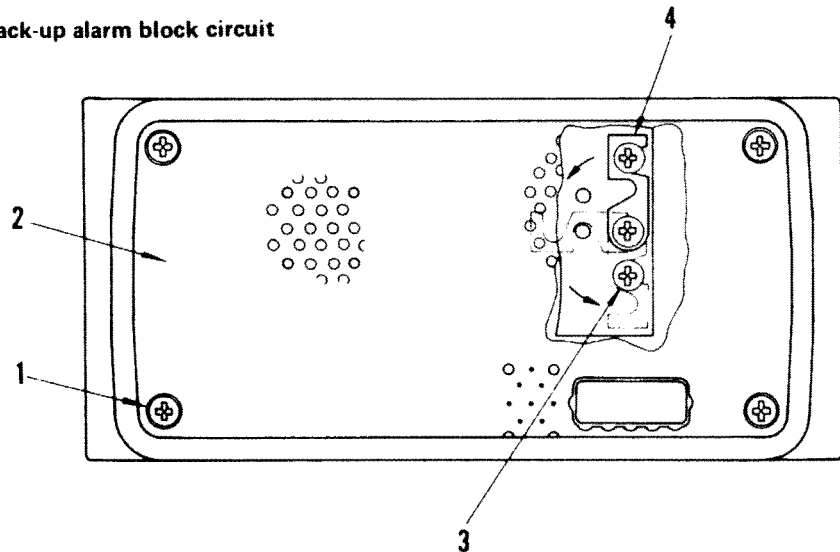

TROUBLE SHOOTING GUIDE

When any trouble not covered in this section is found, request Komatsu distributor for repair.

ENGINE

Oil pressure gauge pointer will not return to the red range (at the left side on the dial) when the engine is stopped.

- Replace oil pressure gauge.

Oil pressure gauge pointer fluctuates abnormally.

- Refill oil to the specified oil level.

Oil pressure gauge pointer goes to the red range (at the left side on the dial).

- Refill oil to the specified oil level.
- Check and repair oil piping and piping joints.
- Check and repair full-flow oil filter.
- Replace oil pressure gauge.

The pressure valve on the radiator filler cap blow off steam. Water temperature gauge pointer goes to the red range at the right side on the dial.

- Check and refill cooling water.
- Check belt tension.
- Changing cooling water and clean inside of cooling system.
- Clean or repair the radiator fin.
- Replace water temperature gauge.
- Replace thermostat.
- Replace thermostat seal.
- Retighten or replace radiator filler cap.

Water temperature gauge pointer goes to the white range at the left side on the dial.

- Replace water temperature gauge.
- Replace thermostat.
- Put radiator curtain.

ENGINE

Engine fails to start when the starting motor has been started.

- Supply fuel
- Repair place where air leaks in.
- Fill fuel in the filter.
- Refer to the section.
"ELECTRICAL SYSTEM"
- Adjust valve clearance.

Fuel supply is stopped from time to time.

- Clean breather.
- Replace breather tube.

A large quantity of oil is consumed. Exhaust gas color is white or bluish.

- Check and repair oil leaks.
- Refill oil to the specified oil level.
- Replace piston, ring and cylinder liner.
- Replace with the specified fuel.
- Check and repair turbocharger.

Exhaust gas color is black.

- Clean or replace air cleaner element.
- Replace piston, ring and cylinder liner.
- Adjust engine valve clearance.
- Check and replace turbocharger.

Engine is hunting.

- Repair place where air leaks in.

Engine is knocking (firing or mechanical).

- Replace with the specified fuel.
- Refer to section "Water temperature gauge goes to the red range at the right side on the dial".

ELECTRICAL SYSTEM

Ammeter pointer fluctuates abnormally when engine runs at a fixed speed. Lights are not bright enough even when the engine is running at maximum rpm. Lights flicker while engine is running.

- Check and correct loose terminals and discontinued wiring.
- Adjust belt tension.

Ammeter doesn't deflect when the engine runs.

- Replace ammeter.
- Check and repair wiring.

Unusual noise is emitted from the alternator.

- Replace alternator.

Starting motor fails to start even if the starting switch key is turned to "START".

- Check and repair wiring.
- Replace switch.
- Charge the battery.
- Replace switch.
- Return lever to NEUTRAL position.

Starting motor turns the engine sluggishly.

- Check and repair wiring.
- Charge the battery.

Starting motor disengages before the engine start up.

- Check and repair wiring.
- Charge the battery.

MECHATRONICS

No.	LED display		Failure mode	Contents of failure
	Red	Green		
1	Lighting	Lighting	MODEL SELECTION SAFETY	Defect of input side harness
2	Flashing alternately		STARTING SAFETY	Engine starts at other than N
3	Lighting	Fast flashing	SOLENOID VALVE SAFETY	Defect of solenoid valve and/or output side harness
4	Lighting	Slow flashing	T/M SOLENOID VALVE SAFETY	Defect of solenoid valve and/or output side harness
5	Lighting	Off	T/M FAST ROTATION SAFETY	T/M overrun
6	Fast flashing	Off	T/M OUTPUT SENSOR SAFETY	Failure of T/M output side sensor system
7	Slow flashing	Off	SHIFT POSITION SAFETY	Failure of shift position sensor system
8	Slow flashing	Lighting	THROTTLE SAFETY	Failure of throttle switch system
9	Fast flashing	Lighting	T/M INPUT SENSOR SAFETY	Failure of T/M input side sensor system
10	Simultaneous flashing		PROGRAM SAFETY	Failure of AESC
11	Off	Off	POWER SOURCE OFF	Failure of power circuit
12	Off	Lighting	NORMAL	In operation

- ★ If any abnormality occurs as listed on the left, please park the car, pull the parking brake, check the LED display of the controller, and then contact your Komatsu distributor for repair.
- ★ Please contact your Komatsu distributor for repair of any abnormalities other than those listed on the left.
- ★ If the starting procedure of the engine is wrong the display will show "STARTING SAFETY" and the engine will not start. (Please refer to "TO START THE ENGINE".)
- ★ "TM/OVERRUN" does not mean the failure of the car. Please try again to start the engine.

CHASSIS

Defective torque converter

Torque converter oil pressure is low. Torque converter is overheated.

- Check and repair oil piping and pipe joints.
- Check and replace gear pump.
- Supply oil to the specified level.
- Clean oil filter element in transmission case.
- Replace belt.
- Refer to "ENGINE" section.
- Clean or replace oil cooler.
- Drive at direct range.

Heavy steering

- Grease.

Brake is not effective if the brake pedal is depressed.

Brake effect is unbalanced.

- Replace pad.
- Replace rear disc.
- Charge air to the specified level.
- Supply oil in brake oil reservoir.
- Bleed air.

Dump body operation speed is too low. Response of dump body to operation is slow.

- Refill oil to the specified level.
- Replace gear pump.

Suspension is hard.

- Replace U-packing.
- Replace valve core.

Only the single side of the rear wheel is likely to slip.

- Bleed air (from the right and left).
- Replace tires.
- Level the load.
- Disassemble the brake and check.

SERVICE METER

This meter indicates the integrated work hours. So, use it according to the following instructions.

- Record the readings at the start and the end of a work, which will be a work record of the machine.
- The time for periodical maintenance is informed.
- It indicates the integrated working hours which must be informed at trouble information.

★ How the meter measures:

The meter adds one unit for each hour of engine operation, independent of the speed of engine revolutions. The meter records even when the machine remains stationary, so long as the engine is running.

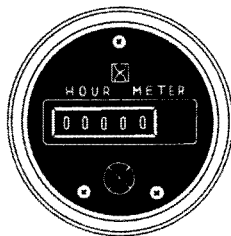

MACHINE AND ENGINE SERIAL NUMBERS

When calling for the services of a mechanic or when ordering replacement parts, be sure to give your Komatsu distributor the machine and engine serial numbers as well as the service meter reading mentioned before.

These numbers are stamped in the locations shown in the photos on the right.

- Location of machine serial number

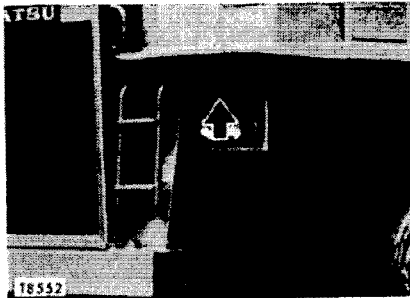

The machine serial number is stamped on the front-end side of the left frame.

- Location of engine serial number

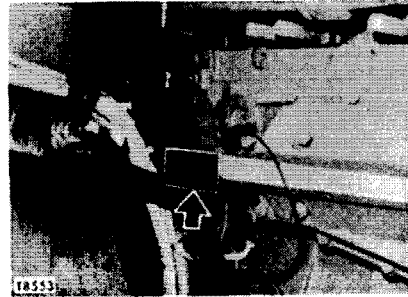

The engine serial number is stamped on the right side of the cylinder block.

FUEL, COOLANT AND LUBRICANTS

PROPER SELECTION OF FUEL, COOLANT AND LUBRICANTS

RESERVOIR	KIND OF FLUID	AMBIENT TEMPERATURE					CAPACITY (ℓ)	
		14 -10	32 0	50 10	68 20	86°F 30°C	Specified	Refill
Engine oil pan	Engine oil	SAE 30					38	30
		SAE 10W						
		SAE 15W-40						
		SAE 10W-30						
Transmission case (incl. torque converter)		SAE 30					165	95
		SAE 10W						
Hydraulic system Front suspension Rear suspension		SAE 10W					165 11.5 (each) 8 (each)	129 11.5 (each) 8 (each)
		SAE 15W-40						
		SAE 10W-30						
Differential case Final drive case		SAE 30					50 13 (each)	45 13 (each)
Fuel tank	Diesel fuel	ASTM D975 No. 2					500	-
		※						
Cooling system	water	Add antifreeze					125	-

※ ASTM D975 No. 1

NOTE:

(1) When fuel sulphur content is less than 0.5%, change oil in the oil pan every periodic maintenance hours described in this manual.

Change oil according to the following table if fuel sulphur content is above 0.5%.

Fuel sulphur content	Change interval of oil in engine oil pan
0.5 to 1.0%	1/2 of regular interval
Above 1.0%	1/4 of regular interval

- (2) When starting the engine in an atmospheric temperature of lower than 0°C, be sure to use engine oil of SAE10W, SAE10W-30 and SAE15W-40, even though an atmospheric temperature goes up to 10°C more or less in the day time.
- (3) Use API classification CD as engine oil and if API classification CC, reduce the engine oil change interval to half.

ASTM: American Society of Testing and Material

SAE: Society of Automotive Engineers

API: American Petroleum Institute

Specified capacity: Total amount of oil including oil for components and oil in piping.

Refill capacity: Amount of oil needed to refill system during normal inspection and maintenance.

OPERATION AND MAINTENANCE (EQUIPPED WITH A ELECTRONIC INSTRUMENT PANEL)

**This section applies when equipped with A ELECTRONIC INSTRUMENT PANEL.
Only the portions which differ from previous sections are noted.**

INSTRUMENTS AND CONTROLS

INSTRUMENT PANEL

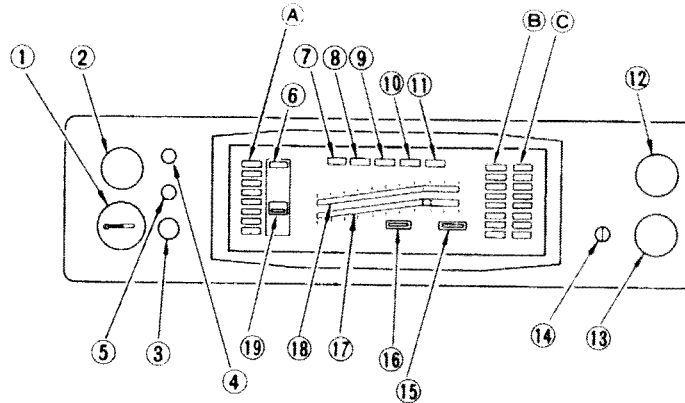

- | | | |
|-----------------------------------|------------------------------------|------------------------------------|
| 1. Emergency brake valve lever | 8. Pilot lamp for kick-down memory | 15. Odometer |
| 2. Engine water temperature gauge | 9. Pilot lamp for hi-beam | 16. Service meter |
| 3. Emergency steering switch | 10. Pilot lamp for parking brake | 17. Tachometer |
| 4. Wiper switch | 11. Pilot lamp for turn signal | 18. Speedometer |
| 5. Lamp switch | 12. Shift indicator | 19. Retarder oil temperature gauge |
| 6. Pilot lamp for retarder | 13. Air pressure gauge | A. CHECK MONITOR GROUP |
| 7. Pilot lamp for turn signal | 14. Starting key switch | B. CAUTION MONITOR GROUP |
| | | C. CAUTION MONITOR GROUP |

MONITOR PANEL

- To check the monitor system, turn the starting switch to ON before starting the engine. Then all the monitor lamps and the central warning lamp flashes and the alarm buzzer sounds for about 5 seconds. If any lamp fails to come on, check the lamp bulb and replace it if it is burnt out.

Ⓐ CHECK MONITOR GROUP



(Check items before starting)

If there is any abnormality, the appropriate monitor lamp will flash.

- ★ When the engine is started, these monitor lamps will go off even if there are abnormalities.

★ Do not rely on the “CHECK MONITOR GROUP (Check before starting)” only for the check before starting. Always make the check by referring to the section on CHECK BEFORE STARTING.

- ★ Park the machine on level ground and check the monitor lamps.

CHECK MONITOR	CAUSE	REMEDY
 FUEL LEVEL	Fuel level is low. (less than 100ℓ)	Check and refill the fuel tank.
 ENGINE OIL LEVEL	Engine oil level is low.	Check and refill the engine oil pan.
 WATER LEVEL	Radiator water level is low.	Check and refill the radiator.



Ⓑ CAUTION MONITOR GROUP
(Caution items)

If any abnormality occurs while the engine is running, the appropriate monitor lamp will flash to indicate the abnormality.

★ Even if any monitor lamp flashes, the machine can operate, but it should be repaired as soon as possible.

★ If the BODY FLOAT monitor lamp flashes, the central warning lamp will flash and alarm buzzer will sound at the same time.







★ Park the machine on level ground and check the monitor lamps.

CAUTION MONITOR	CAUSE	REMEDY
 FUEL LEVEL	Fuel level is low. (less than 72ℓ)	Check and refill the fuel tank.
 CHARGE	Alternator does not generate electricity.	Check alternator, belt, and wiring for faulty or defective parts. Replace faulty or defective parts.
 BODY FLOAT	Dump control lever is not in "FLOAT". Gear shift lever is shifted into position other than "N" positioning dump lever into position other than "FLOAT". (Central warning lamp lights and buzzer also sounds.)	Move the dump control lever back to "FLOAT" position.

Ⓒ CAUTION MONITOR GROUP
(Emergency stop items)

If any abnormality occurs while the engine is running, the appropriate monitor lamp will flash and the alarm buzzer will sound intermittently at the same time.

★ If any monitor lamp flashes, stop the engine or run it at a low idling speed, and repair it immediately.

CAUTION MONITOR	CAUSE	REMEDY
 WATER TEMP	Engine water temperature is too high.	Stop the truck and move the gear shift lever to N. Keep the engine running at low idle and wait for the lamp to go out.
 BRAKE OIL TEMP	Brake oil temperature is too high.	Stop the truck and move the gear shift lever to N. Keep the engine running at 2000 rpm and wait for the lamp to go out.
 ENGINE OIL PRESS	Engine oil pressure is too low.	Inspect the engine and its adjacent components. If no abnormalities are detected, contact your distributor.
 AIR PRESS	Air pressure is too low.	Inspect and correct the air leak. Then, wait for the air pressure to go up to the specified level.
 WATER LEVEL	Water level in radiator is too low.	Stop the engine and correct the water leak or the cause of the low water level. Then, refill the radiator.
 CONVERTER OIL TEMP	Torque converter oil temperature is too high.	Stop the truck and move the gear shift lever to N. Keep the engine running at medium speed with no load and wait for the lamp to go out.
 PARKING	The gear shift lever is put into position other than "N" keeping parking brake on or emergency brake on.	Immediately release the parking brake or emergency brake.

SPEEDOMETER

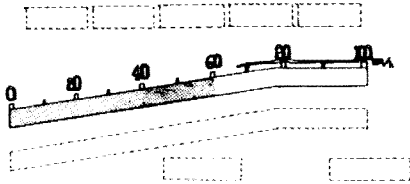

The speedometer indicates the travel speed in kilometers per hour.

An odometer is provided at the lower right side of the speedometer.

ENGINE TACHOMETER

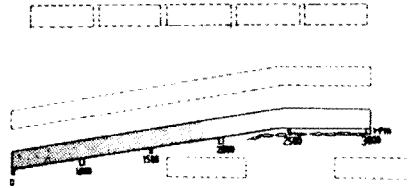

The engine tachometer indicates the engine speed in revolutions per minute (rpm). When the machine is going down a steep hill, the indicator may sometimes enter the orange or red range on the dial. When the indicator is in the red range, the engine has over-run. Drive at appropriate speeds and use the retarder, if necessary, to keep the indicator from entering the red range.

- ★ When the engine speed reaches 2500 rpm, the retarder brake applies automatically, causing both the machine speed and the engine speed to decrease. (In other words, the retarder brake works as an emergency automatic decelerator.)

INSTRUMENTS AND CONTROLS

SERVICE METER

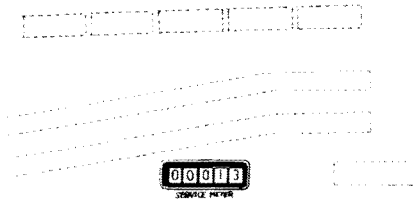

The service meter indicates the total operating hours of the machine. The meter registers as long as the engine is running, even if the machine is at a standstill.

ODOMETER (RED)

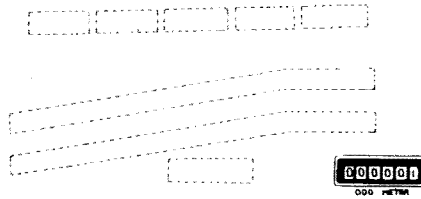

The odometer indicates the total distance traveled by the machine.

PILOT LAMP FOR TURN SIGNAL (GREEN)

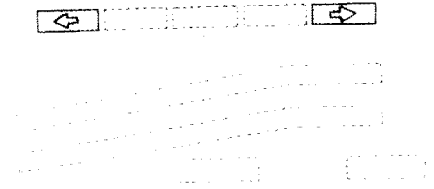

When the machine is changing direction, the L.H. or R.H. pilot lamp (green) blinks according to the position of the turn signal switch lever.

PILOT LAMP FOR KICK DOWN MEMORY (GREEN)

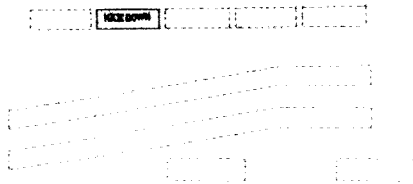

The pilot lamp comes on when the machine reaches the kickdown state. The kick-down state is attained when the accelerator pedal is pressed all the way.

- ★ For details on the kick-down, see section on OPERATING YOUR MACHINE.

PILOT LAMP FOR HI BEAM (BLUE)

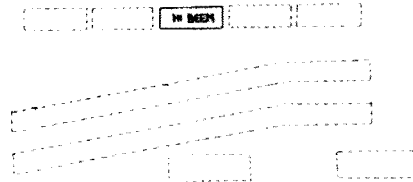

This pilot lamp comes on when the head lamp is on high beam.

PILOT LAMP FOR PARKING BRAKE (RED)

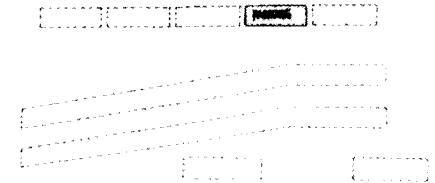

When the parking brake is applied, this pilot lamp (red) will come on.

PILOT LAMP FOR RETADER (GREEN)



This pilot lamp lights up when the retarder brake is on.

RETARDER OIL TEMPERATURE GAUGE

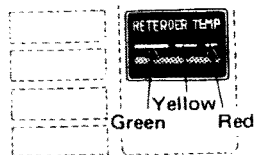

During operation, the indicator should normally register in green range.

If the red range is reached the central warning lamp will light red and a buzzer will sound.

Then retarder oil pilot lamp will twinkle. In this case, stop operation and keep the engine idling at 2000 rpm with the gear shift lever in neutral until the oil temperature falls.

CENTRAL WARNING LAMP (RED)

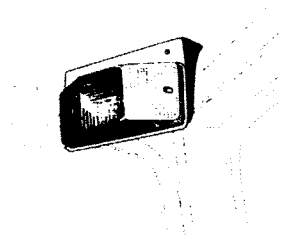

If there is an abnormality in following emergency warning items, this warning lamp twinkle and warning buzzer sounds and pilot lamp (emergency warning items) twinkle on electronic instrument panel. Then, immediately stop machine and check the causes.

(Refer to item "ELECTRONIC INSTRUMENT PANEL – Emergency warning items.)

1. Engine water temperature is too high.
2. Rear brake oil temperature is too high.
3. Engine oil pressure is too low.
4. Air pressure is too low.
5. Water level in radiator is too low.
6. Torque converter oil temperature is too high.
7. The gear shift lever is put into position other than "N", keeping parking brake on.
8. When the gear shift lever is placed in any position other than N, while the dump control lever is in any other position than FLOAT.

CHECK BEFORE STARTING

CHECK FUNCTION OF MONITOR

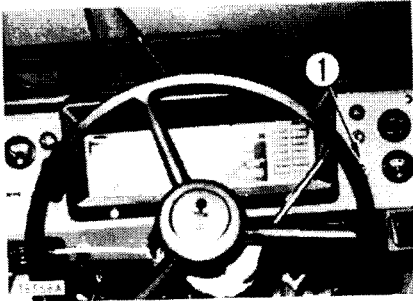

1. Turn on the key of starting switch (1) and confirm that all the lamps light for about five seconds. At the same time, confirm that the central warning lamp is flashing and that the warning buzzer is sounding.
 - ★ If any lamp fails to come on, check the lamp bulb and replace it if it is burnt out.
 - ★ When restarting the engine, wait at least 30 seconds since the engine last stopped.
2. All the lamps should go off within five seconds or so if no abnormalities are monitored.
 - ★ Only the CHECK MONITOR lamp will continue flashing if there is any abnormality.

TROUBLE SHOOTING GUIDE

This guide is not intended to cover every conditions, however many of the more common possibilities are listed.

ENGINE

When the starting switch is turned to ON position, ENGINE OIL LEVEL lamp on monitor panel flashes.

- Add oil to oil pan.
- Check and repair oil piping and piping joints.
- Check and repair wiring for sensor.

WATER LEVEL lamp flashes.

WATER TEMP lamp flashes.

- Check and refill cooling water.
- Check belt tension.
- Changing cooling water and clean inside of cooling system.
- Clean or repair the radiator fin.
- Replace water temperature gauge.
- Replace thermostat.
- Replace thermostat seal.
- Retighten or replace radiator filler cap.
- Check and repair wire for sensor.

CHASSIS

CONVERTER OIL TEMP lamp flashes.

- Check and repair oil piping and pipe joints.
- Check and replace gear pump.
- Supply oil to the specified level.
- Clean oil filter element in transmission case.
- Replace belt.
- Refer to "ENGINE" section.
- Clean or replace oil cooler.
- Drive at direct range.
- Check and repair wiring to sensor.

SAFETY AND OPERATION



CONTENTS

SAFETY HINTS . . . 	2
PRECAUTIONS FOR MAINTENANCE	14
AIR CONDITIONER	21
HANDLING OF BATTERY	25
STORAGE	28
COOLANT AND LUBRICANTS	30

SAFETY HINTS . . . ⚠

GENERAL

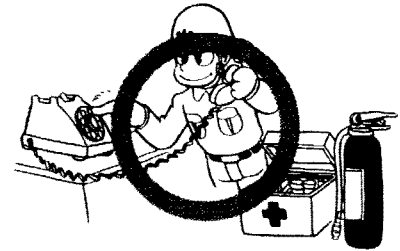
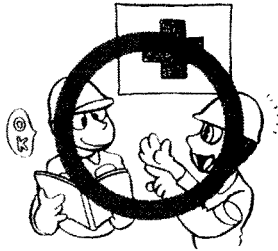
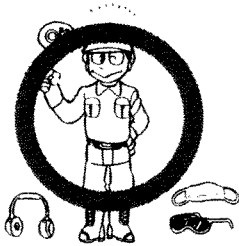

- Wear well-fitting hard hat, safety shoes and working clothes. Never wear loose or unbuttoned clothes as they may catch on protruding parts of machine. Never wear clothes covered in oil. If the nature of the work so requires, wear protective goggles or mask, ear plugs or other protection.
- Accidents or injuries are liable to occur when the operator is careless or inattentive. It is most important to bear safe operation in mind at all times.
- Learn the prohibitions, precautions and rules about work procedures in the job site. Make every effort to prevent accidents by always following these and always bearing safety in mind.
- Do not overwork or drive after drinking. Take care of your health. Driving while unfit can lead to mistakes in judgement in emergencies.
- Never allow more than the permitted number of persons to ride on the machine.
- If there should be an accident or fire or any other such unexpected mishap, deal with it quickly, using the nearest apparatus. In addition, it is necessary to prevent any secondary mishaps. It is also important to know the emergency contact system.
- Learn beforehand the locations and method of use of emergency equipment such as first aid boxes, fire extinguishers or other fire-fighting equipment.



- Fuel, oil and anti-freeze are dangerous. Never smoke or light matches when handling fuel, oil, grease or anti-freeze. Do not handle these substances near any fire or flame. When selecting a place for storing them, take care to choose a place away from where fire is used.
- When operating inside a building always be sure of the clearances of the ceiling, entrances, aisles, etc. and the load limit of the floor.

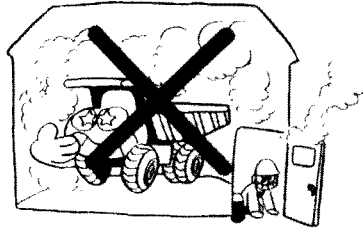

- Exhaust gas is dangerous. When running the engine for long periods in a poorly ventilated area, there is a danger of gas poisoning, so open the windows or doors to ensure a good supply of fresh air.
- Learn how to use the control devices, gauges and warning devices. Be sure you understand the meaning of the caution plates and other signs. Remember the check points and checking method for engine oil, fuel, cooling water and hydraulic oil levels. Always know the demensions and capacity of your machine.

BEFORE STARTING OPERATION

- Examine the lay of the land and the kind of soil at the site to determine the dangerous points and the best method of operation. Proceed with the work only after making safety arrangements about the dangerous points. Avoid operating near cliffs or deep gullies. Be particularly careful of the edge of cliffs, falling rocks or landslides.
- Always carry out inspection and maintenance correctly. Check for leakage of fuel, lubricant or hydraulic oil, and for loose, broken or missing parts.
If there are any such problems always correct them. Never use the machine without correcting all problems.
Use repaired machines only after receiving permission from the serviceman in charge of the repair.

- Adjust the operator's seat until it is in the most comfortable position for operating. Use seat belts if it is equipped to the seat, before you start to drive.



- When getting on or off the machine, use the handrail and step provided. Do not jump up or down from the machine.

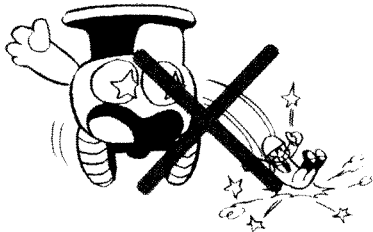

- Learn about the safety devices on your own machine and about how to use them. Confirm that they are correctly attached in the prescribed position.
- Before starting the engine, confirm that all control levers are in "NEUTRAL" or "HOLD".
- To ensure the safety of workers near the machine, always signal or sound the horn to warn them before starting the engine, moving the machine or turning. Be particularly careful to check that the rear is clear before backing the machine.
- Do not leave parts or tools lying around in the vicinity of or on the floor of the operator's compartment. Keep everything in its proper place, to avoid any hindrance while driving.

- Wipe off thoroughly any grease, oil or mud on the step, handrail, floor or control levers. Failure to do this may cause you to slip.
- Check the level of the fuel, lubricants and cooling water. Do not smoke or use naked flames when checking. Extinguish cigarettes before checking or refilling. Check that the radiator cap and all oil filler caps or plugs are firmly tightened.
- When there is a leader, fix standard signals and always follow these signals when operating. Learn the signs and rules used in the job site and always follow them.

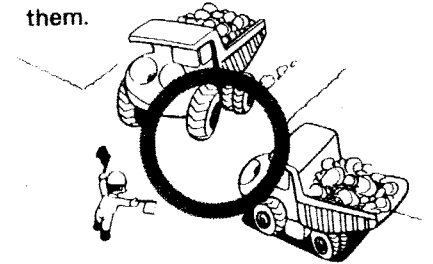

ARRANGEMENTS BEFORE STARTING OPERATIONS PLANNING AND CONSTRUCTION OF HAUL ROADS

Maintenance of haul roads in the job site is of utmost importance, not only for safety but also for reduction of cycle time.

- As far as possible, roads should be for one-way traffic.
- Where it is impossible to make oneway roads, the road should have ample width to allow trucks to pass each other easily.
- Where it is impossible to make the road wide enough, lay-bys should be constructed at frequent intervals.
- Roads must always be constructed to allow loaded trucks to pass on the inside (away from the edge).

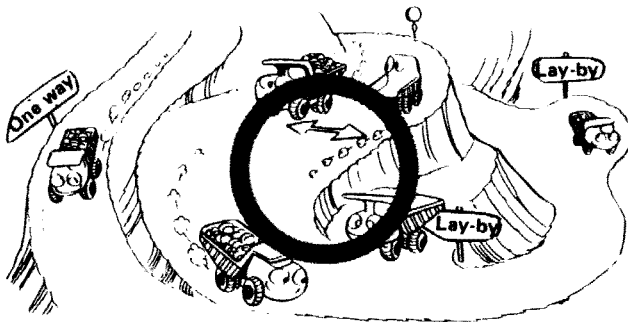

- Place convex mirrors at blind curves or places with poor visibility.
- Place warning signs at least 1.5 meters in from soft road shoulders or from places where there is danger of subsidence.
- To allow night driving, it is important to install lighting or reflectors.
- Gradients should be kept to within about 10%. In case of brake failure, down-hill slopes should be provided with lay-bys.

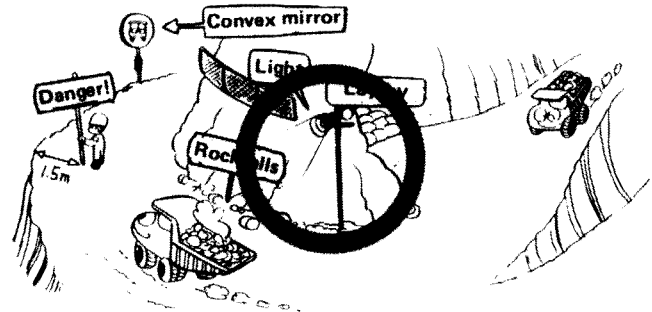

MAKE THE HAUL ROAD LEVEL

When hauling, always drive at a speed suited to the road conditions. For this reason, maintenance of the haul road is essential for both safety and improvement of efficiency. Especially after heavy rain, remember that conditions may have changed from those before the rain.

- Fill in holes, remove bumps, and correct any tilting of the road to one side. Strengthen the road and correct sagging shoulders. Remove rocks, trees or other obstacles.
- The best method is to use bulldozers or motor graders occasionally to maintain the haul road surface.
- Dust can reduce visibility, so it is important to use a sprinkler periodically to keep the dust down.

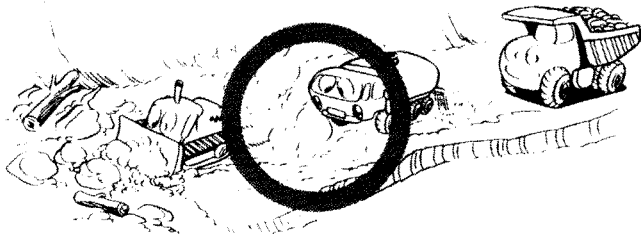

MAKE THE HAUL ROAD AS STRAIGHT AS POSSIBLE

For both safety and efficiency it is important to make as many straight stretches as possible. Especially in the central area where the truck is traveling at high speed, the radius of curves should be made as large as possible. Avoid tight S-bends as they are particularly dangerous. The radius of the curve should be at least 12 to 15 meters. When maintaining a winding haul road, pay attention to the following points:

- Turning radius — large enough to have room to spare
- Road width — larger than for straight roads
- Outer edge — slightly higher than inside
- Outer shoulder — much stronger than for other roads.

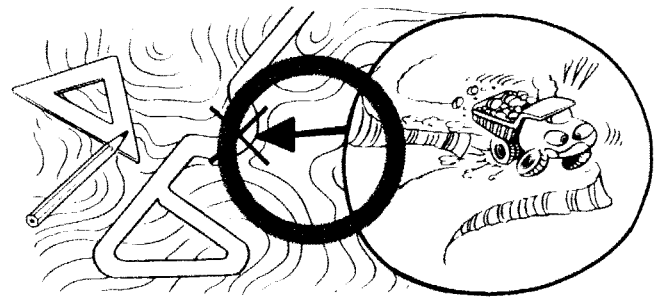

CROSSROADS OR SLOPING ROADS ARE DANGEROUS

As far as possible, avoid having the haul road intersect another road. Particularly on slopes, if the roads intersect at an angle, a ramp is formed, and at high speed, this causes heavy rolling which is dangerous.

Also, when a truck is driven across an unlevelled slope, there is danger of the truck tilting and overturning. Therefore cut out a level haul road across the slope.

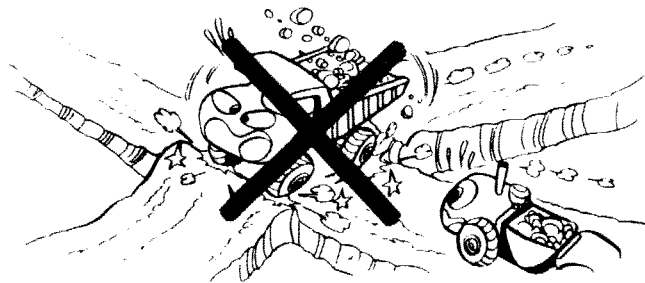

OPERATION DURING OPERATION

- Proceed with the operation steadily step by step. Always aim at unhurried and harmonious safe operation. Dazzling high speed operation may look efficient, but it does not continue for long. It causes breakdowns, in addition to being dangerous, and in the long run is not effective.
- When stopping at crossing, to avoid collisions with other vehicles, keep your distance and confirm who has priority.

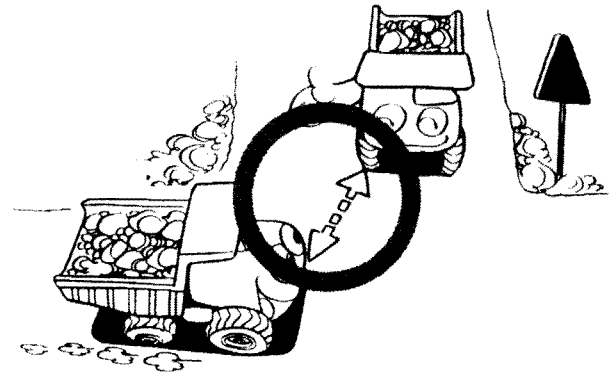

- If there is no one giving instructions during operations, there is danger of being hit by dump trucks. In such places, all persons not concerned with the operation should be kept out of the operating area.

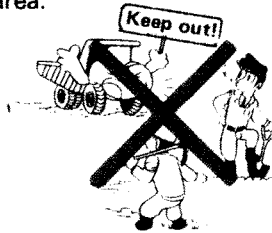

- When driving, sit in the operator's seat correctly so that the truck can be operated properly. Driving while not sitting in the operator's seat, or driving while standing is dangerous.

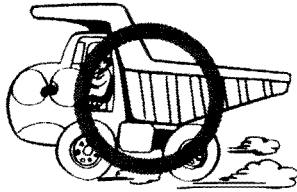

- Always concentrate. It is extremely dangerous to allow yourself to be distracted or to think of other things when operating a machine. Always pay attention to your driving, and to your surroundings. In dangerous places, or where there is restricted visibility, it is important to get down from the machine and confirm whether it is safe before continuing work.

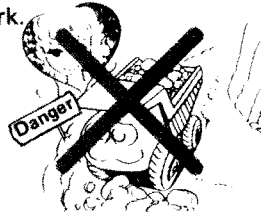

- Never drive off the road, or in place which you consider dangerous or outside the range of your skill.

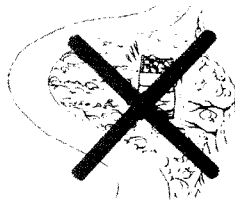

- The machine should always be operated at a speed where it can be correctly controlled. The following are dangerous:

- ★ **Speeding**
- ★ **Snaking**
- ★ **Coasting**



- As far as possible sudden stopping or sudden starting should be avoided except in emergencies. Be careful to avoid repeated stamping on the brakes.

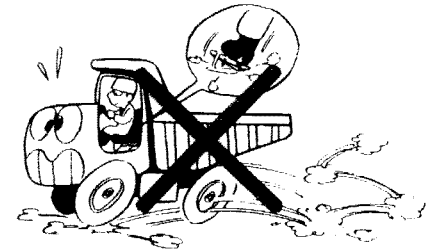

- Before entering curves, slow down. Increase speed when coming out of the curve. If you enter the curve without slowing down, or while braking, the rear wheels may go over the shoulder or the truck may skid. This is very dangerous.

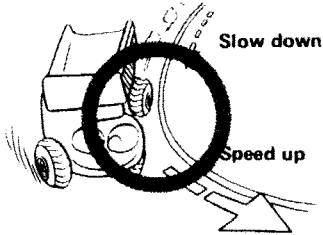

- If you attempt to control the speed of your truck by pressing lightly on the brake pedal, this may cause breakdowns coming from overheating of the brakes. This can be the cause of unexpected accidents, so do not use the brakes in this way.

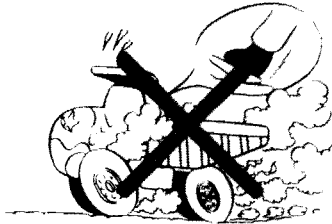

- When there is a danger of going over the edge on road shoulders, on slopes or when passing other vehicles, use a leader and follow his signals.

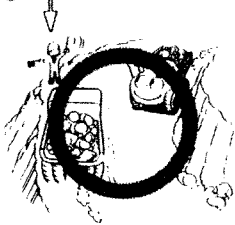

- Where visibility is bad, such as at corners, or when entering or leaving a narrow road, slow down and sound the horn.

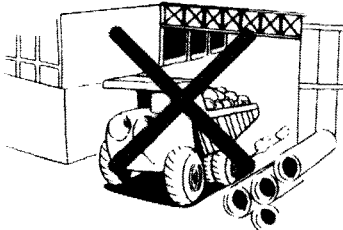

TRAVELING DOWNHILL

Never overrun the engine. Before starting to descend downhill slopes, stop and check that the brakes are working. It is dangerous to use only the brake pedal to control speed on a long downhill slope. In such a case see the Operation & Maintenance Manual for instructions on how to use the retarder. Then, descend the hill using the engine and retarder to brake the machine.

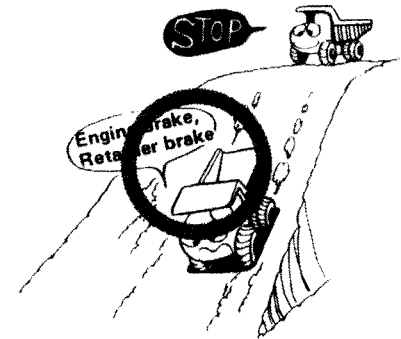

- Take care not to overload the dump body. Overloading not only shortens the service life of the truck, but also overheats the tires, causing them to burst.

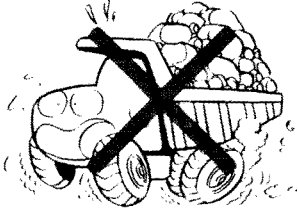

- When the dump truck is loaded with soil, its center of gravity is higher than when unloaded. It therefore is easily affected by the road surface. Failure to remember this can be the cause of overturning or other accidents.



- When driving through puddles, water may get into the wheel brakes. Pay careful attention to this point as it drastically lowers the efficiency of the brakes. In such a case, before driving on, apply the brakes to heat up the brake lining to some extent and this will dry them out.

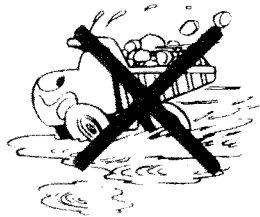

- Before crossing bridges, confirm that the bridge is strong enough to take the weight of the dump truck.

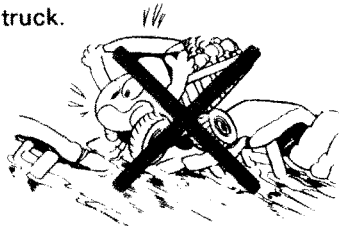

LOADING

Be sure to load the dump truck evenly. If the weight is greater on one side, there is danger of losing control of the steering wheel or overturning.

If the load is too far forward, the steering becomes heavy. If it is too far back, the front wheels tend to leave the ground when going uphill.



- When backing to dump a load, be careful not to back too far. Place blocks or build a small ridge to stop the wheels at the dumping point.

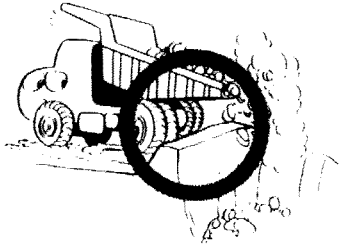

- Never drive with the dump body raised. Always lower the body before moving.

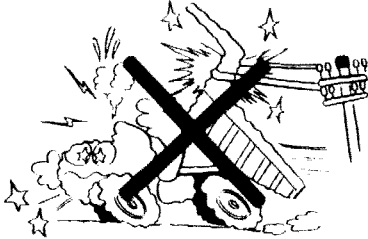

- When continuing operations after rain, remember that conditions may have changed from those before the rain, so proceed with caution. Be particularly careful when approaching the shoulder of the road or cliffs, as they may have been loosened by the rain.

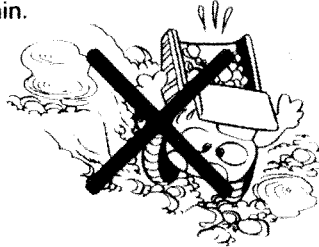

- Always consider the weight of the machine when driving on roads in snow or rain, or on muddy or soft terrain. Be careful to avoid the tires slipping or sinking into the ground.



- When towing a broken-down machine, first check that the brakes are working properly, then connect the machine with a suitable tow-rope or cable. When towing on roads, always follow traffic regulations and attach a correct warning sign.

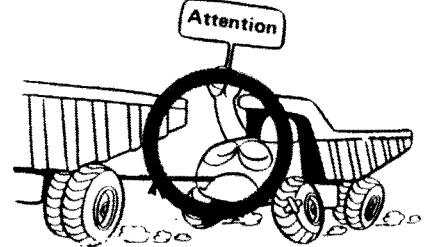

- After earthquakes, confirm that the ground is still firm; after blasting, confirm that there are no unexploded charge remaining. Follow signals or the leader's instructions.

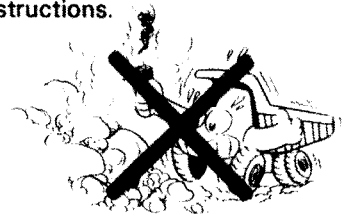

- When visibility is poor, keep a greater distance from the machine in front and drive at a lower speed. When visibility drops below safety level, stop work and wait for the visibility to improve.

This table shows the relation between visibility and traveling speed.

Forward visibility	Traveling speed (max.)
20 m.	15 km/h
40 m.	30 km/h
60 m.	40 km/h

- ★ Safe speed (km/h) =
Forward visibility (m) x 0.7

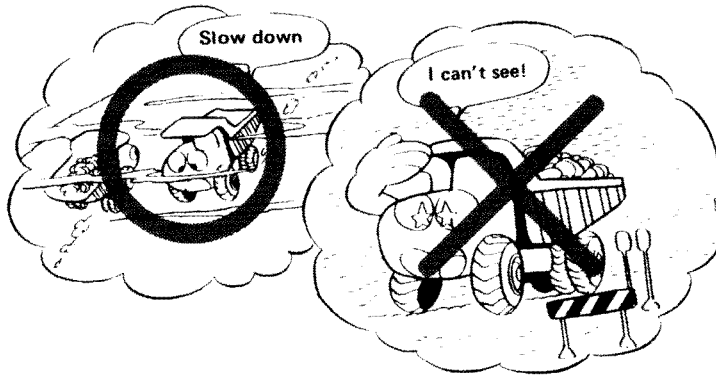

- ★ Use a sprinkler when necessary to keep the dust down and maintain good visibility.

- Always use lights when driving at night or in tunnels, etc. Always dip your lights when meeting an on-coming vehicle.

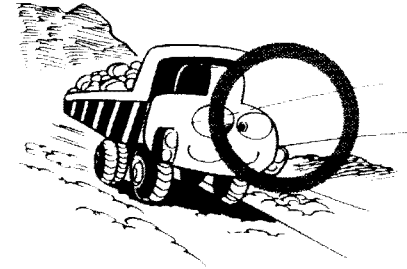

- ★ At night it is very easy to make mistakes in estimating the distance and height of objects and land.
- ★ When driving in fog, mist or smoke, where visibility is poor, drive safely, following the precautions and instructions given in traffic regulations.

- The machine condition can be judged from many factors. Changes in the gauges, sound, vibration, exhaust gas color or response of the control levers can indicate the occurrence of some disorder. If any disorder occurs, park the machine immediately in a safe place and take appropriate action. Be especially careful in the case of fuel leaks as there is danger of fire.

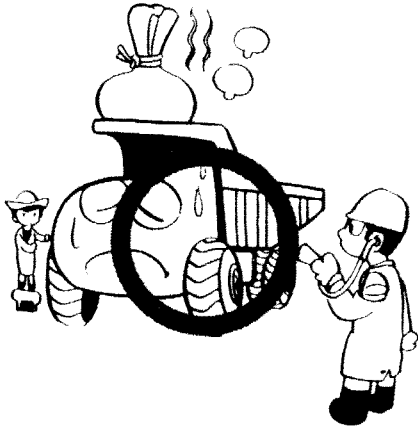

AFTER OPERATION

Stopping the machine

- Apply the brake lock.
- Return the gear shift lever to NEUTRAL.
- Never fail to lower the dump body.

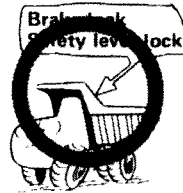

Stopping the engine

- Run the engine at low idling to cool the engine slowly. Then stop the engine.
- Remove the key from the starting switch.

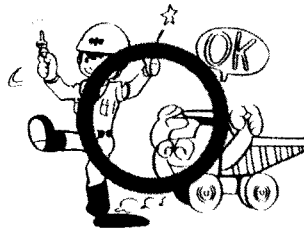

- When parking the machine, park it in a safe place outside the working area, or in the specified place.

The following factors should be considered when choosing a parking place: it should be on flat, firm ground where there is no danger of rockfalls, landslides or floods. If the machine has to be parked on the road, always follow traffic regulations.

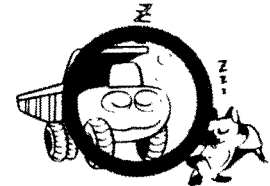

- When the machine has to be parked on a slope, chocks must always be placed under the wheels.

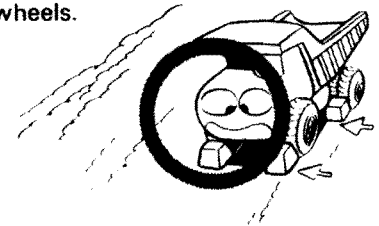

PRECAUTIONS FOR MAINTENANCE

⚠ For safety when carrying out maintenance.

Even simple operations, if carried out carelessly, can be the cause of injuries. At least the following points should be followed, but safety should always be borne in mind when carrying out any operation.

- Wear a well-fitting hard hat, safety shoes and working clothes. If the nature of the work so requires, wear protective goggles, gloves or other protection. Never wear loose or unbuttoned clothes as they may catch on protruding parts of the machine. Never wear clothes covered in oil.

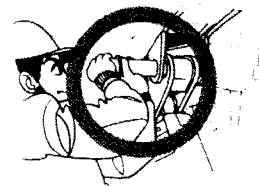
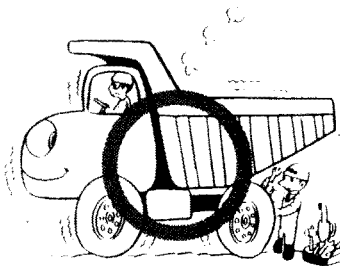
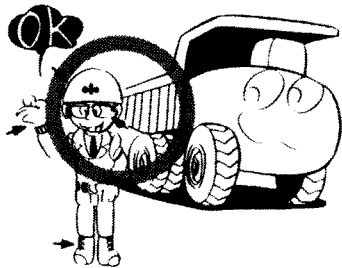

- Unless you have special instructions to the contrary, maintenance should always be carried out with the engine stopped. If maintenance is carried out with the engine running, there must be two men present: one sitting in the operator's seat and the other one performing the maintenance. Both should confirm the operation is safe.
- The body should always be lowered before carrying out any maintenance. However, if the nature of the maintenance requires the dump body to be raised for inspection or maintenance, always use the safety pin, and lock the dump lever in the HOLD position.

- Park the maintenance on firm, flat ground and lower the dump body. Stop the engine, return the gear shift lever to NEUTRAL and apply the parking brake before carrying out the maintenance.

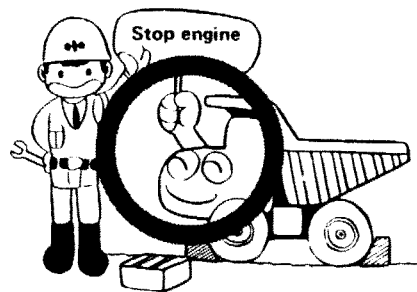

- When working with others, choose a group leader, decide the work procedure and work according to the leader's instructions. Check with the others before doing anything. Do not move any part without warning and do not perform any maintenance beyond the agreed work.

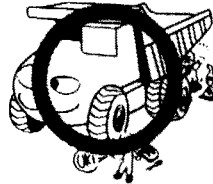

- Always stop the engine before washing the machine or charging oil.

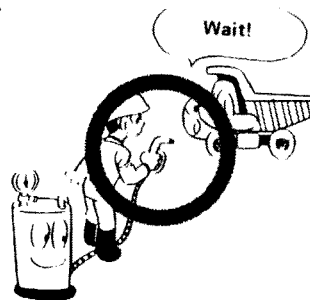

- **Flames should never be used instead of lamps.**

Never use a naked flame to check leaks or the level of oil, fuel, antifreeze or electrolyte.



- **Highly inflammable gas is given off by batteries.**

Do not smoke, make sparks or bring naked flames near the battery. Never check whether the battery is charged by striking the terminal with metal.

During charging, gas is given off. To prevent it from collecting, make sure there is good ventilation. In addition, do not allow sparks or flames near the battery. Never smoke or allow naked flames near when handling fuel or oil.

PRECAUTIONS FOR MAINTENANCE

- Never inspect the fan belt or attempt any maintenance when the engine is running. Always stop the engine before carrying out maintenance on this or other moving parts, or near any moving parts.

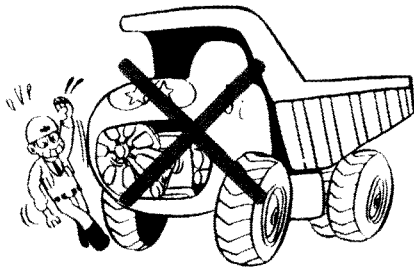

- When working under the machine, hang a caution sign in the operator's compartment, and if necessary, also put signs around the machine.

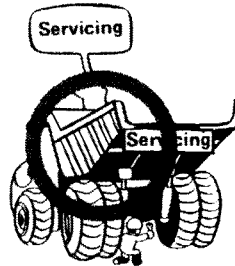

- Do not remove the radiator cap when the water is hot. There is danger that boiling water may spurt out. First release the internal pressure before removing the cap.

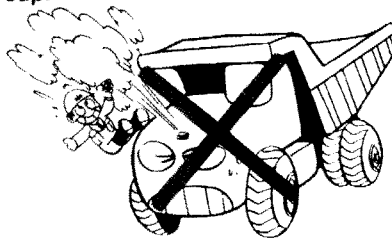

- When carrying out maintenance, pay careful attention to persons in the vicinity. In particular, do not allow anyone to approach the machine unnecessarily.

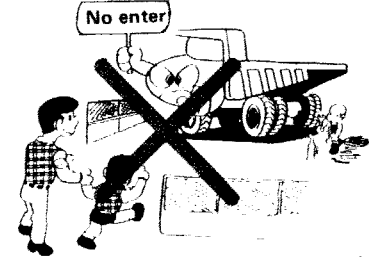

- Always remember that the hydraulic oil circuit is under pressure. When filling or draining the oil tank or carrying out inspection and maintenance, release the pressure first.

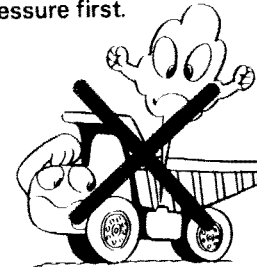

- When carrying out maintenance, pay careful attention to other workers and persons in the vicinity. Care is particularly needed when grinding, welding, or swinging a sledge hammer.

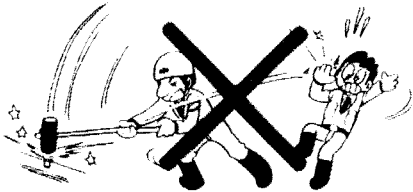

- When working on top of the machine, be careful not to lose your balance and fall. Arrange things beforehand so that no one starts the engine or moves the machine by mistake.

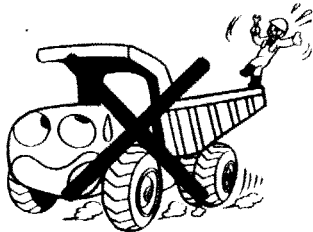

- Immediately remove any oil or grease on the floor of the operator's compartment, or on the handrail. It is very dangerous if someone slips on floor plates.

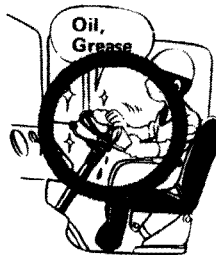

- If air gets into the hydraulic brake line, the brakes will not work properly. In such cases bleed all the air from the circuit. If the air pressure in the air brake line drops, the brakes will not work. Check for leaks in the air circuit, and if any faults are found, repair them.

PRECAUTIONS FOR MAINTENANCE

- When leaning over to inspect cases, there is a risk of dropping things in. Before removing the covers to inspect such cases, empty everything from your pockets. Be particularly careful to remove wrenches and nuts.

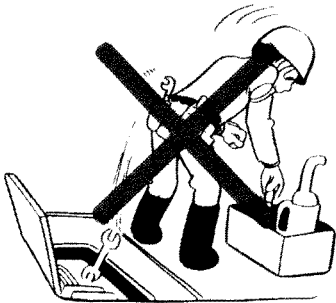

Precautions when changing tires

- When replacing the tires, please contact your Komatsu distributor. It is dangerous to jack up the machine without taking due care.
- Always block the wheels on the opposite side before jacking up the machine. After jacking up the machine, always insert blocks under the machine to prevent it from falling.

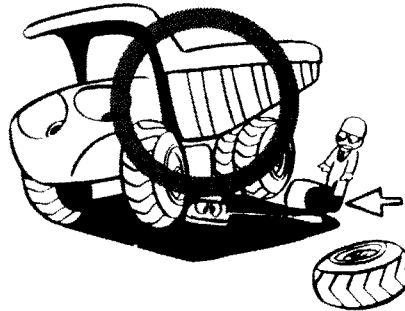

- Do not loosen or remove any part except those needed to be removed when taking off the tire. The tire is under high pressure, so it is extremely dangerous to loosen anything carelessly. In particular, repair of tires should be left to the tire manufacturer's dealer.

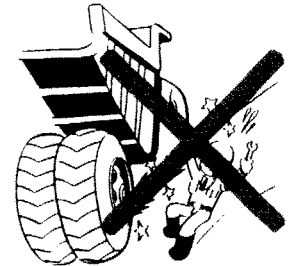



**GENERAL POINTS TO BE BORNE
IN MIND WHEN CARRYING OUT
MAINTENANCE**

- Thoroughly wash the machine. In particular, be careful to clean the filler caps, grease fittings and the area around the dipsticks. Be careful not to let any dirt or dust into the system.
- When replacing parts, always use the genuine Komatsu parts specified in the Parts Book.
- Always use the grades of grease and oil recommended by Komatsu. Choose the viscosity specified for the ambient temperature.
- Always use pure oil or grease, and be sure to use clean containers, to prevent any dirt from getting in.
- When checking or changing the oil, do it in a place free of dust, and prevent any dirt from getting into the oil.
- Before draining the oil, warm it up to a temperature of 20 to 40°C.
- Be particularly careful when removing the radiator cap or the hydraulic oil tank filler cap.
- After replacing or cleaning the oil filter element or strainer, bleed the air from the circuit.
- When the strainer is located in the oil filler, the strainer must not be removed while adding oil.
- There should be neither too much nor too little lubricant. When adding oil or checking the oil level, check that the oil is at the correct level.
- After greasing up, always wipe off the old grease that was forced out.
- When changing the oil or filter, check the drained oil and filter for any signs of excessive metal particles or other foreign materials.
- When removing parts containing O-rings, gaskets or seals, clean the mounting surface and replace with new sealing parts.
- Special measuring apparatus is needed for testing hydraulic pressure. When carrying out other difficult maintenance work, carrying them out carelessly can cause unexpected accidents. If you consider the maintenance is too difficult, always request your Komatsu distributor to carry out it.

STANDARD TIGHTENING TORQUE OF BOLTS AND NUTS

The following charts give the standard tightening torques of bolts and nuts. Exceptions are given in sections of "MAINTENANCE".

Thread diameter of bolt (mm)	Width across flat (mm)		
		kgm	Nm
6	10	1.35 ± 0.15	13.2 ± 1.4
8	13	3.2 ± 0.3	31.4 ± 2.9
10	17	6.7 ± 0.7	65.7 ± 6.8
12	19	11.5 ± 1.0	112 ± 9.8
14	22	18.0 ± 2.0	177 ± 19
16	24	28.5 ± 3	279 ± 29
18	27	39 ± 3	383 ± 39
20	30	56 ± 6	549 ± 58
22	32	76 ± 8	745 ± 78
24	36	94.5 ± 10	927 ± 98
27	41	135 ± 15	1320 ± 140
30	46	175 ± 20	1720 ± 190
33	50	225 ± 25	2210 ± 240
36	55	280 ± 30	2750 ± 290
39	60	335 ± 35	3280 ± 340

This torque table does not apply to the bolts with which nylon packings or other non-ferrous metal washers are to be used, or which require tightening to otherwise specified torque.

★ Nm (newton meter): 1Nm ≈ 0.1 kgm

AIR CONDITIONER

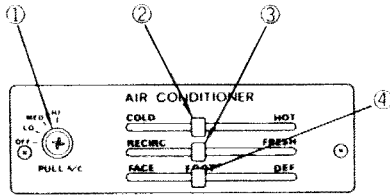

1. Blower switch

The switch is used to control the cooling and heating air flow and also functions as the air conditioner switch.

- The air flow can be set to one of three stages: "HIGH", "MEDIUM", or "LOW".

OFF: Cut off

LO: Low

MED: Medium

HI: High

- When the switch is pulled, the cooling and dehumidifying systems are switched on.

2. Temperature control lever

The lever controls the air temperature at the vent.

COLD: Lowers the temperature.

HOT: Raises the temperature.

3. Inside/outside air changeover lever

The air suction inlet is changed over with this lever as required for cooling or heating.

- RECIRC (Recirculation of the internal air)

The unit draws the air from inside the cab (generally used for cooling).

- FRESH (introduction of outside air)

The outside air is used in addition to the internal air.

4. Vent changeover lever

The lever changes the outlet for cold air to that for warm air and vice versa.

Lever position	Vent	Use
FACE	Upper vent	Cooling and heating
FOOT	Foot vent Defroster vent	Heating
DEF	Defroster vent	Removing mist from windshield glass

AIR CONDITIONER

HOW TO OPERATE THE AIR CONDITIONER

FOR COOLING

Move the control levers as shown below, and cool air will blow out of the outlet port at the operator's face.

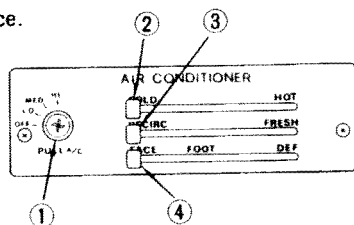

- Place levers (2) through (4) in the positions shown.
- Pull blower switch (1).
- Adjust blower switch (1) so that the breeze blows in the desired direction.

FOR COLD-AIR VENTILATION

If the air in the cab becomes dirty, ventilate with fresh cold air as shown below.

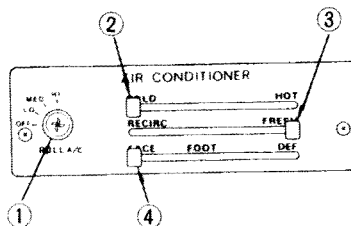

- Place levers (2) through (4) in the positions shown.
- Pull blower switch (1).
- Adjust blower switch (1) so that the breeze blows in the desired direction.
- ★ If cold-air ventilating operation continued for many hours, the cooling may stop being effective. After changing the air, be sure to return inside-outside air changeover lever (3) to RECIRC. (inside air circulation).

FOR HEATING

Move the control levers as shown, and warm air will blow out of the outlet port at the operator's feet.

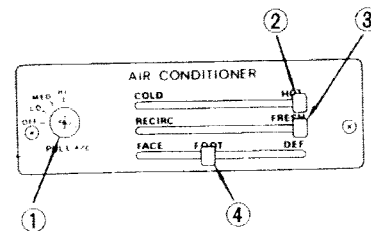

- Place levers (2) through (4) in the positions shown.
- Adjust blower switch (1) so that the breeze blows in the desired direction.

FOR HEATING THE INSIDE AIR

If the outside air is dirty or smells bad, use inside air heating as shown.

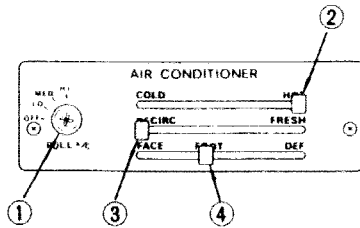

- Place levers (2) through (4) in the positions shown.
- Adjust blower switch (1) so that the breeze blows in the desired direction.
- ★ If the inside air heating operation continues for many hours, the inside air will become dirty. In ordinary machine operation, be sure to return inside-outside air changeover lever (3) to FRESH (introduction of outside air).

FOR DEHUMIDIFYING AND HEATING

Move the control levers as shown, and dehumidified hot air will blow out of the outlet port at the operator's feet.

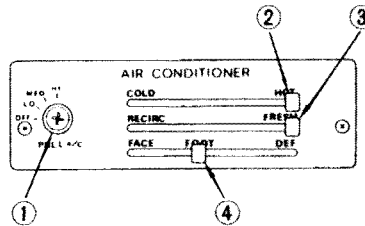

- Place levers (2) through (4) in the positions shown.
- Adjust blower switch (1) so that the breeze blows in the desired direction.
- Pull switch (1).
- ★ If this dehumidifying heating operation is used when the air in the cab is damp, as in the rainy season, comfortable heating will be provided without fogging the windows.

FOR VENTILATION

Move the control levers as shown, and fresh outside air will blow out of the upper outlet port, thereby ventilating the cab.

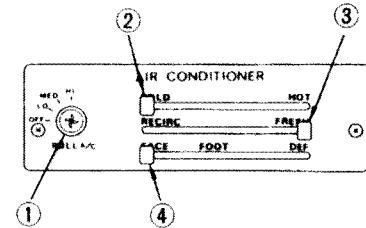

- Place levers (2) through (4) in the positions shown.
- Adjust blower switch (1) so that the breeze blows in the desired direction.

DEFROSTER

Move the control levers as shown, and hot air will blow out of the defroster outlet port, defrosting the windows to prevent them from fogging.

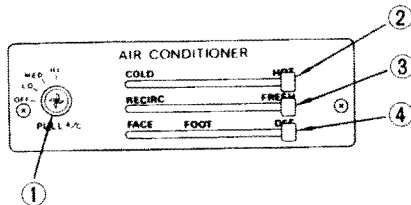

- Place levers (2) through (4) in the positions shown.
- Adjust switch (1) so that the breeze blows in the desired direction.

PRECAUTIONS FOR OPERATING THE AIR CONDITIONER

From time to time, ventilate the cab while it is being air-conditioned.

If you smoke in an air-conditioned cab, your eyes may smart from the smoke. In this case, ventilate the cab to replace the smoky air with fresh cool air.

If operating the air conditioner for many hours, ventilate the cab with fresh air once an hour.

Be careful not to excessively cool the air in the cab.

For your health, the best air temperature is one that feels just a little cool (5°C or 6°C lower than the outside temperature) to the operator entering the cab. For your health, control the air temperature carefully.

IN-SEASON HANDLING

For the satisfactory performance of the air conditioner and comfortable environment in the cab, be sure to contact your Komatsu distributor when it is necessary to replace the refrigerant and inspect or service the air conditioner.

OUT-OF-SEASON HANDLING

Even during the off-season, operate the air conditioner for several minutes a few times every month to keep the compressor and various parts lubricated.

HANDLING OF BATTERY

PRECAUTIONS FOR CHARGING BATTERY

1. Before charging, disconnect the cable from the negative (-) terminal of the battery. Otherwise, an unusually high voltage will damage the alternator.
2. While charging the battery, remove all battery plugs for satisfactory ventilation.
To avoid gas explosions, do not bring fire or sparks near the battery.
3. If the electrolyte temperature exceeds 45°C, stop charging for a while.
4. Turn off the charger as soon as the battery is charged.
Overcharging the battery may cause followings:
 - 1) Overheating the battery
 - 2) Decreasing the quantity of electrolyte
 - 3) Damaging the electrode plate
5. If the electrolyte gets on your skin or clothes, immediately wash with plenty of clean water.
6. Do not mix up cables (positive (+) to negative (-) or negative (-) to positive (+)), as it will damage the alternator.
7. When inspecting or servicing a battery, be sure to stop the engine and turn the starting switch to (OFF) position.
8. When performing any service to battery besides checking the electrolyte level or measuring the specific gravity, disconnect cables from the battery.

HANDLING OF BATTERY

REMOVAL AND INSTALLATION OF BATTERY

- When removing battery, first disconnect the cable from the ground (normally, from the negative (–) terminal). If a tool touches a cable connecting the positive terminal and the chassis, there is danger of sparks being emitted.
- When installing battery, the ground cable should be connected to the ground terminal as the last step.

STARTING ENGINE WITH A BOOSTER CABLE

When starting up the engine with a booster cable, do as follows:

1. Before connecting the booster cable
 - 1) Size of booster cable and clip should be suitable for the battery size.
 - 2) Check cables and clips for breaks, corroded surfaces, etc.
 - 3) Make sure cables and clips are firmly secured.
 - 4) Keep the starting switch in "OFF" position.
 - 5) The battery of the running engine must be the same capacity as that of engine to be started.

2. Connect the booster cables in the following manner.

- 1) Connect one clip of booster cable A to the positive (+) terminal of the engine to be started.
 - 2) Connect the other clip to the positive (+) terminal to the engine which is running.
 - 3) Connect one clip of booster cable B to the negative (–) terminal of the engine which is running.
 - 4) Connect the other clip to the body of the machine to be started.
- ★ Make sure the clips are firmly connected to battery terminals. Then, start the engine.

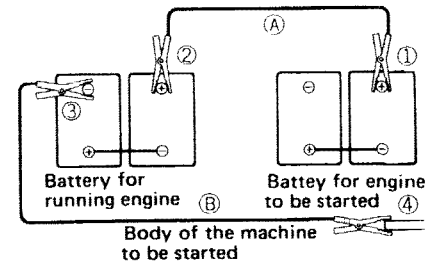

⚠ When connecting the cables, never contact the positive (+) and negative (-) terminals.

⚠ Make sure that the booster cable connections are correct. Connect the booster cable to the body as far as possible from the battery.

3. Starting the engine

- 1) Turn the starting switch to START position and start up the engine.
- 2) If the engine doesn't start at first, try again after 2 minutes or so.

After the engine has started, the booster cables should be disconnected in the reverse order in which they were connected.

- 1. Disconnecting the booster cables
 - 1) Disconnect the clip of booster cable B from the body of the machine which was started.
 - 2) Disconnect the other clip from the negative (-) terminal of the running engine.

- 3) Disconnect the clip of booster cable A from the positive (+) terminal of the running engine.
- 4) Disconnect the other clip from the positive (+) terminal of the engine which was started.

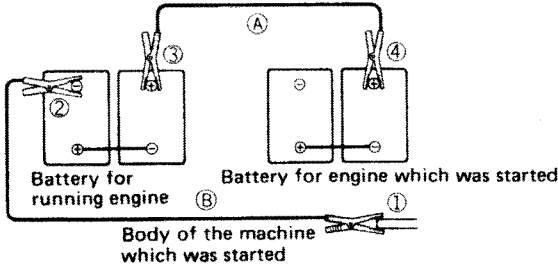

STORAGE

BEFORE STORAGE

To place the machine in storage for an extended period of time, the following measures must be taken to insure that it can be returned to duty operation with minimum of service.

- After every part is washed and dried, the machine shall be housed in a dried building. Never leave it outdoors.
In case it is indispensable to leave it outdoors, search a flat ground and lay wood plates on the ground, and the machine shall be placed on the wood plates and covered by canvass etc.
- Completely fill fuel tank, lubricate and change oil before storage.

- Give a thin coat of grease to metal surface (hydraulic piston rods.)
- As to batteries, remove the minus terminals and place cover on them, or remove them from the machine and store separately.
- All control levers shall be set to neutral or hold.
- Since low pressure tire would be easily damaged, check tire pressure (more than 3 kg/cm²).
- When the atmospheric temperature is anticipated to drop below 0°C, always add antifreeze in the cooling water.

DURING STORAGE

- Operate the engine and move the machine for a short distance once a month so that new oil film will be coated over movable parts and component surfaces.
- Before operating the working equipment, wipe off the grease the hydraulic piston rod.



If it is unavoidably necessary to carry out rust-preventive operation while the machine is indoors, open up doors and windows to improve ventilation and prevent the gas poisoning.

AFTER STORAGE

If the machine is to be used after a long period or storage, carry out the following procedure first.

- Wipe off the grease from the hydraulic cylinder rods.
 - Add oil and grease to all the prescribed places.
 - ★ Please contact your Komatsu distributor before using a machine on which the monthly rust prevention operation has not been carried out.
- Precautions before driving machine after long period of storage
 1. Check all oil and water levels before driving the machine.
 2. Drive the machine forward at 10 — 15 km/h for 5 minutes or 1 km to run in the machine before starting normal driving.

COOLANT AND LUBRICANTS

No.	Supplier Name	Engine Oil [CD] SAE10W, SAE30, SAE10W/30, SAE15W/40	Grease [Lithium-Base] NLGI-2	Anti-Freeze Coolant [Ethylene Glycol Base] [Permanent Type]
1	AGIP	Diesel Sigma S Superdiesel Multigrade	GR M	—
2	AMOCO	Amoco 300	Super Permalube Grease	—
3	ARCO	Arco Fleet S-3 Plus	Litholine H-EP	—
4	BP	Vanellus C-3	Energrease L2 Energrease LS2	Antifreeze
5	CALTEX	RPM Delo 300 RPM Delo 400	Marfak Multipurpose Marfak All Purpose	AF Engine Coolant
6	CASTROL	RX Super CRD	LM Grease	Antifreeze
7	CHEVRON	Delo 300 Delo 400	Multi-Motive Grease Ultra-Duty Grease 2	—
8	ELF	Multiperformance 3C Performance 3C	Multi EPEXA 2	Glacelf
9	EXXON (ESSO)	Essolube D-3 Essolube XD-3 Essolube XD-3 Extra	Multi Purpose Grease Beacon EP2	—

COOLANT AND LUBRICANTS

No.	Supplier Name	Engine Oil [CD] SAE10W, SAE30, SAE10W/30, SAE15W/40	Grease [Lithium-Base] NLGI-2	Anti-Freeze Coolant [Ethylene Glycol Base] [Permanent Type]
10	GULF	Super Duty	Gulfcrown Grease No. 2 Gulfcrown EP Special Grease No. 2	Cruisemaster Antifreeze and Summer Coolant
11	MOBIL	Delvac 1300 Delvac 1400 Delvac 1400 Super	Mobilgrease MP Mobilgrease 77 Mobilgrease 532 Mobilux EP2	Permazone
12	PENNZOIL	Supreme Duty Fleet Multi-Duty	Multi-Purpose No. 705 Wheel Bearing No. 707L	Anti Freeze & Summer Coolant
13	SHELL	Rimula Rimula X	Alvania Grease EP	—
14	SUN	Sunfleet Dieselube XL Sunfleet Super C	Sunfleet HP Sun Prestige 742 EP	Sunoco Multi-Season Anti-Freeze
15	TEXACO	Ursa Super Plus Ursa Oil LA Ursa Super LA	Marfak All Purpose Marfak Multi Purpose 2	Startex AF & Summer Coolant
16	TOTAL	Rubia S Rubia x	Multis EP2	Antifreeze
17	UNION	Guardol	Unoba EP	—