

# Operation & Maintenance Manual

**KOMATSU**

**WA380-1**

**WA420-1**

**WHEEL LOADER**

SERIAL NUMBERS  
**WA380 -20292** and up  
**WA420 -20159**

## FOREWORD

This manual describes procedures for operation, handling, lubrication, maintenance, checking, and adjustment. It will help the operator or anyone realize peak performance through effective, economical and safe machine operation and maintenance.

- Please read this manual carefully BEFORE operating the machine.
  - Please continue studying this manual until proper operation is completely reinforced into personal habit.
  - This manual describes the basic techniques. Skill is performed as the operator or anyone get the correct knowledge and performance of the machine.
  - Operation, inspection, and maintenance should be carefully carried out, and the safety must be given the first priority. Safety precautions are indicated with  marks and technical precautions with ★ marks in this manual. The safety information contained in this manual is intended only to supplement safety codes, insurance requirements, local laws, rules and regulations.
  - Some photographs and illustration pictures are different from your machine as technical improvement is continuously reflected on it. Revision to up-to-date manual's content is performed in later editions.
  - This operation & maintenance manual may contain attachments and optional equipment that are not available in your area. Please consult your local Komatsu distributor for those items you may require.
- Materials and specifications are subject to change without notice.

## BREAKING IN YOUR NEW MACHINE

Each machine is carefully adjusted and tested before shipment. However, a new machine requires careful operation during the first 100 hours to break in the various parts.

If a machine is subjected to unreasonably hard use at the initial operation stage, the potential of performance will prematurely deteriorate and the service life will be reduced. A new machine must be operated with care, particularly with regard to the following items.

- After starting, let the engine idle for 5 minutes to allow proper engine warm-up prior to actual operation.
- Avoid operation with heavy loads or at high speeds.
- Sudden starting or acceleration, unnecessarily abrupt braking and sharp turning should be avoided.
- If the machine is delivered without any cooling water in the radiator, flush the cooling system with ample clean water to clean the system, then fill the radiator with cooling water.
- ★ When replacing oil filter elements (cartridges), check their interiors for dirt and dust. If heavily collected, check for possible cause before starting operation.
- ★ Hours of operation are indicated by the service meter.

# CONTENTS

## OPERATION

GENERAL LOCATIONS AND SPECIFICATIONS .....	4
INSTRUMENTS AND CONTROLS .....	5
CHECK BEFORE STARTING .....	33
OPERATING YOUR MACHINE .....	39
ADJUSTMENT OF WORK EQUIPMENT .....	50
HANDLING THE TIRES .....	52
TOWING .....	55
COLD WEATHER OPERATION .....	57

## MAINTENANCE

PERIODIC MAINTENANCE .....	63
BLEEDING AIR FROM CIRCUIT .....	64
PERIODICAL REPLACEMENT OF SAFETY PARTS .....	65
MAINTENANCE TABLE .....	66
OIL FILLER AND LEVEL GAUGE POSITIONS .....	69
EVERY 50 HOURS SERVICE .....	70
EVERY 100 HOURS SERVICE .....	71
EVERY 250 HOURS SERVICE .....	73
EVERY 500 HOURS SERVICE .....	79
EVERY 1000 HOURS SERVICE .....	82
EVERY 2000 HOURS SERVICE .....	87
EVERY 4000 HOURS SERVICE .....	93
WHEN REQUIRED .....	94
ADJUSTMENT .....	108
TROUBLE SHOOTING GUIDE .....	112
SERVICE METER .....	116
MACHINE AND ENGINE SERIAL NUMBERS .....	117
FUEL, COOLANT AND LUBRICANTS .....	118

## GENERAL LOCATIONS AND SPECIFICATIONS

- |                     |                  |
|---------------------|------------------|
| 1. Tilt lever       | 6. Front wheel   |
| 2. Lift arm         | 7. Lift cylinder |
| 3. Head lamp        | 8. Dump cylinder |
| 4. Turn signal lamp | 9. Bucket        |
| 5. Rear wheel       |                  |

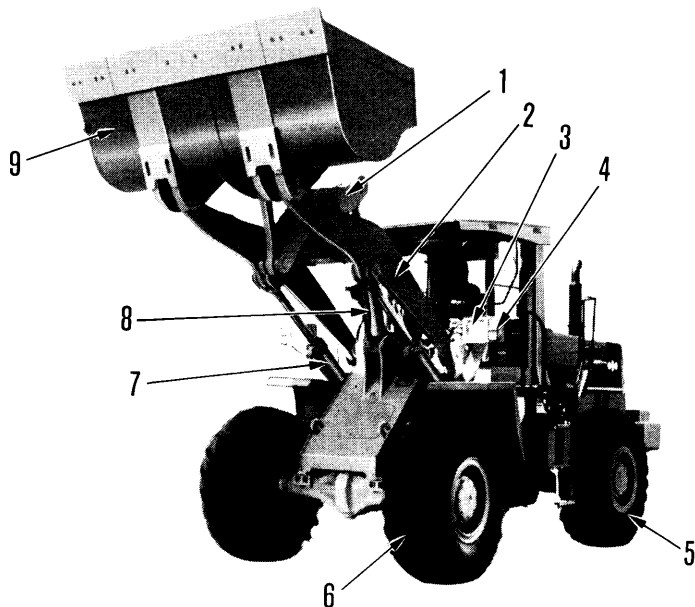

WA380 with cab and ROPS canopy

### WA380-1

#### PERFORMANCE

- |                             |                           |
|-----------------------------|---------------------------|
| 1. Bucket capacity (Heaped) | 3.1 m <sup>3</sup>        |
| 2. Travel speeds            |                           |
| Forward                     | Max. 34.3 km/h (21.3 MPH) |
| Reverse                     | Max. 36.1 km/h (22.4 MPH) |

#### OPERATING WEIGHT

16570 kg

#### ENGINE

- |                                      |                                 |
|--------------------------------------|---------------------------------|
| 1. Model                             | Komatsu SA6D110-1 diesel engine |
| 2. Flywheel horsepower (at 2200 rpm) | 180 HP                          |

### WA420-1

#### PERFORMANCE

- |                             |                           |
|-----------------------------|---------------------------|
| 1. Bucket capacity (Heaped) | 3.7 m <sup>3</sup>        |
| 2. Travel speeds            |                           |
| Forward                     | Max. 34.1 km/h (21.2 MPH) |
| Reverse                     | Max. 37.4 km/h (23.2 MPH) |

#### OPERATING WEIGHT

18915 kg

#### ENGINE

- |                                      |                                 |
|--------------------------------------|---------------------------------|
| 1. Model                             | Komatsu SA6D110-1 diesel engine |
| 2. Flywheel horsepower (at 2200 rpm) | 204 HP                          |

NOTE: Specifications are subject to change without notice.

# INSTRUMENTS AND CONTROLS

## MONITOR PANEL

This monitor system consists of monitor lamp groups (A, B, C), meter group D and warning lamp E.

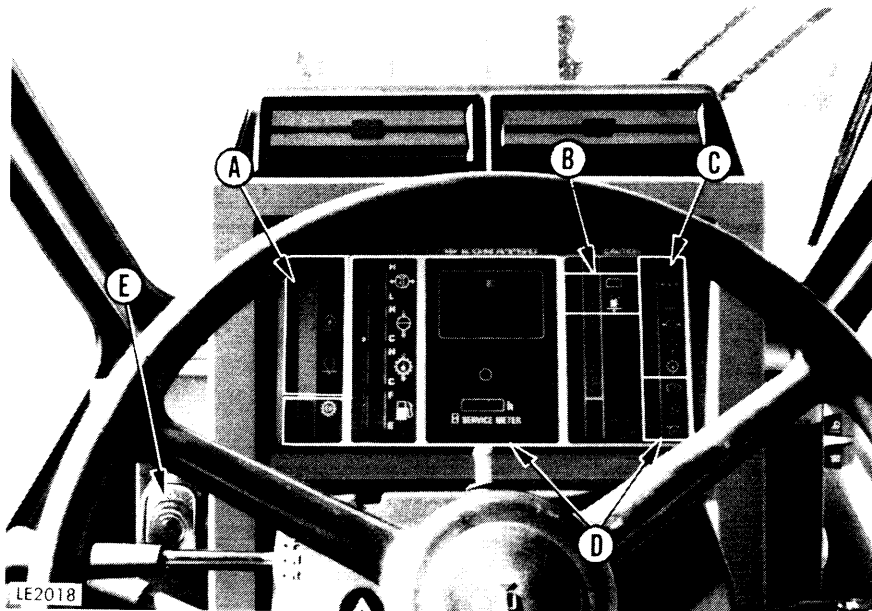

- To check the monitor system, turn the starting switch to ON before starting the engine. Then all the monitor lamps, the gauges and the warning lamp light up for about 3 seconds and the alarm buzzer sounds for about 1 second. Three figures, 188, are displayed on the speedometer while the monitor system is being checked. After that all lamps go off and the buzzer stops. If any monitor lamp does not light up, ask your Komatsu distributor to inspect that monitor lamp.
- ★ When the starting switch is turned to ON, if the directional lever is not at neutral, the warning lamp will flash and the alarm buzzer will continue to sound. If this happens, return the lever to neutral. The lamp will go out and the buzzer will stop.

- ★ To check the monitor immediately when the engine is stopped, wait for at least 30 seconds after the engine is stopped.

**Ⓐ CHECK MONITOR GROUP**  
**(Check items before starting)**

If there is any abnormality, the appropriate monitor lamp will flash.

Check the location where the monitor lamp is flashing, and carry out the checks before starting.

- ★ When the engine is started, these monitor lamps will go off even if there are abnormalities.

**Ⓑ CAUTION MONITOR GROUP**  
**(Caution items)**

If any abnormality occurs while the engine is running, the appropriate monitor lamp will flash to indicate the abnormality.

- ★ Even if any monitor lamp flashes, the machine can operate, but it should be repaired as soon as possible.

**Ⓒ CAUTION MONITOR GROUP**  
**(Emergency stop items)**

If any abnormality occurs while the engine is running, the appropriate monitor lamp will flash and the alarm buzzer will sound intermittently at the same time.

- ★ If any monitor lamp flashes, stop the engine or run it at a low idling speed, and repair it immediately.

**Ⓓ METER GROUP**

This group consists of air pressure gauge, engine water temperature gauge, torque converter oil temperature gauge, fuel gauge, speedometer, service meter and pilot display.

**Ⓔ WARNING LAMP**

The warning lamp will flash when there is an abnormality in any Ⓑ group item.

The warning lamp will flash and the alarm buzzer will sound when there is an abnormality in any Ⓒ group item or when the parking brake is applied, but the directional lever is not at neutral.

## A: CHECK MONITOR GROUP (Check items before starting)

- ★ Do not rely on the "CHECK MONITOR GROUP (Check before starting)" only for the check before starting. Always make the check by referring to the section on CHECK BEFORE STARTING.

### 1. ENGINE OIL LEVEL MONITOR

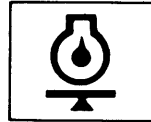

This monitor indicates a low oil level in the engine oil pan.

If the monitor lamp flashes, check the oil level in the engine oil pan and add oil as required.

### 2. COOLANT LEVEL MONITOR

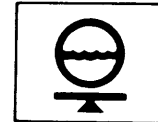

This monitor indicates a low radiator coolant level.

If the monitor lamp flashes, check the coolant level and add water as required.

- ★ Park the machine on level ground and check the monitor lamps.
- ★ Confirm that these monitor lamps light for about 3 seconds after turning the starting switch to **ON**. If any monitor lamp does not light, ask your Komatsu distributor to inspect that monitor lamp.

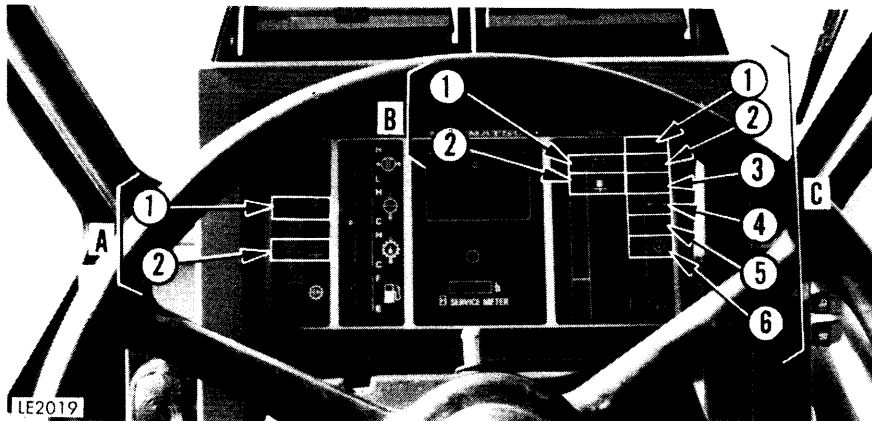



## B: CAUTION MONITOR GROUP

### (Caution items)

If any abnormality occurs while the engine is running, the appropriate monitor lamp and the warning lamp will flash to indicate the abnormality at the same time.

### 1. CHARGE MONITOR

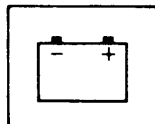

This monitor indicates an abnormality in the charging system while the engine is running.

If the monitor lamp flashes, check the charging circuit.

- ★ This monitor lamp flashes and the alarm buzzer sounds, when the starting switch is turned to ON immediately after the engine is started or immediately before the engine is stopped. It does not indicate an abnormality.

### 2. FUEL LEVEL MONITOR



This monitor indicates there is less than 35 liters of fuel in the tank.

If the monitor lamp flashes, add fuel.

- ★ Park the machine on level ground and check the monitor lamps.
- ★ Confirm that these monitor lamps light for about 3 seconds after turning the starting switch to **ON**. If any monitor lamp does not light, ask your Komatsu distributor to inspect that monitor lamp.

## C: CAUTION MONITOR GROUP

### (Emergency stop items)

If any abnormality occurs while the engine is running, the appropriate monitor lamp and the warning lamp will flash and the alarm buzzer will sound intermittently at the same time.

#### 1. BRAKE LINE FAILURE MONITOR



This monitor indicates a drop in the brake oil pressure when the brakes are operated.

If the lamp flashes, stop the machine immediately and check the brake system.

- ★ After checking and repair of brake system, push in over-stroke sensor rod on the brake chamber. If this operation is not done, a buzzer and lamp will continue to warn of brake line trouble.

#### 2. ENGINE OIL PRESSURE MONITOR

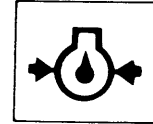

This monitor indicates a low engine oil pressure.

If the lamp flashes, the engine oil pressure is below the lower limit. Immediately stop the engine.

- ★ This monitor lamp flashes and the alarm buzzer sounds, when the starting switch is turned to ON immediately after the engine is started or immediately before the engine is stopped. It does not indicate an abnormality.

### 3. COOLANT LEVEL MONITOR

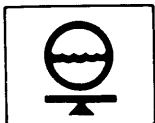

This monitor indicates a low radiator coolant level.

Check the coolant level when the monitor lamp flashes, stop engine and add water as required.

### 4. AIR PRESSURE MONITOR

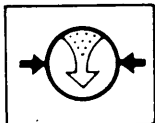

This monitor indicates a drop in the air pressure in the air tank.

If the lamp flashes, increase the engine speed and wait until the lamp goes out.

### 5. COOLANT TEMPERATURE MONITOR

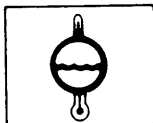

This monitor indicates a rise in the cooling water temperature.

When the monitor lamp flashes, run the engine with no load at midrange speed until the green range of the engine water temperature gauge lights.

- ★ Park the machine on level ground and check the monitor lamps.
- ★ Confirm that these monitor lamps light for about 3 seconds after turning the starting switch to **ON**. If any monitor lamp does not light, ask your Komatsu distributor to inspect that monitor lamp.

### 6. TORQUE CONVERTER OIL TEMPERATURE MONITOR

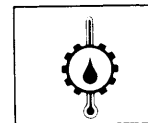

This monitor indicates a rise in the torque converter oil temperature.

When the monitor lamp flashes, stop the machine and run the engine with no load at midrange speed until the green range of the temperature gauge lights.

**D: METER GROUP  
PILOT DISPLAY**

When the starting switch is turned to ON, this lights up to indicate that the display items are working.

**1. PARKING BRAKE PILOT LAMP**

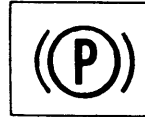

This lamp lights up when the parking brake is applied.

**2. PILOT LAMP FOR WORKING LAMP**



This lamp lights up when the working lamps are switched on.

**3. ENGINE PRE-HEATING PILOT LAMP**

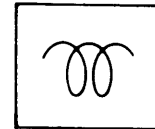

This lamp lights up when electrical heating circuit activates.

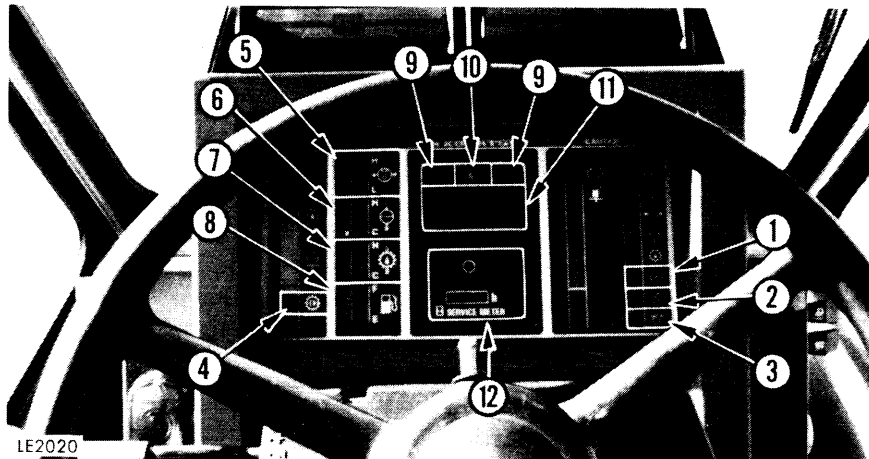

LE2020

#### 4. TRANSMISSION CUT-OFF SELECTOR PILOT LAMP

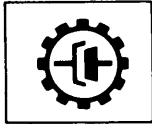

This lamp lights up when the transmission cut-off selector switch is turned to ON.

★ If the monitor lamp is ON and the left brake pedal is depressed, the transmission will be returned to neutral.

#### 5. AIR PRESSURE GAUGE

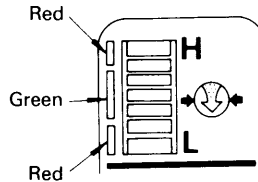

This gauge indicates the air pressure in the air tank. The green range should be lighted during normal operation.

If the red range lights up during operations, the alarm buzzer will sound, the warning lamp will flash, and the air pressure monitor lamp will flash.

If this happens, stop the machine, increase the engine speed and wait until the green range lights up.

★ If the air pressure drops even lower, the parking brake will be automatically applied.

#### 6. ENGINE COOLING WATER TEMPERATURE GAUGE

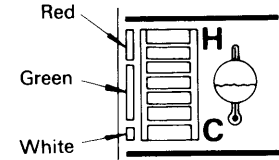

This gauge indicates the temperature of the cooling water. If the temperature is normal during operation, the green range will light. If the red range lights during operation, stop the machine and run the engine with no load at midrange speed until the green range lights.

If the top lamp in the red range lights up, the alarm buzzer will sound, the warning lamp will flash and the coolant temperature monitor lamp will flash at the same time.

## 7. TORQUE CONVERTER OIL TEMPERATURE GAUGE

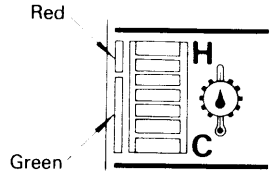

This gauge indicates the temperature of the torque converter oil. If the temperature is normal during operation, the green range will light. If the red range lights during operation, stop the machine and run the engine with no load at midrange speed until the green range lights.

If the top lamp in the red range lights up, the alarm buzzer will sound, the warning lamp will light up and the torque converter oil temperature monitor lamp will flash at the same time.

## 8. FUEL GAUGE

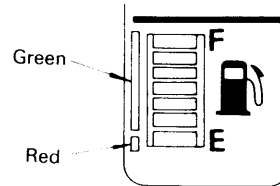

This gauge indicates the amount of fuel in the fuel tank. If there is enough fuel in the tank while the engine is running, the green range lights. If the red range lights, there is less than 21 liters of fuel in the tank.

When the red range lights, add fuel.

## 9. TURN SIGNAL PILOT LAMP

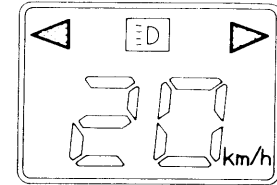

When the turn signal lamp flashes, the pilot lamp also flashes.

★ If the wiring of the turn signal lamp is disconnected, the pilot lamp will flash faster.

## 10. HIGH BEAM PILOT LAMP

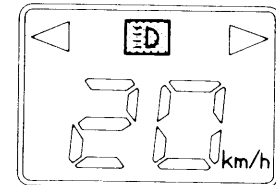

This lamp lights up when the head lamp is at high beam.

## 11. SPEEDOMETER

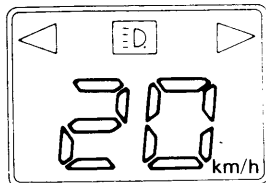

This meter indicates the running speed of the machine.

- ★ A speedometer for MPH is also available.

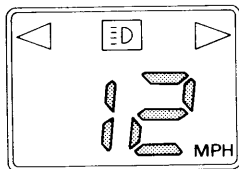

## 12. SERVICE METER

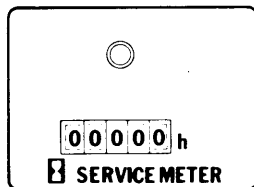

This meter shows the total operation hours of the machine. The service meter advances while the engine is running - even if the machine is not traveling.

Refer to the section "SERVICE METER".

- ★ While engine is running, green pilot lamp on the service meter flashes to show the service meter advances.

## SWITCHES

### 1. TRANSMISSION CUT-OFF SELECTOR SWITCH

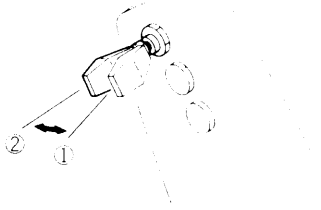

This switch selects the operation of the left brake pedal. Normally, put this switch in ON position.

① OFF:

Depressing the left brake pedal operates the wheel brakes (like right brake pedal).

② ON:

Depressing the left brake pedal operates the wheel brakes, and also returns the transmission to NEUTRAL.

★ If the switch is at ON, the transmission cut-off selector pilot lamp will light up.

**!** If the machine has to be started on a slope, always turn the transmission cut-off selector switch to OFF and depress the left brake pedal. Then depress the accelerator pedal while releasing the left brake pedal to start the machine off slowly.

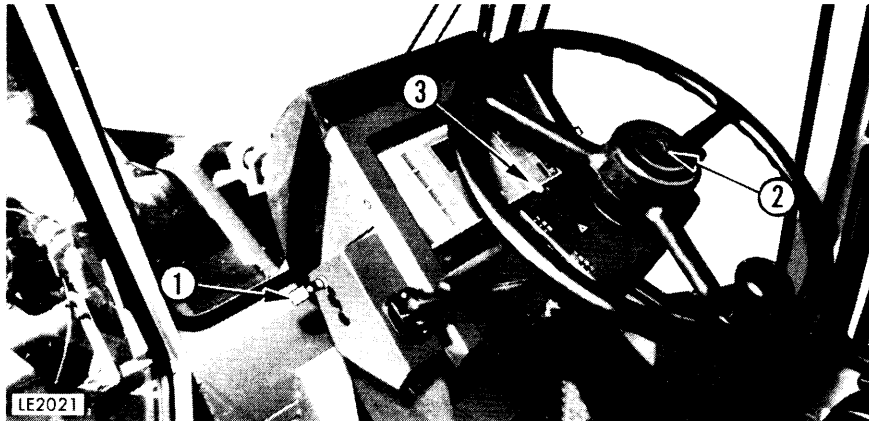

LE2021

### 2. HORN BUTTON

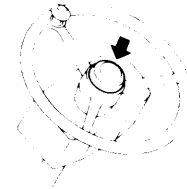

When the button in the center of the steering wheel is pressed, the horn will sound.



### 3. HAZARD LAMP SWITCH

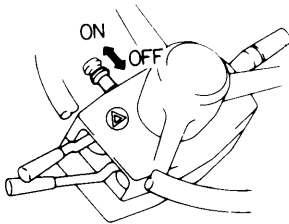

This switch is used in emergencies, such as when the machine breaks down.

ON: All turn signal lamps flash.

★ All turn signal lamps and pilot lamp on the steering column flash, when this switch is put to ON.

**!** Do not use this switch unless abnormality is occurred.

### 4. PARKING BRAKE SWITCH

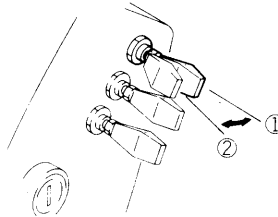

This switch operates the parking brake.

① ON position:

The parking brake is applied, and the parking brake pilot lamp lights up.

② OFF position:

The parking brake is released.

**!** Always apply the parking brake when leaving the machine or parking it.

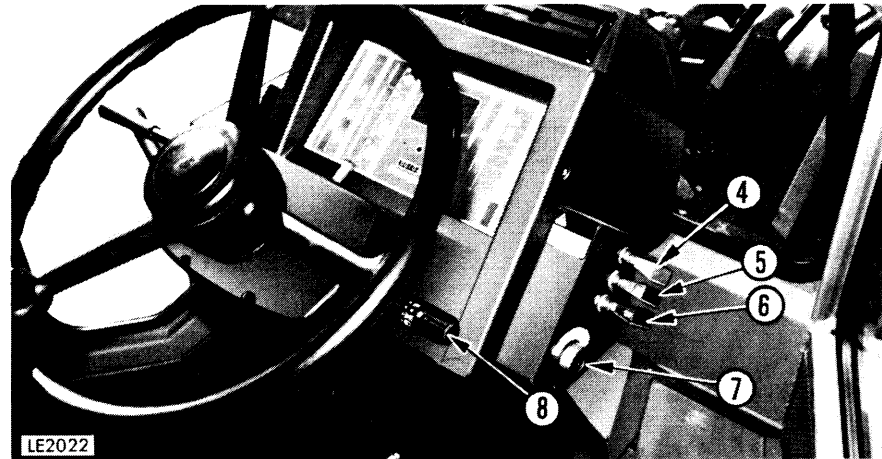

## 5. WORKING LAMP SWITCH

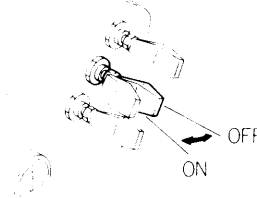

When the front and rear working lamps are turned ON, the pilot lamp and illumination lamp for monitor panel will also light up.

ON: Working lamps are ON.

**⚠ When traveling on public roads, turn the working lamps OFF.**

- ★ If the directional lever is placed in F (FORWARD) or R (REVERSE) with the parking brake applied, the warning lamp will flash and the alarm buzzer will sound.
- ★ When the starting switch is turned to OFF, the parking brake is automatically applied. Before starting the engine, turn the parking brake switch to ON, then turn it to OFF.
- ★ The machine does not start when the directional lever is operated with parking brake applied.

## 6. PREHEATER SWITCH

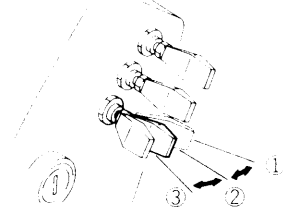

This switch is used to warm the intake air in cold weather. Normally, put this switch in AUTO position.

① OFF

The automatic preheating circuit is not actuated.

② AUTO

The automatic preheating circuit is actuated automatically, when the atmospheric temperature is lower than  $-5^{\circ}\text{C}$ .

### 7. STARTING SWITCH

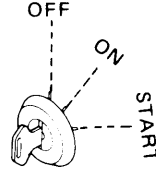

This switch is used to start or stop the engine.

#### OFF

Key insertion-withdrawal position. None of electrical circuits activate.

The hazard lamp and the parking lamp will remain on, however, when the switch is turned OFF.

To stop the engine, turn the switch to OFF.

#### ON

Charging and lamp circuits activate. Keep key at ON after starting.

#### START

At this key position, the starting motor will crank the engine. Release the key immediately after starting, and the key will return automatically to ON.

#### ③ ON

Pull up the switch from AUTO position to heat the intake air, when automatic heating is not enough.

Use this position in cold weather if the engine will not start with the preheater switch at the AUTO position.

★ If the switch is released when at the ON position, it will automatically return to AUTO.

### 8. LAMP SWITCHES

(for lamps, turn signal lamps, dimmer switch)

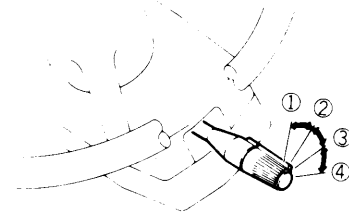

#### Lamp switch

Position ①  $\cdot P \equiv$  :

Parking lamp lights up.

Position OFF ②  $- \cdot \bullet$  :

Lamps go off.

Position ③  $\equiv \triangleright \cdot \triangleleft \equiv$  :

Clearance lamps, tail lamps and machine monitor lighting light up.

Position ④  $\equiv \triangleright \cdot$  :

Head lamps light up in addition to the lamps in position ③  $\equiv \triangleright \cdot \triangleleft \equiv$  .

★ The lamp switch can be operated regardless of the position of the lever.

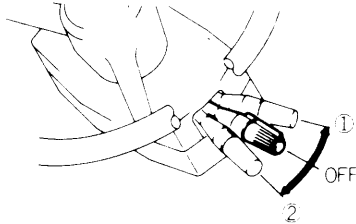

### Turn signal lever

This lever operates the turn signal lamps.

- ① LEFT TURN:  
Push lever FORWARD.
- ② RIGHT TURN:  
Pull lever BACK.

- ★ When the lever is operated, the turn signal pilot lamp will also light up.
- ★ When the steering wheel is turned to the neutral position, the turn signal lever will return automatically to OFF. If not, return the lever to OFF manually.

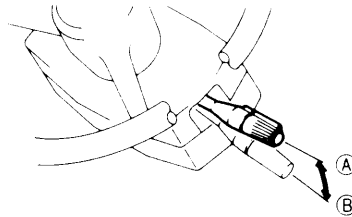

### Dimmer switch

This switches the head lamp between high beam and low beam.

- Ⓐ Low beam
- Ⓑ High beam

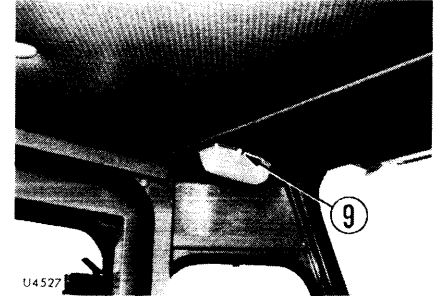

### 9. ROOM LAMP SWITCH

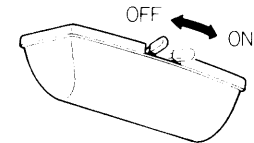

When this switch is moved to ON position, room lamp will light.

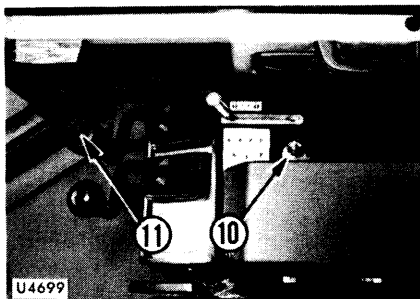

### 10. CIGARETTE LIGHTER

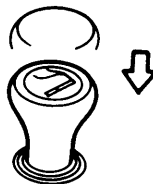

This is used to light cigarettes. To use, push the lighter in. After the few seconds it will spring back. At that time, remove the lighter and light your cigarette.

### 11. KICKDOWN SWITCH

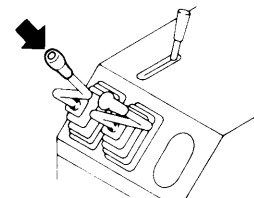

If this switch is pushed when the speed control lever is in 2nd, the transmission shift down to 1st.

This switch is used to increase the drawbar pull in digging operations.

★ To cancel the kickdown switch, move the directional lever to REVERSE or NEUTRAL, or move the speed control lever to any position except 2nd. It is also possible to cancel the kickdown switch by operating the parking brake switch or by turning the starting switch OFF.

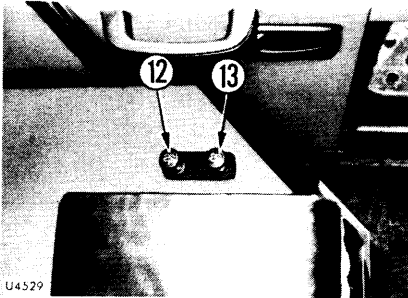

U4529

### 12. FRONT WIPER SWITCH

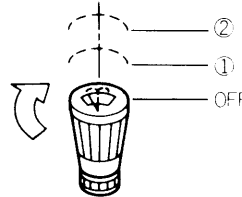

- ① The wiper is actuated at low speed.
- ② The wiper works at high speed.

When this switch is turned clockwise, solvent will be sprayed on glass.

### 13. REAR WIPER SWITCH

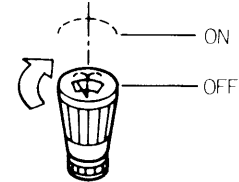

When this switch is pulled to ON position, wiper operates on rear glass.

When this switch is turned clockwise, solvent will be sprayed on glass.

## LEVERS AND PEDALS

### 1. DIRECTIONAL LEVER

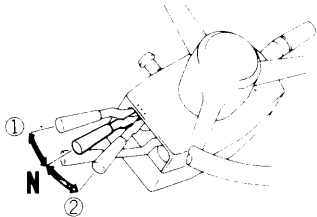

This lever is used to change the direction of travel of the machine.

- ① Forward
- ② Reverse
- N Neutral

- ★ The engine cannot be started if the directional lever is not at N (neutral).
- ★ It is possible to change the length of the lever. For details of changing the length, see ADJUSTMENT.

### 2. SPEED CONTROL LEVER

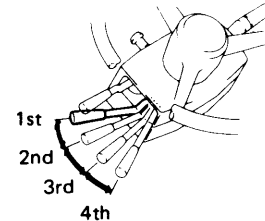

This lever controls the travel speed of machine.

This machine has a 4-FORWARD, 4-REVERSE speed transmission. Place the speed control lever in a suitable position to obtain the desired speed range.

- ★ 1st and 2nd speeds are used for working.
- 3rd and 4th speeds are used for traveling.
- ★ It is possible to change the length of the lever. For details of changing the length, see ADJUSTMENT.

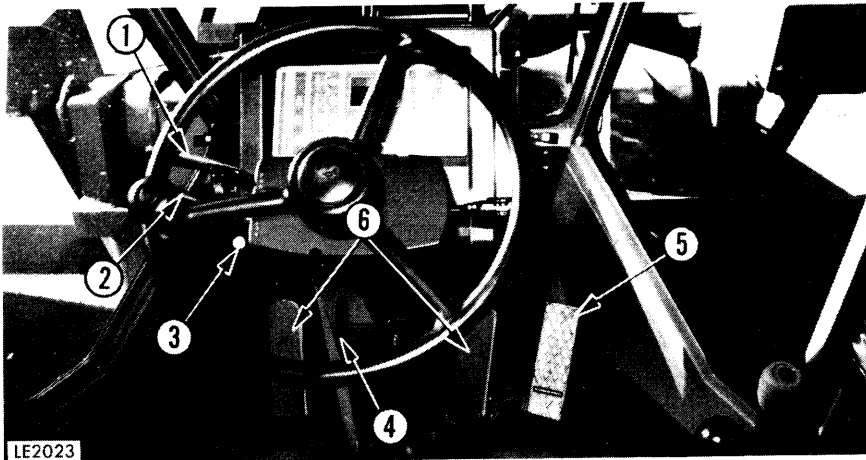

### 3. SPEED CONTROL LEVER STOPPER

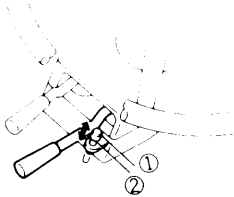

This stopper prevents the speed control lever from entering the 3rd and 4th positions, when working.

Position ①

Stopper actuated.

Position ②

Stopper released.

### 4. STEERING COLUMN TILT LEVER

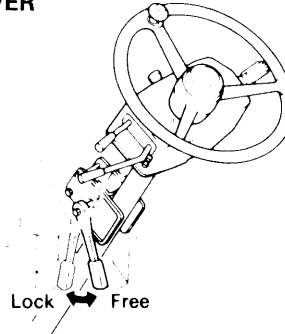

This lever allows the steering column to be tilted forward or backward.

Pull the lever up and move the steering wheel to the desired position. Then push the lever down to lock the steering wheel in position.

★ Range of adjustment:

100 mm (stepless)

**⚠ Stop the machine before adjusting the angle of the steering wheel.**

### 5. ACCELERATOR PEDAL

This pedal controls the engine speed and output. The engine speed can be freely controlled between low idling and full speed.

### 6. BRAKE PEDALS

#### Right brake pedal

The right brake pedal operates the wheel brakes, and is used for normal braking.

**⚠ When traveling downhill, use the engine as a brake, and always use the right brake pedal.**

#### Left brake pedal

The left brake pedal operates the wheel brakes, and if the transmission cut-off selector switch is at ON, it also returns the transmission to neutral.

If the transmission cut-off selector switch is at OFF, the left brake pedal acts in the same way as the right brake pedal.



**!** Do not use the brake pedals repeatedly unless necessary.

**!** Do not use the brake pedals as footrests. Use them only when applying the brakes.

★ When the accelerator is being used for operating the work equipment, always use the left brake pedal to slow or stop the machine after putting the transmission cut-off selector switch in ON.

## 7. LIFT ARM CONTROL LEVER

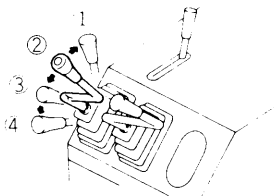

This lever is used to operate the lift arm.

1. Raise (  )

2. Hold (  ):

The lift arm is kept in the same position.

3. Lower (  )

4. Float (  ):

The lift arm moves freely under external force.

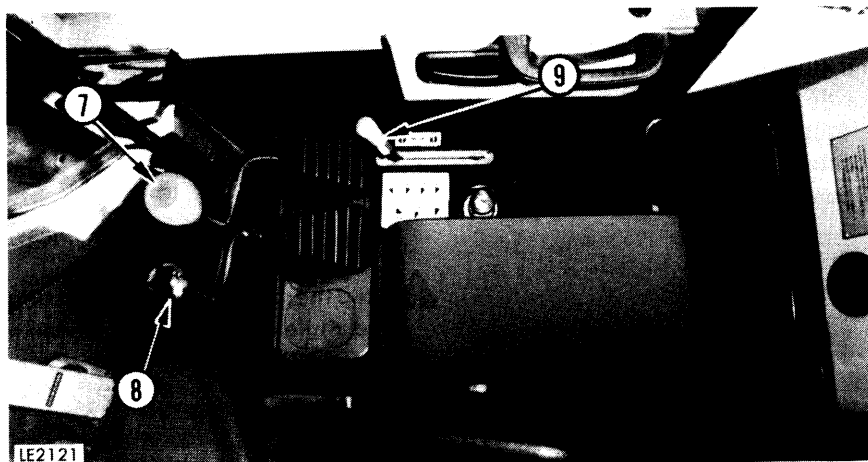

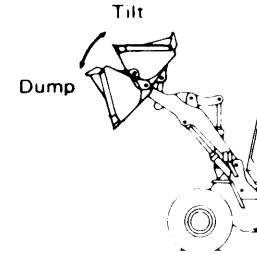
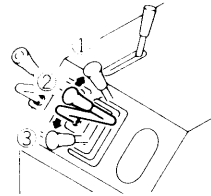
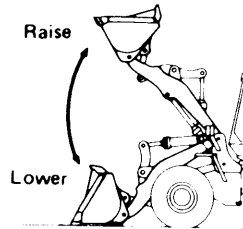

## 8. BUCKET CONTROL LEVER



- ★ When the lift arm control lever is pulled further from ① position, the lever is stopped in this position until lift arm reaches the preset position of kick-out, and the lever is backed to hold position.

This lever operates the bucket.

- ① Tilt (  )
- ② Hold (  ):
- The bucket is kept in the same position.
- ③ Dump (  )

- ★ When the bucket control lever is pulled further from ① position, the lever is stopped in this position until bucket reaches the preset position of bucket positioner, and the lever is backed to hold position.

## 9. SAFETY LOCK

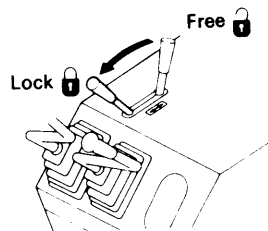

This is used to lock the lift arm and bucket control levers.

**⚠ When parking or leaving the machine, or when performing maintenance, always lower the bucket to the ground, put the work equipment levers in hold position and check that safety lock lever is locked.**

## DUST INDICATOR

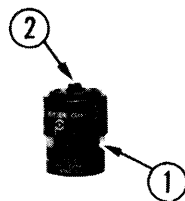

18774

This device indicates clogging of the air cleaner element. When red piston (1) appears in the transparent part of this indicator, the element is clogged. Immediately clean element.

After cleaning, push indicator button (2) to return red piston to original position.

Dust indicator is on hood in insect cover at the side of the brake oil tank.

## SAFETY BAR

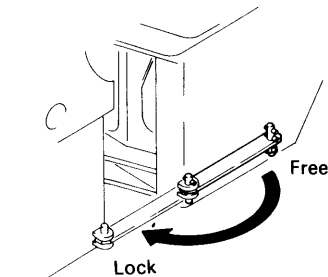

The safety bar is used during maintenance or when transporting the machine. It locks the front frame and rear frame, and prevents the front and rear frames from bending.

**⚠ Always use the safety bar for maintenance or when transporting the machine.**

**⚠ Always remove the safety bar during normal travel operations.**

## WORK EQUIPMENT CONTROL LEVER (MONO-LEVER TYPE)

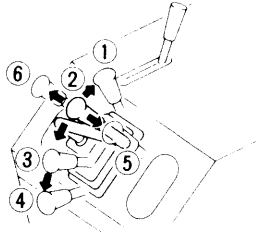

This lever is used to operate the lift arm and the bucket.

① Raise (  )

② Hold (  ):

The lift arm and the bucket are kept in the same position.

③ Lower (  )

④ Float (  ):

The lift arm moves freely under external force.

⑤ Tilt (  )

⑥ Dump (  ):

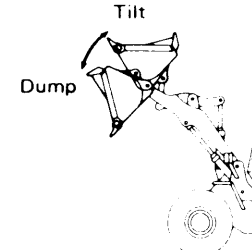
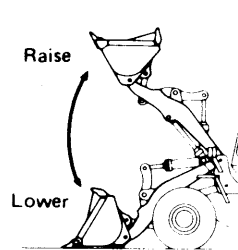

★ When the work equipment control lever is pulled further from ① position, the lever is stopped in this position until the lift arm reaches the preset position of kick-out, and the lever is backed to hold position.

★ When the work equipment control lever is pulled further from ⑤ position, the lever is stopped in this position until the bucket reaches the preset position of bucket positioner, and the lever is backed to hold position.

## CIRCUIT BREAKER (MAIN)

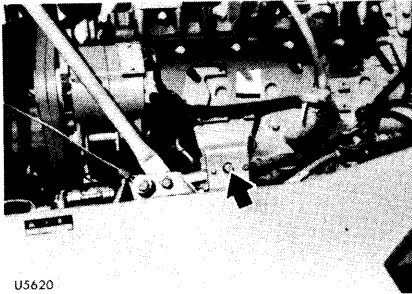

U5620

This prevents damage to the electrical components and electric wiring.

When the breaker has been actuated, press the reset button to reset the system. However, if the circuit breaker is actuated again after the button is pressed, or the circuit breaker is frequently actuated, there may be a short circuit in the electrical system. In such cases, contact your Komatsu distributor for repairs.

- ★ The circuit breaker is not reset for 45 seconds after the breaker is actuated.

## DOOR-OPEN LOCK

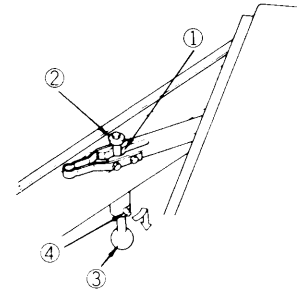

This can be used to hold the door open.

Open the door so that tip (2) of the lever is aligned with groove (1) for the lock, then pull down knob (3) as shown in the diagram.

When releasing the lock and closing the door, push up knob (3) and insert pin (4) securely in the groove.

- ★ When using the door-open lock, be sure to apply the lock securely.

## HOOD TILT LOCK

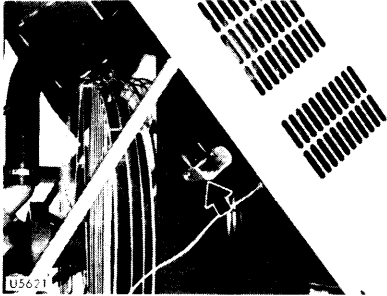

This is a safety device for the engine hood, and is used when operating with the engine hood raised, such as during inspection and maintenance.

Open the engine hood fully and apply the lock.

**⚠ When carrying out inspection or maintenance with the engine hood raised, always use the lock.**

## FUSE BOX

The fuses protect the electric devices and wiring from burning out. If any fuse is rusted or coated with white powder, replace it.

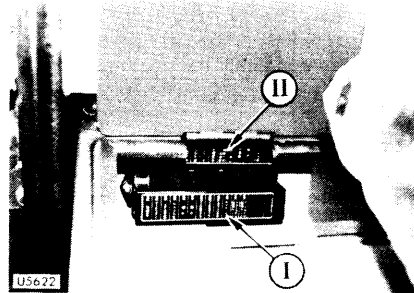

★ Replace a fuse with another of the same capacity.

**⚠ Before replacing a fuse, be sure to turn off the starting switch.**

**Fuse arrangement and circuit**

**Fuse box II**

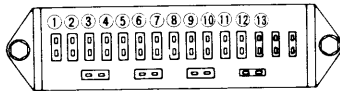

**Fuse box I**

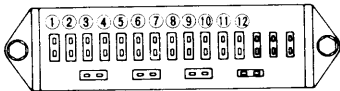

**Fuse box I (Lower side)**

No.	Fuse capacity	Circuit
①	20 A	Working lamp
②	10 A	Parking brake
③	10 A	Monitor lamp
④	10 A	Bucket positioner Boom kick-out
⑤	10 A	—
⑥	10 A	—
⑦	20 A	Air conditioner (Fan outside room)
⑧	10 A	Air conditioner (Fan inside room)
⑨	10 A	Radio, Room lamp
⑩	10 A	Cigarette lighter
⑪	10 A	Rear wiper
⑫	10 A	Front wiper

**Fuse box II (Upper side)**

No.	Fuse capacity	Circuit
①	20 A	Starting switch
②	10 A	Hazard lamp
③	10 A	Left head lamp
④	10 A	Right head lamp
⑤	10 A	Left side clearance lamp
⑥	10 A	Right side clearance lamp
⑦	20 A	Lighting
⑧	10 A	Turn signal lamp
⑨	10 A	Brake lamp, Back up lamp
⑩	10 A	Transmission control valve
⑪	10 A	Horn
⑫	10 A	—
⑬	5 A	Engine stop

## OPERATOR'S SEAT

The seat adjustment should be checked at the beginning of each shift and when operators change.

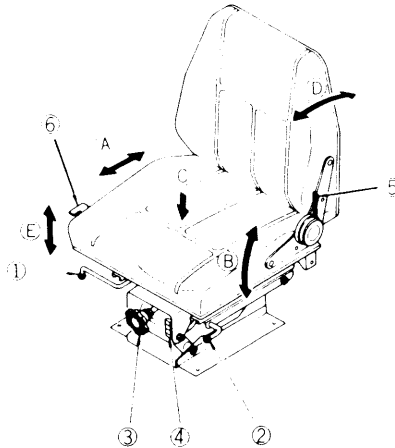

### A: Forward-backward adjustment

Move lever (1) to the right, move the seat to the best position and release the lever. The seat can be moved forward or backward within a range of 140 mm in 7 stages.

### B: Seat angle adjustment

Move lever (2) up, set the seat to the desired angle, and release the lever.

The seat can be tilted up or down about 3°.

### C: Seat cushion adjustment

Rotate grip (3) under the seat to adjust scale (4) on the cushion adjustment to your own weight. (50 to 120 kg)

### D: Backrest adjustment

Pull lever (5), move the backrest to the best position and release the lever. The backrest can be set to 11 steps.

### E: Seat height adjustment

Move lever (6) upward, set the seat to the desired height and release the lever.

The seat can be set within 50 mm.



**Park the machine in a safe place and stop the engine when carrying out adjustment of the operator's seat.**

## RIGHT SIDE ARMREST

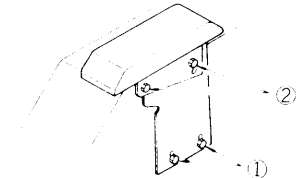

### Forward-backward adjustment

Loosen bolts (1) to move the arm-rest to the desired position, and tighten the bolts.

### Angle adjustment

Loosen bolts (2) to move the armrest to the desired angle and tighten the bolts.



## SEAT BELT

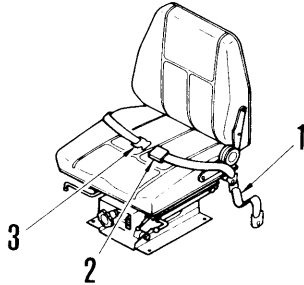

**! Before fastening the seat belt, inspect the securing brackets and belt for abnormal conditions.**

Fasten the belt and remove it in the following manner.

1. Adjust the seat so that the brake pedal can be depressed all the way with the operator's back against the backrest.
2. After positioning the seat, install the tether belt (1). With the seat unoccupied, tense the belt slightly across the seat and install.

**! Check that there are no kinks in the belt.**

3. Sit in the seat. Hold buckle (2) and insert (3) into the buckle (2). Check that the belt has locked by pulling it.

4. When removing the belt, raise the tip of the buckle lever to release it.

★ When leaving the operator's seat, release the seat belt and hang it over the arm rest.

★ Fasten belt along your body without kinking it. Adjust the lengths of the belt on both the buckle and the insert sides so that the buckle is located at the mid-point of your body front.

Adjust the belt length in the following manner.

- i) To shorten the belt, pull the free end of the belt on either the buckle body or insert side.

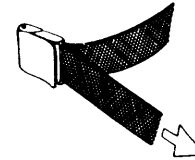

- ii) To lengthen, pull the belt while holding it at a right angle to buckle or insert.

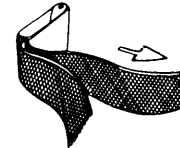

5. When operating a machine equipped with ROPS, be sure to use the seat belt.

★ Inspect bolts and fittings on the chassis for tightness. Retighten any loose bolts to 2 to 3 kgm torque.

★ If the seat is scratched or frayed or if any of the fittings are broken or deformed from long service, replace the seat belt immediately.

# CHECK BEFORE STARTING

Pre-operation checks forestall machine trouble. Never neglect them.

## a. WALK-AROUND CHECK

Look around the machine and under the machine to check for loose nut or bolts, collection of dirt, or leakage of oil, fuel, or coolant, and check the condition of the work equipment and hydraulic system. Check also for loose wiring, play, and collection of dust at places which reach high temperatures.

1. Check bucket for wear.
2. Check tire for wear and damage.
3. Check transmission case joints for oil leak.
4. Check brake system for air leak and oil leak.
5. Check tightness of air cleaner mounting bolt.

6. Check tightness of battery terminal.
7. Check radiator and sub-tank for water leak.
8. Check around the engine for water and oil leaks.
9. Check axle for oil leak.
10. Check hydraulic tank joint for oil leak.
11. Check for oil leak at high pressure hose and high pressure hose joints.

## b. CHECK MONITOR PANEL

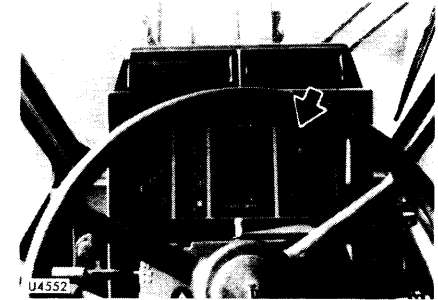

1. Turn the starting switch to ON.
  2. Check that all the monitor lamps, the gauges and the warning lamp light up for about 3 seconds and the alarm buzzer sounds for about 1 second.
- ★ If any monitor lamp does not light up, ask your Komatsu distributor to inspect that monitor lamp.
  - ★ Always make the check by referring to this section on CHECK BEFORE STARTING.

## CHECK BEFORE STARTING

### c. CHECK AND REFILL COOLANT

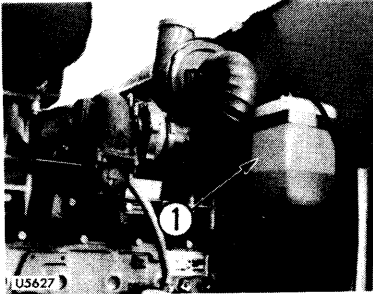

1. Open the engine hood and apply the hood lock at the side of the radiator.
2. Check the level of the coolant. The water level must be between the FULL and LOW marks on sub-tank (1).

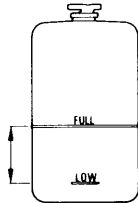

3. If the level is too low, add water to sub-tank (1).

**!** Do not open the radiator cap unless necessary. Check always the coolant level of the sub-tank when engine is cold.

- ★ If the volume of coolant added is more than usual, check for possible water leakage.

### d. CHECK OIL LEVEL AND REFILL IN ENGINE OIL PAN

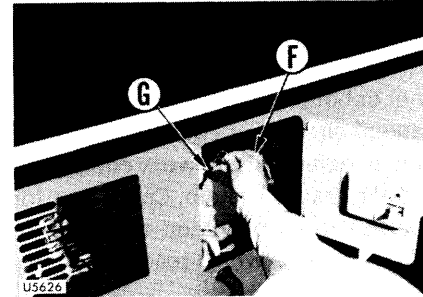

1. Open the inspection window at the rear right side of the machine.
2. Use dipstick (G) to check the oil level.
3. The oil level should be between mark L and H, if necessary, add oil at oil filler (F).

★ The type of lubricant used depends on the ambient temperature. Select according to the table "FUEL, COOLANT AND LUBRICANTS".

**e. CHECK FUEL LEVEL AND  
REFILL FUEL**

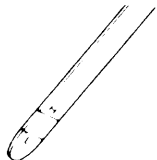

- ★ When checking the oil level, park the machine on a level surface, stop the engine and wait for 15 minutes before checking.

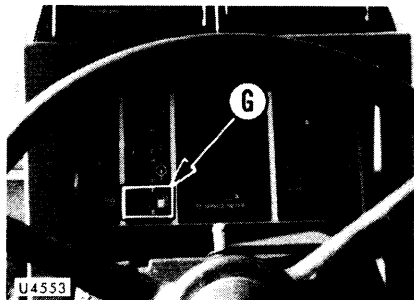

1. Check the fuel level using fuel gauge (G) on the monitor panel.

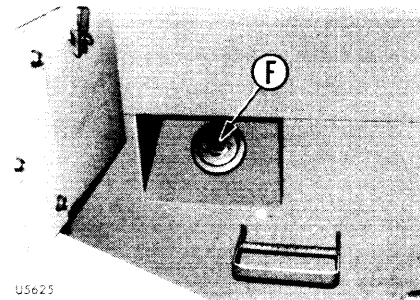

2. Upon completion of work, pour in addition fuel from filler (F) until the fuel tank is full.
- ★ Fuel capacity
    - WA380: 270 ℓ
    - WA420: 293 ℓ
  - ★ When adding fuel, never let the fuel overflow. This may cause a fire.

**f. CHECK ELECTROLYTE LEVEL  
IN BATTERY**

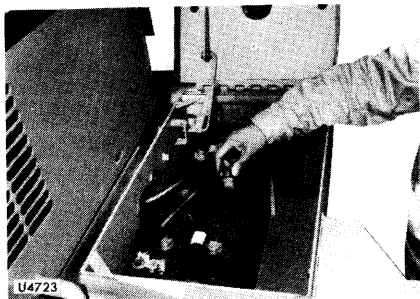

1. Open the battery box covers.
  2. If the electrolyte level is lower than the prescribed level (10 to 12 mm above the plate), supply distilled water.
- ★ Should any of the acid be spilt, have it replenished by the nearest battery shop with acid of the correct specific gravity.
  - ★ When inspecting electrolyte level, clean the air hole of the battery cap.

**!** If the electrolyte gets on your skin or clothes, immediately wash with plenty of clean water.

**!** To avoid gas explosions, do not bring fire or sparks near the battery.

**g. CHECK DUST INDICATOR**

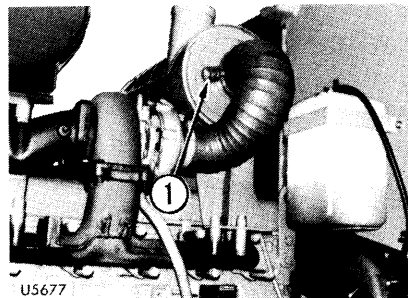

When air cleaner element is clogged, the red piston of dust indicator (1) reaches service level and gets locked.

In that case, clean element referring to the section "WHEN REQUIRED".

After cleaning element, push button to return red piston.

**h. DRAIN WATER FROM AIR TANK**

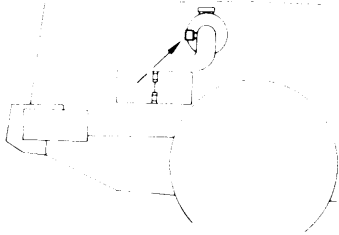

It is possible to inspect through the engine oil inspection window.

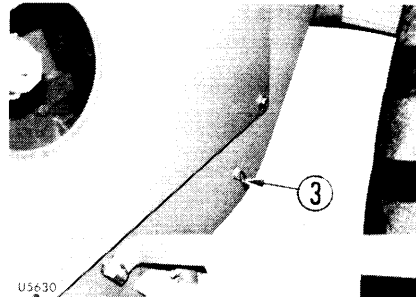
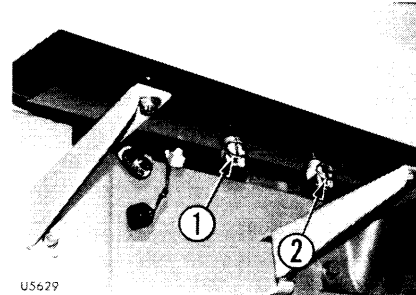

Upon completion of work, open drain valves (1), (2) and (3), and drain water out of the tank.

**i. CHECK FOR SEDIMENT AND WATER IN THE WATER SEPARATOR**

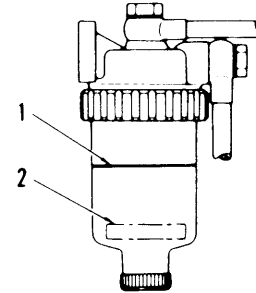

The water separator separates water mixed in the fuel. If float (2) is at or above red line (1), drain the water. For the draining procedure, see section "WHEN REQUIRED".

★ Even if a water separator is installed, be sure to check the fuel tank to remove water and sediment in the fuel.

CHECK BEFORE STARTING

- j. **CHECK THAT PARKING BRAKE WORKS PROPERLY.**
- k. **CHECK THAT BRAKES WORK PROPERLY.**
- l. **CHECK THAT HORN SOUNDS PROPERLY.**
- m. **CHECK THAT LAMPS FLASH PROPERLY; CHECK FOR DIRT OR DAMAGE.**
- n. **CHECK DIRECTION OF REAR VIEW MIRROR; CHECK FOR DIRT OR DAMAGE.**
- o. **CHECK THAT ENGINE EXHAUST GAS COLOR AND SOUND ARE NORMAL.**
- p. **CHECK THAT GAUGES AND INSTRUMENTS WORK PROPERLY.**
- q. **CHECK STEERING PLAY; CHECK THAT STEERING WORKS PROPERLY.**
- r. **CHECK THAT BACK-UP BUZZER SOUNDS PROPERLY.**
- s. **CHECK ELECTRICAL WIRING**
  - Check for damage of the fuse and any sign of disconnection or short circuit in the electric wiring. Check also for loose terminals and tighten any loose parts.
  - Battery
  - Starting motor
  - Alternator



**If the fuse is damaged or there is any sign of shortcircuiting in the electric wiring, always investigate the cause and correct it.**

- ★ Please contact your Komatsu distributor for investigation and correction of the cause.

## OPERATING YOUR MACHINE

### BEFORE STARTING THE ENGINE

**!** Before starting the engine, use a damp cloth to wipe off the dust accumulated on the top surface of the battery.

**!** If the control levers are touched by accident, the work equipment may move suddenly. When leaving the operator's compartment, always set the safety lock securely to the LOCK position.

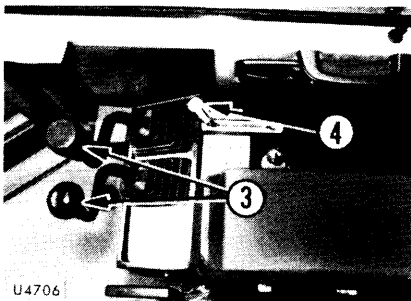
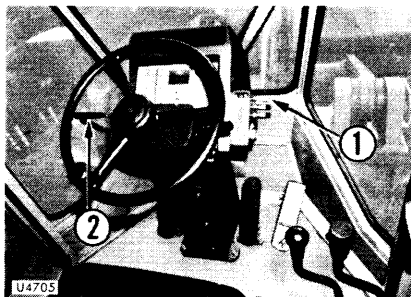

1. Carry out an initial inspection. (For details of the inspection, see CHECK BEFORE STARTING.)
2. With your back against the back rest of the operator's seat, adjust the seat position so that the brake pedal can be easily depressed.
3. Is parking brake switch (1) in ON position?

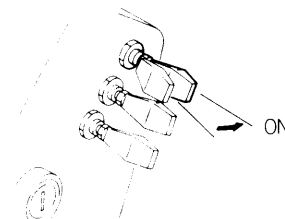



4. Is directional lever (2) in N (neutral) position?

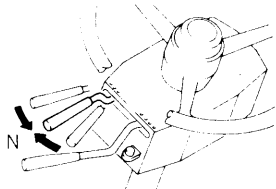

★ The engine will not start while directional lever (2) is in any position other than N (neutral).

5. Are work equipment control levers (3) locked by safety lock (4)?

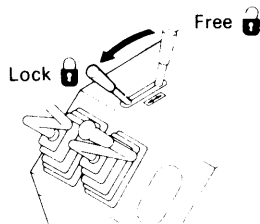

6. Is the machine monitoring system working properly?

### TO START THE ENGINE

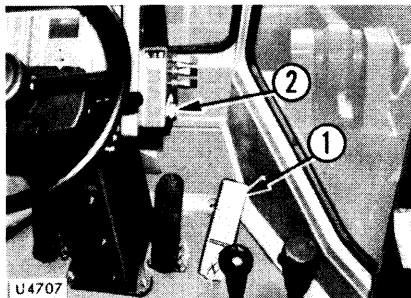

1. Depress accelerator pedal (1) lightly.
2. Check that the preheat pilot lamp is out, then turn the key of starting switch (2) to the START position to start the engine.

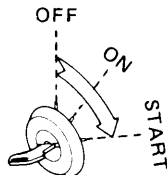

3. When the engine is started, release the key of starting switch (2) and the key will return automatically to ON.

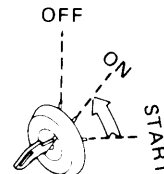

- ★ If engine will not start, repeat the starting procedure after about 2 minutes.
- ★ Do not leave the key in START for more than 20 seconds.
- ★ If using a fuel with a low cetane value, starting at normal temperatures may be difficult. In such a case, use the methods for starting in cold weather.
- ★ To start engine in cold weather, refer to COLD WEATHER OPERATION.

**Special starting**

When starting after running out of fuel, fill with fuel, and bleed the air from the fuel system before starting.

Refer to FUEL FILTER in every 500 hours services.

**CHECKS AFTER STARTING**

After starting make the following checks.

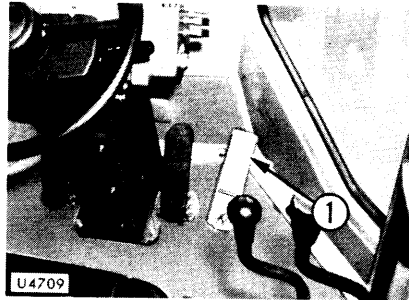

1. Depress accelerator pedal (1) lightly and run the engine with no load at midrange speed for about 5 minutes.
2. After warm-up run is completed, check monitor lamps for proper operation.
  - ★ Continue to run the engine at light load until the green ranges of the engine water temperature gauge and torque converter oil gauge light.
3. Check if the exhaust color is normal or whether there is any abnormal noise or vibration.
  - ★ Avoid abruptly accelerating the engine until the completion of warm-up.
  - ★ Do not run the engine at low idling or high idling for more than 20 minutes. If it is necessary to run the engine at idling, apply a load from time to time or raise the engine speed to a midrange speed.

## TO MOVE THE MACHINE OFF

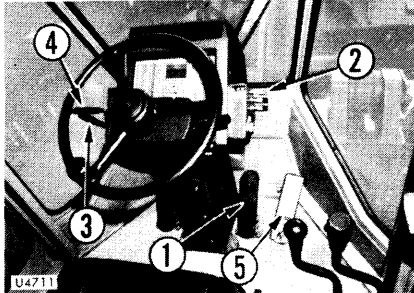

1. Check that the warning item is not displayed on the monitor panel.
2. Free the safety lock for work equipment control lever. Bring the work equipment in the traveling posture.

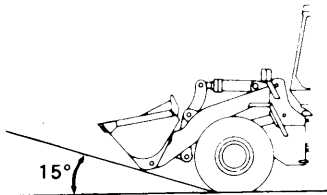

3. Depress right brake pedal (1), and turn parking brake switch (2) to OFF (release) to release the parking brake.

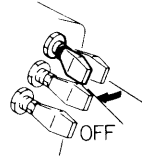

- ★ When the parking brake is applied with parking brake switch (2) put in OFF, put switch (2) to ON and return it to OFF again.

4. Set speed control lever (3) and directional lever (4) to the desired position.

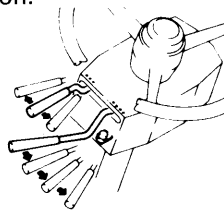

5. Release right brake pedal (1), then depress accelerator pedal (5) to move the machine off.

**!** If the machine has to be started on a slope, always turn the transmission cut-off selector switch to OFF and depress the left brake pedal. Then depress the accelerator pedal while releasing the left brake pedal to start the machine off slowly.

## CHANGING GEAR SPEED

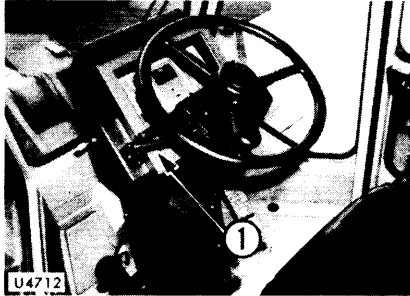

Move speed control lever (1) to the desired position.

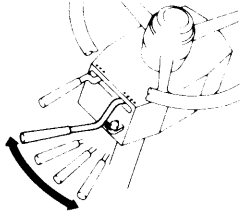

- ★ To use 1st or 2nd speeds for digging and loading operations, actuate speed control lever stopper.

- ★ This machine is equipped with a kickdown switch that shifts the gear down to 1st if the button at the tip of the lift arm control lever is pushed when the machine is traveling in 2nd gear. We recommend the use of the kickdown switch when carrying out digging or loading operations in 1st or 2nd gear. For details of use, see INSTRUMENTS AND CONTROLS.

## CHANGING DIRECTION

There is no need to stop the machine even when switching between FORWARD and REVERSE.

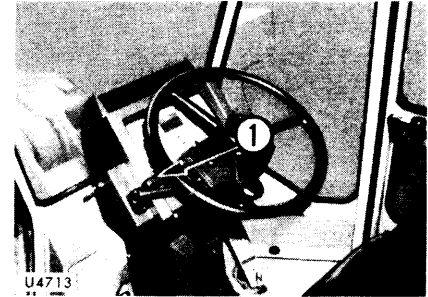

Place directional lever (1) in the desired position.

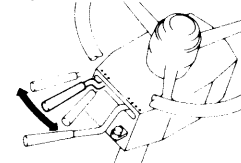

- ⚠ **Before changing direction, check that it is safe.**
- ⚠ **Never change between FORWARD and REVERSE at high speed.**

## TURNING



When traveling, use steering wheel (1) to turn the machine.

- ★ With this machine, the front frame is joined to the rear frame at the center of the machine by the center pin. The front and rear frames bend at this point, and the rear wheels follow in the same track as the front wheels when turning?

- ★ Turn the steering wheel lightly to follow the machine as it turns. When turning the steering wheel fully, do not turn it beyond the end of the stroke.

**!** It is dangerous to turn the machine suddenly at high speed, or to turn on steep hills.

**!** If the engine stops when the machine is traveling, the steering cannot be used. This is particularly dangerous on hills, so never stop the engine when the machine is traveling.

## TO STOP THE MACHINE

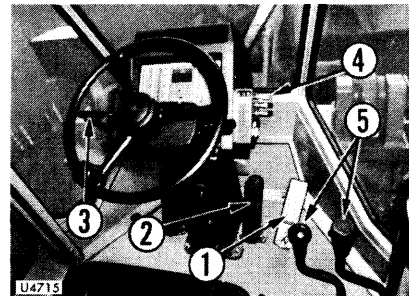

1. Release accelerator pedal (1), and depress brake pedal (2) to stop the machine.
2. Place directional lever (3) in N (neutral).

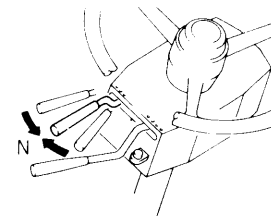

- Turn parking brake switch (4) to ON to apply the parking brake.



- ★ When the parking brake is applied, the transmission is automatically returned to neutral.
- Operate work equipment lever (5) and lower the bucket to the ground, then locate work equipment control levers (5) to hold position surely and then lock safety lock of control levers.

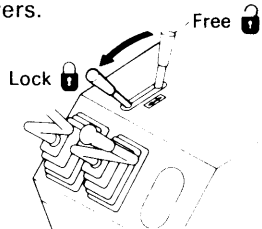

**⚠ Stop the machine in a safe place on firm level ground. If the machine has to be stopped on a slope, put blocks under the wheels. In addition, dig the bucket into the ground to increase safety.**

## TO STOP THE ENGINE

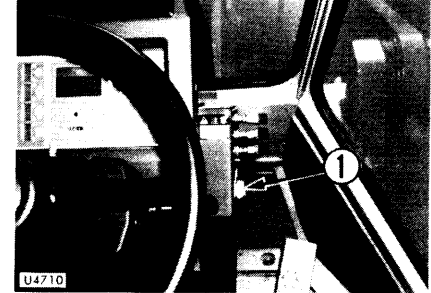

- Run the engine at low idling speed for about 5 minutes to allow it to gradually cool down.
- Return starting switch (1) to the OFF position and remove the key.

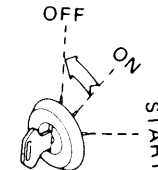

### MAXIMUM DEPTH OF WATER

When working in water or on swampy ground, do not let the water come above the bottom of the axle housing.

- ★ After finishing the operation, wash and check the lubricating points.

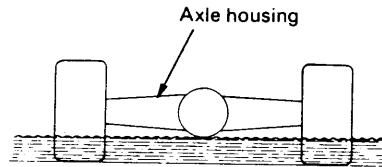

- ★ If the engine is abruptly stopped before it has cooled down, engine life may be greatly shortened. Consequently, do not abruptly stop the engine apart from an emergency.
- ★ In particular, if the engine has overheated, do not abruptly stop it but run it at medium speed to allow it to cool gradually, then stop it.

### IF WHEEL BRAKE DOES NOT WORK

If the machine is not stopped by depressing brake pedal, use the parking brake to stop the machine.

### PRECAUTIONS WHEN DRIVING UP OR DOWN SLOPES

#### Lower the center of gravity when turning.

When turning on slopes, lower the work equipment to lower the center of gravity before turning. It is dangerous to turn the machine with the work equipment raised.

**Braking on downhill slopes**

If the service brake is used too frequently when traveling downhill, the brake may overheat and be damaged. To avoid this problem, shift down to a low range and make full use of the braking force of the engine. When braking, use the right brake pedal.

If the speed control lever is not placed in a proper speed position, the torque converter oil may overheat. If it overheats, place the speed control lever in the next lower gear speed to lower the oil temperature.

If the temperature gauge does not indicate the green range of the scale even with the lever in the 1st speed position, stop the machine, place the lever in neutral, and run the engine at medium speed until the gauge indicates the green range.

**If engine stops**

If the engine stops on a slope, depress the right brake pedal fully. Next, lower the work equipment to the ground and apply the parking brake. Then put the directional and speed control levers in neutral, and start the engine again. (If the directional lever is not in neutral, the engine will not start.)



**PROPER BUCKET AND TIRE  
(WA380)**

Select the most suitable bucket and tires for the type of work and the ground conditions on the jobsite.

Type of work	Bucket	Ground conditions	Tire
<ul style="list-style-type: none"> <li>• Loading materials</li> <li>• Loading and carrying materials</li> </ul>	Stockpile bucket (3.1 m <sup>3</sup> )	General ground conditions	20.5 – 25 – 16PR (Rock)
		Leveled ground	20.5 – 25 – 16PR (Traction)
		Soft ground	23.5 – 25 – 12PR (Traction)
<ul style="list-style-type: none"> <li>• Loading materials and blasted rock</li> </ul>	Excavating bucket (2.75 m <sup>3</sup> )	General ground conditions	20.5 – 25 – 16PR (Rock)

Type of work	Bucket	Ground conditions	Tire
<ul style="list-style-type: none"> <li>• Loading blasted rock</li> </ul>	Excavating bucket (2.6 m <sup>3</sup> )	General ground conditions	20.5 – 25 – 16PR (Rock)
		Soft ground	23.5 – 25 – 12PR (Rock)
	Spade nose bucket (2.6 m <sup>3</sup> )	Ground with many bulders	20.5 – 25 – 16PR (Rock, side steel breaker)
		Soft ground with many boulders	23.5 – 25 – 12PR (Rock, side steel breaker)
<ul style="list-style-type: none"> <li>• Loading and carrying blasted rock</li> </ul>	Spade nose bucket (2.6 m <sup>3</sup> )	General ground conditions	20.5 – 25 – 16PR (Rock)
		Soft ground	23.5 – 25 – 16PR (Rock)
		Ground with many rocks	20.5 – 25 – 16PR (Rock, side steel breaker)
		Soft ground with many rocks	23.5 – 25 – 12PR (Rock, side steel breaker)

**(WA420)**

Select the most suitable bucket and tires for the type of work and the ground conditions on the jobsite.

Type of work	Bucket	Ground conditions	Tire
<ul style="list-style-type: none"> <li>• Loading materials</li> <li>• Loading and carrying materials</li> </ul>	Stockpile bucket (3.7 m <sup>3</sup> )	General ground conditions	23.5 – 25 – 12PR (Rock) 26.5 – 25 – 16PR (Rock)
		Soft ground	23.5 – 25 – 20PR (Traction) 26.5 – 25 – 16PR (Rock)
<ul style="list-style-type: none"> <li>• Loading materials and blasted rock</li> </ul>	Excavating bucket (3.3 m <sup>3</sup> )	General ground conditions	23.5 – 25 – 12PR (Rock)
		Soft ground	23.5 – 25 – 16PR (Traction)
		Ground with many rocks	23.5 – 25 – 16PR (Rock)
		Ground with many boulders	23.5 – 25 – 16PR (Rock)

Type of work	Bucket	Ground conditions	Tire
<ul style="list-style-type: none"> <li>• Loading blasted rock</li> </ul>	Excavating bucket (3.1 m <sup>3</sup> )	General ground conditions	23.5 – 25 – 12PR (Rock)
		Ground with many rocks	23.5 – 25 – 16PR (Rock)
	Spade nose bucket (3.1 m <sup>3</sup> )	Ground with many boulders	23.5 – 25 – 16PR (Rock, side steel breaker)
		Hard ground	23.5 – 25 – 12PR (Rock)
<ul style="list-style-type: none"> <li>• Loading and carrying blasted rock</li> </ul>	Spade nose bucket (3.1 m <sup>3</sup> )	General ground conditions	23.5 – 25 – 12PR (Rock)
		Ground with many rocks	23.5 – 25 – 16PR (Rock)

## ADJUSTMENT OF WORK EQUIPMENT

The boom kickout makes it possible to set the bucket so that it automatically stops at the desired lifting height (lift arm higher than horizontal) and the bucket positioner makes it possible to set the bucket so that it automatically stops at the desired digging angle. The setting can be adjusted to match the working conditions.

### ADJUSTING BOOM KICKOUT

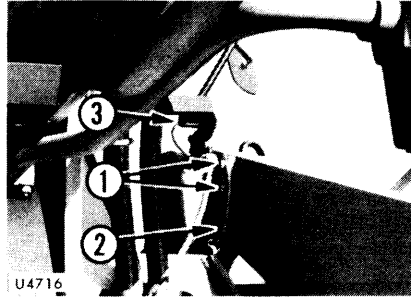

1. Raise the bucket to the desired height, set the lift arm control lever at HOLD and lock the lever in position. Then stop the engine and adjust as follows.
2. Loosen two bolts (1), and adjust plate (2) so that the bottom edge is in line with the center of the sensing surface of proximity switch (3). Then tighten the bolts to hold the plate in position.

3. Loosen two nuts (4) to make a clearance of 3 to 5 mm between plate (2) and the sensing surface of proximity switch (3). Then tighten the nuts to hold in position.

★ Tightening torque:

$1.75 \pm 0.25$  kgm

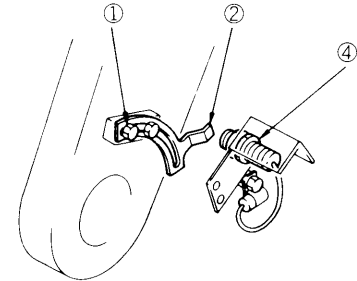

4. After adjusting, start the engine and operate the lift arm control lever. Check that the lever is automatically returned to HOLD when the bucket reaches the desired height.

## ADJUSTING BUCKET POSITIONER

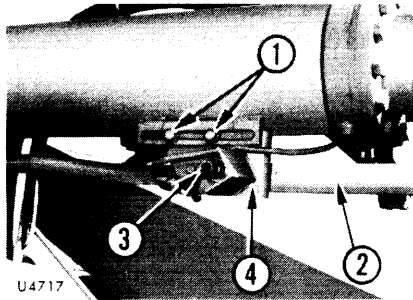

1. Lower the bucket to the ground and adjust the bucket to the desired digging angle. Set the bucket control lever at HOLD, stop the engine and adjust as follows.
2. Loosen two bolts (1) and adjust mounting bracket (4) of the proximity switch so that the rear tip of angle (2) is in line with the center of the sensing surface of proximity switch (3). Then tighten the bolts to hold the bracket in position.

3. Loosen two nuts (5) and to make a clearance of 3 to 5 mm between angle (2) and the sensing surface of proximity switch (3). Then tighten the nuts to hold in position.

★ Tightening torque:

$1.75 \pm 0.25 \text{ kgm}$

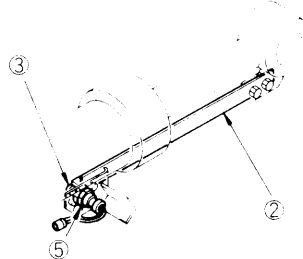

4. After adjusting, start the engine and raise the lift arm. Operate the bucket control lever to the DUMP position, then operate it to the TILT position and check that the bucket control lever is automatically returned to HOLD when the bucket reaches the desired angle.

## BUCKET LEVEL INDICATOR

(A) and (B) at the top rear of the bucket are the level indicators, so the bucket angle can be checked during operations.

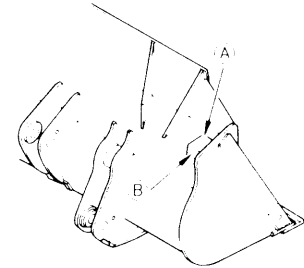

A: Parallel with cutting edge  
B: 90° to cutting edge

# HANDLING THE TIRES

## PRECAUTIONS WHEN HANDLING TIRES

If the following defects are found in tires, for safety reasons the tire should be replaced with a new tire.

- Bead wire is broken or bent, or the tire is greatly deformed.
- Wear is excessive and the carcass ply (excluding breaker) is exposed for more than 1/4 of the circumference.
- Damage to the carcass exceeds 1/3 of the tire width.
- Tire layers are separated.
- Radial cracks reach the carcass.
- Deformation or damage which makes the tire unsuitable for use.

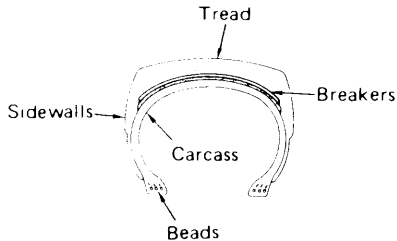

## PRECAUTIONS WHEN DRIVING MACHINE

When the machine travels at high speed for a long distance, the tires become extremely hot. This causes early wear of the tires, so it should be avoided as far as possible. If the machine must be driven for a long distance, take the following precautions.

- Follow the regulations related to this machine, and drive carefully.
- The most suitable tire pressure, travel speed, or tire type differ according to the condition of the travel surface. Contact your Komatsu distributor or tire dealer for information.

- The following is a guide to suitable tire pressures and speeds when traveling on a paved surface with standard tires.

WA380

Tire pressure: 2.8 kg/cm<sup>2</sup>

Speed: 14 km/h (8.7 MPH)

WA420

Tire pressure: 3.5 kg/cm<sup>2</sup>

Speed: 15 km/h (9.3 MPH)

- Check the tire pressure before starting, when the tire is cool.
- After traveling for 1 hour, stop for 30 minutes. Check the tires and other parts for damage; also check the oil and coolant levels.
- Always travel with the bucket empty.
- Never put calcium chloride or dry ballast in the tires when traveling.

**TIRE PRESSURE**

Measure the tire pressure before starting operations, when the tires are cool.

If the inflation pressure is too low, it causes overload on the tires; if the inflation pressure is too high, the tire may be cut or may burst under shock. Therefore adjust the inflation pressure to the values in the following table.

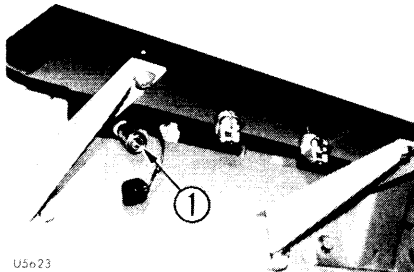
**Inflating tires**

U5623

Connect the air charge hose to air pickup (1) to inflate the tires.

**(For WA380)**

Tire size (pattern)	Ply rating	Inflation pressure (kg/cm <sup>2</sup> )				When shipped from factory
		Soft ground (sandy ground)	Normal road			
			Stockpile	Digging		
20.5 – 25 (L <sub>3</sub> Rock)	16	2.6 – 3.8	2.8 – 4.5	2.8 – 4.5	Front tire: 4.0 Rear tire: 3.1	
20.5 – 25 (L <sub>2</sub> Traction)	16					
23.5 – 25 (L <sub>3</sub> Rock)	12	–	2.6 – 3.6	–	Front tire: 3.1 Rear tire: 3.1	
23.5 – 25 (L <sub>2</sub> Traction)	12	2.4 – 3.6				
23.5 – 25 (L <sub>3</sub> Rock)	16 20	2.4 – 3.6	2.6 – 3.6	–	Front tire: 3.1 Rear tire: 3.1	
23.5 – 25 (L <sub>2</sub> Traction)	16 20					

**(For WA420)**

Tire size (pattern)	Ply rating	Inflation pressure (kg/cm <sup>2</sup> )				When shipped from factory
		Soft ground (sandy ground)	Normal road			
			Stockpile	Digging		
23.5 – 25 (L <sub>3</sub> Rock)	12 16 20	2.4 – 3.6	2.6 – 3.6	2.6 – 3.6	Front tire: 4.0 Rear tire: 3.5	
23.5 – 25 (L <sub>2</sub> Traction)	12 16 20					
26.5 – 25 (L <sub>3</sub> Rock)	16 20	3.5 – 4.0	3.5 – 4.0	–		

- For operations on normal road surfaces, rock digging operations: .....  
High end of range in air pressure chart
  - Stockpile operations on soft ground: .....  
Average pressure in air pressure chart
  - Operations on sand (operations not using much digging force) ...  
Low end of range in air pressure chart
- If the deflection of the tire is excessive, raise the inflation pressure within the limits given in the table to give a suitable deflection (see deflection ratio).
- ★ Stockpile operations mean the loading of sand and other loose materials.

- ★ Deflection ratio (deflection/free height)

$$= \frac{H - h}{H} \times 100$$

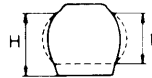

H: Free height  
h: Height when loaded

As a guide for visual checks, the deflection ratio (deflection/free height) of the front tire should be as follows.

- Normal loading and carrying operations (lift arm horizontal):  
approx. 15 – 25%
- Digging operations (rear wheels off ground):  
approx. 25 – 35%

- ★ When checking the tire pressure, check also for small cracks and damage, and for wire or small pieces of metal which may cause punctures. Check also for abnormal wear.
- ★ Operating costs can be reduced and tire life increased by keeping the operating area in good condition and free from fallen rocks.

# TOWING

## TOWING THE MACHINE

This machine must not be towed except in emergencies. When towing the machine, take the following precautions.

 **If there is a failure in the brake line, the brakes cannot be used, so be extremely careful when towing.**

### When engine can be used.

- Always keep the engine running when towing the machine, so that the steering and braking can be used.

### When engine cannot be used.

- No lubrication oil flows in the transmission, so disconnect the front and rear drive shafts before moving the machine.
- The steering cannot be used, so disconnect the steering cylinder and steering linkage.
- ★ The machine should be towed only to the nearest place for inspection and maintenance. Do not tow the machine for long distances.
- ★ If leakage in the air circuit has caused the pressure inside the air tank to drop, the parking brake will be applied. When towing the machine, release the parking brake.



## RELEASING PARKING BRAKE

1. Remove air charge socket (1) installed on the front left of the rear frame.

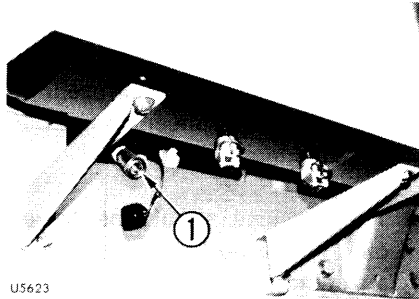

U5623

2. Remove the air hose for the parking brake chamber, then install the socket again.
3. Install the air charge hose for the tire to the air charge socket.

**⚠** If there is a failure in the air circuit, the brakes cannot be used. This is dangerous, so always tow the machine at low speed. Keep the engine running so that the steering can be used.

4. Push the end of the hose on the tire valve, and air will be supplied to the brake chamber to release the brake.
5. When the parking brake is released, remove the air charge hose. Tow the machine immediately to a safe place.

**⚠** Stop the machine on a flat surface when releasing the parking brake, and check that the surroundings are safe. In emergencies or when the parking brake must be released on a hill, block the tires carefully before releasing the brake.

# COLD WEATHER OPERATION

## PREPARATION FOR LOW TEMPERATURE

If the temperature becomes low, it becomes difficult to start the engine, and the coolant may freeze, so do as follows.

### FUEL AND LUBRICANTS

Change to fuel and oil with low viscosity for all components. For details of the specified viscosity, see the TABLE OF FUEL, COOLANT AND LUBRICANTS.

## COOLANT

After cleaning inside of the cooling system, add antifreeze to the coolant to prevent the coolant from freezing when the machine is not being used.

- ★ For details of the antifreeze mixture when changing the coolant, see WHEN REQUIRED.

## Care in using Antifreeze

Use a Permanent Antifreeze (ethylene glycol mixed with corrosion inhibitor, antifoam agent, etc.) meeting the standard requirements as shown below. With permanent antifreeze, no change of coolant is required for a year. If it is doubtful that an available antifreeze meets the standard requirements, ask the supplier of that antifreeze for information.

Standard requirements for permanent antifreeze

- SAE ..... J1034
- FEDERAL STANDARD  
..... O-A-548D

- ★ Never use methanol, ethanol or propanol based antifreeze.
- ★ Where no permanent antifreeze is available, an ethylene glycol antifreeze without corrosion inhibitor may be used only for the cold season. In this case, clean the cooling system twice a year (in spring and autumn). When refilling the cooling system, add antifreeze in autumn, but do not add any in spring.
- ★ Absolutely avoid using any water leak preventing agent irrespective of whether it is used independently or mixed with an antifreeze.
- ★ Do not mix one antifreeze with a different brand.

 **Antifreeze is flammable, so keep it away from any flame.**

● **Battery**

As ambient temperature drops, battery capacity will drop, and electrolyte may sometimes freeze if battery charge is low. Maintain battery at a charge level of approx. 100% and insulate it against cold temperature so that machine can be readily started the next morning.

- ★ Measure specific gravity of fluid and obtain rate of charge from the following conversion table:

Temp. of fluid Rate of charge	20°C	0°C	-10°C	-20°C	-30°C
100%	1.28	1.29	1.30	1.31	1.32
90%	1.26	1.27	1.28	1.29	1.30
80%	1.24	1.25	1.26	1.27	1.28
75%	1.23	1.24	1.25	1.26	1.27

- ★ When electrolyte level is low, add distilled water in the morning before work instead of after the day's work. This is to prevent fluid from freezing at night.

 **To avoid gas explosions, do not bring fire or sparks near the battery.**

 **If the electrolyte gets on your skin or clothes, immediately wash with plenty of clean water.**

## STARTING IN COLD WEATHER

For the pre- and post-starting inspection, refer to the section OPERATING YOUR MACHINE.

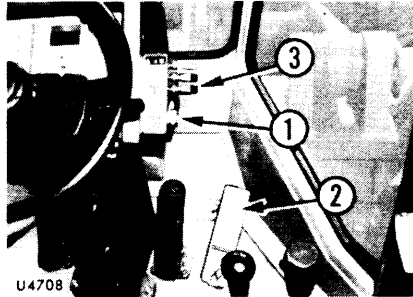

1. Turn the key of starting switch (1) to ON.

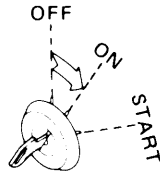

2. Preheating will start automatically, and the preheating pilot lamp will light up.
3. Depress accelerator pedal (2) halfway.
4. When preheating is finished, the pilot lamp will go out. Turn the key of starting switch (1) to the START position to start the engine.

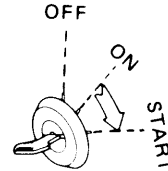

- ★ When starting, the monitor may flash when the starting motor is being cranked. If this flashing stops after the engine is started, there is no abnormality.

5. Release the key of starting switch (1), and the key will return automatically to ON.

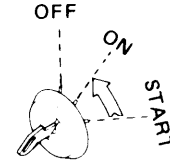

- ★ If the engine does not start after following this procedure, turn heater switch (3) to ON and pre-heat fully before trying to start.

The table below gives a guide to preheating time.

Temperature	Preheating time
0°C to -5°C	-
-5°C to -10°C	15 seconds
-10°C to -20°C	30 seconds
-20°C to -30°C	45 seconds

 **Never use starting aid fluids as they may cause explosions.**

★ The standard specification machine is designed to work in ambient temperature from -20 to 40°C.

When operating the machine at temperatures below -20°C, special equipment is needed. Contact your Komatsu distributor for details.

★ For machines where the air dryer is installed as an option, in cold temperatures below -10°C, when operating the machine after it has been stopped for several hours, run the engine for at least 10 minutes after starting before moving the machine.

### WARMING-UP OPERATION

When starting the engine in cold weather, do not start operations immediately. First, carry out the following.

1. Warm up the engine.

Guideline for warming-up time (engine idling)

Ambient temperature	-20°C	-10°C	0°C and above
Warming-up time	15 min.	10 min.	5 min.

★ Avoid sudden acceleration of the engine before the warming-up operation is completed.

★ Do not run the engine at idling continuously for more than 20 minutes.

2. Warm up the work equipment circuits  
After completing the warming-up operation for the engine, warm up the work equipment circuit.

1) Move the lift arm control lever slowly to the RAISE position and raise the bucket slightly.

2) Move the lift arm control lever slowly to the LOWER position and lower the bucket slightly.

3) Repeat the above operation several times and gradually increase the amount you move the lift cylinder.

4) Repeat Steps 1) – 3) for the bucket control lever to warm up the work equipment circuit.

★ Run the engine with the throttle at the 1/3 position or below.

5) Raise the bucket 10 – 30 cm from the ground, operate the bucket control lever to the tilt position, relieve the circuit for approx. 5 seconds, then return the lever to the neutral position and hold it for approx. 2 seconds. Repeat this operation to warm up the work equipment circuit.

★ Raise the engine speed gradually from the idling speed.

 **If the machine is operated suddenly before the warming-up operation is carried out, the work equipment may be damaged. The warming-up operation is also necessary for safety reasons, so always carry it out without fail.**

3. Warm up the steering circuit.  
Turn the steering wheel slowly to the left and right to warm up the oil inside the steering valve. (Repeat this operation about 10 times.)
- ★ Turn the steering wheel a short distance, then stop it, and check that the chassis stops in accordance with the amount the steering wheel is turned.

**⚠ If this operation is carried out when the oil temperature is still low, even when the steering wheel is turned and stopped, there may be a time lag before the chassis turns. In such cases, carry out the warming-up operation in a large open area. In addition, use the safety bar to ensure safety. In this case, do not relieve the circuit for more than 5 seconds.**

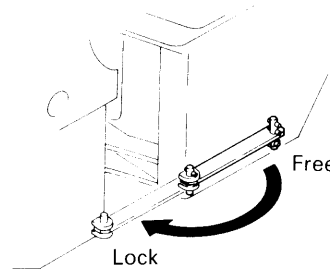

4. Recommended oil for work equipment  
Use the oil in the table below in accordance with the ambient temperature.

Type of oil	Ambient temperature							
	-30	-20	-10	0	10	20	30°C	
Hydraulic oil	Engine oil	SAE 10WCD						
		SAE 5W-20CD						

- ★ When using SAE5W-20CD oil in cold areas, return to SAE10WCD when the cold season finishes.

### **CAUTIONS AFTER COMPLETION OF WORK**

1. Mud and water on the machine body should be completely removed.

Park the machine on concrete or hard ground. If this is impossible, park the machine on wooden boards. This will prevent the accessories from freezing to the ground thereby preventing machine movement the next morning. Particular attention should be given to water drops collected on the surface of the hydraulic cylinder piston rods. Such droplets must be fully wiped off because if water is frozen to the rod when the cylinder is utilized, the cylinder oil seals may be damaged.

2. Drain water collected in air tank and fuel system so that such water may be frozen at night.
3. As battery capacity drops at low ambient temperature, cover the battery or remove it from the machine to be kept warm at night.

### **AFTER COLD WEATHER**

When weather becomes warm, perform the following without fail:

- Replace lubricating oils for various units with the ones specified for warm-weather use.
- If for any reason permanent anti-freeze cannot be used, and an ethyl glycol base antifreeze (winter, one season type) is used instead, or if no antifreeze is used, drain the cooling system completely, then clean out the inside of the cooling system thoroughly, and fill with fresh water.

# PERIODIC MAINTENANCE

Proper lubrication and maintenance assure trouble-free operation and long machine life. Time and money spent for scheduled periodic maintenance will be amply compensated by prolonged machine operation and reduced operating cost.

All hourly figures given in the following descriptions are based on service meter readings. In practice, however, it is recommended to rearrange all of them into units of days, weeks and months to make the maintenance schedule more convenient. Under rough job site or operating conditions, it is necessary to somewhat shorten the maintenance intervals stated in this manual.



## BLEEDING AIR FROM CIRCUIT

### BLEEDING AIR FROM HYDRAULIC CIRCUIT

- After replacing oil, filter element or strainer, bleed the air from the circuit.
  - To bleed the air from the hydraulic cylinders or hydraulic piping, run the engine at low idling and do as follows.
    1. Operate each hydraulic cylinders (of steering, bucket and lift arm) 4 to 5 times, stopping 100 mm from stroke end.
    2. Next, operate each cylinder 3 to 4 times to the end of its stroke, then stop the engine and loosen air bleeding plug (1) of the hydraulic tank to bleed the air.
    3. Increase the engine speed, and repeat step 2 to bleed the air until no more bubbles come out from plug (1).
- ★ If the engine is run at high speed at first, or if the cylinder is moved to the end of its stroke, the air in the cylinder may damage the piston packing, etc.
4. After bleeding the air, tighten air bleeding plug (1).
- ★ Tightening torque of the plug:  
 $1.15 \pm 0.15 \text{ kgm}$

(For WA380)

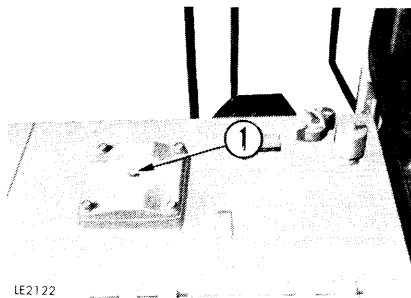

(For WA420)

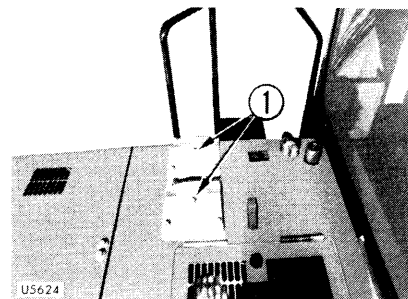

## PERIODICAL REPLACEMENT OF SAFETY PARTS

The users of our machine should carry out periodical maintenance in order to ensure the working and operation safety. Those parts, as listed on the right, which are closely connected with safety, must be replaced periodically so that the highest safety standard can be maintained.

These parts with the passage of time have a great tendency to deteriorate in quality and to wear or deform. Furthermore, their defective condition is difficult to detect during periodical maintenance. These parts must, therefore, be replaced with new ones after a predetermined service period even though there is no apparent abnormality.

It goes without saying that if any abnormality should be found, these parts must be replaced or repaired even before the predetermined period expires.

The periodical replacement is completely different from the replacement due to the claim against the guarantee by the manufacturer, so they must be treated separately.

	Safety parts for periodic replacement	Replacement interval	Remarks
1	Brake hose	Every year	
2	Rubber parts for power cluster	Every year	Replace with repair kit
3	Packings, seals, O-rings of steering cylinder	Every 2 years	
4	Rubber hose for steering cylinder	Every 2 years	
5	Fuel hose	Every 2 years	
6	Rubber parts for treadle valve	Every year	Replace with repair kit
7	Rubber parts for parking brake spring cylinder	Every year	Replace with repair kit
8	Rubber parts for slack adjuster	Every year	Replace with repair kit

## MAINTENANCE TABLE

No.	ITEM	SERVICE	PAGE
	<b>CHECK BEFORE STARTING</b>		
a	Walk-around check		33
b	Monitor panel	Check	33
c	Coolant	Check and supply	34
d	Engine oil pan	Check and supply	34
e	Fuel tank	Check and supply	35
f	Battery electrolyte	Check fluid level	36
g	Dust indicator	Check	36
h	Air tank	Drain water	37
i	Water separator	Check	37
j	Parking brake	Check function	38
k	Foot brake	Check function	38
l	Horn	Check function	38
m	Lamps	Check function	38
n	Rear view mirror	Check	38

No.	ITEM	SERVICE	PAGE
o	Exhaust gas and color	Check	38
p	Instrument	Check function	38
q	Steering wheel	Check play	38
r	Back-up buzzer	Check function	38
s	Electrical wiring	Check	38
	<b>EVERY 50 HOURS SERVICE</b>		
a	Fuel tank	Drain water and sediment	70
b	Tires	Check air pressure and damage	70
	<b>EVERY 100 HOURS SERVICE</b>		
a	Hydraulic tank	Check and supply	71
b	Lubricating		71
-1	Rear axle pivot pin	Lubricate 2 points	71
c	Air conditioner filter	Clean element	72

No.	ITEM	SERVICE	PAGE
<b>EVERY 250 HOURS SERVICE</b>			
(The items marked * are carried out after the first 250 hours only for new machines.)			
*	Fuel filter	Replace cartridge	73
*	Transmission oil filter	Replace element	73
*	Engine valve clearance	Check and adjust	73
a	Engine oil pan and filter	Change oil and replace cartridge	73
b	Fan belt	Check tension	75
c	Air conditioner compressor belt	Check tension	76
d	Wheel hub nuts	Check and retighten	76
e	Lubricating		77
-1	Bucket pin	Lubricate 2 points	77
-2	Bucket link pin	Lubricate 2 points	77
-3	Dump cylinder pin	Lubricate 2 points	78
-4	Lift cylinder pin	Lubricate 4 points	78
-5	Lift arm pivot pin	Lubricate 2 points	78
-6	Tilt lever pin	Lubricate 1 point	78
-7	Steering cylinder pin	Lubricate 4 points	78

No.	ITEM	SERVICE	PAGE
<b>EVERY 500 HOURS SERVICE</b>			
a	Fuel filter	Replace cartridge	79
b	Transmission oil filter	Replace element	80
c	Lubricating		80
-1	Center drive shaft spline	Lubricate 1 point	80
d	Air dryer	Check	81
<b>EVERY 1000 HOURS SERVICE</b>			
a	Transmission case and strainer	Change oil and clean strainer	82
b	Transmission case breather	Clean	83
c	Lubricating		84
-1	Center hinge pin	Lubricate 2 points	84
-2	Front drive shaft	Lubricate 2 points	84
-3	Drive shaft center support	Lubricate 1 point	84
-4	Rear drive shaft	Lubricate 2 points	84
-5	Center drive shaft	Lubricate 2 points	84
-6	Parking brake caliper (For WA420)	Lubricate 1 point	84
-7	Engine stop motor linkage	Lubricate 1 point	85

MAINTENANCE TABLE

No.	ITEM	SERVICE	PAGE
d	Turbocharger rotor	Check play	85
e	Turbocharger various fasteners	Check and retighten	86
f	Corrosion resistor	Replace cartridge	86
<b>EVERY 2000 HOURS SERVICE</b>			
a	Hydraulic tank and filter	Change oil and replace element	87
b	Hydraulic tank breather	Replace element	88
c	Axle (Front and rear)	Change oil	89
d	Air conditioner filter	Replace element	90
e	Engine breather	Clean element	91
f	Turbocharger	Check and clean	91
g	Alternator and starting motor	Check	92
h	Engine valve clearance	Check and adjust	92
i	Brake disc	Check and repair	92
j	Internal part of air dryer	Replace	92
<b>EVERY 4000 HOURS SERVICE</b>			
a	Water pump	Check	93
b	Vibration damper	Check	93

No.	ITEM	SERVICE	PAGE
c	Air compressor	Check and adjust	93
<b>WHEN REQUIRED</b>			
a	Cooling system	Clean	94
b	Air cleaner element	Check, clean or replace when required	97
c	Transmission oil	Check and supply	99
d	Radiator fins	Clean	100
e	Axle oil	Check and supply	101
f	Axle case breather	Clean	101
g	Electrical intake air heater	Check once a year	102
h	Condenser of air conditioner	Check and clean	102
i	Air conditioner	Check	103
j	Lubricating		104
-1	Work equipment control valve linkage	Lubricate 2 points	104
-2	Steering column	Lubricate 1 point	104
k	Window washer	Check and supply	104
l	Water separator	Drain water	105
m	Bucket teeth	Replace	105

# OIL FILLER AND LEVEL GAUGE POSITIONS

- |  |   |   |
|--|---|---|
| 1. Front axle drain plug                           | 10. Front final drive case level plug<br>and oil filler | 16. Rear final drive case drain plug      |
| 2. Front axle level plug                           | 11. Front axle brake chamber drain<br>plug              | 17. Fuel tank drain valve                 |
| 3. Hydraulic tank oil filler                       | 12. Cooling water inlet                                 | 18. Engine oil pan drain valve            |
| 4. Hydraulic tank level gauge                      | 13. Engine oil pan level gauge                          | 19. Rear axle drain plug                  |
| 5. Hydraulic tank drain plug                       | 14. Engine oil pan oil filler                           | 20. Rear axle brake chamber drain<br>plug |
| 6. Cooling water drain valve                       | 15. Rear final drive case level plug<br>and oil filler  | 21. Rear axle level plug                  |
| 7. Transmission case level gauge<br>and oil filler |   | 22. Fuel tank oil filler                  |
| 8. Transmission case drain plug                    |   |   |
| 9. Front final drive case drain plug               |   |   |

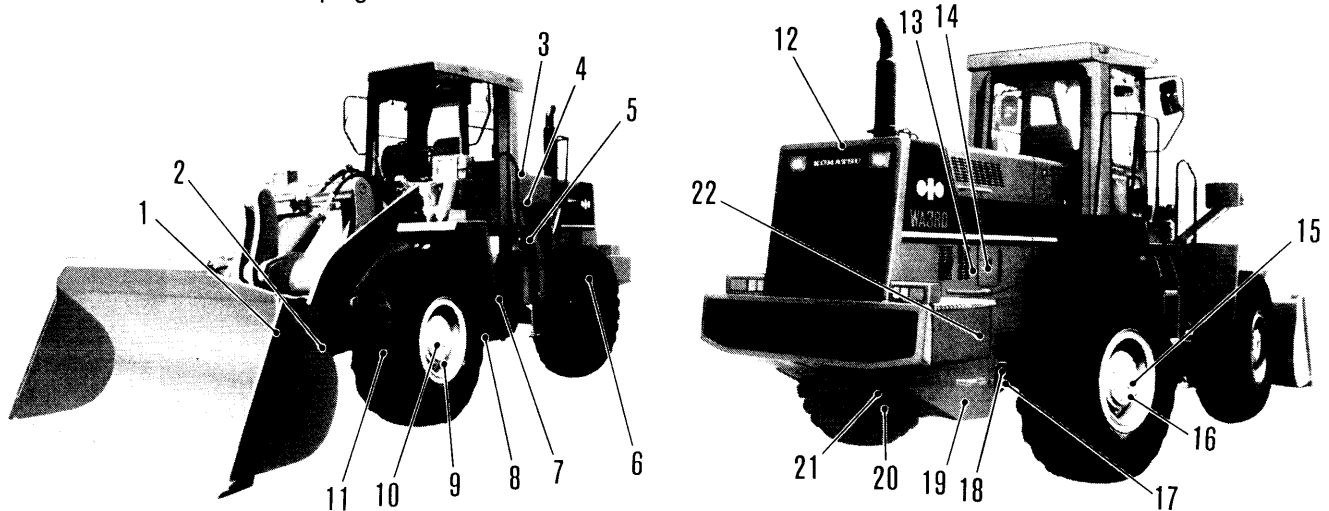

CHECK BEFORE STARTING  
EVERY 50 HOURS SERVICE

## CHECK BEFORE STARTING

See the section on CHECK  
BEFORE STARTING afore-  
mentioned.

## EVERY 50 HOURS SERVICE

### a. FUEL TANK

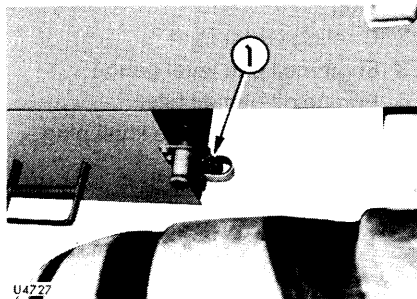

Loosen valve (1) on the bottom  
of the tank so that the precipitation  
and mixed water will be drained in  
accompaniment with fuel.

### b. TIRE

Measure the tire pressure before  
operations when the tires are cool.  
(Refer to HANDLING THE TIRES.)

## EVERY 100 HOURS SERVICE

### a. HYDRAULIC TANK

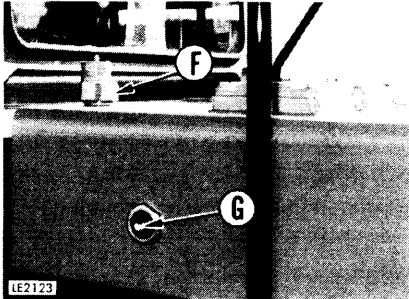

1. Lower the bucket horizontally to the ground and stop the engine. Wait for 5 minutes, then check sight gauge (G). The oil should be visible in sight gauge (G).
2. Add engine oil from oil filler (F), if necessary.

★ The type of lubricant used depends on the ambient temperature. Select according to the table "FUEL, COOLANT AND LUBRICANTS".

**⚠** When removing the cap, turn it slowly to relieve inner pressure.

★ Maintenance for every 50 hours should be carried out at the same time.

### b. LUBRICATING

Apply grease to the grease fittings shown by arrows.

1. Rear axle pivot pin (2 points)

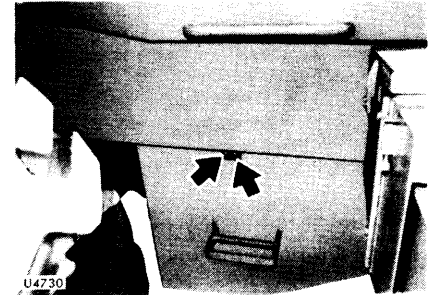



### c. AIR CONDITIONER FILTER

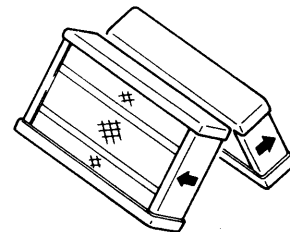
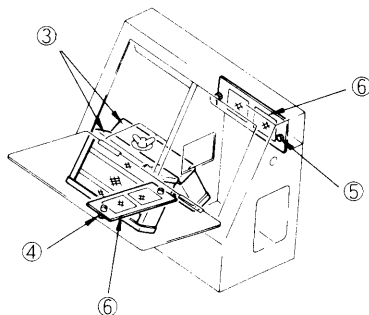
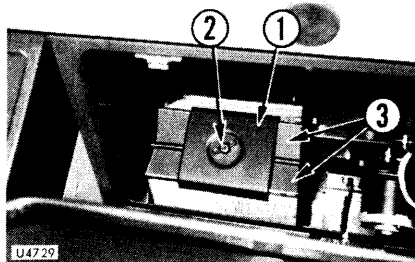

If the air conditioner has been used, the air filter should be cleaned.

★ Stop the air conditioner before cleaning the element.

1. Move the operator's seat forward, then tilt the backrest forward.
2. Loosen the bolts and remove the cover.
3. Loosen screw (2) and cover (1) holding the filter element, pull out element (3) and clean it.

4. Remove screw (4) and bolt (5) holding the filter element, then take out element (6) and clean it.
- ★ Direct dry compressed air (less than 7 kg/cm<sup>2</sup>) to element from inside along its folds, then direct it from outside along its folds and again from inside, and check element.

**⚠ When using compressed air, wear safety glasses and other things required to maintain safety.**

5. After cleaning the element, align it with the direction shown by the arrow, and install.

## EVERY 250 HOURS SERVICE

Carry out the following maintenance only after the first 250 hours.

- FUEL FILTER, REPLACE CARTRIDGE
- TRANSMISSION OIL FILTER, REPLACE ELEMENT
- ENGINE VALVE CLEARANCE, CHECK AND ADJUST

For details of the method of replacing or maintaining, see the section on EVERY 500 HOURS AND 2000 HOURS SERVICE.

- ★ Maintenance for every 50 hours should be carried out at the same time.

### a. ENGINE OIL PAN AND FILTER

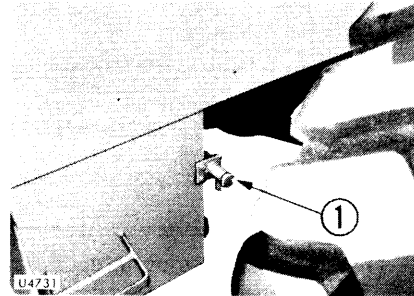

1. Open the engine hood and apply the hood lock at the side of the radiator.
2. Open oil filler (F) and remove drain plug (1) to drain oil. After draining, tighten the drain plug.

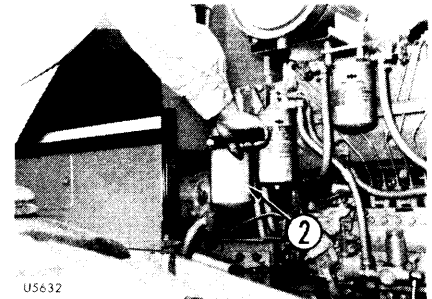

3. Using a filter wrench, remove cartridge (2) of the engine oil filter by turning it counterclockwise.
  4. Clean the filter base and fill a new filter cartridge with engine oil. Then, apply engine oil or a thin coat of grease to the seal.
- ★ When installing, tighten until the packing surface contacts the seal surface of the filter base, then screw it up 3/4 to 1 of a turn.

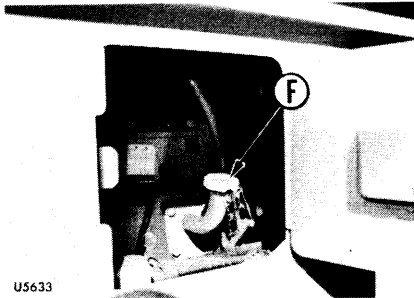

U5633

5. After replacing the cartridge, pour in the specified quantity of engine oil from oil filler (F).
  6. After pouring in oil, run the engine for several minutes, then once again check the oil level and ensure that it is correct.
  7. Close the engine side cover.
- ★ Refill capacity

WA380: 18ℓ

WA420: 22ℓ

- ★ The type of lubricant used depends on the ambient temperature. Select according to the table "FUEL, COOLANT AND LUBRICANTS".
- ★ Be sure to fit a genuine Komatsu cartridge.
- ★ Replace once every 6 months, regardless of the number of hours operated.

- ★ If filter cartridge (2) is removed immediately after stopping the engine, oil will spill. Wait at least 10 minutes after stopping the engine before replacing the filter cartridge.
- ★ Use API category CD class oil. If CC class oil must be used, change the oil and replace the oil filter at half the usual interval.

**b. FAN BELT**

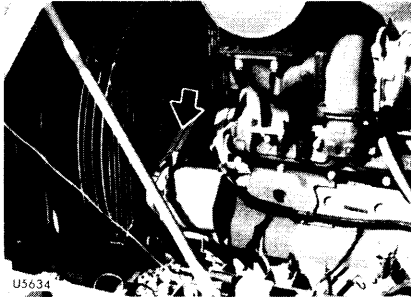

1. Open the engine hood and apply the hood lock at the side of the radiator.

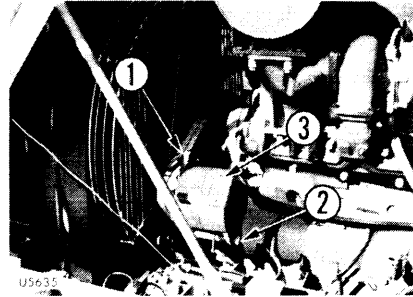
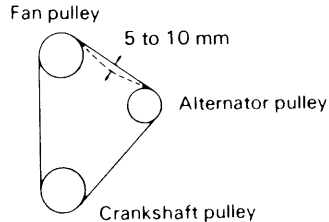

2. The belt tension should normally deflect by 5 to 10 mm when pressed with the finger at a point midway between the alternator pulley and the fan pulley (approx. 6 kg).
  3. To adjust the belt tension, loosen bolt (1) and nut (2) and shift alternator (3) slightly.
  4. After adjustment, tighten bolt (1) and nut (2) securely.
- ★ When V-belts are replaced, you should replace both them at the same time.

- ★ When adjusting the V-belt, do not attempt to push alternator (3) directly with a bar or the like, but use a wood pad to prevent damage to the core.
- ★ Check each pulley for damage, and V-grooves and V-belt for wear. Particularly, check whether V-belt is in contact with bottom of V-groove through wear.
- ★ Replace belt if it has stretched, leaving no allowance for adjustment, or if there is a cut or crack on belt.

### c. AIR CONDITIONER COMPRESSOR BELT

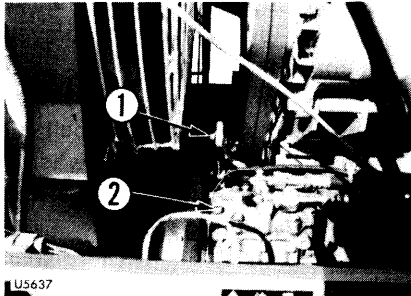
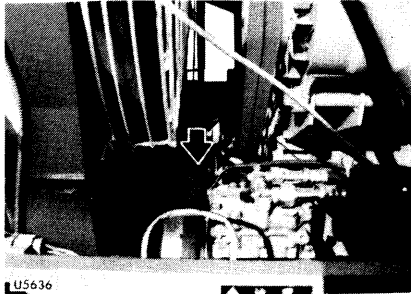

1. The belt tension should normally deflect by about 10 mm when pressed with the finger at a point midway between the air conditioner compressor pulley and the fan pulley (approx. 6 kg).
  2. To adjust the belt tension, loosen bolt (1) and shift compressor (2) slightly.
  3. After adjustment, tighten bolt (1) securely.
- ★ When adjusting the V-belt, do not attempt to push compressor (2) directly with a bar or the like, but use a wood pad to prevent damage to the core.
  - ★ Check each pulley for damage, and V-grooves and V-belt for wear. Particularly, check whether V-belt is in contact with bottom of V-groove through wear.
  - ★ Replace belt if it has stretched, leaving no allowance for adjustment, or if there is a cut or crack on belt.

### d. WHEEL HUB NUTS

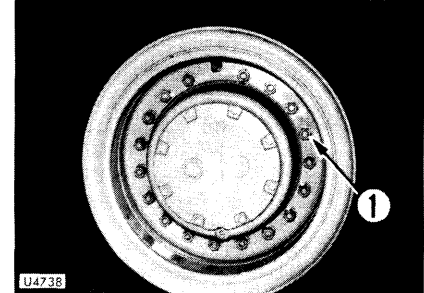

If wheel hub nuts (1) are loose, tire wear will be increased and accidents may be caused. If any hub nuts are loose, tighten them to the specified tightening torque.

- ★ Tightening torque:  $48 \pm 5$  kgm
- ★ If any wheel bolt is broken, replace all bolts for that wheel.
- ★ Always rotate in the direction of tightening when checking for loose nuts.

**e. LUBRICATING**

Apply grease to the grease fittings shown by arrows.

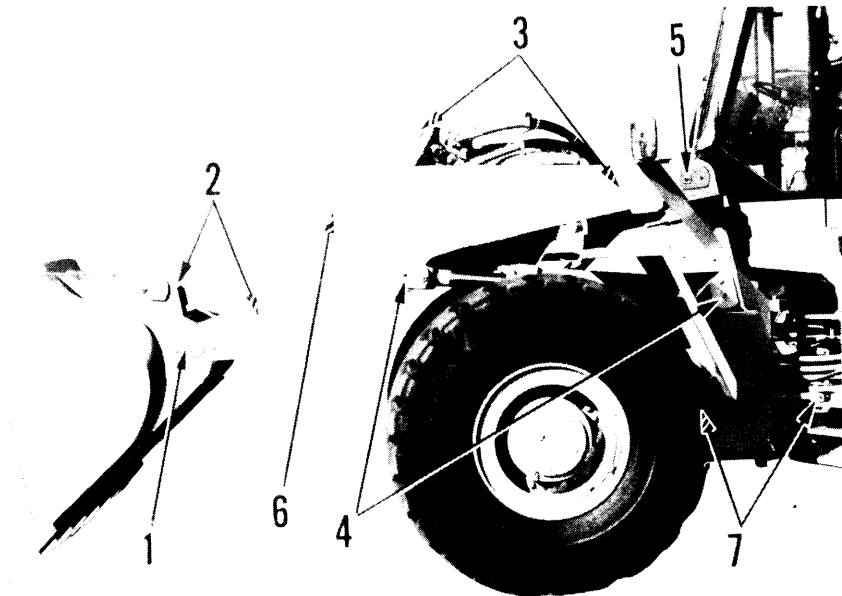

LE2124

1. Bucket pin (2 points)

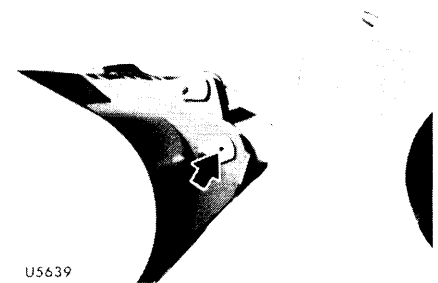

2. Bucket link pin (2 points)



EVERY 250 HOURS SERVICE

3. Dump cylinder pin (2 points)

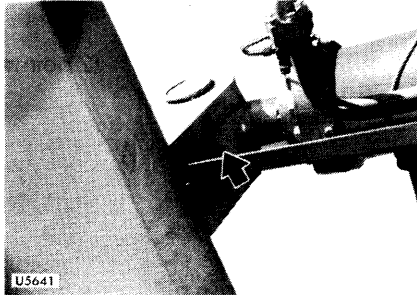

4. Lift cylinder pin (4 points)

5. Lift arm pivot pin (2 points)

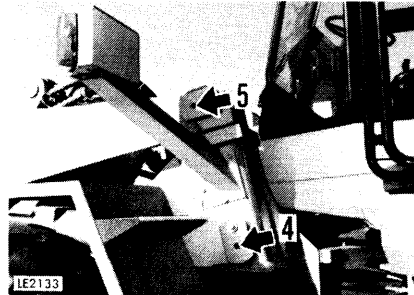

6. Tilt lever pin (1 point)

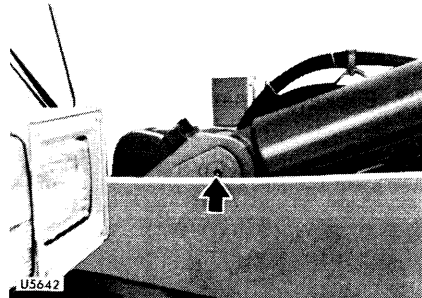
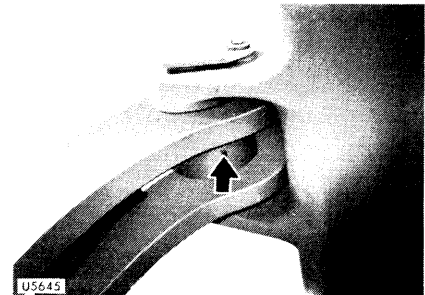

7. Steering cylinder pin (4 points)

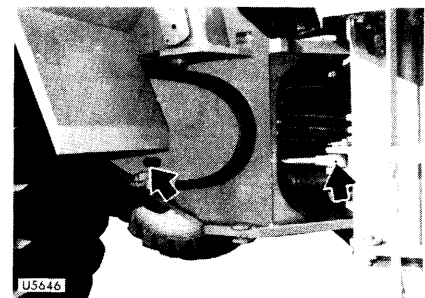
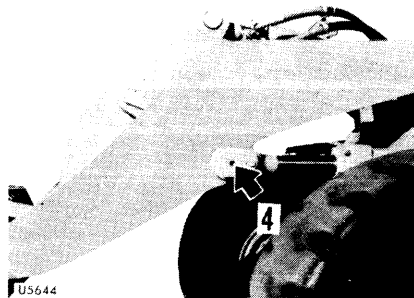

## EVERY 500 HOURS SERVICE

★ Maintenance for every 50, 100 and 250 hours should be carried out at the same time.

### a. FUEL FILTER

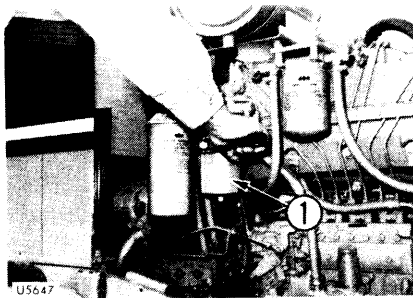

1. Open the engine hood and apply the hood lock at the side of the radiator.
2. Using a filter wrench, remove cartridge (1) by turning it counter-clockwise.
3. Clean the filter base, fill the new cartridge with clean fuel and refit it after applying a dab of oil to the gasket face.

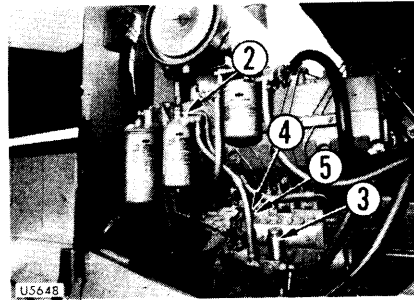

- ★ To refit the cartridge, place the gasket face in contact with the seal face of the filter stand, then screw up the cartridge 1/2 to 3/4 of a turn.
4. After replacing the cartridge, slacken off air vent plug (2).
  5. Loosen the knob of feed pump (3) and move the pump up and down to draw off fuel until air ceases to come out of plug (2).
  6. Tighten up air vent plug (2).

7. Hold the fuel injection pump sleeve (5) and loosen air vent plug (4). Bleed air from the fuel injection pump using the same procedure as described for the fuel filter.
  8. After air bleeding, tighten plug (4) with holding sleeve (5). Push in feed pump knob (3) and tighten it.
- ★ After replacing the cartridge, start up the engine and check the filter seal face for possible fuel leakage.
  - ★ Be sure to use a genuine Komatsu cartridge.



## b. TRANSMISSION OIL FILTER

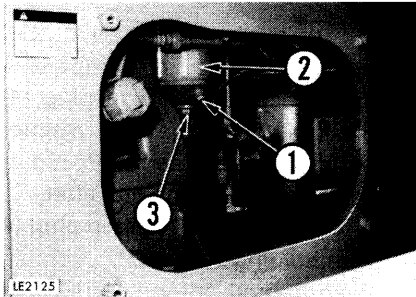

1. Remove drain plug (1) at the bottom of the filter case, and drain the oil. After draining the oil, tighten the plug.
  2. Hold case (2) and loosen center bolt (3), then remove case (2).
  3. Remove the element, and clean the inside of the case. Assemble a new element, then install the case.
- ★ Be careful not to apply excessive torque to center bolt (3).  
Tightening torque:  $18.5 \pm 1.5$  kgm

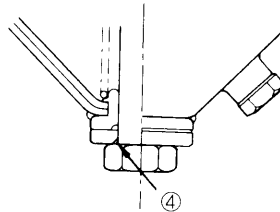

4. Run the engine for a short time at idling speed, then stop the engine. Check that the oil is at the specified level (for details, see WHEN REQUIRED).
- ★ Use a genuine Komatsu element.
  - ★ Replace the filter gasket and O-rings with new parts. Coat the gasket and O-rings with clean engine oil before installing.
  - ★ When tightening center bolt (3), install so that chamfered surface (4) of the washer faces the hexagonal head of the center bolt.

## c. LUBRICATING

Apply grease to the grease fitting shown by arrows.

1. Center drive shaft spline (1 point)

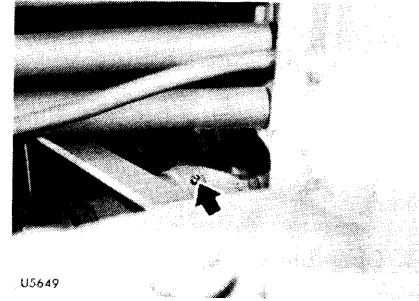

**d. AIR DRYER**

If the air dryer is installed as an option, carry out the following inspection, and if there is any abnormality, contact your Komatsu distributor.

- Open the air tank drain valve and check that nothing is drained. Note that if the temperature around the tank is lower than 16°C, a small amount of water may be collected in the drain.
- Check that there is no abnormal inclusion of oil in the water drain from the exhaust port of the air dryer.

## EVERY 1000 HOURS SERVICE

★ Maintenance for every 50, 100, 250 and 500 hours should be carried out at the same time.

### a. TRANSMISSION CASE AND STRAINER

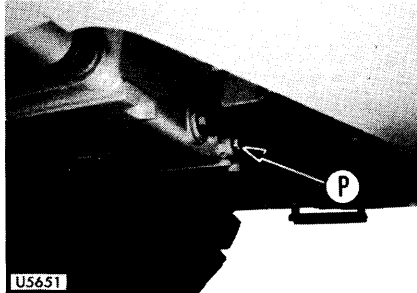

1. Loosen drain plug (P) to drain oil. After draining off the oil, tighten up drain plug (P).
- ★ After loosening drain plug (P), pull out the plug slowly to prevent the oil spouting out.
2. Loosen drain plug (1) of transmission oil filter to drain oil. After draining off the oil, tighten up drain plug (1).

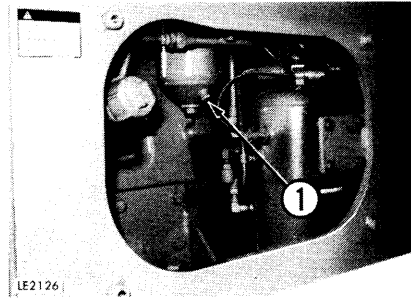

3. Remove bolt (2) and cover (3), then remove spring (4) together with strainer (5).
4. Remove all dirt from the surface of strainer (5), then wash in clean light oil. If strainer (5) is damaged, replace with a new part.

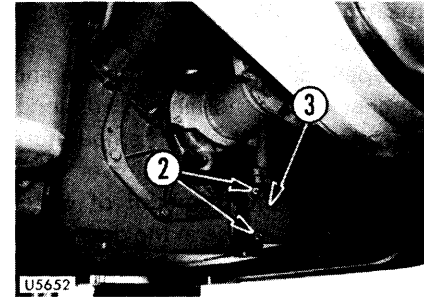

5. Install spring (4) and strainer (5) in cover (3). Replace the O-ring of the cover with a new part, then install the cover.

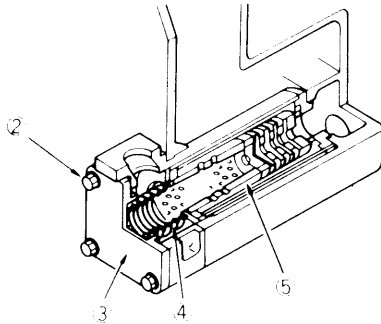

6. Pour in the specified amount of engine oil from oil filler (F).
7. After refilling, check the oil level and ensure that it is correct. (Refer to WHEN REQUIRED.)

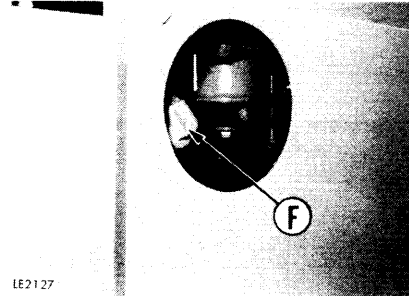

- ★ The type of lubricant used depends on the ambient temperature. Select according to the table "FUEL, COOLANT AND LUBRICANTS".
- ★ Refill capacity   WA380: 53 ℓ  
                          WA420: 47 ℓ
- ★ Check for oil leak at transmission case and filter.

## b. TRANSMISSION CASE BREATHER

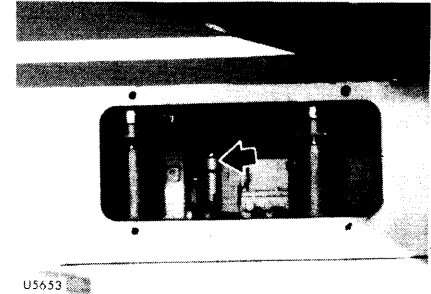

Remove all mud and dirt from around the breather, then remove the breather. Put in cleaning fluid and clean the breather.

**c. LUBRICATING**

Apply grease to the grease fittings shown by arrows.

1. Center hinge pin (2 points)

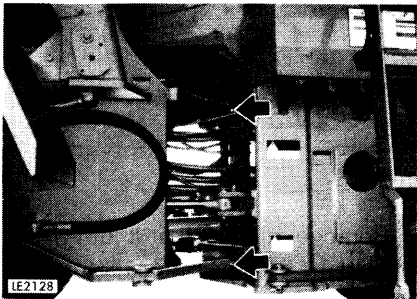

3. Drive shaft center support (1 point)

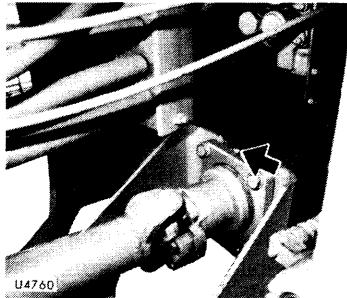

5. Center drive shaft (2 points)

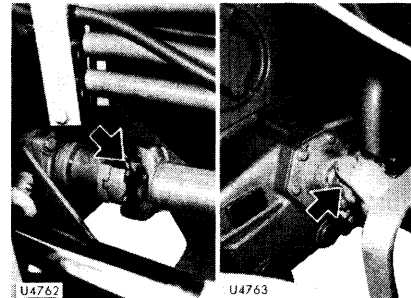

2. Front drive shaft (2 points)

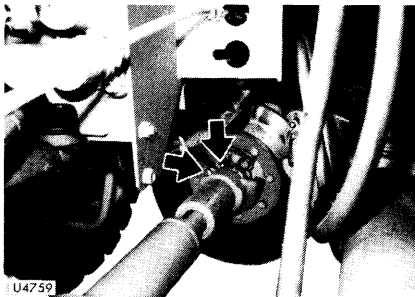

4. Rear drive shaft (2 points)

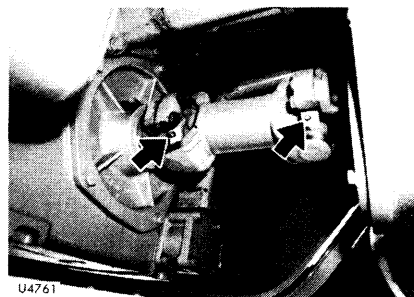

6. Parking brake caliper (For WA420) (1 point)

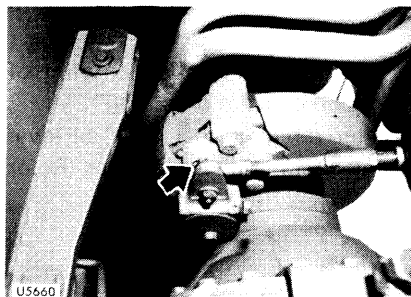

7. Engine stop motor linkage  
(1 point)

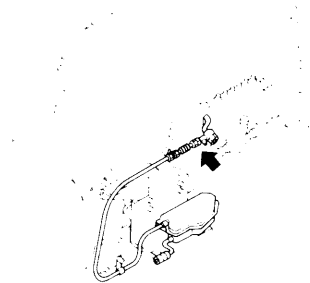

**d. TURBOCHARGER ROTOR PLAY**

Check the turbocharger rotor plays by the following procedure. If necessary, consult a Komatsu distributor for servicing.

To check the rotor plays, remove the air cleaner intake pipe and the muffler, and proceed as follows:

1. Axial play

Check axial play by moving rotor in axial direction.

Play:

Standard      0.025 – 0.100 mm

2. Radial play

Measure radial play by moving rotor holding both ends by hands in radial direction in parallel.

Play:

Standard      0.075 – 0.180 mm

- ★ If the play is over the limit, consult your Komatsu distributor.
- ★ If the rotor is excessively soiled with dust or carbon or if any oil leakage caused by turbocharger trouble is noted, have the turbocharger repaired by your Komatsu distributor.

### e. TURBOCHARGER VARIOUS FASTENERS

Connect your Komatsu distributor for repairs, or check as follows. Tighten if necessary.

- Turbine housing mounting bolt  
Tightening torque: 1.84 – 2.19 kgm
- Clamp for Blower housing side  
Tightening torque: 1.15 – 1.50 kgm
- Turbocharger mounting bolt (for securing the exhaust manifold and turbine housing together)  
Tightening torque: 6.5 – 7.5 kgm
- Turbocharger oil feed pipe (inlet line)  
Tightening torque: 2.8 – 3.5 kgm
- Turbocharger oil feed pipe (outlet line)  
Tightening torque: 6.5 – 7.5 kgm

### f. CORROSION RESISTOR

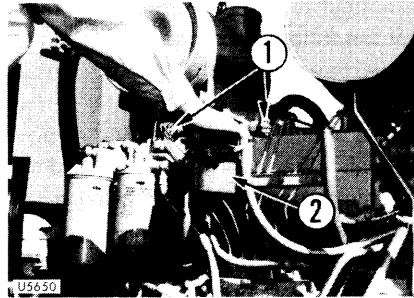

1. Open the engine hood and apply the hood lock at the side of the radiator.
2. Close valves (1) (2 points).
3. Using the filter wrench provided, remove cartridge (2) by turning it counterclockwise.
4. Clean the filter base and fit a new cartridge after applying a dab of engine oil to the seal face.

- ★ To fit the cartridge, put the seal face in contact with head, then screw it up about 2/3 of a turn. (Be careful not to apply excessive torque.)
- 5. After replacement, open valves (1) (2 points).
- ★ Be sure to use a genuine Komatsu cartridge.
- ★ After replacing the cartridge, start the engine and check that there is no leakage of water from the filter seal surface.

## EVERY 2000 HOURS SERVICE

- ★ Maintenance for every 50, 100, 250, 500 and 1000 hours should be carried out at the same time.

### a. HYDRAULIC TANK AND FILTER

(For WA380)

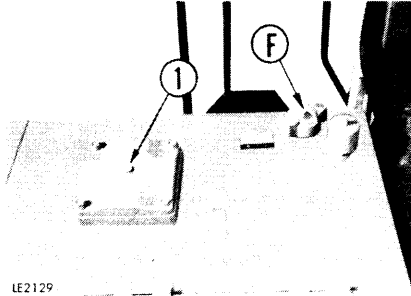

LE2129

1. Lower the bucket horizontally to the ground and apply the parking brake, then stop the engine.
2. Remove the cap of oil filler (F) and air vent plug (1) on filter case.

**!** When removing the cap, turn it slowly to relieve inner pressure.

(For WA420)

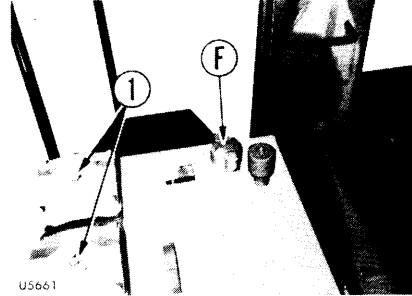

U5661

3. Open drain valve (2) to drain oil. After draining, tighten the drain valve.

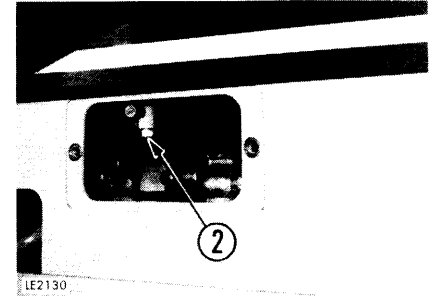

LE2130

- ★ After loosening drain valve (2), pull it out slowly to drain oil.
4. Remove mounting bolt (4) of the filter cover, then remove cover (3).

**!** The cover is pushed by a spring, so hold the cover when removing the bolts.



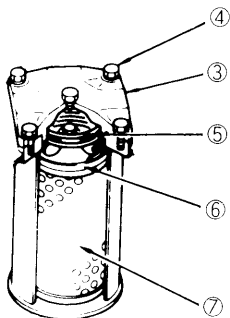

5. Remove spring (5) and bypass valve (6), then remove element (7).

★ Check that there is no foreign matter inside the tank before cleaning it.

6. Install a new element, then install bypass valve (6), spring (5), and cover (3).

★ If the O-ring of the cover is damaged or deteriorated, replace it with a new part.

★ When installing the cover bolts, push down the cover and tighten the bolts evenly.

7. Pour in the specified quantity of engine oil from filler (F).

8. Bleed the air from the hydraulic circuit, lower the bucket horizontally to the ground, and stop the engine. See "BLEEDING AIR FROM CIRCUIT" for the air bleeding procedure.

9. Check the oil level and ensure that is correct. (Refer to EVERY 100 HOURS SERVICE.)

★ The type of lubricant used depends on the ambient temperature. Select according to the table "FUEL, COOLANT AND LUBRICANTS".

★ Refill capacity

WA380: 114 ℓ

WA420: 103 ℓ

★ Check that there is no oil leaking from the filter cover mount.

## b. HYDRAULIC TANK BREATHER

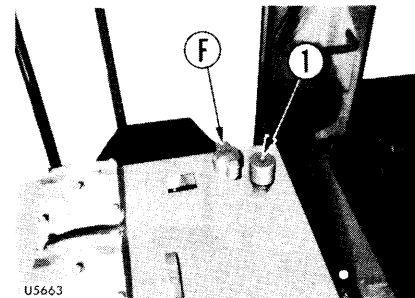

1. Remove cap of oil filler (F).

**⚠ When removing the cap, turn it slowly to relieve inner pressure.**

2. Remove snap ring on breather (1), then remove breather cap.

3. Replace filter element with a new part, then install cap and snap ring.

**c. AXLE**

**Front**

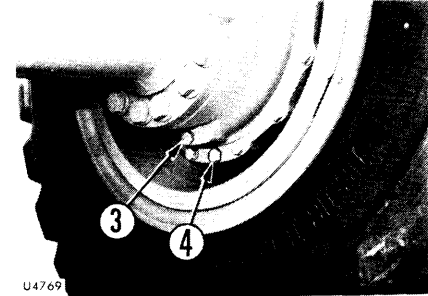
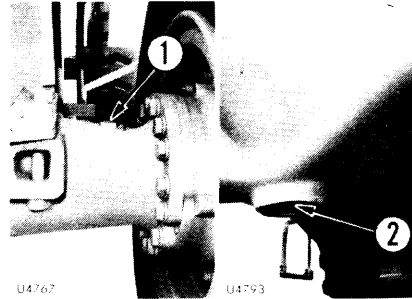

★ It is possible to replace the element with the breather installed in the tank. However, if the breather is removed, do not wrap the taper thread of the breather with seal tape when assembling again, and be careful not to tighten too much.

**Rear**

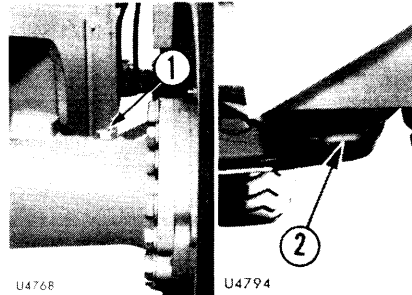

1. Remove front and rear oil filler plugs (1), then remove drain plugs (2) to drain the oil. After draining the oil, tighten drain plugs.
2. Remove drain plugs (3) and (4), and drain the oil.

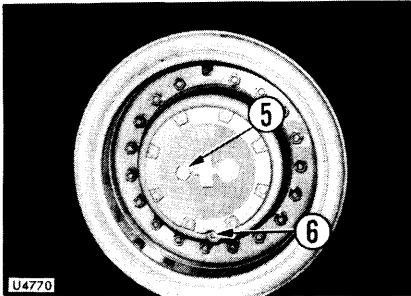

3. Stop the machine so that drain plug (6) of the final drive is at the bottom. Remove oil filler plug (5) and drain plug (6), and drain the oil.
4. After draining the oil, clean drain plugs (3), (4) and (6), then install them.

5. Add oil to the specified level through the oil filler ports (1), (5) of the axle housing and left and right final drives.
  6. Check the oil level and ensure that is correct. (Refer to WHEN REQUIRED.)
- ★ Use the same procedure to change the oil for the front and rear axles.
  - ★ Refill capacity
    - WA380: 48ℓ (each axle)
    - WA420: 55ℓ (each axle)
  - ★ The type of lubricant used depends on the ambient temperature. Select according to the table "FUEL, COOLANT AND LUBRICANTS".

#### d. AIR CONDITIONER FILTER

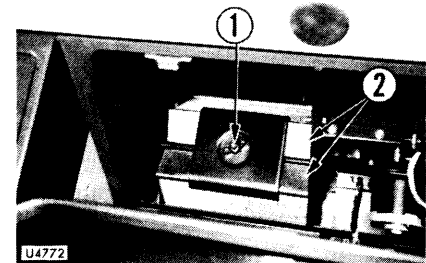

1. Move the operator's seat forward, then tilt the backrest forward.
2. Open the panel and loosen screw (1) holding the filter element, pull out element (2).
3. Install a new element and close the panel.
4. Return the operator's seat to its original position.

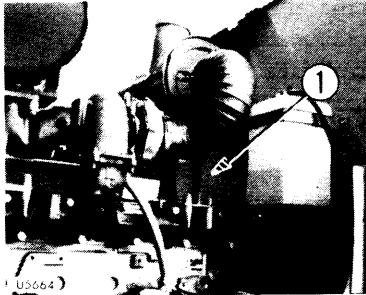
**e. ENGINE BREATHER**

1. Remove breather (1) from the cylinder head.
2. Rinse the whole breather in diesel oil or flushing oil, dry with compressed air, then install again in the cylinder head.
3. Check the inside of the breather hose or pipe, and if there is any deteriorated oil (sludge) inside, replace with a new hose or pipe.

- ★ Before taking the breather out of place, wipe the dust off the surrounding area.
- ★ When restoring the element to its original position, be sure to coat the new O-ring with engine oil.

**f. TURBOCHARGER**

Excessive carbon or oil sludge adhering to turbocharger blower impeller may lead to deterioration of normal charger performance, and possible damage. Have turbocharger cleaned by Komatsu distributor.

1. Remove the turbocharger oil filler pipe and drain pipe, then remove the intake air pipe connector and blower housing so that the blower impeller can be seen.
2. Using light oil as a cleaning agent, remove the carbon, sludge and other dirt from the blower impeller. Do not use a wire brush or other tool which may damage the impeller.
3. Pour in light oil through the turbocharger oil filler and rotate the blower impeller several times to wash out the sludge.

4. Rotate the impeller by hand at least one turn at speed to check that there is contact noise or catching inside.

If the impeller does not turn smoothly, contact your Komatsu distributor for repair or replacement.

5. If there is no abnormality, dry off the light oil with compressed air after inspection, then add engine oil.

#### **g. ALTERNATOR AND STARTING MOTOR**

The brush may be worn, or the bearing may have run out of grease, so please contact your Komatsu distributor for inspection or repair.

- ★ If the engine is started frequently, carry out inspection every 1000 hours.

#### **h. ENGINE VALVE CLEARANCE**

Ask Komatsu distributor to check engine valve clearance because special tools should be used.

#### **i. BRAKE DISC**

Ask Komatsu distributor to check and repair brake disc.

#### **j. INTERNAL PART OF AIR DRYER**

If the air dryer is installed as an option, replace the following internal parts of the air dryer:

Desiccant, oil filter, filter, and all rubber parts.

Contact your Komatsu distributor to have these parts replaced.

## EVERY 4000 HOURS SERVICE

★ Maintenance for every 50, 100, 250, 500, 1000 and 2000 hours should be carried out at the same time.

### a. WATER PUMP

Check that there is no play in the pulley, grease leakage, water leakage, or clogging of the drain hole. If any abnormality is found, please contact your Komatsu distributor for disassembly and repair or replacement.

### b. VIBRATION DAMPER

Check decrease of damper fluid, dent or out-of-flat. If there is any abnormality, contact Komatsu distributor for repair.

### c. AIR COMPRESSOR

Ask Komatsu distributor to check and adjust.

## WHEN REQUIRED

### a. CLEAN INSIDE OF COOLING SYSTEM

Clean the inside of the cooling system, change the coolant, and replace the corrosion resistor, according to the table.

- ★ Stop the machine on level ground when cleaning or changing the coolant.
- ★ Use a permanent type of antifreeze. If, for some reason, it is impossible to use permanent type antifreeze, use an antifreeze containing ethylene glycol.

- ★ Be sure to replace the corrosion resistor cartridge.
- ★ Use city water for the cooling water. If river water, well water or other such water supply must be used, contact your Komatsu distributor.

 **Antifreeze is flammable, so keep it away from any flame.**

Type of antifreeze solution	Cleaning inside of cooling system and changing coolant	Replacing corrosion resistor
Permanent type antifreeze (All season type)	Every year (autumn) or every 2000 hours whichever comes first	Every 1000 hours and when cleaning the inside of the cooling system and when changing coolant
Non permanent type antifreeze containing ethylene glycol (Winter, one season type)	Every 6 months (spring, autumn) (Drain antifreeze in spring, add antifreeze in autumn)	
When not using antifreeze	Every 6 months or every 1000 hours whichever comes first	

- Add antifreeze in the cooling water. When deciding the ratio of antifreeze to water, check the lowest temperature in the past, and decide from the mixing rate table given below. It is actually better to estimate a temperature about 10°C lower when deciding the mixing rate.

#### Mixing rate of water and antifreeze

Min. atmospheric temperature (°C)	-5	-10	-15	-20	-25	-30
Amount of antifreeze (ℓ)	13	16	19	21	24	26
Amount of water (ℓ)	39	36	33	31	28	26

- ★ We recommend use of an antifreeze density gauge to control the mixing proportion.

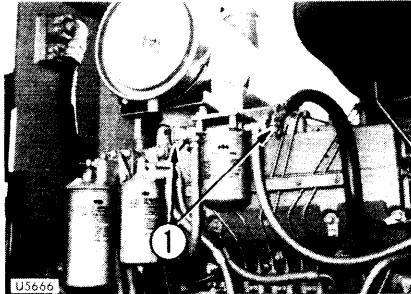
**Corrosion resistor**

1. Stop the engine and tighten up corrosion resistor valve (1).
2. Turn cap (2) slowly until it comes off.
3. Open drain valve (3) at the bottom of the radiator and plug (4) on the side of cylinder block to drain off the cooling water.
4. Drain off all the water, then close up drain valve (3), plug (4), and pour in soft water (ex: city water) up to the vicinity of the water filler.

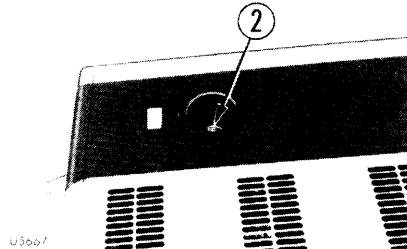
**Water filler**

5. When the water reaches the vicinity of the water filler, put the engine at low idling, open drain valve (3) and plug (4), then pass water through the cooling system for 10 minutes.
- ★ When doing this, adjust the inflow and outflow of water so that the radiator is always full.
6. After flushing with water, stop the engine. Close drain valve (3) and drain plug (4) after draining water.

**Drain valve (bottom of radiator)**

7. After draining water, use a flushing agent to clean.
- ★ We recommend the use of Komatsu genuine goods as the flushing agent. Follow the instructions on the label of the flushing agent to clean the system.
8. After washing the cooling system, drain off all the water, then close up drain valve (3) and plug (4), and pour in soft water (ex: city water) up to the vicinity of the water filler.



### Drain plug (cylinder block)

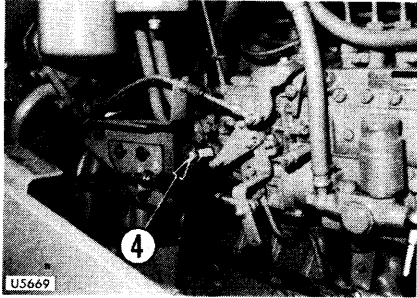

9. When the water reaches the vicinity of the water filler, put the engine at low idling, open drain valve (3) and plug (4), then pass water through the cooling system until clean water comes out from drain valve (3) and plug (4).
- ★ When doing this, adjust the inflow and outflow of water so that the radiator is always full.
10. When the water becomes completely clean, stop the engine, close drain valve (3) and plug (4).

### Sub-tank

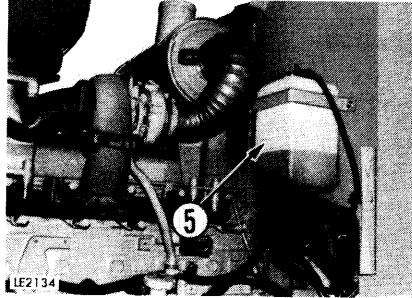

11. Replace the corrosion resistor cartridge and open corrosion resistor valve (1).
- ★ For details of replacement of the corrosion resistor, see EVERY 1000 HOURS SERVICE.
12. Supply water up to the vicinity of the water filler.
13. Run the engine for 5 minutes at low idling to eliminate air trapped in the cooling system, and run the engine for 5 minutes at high idling. (leave water filler cap (2) off during this operation.)
14. Stop the engine and 3 minutes later supply water again up to vicinity of the water filler and tighten water filler cap (2).
15. Drain the cooling water inside sub-tank (5), then clean the inside of the sub-tank and fill again with water to a point between the H and L lines.



**Do not remove the cap while cooling water is hot. Hot water may spout out.**  
**When removing radiator cap, lift the lever to relieve inner pressure.**

## b. CHECK, CLEAN AND REPLACE AIR CLEANER ELEMENT

### Checking

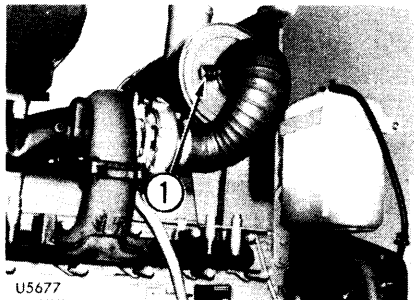

Whenever the red piston in dust indicator (1) appears, clean the air cleaner outer element. Stop the engine when cleaning the element.

### Cleaning or replacing outer element

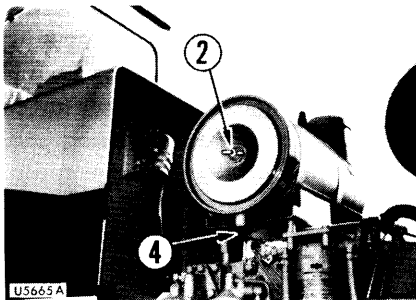

1. Loosen wing bolt (2) and remove outer element.
2. Clean the air cleaner body interior.
3. Clean and inspect the element. (See the item "Cleaning outer element" for cleaning procedure.)
4. Install the cleaned element.
5. Push the dust indicator reset button to return the red piston to the original position.

- ★ Replace the outer element which has been cleaned 6 times repeatedly or used throughout a year. Replace the inner element at the same time.
- ★ Replace both inner and outer elements when the dust indicator red piston appears soon after installing the cleaned outer element even though it has not been cleaned 6 times.

- ★ Remove one seal from the outer element. The number of times the outer element has been cleaned can be seen by the number of removed seals.
- ★ Check inner element mounting nuts for looseness and, if necessary, retighten.
- ★ When inspecting or cleaning the air cleaner, remove evacuator valve (4) and clean with compressed air.
- ★ Replace seal washer (3) or wing nut (2) if they are broken.

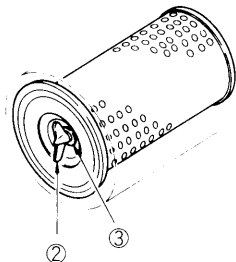

### Replacing inner element

1. First remove the cover and the outer element, and then remove the inner element.
2. Place the cover over the air intake part to prevent dust entering. Clean the air cleaner body interior, then remove the cover from the air intake port.
3. Fit a new inner element and tighten it with nuts.
4. Install the outer element and the cover. Push the dust indicator reset button.

**NOTE:** Do not attempt to reinstall a cleaned inner element.

**!** Do not clean or replace the air cleaner element with the engine running.

### Cleaning outer element

#### With compressed air

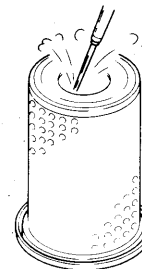

Direct dry compressed air (less than 7 kg/cm<sup>2</sup>) to element from inside along its folds, then direct it from outside along its folds and again from inside, and check element.

**!** When using compressed air, wear safety glasses and other things required to maintain safety.

The following methods require spare parts.

#### With water

Dash city water (less than 3 kg/cm<sup>2</sup>) on element from inside along folds, then from outside and again from inside. Dry and check it.

#### With cleaning agent

For removing oils and fats as well as carbon etc. attached on the element, the element may be cleaned in lukewarm solution of mild detergent, then rinsed in clean water and left to drip dry.

- ★ Drying can be speeded up by blowing dried compressed air (less than 7 kg/cm<sup>2</sup>) from the inside to the outside of the element.  
Never attempt to heat the element.
- ★ Using warm water (about 40°C) instead of soapy water may also be effective.

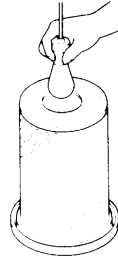

- ★ If small holes or thinner parts are found on element when it is checked with an electric bulb after cleaning and drying, replace the element.
- ★ If element is usable, wrap it and store it in dry place.
- ★ Do not use element whose folds or gasket or seal are damaged.
- ★ When cleaning element, do not hit it or beat it against something.

#### c. CHECK AND REFILL TRANSMISSION OIL

Carry out this procedure if there is any sign of oil on the transmission case, or if there is oil mixed with the cooling water.

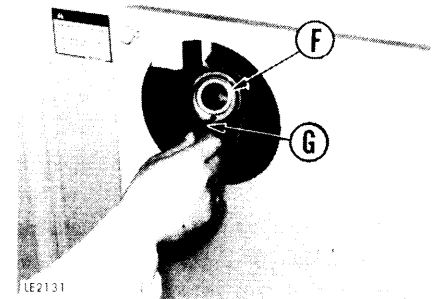

1. Stop the engine and remove the cap of oil filler (F).
2. Use dipstick (G) to check the oil level.
3. The oil level should be between mark L and H, if necessary, add oil at the oil filler (F).

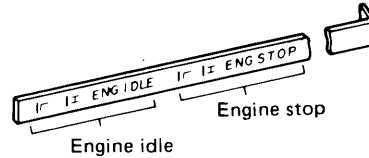

- ★ The type of lubricant used depends on the ambient temperature. Select according to the table "FUEL, COOLANT AND LUBRICANTS".
- ★ There are two sets of level marks on the same side of the dipstick: one is for measuring when the engine is stopped (ENGINE STOP), and the other is for measuring when the engine is idling (ENGINE IDLE).

- ★ When measuring the oil level, wait for at least 60 minutes after stopping the engine, and measure with the ENGINE STOP marks. It is also possible to measure when the engine is at low idling, but in such cases, do as follows. Start the engine and run it until the oil level is stable, then wait for 5 minutes and measure with the ENGINE IDLE marks.

**⚠ When checking the oil level, apply the parking brake, and lock the front and rear frames with the safety bar and pin.**

#### d. CLEAN RADIATOR FINS

Carry out this procedure if there is any mud or dirt seen stuck to the radiator.

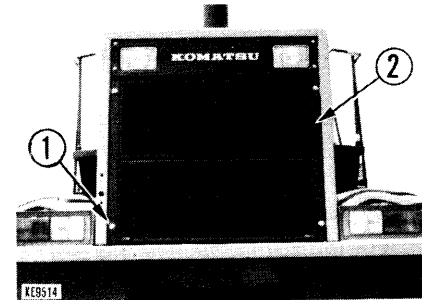

1. Loosen bolt (1) and remove radiator grille (2).
  2. Clean the radiator fins and oil cooler fins clogged with mud, dust and leaves with compressed air. Steam or water may be used instead of compressed air.
- ★ The rubber hose should be checked at the same time. If the hose is found to have cracks or to be hardened by ageing, such hose should be replaced by new one. Further, loosened hose clamp should also be checked.

**e. CHECK AND REFILL AXLE OIL**

Carry out this procedure if there is any sign of oil on the axle case.

**Front**

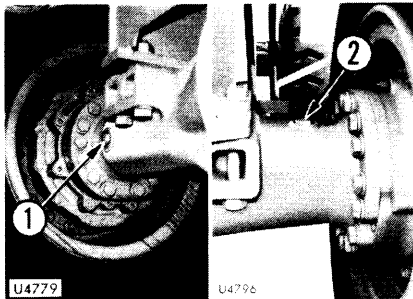

Remove oil level plug (1), and check that the oil level reaches the bottom of the plug hole. If necessary, add oil through the hole of plug (2).

**Rear**

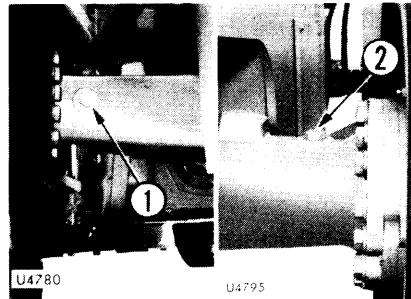

★ The type of lubricant used depends on the ambient temperature. Select according to the table "FUEL, COOLANT AND LUBRICANTS".

**f. CLEAN AXLE CASE BREATHER**

Carry out this procedure if there is any mud or dirt stuck around the breather.

**Front**

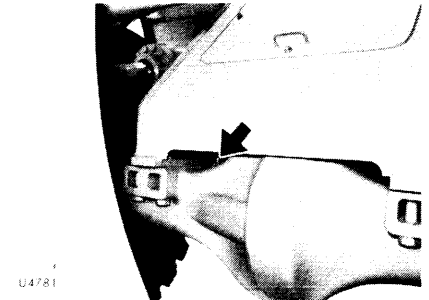

Remove all mud and dirt from around the breather with brush.

★ Clean the breathers of the front and rear axles in the same way.

Rear

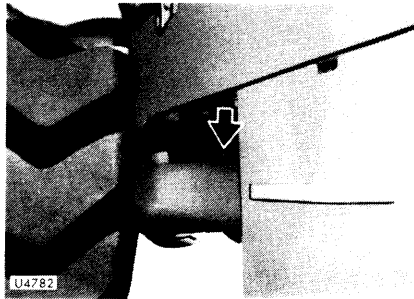

### g. CHECK ELECTRICAL INTAKE AIR HEATER

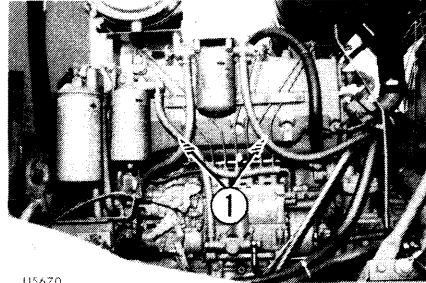

Check electrical intake air heater (1) once a year before commencing work in the cold season.

Remove electrical intake air heater (1) from the engine intake connection, and check it for possible open-circuits and dirt.

When inspecting and replacing electrical intake air heater (1), replace the gasket with new one.

★ Ask your Komatsu distributor to check electrical intake air heater.

### h. CLEAN CONDENSER OF AIR CONDITIONER

If there is mud or dust on the air conditioner condenser, clean it with water.

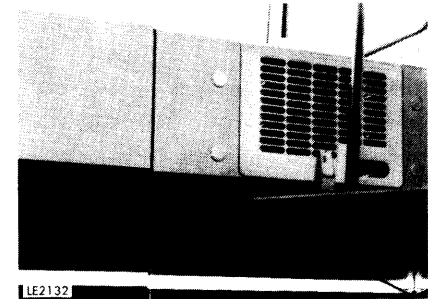

★ If the water pressure is too high, the fins may get deformed. When washing with a high pressure washing machine, apply the water from a reasonable distance.

**!** Do not wash the condenser with a steam cleaner. Otherwise, the condenser will get hot and may break down.

**i. CHECK AIR CONDITIONER**

Check twice a year, in spring and autumn.

**Check levels of refrigerant (gas)**

Operate the cooler of the air conditioner for 5 – 10 minutes, then touch the high pressure portion and low pressure portion of the compressor (or high pressure hose and low pressure hose joint) by hand. At the same time, inspect the flow of refrigerant gas (freon 12) through the sight glass to check the gas level.

Please contact your Komatsu distributor for this inspection.

The sight glass is installed at the side of the window washer tank inside the cover at the top behind the operator's seat.

**⚠ The cooler refrigerant is colorless and odorless and does not cause pollution of the atmosphere. However it may cause injury if it gets in the eyes or on the hands, so never loosen any parts of the refrigerant circuit.**

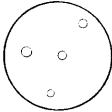
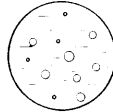
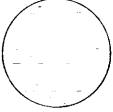
Cooler condition	Normal	Abnormal	
Temp. of high, and low pressure pipes	High pressure pipe is hot. Low pressure pipe is cold. Clear difference in temperature	High pressure pipe is warm. Low pressure pipe is cold. Little difference in temperature	Almost no difference in temperature between high and low pressure pipes.
Sight glass	Almost transparent. Any bubbles disappear if the engine speed is raised or lowered.	Bubbles are always flowing. Sometimes becomes transparent, or white bubbles appear.	Misty substance is flowing.
			
Connections of pipes	Properly connected	Some parts dirty with oil	Some parts very dirty with oil
General condition of cooler	Coolant level correct, no abnormalities. Ready for use	May be a leak somewhere. Call service repair shop for inspection.	Almost all coolant has leaked out. Contact service repair shop immediately.



**j. LUBRICATING**

Apply grease to the grease fittings shown by arrows.

- 1. Work equipment control valve linkage (2 points)

If the work equipment control lever is heavy or does not move smoothly, apply grease.

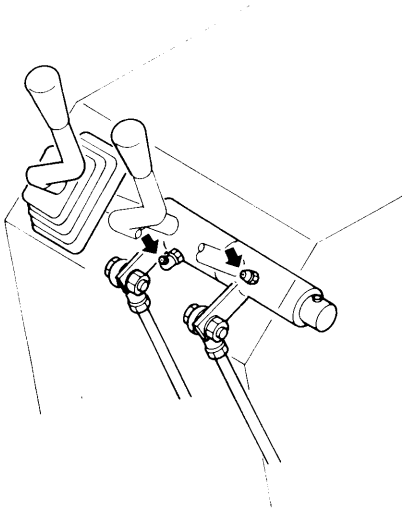

- 2. Steering column (1 point)

If the play of the steering column is heavy or does not return properly, apply grease.

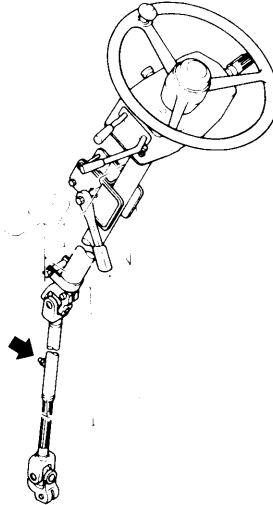

**k. CHECK AND REFILL WINDOW WASHING FLUID**

Do this, when there is air in the window washing fluid.

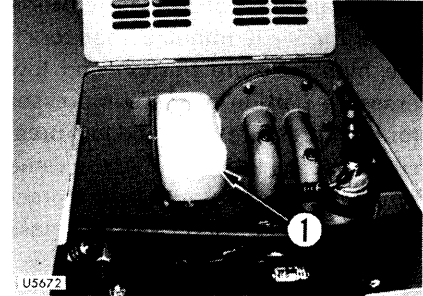

Check the washing fluid level in washer tank (1). When the fluid has run short, add automotive window washing fluid.

★ To prevent the nozzles from clogging, be careful not to let dust get into the fluid.

## I. WATER SEPARATOR

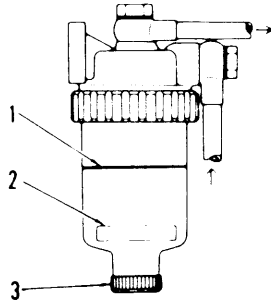

When float (2) is at or above red line (1), drain the water according to the following procedure:

1. Loosen drain plug (3) and drain the accumulated water until the float reaches the bottom.
2. Tighten drain plug (3).
3. If the air is sucked into fuel line when drain the water, be sure to bleed air in the same manner as for the fuel filter.

(See Fuel Filter Cartridge in EVERY 500 HOURS SERVICE section.)

## m. REPLACING BUCKET TEETH

If the bucket equipped with bolt-on tooth

When the bucket teeth are worn, replace them as follows.

1. Raise the bucket to a convenient height, and put blocks under the bucket to prevent it from coming down.
- ★ Raise the bucket so that the bottom is horizontal.

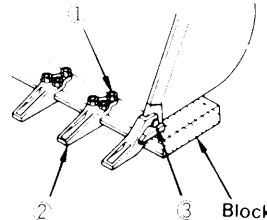

2. Remove the bolts and nut (1), (3) then remove bucket tooth (2).

3. Install the new teeth on the bucket. When installing the teeth, insert the shim so that there is no clearance between teeth and top surface of the bucket.
- ★ Continue to adjust with shims until it becomes impossible to insert a shim of thickness 0.5 mm.
4. To prevent any clearance between the tooth and the edge of the bucket, tighten the nut partially, then hit the tip of the tooth with a hammer.
- ★ Tightening torque of mounting bolt.
- mounting bolt (1):  $92 \pm 4$  kgm  
 mounting bolt (3):  $63 \pm 3$  kgm
- ★ After operating the machine for a few hours, tighten the mounting bolts again.

**If the bucket is equipped with bolt-on cutting edge**

If the bolt-on cutting edge is worn, turn the edge.

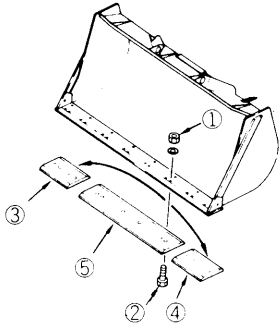

1. Raise the bucket to a convenient height, and put blocks under the bucket to prevent it from coming down.  
★ Raise the bucket so that the bottom is horizontal.
2. Loosen nut (1) and remove belt (2). Then, turn the cutting edge.

3. Exchange cutting edges (3) and (4), and install edge (5) in the opposite direction.
  4. After exchanging, tighten with bolts (2) and nuts (1).
- ★ Tightening torque:  $76 \pm 11$  kgm

**If the bucket equipped with tip tooth.**

Replace the teeth before they wear down as far as the adaptor.

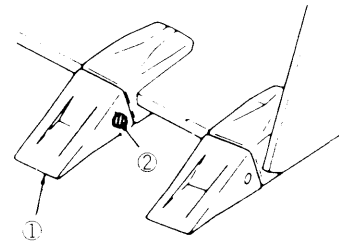

1. Extract pin (2) fitted to the bucket and then remove tooth (1).

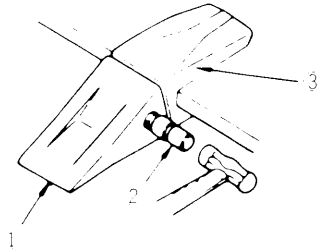

- ★ When extracting pin (2), strike the part (either the left or right part) with a sharp object. This will enable the pin to be extracted from the opposite side.
- 2. Insert the new tooth (1) into the adaptor (3), and insert pin (2) partway as shown in the diagram. Then drive it home by means of a hammer.

## ADJUSTING PARKING BRAKE (WA380)

If the effect of the parking brake is poor, adjust as follows.

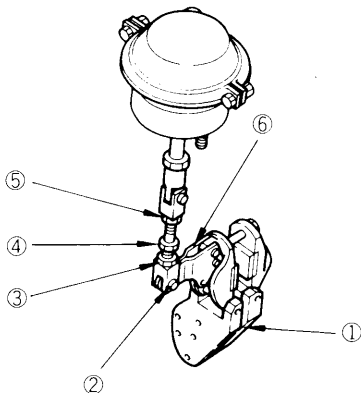

1. Turn the parking brake switch to OFF, release the parking brake and release caliper (1).

## ADJUSTMENT

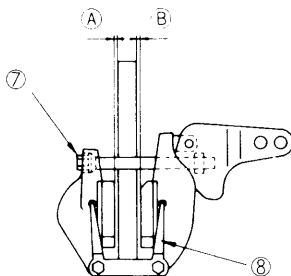

2. Loosen nut (3) and (5), then remove pin (2) from caliper lever (6).
3. Using adjustment bolt (7), adjust the clearance A and B between pad and disc so that it is 0.05 to 0.2 mm on one side.
4. Rotate turnbuckle (4), and align the holes of pin and caliper lever (6). Insert pin (2) and lock with cotter pin.
5. Rotate turnbuckle (4) and tighten nuts (3) and (5).

- ★ Be careful not to tighten adjustment bolt (7) too much.
- ★ After adjusting, make sure that there is no play in adjustment bolt (7) in the axial direction.

**!** When adjusting, always put blocks under the tires to prevent the wheels from moving.

**!** To prevent the parking from being applied automatically during adjustment, raise the air pressure, and put a warning tag on the parking brake switch to prevent other people from touching it.

**(WA420)**

If the effect of the parking brake is poor, adjust as follows.

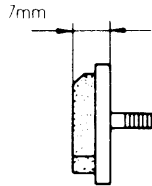

When the pad wears to a thickness of less than 7 mm (including backing plate), replace the pad.

- ★ Replace two pads as one set, and replace the retraction plate (8) at the same time.
- ★ Have the pads replaced by your Komatsu distributor.

**⚠ Do not get any oil or grease on the surface of the brake pad or disc.**

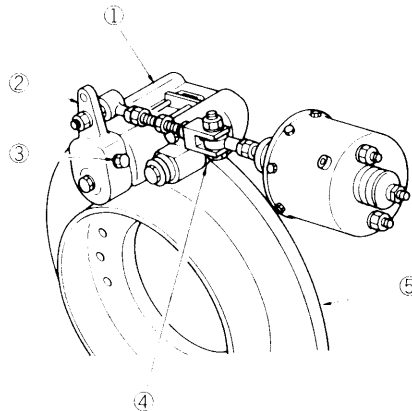

1. Turn the parking brake switch to OFF, release the parking brake and release caliper (1).

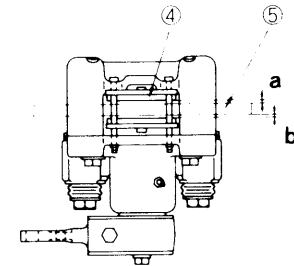

2. Turn adjustment bolt (3) of caliper lever (2) to clockwise so that pad (4) is in contact with disc (5) lightly.
- ★ If adjustment bolt (3) is turned until pad (4) comes into contact with disc (5) tightly, it causes brake noise and heat generation on disc.



3. Turn adjustment bolt (3) one click to counterclockwise. The total clearance (a + b) on the both side between pad (4) and disc (5) becomes 0.3 to 0.6 mm.

**⚠ When adjusting, always put blocks under the tires to prevent the wheels from moving.**

**⚠ To prevent the parking brake from being applied automatically during adjustment, raise the air pressure, and put a warning tag on the parking brake switch to prevent other people from touching it.**

When the pad wears to a thickness of less than 8 mm (including backing plate), replace the pad.

- ★ Replace two pads as one set.
- ★ Have the pads replaced by your Komatsu distributor.

**⚠ Do not get any oil or grease on the surface of the brake pad or disc.**

## ADJUSTING LENGTH OF LEVER

It is possible to adjust the length of the directional lever and speed control lever.

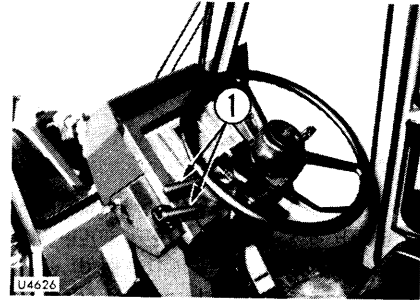

1. Pull out knob (1).

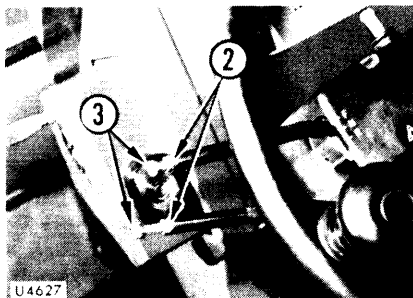

2. Loosen locknut (2) and turn bolt (3) to adjust.
3. After adjusting, tighten locknut (2), and push in knob (1) fully.

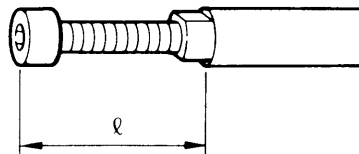

- ★ Keep distance  $\ell$  under 43 mm. If it is not screwed in far enough it is dangerous.



# TROUBLE SHOOTING GUIDE

This guide is not intended to cover every conditions, however many of the more common possibilities are listed.

## ELECTRICAL SYSTEM

**Lamp does not glow brightly even when engine runs at high speed.**

**Lamp flickers while engine runs.**

- Check for loose terminals and open-circuit wiring.
- Adjust belt tension.

**Charge monitor does not go out even when engine runs at high speed.**

- Replace the alternator.
- Check and repair wiring.

**Unusual noise is emitted from the alternator.**

- Replace the alternator.

**Starting motor does not turn when starting switch is turned on.**

- Check and repair the wiring.
- Charge the battery.

**The pinion of the starting motor keeps going in and out.**

- Charge the battery.

**Starting motor turns the engine sluggishly.**

- Charge the battery.
- Replace the starting motor.

**The starting motor disengages before the engine starts up.**

- Check and repair the wiring.
- Charge the battery.

**The engine pre-heating monitor does not flash.**

- Check and repair wiring.
- Replace the heater relay.
- Replace the monitor.

**The engine oil pressure monitor does not light up when engine is stationary (when the starting switch is in ON position.)**

- Replace the monitor.
- Replace the monitor switch.

**Charge monitor does not light up when the engine is stationary. (When the starting switch is in ON position.)**

- Replace the monitor.
- Check and repair the wiring.

**Outside the electrical intake air heater is not warm when touched with the hand.**

- Check and repair wiring.
- Replace the electrical intake air heater.
- Check and repair the heater switch.

## ENGINE

**The engine oil pressure monitor flashes when engine speed is raised after completion of warm-up.**

- Add the oil to the specified level.
- Replace the oil element.
- Check oil leakage from the pipe or the joint.
- Replace the monitor.

**Steam is emitted from the top part of the radiator (the pressure valve).**

**The radiator cooling water level monitor flashes.**

- Supply the cooling water and check leakage.
- Adjust fan belt tension.
- Wash out inside of cooling system.
- Clean or repair the radiator fin.
- Replace the thermostat.
- Tighten the radiator cap firmly or replace the gasket of it.
- Replace the monitor.

**The engine does not start when the starting motor is turned over.**

- Add fuel.
- Repair where air is leaking into fuel system.
- Replace the injection pump or the nozzle.
- Check the valve clearance.
- Check engine compression pressure.
- Refer to the section of electrical system.

**Exhaust gas is white or blue.**

- Adjust to specified oil quantity.
- Replace with specified fuel.

**Exhaust gas occasionally turns black.**

- Clean or replace the air cleaner element.
- Replace the nozzle.
- Check engine compression pressure.
- Clean or replace the turbocharger.

**Combustion noise occasionally changes to breathing sound.**

- Replace the nozzle.

**Unusual combustion noise or mechanical noise.**

- Replace with specified fuel.
- Check over-heating.
- Replace the muffler.
- Adjust valve clearance.

## CHASSIS

### Transmission

**Engine is running but machine will not move.**

- Release parking brake.
- Put directional lever in position properly.
- Add oil to transmission case to the specified level.

**Even at full throttle, machine moves slowly and lacks power.**

- Add oil to transmission case to the specified level.
- Disassemble transmission strainer and clean.

### Oil overheats

- Add oil to transmission case to the specified level or drain oil.
- Use a suitable gear speed.
- Reduce time using torque converter at stall speed.
- Check engine.

**Abnormal noise is produced.**

- Add oil to transmission case to the specified level.

### Axle

**Abnormal noise is produced.**

- Add oil to axle case to the specified level.

### Disc brake

**Brake does not work when pedal is depressed.**

- Raise air pressure to specified level.
- Replace disc.
- Bleed air from brake system.

**Brake drags or stays applied**

- Clean exhaust hole of treadle valve.
- Clean breather of power cluster.
- Check and repair slack adjuster.

**Brake slips.**

- Replace disc.

### Parking brake

**Brake does not work properly.**

- Adjust linkage.
- Clean brake pad.
- Replace spring in air cylinder.
- Adjust or replace brake pad.

## **Steering**

### **Steering wheel is heavy.**

- Adjust steering gear.
- Check linkage, replace parts.

## **Hydraulic system**

### **Bucket lacks lifting power.**

#### **Bucket lifting speed is slow.**

- Add oil.
- Replace filter in hydraulic tank.

#### **Many bubbles from in oil.**

- Replace with specified oil.
- Add oil.
- Bleed air from oil line.

#### **Oil pressure is too low.**

- Add oil and bleed air.

#### **Cylinder vibrates when operating.**

- Add oil.

## SERVICE METER

This meter indicates the integrated work hours. So, use it according to the following instructions.

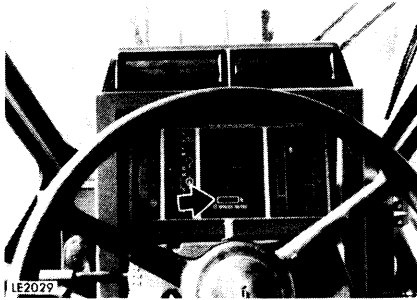

- Record the readings at the start and the end of work, this is the work record of the machine.
  - This record will indicate, when periodical maintenance is due.
  - It also indicates the integrated working hours when machine problems are encountered.
- ★ **How the meter progresses**
- The service meter progresses by 1 when the engine is operated for one hour, regardless of the engine speed.
- Consequently, if the engine is running, the service meter will advance even if the machine does not move.
- While engine is running, green pilot lamp on the service meter flashes to show the service meter advances.

# MACHINE AND ENGINE SERIAL NUMBERS

When calling for a service of mechanic or when making replacement-parts order, be sure to give Komatsu distributor the machine and engine serial numbers as well as the service meter reading before mentioned. These numbers are found on the plates shown in the photos below.

- Location of the machine serial number mark

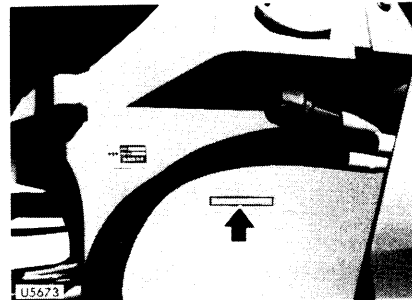

This is seen on the center right of the front frame.

- Location of the engine serial number mark

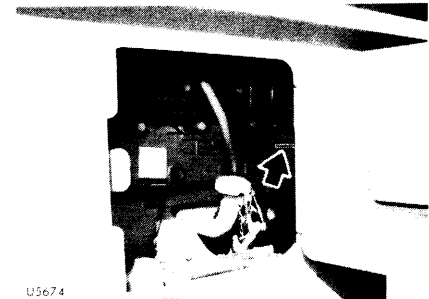

This is seen on the right of the cylinder block, when seen from the fan side.

# FUEL, COOLANT AND LUBRICANTS

## PROPER SELECTION OF FUEL, COOLANT AND LUBRICANTS

RESERVOIR	KIND OF FLUID	AMBIENT TEMPERATURE									CAPACITY (ℓ)	
		-22 -30	-4 -20	14 -10	32 0	50 10	68 20	86 30	104 40	122° F 50° C	Specified	Refill
Engine oil pan	Engine oil	SAE 30									24	18 [22]
		SAE 10W										
		SAE 10W-30										
		SAE 15W-40										
Transmission case	Engine oil	SAE 30									55 [54]	53 [47]
		SAE 10W										
Hydraulic system (Incl. brake system)	Engine oil	SAE 10W									140 [165]	114 [103]
		SAE 10W										
Axle (Front and rear)		See NOTE (4)									each 48 [each 55]	each 48 [each 55]
Fuel tank	Diesel fuel	ASTM D975 No. 1									270 [293]	-
		ASTM D975 No. 2										
Cooling system	Water	Add antifreeze									52	-

[ ]: WA420

**NOTE:**

- (1) When fuel sulphur content is less than 0.5%, change oil in the oil pan every periodic maintenance hours described in this manual.  
Change oil according to the following table if fuel sulphur content is above 0.5%.

Fuel sulphur content	Change interval of oil in engine oil pan
0.5 to 1.0%	1/2 of regular interval
Above 1.0%	1/4 of regular interval

- (2) When starting the engine in an atmospheric temperature of lower than 0°C, be sure to use engine oil of SAE10W, SAE10W-30 and SAE15W-40, even though an atmospheric temperature goes up to 10°C more or less in the day time.
- (3) Use API classification CD as engine oil and if API classification CC, reduce the engine oil change interval to half.
- (4) There is no problem if single grade oil is mixed with multigrade oil (SAE10W-30, 15W-40), but be sure to add single grade oil that matches the temperature in the table on the left.

- (5) We recommend Komatsu genuine oil which has been specifically formulated and approved for use in engine and hydraulic work equipment applications.
- (6) For axle oil, use only recommended oil as follows.  
SHELL: DONAX TT or TD  
CALTEX: RPM TRACTOR HYDRAULIC FLUID  
CHEVRON: TRACTOR HYDRAULIC FLUID  
TEXACO: TDH OIL  
MOBIL: MOBILAND SUPER UNIVERSAL

- ★ It is possible to substitute engine oil CLASS-CD SAE30 for axle oil.  
If noise comes from the brake, it is no problem of durability.

ASTM: American Society of Testing and Material  
SAE: Society of Automotive Engineers  
API: American Petroleum Institute

Specified capacity: Total amount of oil including oil for components and oil in piping.  
Refill capacity: Amount of oil needed to refill system during normal inspection and maintenance.



# SAFETY AND OPERATION



# CONTENTS

SAFETY HINTS . . . 	2
PRECAUTIONS FOR MAINTENANCE .....	16
BUCKET OPERATION .....	22
OPERATING THE AIR CONDITIONER .....	28
OPERATING THE CAR HEATER .....	31
LOCKING CAP .....	33
HANDLING OF BATTERY .....	34
TRANSPORTATION .....	37
STORAGE .....	38
COOLANT AND LUBRICANTS .....	40

# SAFETY HINTS . . .

## OPERATION GENERAL

Protect yourself and others. Safety is always first.

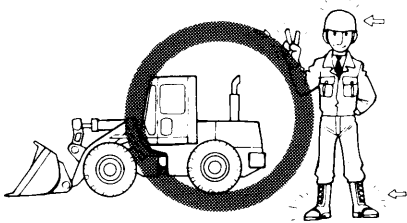

- Wear proper clothes  
Loose clothes, ornaments or other things that may possibly contact the control lever or other machine parts must not be worn. Do not let you clothes get caught on protruding parts of the machine. Do not wear oily clothes since they may catch fire.
- Wear well-fitting helmet, safety shoes and working clothes. If the nature of the work requires safety, wear protective goggles or mask, thick gloves, ear plugs or other protection.
- Take care of your health. Do not operate when tired, or after drinking.

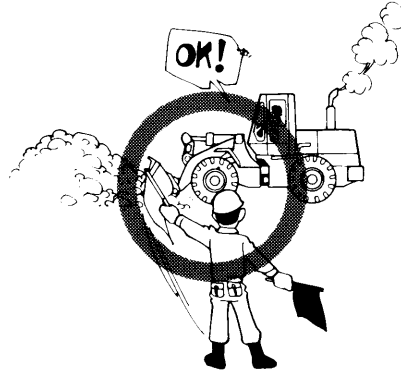

- When there is a leader, fix standard signals and always follow these signals when operating.
- Learn the prohibitions, cautions and rules about work procedures in the work site.

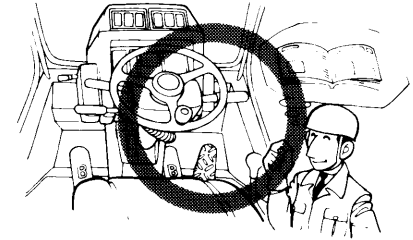

- Read the Operation and Maintenance Manual carefully. Learn how to use the control devices, gauges and warning devices. Be sure you understand the meaning of the caution plates.

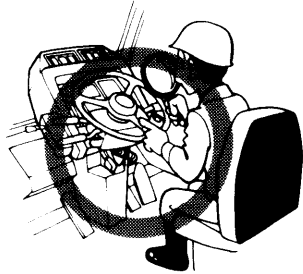

- Confirm that all gauges and warning devices are functioning correctly, and that the gauge readings are within the prescribed range.
- Learn about the safety devices on your own machine and about how to use them.
- Never allow another person to operate the machine.



- If there should be an accident or fire or any other such unexpected mishap, deal with it quickly, using the nearest apparatus. Learn beforehand the locations of the first aid boxes and fire extinguishers and how to use them. It is also important to know the emergency contact system.

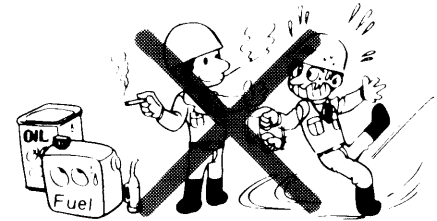

- Fuel or oil are dangerous substances. Never handle fuel, oil, grease or oily cloth in places where there is any fire of flame.

## CHECKING JOBSITE CONDITIONS



- Examine the lay of the land and the kind of soil at the work site to determine the dangerous points and the best method of operation.

Proceed with the work only after making safety arrangements about the dangerous points.

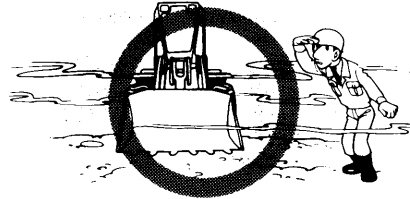

- Do not work when visibility is reduced by smoke, fog or dust. If the jobsite is dark, install lighting if necessary.
- Keep work site flat!  
By continually grading the work site, work efficiency will be improved and machines will be able to drive smoothly over the site. If the work site is very sandy or dusty, sprinkle water over the ground before working on the site.

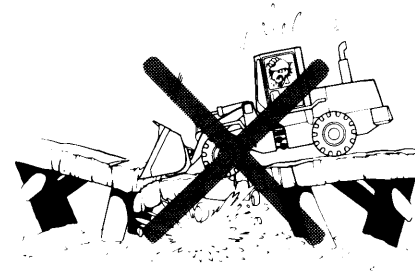

- Check the load limits of bridges before crossing.

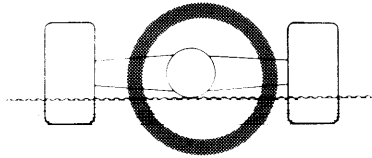

- When operating a machine in water or fording streams, survey the water depth, ground condition and velocity of the water in advance. Do not take the machine in water exceeding the allowable depth (up to the underside of the axle housing).

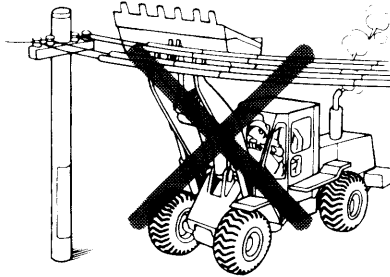

- The overall height of the machine is restricted by tunnels, roof height or overhead electric wires, so check first whether the jobsite is safe. Be particularly careful when working near power lines as electric shock can be caused if the machine touches the electric cables.

## **BEFORE STARTING OPERATION CHECK BEFORE STARTING**

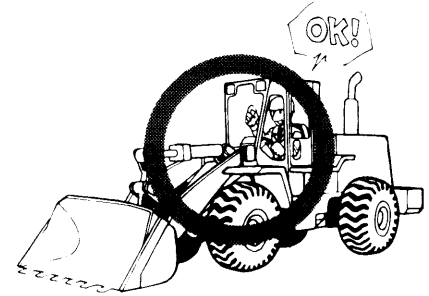

- Carry out checks before starting the machine. If any problem is found, do not start the engine, but inform the foreman immediately. Always keep the machine in good condition.

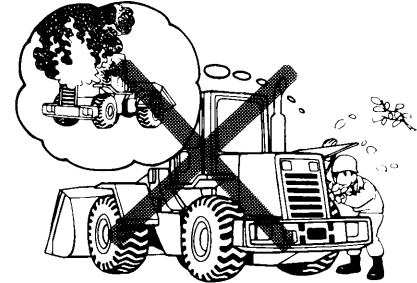
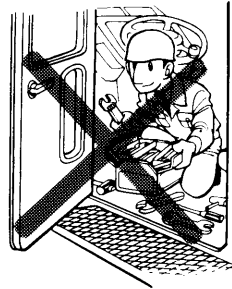
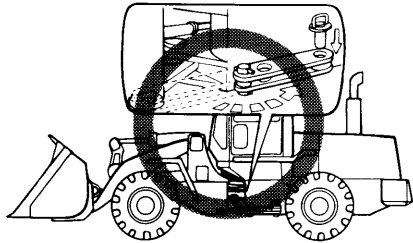

- Before operating the machine, be sure to check the bar and pins for setting in storage position. The machine can not be steered with frames locked. (In articulate frame model)
- Always stop the engine when adding fuel. After adding fuel, tighten the fuel cap properly. Repair any fuel or oil leakage, and wipe off all dirty oil.
- Do not leave parts or tools lying around in the vicinity of or on the floor of the operator's compartment. Keep everything in its proper place. Wipe off thoroughly any grease, oil or mud on the handrail, floor or control levers. Failure to do this may cause you to slip.
- Combustible objects such as pieces of wood, dead leaves, and pieces of paper may cause fire, so inspect the inside of the engine room and remove them.

## PRECAUTIONS WHEN GETTING ON THE MACHINE

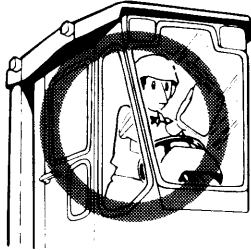

- If the machine is fitted with a cab, make sure the windows are clean and check the visibility. Always lock the door before starting operations.

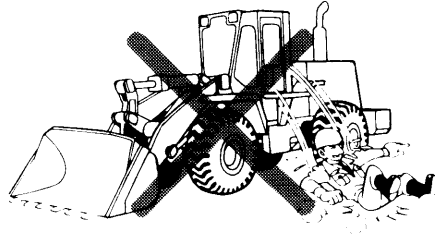

- When getting on or off the machine, use the handrail and step provided. Do not jump up onto or down from the machine.
- If a seat belt is provided, always use it. If the belt is damaged or worn, replace it with a new one.

## PRECAUTIONS WHEN STARTING THE ENGINE

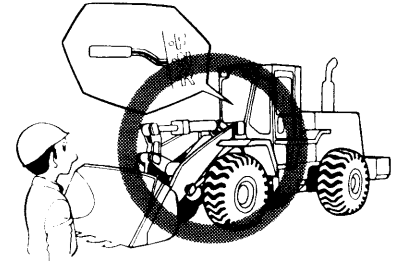

- Before starting the engine, confirm that all control levers are in neutral position.



## CHECKS AFTER STARTING THE ENGINE

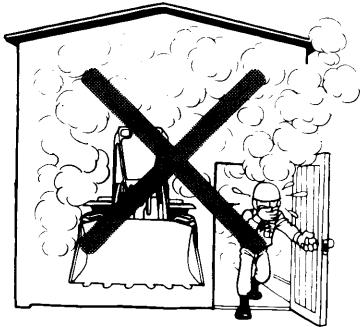

- Exhaust gas is dangerous. When working inside, be particularly careful to have good ventilation.
- To ensure the safety of workers near the machine, always sound the horn to warn them before starting the engine and moving the machine. Be particularly careful to check that the rear is clear before backing the machine.

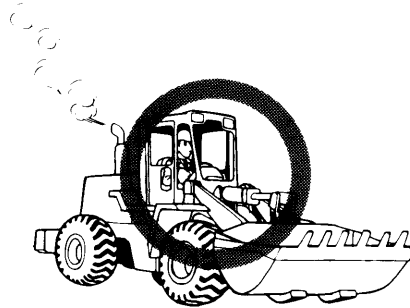

- Before starting work, test drive the machine in a safe place and check that the transmission, brakes, accelerator, and steering are working properly. At the same time, check that there is not abnormal noise or vibration, or any abnormality in the instruments and gauges.

## DURING OPERATION

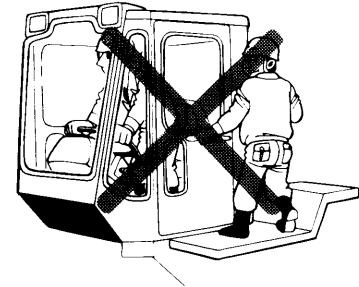

- Always sit in the operator's seat when operating the machine.
- Do not allow anyone except the operator on the machine.

## ATTENTION TO SURROUNDINGS

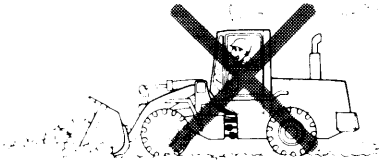

- Always be aware of the operating capacity of the machine. Using the machine to do work beyond its capacity will not only damage the machine, but may even cause unexpected accidents.

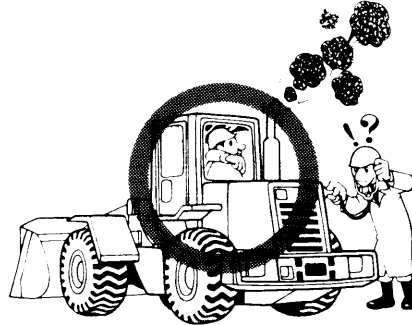

- The machine condition can be judged from many factors. Changes in the gauges, sound, vibration, exhaust gas color or response of the control levers can indicate the occurrence of some disorder. If any disorder occurs, park the machine immediately in a safe place and take appropriate action.

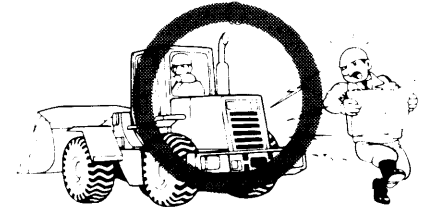

- To ensure the safety of workers near the machine, always sound the horn to warn them before starting the engine and moving the machine. Be particularly careful to check that the rear is clear before backing the machine.

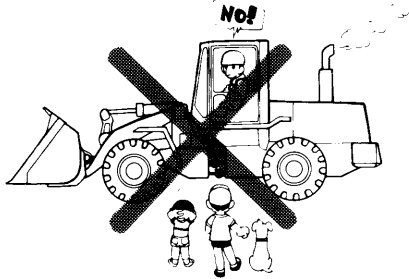

- Do not allow unauthorized persons into the work area.
- Always concentrate. It is extremely dangerous to allow yourself to be distracted or to think of other things when operating a machine.

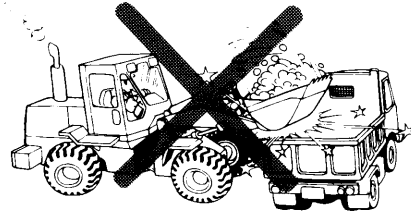

- When loading trucks or hoppers, be careful not to hit the truck or hopper with the bucket. Do not bring the bucket over people's heads or over the cab of the truck.
- In dangerous places or in places where the visibility is poor, get down from the machine and check that it is safe before continuing the operation.



- The machine should always be operated at a speed where it can be correctly controlled. Never do the following:
  - ★ Speeding
  - ★ Sudden starting, sudden braking, sudden turning
  - ★ Snaking
  - ★ Coasting

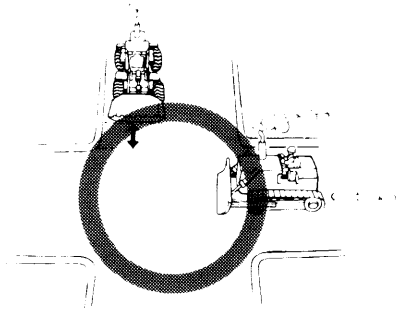

- Always operate slowly in crowded places. On haul roads or in narrow places, give way to loaded machines.

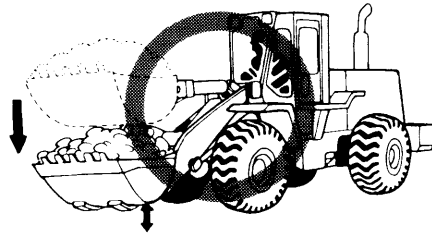

- When traveling, keep the work equipment close to the ground to maintain the stability of the machine. Pay particular careful attention to the stability of the machine when traveling with a load.
- If the machine has to travel on rough ground, be careful to avoid obstacles as far as possible.
- Always travel at a slow speed, and do not suddenly change direction.
- Do not use the bucket as a brake except in emergencies.
- If the engine stops when the machine is traveling, it is impossible to use the steering. This is dangerous, so apply the brake immediately to stop the machine.

## RESTRICTIONS CREATED BY JOBSITE

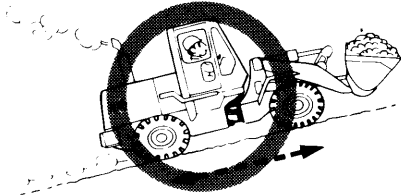

- When traveling on hills with a loaded bucket, travel forward up the hill and in reverse down the hill.

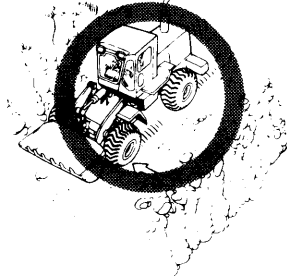

- Do not approach the edge of the cliff or road shoulder.
- In dangerous places, always work in teams of two; one man to operate the machine, and the other to give instructions.
- On windy days, always load downwind.

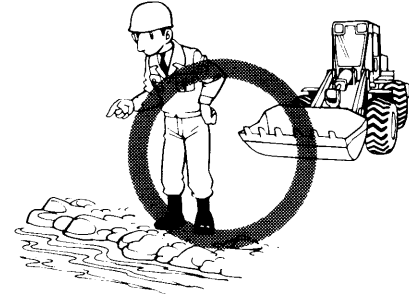

- When continuing operations after rain, remember that conditions will have changed from those before the rain started, so proceed with caution. Be careful when working on the place made of piled soil, after earthquakes or after blasting.

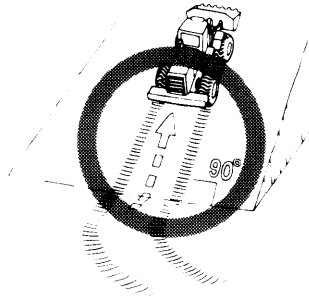

- Always travel directly up or down slopes. When traveling down a slope, use the same gear speed as when going up the slope. When traveling down a slope, never put the transmission in neutral.

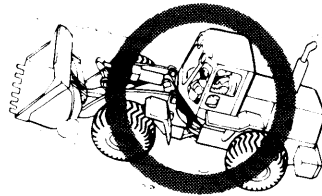

- If the engine stops on a slope, apply the brake quickly and carefully. Next, lower the work equipment to the ground and apply the parking brake. Then put the directional and speed control levers in neutral, and start the engine again.
- Be careful when traveling on planks or steel plates, as these can cause slippage.



- When operating at night, remember the following points:
  - Be sure to arrange an adequate lighting system.
  - At night it is very easy to make mistakes in assuming the distance and height of objects and land.

## PARKING

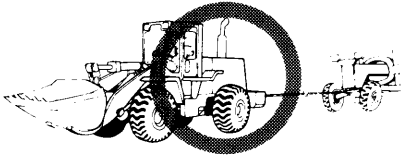

- Before towing operations, always check the wire rope.
- Before starting towing operations, make sure that no one is near the machine. Start the machine slowly to take up the slack in the wire rope. Then start towing carefully. Do not tow any machine whose brakes or steering have broken down.

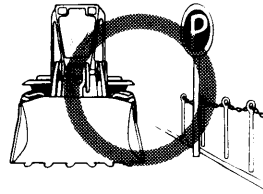

- When parking the machine, park it in a safe place outside the working area, or in the specified place. The following factors should be considered when choosing a parking place: it should be on flat, firm ground where there is no danger of rock-falls, landslides or floods.

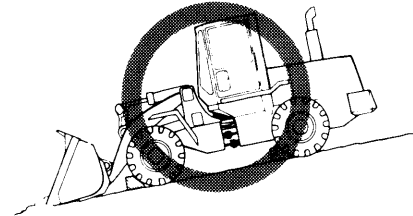

- If the machine has to be parked on a slope, it should be parked facing directly up or down the slope, and chocks should be placed under the tires.

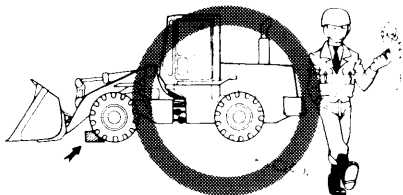

- When leaving the machine, always lower the work equipment completely to the ground, and put all control levers in neutral. Next, apply the parking brake and lock all levers. Then put blocks under the tires.
- After stopping the engine, always remove the starting key.



## PRECAUTIONS FOR MAINTENANCE

### GENERAL



- Wear proper clothes  
Loose clothes, ornaments or other things that may possibly contact the control lever or other machine parts must not be worn. Do not let you clothes get caught on protruding parts of the machine. Do not wear oily clothes since they may catch fire.
- Wear well-fitting helmet, safety shoes and working clothes. When drilling, grinding or hammering, always wear protective goggles.

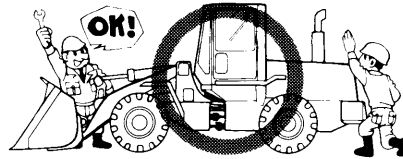

- When working with others, choose a group leader and work according to his instructions. Do not perform any maintenance beyond the agreed work.



- Hand a caution sign in the operator's compartment (for example "Do not start" or "Maintenance in progress").  
This will prevent anyone from starting or moving the machine by mistake.



- Smoke only in designated places. Never smoke while working.
- Always keep the work shop in good condition. Make sure there is no mud or oil on the floor.
- Keep oily cloths and other combustible things in a safe place away from fire. In addition, learn the location and method of operation of fire extinguishers.

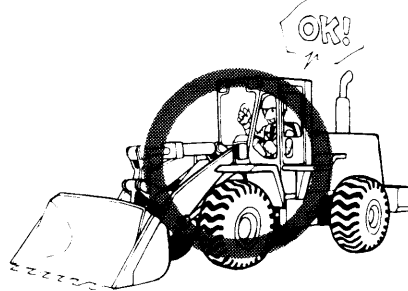

- Always stop the engine before cleaning the machine or adding fuel.



- Flame should never be used instead of lamps. Never use a naked flame to check leaks or the level of oil, fuel, anti-freeze or electrolyte.
- Always use non-inflammable cleaning agents when cleaning parts.

## PRECAUTIONS FOR MAINTENANCE

### BEFORE MAINTENANCE

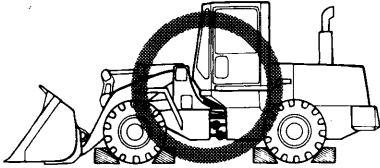

- Before starting work, stop the machine on a firm, level surface, and use blocks to keep the machine from moving during operations.
- Lower the bucket to the ground. If this is impossible, use the safety pin and blocks to hold the work equipment securely in position. In addition, apply the locks to all control levers.

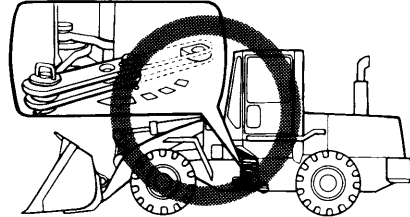

- Always lock the front and rear frames before inspecting and servicing the machine.  
(In articulate frame model)



- Remove all oil and mud from the machine. In particular, be sure that the steps, hand grips, and the floor of the operator's compartment are clean.
- Always use the standard ROPS equipment. Do not modify the ROPS equipment.

**DURING MAINTENANCE**

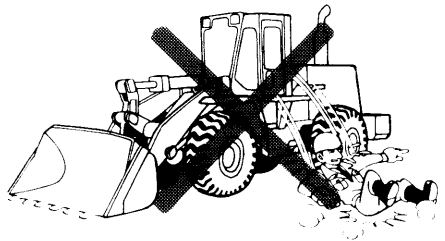

- When getting on or off the machine, use the steps, hand grips and ladders. Never jump on or off the machine. If the steps, hand grips, or ladder cannot be used, use a stand to give firm footing.
- If necessary, remove the cables from the battery terminals. When charging the battery, make sure the area is well ventilated.

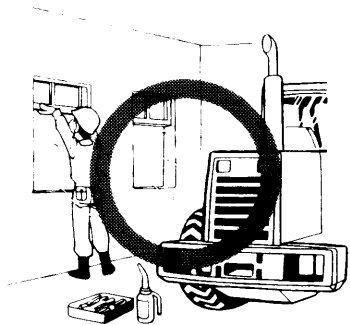

- Exhaust gas is dangerous. When working inside, be particularly careful to have good ventilation.
- When opening inspection covers, stop the engine. If the hood or other covers are fitted with a lock, always apply the locks securely when opening or closing the hood or cover.
- Always stop the engine before adjusting belt tension or before checking or servicing the water pump.

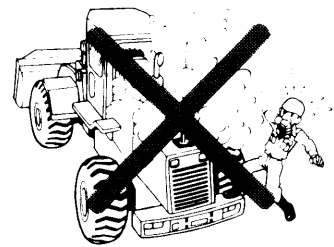

- Be particularly careful when removing the radiator cap or the hydraulic oil tank filler cap. If this is done immediately after using the machine, there is a danger that boiling water or oil may spurt out.
- Always release the pressure in the circuit before checking or servicing the oil, water or air circuits.
- When the engine stops, the water and oil in the circuit is hot, so be careful not to get burned. Wait for the water and oil to cool before starting any work on the machine.

## MISCELLANEOUS

- Thoroughly wash the machine, particularly the oiling and greasing parts and the vicinity, thereof, in order to prevent the ingress of dust.
- Use genuine Komatsu replacement parts specified in the parts list.
- Use Komatsu specified oil and grease. Use oil and grease having the recommended viscosity for the particular ambient temperature.
- Use clean oil and grease and keep them in clean containers to avoid the ingress of dust.
- Inspect or replace oil in a dust-free location to prevent the ingress of dirt.
- Drain off used oil after heating it to a suitable temperature (about 20 to 40°C).
- When the strainer is located in the oil filler, the strainer must not be removed while adding oil.
- When adding oil or checking the oil level, check that the oil is at the correct level.  
When adding oil or fuel, do not let the oil or fuel overflow.
- If oil or water are spilled, always wipe it up. Spilled oil or water may cause people to slip; spilled oil may cause fire.  
If soil is piled on top of a place where fuel has been spilled, remove the soil.
- After greasing up, always wipe off the old grease that was forced out.
- When changing the oil or filter, check the drained oil and filter for any signs of excessive metal particles or other foreign materials.
- When removing parts containing O-rings, gaskets or seals, clean the mounting surface and replace with new sealing parts.
- When washing the machine, ensure that water does not get onto the alternator.
- Special measuring apparatus is needed for testing hydraulic pressure.
- Thoroughly wash the machine. In particular, be careful to clean the filler caps, grease fittings and the area around the dipsticks. Be careful not to let any dirt or dust into the system.
- When check an open cover there is a risk of dropping things in. Before removing the covers to inspect cover, empty everything from your pockets. Be particularly careful to remove wrenches and nuts.

- When working on the sea shore, carefully clean all electrical equipment to ensure that it does not corrode.
- Before working in muddy water, rain or snow, check that the various plugs, valves, are properly screwed up. Upon completion of work, wash the machine, then check the various parts of the machine for cracking, scratching, loose or missing nuts and bolts. Also, oil and grease the various parts of the machine.
- When working on rocky ground, be careful of damage to the undercarriage, loose nuts and bolts, cracks, wear and other damage.
- When working in a dusty location, be careful of the following:
  - 1) Inspect the dust indicator to see whether the air cleaner is blocked up. Clean the air cleaner as soon as it becomes dirty.
  - 2) Clean the radiator core so that it does not become blocked up.
  - 3) Clean or replace the fuel filter as soon as it becomes dirty.
  - 4) Clean the electrical equipment, particularly the starting motor and alternator, to prevent accumulation of dust.
- When installing car radio and a walkie-talkie or citizen band, contact your Komatsu distributor.
- When washing the machine, take care not to splash water over the electrical equipment. If it is soaked with water, it may not operate normally.
- After disconnecting the connector, cover it with a vinyl bag to prevent oil or dust from sticking to its contact section.
- When welding, be careful of the following:
  - 1) Turn OFF the power (starting switch).
  - 2) Do not continuously apply more than 200 V.
  - 3) Install the ground cable at least 1 m from the range to be welded.
  - 4) Take care not to install the seals between the grounded point and the range to be welded.
- ★ Use ordinary automobile washer fluid. Be careful not to let dirt or dust get in.

### **Greasing the rod end**

Because the rod end is of the oilless type, no greasing is required, although a grease nipple is fit to the rod end on the lever linkage.

The rod end should be greased only when it becomes stiff after using it for a long span of time.

## BUCKET OPERATION

Various types of attachments are available to extend the range of application beyond the applications described below.

### EXCAVATION

- When loading piled soil or blasted rock, drive the machine forward as follows to load. To prevent cutting of the tires caused by the tires slipping, be careful of the following points during the operation.
- ★ Always keep the operating jobsite flat, and remove any fallen rocks.
- ★ When working with stockpiles, operate the machine in 1st or 2nd, operate the machine in 1st when loading blasted rock.

1. When driving the machine forward and lowering the bucket, stop the bucket about 30 cm from the ground, then lower it slowly.
- ★ If the bucket hits the ground, the front tires will come off the ground, and the tires will slip.

2. Shift down immediately in front of the material to be loaded. When completing the shift down, depress the accelerator pedal at the same time and thrust the bucket into the load.

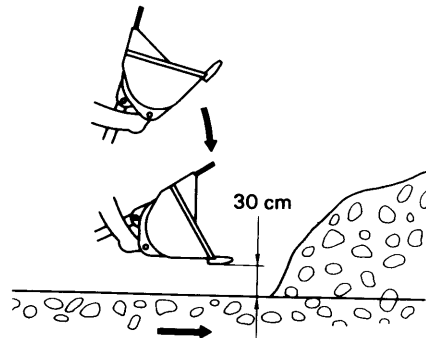

stockpile

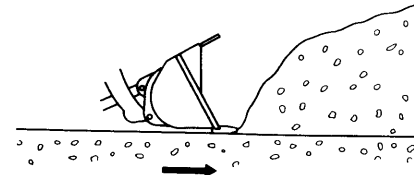

3. When the material is in a stockpile, keep the cutting edge of the bucket horizontal; when loading blasted rock, have the bucket tilting slightly down.
  - ★ Be careful not to get blasted rock under the bucket. This will make the front tires come off the ground and slip.
  - ★ Try to keep the load in the center of the bucket; if the load is on one side of the bucket, the load will be unbalanced.

4. At the same time as thrusting the bucket into the material, raise the lift arm to prevent the bucket from going in too far. By raising the lift arm, ample traction will be produced by the front tires.

5. Check that there is enough material loaded into the bucket, then operate the bucket control lever to tilt the bucket and load the bucket fully.
  - ★ If the bucket edge is moved up and down while pushing in the bucket and digging, the front tires will come off the ground and this will cause the tires to slip.

Blasted rock

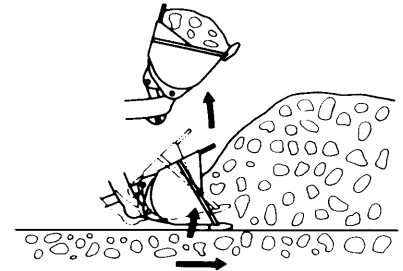
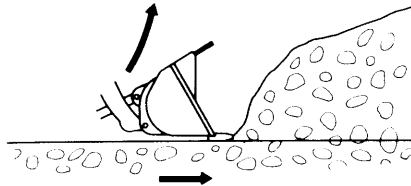
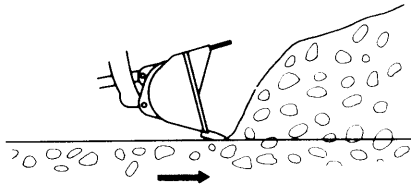



## BUCKET OPERATION

6. If there is too much material loaded in the bucket, dump and tilt the bucket quickly to remove the excessive load. This prevents spillage of the load during hauling.

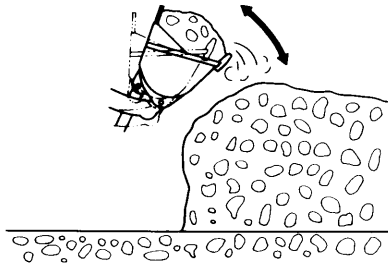

- When digging and loading on level ground, set the bucket edge facing down slightly as follows and drive the machine forward. Always be careful not to load the bucket on one side and cause an unbalanced load.
- ★ This operation should be carried out in 1st gear.
1. Set the edge of the bucket facing slightly down.

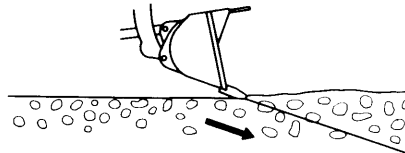

2. Drive the machine forward and operate the lift arm control lever forward to cut a thin layer of the surface each time when excavating the soil.

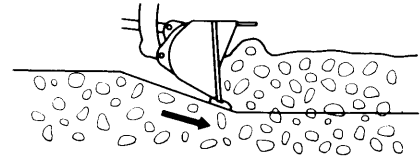

3. Operate the lift arm control lever slightly up and down to reduce the resistance when driving the machine forward.

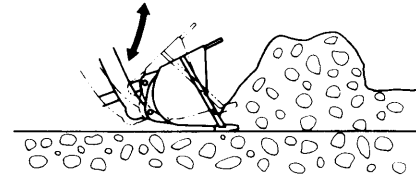

- ★ When digging with the bucket, avoid imposing the digging force onto only one side of the bucket.

**⚠ Never dig or scoop when the machine body is articulated.**

**Precautions when scooping up materials.**

When scooping up materials, be careful not to let the counterweight at the rear touch the ground.

- ★ Do not allow tires slipping to occur during operation. Tires slipping shortens tire's life.

**LEVELING**

1. Scoop soil into the bucket. Move the machine backward while spreading soil from the bucket little by little.
  2. Go over the spread soil with the bucket teeth touching the ground and level the ground by back-dragging.
  3. Scoop some more soil into the bucket, put the lift arm in float, level the bucket at ground level, and smooth the ground by moving backward.
- ★ Always move the machine backward during leveling operations.

**⚠ If leveling by forward travel can not be avoided, do not dump the bucket beyond 20°. This will prevent quick wear and damage of the work equipment and frame.**

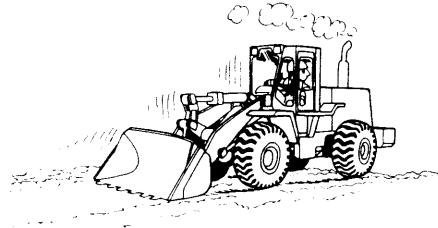

## LOAD AND CARRY OPERATIONS

Load and carry operation is a series of processes (scooping → carrying → loading to a hopper or glory hole) carried out by the wheel loader.

★ Always maintain the road in good condition.

**⚠ Lower the bucket to bring down the center of gravity when carrying material.**

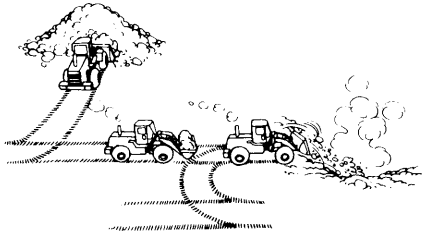

## LOADING

Select and proceed effective operation which avails less turning and the shortest hauling distance according to ground conditions.

## CROSS DRIVE LOADING

When a wheel loader is operated, the digging should be made at a right angle toward accumulated soil. When the scooping is completed, the machine should be traveled backwards as it is. Then, bring the truck between the accumulated soil and the wheel loader for the purpose of loading upon the dump truck.

**⚠ Provide a flat road free of rocks and hollows. When the boom is raised with the bucket loaded, do not make quick turns or quick braking because it is very dangerous.**

**⚠ Do not load the bucket by thrusting into a pile of soil or gravel at high speed because it is dangerous.**

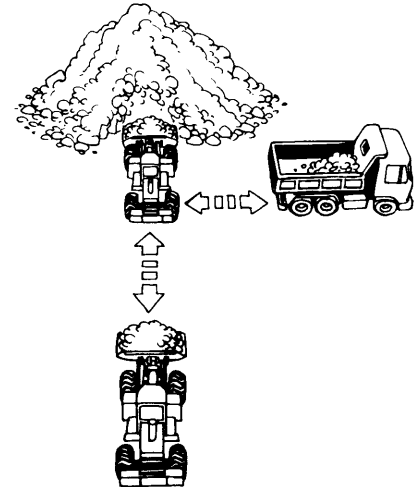

### V-SHAPE LOADING

Stop the truck with the angle of about  $60^\circ$  toward the scooping direction of the wheel loader. After scooping the soil, back the wheel loader in such a way that it makes a right angle to the truck. The loading on the truck is made by the wheel loader going forward.

The smaller the turning angle, the higher the efficiency. However, turning of  $90^\circ$  can be made if necessary.

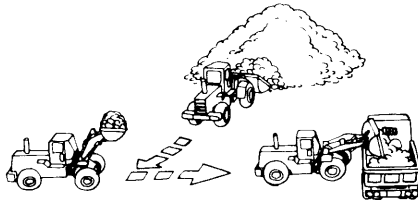

# OPERATING THE AIR CONDITIONER

It is possible to use the air conditioner to good effect in dusty job-sites. The outside air is passed through the filter and is sent to the operator's cab to increase the pressure inside the cab. In this way, dust is prevented from entering, so comfortable operating conditions are always maintained for the operator.

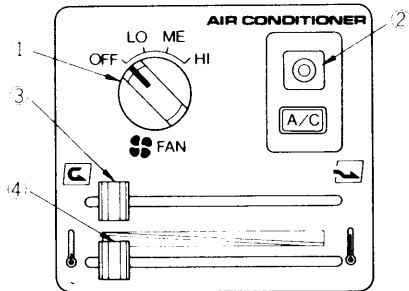

## EQUIPMENT ON CONTROL PANEL

### ① Fan switch

- This is used for controlling the air flow when cooling or heating.
  - It can control the air flow to three levels:  
LO (Low), ME (medium) and HI (High)

### ② Air conditioner switch

- This is the switch for cooling.
  - ON: Push the button to carry out dehumidification and cooling. The blue lamp lights up to indicate that the cooling system is on.
  - OFF: If the system is ON and the button is pressed again, the switch returns to its original position and the air conditioner is switched off.
- ★ Turn the air conditioner switch on after turning the fan switch on.

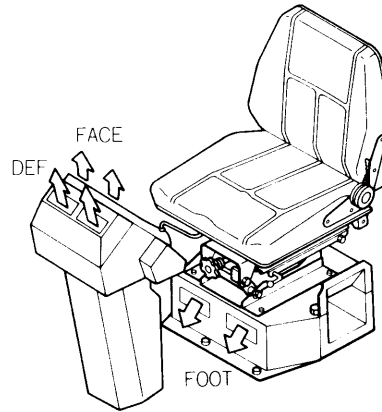

③ **Air intake selector lever**

- This switches the air intake port when cooling or heating.

**FRESH:** Operate the lever to the right.

Fresh air is taken in from outside in addition to the air inside the compartment. (This is used for ordinary cooling or heating, and when pressurizing the inside of the cab.)

**RECIRC:** Operate the lever to the left.

Only the air inside the compartment is used. (This is mainly used for quick cooling or heating.)

④ **Temperature control lever**

- This is used to control the temperature for cooling or heating.

The farther the lever is moved to the left, the lower the temperature of the air blown out from the vent.

The farther the lever is moved to the right, the higher the temperature of the air blown out from the vent.

**METHOD OF OPERATION**  
**OPERATION OF CONTROL PANEL**

Lever switch Purpose		Fan switch	Air conditioner switch	Temperature control lever	Air intake selector lever
Cooling	Quick	HI	ON	Move fully to left	Left
	Normal	HI - LO	ON	From left side to near center	Right
Dehumidifying, heating		HI - LO	ON	From center to near right side	Right
Heating	Quick	HI	OFF	Move fully to near right side	Left
	Normal	HI - LO	OFF	From center to near right side	Right
Defrosting		HI	ON	From center to near right side (move fully to the right when carrying out quick defrosting or demisting.)	Right
Ventilation or pressurizing		HI - LO	OFF	Move fully to left	Right

- ★ If the outside air is extremely dusty, set the fan switch to the HI position. This will pressurize the cab and prevent the dust from entering.

## METHOD OF OPERATION SELECTING AIR VENT

Vent Purpose \	FACE	FOOT	DEF
Cooling	Open	Open or closed	Closed
Heating	Open or closed	Open	Open or closed
Defrosting	Closed	Open or closed	Open
Ventilation	Open	Open	Open

- ★ The effectiveness of the air conditioning system can be increased by selecting the most suitable vent.
- ★ Do not turn the fan switch on when all the vents are closed.

### Precautions for using air conditioner

- When cooling, change the air occasionally.
- Smoking in the air-conditioned cab will cause your eyes to get sore. While smoking, open the window to let the smoke out of the cab.
- While using the air conditioner, open the window once every hour.
- Be careful not to overcool the cab.
- The cab should feel cool when entering there from outside (5°C or 6°C lower than the outside temperature). It is not good for the health to have the temperature in the cab too low. Always give careful consideration to temperature regulation.

### Handling the air conditioner in season

To use the air conditioner comfortably during its season, ask your Komatsu distributor to check the air conditioner and add the refrigerant if necessary.

- The standard cleaning cycle for the fresh air filter is EVERY 100 HOURS, but if it becomes clogged, it will be impossible to pressurize the inside of the cab, and in addition, it may cause failures, so check and clean the filter immediately.
- For details of cleaning, see PERIODIC MAINTENANCE.
- If a large amount of dirt or dust collects on the condenser, the cooling capacity drops, so check and clean when necessary. For details, see WHEN REQUIRED.

### Handling the air conditioner in off-seasons

To lubricate each part of the compressor during the off-seasons, operate the air conditioner for a few minutes two or three times a month.

# OPERATING THE CAR HEATER

It is possible to use the car heater to good effect in dusty jobsites. The outside air is passed through the filter and is sent to the operator's cab to increase the pressure inside the cab. In this way, dust is prevented from entering, so comfortable operating conditions are always maintained for the operator.

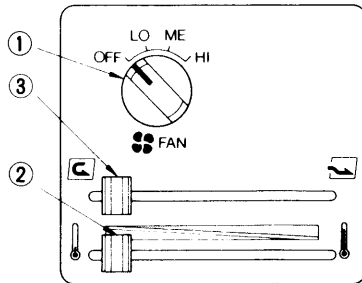

## EQUIPMENT ON CONTROL PANEL

### ① Fan switch

- This controls the air flow when the car heater is used for heating.
  - There are 3 levels: LO (Low), ME (Medium) and HI (High)

### ② Temperature control lever

- This is used to control the temperature for cooling or heating.
  - The farther the lever is moved to the right, the higher the temperature of the air blown out from the vent.

### ③ Air intake selector lever

- This switches the air intake port when heating.
  - FRESH: Operate the lever to the right. Fresh air is taken in from outside in addition to the air inside the compartment. (This is used for ordinary heating, and when pressurizing the inside of the cab.)
  - RECIRC: Operate the lever to the left. Only the air inside the compartment is used. (This is mainly used for quick heating.)

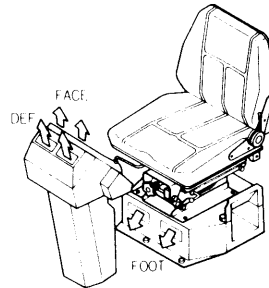



**METHOD OF OPERATION**  
**OPERATION OF CONTROL PANEL**

Purpose		Lever switch	Fan switch	Temperature control lever	Air intake selector lever
Heating	Quick	HI		Move fully to right	Left
	Normal	HI – LO		From center to near right side	Right
Defrosting			HI	From center to near right side (move fully to the right when carrying out quick defrosting or demisting.)	Right
Ventilation or pressurizing			HI – LO	Move fully to left	Right

- ★ If the outside air is extremely dusty, set the fan switch to the HI position. This will pressurize the cab and prevent the dust from entering.

**SELECTING AIR VENT**

Vent Purpose	FACE	FOOT	DEF
Heating	Open or closed	Open	Open or closed
Defrosting	Closed	Open or closed	Open
Ventilation	Open	Open	Open

- ★ The effectiveness of the heating system can be increased by selecting the most suitable vent.
- ★ Do not turn the fan switch on when all the vents are closed.

## LOCKING CAP

The fuel tank filler port and the hydraulic tank filler port are equipped with locks.

- ★ Use the starting key to open and close the cap.

Open and close locking cap as follows:

### (For the fuel tank filler port)

- To open the cap
1. Insert the key into the cap.

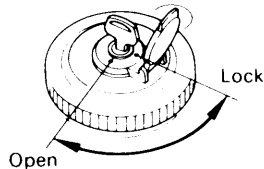

2. Turn the key clockwise, align the match mark on the cap with the rotor groove, then remove the cap.

- To lock the cap
1. Turn the cap into place.
  2. Turn the key counterclockwise and take the key out.

### (For the hydraulic tank filler port)

- To open the cap
1. Insert the key into the cap.

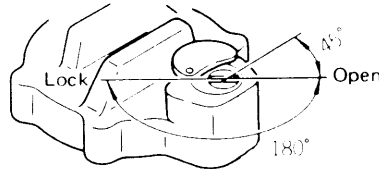

2. Turn the key counterclockwise and bring the rotor groove in line with the aligning mark on the cap. Turn the cap slowly until a "clicking" sound is made. This releases the lock and allows the cap to be opened.



- To lock the cap
1. Turn the cap into place.
  2. Turn the key clockwise and take the key out.
- ★ When the cap is locked (against vandalism), it rotates freely.
  - ★ Insert the key as far as it will go. If the key is turned before it is inserted all the way, it may break.

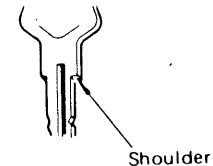

## HANDLING OF BATTERY

 **Before starting the engine, use a damp cloth to wipe off the dust accumulated on the top surface of the battery.**

### PRECAUTIONS FOR CHARGING BATTERY

1. Before charging, disconnect the cable from the negative (-) terminal of the battery. Otherwise, an unusually high voltage will damage the alternator.
2. While charging the battery, remove all battery plugs for satisfactory ventilation.  
To avoid gas explosions, do not bring fire or sparks near the battery.

3. If the electrolyte temperature exceeds 45°C, stop charging for a while.
4. Turn off the charger as soon as the battery is charged.  
Overcharging the battery may cause followings:
  - 1) Overheating the battery
  - 2) Decreasing the quantity of electrolyte.
  - 3) Damaging the electrode plate.
5. If the electrolyte gets on your skin or clothes, immediately wash with plenty of clean water.
6. Do not mix up cables (positive (+) to negative (-) or negative (-) to positive (+)), as it will damage the alternator.
7. When inspecting or servicing a battery, be sure to stop the engine and turn the starting switch key to "OFF" position.
8. When performing any service to battery besides checking the electrolyte level or measuring the specific gravity, disconnect cables from the battery.

## REMOVAL AND INSTALLATION OF BATTERY

- When removing battery, first disconnect the cable with black tube from the ground (normally, from the negative (-) terminal). If a tool touches a cable connecting the positive terminal and the chassis, there is danger of sparks being emitted.
- When installing battery, the ground cable should be connected to the ground terminal as the last step.
- ★ The batteries are mounted on both side of the machine. The grounding cable is connected to the left side battery.

## STARTING ENGINE WITH A BOOSTER CABLE

When starting up the engine with a booster cable, do as follows:

1. Before connecting the booster cable
  - 1) Size of booster cable and clip should be suitable for the battery size.
  - 2) Check cables and clips for breaks, corroded surfaces, etc.
  - 3) Make sure cables and clips are firmly secured.
  - 4) Keep the starting switch in "OFF" position.
  - 5) The battery of the running engine must be the same capacity as that of engine to be started.

2. Connect the booster cables in the following manner.

- 1) Connect one clip of booster cable A to the positive (+) terminal of the engine to be started.
  - 2) Connect the other clip to the positive (+) terminal to the engine which is running.
  - 3) Connect one clip of booster cable B to the negative (-) terminal of the engine which is running.
  - 4) Connect the other clip to the engine block to be started.
- ★ Make sure the clips are firmly connected to battery terminals. Then, start the engine.

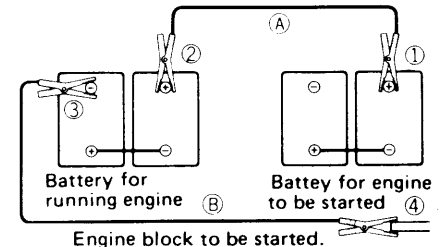

**!** When connecting the cables, never contact the positive (+) and negative (–) terminals.

**!** Make sure that the booster cable connections are correct. Connect the booster cable to the engine block as far as possible from the battery.

3. Starting engine

- 1) Turn the starting switch to START position and start up the engine.
- 2) If the engine doesn't start at first, try again after 2 minutes or so.

After the engine has started, the booster cables should be disconnected in the reverse order in which they were connected.

1. Disconnecting the booster cables
  - 1) Disconnect the clip of booster cable B from the engine block which was started.
  - 2) Disconnect the other clip from the negative (–) terminal of the running engine.
- 3) Disconnect the clip of booster cable A from the positive (+) terminal of the running engine.
- 4) Disconnect the other clip from the positive (+) terminal of the engine which was started.

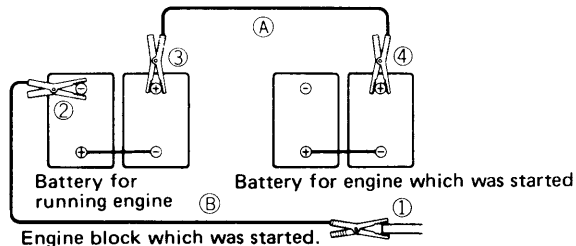

## TRANSPORTATION

When transporting the machine, observe the various road rules, road transportation vehicle laws and vehicle limit ordinances, etc. It is a good idea to obtain a special platform for loading and unloading the machine. When it is unavoidably necessary to use a gangplank, however, at the very least observe the following for the sake of safety.

1. Properly apply the brakes on the trailer and insert blocks beneath the tires to ensure that it does not move. Then fix the gangplank in line with the centers of the trailer and the machine.
    - ★ Make sure the gangplank has sufficient width, length and thickness to enable the machine to be safely loaded and unloaded. If the gangplank sags appreciably, reinforce it with blocks, etc.
  2. Determine the direction of the gangplank, then slowly load or unload the machine.
    - ★ When transmission cut-off switch is put in OFF, the left brake pedal and accelerator pedal are operated at the same time.
  3. Correctly load the machine onto the specified part of the trailer.
  4. Lower the bucket and lock each control lever using safety lock.
  5. Lock front frame and rear frame with safety bar.
- ⚠ Remove the mud from the undercarriage to prevent the machine from slipping to the side on slopes.**
- ⚠ Do not on any account change the direction of the machine while it is on the gangplank. To change the direction of the machine, first take it down from the gangplank.**
6. When transporting the machine, place blocks underneath the front and rear wheels to prevent the machine from moving about. Also, hold it down with chains or wire ropes.
    - ★ Determine the route for transporting the machine by taking into account the width, height and weight of the machine.
- ⚠ When loading the machine, park the trailer on a flat firm roadbed. Keep a fairly long distance between the road shoulder and the machine.**

## STORAGE

### BEFORE STORAGE

To place the machine in storage for an extended period of time, the following measures must be taken to insure that it can be returned to operation with minimum of service.

- After every part is washed and dried, the machine shall be housed in a dry building. Never leave it outdoors.  
In case it is indispensable to leave it outdoors, lay wood plates on the ground, and park the machine on the wood plates and cover it with canvas etc.
- Completely fill fuel tank, lubricate and change oil before storage.

- Apply a thin coat of grease to metal surface (hydraulic piston rods and splined shaft).
- As to batteries, remove the terminals and cover them, or remove them from the machine and store separately.
- When the ambient temperature is anticipated to drop below 0°C, always add antifreeze in the cooling water.
- Set each control levers to neutral or hold position, lock them and apply the parking brake.
- Open the drain valve of the air tank to drain condensation. Close after completely drained.

### DURING STORAGE

- Operate the engine and move the machine for a short distance once a month so that new oil film will be coated over movable parts and component surfaces.
- Before operating the work equipment, wipe off the grease on the hydraulic piston rod.



**If it is unavoidably necessary to carry out rust-preventive operation while the machine is indoors, open up doors and windows to improve ventilation and prevent the gas poisoning.**

**AFTER STORAGE**

Carry out the following procedure when taking the machine out of long-term storage.

- Wipe off the grease on the hydraulic piston rod.
- Completely fill fuel tank, lubricate and add oil.
- ★ If the machine is stored without carrying out the monthly rust prevention operation, request your Komatsu distributor for service.



# COOLANT AND LUBRICANTS

No.	Supplier	Engine Oil [CD or CE] SAE10W, 30, 40 10W30, 15W40 (The 15W40 oil marked * is CE.)	Grease [Lithium-Base] NLGI No. 2	Anti-freeze Coolant [Ethylene Glycol Base] Permanent Type
1	KOMATSU	EO10-CD EO30-CD EO10-30CD EO15-40CD	G2-LI G2-LI-S	AF-ACL AF-PTL AF-PT (Winter, one season type)
2	AGIP	Diesel sigma S Super diesel multigrade * Sigma turbo	GR MU/EP	-
3	AMOCO	* Amoco 300	RYKON premium grease	-
4	ARCO	* Arcofleet S3 plus	Litholine HEP 2 Arco EP moly D	-
5	BP	Vanellus C3	Energrease LS-EP2	Antifreeze
6	CALTEX	* RPM delo 400 RPM delo 450	Marfak all purpose 2 Ultra-duty grease 2	AF engine coolant
7	CASTROL	* Turbomax * RX super CRD	MS3 Spheerol EPL2	Anti-freeze
8	CHEVRON	* Delo 400	Ultra-duty grease 2	-

No.	Supplier	<b>Engine Oil</b> <b>[CD or CE]</b> SAE10W, 30, 40 10W30, 15W40 (The 15W40 oil marked * is CE.)	<b>Grease</b> <b>[Lithium-Base]</b> <b>NLGI No. 2</b>	<b>Anti-freeze</b> <b>Coolant</b> <b>[Ethylene Glycol</b> <b>Base]</b> <b>Permanent Type</b>
9	CONOCO	* Fleet motor oil	Super-sta grease	-
10	ELF	Multiperformance 3C Performance 3C	Tranself EP Tranself EP type 2	Glacelf
11	EXXON (ESSO)	Essolube D3 * Essolube XD-3 * Essolube XD-3 Extra * Esso heavy duty Exxon heavy duty	Beacon EP2	All season coolant
12	GULF	Super duty motor oil * Super duty plus	Gulfcrown EP2 Gulfcrown EP special	Antifreeze and coolant
13	MOBIL	Delvac 1300 * Delvac super 10W-30, 15W-40	Mobilux EP2 Mobilgrease 77 Mobilgrease special	-

COOLANT AND LUBRICANTS

No.	Supplier	<b>Engine Oil</b> <b>[CD or CE]</b> SAE 10W, 30, 40 10W30, 15W40 (The 15W40 oil marked * is CE.)	<b>Grease</b> <b>[Lithium-Base]</b> <b>NLGI No. 2</b>	<b>Anti-freeze</b> <b>Coolant</b> <b>[Ethylene Glycol</b> <b>Base]</b> <b>Permanent Type</b>
14	PENNZOIL	* Supreme duty fleet motor oil	Multi-purpose white grease 705 707L White - Bearing grease	Anti-freeze and summer coolant
15	PETROFINA	FINA kappa TD	FINA marson EPL2	FINA tamidor
16	SHELL	Rimula X	Alvania EP grease	-
17	SUN	-	Sunoco ultra prestige 2EP Sun prestige 742	Sunoco antifreeze and summer coolant
18	TEXACO	* Ursa super plus Ursa premium	Multifak EP2 Starplex 2	Code 2055 startex antifreeze coolant
19	TOTAL	Rubia S * Rubia X	Multis EP2	Antigel/antifreeze
20	UNION	* Guardol	Unoba EP	-
21	VEEDOL	* Turbostar * Diesel star MDC	-	Antifreeze