

CEAM014901

Operation & Maintenance Manual

730E

DUMP TRUCK

SERIAL NUMBERS **A30310, A30312 - A30426**

KOMATSU[®]

EMISSION CONTROL WARRANTY

EMISSION CONTROL WARRANTY STATEMENT (APPLIES TO CANADA ONLY)

1. Products Warranted

Komatsu America International Company, Komatsu Mining Systems Inc. and Komatsu Utility Corporation (collectively "Komatsu") produce and/or market products under brand names of Komatsu, Dresser, Dressta, Haulpak and Galion. This emissions warranty applies to new engines bearing the Komatsu name installed in these products and used in Canada in machines designed for industrial off-highway use. This warranty applies only to these engines produced on or after January 1, 2000. This warranty will be administered by Komatsu distribution in Canada.

2. Coverage

Komatsu warrants to the ultimate purchaser and each subsequent purchaser that the engine is designed, built and equipped so as to conform, at the time of sale by Komatsu, with all U.S. Federal emission regulations applicable at the time of manufacture and that it is free from defects in workmanship or material which would cause it not to meet these regulations within five years or 3,000 hours of operation, whichever occurs first, as measured from the date of delivery of the engine to the ultimate purchaser.

3. Limitations

Failures, other than those resulting from defects in materials or workmanship, are not covered by this warranty. Komatsu is not responsible for failures or damage resulting from what Komatsu determines to be abuse or neglect, including, but not limited to: operation without adequate coolant or lubricants; over fueling; over speeding; lack of maintenance of lubricating, cooling or intake systems; improper storage, starting, warm-up, run-in or shutdown practices; unauthorized modifications of the engine. Komatsu is also not responsible for failures caused by incorrect fuel or by water, dirt or other contaminants in the fuel. Komatsu is not responsible for non-engine repairs, "downtime" expense, related damage, fines, all business costs or other losses resulting from a warrantable failure.

KOMATSU IS NOT RESPONSIBLE FOR INCIDENTAL OR CONSEQUENTIAL DAMAGES.

This warranty, together with the express commercial warranties, are the sole warranties of Komatsu. **THERE ARE NO OTHER WARRANTIES, EXPRESS OR IMPLIED, OR OF MERCHANTABILITY OR FITNESS FOR A PARTICULAR PURPOSE.**

GARANTIE SUR LE CONTRÔLE DES ÉMISSIONS

ÉNONCÉ DE GARANTIE SUR LE CONTRÔLE DES ÉMISSIONS (APPLICABLE AU CANADA SEULEMENT):

1. Produits garantis:

Komatsu America International Company, Komatsu Mining Systems Inc. et Komatsu Utility Corporation (collectivement Komatsu) produisent et/ou font la mise en marché de produits portant les noms de marque Komatsu, Dresser, Dressta, Haulpak et Galion. Cette garantie sur les émissions s'applique à tous les nouveaux moteurs portant le nom Komatsu, installés dans ces produits et utilisés au Canada dans des machines conçues pour utilisation industrielle non-routière. Cette garantie s'applique seulement sur les moteurs produits à partir du 1er Janvier 2000. Cette garantie sera administrée par la distribution de Komatsu au Canada.

2. Couverture:

Komatsu garantit à l'acheteur ultime et chaque acheteur subséquent que le moteur est conçu, construit et équipé en toute conformité, au moment de la vente par Komatsu, avec toutes les Réglementations fédérales américaines sur les émissions applicables au moment de la fabrication et qu'il est exempt de défauts de construction ou de matériaux qui auraient pour effet de contrevenir à ces réglementations en dedans de 5 ans ou 3000 heures d'opération, mesuré à partir de la date de livraison du moteur au client ultime.

3. Limitations:

Les bris, autres que ceux résultant de défauts de matériaux ou de construction, ne sont pas couverts par cette Garantie. Komatsu n'est pas responsable pour bris ou dommages résultant de ce que Komatsu détermine comme étant de l'abus ou négligence, incluant mais ne se limitant pas à: l'opération sans lubrifiants ou agent refroidissants adéquats; la suralimentation d'essence; la survitesse; le manque d'entretien des systèmes de lubrification, de refroidissement ou d'entrée; de pratiques non-propices d'entreposage, de mise en marche, de réchauffement, de conditionnement ou d'arrêt; les modifications non-autorisées du moteur. De plus, Komatsu n'est pas responsable de bris causés par de l'essence inadéquate ou de l'eau, des saletés ou autres contaminants dans l'essence. Komatsu n'est pas responsable des réparations non-relées au moteur, des dépenses encourues suite aux temps d'arrêts, des dommages relatifs, amendes, et de tout autre coût d'affaires ou autres pertes résultant d'un bris couvert par la garantie.

KOMATSU N'EST PAS RESPONSABLE DES INCIDENTS OU DOMMAGES CONSÉQUENTS.

Cette garantie, ainsi que les garanties expresses commerciales, sont les seules garanties de Komatsu. **IL N'Y A AUCUNE AUTRE GARANTIE, EXPRESSE OU SOUS-ENTENDUE, MARCHANDABLE OU PROPICE A UNE UTILISATION PARTICULIÈRE.**

INFORMATION IMPORTANTE SUR LE MOTEUR
 CE MOTEUR EST CONFORME AUX NORMES AMÉRICAINES DEL'EPA (ANNÉE DU MODÈLE) ET DE LA CALIFORNIE POUR LES MOTEURS LARGES NON-ROUTIERS A IGNITION PAR COMPRESSION. CE MOTEUR EST CERTIFIÉ POUR OPERATION À ESSENCE DIÉSEL.

AVERTISSEMENT
 DES BLESSURES PEUVENT RÉsulTER ET LA GARANTIE S'ANNULER SI LES RPM DU TAUX D'ESSENCE OU L'ALTITUDE EXCÈDENT LES VALEURS MAXIMALES PUBLIÉES POUR CE MODÈLE ET SON APPLICATION.

IMPORTANT ENGINE INFORMATION
 THIS ENGINE CONFORMS TO YYYY MODEL YEAR U.S. EPA REGULATION AND THE CALIFORNIA REGULATIONS LARGE NON ROAD COMPRESSION IGNITION ENGINES. THIS ENGINE IS CERTIFIED TO OPERATE ON DIESEL FUEL.

WARNING
 INJURY MAY RESULT AND WARRANTY IS VOIDED IF FUEL RATE RPM OR ALTITUDES EXCEED PUBLISHED MAXIMUM VALUES FOR THIS MODEL AND APPLICATION.

| | | | |
|---------------------------------|-----------|---------------------------------------|-------------------------|
| ENGINE MODEL | | SERIAL NO. | |
| ENGINE FAMILY | | DISPLACEMENT | LITERS |
| EXHAUST EMISSION CONTROL SYSTEM | | FIRING ORDER | 1 - 5 - 3 - 6 - 2 - 4 |
| ADV. LOAD OUTPUT | | Kw (HP) | RPM |
| VALVE LASH COLD (mm) | IN. EX. | FUEL RATE AT ADV. | mm ³ /STROKE |
| IDLE SPEED | | RPM | FAMILY EMISSION LIMIT |
| INITIAL INJECTION TIMING | DEG. BTDC | DATE OF MANUFACTURE | |
| | | KOMATSU LTD. MADE IN JAPAN | KOMATSU |

**KOMATSU LTÉE
FABRIQUÉ AU JAPON**

MODÈLE DU MOTEUR

FAMILLE DU MOTEUR

SYSTÈME DE CONTROLE DES ÉMISSIONS D'ÉCHAPPEMENT

CHARGE DE SORTIE ADV.

PORTÉE DE VALVE À FROID (mm)

VITESSE STATIQUE

RÉGLAGE DE L'ALLUMAGE - INJECTION INITIALE

DEG. BTDC

NO. SÉRIE

DÉPLACEMENT

LITRES

SÉQUENCE DE MISE À FEU

mm³/BATTEMENT

TAUX D'ESSENCE À ADV.

LIMITE D'ÉMISSION DE LA FAMILLE

DATE DE FABRICATION

ENGINE DATAPLATE - ENGLISH / FRENCH

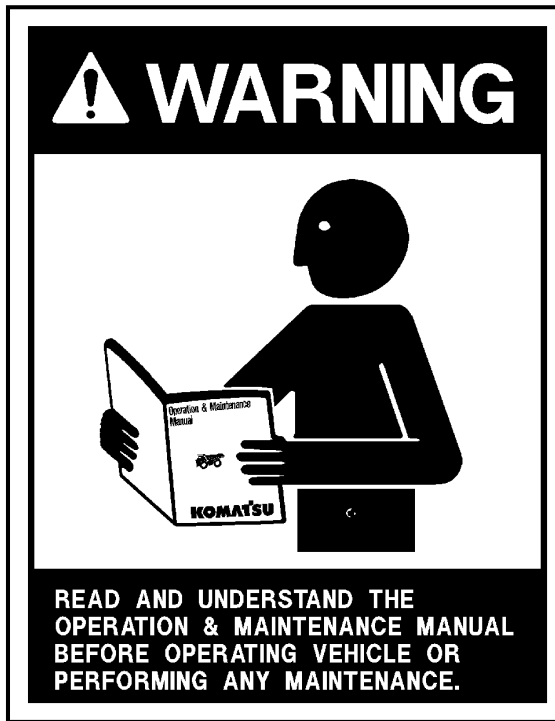

Unsafe use of this machine may cause serious injury or death. Operators and maintenance personnel must read and understand this manual before operating or maintaining this machine.

This manual should be kept in or near the machine for reference, and periodically reviewed by all personnel who will come into contact with it.

This material is proprietary to Komatsu America Corp (KAC), and is not to be reproduced, used, or disclosed except in accordance with written authorization from KAC.

It is the policy of the Company to improve products whenever it is possible and practical to do so. The Company reserves the right to make changes or add improvements at any time without incurring any obligation to install such changes on products sold previously.

Because of continuous research and development, periodic revisions may be made to this publication. Customers should contact their local Komatsu distributor for information on the latest revision.

CALIFORNIA

Proposition 65 Warning

Diesel engine exhaust, some of its constituents, and certain vehicle components contain or emit chemicals known to the State of California to cause cancer, birth defects or other reproductive harm.

CALIFORNIA

Proposition 65 Warning

Battery posts, terminals and related accessories contain lead and lead compounds, chemicals known to the State of California to cause cancer and birth defects or other reproductive harm. Wash hands after handling.



NON-OEM PARTS IN CRITICAL SYSTEMS

For safety reasons, Komatsu America Corp. strongly recommends against the use of non-OEM replacement parts in critical systems of all Komatsu equipment. Critical systems include but are not limited to steering, braking and operator safety systems.

Replacement parts manufactured and supplied by unauthorized sources may not be designed, manufactured or assembled to Komatsu's design specifications; accordingly, use of such parts may compromise the safe operation of Komatsu products and place the operator and others in danger should the part fail.

Komatsu is also aware of repair companies that will rework or modify an OEM part for reuse in critical systems. Komatsu does not generally authorize such repairs or modifications for the same reasons as noted above.

Use of non-OEM parts places full responsibility for the safe performance of the Komatsu product on the supplier and user. Komatsu will not in any case accept responsibility for the failure or performance of non-OEM parts in its products, including any damages or personal injury resulting from such use.

INTRODUCTION

FOREWORD

This manual is written for use by the operator and/or the service technician. It is designed to help these persons to become fully knowledgeable of the truck and all its systems in order to keep it operating safely and efficiently. All operators and maintenance personnel must read and understand the materials in this manual before operating the truck or performing maintenance and/or operational checks on the truck. All safety notices, warnings, and cautions must be understood and followed when operating or repairing the truck.

A product identification plate is located on the frame in front of the right side front wheel and designates the truck model number, product identification number (vehicle serial number), and maximum GVW (Gross Vehicle Weight) rating.

The Komatsu truck model designation consists of three numbers and one letter (i.e. 930E).

The three numbers represent the basic truck model.

The letter E, when present, designates an electrical wheel motor drive system.

The product identification number (vehicle serial number) contains information which will identify the original manufacturing bill of material for this unit. This complete number will be necessary for proper ordering of many service parts and/or warranty consideration.

The GVW is what determines the load on the drive train, frame, tires, and other components. The vehicle design and application guidelines are sensitive to the total maximum Gross Vehicle Weight (GVW). GVW is total weight: the empty vehicle weight + the fuel and lubricants + the payload.

To determine allowable payload, fill all lubricants and fuel tank to the proper level. Weigh the truck and record this value. Subtract it from the GVW to determine the allowable payload.

NOTE: Accumulations of mud, frozen material, etc., become part of the GVW and reduces allowable payload. To maximize payload and to keep from exceeding the GVW rating, these accumulations must be removed as often as practical.

Exceeding the allowable payload will reduce the expected life of truck components.

▲WARNING

Unsafe use of this machine may cause serious injury or death. Operators and maintenance personnel must read this manual before operating or maintaining this machine. This manual should be kept in or near the machine for reference and periodically reviewed by all personnel who come in contact with it.

TRUCK MODEL ILLUSTRATION

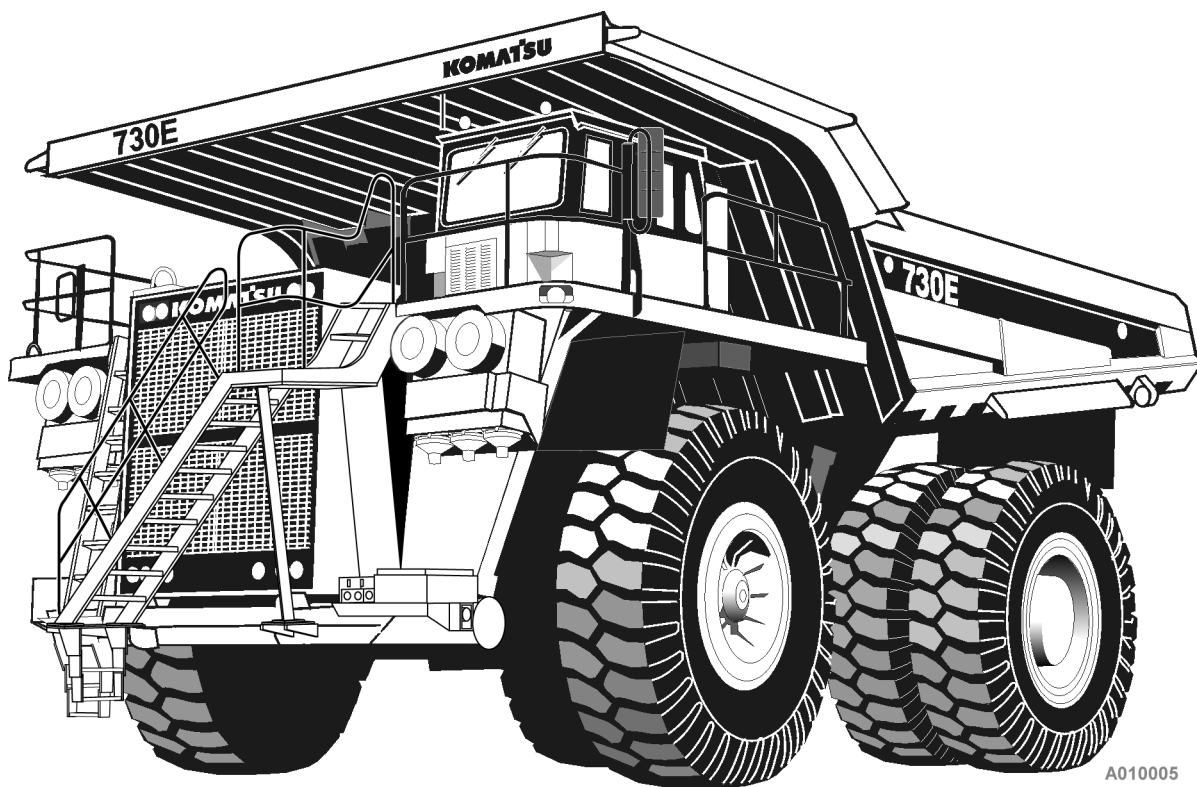

KOMATSU MODEL 730E DUMP TRUCK

ABOUT THIS MANUAL

The front cover of this manual includes a form number. This form number must be referenced when ordering additional copies of this manual, or for any other correspondence regarding the coverage in this manual.

Direct all inquiries to:

Komatsu America Corp.
Datakom, Peoria Technical Publications
P.O. Box 240
Peoria, IL 61650-0240
United States of America
Fax (309) 672-7072

This first section is an Introduction to the manual. It contains the Table of Contents for locating specific areas of interest. Other sections include:

- Standard Charts and Tables
- Safety
- Warnings and Cautions
- Operating Instructions
- Operator Cab and Controls
- Lubrication and Service
- Automatic Lubrication System
- Major Component Descriptions/Specifications
- Payload Meter III
- Radio, AM/FM, Cassette

When searching for a specific area of interest, go first to the Table of Contents to locate the section in which the subject might generally be included. Then, go to that section of the Table of Contents to find a subject description that most closely describes the specific area of interest to find a page number, and go to that page. Section numbers and page numbers are located at the top, outside corner of the page.

At the top, inside corner of the page is a document (module) number. If there is ever a question regarding the information in a particular section, refer to the document (module) number, the manual form number, and use the address shown above to correspond. If there is a date (month/year) behind the document (module) number, that date indicates the latest revision date of that page.

The illustrations used in this manual are typical of the component shown, and may not be an exact reproduction of what is found on the truck.

This manual shows dimensioning of U.S. standard and metric (SI) units throughout. All references to right, left, front, or rear are made with respect to the operator's normal seated position, unless specifically stated otherwise.

When assembly instructions are provided without references to torque values, standard torque values must be used. Standard torque requirements are shown in the torque charts on the following pages of the next section and in the General Information section of the truck shop manual. Individual torques, when provided in the text, are in bold face type, such as **135 N·m (100 ft lbs)**. All torque specifications have $\pm 10\%$ tolerance, unless otherwise specified.

ALERTS PAGE



This ALERT symbol is used in this manual, along with the signal words CAUTION, DANGER, and WARNING, to alert the reader to hazards arising from improper operating and maintenance practices.



*DANGER identifies a specific potential hazard
WHICH WILL RESULT
in either INJURY OR DEATH
if proper precautions are not taken.*



*WARNING identifies a specific potential hazard
WHICH MAY RESULT
in either INJURY OR DEATH
if proper precautions are not taken.*



*CAUTION is used for general reminders
of proper safety practices
OR
to direct the reader's attention to avoid unsafe
or improper practices which may result
in damage to the equipment.*

TABLE OF CONTENTS

| SUBJECT | SECTION/PAGE |
|---|-----------------------|
| INTRODUCTION | SECTION 10 |
| FOREWORD | 10-1 |
| TRUCK MODEL ILLUSTRATION | 10-2 |
| ABOUT THIS MANUAL | 10-3 |
| ALERTS PAGE | 10-4 |
| TABLE OF CONTENTS | 10-5 |
| STANDARD CHARTS AND TABLES | SECTION 12 |
| GENERAL SAFETY | SECTION 20 |
| PERSONAL SAFETY | 20-1 |
| PRECAUTIONS FOR TRUCK OPERATION | 20-4 |
| OPERATING THE MACHINE | 20-5 |
| TOWING | 20-8 |
| WORKING NEAR BATTERIES | 20-8 |
| PRECAUTIONS FOR MAINTENANCE | 20-9 |
| BEFORE PERFORMING MAINTENANCE | 20-9 |
| DURING MAINTENANCE | 20-10 |
| TIRES | 20-12 |
| ADDITIONAL JOB SITE RULES | 20-13 |
| WHEN REPAIRS ARE NECESSARY | 20-14 |
| WARNINGS AND CAUTIONS | SECTION 22 |
| OPERATING INSTRUCTIONS | SECTION 30 |
| PREPARING FOR OPERATION | 30-1 |
| SAFETY IS THINKING AHEAD | 30-1 |
| WALK-AROUND INSPECTION | 30-1 |
| ENGINE START-UP | 30-5 |
| AFTER ENGINE HAS STARTED | 30-5 |

| SUBJECT | SECTION/PAGE |
|---|---------------------|
| MACHINE OPERATION SAFETY PRECAUTIONS | 30-6 |
| LOADING | 30-7 |
| HAULING | 30-7 |
| PASSING | 30-7 |
| DUMPING | 30-8 |
| TOWING | 30-9 |
| SAFE PARKING PROCEDURES | 30-10 |
| ENGINE SHUTDOWN PROCEDURE | 30-10 |
| DELAYED ENGINE SHUTDOWN PROCEDURE | 30-10 |
| SUDDEN LOSS OF POWER | 30-11 |
| EMERGENCY STEERING SYSTEM | 30-12 |
| OPERATOR CAB AND CONTROLS..... | SECTION 32 |
| STEERING WHEEL AND CONTROLS | 32-2 |
| STEERING WHEEL | 32-2 |
| HORN BUTTON | 32-2 |
| TILT/TELESCOPE LEVER | 32-2 |
| MULTI-FUNCTION TURN SIGNAL SWITCH | 32-2 |
| PEDALS | 32-3 |
| SERVICE BRAKE PEDAL | 32-3 |
| DYNAMIC RETARDER PEDAL | 32-3 |
| THROTTLE PEDAL | 32-3 |
| CAB CLIMATE CONTROL | 32-4 |
| HEATER/AIR CONDITIONER VENTS | 32-4 |
| HEATER/AIR CONDITIONER CONTROLS AND VENTS | 32-4 |
| OVERHEAD PANEL CONTROLS AND COMPONENTS | 32-5 |
| GRADE/SPEED WARNING CHART | 32-5 |
| RADIO SPEAKERS | 32-5 |
| WARNING ALARM BUZZER | 32-5 |

| SUBJECT | SECTION/PAGE |
|---|---------------------|
| CAB RADIO | 32-5 |
| WARNING LIGHTS DIMMER CONTROL | 32-5 |
| WARNING/STATUS INDICATOR LIGHT PANEL | 32-5 |
| AIR CLEANER VACUUM GAUGES | 32-5 |
| WINDSHIELD WIPERS | 32-5 |
| CENTER CONSOLE | 32-6 |
| TRUCK CONTROLS | 32-6 |
| CONSOLE SWITCHES AND CONTROLS | 32-7 |
| PAYLOAD METER | 32-9 |
| OPERATOR SEAT | 32-10 |
| ADJUSTMENT | 32-10 |
| INSTRUMENT PANEL | 32-11 |
| GENERAL INFORMATION | 32-11 |
| CONTROL SYMBOLS | 32-11 |
| CONTROL SWITCHES AND GAUGES | 32-12 |
| OVERHEAD STATUS/WARNING INDICATOR LIGHT PANEL | 32-16 |
| DESCRIPTION OF INDICATOR SYMBOLS | 32-16 |
| INDICATOR LIGHT FUNCTIONS | 32-17 |
| CENTRY™ FUEL SYSTEM DIAGNOSTICS | 32-21 |
| GENERAL OPERATION | 32-21 |
| DETERMINING FAULT CODES | 32-21 |
| EXITING THE DIAGNOSTICS MODE | 32-22 |
| LUBRICATION AND SERVICE | SECTION 40 |
| GENERAL INFORMATION | 40-1 |
| HYDRAULIC TANK SERVICE | 40-1 |
| COOLING SYSTEM | 40-2 |
| LUBRICATION CHART | 40-3 |
| 10 HOUR LUBE AND MAINTENANCE CHECKS | 40-4 |
| 50 HOUR LUBRICATION AND MAINTENANCE CHECKS | 40-5 |

| SUBJECT | SECTION/PAGE |
|--|---------------------|
| 100 HOUR LUBRICATION AND MAINTENANCE CHECKS | 40-6 |
| 250 HOUR LUBRICATION AND MAINTENANCE CHECKS | 40-7 |
| 500 HOUR LUBRICATION AND MAINTENANCE CHECKS | 40-9 |
| 1,000 HOUR LUBRICATION AND MAINTENANCE CHECKS | 40-10 |
| 1,500 HOUR LUBRICATION AND MAINTENANCE CHECKS | 40-10 |
| 2,500 HOUR LUBRICATION AND MAINTENANCE CHECKS | 40-11 |
| 5,000 HOUR LUBRICATION AND MAINTENANCE CHECKS | 40-11 |
| 10,000 HOUR LUBRICATION AND MAINTENANCE CHECKS | 40-12 |
| AUTOMATIC LUBRICATION SYSTEM | SECTION 42 |
| GENERAL DESCRIPTION | 42-1 |
| SYSTEM COMPONENTS | 42-2 |
| SYSTEM OPERATION | 42-6 |
| GENERAL INSTRUCTIONS | 42-8 |
| LUBRICANT REQUIRED FOR SYSTEM | 42-8 |
| SYSTEM PRIMING | 42-8 |
| LUBRICANT PUMP | 42-8 |
| INJECTORS (SL-1 Series H) | 42-10 |
| INJECTOR OPERATION | 42-11 |
| SYSTEM CHECKOUT | 42-12 |
| PREVENTIVE MAINTENANCE INSPECTION | 42-13 |
| SYSTEM TROUBLESHOOTING CHART | 42-15 |
| MAJOR COMPONENT DESCRIPTION | SECTION 50 |
| PAYLOAD METER III TM | SECTION 60 |
| RADIO, AM/FM, CASSETTE | SECTION 70 |
| GENERAL RECEIVER FUNCTIONS | 70-1 |
| SETTING THE TIME | 70-2 |

SUBJECT **SECTION/PAGE**

OPERATING THE RADIO 70-2

ADJUSTING THE RECEIVER SETTINGS 70-3

PROGRAMMING PRESET STATIONS 70-3

OPERATION OF THE WEATHERBAND (U.S.) 70-3

SATELLITE RADIO 70-4

CASSETTE PLAYER 70-5

NOTES

STANDARD CHARTS AND TABLES

This manual provides dual dimensioning for most specifications. U.S. standard units are specified first, with metric (SI) units in parentheses.

References throughout the manual to standard torques or other standard values will be to one of the following charts or tables. For values not shown in these charts or tables, standard conversion factors for most commonly used measurements are provided in TABLE XIII, page 12-6.

Standard torque values are not to be used when “turn-of-the-nut” tightening procedures are recommended.

INDEX OF TABLES

TABLE I Standard Torque Chart (SAE) . . 12-1
 TABLE II . Standard Torque, 12-Point, Grade 9 . . 12-2
 TABLE III . . Standard Metric Assembly Torque . . 12-2
 TABLE IV JIC Swivel Nuts Torque Chart . . 12-3
 TABLE V Pipe Thread Torque Chart . . 12-3
 TABLE VI O-Ring Boss Torque Chart . . 12-3
 TABLE VII O-Ring Face Seal Torque Chart . . 12-3
 TABLE VIII . Torque Conversions (ft lbs to N•m) . . 12-4
 TABLE IX . Torque Conversions (ft lbs to kg•m) . . 12-4
 TABLE X . . Pressure Conversions (psi to kPa) . . 12-4
 TABLE XI . Pressure Conversions (psi to MPa) . . 12-5
 TABLE XII Temperature Conversions . . 12-5
 TABLE XIII . . . Common Conversion Multipliers . . 12-6

EFFECT OF SPECIAL LUBRICANTS On Fasteners and Standard Torque Values

The Komatsu engineering department does not recommend the use of special friction-reducing lubricants, such as Copper Coat, Never-Seez®, and other similar products, on the threads of standard fasteners where standard torque values are applied. The use of special friction-reducing lubricants will significantly alter the clamping force being applied to fasteners during the tightening process.

If special friction-reducing lubricants are used with the standard torque values listed below in Table I (and in Komatsu shop manuals), excessive stress and possible breakage of the fasteners may result.

Where the torque tables specify “Lubricated Threads” for the standard torque values listed, these standard torque values are to be used with simple lithium base chassis grease (multi-purpose EP NLGI) or a rust-preventive grease (see list, page 12-2) on the threads and seats unless specified otherwise.

NOTE: Ensure the threads of fasteners and tapped holes are free of burrs and other imperfections before assembling.

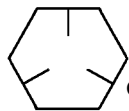

Grade 5

TABLE I. STANDARD TORQUE CHART
SAE HEX HEAD CAP SCREW AND NUT ASSEMBLY
(LUBRICATED THREADS)
TOLERANCES ±10%

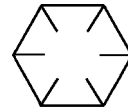

Grade 8

| Capscrew Thread Size | TORQUE - GRADE 5 | | | TORQUE - GRADE 8 | | | Capscrew Thread Size | TORQUE - GRADE 5 | | | TORQUE - GRADE 8 | | |
|----------------------|------------------|------|------|------------------|------|------|----------------------|------------------|-------|------|------------------|-------|------|
| | ft lbs | kg•m | N•m | ft lbs | kg•m | N•m | | ft lbs | kg•m | N•m | ft lbs | kg•m | N•m |
| 1/4-20 | 7 | 0.97 | 9.5 | 10 | 1.38 | 13.6 | 3/4-16 | 235 | 32.5 | 319 | 335 | 46.3 | 454 |
| 1/4-28 | 8 | 1.11 | 10.8 | 11 | 1.52 | 14.9 | 7/8-9 | 350 | 48.4 | 475 | 500 | 69.2 | 678 |
| 5/16-18 | 15 | 2.07 | 20.3 | 21 | 2.90 | 28 | 7/8-14 | 375 | 51.9 | 508 | 530 | 73.3 | 719 |
| 5/16-24 | 16 | 2.21 | 22 | 22 | 3.04 | 30 | 1.0-8 | 525 | 72.6 | 712 | 750 | 103.7 | 1017 |
| 3/8-16 | 25 | 3.46 | 34 | 35 | 4.84 | 47 | 1.0-12 | 560 | 77.4 | 759 | 790 | 109.3 | 1071 |
| 3/8-24 | 30 | 4.15 | 41 | 40 | 5.5 | 54 | 1.0-14 | 570 | 78.8 | 773 | 800 | 110.6 | 1085 |
| 7/16-14 | 40 | 5.5 | 54 | 58 | 8.0 | 79 | 1 1/8-7 | 650 | 89.9 | 881 | 1050 | 145 | 1424 |
| 7/16-20 | 45 | 6.2 | 61 | 62 | 8.57 | 84 | 1 1/8-12 | 700 | 96.8 | 949 | 1140 | 158 | 1546 |
| 1/2-13 | 65 | 9 | 88 | 90 | 12.4 | 122 | 1 1/4-7 | 910 | 125.9 | 1234 | 1480 | 205 | 2007 |
| 1/2-20 | 70 | 9.7 | 95 | 95 | 13.1 | 129 | 1 1/4-12 | 975 | 134.8 | 1322 | 1580 | 219 | 2142 |
| 9/16-12 | 90 | 12.4 | 122 | 125 | 17.3 | 169 | 1 3/8-6 | 1200 | 166 | 1627 | 1940 | 268 | 2630 |
| 9/16-18 | 95 | 13.1 | 129 | 135 | 18.7 | 183 | 1 3/8-12 | 1310 | 181 | 1776 | 2120 | 293 | 2874 |
| 5/8-11 | 125 | 17.3 | 169 | 175 | 24.2 | 237 | 1 1/2-6 | 1580 | 219 | 2142 | 2560 | 354 | 3471 |
| 5/8-18 | 135 | 18.7 | 183 | 190 | 26.2 | 258 | 1 1/2-12 | 1700 | 235 | 2305 | 2770 | 383 | 3756 |
| 3/4-10 | 220 | 30.4 | 298 | 310 | 42.8 | 420 | | | | | | | |

1 ft. lbs. = 0.138 kg•m = 1.356 N•m

STANDARD ASSEMBLY TORQUES For 12-Point, Grade 9 Cap screws (SAE)

The following specifications apply to required assembly torques for all 12-point, grade 9 (170,000 psi minimum tensile) cap screws.

- Cap screw threads and seats shall be lubricated when assembled.

NOTE: Unless the instructions specifically recommend otherwise, these standard torque values are to be used with simple lithium base chassis grease (multi-purpose EP NLGI) or a rust preventive grease (see list, this page) on the threads.

- Torques are calculated to give a clamping force of approximately 75% of proof load.
- The maximum torque tolerance shall be $\pm 10\%$ of the torque value shown.

**TABLE II. STANDARD ASSEMBLY TORQUE
for 12-Point, Grade 9 Cap screws**

| CAPSCREW SIZE* | TORQUE ft lbs | TORQUE N•m | TORQUE kg•m |
|--|---------------|------------|-------------|
| 0.250 - 20 | 12 | 16 | 1.7 |
| 0.312 - 18 | 24 | 33 | 3.3 |
| 0.375 - 16 | 42 | 57 | 5.8 |
| 0.438 - 14 | 70 | 95 | 9.7 |
| 0.500 - 13 | 105 | 142 | 14.5 |
| 0.562 - 12 | 150 | 203 | 20.7 |
| 0.625 - 11 | 205 | 278 | 28.3 |
| 0.750 - 10 | 360 | 488 | 49.7 |
| 0.875 - 9 | 575 | 780 | 79.4 |
| 1.000 - 8 | 860 | 1166 | 119 |
| 1.000 - 12 | 915 | 1240 | 126 |
| 1.125 - 7 | 1230 | 1670 | 170 |
| 1.125 - 12 | 1330 | 1800 | 184 |
| 1.250 - 7 | 1715 | 2325 | 237 |
| 1.250 - 12 | 1840 | 2495 | 254 |
| 1.375 - 6 | 2270 | 3080 | 313 |
| 1.375 - 12 | 2475 | 3355 | 342 |
| 1.500 - 6 | 2980 | 4040 | 411 |
| 1.500 - 12 | 3225 | 4375 | 445 |
| * Shank Diameter (in.) - Threads per inch | | | |
| This table represents standard values only. Do not use these values to replace torque values which are specified in assembly instructions. | | | |

STANDARD ASSEMBLY TORQUES For Class 10.9 Cap screws & Class 10 Nuts

The following specifications apply to required assembly torques for all metric Class 10.9 finished hexagon head cap screws and Class 10 nuts.

- Cap screw threads and seats shall not be lubricated when assembled. These specifications are based on all cap screws, nuts, and hardened washers being phosphate and oil coated.

NOTE: If zinc-plated hardware is used, each piece must be lubricated with simple lithium base chassis grease (multi-purpose EP NLGI) or a rust preventive grease (see list, this page) to achieve the same clamping forces provided below.

- Torques are calculated to give a clamping force of approximately 75% of proof load.
- The maximum torque tolerance shall be within $\pm 10\%$ of the torque value shown.

**TABLE III. STANDARD ASSEMBLY TORQUE
for Metric Class 10.9 Cap screws & Class 10 Nuts**

| CAPSCREW SIZE* | TORQUE N•m | TORQUE ft lbs | TORQUE kg•m |
|--|------------|---------------|-------------|
| M6 x 1 | 12 | 9 | 1.22 |
| M8 x 1.25 | 30 | 22 | 3.06 |
| M10 x 1.5 | 55 | 40 | 5.61 |
| M12 x 1.75 | 95 | 70 | 9.69 |
| M14 x 2 | 155 | 114 | 15.81 |
| M16 x 2 | 240 | 177 | 24.48 |
| M20 x 2.25 | 465 | 343 | 47.43 |
| M24 x 3 | 800 | 590 | 81.6 |
| M30 x 3.5 | 1600 | 1180 | 163.2 |
| M36 x 4 | 2750 | 2028 | 280.5 |
| * Shank Diameter (mm) - Threads per millimeter | | | |
| This table represents standard values only. Do not use these values to replace torque values which are specified in assembly instructions. | | | |

Suggested* Sources for Rust Preventive Grease:

- AMERICAN ANTI-RUST GREASE #3-X from Standard Oil Company (also American Oil Co.)
- GULF NORUST #3 from Gulf Oil Company.
- MOBILARMA 355, Product No. 66705 from Mobil Oil Corporation.
- RUST BAN 326 from Humble Oil Company.
- RUSTOLENE B GREASE from Sinclair Oil Co.
- RUST PREVENTIVE GREASE - CODE 312 from the Southwest Grease and Oil Company.

NOTE: This list represents the current engineering approved sources for use in Komatsu manufacture. It is not exclusive. Other products may meet the same specifications of this list.

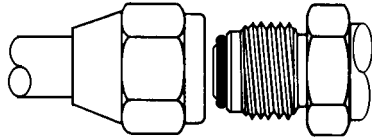

TABLE IV.
TORQUE CHART FOR JIC 37° SWIVEL NUTS
WITH OR WITHOUT O-RING SEALS

| SIZE CODE | TUBE SIZE (O.D.) | THREADS UNF-2B | TORQUE FT. LBS. |
|-----------|------------------|----------------|-----------------|
| - 2 | 0.125 | 0.312 - 24 | 4 ±1 |
| - 3 | 0.188 | 0.375 - 24 | 8 ±3 |
| - 4 | 0.250 | 0.438 - 20 | 12 ±3 |
| - 5 | 0.312 | 0.500 - 20 | 15 ±3 |
| - 6 | 0.375 | 0.562 - 18 | 18 ±5 |
| - 8 | 0.500 | 0.750 - 16 | 30 ±5 |
| - 10 | 0.625 | 0.875 - 14 | 40 ±5 |
| - 12 | 0.750 | 1.062 - 12 | 55 ±5 |
| - 14 | 0.875 | 1.188 - 12 | 65 ±5 |
| - 16 | 1.000 | 1.312 - 12 | 80 ±5 |
| - 20 | 1.250 | 1.625 - 12 | 100 ±10 |
| - 24 | 1.500 | 1.875 - 12 | 120 ±10 |
| - 32 | 2.000 | 2.500 - 12 | 230 ±20 |

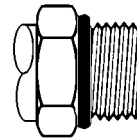

TABLE VI.
TORQUE CHART FOR
O-RING BOSS FITTINGS

| SIZE CODE | TUBE SIZE (O.D.) | THREADS UNF-2B | TORQUE FT. LBS. |
|-----------|------------------|----------------|-----------------|
| - 2 | 0.125 | 0.312 - 24 | 4 ±2 |
| - 3 | 0.188 | 0.375 - 24 | 5 ±2 |
| - 4 | 0.250 | 0.438 - 20 | 8 ±3 |
| - 5 | 0.312 | 0.500 - 20 | 10 ±3 |
| - 6 | 0.375 | 0.562 - 18 | 13 ±3 |
| - 8 | 0.500 | 0.750 - 16 | 24 ±5 |
| - 10 | 0.625 | 0.875 - 14 | 32 ±5 |
| - 12 | 0.750 | 1.062 - 12 | 48 ±5 |
| - 14 | 0.875 | 1.188 - 12 | 54 ±5 |
| - 16 | 1.000 | 1.312 - 12 | 72 ±5 |
| - 20 | 1.250 | 1.625 - 12 | 80 ±5 |
| - 24 | 1.500 | 1.875 - 12 | 80 ±5 |
| - 32 | 2.000 | 2.500 - 12 | 96 ±10 |

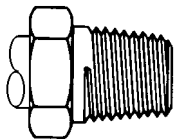

TABLE V.
TORQUE CHART FOR
PIPE THREAD FITTINGS

| SIZE CODE | PIPE THREAD SIZE | WITH SEALANT FT. LBS. | WITHOUT SEALANT FT. LBS. |
|-----------|------------------|-----------------------|--------------------------|
| - 2 | 0.125 - 27 | 15 ±3 | 20 ±5 |
| - 4 | 0.250 - 18 | 20 ±5 | 25 ±5 |
| - 6 | 0.375 - 18 | 25 ±5 | 35 ±5 |
| - 8 | 0.500 - 14 | 35 ±5 | 45 ±5 |
| - 12 | 0.750 - 14 | 45 ±5 | 55 ±5 |
| - 16 | 1.000 - 11.50 | 55 ±5 | 65 ±5 |
| - 20 | 1.250 - 11.50 | 70 ±5 | 80 ±5 |
| - 24 | 1.500 - 11.50 | 80 ±5 | 95 ±10 |
| - 32 | 2.000 - 11.50 | 95 ±10 | 120 ±10 |

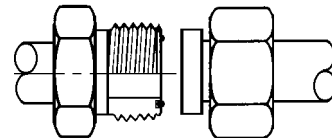

TABLE VII.
TORQUE CHART FOR
O-RING FACE SEAL FITTINGS

| SIZE CODE | TUBE SIZE (O.D.) | THREADS UNF-2B | TORQUE FT. LBS. |
|-----------|------------------|----------------|-----------------|
| - 4 | 0.250 | 0.438 - 20 | 11 ±1 |
| - 6 | 0.375 | 0.562 - 18 | 18 ±2 |
| - 8 | 0.500 | 0.750 - 16 | 35 ±4 |
| - 10 | 0.625 | 0.875 - 14 | 51 ±5 |
| - 12 | 0.750 | 1.062 - 12 | 71 ±7 |
| - 16 | 1.000 | 1.312 - 12 | 98 ±6 |
| - 20 | 1.250 | 1.625 - 12 | 132 ±7 |
| - 24 | 1.500 | 1.875 - 12 | 165 ±15 |

TABLE VIII. TORQUE CONVERSIONS
Foot Pounds (ft. lbs.) to Newton-meters (N·m)

| ft lbs | 0 | 1 | 2 | 3 | 4 | 5 | 6 | 7 | 8 | 9 |
|--------|--------|--------|--------|--------|--------|--------|--------|--------|--------|--------|
| 0 | (N.m) | 1.36 | 2.71 | 4.07 | 5.42 | 6.78 | 8.14 | 9.49 | 10.85 | 12.20 |
| 10 | 13.56 | 14.91 | 16.27 | 17.63 | 18.98 | 20.34 | 21.69 | 23.05 | 24.40 | 25.76 |
| 20 | 27.12 | 28.47 | 29.83 | 31.18 | 32.54 | 33.90 | 35.25 | 36.61 | 37.96 | 39.32 |
| 30 | 40.67 | 42.03 | 43.39 | 44.74 | 46.10 | 47.45 | 48.81 | 50.17 | 51.52 | 52.87 |
| 40 | 54.23 | 55.59 | 56.94 | 58.30 | 59.66 | 60.01 | 62.37 | 63.72 | 65.08 | 66.44 |
| 50 | 67.79 | 69.15 | 70.50 | 71.86 | 73.21 | 74.57 | 75.93 | 77.28 | 78.64 | 80.00 |
| 60 | 81.35 | 82.70 | 84.06 | 85.42 | 86.77 | 88.13 | 89.48 | 90.84 | 92.20 | 93.55 |
| 70 | 94.91 | 96.26 | 97.62 | 98.97 | 100.33 | 101.69 | 103.04 | 104.40 | 105.75 | 107.11 |
| 80 | 108.47 | 109.82 | 111.18 | 112.53 | 113.89 | 115.24 | 116.60 | 117.96 | 119.31 | 120.67 |
| 90 | 122.03 | 123.38 | 124.74 | 126.09 | 127.45 | 128.80 | 130.16 | 131.51 | 132.87 | 134.23 |

See NOTE on page 12-5 regarding table usage.

TABLE IX. TORQUE CONVERSIONS
Foot Pounds (ft. lbs.) to kilogram-meters (kg·m)

| ft lbs | 0 | 1 | 2 | 3 | 4 | 5 | 6 | 7 | 8 | 9 |
|--------|--------|-------|-------|-------|-------|-------|-------|-------|-------|-------|
| 0 | (kg.m) | 0.138 | 0.277 | 0.415 | 0.553 | 0.692 | 0.830 | 0.968 | 1.106 | 1.245 |
| 10 | 1.38 | 1.52 | 1.66 | 1.80 | 1.94 | 2.07 | 2.21 | 2.35 | 2.49 | 2.63 |
| 20 | 2.77 | 2.90 | 3.04 | 3.18 | 3.32 | 3.46 | 3.60 | 3.73 | 3.87 | 4.01 |
| 30 | 4.15 | 4.29 | 4.43 | 4.56 | 4.70 | 4.84 | 4.98 | 5.12 | 5.26 | 5.39 |
| 40 | 5.53 | 5.67 | 5.81 | 5.95 | 6.09 | 6.22 | 6.36 | 6.50 | 6.64 | 6.78 |
| 50 | 6.92 | 7.05 | 7.19 | 7.33 | 7.47 | 7.61 | 7.74 | 7.88 | 8.02 | 8.16 |
| 60 | 8.30 | 8.44 | 8.57 | 8.71 | 8.85 | 8.99 | 9.13 | 9.27 | 9.40 | 9.54 |
| 70 | 9.68 | 9.82 | 9.96 | 10.10 | 10.23 | 10.37 | 10.51 | 10.65 | 10.79 | 10.93 |
| 80 | 11.06 | 11.20 | 11.34 | 11.48 | 11.62 | 11.76 | 11.89 | 12.03 | 12.17 | 12.30 |
| 90 | 12.45 | 12.59 | 12.72 | 12.86 | 13.00 | 13.14 | 13.28 | 13.42 | 13.55 | 13.69 |

See NOTE on page 12-5 regarding table usage.

TABLE X. PRESSURE CONVERSIONS
Pounds per square inch (psi) to Kilopascals (kPa)
Formula: psi x 6.895 = kPa

| psi | 0 | 1 | 2 | 3 | 4 | 5 | 6 | 7 | 8 | 9 |
|-----|-------|-------|-------|-------|-------|--------|--------|--------|-------|-------|
| 0 | (kPa) | 6.895 | 13.79 | 20.68 | 27.58 | 34.47 | 41.37 | 48.26 | 55.16 | 62.05 |
| 10 | 68.95 | 75.84 | 82.74 | 89.63 | 96.53 | 103.42 | 110.32 | 117.21 | 124.1 | 131.0 |
| 20 | 137.9 | 144.8 | 151.7 | 158.6 | 165.5 | 172.4 | 179.3 | 186.2 | 193.1 | 200.0 |
| 30 | 206.8 | 213.7 | 220.6 | 227.5 | 234.4 | 241.3 | 248.2 | 255.1 | 262.0 | 268.9 |
| 40 | 275.8 | 282.7 | 289.6 | 296.5 | 303.4 | 310.3 | 317.2 | 324.1 | 331.0 | 337.9 |
| 50 | 344.7 | 351.6 | 358.5 | 365.4 | 372.3 | 379.2 | 386.1 | 393.0 | 399.9 | 406.8 |
| 60 | 413.7 | 420.6 | 427.5 | 434.4 | 441.3 | 448.2 | 455.1 | 462.0 | 468.9 | 475.8 |
| 70 | 482.6 | 489.5 | 496.4 | 503.3 | 510.2 | 517.1 | 524.0 | 530.9 | 537.8 | 544.7 |
| 80 | 551.6 | 558.5 | 565.4 | 572.3 | 579.2 | 586.1 | 593.0 | 599.9 | 606.8 | 613.7 |
| 90 | 620.5 | 627.4 | 634.3 | 641.2 | 648.1 | 655.0 | 661.9 | 668.8 | 675.7 | 682.6 |

See NOTE on page 12-5 regarding table usage.

TABLE XI. PRESSURE CONVERSIONS
Pounds per square inch (psi) to Megapascals (MPa)
Formula: $\text{psi} \times 0.0069 = \text{MPa}$

| psi | 0 | 10 | 20 | 30 | 40 | 50 | 60 | 70 | 80 | 90 |
|------------|-------|-------|------|------|------|------|------|------|------|------|
| 0 | (MPa) | 0.069 | 0.14 | 0.21 | 0.28 | 0.34 | 0.41 | 0.48 | 0.55 | 0.62 |
| 100 | 0.69 | 0.76 | 0.83 | 0.90 | 0.97 | 1.03 | 1.10 | 1.17 | 1.24 | 1.31 |
| 200 | 1.38 | 1.45 | 1.52 | 1.59 | 1.65 | 1.72 | 1.79 | 1.86 | 1.93 | 2.00 |
| 300 | 2.07 | 2.14 | 2.21 | 2.28 | 2.34 | 2.41 | 2.48 | 2.55 | 2.62 | 2.69 |
| 400 | 2.76 | 2.83 | 2.90 | 2.96 | 3.03 | 3.10 | 3.17 | 3.24 | 3.31 | 3.38 |
| 500 | 3.45 | 3.52 | 3.59 | 3.65 | 3.72 | 3.79 | 3.86 | 3.93 | 4.00 | 4.07 |
| 600 | 4.14 | 4.21 | 4.27 | 4.34 | 4.41 | 4.48 | 4.55 | 4.62 | 4.69 | 4.76 |
| 700 | 4.83 | 4.90 | 4.96 | 5.03 | 5.10 | 5.17 | 5.24 | 5.31 | 5.38 | 5.45 |
| 800 | 5.52 | 5.58 | 5.65 | 5.72 | 5.79 | 5.86 | 5.93 | 6.00 | 6.07 | 6.14 |
| 900 | 6.21 | 6.27 | 6.34 | 6.41 | 6.48 | 6.55 | 6.62 | 6.69 | 6.76 | 6.83 |

See NOTE below regarding Table usage.

NOTE: Tables such as Table VIII, IX, X, and XI may be used as in the following example:

Example: Convert 975 psi to kilopascals (kPa).

1. Select Table X.

2. Go to psi row 90, column 7; read 668.8
97 psi = 668.8 kPa.

3. Multiply by 10:

970 psi = 6688 kPa.

4. Go to psi row 0, column 5; read 34.475
psi = 34.47 kPa. Add to step 3.

5. $970 + 5 \text{ psi} = 6688 + 34 = 6722 \text{ kPa}$.

TABLE XII. TEMPERATURE CONVERSIONS
Formula: $F^\circ - 32 \times 1.8 = C^\circ$ or $C^\circ \times 1.8 + 32 = F^\circ$

| CELSIUS C° | | FAHRENHEIT F° | CELSIUS C° | | FAHRENHEIT F° | CELSIUS C° | | FAHRENHEIT F° |
|---------------|-----|------------------|---------------|-----|------------------|---------------|-----|------------------|
| 121 | 250 | 482 | 63 | 145 | 293 | 4 | 40 | 104 |
| 118 | 245 | 473 | 60 | 140 | 284 | 2 | 35 | 95 |
| 116 | 240 | 464 | 57 | 135 | 275 | -1 | 30 | 86 |
| 113 | 235 | 455 | 54 | 130 | 266 | -4 | 25 | 77 |
| 110 | 230 | 446 | 52 | 125 | 257 | -7 | 20 | 68 |
| 107 | 225 | 437 | 49 | 120 | 248 | -9 | 15 | 59 |
| 104 | 220 | 428 | 46 | 115 | 239 | -12 | 10 | 50 |
| 102 | 215 | 419 | 43 | 110 | 230 | -15 | 5 | 41 |
| 99 | 210 | 410 | 41 | 105 | 221 | -18 | 0 | 32 |
| 96 | 205 | 401 | 38 | 100 | 212 | -21 | -5 | 23 |
| 93 | 200 | 392 | 35 | 95 | 203 | -23 | -10 | 14 |
| 91 | 195 | 383 | 32 | 90 | 194 | -26 | -15 | 5 |
| 88 | 190 | 374 | 29 | 85 | 185 | -29 | -20 | -4 |
| 85 | 185 | 365 | 27 | 80 | 176 | -32 | -25 | -13 |
| 82 | 180 | 356 | 24 | 75 | 167 | -34 | -30 | -22 |
| 79 | 175 | 347 | 21 | 70 | 158 | -37 | -35 | -31 |
| 77 | 170 | 338 | 18 | 65 | 149 | -40 | -40 | -40 |
| 74 | 165 | 329 | 15 | 60 | 140 | -43 | -45 | -49 |
| 71 | 160 | 320 | 13 | 55 | 131 | -46 | -50 | -58 |
| 68 | 155 | 311 | 10 | 50 | 122 | -48 | -55 | -67 |
| 66 | 150 | 302 | 7 | 45 | 113 | -51 | -60 | -76 |

Note: The numbers in the unmarked columns refer to temperature in either degrees Celsius (C°) or Fahrenheit (F°). Select a number in this unmarked column and read to the left to convert to degrees Celsius (C°) or read to the right to convert to degrees Fahrenheit (F°). If starting with a known temperature (either C° or F°), find that temperature in the marked column and read the converted temperature in the center, unmarked column.

**Table XIII. TABLE XIII
COMMON CONVERSION MULTIPLIERS**

| COMMON CONVERSION MULTIPLIERS ENGLISH TO METRIC | | |
|--|---|--------------------|
| To Convert From | TO | Multiply By |
| inch – in. | millimeter (mm) | 25.40 |
| inch – in. | centimeter (cm) | 2.54 |
| foot – ft. | meter (m) | 0.3048 |
| yard – yd. | meter (m) | 0.914 |
| mile – mi. | kilometer (km) | 1.61 |
| sq. in. – in. ² | sq. centimeters (cm ²) | 6.45 |
| sq. ft. – ft. ² | sq. centimeters (cm ²) | 929 |
| cu. in. – in. ³ | cu. centimeters (cm ³) | 16.39 |
| cu. in. – in. ³ | liters (l) | 0.016 |
| cu. ft. – ft. ³ | cu. meters (m ³) | 0.028 |
| cu. ft. – ft. ³ | liters (l) | 28.3 |
| ounce – oz. | kilogram (kg) | 0.028 |
| fluid ounce – fl. oz. | milliliter (ml) | 29.573 |
| pound (mass) | kilogram (kg) | 0.454 |
| pound (force) – lbs. | Newton (N) | 4.448 |
| in. lbs. (force) | Newton-meters (N•m) | 0.113 |
| ft. lbs. (force) | Newton-meters (N•m) | 1.356 |
| ft. lbs. (force) | kilogram-meters (kg•m) | 0.138 |
| psi (pressure) | kilopascals (kPa) | 6.895 |
| psi (pressure) | megapascals (MPa) | 0.007 |
| psi (pressure) | kilograms/cm ² (kg/cm ²) | 0.0704 |
| ton (short) | kilogram (kg) | 907.2 |
| ton (short) | metric ton | 0.0907 |
| quart – qt. | liters (l) | 0.946 |
| gallon – gal. | liters (l) | 3.785 |
| HP (horsepower) | Watts | 745.7 |
| HP (horsepower) | kilowatts (kw) | 0.745 |

| COMMON CONVERSION MULTIPLIERS METRIC TO ENGLISH | | |
|--|----------------------------|--------------------|
| To Convert From | TO | Multiply By |
| millimeter (mm) | inch – in. | 0.0394 |
| centimeter (cm) | inch – in. | 0.3937 |
| meter (m) | foot – ft. | 3.2808 |
| meter (m) | yard – yd. | 1.0936 |
| kilometer (km) | mile – mi. | 0.6210 |
| sq. centimeters (cm ²) | sq. in. – in. ² | 0.1550 |
| sq. centimeters (cm ²) | sq. ft. – ft. ² | 0.001 |
| cu. centimeters (cm ³) | cu in – in. ³ | 0.061 |
| liters (l) | cu in – in. ³ | 61.02 |
| cu. meters (m ³) | cu ft – ft. ³ | 35.314 |
| liters (l) | cu ft – ft. ³ | 0.0353 |
| grams (g) | ounce – oz. | 0.0353 |
| milliliter (ml) | fluid ounce – fl. oz. | 0.0338 |
| kilogram (kg) | pound (mass) | 2.2046 |
| Newton (N) | pound (force) – lbs. | 0.2248 |
| Newton-meters (N•m) | kilogram-meters (kg•m) | 0.102 |
| Newton-meters (N.m) | ft lbs | 0.7376 |
| kilogram-meters (kg•m) | ft lbs | 7.2329 |
| kilogram-meters (kg•m) | Newton-meters (N•m) | 9.807 |
| kilopascals (kPa) | psi | 0.1450 |
| megapascals (MPa) | psi | 145.038 |
| kilograms/cm ² (kg/cm ²) | psi | 14.2231 |
| kilograms/cm ² (kg/cm ²) | kilopascals (kPa) | 98.068 |
| kilogram (kg) | ton | 0.0011 |
| metric ton | ton | 1.1023 |
| liters (l) | quart – qt. | 1.0567 |
| liters (l) | gallon – gal. | 0.2642 |
| Watts | Horsepower HP | 0.00134 |
| kilowatts (kw) | Horsepower HP | 1.3410 |

GENERAL SAFETY

Safety records of most organizations will show that the greatest percentage of accidents are caused by unsafe behavior. The remainder are caused by unsafe mechanical or physical conditions. Report all unsafe conditions to the proper authority.

The following safety rules are provided as a guide for the operator. However, local conditions and regulations may add many more to this list.



Read and follow all safety precautions. Failure to do so may result in serious injury or death.

PERSONAL SAFETY

Safety Rules

- Only trained and authorized personnel can operate and maintain the machine.
- Follow all safety rules, precautions, and instructions when operating or performing maintenance on the machine.
- When working with another operator, or a person on work site traffic duty, ensure all personnel understand all hand signals that are to be used.

Truck Safety Features

- Ensure all guards and covers are in their proper position. Repair any damaged guards and covers. (See Walk-Around Inspection, later in this section.)
- Learn the proper use of safety features, such as safety locks, safety pins, and seat belts. Use these safety features properly.
- DO NOT remove any safety features. Keep safety features in good operating condition.
- Improper use of safety features may result in serious bodily injury or death.

Clothing And Personal Items

- Avoid wearing loose clothing, jewelry, and loose long hair. They can catch on controls or in moving parts and cause serious injury or death. Additionally, DO NOT wear oily clothes as they are flammable.

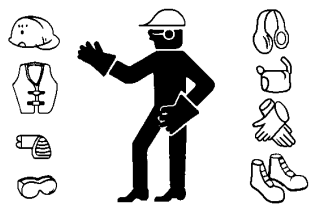

A0055010

- Wear a hard hat, safety glasses, safety shoes, mask, and gloves when operating or maintaining a machine. Wear safety goggles, a hard hat, and heavy gloves if your job involves scattering metal chips or very small materials--particularly when driving pins with a hammer, or when cleaning air cleaner elements with compressed air. Also, ensure that the work area is free of other personnel during such tasks.

Unauthorized Modification

- Any modification made to this vehicle, without authorization from Komatsu America Corp., can possibly create hazards.
- Before making any modification, consult your authorized regional Komatsu America Corp. distributor. Komatsu will not be responsible for any injury or damage caused by any unauthorized modification.

Leaving The Operator's Seat

- When leaving the operator's seat, DO NOT touch any controls. To prevent accidents from occurring, perform the following:

Move the selector switch to NEUTRAL, and apply the parking brake.

Lower the dump body, and move the hoist control lever to the FLOAT position.

Stop the engine. When exiting the machine, lock compartments, and take the keys with you to prevent entry from unauthorized persons.

Mounting And Dismounting

- DO NOT jump on or off the machine. DO NOT climb on or off a machine while it is moving.
- When climbing on or off a machine, face the machine and use the handhold and steps.
- DO NOT hold any control levers when getting on or off a machine.
- Maintain three-point contact with the handholds and steps to ensure that you support yourself.
- When bringing tools up to the operating deck, pass them by hand or pull them up by rope.
- If there is any oil, grease, or mud on the handholds or steps, wipe them clean immediately. Keep these components clean. Repair any damage, and tighten any loose bolts.

Use the handrails and steps marked by arrows in the diagram below when climbing on or off the machine.

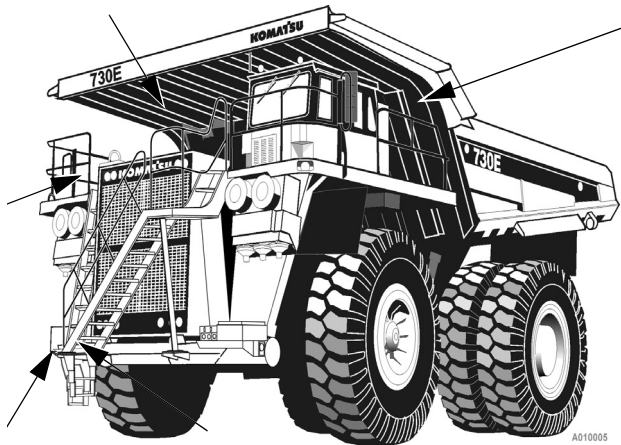

Fire Extinguishers And First Aid Kits

- Ensure fire extinguishers are accessible and proper usage techniques are known.
- Provide a first aid kit at the storage point.
- Know what to do in the event of a fire.
- Keep the phone numbers of persons you must contact in case of an emergency.

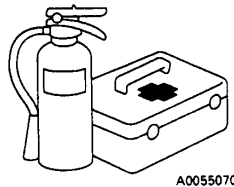

Precautions For High Temperature Fluids

- Immediately after operating the truck, engine coolant, engine oil, and hydraulic oil are at high temperatures and are pressurized. If the cap is removed, the fluids drained, the filters are replaced, etc., there is danger of serious burns. Allow heat and pressure to dissipate before performing such tasks, and follow proper procedures, as outlined in the service manual.
- To prevent hot coolant from spraying:
 1. Stop the engine, and wait for the coolant temperature to decrease.
 2. Depress the pressure relief button on the radiator cap.
 3. Turn the radiator cap slowly to allow pressure to dissipate.

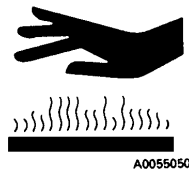

- To prevent hot engine oil spray:
 1. Stop the engine.
 2. Wait for the oil temperature to cool.
 3. Turn the cap slowly to allow pressure to dissipate.

Asbestos Dust Hazard Prevention

Asbestos dust is hazardous to your health when inhaled. If you handle materials containing asbestos fibers, follow the guidelines below:



- DO NOT use compressed air for cleaning.
- Use water for cleaning and to control dust.
- Operate the machine or perform tasks with the wind to your back, whenever possible.
- Use an approved respirator, when necessary.

Fire Prevention For Fuel And Oil

- Fuel, oil, and antifreeze can be ignited by a flame. These fluids are extremely flammable and hazardous.
- Keep flames away from flammable fluids.
- Stop the engine while refueling.
- DO NOT smoke while refueling.
- Tighten all fuel and oil tank caps securely.
- Refuel and maintain oil in well-ventilated areas.
- Keep oil and fuel in a designated location. DO NOT allow unauthorized persons to enter.



A030010

ROPS Precautions

- The Rollover Protection Structure (ROPS) must be properly installed before using the truck.
- The ROPS is intended to protect the operator if the machine rolls over. It is designed not only to support the load of the machine, but also to absorb the energy of the impact.
- ROPS structures, installed on equipment manufactured and designed by Komatsu America Corp., fulfill all of the regulations and standards for all countries. If it is modified or repaired without authorization from Komatsu, or is damaged when the machine rolls over, the strength of the structure will be compromised and will not be able to fulfill its intended purpose. Optimum strength of the structure can only be achieved if it is repaired or modified, as specified by Komatsu.
- When modifying or repairing the ROPS, consult your nearest Komatsu distributor.
- Even with the ROPS installed, the operator must use the seat belt when operating the machine.

Preventing Injury From Work Equipment

- DO NOT position any part of your body between movable parts, such as the dump body, chassis, or cylinders. If the work equipment is operated, clearances will change and may cause serious bodily injury or death.

Precautions For Optional Attachments

- When installing and using optional equipment, read the instruction manual for the attachment and the information related to attachments in this manual.
- DO NOT use attachments that are not authorized by Komatsu America Corp., or the authorized regional Komatsu distributor. Use of unauthorized attachments could create a safety problem and adversely affect the proper operation and useful life of the machine.
- Any injuries, accidents, and product failures resulting from the use of unauthorized attachments, will not be the responsibility of Komatsu America Corp., or the authorized regional Komatsu distributor.

Precautions When Starting The Machine

- Start the engine from the operator's seat only.
- DO NOT attempt to start the engine by shorting across the starter terminals. This may cause fire or serious injury or death to anyone in the machine's path.



PRECAUTIONS FOR TRUCK OPERATION

Safety Is Thinking Ahead

Prevention is the best safety program. Prevent a potential accident by knowing the employer's safety requirements and all necessary job site regulations. In addition, know the proper use and care of all the safety equipment on the truck. Only qualified operators or technicians may attempt to operate or maintain a Komatsu truck.

Safe practices start before the operator gets to the equipment!

Safety At The Work Site

- When walking to and from a truck, maintain a safe distance from all machines, even when the operator is visible.
- Before starting the engine, thoroughly check the area for any unusual conditions that could be dangerous.
- Examine the road surface at the job site, and determine the best and safest route.
- Choose an area where the ground is as horizontal and firm as possible before performing the inspection.
- If you need to operate on or near a public road, protect pedestrians and cars by designating a person for work site traffic duty, or by installing fences around the work site.
- The operator must personally check the work position, the roads to be used, and the existence of obstacles before starting the truck.
- Determine the travel roads to be used at the work site. Travel roads must be maintained in order to ensure safe machine travel.
- If travel through wet areas is necessary, check the depth and flow of water before crossing the shallow parts. DO NOT drive through water which exceeds the permissible water depth.

Fire Prevention

- Thoroughly remove wood chips, leaves, paper, and other flammable items accumulated in the engine compartment, as they could cause a fire.



A0055020

- Check fuel, lubrication, and hydraulic systems for leaks. Repair any leaks. Clean any excess oil, fuel, or other flammable fluids, and dispose of properly.
- Ensure a fire extinguisher is present and in proper working condition.
- DO NOT operate the machine near open flames.

Preparing For Operation

- Mount and dismount while facing the truck. DO NOT attempt to mount or dismount the truck while it is in motion. Use handrails and ladders when mounting or dismounting the truck.
- Check the deck areas for debris, loose hardware, and tools. Check for people and objects that remain on or around the truck.
- Become familiar with and use all protective equipment devices on the truck. Ensure that these items (anti-skid material, grab bars, seat belts, etc.) are securely in place.

Ventilation For Enclosed Areas

- If it is necessary to start the engine in an enclosed area, provide adequate ventilation. Exhaust fumes from the engine can kill.



A0055060

Mirrors, Windows, And Lights

- Remove any dirt from the surface of the windshield, cab windows, mirrors, and lights. Good visibility may prevent an accident.
- Adjust the mirrors to a position where the operator can see best from the operator's seat.
- Ensure the headlights, work lights, and taillights are in proper working order. Ensure that the machine is equipped with the proper work lamps needed for the operating conditions.
- Replace any broken mirrors, windows, or lights.

In The Operator's Cab - Before Starting The Engine

- DO NOT leave tools or spare parts lying around or allow trash to accumulate in the cab of the truck. Keep all unauthorized reading material out of the truck cab.
- Keep the cab floor, controls, steps, and handrails free of oil, grease, snow, and excess dirt.
- Check the seat belt, buckle, and hardware for damage or wear. Replace any worn or damaged parts. Use the seat belts when operating a machine.
- Read and understand the contents of the Operation and Maintenance manual. Read the safety and operating instructions with special attention. Become thoroughly acquainted with all the gauges, instruments, and controls before operating the truck.
- Read and understand the warning and caution decals in the operator's cab.
- Ensure the steering wheel, horn, controls, and pedals are free of any oil, grease, or mud.
- Check the windshield wiper, the condition of the wiper blades, and the washer fluid reservoir level.
- Be familiar with all steering and brake system controls, warning devices, road speeds, and loading capabilities before operating the truck.

OPERATING THE MACHINE

Starting The Engine

- DO NOT attempt to start the machine by shorting across the starter terminals. This may cause a fire, or serious injury or death, to anyone in the machine's path.
- Check for people and objects that remain on or around the truck.
- DO NOT start the engine if a warning tag has been attached to the controls.
- When starting the engine, sound the horn as an alert.
- Start and operate the machine only while seated in the operator's seat.
- DO NOT allow any unauthorized persons in the operator's compartment or any other place on the machine.
- For machines equipped with a back-up alarm, check that the alarm works properly.

Truck Operation - General

- Wear seat belts at all times.
- Only authorized persons are allowed to ride in the truck. Passengers must be in the cab and belted in the passenger seat.
- DO NOT allow anyone to ride on the decks or on the steps of the truck.
- DO NOT allow anyone to get on or off the truck while it is in motion.
- DO NOT move the truck in or out of a building without a signal person present.
- Know and obey hand signal communications between the operator and spotter. When other machines and personnel are present, the operator must move in and out of buildings, loading areas, and through traffic, under the direction of a signal person. Courtesy at all times is a safety precaution!
- Immediately report any adverse conditions on the haul road, pit, or dump area that may cause an operating hazard.

- Check for flat tires periodically during a shift. If the truck has been operating on a flat, DO NOT park indoors until the tire cools. If the tire must be changed, DO NOT stand in front of the rim and locking ring when inflating a tire mounted on the machine. Observers must not be permitted in the area and must be kept away from the side of such tires.



The tire and rim assembly may explode if subjected to excessive heat. Personnel must move to a remote or protected location if there is a fire near the tire and wheel area, or if the smell of burning rubber or excessively hot brakes is evident.

If the truck must be approached, such as to fight a fire, those personnel must do so only while facing the tread area of the tire (front or back), unless protected by the use of large heavy equipment as a shield. Stay at least 15 m (50 ft) from the tread of the tire.

In the event of fire in the tire and wheel area (including brake fires), stay away from the truck for at least eight hours, or until the tire and wheel are cool.

- Keep serviceable, fire fighting equipment nearby. Report used extinguishers for replacement or refilling.
- Apply the parking brake when the truck is parked and unattended. DO NOT leave the truck unattended while the engine is on.
- Park the truck a safe distance away from other vehicles, as determined by the supervisor.
- Stay alert at all times! In the event of an emergency, be prepared to react quickly and avoid accidents. If an emergency arises, know where to get prompt assistance.

Traveling In The Truck

- When traveling on rough ground, travel at low speeds. When changing direction, avoid turning suddenly.
- Lower the dump body, and set the dump lever to the FLOAT position before traveling.

- If the engine stops while the truck is in motion, the steering and brakes will continue to operate, but only for a fixed amount of oil consumption. Steer immediately to a safe spot, and stop the truck. When the truck is completely stopped, apply the parking brake.

Precautions When Traveling In Reverse

Before operating the machine or work equipment, do as follows:

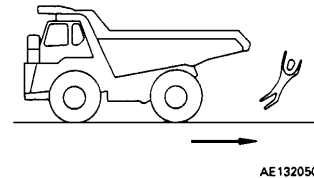

- Ensure the back-up alarm works properly.
- Sound the horn to warn people in the area.
- Check for personnel near the machine. Do a thorough check behind the machine.
- When necessary, designate a person to watch the area for the truck operator. This is particularly necessary when traveling in reverse.
- When operating in hazardous areas and areas with poor visibility, designate a person to direct work site traffic.
- DO NOT allow anyone to enter the line of travel of the machine. This rule must be strictly obeyed, even with machines equipped with a back-up alarm or rearview mirror.

Traveling On Slopes

- Traveling on slopes could result in the machine tipping over or slipping.
- DO NOT change direction on the slopes. To ensure safety, drive to level ground before turning.
- DO NOT travel up and down on grass, fallen leaves, or wet steel plates. These materials may cause the machine to slip on even the slightest slope. Avoid traveling sideways, and keep travel speed low.
- When traveling downhill, use the retarder to reduce speed. DO NOT turn the steering wheel suddenly. DO NOT use the foot brake, except in an emergency.
- If the engine stops on a slope, apply the service brakes fully and stop the machine. Apply the parking brake after the machine has stopped.

Ensuring Good Visibility

- When working in dark places, install work lamps and headlamps.
- Safely stop the truck if visibility is poor, such as in mist, snow, or rain. Wait for the weather to improve to allow safe travel.

Operating On Snow

- When working on snowy or icy roads, there is danger that the machine may slip on even the slightest slope. Travel slowly and avoid sudden starting, turning, or stopping in these conditions.
- Use caution when clearing snow. The road shoulder and other objects may be buried in the snow and cannot be seen. When traveling on snow-covered roads, install tire chains.

Avoid Damage To The Dump Body

- When working in tunnels, on bridges, under electric cables, or when entering an enclosed area where there are height limits, use extreme caution. The dump body must be completely lowered before driving.



Driving with a raised dump body, or raising the dump body in an enclosed area, may result in serious damage and bodily injury or death. Drive with the dump body resting on the frame.

Driving Near High-Voltage Cables

- Driving near high-voltage cables can cause electric shock. Maintain the safe distances between the machine and the electric cable, as listed below.

| Voltage | Minimum Safe Distance | |
|----------|-----------------------|-------|
| 6.6 kV | 3 m | 10 ft |
| 33.0 kV | 4 m | 14 ft |
| 66.0 kV | 5 m | 17 ft |
| 154.0 kV | 8 m | 27 ft |
| 275.0 kV | 10 m | 33 ft |

The following actions are effective in preventing accidents while working near high voltages:

- Wear shoes with rubber or leather soles.
- Use a signalman to give warning if the machine approaches an electric cable.
- If the work equipment must touch an electric cable, the operator must remain in the cab.
- When working near high-voltage cables, DO NOT allow anyone to approach the machine.
- Check with the electrical maintenance department about the voltage of the cables before operating the truck.

When Loading The Truck

- Ensure the surrounding area is safe. If so, stop the machine in the correct loading position and evenly load the body.
- DO NOT leave the operator's seat during loading.

When Dumping

- Before starting, check that there is no person or objects behind the machine.
- Stop the machine in the desired location. Check again for persons or objects behind the machine. Give the determined signal, then slowly operate the dump body. If necessary, use blocks for the wheels or position a flagman.
- When dumping on slopes, machine stability is poor and there is danger of tip over. Avoid dumping on slopes whenever possible.
- DO NOT travel with the dump body raised.

Working On Loose Ground

- Avoid operating the machine near cliffs, overhangs, and deep ditches. If these areas collapse, the machine could fall or tip over and result in serious injury or death. Remember that ground surfaces in these areas may be weakened after heavy rain or blasting.
- Freshly laid soil and the soil near ditches is loose. It can collapse under the weight or vibration of the machine. Avoid these areas whenever possible.

Parking The Machine

- Choose a horizontal road surface to park the machine. If the machine has to be parked on a slope, install wheel chocks to prevent the machine from moving.
- When parking on public roads, provide fences and signs, such as flags or lights, on the machine to warn pedestrians and other vehicles. Ensure that the machine, flags, or lights DO NOT obstruct the traffic.
- Before leaving the machine, lower the dump body fully, activate the parking brake, stop the engine, and lock everything. Take the key with you.

TOWING

- Improper towing methods may lead to serious personal injury and/or damage.
- Use a towing device with ample strength for the weight of this machine.
- DO NOT tow a machine on a slope.
- When connecting a machine to be towed, DO NOT allow anyone to go between the tow machine and the disabled machine.
- Set the coupling of the machine being towed in a straight line with the towing portion of the tow machine. Secure it in position.
- DO NOT stand next to the towing device while the truck is moving.

For more towing information, refer to Section 30, Operating Instructions - Towing.

WORKING NEAR BATTERIES

Battery Hazard Prevention

- Battery electrolyte contains sulfuric acid and can quickly burn the skin and eat holes in clothing. If the electrolyte comes in contact with the skin, immediately flush the area with water.
- Battery acid can cause blindness if splashed into the eyes. If acid gets into the eyes, flush them immediately with large quantities of water. See a doctor immediately.
- If acid is accidentally ingested, drink a large quantity of water, milk, beaten eggs, or vegetable oil. Call a doctor or poison prevention center immediately.
- Wear safety glasses or goggles when working with batteries.

- Batteries generate hydrogen gas. Hydrogen gas is very explosive and is easily ignited with a small spark or flame.

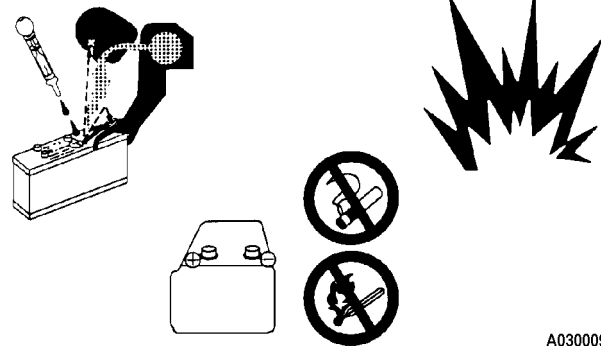

- Before working with the batteries, shut the engine off and turn the key switch to the OFF position.
- Avoid short-circuiting the battery terminals through accidental contact with metallic objects, such as tools, across the terminals.
- When removing or installing a battery, identify the positive (+) terminal and negative (-) terminals. DO NOT short-circuit the terminals by touching positive to negative.
- Tighten the battery caps securely.
- Tighten the battery terminals securely. Loose terminals can generate sparks and lead to an explosion.

Jump-Starting With Booster Cables

- Wear safety glasses or goggles when connecting booster cables.
- While jump-starting with another machine, DO NOT allow the two machines to touch.
- Connect the positive (+) cable first when installing the booster cables. Disconnect the ground or negative (-) cable first during removal.
- Connect the ground cable to the frame on the disabled machine. Connect the ground as far as possible from the battery.
- Connect the batteries in parallel: positive to positive and negative to negative.
- If any tool touches between the positive (+) terminal and the chassis, it will cause sparks. Use caution when using tools near the battery.

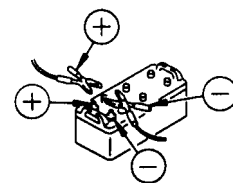

PRECAUTIONS FOR MAINTENANCE

BEFORE PERFORMING MAINTENANCE

Stopping The Engine Before Service

- Before performing inspections or maintenance, stop the machine on firm, flat ground. Lower the dump body, shut the engine off, and apply the parking brake. Install wheel chocks.
- If the engine must be operated during service, move the selector switch to the NEUTRAL position, and apply the parking brake. Perform this work with two people. One person must sit in the operator's seat to stop the engine, if necessary. **DO NOT** move any controls during these situations unless necessary for service.
- When servicing the machine, **DO NOT** touch any moving parts. **DO NOT** wear loose clothing.
- When servicing the truck with the dump body raised, place the dump lever in the HOLD position. Install the body-up retention cable securely.

Warning Tag

- **DO NOT** start the engine or operate the controls while a person is performing maintenance on the truck. Serious injury or death may result.
-
- Attach a warning tag to the control lever in the operator's cab to alert others that you are working on the machine. Attach additional warning tags around the machine, if necessary.
 - These tags are available from your Komatsu distributor. Part No. 09963-03000.

Proper Tools

- Use only tools suited to the task. Using damaged, low quality, faulty, or makeshift tools can cause personal injury.
-
- A0055120
- Extra precaution must be used when grinding, welding, and using a sledgehammer.

Securing The Dump Body



Any time personnel are required to perform maintenance on the vehicle with the dump body in the raised position, the body-up retention cable must be installed.

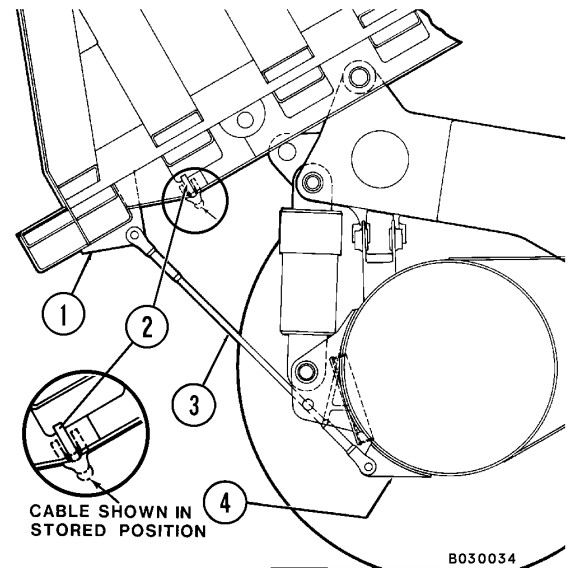

- | | |
|--------------------------|---------------------|
| 1. Rear Body Ear | 3. Cable |
| 2. Cable Stored Position | 4. Axle Housing Ear |

1. To hold the dump body in the up position, raise the body to its maximum height.
2. Remove cable (3) from its stored position on the body, and install between rear body ear (1) and axle housing ear (4).
3. Secure the cable clevis pins with cotter pins.
4. Return the cable to stored position (2) after maintenance is complete.

DURING MAINTENANCE

Personnel

- Only authorized personnel may service and repair the machine.

Attachments

- Place attachments that have been removed from the machine in a safe place. Secure the attachments to prevent them from falling.



Working Under The Machine

- Lower all movable work equipment to the ground, or to their lowest position, before performing service under the machine.
- Chock the tires of the machine securely.
- DO NOT work under the machine if the machine is poorly supported.

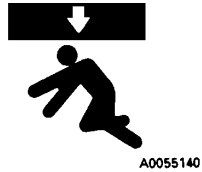

Keeping The Machine Clean

- Spilled oil or grease, scattered tools, etc. can cause you to slip or trip. Keep your machine clean and tidy.
- If water gets into the electrical system, the machine may move unexpectedly and/or damage to components may occur. DO NOT use water or steam to clean any sensors, connectors, or the inside of the operator's compartment.
- Use extreme care when washing the electrical control cabinet. DO NOT allow water to enter the control cabinet around the doors or vents. DO NOT allow any water to enter the cooling air inlet duct above the electrical control cabinet. If water enters the control cabinet through any opening or crevice, major damage to the electrical components may occur.
- DO NOT spray water into the rear wheel electric motor covers. Damage to the wheel motor armatures may occur.
- DO NOT spray water into the retarding grids. Excess water in the retarding grids can cause a ground fault, which will prevent propulsion.

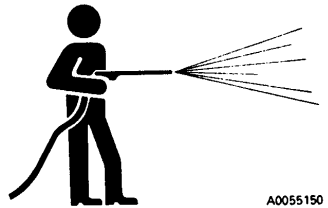

Rules To Follow When Adding Fuel Or Oil

- Spilled fuel and oil may cause slipping. Clean up spills immediately.
- Tighten the fuel cap and the oil cap securely.
- DO NOT use fuel to wash parts.
- Add fuel and oil in a well-ventilated area.

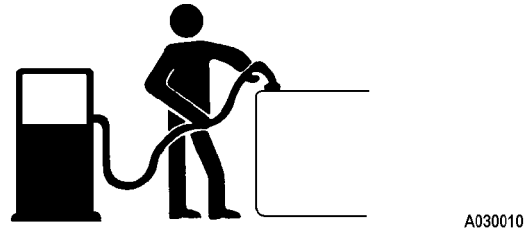

Radiator Coolant Level

- If it is necessary to add coolant to the radiator, shut the engine off, and allow the engine and radiator to cool before adding the coolant.
- Depress the pressure relief button on the radiator cap.
- Slowly loosen the cap to relieve the pressure during removal.

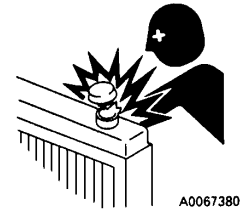

Use Of Lighting

- When checking fuel, oil, coolant, or battery electrolyte, use lighting with anti-explosion specifications. If lighting without this protection is used, there is a danger of explosion.



Precautions With The Battery

- When repairing the electrical system, or when arc welding, remove the negative (-) terminal of the battery to stop the flow of current.



A0055170

Handling High-Pressure Hoses

- DO NOT bend or hit high-pressure hoses. DO NOT use bent or cracked piping, tubes, or hoses. They may burst during use.
- Repair any loose or broken hoses. Fuel and/or oil leaks may result in a fire.

Precautions With High-Pressure Oil

- Hydraulic circuits may be pressurized. Ensure that all pressure is released before loosening hydraulic fittings or hoses.
- DO NOT service a system before completely releasing the internal pressure.



A030007

- Small, high-pressure pinhole leaks are extremely dangerous. The jet of high-pressure oil can pierce the skin and eyes. Wear safety glasses and thick gloves. Use a piece of cardboard or a sheet of wood to check for oil leakage.

Maintenance Near High Temperatures And High Pressures

- Immediately after stopping, the engine coolant and operating oils are at high temperature and may be pressurized. In these conditions, opening the system or replacing the filters, may result in burns or other injury. Wait for the temperature to cool and the pressure to subside before servicing.



A0055050

Rotating Fan And Belts

- Keep a safe distance from rotating parts, such as the radiator fan and fan belts.
- Serious bodily injury may result from direct or indirect contact with rotating parts and flying objects.

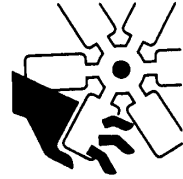

A0063830

Waste Materials

- DO NOT dump oil or other harmful fluids into a sewer system, rivers, etc.
- Obey appropriate laws and regulations when disposing of harmful objects, such as oil, fuel, coolant, solvent, filters, batteries, and others.

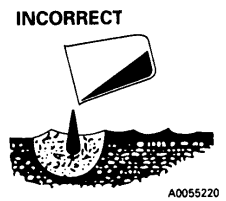

A0055220

- Drain fluids from your machine into the appropriate containers. DO NOT drain fluids directly onto the ground.

TIRES

Handling Tires

Rim and tire maintenance can be hazardous unless the correct procedures are followed by trained personnel.

Improperly maintained or inflated tires can overheat and burst due to excessive pressure. Improper inflation can also result in cuts in the tire caused by sharp stones. Both of these conditions can lead to tire damage, serious personal injury, or even death.

To safely maintain a tire, adhere to the following conditions:

- Inflate the tires to their specified pressure. Abnormal heat is generated, particularly when the inflation pressure is too low.

NOTE: To prevent injury from the wheel rims during tire inflation, use one of the following:

1. A wheel cage or other restraining device that will constrain all wheel rim components during an explosive separation of a multi-piece wheel rim, or during the sudden release of air.
 2. A stand-off inflation device which permits a person to stand outside of the potential trajectory of the wheel components.
- Use the specified tires.

The tire inflation pressure and permissible speeds, given in this manual, are general values. The actual values may differ, depending on the type of tire and the specific operating conditions. For details, please consult the tire manufacturer.

When the tires become overheated, a flammable gas is produced inside the tire which can ignite. It is particularly dangerous if the tires become overheated while the tires are pressurized. If the gas generated inside the tire ignites, the internal pressure will suddenly rise, and the tire will explode, resulting in danger and/or death to personnel in the area. Explosions differ from punctures or tire bursts because the destructive force of the explosion is extremely large. Therefore, the following operations are strictly prohibited when the tire is pressurized:

- Welding the rim.
- Welding near the wheel or tire.
- Smoking or creating open flames.



A0055110

Tire Maintenance

If the proper procedure for performing maintenance or replacement of the wheel or tire is not used, the wheel or tire may burst, causing damage, serious injury, or even death. When performing such maintenance, consult your authorized regional Komatsu distributor, or the tire manufacturer.

Refer to the Society of Automotive Engineers (SAE), SAE J1337, Off-Road Rim Maintenance Procedures and Service Precautions, Section 4.2 for additional information on demounting the tires and rim assemblies. Also, refer to Section 4.4 of SAE J1337 for assembly and inflation recommendations.

The U.S. Department of Labor Mine Safety and Health Administration (MSHA) addresses tire repairs in its Title 30 Code of Federal Regulations, 30 CFR 57.14104.



DO NOT stand in front of a rim and locking ring when inflating a tire mounted on the machine. Observers must not be permitted in the area.

DO NOT weld or heat the rim assembly with the tire mounted on the rim. Resulting gases inside the tire may ignite, causing explosion of the tire and rim.

Storing Tires After Removal

- As a basic rule, store the tires in a warehouse in which unauthorized persons cannot enter. If the tires are stored outside, erect a fence around the tires with No Entry and other warning signs.
- Stand the tire on level ground, and block it securely so that it cannot roll or fall over.
- If the tire falls, flee the area as quickly as possible. The tires for mining equipment are extremely heavy. DO NOT attempt to hold a tire upright when the tire is falling. The weight of these tires may lead to serious injury or death.

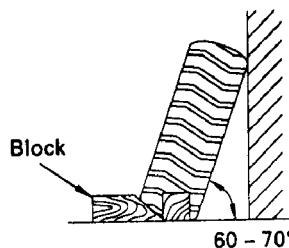

A030008

Mounted tires stored as spares must be inflated to the minimum inflation pressure necessary to keep the tire beads properly seated. Maximum inflation pressure of the stored tire must, in no instance, exceed 15% of the tire's cold inflation pressure.

WHEN REPAIRS ARE NECESSARY

1. Only qualified maintenance personnel, who understand the systems being repaired, must attempt repairs.
2. Many components on the Komatsu truck are large and heavy. Ensure that the lifting equipment - hoists, slings, chains, lifting eyes - are of adequate capacity.
3. DO NOT stand under a suspended load. DO NOT work under the raised body unless the body safety cable is in place to hold the body in the up position.
4. DO NOT service the truck while the engine is on, except when absolutely necessary. Keep a safe distance from moving parts.
5. When servicing the air conditioning system, wear a face shield and cold-resistant gloves for protection against frostbite. Follow all current regulations for handling and recycling refrigerants.
6. Follow the package directions carefully when using cleaning solvents.
7. If an auxiliary battery assist is needed, first use one cable to connect the 24V positive (+) post of the disabled truck batteries to the 24V positive (+) post of the auxiliary assist. Use the second cable to connect the 24V negative (-) post of the auxiliary assist battery to a frame ground (-) on the disabled truck away from the battery.
8. Disconnect the positive and negative battery cables before arc welding on the truck. Failure to do so may seriously damage the battery and the electrical equipment. Disconnect the battery charging alternator lead wire and isolate the electronic control components before making the welding repairs. It is not necessary to disconnect or remove any control circuit cards or any of the Alarm Indicating Device (AID) circuit control cards.

Fasten the welding machine ground (-) lead to the piece being welded; the grounding clamp must be attached as near as possible to the weld area. DO NOT allow welding current to pass through the ball bearings, roller bearings, suspensions, or hydraulic cylinders. Avoid laying the welding cables over or near the vehicle electrical harnesses. The welding voltage could be induced into the electrical harness and cause damage to the components.

9. If the truck is to be towed for any reason, use a rigid tow bar. Check the truck cab for decals for special towing precautions. Refer to Section 30, Operating Instructions - Towing.
10. Drain, clean, and ventilate the fuel tanks and/or hydraulic tanks before welding.

NOTE: If it is necessary to weld the hydraulic tank or fuel tank, drain, clean, and ventilate the tank(s) before welding.



Pressurized hydraulic fluid may penetrate the skin. Serious injury and possibly death may result if the proper medical treatment by a physician familiar with this injury is not received immediately.

11. Relieve system pressure before disconnecting hoses or components.
12. After adjustments or repairs, replace all shields, screens, and clamps.
13. Working near tires can be dangerous. Use extreme caution when working around tires. Refer to Tires earlier in this chapter.
14. Only a qualified operator may operate the truck in the repair facility or during road testing.

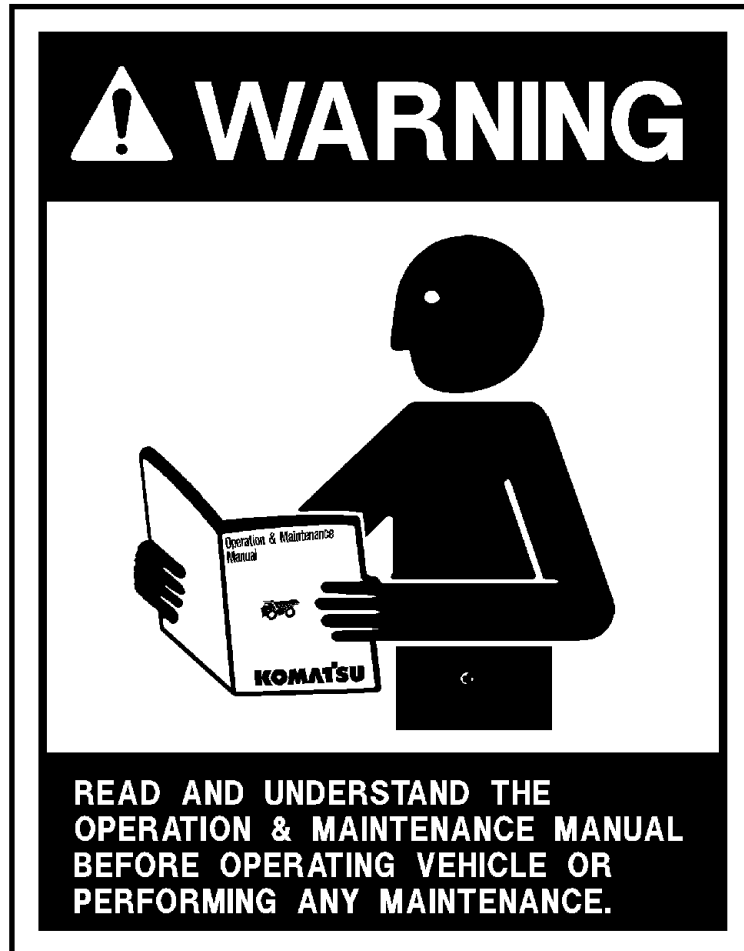

NOTES

WARNINGS AND CAUTIONS

The following pages provide a brief explanation of the warning, caution, and service instruction plates and decals attached to the truck. The plates and decals listed here are typical of this model. Because of customer options, individual trucks may have plates and decals that are different from those shown here.

The plates and decals must be kept clean and legible. If any decal or plate is illegible or damaged, it must be replaced with a new one.

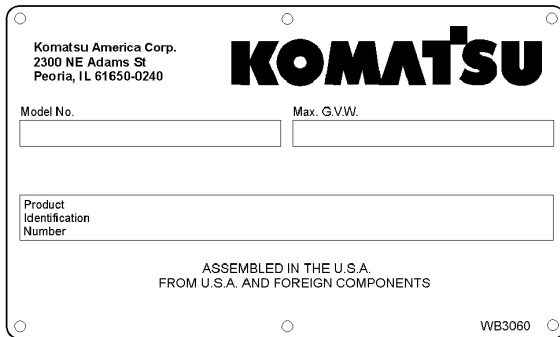

A product identification plate is located on the frame in front of the right side front wheel. It shows the truck model number, maximum Gross Vehicle Weight (GVW), and Product Identification Number (PIN).

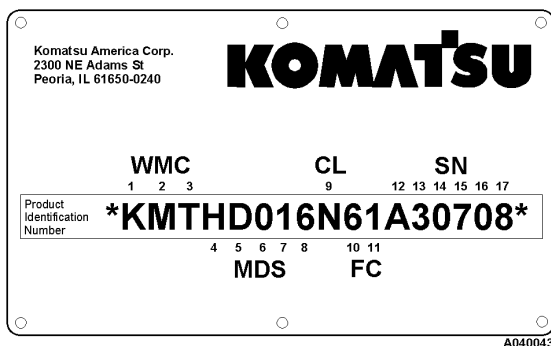

The PIN consists of 19 total characters. The first and last characters are tamper preventative symbols (*). The remaining 17 alpha/numeric characters are used to identify five characteristics of the machine. The five characteristics are detailed below.

WMC - Character positions 1, 2, and 3 identify the Worldwide Manufacturer Code (WMC). The WMC designates the manufacturer of the product. Komatsu brand products are identified with the letters KMT.

MDS - Character positions 4, 5, 6, 7, and 8 identify the Machine Descriptor Section (MDS). The MDS code identifies general information regarding machine specifications. The MDS is a code for the machine type and model.

CL - Character position 9 identifies the Check Letter (CL). The CL is used to verify the accuracy of the individual PIN.

FC - Character positions 10 and 11 identify the Factory Code (FC). The FC identifies the Komatsu factory in charge of claims for the product. The FC for electric drive trucks is 61.

SN - Character positions 12, 13, 14, 15, 16, and 17 identify the Serial Number (SN). The SN is a unique sequential number.

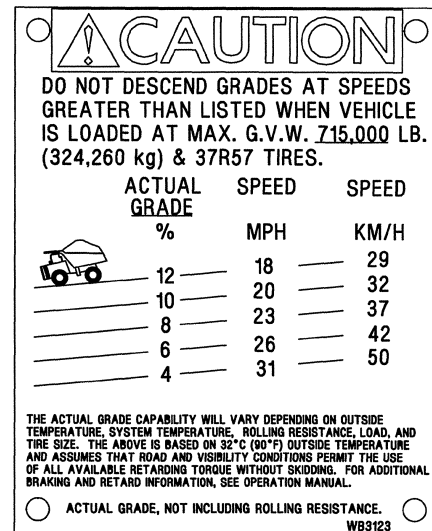

A grade/speed plate is located on the left front post of the operator's cab. The decal provides the recommended maximum speeds to be used when descending various grades with a loaded truck.

Refer to the decal in the operator's cab. This decal may change with the optional truck equipment.

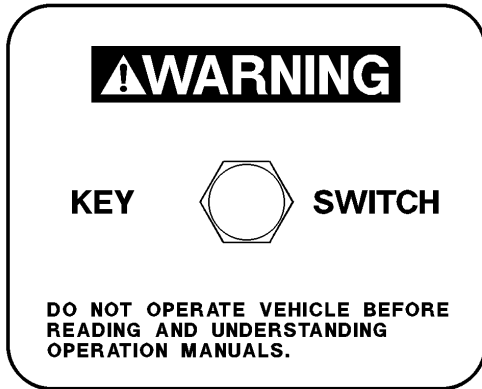

WA4368A

A warning decal surrounds the key switch. The warning stresses the importance of reading the operator's manual before operation.



WB2437

Warning plates are attached to the hydraulic tank and the fuel tank. The decals alert technicians not to work on the truck with the body raised unless the body-up retention cable is in position.

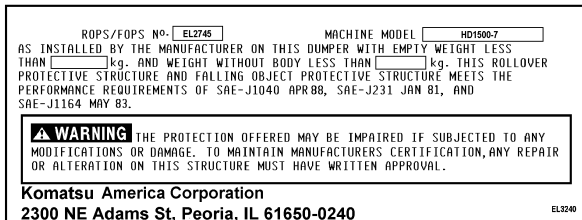

A plate attached to the right rear corner of the cab states the Rollover Protective Structure (ROPS) and Falling Object Protective Structure (FOPS) meet various SAE performance requirements.



WB2440

Warning plates are mounted on the truck frame in front of and to the rear of both front tires. The decal alerts all persons to remain at a distance when the truck is being started.



DO NOT make modifications to the ROPS components. DO NOT attempt to repair damage without written approval from the manufacturer. Unauthorized repairs will void certification.



A warning plate is mounted on top of the radiator surge tank cover near the radiator cap. The engine cooling system is pressurized when the engine is on and/or when the system is hot. Turn the engine off and allow the engine to cool before removing the radiator cap. Release the internal pressure by depressing the pressure relief. Unless the pressure is first released, removing the radiator cap will result in the hot coolant being expelled from the radiator. Serious scalding and burning can result.



A caution decal is attached below the hydraulic tank oil level sight gauge. Check the oil level with the body down, engine stopped, and the key switch OFF. Refer to the filling instructions outlined in Section 40, Lubrication and Service. Instructions are also outlined on the following decal.

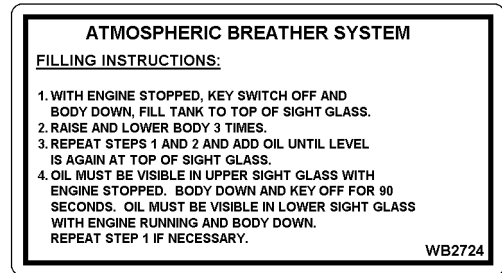

A plate on the side of the hydraulic tank provides instructions for filling the hydraulic tank.

Keep the system open to the atmosphere only as long as necessary to lessen the chances of system contamination. Service the tank with clean type C-4 hydraulic oil. All oil being put into the hydraulic tank must be filtered to three microns.

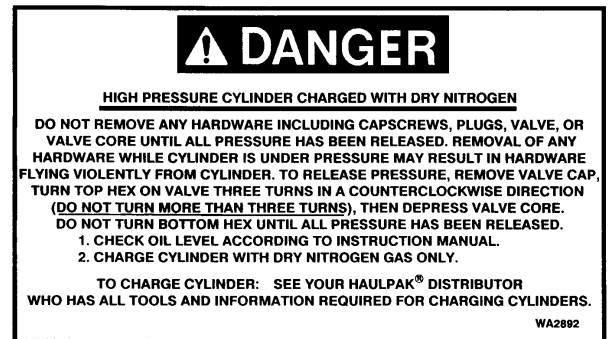

This danger plate is attached to each suspension and steering accumulator. These plates warn that the suspension and accumulators are charged with high-pressure nitrogen. Read the service manual, and follow the safety procedures when performing service on these components.



A warning plate is attached to the frame above the hydraulic system Auxiliary Power Unit (APU) quick disconnect fittings. The plate alerts technicians that high-pressure hydraulic oil is present during operation. Use caution when opening the hydraulic system. There is a chance of residual pressure being present. Loosen the fittings slowly to allow pressure to dissipate before removing any connections.



Pressurized hydraulic fluid may penetrate the skin. Serious injury and death may result if proper medical treatment from a physician familiar with this injury is not received immediately.



This plate is located on the battery box near the battery disconnect switches, and indicates that the battery system is a negative ground system.

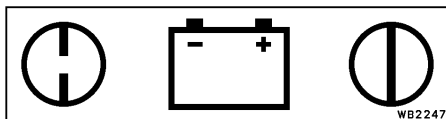

These decals are placed above the battery disconnect switches on the right side of the front bumper to indicate the OFF and ON positions of the switches.

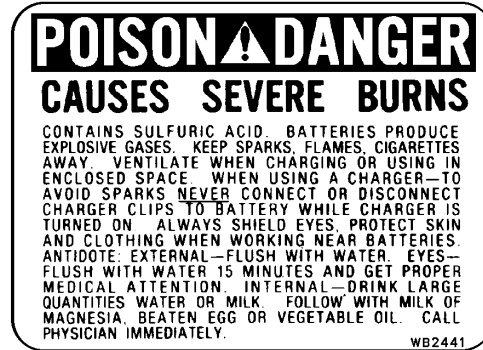

Attached to the exterior of the battery compartment is a danger plate. This plate stresses the prevention of sparks near the battery. When another battery or 24VDC power source is used for auxiliary power, all switches must be OFF prior to connecting. Maintain correct polarity: connect the positive (+) posts together and then connect the negative (-) lead of the auxiliary power cable to a good frame ground. DO NOT connect to the negative posts of the truck batteries. DO NOT connect near the battery box. These precautions minimize the danger of sparks near the batteries.

Sulfuric acid is corrosive, toxic, and explosive. Use safety goggles, rubber gloves, and a rubber apron when working near batteries.

If battery electrolyte is splashed into the eyes or ingested, get the proper medical attention immediately.

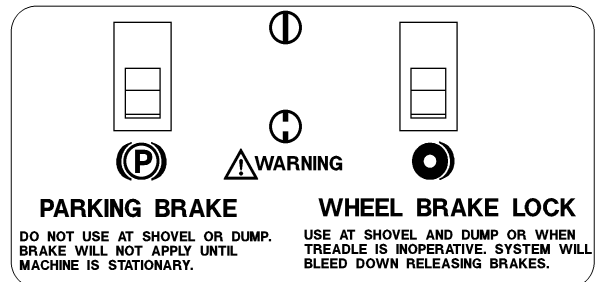

A warning instruction is located below the parking brake and brake lock switches, which are located to the right of the steering column on the instrument panel. Pushing the top of the rocker-style switch turns the function ON; pushing the bottom, turns it OFF.

The parking brake is spring-applied and hydraulically released. It is designed to hold a stationary truck when the engine is off. The truck must be completely stopped before applying the parking brake, or damage may occur to the parking brake. To apply the parking brake, press the rocker switch toward the ON symbol. To release the parking brake, press the rocker switch toward the OFF symbol. When the key switch is ON and the parking brake switch is applied, parking brake indicator light (A3, overhead panel) will be illuminated.

NOTE: DO NOT use the parking brake when loading or dumping. With the key switch ON and the engine on, sudden shock caused by loading or dumping could cause the system's motion sensor to release the parking brake.

The brake lock switch is for holding the truck while parked at the shovel during loading or while dumping. It applies the rear service brakes only. If the brake pedal malfunctions while the truck is in motion, apply the brake lock to stop the truck. DO NOT use this brake as a parking brake when leaving the truck. With the engine off, the hydraulic system will depressurize, releasing the service brakes.

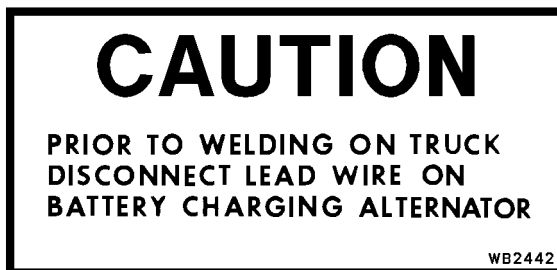

High voltage danger plates and caution plates are attached to the doors of the electrical control cabinet. The high voltage plate is also attached to the blown grid housing, extended range housing, rectifier housing, inlet duct, and rear hatch cover.

Before arc welding on the truck, disconnect the positive and negative battery cables of the vehicle. Failure to do so may seriously damage the battery and electrical equipment. Disconnect the battery charging alternator lead wire and isolate the electronic control components before welding. It is not necessary to disconnect or remove any control circuit cards or any of the Alarm Indicating Device (AID) circuit control cards.

Fasten the welding machine ground (-) lead to the piece being welded. The grounding clamp must be attached as near as possible to the weld area. DO NOT allow welding current to pass through the ball bearings, roller bearings, suspensions, or hydraulic cylinders. DO NOT lay welding cables over or near the vehicle electrical harnesses. The welding voltage could be induced into the electrical harness and possibly cause damage to the components.



This plate is mounted on the top side of the blown grid housings. Stepping or standing here may result in serious personal injury.

DUMP PROCEDURE FOR DISABLED TRUCK

1. HOOK UP QUICK DISCONNECTS: ONE LINE FROM LARGE HOIST CROSS TUBE ON DISABLED TRUCK TO SMALL HOIST CROSS TUBE ON GOOD TRUCK. THEN OTHER LINE FROM SMALL HOIST CROSS TUBE ON DISABLED TRUCK TO LARGE HOIST CROSS TUBE ON GOOD TRUCK.
2. PLACE HOIST VALVE OF DISABLED TRUCK IN "HOLD" POSITION, AND MAINTAIN THIS POSITION THROUGH DUMP CYCLE.
3. DUMP LOAD OF DISABLED TRUCK BY ACTUATING HOIST VALVE OF GOOD TRUCK TO "POWER DOWN" POSITION
4. AFTER LOAD HAS BEEN DUMPED, PLACE HOIST VALVE ON GOOD TRUCK TO "FLOAT" POSITION AND ALLOW TRUCK BODY ON DISABLED TRUCK TO FLOAT DOWN.

WA8890

A decal plate is located on top of the center cross tube. The decal provides the operator or technician with the hook-up procedure for dumping a loaded, disabled truck, by using a functional truck for hydraulic power.

Refer to the service manual for additional instructions for using this procedure.



DANGER

HIGH PRESSURE CYLINDER

READ WARNING LABEL MOUNTED ON SIDE OF ACCUMULATOR HOUSING BEFORE LOOSENING OR DISASSEMBLING ANY PARTS

WB2438

Warning and danger plates are located inside the door of the brake system cabinet behind the cab.

This plate alerts technicians to read the warning labels attached to the accumulators prior to releasing internal nitrogen pressure, or disconnecting any hydraulic lines or hardware.

WARNING

**HIGH PRESSURE
DO NOT LOOSEN OR DISCONNECT
ANY HYDRAULIC BRAKE LINE OR
COMPONENT UNTIL ENGINE IS
STOPPED, KEY SWITCH IS OFF AND
DRAIN VALVES ON ACCUMULATORS
ARE OPENED.**

WB2691

This plate warns the technician to stop the engine, before loosening or disconnecting a brake line. Turn the key switch off, and open the drain valves on all three accumulators to bleed the hydraulic pressure.

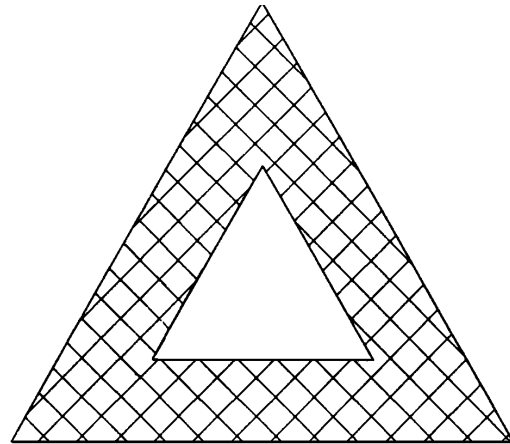

WB2268

This plate is placed near the four jacking points on the truck. Two are placed at the front of the truck next to the right and left frame upright supports. Two are placed at the rear of the truck under the right and left suspension supports.

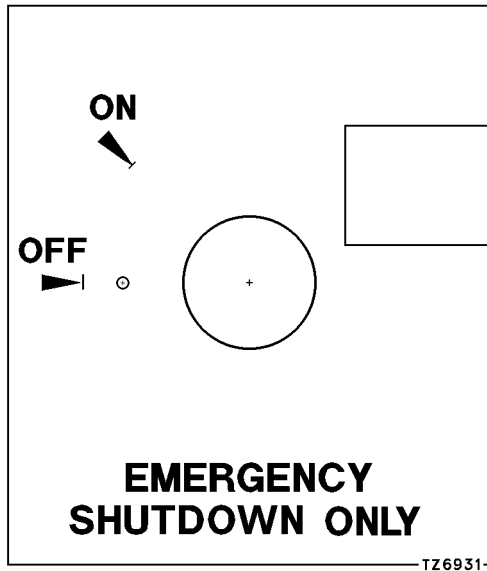

This plate is located below the left-hand battery box. It identifies the emergency engine shutdown switch. This switch is spring-loaded to the OFF position. It must be held in the ON position until the engine stops.

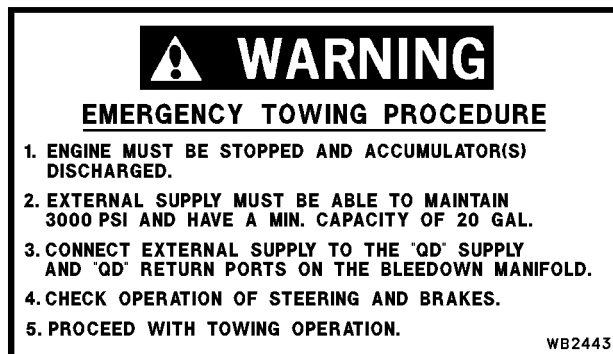

A warning plate is located above the hydraulic system (APU) quick disconnect fittings in front of the hydraulic tank. The plate provides instructions to the operator or technician for towing a disabled truck. This plate specifies the requirements for an auxiliary source of supply for hydraulic oil and the proper hook-up.

Ensure the steering and brake systems are operating properly before towing the truck.

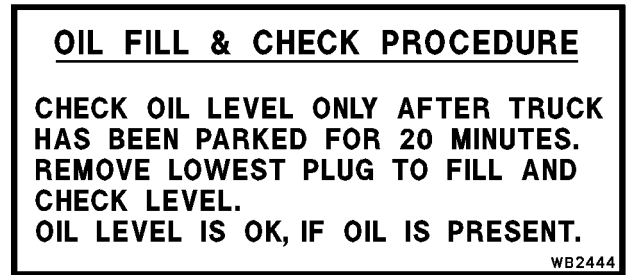

A wheel motor oil level decal is attached to the gear cover on both the electric wheel motors. This decal stresses that the truck must be on a level surface and parked for 20 minutes prior to checking the oil level. This is necessary in order to get an accurate reading.

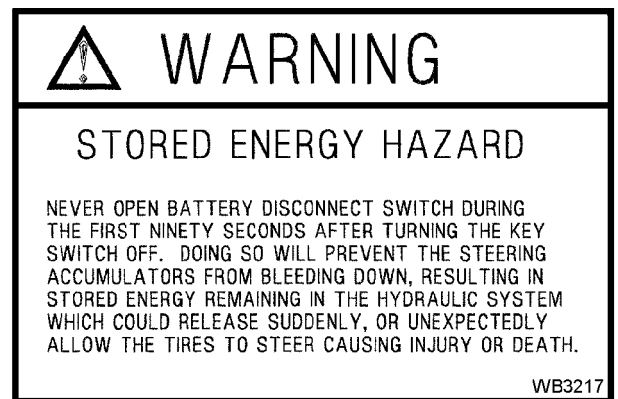

This plate is located on the battery equalizer box. After the key switch is turned OFF, allow at least 90 seconds of time to pass before opening (disconnecting) the battery disconnect switch. This time period allows hydraulic pressure to be released from the steering accumulators.

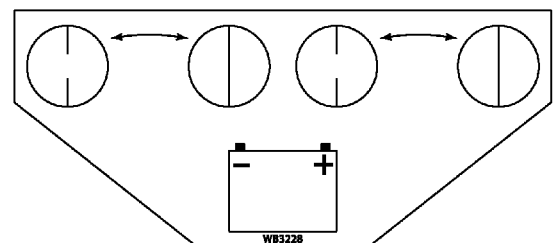

This plate is located on the battery equalizer box. When the battery disconnect lever is in the left-hand position, it disconnects power (opens the circuit) from the batteries to the truck. When the lever is in the right-hand position, it connects (closes the circuit) from the batteries to the truck.

WB3228

LUBRICATION CHART

| LUBRICATION SPECIFICATIONS | | | | | | | | | | | | | |
|----------------------------|---|-----|----------|-------|-------------------------|--------|--------|-----------------------------------|---------|---------|---------|--|--|
| LUBE KEY | TYPE LUBRICANT | | | | | | | | | | | | |
| A | ENGINE OIL - - - - SEE ENGINE MANUAL | | | | | | | | | | | | |
| B | HYDRAULIC OIL - - - - SAE 10W C - 4 - - - - AUXILIARY HEATERS REQUIRED BELOW -10°F(-23°C) | | | | | | | | | | | | |
| C | HEAVY-DUTY SYNTHETIC GEAR OIL - - - - SEE DRIVE SYSTEM MANUAL | | | | | | | | | | | | |
| D | MULTI - PURPOSE EXTREME PRESSURE GREASE - - - - NLGI NO.2 (5% MIN. MOLY-DISULFIDE) | | | | | | | | | | | | |
| E | MULTI - PURPOSE GEAR OIL - - - - SAE 80W - 90 | | | | | | | | | | | | |
| SYM | DESCRIPTION | PTS | LUBE KEY | 10 HR | 50 HR | 100 HR | 250 HR | 500 HR | 1000 HR | 2000 HR | 2500 HR | | |
| 1 | CRANKCASE OIL LEVEL | 1 | A | CHECK | SEE ENGINE MANUAL | | | | | | | | |
| 2 | ENGINE LUBE OIL FILTERS | | | | SEE ENGINE MANUAL | | | | | | | | |
| 3 | FUEL FILTER | | | | SEE ENGINE MANUAL | | | | | | | | |
| 4 | FUEL SEPERATOR (DAVCO) | | | | SEE ENGINE MANUAL | | | | | | | | |
| 5 | FUEL TANK | 1 | | | | | | DRAIN H ₂ O & SEDIMENT | | | | | |
| 6 | GE PREFILTER BLOWER | 1 | D | | | | | GREASE | | | | | |
| 7 | FUEL TANK BREATHER | 1 | | | | | | | | CLEAN | | | |
| 8 | HYDRAULIC OIL LEVEL | 1 | B | CHECK | | | | | | *CHANGE | | | |
| 9 | HYDRAULIC STRAINER | 2 | | | | | | | | CLEAN | | | |
| 10 | HYDRAULIC TANK BREATHER | 2 | | | | | | | | CHANGE | | | |
| 11 | HYDRAULIC FILTERS | 3 | | | ** | ** | ** | | | CHANGE | | | |
| 12 | MOTORIZED WHEEL OIL LEVEL | 2 | C | | SEE DRIVE SYSTEM MANUAL | | | | | | | | |
| 13 | HYD. PUMP DRIVE SHAFT | 2 | D | | | | | GREASE | | | | | |
| 14 | CHASSIS LUBE LEVEL | 1 | D | | | | | GREASE | | | | | |
| 15 | SEAT SLIDES & STEER SHAFT | 4 | D | | | | | | | GREASE | | | |
| 16 | WHEEL MOTOR BLOWER | 2 | D | | | | | GREASE | | | | | |
| 17 | FRONT WHEEL BEARINGS *** | 2 | E | | | | | CHECK | | | CHANGE | | |
| 18 | FRONT TRUNION | 1 | D | | | | | | | GREASE | | | |
| 19 | MAGNETIC PLUG FRONT WHL COVER **** | 2 | | | | | | CHECK | | | | | |

* 1000 HR INTERVAL CAN BE EXTENDED TO 2500 HR PROVIDED OIL SAMPLING AND ANALYSIS IS CONDUCTED EVERY 250 HR.

** ONE-TIME CHANGE AT 50, 100 AND 250 HR.

*** NOT APPLICABLE FOR 930E

**** APPLICABLE FOR 930E ONLY

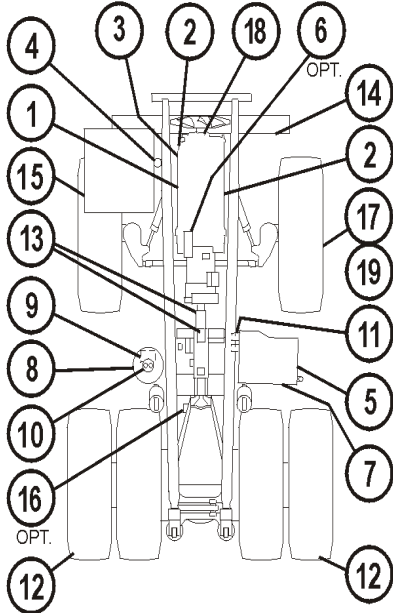

630E, 730E, 830E, & 930E

WB2790

The lubrication chart is located on the right-hand side of the radiator grille. The chart specifies some of the critical maintenance items to be checked. Component location and service intervals are specified on the chart. The lube key lists the proper lubricants to be used. Refer to Section 40, Lubrication and Service, for more information on maintenance items.

OPERATING INSTRUCTIONS

PREPARING FOR OPERATION

The safest trucks are those which have been properly prepared for operation. At the beginning of each shift, a careful inspection of the truck must be completed by the operator before starting the engine.

SAFETY IS THINKING AHEAD

Prevention is the best way to avoid an accident. Prevent potential accidents by knowing the employer's safety requirements and all necessary job site regulations. In addition, know the proper use and care of all the safety equipment on the truck. Operators or technicians must be qualified to operate or maintain a Komatsu truck.

Safe practices start before the operator gets to the truck! Refer to Section 20, General Safety, for safety guidelines.

WALK-AROUND INSPECTION

At the beginning of each shift, perform a careful walk-around inspection of the truck before engine start-up. A walk-around inspection is a ground level check of the truck and its components to ensure the truck is safe to operate.

Start at the left front corner of the truck (see illustration, next page.) Move in a counterclockwise direction, around the truck, and back to the starting point.

Inspection of the truck before every shift can help avoid many potential problems. Downtime and loss of production can be reduced by scheduled maintenance.

Local work practices may prevent an operator from performing all tasks suggested here. To the extent permitted, the operator must follow this or a similar routine.

1. Start at the left front of the truck. During the walk-around inspection, visually inspect all lights and safety equipment for external damage. Ensure all light housing lenses are clean and unbroken.

Empty the dust pans on the left side air cleaners. Ensure the battery box covers are in place and securely fastened.

2. Move behind the front left tire. Check the hub and brake assemblies for leaks, and any abnormal wear or signs of damage.

Check the oil level in the front wheel hub sight gauge. Refill, if necessary.

3. With the engine stopped, check the engine oil level. If necessary, use the service light to illuminate the area. Ensure the light is turned off when the inspection of this area is complete.

4. Inspect the fan and air conditioner belts for correct tension and tracking. Also, check for belt wear or damage.

Verify the fan guard bolts are installed and properly tightened.

5. Ensure the anchor end of the steering cylinder pin is properly greased and tightened.

6. Move outboard of the front wheel and inspect the attaching lugs/wedges to ensure they are properly tightened. Replace any parts that are missing.

Inspect the tires for damage. Check for proper inflation.

7. Move behind the rear of the front wheel. Ensure the suspension protective boot is in good condition. Verify all suspension attaching hardware bolts are completely tightened. Inspect the mounting key area for evidence of wear. Verify the suspension extension (exposed piston rod) is correct. Check for leaks.

Check for leaks around the hub and brakes. Also, check for any unusual wear conditions or damage.

Ensure the rod end of the steering cylinder is properly greased. Verify all mounting hardware is properly tightened. Check for any hydraulic leaks.

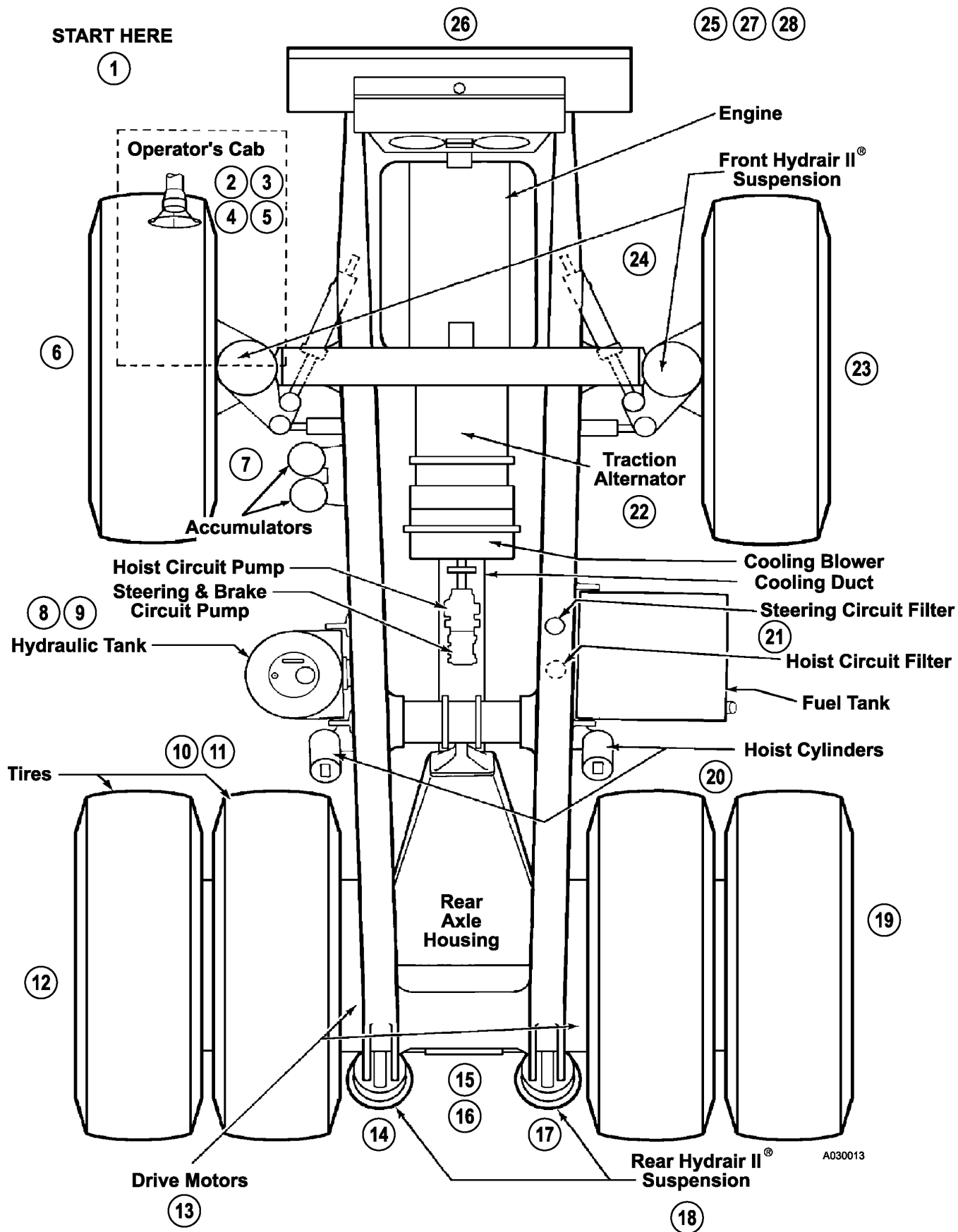

8. Check the oil level in the hydraulic tank. With the engine stopped and the body down, hydraulic fluid must be visible in the upper sight glass.
9. Verify all hydraulic tank shut off valves are locked in the fully open position.
10. Move around the hydraulic tank in front of the rear dual tires.

Inspect the hoist cylinder for any damage or hydraulic oil leaks.

Verify the lower guard is in place.

Ensure both the upper and lower hoist cylinder pins are properly tightened and greased.
11. Inspect the lower edge of the chassis.

Ensure the blower hose is in good condition with no holes or breakage.

Check the main hydraulic pumps for leakage.

Check for other unusual conditions with the pumps or the pump drive shaft.
12. Move around the left side dual tires. Inspect the attaching lugs/wedges to ensure they are properly tightened. Replace any parts that are missing.

Inspect the wheel cover for cracks or damage. Verify the latches are properly fastened. Inspect the area for any oil leakage from inside the wheel cover (could indicate brake or wheel motor leakage).

Inspect the dual tires for damage. Verify proper inflation pressure. If the truck has been operating with low tire pressure, the tire must be cooled before parking the truck inside.
13. Move to the rear of the dual tires. Check for and remove any rocks lodged between the dual tires. To prevent tire damage, verify the rock ejector is in good condition and straight.
14. Inspect the left rear suspension for damage. Verify all suspension attaching hardware is completely tightened.

Verify the suspension is properly charged. Ensure there are no leaks. Verify the suspensions are properly greased. Verify the cover over the chromed piston rod is in good condition.
15. Move to the rear center of the truck. Open the rear hatch cover, and turn on the work light, if necessary. Inspect the condition of the hatch cover gasket. Inspect the housing for any foreign objects or misplaced tools.

Check for leaks around the mounting surface of the rear housing wheel motor and any brake hose fittings.

Verify the covers on the wheel motor sump are firmly attached. Turn off the work light, if used, and close and latch the rear hatch cover.
16. While standing in front of the rear hatch, verify the rear lights and back-up horns are working. Inspect the panhard rod for proper lubrication. Also, inspect both body hinge pins for damage and proper lubrication.
17. Inspect the right rear suspension for damage. Verify all suspension attaching hardware is completely tightened.

Verify the suspension is properly charged.

Ensure there are no leaks. Verify the suspensions are properly greased. Verify the cover over the chromed piston rod is in good condition.
18. Move behind the rear right side dual tires. Check for and remove any rocks lodged between the dual tires. To prevent tire damage, verify the rock ejector is in good condition and straight.
19. Move around the right side dual tires. Inspect the attaching lugs/wedges to ensure they are properly tightened. Replace any parts that are missing.

Inspect the wheel cover for cracks or damage. Verify the latches are properly fastened. Inspect the area for any oil leakage from inside the wheel cover (could indicate brake or wheel motor leakage).

Inspect the dual tires for damage. Verify proper inflation pressure. If the truck has been operating with low tire pressure, the tire must be cooled before parking the truck inside.
20. Move in front of the right side dual tires.

Inspect the hoist cylinder for any damage or hydraulic oil leaks. Verify the lower guard is in place. Ensure both the upper and lower hoist cylinder pins are properly tightened and greased.

Check the secureness and condition of the body-up limit switch. Remove any mud/dirt accumulation from the switch.

21. Move to the fuel tank.

Verify the fuel gauge on the tank agrees with the gauge in the cab.

Inspect the tank mounting connections to the frame. Ensure they are tight and not damaged.

22. Move behind the right side front wheel.

Ensure the suspension protective boot is in good condition. Verify all suspension attaching hardware bolts are completely tightened. Inspect the mounting key area for evidence of wear. Verify the suspension extension (exposed piston rod) is correct. Check for leaks.

Check for leaks around the hub and brakes. Also, check for any unusual wear conditions or damage.

Ensure the rod end of the steering cylinder is properly greased. Verify all mounting hardware is properly tightened. Check for any hydraulic leaks.

23. Move outboard of the front wheel, and inspect the attaching lugs/wedges to ensure they are properly tightened. Replace any parts that are missing.

Inspect the tires for damage. Check for proper inflation.

24. Inspect the engine compartment for any leaks or unusual conditions.

Inspect the fan guard and belts for excessive wear or damage.

Remove any foreign objects or debris from behind the radiator.

Inspect the auto lube system. See Lubrication and Maintenance, Section 40, for specific details concerning the auto lube system.

If used, turn the work light off and secure the ladder in a stored position.

25. Move around to the right front of the truck.

Remove the air cleaner pans and remove any dirt buildup. Reinstall and securely attach the pans.

Inspect the battery box cover for damage. Verify it is securely attached.

26. Move to the front of the radiator.

Remove any debris or foreign objects.

Check for coolant leaks.

Inspect all headlights and fog lights for damage. Verify all lights are working.

27. Verify the ground level engine shutdown switch and battery disconnect switches are in the ON position.

28. Clean the stairs, ladder, and/or handrails of any foreign material, such as ice, snow, oil, or mud.



Use the handrails when mounting or dismounting the truck. Always face the truck when using the ladders. DO NOT mount or dismount the truck while it is in motion.

29. Check the coolant in the radiator using the coolant level sight gauge, or observe the coolant level through the opening in the end of the hood.

If it is necessary to remove the radiator cap, shut the engine off, allow the engine to cool, and slowly remove the radiator cap. DO NOT remove the radiator cap when the cooling system is pressurized.



If the engine is hot, allow the coolant to cool before removing the fill cap or draining the radiator. Serious burns may result if the coolant is not allowed to cool.

30. Inspect the covers over the braking grids to ensure the latches are securely fastened.

Inspect the main air inlet to ensure it is clear of all foreign objects and debris that would prevent complete air flow into the inlet.

Verify all the cabinet door latches are securely fastened.

31. Move around the cab to the back.

Open the doors to the brake cabinet and check for any hydraulic oil leaks

If used, turn the work light off.

Close the door and verify the latches are securely fastened.

32. Clean the cab windows and mirrors.
Remove dirt or debris from the cab floor. Ensure the steering wheel, controls, and pedals are free of any oil, grease, or mud.
33. Store any personal gear in the cab so it does not interfere with the operation of the truck. DO NOT carry tools or supplies in the cab of the truck or on the deck.
34. Adjust the seat and steering wheel so that it is comfortable for use.
35. Read and understand the Operator Controls and Instrument Panel discussion in this section. Be familiar with all the control locations and functions before operating the truck.

ENGINE START-UP

1. Ensure all personnel are clear of the truck before starting the engine. Sound the horn as a warning before actuating any operational controls. If the truck is in an enclosure, ensure adequate ventilation before start-up. Exhaust fumes are dangerous!
2. Ensure the parking brake switch is in the ON position. The selector switch must be in NEUTRAL before starting the truck.
3. If the truck is equipped with auxiliary cold weather heaters, DO NOT start the engine while the heaters are on. Damage to the coolant heaters will result.
4. The key switch is a three position (OFF, RUN, START) switch. When the switch is rotated one position clockwise, it is in the RUN position and all electrical circuits (except START) are activated. With the selector switch in NEUTRAL, rotate the key switch fully clockwise to the START position and hold this position until the engine starts. The START position is spring loaded to return to RUN when the key is released.

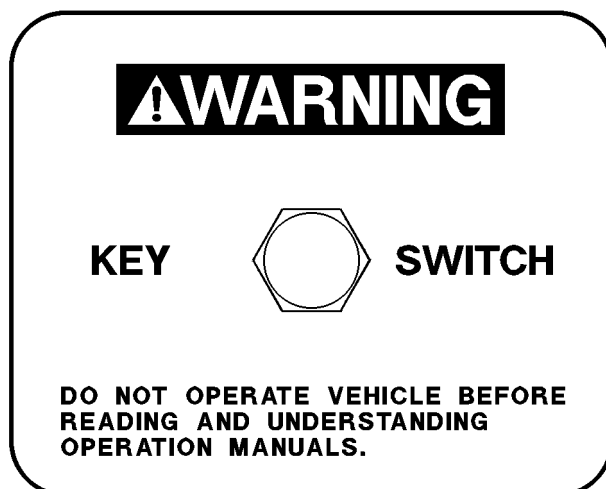

NOTE: If the truck is equipped with an engine prelube system, a noticeable time delay will occur (while the engine lube oil passages are being filled) before the starter engages. The colder the engine oil temperature, the longer the time delay. In addition, if the truck is equipped with an engine starting aid for cold weather starting, the engine prelube system must be engaged for 5-10 seconds, or until the starter is engaged, before activating the engine starting aid.



**Starting fluid is extremely volatile and flammable!
Use with extreme care.**

If the truck is equipped with the optional engine starting aid and the ambient temperature is below 10°C (50°F), turn the key switch to the START position. While cranking the engine, move the engine starting aid switch to the ON position for three seconds maximum, then release the engine starting aid. If the engine does not start, wait at least fifteen seconds before repeating the procedure.

DO NOT crank an electric starter for more than thirty seconds at one time. Allow two minutes for cooling before attempting to start the engine again. Severe damage to the starter motor can result from overheating.

AFTER ENGINE HAS STARTED

1. Become thoroughly familiar with the steering and emergency controls. After the engine has started and the low pressure and warning systems are normal, test the truck steering in extreme right and left directions. If the steering system is not operating properly, shut the engine off immediately. Determine the steering system problem and repair before resuming operation.
2. Check the brakes before moving the truck. Start the engine and allow the hydraulic system to fully pressurize. Activate the service brake, parking brake, and brake lock at least twice. If a warning alarm is activated when a brake is applied or released, DO NOT operate the truck. If the application and release of any brake appears slow or improper, DO NOT operate the truck. If a brake problem is suspected, shut the engine off and notify maintenance personnel.

3. Check the gauges, warning lights, and instruments before moving the truck to ensure proper system operation and proper instrument functioning. Observe the braking and steering circuit hydraulic warning lights. If the warning lights come on, shut the engine off immediately and determine the cause.
4. Ensure the headlights, work lights, and taillights are in proper working order. Good visibility may prevent an accident. Check the operation of the windshield wipers.
5. When the truck body is in the dump position, DO NOT allow anyone beneath it unless the body-up retaining pin or cable is in place.
6. DO NOT allow unauthorized personnel to ride in the truck. DO NOT allow anyone to ride on the stairs or ladder of the truck.
7. DO NOT leave the truck unattended while the engine is on. Shut the engine off, and apply the parking brake before getting out of the cab.

MACHINE OPERATION SAFETY PRECAUTIONS

After the truck engine is started and all the systems are functioning properly, the operator must follow all the local safety rules to ensure safe machine operation.

WARNING

If any of the red warning lights come on, or if any gauge reads in the red area during truck operation, a malfunction is indicated. Stop the truck as soon as safety permits, shut the engine off, and have the problem corrected before resuming truck operation.

CAUTION

Operating the truck with stalled or free spinning wheel motors may cause serious damage to the wheel motors! If the truck does not begin to move within 10 seconds after depressing the throttle pedal (selector switch in a drive position), release the throttle pedal. Allow the wheels to regain traction before accelerating the engine again.

1. Look to the rear before backing the truck. Watch for and obey the ground spotter's hand signals before reversing. Sound the warning horn three times. The spotter must have a clear view of the total area at the rear of the truck.
2. Operate the truck only while properly seated with the seat belt fastened. Keep hands and feet inside the cab compartment while the truck is in operation.
3. Check the gauges and instruments frequently during operation for proper readings.
4. Observe all regulations pertaining to the job site's traffic pattern. Be alert to any unusual traffic pattern. Obey the spotter's signals.
5. Match the truck speed to the haul road conditions. Slow the truck in congested areas. Keep a firm grip on the steering wheel at all times.
6. DO NOT allow the engine to idle for extended periods of time.
7. Check the parking brake periodically during the shift while the truck is stopped. Use the parking brake only for parking. DO NOT use the parking brake for loading/dumping.

WARNING

DO NOT use the brake lock for parking. With the engine stopped, hydraulic pressure will bleed-down, allowing the brakes to release!

8. Check the brake lock performance periodically for safe loading and dumping.
9. Proceed slowly on rough terrain to avoid deep ruts or large obstacles. Avoid traveling close to the soft edges and the edge of the fill area.
10. Truck operation requires concentrated effort by the driver. Avoid distractions of any kind while operating the truck.
11. Before driving the truck, ensure the tires are properly inflated. If the truck has been driven with an under-inflated tire, do not park the truck inside a building until the tire has cooled to ambient temperature.

LOADING

1. Pull into the loading area with caution. Remain at a safe distance while the truck ahead is being loaded.
2. DO NOT drive over unprotected power cables.
3. When approaching or leaving a loading area, watch for other vehicles and for personnel working in the area.
4. When pulling in under a loader or shovel, follow the spotter or shovel operator signals. The truck operator may speed up loading by observing the location and loading cycle of the truck being loaded ahead. Then follow a similar pattern.
5. When the truck is being loaded, the operator must stay in the truck cab with the engine on. Place the selector switch in NEUTRAL, and apply the brake lock.
6. When loaded, drive away from the shovel quickly, but with extreme caution.

HAULING

1. Stay alert! Drive with extreme caution. Cab doors must remain closed at all times if the truck is in motion or unattended.
2. Obey all road signs. Operate the truck in a controlled manner. Govern the truck speed by the road conditions, weather, and visibility. Report haul road conditions immediately. Muddy or icy roads, pot holes, or other obstructions can present hazards.
3. When backing the truck, give the back-up signal three sounds of the horn. When starting forward, two sounds of the horn. These signals must be given each time the truck is moved forward or backward.
4. Use extreme caution when approaching a haul road intersection. Maintain a safe distance from oncoming vehicles.
5. Maintain a safe distance of 15 m (50 ft) when following another vehicle. When driving downhill, maintain a distance of 30 m (100 ft).

6. DO NOT stop or park on a haul road unless unavoidable. If you must stop, move the truck to a safe place, apply the parking brake, and shut the engine off before leaving the cab. Chock the wheels securely, and notify maintenance personnel for assistance.
7. Before starting up or down a grade, maintain a speed that will ensure safe driving and provide effective retarding. Refer to the grade/speed decal in the operator's cab.
8. When operating the truck in darkness, or when visibility is poor, DO NOT move the truck unless all the headlights, clearance lights, and tail lights are on. DO NOT back the truck if the back-up horn or lights are inoperative. Dim the headlights when meeting oncoming vehicles.
9. If the emergency steering light and/or low brake pressure warning light illuminate during operation, immediately steer the truck to a safe stopping area, away from other traffic.
10. The Statex III w/fuel enhancement system monitors wheel motor, ambient, and static exciter temperatures. If any one of these values is outside the limits established, the Statex III controls will cause the engine to increase to 1650 rpm. Normal engine rpm for haul road/retarding operation is 1250 rpm.
11. When the maximum truck speed is reached, haul trucks equipped with Statex III w/fuel enhancement (fuel saver) system will experience a decrease in engine rpm.

NOTE: This is different from trucks equipped with Statex II or Statex III without fuel enhancement, which increase rpm upon reaching the speed limit.

PASSING

1. DO NOT pass another truck on a hill or blind curve!
2. Before passing, ensure the road ahead is clear. If a disabled truck is blocking your lane, slow down and pass with extreme caution.
3. Use only the areas designated for passing.

DUMPING

1. Approach the dump area with extreme caution. Ensure the area is clear of persons and obstructions, including overhead utility lines. Obey signals directed by the spotter, if present.

Avoid unstable areas. Stay a safe distance from the edge of the dump area. Position the truck on a solid, level surface before dumping.



As the body raises, the truck center of gravity will move. The truck must be on a level surface to prevent tipping/rolling!

2. Carefully maneuver the truck into the dump position. When backing the truck into the dump position, use only the brake pedal to stop and hold the truck. DO NOT rely on the wheel brake lock to stop the truck. This control is unmodulated and applies the rear service brakes only.
3. When the truck is stopped and in the dump position, apply the wheel brake lock. Move the selector switch to the NEUTRAL position.

To Raise The Dump Body:



Dumping certain types of material can result in sudden and violent movement of the truck. This truck movement may cause injury to the operator. It may also cause damage to the hoist cylinders, frame, and/or body hinge pins. Use caution when dumping large rocks (10% of payload, or greater) to prevent the load from shifting too quickly. Sticky material (loads that do not flow freely from the body) may also cause sudden truck movement if the load releases quickly.

4. Move the lever to the HOIST position. Refer to Fig. 30-1. Releasing the lever while in the HOIST position will cause the lever to move to the HOLD position.
5. Raise the engine rpm to accelerate the hoist speed.



If dumping very large rocks or sticky material, as described in the warning, slowly accelerate the engine rpm to raise the body. When the material starts to move, release the hoist lever to the HOLD position. If the material does not continue to exit the body, repeat this procedure as necessary.

6. Reduce the engine rpm as the last stage of the hoist cylinder begins to extend. Let the engine go to low idle as the last stage reaches half-extension.

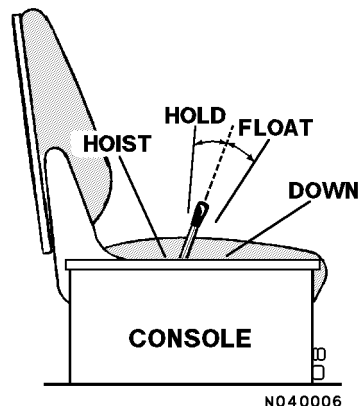

FIGURE 30-1. HOIST LEVER POSITIONS

7. Release the hoist lever as the last stage of the hoist cylinder reaches full extension.

To Lower The Dump Body:

(When dumping over a berm or into a crusher):

8. Move the hoist lever forward to the DOWN position and release. Releasing the lever places the hoist control valve in the FLOAT position, allowing the body to return to the frame.



DO NOT drive forward in the fully raised position if the dump body will not clear an obstacle, such as a crusher wall. DO NOT move the truck with a raised dump body raised except in an emergency. Failure to lower the body before moving the truck may cause damage to the hoist cylinders, frame, and/or body hinge pins.

NOTE: If the dumped material builds up at the rear of the truck and the body cannot be lowered, perform the following steps:

- a. Move the hoist lever back to the HOIST position and fully raise the dump body. Continue to hold the hoist lever until the body is completely raised.

NOTE: If the body is not completely raised, it may lower very rapidly when the truck is moved forward and the material is cleared from the rear of the truck.

- b. Once the body is fully raised, release the hoist lever (it will return to the HOLD position).
- c. Shift the selector switch to FORWARD, release the brake lock, and press the override button.
- d. Slowly drive forward to clear the material.
- e. Once the material is cleared, stop the truck, place the selector switch in NEUTRAL, and apply the brake lock.
- f. Completely lower the body.

NOTE: Failure to hoist the body, after making an unsuccessful attempt at lowering the body, may result in the dump body suddenly lowering after the truck has pulled ahead of the material that was previously preventing the body from lowering.

To Lower The Dump Body (When dumping on flat ground):

9. It is very likely when dumping on flat ground that the dumped material will prevent the body from lowering. In this instance, the truck will have to be driven forward a short distance (just enough to clear the material) before the body can be lowered.
 - a. Shift the selector switch to FORWARD, release the brake lock, and depress the override button. Drive forward enough for the body to clear the material. Stop, shift the selector switch to NEUTRAL, and apply the brake lock.
 - b. Move the hoist lever forward to the DOWN position and release. Releasing the lever places the hoist control valve in the FLOAT position, allowing the body to return to the frame.

NOTE: If the dumped material builds up at the rear of the body and the body cannot be lowered, then perform steps c and d below:

- c. Move the hoist lever back to the HOIST position to fully raise the dump body. Then release the hoist lever so it returns to the HOLD position.
- d. Shift the selector switch to forward, release the brake lock, and depress the override button. Drive forward to clear the material. Stop, shift the selector switch to NEUTRAL, and apply the brake lock. Lower the body again.

NOTE: Failure to hoist the body, after making an unsuccessful attempt at lowering the body, may result in the dump body suddenly lowering after the truck has pulled ahead of the material that was previously preventing the body from lowering.



DO NOT move the truck with a raised dump body raised except in an emergency. Failure to lower the body before moving the truck may cause damage to the hoist cylinders, frame, and/or body hinge pins.



10. With the body returned to the frame, move the selector switch to FORWARD, release the brake lock, and exit the dump area carefully.

TOWING

Prior to towing a truck, many factors must be carefully considered. Serious personal injury and/or significant property damage may result if important safety practices, procedures, and preparation for moving heavy equipment are not observed.

DO NOT tow the truck any faster than 8 kph (5 mph).

A disabled machine may be towed after adhering to the following minimum precautions.

1. Shut the engine off. Chock wheels on disabled truck to prevent movement while attaching tow bar.
2. If the truck is equipped, install the hydraulic connections for steering and dumping between the towing and towed vehicles. Check the towed vehicle braking system.

3. Empty all material from dump body of truck that is to be towed.
4. Determine that the towing vehicle has adequate capacity to both move and stop the towed truck in all conditions.
5. Inspect the tow bar. The tow bar capacity must be approximately 1.5 times the gross vehicle weight of the truck being towed.
6. Block the disabled truck to prevent movement while attaching the tow bar.
7. Release the disabled truck brakes and remove the wheel chocks.
8. Sudden movement may cause tow bar failure. Smooth and gradual truck movement is preferred.
9. Minimize the tow angle at all times. DO NOT exceed 30°. The towed truck must be steered in the direction of the tow bar.

SAFE PARKING PROCEDURES

The operator must continue the use of safety precautions when preparing for parking and engine shutdown.

In the event that the equipment is being worked in consecutive shifts, any questionable truck performance the operator may have noticed must be checked by maintenance personnel before the truck is released to another operator.

1. Park the truck on level ground, if possible. If parking on a grade, position the truck perpendicular to the grade.
2. Apply the parking brake and install wheel chocks so that the truck cannot roll. Park each truck a safe distance from one another.
3. Haul roads are not safe parking areas. In an emergency, pick the safest spot most visible to other machines in the area. If the truck becomes disabled, mark the truck with warning flags in daylight, or flares at night.

ENGINE SHUTDOWN PROCEDURE

The following procedure must be followed at each engine shutdown.

1. Stop the truck. Reduce the engine rpm to low idle. Place the selector switch in NEUTRAL and apply the parking brake switch. If the engine shutdown with timer delay is preferred, refer to the Delayed Engine Shutdown procedure.

2. Allow the engine to cool gradually at low idle for three to five minutes.
3. With the truck stopped and the engine cool, turn the key switch counterclockwise to OFF for normal shutdown of the engine. If the engine does not shutdown with the key switch, use the engine shutdown switch on the center console (see Operator Controls section).
4. With the key switch OFF and the engine stopped, wait at least 90 seconds. Ensure the pressure is relieved in the steering circuit by turning the steering wheel back and forth several times. No front wheel movement will occur when hydraulic pressure is relieved.
5. Close and lock all windows, remove the key from the key switch, and lock the cab to prevent possible unauthorized truck operation. Dismount the truck properly.

DELAYED ENGINE SHUTDOWN PROCEDURE

Refer to Section 32, Operator Cab and Controls, for identification of the various switches and indicator lights.

1. Stop the truck. The truck must be away from other traffic, on a level surface, and away from overhead power lines or other obstructions.
2. Reduce the engine speed to low idle.
3. Place the selector switch in NEUTRAL.
4. Apply the parking brake switch. Ensure the parking brake applied indicator light in the overhead display panel is illuminated.
5. Move the top of the engine shutdown switch to the ON (center) position. Then, firmly press the switch to the MOMENTARY (upper) position. Hold this position briefly to activate the five minute idle timer. The switch is spring-loaded and will return to the ON position when released.

6. When the engine shutdown timer has been activated, the timer delay indicator light in the overhead display panel will illuminate to indicate that the shutdown timing sequence has been started. The engine will continue to idle for approximately five minutes to allow the engine to properly cool before turning off.

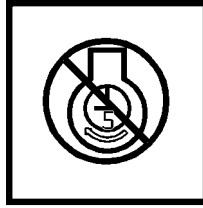

NOTE: The engine shutdown timer switch does not turn off the 24VDC electric power.

7. Turn the key switch to the OFF position to allow the engine to turn off when the timing sequence is complete. When the engine stops after the five minute idle period, the hydraulic bleed-down timer will be activated and the 24VDC electric circuits will turn off.

▲ IMPORTANT ▲

The engine will only shut off if the key switch is in the OFF position.

NOTE: To cancel the five minute idle timer sequence, move the timer delay shutdown switch to the OFF (lower) position. If the key switch is in the OFF position, the engine will stop. If the key switch is in the ON position, the engine will continue to run.

8. With the key switch OFF and the engine stopped, wait at least 90 seconds. Relieve the steering circuit pressure by turning the steering wheel back and forth several times. No front wheel movement will occur when hydraulic pressure is relieved.
9. Close and lock all windows, remove the key from the key switch, and lock the cab to prevent possible unauthorized truck operation. Dismount the truck properly.

SUDDEN LOSS OF POWER

If the engine suddenly stops while the truck is in motion, there is enough hydraulic pressure stored in the brake and steering accumulators to allow the operation of the steering and brake functions. However, this oil supply is limited so it is important to stop the truck as quickly and safely as possible after the loss of engine power. If the brake supply pressure drops to a predetermined level, the low brake pressure warning light will illuminate and a buzzer will sound. If the brake pressure continues to decrease, the auto-apply feature will activate and the service brakes will apply automatically to stop the truck.

1. Stop the truck as quickly as possible by using the foot pedal to apply the service brakes.

▲ WARNING ▲

Dynamic retarding will not be available! DO NOT use the service brakes for continuous retarding purposes.

2. If possible, steer the truck to the side of the road while braking.
3. When stopped, shift to NEUTRAL and apply the parking brake.
4. Turn the key switch OFF, and notify maintenance personnel immediately.
5. Install wheel chocks so the truck cannot roll.
6. Mark the truck with warning flags during daylight hours or use flares at night. Adhere to local regulations.

EMERGENCY STEERING SYSTEM

Operation

The truck is equipped with an emergency steering system. This system is a backup in the event of loss of oil supply to the main steering system. The emergency steering system was designed to meet or exceed SAE J1511 and ISO 5010 standards.

If the low steering system pressure indicator light and alarm are activated, a failure in the hydraulic oil supply to the steering and brake system exists. When the alarm is activated, typically there is enough hydraulic pressure stored in the brake and steering accumulators to allow brief operation of the steering and brake functions. However, this oil supply is limited. Therefore, it is important to stop the truck as quickly and safely as possible after the alarm is first activated.

If the oil supply pressure drops to a predetermined level, the low brake pressure warning light will also illuminate. If the oil pressure continues to decrease, the brake auto-apply feature will activate and the service brakes will apply automatically to stop the truck.

Testing

This test can only be performed with an empty truck.

1. Ensure no one is near the front tires during this test. Use a spotter to keep the area around the front tires clear of personnel during this test.
2. Start the engine. Allow the hydraulic system to reach full pressure and the accumulators to fill with oil.
3. Shut the engine off by using the engine stop button located on the center console. DO NOT turn the key switch OFF.
4. Turn the steering wheel.
 - a. If the front tires respond when the steering wheel is turned, the emergency steering system is functioning properly. Turn the key switch OFF.
 - b. If the front tires do not steer, turn the key switch OFF and notify maintenance personnel immediately. DO NOT drive the truck until the problem has been repaired and the truck can pass this test.

If the truck passes this test, the emergency steering system is functioning properly.

OPERATOR CAB AND CONTROLS

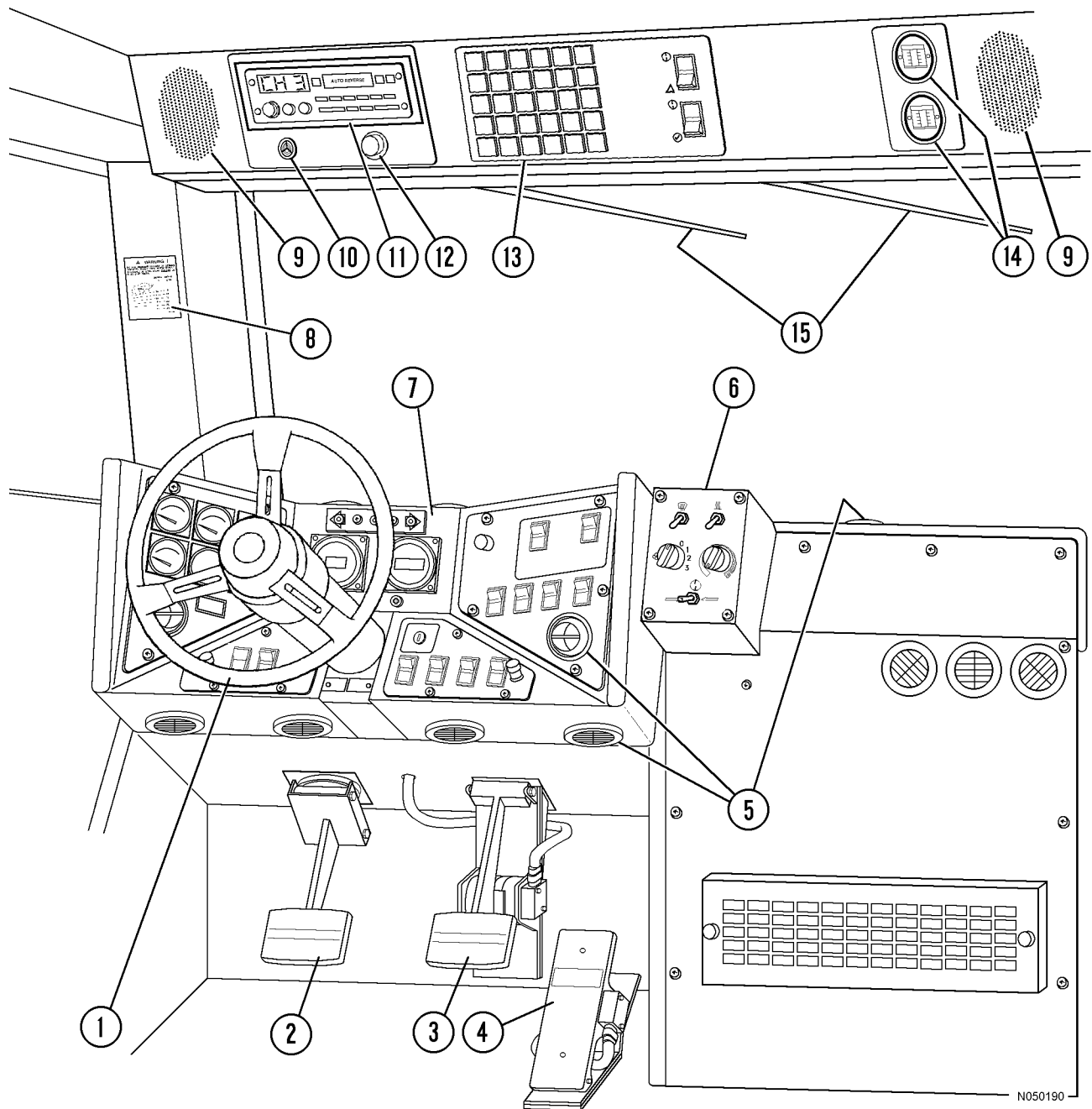

FIGURE 32-1. CAB INTERIOR - OPERATOR VIEW

- 1. Steering Wheel and Controls
- 2. Service Brake Pedal
- 3. Dynamic Retarder Pedal
- 4. Throttle/Accelerator
- 5. Heater/Air Conditioner Vents

- 6. Heater/Air Conditioner and Controls
- 7. Instrument Panel
- 8. Grade/Speed Warning Chart
- 9. Radio Speakers
- 10. Warning Alarm Buzzer

- 11. Radio, AM/FM, Cassette
- 12. Warning Lights Dimmer Control
- 13. Warning/Status Indicator Light Panel
- 14. Air Cleaner Vacuum Gauges
- 15. Windshield Wipers

STEERING WHEEL AND CONTROLS

STEERING WHEEL

Steering wheel (1, Figure 32-2) will telescope in and out and adjust through a tilt angle to provide a comfortable wheel position for most operators.

HORN BUTTON

Horn button (2, Figure 32-2) is actuated by pushing the button in the center of the steering wheel. Operation of the horn must be verified before moving the truck. Observe all local safety rules regarding the use of the horn as a warning signal device before starting the engine and moving the vehicle.

TILT/TELESCOPE LEVER

The steering column can be telescoped or wheel tilted with lever (3, Figure 32-2) in front of the turn signal lever.

Adjust the tilt of the steering wheel by pulling the lever toward the steering wheel and moving the wheel to the desired angle. Releasing the lever will lock the wheel in the desired location.

Adjust the telescope function by pushing the lever forward to unlock. After positioning, release the lever to the lock position.

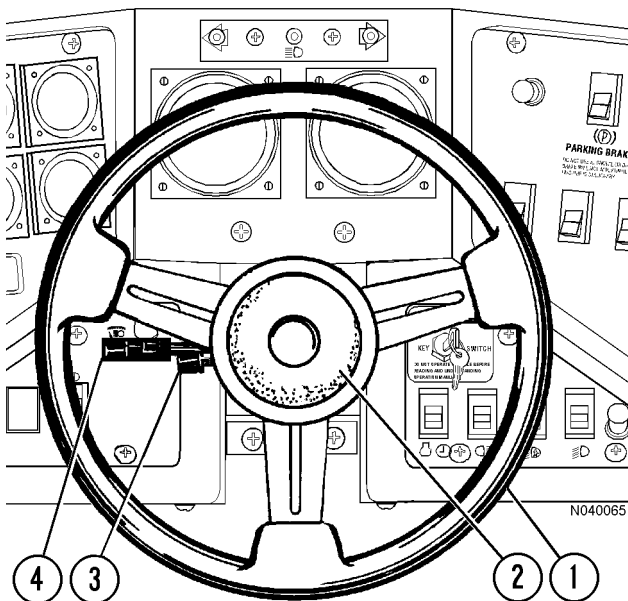

FIGURE 32-2. STEERING WHEEL AND CONTROLS

- | | |
|-------------------|-------------------------------|
| 1. Steering Wheel | 3. Tilt/Telescope Lever |
| 2. Horn | 4. Multi-Function Turn Signal |

MULTI-FUNCTION TURN SIGNAL SWITCH



FIGURE 32-3. MULTI-FUNCTION TURN SIGNAL SWITCH

Multi-function turn signal switch (4, Figure 32-2) is used to activate the turn signal lights, the windshield wipers, and to select either high or low beam headlights.

Turn Signal Operation

Move the lever upward to signal a turn to the right.



An indicator in the top, center of the instrument panel will illuminate to indicate the turn direction selected. Refer to Instrument Panel and Indicator Lights in this section.

Move the lever downward to signal a turn to the left.



NOTE: The turn signal will not automatically stop after the turn has been completed.

High Beam Headlight Operation

Moving the lever inward toward the rear of the cab changes the headlights to high beam. When the high beams are selected, the indicator in the top, center of the instrument panel will illuminate. Moving the switch back to the original position will return the headlights to low beam.



Windshield Wiper Operation



Windshield Wipers Off



Intermittent - Long Delay



Intermittent - Medium Delay



Intermittent - Short Delay



Low Speed



High Speed



Depressing the button at the end of the lever will activate the windshield washer fluid and turn on the windshield wipers.

PEDALS

SERVICE BRAKE PEDAL

Service brake pedal (2, Figure 32-4) is a foot-operated pedal which applies the service brakes.

NOTE: In some optional installations, the service brake pedal may not be present, because it is incorporated into a single pedal function with retarder pedal (3).

DYNAMIC RETARDER PEDAL

Dynamic retarder pedal (3, Figure 32-4) is a foot-operated pedal which allows the operator to slow the truck and maintain a safe productive speed without the use of the service brakes. For normal truck operation, only dynamic retarding is used to slow and control the speed of the truck. Refer to Grade/Speed Warning chart (8, Figure 32-1) to determine the maximum safe truck speeds for descending various grades with a loaded truck. Apply the service brakes only when dynamic retarding requires additional braking force to slow the truck speed quickly and to completely stop the truck.

When dynamic retarding is activated, the engine rpm will automatically go to an advance rpm retard speed setting (usually 1250 rpm, see note below.) Dynamic retarding will be applied automatically if the speed of the truck reaches the predetermined overspeed retard setting. Dynamic retarding is available in FORWARD/REVERSE at all truck speeds above 0 kph (mph) but is available in NEUTRAL only when the truck speed is above 5 kph (3 mph).

NOTE: The exact engine speed in retarding may vary (1250 - 1650 rpm) due to the temperature of certain components, This is controlled by the Statex III control system.

Optional - Dual Function/Single Pedal

The dynamic retarding/brake pedal is a single foot-operated pedal which controls both retarding and service brake functions. Thus, the operator must first apply, and maintain, full dynamic retarding in order to apply the service brakes.

When pedal (3) is partially depressed, dynamic retarding is activated (actuation is modulated). Pressing the pedal further applies full retarding. During full retarding the service brakes also begin to apply. Completely depressing the pedal causes full application of both the dynamic retarding and the service brakes.

THROTTLE PEDAL

Throttle pedal (4, Figure 32-4) is a foot-operated pedal which allows the operator to control the engine rpm, depending on the pedal depression.

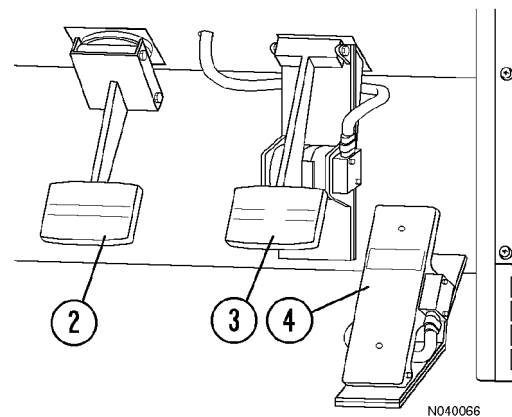

FIGURE 32-4. PEDALS

- | | |
|------------------------|---------------------------|
| 1. Cab Floor | 3. Dynamic Retarder Pedal |
| 2. Service Brake Pedal | 4. Throttle Pedal |

CAB CLIMATE CONTROL

HEATER/AIR CONDITIONER VENTS

The operator has complete control of the air flow in the cab. Heater/air conditioner vents (5, Figure 32-1) are flapper-type vents. The vents may be individually opened or closed, and may be rotated 360° for optimum air flow. There are four (three not shown) across the top of the panel, two in front of the operator (one each in the right and left panel modules), and four below the panel.

HEATER/AIR CONDITIONER CONTROLS AND VENTS

Heater/air conditioner unit (6, Figure 32-1) contains heater/air conditioner controls and the heater/air conditioner components, such as the blower motor and heater coils. Optimum cab air climate can be selected by using the following controls in various combinations.

Defroster Vent Control Switch

Defroster vent control switch (1, Figure 32-5) directs heated air to the windshield for defrosting. The down position of the toggle switch is off, and the up position is on.

Heat Control Switch

Heat control switch (2, Figure 32-5) directs heated air to the cab floor for heating of the cab. The down position of the toggle switch is off. The up position of the toggle switch is on.

Temperature Control Knob

Temperature control knob (3, Figure 32-5) adjusts the outlet air temperature of the heater/air conditioner.

Rotating the knob counterclockwise (blue arrow) will select cooler temperatures. Full counterclockwise position is the coldest air setting.

Rotating the knob clockwise (red arrow) will select warmer temperatures. Full clockwise position is the warmest heater setting.

Fan Control Knob

Fan control knob (4, Figure 32-5) controls the 3-speed heater/air conditioner internal fan unit. Full counterclockwise is the off position. Rotating the knob clockwise selects increasingly higher fan speeds.

Heater/Air Conditioner Selector Switch

Heater/air conditioner selector switch (5, Figure 32-5) allows the operator to select heat, A/C, or neither. The left position of the switch activates the air conditioning, and the right side of the switch activates the heater. The middle position is off (no heat or air conditioning).

NOTE: The air conditioner will not operate unless the fan control knob is turned on.

Heater/Air Conditioner Vents

Heater/air conditioner vents (6, Figure 32-5) may be rotated 360°. Air flow through the vents is controlled by manually opening/closing, or turning the louvers.

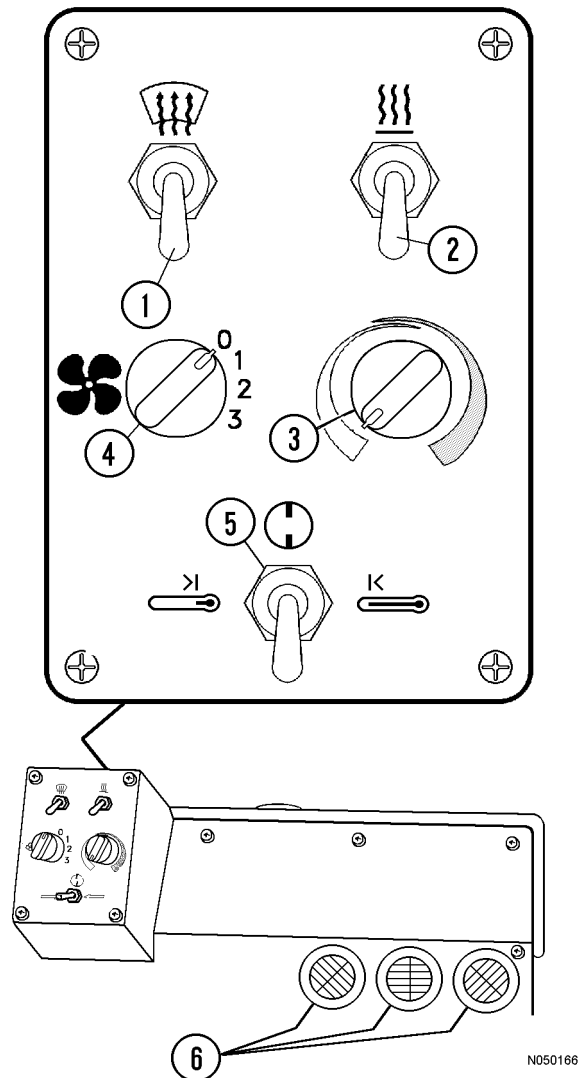

FIGURE 32-5. A/C AND HEATER CONTROLS

- | | |
|----------------------------------|---|
| 1. Defroster Vent Control Switch | 5. Heater/Air Conditioner Selector Switch |
| 2. Heat Control Switch | 6. Heater/Air Conditioner Vents |
| 3. Temperature Control Knob | |
| 4. Fan Control Knob | |

OVERHEAD PANEL CONTROLS AND COMPONENTS

GRADE/SPEED WARNING CHART

Grade/Speed Warning chart (Figure 32-6) provides the recommended maximum truck speeds for descending various grades with a loaded truck.

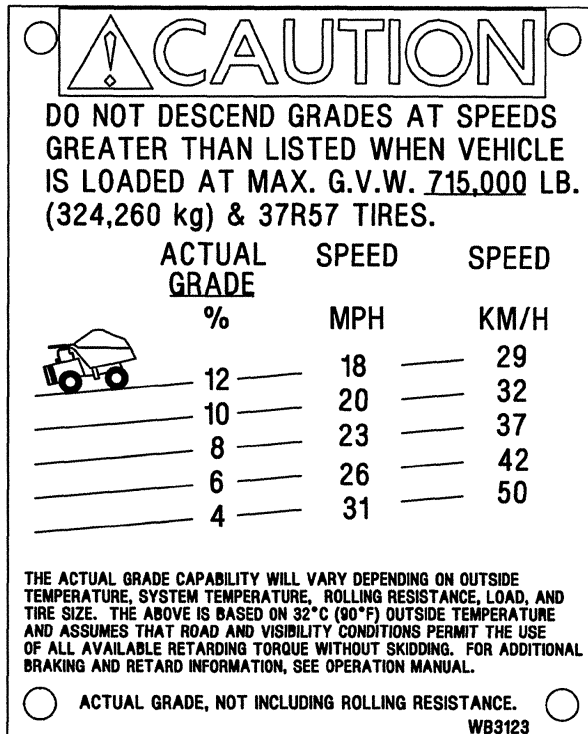

FIGURE 32-6. GRADE/SPEED WARNING CHART

The operator must refer to the grade/speed warning chart before descending any grade with a loaded truck. Proper use of dynamic retarding will maintain a safe speed.

DO NOT exceed the recommended maximum speed when descending a grade with a loaded truck.

This decal may change with optional truck equipment such as: wheel motor drive train ratios, retarder grids, tire sizes, etc.

RADIO SPEAKERS

Radio speakers (9, Figure 32-1) for the AM/FM radio are located at the far left and right of the overhead panel.

WARNING ALARM BUZZER

Warning alarm buzzer (10, Figure 32-1) will sound when activated by any one of several truck functions. Refer to Instrument Panel in this module for a detailed description of the functions and indicators that will activate this alarm.

CAB RADIO

This panel will normally contain AM/FM radio (11, Figure 32-1). Refer to Section 70 for a complete description of the radio and its functions. Individual customers may use this area for other purposes, such as a two-way communications radio.

WARNING LIGHTS DIMMER CONTROL

Warning lights dimmer control (12, Figure 32-1) permits the operator to adjust the brightness of the warning indicator lights. This control may not be on all model trucks.

WARNING/STATUS INDICATOR LIGHT PANEL

Warning/status indicator light panel (13, Figure 32-1) contains an array of indicator lights to provide the operator with important status messages concerning selected truck functions. Refer to Overhead Status/Warning Indicator Light Panel in this module for a detailed description of these indicators.

AIR CLEANER VACUUM GAUGES

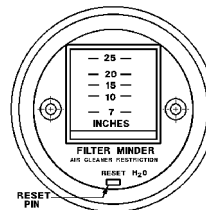

Air cleaner vacuum gauges (14, Figure 32-1) provide a continuous reading of maximum air cleaner restriction reached during operation. The air cleaner(s) must be serviced when the gauge(s) display 6.2 kPa (25 in. H₂O).

NOTE: After service, push the reset button on the face of the gauge to allow the gauge to return to zero.

WINDSHIELD WIPERS

Windshield wipers (15, Figure 32-1) are powered by an electric motor. Refer to Multi-Function Turn Signal Switch in this module for a location and description of the windshield wiper and washer controls.

CENTER CONSOLE

1. Center Console
2. F-N-R Selector Switch
3. Hoist Control Lever
4. Ashtray
5. Cigarette Lighter
6. LH Window Control Switch
7. RH Window Control Switch
8. Engine Shutdown Switch
9. Override Switch
10. Blank - Not used on this truck
11. RSC ON/OFF Switch
12. Retarder Speed Control (RSC) Dial
13. Statex III Download Port
14. Engine Diagnostic Port (CENSE)
15. Modular Mining Port (Optional)
16. Passenger Seat (mounted on top of the right-hand portion of the console)
17. Engine Diagnostic Connectors (Optional Quantum/Centry)
18. Engine Diagnostics Connector (Optional)
19. Data Storage Button

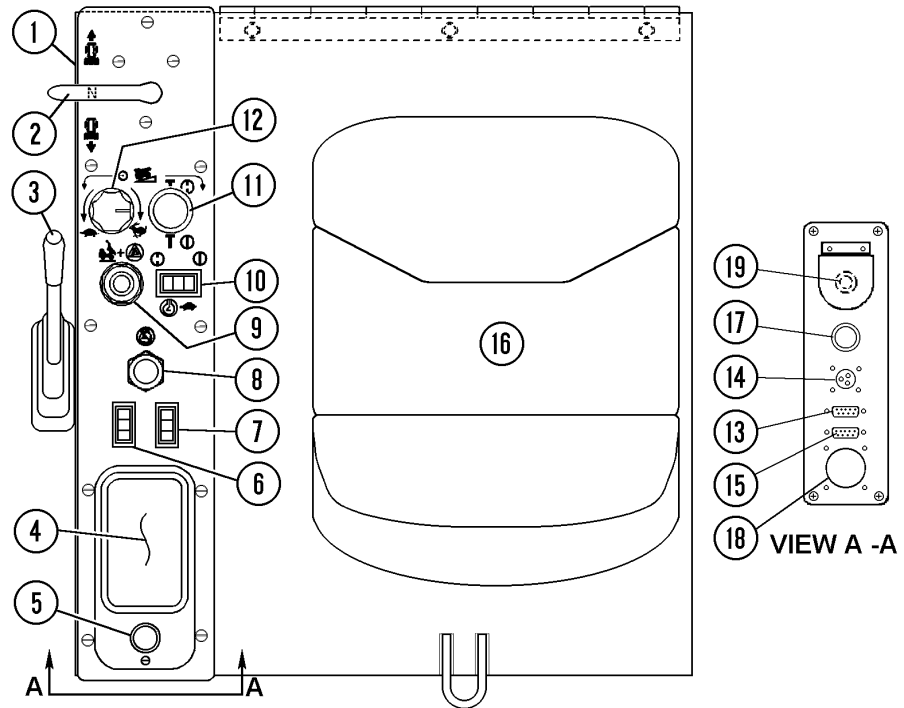
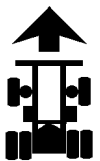

FIGURE 32-7. CENTER CONSOLE

TRUCK CONTROLS

F-N-R Selector Switch

F-N-R selector switch (2, Figure 32-7) is mounted on a console to the right of the operator's seat. It is a three-position switch that controls the forward-neutral-reverse motion of the truck. When the selector switch handle is in the center N position, it is in NEUTRAL. The handle must be in NEUTRAL to start the engine.



The operator can select forward drive by moving the handle forward.

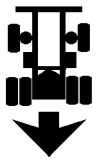

Reverse drive can be selected by moving the handle rearward.

The truck must be stopped before the selector handle is moved to a forward or reverse drive position.

Hoist Control Lever

Hoist control lever (3, Figure 32-7) is a four-position, hand-operated lever located between the operator seat and the center console.

Refer to Safety, Section 20, When Dumping, and Section 30, Dumping, for complete details concerning this control.

CONSOLE SWITCHES AND CONTROLS

Ashtray

Ashtray (4, Figure 32-7) is used for extinguishing and depositing smoking materials. DO NOT use for flammable materials, such as paper.

Ensure that all fire ash is extinguished!

Cigarette Lighter

Cigarette lighter (5, Figure 32-7) may be used for lighting cigars/cigarettes.

Use caution with smoking materials!

This socket may also be used for a 12VDC power supply.

Left-Hand Window Control Switch

Left-hand window control switch (6, Figure 32-7) is spring-loaded to the OFF position. Pushing the front of the switch raises the left side cab window. Pushing the rear of the switch lowers the window.

Right-Hand Window Control Switch

Right-hand window control switch (7, Figure 32-7) is spring-loaded to the OFF position. Pushing the front of the switch raises the right side cab window. Pushing the rear of the switch lowers the window.

Engine Shutdown Switch

Engine shutdown switch (8, Figure 32-7) is used to turn the engine off. Pull the switch up to stop the engine. Push the switch down to enable the engine to start.



Use this switch to shut the engine off if the key switch fails to operate, or to stop the engine without turning off the 24VDC electrical circuits.

A ground level engine shutdown switch is also located at the right, front corner of the truck.

Override Switch

Override switch (9, Figure 32-7) is spring-loaded to the OFF position. When pushed inward and held, this switch has several uses.

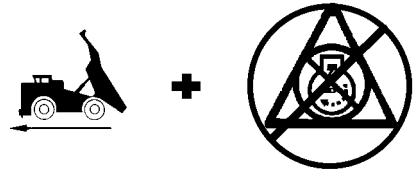

1. The override switch permits the operator to move the truck forward when the selector switch is in FORWARD, the dump body is raised, and the brakes are released.



Only use the override switch in emergency situations.

2. If the operator stops the truck on an uphill incline, the override switch can be used to set up the forward propulsion while the brakes are applied. As soon as the forward propulsion is felt, release the brakes. As the truck begins to move forward, release the override switch.
3. The override switch deactivates the retard pedal function when the speed of the truck is below 5 kph (3 mph).
4. The override switch is also used to reset an electric system fault when indicated by the red warning light. Refer to Overhead Warning/Status Indicator Light Panel in this section.

Retard Speed Control (RSC) Switch

Retard speed control switch (11, Figure 32-7) turns the system off or on. Push the knob in to turn the system off, and pull the knob out to turn the system on.

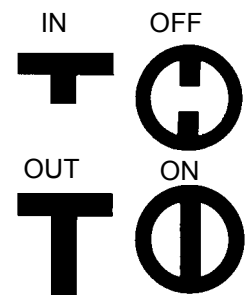
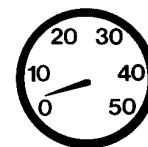

Retard Speed Control (RSC) Dial

RSC dial (12, Figure 32-7) allows the operator to vary the downhill truck speed that the retard speed control system will maintain when descending a grade.

When the dial is rotated counterclockwise toward the turtle symbol, the truck will descend a grade at lower speeds.



When the dial is rotated clockwise toward the rabbit symbol, the truck speed will increase.



The throttle pedal position will override the RSC setting. If the operator depresses the throttle pedal to increase the truck speed, dynamic retarding will not activate unless the truck overspeed setting is reached, or the retard pedal is used. When the throttle pedal is released, dynamic retarding will activate at the RSC preset speed. The RSC control will maintain the truck speed at the preset limit.

To adjust the RSC control, pull switch (11) to the ON position. Start with dial (12) rotated toward the fastest speed while driving the truck at the desired maximum speed. Relax the throttle pedal to let the truck coast, and turn the RSC dial slowly counterclockwise until dynamic retarding is activated. Dynamic retarding will now be activated automatically anytime the set speed is reached, the RSC switch is ON, and the throttle pedal is released.

With the RSC switch in the ON position and the dial adjusted, the system will function as follows: As the truck speed increases to the set speed and the throttle pedal released, dynamic retarding will apply. As the truck speed tries to increase, the amount of retarding effort will automatically adjust to keep the selected speed. When the truck speed decreases, the retarding effort is reduced to maintain the selected speed. If the truck speed continues to decrease to approximately 5 kph (3 mph) below the set speed, dynamic retarding will turn off automatically. If the truck speed must be reduced further, the operator can turn the dial to a new setting or depress the retard pedal.

If the operator depresses the retard pedal, and the retard effort called for is greater than that from the automatic system, the demand from the pedal will override the RSC.

Statex III Download Port

Statex III download port (13, Figure 32-7) is used by qualified personnel to access the STATEX III electric propulsion diagnostic information and data.

Engine Diagnostic Port (CENSE)

Engine diagnostic port (14, Figure 32-7) is used by qualified personnel to access the engine diagnostic information for the CENSE system. Refer to the engine manufacturer's service publications for troubleshooting information.

Modular Mining Port

Modular mining port (15, Figure 32-7) is used if the optional modular mining system is installed on the truck.

Passenger Seat

Passenger seat (16, Figure 32-7) is mounted on top of the right-hand portion of the center console.

The area beneath the passenger seat provides a cabinet for various 24VDC electrical components. Consult the service manual for service involving any of these components.

Engine Diagnostic Connectors

Engine diagnostic connectors (17, Figure 32-7) are used by qualified personnel to access the engine Centry™ fuel control system diagnostic information. The Centry system is optional.

Engine Diagnostics Connector

Engine diagnostics connector (18, Figure 32-7) is used by qualified personnel to access engine diagnostic information. This function is optional.

Data Storage Button

Data storage button (19, Figure 32-7) is used to record a snapshot of the Statex III drive system.

PAYLOAD METER

Payload meter (1, Figure 32-9) and payload meter download connector (2) are used to provide management with operational data, such as tonnage hauled and cycle times.

Refer to Section 60, Payload Meter III, for a complete description of the payload meter and its functions.

Payload Meter Download Connector

Payload meter download connector (2, Figure 32-9) is used with a special cable to allow payload meter (1) to communicate with a portable computer.

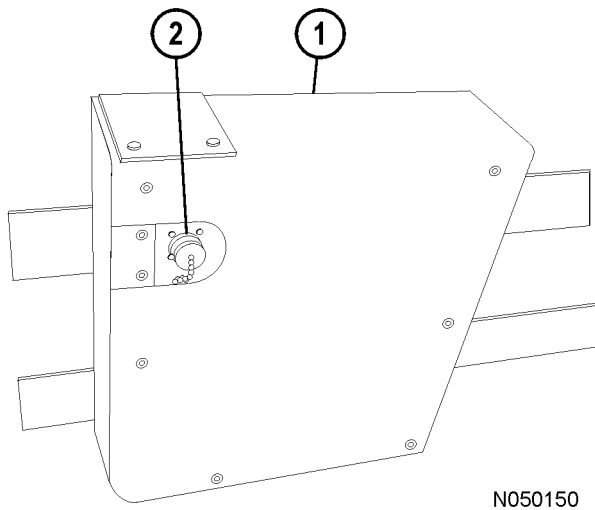

FIGURE 32-9. PAYLOAD METER

1. Payload Meter

2. Payload Meter
Download
Connector

OPERATOR SEAT

The operator's seat provides a fully adjustable cushioned ride for the driver's comfort.

ADJUSTMENT

The following adjustments must be made while sitting in the seat.

1. **Headrest:** Move up, down, fore, or aft by moving headrest (1, Figure 32-10) to the desired position.
2. **Armrests:** Rotate the adjusting knob until the armrest is in the desired position. The knobs are located at the front of the armrests.
3. **Backrest:** Lift backrest adjustment (3) to release, and select the backrest angle. Release the control handle to set.
4. **Seat Belt:** The operator must have seat belt (4) buckled in place and properly adjusted whenever the vehicle is in motion.
5. **Seat Slope:** Lift seat slope adjustment (5) and hold to adjust the slope of the seat. Release the lever to lock the adjustment.
6. & 7. **Air Pillow Lumbar Support:** Each upper/lower air pillow lumbar support (6 or 7) controls an air pillow. Switch (7) controls the lower air pillow, and switch (6) controls the upper air pillow. To inflate, press on top of the rocker switch and hold for the desired support, then release. To deflate, press on the bottom of the rocker switch and hold for the desired support, then release. Adjust each pillow for the desired support.
8. **Seat Suspension:** Move suspension adjustment (8) up to increase ride stiffness and down to decrease ride stiffness.
9. **Horizontal Adjustment:** Lift horizontal adjustment (9) and hold. Bend knees to move the seat to a comfortable position. Release the control lever to the lock adjustment.
12. **Seat Height:** Lift seat height adjustment (12) and hold to adjust the height of the seat. Release the lever to lock the adjustment.

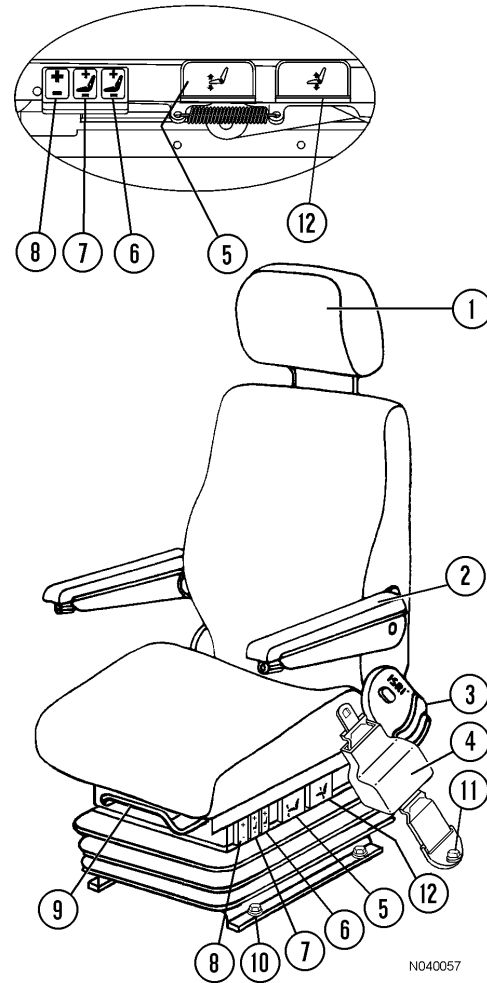

FIGURE 32-10. OPERATOR SEAT
ADJUSTMENT CONTROLS

1. Headrest
2. Armrest Adjustment
3. Backrest Adjustment
4. Seat Belt
5. Seat Slope Adjustment
6. Upper Air Pillow Lumbar Support
7. Lower Air Pillow Lumbar Support
8. Suspension Adjustment
9. Horizontal Adjustment
10. Mounting Cap Screws and Hardware
11. Seat Belt Tether Cap Screw
12. Seat Height Adjustment

INSTRUMENT PANEL

GENERAL INFORMATION

The operator must understand the function and operation of each instrument and control (Figure 32-11). Control functions are identified with international symbols that the operator must learn to recognize immediately. This knowledge is essential for proper and safe operation.

Items that are marked as optional do not apply to every truck.

CONTROL SYMBOLS

The following symbols are general indicators and may appear in multiple locations and combinations on the instrument panel.

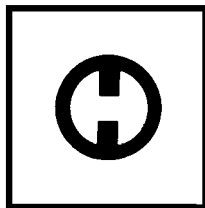

This symbol may be used alone or with another symbol. This symbol identifies the OFF position of a switch or control.

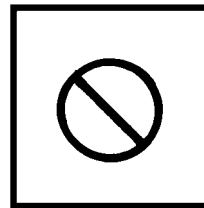

This symbol, when it appears on an indicator or control, identifies that this indicator or control is not used.

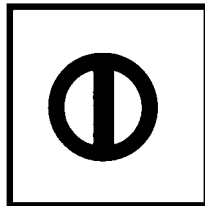

This symbol may be used alone or with another symbol. This symbol identifies the ON position of a switch or control.

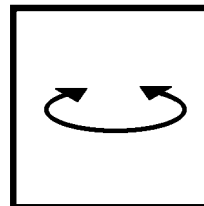

This symbol identifies a rotary control or switch. Rotate the knob clockwise or counterclockwise for functions.

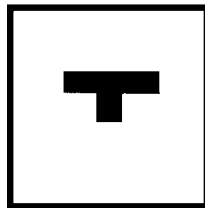

This symbol identifies the pushed in position of a push-pull switch or control.

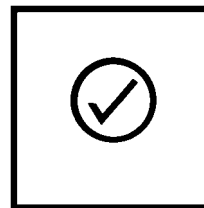

This symbol identifies a switch used to test or check a function. Press the switch on the side near the symbol to perform the test.



This symbol identifies the pulled out position of a push-pull switch or control.

CONTROL SWITCHES AND GAUGES

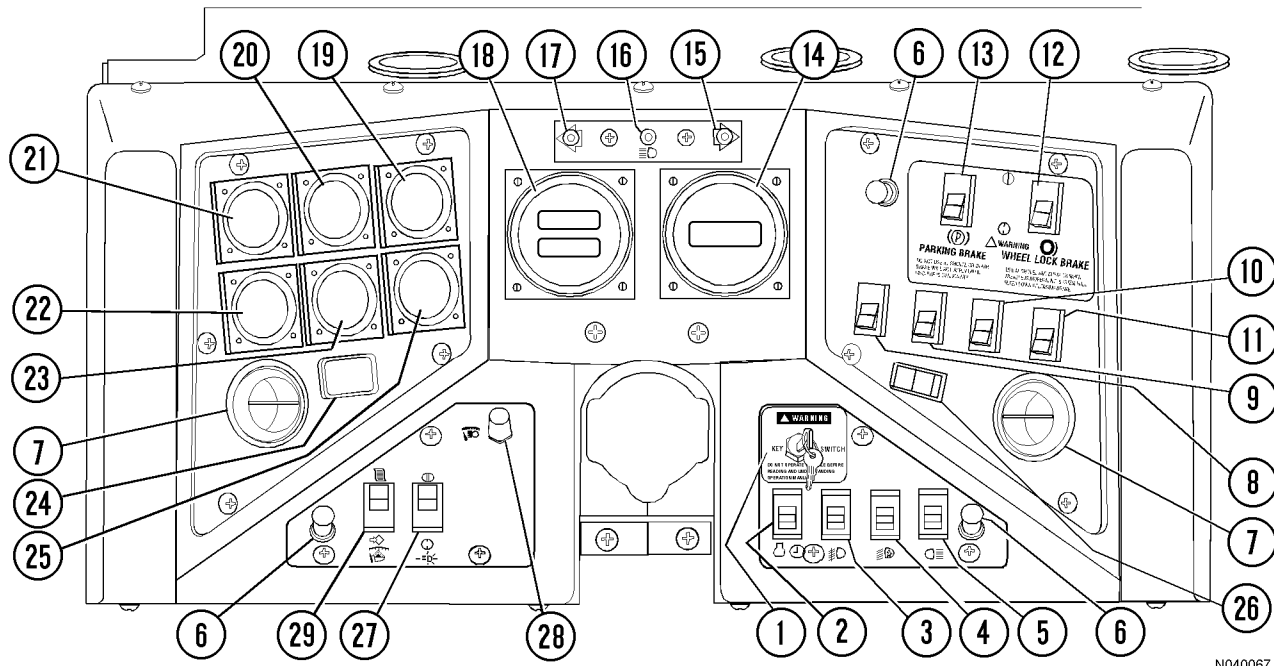

FIGURE 32-11. PANEL, GAUGES, INDICATORS, AND CONTROLS

- | | |
|---|--|
| <ol style="list-style-type: none"> 1. Key Switch 2. Timer Delayed Engine Shutdown Switch 3. Fog Light Switch (Optional) 4. Ladder Light Switch 5. Backup Light Switch 6. Panel Illumination Lights 7. Vent(s) - Cab Air Conditioner/Heater 8. Engine Cold Weather Starting Aid Switch (Optional) 9. Rotating Beacon Light Switch (Optional) 10. Heated Mirror Switch (Optional) 11. Not Used 12. Wheel Brake Lock Switch 13. Parking Brake Switch 14. Digital Tachometer 15. Right Turn Signal Indicator Light | <ol style="list-style-type: none"> 16. High Beam Headlight Indicator Light 17. Left Turn Signal Indicator Light 18. Digital Speedometer/Payload Meter Display 19. Voltmeter Gauge 20. Engine Oil Pressure Gauge 21. Engine Water Temperature Gauge 22. Fuel Gauge 23. Gauge - Not Used In This Application 24. Engine Hourmeter 25. Gauge - Not Used In This Application 26. Switch - Not Used In This Application 27. Headlight Switch 28. Panel Illumination Lights Dimmer Rheostat 29. Payload Meter Switch |
|---|--|

Key Switch

Key switch (1, Figure 32-11) is a three-position (OFF, RUN, START) switch. When the switch is rotated one position clockwise, it is in the RUN position and all electrical circuits (except start) are activated.

With the selector switch in neutral, rotate the key switch fully clockwise to the START position, and hold this position until the engine starts. The START position is spring-loaded to return to RUN when the key is released. With the truck stopped, turn the key switch counterclockwise to OFF for normal engine shutdown. Use the engine shutdown switch on the center console if the engine does not shut off with the key switch.

NOTE: A ground level shutdown switch is located on the lower, front left side of the truck.

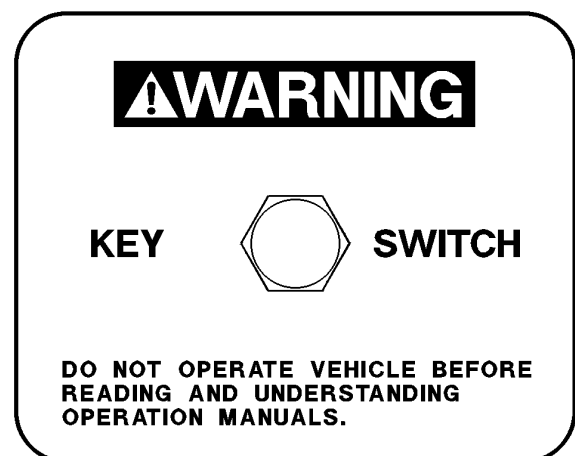

Engine Shutdown Switch With Timer Delay

Engine shutdown switch with timer delay (2, Figure 32-11) is a three-position, rocker-type switch (OFF, ON, MOMENTARY). Refer to Timer Delayed Engine Shutdown Switch procedure, Section 30, for a complete detailed operation of this switch.

Fog Light Switch

Fog light switch (3, Figure 32-11) is used by pressing the top of the rocker switch to turn the lights on. Pressing the bottom of the switch turns the lights off. The fog lights are optional.

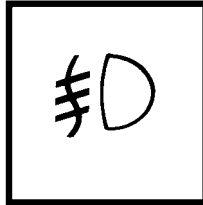

Ladder Light Switch

Ladder light switch (4, Figure 32-11) turns the ladder lights on and off. Pressing the top of the rocker switch turns the lights on. Pressing the bottom of the switch turns the lights off. Another switch is mounted at the front left of the truck near the base of the ladder.

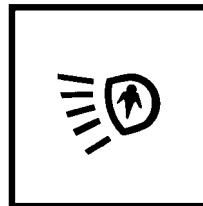

Backup Light Switch

Backup light switch (5, Figure 32-11) allows the backup lights to be turned ON providing added visibility and safety when the selector switch (see operator controls) is not in the REV position. When the switch is pressed toward the ON position, manual backup light indicator (B4, overhead panel) will be illuminated.

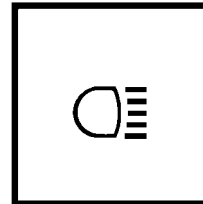

Panel Illumination Lights

Panel illumination lights (6, Figure 32-11) provide illumination for the instrument panel. Brightness is controlled by panel illumination lights dimmer rheostat (28).

Cab Air Conditioner/Heater Vents

Cab air conditioner/heater vents (7, Figure 32-11) are spherically mounted and may be directed by the operator to provide the most comfortable cabin air flow.

Engine Cold Weather Starting Aid Switch

Optional engine cold weather starting aid switch (8, Figure 32-11) is spring-loaded to the OFF position. Use only when the ambient temperature is below 10°C (50°F). When the switch is held in the ON position, ether is injected into the engine intake manifold to aid the engine starting in cold weather. For additional information, refer to Section 30, Engine Start-Up.

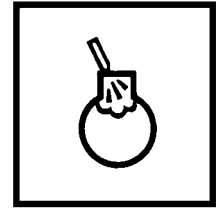

Rotating Beacon Light Switch

Press rotating beacon light switch (9, Figure 32-11) to the ON position to activate the rotating beacon. This is an optional feature.

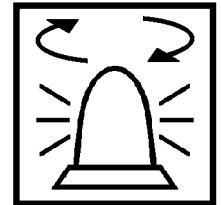

Heated Mirror Switch

Press heated mirror switch (10, Figure 32-11) to activate the heating element in the mirrors. This is an optional feature.

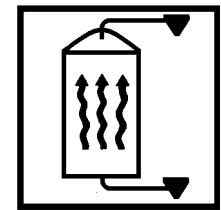

Wheel Brake Lock Switch



Wheel brake lock switch (12, Figure 32-11) must only be used when the engine is on. Use this function during dumping and loading. The brake lock switch actuates the hydraulic brake system, which locks the rear wheel service brakes only. When approaching the shovel or dump area, stop the truck using the service brake pedal. When the truck is completely stopped and in the loading position, apply the brake lock by pressing the rocker switch toward the ON symbol. To release, press the rocker switch toward the OFF symbol.

⚠ WARNING

The wheel brake lock is used at the shovel and the dump only to hold the truck in position. DO NOT use this switch to stop the truck, unless the foot-operated treadle valve does not work. Use of this switch applies the rear service brakes with unmodulated pressure! DO NOT use the brake lock for parking because when the engine is stopped, hydraulic pressure will dissipate, allowing the brakes to release!

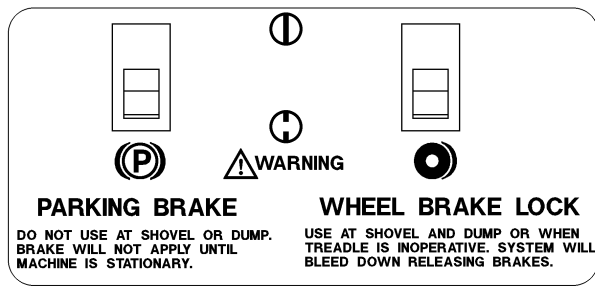

Parking Brake Switch



Parking brake switch (13, Figure 32-11) is spring-applied and hydraulically released. It is designed to hold the truck stationary when the engine is shut off and the key switch is turned OFF. The truck must be completely stopped before applying the parking brake, or damage may occur to the parking brake. To apply the parking brake, press the rocker switch toward the ON symbol. To release the parking brake, press the rocker switch toward the OFF symbol. When the key switch is ON and the parking brake switch is applied, parking brake indicator light (A3, overhead panel) will be illuminated.

NOTE: DO NOT use the parking brake at the shovel or dump. With the key switch ON and the engine on, sudden shock caused by loading or dumping could cause the system's motion sensor to release the park brake.

Digital Tachometer

Digital tachometer (14, Figure 32-11) displays the engine crankshaft speed in revolutions per minute (rpm).

Governed rpm:

Low Idle - 750 rpm

High Idle, No load - 1950 rpm maximum

High Idle, Full Load - 1900 rpm

Right Turn Signal Indicator Light

Right turn signal indicator light (15, Figure 32-11) illuminates to indicate the right turn signals are operating.

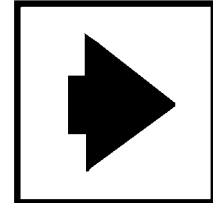

High Beam Headlight Indicator Light

High beam headlight indicator light (16, Figure 32-11), when lit, indicates that the truck headlights are on high beam.

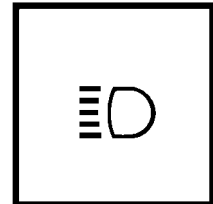

Left Turn Signal Indicator Light

Left turn signal indicator light (17, Figure 32-11) illuminates to indicate the left turn signals are operating.

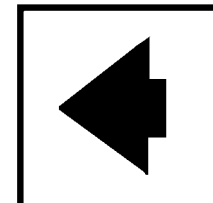

Digital Speedometer/Payload Meter Display

Digital speedometer/payload meter display (18, Figure 32-11) indicates the truck speed in miles per hour (mph). With an optional speedometer, it may indicate the truck speed in kilometers per hour (kph). The display also shows the payload meter information. For more information, see Payload Meter, Section 60.

Voltmeter Gauge

Voltmeter gauge (19, Figure 32-11) indicates the voltage of the 24V battery system. Normal indicated voltage at high rpm is 27 to 28 volts with the batteries in the fully charged condition. When key switch (1) is in the RUN position and the engine is stopped, the voltmeter gauge indicates the battery charge condition.

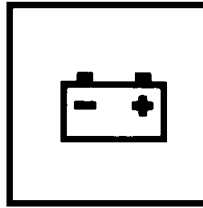

Engine Oil Pressure Gauge

Engine oil pressure gauge (20, Figure 32-11) indicates the pressure in the engine lubrication system in pounds per square inch (psi). Normal operating pressure after engine warm up is 138 - 250 kPa (20 to 35 psi) at idle speed. If oil pressure is below this range, a problem may exist. Shut the engine off and notify maintenance personnel.

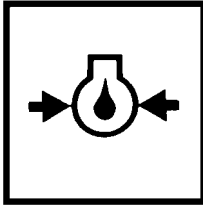

Engine Water Temperature Gauge

Engine water temperature gauge (21, Figure 32-11) indicates the temperature of the coolant in the engine cooling system. The temperature range after engine warm-up in normal conditions is 74° - 91°C (165° - 195°F). Temperatures outside of this range may indicate a problem.

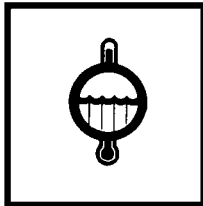

Fuel Gauge

Fuel gauge (22, Figure 32-11) indicates how much diesel fuel is in the fuel tank. Fuel tank capacity is 3217 liters (850 gallons.)

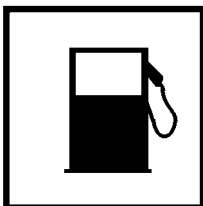

Engine Hourmeter

Engine hourmeter (24, Figure 32-11) displays the total number of hours the engine has been in operation.

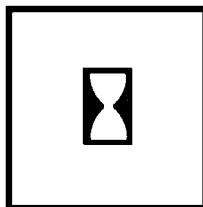

Headlight Switch

Instrument panel lights, clearance lights, and headlights are controlled by headlight switch (27, Figure 32-11). OFF is selected by pressing the bottom of the switch. Press the top of the switch until it reaches the first detent to select the panel, clearance, and tail lights only. Press the top of the switch again until it reaches the second detent to select the headlights, as well as the panel, clearance, and tail lights.

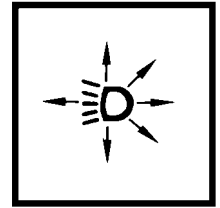

Panel Illumination Lights Dimmer Rheostat

Panel illumination lights dimmer rheostat (28, Figure 32-11) allows the operator to vary the brightness of the instruments and panel lights. Rotating the knob to the full counterclockwise position turns the panel lights on to the brightest condition. Rotating the knob clockwise continually dims the lights until the OFF position is reached at the full clockwise rotation.

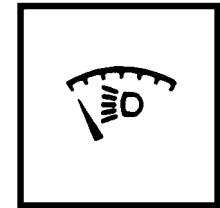

Payload Meter Switch

Payload meter switch (29, Figure 32-11) is a two-way, momentary switch. The top position is the select position which is used to step through the different displays. The lower position is the set position which is used to set the operator ID or clear the load and total ton counters. Refer to Payload Meter in this module for a complete description of the payload meter system and its functions.

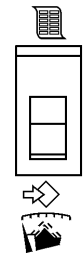

OVERHEAD STATUS/WARNING INDICATOR LIGHT PANEL

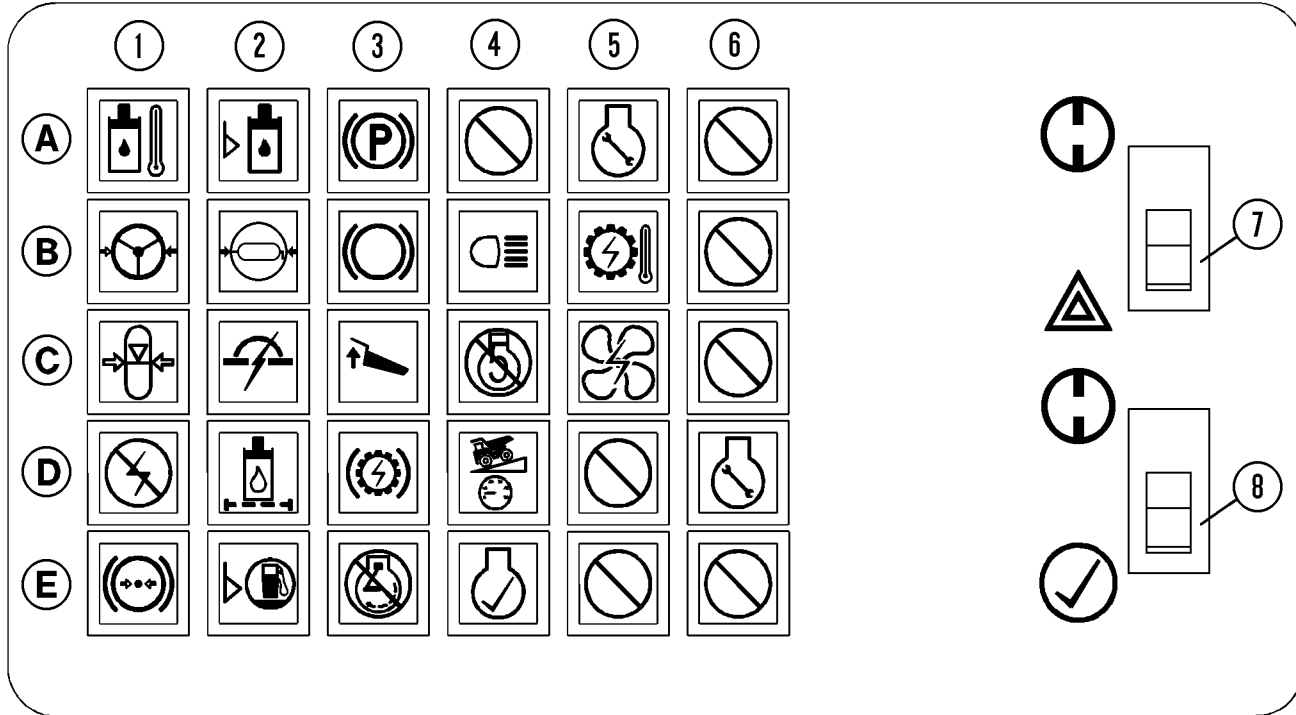

N050286

FIGURE 32-12. STATUS/INDICATOR LIGHTS

DESCRIPTION OF INDICATOR SYMBOLS

| Row/ Column | Indicator Description | Indicator Color Wire Index |
|----------------|---|-------------------------------|
| A1 | High Hydraulic Oil Temperature | Red - 12F/34TL |
| B1 | Low Steering Pressure | Red - 12F/33A |
| C1 | Low Accumulator Precharge Pressure | Red - 12F/33K |
| D1 | Electric System Fault Warning | Red - 12F/79V |
| E1 | Low Brake Pressure | Red - 12F/33L |
| A2 | Low Hydraulic Tank Level | Red - 12F/34LL |
| B2 | Low Automatic Lubrication System Pressure | Yellow - 12FD8/68LLP |
| C2 | Circuit Breaker Tripped | Yellow - 12F/31CB |
| D2 | Hydraulic Oil Filter | Yellow - 12F/39 |
| E2 | Low Fuel Indicator | Yellow - 12F/38 |
| A3 | Parking Brake Indicator | Yellow - 12M/52A |
| B3 | Service Brake Indicator | Yellow - 12M/44L |
| C3 | Body Up Indicator | Yellow - 12M/63L |
| D3 | Dynamic Retarding Indicator | Yellow - 12M/44DL |
| E3 | Stop Engine Warning | Red - 12M/509MA |

| Row/ Column | Indicator Description | Indicator Color Wire Index |
|----------------|---|-------------------------------|
| A4 | Blank - For Future Use | Yellow - 12M/SP2 |
| B4 | Backup Indicator | Yellow - 12M/47L |
| C4 | Engine Shutdown Timer Switch - Five Minute Idle | Yellow - 12M/23L1 |
| D4 | Retard Speed Control | Yellow - 12M/31R |
| E4 | Not Used | Yellow - 12M/419 |
| A5 | Service Engine Indicator (AEM) | Blue - 12M/528A |
| B5 | High Wheel Motor Temperature Indicator | Red - 12F/722L |
| C5 | Blower Fault Warning | Red - 12F/32B |
| D5 | Blank - For Future Use | Yellow - 12F/SP4 |
| E5 | Blank - For Future Use | Yellow - 12F/SP5 |
| A6 | Blank - For Future Use | Yellow - 12M/SP6 |
| B6 | Blank - For Future Use | Red - 12M/SP7 |
| C6 | Blank - For Future Use | Yellow - 12M/SP8 |
| D6 | Service Engine (CENSE) | Yellow - 528/12M |
| E6 | Blank - For Future Use | Red - 12M/SP9 |

7. HAZARD LIGHT SWITCH - Wires 11L/45L/45R

8. LAMP CHECK SWITCH (Momentary) -
Wire 712/52B/33H/710

INDICATOR LIGHT FUNCTIONS

Amber indicator lights alert the operator the indicated truck function requires some precaution when lighted.

Red indicator lights alert the operator the indicated truck function requires immediate action. Safely stop the truck and shut the engine off.

WARNING

To prevent possible death or severe injury, DO NOT operate the truck with a red warning light illuminated.

Refer to Figure 32-12 and the descriptions below for explanations of the symbols. Location of the symbols is described by rows (A-E) and columns (1-6).

High Hydraulic Oil Temperature

High hydraulic oil temperature (A1) warning light indicates high oil temperature in the hydraulic tank. Continued operation could damage the components in the hydraulic system. Notify maintenance personnel immediately. The light turns on when hydraulic oil reaches 107°C (225°F).

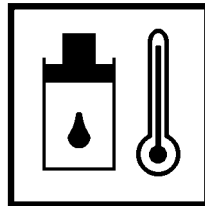

Low Steering Pressure

When the key switch is turned ON, low steering pressure warning light (B1) will illuminate until the steering system hydraulic pressure reaches 14.7 kPa (2100 psi). The warning horn will also turn on, and both will remain on until the accumulator has been charged.

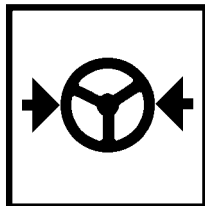

During truck operation, the low steering pressure warning light and warning horn will sound if the steering system hydraulic pressure drops below 14.7 kPa (2100 psi.)

- If the light illuminates momentarily (flickers) while turning the steering wheel at low truck speed and low engine rpm, this may be considered normal, and the truck operation may continue.
- If the indicator light illuminates at higher truck speed and high engine rpm, stop the truck and notify maintenance.

WARNING

If the low steering warning light continues to illuminate and the alarm continues to sound, low steering pressure is indicated. The remaining pressure in the accumulators allows the operator to control the truck to a stop. DO NOT attempt further operation until the malfunction is located and corrected.

Low Accumulator Precharge Pressure Warning

Low accumulator precharge pressure warning light (C1), if illuminated, indicates low nitrogen precharge for the steering accumulator(s). To check for proper accumulator nitrogen precharge, the engine must be stopped and the hydraulic system completely depressurized. Then turn the key switch to the RUN position. The warning light will not illuminate if the system is properly charged. The warning light will flash if the nitrogen precharge within the accumulator(s) is below 7585 ± 310 kPa (1100 ± 45 psi.)

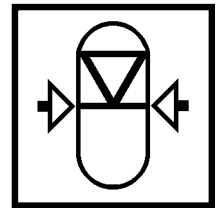

WARNING

If the low accumulator precharge warning light flashes, notify maintenance personnel. To prevent possible death or severe injury, DO NOT attempt further operation until the accumulators have been recharged with nitrogen to 9653 kPa (1400 psi.) Sufficient energy for emergency steering may not be available if the system is not properly charged.

Electric System Fault Warning

Electric system fault warning light (D1) will flash on and off when a malfunction occurs in the electrical system. The warning horn will also sound intermittently. When the light comes ON, the propulsion will be dropped automatically. Reset by pushing the override button. If the fault repeats again, stop the truck and report the problem to maintenance personnel.

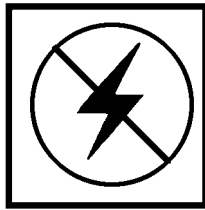

NOTE: STATEX III records the number of faults/events. When a predetermined number of faults/events are recorded within a given time frame, the operator will not be able to reset the fault/event by using the override switch. If this occurs, notify maintenance personnel immediately.

Low Brake Pressure Indicator

Red low brake pressure indicator light (E1) indicates a malfunction within the hydraulic brake circuit. If this light comes on and the buzzer sounds, shut off the truck and notify maintenance personnel.

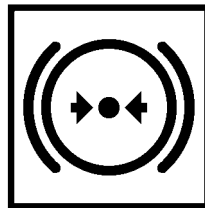

NOTE: Adequate hydraulic fluid is stored to allow the operator to safely stop the truck.

Low Hydraulic Tank Level

Low hydraulic tank level light (A2) indicates the oil level in the hydraulic tank is below the recommended level. Damage to the hydraulic pumps may occur if operation continues. Shut the truck off and notify maintenance personnel immediately.

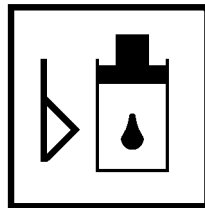

Low Automatic Lubrication System Pressure

Amber low automatic lubrication system pressure light (B2) will illuminate if the automatic lubrication system fails to reach 2,000 psi (15168 kPa) at the junction block located on the rear axle housing within one minute after the lube timer indicates a cycle of grease. To turn the light off, turn the key switch off, then back on again. Notify maintenance personnel at the earliest opportunity after the light comes on.

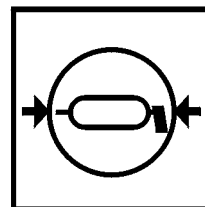

Circuit Breaker Tripped

Circuit breaker tripped light (C2) will illuminate if any of the circuit breakers in the relay circuit control boards are tripped. The relay circuit boards are located in the electrical control cabinet.

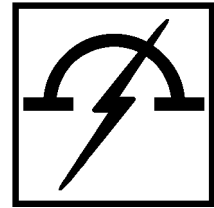

NOTE: Additional circuit breakers are located in the operator cab behind the center console. However, tripping of these circuit breakers will not activate this light.

Hydraulic Oil Filter

Hydraulic oil filter light (D2) indicates a restriction in the high pressure filter assembly for either the steering or hoist circuit. This light will illuminate before the filters start to bypass. Notify maintenance personnel at the earliest opportunity after the light illuminates.

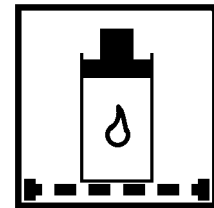

NOTE: The filter monitor warning light may also illuminate after the engine is initially started if the oil is cold. If the light turns off after the oil has warmed, filter maintenance is not required.

Low Fuel Indicator

Amber low fuel indicator light (E2) will illuminate when the fuel remaining in the tank is below 95 liters (25 gallons). A warning buzzer will also sound.

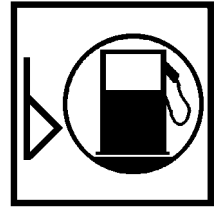

Parking Brake Indicator

Amber parking brake indicator light (A3) will illuminate when the parking brake is applied. DO NOT attempt to drive the truck with the parking brake applied.

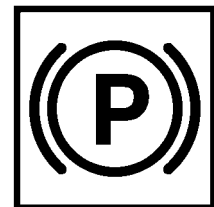

Service Brake Indicator

Amber service brake indicator light (B3) will illuminate when the service brake pedal is applied, or when the wheel brake lock or emergency brake is applied. DO NOT attempt to drive the truck with the service brakes applied.

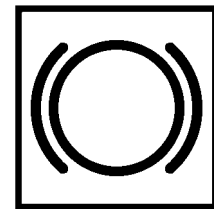

Body Up Indicator

Amber body up indicator light (C3), when illuminated, indicates the body is not completely at rest on the frame. DO NOT drive the truck until the body is down and the light is off.

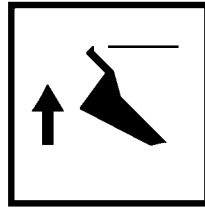

Dynamic Retarding Indicator

Amber dynamic retarding indicator light (D3) illuminates when the retarder pedal is pressed, the RSC (Retarder Speed Control) is activated, or the automatic over-speed retarding circuit is energized.

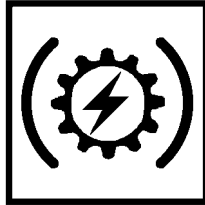

Stop Engine Warning

Red stop engine warning light (E3) will illuminate if a serious engine malfunction is detected in the electronic engine control system. Electric propulsion to the wheel motors will be discontinued, and the maximum engine speed will be reduced to 1250 rpm. Dynamic retarding will still be available if needed to slow or stop the truck.

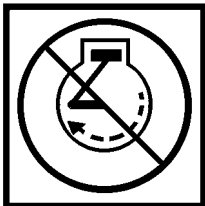

⚠ WARNING

Stop the truck as quickly as possible in a safe area and apply the parking brake. Shut the engine off immediately. Additional engine damage is likely to occur if the engine continues to operate.

Backup Indicator

Amber backup indicator light (B4) will illuminate when backup light switch (5, Figure 32-11) is turned on.

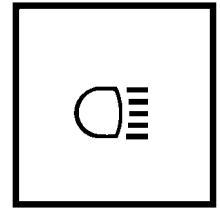

Engine Shutdown Timer Switch- Five Minute Idle

When engine shutdown timer switch (2, Figure 32-11) has been activated, indicator light (C4) will illuminate to indicate the shutdown timing sequence has started.

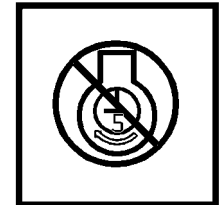

Retard Speed Control

Amber retard speed control light (D4) is illuminated when the RSC switch is pulled out to the ON position.

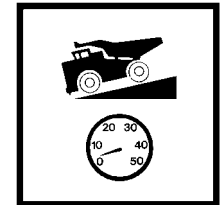

Service Engine Indicator (AEM)

Amber service engine indicator light (A5) will illuminate when the Advanced Engine Monitor (AEM) system detects a fault. A warning buzzer will also sound.

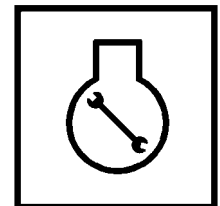

High Wheel Motor Temperature Indicator

When high wheel motor temperature indicator light (B5) is illuminated and the alarm sounds, high wheel motor temperature is indicated. Stop the truck, place the selector switch in NEUTRAL, and raise the engine rpm to high idle for several minutes to cool the wheel motors. If the indicator does not turn off, notify maintenance personnel.

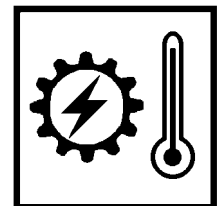

Blower Fault Warning

Blower fault warning light (C5) will flash on and off. An alarm will sound if a malfunction occurs in the cooling air circuit for the alternator and motorized wheels. Stop the truck immediately, and notify maintenance personnel if the warning light is illuminated. Damage to electrical components may result without the proper ventilation of the blower.

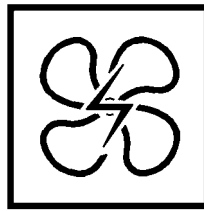

Service Engine Indicator (CENSE)

When the key switch is turned to the RUN position before starting the engine, amber service engine indicator light (D6) will illuminate for about two seconds. The light will then turn off if no faults are detected in the system. If this indicator remains on, or flashes when equipped with the Centry™ fuel control system, alert maintenance personnel as soon as possible.

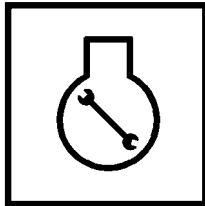

Komatsu Engines w/Centry™ Fuel Control

This indicator monitors the Centry™ fuel system. During engine operation, if a fault is detected in the system, the light will turn on and stay on indicating a warning fault. For more severe faults that can affect engine operation, the light will flash indicating that immediate attention is required.

- Warning faults (light on) are ones that require attention in the near future, but in most conditions, will not greatly affect governing performance.
- Severe faults (light flashing) are ones that require immediate attention, because Centry™ governor performance could be significantly affected, resulting in a backup mode of operation.

Active fault conditions must be corrected as soon as possible.

Refer to the lamp test/diagnostic test switch for additional description of this light's function.

Hazard Warning Light Switch

Hazard warning light switch (7) flashes all the turn signal lights. Pressing the bottom side of the rocker switch toward the triangle activates these lights. Pressing the top side of the rocker switch toward the OFF symbol turns these lights off.

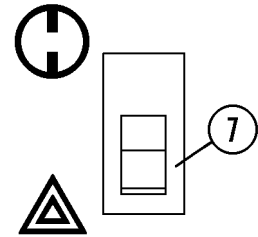

Lamp Test Switch/Centry™ Diagnostic Test Switch

This switch may be used for the lamp test, and for Centry™ diagnostic tests (8) on engines equipped with Centry™ fuel control.

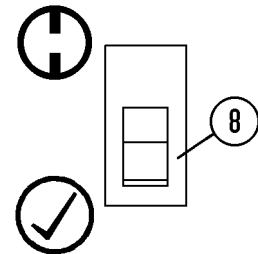

The lamp test switch is provided to allow the operator to test the indicator lamps prior to starting the engine. To test the lamps and the warning horn, turn key switch (1, Figure 32-11) to the RUN position, and press the bottom side of the rocker switch for the CHECK position. All lamps will illuminate, except those which are for optional equipment that is not installed. The warning horn will also sound. Any lamps that do not illuminate indicate a problem in that circuit. Notify maintenance before driving the truck. Releasing the spring-loaded switch will allow the switch to return to the OFF position.

For diagnostic tests of a Komatsu engine equipped with the Centry™ fuel control, refer to Centry™ Diagnostics at the end of this section.

CENTRY™ FUEL SYSTEM DIAGNOSTICS

GENERAL OPERATION

Service engine indicator light (D6, Figure 32-12) monitors the Centry™ fuel system.

When the key switch is turned on, this light will illuminate for about two seconds and then turn off, if no faults are detected in the system. If the light stays on or flashes, then active faults have been detected by the system. DO NOT start the engine if the indicator remains lit.

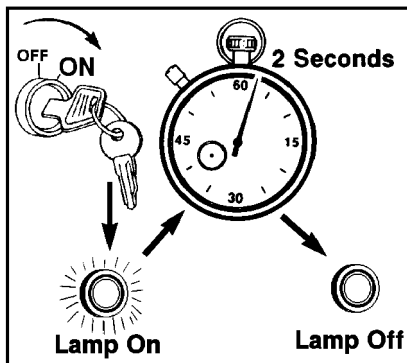

N040008

DETERMINING FAULT CODES

During engine operation, if a fault is detected in the system, the light will turn on and stay on indicating a warning fault. For more severe faults that can affect engine operation, the light will flash indicating that immediate attention is required..

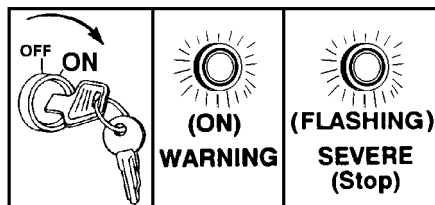

Warning faults (light on) are ones that require attention in the near future, but in most conditions, will not greatly affect governing performance.

Severe faults (light flashing) are ones that require immediate attention, because Centry™ governor performance could be significantly affected, resulting in a backup mode of operation.

Active fault conditions must be corrected as soon as possible.

Lamp test/diagnostic test switch (8, Figure 32-12) may be used to activate the Centry™ fuel system diagnostic codes. When the Centry™ fuel system detects a fault and service engine indicator light (D6, Figure 32-12) illuminates, this switch will permit identification of the fault(s) detected.

Centry™ fault codes consist of three numerical digits. Each digit is indicated with up to five light flashes (service engine indicator light) per each digit. There is a short pause between each digit of the fault code. Once all three digits are flashed, there is a longer pause, followed by a repeat of the same fault code sequence.

1. To determine an active Centry™ fault, turn the key switch to the OFF position. Ensure the engine completely stops, if it was on.
2. Turn the key switch to the ON position (engine not on), and press the lamp test switch to the bottom (√) position for one to two seconds, then release. The switch is spring-loaded and will return to the OFF position.

NOTE: Since this is the lamp test switch, all red warning lights and amber indicator lights will light except those that are blank. The warning horn will also sound.

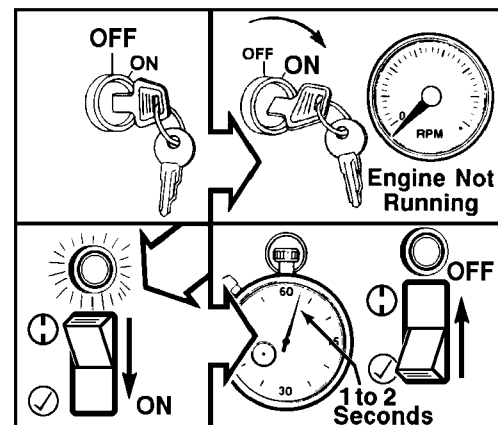

3. If there is an active fault after releasing the switch, there will be a short pause, followed by the first fault code.

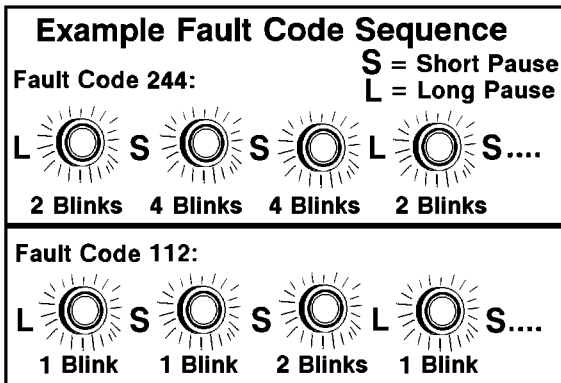

4. Pressing the lamp test switch to the bottom (√) again will advance to the next fault code (if more than one code is present). Once all the active fault codes have been displayed, the fault code display sequence will be repeated, starting from the first fault code.

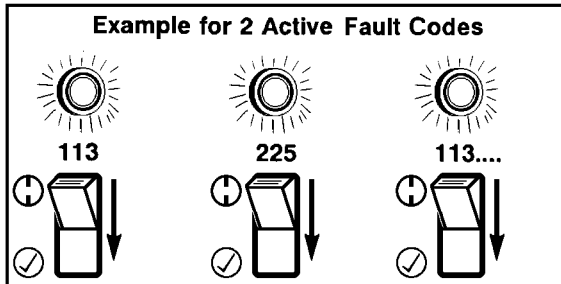

EXITING THE DIAGNOSTICS MODE

Starting the engine or turning the key switch to the OFF position will exit the diagnostics fault flash mode.

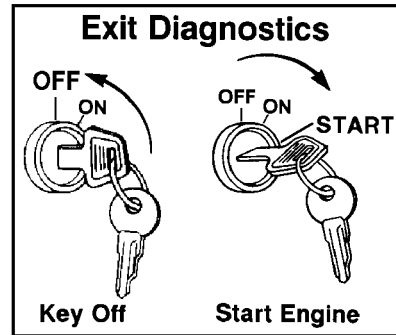

If active fault codes have been identified, refer to the Cummins Centry™ System Troubleshooting and Repair Manual, Bulletin No. 3666070, or contact an authorized repair location.

LUBRICATION AND SERVICE

GENERAL INFORMATION

The recommended preventive maintenance will contribute to the long life and dependability of the truck and its components. The use of proper lubricants and the performance of checks and adjustments at recommended intervals is most important.

Lubrication requirements are referenced to the lube key found in the Lubrication chart in this section. For detailed service requirements for specific components, refer to the shop manual.

Refer to the manufacturer's service manual when servicing any components of the General Electric system.

Refer to the engine manufacturer's service manual when servicing the engine or any of its components.

| 730E SERVICE CAPACITIES | | |
|--|---------------|---------------------|
| | Liters | U.S. Gallons |
| Crankcase (including lube oil filters) | 223 | 59 |
| Cooling System | 409 | 108 |
| Hydraulic System | 731 | 193 |
| Wheel Motor Gear Box (each side) | 40 | 10.5 |
| Fuel Tank (diesel fuel only) | 3217 | 850 |

The service intervals presented here are in hours of operation. These intervals are recommended as a substitute for an oil analysis program, which may determine different intervals. However, if the truck is being operated in extreme conditions, some, or all of the intervals, may need to be shortened and the service performed more frequently.

Komatsu trucks are equipped with an automatic lubrication system. The system is designed to automatically deliver the proper amount of lubricant to a specified lubrication point such as a steering cylinder pin or body pivot pin. This system uses lubrication injectors, one for each lubrication point, which can be adjusted to supply the precise amount of lubricant to each specific lubrication point. A timer is also designed into the system to activate the lube pump on a preset interval. This time interval is adjustable, depending on the requirements for lubrication. For additional information on the system, refer to Automatic Lubrication System in this manual.

HYDRAULIC TANK SERVICE

There are two sight gauges on the side of the hydraulic tank. With the engine stopped, key switch off, hydraulic system not pressurized, and body down, the oil must be visible in the top sight gauge. If the hydraulic oil is not visible in the top sight gauge, follow the Adding Oil instructions below.

Adding Oil

Keep the system open to the atmosphere only as long as absolutely necessary to lessen the chances of system contamination.

Service the tank with clean type C-4 hydraulic oil only. All oil being put into the hydraulic tank must be filtered to a cleanliness of 3 microns or less.

1. With the engine stopped, key switch off, hydraulic system not pressurized, and body down, hydraulic oil must be visible in the top sight glass.
2. If the hydraulic oil is not visible in the top sight gauge, remove the tank fill cap and add clean, filtered C-4 hydraulic oil. Fill with oil until it is visible in the top sight glass.
3. Install the fill cap.
4. Start the engine. Raise and lower the dump body three times.
5. Repeat this procedure until the oil is maintained in the top sight glass with the engine stopped, body down, and hydraulic system not pressurized.

COOLING SYSTEM

Coolant Level Check

Check the coolant sight gauge. If the coolant cannot be seen in the sight gauge, add coolant to the cooling system before operating the truck. Refer to the following section for the proper filling procedure.

Radiator Filling Procedure



The engine coolant must be visible in the sight gauge before operating the truck. After operating the truck, the cooling system will be pressurized due to the thermal expansion of coolant. DO NOT remove the radiator cap while the engine and coolant are hot. Severe burns may result.

1. With the engine and coolant at ambient temperature, press the pressure relief button to release any remaining pressure, and remove the radiator cap.

NOTE: If the coolant is added using the Wiggins quick fill system, the radiator cap must be removed prior to adding the coolant.

2. Fill the radiator with the proper coolant mixture, as specified by the engine manufacturer, until the coolant is visible in the sight gauge.
3. Install the radiator cap.
4. Start the engine. Allow the engine to idle for five minutes. Check the coolant level at the sight gauge.
5. If the coolant is not visible in the sight gauge, repeat the procedure. Any excess coolant will be discharged through a vent hose after the engine reaches normal operating temperature.

Antifreeze Temperature Recommendations

| COOLING SYSTEM ANTIFREEZE RECOMMENDATIONS (Ethylene Glycol Permanent Type Antifreeze) | | |
|--|----------------------|--------|
| Percentage of Antifreeze | Protection To | |
| 10 | - 5°C | +23°F |
| 20 | - 9°C | +16°F |
| 25 | - 11°C | +11°F |
| 30 | - 16°C | +4°F |
| 35 | - 19°C | - 3°F |
| 40 | - 24°C | - 12°F |
| 45 | - 30°C | - 23°F |
| 50 | - 36°C | - 34°F |
| 55 | - 44°C | - 48°F |
| 60 | - 52°C | - 62°F |

Use only antifreeze that is compatible with the engine, as specified by the engine manufacturer.

LUBRICATION CHART

LUBRICATION CHART

LUBRICATION SPECIFICATIONS

| LUBE KEY | TYPE LUBRICANT | PTS | LUBE KEY | 10 HR | 50 HR | 100 HR | 250 HR | 500 HR | 1000 HR | 2000 HR | 2500 HR |
|----------|--|-----|----------|-------|-------|--------|--------|--------|---------|---------|---------|
| A | ENGINE OIL - - - - - SEE ENGINE MANUAL | | | | | | | | | | |
| B | HYDRAULIC OIL - - - - - SAE 10W C-4 - - - - - | | | | | | | | | | |
| C | HEAVY-DUTY SYNTHETIC GEAR OIL - - - - - SEE DRIVE SYSTEM MANUAL | | | | | | | | | | |
| D | MULTI-PURPOSE EXTREME PRESSURE GREASE - - - - - NLGI NO.2 (5% MIN. MOLY-DISULFIDE) | | | | | | | | | | |
| E | MULTI-PURPOSE GEAR OIL - - - - - SAE 80W-90 | | | | | | | | | | |
| SYM | DESCRIPTION | PTS | LUBE KEY | 10 HR | 50 HR | 100 HR | 250 HR | 500 HR | 1000 HR | 2000 HR | 2500 HR |
| 1 | CRANKCASE OIL LEVEL | 1 | A | CHECK | | | | | | | |
| 2 | ENGINE LUBE OIL FILTERS | | | | | | | | | | |
| 3 | FUEL FILTER | | | | | | | | | | |
| 4 | FUEL SEPARATOR (DAVCO) | | | | | | | | | | |
| 5 | FUEL TANK | 1 | | | | | | | | | |
| 6 | GE PREFILTER BLOWER | 1 | D | | | | | | | | |
| 7 | FUEL TANK BREATHER | 1 | B | CHECK | | | | | | | |
| 8 | HYDRAULIC OIL LEVEL | 2 | | | | | | | | | |
| 9 | HYDRAULIC STRAINER | 2 | | | | | | | | | |
| 10 | HYDRAULIC TANK BREATHER | 2 | | | | | | | | | |
| 11 | HYDRAULIC FILTERS | 3 | | | ** | ** | ** | ** | ** | ** | ** |
| 12 | MOTORIZED WHEEL OIL LEVEL | 2 | C | | | | | | | | |
| 13 | HYD. PUMP DRIVE SHAFT | 2 | D | | | | | | | | |
| 14 | CHASSIS LUBE LEVEL | 1 | D | | | | | | | | |
| 15 | SEAT SLIDES & STEER SHAFT | 4 | D | | | | | | | | |
| 16 | WHEEL MOTOR BLOWER | 2 | D | | | | | | | | |
| 17 | FRONT WHEEL BEARINGS *** | 2 | E | | | | | | | | CHANGE |
| 18 | FRONT TRUNION | 1 | D | | | | | | | | |
| 19 | MAGNETIC PLUG FRONT WHL COVER **** | 2 | | | | | | | | | CHECK |

SEE ENGINE MANUAL

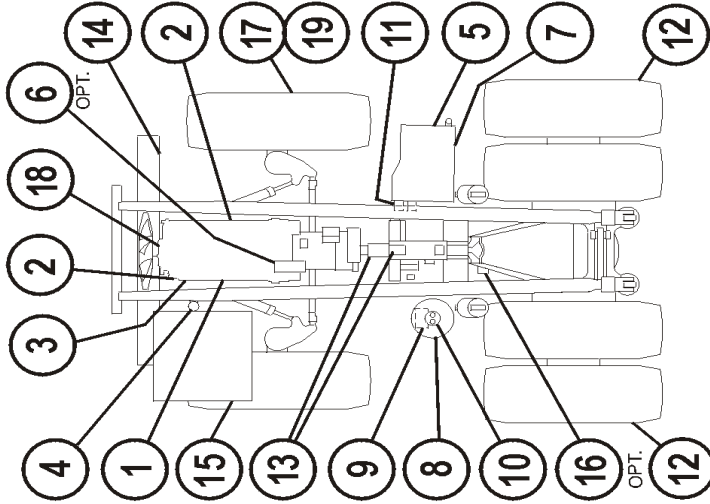

630E, 730E, 830E, & 930E

* 1000 HR INTERVAL CAN BE EXTENDED TO 2500 HR PROVIDED OIL SAMPLING AND ANALYSIS IS CONDUCTED EVERY 250 HR.
 ** ONE-TIME CHANGE AT 50, 100 AND 250 HR.
 *** NOT APPLICABLE FOR 930E
 **** APPLICABLE FOR 930E ONLY

10 HOUR LUBE AND MAINTENANCE CHECKS

| Truck Serial Number _____ Site Unit Number _____ Date _____ Hourmeter _____ Name of Service Technician _____ | | | | |
|---|--|----------|---------|----------|
| | TASK | COMMENTS | CHECKED | INITIALS |
| 1. | MACHINE - Inspect the entire truck for leaks, worn parts, and damage. Repair as necessary. | | | |
| 2. | TURBOCHARGERS - Check for leaks, vibration, or unusual noise. | | | |
| 3. | ALTERNATOR - Check the alternator, belt condition, and alignment. | | | |
| 4. | RADIATOR - Check the coolant level and fill with the proper mixture, as shown in the Cooling System Anti-freeze Recommendation chart in this section. Refer to the engine service manual for the proper DCA levels. | | | |
| 5. | ENGINE - Check the oil level. Refer to the engine manufacturer's service manual for oil recommendations. | | | |
| 6. | AIR CLEANERS - Check the air cleaner vacuum gauges in the operator cab. The air cleaner(s) must be serviced if the maximum restriction reaches: 6.2 kPa (25 in. of H ₂ O). See Section C of the Shop manual for servicing the air cleaner elements. Empty the air cleaner dust caps. <i>NOTE: After service, push the reset button on the face of the gauge to allow the gauge to return to zero.</i> | | | |
| 7. | WHEELS AND TIRES - FRONT AND REAR <ul style="list-style-type: none"> a. Verify the tires are properly inflated. b. Inspect the tires for abnormal wear or damage. c. Check for embedded debris in the tires. After each wheel installation, recheck the tightness of the wheel nuts after approximately five hours of operation. Check again at the end of the shift, and then periodically until all the nuts remain at 610 N·m (450 ft lbs) . | | | |
| 8. | BODY-UP SWITCH - Clean the sensing area of the switch. | | | |
| 9. | HOIST LIMIT SWITCH - Clean the sensing area of the switch. | | | |
| 10. | HYDRAULIC TANK - Check the oil level in the tank. The oil must be visible in the top sight glass. Add oil, if necessary, but do not overfill. Refer to Hydraulic Tank Service in this section for additional information. Use Lube Key B. | | | |

50 HOUR LUBRICATION AND MAINTENANCE CHECKS

| Truck Serial Number _____ Site Unit Number _____ Date _____ Hourmeter _____ Name of Service Technician _____ | | | | |
|---|---|----------|---------|----------|
| | TASK | COMMENTS | CHECKED | INITIALS |
| 1. | FAN - After the first 50 hours of operation (new truck or new fan installation), check the tightness of the fan mounting cap screws - 122 N·m (90 ft lbs) . | | | |
| 2. | MOTORIZED WHEELS - Check oil level. Refer to Motorized Wheel Maintenance Schedule in Section P of the shop manual for the lubrication specifications and service intervals. | | | |

Complete the 10 hour lube and maintenance checks.

100 HOUR LUBRICATION AND MAINTENANCE CHECKS

| Truck Serial Number _____ Site Unit Number _____ Date _____ Hourmeter _____ Name of Service Technician _____ | | | | |
|---|---|----------|---------|----------|
| | TASK | COMMENTS | CHECKED | INITIALS |
| 1. | HYDRAULIC SYSTEM OIL FILTERS - Change the filter elements after the initial 100 hours of operation and again at 250 hours. The normal service interval for these elements is 500 hours. | | | |
| 2. | WHEEL MOTORS - Take oil samples every 100 hours for the first 1000 hours. After 1000 total hours, oil samples must be taken every 250 hours. | | | |
| 3. | AUTOMATIC LUBE SYSTEM - Perform the preventative maintenance inspection, as outlined in Automatic Lubrication, Section 42, in this manual. | | | |

Complete the 10 and 50 hour lubrication and maintenance checks.

250 HOUR LUBRICATION AND MAINTENANCE CHECKS

| Truck Serial Number _____ Site Unit Number _____ Date _____ | | | | |
|---|--|----------|---------|----------|
| Hourmeter _____ Name of Service Technician _____ | | | | |
| | TASK | COMMENTS | CHECKED | INITIALS |
| 1. | <p>ENGINE - Refer to the engine operation and maintenance manual for the complete specifications regarding the engine lube oil specifications.</p> <p><i>NOTE: If the engine is equipped with the Centinel™ oil system, and/or the Eliminator™ filter system, the engine oil and filter change intervals are extended beyond 250 hours. Refer to the engine service manual for specific oil and filter change intervals.</i></p> <p>a. Change the engine oil. Refer to the engine service manual for oil specifications.</p> <p>b. Replace the oil filters.</p> <p><i>NOTE: When installing the spin-on filter elements, follow the instructions, as specified by the filter manufacturer. The tightening instructions are normally printed on the outside of the filter. DO NOT use a wrench or strap to tighten the filter elements.</i></p> <p>c. If the truck is equipped with a reserve engine oil tank, change the reserve tank oil filter.</p> <p>d. Check the fan belt tension. Refer to the engine service manual for fan belt adjustment instructions.</p> | | | |
| 2. | HYDRAULIC SYSTEM OIL FILTERS - Change the filter elements after the initial 250 hours, then each 500 hours of operation thereafter. | | | |
| 3. | FUEL FILTER - Change the filters. | | | |
| 4. | MOTORIZED WHEEL GEAR CASE - Refer to Motorized Wheel Maintenance Schedule in Section P of the shop manual. Check the oil level. Use Lube Key C. | | | |
| 5. | STEERING LINKAGE - Ensure the steering pin nuts are tightened to 465 ± 46 N·m (343 ± 34 ft lbs) . | | | |
| 6. | COOLING SYSTEM DCA WATER FILTERS - Change the spin-off filters. Check the cooling system for the proper coolant mixture and add, as required. | | | |
| 7. | PUMP DRIVE SHAFT - Add grease to each grease fitting on the drive shaft. Use Lube Key D. | | | |
| 8. | FRONT WHEEL BEARINGS - Check the oil level. Position the fill plug at the 12 o'clock position. The floating ball in the sight gauge must be at its highest position. Add oil as necessary. | | | |
| 9. | FUEL TANK - Drain water and sediment. | | | |
| 10. | GE PREFILTER BLOWER - Add grease to the grease fitting. Use Lube Key D. | | | |

250 HOUR LUBRICATION AND MAINTENANCE CHECKS

| | | | | |
|-----|---|--|--|--|
| 11. | GREASE RESERVOIR - Add grease to the in-frame grease reservoir. When grease is pumped out of the overflow tube, the reservoir is full. Use Lube Key D. | | | |
| 12. | BATTERIES - Check the electrolyte level and add water, if necessary. | | | |
| 13. | WHEEL MOTORS - Take an oil sample for oil analysis. | | | |
| 14. | AC DRIVE BELT - Check the belt for wear or damage. Verify the belt tension is correctly set. Ensure the pulleys are aligned with each other within 3 mm (0.13 in.). | | | |
| 15. | CAB AIR FILTER - Clean the filter element with mild soap and water. Rinse completely clean, and air dry. In extremely dusty conditions, service as frequently as required. Reinstall the filter. Replace the filters every 2000 hours of service. | | | |
| 16. | AUTOMATIC LUBE SYSTEM - Perform 250 hour checks as outlined in Automatic Lubrication System, Section 42, in this manual. | | | |

Complete the 10, 50, and 100 hour lubrication and maintenance checks.

500 HOUR LUBRICATION AND MAINTENANCE CHECKS

| Truck Serial Number _____ Site Unit Number _____ Date _____ | | | | |
|---|---|----------|---------|----------|
| Hourmeter _____ Name of Service Technician _____ | | | | |
| | TASK | COMMENTS | CHECKED | INITIALS |
| 1. | FINAL DRIVE CASE BREATHERS - Remove the breather elements from the motorized wheels. Clean or replace the elements. | | | |
| 2. | HYDRAULIC SYSTEM OIL FILTERS - Replace the filter elements. Check the oil level in the hydraulic oil tank and add oil, as necessary. Use Lube Key B. | | | |
| 3. | HYDRAIR® SUSPENSION - Check for the proper piston extension (front and rear). Refer to Section H4 in the service manual for more information on proper suspension extension and maintenance procedures. | | | |
| 4. | THROTTLE AND BRAKE PEDAL - Lubricate the treadle roller and hinge pins with lubricating oil. Lift the boot from the mounting plate and apply a few drops of oil between the mounting plate and plunger. Use Lube Key B. | | | |
| 5. | HYDRAULIC TANK BREATHER - Replace the breather. | | | |
| 6. | ACCUMULATOR PRE-CHARGE - Check the steering and brake system accumulator pre-charge pressures. Refer to the shop manual for details. | | | |
| 7. | WHEEL MOTORS - Check the armature section for wear or damage. Refer to Motorized Wheel Maintenance Schedule in Section P of the shop manual. | | | |
| 8. | PARKING BRAKE LINING - Check the parking brake lining by: a. Apply the parking brake. b. Use a feeler gauge to measure the gap between the piston and the surface of the parking brake disc. c. If the gap is 0.76 mm (0.03 in.) or less, the parking brake lining must be replaced. To replace the parking brake lining, follow the Parking Brake Lining Replacement procedure in Section J of the shop manual. | | | |
| 9. | FRONT BRAKE DISC - Measure the thickness of the disc. If 20 to 25% of the disc wear surface is worn below 28.7 (1.13 in.), the disc must be replaced. Refer to the shop manual, Parking Brake, Section J, for additional information. | | | |
| 10. | VHMS DATA DOWNLOAD - Using a laptop PC with the VHMS Technical Analysis Tool box program, perform a data download from the VHMS controller. Send the data to WebCARE using the FTP feature. Refer to Section D in the applicable shop manual for more detailed instructions. | | | |

Complete the 10, 50, 100, and 250 hour lubrication and maintenance checks.

1000 HOUR LUBRICATION AND MAINTENANCE CHECKS

| Truck Serial Number _____ Site Unit Number _____ Date _____ | | | | |
|---|---|----------|---------|----------|
| Hourmeter _____ Name of Service Technician _____ | | | | |
| | TASK | COMMENTS | CHECKED | INITIALS |
| 1. | HYDRAULIC TANK - Drain the hydraulic oil, and clean the inlet strainer. Refill the tank with new oil, approximate capacity 507 l (134 gal). Use Lube Key B. | | | |
| 2. | RADIATOR - Clean the cooling system with a quality cleaning compound and flush with water. Refill the system with DCA or antifreeze and water solution. Check the Cooling System Antifreeze Recommendation chart in this section for the correct mixture. | | | |
| 3. | FUEL TANK - Remove the breather and clean it in solvent. Dry with pressurized air and reinstall. | | | |
| 4. | ENGINE - Remove, clean, and dry the crankcase breather elements. | | | |
| 5. | OPERATOR'S SEAT - Apply grease to the slide rails. Use Lube Key D. | | | |
| 6. | AUTOMATIC BRAKE APPLICATION - Ensure the brakes are automatically applied when the brake pressure decreases below the specified limit. Refer to the shop manual, Section J, Brake Checkout Procedure. | | | |
| 7. | AUTOMATIC LUBE SYSTEM PUMP - Check the pump housing oil level. Refill to the bottom of the level plug with SAE 10W-30 motor oil. | | | |
| 8. | AUTOMATIC LUBE SYSTEM - Perform checks as outlined in the Preventative Maintenance procedure of Section 42 in this manual. | | | |

Complete the 10, 50, 100, 250, and 500 hour lubrication and maintenance checks.

1500 HOUR LUBRICATION AND MAINTENANCE CHECKS

| Truck Serial Number _____ Site Unit Number _____ Date _____ | | | | |
|---|---|----------|---------|----------|
| Hourmeter _____ Name of Service Technician _____ | | | | |
| | TASK | COMMENTS | CHECKED | INITIALS |
| 1. | WHEEL MOTORS - Change oil. Clean sump magnetic plugs. Refer to Motorized Wheel Maintenance Schedule in Section P of the shop manual for additional information. | | | |

Complete the 10, 50, 100, 250, and 500 hour lubrication and maintenance checks.

2500 HOUR LUBRICATION AND MAINTENANCE CHECKS

| Truck Serial Number _____ Site Unit Number _____ Date _____ | | | | |
|---|--|----------|---------|----------|
| Hourmeter _____ Name of Service Technician _____ | | | | |
| | TASK | COMMENTS | CHECKED | INITIALS |
| 1. | WHEEL MOTORS - Check for spline and gear wear. Refer to Motorized Wheel Maintenance Schedule in Section P of the shop manual. | | | |
| 2. | FRONT WHEELS - Drain and refill with oil. a. Remove the drain plug and drain the oil from the front wheel hub. Inspect and reinstall the drain plug. b. If necessary, rotate the wheel hub to position the fill plug at 12 o'clock. c. Remove the fill plug. d. Fill wheel hub assembly with SAE 80W-90 oil. e. When properly filled, the floating ball in the sight gauge will be at its highest position. f. Replace the fill plug. Use Lube Key C. Oil may need to be changed more frequently, depending on mine conditions and the results of the oil sample tests. | | | |

Complete the 10, 50, 100, 250, and 500 hour lubrication and maintenance checks.

5000 HOUR LUBRICATION AND MAINTENANCE CHECKS

| Truck Serial Number _____ Site Unit Number _____ Date _____ | | | | |
|---|---|----------|---------|----------|
| Hourmeter _____ Name of Service Technician _____ | | | | |
| | TASK | COMMENTS | CHECKED | INITIALS |
| 1. | AIR CLEANERS - Clean the Donaclone tubes in the pre-cleaner section of the air filter. Use low pressure cold water or low pressure air to clean the tubes. Refer to Section C of the service manual for additional information. | | | |
| 2. | FRONT WHEELS - Check the front wheel bearing preload, as per Section G in the Shop manual for Disassembly and Assembly procedures. | | | |

Complete the 10, 50, 100, 250, 500, 1000, and 2500 hour lubrication and maintenance checks.

10,000 HOUR LUBRICATION AND MAINTENANCE CHECKS

| | | |
|---------------------------|----------------------------------|------------|
| Truck Serial Number _____ | Site Unit Number _____ | Date _____ |
| Hourmeter _____ | Name of Service Technician _____ | |

| TASK | COMMENTS | CHECKED | INITIALS |
|--|----------|---------|----------|
| 1. WHEEL MOTORS - Clean the area around the grease ports to prevent dirt or other contaminants from entering. Remove the six grease port plugs on each wheel motor. Grease the inboard and outboard wheel hub bearings with 414 mL (14 oz) of grease per each grease port. | | | |

Complete the 10, 50, 100, 250, 500, 1000, 2500, and 5000 hour lubrication and maintenance checks.

AUTOMATIC LUBRICATION SYSTEM

GENERAL DESCRIPTION

The automatic lubrication system is a pressurized lubricant delivery system which delivers a controlled amount of lubricant to designated lubrication points. The system is controlled by an electric timer which signals a solenoid valve to operate a hydraulic motor powered grease pump. Hydraulic oil for pump operation is supplied by the truck steering circuit.

Grease output is proportional to the hydraulic motor input flow. A pump control manifold (4, Figure 42-1), mounted on top of hydraulic motor (2), controls input flow and pressure. 24VDC solenoid (5) mounted on the manifold turns the pump on and off.

NOTE: Newer models are equipped with fixed hydraulic motor controls.

The pump is driven by the rotary motion of the hydraulic motor, which is then converted to reciprocating motion through an eccentric crank mechanism. The reciprocating action causes the pump cylinder to move up and down. The pump is a positive displacement, double-acting type as grease output occurs on both the up and the down stroke.

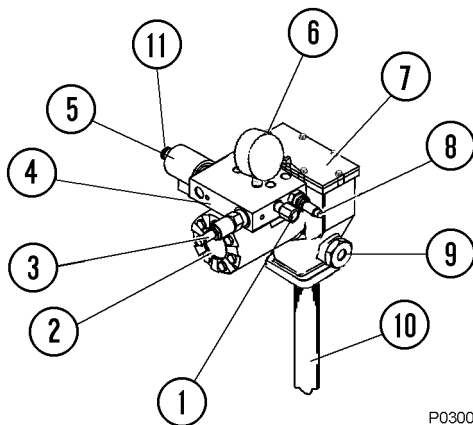

P030046

FIGURE 42-1. PUMP COMPONENTS

- | | |
|----------------------------|------------------------|
| 1. Orifice Fitting | 5. Solenoid Valve |
| 2. Hydraulic Motor | 6. Pressure Gauge |
| 3. Pressure Reducing Valve | 7. Pump Assembly |
| 4. Pump Control Manifold | 8. Flow Control Valve |
| | 9. Grease Outlet |
| | 10. Grease Pickup Tube |
| | 11. Manual Override |

During the down stroke, the pump cylinder is extended into the grease. Through the combination of shovel action and vacuum generated in the pump cylinder, the grease is forced into the pump cylinder. Simultaneously, grease is discharged through outlet (9) of the pump. The volume of grease during intake is twice the amount of grease output during one cycle. During the upstroke, the inlet check valve closes, and one-half of the grease taken in during the previous stroke is transferred through the outlet check and discharged to the outlet port.

WARNING

Over-pressurizing of the system, modifying parts, using incompatible chemicals and fluids, or using worn or damaged parts, may result in equipment damage and/or serious personal injury.

- **DO NOT exceed the stated maximum working pressure of the pump, or of the lowest rated component in the system.**
- **DO NOT alter or modify any part of this system unless approved by factory authorization.**
- **DO NOT attempt to repair or disassemble the equipment while the system is pressurized.**
- **Ensure all fluid connections are securely tightened before using this equipment.**
- **Read and follow the fluid manufacturer's recommendations regarding fluid compatibility, and the use of protective clothing and equipment.**
- **Check all equipment regularly and repair, or replace, worn or damaged parts immediately.**

This equipment generates very high grease pressure. Extreme caution must be used when operating this equipment, as material leaks from loose or ruptured components can inject fluid through the skin and into the body, causing serious bodily injury, including possible need for amputation. Adequate protection is recommended to prevent splashing of material onto the skin or into the eyes.

If any fluid appears to penetrate the skin, get emergency medical care immediately! DO NOT treat as a simple cut. Tell attending physician exactly what fluid was injected.

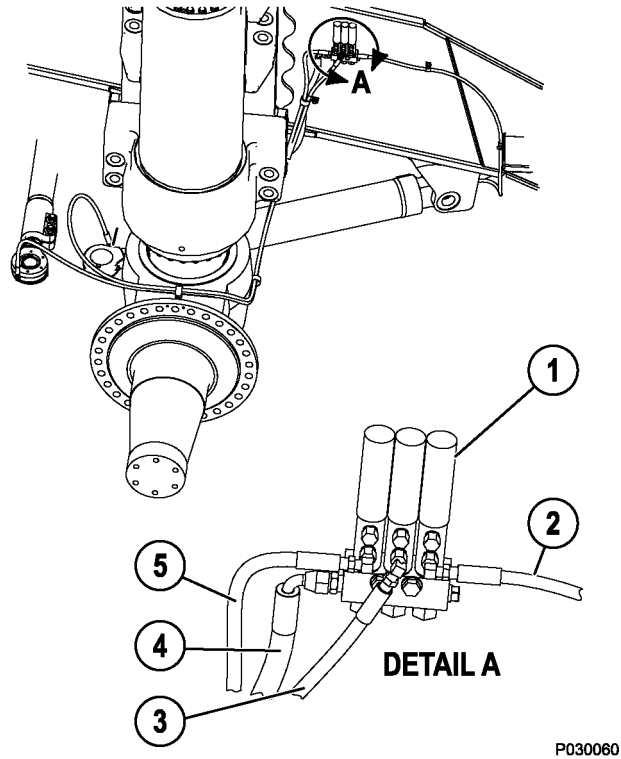

FIGURE 42-2. STEERING CYLINDER AND TIE ROD INJECTORS

- | | |
|--|---------------------------------|
| 1. Steering Cylinder/Tie Rod Injectors | 3. To Steering Cylinder Rod End |
| 2. To Steering Cylinder Cap End | 4. Supply From Pump |
| | 5. To Tie Rod |

SYSTEM COMPONENTS

Filter Assembly

Filter assembly (14, Figure 42-3) filters the grease prior to refilling reservoir (6) from the shop supply. Dirty filter indicator (13) alerts service personnel when the filter requires replacement.

Hydraulic Motor and Grease Pump

Hydraulic motor and grease pump (16 & 4, Figure 42-3) is a hydraulically operated grease pump. Integrated pump control manifold (4, Figure 42-1) is incorporated with the motor to control input flow and pressure.

NOTE: The pump crankcase oil level must be maintained to the level of oil fill plug (22, Figure 42-3). If necessary, refill with 10W-30 motor oil.

⚠ WARNING

Hydraulic inlet pressure must not exceed 20685 kPa (3000 psi). Exceeding the rated pressure may result in damage to system components and possible personal injury.

Specifications are as follows:

Maximum hydraulic oil inlet pressure:

..... 20685 kPa (3000 psi)

Hydraulic oil operating pressure:

..... 2240-2415 kPa (325-350 psi)

Hydraulic inlet flow:

..... up to 28 L/min. (7 GPM)

Pump ratio:

..... approx. 9:1 @ 2068 to 2415 kPa (300 to 350 psi) oil pressure = less than 7 L/min. (2 GPM) flow

Operating temperature:

..... -10 to +65°C (-20 to +150°F)

Reservoir

Reservoir (6) has an approximate capacity of 97 kg (214 lbs) of grease. When the grease supply is replenished by filling the system at the service center, the grease is passed through filter assembly (14) to remove contaminants before it flows into the reservoir.

Fixed Pressure Reducing Valve

Pressure reducing valve (12, Figure 42-3), located on the manifold, is preset and reduces the hydraulic supply pressure from the truck steering circuit to a suitable operating pressure of 2240 - 2415 kPa (325 - 350 psi) for the hydraulic motor used to drive the lubricant pump.

The pressure reducing valve has a fixed pressure setting and must not be changed.

Flow Control Valve

Flow control valve (23, Figure 42-3), mounted on the manifold, is preset and controls the amount of oil flow to the hydraulic motor at 2.5 GPM (9.5 L/min).

The flow control valve has a fixed pressure setting and must not be changed.

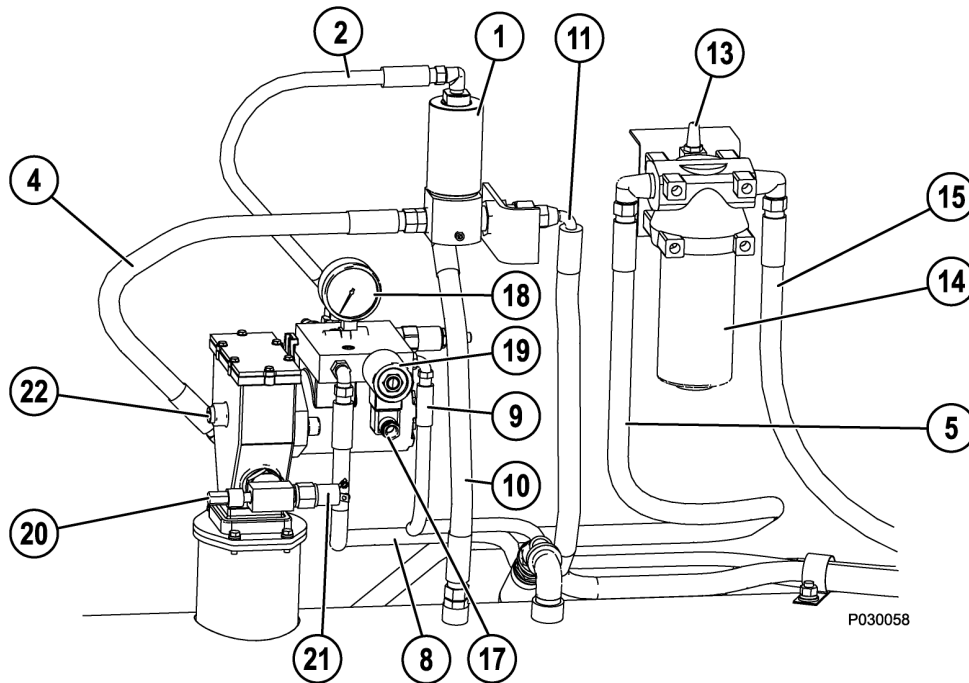
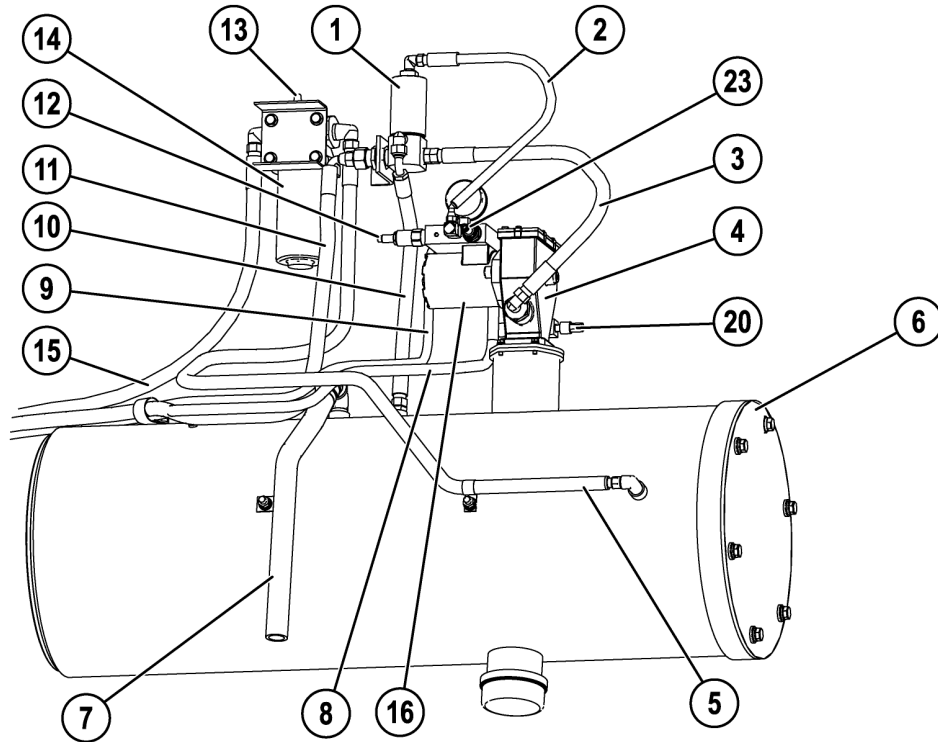

P030058

FIGURE 42-3. AUTO LUBRICATION SYSTEM (FRONT AND REAR VIEW)

- | | | | |
|---|-----------------------------------|--|--|
| 1. Vent Valve | 7. Reservoir Vent Tube | 13. Dirty Filter Indicator | 20. Unloader Valve (Not Adjustable) |
| 2. Vent Valve/Vent Hose | 8. Hydraulic Oil Return | 14. Filter Assembly | 21. Pump Cutoff Pressure Switch |
| 3. Grease Pump Supply Hose To Vent Valve | 9. Hydraulic Oil Supply | 15. Reservoir Fill Hose (To Filter) | 22. Oil Fill Plug |
| 4. Grease Pump | 10. Vent Valve Return Hose | 16. Hydraulic Motor | 23. Flow Control Valve |
| 5. Grease Supply From Filter | 11. Grease Supply To Injectors | 17. Manual Override Button | |
| 6. Reservoir | 12. Pressure Reducing Valve | 18. Pressure Gauge | |
| | | 19. Solenoid Valve | |

Solenoid Valve

Solenoid valve (19), when energized, allows oil to flow to the hydraulic motor.

Vent Valve

With vent valve (1, Figure 42-3) closed, the pump continues to operate until maximum grease pressure is achieved. As this occurs, the vent valve opens and allows the grease pressure to drop to zero, so the injectors can recharge for their next output cycle.

24VDC Lubrication Cycle Timer

Lubrication cycle timer (2, Figure 42-11) provides a 24VDC timed-interval signal to operate solenoid valve (19, Figure 42-3), causing the grease pump motor to operate. This timer is mounted in the cab interface compartment.

Time Delay Module

Time delay module (7, Figure 42-6), located in the electrical interface cabinet, provides a one minute delay in the low pressure warning light circuit to allow a normally operating system to attain full grease system pressure without activating the warning light. If the system fails to reach 13789 kPa (2000 psi) within this period of time, the timer will apply 24VDC to several relays, which will illuminate the low pressure warning light in the overhead panel. An external 604K ohm resistor determines the delay period.

Pump Cutoff Pressure Switch

Pump cutoff pressure switch (21, Figure 42-3) is a normally open switch set at 20685 kPa (3000 psi). This switch de-energizes the pump solenoid relay when the grease line pressure reaches the switch pressure setting, turning off the motor and pump.

Unloader Valve

Unloader valve (20) is mounted on a tee fitting with pump cutoff pressure switch (21). This valve will relieve grease pressure in the pump if pressure exceeds 27,600 kPa (4000 psi). This valve has been factory adjusted and is not repairable.

Pressure Switch

Pressure switch (15, Figure 42-4) is a normally open switch set at 13789 kPa (2000 psi). This switch monitors grease pressure in the injector bank on the rear axle housing. If the proper pressure is not sensed within 60 seconds and the switch contacts do not close, a warning light notifies the operator a problem exists in the lubrication system.

Pressure Gauge

Pressure gauge (18, Figure 42-3) monitors hydraulic oil pressure to the inlet of the hydraulic motor.

Manual Override Button

Manual override button (17, Figure 42-3) is used to actuate the hydraulic motor to manually activate a lubrication cycle.

Injectors

Injectors deliver a controlled amount of pressurized lubricant to a designated lubrication point. Refer to Figure 42-3 and 42-4 for the locations of each lubricated component.

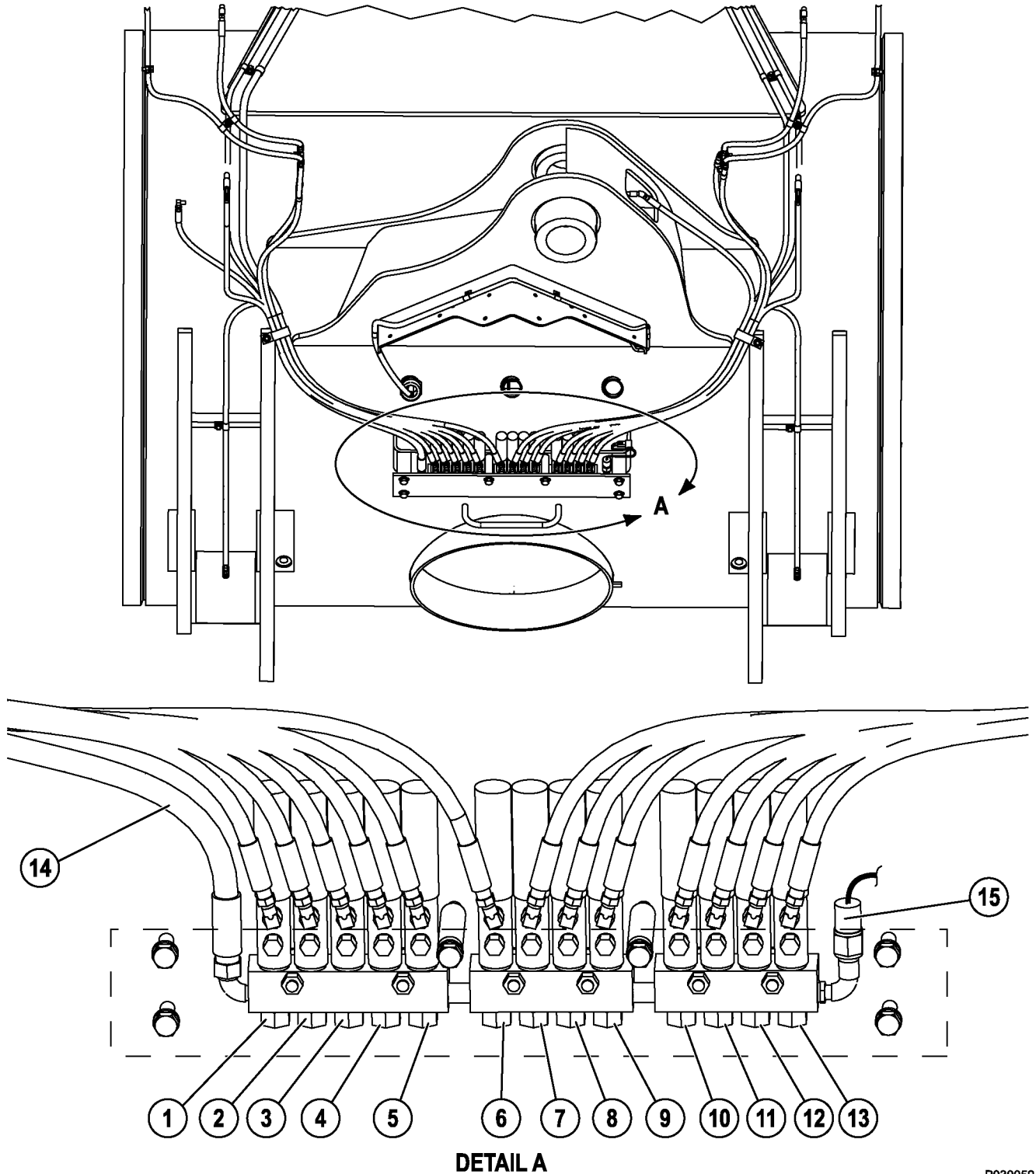

FIGURE 42-4. REAR LUBRICATION INJECTORS

P030059

- | | | |
|-----------------------------|-----------------------------|-------------------------|
| 1. LH Lower Suspension | 7. RH Anti-Sway Bar | 13. RH Lower Suspension |
| 2. LH Top Suspension | 8. Rear Axle Pivot Pin | 14. Grease Supply |
| 3. LH Body Pivot Pin | 9. RH Bottom Hoist Cylinder | 15. Pressure Switch |
| 4. LH Top Hoist Cylinder | 10. RH Top Hoist Cylinder | 13790 kPa (2000 psi) |
| 5. LH Anti-Sway Bar | 11. RH Body Pivot Pin | |
| 6. LH Bottom Hoist Cylinder | 12. RH Top Suspension | |

SYSTEM OPERATION

Normal Operation

Refer to Figure 42-5 and 42-6:

1. During truck operation, lubrication cycle timer (1, Figure 42-6) will energize the system at a preset time interval.
2. The lubrication cycle timer provides a 24VDC signal through normally closed relay board (12) used to energize pump solenoid valve (3, Figure 42-5), allowing hydraulic oil provided by the truck steering pump circuit to flow to the pump motor and initiate a pumping cycle.
3. The hydraulic oil pressure from the steering circuit is reduced to 2240 to 2413 kPa (325 to 350 psi) by pressure reducing valve (4, Figure 42-5) before entering the motor. In addition, the amount of oil supplied to the pump is limited by flow control valve (6). Pump pressure can be read using pressure gauge (5) mounted on the manifold.
4. With oil flowing into the hydraulic motor, the grease pump will operate, pumping grease from the reservoir to vent valve (11) and then to injectors (13). Pressure switch (9) prevents over pressurization.
5. During this period, the injectors will meter the appropriate amount of grease to each lubrication point.

6. When 20685 kPa (3000 psi) grease pressure reaches pressure switch (4, Figure 42-6) setting, the switch contacts will close and energize relay K1 (12), removing power from grease pump solenoid valve (5) and the pump will stop. The relay will remain energized until grease pressure drops and the pressure switch opens again or until the timer turns off.
7. After the pump solenoid valve is de-energized, hydraulic pressure in the manifold drops and vent valve (11, Figure 42-5) will open, releasing grease pressure in the lines to the injector banks. When this occurs, the injectors are then able to recharge for the next lubrication cycle.
8. Unloader valve (10) prevents excessive grease pressure if the pressure switch fails to close and shut off the hydraulic supply to the pump. The unloader valve will open at approximately 27.6 MPa (4000 psi).
9. The system will remain at rest until the lubrication cycle timer turns on and initiates a new grease cycle.
10. During the normal lubrication cycle, if grease pressure fails to reach 13790 kPa (2000 psi) at the pressure switch located on the rear axle housing, an amber indicator light will illuminate on the overhead panel.

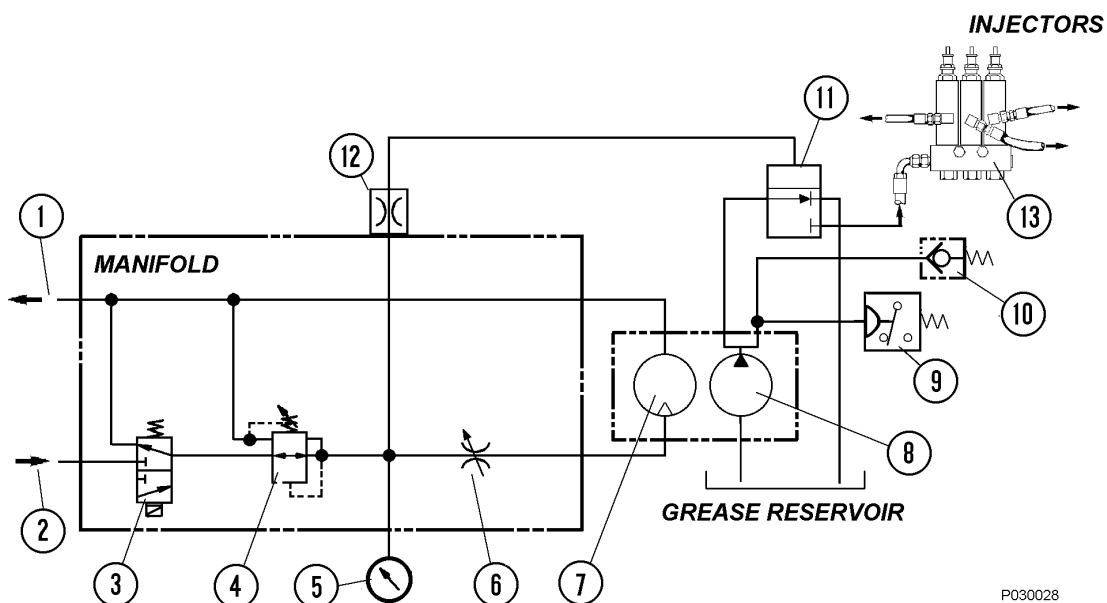

FIGURE 42-5. HYDRAULIC SCHEMATIC

- | | | |
|----------------------------|-----------------------|-------------------------|
| 1. Hydraulic Oil Return | 5. Pressure Gauge | 9. Pressure Switch (NO) |
| 2. Hydraulic Oil Supply | 6. Flow Control Valve | 10. Unloader Valve |
| 3. Pump Solenoid Valve | 7. Hydraulic Motor | 11. Vent Valve |
| 4. Pressure Reducing Valve | 8. Grease Pump | 12. Orifice |
| | | 13. Injector Bank |

P030028

Pressure Failure Detection Circuits

1. When the lubrication cycle is initiated, 24VDC flows through relay RB6-K4 (8, Figure 42-6) N.C. contacts to one minute time delay module (7).
2. If the system is operating normally, grease pressure at the rear axle injector bank will rise to pressure switch (9) setting of 13.8 MPa (2000 psi), closing the switch contacts and energizing relay RB6-K4 (8), removing 24 Volts from the time delay module. The timer is then reset and no current will flow from the timer output terminal.

3. If a problem occurs and the system is not able to attain 13.8 MPa (2000 psi), then time delay module (7) will energize relay RB6-K2 after 60 seconds, turning on the Low Lubrication System Pressure warning lamp on the overhead display. After RB6-K2 energizes, it will ground the coil of RB6-K6 and allow it to energize.
4. Once RB6-K6 is energized, it will latch and remain latched as long as the key switch is on. Also, RB6-K2 will remain energized and the Low Lubrication Pressure Warning light will remain on to notify the operator a problem exists and the system requires service.
5. The warning circuits are reset when the key switch is turned off.

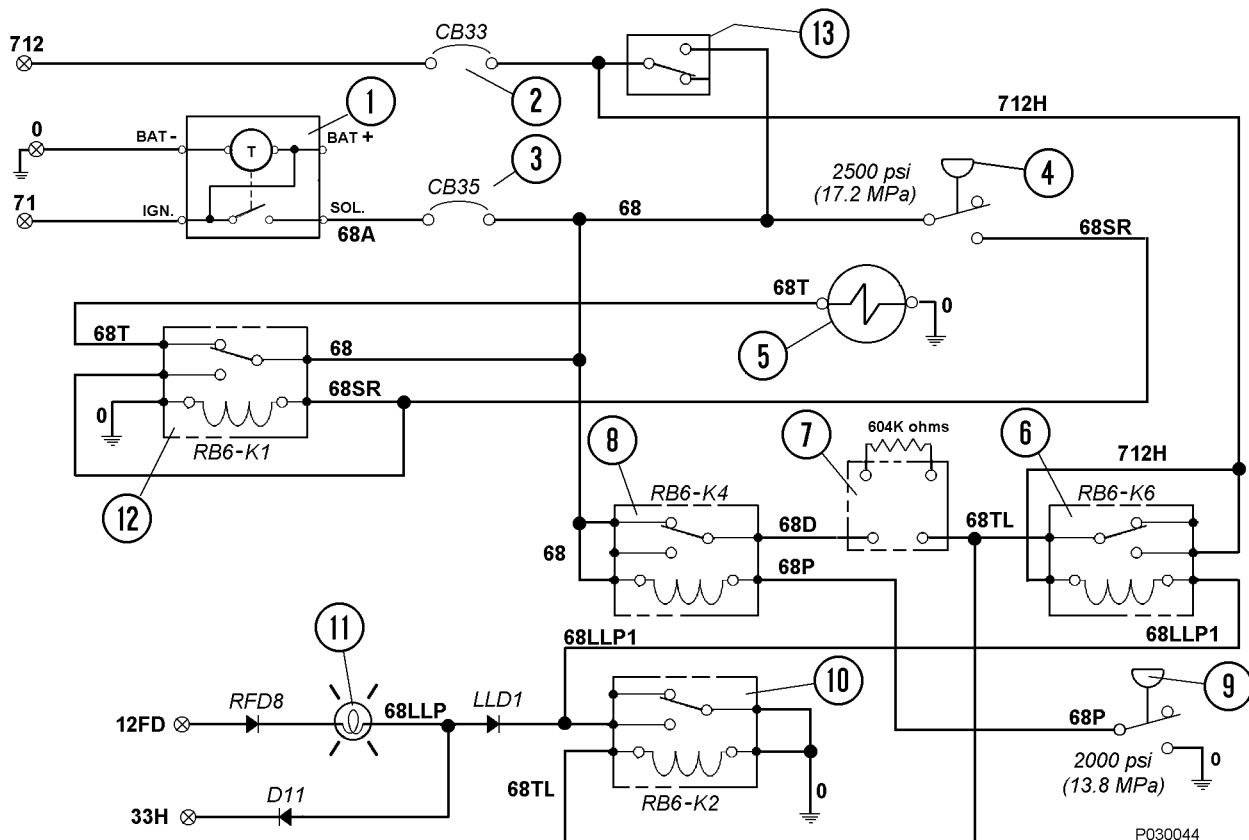

FIGURE 42-6. ELECTRICAL SCHEMATIC

- | | |
|---|--|
| <ol style="list-style-type: none"> 1. Lubrication Cycle Timer 2. Circuit Breaker 33 (Power Distribution Module in Cab) 3. Circuit Breaker 35 (Power Distribution Module in Cab) 4. Pressure Switch (On Grease Pump) - 20685 kPa (3000 psi) 5. Grease Pump Solenoid Valve | <ol style="list-style-type: none"> 6. Relay Board 6, Relay K6 7. Time Delay Module 8. Relay Board 6, Relay K4 9. Pressure Switch (Rear Axle Injector Bank) - 13789 kPa (2000 psi) 10. Relay Board 6, Relay K2 11. Auto Lubrication Low Pressure Warning Lamp 12. Relay Board 6, Relay K1 13. Manual Override |
|---|--|

GENERAL INSTRUCTIONS

LUBRICANT REQUIRED FOR SYSTEM

Grease requirements will depend on ambient temperatures encountered during truck operation:

- Above 32°C (90°F) - Use NLGI No.2 multipurpose grease (MPG).
- -32° to 32°C (-25° to 90°F) - Use NLGI No. 1 multipurpose grease (MPG).
- Below -32°C (-25°F) - Refer to local supplier for extreme cold weather lubricant requirements.

SYSTEM PRIMING

The system must be full of grease and free of air pockets to function properly. After maintenance, if the primary or secondary lubrication lines were replaced, it will be necessary to prime the system to eject all entrapped air.

1. Fill lubrication reservoir with lubricant, if necessary.
2. To purge air from the main supply line, remove the main supply line at outlet port (6, Figure 42-7) and connect an external grease supply to the line.
3. Remove plugs from each injector group in sequence (right front, left front, and rear axle).
4. Using an external grease source, pump grease until grease appears at the group of injectors and re-install the pipe plug. Repeat for remaining injector groups.
5. Remove the caps from each injector and connect an external grease supply to the zerk on the injector and pump until grease appears at the far end of the individual grease hose or the joint being greased.

LUBRICANT PUMP

Pump Housing Oil Level

The pump housing must be filled to the proper level with SAE 10W-30 motor oil. Oil level must be checked at 1000 hour intervals. To add oil, remove oil level plug (4, Figure 42-7) and fill housing to bottom of plug hole.

Pump Pressure Control

High pressure hydraulic fluid from the truck steering system is reduced to 2240 to 2413 kPa (325 to 350 psi) by the pressure reducing valve located on the manifold on top of the pump motor. This pressure can be read on the gauge installed on the manifold and must be checked occasionally to verify pressure is within the above limits.

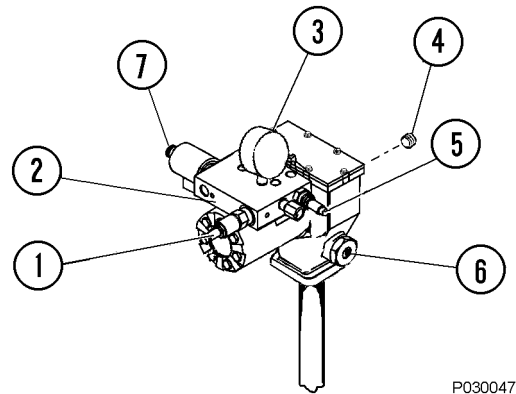

P030047

FIGURE 42-7. PUMP CONTROLS

- | | |
|--------------------------|-----------------------|
| 1. Pump Pressure Control | 4. Oil Level Plug |
| 2. Manifold | 5. Flow Control Valve |
| 3. Pressure Gauge | 6. Outlet Port |
| | 7. Manual Override |

FILTER AND RESERVOIR

Filter assembly (2, Figure 42-8) is mounted on right upright (1) and filters the grease when the grease supply is refilled through the quick fill fittings.

Grease is pumped into the filter through filter inlet hose (4) routed from the service center and then flows out the filter through hose (3) to grease reservoir (5). Vent hose (7) purges air from the reservoir as it is being filled and prevents a vacuum as grease is pumped out.

Cap (6) allows the reservoir to be drained, if desired, and a plate secured on the end of the reservoir (frame torque tube) can be removed if the reservoir requires cleaning.

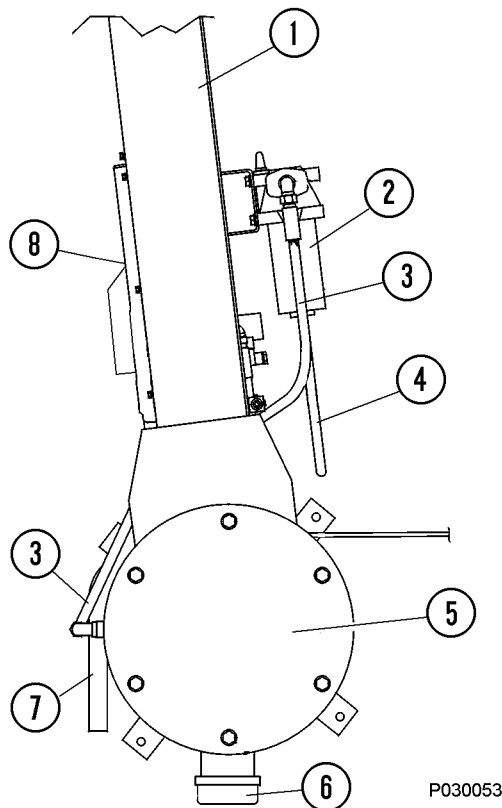

FIGURE 42-8. FILTER AND RESERVOIR

- | | |
|-----------------------|---------------------|
| 1. RH Upright | 5. Grease Reservoir |
| 2. Filter Assembly | 6. Cap |
| 3. Filter Outlet Hose | 7. Vent Hose |
| 4. Filter Inlet hose | 8. Pump Access Door |

Filter Assembly Element

Filter assembly element (5, Figure 42-9) must be replaced if bypass indicator (2) shows excessive element restriction.

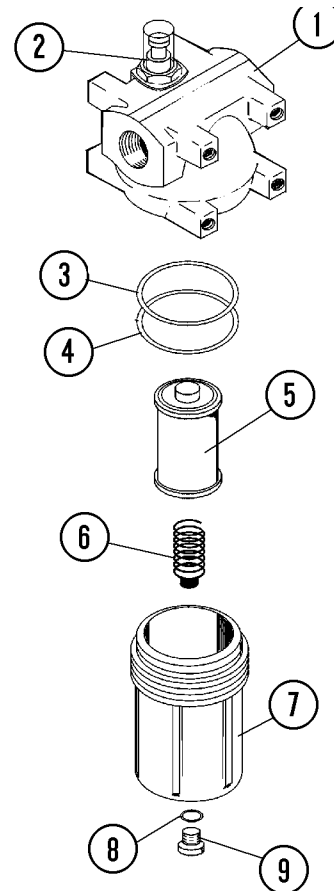

FIGURE 42-9. FILTER ASSEMBLY

- | | |
|----------------------------|-----------|
| 1. Housing | 6. Spring |
| 2. Bypass Indicator | 7. Bowl |
| 3. O-Ring | 8. O-Ring |
| 4. Backup Ring | 9. Plug |
| 5. Filter Assembly Element | |

INJECTORS (SL-1 Series H)

Injector Specifications

- Each lubrication injector services only one grease point. In case of pump malfunction, each injector is equipped with a covered grease fitting to allow the use of external lubricating equipment.
- Injector Output Volume:
Maximum Output = 1.31 cc (0.08 in³)
Minimum Output = 0.13 cc (0.008 in³)
- Operating Pressure:
Minimum - 12755 kPa (1850 psi)
Maximum - 24133 kPa (3500 psi)
Recommended - 17238 kPa (2500 psi)
- Maximum Vent Pressure (Recharge):
4137 kPa (600 psi)

Injector Adjustment

The injectors may be adjusted to supply from 0.13 - 1.31 cc (0.008 - 0.08 in³) of lubricant per injection cycle. The injector piston travel distance determines the amount of lubricant supplied. This travel is controlled by an adjusting screw in the top of the injector housing.

Turn adjusting screw (1, Figure 42-10) counterclockwise to increase lubricant amount delivered and clockwise to decrease the lubricant amount.

When the injector is not pressurized, maximum injector delivery volume is attained by turning adjusting screw (1) fully counterclockwise until piston assembly (8) touches the adjusting screw. At the maximum delivery point, about 9.7 mm (0.38 in.) adjusting screw threads must be showing. Decrease the delivered lubricant amount by turning the adjusting screw clockwise to limit injector piston travel. If only half the lubricant is needed, turn the adjusting screw to the point where about 4.8 mm (0.19 in.) threads are showing. The injector will be set at the minimum delivery point with about 0.22 mm (0.009 in.) thread showing.

NOTE: The above information concerns adjustment of injector delivery volume. The timer adjustment must also be changed if overall lubricant delivery is too little or too much. Injector output must not be adjusted to less than one-fourth capacity.

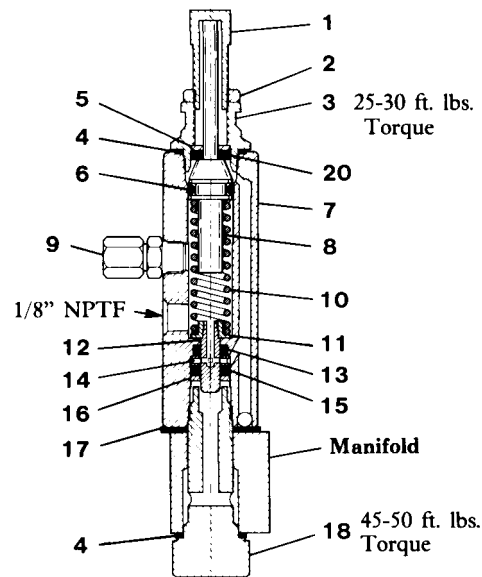

FIGURE 42-10. TYPE SL-1 INJECTOR

- | | |
|---------------------------|-------------------|
| 1. Adjusting Screw | 11. Spring Seat |
| 2. Locknut | 12. Plunger |
| 3. Piston Stop Plug | 13. Viton Packing |
| 4. Gasket | 14. Inlet Disc |
| 5. Washer | 15. Viton Packing |
| 6. Viton O-Ring | 16. Washer |
| 7. Injector Body Assembly | 17. Gasket |
| 8. Piston Assembly | 18. Adapter Bolt |
| 9. Fitting Assembly | 19. Adapter |
| 10. Plunger Spring | 20. Viton Packing |

NOTE: Piston assembly (8) has a visible indicator pin at the top of the assembly to verify injector operation.

*NOTE: Piston stop plug (3) must be tightened to **34-41 N·m (25-30 ft lbs)**. Adapter (19) must be tightened to **61-68 N·m (45-50 ft lbs)**.*

INJECTOR OPERATION

STAGE 1.

Injector piston (2) is in its normal or rest position. Discharge chamber (3) is filled with lubricant from the previous cycle. Under the pressure of incoming lubricant (6), slide valve (5) is about to open passage (4) leading to measuring chamber (1) above injector piston (2).

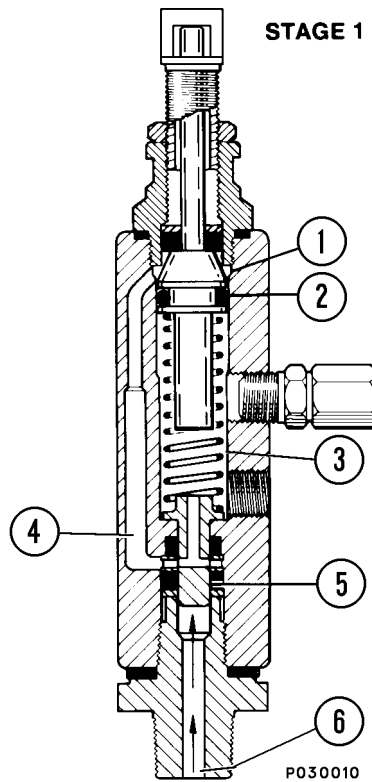

STAGE 2.

When slide valve (5) uncovers passage (4), lubricant (6) is admitted to measuring chamber (1) above injector piston (2), which forces the lubricant from discharge chamber (3) through outlet port (7) to the bearing.

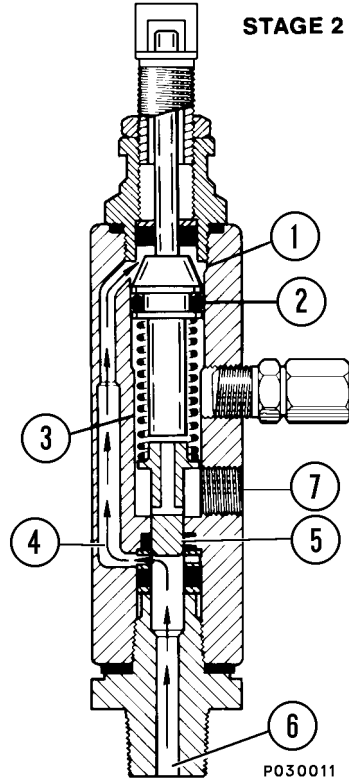

STAGE 3.

As injector piston (2) completes its stroke, it pushes slide valve (5) past passage (4), cutting off further admission of lubricant (6) to passage (4) and measuring chamber (1). Injector piston (2) and slide valve (5) remain in this position until the lubricant pressure in supply line (6) is vented.

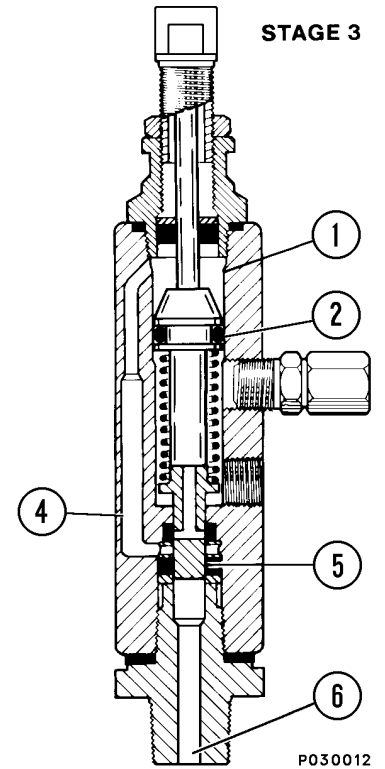

STAGE 4.

After venting, the injector spring expands, causing slide valve (5) to move, so that passage (4) and discharge chamber (3) are connected by valve port (8). Further expansion of the spring causes the piston to move upward, forcing the lubricant in measuring chamber (1) through passage (4) and valve port (8) to refill discharge chamber (3).

The injector is now ready for the next cycle.

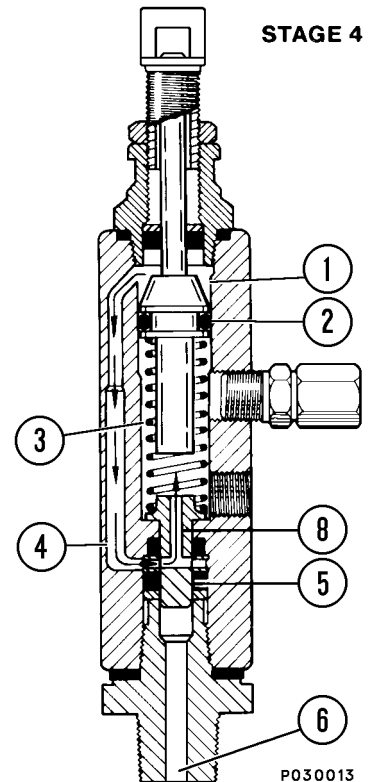

SYSTEM CHECKOUT

To check system operation, not including the timer, proceed as follows:

1. Start the engine.
2. Actuate the test switch at the reservoir/pump assembly.
3. The motor and pump will operate until the system attains 20685 kPa (3000 psi).
4. Once the required pressure is achieved, the pump motor will turn off and the system will vent.
5. Check for pump, hose, or injector damage or leakage when the system is pressurized.
6. After checking the system, shut the engine off. Observe normal precautions regarding high voltage present in the propulsion system before attempting to repair the lubrication system.

Lubrication Cycle Timer Check

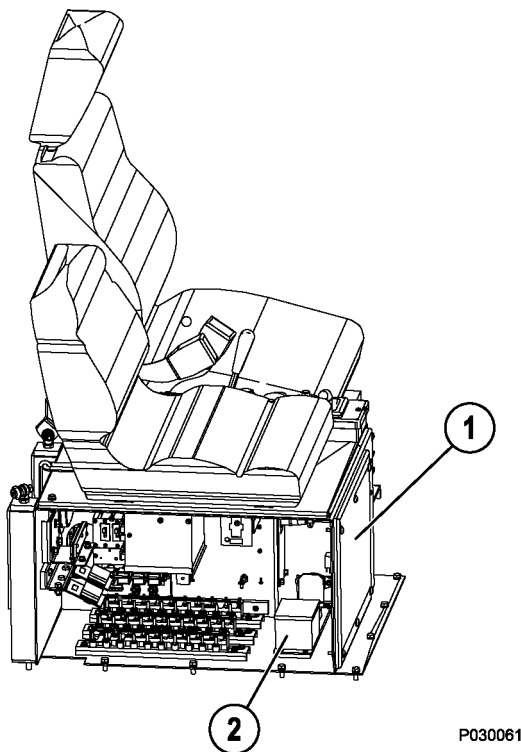

FIGURE 42-11. LOCATION OF LUBRICATION CYCLE TIMER

1. Cab Interface Compartment
2. Lubrication Cycle Timer

To check the solid-state timer operation without waiting for the normal timer setting, proceed as follows:

NOTE: The timer incorporates a liquid and dust-tight cover which must be in place and secured at all times during truck operation.

1. Remove the dust cover.
2. Adjust timer selector (3, Figure 42-12) to the five minute interval setting

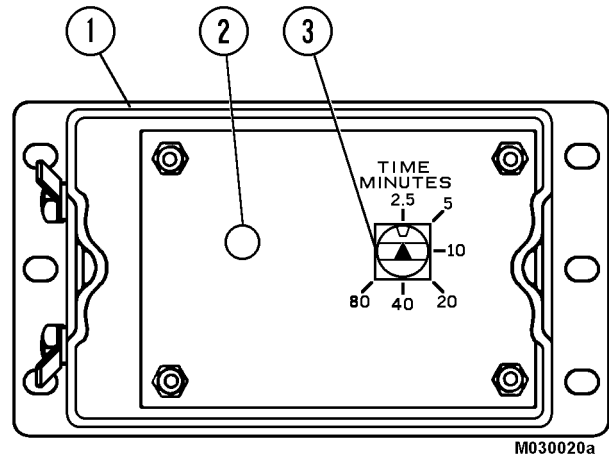

FIGURE 42-12. LUBRICATION CYCLE TIMER (Shown With Cover Removed)

1. Timer Enclosure
2. Red LED
3. Timer Selector

3. The timer must cycle in five minutes if the truck is operating.

NOTE: If the timer check is being made on a cold start, the first cycle will be approximately double the nominal setting. All subsequent cycles must be within the selected time tolerance.

4. Perform voltage checks at the timer if the above checks do not identify the problem.
 - a. Ensure that the timer ground connection is clean and tight.
 - b. With the key switch on, use a voltmeter to read the voltage between the positive and negative posts on the solid-state timer. A normal reading must be 18 to 26VDC, depending upon whether the engine is on or not.

Lubrication Cycle Timer Adjustment

The timer is set at the factory for a nominal 2.5 minute (off time) interval. Dwell time is approximately 75 seconds. A longer interval (off time) is obtained by turning the timer selector to the desired position.

Set the timer by turning the timer selector to the 2.5 minute setting. Then turn the selector clockwise one detent at a time to the desired setting, or until the maximum limit of 80 minutes is reached.

NOTE: The timer is a sealed unit. DO NOT attempt to disassemble it.

PREVENTIVE MAINTENANCE INSPECTION

Use the following maintenance procedures to ensure proper system operation.

10 Hour Lubrication System Inspection

1. Check the grease reservoir level.
Inspect the grease level height after each shift of operation. The grease usage must be consistent from day-to-day operations.

Lack of lubricant usage would indicate an inoperative system. Excessive usage would indicate a broken supply line.
2. Check the filter bypass indicator when filling the reservoir. Replace the element if bypassing.
3. Check all the grease hoses from the SL-1 injectors to the lubrication points.
 - a. Repair or replace all damaged feed line hoses.
 - b. Ensure all air is purged and all new feed line hoses are filled with grease before sending the truck back into service.
4. Inspect the key lubrication points for a bead of lubricant around the seal. If a lubrication point appears dry, troubleshoot and repair the problem.

250 Hour Inspection

1. Check all grease hoses from the SL-1 injectors to the lubrication points. Refer to Figure 42-2.
 - a. Repair or replace all worn and broken hoses.
 - b. Ensure all the air is purged and all new feed line hoses are filled with grease before sending the truck back into service.
2. Check all grease supply line hoses from the pump to the SL-1 injectors.
 - a. Repair or replace all worn and broken supply lines.
 - b. Ensure all air is purged and all new supply line hoses are filled with grease before sending the truck back into service.
3. Check the grease reservoir level.
 - a. Fill the reservoir if low. Check the filter bypass indicator when filling the reservoir. Replace the element if bypassing.
 - b. Check the reservoir for contaminants. Clean, if required.
 - c. Check that all filler plugs, covers, and breather vents on the reservoir are intact and free of contaminants.
4. Inspect all bearing points for a bead of lubricant around the bearing seal.

It is good practice to manually lubricate each bearing point at the grease fitting provided on each Injector. This will indicate if there are any frozen or plugged bearings, and will help flush the bearings of contaminants.
5. System Checkout.
 - a. Remove all SL-1 injector cover caps to allow visual inspection of the injector cycle indicator pins during system operation.
 - b. Start the truck engine.
 - c. Actuate manual override switch (6, Figure 42-1). The hydraulic motor and grease pump must operate.

- d. With the system pressurized, check each SL-1 injector assembly. The cycle indicator pin will be retracted inside the injector body.
- e. When the system attains 20685 kPa (3000 psi), the pump will shut off and the pressure in the system will drop to zero, venting back to the grease reservoir.
- f. With the system vented, check all of the SL-1 injector indicator pins. All of the pins must be visible. Replace or repair the injectors, if defective.
- g. Reinstall all the injector cover caps.
- h. Check the timer operation.

NOTE: With the engine on, the lubrication system will activate within five minutes. System pressure will build to 20685 kPa (3000 psi) within 25-40 seconds.

- i. If the system is working properly, the machine is ready for operation.
- j. If the system is malfunctioning, refer to the troubleshooting chart.

1000 Hour Inspection

1. Check the pump housing oil level. Refill to the bottom of the level plug with SAE 10W-30 motor oil, if necessary

SYSTEM TROUBLESHOOTING CHART

NOTE: If the following procedures do not correct the problem, contact a factory authorized service center.

| PROBLEM | POSSIBLE CAUSES | SUGGESTED CORRECTIVE ACTION |
|---|--|---|
| Pump Does Not Operate. | Lubrication system not grounded. | Correct grounding connections to pump assembly and truck chassis. |
| | Electrical power loss. | Locate cause of power loss and repair. 24VDC power required. Ensure key switch is on. |
| Pump Does Not Operate. | Timer malfunction. | Replace timer assembly. |
| | Solenoid valve malfunctioning. | Replace solenoid valve assembly. |
| | Relay malfunctioning. | Replace relay. |
| | Motor or pump malfunction. | Repair or replace motor and/or pump assembly. Refer to the Service manual for rebuild instructions. |
| | <i>NOTE: On initial startup of the lubrication system, the timing capacitor will not contain a charge. Therefore, the first timing cycle will be about double in length compared to the normal interval. Subsequent timer cycles must be as specified.</i> | |
| Pump Will Not Prime. | Low lubricant supply. | Dirt in reservoir, pump inlet clogged, filter clogged. |
| Pump Will Not Build Pressure. | Air trapped in lubricant supply line. | Prime system to remove trapped air. |
| | Lubricant supply line leaking. | Check lines and connections to repair leakage. |
| | Vent valve leaking. | Clean or replace vent valve. |
| | Pump worn or scored. | Repair or replace pump assembly. Refer to the Service manual for rebuild instructions. |
| Injector Indicator Stem Does Not Operate. | <i>NOTE: During operation, the injector indicator stem will move into the body of the injector when pressure builds properly. When the system vents (pressure release), the indicator stem will again move out into the adjusting yoke.</i> | |
| | Malfunctioning injector - usually indicated by the pump building pressure and then venting. | Replace individual injector assembly. |
| | All injectors inoperative - pump build up not sufficient to cycle injectors. | Service and/or replace pump assembly. Refer to the Service manual for rebuild instructions. |
| Pressure Gauge Does Not Register Pressure. | No system pressure to pump motor. | Check hydraulic hose from steering system. |
| | No 24VDC signal at pump solenoid. | Determine problem in 24VDC electric system. |
| | Pressure reducing valve set too low. | Refer to Pressure Control Valve Adjustment. |
| | 24V Relay (RB7K8 or RB7K5) may be defective. | Replace relay. |

| PROBLEM | POSSIBLE CAUSES | SUGGESTED CORRECTIVE ACTION |
|---|--|--|
| Pump Pressure Builds Very Slowly Or Not At All. | No signal at solenoid. | Check timer. |
| Controller Does Not Operate. | No electric power to controller. | Turn on electric power to pump. Power LED must light, pump on LED must light when manual lubrication is pressed. |
| Pump On LED Lights, But Load Connected To Terminals 3 & 4 Will Not Energize. | Printed circuit board failure. | Remove and replace. |
| Load Connected To Terminals 3 & 4 Energized, But Pump On LED Does Not Light. | Printed circuit board failure or keypad failure. | Remove and replace. |
| Bearing Points Excessively Lubricated. | Controller memory mode is off. | Switch controller memory mode to on. |
| | Injector output adjustment setting too high. | Readjust to lower setting. |
| Bearing Points Are Not Sufficiently Lubricated. | Timer/controller cycle time setting too low. | Set to longer cycle time or re-evaluate lubrication requirements. |
| | Injector output adjustment setting too low. | Readjust injector output setting. |
| | Timer/controller cycle time setting does not deliver lubricant often enough. | Set to shorter cycle time or re-evaluate lubrication requirements. |
| | System too large for pump output. | Calculate system requirements per planning manual. |

MAJOR COMPONENT DESCRIPTION

The Komatsu model 730E dump truck is an electric drive, off-highway, rear dump truck whose gross vehicle weight is 324,322 kg (715,000 lbs) rated for a nominal payload of 185 t (203 tons).

ENGINE

The Komatsu 730E dump truck is powered by a Komatsu SSA16V159 engine rated at 2000 HP (1492 kW).

ALTERNATOR (GE GTA-22)

The diesel engine drives an alternator mounted in-line with the engine. The Alternating Current (AC) output of the alternator is rectified to Direct Current (DC) and sent to the DC drive wheel motors.

WHEEL MOTORS (GE 788)

The output of the alternator supplies electrical energy to the two wheel motors attached to the rear axle housing. The two wheel motors convert electrical energy back to mechanical energy through built-in gear trains within the wheel motor assembly. The direction of the wheel motors is controlled by a forward or reverse hand selector switch located on a console to the right side of the operator.

BLOWER

The blower supplies cooling air for the rectifiers, AC alternator, and to both wheel motors, where it is then exhausted to the atmosphere.

OPERATOR'S CAB

The operator's cab for the Komatsu 730E dump truck has been engineered for operator comfort and to allow for efficient and safe operation of the truck.

The cab provides for wide visibility, with an integral four-post Rollover Protective Structure/Falling Object Protective Structure (ROPS/FOPS), and an advanced analog operator environment. It includes a tinted safety-glass windshield and power-operated side windows, a deluxe interior with a fully adjustable seat with lumbar support, a fully adjustable/tilt steering wheel, controls mounted within easy reach of the operator, and an analog instrument panel which provides the operator with all instruments and gauges, which are necessary to control and/or monitor the truck's operating systems.

POWER STEERING

The Komatsu 730E dump truck is equipped with a full-time power steering system, which provides positive steering control with a minimum of effort by the operator. The system includes nitrogen-charged accumulators which automatically provide emergency power if the steering hydraulic pressure is reduced below an established minimum.

DYNAMIC RETARDING

Dynamic retarding is used to slow the truck during normal operation or control the speed coming down a grade. The dynamic retarding ability of the DC electric system is controlled by the operator through the activation of the retarder pedal in the operator's cab and by setting the RSC (Retarder Speed Control). Dynamic retarding is automatically activated if the truck goes to a preset overspeed setting.

BRAKE SYSTEM

The wheel service brakes are caliper/dry disc brakes applied by an all hydraulic actuation system. Depressing the brake pedal actuates wheel-speed single disc front brakes and armature-speed dual disc rear brakes. The rear brakes can also be activated by operating a switch on the instrument panel.

All wheel brakes will be applied automatically if the system pressure decreases below a preset minimum.

The parking brake is a caliper/disc type, mounted on each rear wheel motor, and is spring-applied and hydraulically-released with wheel speed application protection (will not apply with the truck moving.)

SUSPENSION

Hydrair®II suspension cylinders, located at each wheel, provide a smooth and comfortable ride for the operator and dampens shock loads to the chassis during loading and operation.

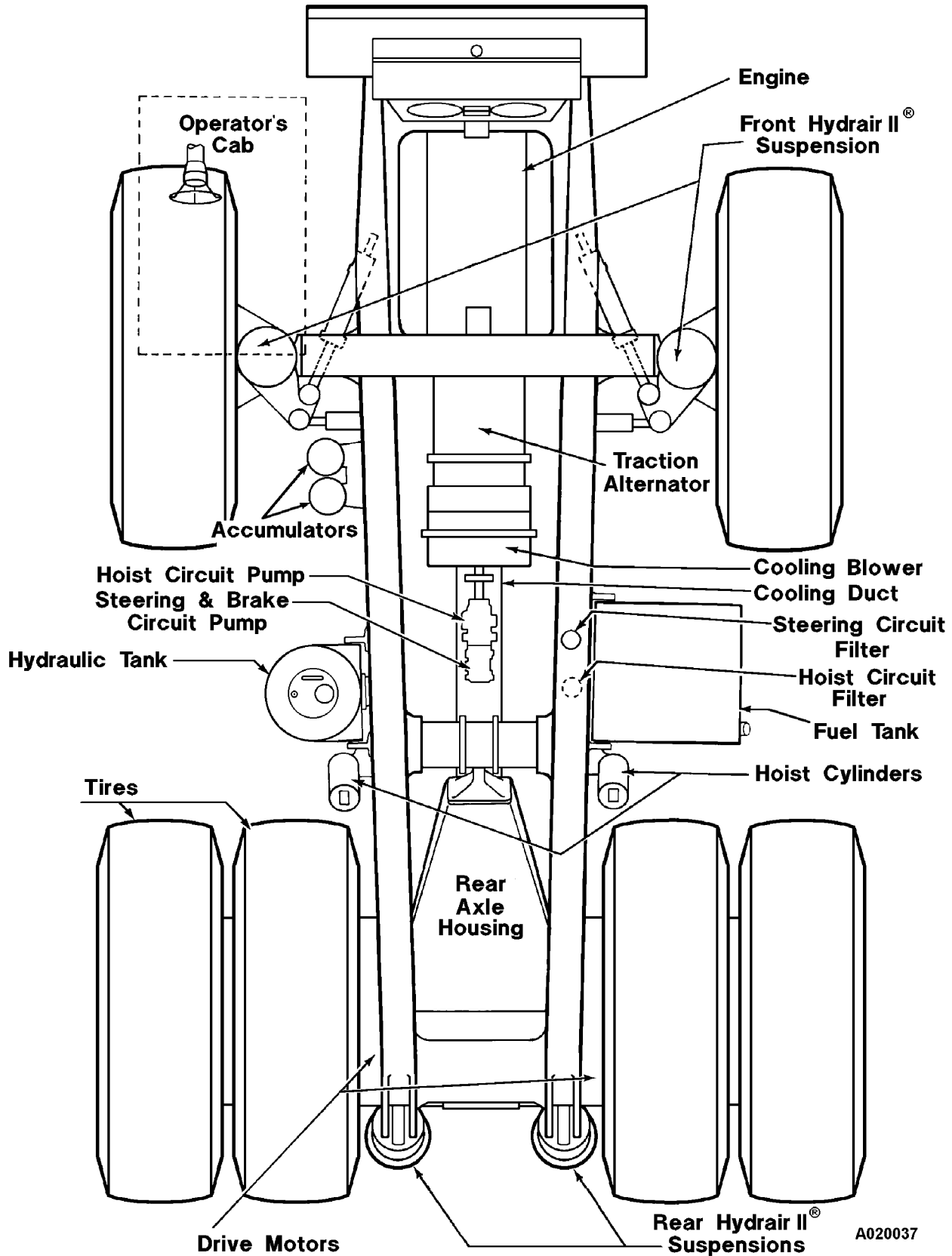

730E MAJOR COMPONENTS

SPECIFICATIONS

These specifications are for the standard 730E dump truck. Customer options may change this listing.

ENGINE

| | |
|---------------------|------------------------------|
| Komatsu SSA16V159 | |
| Number of Cylinders | 16 |
| Operating Cycle | 4-Stroke |
| Rated Brake HP | 1491 kW (2000 HP) @ 1900 RPM |
| Flywheel HP | 1388 kW (1860 HP) @ 1900 RPM |
| Weight (Wet) | 5294 kg (11,670 lbs) |

ELECTRIC DRIVE SYSTEM

| | |
|------------------------|---------------------------|
| STATEX III w/Fuelsaver | AC/DC Current |
| Alternator | General Electric GTA - 22 |
| Motorized Wheels | General Electric 788* |
| Standard Gear Ratio* | 26.825:1 |
| Maximum Speed | 34.6 mph (55.7 km/h) |

*NOTE: Wheel motor application depends upon GVW, haul road grade, haul road length, rolling resistance, and other parameters. KOMATSU & G.E. must analyze each job condition to assure proper application.

DYNAMIC RETARDING

| | |
|--|-----------------------------------|
| Electric Dynamic Retarding | Standard |
| Maximum Retarding | 2759 kW (3700 HP) |
| | With Continuous Rated Blown Grids |
| Two-Speed Overspeed & Extended Range Retarding | |
| | Reverse Retarding |

BATTERY ELECTRIC SYSTEM

| | |
|--------------|---|
| Batteries | Bumper-Mounted in Polyethylene Boxes |
| | Four 12-Volt Batteries in Series/Parallel |
| | 220 Ampere-Hour Capacity |
| | With Disconnect Switch |
| Alternator | 24-Volt, 220 Ampere Output |
| Lighting | 24-Volt |
| Starters (2) | 24-Volt |

SERVICE CAPACITIES

| | Liters | U.S. Gallons |
|---------------------------------------|----------|--------------|
| Crankcase (includes lube oil filters) | | |
| Komatsu | 223 | 59 |
| Cooling System | 409 | 108 |
| Fuel | 3217 | 850 |
| Hydraulic System | 731 | 193 |
| Wheel Motor Gear Box | 40/Wheel | 10.5/Wheel |

HYDRAULIC SYSTEM

Pumps:

| | |
|--|---|
| Hoist (gear-type) | 513 l/min (135.6 GPM) |
| | at 17240 kPa (2500 psi) @ 1900 rpm |
| Steering/Brake (vane-type) | 235 l/min (62 GPM) |
| | at 18960 kPa (2750 psi) @ 1900 RPM |
| Relief Pressure-Hoist | 17240 kPa (2500 psi) |
| Relief Pressure-Steering | 27580 kPa (4000 psi) |
| Hoist | Two Three-Stage Hydraulic Cylinders |
| Tank | Vertical - Cylindrical, Non-Pressurized |
| Service Capacity | 731 Liters (193 U.S. Gal) |
| Filtration | In-line Replaceable Elements |
| Suction | Single, Full Flow, 100 Mesh |
| Hoist and Steering High-Pressure Filters | |
| | Dual, Full Flow, Seven Micron |
| | Beta 12 rating = 200 |

SERVICE BRAKES

| | |
|-----------|------------------------------|
| Actuation | All Hydraulic - Caliper/Disc |
| | (Front) (Rear) |
| Type | Single Disc Dual Disc |
| | Wheel Speed Armature Speed |

STEERING

| | |
|---|----------------|
| Turning Circle (SAE) | 28.0 m (92 ft) |
| Twin hydraulic cylinders with accumulator assist to provide constant rate steering. | |

Emergency power steering automatically provided by accumulators (meets SAE J1511).

These specifications are for the 730E dump truck without trolley assist. Specifications for trolley trucks will be different.

STANDARD DUMP BODY*

Capacity:

- Struck 77 m³ 101 yds³
- Heaped @ 2:1 (SAE) 111 m³ 145 yds³
- Width (inside) 5.61 m (22 ft 6 in.)
- Depth 2.08 m (6 ft 10 in.)
- Loading Height 5.61 m (18 ft 5 in.)
- Dumping Angle 45°

* Optional capacity dump bodies are available.

TIRES

- Radial Tires (standard)..... 37.00 R57
- Rock Service, Deep Tread Tubeless
- Rims . (Patented Phase II New Generation™ Rims)
- Tires and Rims Interchangeable

WEIGHT DISTRIBUTION

| Empty Vehicle | Kilograms | (Pounds) |
|------------------|-----------|-----------|
| Front Axle | 66,840 | (147,357) |
| Rear Axle | 73,752 | (162,593) |

| | | |
|-----------------------------|---------|-----------|
| Total (100% fuel) | 140,592 | (309,950) |
| Standard Komatsu Body | 25,612 | (61,000) |
| Standard Tire Weight..... | 18,371 | (40,500) |

| Loaded Vehicle | Kilograms ... | (Pounds) |
|------------------|---------------|----------|
| Front Axle | 107,026 | 235,950 |
| Rear Axle..... | 217,296 | 479,050 |

| | | |
|-----------------------|---------|-----------|
| Total * | 324,322 | (715,000) |
| Nominal Payload | 183,730 | (405,050) |

*Nominal payload is defined by Komatsu America Corporation's payload policy documentation. In general, the nominal payload must be adjusted for the specific vehicle configuration and site application. The figures above are provided for basic product description purposes. Please contact your Komatsu distributor for specific application requirements.

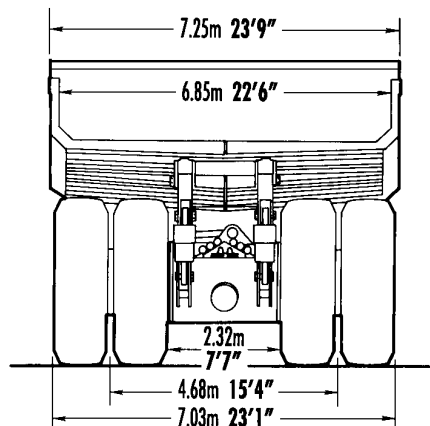
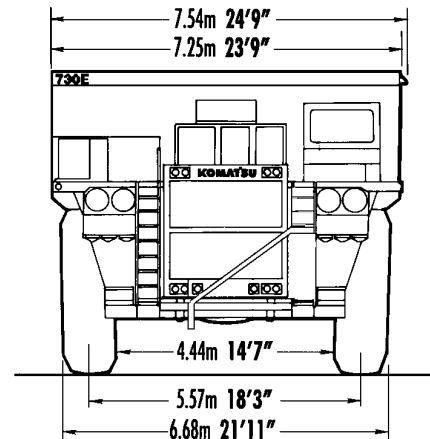
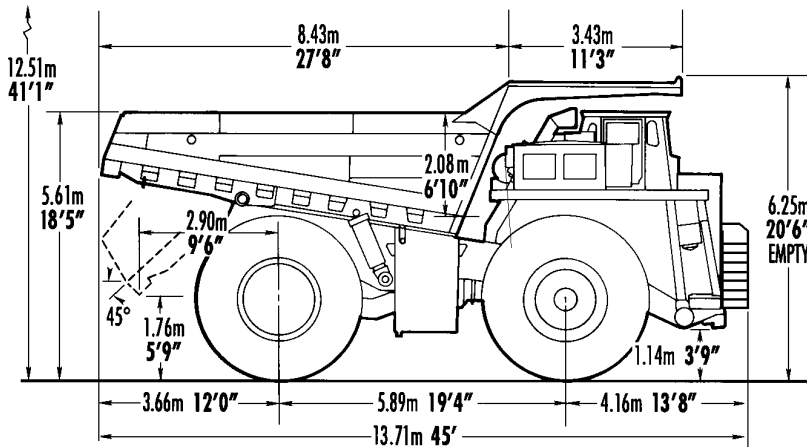

All dimensions are with 77/111m³ 101/145 cu. yd. body.
Vertical dimensions are for standard empty vehicle
– subtract 150mm/5.9” for vehicle loaded to max. GVW.
Minimum ground clearance (at max. GVW) 0.72m 2'4”

| BODIES | Struck | | 2:1 Heap | | Loading Height | | Additional Weight | |
|----------------|----------------|----------|----------------|----------|----------------|-------|-------------------|-------|
| | M ³ | Cu. Yds. | M ³ | Cu. Yds. | M | Feet | Kg | Lbs. |
| Standard | 77 | 101 | 111 | 145 | 5.61 | 18'5" | – | – |
| Std/Optional | 96 | 125 | 125 | 163 | 6.00 | 19'8" | +1112 | +2452 |
| Hi-density* | 48 | 63 | 86 | 113 | 5.04 | 16'6" | +2400 | +5291 |
| H.D. Optional* | 60 | 78 | 96 | 126 | 5.26 | 17'3" | +3030 | +6680 |
| Coal** | 176 | 230 | 209 | 273 | 7.16 | 23'6" | +2540 | +5600 |

* Floor – 1” (25mm); Front 0.625” (16mm); Sides 0.50” (12mm)
** Coal = 3:1 heap capacity - tailgate not included.

PAYLOAD METER III

SECTION 60

INDEX

| | |
|---|-------|
| PAYLOAD METER III | 60-5 |
| Introduction | 60-5 |
| Data Summary | 60-5 |
| Data Gathering | 60-5 |
| COMPONENT DESCRIPTION | 60-6 |
| System Diagram | 60-6 |
| Suspension Pressure Sensors | 60-6 |
| Inclinometer | 60-6 |
| Operator Display | 60-6 |
| Payload Operator Switch | 60-7 |
| Speed Input | 60-7 |
| Body-Up Switch | 60-7 |
| Brake Lock Switch | 60-7 |
| Payload Meter | 60-7 |
| Communications Ports | 60-7 |
| Key Switch Input | 60-8 |
| Payload Meter Power | 60-8 |
| Load Lights | 60-8 |
| Wiring and Termination | 60-9 |
| TCI Outputs | 60-9 |
| OPERATOR'S DISPLAY AND SWITCH | 60-10 |
| Reading the Speedometer | 60-10 |
| Reading the Load Display | 60-10 |
| Using the Operator ID | 60-10 |
| Using the Load and Ton Counter | 60-10 |
| Total Ton Counter | 60-10 |
| Total Load Counter | 60-11 |
| Clearing the Counters | 60-11 |
| Viewing Live Sensor Data | 60-11 |
| Other Display Messages | 60-11 |
| PAYLOAD OPERATION AND CALCULATION | 60-12 |
| Description of Haul Cycle States | 60-12 |
| Haul Cycle Description | 60-12 |
| Load Calculation | 60-13 |
| Carry Back | 60-13 |
| Measurement Accuracy | 60-13 |

| | |
|---------------------------------------|-------|
| SOURCES FOR PAYLOAD ERROR | 60-13 |
| Payload Error | 60-13 |
| Loading Conditions | 60-14 |
| Pressure Sensors | 60-14 |
| Swingloads | 60-14 |
| Speed and Distance | 60-14 |
| HAUL CYCLE DATA | 60-14 |
| Haul Cycle Data | 60-15 |
| Haul Cycle Warning Flags | 60-16 |
| M: Haul Cycle Too Long | 60-17 |
| N: Sensor Input Error | 60-17 |
| Frame Torque Data | 60-17 |
| Sprung Weight Data | 60-17 |
| Maximum Speed Data | 60-17 |
| Alarm Records | 60-17 |
| Fault Code Data | 60-18 |
| PC SOFTWARE OVERVIEW | 60-19 |
| PC Overview | 60-19 |
| System Configuration | 60-19 |
| Installing the PLM III Software | 60-19 |
| DOWNLOADING DATA | 60-20 |
| PLM III SYSTEM CONFIGURATION | 60-21 |
| Starting Communications | 60-21 |
| Displayed Payload Units | 60-21 |
| Time Units | 60-21 |
| Connection Menu | 60-21 |
| Connecting to the Payload Meter | 60-22 |
| Configure the Payload Meter | 60-22 |
| Setting the Date and Time | 60-22 |
| Setting the Truck Type | 60-23 |
| Setting the Gauge Display Units | 60-23 |
| Setting the Frame Serial Number | 60-23 |
| Setting the Truck Number | 60-23 |
| Setting the Komatsu Distributor | 60-23 |
| Setting the Komatsu Customer | 60-23 |
| Clean Truck Tare | 60-24 |
| Inclinometer Calibration | 60-24 |
| DATA ANALYSIS | 60-25 |
| Creating a Query | 60-25 |
| Sorting on Truck Unit Number | 60-25 |
| Sorting on Truck Type | 60-25 |

| | |
|------------------------------------|--------|
| Sorting on Date Range | .60-26 |
| Sorting on Time Range | .60-26 |
| Payload Detail Screen | .60-27 |
| Creating Reports | .60-27 |
| Summary - One Page Report | .60-28 |
| Detailed - Multi-Page Report | .60-28 |
| Creating Graphs | .60-29 |
| Exporting Data | .60-29 |
| CSV Export | .60-29 |
| Compressed | .60-31 |
| Importing Data | .60-31 |
| Deleting Haul Cycle Records | .60-31 |
| Viewing Alarms | .60-32 |
| Deleting Alarm Records | .60-32 |

NOTES

PAYLOAD METER III

INTRODUCTION

Payload Meter III (PLM III) measures, displays and records the weight of material being carried by an off-highway truck. The system generally consists of a payload meter, a gauge display, deck-mounted lights, and sensors. The primary sensors are four suspension pressures and an inclinometer. Other inputs include a body-up signal, brake lock signal, and speed.

Data Summary

5208 haul cycles can be stored in memory. The following information is recorded for each haul cycle:

- Payload
- Operator ID number (0000-9999)
- Distance traveled loaded and empty
- The amount of time spent empty run/stop, loading, loaded run/stop, and dumping
- Maximum speed loaded and empty with time of day
- Average speed loaded and empty
- Empty carry-back load
- Haul-cycle, loading, dumping start time of day
- Peak positive and peak negative frame torque with time of day
- Peak sprung load with time of day
- Tire ton-mph for each front and average per rear tires

The payload meter stores lifetime data that cannot be erased. This data includes:

- Top five maximum payloads and time stamps.
- Top five positive and negative frame torque and time stamps
- Top five maximum speeds and time stamps

Data Gathering

Windows 95/98/NT software is available to download, store, and view payload and fault information. The PC software will download an entire truck fleet into one Paradox database file. Users can query the database by date, time, truck type, and truck number to produce reports, graphs, and export the data. The software can export the data in '.CSV' format that can be easily imported into most spreadsheet applications. The Windows software is not compatible with the Payload Meter II system.

It is important that each payload meter be configured for each truck using the PC software. The information for frame serial number and truck number is used by the database program to organize the payload data. In addition, the payload meter must be configured to make calculations for the proper truck model. Improper configuration can lead to data loss and inaccurate payload calculations.

COMPONENT DESCRIPTION

System Diagram

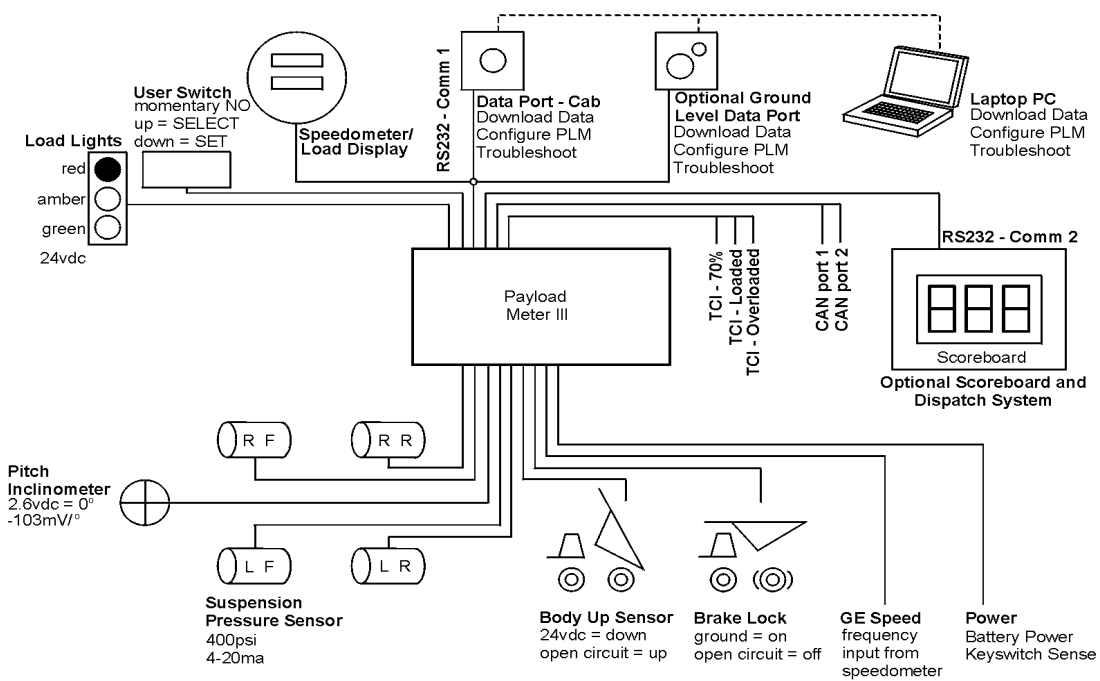

70422

Suspension Pressure Sensors

PLM III uses a two-wire pressure sensor. The range for the pressure sensor is 281 kPa (4000 psi) and the overload limit is 700 kPa (0000 psi). One wire to the sensor is the supply voltage and the other is the signal. The 0-4000 psi range is converted into an electrical current between 4-20 ma. The supply voltage for the sensor is nominally +18 VDC. Each pressure sensor has a 3000 mm (118 in.) length of cable. The cable is specially shielded and reinforced to provide mechanical strength and electronic noise immunity.

Inclinometer

The inclinometer is used to increase the accuracy of load calculations on an incline. The inclinometer uses three wires. For the sensor, red is the +18 VDC supply voltage, black is ground, and the white is the signal. The incline signal is a voltage between 1 and 4 volts. Zero degrees of incline is represented by 2.6 VDC on the signal line. The voltage signal will be decreased by 0.103 VDC for every degree of nose up incline.

Operator Display

The speedometer/display gauge is used as a speedometer and payload display. The top display is used for speed and can display metric (km/h) or English (mph) units. Grounding terminal #4 on the back of the speedometer will switch the meter to display metric units. Leaving terminal #4 unconnected will cause the gauge to display English units. The speedometer can be adjusted using a calibration potentiometer in the back just like existing speedometers.

The payload meter uses the lower display for payload information. The normal display mode shows the current payload. The display can be changed to show the load and total tons counter or the operator ID. Using the operator switch on the dash panel, the current suspension pressures and incline can be displayed. The units for display are set using the PC software. Payloads can be displayed in short tons, long tons, or metric tons.

Payload Operator Switch

The payload operator switch is used to set, view, and clear the total load counter and total ton counter. It is also used to enter the operator ID number (0-9999). This switch can also be used to view the suspension pressures and inclinometer. The payload meter operator switch is located on the dashboard. It is a two-way momentary switch. The top position is the SELECT position. The SELECT position is used to step through the different displays. The lower position is the SET position. The SET position is used to set the operator ID or clear the load and total ton counters. Normally the inputs from the switch to the payload meter are open circuit. The switch momentarily connects the circuit to ground.

Speed Input

PLM III uses a speed signal to calculate speed, distance, and other performance data. This input is critical to the proper operation of the system. PLM III receives this signal from the speedometer/operator display on the dashboard. The same signal displayed to the operator is used by the system. Distance calculations are made based on the rolling radius of the tires for a particular truck.

Body-Up Switch

The body-up input signal is received from a magnetic switch located on the inside of the truck frame, forward the pivot pin of the truck body. This is the same switch typically used for input to the drive system. When the body is down, the switch closes and completes the circuit to 71-control power. 24 VDC indicates the body is down. Open circuit indicates that the body is up.

Brake Lock Switch

The brake lock is used to lock the rear brakes on the truck. It is necessary for the accurate calculation of swingloads during the loading process. Without the brake lock applied, the payload meter will not calculate swingloads during the loading process. Without the brake lock, the payload meter will assume that the truck was loaded using a continuous loader and flag the haul cycle record. All other functions will be normal regardless of brake lock usage. The brake lock input comes from the switch located on the dash panel. The brake lock switch connects the circuit to ground. Open circuit indicates brake lock off. Ground indicates brake lock on.

Payload Meter

The payload meter is housed in a black aluminum housing. There is a small window on the face of the unit. Status and active alarm codes can be viewed through the window. During normal operation, a two-digit display flashes 0 back and forth. Active fault codes will be displayed for two seconds. These codes are typically viewed using the laptop computer connected to the serial communications port.

There is one 40-pin connector on the payload meter. A jack-screw is used to hold the payload meter and wire harness connector housings together. This screw requires a 4mm or 5/32 hex wrench. The correct tightening torque for this screw is **2.8 N·m (25 lb-in.)**. Four bolts hold the payload meter housing to its mounting bracket in the cab.

The circuit board inside the payload meter housing is made from multi-layer, dual-sided surface-mount electronics. There are no field serviceable components inside. The electronics are designed to withstand the harsh operating environment of the mining industry. Opening the payload meter housing will result in voiding the warranty.

Communications Ports

The payload meter has two RS232 serial communications ports and two CAN ports. Connections for the two serial ports are available inside the payload meter junction box. The two CAN ports are available for future electronics systems.

Serial port #1 is used to communicate with the dashboard display. It is also used to connect to the laptop computer. The display gauge will remain blank when the PC is using the serial port. This port initially operates with serial settings at 9600,8,N,1. These settings change automatically to increase the communications rate when the PC is using the port. This serial port uses a three-wire hardware connection.

Serial port #2 is used to communicate to other on-board electronics like Modular Mining's Dispatch® system or the scoreboard from Komatsu. This port uses a three-wire hardware connection. Connections to this serial port need to be approved by Komatsu. Several protocol options are available and detailed technical information is available, depending on licensing.

Key Switch Input

PLM III monitors the status of the key switch. 24VDC indicates that the key switch is ON. Open indicates the key switch is OFF. The payload meter does not receive its electrical power from the key switch circuit. The payload meter will remain on for several seconds after the key switch is removed. When the key switch power is removed, payload meter performs a series of internal memory operations before turning itself off. To allow for these operations, the key switch must be turned off for at least 15 seconds before turning the key switch back ON. The payload meter will automatically reset itself without error if not enough time is given for these operations. The display may blink briefly.

Payload Meter Power

The payload meter receives its power from the battery circuit on the truck. Removing battery power from the payload meter before removing the key switch and waiting 15 seconds may result in lost haul cycle data. The payload meter turns itself off approximately 15 seconds after the key switch power is removed. Some haul cycle data will be lost if battery power is removed before waiting 15 seconds. The payload meter system operates at a nominal voltage of 24 VDC at 1 to 2 amps, depending on options. The payload meter is designed to turn itself off if the supply voltage rises above 36 VDC. The payload meter is also protected by a 5 amp circuit breaker located in the junction box.

Power to the load lights comes from the same battery circuit. The load lights are powered through a relay. The key switch circuit controls the relay. The load lights are also protected by a 15 amp circuit breaker in the junction box.

Load Lights

PLM III uses load lights to indicate to the shovel operator the approximate weight of the material in the truck. The load lights are illuminated only when the brake lock is applied. The lights are controlled by the payload meter through a series of relays in the junction box. The payload meter controls the relays with 24 VDC outputs. A 24 VDC signal from the payload meter powers the relay coil and connects battery power to the load light. When the relay is not powered by the payload meter, a pre-warm resistor connects the load light to a reduced voltage. This circuit pre-warms the load light filaments and reduces the inrush current when the light is fully illuminated. This lengthens the operating life of the load lights.

The load lights progressively indicate to the shovel operator the approximate weight of the material in the truck.

A flashing green light indicates the next swingload will make the measured load greater than 50% of rated load. A solid green light indicates that the current load is greater than 50% of rated capacity.

A flashing amber light indicates the next swingload will make the measured load greater than 90% of rated load. A solid amber light indicates that the current load is greater than 90% of rated capacity.

A flashing red light indicates the next swingload will make the measured load greater than 105% of rated load. A solid red light indicates that the current load is greater than 105% of rated capacity.

The optimal loading target is a solid green and amber lights with a flashing red light. This indicates that the load is between 90% and 105% of rated load for the truck and the next swingload will load the truck over 105%.

Wiring and Termination

Most of the PLM III truck connections use a heavy-duty cable. This yellow multi-conductor cable uses a 16awg, finely stranded wire designed for continuous motion operations. The conductors are protected by a foil and braided shield for electronic noise immunity and physical strength. This wire is typically terminated with a #10 ring terminal. Most connections for the PLM III system are made in the payload meter junction box.

TCI Outputs

The GE drive system on the 930E/960E requires information from the payload meter regarding the loaded condition of the truck. There are three outputs from the payload meter to GE to indicate the relative load in the truck. 24VDC on the 73MSL circuit indicates that the load is 70% of rated load. 24VDC on the 73FSL circuit indicates the truck is 100% loaded. The 73OSL circuit is not currently used.

OPERATOR'S DISPLAY AND SWITCH

Reading the Speedometer

The top window of the speedometer/display gauge is the speedometer section. The display shows the speed indicated by the frequency being received by the gauge. This can be adjusted using the potentiometer on the back of the gauge. In addition, the units for the display can be changed. Terminal #4 controls the displayed units. If #4 is grounded, the display will be metric. If terminal #4 is left open, the display will be in English units.

Reading the Load Display

The lower display on the speedometer/display gauge is used for payload information. The SELECT position on the operator switch allows the user to scroll through a number of useful displays. The order for the displays is as follows:

- PL = Payload
- Id = Operator ID
- LL = Total Shift Tons
- LC = Shift Load Counter
- LF = Left Front Suspension Pressure
- rF = Right Front Suspension Pressure
- Lr = Left Rear Suspension Pressure
- rr = Right Rear Suspension Pressure
- In = Inclinometer

The display holds the displayed information until the SELECT switch is pressed again. The suspension pressures, inclinometer, and payload displays are based on current sensor inputs.

Communications to the display use the same serial link as the download connection. Whenever another computer is connected to serial port #1 to download or configure the system, the lower display will blank. This is not the same connection used by mine dispatch systems.

Using the Operator ID

The current operator ID number is recorded with each haul cycle. The number can be between 0 and 9999.

To set the Operator ID:

1. Press the SELECT switch until $Id=$ is displayed.
2. Hold the SET button until 0000 is displayed. The first digit will be flashing.
3. Press the SET button again to change the digit.
4. Press the SELECT button once to adjust the second digit.
5. Use the SET button again to change the digit.
6. Press the SELECT button once to adjust the third digit.
7. Use the SET button again to change the digit.
8. Press the SELECT button once to adjust the fourth digit.
9. Use the SET button again to change the digit
10. Press the SELECT button one more time to enter the ID.

If no buttons are pressed for 30 seconds, the display will return to normal operation. The number being entered will be lost and the ID number returns to the previous ID number.

Using the Load and Ton Counter

PLM III allows the truck operator to monitor and track the total tons hauled and the number of haul cycles during the shift. This display can be cleared at the beginning of each shift to allow the operator to record how many loads and tons have been hauled during the shift.

Total Ton Counter

The total ton counter records the number of tons hauled since the last time it was cleared. This display is in 100's of tons. For example, if the display shows 432 , the total tons is 43,200. This display can be cleared at the beginning of each shift to allow the operator to record how many tons have been hauled during the shift. The units are selected using the PC software.

- To view the total ton count, press and release the SELECT switch until LL = is displayed on the gauge.

Total Load Counter

The total load counter records the number of loads hauled since the last time it was cleared. This display can be cleared at the beginning of each shift to allow the operator to record how many loads have been hauled during the shift.

- To view the total load counter, press and release the SELECT switch until $\overline{L} \overline{L} =$ is displayed on the gauge.

Clearing the Counters

Clearing the total ton counter or total load counter clears both records.

To clear the total ton and total load counter:

- Press the SELECT switch until $\overline{L} \overline{L} =$ or $\overline{L} \overline{L} =$ is displayed.
- Hold the SET button until the display clears.

Viewing Live Sensor Data

The display can also be used to quickly show the current readings from the four suspension pressure sensors and the inclinometer. This can be used during regularly scheduled service periods to check the state of the suspensions. These displays are live and will update as the values change.

The live displays cannot be cleared and the SET button will have no effect.

The units for the display are controlled by the configuration of the payload meter. If the payload meter is set to display metric units, the pressures will be displayed in tenths of kPa (PSI). For example, if the display shows $\overline{20} \overline{2}$, the actual value is 20.2 kPa (. If the payload meter is set to display short tons, the pressures will be displayed in lbs/in² (psi). Multiply by 14.2 to convert kg/cm² to psi. (example -- 1kg/cm² x 14.2 = 14.2 psi). There is no way to detect the units setting for the gauge without the PC software.

The inclinometer displays whole degrees of incline. Positive incline is truck nose up. The gauge will quickly display the type of information shown every 10 seconds. For example, if the left-front pressure is being displayed, $\overline{L} \overline{F} =$ will flash on the display every minute. Only the payload display, $\overline{P} \overline{L} =$ does not display this information.

- Left Front Pressure - To display the pressure in the left-front suspension, press and release the SELECT switch until $\overline{L} \overline{F} =$ is displayed.
- Right Front Pressure - To display the pressure in the right-front suspension, press and release the SELECT switch until $\overline{R} \overline{F} =$ is displayed.
- Left Rear Pressure - To display the pressure in the left-rear suspension, press and release the SELECT switch until $\overline{L} \overline{R} =$ is displayed.
- Right Rear Pressure - To display the pressure in the right-rear suspension, press and release the SELECT switch until $\overline{R} \overline{R} =$ is displayed.
- Inclinometer - To display the truck incline, press and release the SELECT switch until $\overline{I} \overline{N} =$ is displayed.

Other Display Messages

On startup of the payload meter system, the gauge display will scroll the truck type that the PLM III is configured for. For example, on a 930E, the gauge will scroll, $----\overline{930E}---$.

If the PLM III encounters memory problems, it will display $\overline{E} \overline{R} \overline{8} \overline{8}$ where 88 is the specific memory error. In this very rare circumstance, the system must be turned off for 30 seconds and restarted.

PAYLOAD OPERATION AND CALCULATION

Description of Haul Cycle States

The typical haul cycle can be broken down into eight distinct stages or states. Each state requires the payload meter to make different calculations and store different data.

States or stages of a typical haul cycle:

1. Tare Zone
2. Empty
3. Loading
4. Maneuvering
5. Final Zone
6. Hauling
7. Dumping
8. After Dump

Haul Cycle Description

A new haul cycle is started after the load has been dumped from the previous cycle. The payload meter will stay in the after_dump state for 10 seconds to confirm that the load has actually been dumped. If the current payload is less than 20% of rated load, the payload meter will switch to the tare_zone and begin calculating a new empty tare. If, after dumping, the payload has not dropped below 20% of the rated load, the meter will return to the maneuvering or hauling states. In this case, the false_body_up flag will be recorded in the haul cycle record.

While in the tare_zone state, and moving faster than 5 km/h (3 mph), the payload meter calculates the empty sprung weight of the truck. This tare value will be subtracted from the loaded sprung weight to calculate the final payload. The payload meter will switch from the tare_zone or empty to the loading state if swingloads are detected. By raising the dump body while in the empty state, the payload meter can be manually switched back to the tare_zone to calculate a new tare.

From the empty state, the payload meter will switch to the loading state through one of two means. If the brake lock is applied, the payload meter will be analyzing the suspension pressures to detect a swingload. If a swingload is detected, the meter will switch to the loading state. The minimum size for swingload detection is 10% of rated load. Swingload detection usually takes 4-6 seconds. The second method to switch from empty to loading is through continuous loading. This can happen if the brake lock is not used during loading. If the load increases above 50% of rated load for 10 seconds without the brake lock applied, the meter will switch to loading and record the continuous_loading flag in the haul cycle.

The payload meter switches from loading to maneuvering as soon as the truck begins moving. The maneuvering zone is 160m and is designed to allow the operator to reposition the truck under the shovel. More payload can be added anytime within the maneuvering zone. Once the truck travels 160m (0.1 miles), the payload meter switches to the final_zone and begins calculating payload. If the body is raised while the payload meter is in the maneuvering state, the no_final_load flag will be recorded in the haul cycle record, no payload will be calculated, and the meter will switch to the dumping state.

While in the final_zone moving faster than 5 km/h (3 mph), the payload meter calculates the loaded sprung weight of the truck. The same advanced algorithm is used to calculate the empty and loaded sprung weights. The payload meter will switch from the final_zone to the dumping state if the body-up signal is received. If the truck has moved for less than one minute in the final_zone, the payload meter will calculate the final payload using an averaging technique which may be less accurate. If this happens, the average_load flag will be recorded in the haul cycle.

The payload meter switches to the dumping state when the dump body rises. The payload meter will switch from dumping to after_dump when the dump body comes back down.

From the after_dump, the payload meter will switch to one of three states:

1. If the average payload is greater than 20% of rated load and no final payload has been calculated, the payload meter will return to the maneuvering state. After the truck travels 160m (0.1 mile), the meter will switch to the final_zone and attempt to calculate the payload again. The false_body_up flag will be recorded in the haul cycle record.
2. If the average payload is greater than 20% of rated load and the final payload has been calculated, the payload meter will switch back to the hauling state. The false_body_up flag will be recorded in the haul cycle record.
3. If the average payload is less than 20% of rated load, the payload meter will switch to the tare_zone and begin to calculate a new empty tare.

Load Calculation

The final load calculation is different from the last swingload calculation. The accuracy of the swing load calculation depends on loading conditions and the position of the truck during loading. The last swingload calculation is not the value recorded in memory as the final load. The final load is determined by a series of calculations made while the truck is traveling to the dump site.

Carry Back

Carry back is calculated as the difference between the current truck tare and the clean truck tare. The clean truck tare is calculated using the PC software. When the suspensions are serviced or changes are made that may affect the sprung weight of the truck, a new clean truck tare must be calculated.

Measurement Accuracy

Payload measurements are typically repeatable within 1%. Accuracy for a particular scale test depends on specific combinations of pressure sensors and payload meters as well as the specifics of each scale test. Comparisons from different scale tests are often made without considering the differences introduced by the specific installation and operation of the scales for each test. In addition, each pressure sensor and payload meter introduces its own non-linearity. Each truck becomes an individual combination of sensors and payload meter. Errors from these sources can introduce up to a $\pm 7\%$ bias in the payload meter calculations for a specific scale test, for an individual truck.

Because the PLM III calculates a new empty tare for each payload, a detailed scale test must weigh the trucks empty and loaded for each haul cycle. Using a simple average of two or three empty truck weights as an empty tare for the entire scale test will introduce significant error when comparing scale weights to PLM III weights.

SOURCES FOR PAYLOAD ERROR

Payload Error

The number one source of error in payload calculation is improperly serviced suspensions. The payload meter calculates payload by measuring differences in the sprung weight of the truck when it is empty and when it is loaded. The sprung weight is the weight of the truck supported by the suspensions. The only method for determining sprung weight is by measuring the pressure of the nitrogen gas in the suspensions. If the suspensions are not properly maintained, the payload meter cannot determine an accurate value for payload. The two critical factors are proper oil height and proper nitrogen charge.

If the suspensions are overcharged, the payload meter will not be able to determine the empty sprung weight of the truck. The suspension cylinder must be able to travel up and down as the truck drives empty. The pressure in an overcharged suspension can push the suspension rod to full extension. In this case, the pressure inside the cylinder does not accurately represent the force necessary to support that portion of the truck.

If the suspensions are undercharged, the payload meter will not be able to determine the loaded sprung weight of the truck. The suspension cylinder must be able to travel up and down as the truck drives loaded. If the pressure in an undercharged suspension cannot support the load, the suspension will collapse and make metal-to-metal contact. In this case, the pressure inside the cylinder does not accurately represent the force necessary to support that portion of the truck.

Low oil height can also introduce errors by not correctly supporting a loaded truck. This is why the correct oil height and nitrogen charge are the most critical factors in the measurement of payload. If the suspensions are not properly maintained, accurate payload measurement is not possible. In addition, suspension maintenance is very important to the life of the truck.

Loading Conditions

The final load calculation of the PLM III system is not sensitive to loading conditions. The final load is calculated as the truck travels away from the shovel. Variations in road conditions and slope are compensated for in the complex calculations performed by the payload meter.

Pressure Sensors

Small variations in sensors can also contribute to payload calculation error. Every pressure sensor is slightly different. The accuracy differences of individual sensors along the range from 0 to 27579 kPa (0 to 4000 psi) can add or subtract from payload measurements. This is also true of the sensor input circuitry within individual payload meters. These differences can stack up 7% in extreme cases. These errors will be consistent and repeatable for specific combinations of payload meters and sensors on a particular truck.

Swingloads

Swingload calculations can be affected by conditions at the loading site. Parking the truck against the berm or large debris can cause the payload meter to inaccurately calculate individual swingloads. While the PLM III system uses an advanced calculation algorithm to determine swingloads, loading site conditions can affect the accuracy.

Speed and Distance

The payload meter receives the same speed signal as the speedometer. This signal is a frequency that represents the speed of the truck. The payload meter uses this frequency to calculate speeds and distances. The meter assumes a single value for the rolling radius of the tire. The rolling radius may change at different speeds by growing larger at higher speeds. The actual rolling radius of the tire will also change between a loaded and empty truck. The payload meter does not compensate for these changes.

NOTE: Earlier 730E and 830E models are subject to incorrect speed data due to electrical interference. The incorrect speeds are generated while the truck is stopped. An attenuator was added to newer production models to prevent this error from occurring. A kit was released to update older PLM III systems with the attenuator. Consult your area service representative for details.

HAUL CYCLE DATA

PLM III records and stores data in its on-board flash memory. This memory does not require a separate battery. The data is available through the download software.

PLM III can store 5208 payload records. When the memory is full, the payload meter will erase the oldest 745 payload records and continue recording.

PLM III can store 512 alarm records in memory. When the memory is full, the payload meter will erase the oldest 312 alarm records and continue recording.

All data is calculated and stored in metric units within the payload meter. The data is downloaded and stored in metric units within the Paradox database on the PC. The analysis program converts units for displays, graphs, and reports.

The units noted in the Table 1 are the actual units stored in the data file. The value for the haul cycle start time is the number of seconds since January 1, 1970 to the start of the haul cycle. All other event times are referenced in seconds since the haul cycle start time. The PC download and analysis program converts these numbers into dates and times for graphs and reports.

Haul Cycle Data

The following information is recorded for each haul cycle:

| Table 1: HAUL CYCLE DATA | | |
|---------------------------------|---------------|---|
| Data | Unit | Remark |
| Truck # | alpha-numeric | Up to 22 characters can be stored in this field to identify the truck. Typically this field will be just the truck number. |
| Haul Cycle Start Date/Time | seconds | Number of seconds from 1/1/70 to the start of the haul cycle, haul cycle starts when the meter transitions from dumping to empty state after the previous haul cycle, download program converts seconds into date and time for display. |
| Payload | tons | Stored as metric, download program allows for conversion to short or long tons. |
| Number of Swingloads | number | The number of swingloads detected by the payload meter. |
| Operator ID | number | This is a 4 digit number that can be entered by the operator at the start of the shift. |
| Warning Flags | alpha | Each letter represents a particular warning message about the haul cycle. Details are located on page 19. |
| Carry-back load | tons | The difference between the latest empty tare and the clean truck tare. |
| Empty haul time | seconds | Number of seconds in the tare_zone and empty states with the truck moving. |
| Empty stop time | seconds | Number of seconds in the tare_zone and empty states with the truck stopped. |
| Loading time | seconds | Number of seconds in the loading state. |
| Loaded haul time | seconds | Number of seconds in the maneuvering, final_zone and loaded states with the truck moving. |
| Loaded stop time | seconds | Number of seconds in the maneuvering, final_zone and loaded states with the truck stopped. |
| Dumping time | seconds | Number of seconds in the dumping state. |
| Loading start time | seconds | Number of seconds from the start of the haul cycle to when the meter transitions from empty to loading state. |
| Dump start time | seconds | Number of seconds from the start of the haul cycle to the time when the meter switches from loaded to dumping state. |
| Loaded haul distance | m | Distance traveled while loaded. |
| Empty haul distance | m | Distance traveled while empty. |
| Loaded max speed | km/h | Maximum speed recorded while the truck is loaded. |
| Loaded max speed time | seconds | Number of seconds from the start of the haul cycle to the time when the max speed occurred. |
| Empty max speed | km/h | Maximum speed recorded while the truck is empty. |
| Empty max speed time | seconds | Number of seconds from the start of the haul cycle to the time when the max speed occurred. |
| Peak positive frame torque | ton-meter | Positive frame torque is measured as the frame twists in the clockwise direction as viewed from the operator's seat. |
| Peak frame torque time | seconds | Number of seconds from the start of the haul cycle to the peak torque, download program converts to time for display. |
| Peak negative frame torque | ton-meter | Negative frame torque is measured as the frame twists in the counter-clockwise direction as viewed from the operator's seat. |
| Peak frame torque time | seconds | Number of seconds from the start of the haul cycle to the peak torque, download program converts to time for display. |
| Peak sprung load | tons | Peak dynamic load calculation. |
| Peak sprung load time | seconds | Number of seconds from the start of the haul cycle to the peak instantaneous load calculation. |
| Front-left tire-ton-km/h | t-km/h | Tire ton-km/h for haul cycle. |
| Front-right tire-ton-km/h | t-km/h | Tire ton-km/h for haul cycle. |
| Average rear tire-ton-km/h | t-km/h | Tire ton-km/h for haul cycle. |
| Truck Frame Serial Number | alpha | The truck serial number from the nameplate on the truck frame. |
| Reserved 1-10 | number | These values are internal calculations used in the continued development of the PLM III system and must be ignored. |

Haul Cycle Warning Flags

The payload meter expects haul cycles to progress in a particular way. When something unexpected takes place, the system records a warning flag. Several events within the haul cycle can cause a warning flag to be generated. Each one indicates an unusual occurrence during the haul cycle. They do not necessarily indicate a problem with the payload meter or payload calculation.

A: Continuous Loading

This message is generated when the truck is loaded over 50% full without the payload meter sensing swingloads. This indicates that a continuous loading operation was used to load the truck. It may also indicate that the payload meter did not receive the brake lock input while the truck was being loaded. There may be a problem with the wiring or the brake lock was not used. The payload meter will not measure swingloads unless the brake lock is used during the loading process.

B: Loading to Dumping Transition

This message is generated when the payload meter senses a body-up input during the loading process. This message is usually accompanied by a `no_final_load` flag.

C: No Final Load

This message is generated when the payload meter is unable to determine the final payload in the truck. Typically, this means that the payload meter switched from a loaded state to the dumping state before the load could be accurately measured.

D: Maneuvering to Dumping Transition

This message is generated when the payload meter senses a body-up input during the maneuvering or repositioning process indicating that the operator has dumped the load. It may also be generated if the body-up signal is not properly reaching the payload meter and the weight in the truck falls dramatically while the truck is maneuvering or repositioning.

E: Average Load or Tare Used

This message indicates that the recorded payload may not be as accurate as a typical final load calculation. Typically, this is recorded when loading begins before an accurate tare is calculated or the load is dumped before the load can be accurately measured.

F: Final Zone to Dumping Transition

This message is generated when the payload meter senses a body-up while it is calculating the final payload indicating that the operator has dumped the load. It may also be generated if the body-up signal is not properly reaching the payload meter and the weight in the truck falls dramatically while the truck is calculating the final payload.

H: False Body-Up

This message indicates that the body was raised during the haul cycle without the load being dumped. The body-up signal indicated that the truck was dumping, but the weight of the truck did not fall below 20% of the rated load.

I: Body-Up Signal Failed

This message indicates that the load was dumped without a body-up signal being received by the payload meter. The weight of the truck fell below 20%, but the payload meter did not receive a body-up signal from the sensor.

J: Speed Sensor Failed

This message indicates that the payload meter sensed the truck loading and dumping without receiving a speed signal.

K: New Tare Not Calculated

The payload meter was not able to accurately calculate a new empty sprung weight for the truck to use as the tare value for the haul cycle. The tare value from the last haul cycle was used to calculate payload.

L: Incomplete Haul Cycle

The payload meter did not have proper data to start the haul cycle with after powering up. When the PLM III powers off, it records the data from the haul cycle in progress into memory. This flag indicates that this data was not recorded the last time the payload meter was shut down. This can happen when the main battery disconnect is used to shut the truck down instead of the key switch. A haul cycle with this warning flag will not be considered accurate. Haul cycles with this warning are displayed in red on the payload summary window and are not included in the summary statistics for reports or display.

M: Haul Cycle Too Long

The haul_cycle_too_long flag indicates that the haul cycle took longer than 18.2 hours to complete. The times stored for particular events may not be accurate. This does not affect the payload calculation.

N: Sensor Input Error

An alarm was set for one of the five critical sensor inputs during the haul cycle. The five critical sensors are the four pressure sensors and the inclinometer. Without these inputs, the payload meter cannot calculate payload. A haul cycle with this warning flag will not be considered accurate. Haul cycles with this warning are displayed in red on the payload summary window and are not included in the summary statistics for reports or display.

Frame Torque Data

Payload meter records the top five peak positive and negative frame torque values and the time they occurred. The frame torque is a measure of the twisting action along the centerline of the truck. Positive frame torque is measured when the suspension forces on the front of the truck act to twist the frame in the clockwise direction as viewed from the operator's seat. Negative frame torque is measured when the forces from the suspensions act in the opposite direction.

For example, if the left front and right rear pressure rises as the right front and left rear pressure drops, the truck frame experiences a twisting motion along the longitudinal centerline. In this case, the payload meter will record a positive frame torque.

The five highest values in the positive and negative direction are stored in permanent memory within the payload meter.

Sprung Weight Data

The payload meter is constantly monitoring the live payload calculation. This value naturally rises and falls for a loaded truck depending on road and driving conditions. The payload meter records the top five highest payload calculations and the time they occurred. This information is stored in permanent memory inside the meter.

Maximum Speed Data

The payload meter records the top five highest speeds and the time they occurred. This information is stored in permanent memory inside the meter.

Alarm Records

The payload meter stores alarm records to give service personnel a working history of the system. All codes are viewed using the PC connected to the payload meter. Active codes are also displayed on the two-digit display on the meter itself. Each code has a specific cause and will lead to an investigation for correction. Some failures can be overcome by the payload meter. Haul cycle data will indicate if an alarm condition was present during the cycle. Failures with the suspension or inclinometer sensors cannot be overcome.

Fault Code Data

| Table 2: | | |
|-------------------|----------------------------|--|
| Fault Code | Name | Description |
| 1 | Left front pressure high | Input current > 22 ma |
| 2 | Left front pressure low | Input current < 2 ma |
| 3 | Right front pressure high | Input current > 22 ma |
| 4 | Right front pressure low | Input current < 2 ma |
| 5 | Left rear pressure high | Input current > 22 ma |
| 6 | Left rear pressure low | Input current < 2 ma |
| 7 | Right rear pressure high | Input current > 22 ma |
| 8 | Right rear pressure low | Input current < 2 ma |
| 9 | Inclinometer high | Input voltage < 0.565 VDC |
| 10 | Inclinometer low | Input voltage > 5.08 VDC |
| 11 | Speed input failure | Not Used. |
| 12 | Brake lock input failure | Not Used. |
| 13 | Body-up input failure | Payload meter detected dumping activity without receiving a body-up signal. |
| 16 | Memory write failure | Indicates possible memory problem at power start up. Cycle power and recheck. |
| 17 | Memory read failure | Indicates possible memory problem at power start up. Cycle power and recheck. |
| 18 | Rear right suspension flat | Payload meter detected an undercharged suspension condition on the rear right suspension. |
| 19 | Rear left suspension flat | Payload meter detected an undercharged suspension condition on the rear left suspension. |
| 20 | Time change | Payload meter time was changed by more than 10 minutes. The Alarm Set time indicates original time. The Alarm Clear time indicates the new time. |
| 21 | Tare value reset | The user manually forced the payload meter to reset the haul cycle empty (tare) sprung weight. This forced the meter into the tare_zone state and lost all data for the previous haul cycle. |
| 22 | Excessive carryback | The payload meter detected an empty carryback load in excess of the user-defined carryback threshold on two consecutive haul cycles. |
| 26 | User switch fault - SELECT | Select switch on for more than two minutes may indicate short to ground. |
| 27 | User switch fault - SET | Set switch on for more than two minutes may indicate short to ground. |

PC SOFTWARE OVERVIEW

PC Overview

The PC software has several basic functions:

- Configure the PLM III system on the truck
- Troubleshoot and check the PLM III system
- Download data from the PLM III system
- Analyze data from the payload systems

Configuration, troubleshooting, and downloading require a serial connection to the payload meter on the truck. Analysis can be done at any time without a connection to the payload meter.

Payload data is downloaded from several trucks into one database on the PC. The database can be queried to look at the entire fleet, one truck or truck model. The data can be graphed, reported, imported, or exported. The export feature can take payload data and save it in a format that spreadsheet programs like Excel or word processing programs can easily import.

System Configuration

PLM III needs to be configured for operation when it is first installed on the truck. This process requires several steps and uses the laptop computer to make the necessary settings. The setup procedure can be broken down into several steps:

- Connecting the laptop to the PLM III system
- Starting communications
- Setting the time and date
- Setting the truck type
- Setting the truck ID
- Setting the speedometer/display gauge units

Installing the PLM III Software

The CD ROM containing the Payload Data Management (PDM) Software will automatically begin installation when it is inserted into the drive on the PC. If this does not happen, the software can be installed by running the Setup.exe program on the CD ROM.

The minimum PC requirements for running the software is a Pentium 133Mhz with 64 MB of ram and at least 300 MB of free hard drive space available. For improved performance, the recommended PC would be a Celeron, AMD K6-2 or better processor with 128 MB of ram running at 400 Mhz. The PDM software uses a powerful database to manipulate the large amounts of data gathered from the PLM III system. Using a more powerful computer and added memory to run the software can result in a significant improvement in performance. The software is written to use a minimum 800x600 screen resolution.

DOWNLOADING DATA

PLM III records many types of data. The PLM III PC software is designed to download the data from a whole truck fleet. Instead of creating one data file for each truck, the PC software combines all the data from many trucks into one database on the hard drive of the computer. The software then allows users to query the database to create custom reports and graphs. Data for individual trucks or groups of trucks can be easily analyzed. This same data can be exported for use in other software applications like word processors and spreadsheet applications.

As the database grows, performance of the PC software for analysis will slow down. It may be helpful to periodically export data. For example, query the database to show the oldest quarter, month, or half year and print out a summary report. Then export the data to a compressed format and save the file in a secure location. Once the data is exported, delete the entire query results from the database. If necessary, the data can easily be imported back into the main database for analysis at a future date. Removing this older data will improve performance.

To download the payload meter:

1. Connect to the payload meter and start the PC software.
2. From the main menu, select "Connect to Payload Meter". The PC will request the latest status information from the payload meter. The number of haul cycles and alarms will be displayed.
3. Select the "Begin Download" button. The PC will request the payload and alarm data from the payload meter and save it into the database. This may take several minutes. A progress bar at the bottom will show the approximate time left.



The PC software downloads the data from the payload meter into a single Paradox database. The data from all the trucks is added to the same database. Downloading the payload meter can take several minutes. The data is added to the database on the laptop used to download.

To move the data to another computer, a query must be run to isolate the particular data for export. DO NOT press the operator switch on the dashboard while downloading.

PLM III SYSTEM CONFIGURATION

Starting Communications

The PDM software allows users to download and configure the system.

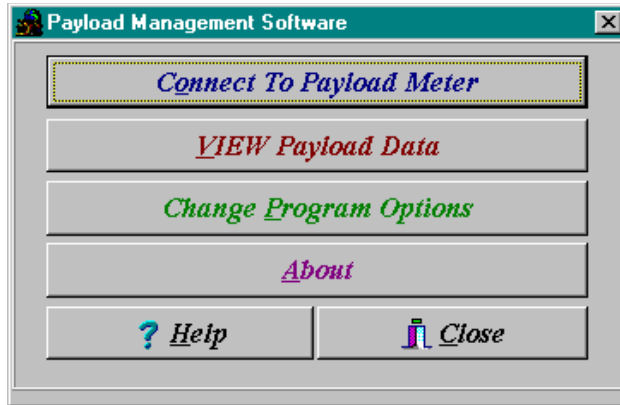

Before connecting to the payload meter, select "Change Program Options" and confirm that the program has selected the correct laptop serial port. Most laptops use Comm 1 for serial communications. The units displayed for reports and graphs by the PC software can be set on this form. Click "Done" to return to the main menu.

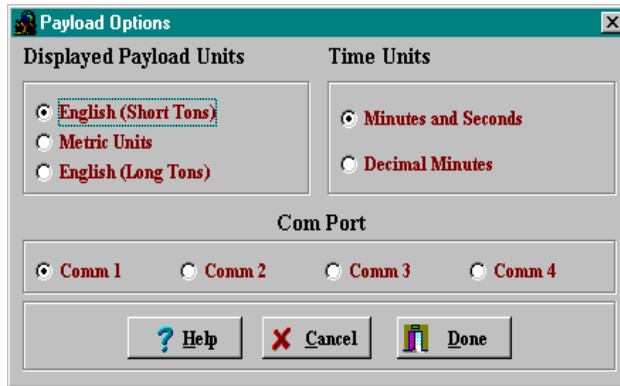

From the main menu, click the "Connect to Payload Meter" button. The PC will try to connect to the payload meter and request basic information from the system. In the event of communications trouble, the PC will try three times to connect before timing-out. This may take several seconds.

Displayed Payload Units

Three options are available for the display of units in the PC software, reports, and graphs:



Short Tons: Payload is displayed in short tons, distances and speeds will be displayed in Miles.

Metric Tons: Payload is displayed in metric tons, distances and speeds are displayed in Kilometers.

Long Tons: Payload is displayed in long tons, distances and speeds are displayed in Miles.

Time Units

Minutes and seconds example:

Five minutes and thirty-two seconds = 5:32

Decimal minutes example:

Five minutes and thirty-two seconds = 5.53

Connection Menu

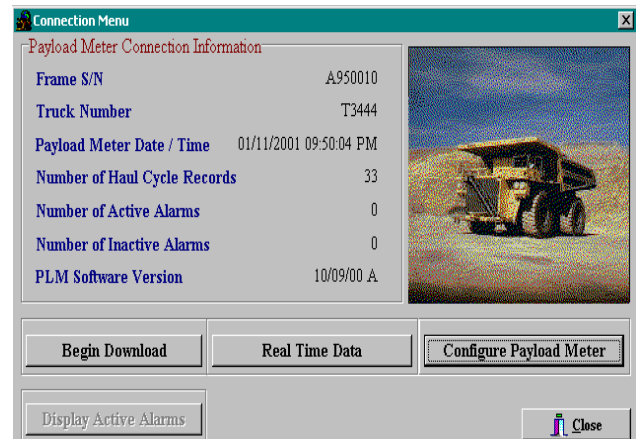

The connection screen displays basic system information to the user.

- Frame S/N must agree with the truck serial number from the serial plate located on the truck frame.
- Truck number is an ID number assigned to the truck by the mine.
- The payload meter date/time values come from the payload meter at the moment of connection.
- Number of haul cycle records is the number of haul cycles records stored in memory and available for download.
- Number of active alarms shows how many alarms are currently active in the system at the time of connection. If there are active alarms, the "Display Active Alarms" button is available.
- Number of inactive alarms shows how many alarms have been recorded in memory and are available for download.
- PLM software version displays the current version of software in the payload meter.

The information on the connection menu comes from the configuration of the payload system on the truck.

There are also many configuration and download options available from this screen. The connection menu is updated only when the connection is first made. It does not update automatically. To view changes made while connected, the user must close the window and reconnect to the payload meter.

The connection menu is displayed after a serial connection has been established and the PC software has connected to the payload meter.

Connecting to the Payload Meter

Communications to the PLM III requires a laptop computer running the PDM software. The software connects to the payload meter through the meter's serial port #1. This is the same port used by the speedometer/display gauge. When the laptop is using the serial port, the lower display on the operator gauge on the dashboard will be blank. This does not affect the operation of the speedometer.

- Connect the laptop to the system using the EF9160 communications harness. The download connector is typically located on the housing mounted in the cab to the back wall. The PLM III system uses the same connection as the Payload Meter II system.

Configure the Payload Meter

Configuration of the payload meter requires a serial connection to the PLM III system. Clicking the "Configure Payload Meter" button will bring up the truck configuration screen and menu. This screen displays the latest configuration information stored on the payload meter.

When changes are made to the configuration, the "Save Changes" button must be pressed to save the changes into the payload meter. To confirm the changes, exit to the main menu and re-connect to the payload meter.

The screenshot shows the 'Truck Configuration' window. It has several sections: 'PLM Date and Time' with 'Edit Time' set to 10:59:38 AM and 'Edit Date' set to 4/11/01; 'Gauge Units' with 'Metric Tons' selected; 'Truck Type' set to 930E; and a list of fields: 'Frame Serial Number' (A950010), 'Truck Number' (T611), 'KMS Distributor' (RMS), and 'KMS Customer' (Big Mine). At the bottom are buttons for 'Save Changes', 'Clean Truck Tare', 'Inclinometer', and 'Close'.

Setting the Date and Time

The screenshot shows the 'PLM Date and Time' dialog box. It has a 'Change To' button, an 'Edit Time' field set to 9:51:36 PM, and an 'Edit Date' field set to 1/11/2001.

The time shown on the form is the time transmitted from the payload when the connection was first established.

The screenshot shows a calendar for August 2000. The date 10/17/00 is highlighted in blue. Below the calendar, it says 'Today: 10/17/00'.

The date and time are maintained by a special chip on the PLM III circuit board. The memory for this chip is maintained by a very large capacitor when the power is removed from the payload meter. This will maintain the date and time settings for approximately 30 days. After this time, it is possible for the payload meter to lose the date and time setting. It is recommended that the system be powered every 20 days to maintain the date and time. If the date and time is lost, simply reset the information using this procedure. It takes approximately 90 minutes to recharge the capacitor.

Changing the date and time will affect the haul cycle in progress and may produce unexpected results in the statistical information for that one haul cycle.

To change the time:

1. Click on the digit that needs to be changed.
2. Use the up/down arrows to change or type in the correct value.
3. Press the "Save Changes" button to save the new time in the payload meter.

To change the date:

1. Click on the digit that needs to be changed.
2. Type in the correct value or use the pull-down calendar to select a date.
3. Press the "Save Changes" button to save the new time in the payload meter.

Setting the Truck Type



1. From the truck configuration screen, use the pull-down menu to select the truck type that the payload meter is installed on.
2. Press the "Save Changes" button to program the change into the meter.

Setting the Gauge Display Units

The payload meter speedometer/display gauge displays the speed on the upper display. The units for the speed display are selected using a jumper on the rear of the case.

The payload units on the lower display can be changed from metric to short tons or long tons using the truck configuration screen. This selection also switches between metric (kg/cm²) and psi (lbs/in²) for the live display of pressure on the gauge.

1. From the truck configuration screen, select the payload units to be used on the lower display of the speedometer/display gauge.
2. Press the "Save Changes" button to program the change into the payload meter.

Setting the Frame Serial Number

| | |
|---------------------|----------|
| Frame Serial Number | A950010 |
| Truck Number | T3444 |
| KMS Distributor | RMS |
| KMS Customer | Pit Mine |

The frame serial number is located on the plate mounted to the truck frame. The plate is outboard on the lower right rail facing the right front tire. It is very important to enter the correct frame serial number. This number is one of the key fields used within the haul cycle database. The field will hold 20 alpha-numeric characters.

1. On the Truck Configuration screen, enter the truck frame serial number in the appropriate field.
2. Press the "Save Changes" button to program the change into the payload meter.

Setting the Truck Number

Most mining operations assign a number to each piece of equipment for quick identification. This number or name can be entered in the truck number field. It is very important to enter a unique truck number for each truck using the PLM III system. This number is one of the key fields used within the haul cycle database. The field will hold 20 alpha-numeric characters.

1. On the truck configuration screen, enter the truck number in the appropriate field.
2. Press the "Save Changes" button to program the change into the payload meter.

Setting the Komatsu Distributor

This field in the haul cycle record can hold the name of the Komatsu distributor that helped install the system. Komatsu also assigns a distributor number to each distributor. This number is used on all warranty claims. This Komatsu distributor number can also be put into this field. The field will hold 20 alpha-numeric characters.

1. On the truck configuration screen, enter the distributor name or number in the appropriate field.
2. Press the "Save Changes" button to program the change into the payload meter.

Setting the Komatsu Customer

This field in the haul cycle record can hold the name of the mine or operation where the truck is in service. Komatsu also assigns a customer number to each customer. This number is used on all warranty claims. This Komatsu customer number can also be put into this field. The field will hold 20 alpha-numeric characters.

1. On the truck configuration screen, enter the customer name or number in the appropriate field.
2. Press the "Save Changes" button to program the change into the payload meter.

Clean Truck Tare

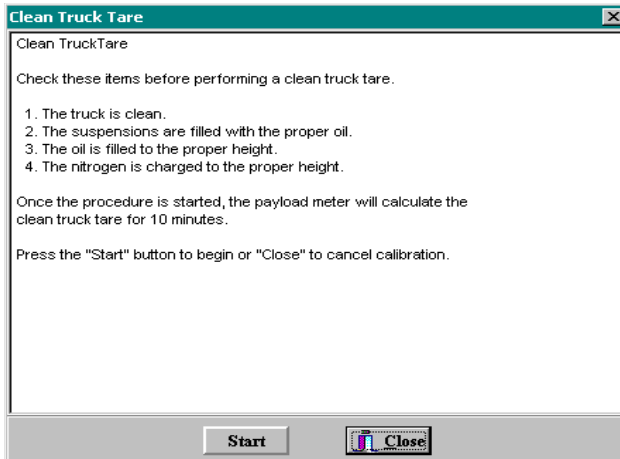

The payload meter uses the clean truck tare value to calculate carry-back load for each haul cycle. The carry-back stored in the haul cycle record is the new empty tare minus the clean truck tare.

This procedure must be performed after service to the suspensions or when significant changes are made to the sprung weight of the truck. Before performing this procedure, ensure the suspensions are properly filled with oil and charged. It is critical to payload measurement that the proper oil height and gas pressure be used.

Once the clean tare process is started, the payload meter will begin to calculate the clean, empty sprung weight of the truck. This calculation continues while the truck drives to the next loading site. Once the procedure is started, there is no reason to continue to monitor the process with the PC. The truck does not need to be moving to start this procedure.

1. After cleaning debris from the truck and checking to see that the suspensions are properly serviced, use the PLM III software to connect to the payload meter.
2. From the "Truck Configuration" screen, select "Clean Truck Tare".
3. Follow the screen instructions.

Inclinometer Calibration

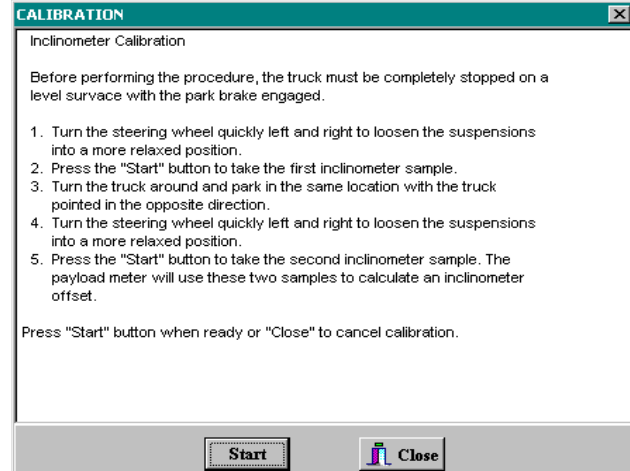

The inclinometer calibration procedure is designed to compensate for variations in the mounting attitude of the inclinometer. The inclinometer input is critical to the payload calculation.

This procedure must be performed on relatively flat ground. Often the maintenance area is an ideal location for this procedure.

1. After cleaning debris from the truck and checking to see that the suspensions are properly serviced, use the PLM III software to connect to the payload meter.
2. From the "Truck Configuration" screen, select "Inclinometer".
3. With the truck stopped and the brake lock on, press the "Start" button. This instructs the payload meter to sample the inclinometer once.
4. Turn the truck around. Drive the truck around and park in the exact same spot as before, facing the other direction.
5. With the truck stopped and the brake lock on, press the "Start" button. This instructs the payload meter to sample the inclinometer again. The payload meter will average the two samples to determine the average offset.
6. Follow the screen instructions.

DATA ANALYSIS

PAYLOAD SUMMARY FORM

Date: Sorts the data within a date range. eg. "Dec 1, 2000 through Dec 31, 2000"

Truck Number: Sorts the data by the truck unit number, eg. "374"

Time: Sorts the data within a time for each day within the data range. "8:00 AM to 5:00PM"

Truck Type: Sorts the data by the truck type, eg. "930E" or "830E"

Query Database & Display: Sorts the data by the selected query options (unit, type, date, time) and displays the results.

Cycle Summary: Cycle time summary from the selected query.

Output Options: Use to create reports, graphs and expert data from the selected query.

Payload Data Summary: Summary statistical analysis of the payloads from the selected query.

| Payload Data Summary | | | Cycle Time Summary | | |
|-----------------------|---------------|-----------------------|-----------------------|--|------|
| Units - (Metric Tons) | Final Payload | Payload Est. @ Shovel | Units - (num:ss) | | |
| Total Tons | 28,360,482 | 17,011,874 | Avg. Load Time | | 0:32 |
| Max. Payload | 360 | 348 | Avg. Haul Time | | 0:40 |
| Min. Payload | 252 | 258 | Avg. Haul Stop Time | | 0:23 |
| Avg. Payload | 318 | 315 | Avg. Return Time | | 1:01 |
| Std. Deviation | 25 | 25 | Avg. Return Stop Time | | 0:59 |
| | | | Avg. Operating Time | | 4:08 |
| | | | Avg. Dump Time | | 0:22 |

| Haul Cycle Records | | | | | | |
|--------------------|------------|------------|---------|----------|------------|--|
| Truck Number | Date | Time | Payload | # Swings | Total Time | |
| 351 | 07/10/2000 | 8:22:40 AM | 323.8 | 5 | 7:09 | |
| 351 | 07/10/2000 | 8:36:12 AM | 323.8 | 5 | 5:23 | |
| 351 | 07/10/2000 | 8:41:35 AM | 323.8 | 5 | 5:24 | |
| 351 | 07/10/2000 | 8:46:58 AM | 321.5 | 1 | 30:11 | |
| 351 | 07/10/2000 | 9:17:06 AM | 321.9 | 0 | 0:32 | |
| 351 | 07/10/2000 | 9:17:37 AM | 318.0 | 0 | 0:32 | |

Haul Cycle Records:
Summary view of the haul cycle records from the selected query. Double Click to view the details for individual haul cycle records.
Haul cycles in red area are not included in the summary statistics..

The data analysis tools allow the user to monitor the performance of the payload systems across the fleet. Analysis begins when the "View Payload Data" button is pressed. This starts an all trucks, all dates, all times query of the database and displays the results in the payload summary form.

The user can change the query by changing the dates, times, or trucks to include in the query for display.

Haul cycles in the data grid box at the bottom can be double-clicked to display the detailed results of that haul.

Creating a Query

The program defaults to show all trucks, all types, all dates, and all times for the initial query. The display can be narrowed by selecting which trucks or types to view and for what dates and times.

The query items are added in the AND condition. If the user selects a truck # and date range, the query will sort the data for that truck number and the date range.

Sorting on Truck Unit Number

The truck unit number is the truck unit number entered into the payload meter when it was configured at installation. The query can be set to look for all trucks or one particular truck number. When the program begins, it searches through the database for all the unique truck numbers and creates a list to select from.

Choosing one particular truck number will limit the data in the displays, summaries, and reports to the one selected truck. To create reports for truck number 374, select 374 from the pull-down menu and hit the "Query Database and Display" button.

Sorting on Truck Type

The truck type is the size of the truck from the family of Komatsu trucks. This allows the user to quickly view results from different types of trucks on the property. For example, a separate report can be generated for 830E and 930E trucks.

Sorting on Date Range

The default query starts in 1995 and runs through the current date on the PC. To narrow the range to a specific date, change the From and To dates.

For example, to view the haul cycle reports from truck 374 for the month of July, 2000:

1. Select truck 374 from the truck unit pull-down menu.



2. Change the From date to July 1, 2000.



3. Change the To date to July 31, 2000.
4. Press the "Query Database and Display" to view the results.

Sorting on Time Range

The time range sorts the times of the day for valid dates. Changing the time range to 6:00 AM to 6:00 PM will limit the payloads displayed to the loads that occurred between those times for each day of the date range. Times are entered in 24:00 format. To view the haul cycle reports from the first shift for truck 374 from January 5, 2000 to January 8, 2000:

1. Select truck 374 from the truck unit pull-down menu.



2. Change the From date to January 5, 2000.

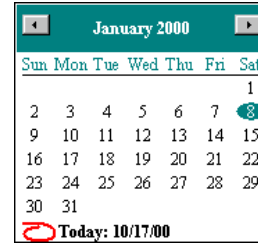

3. Change the To date to January 8, 2000.
4. Change the From time to 06:00.
5. Change the To time to 18:00.

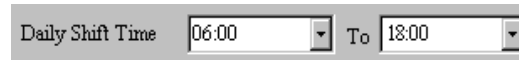

6. Press the "Query Database and Display" to view the results.

This query will display haul cycles from January 5 to January 8, from 6:00 AM to 6:00 PM.

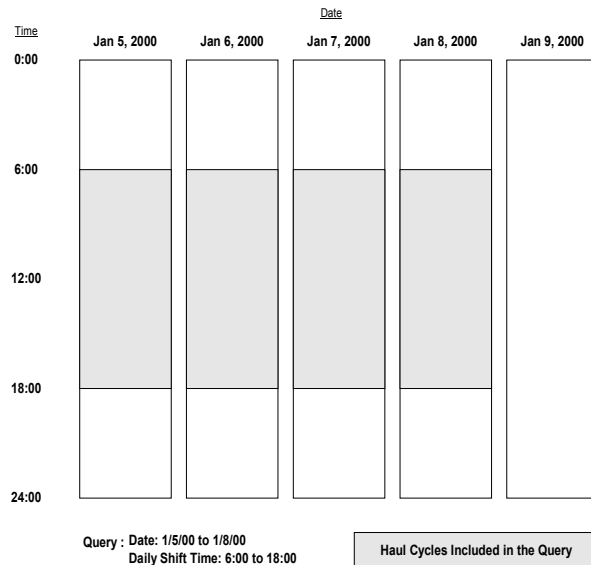

The shift times selected can extend the query past the original date. If the dates set for the query are January 5 to January 8 and the times were changed to query the 6:00 PM (18:00) to 6:00 AM (06:00) shift, the results would extend into the morning of the 9th. This can be seen in the following example:

Creating Reports

Reports can be generated and viewed on the screen or printed. These reports are generated from the query displayed on the payload summary screen. From the example in Sorting on Time Range, the report printed would only contain data from truck 374 during the month of July 2000, from 8:00 AM to 5:00 PM.

It is important to carefully select the query data and press the "Query Database & Display" button before printing a report.

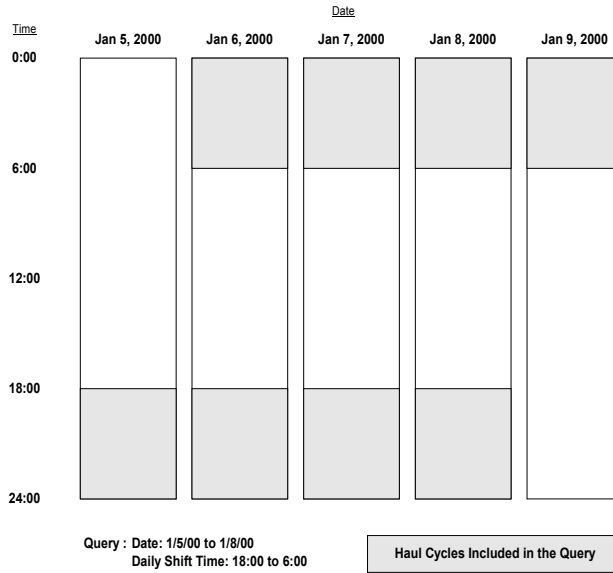

Payload Detail Screen

The payload detail screen gives the details for any individual haul cycle. From the "Payload Summary" screen, double-click on any haul cycle to display the detail.

| PAYLOAD (Short tons) | | CYCLE TIMES (Min:Sec) | | START TIME (hh:mm:ss) | | |
|--|-----------------------------|-----------------------|-----------|----------------------------|----------------|----------------|
| Truck ID | 374 | Load Time | 2:26 | Payload Start Time | 12:26:19 | |
| Operator ID | 4200 | Haul Time | 12:03 | Load Start Time | 12:33:12 | |
| Payload Start Date | 11/06/2000 | Haul Stop Time | 0:31 | Dump Start Time | 12:48:10 | |
| Dump Date | 11/06/2000 | Dump Time | 0:49 | CYCLE DISTANCE (mi) | | |
| Carry Back | -0.77 | Return Time | 5:42 | Haul Distance | 1.76 | |
| Swingloads | 5 | Return Stop Time | 1:23 | Return Distance | 1.68 | |
| Final Payload | 317 | Total Operating Time | 22:54 | Total Distance | 3.44 | |
| Payload Est @ Shovel | 322 | | | SPEEDS (mph) | | |
| SPRUNG LOAD and TIRE TON MPH (hh:mm:ss) | | | | LOADED TIME | | |
| Peak Sprung Load | 562.40 (Short Tons) | 12:35:59 | Max Speed | | 25.02 12:44:50 | |
| Left Front Tire | 460.97 (Tire Short Ton MPH) | | | Avg Speed | | 8.43 |
| Right Front Tire | 507.54 (Tire Short Ton MPH) | | | EMPTY | | |
| Rear Tire | 374.66 (Tire Short Ton MPH) | | | Max Speed | | 28.03 12:27:20 |
| | | | | Avg Speed | | 14.21 |

Buttons: ? Help, Warning Flags, Close

NOTE: Some haul cycles may contain the sensor input warning flag. This indicates that one of the four pressure sensors or inclinometer was not functioning properly during the haul cycle. Haul cycles with this warning are displayed in red on the payload summary window and are not included in the summary statistics for reports or display.

Summary - One Page Report

A summary of the queried data can be printed onto one page. The cycle data is summarized onto one sheet. Displayed is the speeds, cycle times, load statistics, frame, and tire data.

Detailed - Multi-Page Report

The detail report starts with the summary report and follows with pages of data for each haul cycle. The detailed report prints date, time, payload, cycle times, and cycle distances, speeds, and the number of swing loads.

| Payload Summary Report | | | |
|-----------------------------|--|----------------------------------|--|
| Report Date: April 11, 2001 | | | |
| Query used for summary: | | | |
| Truck Number: ALL | | Dates: 2/10/00 to 2/19/01 | |
| Truck Type: ALL | | Daily Shift Time: 00:00 to 24:00 | |

| Time Period | Date | Time | Cycle Distance Averages (miles) |
|-------------|------------|-------------|---------------------------------|
| First Load | 02/10/2000 | 03:25:30 PM | Loaded 1.9 |
| Last Load | 02/19/2001 | 07:20:30 AM | Empty 2.0 |
| | | | Avg Total Distance 3.9 |

| Payload Data | Short Tons | Date | Time |
|---------------------------|------------|------------|-------------|
| Final Payload | | | |
| Total, All Loads | 1,495,086 | | |
| Maximum | 421 | 01/24/2001 | 09:05:22 AM |
| Minimum | 0 | 01/27/2001 | 04:11:24 AM |
| Average | 321 | | |
| Standard Deviation | 28.6 | | |
| Payload Estimate @ Shovel | | | |
| Total, All Loads | 1,532,025 | | |
| Maximum | 425 | 01/11/2001 | 06:45:58 PM |
| Minimum | 250 | 02/11/2000 | 06:27:34 AM |
| Average | 320 | | |
| Standard Deviation | 36.3 | | |
| Number of Loads | 4,654 | | |
| Avg Carry Back | 2.2 | | |

| Cycle Time Averages (Min:Sec) | Avg Tire (Ton-MPH) |
|-------------------------------|--------------------|
| Load 2:34 | Left Front 583 |
| Haul Run 9:48 | Right Front 576 |
| Haul Stop 1:08 | Rear 415 |
| Empty Run 6:09 | |
| Empty Stop 4:19 | |
| Dump 1:17 | |
| Avg Total Cycle Time 25:17 | |

| Speed Data (mph) |
|------------------|
| Loaded Max 37.32 |
| Loaded Avg 10.57 |
| Empty Max 37.97 |
| Empty Avg 11.43 |

| Payload Detail Report | | | | | | | | | | | | | | Page 1 | | | | |
|----------------------------------|---------|--------|----------------|---------|----------------------|-------|-----------|------|--------|---------------------|--------|------|--------|-------------|-------|----------|-------|------------|
| Report Date: October 17, 2000 | | | | | | | | | | | | | | | | | | |
| Query used for summary: | | | | | | | | | | | | | | | | | | |
| Truck Number: ALL | | | | | | | | | | | | | | | | | | |
| Truck Type: ALL | | | | | | | | | | | | | | | | | | |
| Dates: 8/28/00 to 10/3/00 | | | | | | | | | | | | | | | | | | |
| Daily Shift Time: 00:00 to 24:00 | | | | | | | | | | | | | | | | | | |
| No. | Date | Time | Payload S.Tons | #Swings | CYCLE Times(min.sec) | | | | | CYCLE DISTANCE(mi.) | | | | SPEEDS(mph) | | | | |
| | | | | | Load | Haul | Haul Stop | Dump | Return | Return Stop | Total | Haul | Return | Total | Max | Haul Avg | Max | Return Avg |
| 1 | 8/28/00 | 3:54P | 347 | 7 | 4.40 | 11:11 | 0:06 | 0:52 | 7:54 | 14:28 | 39:11 | 1.9 | 2.0 | 4.0 | 21.99 | 10.14 | 31.03 | 5.48 |
| 2 | 8/28/00 | 5:18P | 301 | 6 | 3.39 | 11:10 | 0:25 | 0:43 | 8:12 | 3:43 | 27:52 | 1.9 | 1.9 | 3.8 | 23.02 | 9.91 | 26.05 | 9.42 |
| 3 | 8/28/00 | 5:46P | 300 | 6 | 3.32 | 11:32 | 2:32 | 0:56 | 7:07 | 0:09 | 25:48 | 1.9 | 1.9 | 3.8 | 23.02 | 8.30 | 25.02 | 15.49 |
| 4 | 8/28/00 | 6:11P | 330 | 4 | 1:58 | 17:51 | 2:49 | 1:58 | 11:34 | 1:41 | 37:51 | 3.9 | 2.6 | 6.5 | 36.21 | 11.37 | 24.07 | 11.73 |
| 5 | 8/28/00 | 6:49P | 344 | 4 | 1:54 | 18:26 | 13:04 | 1:50 | 11:20 | 0:24 | 46:58 | 4.0 | 3.9 | 7.9 | 34.97 | 7.56 | 37.06 | 20.15 |
| 6 | 8/28/00 | 7:36P | 380 | 5 | 2:12 | 19:52 | 1:07 | 1:39 | 11:32 | 0:48 | 37:10 | 4.0 | 4.0 | 8.0 | 30.00 | 11.28 | 34.03 | 19.59 |
| 7 | 8/28/00 | 8:13P | 352 | 4 | 2:26 | 18:17 | 0:23 | 1:54 | 11:54 | 1:56 | 36:50 | 3.9 | 4.0 | 8.0 | 31.97 | 12.62 | 34.07 | 17.49 |
| 8 | 8/28/00 | 8:50P | 356 | 4 | 1:56 | 18:52 | 0:21 | 1:55 | 11:59 | 0:38 | 35:41 | 4.0 | 4.0 | 8.0 | 36.17 | 12.34 | 36.21 | 19.09 |
| 9 | 8/28/00 | 9:25P | 370 | 5 | 2:18 | 16:17 | 2:18 | 0:53 | 12:25 | 0:25 | 34:36 | 2.7 | 4.1 | 6.7 | 34.97 | 8.55 | 36.17 | 19.14 |
| 10 | 8/28/00 | 10:00P | 363 | 5 | 3:07 | 16:56 | 5:48 | 0:52 | 9:02 | 0:33 | 36:18 | 2.7 | 2.7 | 5.3 | 32.97 | 6.99 | 32.97 | 16.61 |
| 11 | 8/28/00 | 10:36P | 341 | 7 | 3:58 | 12:23 | 0:23 | 0:53 | 7:26 | 0:57 | 26:00 | 2.0 | 2.0 | 3.9 | 21.03 | 9.20 | 32.00 | 14.10 |
| 12 | 8/28/00 | 11:02P | 321 | 4 | 2:24 | 16:19 | 5:06 | 0:50 | 10:17 | 1:05 | 36:01 | 2.7 | 2.6 | 5.3 | 34.03 | 7.49 | 31.97 | 13.71 |
| 13 | 8/28/00 | 11:38P | 316 | 5 | 2:49 | 15:21 | 7:06 | 0:58 | 13:01 | 13:11 | 52:26 | 3.9 | 4.0 | 7.9 | 40.12 | 10.30 | 40.12 | 9.16 |
| 14 | 8/29/00 | 12:56A | 320 | 5 | 2:23 | 15:18 | 0:07 | 0:55 | 13:16 | 11:43 | 43:42 | 3.9 | 3.8 | 7.7 | 36.21 | 14.99 | 41.10 | 9.18 |
| 15 | 8/29/00 | 1:40A | 302 | 4 | 1:55 | 14:12 | 0:08 | 0:54 | 10:34 | 0:11 | 27:54 | 3.9 | 3.9 | 7.7 | 40.12 | 16.15 | 41.10 | 21.64 |
| 16 | 8/29/00 | 2:08A | 310 | 5 | 2:21 | 15:14 | 4:55 | 1:01 | 9:46 | 4:59 | 38:16 | 3.9 | 3.9 | 7.7 | 40.12 | 11.51 | 41.16 | 15.67 |
| 17 | 8/29/00 | 2:46A | 318 | 5 | 2:25 | 14:44 | 0:15 | 0:54 | 10:36 | 0:19 | 29:13 | 3.9 | 3.9 | 7.7 | 41.10 | 15.50 | 41.10 | 21.28 |
| 18 | 8/29/00 | 3:15A | 278 | 4 | 2:01 | 15:53 | 1:12 | 0:46 | 10:38 | 2:08 | 32:38 | 4.3 | 3.8 | 8.1 | 38.13 | 15.06 | 41.10 | 18.05 |
| 19 | 8/29/00 | 3:48A | 328 | 5 | 2:25 | 17:38 | 3:08 | 0:57 | 10:07 | 0:20 | 34:35 | 4.3 | 3.9 | 8.2 | 34.03 | 12.41 | 41.10 | 22.19 |
| 20 | 8/29/00 | 4:22A | 287 | 4 | 2:49 | 17:00 | 15:44 | 1:02 | 11:59 | 4:49 | 53:23 | 4.3 | 4.0 | 8.2 | 40.12 | 7.87 | 41.10 | 14.09 |
| 21 | 8/29/00 | 1:41P | 285 | 4 | 2:15 | 16:08 | 6:14 | 5:21 | 9:02 | 14:43 | 53:43 | 4.0 | 3.0 | 6.9 | 34.97 | 10.58 | 34.03 | 7.55 |
| 22 | 8/29/00 | 2:50P | 340 | 7 | 3:38 | 10:14 | 0:06 | 0:54 | 8:41 | 7:10 | 30:43 | 1.8 | 3.3 | 5.2 | 27.07 | 10.54 | 39.07 | 12.65 |
| 23 | 8/29/00 | 3:20P | 326 | 5 | 3:32 | 9:47 | 0:08 | 1:09 | 5:21 | 0:16 | 20:13 | 1.8 | 1.8 | 3.6 | 27.05 | 10.98 | 30.02 | 18.98 |
| 24 | 8/29/00 | 3:41P | 342 | 6 | 3:59 | 11:24 | 0:08 | 0:47 | 19:49 | 15:18 | 51:25 | 1.9 | 6.2 | 8.1 | 23.02 | 10.02 | 32.00 | 10.56 |
| 25 | 8/29/00 | 4:43P | 349 | 7 | 4:46 | 11:12 | 0:18 | 0:57 | 7:32 | 3:12 | 27:57 | 1.8 | 1.9 | 3.8 | 23.02 | 9.50 | 27.07 | 10.87 |
| 26 | 8/29/00 | 5:11P | 322 | 4 | 2:11 | 5:29 | 19:58 | 1:29 | 15:38 | 59:19 | 104:04 | 1.1 | 5.1 | 6.1 | 42.20 | 2.52 | 42.20 | 4.05 |
| 27 | 8/30/00 | 4:27A | 330 | 7 | 4:27 | 10:33 | 0:09 | 1:02 | 21:08 | 159:27 | 196:46 | 1.7 | 4.3 | 6.0 | 23.02 | 9.69 | 28.01 | 1.42 |
| 28 | 8/30/00 | 4:55P | 320 | 6 | 3:52 | 10:42 | 0:14 | 1:00 | 5:43 | 1:42 | 23:13 | 1.7 | 1.7 | 3.4 | 24.07 | 9.55 | 29.06 | 13.47 |
| 29 | 8/30/00 | 5:18P | 338 | 6 | 3:16 | 10:45 | 0:51 | 0:58 | 6:00 | 2:34 | 24:24 | 1.7 | 1.6 | 3.3 | 23.02 | 8.71 | 29.04 | 11.36 |
| 30 | 8/30/00 | 5:42P | 343 | 6 | 3:52 | 10:28 | 0:08 | 1:01 | 6:06 | 0:25 | 22:00 | 1.7 | 1.6 | 3.3 | 24.08 | 9.57 | 28.03 | 14.70 |

Creating Graphs

The PLM III software can generate graphs that quickly summarize payload data. These graphs can be customized for printing. Just like the reports, the graphs are generated from the query displayed on the payload summary screen. From the Sorting on Time Range example, the graph that is printed would only contain data from truck 374 during the month of July 2000, from 8:00 AM to 5:00 PM.

It is important to carefully select the query data and press the "Query Database & Display" button before creating a graph.

1. From the payload summary screen select the "Graph" button at the bottom. The "Histogram Setup" screen will display

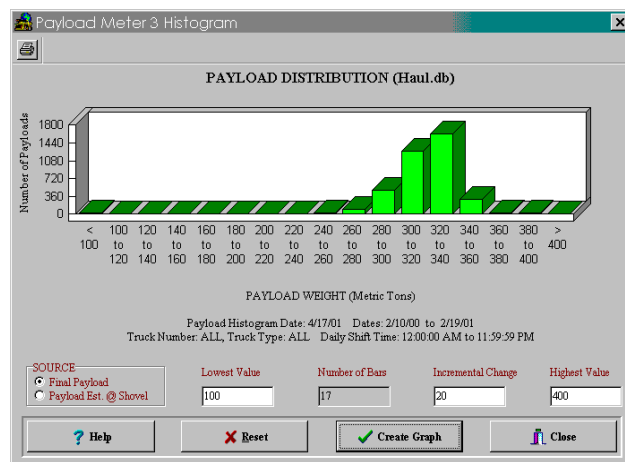

2. Enter the lowest value. This will be the lowest payload on the graph. Any payloads less than this value will be summed in the first bar.
3. Enter the highest value. This will be the highest value on the graph. Payloads over this value will be summed in the last bar.
4. Enter the incremental change. This will determine the number of bars and the distance between them. The program limits the number of bars to 20. This allows graphs to fit on the screen and print onto one page.
5. Press the "Create Graph" button.

The graph will be displayed based on the query settings from the payload summary screen. The graph can be customized and printed.

Exporting Data

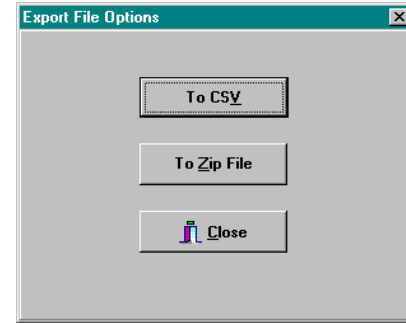

The data from the database can be exported for use with other software applications. The data is selected from the currently displayed query. The exported data can be put into a .CSV file or a compressed .zip file.

- The .CSV format allows data to be easily imported into spreadsheet applications and word processing applications.
- The .Zip format allows data to be transferred from one computer to the PDM software database on another computer. This offers a compact way to transfer data from one computer to another.

CSV Export

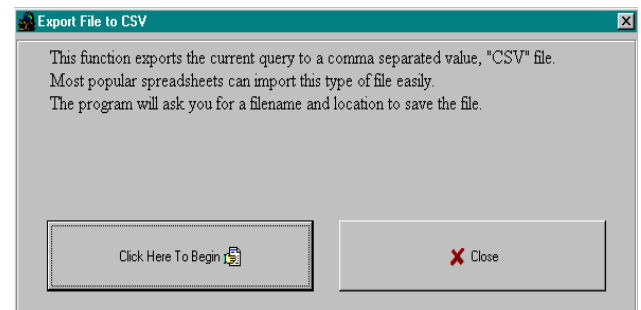

CSV stands for Comma Separated Value. This is an ASCII text file format that allows spreadsheet applications like Excel and Lotus 123 to import data easily. To export the data into a .csv file, press the "Export" button at the bottom of the payload summary screen and select "To CSV". The program will request a filename and location for the file.

| Truck # | Date | Time | Payload | Swingload | Operator | Status | Fla | Carry | Bac | Total Cyc | E-Run | Tin | E-Stop | Tr Loading |
|---------|---------|------------|---------|-----------|----------|--------|-----|-------|------|-----------|-------|-----|--------|------------|
| 374 | 2/11/00 | 4:06:48 PM | 294.4 | 2 | 0 | E | | -1.2 | 2.7 | 1 | 0.2 | 0 | | |
| 374 | 2/11/00 | 4:10:09 PM | 298.6 | 2 | 0 | I | | -1.4 | 7.2 | 0.6 | 0.6 | 0 | | |
| 374 | 2/11/00 | 4:41:01 PM | 265.5 | 3 | 0 | | | 15.6 | 20.1 | 4.6 | 3.9 | 2 | | |
| 374 | 2/11/00 | 5:24:54 PM | 277.5 | 0 | 0 | AK | | 0 | 27 | 4.6 | 6.4 | 1 | | |
| 374 | 2/11/00 | 6:21:27 PM | 231 | 3 | 0 | | | 15.5 | 27.7 | 4.5 | 5 | 1 | | |
| 374 | 2/11/00 | 7:09:08 PM | 265.5 | 3 | 0 | H | | 17.1 | 23.9 | 4.2 | 3.2 | 1 | | |
| 374 | 2/11/00 | 7:59:53 PM | 262.4 | 4 | 0 | | | 14.1 | 29.7 | 4.3 | 3.7 | 2 | | |
| 374 | 2/11/00 | 8:29:32 PM | 225.1 | 3 | 0 | | | 15.6 | 27.7 | 4.5 | 5 | 1 | | |
| 374 | 2/11/00 | 8:57:11 PM | 265.5 | 3 | 0 | | | 15.6 | 20.1 | 4.6 | 3.9 | 2 | | |
| 374 | 2/11/00 | 9:17:13 PM | 265.4 | 3 | 0 | H | | 17 | 23.9 | 4.2 | 3.1 | 1 | | |
| 374 | 2/11/00 | 9:41:05 PM | 277.6 | 0 | 0 | AK | | 0 | 27 | 4.6 | 6.4 | 1 | | |

Two sets of data are exported. At the top of the file will be the haul cycle data. The columns, left to right, are:

- Truck number
- Haul cycle start date
- Haul cycle start time
- Payload
- Swingloads
- Operator ID
- Warning flags
- Carry back
- Total haul cycle time
- Empty running time
- Empty stop time
- Loading time
- Loaded running time
- Loaded stopped time
- Dumping time
- Loading start time
- Dumping start time
- Loaded haul distance
- Empty haul distance
- Loaded maximum speed
- Time when loaded maximum speed occurred
- Empty maximum speed
- Time when loaded maximum speed occurred
- Maximum + frame torque
- Time when the maximum + frame torque occurred

- Maximum - frame torque
- Time when the maximum - frame torque occurred
- Maximum sprung weight calculation
- Time when the maximum sprung weight calculation occurred
- Left front tire-kilometer-hour
- Right front tire-kilometer-hour
- Average rear tire-kilometer-hour
- Frame serial number
- Reserved 1-5, 7-10: These values are internal calculations used in the continued development of PLM III and must be ignored.
- Reserved 6: This value is the payload estimate at the shovel just before the truck begins to move.

| Alarm Records | | | | | |
|---------------|----------|----------|-------------|----------------|---------------------|
| Alarm Type | Date Set | Time Set | Description | Date Cleared | Time Cleared |
| | 10 | 12/5/99 | 8:51:25 AM | INCL SENSOR LO | 12/5/99 8:51:29 AM |
| | | 12/5/99 | 8:56:07 AM | INCL SENSOR LO | 12/5/99 8:56:12 AM |
| | | 12/5/99 | 9:00:49 AM | INCL SENSOR LO | 12/5/99 9:00:54 AM |
| | | 12/5/99 | 9:05:31 AM | INCL SENSOR LO | 12/5/99 9:05:36 AM |
| | | 12/5/99 | 9:10:13 AM | INCL SENSOR LO | 12/5/99 9:10:17 AM |
| | | 12/5/99 | 9:14:54 AM | INCL SENSOR LO | 12/5/99 9:14:59 AM |
| | | 12/5/99 | 9:19:37 AM | INCL SENSOR LO | 12/5/99 9:19:41 AM |
| | | 12/5/99 | 9:24:19 AM | INCL SENSOR LO | 12/5/99 9:24:24 AM |
| | | 12/5/99 | 9:29:01 AM | INCL SENSOR LO | 12/5/99 9:29:06 AM |
| | | 12/5/99 | 9:33:44 AM | INCL SENSOR LO | 12/5/99 9:33:48 AM |
| | | 12/5/99 | 9:38:26 AM | INCL SENSOR LO | 12/5/99 9:38:30 AM |
| | | 12/5/99 | 9:43:08 AM | INCL SENSOR LO | 12/5/99 9:43:13 AM |
| | | 12/5/99 | 9:47:50 AM | INCL SENSOR LO | 12/5/99 9:47:55 AM |
| | | 12/5/99 | 9:52:32 AM | INCL SENSOR LO | 12/5/99 9:52:37 AM |
| | | 12/5/99 | 9:57:13 AM | INCL SENSOR LO | 12/5/99 9:57:17 AM |
| | | 12/5/99 | 10:01:55 AM | INCL SENSOR LO | 12/5/99 10:01:59 AM |

The second series of data below the haul cycle data is the alarms. The alarm columns, left to right, are:

- The alarm type
- The date the alarm was set
- The time the alarm was set
- Alarm description
- The date the alarm was cleared
- The time the alarm was cleared

Compressed

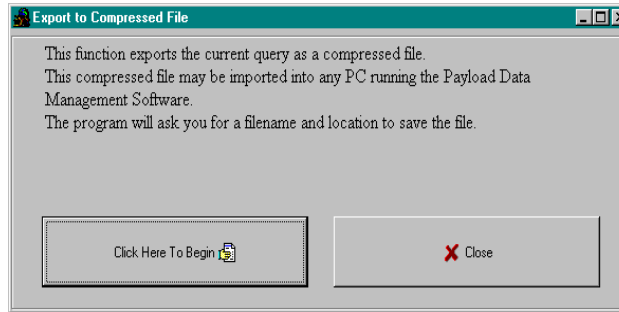

This export function allows the data from one laptop to be transferred to another computer. This can be useful when a service laptop is used to download multiple machines and transfer the data to a central computer for analysis. This can also be used to copy haul data from a particular truck onto a diskette for analysis.

The file format is a compressed binary form of the displayed query. The file can only be imported by another computer running the PDM software.

To export data in ZIP format:

1. Confirm that the data displayed is the query data that needs to be exported.
2. From the payload summary screen, press the "EXPORT" button and select "To ZIP".
3. The program will ask for a filename and location.

Importing Data

This import function allows the data from one laptop to be transferred to another computer. This can be useful when a service laptop is used to download multiple machines and transfer the data to a central computer for analysis. This can also be used to copy haul data from a particular truck from a diskette into a database for analysis.

To import data, press the "IMPORT" button at the bottom of the payload summary screen. The program will ask for a .zip file to import, locate the file and press "Open". The program will only import .zip files created by another computer running the PDM software.

Deleting Haul Cycle Records

To delete haul cycle records from the main database, press the "Delete" button at the bottom of the payload summary screen. The program will display a summary of the records from the displayed query. To delete a record, select one at a time and press the "Delete" button. It is recommended that records be exported to a zip file for archival purposes before deletion. Multiple records may be selected by holding down the shift key. Pressing the "Delete All" button will select all the records from the current query and delete them.

NOTE: There is no recovery for records that have been deleted from the main database. It is highly recommended that all records be exported and archived in a compressed file format for future reference before being deleted.

| Truck Number | Date | Time | Payload | # Swings | Total Time |
|--------------|------------|-------------|---------|----------|------------|
| 374 | 08/28/2000 | 3:54:13 PM | 346.7 | 7 | 39:11 |
| 374 | 08/28/2000 | 5:18:14 PM | 301.5 | 6 | 27:52 |
| 374 | 08/28/2000 | 5:46:04 PM | 300.0 | 6 | 25:48 |
| 374 | 08/28/2000 | 6:11:50 PM | 330.5 | 4 | 37:51 |
| 374 | 08/28/2000 | 6:49:37 PM | 343.7 | 4 | 46:58 |
| 374 | 08/28/2000 | 7:36:31 PM | 379.9 | 5 | 37:10 |
| 374 | 08/28/2000 | 8:13:37 PM | 351.6 | 4 | 36:50 |
| 374 | 08/28/2000 | 8:50:22 PM | 356.3 | 4 | 35:41 |
| 374 | 08/28/2000 | 9:25:59 PM | 369.6 | 5 | 34:36 |
| 374 | 08/28/2000 | 10:00:31 PM | 362.6 | 5 | 36:18 |
| 374 | 08/28/2000 | 10:36:44 PM | 340.5 | 7 | 26:00 |
| 374 | 08/28/2000 | 11:02:42 PM | 320.9 | 4 | 36:01 |
| 374 | 08/28/2000 | 11:38:40 PM | 316.5 | 5 | 52:26 |
| 374 | 08/29/2000 | 12:56:37 AM | 319.7 | 5 | 43:42 |
| 374 | 08/29/2000 | 1:40:16 AM | 301.6 | 4 | 27:54 |

Viewing Alarms

From the payload summary screen, click the "Alarms" button to display the alarm screen. The alarms are sorted by the query settings from the payload summary screen. Alarms can be displayed as active or inactive.

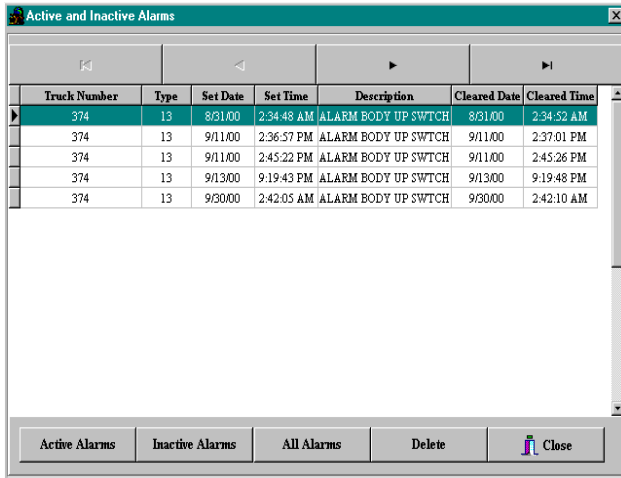

| Truck Number | Type | Set Date | Set Time | Description | Cleared Date | Cleared Time |
|--------------|------|----------|------------|----------------------|--------------|--------------|
| 374 | 13 | 8/31/00 | 2:34:48 AM | ALARM BODY UP SWITCH | 8/31/00 | 2:34:52 AM |
| 374 | 13 | 9/11/00 | 2:36:57 PM | ALARM BODY UP SWITCH | 9/11/00 | 2:37:01 PM |
| 374 | 13 | 9/11/00 | 2:45:22 PM | ALARM BODY UP SWITCH | 9/11/00 | 2:45:26 PM |
| 374 | 13 | 9/13/00 | 9:19:43 PM | ALARM BODY UP SWITCH | 9/13/00 | 9:19:48 PM |
| 374 | 13 | 9/30/00 | 2:42:05 AM | ALARM BODY UP SWITCH | 9/30/00 | 2:42:10 AM |

Deleting Alarm Records

To delete alarm records from the main database, press the "Delete" button at the bottom of the alarm display screen. The program will display a summary of the alarms from the query. To delete an alarm, select one at a time and press the "Delete" button. It is recommended that the query data be exported to a .zip file for archival purposes before deletion. Multiple records may be selected by holding down the shift key. Pressing the "Delete All" button will select all the alarms from the current query and delete them.

NOTE: There is no recovery for alarms that have been deleted from the main database. It is highly recommended that all records be exported and archived in a compressed file format for future reference before being deleted.

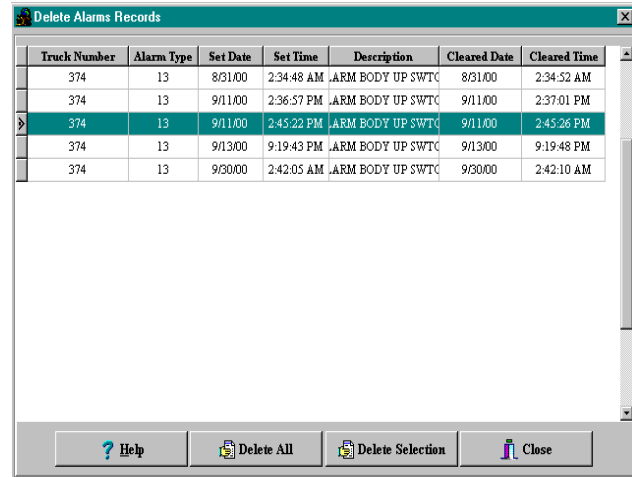

| Truck Number | Alarm Type | Set Date | Set Time | Description | Cleared Date | Cleared Time |
|--------------|------------|----------|------------|--------------------|--------------|--------------|
| 374 | 13 | 8/31/00 | 2:34:48 AM | ALARM BODY UP SWTC | 8/31/00 | 2:34:52 AM |
| 374 | 13 | 9/11/00 | 2:36:57 PM | ALARM BODY UP SWTC | 9/11/00 | 2:37:01 PM |
| 374 | 13 | 9/11/00 | 2:45:22 PM | ALARM BODY UP SWTC | 9/11/00 | 2:45:26 PM |
| 374 | 13 | 9/13/00 | 9:19:43 PM | ALARM BODY UP SWTC | 9/13/00 | 9:19:48 PM |
| 374 | 13 | 9/30/00 | 2:42:05 AM | ALARM BODY UP SWTC | 9/30/00 | 2:42:10 AM |

PORTIONS OF THIS PRODUCT RELATING TO PAYLOAD MEASURING SYSTEMS ARE
MANUFACTURED UNDER LICENSE FROM

L. G. HAGENBUCH holder of
U.S. Patent Numbers 4,831,539 and 4,839,835

RADIO / CASSETTE PLAYER

FIGURE 70-1. RADIO / CASSETTE PLAYER

GENERAL RECEIVER FUNCTIONS**Turning The Power On And Off**

1. Turn the key switch to ON.
2. Press PWR (1, Figure 70-1) to turn the receiver on and off. Pushing ON/AUDIO (6) also turns the receiver power on.

Display

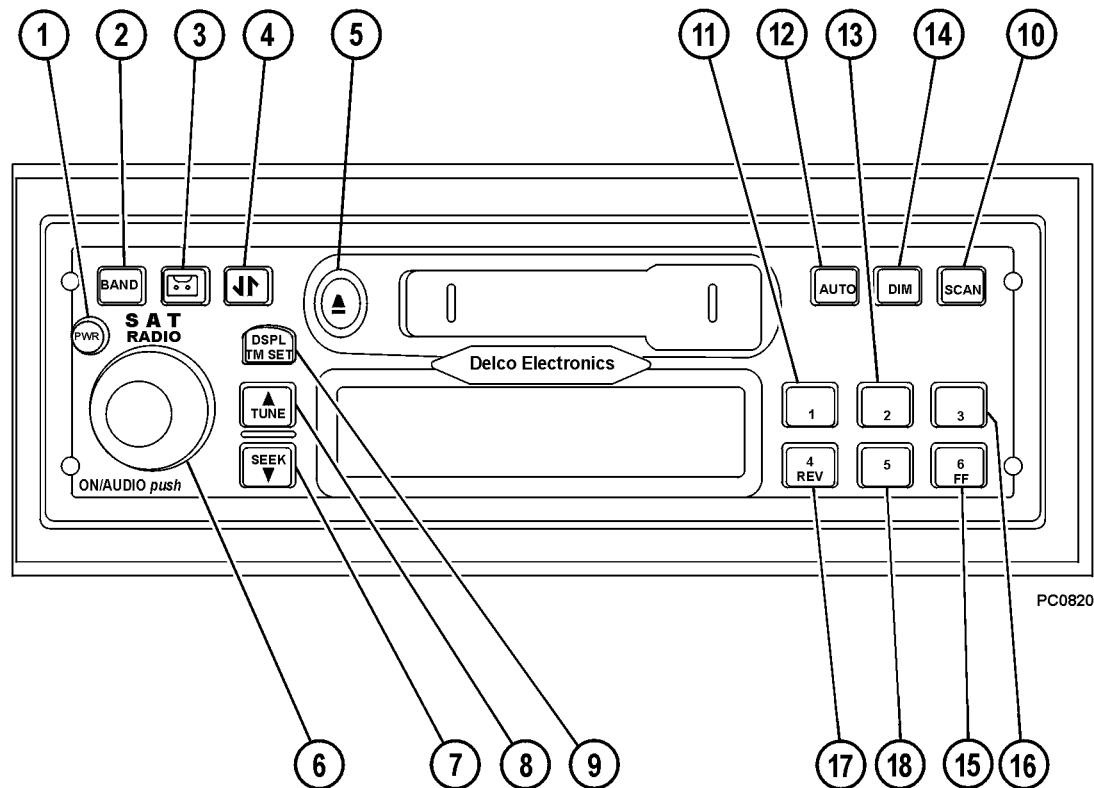
With the receiver off, the clock will be displayed. Momentarily pressing DSP/TM SET (9) with the receiver on will allow the operator to toggle between displays.

- When the receiver is in AM, FM1, FM2, or WX, the display will toggle between the frequency and the clock.
- When the receiver is in an active satellite mode and the provider is transmitting the available information, the display will toggle between the clock, frequency, station name, artist, song title and music type.
- When the receiver is in the cassette mode, the display will toggle between TP SIDE 1 or TP SIDE 2, and the clock.

Setting The Default Display

1. Press and hold DSPL/TM (9) for two seconds until the hour digits flash.
2. Press push-button 6/FF (15) to change the default display.

After five seconds of inactivity has elapsed, the selected default will display.

Adjusting Display Brightness

1. Press and hold DIM (14) until DIM appears on the display.
2. Rotate ON/AUDIO knob (6) clockwise or counterclockwise until the desired brightness is obtained.

SETTING THE TIME

1. Turn the key switch ON.
2. Press and hold DSPL/TM SET (9, Figure 70-1) for two seconds. When the number display flashes, time set mode is active.
3. Press ▲TUNE / SEEK▼ (7 & 8) to change the hour setting.
4. Press the DSPL/TM button to switch to minutes. The minute digits will flash when in this mode.
5. Press ▲TUNE / SEEK▼ to change the minute setting.

After five seconds of inactivity, the display will return to the default mode. The clock will now display the correct time of day.

OPERATING THE RADIO

BAND

Press BAND (2, Figure 70-1) to switch between FM1, FM2, AM, and WX Weather (US) and Satellite (XM1, XM2 or SR1, SR2). If a separate satellite receiver is not connected to your radio and operational, the satellite bands will not appear in the display.

▲TUNE/SEEK▼

▲TUNE (7) / SEEK▼ (8) allows you to move up or down in frequency to other stations. There are two modes of operation for finding other stations, manual tuning and seek mode.

Press and hold both ▲TUNE (8) and BAND (2) for two seconds to toggle between the two modes. The display will read either MANUAL or SEEK to indicate the mode the receiver is in.

Manual Tuning

Press ▲TUNE (8) to tune to the next higher frequency. Press SEEK▼ (7) to tune to the next lower frequency. Holding either of the buttons for more than 0.5 seconds will activate fast tuning for increased speed.

When in satellite mode, press and release either the ▲TUNE or the SEEK▼ buttons to navigate to the next channel. Pressing and holding either of the two buttons for more than 0.5 seconds will increase the cycle speed through the channels. The increase cycle speed is approximately 10 channels per second.

SEEK Mode

Hold either the ▲TUNE or SEEK▼ buttons for more than 0.5 seconds to enter the seek mode. SEEK will appear on the display when this mode is activated. In this mode, the radio will scroll through stations and stop on the next station with a strong signal.

NOTE: If the receiver can not find a strong enough signal after two band cycles, the seek mode will discontinue and the receiver will return to the initial starting point.

When in satellite mode, press ▲TUNE or SEEK▼ to navigate through the channels. Pressing and holding either of the two buttons for more than two seconds will increase the cycle speed through the channels. The increase cycle speed is approximately 10 channels per second.

SCAN

Press SCAN button (10) to scan all stations on the current band. When a strong frequency is found, the receiver will pause on that station for about five seconds and then continue scanning. Scan will appear on the display along with the frequency when this mode is active. To stop scanning, press the SCAN button again.

AUTO

AUTO (12) allows the receiver to store the six strongest stations onto push-buttons 1 through 6. Press AUTO until AUTO and AS appear on the display. The presets on the current band only will now be programmed with the six strongest frequencies. Presets on the other inactive bands will not be changed. Pressing AUTO again will delete the stations and default to the original preset stations.

NOTE: The AUTO function is not functional on the satellite band.

ADJUSTING THE RECEIVER SETTINGS

VOLUME: Rotate ON/AUDIO (6, Figure 70-1) knob clockwise to increase the volume and counter-clockwise to decrease the volume. VOL will be displayed along with the volume level.

BASS: Push and release ON/AUDIO (6) knob until BASS and the current bass level is displayed. Rotate the knob clockwise to increase the bass and counter-clockwise to decrease the bass.

TREBLE: Push and release ON/AUDIO (6) knob until TREB and the current treble level is displayed. Rotate the knob clockwise to increase the treble and counter-clockwise to decrease the treble.

FADE: Push and release ON/AUDIO (6) knob until FADE and the current level is displayed. Rotate the knob clockwise to move the sound to the front speakers and counter-clockwise to move the sound to the rear speakers.

BALANCE: Push and release ON/AUDIO (6) knob until BAL and the present level is displayed. Rotate the knob clockwise to move the sound to the right speakers and counter-clockwise to move the sound to the left speakers.

SPEAKER: Push and release ON/AUDIO (6) knob until SPKR and the current setting is displayed. Rotate the ON/AUDIO knob to select two-speaker or four-speaker operation. With two-speaker operation active, the rear speakers are muted and the FADE option will not appear on the menu.

PROGRAMMING PRESET STATIONS

Presets are stations that are stored on each of the 6 push-buttons. After a station has been programmed into one of the preset buttons, pushing the preset provides a quick return to that station. The six buttons can each store a preset channel per band.

NOTE: The receiver is equipped with two FM radio bands: FM1 and FM2. The two bands are identical. However, each one allows the operator to set 6 preset channels for a total of 12 FM presets.

Perform the following steps to program the presets:

1. Turn the receiver on.
2. Select the band and the desired station.
3. Press and hold one of the six push-buttons for at least two seconds. During this period, receiver output will be muted and the push-button number will not show on the display. When the station has been committed to memory, the audio and the preset icon will return.

OPERATION OF THE WEATHERBAND (U.S.)

NOAA - weather radio is a service of the National Weather Service. It provides continuous broadcasts of the latest weather information directly from the National Weather Service offices. Taped weather messages are repeated every four to six minutes and are routinely revised every one to three hours, or more frequently if needed. Most of the stations operate 24 hours, daily.

The weather for the area you are in may be found on one of seven stations. When in the Weatherband mode, the display will show the WX icon and CHAN # to indicate the channel. The channel may be adjusted through the ▲TUNE /SEEK▼ buttons, and may be preset as in the radio mode.

The frequency associated with each channel is as follows:

- | | |
|----------------|----------------|
| 1. 162.550 MHz | 5. 162.450 MHz |
| 2. 162.400 MHz | 6. 162.500 MHz |
| 3. 162.475 MHz | 7. 162.525 MHz |
| 4. 162.425 MHz | |

The National Weather Service operates approximately 372 stations. Close to 90 percent of the nation's population is within the listening range of a NOAA weather radio broadcast.

SATELLITE RADIO

To use the satellite radio function on your radio, a subscription must be ordered from a provider. There are currently two providers in the U.S.: XM and Sirius Satellite Radio. When a subscription is ordered, you will need to get an additional receiver and antenna from your provider.

To activate the external satellite receiver, you must supply the provider with your Electronic Serial Number (ESN). To find the ESN, first install the satellite receiver per the instructions from the your provider. Next, follow the instructions below.

XM Satellite Radio:

1. Turn both the radio and the satellite receiver on. Press the BAND button on the radio and select either XM1 or XM2.
2. Tune your satellite receiver to channel 0 to see the ESN display.

Record the ESN.

The display will return to the default setting after five seconds.

Sirius Satellite Radio:

1. Turn the radio on and with the display showing the clock, press and hold the DSPL/TM SET button until the hours segment is flashing.
2. Press the BAND button and the ESN will be displayed.

Record the ESN.

The display will return to the default setting after five seconds.

NOTE: Only one satellite receiver can be installed and connected to your receiver at one time.

Obstructions in the satellite signal may impair your satellite radio reception. Contact your provider for satellite radio reception problems.

Operating Satellite Radio

1. Use the BAND button to select the proper satellite radio band. (XM1, XM2, SR1, SR2)
2. Use the ▲TUNE and SEEK▼ buttons to navigate through the channels.

Program Type Search (PTY)

XM and Sirius both allow you to search by music type. Program Type Search (PTY) allows you to perform a music search by type. Perform the following steps in order to do a PTY search.

1. Press SCAN and push-button 1 at the same time. PTY will appear on the display.
2. Continue to press push-button 1 until the desired genre of programming is displayed.
3. Once the desired genre has been selected, press the ▲TUNE and SEEK▼ buttons to scroll through the different channels in that genre. Station names will appear on the display as you scroll.

You may also scan through the channels using the scan feature. Press the SCAN button to begin scanning the channels. Press the SCAN button again to stop at the desired channel.

CASSETTE PLAYER

The cassette player that the radio is equipped with works best with cassettes that range from 30 to 90 minutes long. Cassettes that are longer than 90 minutes have thinner tape, and do not work well in this model cassette player.

It is also important to only use cassettes that are in good condition. Cassettes that are dirty, damaged, or have been exposed to excessive heat and/or sunlight could cause damage to the cassette player and possible failure.

The cassette player is equipped with automatic equalization and metal tape sensing functions. An M will appear on the display when a metal tape is sensed.

Cleaning the cassette player is a recommended maintenance item. Clean the player at 35 hour (cassette play) intervals. Failure to clean the cassette player may diminish sound quality and cause cassette player failure.

Playing A Cassette

1. Turn the receiver ON.
2. Insert a cassette into the player. The cassette icon will appear on the display. The tape will begin to play when the icon appears.

Press  button (3, Figure 70-1) to change from the radio to a cassette. TP SIDE 1 or TP SIDE 2 will appear on the display depending on which side of the cassette is currently being played. If a cassette is not loaded in the player, NO TAPE will appear on the display.

NOTE: A tape may be inserted when the receiver is off by pressing the eject button and inserting the tape within 25 seconds.

Cassette Functions

The 4/REV button (17) rewinds the cassette. The cassette will continue to rewind until the button is pressed again, or until the cassette reaches the end of the tape. <REW will appear on the display as the cassette is rewinding.

The 6/FF button (15) fast forwards the cassette. The cassette will continue to fast forward until the button is pressed again, or until the cassette reaches the end of the tape. FWD> will appear on the display as the cassette is fast forwarding.

Press  Eject (5) to remove the cassette from the player. When the eject button is held, it acts as a stop button.

The  button (4) causes the cassette player to reverse directions and play the opposite side of the cassette. Pressing the button a second time will reverse the cassette back to the original side.

NOTE: The cassette will automatically flip to the opposite side when the end of the tape is reached.

Programmable Eject Default

The cassette player has been pre-programmed to return to the radio after a tape has been ejected. This default may be changed to an "eject audio mute" mode. This mode will mute the radio after a cassette has been ejected. When this occurs, "NO TAPE" will appear on the display and the radio will remain muted until BAND (2) is pressed. Pressing this button will enable the radio.

Perform the following steps to change the eject default mode:

1. Press and hold DSP/TM SET (9, Figure 70-1) for at least 2 seconds until the hour digits flash.
2. Press  button (3) to toggle between "P.PLAY" and "EJMUTE". After five seconds of inactivity, the receiver will return to the default display.

Bad Tape Detect

If the receiver detects a bad cassette, "BAD TAPE" will appear on the display and the tape will be ejected. If this occurs, remove the cassette from the player and do not re-insert.

The bad tape detector must be turned off to use a cleaning tape or a CD adapter in the cassette player. Perform the following steps to disable this mode:

1. Turn off receiver and turn key switch to OFF.
2. Press and hold  button (3) for five seconds. "BAD TAPE DETECT OFF" will appear on the display. When this is displayed, the detector has been disabled.

Repeat this procedure to reactivate the bad tape detector. "BAD TAPE DETECT ON" will appear on the display after the detector has been activated.

Cleaning The Cassette Player

After 35 hours of cassette play, the display will read TP CLEAN for five seconds. This indicates that it is time to clean the cassette player.

1. Turn key switch to ON and turn off receiver.
2. Disable BAD TAPE DETECT mode. Press and hold  button (3, Figure 70-1) for five seconds. "BAD TAPE DETECT OFF" will appear on the display. When this is displayed, the detector has been disabled.
3. Turn the receiver on.
4. Insert a wet-type, non-abrasive, scrubbing cassette cleaner. Follow the instructions provided with the cleaner.
5. Reset the clean tape timer. With the receiver on, press and hold the eject button for five seconds. TP CLEAN will appear on the display and the tape icon will flash after three seconds has elapsed. After five seconds CLN RST will appear on the display. When this occurs, the clean tape timer will be reset to zero hours. If the button was released before CLN RST was displayed, the timer will not be reset.

KOMATSU®

www.komatsuamerica.com