

Operation & Maintenance Manual

CEAM010001

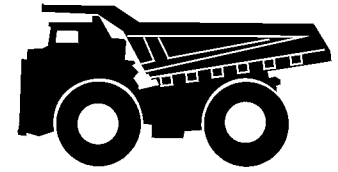

930E-2

DUMP TRUCK

SERIAL SUFFIX

930E A30246 and up

KOMATSU

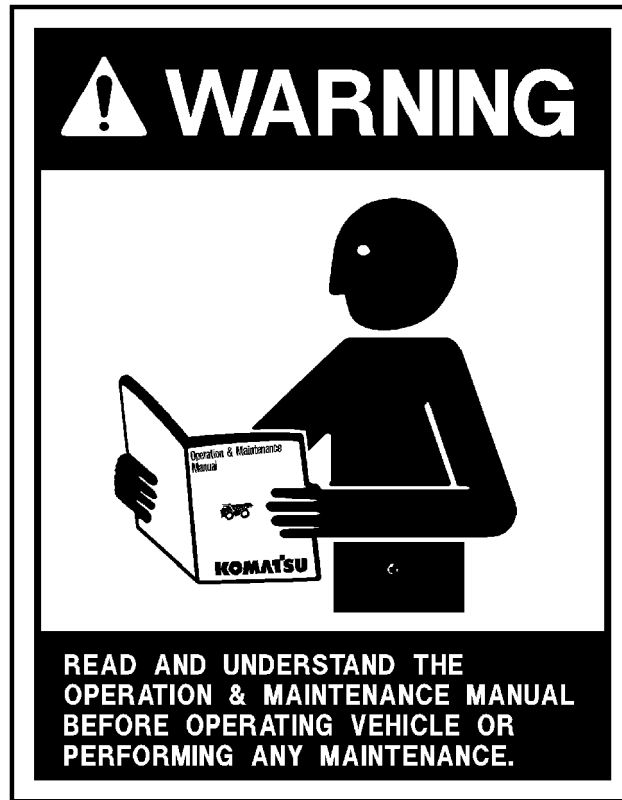

***Unsafe use of this machine may cause serious injury or death. Operators and maintenance personnel must read and understand this manual before operating or maintaining this machine.
This manual should be kept in or near the machine for reference, and periodically reviewed by all personnel who will come into contact with it.***

This material is proprietary to Komatsu Mining Systems, Inc. and is not to be reproduced, used, or disclosed except in accordance with written authorization from Komatsu Mining Systems, Inc.

It is the policy of the Company to improve products whenever it is possible and practical to do so. The Company reserves the right to make changes or add improvements at any time without incurring any obligation to install such changes on products sold previously.

Because of continuous research and development, periodic revisions may be made to this publication. Customers should contact their local distributor for information on the latest revision.

**CALIFORNIA
Proposition 65 Warning**

Diesel engine exhaust, some of its constituents, and certain vehicle components contain or emit chemicals known to the State of California to cause cancer, birth defects or other reproductive harm.

**CALIFORNIA
Proposition 65 Warning**

***Battery posts, terminals and related accessories contain lead and lead compounds, chemicals known to the State of California to cause cancer and birth defects or other reproductive harm.
Wash hands after handling.***

EMISSION CONTROL WARRANTY

EMISSION CONTROL WARRANTY STATEMENT (APPLIES TO CANADA ONLY)

1. Products Warranted

Komatsu America International Company, Komatsu Mining Systems Inc. and Komatsu Utility Corporation (collectively "Komatsu") produce and/or market products under brand names of Komatsu, Dresser, Dressta, Haulpak and Galion. This emissions warranty applies to new engines bearing the Komatsu name installed in these products and used in Canada in machines designed for industrial off-highway use. This warranty applies only to these engines produced on or after January 1, 2000. This warranty will be administered by Komatsu distribution in Canada.

2. Coverage

Komatsu warrants to the ultimate purchaser and each subsequent purchaser that the engine is designed, built and equipped so as to conform, at the time of sale by Komatsu, with all U.S. Federal emission regulations applicable at the time of manufacture and that it is free from defects in workmanship or material which would cause it not to meet these regulations within five years or 3,000 hours of operation, whichever occurs first, as measured from the date of delivery of the engine to the ultimate purchaser.

3. Limitations

Failures, other than those resulting from defects in materials or workmanship, are not covered by this warranty. Komatsu is not responsible for failures or damage resulting from what Komatsu determines to be abuse or neglect, including, but not limited to: operation without adequate coolant or lubricants; over fueling; over speeding; lack of maintenance of lubricating, cooling or intake systems; improper storage, starting, warm-up, run-in or shutdown practices; unauthorized modifications of the engine. Komatsu is also not responsible for failures caused by incorrect fuel or by water, dirt or other contaminants in the fuel. Komatsu is not responsible for non-engine repairs, "downtime" expense, related damage, fines, all business costs or other losses resulting from a warrantable failure.

KOMATSU IS NOT RESPONSIBLE FOR INCIDENTAL OR CONSEQUENTIAL DAMAGES.

This warranty, together with the express commercial warranties, are the sole warranties of Komatsu. **THERE ARE NO OTHER WARRANTIES, EXPRESS OR IMPLIED, OR OF MERCHANTABILITY OR FITNESS FOR A PARTICULAR PURPOSE.**

GARANTIE SUR LE CONTRÔLE DES ÉMISSIONS

ÉNONCÉ DE GARANTIE SUR LE CONTRÔLE DES ÉMISSIONS (APPLICABLE AU CANADA SEULEMENT):

1. Produits garantis:

Komatsu America International Company, Komatsu Mining Systems Inc. et Komatsu Utility Corporation (collectivement Komatsu) produisent et/ou font la mise en marché de produits portant les noms de marque Komatsu, Dresser, Dressta, Haulpak et Galion. Cette garantie sur les émissions s'applique à tous les nouveaux moteurs portant le nom Komatsu, installés dans ces produits et utilisés au Canada dans des machines conçues pour utilisation industrielle non-routière. Cette garantie s'applique seulement sur les moteurs produits à partir du 1er Janvier 2000. Cette garantie sera administrée par la distribution de Komatsu au Canada.

2. Couverture:

Komatsu garantit à l'acheteur ultime et chaque acheteur subséquent que le moteur est conçu, construit et équipé en toute conformité, au moment de la vente par Komatsu, avec toutes les Réglementations fédérales américaines sur les émissions applicables au moment de la fabrication et qu'il est exempt de défauts de construction ou de matériaux qui auraient pour effet de contrevenir à ces réglementations en dedans de 5 ans ou 3000 heures d'opération, mesuré à partir de la date de livraison du moteur au client ultime.

3. Limitations:

Les bris, autres que ceux résultant de défauts de matériaux ou de construction, ne sont pas couverts par cette Garantie. Komatsu n'est pas responsable pour bris ou dommages résultant de ce que Komatsu détermine comme étant de l'abus ou négligence, incluant mais ne se limitant pas à: l'opération sans lubrifiants ou agent refroidissants adéquats; la suralimentation d'essence; la survitesse; le manque d'entretien des systèmes de lubrification, de refroidissement ou d'entrée; de pratiques non-propices d'entreposage, de mise en marche, de réchauffement, de conditionnement ou d'arrêt; les modifications non-autorisées du moteur. De plus, Komatsu n'est pas responsable de bris causés par de l'essence inadéquate ou de l'eau, des saletés ou autres contaminants dans l'essence. Komatsu n'est pas responsable des réparations non-relées au moteur, des dépenses encourues suite aux temps d'arrêts, des dommages relatifs, amendes, et de tout autre coût d'affaires ou autres pertes résultant d'un bris couvert par la garantie.

KOMATSU N'EST PAS RESPONSABLE DES INCIDENTS OU DOMMAGES CONSÉQUENTS.

Cette garantie, ainsi que les garanties expresses commerciales, sont les seules garanties de Komatsu. **IL N'Y A AUCUNE AUTRE GARANTIE, EXPRESSE OU SOUS-ENTENDUE, MARCHANDABLE OU PROPICE A UNE UTILISATION PARTICULIÈRE.**

INFORMATION IMPORTANTE SUR LE MOTEUR
 CE MOTEUR EST CONFORME AUX NORMES AMÉRICAINES DEL'EPA (ANNÉE DU MODÈLE) ET DE LA CALIFORNIE POUR LES MOTEURS LARGES NON-ROUTIERS A IGNITION PAR COMPRESSION. CE MOTEUR EST CERTIFIÉ POUR OPERATION À ESSENCE DIÉSEL.

AVERTISSEMENT
 DES BLESSURES PEUVENT RÉsulTER ET LA GARANTIE S'ANNULER SI LES RPM DU TAUX D'ESSENCE OU L'ALTITUDE EXCÈDENT LES VALEURS MAXIMALES PUBLIÉES POUR CE MODÈLE ET SON APPLICATION.

IMPORTANT ENGINE INFORMATION			
THIS ENGINE CONFORMS TO YYYY MODEL YEAR U.S. EPA REGULATION AND THE CALIFORNIA REGULATIONS LARGE NON ROAD COMPRESSION IGNITION ENGINES. THIS ENGINE IS CERTIFIED TO OPERATE ON DIESEL FUEL.			
WARNING			
INJURY MAY RESULT AND WARRANTY IS VOIDED IF FUEL RATE RPM OR ALTITUDES EXCEED PUBLISHED MAXIMUM VALUES FOR THIS MODEL AND APPLICATION.			
ENGINE MODEL		SERIAL NO.	
ENGINE FAMILY		DISPLACEMENT	LITERS
EXHAUST EMISSION CONTROL SYSTEM		FIRING ORDER	1 - 5 - 3 - 6 - 2 - 4
ADV. LOAD OUTPUT		Kw (HP)	RPM
VALVE LASH COLD (mm)	IN. EX.	FUEL RATE AT ADV.	mm ³ /STROKE
IDLE SPEED		RPM	FAMILY EMISSION LIMIT
INITIAL INJECTION TIMING	DEG. BTDC	DATE OF MANUFACTURE	
		KOMATSU LTD. MADE IN JAPAN	KOMATSU

MODÈLE DU MOTEUR

FAMILLE DU MOTEUR

SYSTÈME DE CONTRÔLE DES ÉMISSIONS D'ÉCHAPPEMENT

CHARGE DE SORTIE ADV.

PORTÉE DE VALVE À FROID (mm)

VITESSE STATIQUE

RÉGLAGE DE L'ALLUMAGE - INJECTION INITIALE

DEG. BTDC

NO. SÉRIE

DÉPLACEMENT

LITRES

SÉQUENCE DE MISE À FEU

mm³/BATTEMENT

TAUX D'ESSENCE À ADV.

LIMITE D'ÉMISSION DE LA FAMILLE

DATE DE FABRICATION

KOMATSU LTÉE
FABRIQUÉ AU JAPON

ENGINE DATAPLATE - ENGLISH / FRENCH

FOREWORD

This manual is written for use by the operator and/or the service technician and is designed to help these persons to become fully knowledgeable of the truck and all its systems in order to keep it operating safely and efficiently.

All operators and maintenance personnel should read and understand the materials in this manual before operating the truck or performing maintenance and/or operational checks on the truck. All safety notices, warnings and cautions should be understood and followed when operating or accomplishing repairs on the truck.

The first section is an Introduction to the manual and contains a Table of Contents to locate specific areas of interest. Other sections include Safety, Operation, Maintenance, Specifications, and Optional Equipment.

The illustrations used in this manual are *TYPICAL* of the component shown and may not be an exact reproduction of what is found on the truck.

A product identification plate is located on the frame in front of the right side front wheel and designates the Truck Model Number, Product Identification Number (vehicle serial number), and Maximum G.V.W. (Gross Vehicle Weight) rating.

The KOMATSU Truck Model designation consists of three numbers and one letter (i.e. 930E).

The three numbers represent the basic truck model.

The letter "M", when present, designates a Mechanical drive system;

The letter "E", when present, designates an Electrical wheel motor drive system.

The Product Identification Number (vehicle serial number) contains information which will identify the original manufacturing bill of material for this unit. This complete number will be necessary for proper ordering of many service parts and/or warranty consideration.

The Gross Vehicle Weight (GVW) is what determines the load on the drive train, frame, tires, and other components. The vehicle design and application guidelines are sensitive to the total maximum **Gross Vehicle Weight (GVW)** and this means the **TOTAL WEIGHT: the Empty Vehicle Weight + the fuel & lubricants + the payload**.

To determine allowable payload:

Service all lubricants for proper level and fill fuel tank of empty truck (which includes all accessories, body liners, tailgates, etc.) and then weigh truck.

Record this value and subtract from the GVW rating. The result is the allowable payload.

NOTE: Accumulations of mud, frozen material, etc. become a part of the GVW and reduces allowable payload. To maximize payload and to keep from exceeding the GVW rating, these accumulations should be removed as often as practical.

Exceeding the allowable payload will reduce expected life of truck components.

⚠ WARNING

Unsafe use of this machine may cause serious injury or death. Operators and maintenance personnel must read this manual before operating or maintaining this machine. This manual should be kept in or near the machine for reference and periodically reviewed by all personnel who come in contact with it.



This “ALERT” symbol is used with the signal words, “CAUTION”, “DANGER”, and “WARNING” in this manual to alert the reader to hazards arising from improper operating and maintenance practices.



*“DANGER” identifies a specific potential hazard
WHICH WILL RESULT
in either INJURY OR DEATH
if proper precautions are not taken.*



*“WARNING” identifies a specific potential hazard
WHICH MAY RESULT
in either INJURY OR DEATH
if proper precautions are not taken.*



*“CAUTION” is used for general reminders
of proper safety practices
OR
to direct the reader’s attention to avoid unsafe
or improper practices which may result
in damage to the equipment.*

TABLE OF CONTENTS

SUBJECT SECTION / PAGE

INTRODUCTION SECTION 1

- Foreword 1-1
- ALERTS Page - a description of the DANGER, WARNING, and CAUTION symbols used in this manual. . . . 1-2
- TABLE OF CONTENTS 1-3
- Truck Model Illustration 1-6
- About This Manual 1-7
- STANDARD CHARTS and TABLES 1-9 through 1-14

SAFETY SECTION 2

Safety records of most organizations will show that the greatest percentage of accidents are caused by unsafe acts of persons. The remainder are caused by unsafe mechanical or physical conditions. Report all unsafe conditions to the proper authority. These safety rules are provided as a guide for the Komatsu truck operator. However, local conditions and regulations may add many more to this list.

- GENERAL SAFETY 2-1
- PRECAUTIONS DURING OPERATION 2-5
 - Operating Machine 2-6
 - Towing 2-9
 - Battery 2-10
- PRECAUTIONS FOR MAINTENANCE 2-11
 - Before Carrying Out Maintenance 2-11
 - During Maintenance 2-12
 - Tires 2-15
 - Additional Job Site Rules 2-16
- WHEN REPAIRS ARE NECESSARY 2-17
 - Special Precautions for Working on a 930E Truck 2-18
- WARNING, CAUTION, and Instruction Plates / Decals 2-21 through 2-30

OPERATION SECTION 3

This portion of the manual covers identification, location, and operation of the controls, switches, and indicators in the Operator's Cab and use / function of these controls, switches, and indicators.

- OPERATING INSTRUCTIONS 3-1
 - Preparing For Operation 3-1
 - Safety Is Thinking Ahead 3-1
 - At The Truck - Ground Level Walk-Around Inspection 3-1
- ENGINE START-UP SAFETY PRACTICES 3-4
- AFTER ENGINE HAS STARTED 3-5
- MACHINE OPERATION SAFETY PRECAUTIONS 3-6
- MACHINE OPERATION ON THE HAUL ROAD 3-6
- STARTING ON A GRADE WITH A LOADED TRUCK 3-7
- PASSING 3-7
- LOADING 3-7
- DUMPING 3-8
- TOWING 3-9
- SAFE PARKING PROCEDURES 3-10
- NORMAL ENGINE SHUTDOWN PROCEDURE 3-10

TABLE OF CONTENTS (Continued)

<u>SUBJECT</u>	<u>SECTION / PAGE</u>
<u>OPERATION (Continued)</u> <u>SECTION 3</u>	
DELAYED ENGINE SHUTDOWN PROCEDURE	3-11
SUDDEN LOSS OF ENGINE POWER	3-12
RESERVE ENGINE OIL SYSTEM	3-13
OPERATOR CAB and CONTROLS	3-15
STEERING WHEEL AND CONTROLS	3-16
DYNAMIC RETARDER/SERVICE BRAKE PEDAL	3-17
ACCELERATOR (THROTTLE) PEDAL	3-17
HEATER / AIR CONDITIONER VENTS	3-17
HEATER / AIR CONDITIONER COMPARTMENT AND CONTROLS	3-18
GRADE SPEED CHART	3-19
CENTER CONSOLE CONTROLS AND FEATURES	3-21
Hoist Control Lever	3-22
OPERATOR SEAT	3-25
INSTRUMENT PANEL AND INDICATOR LIGHTS	3-27
Control Symbols	3-27
INSTRUMENT PANEL (Figure 3-7)	3-28
PANEL GAUGES, INDICATORS, AND CONTROLS (Discussion of items 1 - 29, Figure 3-7)	3-29
OVERHEAD STATUS / WARNING INDICATOR LIGHT PANEL (Figure 3-8)	3-35
STATUS/WARNING INDICATOR LIGHT SYMBOLS - Refer to Figure 3-8 by rows (A-E) and columns (1 - 6).	3-36
Hazard Warning Lights (7)	3-42
Lamp Test Switch (8)	3-42
LINK-ON WARNING LIGHT	3-42

MAINTENANCE **SECTION 4**

This portion of the manual pertains mainly to the periodic Lubrication and Service required to keep the truck operating at its design potential. Routine lubrication and maintenance procedures are provided in this section. For major repairs, refer to the appropriate section in the Truck Service Manual.

Refer to the engine manufacturer's service manual when servicing the engine.

Lubrication and Service	4-1
Service Capacities	4-1
Hydraulic Tank Service	4-1
Coolant Level Check	4-2
Radiator Filling Procedure	4-2
Cooling System Recommendations	4-2
Reserve Engine Oil System	4-2
Lubrication Chart	4-3
10 HOUR (SHIFT) Lubrication And Maintenance Checks	4-4
50 HOUR Lubrication And Maintenance Checks	4-6
100 HOUR Lubrication And Maintenance Checks	4-7
250 HOUR Lubrication And Maintenance Checks	4-8
500 HOUR Lubrication And Maintenance Checks	4-10
1000 HOUR Lubrication And Maintenance Checks	4-11
2500 HOUR Lubrication And Maintenance Checks	4-12
5000 HOUR Lubrication And Maintenance Checks	4-12
Lincoln Automatic Lubrication System (Rotary Pump)	4-13
General Description	4-13
System Components	4-15

TABLE OF CONTENTS (Continued)

SUBJECT SECTION / PAGE

Lincoln Automatic Lubrication System (CONTINUED)

- System Operation 4-16
- General Instructions 4-18
- Lubricant Required For System 4-18
- System Priming 4-18
- Filter Assembly 4-18
- Lubricant Pump 4-19
- Injector Operation 4-20
- Injectors 4-21
- System Check-out 4-22
- Lubrication Cycle Timer Check 4-22
- System Troubleshooting Chart 4-23
- Preventative Maintenance Procedures 4-26

SPECIFICATIONS SECTION 5

This portion of the manual covers major component descriptions and truck specifications.

- Major Component Descriptions 5-1
- Specifications 5-3

OPTIONAL EQUIPMENT SECTION 6

This portion of the manual covers operation/maintenance of OPTIONAL EQUIPMENT.

- PAYLOAD METER 3 (Refer to separate PAYLOAD METER 3 Index) 6-1
- AM/FM CASSETTE RADIO 7-1

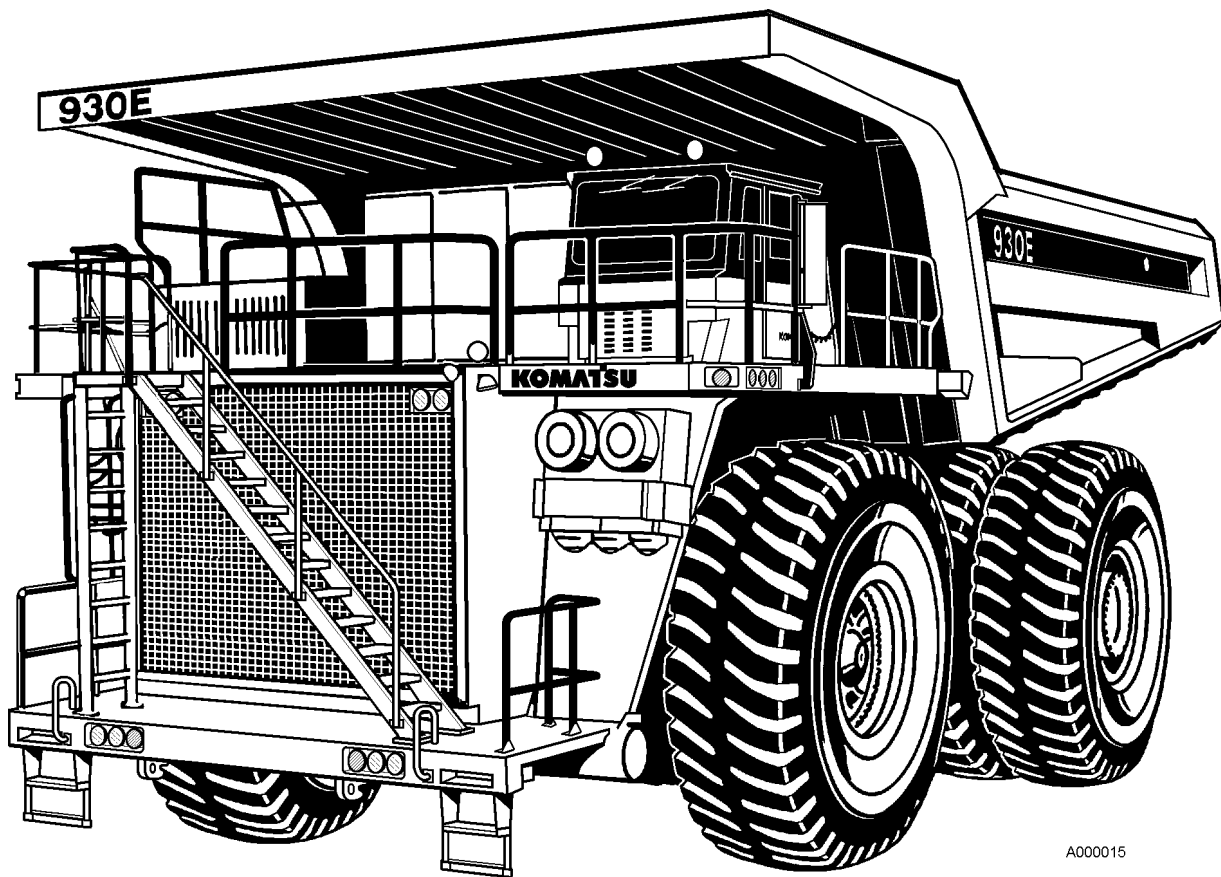

A000015

KOMATSU MODEL 930E Dump Truck

About This Manual

This Manual is written for use by the operator and/or the service technician and is designed to help these persons to become fully knowledgeable of the truck and all its systems in order to keep it operating safely and efficiently. All operators and maintenance personnel should read and understand the materials in this manual before operating the truck or performing maintenance and/or operational checks on the truck. All safety notices, warnings, and cautions should be understood and followed when operating or accomplishing repairs on the truck.

The front cover of this manual includes a Form Number. This Form No. should be referenced when ordering additional copies of this manual, or for any other correspondence regarding the coverage in this manual.

Direct all inquiries to:

Datakom Publishing Corporation
Peoria Operations
P.O. Box 240
Peoria, IL 61650-0240
(309)-672-7072 – FAX

This first section is an Introduction to the manual and contains a Table of Contents to locate specific areas of interest. Other sections include Safety, Operation, Maintenance, Specifications, and Optional Equipment.

When searching for a specific area of interest, go first to the Table of Contents to locate the Section in which the subject might generally be included. Then, go to that Section of the Table of Contents to find a Subject description that most closely describes the specific area of interest to find a page number and go to that page. Section Numbers and Page Numbers are located at the top, outside corner of the page. 

 At the top, inside corner of the page is a document (module) number. If there is ever a question regarding the information in a particular Section, refer to the document (module) number, the manual Form No., and use the address shown above to correspond. If there is a date (month/year) behind the document (module) number, that indicates the latest revision date of that page.

The illustrations used in this manual are *TYPICAL* of the component shown and *may not be an exact* reproduction of what is found on the truck.

This manual shows dimensioning of U.S. standard and metric (SI) units throughout. All references to “Right”, “Left”, “Front”, or “Rear” are made with respect to the operator’s normal seated position, unless specifically stated otherwise.

When assembly instructions are provided without references to torque values, standard torque values should be assumed. Standard torque requirements are shown in torque charts on the following pages of this section, and in the General Information section of the truck service manual. Individual torques when provided in the text are in bold face type, such as **100 ft.lbs. (135 N.m)** torque. All torque specifications have $\pm 10\%$ tolerance unless otherwise specified.

NOTES

STANDARD CHARTS AND TABLES

This manual provides dual dimensioning for most specifications. U.S. standard units are specified first, with metric (SI) units in parentheses. References throughout the manual to standard torques or other standard values will be to one of the following Charts or Tables. For values not shown in any of the charts or tables, standard conversion factors for most commonly used measurements are provided in TABLE XIII, page 1-14.

INDEX OF TABLES

TABLE I	Standard Torque Chart (SAE)	1-9
TABLE II	Standard Torque, 12-Point, Grade 9	1-10
TABLE III . .	Standard Metric Assembly Torque	1-10
TABLE IV	JIC Swivel Nuts Torque Chart	1-11
TABLE V	Pipe Thread Torque Chart	1-11
TABLE VI	O-Ring Boss Torque Chart	1-11
TABLE VII	O-Ring Face Seal Torque Chart	1-11
TABLE VIII . .	Torque Conversions (ft.lbs – N.m)	1-12
TABLE IX .	Torque Conversions (ft.lbs – kg.m)	1-12
TABLE X . .	Pressure Conversions (psi – kPa)	1-12
TABLE XI . .	Pressure Conversions (psi – MPa)	1-12
TABLE XII	Temperature Conversions	1-13
TABLE XIII . . .	Common Conversion Multipliers	1-14

EFFECT OF SPECIAL LUBRICANTS On Fasteners And Standard Torque Values

Komatsu Mining Systems, Inc., Peoria Operations, does NOT recommend the use of special “friction-reducing” lubricants such as, “Copper Coat”, “Never Seize”, and other similar products on the threads of standard fasteners where “standard torque” values are applied.

The use of special “friction-reducing” lubricants will significantly alter the clamping force being applied to fasteners during the tightening process. If special “friction-reducing” lubricants are used with the “Standard Torque” values listed below in Table I (and most Shop or Maintenance manuals), *excessive stress and possible breakage of the fasteners may result.*

Where Torque Tables specify “Lubricated Threads” for the Standard Torque values listed, **these standard torque values are to be used with simple lithium base chassis grease (multi-purpose EP NLGI) or a rust- preventive grease (see list, page 1-10) on the threads and seats**, unless specified otherwise.

NOTE: Always be sure threads of fasteners and tapped holes are free of burrs or other imperfections before assembling.

Standard Torque values are NOT to be used when “Turn-of-the-Nut” tightening procedures are recommended.

CAP-SCREW THREAD SIZE		TORQUE – GRADE 5			TORQUE – GRADE 8			CAPSCREW THREAD SIZE	TORQUE – GRADE 5			TORQUE – GRADE 8		
		ft. lbs.	kg.m	N.m	ft. lbs.	kg.m	N.m		ft. lbs.	kg.m	N.m	ft. lbs.	kg.m	N.m
1/4-20	7	0.97	9.5	10	1.38	13.6	3/4-16	235	32.5	319	335	46.3	454	
1/4-28	8	1.11	10.8	11	1.52	14.9	7/8-9	350	48.4	475	500	69.2	678	
5/16-18	15	2.07	20.3	21	2.90	28	7/8-14	375	51.9	508	530	73.3	719	
5/16-24	16	2.21	22	22	3.04	30	1.0-8	525	72.6	712	750	103.7	1017	
3/8-16	25	3.46	34	35	4.84	47	1.0-12	560	77.4	759	790	109.3	1071	
3/8-24	30	4.15	41	40	5.5	54	1.0-14	570	78.8	773	800	110.6	1085	
7/16-14	40	5.5	54	58	8.0	79	1 1/8-7	650	89.9	881	1050	145	1424	
7/16-20	45	6.2	61	62	8.57	84	1 1/8-12	700	96.8	949	1140	158	1546	
1/2-13	65	9	88	90	12.4	122	1 1/4-7	910	125.9	1234	1480	205	2007	
1/2-20	70	9.7	95	95	13.1	129	1 1/4-12	975	134.8	1322	1580	219	2142	
9/16-12	90	12.4	122	125	17.3	169	1 3/8-6	1200	166	1627	1940	268	2630	
9/16-18	95	13.1	129	135	18.7	183	1 3/8-12	1310	181	1776	2120	293	2874	
5/8-11	125	17.3	169	175	24.2	237	1 1/2-6	1580	219	2142	2560	354	3471	
5/8-18	135	18.7	183	190	26.2	258	1 1/2-12	1700	235	2305	2770	383	3756	
3/4-10	220	30.4	298	310	42.8	420								

1 ft. lbs. = 0.138 kg.m = 1.356 N.m

Standard Assembly Torques For 12-Point, Grade 9, Capscrews (SAE)

The following specifications apply to required assembly torques for all 12-Point, Grade 9 (170,000 psi minimum tensile), Capscrews.

- Capscrew threads and seats SHALL be lubricated when assembled.

Unless instructions specifically recommend otherwise, these standard torque values are to be used with simple lithium base chassis grease (multi-purpose EP NLGI) or a rust- preventive grease (see list, this page) on the threads.

- Torques are calculated to give a clamping force of approximately 75% of proof load.
- The maximum torque tolerance shall be $\pm 10\%$ of the torque value shown.

TABLE II - STANDARD ASSEMBLY TORQUE for 12-Point, Grade 9, Capscrews			
CAPSCREW SIZE*	TORQUE ft. lbs.	TORQUE N.m	TORQUE kg.m
0.250 - 20	12	16	1.7
0.312 - 18	24	33	3.3
0.375 - 16	42	57	5.8
0.438 - 14	70	95	9.7
0.500 - 13	105	142	14.5
0.562 - 12	150	203	20.7
0.625 - 11	205	278	28.3
0.750 - 10	360	488	49.7
0.875 - 9	575	780	79.4
1.000 - 8	860	1166	119
1.000 - 12	915	1240	126
1.125 - 7	1230	1670	170
1.125 - 12	1330	1800	184
1.250 - 7	1715	2325	237
1.250 - 12	1840	2495	254
1.375 - 6	2270	3080	313
1.375 - 12	2475	3355	342
1.500 - 6	2980	4040	411
1.500 - 12	3225	4375	445
* Shank Diameter (in.) - Threads per in.			
This Table represents standard values only. Do not use these values to replace torque values which are specified in assembly instructions.			

Standard Metric Assembly Torque For Class 10.9 Capscrews & Class 10 Nuts

The following specifications apply to required assembly torques for all metric Class 10.9 finished hexagon head capscrews and Class 10 nuts.

- Capscrews threads and seats SHALL NOT be lubricated when assembled. These specifications are based on all capscrews, nuts, and hardened washers being **phosphate and oil** coated.

NOTE: If zinc-plated hardware is used, each piece must be lubricated with a Rust Preventive Grease or Lithium-base grease to achieve the same clamping forces provided below.

- Torques are calculated to give a clamping force of approximately 75% of proof load.
- The maximum torque tolerance shall be within $\pm 10\%$ of the torque value shown.

TABLE III - STANDARD METRIC ASSEMBLY TORQUE			
CAPSCREW SIZE*	TORQUE N.m	TORQUE ft. lbs.	TORQUE kg.m
M 6 x 1	12	9	1.22
M 8 x 1.25	30	22	3.06
M10 x 1.5	55	40	5.61
M12 x 1.75	95	70	9.69
M14 x 2	155	114	15.81
M16 x 2	240	177	24.48
M20 x 2.5	465	343	47.43
M24 x 3	800	590	81.6
M30 x 3.5	1600	1180	163.2
M36 x 4	2750	2028	280.5
* Shank Diameter (mm) x Threads per mm.			
This Table represents standard values only. Do not use these values to replace torque values which are specified in assembly instructions.			

SUGGESTED* SOURCES FOR RUST PREVENTIVE GREASE:

- AMERICAN ANTI-RUST GREASE # 3-X from Standard Oil Company (also American Oil Co.)
- GULF NORUST # 3 from Gulf Oil Company.
- MOBILARMA 355, Product No. 66705 from Mobil Oil Corporation.
- RUST BAN 326 from Humble Oil Company.
- RUSTOLENE B GREASE from Sinclair Oil Company.
- RUST PREVENTIVE GREASE - CODE 312 from the Southwest Grease and Oil Company.

* NOTE: This list represents the current Engineering approved sources for use in KMS, Peoria Operations, manufacture. It is not exclusive. Other products may meet the same specifications of this list.

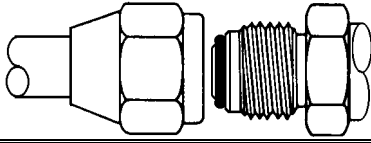

TABLE IV TORQUE CHART FOR JIC 37° SWIVEL NUTS WITH OR WITHOUT O-RING SEAL			
SIZE CODE	TUBE SIZE (O.D.)	THREADS UNF - 2B	TORQUE FT. LBS.
-2	0.125	0.312-24	4 ± 1
-3	0.188	0.375-24	8 ± 3
-4	0.250	0.438-20	12 ± 3
-5	0.312	0.500-20	15 ± 3
-6	0.375	0.562-18	18 ± 5
-8	0.500	0.750-16	30 ± 5
-10	0.625	0.875-14	40 ± 5
-12	0.750	1.062-12	55 ± 5
-14	0.875	1.188-12	65 ± 5
-16	1.000	1.312-12	80 ± 5
-20	1.250	1.625-12	100 ± 10
-24	1.500	1.875-12	120 ± 10
-32	2.000	2.500-12	230 ± 20

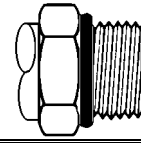

TABLE VI TORQUE CHART FOR O-RING BOSS FITTINGS			
SIZE CODE	TUBE SIZE (O.D.)	THREADS UNF - 2B	TORQUE FT. LBS.
-2	0.125	0.312-24	4 ± 2
-3	0.188	0.375-24	5 ± 2
-4	0.250	0.438-20	8 ± 3
-5	0.312	0.500-20	10 ± 3
-6	0.375	0.562-18	13 ± 3
-8	0.500	0.750-16	24 ± 5
-10	0.625	0.875-14	32 ± 5
-12	0.750	1.062-12	48 ± 5
-14	0.875	1.188-12	54 ± 5
-16	1.000	1.312-12	72 ± 5
-20	1.250	1.625-12	80 ± 5
-24	1.500	1.875-12	80 ± 5
-32	2.000	2.500-12	96 ± 10

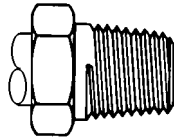

TABLE V TORQUE CHART FOR PIPE THREAD FITTINGS			
SIZE CODE	PIPE THREAD SIZE	WITH SEALANT FT. LBS.	WITHOUT SEALANT FT. LBS.
-2	0.125-27	15 ± 3	20 ± 5
-4	0.250-18	20 ± 5	25 ± 5
-6	0.375-18	25 ± 5	35 ± 5
-8	0.500-14	35 ± 5	45 ± 5
-12	0.750-14	45 ± 5	55 ± 5
-16	1.000-11.50	55 ± 5	65 ± 5
-20	1.250-11.50	70 ± 5	80 ± 5
-24	1.500-11.50	80 ± 5	95 ± 10
-32	2.000-11.50	95 ± 10	120 ± 10

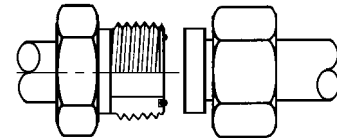

TABLE VII TORQUE CHART FOR O-RING FACE SEAL FITTINGS			
SIZE CODE	TUBE SIZE (O.D.)	THREADS UNF - 2B	TORQUE FT. LBS.
-4	0.250	0.438-20	11 ± 1
-6	0.375	0.562-18	18 ± 2
-8	0.500	0.750-16	35 ± 4
-10	0.625	0.875-14	51 ± 5
-12	0.750	1.062-12	71 ± 7
-16	1.000	1.312-12	98 ± 6
-20	1.250	1.625-12	132 ± 7
-24	1.500	1.875-12	165 ± 15

TABLE VIII TORQUE CONVERSIONS										
Foot Pounds – ft. lbs. To Newton.meters (N.m)										
FT. LBS.	0	1	2	3	4	5	6	7	8	9
0	(N.m)	1.36	2.71	4.07	5.42	6.78	8.14	9.49	10.85	12.20
10	13.56	14.91	16.27	17.63	18.98	20.34	21.69	23.05	24.40	25.76
20	27.12	28.47	29.83	31.18	32.54	33.90	35.25	36.61	37.96	39.32
30	40.67	42.03	43.39	44.74	46.10	47.45	48.81	50.17	51.52	52.87
40	54.23	55.59	56.94	58.30	59.66	61.01	62.37	63.72	65.08	66.44
50	67.79	69.15	70.50	71.86	73.21	74.57	75.93	77.28	78.64	80.00
60	81.35	82.70	84.06	85.42	86.77	88.13	89.48	90.84	92.20	93.55
70	94.91	96.26	97.62	98.97	100.33	101.69	103.04	104.40	105.75	107.11
80	108.47	109.82	111.18	112.53	113.89	115.24	116.60	117.96	119.31	120.67
90	122.03	123.38	124.74	126.09	127.45	128.80	130.16	131.51	132.87	134.23

See NOTE on page 1-13

TABLE IX TORQUE CONVERSIONS										
Foot Pounds – ft. lbs. To kilogram.meter (kg.m)										
FT. LBS.	0	1	2	3	4	5	6	7	8	9
0	(kg.m)	0.138	0.277	0.415	0.553	0.692	0.830	0.968	1.106	1.245
10	1.38	1.52	1.66	1.80	1.94	2.07	2.21	2.35	2.49	2.63
20	2.77	2.90	3.04	3.18	3.32	3.46	3.60	3.73	3.87	4.01
30	4.15	4.29	4.43	4.56	4.70	4.84	4.98	5.12	5.26	5.39
40	5.53	5.67	5.81	5.95	6.09	6.22	6.36	6.50	6.64	6.78
50	6.92	7.05	7.19	7.33	7.47	7.61	7.74	7.88	8.02	8.16
60	8.30	8.44	8.57	8.71	8.85	8.99	9.13	9.27	9.40	9.54
70	9.68	9.82	9.96	10.10	10.23	10.37	10.51	10.65	10.79	10.93
80	11.06	11.20	11.34	11.48	11.62	11.76	11.89	12.03	12.17	12.30
90	12.45	12.59	12.72	12.86	13.00	13.14	13.28	13.42	13.55	13.69

See NOTE on page 1-13

TABLE X PRESSURE CONVERSIONS										
Pounds/sq. in. [psi] To kilopascals (kPa)										
Formula: psi x 6.895 = kPa										
PSI	0	1	2	3	4	5	6	7	8	9
0	(kPa)	6.895	13.79	20.68	27.58	34.47	41.37	48.26	55.16	62.05
10	68.95	75.84	82.74	89.63	96.53	103.42	110.32	117.21	124.1	131.0
20	137.9	144.8	151.7	158.6	165.5	172.4	179.3	186.2	193.1	200.0
30	206.8	213.7	220.6	227.5	234.4	241.3	248.2	255.1	262.0	268.9
40	275.8	282.7	289.6	296.5	303.4	310.3	317.2	324.1	331.0	337.9
50	344.7	351.6	358.5	365.4	372.3	379.2	386.1	393.0	399.9	406.8
60	413.7	420.6	427.5	434.4	441.3	448.2	455.1	462.0	468.9	475.8
70	482.6	489.5	496.4	503.3	510.2	517.1	524.0	530.9	537.8	544.7
80	551.6	558.5	565.4	572.3	579.2	586.1	593.0	599.9	606.8	613.7
90	620.5	627.4	634.3	641.2	648.1	655.0	661.9	668.8	675.7	682.6

See NOTE on page 1-13

TABLE XI PRESSURE CONVERSIONS										
Pounds/sq. in. [psi] To Megapascals (MPa)										
Formula: psi x 0.0069 = MPa										
PSI	0	10	20	30	40	50	60	70	80	90
0	(MPa)	0.069	0.14	0.21	0.28	0.34	0.41	0.48	0.55	0.62
100	0.69	0.76	0.83	0.90	0.97	1.03	1.10	1.17	1.24	1.31
200	1.38	1.45	1.52	1.59	1.65	1.72	1.79	1.86	1.93	2.00
300	2.07	2.14	2.21	2.28	2.34	2.41	2.48	2.55	2.62	2.69
400	2.76	2.83	2.90	2.96	3.03	3.10	3.17	3.24	3.31	3.38
500	3.45	3.52	3.59	3.65	3.72	3.79	3.86	3.93	4.00	4.07
600	4.14	4.21	4.27	4.34	4.41	4.48	4.55	4.62	4.69	4.76
700	4.83	4.90	4.96	5.03	5.10	5.17	5.24	5.31	5.38	5.45
800	5.52	5.58	5.65	5.72	5.79	5.86	5.93	6.00	6.07	6.14
900	6.21	6.27	6.34	6.41	6.48	6.55	6.62	6.69	6.76	6.83

See NOTE on page 1-13

NOTE: Tables such as Table VIII, IX, X, and XI may be used as in the following example:

Example: Convert 975 psi to kilopascals (kPa).

1. Select Table X.
2. Go to **PSI** row **90**, column **7**; read 668.8
97 psi = 668.8 kPa.
3. Multiply by 10:
970 psi = 6688 kPa.
4. Go to **PSI** row **0**, column **5**; read 34.47
5 psi = 34.47 kPa. Add to step 3.
5. 970 + 5 psi = 6688 + 34 = 6722 kPa.
975 psi = 6722 kPa.

TABLE XII TEMPERATURE CONVERSIONS								
FORMULA:			$F^{\circ} - 32 \div 1.8 = C^{\circ}$			$C^{\circ} \times 1.8 + 32 = F^{\circ}$		
CELSIUS C°		FAHRENHEIT F°	CELSIUS C°		FAHRENHEIT F°	CELSIUS C°		FAHRENHEIT F°
121	250	482	63	145	293	4	40	104
118	245	473	60	140	284	2	35	95
116	240	464	57	135	275	-1	30	86
113	235	455	54	130	266	-4	25	77
110	230	446	52	125	257	-7	20	68
107	225	437	49	120	248	-9	15	59
104	220	428	46	115	239	-12	10	50
102	215	419	43	110	230	-15	5	41
99	210	410	41	105	221	-18	0	32
96	205	401	38	100	212	-21	-5	23
93	200	392	35	95	203	-23	-10	14
91	195	383	32	90	194	-26	-15	5
88	190	374	29	85	185	-29	-20	-4
85	185	365	27	80	176	-32	-25	-13
82	180	356	24	75	167	-34	-30	-22
79	175	347	21	70	158	-37	-35	-31
77	170	338	18	65	149	-40	-40	-40
74	165	329	15	60	140	-43	-45	-49
71	160	320	13	55	131	-46	-50	-58
68	155	311	10	50	122	-48	-55	-67
66	150	302	7	45	113	-51	-60	-76

NOTE: The numbers in the unmarked columns refer to temperature in either degrees Celsius (C°) or Fahrenheit, F°. Select a number in this unmarked column and read to the left to convert to degrees Celsius (C°) or read to the right to convert to degrees Fahrenheit, F°. If starting with a known temperature (either C° or F°), find that temperature in the **marked** column and read the converted temperature in the center, **unmarked** column.

**TABLE XIII –
COMMON CONVERSION MULTIPLIERS**

COMMON CONVERSION MULTIPLIERS ENGLISH to METRIC		
TO CONVERT FROM	TO	MULTIPLY BY
inch – in.	millimeter (mm)	25.40
inch – in.	centimeter (cm)	2.54
foot – ft.	meter (m)	0.3048
yard – yd.	meter (m)	0.914
mile – mi.	kilometer (km)	1.61
sq. in. – in. ²	sq. centimeters (cm ²)	6.45
sq. ft. – ft. ²	sq. centimeters (cm ²)	929
cu. in. – in. ³	cu. centimeters (cm ³)	16.39
cu. in. – in. ³	liters (l)	0.016
cu. ft. – ft. ³	cu. meters (m ³)	0.028
cu. ft. – ft. ³	liters (l)	28.3
ounce – oz.	kilogram (kg)	0.028
fluid ounce – fl. oz.	milliliter (ml)	29.573
pound (mass)	kilogram (kg)	0.454
pound (force) – lbs.	Newton (N)	4.448
in. lbs. (force)	Newton.meters (N.m)	0.113
ft. lbs. (force)	Newton.meters (N.m)	1.356
ft. lbs. (force)	kilogram.meters (kg.m)	0.138
kilogram.meters (kg.m)	Newton.meters (N.m)	9.807
psi (pressure)	kilopascals (kPa)	6.895
psi (pressure)	megapascals (MPa)	0.007
psi (pressure)	kilograms/cm ² (kg/cm ²)	0.0704
ton (short)	kilogram (kg)	907.2
ton (short)	metric ton	0.907
quart – qt.	liters (l)	0.946
gallon – gal.	liters (l)	3.785
HP (horsepower)	Watts	745.7
HP (horsepower)	kilowatts (kW)	0.745

COMMON CONVERSION MULTIPLIERS METRIC to ENGLISH		
TO CONVERT FROM	TO	MULTIPLY BY
millimeter (mm)	inch – in.	0.0394
centimeter (cm)	inch – in.	0.3937
meter (m)	foot – ft.	3.2808
meter (m)	yard – yd.	1.0936
kilometer (km)	mile – mi.	0.6210
sq. centimeters (cm ²)	sq. in. – in. ²	0.1550
sq. centimeters (cm ²)	sq. ft. – ft. ²	0.001
cu. centimeters (cm ³)	cu. in. – in. ³	0.061
liters (l)	cu. in. – in. ³	61.02
cu. meters (m ³)	cu. ft. – ft. ³	35.314
liters (l)	cu. ft. – ft. ³	0.0353
grams (g)	ounce – oz.	0.0353
milliliter (ml)	fluid ounce – fl. oz.	0.0338
kilogram (kg)	pound (mass)	2.2046
Newton (N)	pound (force) – lbs.	0.2248
Newton.meters (N.m)	kilogram.meters (kg.m)	0.102
Newton.meters (N.m)	ft. lbs. (force)	0.7376
kilogram.meters (kg.m)	ft. lbs. (force)	7.2329
kilogram.meters (kg.m)	Newton.meters (N.m)	9.807
kilopascals (kPa)	psi (pressure)	0.1450
megapascals (MPa)	psi (pressure)	145.038
kilograms/cm ² (kg/cm ²)	psi (pressure)	14.2231
kilograms/cm ² (kg/cm ²)	kilopascals (kPa)	98.068
kilogram (kg)	ton (short)	0.0011
metric ton	ton (short)	1.1023
liters (l)	quart – qt.	1.0567
liters (l)	gallon – gal.	0.2642
Watts	HP (horsepower)	0.00134
kilowatts (kW)	HP (horsepower)	1.3410

GENERAL SAFETY

Safety records of most organizations will show that the greatest percentage of accidents are caused by unsafe acts of persons. The remainder are caused by unsafe mechanical or physical conditions. Report all unsafe conditions to the proper authority.

The following safety rules are provided as a guide for the operator. However, local conditions and regulations may add many more to this list.



Read and follow all safety precautions. Failure to do so may result in serious injury or death.

SAFETY RULES

- ONLY trained and authorized personnel can operate and maintain the machine.
- Follow all safety rules, precautions and instructions when operating or performing maintenance on the machine.
- When working with another operator or a person on worksite traffic duty, be sure all personnel understand all hand signals that are to be used.
-

SAFETY FEATURES

- Be sure all guards and covers are in their proper position. Have guards and covers repaired if damaged. (See Walk-Around Inspection, Operating Instructions - Section 3)
- Learn the proper use of safety features such as safety locks, safety pins, and seat belts, and use these safety features properly.
- NEVER remove any safety features. ALWAYS keep them in good operating condition.
- Improper use of safety features could result in serious bodily injury or death.
-

CLOTHING AND PERSONAL PROTECTIVE ITEMS

- Avoid loose clothing, jewelry, and loose long hair. They can catch on controls or in moving parts and cause serious injury or death. Also, do not wear oily clothes because they are flammable.
- Wear a hard hat, safety glasses, safety shoes, mask or gloves when operating or maintaining the machine. Always wear safety goggles, hard hat and heavy gloves if your job involves scattering metal chips or minute materials—this is so particularly when driving pins with a hammer and when cleaning the air cleaner element with compressed air. Check also that there is no one near the machine.

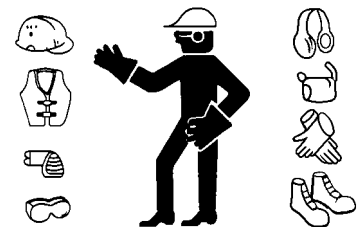

A0055010

UNAUTHORIZED MODIFICATION

- Any modification made to this vehicle without authorization from Komatsu Mining Systems, Inc. can possibly create hazards.
- Before making any modification, consult the authorized regional Komatsu Mining Systems, Inc. distributor. Komatsu will not be responsible for any injury or damage caused by any unauthorized modification.

LEAVING THE OPERATOR'S SEAT

- When preparing to leave the operator's seat, do not touch any control lever that is not locked. To prevent accidental operations from occurring, always carry out the following:
 - Move the shift control lever to the Neutral position (N) and set the parking lever/switch to the PARKING position.
 - Lower the dump body, set the dump lever to the FLOAT position.
 - Stop the engine. When leaving the machine, always lock everything. Always remember to take the key with you. If the machine should suddenly move or move in an unexpected way, this may result in serious bodily injury or death.

MOUNTING AND DISMOUNTING

- NEVER jump on or off the machine. NEVER get on or off a moving machine.
- When getting on or off the machine, face the machine and use the handhold and steps.
- Never hold any control levers when getting on or off the machine.
- Always maintain three-point contact with the handholds and steps to ensure that you support yourself.
- When bringing tools to the operator's compartment, always pass them by hand or pull them up by rope.
- If there is any oil, grease, or mud on the handholds or steps, wipe it off immediately. Always keep these parts clean. Repair any damage and tighten any loose bolts.
- Use the handrails and steps marked by arrows in the diagram below when getting on or off the machine.

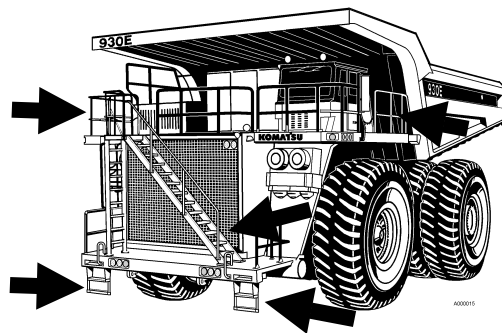

FIRE PREVENTION FOR FUEL AND OIL

- Fuel, oil, and antifreeze can be ignited by a flame. Fuel is particularly FLAMMABLE and can be HAZARDOUS.
- Keep flame away from flammable fluids.
- Stop the engine and do not smoke when refueling.
- Tighten all fuel and oil tank caps securely.
- Refueling and oiling should be made in well ventilated areas.
- Keep oil and fuel in the determined place and do not allow unauthorized persons to enter.



A0055020



A0055030



A0055040

PRECAUTIONS WHEN HANDLING AT HIGH TEMPERATURES

- Immediately after operations, the engine cooling water, engine oil, and hydraulic oil are at high temperature and are under pressure. If the cap is removed, or the oil or water is drained, or the filters are replaced, there is danger of serious burns. Always wait for the temperature to cool down, and carry out the operation according to the specified procedure.
- To prevent hot water from spurting out:
 - 1) Stop the engine.
 - 2) Wait for the water temperature to cool down.
 - 3) Turn the cap slowly to release the pressure before removing the cap.
- To prevent hot engine oil from spurting out:
 - 1) Stop the engine.
 - 2) Wait for the oil temperature to cool down.
 - 3) Turn the cap slowly to release the pressure before removing the cap.

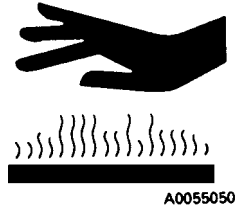

ASBESTOS DUST HAZARD PREVENTION

Asbestos dust can be HAZARDOUS to your health if it is inhaled.

If you handle materials containing asbestos fibers, follow these guidelines as given below:

- NEVER use compressed air for cleaning.
- Use water for cleaning to keep down the dust.
- Operate the machine with the wind to your back, whenever possible.
- Use an approved respirator if necessary.

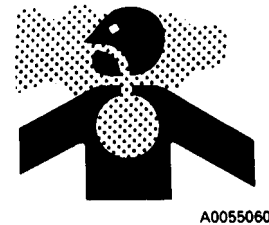

PREVENTION OF INJURY BY WORK EQUIPMENT

- Never enter or put your hand or arm or any other part of your body between movable parts such as the dump body and chassis or cylinders. If the work equipment is operated, the clearance will change and this may lead to serious bodily injury or death.

FIRE EXTINGUISHER AND FIRST AID KIT

- Be sure fire extinguishers have been provided and know how to use them.
- Provide a first aid kit at the storage point.
- Know what to do in the event of a fire.
- Be sure you know the phone numbers of persons you should contact in case of an emergency.

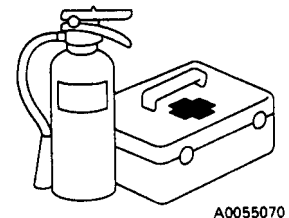

PRECAUTIONS WHEN USING ROPS

- If ROPS is installed, the ROPS must never be removed when operating the machine.
- The ROPS is installed to protect the operator if the machine should roll over. It is designed not only to support the load if the machine should roll over, but also to absorb the impact energy.
- The ROPS installed on equipment manufactured and designed by Komatsu Mining Systems, Inc. fulfills all of the regulations and standards for all countries, but if it is modified or repaired without authorization from Komatsu Mining Systems, Inc., or is damaged when the machine rolls over, the strength will drop and it will not be able to fulfill its function properly. It can only display its performance if it is repaired or modified in the specified way.
- When modifying or repairing the ROPS, always consult the authorized regional Komatsu Mining Systems, Inc. distributor.
- Even if the ROPS is installed, it cannot show its full effect if the operator does not fasten the seat belt properly. Always fasten the seat belt when operating.

PRECAUTIONS FOR ATTACHMENTS

- When installing and using optional equipment, read the instruction manual for the attachment and the information related to attachments in this manual.
- Do not use attachments that are not authorized by Komatsu Mining Systems, Inc., or the authorized regional Komatsu Mining Systems, Inc. distributor. Use of unauthorized attachments could create a safety problem and adversely affect the proper operation and useful life of the machine.
- Any injuries, accidents, and product failures resulting from the use of unauthorized attachments will not be the responsibility of Komatsu Mining Systems, Inc., or the authorized regional Komatsu Mining Systems, Inc. distributor.

PRECAUTIONS DURING OPERATION

SAFETY IS THINKING AHEAD

Prevention is the best safety program. Prevent a potential accident by knowing the employer's safety requirements and all necessary job site regulations. In addition, know the proper use and care of all the safety equipment on the truck. Only qualified operators or technicians should attempt to operate or maintain the Komatsu Truck.

Safe practices start before the operator gets to the equipment!

SAFETY AT WORKSITE

- When walking to and from the truck, maintain a safe distance from all machines even if the operator is visible.
- Before starting the engine, thoroughly check the area for any unusual conditions that could be dangerous.
- Examine the road surface in the jobsite and determine the best and safest method of operation.
- Choose an area where the ground is as horizontal and firm as possible before carrying out the operation.
- If you need to operate on a road, protect pedestrians and cars by designating a person for worksite traffic duty or by installing fences around the worksite.
- The operator must check personally the work position, roads to be used, and existence of obstacles before starting operations.
- Always determine the travel roads in the worksite and maintain them so that it is always safe for the machines to travel.
- If travel through wet areas is necessary, check the depth and flow of water before crossing the shallow parts. NEVER be in water which is in excess of the permissible water depth.

FIRE PREVENTION

- Thoroughly remove wood chips, leaves, paper and other flammable things accumulated in the engine compartment. These could cause a fire.
- Check fuel, lubrication, and hydraulic systems for leaks. Have any leaks repaired. Wipe up any excess oil, fuel or other flammable fluids.
- Be sure a fire extinguisher is present and working.
- Do not operate the machine near any flame.



A005502C

PREPARING FOR OPERATION

- Always mount and dismount facing the truck. Never attempt to mount or dismount the truck while it is in motion. Always use handrails and ladder when mounting or dismounting from the truck.
- Check the deck areas for debris, loose hardware or tools. Check for people and objects that might be in the way.
- Become familiar with and use all protective equipment devices on the truck and insure that these items (anti-skid material, grab bars, seat belts, etc.) are securely in place.

VENTILATION FOR ENCLOSED AREAS

- If it is necessary to start the engine within an enclosed area, provide adequate ventilation. Exhaust fumes from the engine can KILL.



A0055060

IN OPERATOR'S CAB - BEFORE STARTING ENGINE

- Do not leave tools or spare parts lying around in the operator's compartment or allow trash to accumulate in cab of truck. Keep all unauthorized reading material out of truck cab.
- Keep the cab floor, controls, steps, and handrails free of oil, grease, snow, and excess dirt.
- Check the seat belt, buckle and hardware for damage or wear. Replace any worn or damaged parts. Always use seat belts when operating your machine.
- Read and understand the contents of this manual. Read the Section 3 pertaining to safety and operating instructions with special attention. Become thoroughly acquainted with all gauges, instruments and controls before attempting operation of the truck.
- Read and understand the **WARNING** and **CAUTION** decals in the operator's cab.
- Insure steering wheel, horn, controls and pedals are free of any oil, grease or mud.
- Check operation of windshield wiper, condition of wiper blades, and check washer reservoir for fluid level.
- Be familiar with all steering and brake system controls and warning devices, road speeds and loading capabilities, before operating the truck.

KEEP MIRRORS, WINDOWS, AND LIGHTS CLEAN

- Remove any dirt from the surface of the windshield and all cab windows and lights. Good visibility may prevent an accident.
- Adjust the rear view mirror to a position where the operator can see best from the operator's seat, and keep the surface of the mirror clean. If any glass or light should break, replace it with a new part.
- Insure headlights, worklights and taillights are in proper working order. Check that the machine is equipped with the head lamps and working lamps needed for the operating conditions.

OPERATING THE MACHINE

WHEN STARTING ENGINE

- NEVER start the engine if a warning tag has been attached to the control.
- When starting the engine, sound the horn as an alert.
- Start and operate the machine only while seated.
- Do not allow any person other than the operator in the operator's compartment or any other place on the machine.

Truck Operation - General

- **WEAR SEAT BELTS AT ALL TIMES.**
- Only authorized persons are allowed to ride in truck. Riders should be in cab only and belted in passenger seat.
- Do not allow anyone to ride on decks or steps of truck.
- Do not allow anyone to get on or off truck while it is in motion.
- Do not move truck into or out of a building without a signal person present.
- Know and obey the hand signal communications between operator and spotter. When other machines and personnel are present, the operator should move in and out of buildings, loading areas and through traffic, under the direction of a signal person. **Courtesy at all times is a safety precaution!**
- Report immediately to supervisor any conditions on haul road, pit or dump area that may cause an operating hazard.

- Check for flat tires periodically during shift. If truck has been run on a “flat”, **it must not be parked in a building until the tire cools.**
If tire must be changed, do not stand in front of rim and locking ring when inflating tire mounted on the machine. Observers should not be permitted in the area and should be kept away from the side of such tires.

⚠ DANGER

Tire and rim assembly may explode if subjected to excessive heat. Personnel should move to a remote or protected location if sensing excessively hot brakes, smell of burning rubber or evidence of fire near tire and wheel area.

If the truck must be approached, such as to fight a fire, those personnel should do so only while facing the tread area of the tire (front or back), unless protected by use of large heavy equipment as a shield. Stay at least 50 ft. (15 m) from the tread of the tire.

In the event of fire in the tire and wheel area (including brake fires), stay away from the truck at least 8 hours or until the tire and wheel are cool.

- Keep serviceable fire fighting equipment at hand. Report used extinguishers for replacement or refilling.
- Always have parking brake applied when the truck is parked and unattended. **DO NOT** leave truck unattended while engine is running.
- When parking, park a safe distance from other vehicles as determined by supervisor.
- Stay alert at all times! In the event of an emergency, be prepared to react quickly and avoid accidents. If an emergency arises, know where to get prompt assistance.

CHECK WHEN TRAVELING IN REVERSE

Before operating the machine or work equipment, do as follows:

- Sound the horn to warn people in the area. For machines equipped with a back-up alarm, check that the alarm works properly.
- Check that there is no one near the machine. Be particularly careful to check behind the machine.
- If necessary, designate a person to check the safety. This is particularly necessary when traveling in reverse.
- When operating in areas that may be hazardous or have poor visibility, designate a person to direct worksite traffic.
- Do not allow any one to enter the line of travel of the machine. This rule must be strictly observed even on machines equipped with a back-up alarm or rear view mirror.

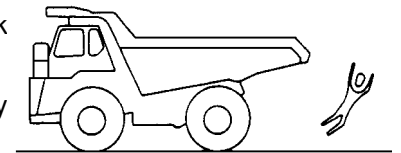

AE132050

TRAVELING

- When traveling on rough ground, travel at low speed. When changing direction, avoid turning suddenly.
- Lower the dump body and set the dump lever to the FLOAT position when traveling.
- If the engine should stop when the machine is traveling, the emergency steering system will be activated. Apply the brakes immediately and stop the machine as quickly and safely as possible, and off the haul road, if possible.

TRAVELING ON SLOPES

- Traveling on slopes could result in the machine tipping over or slipping.
- Do not change direction on slopes. To ensure safety, go down to level ground before turning.
- Do not travel up and down on grass, fallen leaves, or wet steel plates. These materials may make the machine slip on even the slightest slope. Take all possible steps to avoid traveling sideways, and always keep the travel speed low.
- When traveling downhill, use the retarder to reduce speed. Do not turn the steering wheel suddenly. Do not use the foot brake except in an emergency.
- If the engine should stop on a slope, apply the brakes fully and apply the parking brake to stop the machine.

ENSURE GOOD VISIBILITY

- When working in dark places, install working lamps and head lamps, and set up lighting in the work area if necessary.
- Stop operations if the visibility is poor, such as in mist, snow, or rain, and wait for the weather to improve to a condition that allows the operation to be carried out safely.

OPERATE CAREFULLY ON SNOW

- When working on snowy or icy roads, there is danger that the machine may slip to the side on even the slightest slope, so always travel slowly and avoid sudden starting, turning, or stopping.
- Be extremely careful when carrying out snow-clearing operations. The road shoulder and other objects are buried in the snow and cannot be seen. When traveling on snow-covered roads, always install tire chains.

AVOID DAMAGE TO DUMP BODY

- When working in tunnels, on bridges, under electric cables, or when entering a parking place or any other place where there are height limits, always drive extremely carefully and lower the dump body completely before driving the machine.

DO NOT GO CLOSE TO HIGH-VOLTAGE CABLES

- Going close to high-voltage cables can cause electric shock. Always maintain the safe distance given below between the machine and the electric cable.

Voltage	Min. Safety Distance	
6.6 kV	3 m	10 ft
33.0 kV	4 m	14 ft
66.0 kV	5 m	17 ft
154.0 kV	8 m	27 ft
275.0 kV	10 m	33 ft

- The following actions are effective in preventing accidents:
 - 1) Wear shoes with rubber or leather soles.
 - 2) Use a signalman to give warning if the machine approaches too close to the electric cable.
- If the work equipment should touch the electric cable, the operator should not leave the operator's compartment.
- When carrying out operations near high voltage cables, do not let anyone come close to the machine.
- Check with the electrical maintenance department about the voltage of the cables before starting operations.

WHEN DUMPING

- Before starting the dumping operation, check that there is no person or object behind the machine.
- Stop the machine in the correct position, and check again that there is no person or object behind the machine. Give the determined signal, then slowly operate the dump body. If necessary, use blocks for the wheels or position a flagman.
- When carrying out dumping operations on slopes, the machine stability will become poor and there is danger that it may tip over. Always carry out such operations extremely carefully.
- Do not travel with the dump body raised.

WORKING ON LOOSE GROUND

- Avoid operating the machine too close to the edge of cliffs, overhangs, and deep ditches. If these areas collapse, the machine could fall or tip over and result in serious injury or death. Remember that the soil after heavy rain or blasting is weakened in these areas.
- Earth laid on the ground and the soil near ditches is loose. It can collapse under the weight or vibration of the machine. Avoid these areas, if possible.

WHEN LOADING

- Check that the surrounding area is safe, stop the machine in the correct loading position, then load the body uniformly.
- Do not leave the operator's seat during the loading operation.

PARKING THE MACHINE

- Choose a horizontal road surface to park the machine. If the machine has to be parked on a slope, always put blocks under all the wheels to prevent the machine from moving.
- When parking on public roads, provide fences and signs, such as flags or lights, on the machine to warn pedestrians and other vehicles. Be sure that the machine, flags, or lights do not obstruct the traffic.
- Before leaving the machine, lower the dump body fully, set the parking lever to the PARKING position, stop the engine, then lock everything. Always take the key with you.

TOWING

WHEN TOWING, FIX WIRE TO HOOK

- Towing in the wrong way may lead to serious personal injury or damage.
- When using another machine to tow this machine, use a towing device with ample strength for the weight of this machine.
- Never tow a machine on a slope.
- Do not use any towing rope that has kinks or is twisted.
- Do not stand astride the towing cable or wire rope.
- When connecting a machine that is to be towed, do not let any one come between the towing machine and the machine that is being towed.
- Set the coupling of the machine being towed in a straight line with the towing portion of the machine, and secure it in position.
(For towing method, see Section 3, "Operating Instructions, TOWING".)

BATTERY

BATTERY HAZARD PREVENTION

- Battery electrolyte contains sulfuric acid and can quickly burn the skin and eat holes in clothing. If you spill acid on yourself, immediately flush the area with water.
- Battery acid could cause blindness if splashed into the eyes. If acid gets into the eyes, flush them immediately with large quantities of water and see a doctor at once.
- If you accidentally drink acid, drink a large quantity of water or milk, beaten egg or vegetable oil. Call a doctor or poison prevention center immediately.
- When working with batteries ALWAYS wear safety glasses or goggles.
- Batteries generate hydrogen gas. Hydrogen gas is very EXPLOSIVE, and is easily ignited with a small spark of flame.
- Before working with batteries, stop the engine and turn the starting switch to the OFF position.
- Avoid short-circuiting the battery terminals through accidental contact with metallic objects, such as tools, across the terminals.
- When removing or installing, check which is the positive (+) terminal and negative (-) terminal.
- Tighten the battery cap securely.
- Tighten the battery terminals securely. Loosened terminals can generate sparks and lead to an explosion.

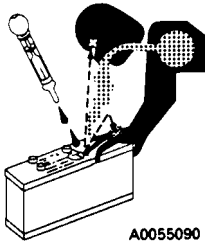

STARTING WITH BOOSTER CABLES

- ALWAYS wear safety glasses or goggles when starting the machine with booster cables.
- When starting from another machine, do not allow the two machines to touch.
- Be sure to connect the positive (+) cable first when installing the booster cables. Disconnect the ground or negative (-) cable first when removing them.
- If any tool touches between the positive (+) terminal and the chassis, it will cause sparks. This is dangerous, so be sure to work carefully.
- Connect the batteries in parallel: positive to positive and negative to negative.
- When connecting the ground cable to the frame of the machine to be started, be sure to connect it as far as possible from the battery.

INCORRECT

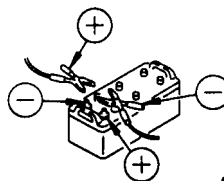

PRECAUTIONS FOR MAINTENANCE

BEFORE CARRYING OUT MAINTENANCE

WARNING TAG

- If others start the engine or operate the controls while you are performing service or lubrication, you could suffer serious injury or death.
- ALWAYS attach the WARNING TAG to the control lever in the operator's cab to alert others that you are working on the machine. Attach additional warning tags around the machine, if necessary.
- These tags are available from your Komatsu distributor. (Part No. 09963-03000)



PROPER TOOLS

- Use only tools suited to the task.
Using damaged, low quality, faulty, or makeshift tools could cause personal injury.



A0055120

STOPPING THE ENGINE BEFORE SERVICE

- When carrying out inspection or maintenance, always stop the machine on firm flat ground, lower the dump body, then stop the engine.
- If the engine must be run during service, such as when cleaning the radiator, always move the shift control lever to the Neutral (N) position and set the parking brake lever to the PARKING position. Always carry out the work with two people. One person should sit on the operator's seat to stop the engine if necessary. NEVER move any controls not needed to operate.
- When servicing the machine, be careful not to touch any moving part or get clothing caught.
- Put blocks under the wheels.
- When carrying out service with the dump body raised, always place the dump lever at the HOLD position, and apply the lock (if equipped). Install the body-up safety pins (or cable) securely.

DURING MAINTENANCE

PERSONNEL

- Only authorized personnel can service and repair the machine. Extra precaution should be used when grinding, welding, and using a sledge-hammer.

ATTACHMENTS

- Place attachments that have been removed from the machine in a safe place so that they do not fall. If they fall on you or others, serious injury could result.

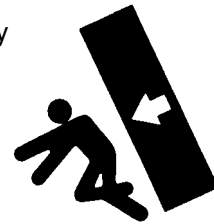

A0055130

WORK UNDER THE MACHINE

- Always lower all movable work equipment to the ground or to their lowest position before performing service or repairs under the machine.
- Always block the tires of the machine securely.
- Never work under the machine if the machine is poorly supported.



A0055140

KEEP THE MACHINE CLEAN

- Spilled oil or grease, or scattered tools or broken pieces are dangerous because they may cause you to slip or trip. Always keep your machine clean and tidy.
- If water gets into the electrical system, there is danger that the machine may not move or may move unexpectedly. Do not use water or steam to clean the sensors, connectors, or the inside of the operator's compartment.

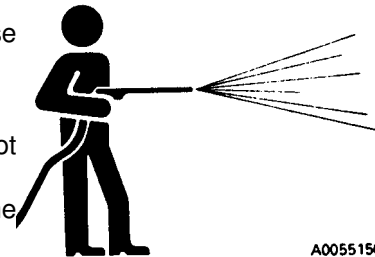

A0055150

RULES TO FOLLOW WHEN ADDING FUEL OR OIL

- Spilled fuel and oil may cause slipping. Always clean up spills immediately.
- Always tighten the cap of the fuel and oil fillers securely.
- Never use fuel for washing any parts.
- Always add fuel and oil in a well-ventilated place.



A0055020

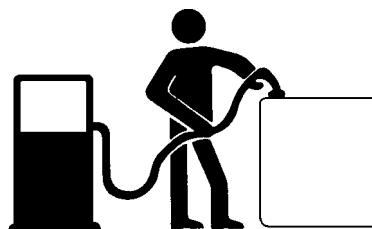

A0055030



A0055040

RADIATOR WATER LEVEL

- If it is necessary to add water to the radiator, stop the engine and allow the engine and radiator to cool down before adding the water.
- Slowly loosen the cap to relieve pressure before removing the cap.

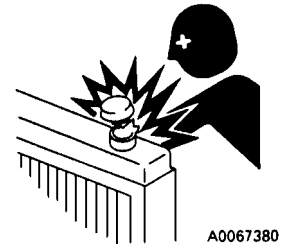

USE OF LIGHTING

When checking fuel, oil, coolant, or battery electrolyte, always use lighting with anti-explosion specifications. If such lighting equipment is not used, there is danger of explosion.



PRECAUTIONS WITH BATTERY

- When repairing the electrical system or when carrying out electrical welding, remove the negative (-) terminal of the battery to stop the flow of current.

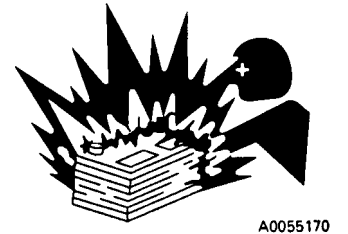

HANDLING HIGH-PRESSURE HOSES

- Do not bend high-pressure hoses or hit them with hard objects. Do not use any bent or cracked piping, tubes or hoses. They may burst during use.
- Always repair any loose or broken fuel hoses or oil hoses. If fuel or oil leaks, it may cause a fire.

PRECAUTIONS WITH HIGH PRESSURE OIL

- Do not forget that the work equipment circuits are always under pressure.
- Do not add oil, drain oil, or carry out maintenance or inspection before completely releasing the internal pressure.
- If oil is leaking under high pressure from small holes, it is dangerous if the jet of high-pressure oil hits the skin or enters the eyes. Always wear safety glasses and thick gloves, and use a piece of cardboard or a sheet of wood to check for oil leakage.
- If you are hit by a jet of high-pressure oil, consult a doctor immediately for medical attention.

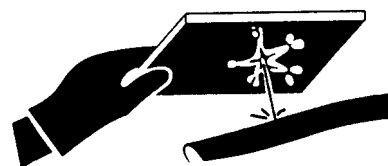

PRECAUTIONS WHEN CARRYING OUT MAINTENANCE AT HIGH TEMPERATURE OR HIGH PRESSURE

- Immediately after stopping operations, the engine cooling water and oil at all parts are at high temperature and under high pressure. In this condition, if the cap is removed, or the oil or water are drained, or the filters are replaced, it may result in burns or other injury. Wait for the temperature to go down, then carry out the inspection and maintenance in accordance with the procedures given in this manual.

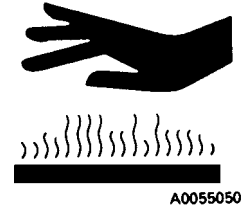

ROTATING FAN AND BELT

- Keep away from rotating parts and be careful not to let anything get caught in them.
- If your body or tools touch the fan blades or fan belt, they may be cut off or sent flying, so never touch any rotating parts.

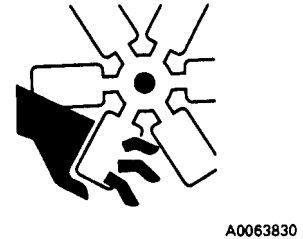

WASTE MATERIALS

- Never dump waste oil in a sewer system, rivers, etc.
- Always put oil drained from your machine in containers. Never drain oil directly on the ground.
- Obey appropriate laws and regulations when disposing of harmful objects such as oil, fuel, coolant, solvent, filters, batteries, and others.

INCORRECT

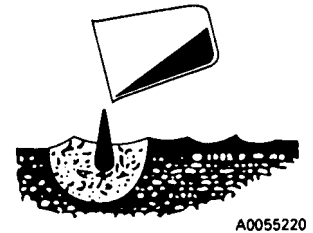

TIRES

HANDLING TIRES

If tires are not used under the specified conditions, they may overheat and burst or be cut and burst by sharp stones on rough road surfaces. This may lead to serious injury or damage.

To maintain safety, always keep to the following conditions:

- Inflate the tires to the specified pressure. Abnormal heat is generated particularly when the inflation pressure is too low.
- Use the specified tires.

The tire inflation pressure and permissible speeds are general values. The actual values may differ depending on the type of tire and the condition under which they are used. For details, please consult the tire manufacturer.

If the tires become hot, a flammable gas is produced, and this may ignite. It is particularly dangerous if the tires become overheated when the tires are under pressure. If the gas generated inside the tire ignites, the internal pressure will suddenly rise, and the tire will explode, and this may lead to serious personal injury. Explosions differ from punctures or tire bursts, because the destructive force is extremely large. Therefore, the following operations are strictly prohibited when the tire is under high internal pressure:

- Welding the rim
- Building fires or carrying out welding near the wheel or tire.

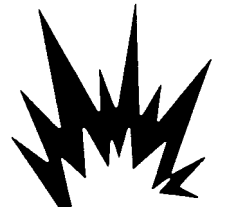

A0055110

If the proper procedure for carrying out maintenance or replacement of the wheel or tire is not used, the wheel or tire may burst and cause serious injury or damage. When carrying out such maintenance, please consult the authorized regional Komatsu Mining Systems, Inc. distributor, or the tire manufacturer.

STORING TIRES AFTER REMOVAL

- As a basic rule, store the tires in a warehouse which unauthorized persons cannot enter. If the tires are stored outside, always erect a fence around the tires and put up "No Entry" and other warning signs that even young children can understand.
- Stand the tire on level ground, and block it securely so that it cannot roll or fall over.
- If the tire should fall over, get out of the way quickly. The tires for construction equipment are extremely heavy, so trying to hold the tire may lead to serious injury.

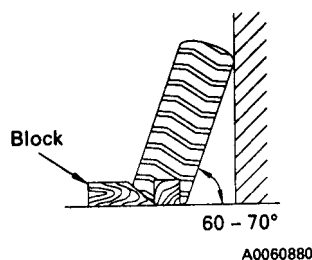

A0055130

WHEN REPAIRS ARE NECESSARY

1. Only qualified maintenance personnel who understand the systems being repaired should accomplish repairs.
2. Many components on the Komatsu Truck are large and heavy. Insure that lifting equipment - hoists, slings, chains, lifting eyes - are of adequate capacity to handle the lift.
3. **DO NOT WORK** under a suspended load. Do not work under raised body unless body safety cables, props, or pins are in place to hold the body in up position.
4. Do not repair or service truck while engine is running, except when adjustments can only be made under such conditions. **Keep a safe distance from moving parts.**
5. When servicing any air conditioning system with refrigerant, wear a face shield and cold resistant gloves for protection against freezing. Be certain to follow all current regulations for handling and recycling refrigerants.
6. Follow package directions carefully when using cleaning solvents.
7. If an auxiliary battery assist is needed, first use one cable to connect the 24V positive (+) post of the disabled truck batteries to the 24V positive (+) post of the auxiliary assist. Use second cable to connect the 24V negative (-) post of the auxiliary assist battery to a **frame ground (-)** on the disabled truck *away from the battery*.
8. Always disconnect the positive and negative battery cables of the vehicle before doing any welding on the unit. Failure to do so may seriously damage the battery and electrical equipment. Disconnect battery charging alternator lead wire and isolate electronic control components before making welding repairs. (It is not necessary to disconnect or remove any control circuit cards on Electric Drive Dump Trucks or any of the "AID" circuit control cards.)

Always fasten the welding machine ground (-) lead to the piece being welded; **grounding clamp MUST BE ATTACHED AS NEAR AS POSSIBLE to the weld area**. Never allow welding current to pass through ball bearings, roller bearings, suspensions, or hydraulic cylinders. Always avoid laying welding cables over or near the vehicle electrical harnesses. Welding voltage could be induced into the electrical harness and possibly cause damage to components.
9. If truck is to be towed for any reason, use a rigid tow bar. Check truck cab for decal recommending special towing precautions. (Also refer to Towing Procedure in OPERATING INSTRUCTIONS.)
10. Drain, clean and ventilate fuel tanks and/or hydraulic tanks before making any welding repairs.

WARNING

Any operating fluid, such as hydraulic oil or brake fluid escaping under pressure, can have sufficient force to enter a person's body by penetrating the skin. Serious injury and possibly death may result if proper medical treatment by a physician familiar with this injury is not received immediately.

11. Relieve pressure in lines or hoses before making any disconnects.
12. After adjustments or repairs, replace all shields, screens and clamps.
13. Tire Care:

WARNING

Do not stand in front of rim and locking ring when inflating tire mounted on the machine. Observers should not be permitted in the area and should be kept away from the side of such tires.

Do not weld or apply heat on the rim assembly with the tire mounted on the rim. Resulting gases inside the tire may ignite, causing explosion of tire and rim.

14. Only a qualified operator or experienced maintenance personnel who are also qualified in operation should move the truck under its own power in the repair facility or during road testing after repairs are complete.

Special Precautions for Working on a 930E Truck

Preliminary Procedures before Welding or Performing Maintenance

Prior to welding and/or repairing the 930E Dump Truck, maintenance personnel should attempt to notify the Komatsu factory representative. Only qualified personnel, specifically trained for servicing the AC Drive System, should perform this service.

If it is necessary to perform welding or repair to the truck without the field engineer present, the following procedures should be followed to ensure that the truck is safe for maintenance personnel to work on and to reduce the chance for damage to equipment.



ANYTIME THE 930E ENGINE IS RUNNING:

- ***Do not open any of the cabinet doors or remove any covers.***
- ***Do not use any of the power cables for hand holds or foot steps.***
- ***Do not touch the retarder grid elements.***



Before opening any cabinets or touching a grid element or a power cable, the engine must be shutdown.

Normal Engine Shutdown Procedure

1. Stop the truck out of the way of other traffic on a level surface (dry, if possible) and free of overhead power lines or other obstructions (in case dump body should need to be raised).
 - a. Reduce engine speed to idle.
Allow engine to cool gradually by running at low idle for 3 to 5 minutes.
 - b. Place the directional Selector Switch (2, Figure 3-4, Section 3 - Operation) in "Neutral".
 - c. Apply the Parking Brake switch (13, Figure 3-6, Section 3 - Operation).
Be sure the "Parking Brake Applied" indicator light in the overhead display panel (A3, Figure 3-7, Section 3 - Operation) is illuminated.
2. Place REST switch (26, Figure 3-6, Section 3 - Operation) in "On" position to put AC Drive System in "REST" mode of operation. Be sure the "REST" indicator light in the overhead panel (B6, Figure 3-7, Section 3 - Operation) is illuminated.
3. With engine cooled down, turn keyswitch (1, Figure 3-6, Section 3 - Operation) counterclockwise to "Off" position for normal shutdown of engine.

If engine does not shutdown with keyswitch, use Engine Shutdown Switch (8, Figure 3-4, Section 3 - Operation) on operator cab center console, and hold this switch down until engine stops.
4. With keyswitch "Off", and engine stopped, wait at least 90 seconds. Insure steering circuit is completely bled down by turning steering wheel back and forth several times. No front wheel movement will occur when hydraulic pressure is relieved.
If the vehicle continues to steer after shutdown, notify maintenance personnel.
5. Verify that all the LINK VOLTAGE lights are OFF (one on back wall of operator cab, and two on deck control cabinets), and notify maintenance personnel, if any light remains illuminated longer than five minutes after engine shutdown.
6. Close and lock all windows, remove key from keyswitch and lock cab to prevent possible unauthorized truck operation. Dismount truck properly. Put wheel chocks in place.

Engine Shutdown Procedure before Welding or Performing Maintenance

Normal operation of the drive system at shutdown should leave the system safe to maintain. However, in the event of a system failure, performing the following procedure prior to any maintenance activities will ensure that no hazardous voltages are present in the AC Drive System.

1. Before shutting down the engine, verify the status of all the drive system warning lights on the overhead display panel (Figure 3-7, Section 3 - Operation). Use the Lamp Test Switch (8, Figure 3-7, Section 3 - Operation) to verify that all lamps are functioning properly.

If any of the **RED** Drive System warning lights remain ON, do not attempt to open any cabinets, disconnect any cables, or reach inside the retarder grid cabinet without a trained drive system technician present - even if engine is shut down.

Only qualified personnel, specifically trained for servicing the AC Drive System, should perform this service.

2. If all red drive system warning lights are off, follow the "Normal Engine Shutdown Procedure".
3. After the engine has been stopped for at least five (5) minutes, inspect the LINK VOLTAGE lights on the exterior of the main control cabinet and back wall of the operator's cab (DID panel). If all lights are OFF, the retard grids, wheel motors, alternator, and power cables connecting these devices are safe to work on.
4. Locate the "GF" Cut-out switch in the access panel on the left side of the main control cabinet. Place the switch in the "Alternator Cutout" position. This will prevent the alternator from re-energizing and creating system voltage, until the switch is returned to its former position.
5. The blower motors, control cabinet and power cables connecting these devices are still unsafe. To establish that these devices are safe, open the top control cabinet cover and inspect the red lights on the blower control panel.

If these lights are OFF, the blower system, blower power cables and remainder of the control cabinet is safe to work on.

If these lights are ON, refer to steps 11 – 12.
6. Before welding on the truck, disconnect all electrical harnesses from the Engine Control System (ECS) inside the electrical cabinet behind the operator's cab. Also, disconnect the ground strap from the ECS.
7. **Do not weld on the rear of the control cabinet!** The metal panels on the back of the cabinet are part of capacitors and cannot be heated.
8. **Do not weld on the retard grid exhaust louvers** - they are made of stainless steel.
Some power cable panels throughout the truck are also made of aluminum, or stainless steel. They must be repaired with the same material, or the power cables may be damaged.
9. Power cables must be cleated in wood or other non-ferrous materials. Do not repair cable cleats by encircling the power cables with metal clamps or hardware. Always inspect power cable insulation prior to servicing the cables and prior to returning the truck to service. Discard cables with broken insulation.
10. Power cables and wiring harnesses should be protected from weld spatter and heat.

Always fasten the welding machine ground (-) lead to the piece being welded; **the grounding clamp MUST BE ATTACHED AS NEAR AS POSSIBLE to the weld area.**

Always avoid laying welding cables over or near the vehicle electrical harnesses. Welding voltage could be induced into the electrical harness and possibly cause damage to components.

Before doing any welding on the truck, always disconnect the battery charging alternator lead wire and isolate electronic control components before making welding repairs.

In addition, always disconnect the positive and negative battery cables of the vehicle. Failure to do so may seriously damage the battery and electrical equipment.

Never allow welding current to pass through ball bearings, roller bearings, suspensions, or hydraulic cylinders.

11. If the red lights on the exterior of the control cabinet and/or the back wall of the operator's cab continue to be illuminated after following the above procedure, a fault has occurred.

Leave all cabinet doors in place, do not touch the rear grid elements, do not disconnect any power cables, or use them as hand or foot holds.

Notify the KMS factory representative immediately. Only qualified personnel, specifically trained for servicing the AC Drive System, should perform this service.

12. If the red lights on the blower control panel are illuminated after following the above procedure, a fault has occurred. Reinstall the control cabinet panel. Do not perform maintenance on the blower control panel, blower motor power cables.

Notify the KMS factory representative immediately. Only qualified personnel, specifically trained for servicing the AC Drive System, should perform this service.

13. Replace all covers and doors and place the "GF" cutout switch and battery disconnect switches in their original positions, and re-connect all harnesses prior to restarting the truck.

Leave the drive system in the REST position until the truck is to be moved.

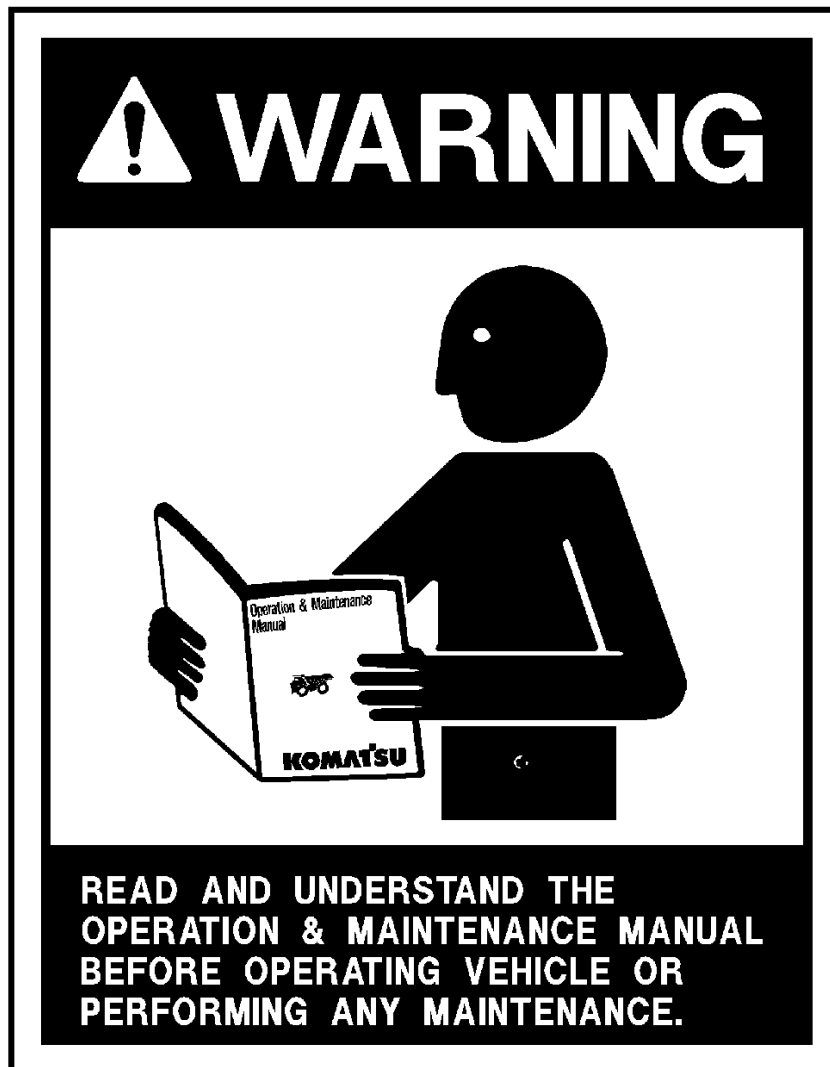

WARNINGS AND CAUTIONS

The following pages give an explanation of the Warning, Caution, and Service Instruction plates and decals attached to the truck. The plates and decals listed here are typical of this Komatsu model, but because of customer options, individual trucks may have plates and decals that are different from those shown here.

The plates and decals must be kept clean and legible. If any decal or plate becomes unable to be read or damaged, it should be replaced with a new one.

A warning decal surrounds the key switch located to the right of the steering column on the instrument panel. The warning stresses the importance of reading the operator's manual before operation.

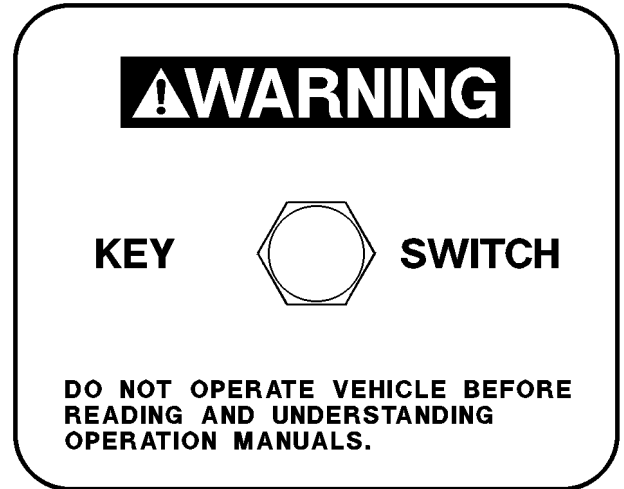

A Grade/Speed plate is located on the left front post of the operator's cab and provides the recommended MAXIMUM speeds to be used when descending various grades with a loaded truck.

Always refer to the decal in operator's cab. This decal may change with OPTIONAL truck equipment such as: wheelmotor drive train ratios, retarder grids, tire sizes, etc.

EFFECTIVE GRADE %	SPEED (CONTINUOUS)		SPEED (SHORT TERM)	
	MPH	(KM/H)	MPH	(KM/H)
12	11	(18)	15	(24)
10	14	(23)	19	(31)
8	19	(31)	23	(37)
6	29	(47)	29	(47)
4	29	(47)	36	(58)

WB2751

A plate attached to the right rear corner of the cab states the Rollover Protective Structure and Falling Object Protective Structure meets various SAE performance requirements.

! WARNING ! Do not make modifications to this structure, or attempt to repair damage without written approval from the Manufacturer. Unauthorized repairs will void certification.

ROPS/FOPS NO. **SM0460** MACHINE MODEL **930E**
 AS INSTALLED BY THE MANUFACTURER ON THIS DUMPER WITH EMPTY WEIGHT LESS THAN **180,532** kg. AND WEIGHT WITHOUT BODY LESS THAN **148,780** kg. THIS ROLLOVER PROTECTIVE STRUCTURE AND FALLING OBJECT PROTECTIVE STRUCTURE MEETS THE PERFORMANCE REQUIREMENTS OF SAE-J1040 APR88, SAE-J231 JAN 81, AND SAE-J1164 MAY 83.

! WARNING ! THE PROTECTION OFFERED MAY BE IMPAIRED IF SUBJECTED TO ANY MODIFICATIONS OR DAMAGE. TO MAINTAIN MANUFACTURERS CERTIFICATION, ANY REPAIR OR ALTERATION ON THIS STRUCTURE MUST HAVE WRITTEN APPROVAL.

Komatsu America International Co. Haulpak Division
 Peoria, Illinois U.S.A. SM2675

A warning instruction is applied below the Parking Brake and the Rear Wheel Brake Lock switches, which are located to the right of the steering column on the instrument panel. Pushing the top of the rocker-style switch turns the function ON, pushing the bottom, turns it OFF.

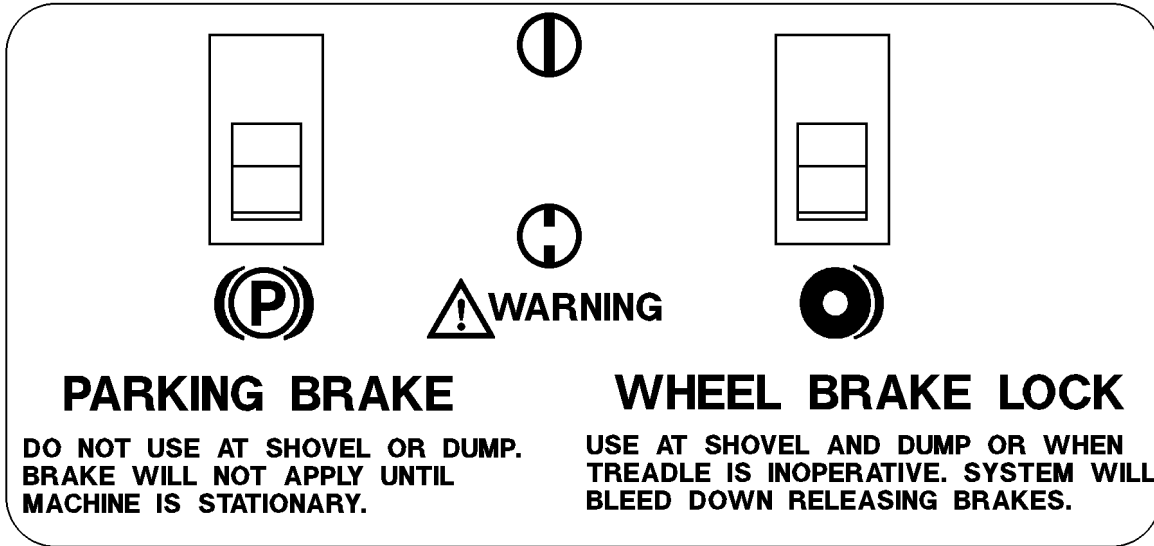

SM2729

 The **Parking Brake** is spring applied and hydraulically released. It is designed to hold a stationary truck when the engine is shutdown and keyswitch is turned "Off". The truck must be completely stopped before applying the parking brake, or damage may occur to parking brake.

To apply the parking brake, press the rocker switch toward the "On" symbol. To release the parking brake, press the rocker switch toward the "Off" symbol. When the keyswitch is "On" and Parking Brake switch is applied, the Parking Brake indicator light (A3, Overhead Panel) will be illuminated.

NOTE: Do not use the parking brake at shovel or dump. With keyswitch "on" and engine running, sudden shock caused by loading or dumping could cause the system's motion sensor to RELEASE the park brake.

 The **Wheel Brake Lock** switch is for holding the truck while parked at the shovel during loading, or while dumping. It applies the **rear service brakes only**. If the brake treadle valve does not operate, apply this brake to stop the truck. Do NOT use this brake as a parking brake when leaving the truck. With engine shut down, the hydraulic system will eventually bleed down, releasing the service brakes.

Attached to the exterior of both battery compartments is a danger plate. This plate stresses the need to keep from making any sparks near the battery. When another battery or 24VDC power source is used for auxiliary power, all switches must be "Off" prior to making any connections. When connecting auxiliary power cables, positively maintain correct polarity; connect the positive (+) posts together and then connect the negative (-) lead of the auxiliary power cable to a good frame ground. **Do not connect to the negative posts of the truck battery or near the battery box.** This hookup completes the circuit but minimizes danger of sparks near the batteries.

Sulfuric acid is corrosive and toxic. Use proper safety gear, goggles, rubber gloves and rubber apron when handling and servicing batteries. Get proper medical help immediately, if required.

This plate is placed on both battery boxes and near the battery disconnect switches to indicate that the battery system (24VDC) is a NEGATIVE (-) GROUND system.

These decals are placed above the battery disconnect switches on the right side of the front bumper to indicate "Off" and "On" positions of the switches.

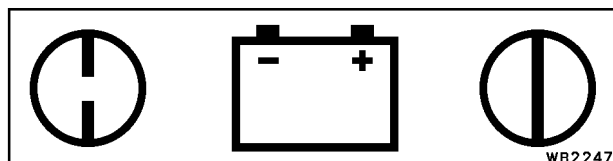
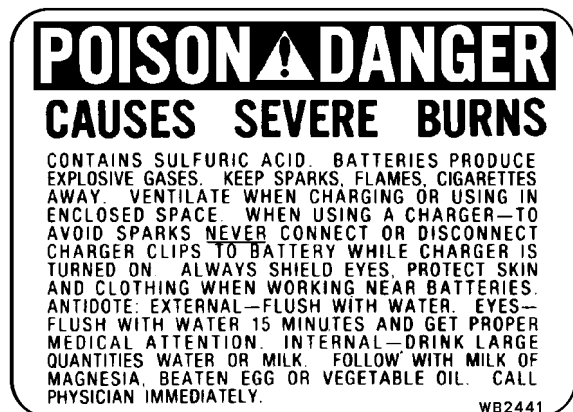

A warning plate is mounted on top of the radiator surge tank cover near the radiator cap.

The engine cooling system is pressurized. **Always turn the key switch off and allow the engine to cool before removing radiator cap.** Unless the pressure is first released, removing the radiator cap after the engine has been running for a time will result in the hot coolant being expelled from the radiator.

Serious scalding and burning can result.

Warning plates are mounted on the frame in front of, and to the rear, of both front tires. All personnel are warned that the clearances change when the truck is steered and could cause serious injury.

Warning plates are attached to both the hydraulic tank and fuel tank to alert technicians **not to work** on the truck **with the body in the raised position** unless body-up retention device (pins or cable) is in position.

These DANGER plates are mounted on the outside of each frame rail to alert technicians to read the warning labels attached to the side of each of the accumulators (see below) prior to releasing internal nitrogen pressure or disconnecting any hydraulic lines or hardware. There are similar decals mounted on top of each of the accumulators (both steering and brake) with the same DANGER message.

These WARNING decals are mounted on the side of each of the accumulators (both steering and brake) to alert technicians to discharge all gas and hydraulic pressure, and to read the maintenance/service manual prior to performing any service.

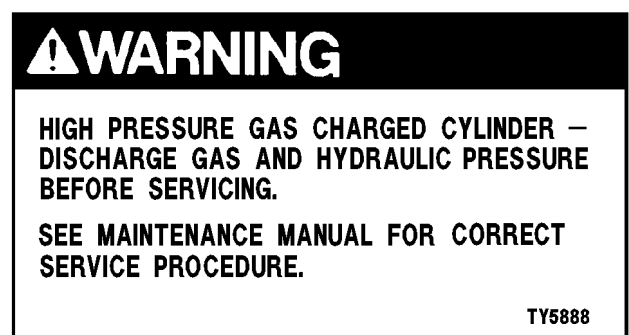
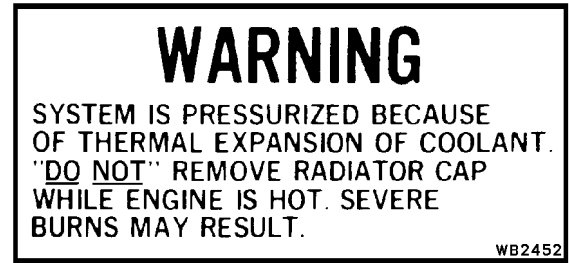

This Danger plate is attached to all four suspensions.

The plate contains instructions for releasing internal pressure before disconnecting any hardware.

Serious injury can occur if these directions are not followed.



DANGER

HIGH PRESSURE CYLINDER CHARGED WITH DRY NITROGEN

DO NOT REMOVE ANY HARDWARE INCLUDING CAPSCREWS, PLUGS, VALVE, OR VALVE CORE UNTIL ALL PRESSURE HAS BEEN RELEASED. REMOVAL OF ANY HARDWARE WHILE CYLINDER IS UNDER PRESSURE MAY RESULT IN HARDWARE FLYING VIOLENTLY FROM CYLINDER. TO RELEASE PRESSURE, REMOVE VALVE CAP, TURN TOP HEX ON VALVE THREE TURNS IN A COUNTERCLOCKWISE DIRECTION (DO NOT TURN MORE THAN THREE TURNS), THEN DEPRESS VALVE CORE. DO NOT TURN BOTTOM HEX UNTIL ALL PRESSURE HAS BEEN RELEASED.

1. CHECK OIL LEVEL ACCORDING TO INSTRUCTION MANUAL.
2. CHARGE CYLINDER WITH DRY NITROGEN GAS ONLY.

TO CHARGE CYLINDER: SEE YOUR HAULPAK® DISTRIBUTOR WHO HAS ALL TOOLS AND INFORMATION REQUIRED FOR CHARGING CYLINDERS.

WA2892

A plate on the side of the hydraulic tank furnishes instructions for filling the hydraulic tank.

Keep the system open to the atmosphere only as long as absolutely necessary to lessen chances of system contamination. Service the tank with clean Type C-4 hydraulic oil. All oil being put into the hydraulic tank should be filtered through 3 micron filters.

ATMOSPHERIC BREATHER SYSTEM

FILLING INSTRUCTIONS:

1. WITH ENGINE STOPPED, KEY SWITCH OFF AND BODY DOWN, FILL TANK TO TOP OF SIGHT GLASS.
2. RAISE AND LOWER BODY 3 TIMES.
3. REPEAT STEPS 1 AND 2 AND ADD OIL UNTIL LEVEL IS AGAIN AT TOP OF SIGHT GLASS.
4. OIL MUST BE VISIBLE IN UPPER SIGHT GLASS WITH ENGINE STOPPED. BODY DOWN AND KEY OFF FOR 90 SECONDS. OIL MUST BE VISIBLE IN LOWER SIGHT GLASS WITH ENGINE RUNNING AND BODY DOWN. REPEAT STEP 1 IF NECESSARY.

WB2724

A CAUTION decal is attached below the hydraulic tank oil level sight gauge. Check level with body down, engine stopped, and key switch "Off". Add oil per filling instructions, if oil level is below top of sight glass.



CAUTION

DO NOT ADD OIL UNLESS ENGINE IS STOPPED, KEY IS OFF, AND BODY IS DOWN

WA6628

A warning plate is attached to the hydraulic tank to inform technicians that high pressure hydraulic oil is present during operation. When it is necessary to open the hydraulic system, be sure engine is stopped and key switch is "Off" to bleed down hydraulic pressure. There is always a chance of residual pressure being present. Open fittings slowly to allow all pressure to bleed off before removing any connections.



WARNING

Any operating fluid, such as hydraulic oil, escaping under pressure can have sufficient force to enter a person's body by penetrating the skin. Serious injury and possibly death may result if proper medical treatment by a physician familiar with this injury is not received immediately.

WARNING

HIGH PRESSURE

DO NOT LOOSEN OR DISCONNECT ANY HYDRAULIC LINE OR COMPONENT UNTIL ENGINE IS STOPPED AND KEY SWITCH IS OFF.

WB2439

A wheel motor oil level decal is attached to the gear cover on both electric wheel motors. This decal stresses the fact that the truck must be on a level surface and parked for 20 minutes prior to checking the oil level. This is necessary in order to get an accurate reading.

A decal plate is located on the frame near the left hoist cylinder which provides the operator or technician with the hook-up procedure for dumping a loaded, disabled truck, by using a functional truck for hydraulic power.

Refer to the Service manual for additional instructions for using this procedure.

Warning decals are applied to both brake accumulators located inside the brake system cabinet behind the operator cab. These decals remind servicing technicians to be sure to close the accumulator drain valves after they have been opened to bleed brake pressure. It further warns not to over-tighten the drain valves to prevent damage to the valve seat(s).

This CAUTION decal is placed near the battery disconnect switches on the right side of the front bumper to alert servicing technicians that before doing any welding on the truck, always disconnect the battery charging alternator lead wire and isolate electronic control components before making welding repairs.

In addition, always disconnect the positive and negative battery cables of the vehicle. Failure to do so may seriously damage the battery and electrical equipment.

Always fasten the welding machine ground (-) lead to the piece being welded; **grounding clamp MUST BE ATTACHED AS NEAR AS POSSIBLE to the weld area**. Never allow welding current to pass through ball bearings, roller bearings, suspensions, or hydraulic cylinders. Always avoid laying welding cables over or near the vehicle electrical harnesses. Welding voltage could be induced into the electrical harness and possibly cause damage to components.

OIL FILL & CHECK PROCEDURE

**CHECK OIL LEVEL ONLY AFTER TRUCK HAS BEEN PARKED FOR 20 MINUTES. REMOVE LOWEST PLUG TO FILL AND CHECK LEVEL.
OIL LEVEL IS OK, IF OIL IS PRESENT.**

WB2444

EMERGENCY DUMP PROCEDURE

1. CONNECT A HYDRAULIC POWER SUPPLY CAPABLE OF 2500 PSI (17.2 MPa) WHICH HAS A RESERVE CAPACITY EXCEEDING 80 GAL. (303 l) TO THE QUICK DISCONNECTS ON L.H. HOIST CYLINDER.
2. PLACE HOIST VALVE IN HOLD POSITION.
3. DUMP LOAD AND LOWER BODY USING CONTROL VALVE ON HYDRAULIC POWER SUPPLY UNIT.

WB2246

WARNING

ALWAYS CLOSE DRAIN VALVES AFTER DISCHARGING ACCUMULATORS. DO NOT OVERTIGHTEN DRAIN VALVES.

WB2447

CAUTION

PRIOR TO WELDING ON TRUCK DISCONNECT LEAD WIRE ON BATTERY CHARGING ALTERNATOR

WB2442

A High Voltage Danger Plate is attached to the door of the rear hatch cover. HIGH VOLTAGE may be present!

Only authorized personnel should access this rear housing.



A CAUTION decal is also attached to the door of the rear hatch cover to alert personnel that HOT EXHAUST AIR is present and may cause injury.



This CAUTION decal is also placed around the Retarding Grid Cabinet.

These WARNING plates are mounted on all of the AC DRIVE CONTROL housings and cabinets. HIGH VOLTAGE may be present, with or without, the engine running! Only authorized personnel should access these cabinets.

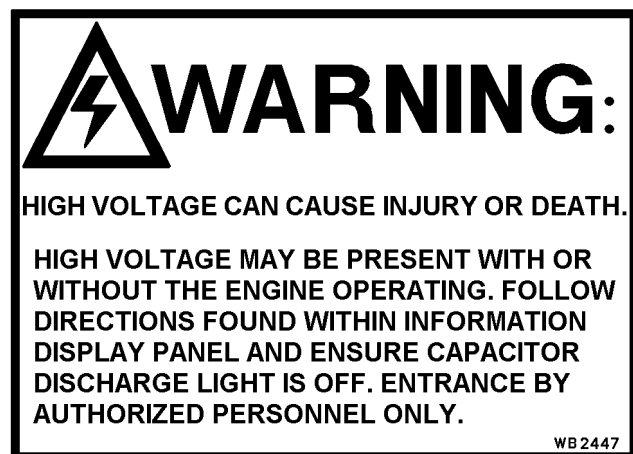

This CAUTION decal is placed on the back of the control cabinet to alert service technicians that this area contains capacitors and must not be disturbed in any manner.

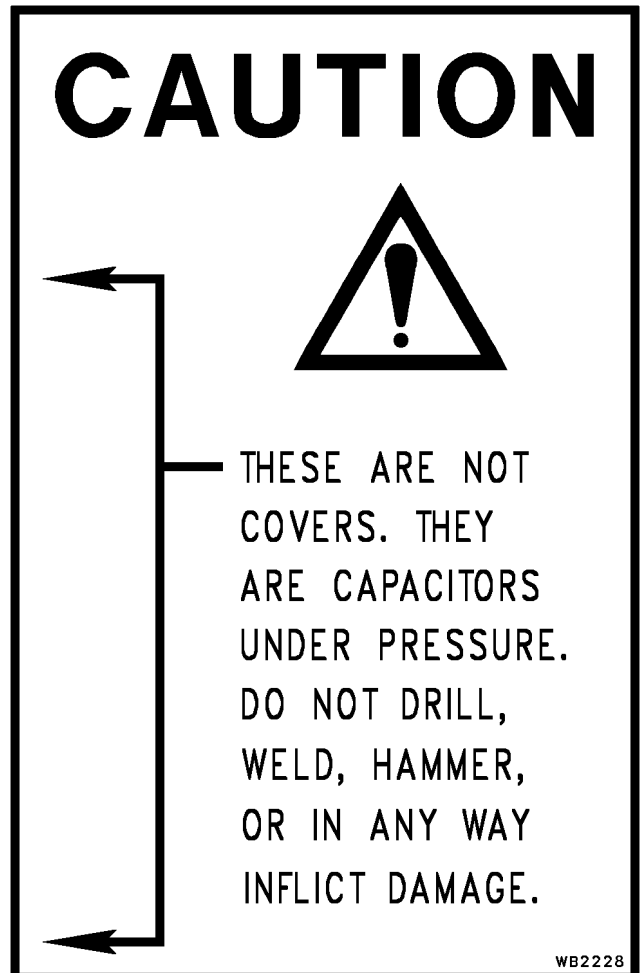

This INFORMATION decal is placed on the outside of the door panel on the control cabinet wall that faces the right side of the operator cab.

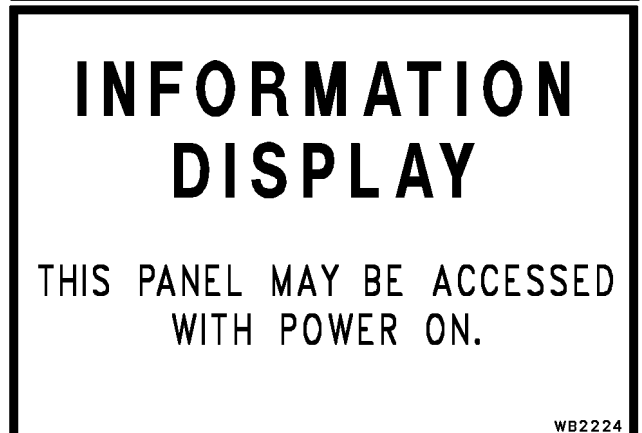

This decal is placed near three different indicator lights:

- In the operator cab, on the D.I.D. panel on the rear wall.
- On the front of the control box which is mounted on the right side of the main control cabinet.
- On the outside of the left control cabinet wall that faces the right side of the operator cab. (See also Information decal above.)

When any of these indicator lights are ON, High Voltage is present throughout the propulsion and retarding system. Extreme care should be exercised!

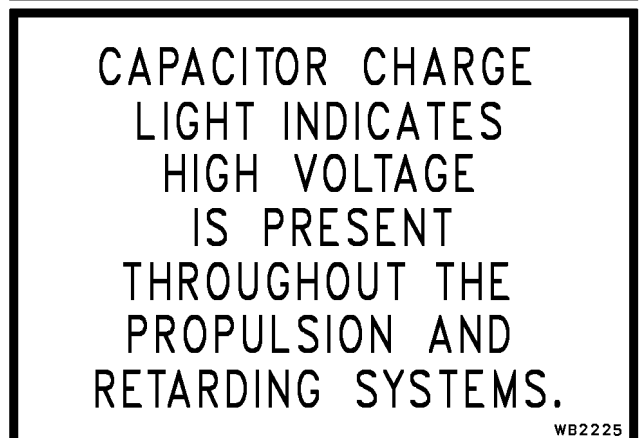

This decal is placed on the ground level engine shut-down switch which is mounted on the left side of the front bumper structure. It specifies that this switch is for emergency shutdown only.

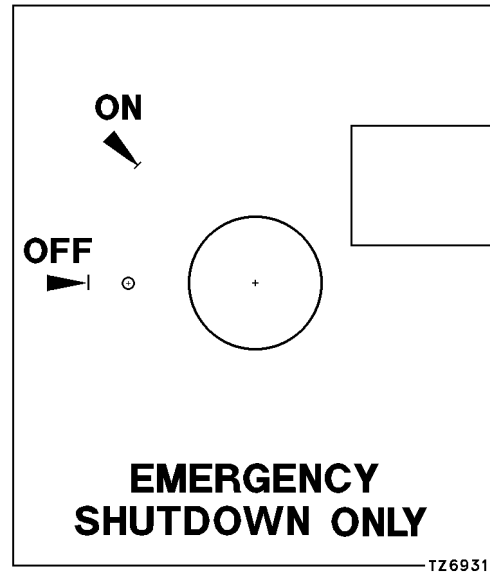

The following display illustrates a variety of decals which are mounted on deck mounted cabinets, housings, and structures which must be lifted in a specific manner, and from specific points, in order to safely move or lift any of these structures. If any of these decals are damaged or defaced, so that it is no longer legible, it should be replaced immediately. Maintenance personnel must follow these lifting instructions.

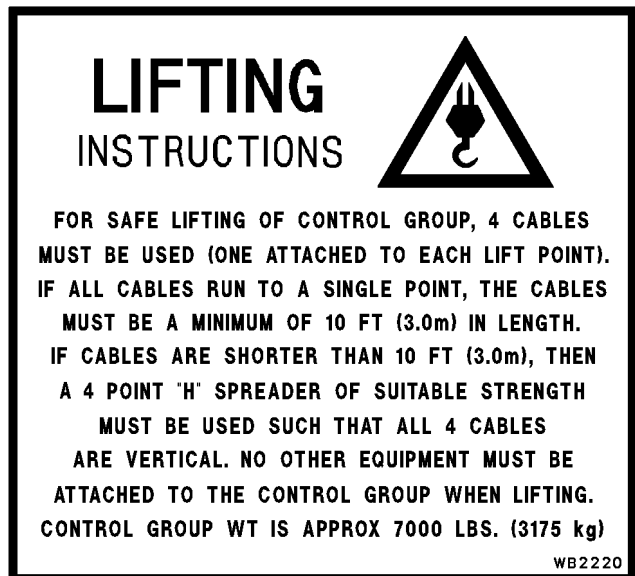
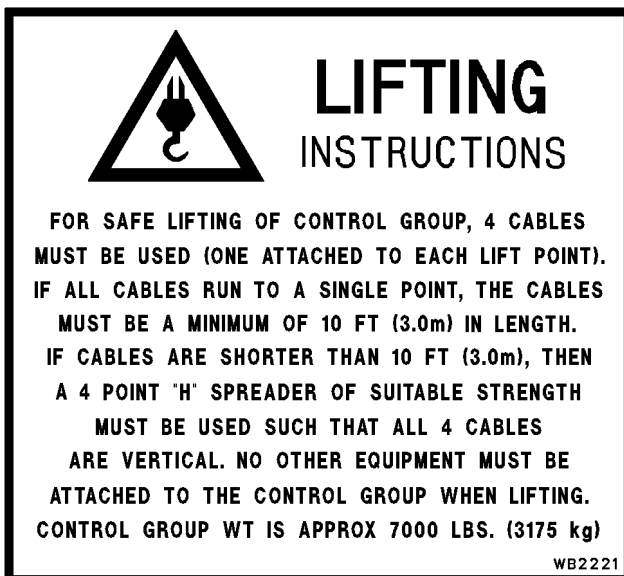
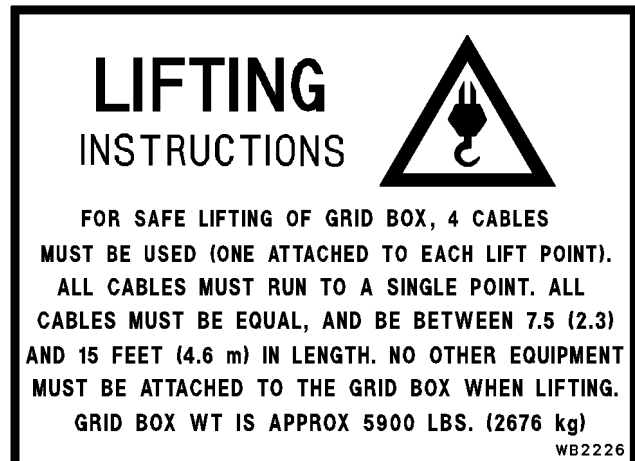
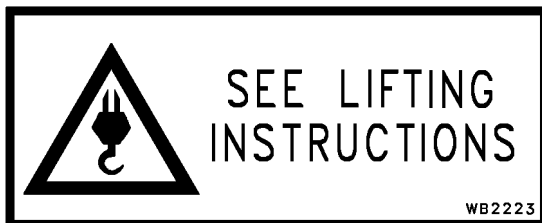
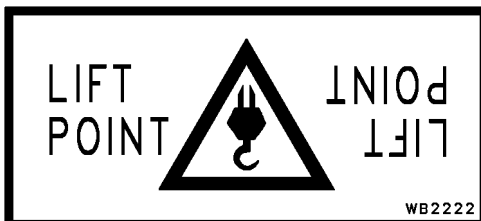

A product identification plate is located on the main frame in front of the right side front wheel and shows the Truck Model Number, Maximum G.V.W. and Product Identification Number (Truck Serial Number).

The Product Identification Number (Truck Serial Number) contains information which will identify the original manufacturing bill of material for this unit.

The complete truck serial number will be required for the proper ordering of many service parts and/or warranty consideration.

Komatsu Mining Systems, Inc.
2300 NE Adams St
Peoria, IL 61650-0240

KOMATSU

Product Identification Number

Model No. **Max. G.V.W.**

Product Identification Number

MADE IN
THE UNITED STATES OF AMERICA
DO NOT DEFACE OR REMOVE THIS PLATE

WB2399

The Lubrication Chart is mounted on the right hand side of the radiator grille structure. Refer to the "Lubrication and Service" section in this manual for more complete lubrication instructions.

LUBRICATION CHART

LUBRICATION SPECIFICATIONS													
LUBE KEY	TYPE LUBRICANT												
A	ENGINE OIL - - - - SEE ENGINE MANUAL												
B	HYDRAULIC OIL - - - - SAE 10W C - 4 - - - - AUXILIARY HEATERS REQUIRED BELOW -10°F(-23°C)												
C	HEAVY-DUTY SYNTHETIC GEAR OIL - - - - SEE DRIVE SYSTEM MANUAL												
D	MULTI - PURPOSE EXTREME PRESSURE GREASE - - - - NLGI NO.2 (5% MIN. MOLY-DISULFIDE)												
E	MULTI - PURPOSE GEAR OIL - - - - SAE 80W - 90												
SYM	DESCRIPTION	PTS	LUBE KEY	10 HR	50 HR	100 HR	250 HR	500 HR	1000 HR	2000 HR	2500 HR		
1	CRANKCASE OIL LEVEL	1	A	CHECK	SEE ENGINE MANUAL								
2	ENGINE LUBE OIL FILTERS				SEE ENGINE MANUAL								
3	FUEL FILTER				SEE ENGINE MANUAL								
4	FUEL SEPERATOR (DAVCO)				SEE ENGINE MANUAL								
5	FUEL TANK	1											
6	GE PREFILTER BREATHER	1	D										
7	FUEL TANK BREATHER	1								CLEAN			
8	HYDRAULIC OIL LEVEL	1	B	CHECK						*CHANGE			
9	HYDRAULIC STRAINER	2								CLEAN			
10	HYDRAULIC TANK BREATHER	2								CHANGE			
11	HYDRAULIC FILTERS	3			**	**	**			CHANGE			
12	MOTORIZED WHEEL OIL LEVEL	2	C		SEE DRIVE SYSTEM MANUAL								
13	HYD. PUMP DRIVE SHAFT	2	D							GREASE			
14	CHASSIS LUBE LEVEL	1	D							GREASE			
15	SEAT SLIDES & STEER SHAFT	4	D							GREASE			
16	WHEEL MOTOR BLOWER	2	D							GREASE			
17	FRONT WHEEL BEARINGS ***	2	E							CHECK	CHANGE		
18	FRONT TRUNION	1	D							GREASE			

630E, 730E, 830E, & 930E

* 1000 HR INTERVAL CAN BE EXTENDED TO 2500 HR PROVIDED OIL SAMPLING AND ANALYSIS IS CONDUCTED EVERY 250 HR.

** ONE-TIME CHANGE AT 50, 100 AND 250 HR.

*** NOT APPLICABLE FOR 930E

WB2790

NOTES

OPERATING INSTRUCTIONS

PREPARING FOR OPERATION

The safest trucks are those which have been properly prepared for operation. At the beginning of each shift, a careful check of the truck should be made by the operator before attempting to start the engine.

SAFETY IS THINKING AHEAD

Prevention is the best safety program. Prevent a potential accident by knowing the employer's safety requirements, all necessary job site regulations, as well as use and care of the safety equipment on the truck. Only qualified operators or technicians should attempt to operate or maintain the Komatsu Truck.

Safe practices start before the operator gets to the equipment!

- Wear the proper clothing. Loose fitting clothing, unbuttoned sleeves and jackets, jewelry, etc., can catch on a protrusion and cause a potential hazard.
- Always use the personal safety equipment provided for the operator such as hard hat, safety shoes, safety glasses or goggles. There are some conditions when protective hearing devices should also be worn for operator safety.
- When walking to and from the truck, maintain a safe distance from all machines even if the operator is visible.

At The Truck - Ground Level Walk Around Inspection

At the beginning of each shift, a careful walk around inspection of the truck should be made before the operator attempts engine start-up. A walk around inspection is a systematic ground level inspection of the truck and its components to insure that the truck is safe to operate before entering the operator's cab.

Start at the left front corner of the truck (see illustration, next page), and move in a counter-clockwise direction, front-to-rear, across the rear, and continuing forward up the opposite side of the truck to the original starting point.

If these steps are taken in sequence, and are repeated from the same point and in the same direction before every shift, many potential problems may be avoided, or scheduled for maintenance. UNSCHEDULED downtime and loss of production can be reduced.

Local work practices may prevent an operator from performing all tasks suggested here, but to the extent permitted, the operator should follow this or similar routine.

! DANGER ! HIGH VOLTAGE MAY BE PRESENT ON THIS TRUCK! DO NOT OPEN ANY ELECTRICAL CABINET DOORS ON THIS TRUCK WHEN THE ENGINE IS RUNNING! NEVER CLIMB ON ANY POWER CABLES OR USE POWER CABLES FOR HANDHOLDS OR FOOTHOLDS, UNLESS THE ENGINE HAS BEEN SHUT DOWN AND SYSTEM HAS BEEN VERIFIED AT "REST"!

1. Start at left front of truck. While performing the walk around inspection, visually inspect all lights and safety equipment for external damage from rocks or misuse. Make sure lenses are clean and unbroken.
Empty the dust pans on the left side air cleaner assemblies. Be sure battery box covers are in place and secure.
2. Move behind the front of the left front tire, inspect the hub and brake assemblies for leaks and any abnormal conditions.
Check that all suspension attaching hardware is secure and inspect mounting key area for evidence of wear. Check that the suspension extension (exposed piston rod) is correct, and that there are no leaks.
3. With engine stopped, check engine oil level. If dark, turn on service light.
4. Inspect air conditioner belts for correct tension, obvious wear, and tracking. Inspect fan guard for security and condition. When leaving this point, be sure to turn off service light, if used.
5. Inspect anchor end of steering cylinder for proper greasing and for security.

START HERE

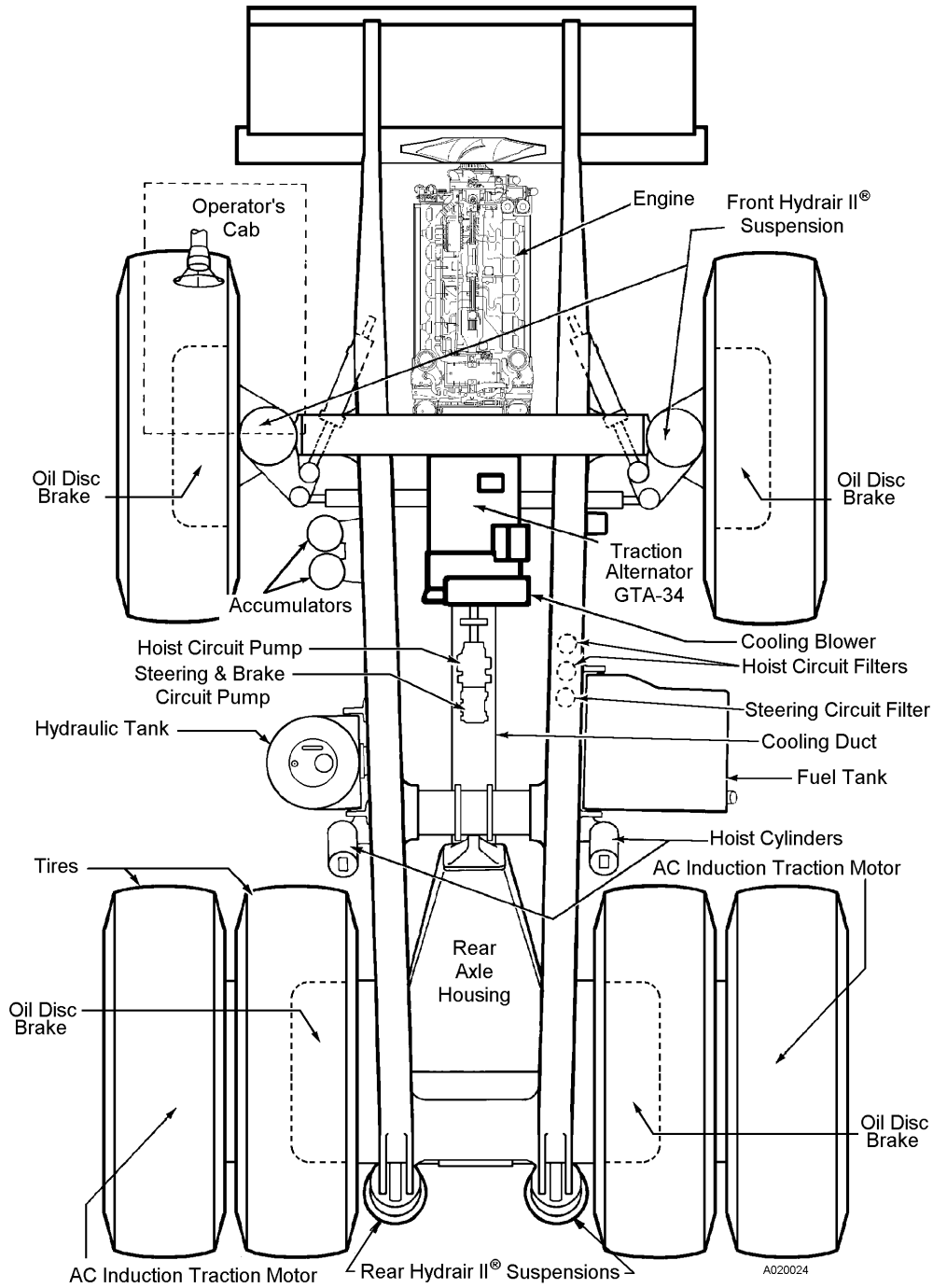

6. Move outboard of the front wheel, and inspect attaching nuts/studs to be sure all are tight and complete. Check tires for cuts, damage or "bubbles" and that inflation appears to be correct.
7. Move behind the rear of the front wheel, inspect for leaks at hub or brakes or any unusual conditions. Inspect wheel speed sensor and harness. Inspect suspension hardware to be sure it is all in place. Inspect live end of steering cylinder for proper greasing, and for security of all parts. Inspect for any hydraulic leaks.
8. Inspect sight glass on hydraulic tank. With engine stopped and body down, hydraulic fluid must be visible in lower sight glass.
9. Move on around the hydraulic tank and in front of the rear dual tires, inspect the hoist cylinder for any damage and leaks, also that lower guard is in place. Inspect both upper and lower hoist cylinder pins for security, and for proper greasing.
10. Before leaving this position, look under the lower edge of the chassis to be sure the flexible duct that carries the air from the main blower to the final drive housing is in good condition with no holes or breakage. Also look up at the main hydraulic pumps to see that there is no leakage or any other unusual condition with pumps or pump drive shafts.
11. Move on around the dual tires, check to see that all nuts/studs are in place and tight. Inspect wheel for any leakage that would indicate brake leakage, or wheel motor leakage.

Check dual tires for cuts, damage or "bubbles" and that inflation appears to be correct. If truck has been run on a "flat", **the tire must be cooled before parking truck inside**. Inspect for any rocks that might be lodged between dual tires, and that rock ejector is in good condition and straight so that it can not damage a tire.
12. Inspect left rear suspension for damage and for correct rod exposure, and that there are no leaks. See that covers over the chromed piston rod are in good condition and inspect for proper greasing.
13. Open rear hatch cover. Inspect for leaks around the parking brakes, and that there are no rags or tools left behind. Inspect condition of cooling air exhaust ductwork to be certain that it is intact and that there are no obstructions.
14. While standing in front of rear hatch, look up to see that rear lights are in good condition, along with dual backup horns. Look up at panhard rod to see that it is getting proper greasing. Also look at both body hinge pins for greasing and any abnormal condition. Check hoist limit switch and clear any mud/debris from contacts.
15. Perform the same inspection on the right rear suspension as done on the left.
16. Move on around the right dual tires, inspect between the tires for rocks, and for condition of the rock ejector, inspect the tires for cuts or damage, and for correct inflation.
17. Perform the same inspection for wheel nuts/studs and wheel leaks that was done on the left hand dual wheels.
18. Move in front of right dual tires, and inspect the hoist cylinder the same as was done on the left side.
Check security and condition of bodyup limit switch. Remove any mud/dirt accumulation from switch.
19. Move on around the fuel tank, inspect the fuel quantity gauge, (this should agree with what will show on the gauge in the cab). Inspect the attaching hardware for the fuel tank at the upper saddles, and then at the lower back of the tank for the security and condition of the mounts. Check hoist filters for leaks.
20. Move in behind the right front wheel, and inspect the steering cylinder, suspension attaching hardware and suspension extension, as well as greasing and attaching hardware for the steering cylinder. Inspect the hub and brakes for leaks and any unusual condition. Inspect wheel speed sensor and harness. Be sure the suspension protective boot is in good condition.
21. Move out and around the right front wheel, inspect that all nuts/studs are in place and tight.
22. Move in behind the front of the right front wheel, check hub and brakes for leaks and any unusual condition. Inspect wheel speed sensor and harness. Inspect steering cylinder for security and for proper greasing. Inspect the engine compartment for any leaks and unusual condition. Inspect the fan guard, and belts also for any rags or debris behind radiator. Turn work light off, if used, and secure the ladder up and latched.
23. Inspect auto lube system. See Maintenance Section 4 for specific details concerning auto lube system.
24. Move on around to the right front of the truck, drop the air cleaner pans to remove dirt, latch up and secure. Inspect battery box cover for damage and be sure it is in place and secure.

25. As you move in front of the radiator, inspect for any debris that might be stuck in front of the radiator and remove it. Check for any coolant leaks. Inspect all head and fog lights.
26. Before climbing ladder to first level, be sure ground level engine shutdown switch is "ON". Inspect fire control actuator to be sure safety pin is in place and plastic tie that prevents accidental actuation is in place and in good condition. Be sure battery disconnect switches are "ON". Always use grab rails and ladder when mounting or dismounting from the truck. Clean ladder and hand rails of any foreign material, such as ice, snow, oil or mud.

CAUTION

Always mount and dismount ladders facing the truck. Never attempt to mount or dismount while the truck is in motion.

27. Use stairs and handrails while climbing from first level to cab deck.
28. When checking coolant in radiator, use coolant level sight gauge (if equipped) or observe coolant level through opening in end of hood. If it is necessary to remove radiator cap, shut down engine (if running), and relieve coolant pressure SLOWLY, before removing radiator cap.

WARNING

If engine has been running, allow coolant to cool, before removing the fill cap or draining radiator. Serious burns may result if coolant is not allowed to cool.

29. Inspect covers over retarding grids to be sure latches are in place and secure. Inspect main air inlet to be sure it is clear. Be sure all cabinet door latches are secure.
30. Move on around the cab to the back, open the doors to the brake cabinet, inspect for leaks. Before latching doors, turn work lights off, if used.
31. Clean cab windows and mirrors; clean out cab floor as necessary. Insure steering wheel, controls and pedals are free of any oil, grease or mud.
32. Stow personal gear in cab so that it does not interfere with any operation of the truck. Dirt or trash buildup, specifically in the operator's cab, should be cleared. Do not carry tools or supplies in cab of truck or on the deck.
33. Adjust seat and steering wheel so that it is comfortable for use.
34. Read and understand the OPERATOR CONTROLS AND INSTRUMENT PANEL discussion in this section. Be familiar with all control locations and functions BEFORE operating truck.

ENGINE START-UP SAFETY PRACTICES

1. Insure all personnel are clear of truck before starting engine. Always sound the horn as a warning before actuating any operational controls. If the truck is in an enclosure, insure adequate ventilation before start-up.
Exhaust fumes are dangerous!
2. Be sure parking brake switch is in "On" position. Check and insure Selector Switch is in "Neutral" before starting.
Place REST switch in "On" position (put drive system in "REST" mode of operation).
Refer to discussion of REST SWITCH (26, Figure 3-6), in "Instrument Panel & Indicator Switches" section.
3. If truck is equipped with auxiliary cold weather heater system(s), do not attempt to start engine while heaters are in operation.
Damage to coolant heaters will result.

4. The keyswitch is a three position (Off, Run, Start) switch. When switch is rotated one position clockwise, it is in the "Run" position and all electrical circuits (except "Start") are activated.
 - a. Turn keyswitch to "Run" (not "Start") position.
 - b. With Selector Switch in "Neutral", rotate keyswitch fully clockwise to "Start" position, and hold this position until engine starts. "Start" position is spring-loaded to return to "Run" when key is released.
 - c. After engine has started, place REST switch in "Off" position (de-activate the "REST" mode of operation). Refer to discussion of REST SWITCH (26, Figure 3-6), in "Instrument Panel & Indicator Switches" section.

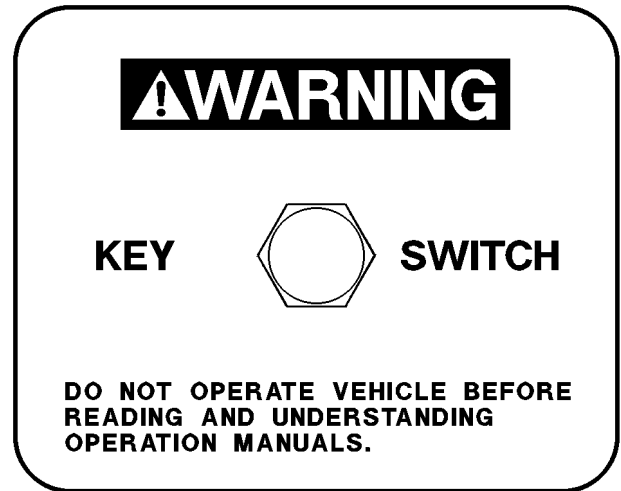

Cold Weather Starting

Do not crank an electric starter for more than 30 seconds.
Allow two minutes for cooling before attempting to start engine again.
Severe damage to starter motor can result from overheating.

AFTER ENGINE HAS STARTED

1. Become thoroughly familiar with steering and emergency controls. After engine has started and low pressure and warning systems are normal, test the truck steering in extreme right and left directions. If the steering system is not operating properly, shut engine down immediately. Determine the steering system problem and have repairs made before resuming operation.
2. Operate each of the truck's brake circuits at least twice prior to operating and moving the truck. These circuits include individual activation from the operator's cab of the service brake, parking brake, and brake lock. With the engine running and with the hydraulic circuit fully charged, activate each circuit individually. If any application or release of any brake circuit appears sluggish or improper, or if warning alarms are activated on application or release, shut the engine down and notify maintenance personnel. Do not operate truck until brake circuit in question is fully operational.
3. Check gauges, warning lights and instruments before moving the truck to insure proper system operation and proper instrument functioning. Give special attention to braking and steering circuit hydraulic warning lights. If warning lights come on, shut down the engine immediately and determine the cause.
4. Insure headlights, worklights and taillights are in proper working order. Good visibility may prevent an accident. Check operation of windshield wiper.
5. When truck body is in dump position, do not allow anyone beneath it unless body-up retaining pin or cable is in place.
6. Do not use the fire extinguisher for any purpose other than putting out a fire! If extinguisher is discharged, report the occurrence so the used unit can be refilled or replaced.
7. Do not allow unauthorized personnel to ride in the truck. Do not allow anyone to ride on the ladder of the truck.
8. Do not leave truck unattended while engine is running. Shut down engine and apply park brake before getting out of cab.

MACHINE OPERATION SAFETY PRECAUTIONS

After the truck engine is started and all systems are functioning properly, the operator must follow all local safety rules to insure safe machine operation.



If any of the red warning lights come “On” or if any gauge reads in the red area during truck operation, a malfunction is indicated. Stop truck as soon as safety permits, shut down engine if problem indicates and have problem corrected before resuming truck operation.



Truck is equipped with “Slip/Slide” control. If this function should become inoperative, operating truck with stalled or free spinning wheel motors may cause serious damage to wheel motors! If truck does not begin to move within 10 seconds after depressing throttle pedal (Selector Switch in a drive position), release throttle pedal and allow wheels to regain traction before accelerating engine again.

1. Always look to the rear before backing the truck. Watch for and obey ground spotter's hand signals before making any reverse movements. Sound the warning horn (3 blasts). Spotter should have a clear view of the total area at the rear of the truck.
2. Operate the truck only while properly seated with seat belt fastened. Keep hands and feet inside the cab compartment while truck is in operation.
3. Check gauges and instruments frequently during operation for proper readings.
4. Observe all regulations pertaining to the job site's traffic pattern. Be alert to any unusual traffic pattern. Obey the spotter's signals.
5. Match the truck speed to haul road conditions and slow the truck in any congested area. Keep a firm grip on steering wheel at all times.
6. Do not allow engine to run at “Idle” for extended periods of time.
7. Check parking brake periodically during shift. Use parking brake **ONLY** for parking. Do not use park brake for loading / dumping.
Do not attempt to apply parking brake while truck is moving!



Do not use “Brake Lock” or “Emergency Brake” (if equipped) for parking. With engine stopped, hydraulic pressure will bleed down, allowing brakes to release!

8. Check brake lock performance periodically for safe loading and dump operation.
9. Proceed slowly on rough terrain to avoid deep ruts or large obstacles. Avoid traveling close to soft edges and the edge of fill area.
10. Truck operation requires concentrated effort by the driver. Avoid distractions of any kind while operating the truck.

MACHINE OPERATION ON THE HAUL ROAD

1. Always stay alert! If unfamiliar with the road, drive with extreme caution.
Cab doors should remain closed at all times if truck is in motion or unattended.
2. Obey all road signs. Operate truck so it is under control at all times. Govern truck speed by the road conditions, weather and visibility. Report haul road conditions immediately. Muddy or icy roads, pot holes or other obstructions can present hazards.
3. Initial propulsion with a loaded truck should begin from a level surface whenever possible, but when there are circumstances where starting on a hill or grade cannot be avoided, use the **“STARTING ON A GRADE WITH A LOADED TRUCK”** procedure (next page).
4. When backing the truck, give backup signal (three blasts on the horn); when starting forward, two blasts on the horn. These signals must be given each time the truck is moved forward or backward.

5. Use extreme caution when approaching a haul road intersection. Maintain a safe distance from oncoming vehicles.
6. Maintain a safe distance when following another vehicle. Never approach another vehicle from the rear, in the same lane, closer than 50 ft. (15 m). When driving on a down grade, this distance should not be less than 100 ft. (30 m).
7. Do not stop or park on a haul road unless unavoidable. If you must stop, move truck to a safe place, apply parking brake, and shut down engine before leaving cab. Block wheels securely and notify maintenance personnel for assistance.
8. Before starting up or down a grade, maintain a speed that will insure safe driving and provide effective retarding under all conditions. Refer to Grade/Speed decal in operator's cab.
9. When operating truck in darkness, or when visibility is poor, do not move truck unless all headlights, clearance lights, and tail lights are on. Do not back truck if backup horn or lights are inoperative. Always dim headlights when meeting oncoming vehicles.
10. If the "Emergency Steering" light and/or "Low Brake Pressure Warning" light (*if equipped*) illuminate during operation, steer the truck **immediately** to a safe stopping area, away from other traffic if possible. Refer to item 7 above.
11. Check tires for proper inflation periodically during shift. If truck has been run on a "flat", or under-inflated tire, **it must not be parked in a building until the tire cools.**

STARTING ON A GRADE WITH A LOADED TRUCK

Initial propulsion with a loaded truck should begin from a level surface whenever possible, but when there are circumstances where the starting on a hill or grade cannot be avoided, use the following procedure:

1. Fully depress the foot-operated retarder/service brake pedal (do NOT use retarder lever) to hold the truck on the grade. With service brakes fully applied, move the selector switch to a drive position (Forward/Reverse) and increase engine RPM with throttle pedal.
2. As engine RPM approaches maximum, and operator senses propulsion effort working against the brakes, release the brakes and let truck movement start. Be sure to completely release the foot-operated retarder/service brake pedal. As truck speed increases above 3-5 MPH (5-8 KPH) the Propulsion System Control (PSC) will drop propulsion, if the retarder is still applied. Releasing and reapplying dynamic retarding during a hill start operation will result in loss of propulsion.

PASSING

1. Do not pass another truck on a hill or blind curve!
2. Before passing, make sure the road ahead is clear. If a disabled truck is blocking your lane, slow down and pass with extreme caution.
3. Use only the areas designated for passing.

LOADING

1. Pull into the loading area with caution. Remain at a safe distance while truck ahead is being loaded.
2. Do not drive over unprotected power cables.
3. When approaching or leaving a loading area, watch out for other vehicles and for personnel working in the area.
4. When pulling in under a loader or shovel, follow "Spotter" or "Shovel Operator" signals. The truck operator may speed up loading operations by observing the location and loading cycle of the truck being loaded ahead, then follow a similar pattern.
5. When being loaded, operator should stay in truck cab with engine running. Place Selector Switch in "Neutral" and apply Wheel Brake Lock.
6. When loaded, pull away from shovel as quickly as possible but with extreme caution.

DUMPING

1. Pull into dump area with extreme caution. Make sure area is clear of persons and obstructions, including overhead utility lines. Obey signals directed by the spotter, if present.

Avoid unstable areas. Stay a safe distance from edge of dump area.

Position truck on a solid, level surface before dumping.

! DANGER

As body raises, the truck Center of Gravity (CG) will move. Truck must be on level surface to prevent tipping / rolling!

2. Carefully maneuver truck into dump position. When backing truck into dump position, use only the foot-operated brake pedal to stop and hold truck; **DO NOT** rely on Wheel Brake Lock to stop truck; this control is unmodulated and applies REAR SERVICE BRAKES ONLY.
3. When truck is stopped and in dump position, apply Wheel Brake Lock and move the Selector Switch to the "Neutral" position.

To Raise dump body:

! WARNING

The dumping of very large rocks (10% of payload, or greater) or sticky material (loads that do not flow freely from the body) may allow the material to move too fast and cause the body to move RAPIDLY and SUDDENLY. This sudden movement may jolt the truck violently and cause possible injury to the operator, and/or damage to the hoist cylinders, frame, and/or body hinge pins. If it is necessary to dump this kind of material, refer to the CAUTION in the following procedure:

4. Pull the lever to the rear to actuate hoist circuit. (Releasing the lever anywhere during "hoist up" will place the body in "hold" at that position.)
5. Raise engine RPM to accelerate hoist speed. Refer to the CAUTION below.

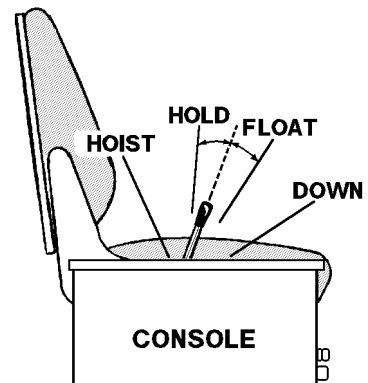

! CAUTION

If dumping very large rocks or sticky material as described in WARNING above, slowly accelerate engine RPM to raise body. When the material starts to move, release hoist lever to "HOLD" position. If material does not continue moving and clear body, repeat this procedure until material has cleared body.

6. Reduce engine RPM as last stage of hoist cylinder begins to extend and let engine go to low idle as last stage reaches half-extension.
7. Release hoist lever as last stage of hoist cylinder reaches full extension.
8. After material being dumped clears body, lower body to frame.

To Lower Body

(When dumping over a berm or into a crusher):

9. Move hoist lever forward to "down" position and release. Releasing the lever places hoist control valve in the "float" position allowing the body to return to frame.

NOTE: If dumped material builds up at the rear of the body and the body cannot be lowered, perform steps "a" & "b" below:

- a. Move hoist lever back to the "hoist" position to fully raise the dump body. Then release the hoist lever so it returns to the "hold" position.

NOTE: **DO NOT** drive forward if the tail of body will not clear the crusher wall in the fully raised position.

- b. Shift Selector Switch to "Forward", release Brake Lock, depress Override button and drive forward to clear the material. Stop, shift Selector Switch to "Neutral", apply Brake Lock and lower body again.

*NOTE: Failure to "hoist" the body after making an unsuccessful attempt at lowering the body may result in the dump body **suddenly lowering** after the truck has pulled ahead of the material that was previously preventing the body from lowering.*



CAUTION! *The truck is not to be moved with the dump body raised except for emergency moves only. Failure to lower body before moving truck may cause damage to hoist cylinders, frame and/or body hinge pins.*



To Lower Body

(When dumping on flat ground):

It is very likely when dumping on flat ground that the dumped material will build up enough to prevent the body from lowering. In this case, the truck will have to be driven forward a short distance (just enough to clear the material) before the body can be lowered.

- a. Shift Selector Switch to "Forward", release Brake Lock, depress Override button and drive just far enough forward for body to clear material. Stop, shift Selector Switch to "Neutral", apply Brake Lock.
- b. Move hoist lever forward to "down" position and release. Releasing the lever places hoist control valve in the "float" position allowing the body to return to frame.

NOTE: If dumped material builds up at the rear of the body and the body cannot be lowered, then perform steps "c" and "d" below:

- c. Move hoist lever back to the "hoist" position to fully raise the dump body. Then release the hoist lever so it returns to the "hold" position.
- d. Shift Selector Switch to "Forward", release Brake Lock, depress Override button and drive forward to clear the material. Stop, shift Selector Switch to "Neutral", apply Brake Lock and lower body again.

*NOTE: Failure to "hoist" the body after making an unsuccessful attempt at lowering the body may result in the dump body **suddenly lowering** after the truck has pulled ahead of the material that was previously preventing the body from lowering.*



CAUTION! *The truck is not to be moved with the dump body raised except for emergency moves only. Failure to lower body before moving truck may cause damage to hoist cylinders, frame and/or body hinge pins.*



10. With body returned to frame, move Selector Switch to "Forward", release Brake Lock, and leave dump area carefully.

TOWING

Prior to towing a truck, many factors must be carefully considered. Serious personal injury and/or significant property damage may result if important safety practices, procedures and preparation for moving heavy equipment are not observed.

Do not tow the truck any faster than 5 MPH (8 kph).

A disabled machine may be towed after the following MINIMUM precautions have been taken.

1. Shut down engine.
2. If truck is equipped, install hydraulic connections for steering and dumping between towing and towed vehicles. Check towed vehicle for braking system.
3. Inspect tow bar for adequacy (approximately 1.5 times the gross vehicle weight of truck being towed).
4. Determine that towing vehicle has adequate capacity to both move and stop the towed truck under all conditions.

TOWING - Continued

5. Protect both operators in the event of tow bar failure.
6. Block disabled truck to prevent movement while attaching tow bar.
7. Release disabled truck brakes and remove blocking.
8. Sudden movement may cause tow bar failure. Smooth and gradual truck movement is preferred.
9. Minimize tow angle at all times - NEVER EXCEED 30°. The towed truck must be steered in the direction of the tow bar.

SAFE PARKING PROCEDURES

The operator must continue the use of safety precautions when preparing for parking and engine shutdown.

In the event that the equipment is being worked in consecutive shifts, any questionable truck performance the operator may have noticed must be checked by maintenance personnel before the truck is released to another operator.

1. The truck should be parked on level ground, if at all possible. If parking must be done on a grade, the truck should be positioned at right angles to the grade.
2. The parking brake must be applied and/or chocks placed fore/aft of wheels so that the truck cannot roll. Each truck should be parked at a reasonable distance from another.
3. Haul roads are not safe parking areas. In an emergency, pick the safest spot most visible to other machines in the area. If the truck becomes disabled where traffic is heavy, mark the truck with warning flags in daylight or flares at night.

NORMAL ENGINE SHUTDOWN PROCEDURE

The following procedure should be followed at each engine shutdown.

1. Stop the truck out of the way of other traffic on a level surface and free of overhead power lines or other obstructions (in case dump body should need to be raised).
 - a. Reduce engine speed to idle. Allow engine to cool gradually by running at low idle for 3 to 5 minutes.
 - b. Place the directional Selector Switch (2, Figure 3-4) in "Neutral".
 - c. Apply the Parking Brake switch (13, Figure 3-6). Be sure the "Parking BrakeApplied" indicator light in the overhead display panel (A3, Figure 3-7) is illuminated.
2. Place REST switch (26, Figure 3-6) in "On" position to put AC Drive System in "REST" mode of operation. Be sure the "REST" indicator light in the overhead panel (B6, Figure 3-7) is illuminated.

NOTE: The truck is equipped with a Timer Delay to allow the engine to run at idle for 5 minutes before Engine Shutdown, if this option is desired, refer to DELAYED ENGINE SHUTDOWN PROCEDURE (next page).

3. With engine cooled down, turn keyswitch (1, Figure 3-6) counterclockwise to "Off" position for normal shutdown of engine.

If engine does not shutdown with keyswitch, use Engine Shutdown Switch (8, Figure 3-4) on operator cab center console, and hold this switch down until engine stops.

4. With keyswitch "Off", and engine stopped, wait at least 90 seconds. Insure steering circuit is completely bled down by turning steering wheel back and forth several times. No front wheel movement will occur when hydraulic pressure is relieved. If the vehicle continues to steer after shutdown, notify maintenance personnel.
5. Verify that all the LINK VOLTAGE lights are OFF (one on back wall of operator cab, and two on deck control cabinets), and notify maintenance personnel, if any light remains illuminated longer than five minutes after engine shutdown.
6. Close and lock all windows, remove key from keyswitch and lock cab to prevent possible unauthorized truck operation. Dismount truck properly. If available, put wheel chocks in place.

DELAYED ENGINE SHUTDOWN PROCEDURE

1. Stop the truck out of the way of other traffic on a level surface and free of overhead power lines or other obstructions (in case dump body should need to be raised).
 - a. Reduce engine speed to low idle.
 - b. Place the directional Selector Switch (2, Figure 3-4) in "Neutral".
 - c. Apply the Parking Brake switch (13, Figure 3-6). Be sure the "Parking BrakeApplied" indicator light in the overhead display panel (A3, Figure 3-7) is illuminated.
2. Place REST switch (26, Figure 3-6) in "On" position to put AC Drive System in "R ST" mode of operation. Be sure the "REST" indicator light in the overhead panel (B6, Figure 3-7) is illuminated.
3. Refer to INSTRUMENT PANEL AND INDICATOR LIGHTS section for location on instrument panel of **Engine Shutdown Switch with 5 Minute Idle Timer Delay** (2, Figure 3-6). This is a 3-position rocker-type switch (Off-On-Momentary).

- a. Press top of switch to the "On" (center position), then press firmly to the "Momentary" (upper position) and hold this position briefly to activate the 5 Minute Idle Timer (switch is spring-loaded to return to "On" position when released).

At the SAME time while holding the "Momentary" switch position, turn the Keyswitch counterclockwise to the "Off" position.

When the engine stops after the 5 minute idle period, the hydraulic bleeddown timer will be activated and turn off the 24 VDC electric circuits controlled by the keyswitch.

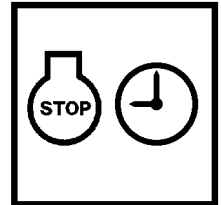

Engine WILL NOT SHUT DOWN, if keyswitch is not turned "Off" in this manner.

NOTE : To cancel the 5 Minute Idle Timer sequence, press Timer Delay Shutdown switch to the "Off" (lower) position.

- If keyswitch is in "Off" position, engine will stop.
- If keyswitch is in "On" position, engine will continue to run.

If engine does not shutdown with keyswitch, use Engine Shutdown Switch (8, Figure 3-4) on operator cab center console, and hold this switch down until engine stops. The Ground Level Shutdown Switch will also stop the engine during this time-out.

- b. When the Engine Shutdown Timer has been activated, the Timer Delay indicator light in the overhead display panel (C4, Figure 3-7) will illuminate to indicate that the shutdown timing sequence has been started. The engine will continue to run at Idle RPM for approximately 5 minutes to allow for proper engine cool-down before stopping.

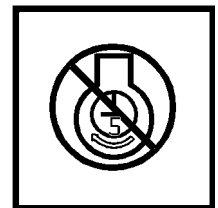

- c. After engine has stopped, perform steps 4, 5, and 6, in "NORMAL ENGINE SHUTDOWN PROCEDURE" above.

SUDDEN LOSS OF ENGINE POWER

Bring the truck to a safe stop as quickly as possible by using the foot pedal to apply the service brakes.



***Dynamic retarding will not be available !
Do not use the service brakes for continuous retarding purposes.***

If possible, steer the truck to the side of the road while bringing it to a complete stop. Apply the parking brake as soon as the truck has stopped moving. Turn key switch "Off" and notify maintenance personnel immediately.

If the truck becomes disabled where traffic is heavy, mark the truck with warning flags in daylight or flares at night.

If the engine suddenly stops, there is enough hydraulic pressure stored in the brake and steering accumulators to allow the operation of the steering and brake functions. However, this oil supply is limited so it is important to stop the truck as quickly and safely as possible after the loss of engine power. If the brake supply pressure drops to a pre-determined level, the "Low Brake Pressure" warning light will illuminate and a buzzer will sound. If the brake pressure continues to decrease, the "Auto-Apply" feature will activate and the service brakes will apply automatically to stop the truck. Apply parking brake as soon as the truck comes to a complete stop.

Reserve Engine Oil System (Optional)

The reserve oil tank for the engine is designed to add more oil capacity to the engine and to make less frequent servicing of the engine oil. The circulation of oil between the engine sump and reserve tank increases the total volume of working oil. This dilutes the effects of contamination and loss of additives and maintains the oil quality over longer periods. A filter in the supply circuit protects the pumping unit and prevents transfer of contaminants to the engine sump which might enter the tank during servicing. It also gives an added level of oil cleanup.

Operation

Engine oil is circulated between the engine sump and the reserve tank by two electrically driven pumps within a single pumping unit (11). The pump unit is mounted on the side of the reserve tank. The pump unit is equipped with an LED monitor light on one side.

Pump 1 (in the pump unit) draws oil from the engine sump at a preset control point (determined by the height of the suction tube). Oil above this point is withdrawn and transferred to the reserve tank (9). This lowers the level in the engine sump until air is drawn.

Air reaching the pumping unit activates Pump 2 (in the pump unit) which returns oil from the reserve tank and raises the engine sump level until air is no longer drawn by Pump 1. Pump 2 then turns "Off". The running level is continuously adjusted at the control point by alternation between withdrawal and return of oil at the sump.

LED Monitor Light

- Steady - Pump 1 is withdrawing oil from the engine sump and bringing down the oil level.
- Regular Pulsing - Pump 2 is returning oil to the engine sump and raising the oil level.
- Irregular Pulsing - Oil is on the correct running level.

Changing Oil

Drain both the engine sump and the reserve tank. Refill both engine and reserve tank with new oil to proper levels.

Change engine and reserve tank filters as required.

Start engine and check for proper operation.

NOTE: Do not use the oil in the reserve tank to fill the engine sump. Both must be at proper level before starting engine.

The engine oil level should be checked with the engine dipstick at every shift change. If the oil level in the engine is incorrect, check for proper operation of the reserve engine oil system.

The oil level in the reserve tank must also be checked at every shift change. Oil must be visible in the middle sight gauge (12). If not, add oil to the reserve tank by using the quick fill system utilizing the tank fill pump (3). For filling instructions, refer to the "Lubrication and Service" section.

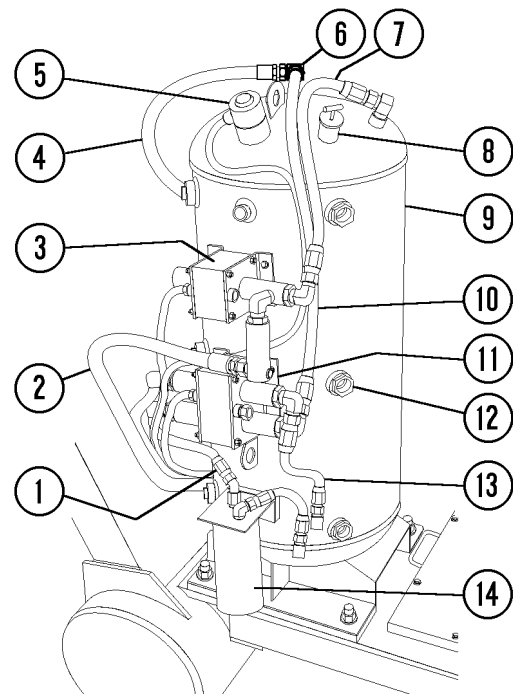

M310001

RESERVE ENGINE OIL SYSTEM

- | | |
|---------------------|----------------------|
| 1. Oil Suction | 8. Fill Cap |
| 2. Oil Tank Fill | 9. Reserve Oil Tank |
| 3. Fill Valve | 10. Engine Fill Line |
| 4. Engine Fill Line | 11. Pump Unit |
| 5. Oil Level Sensor | 12. Sight Gauge |
| 6. Air Valve | 13. Tank Return Line |
| 7. Tank Fill Line | 14. Oil Filter |

NOTES:

OPERATOR CAB AND CONTROLS

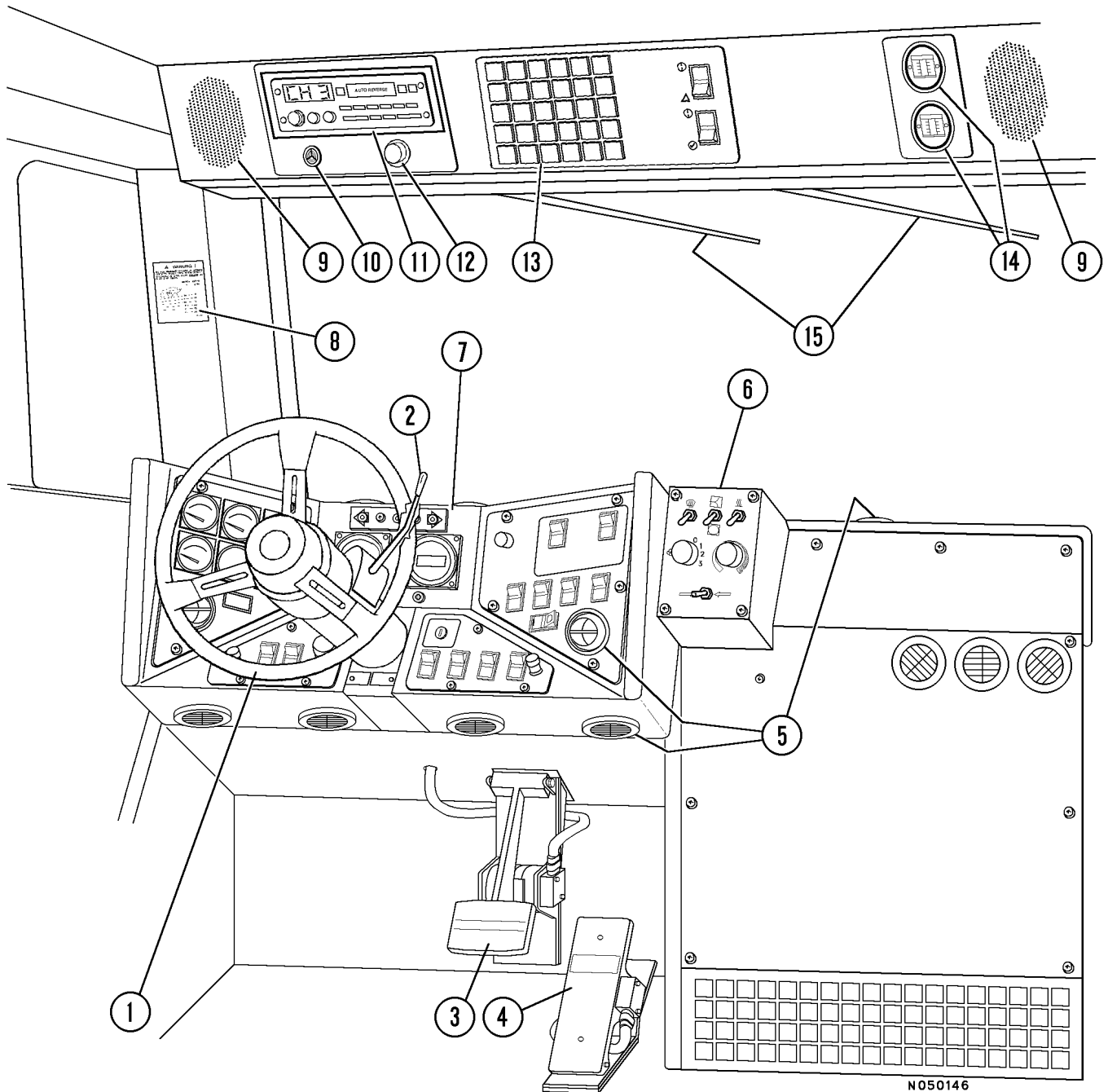

N050146

FIGURE 3-1. CAB INTERIOR - OPERATOR VIEW

- | | | |
|-----------------------------------|------------------------------------|-------------------------------------|
| 1. Steering Wheel | 6. Heater/Air Conditioner Controls | 11. Radio, AM/FM Stereo, Cassette |
| 2. Retarder Control Lever | 7. Instrument Panel | 12. Warning Lights Dimmer Control |
| 3. Retarder / Service Brake Pedal | 8. Grade / Speed Chart | 13. Warning/Status Indicator Lights |
| 4. Throttle / Accelerator Pedal | 9. Radio Speakers | 14. Air Cleaner Vacuum Gauges |
| 5. Heater/Air Conditioner Vents | 10. Warning Alarm Buzzer | 15. Windshield Wipers |

STEERING WHEEL AND CONTROLS

The steering wheel (1, Figure 3-2) will telescope “in” and “out” and adjust through a tilt angle to provide a comfortable wheel position for most operators.

HORN BUTTON

The horn (2, Figure 3-2) is actuated by pushing the button in the center of the steering wheel. Operation of the horn should be verified before moving the truck. Observe all local safety rules regarding the use of the horn as a warning signal device before starting engine and moving the vehicle.

TELESCOPE LOCK RING

The Telescope Lock Ring (3, Figure 3-2) around the horn button locks/unlocks the telescoping function of the steering column. Rotating the ring (*) counter-clockwise (L.H. rotation), releases the column to move “in” or “out”. Rotating the ring clockwise (R.H. rotation), locks the column in the adjusted position.

(*) **DO NOT ROTATE RING MORE THAN 90°!**
Electrical ground wire may be cut!

TILT WHEEL LEVER

Adjust the tilt of the steering wheel by pulling the tilt adjustment lever (4, Figure 3-2) toward the steering wheel and moving the wheel to the desired angle. Releasing the lever will lock the wheel in the desired location.

TURN SIGNAL / HEADLIGHT DIMMER

The Turn Signal Lever (5, Figure 3-2) is used to activate turn signal lights and to select either high or low headlight beams.

Move the lever upward to signal a turn to the right.



An indicator in the top, center of the instrument panel will illuminate to indicate turn direction selected.

Refer to INSTRUMENT PANEL & INDICATOR LIGHTS.

Move the lever downward to signal a turn to the left.



Moving the lever toward the steering wheel changes Headlight beam.

When high beams are selected, the indicator in the top, center of the instrument panel will illuminate.

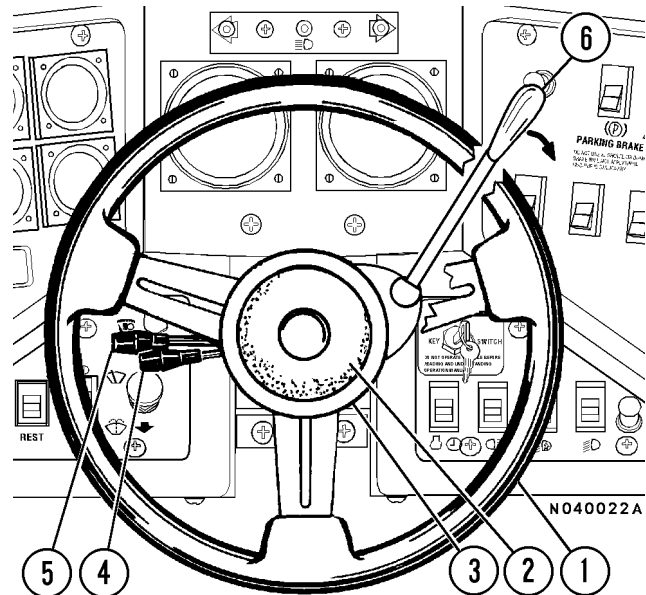

FIGURE 3-2. STEERING WHEEL AND CONTROLS

DYNAMIC RETARDING

Dynamic Retarding is a **braking torque** (not a brake) produced through electrical generation by the wheel-motors when the truck motion (momentum) is the propelling force. For normal truck operation, Dynamic Retarding should be used to slow and control the speed of the truck.

Dynamic Retarding is available in “Forward/Reverse” at all truck speeds above 0 mph/kph; however, as the truck speed slows below 3 mph (4.8 kph), the available retarding force may not be effective. Use the service brakes to bring the truck to a COMPLETE stop.

Dynamic Retarding will NOT hold a stationary truck on an incline; use the Parking Brake or Wheel Lock brake for this purpose.

Dynamic Retarding is available in “Neutral” only when truck speed is above 3 mph (4.8 kph).

When dynamic retarding is in operation, the engine RPM will automatically go to an advance RPM retard speed setting (usually 900 - 1000 RPM*).

* *NOTE: The exact engine speed in retarding may vary due to the temperature of certain components; this is controlled by the Propulsion System Controller.*

Dynamic retarding will be applied **automatically**, if the speed of the truck obtains the maximum truck speed of 40 MPH (64 KPH). Any application of the Dynamic retarding system (automatic, retarder lever, or foot pedal) will cause an indicator light to illuminate in the overhead display panel (D3, Figure 3-7).

The Grade/Speed Chart (8, Figure 3-1) should always be followed to determine MAXIMUM safe truck speeds for descending various grades with a loaded truck.

DYNAMIC RETARDER CONTROL LEVER

The Dynamic Retarder Control Lever (6, Figure 3-2) mounted on the right side of the steering column can be used to modulate retarding effort. The lever will command the full range of retarding and will remain at a fixed position when released.

- a. When the lever is rotated to full “Up” (counter-clockwise) position, it is in the “Off/No Retard” position.
- b. When the lever is rotated to full “Down” (clockwise) position, it is in the full “On/Retard” position.
- c. For long downhill hauls, the lever may be positioned to provide a desired retarding effort, and it will remain where it is positioned.

NOTE: The Retarder Control Lever must be rotated back to the “Off” position before the truck will resume the PROPEL mode of operation.

The lever and foot-operated Retarder/Service Brake pedal can be used simultaneously or independently. The Propulsion System Controller (PSC) will determine which device is requesting the most retarding effort and apply that amount.

DYNAMIC RETARDER/SERVICE BRAKE PEDAL

The Dynamic Retarder/Service Brake Pedal (3, Figure 3-1) is a single, foot-operated pedal which controls both retarding and service brake functions. The first portion of pedal travel commands retarding effort through a rotary potentiometer. The second portion of pedal travel modulates service brake pressure directly through a hydraulic valve. Thus, the operator must first apply, and maintain, full dynamic retarding in order to apply the service brakes. Releasing the pedal returns the brake and retarder to the “off” position.

When the pedal is partially depressed, the dynamic retarding is actuated. As the pedal is further depressed to where dynamic retarding is fully applied; the service brakes (while maintaining full retarding) are then actuated through a hydraulic valve, which modulates pressure to the service brakes. ***Completely depressing the pedal causes full application of both dynamic retarding AND the service brakes.*** An indicator light (B3, Figure 3-7) in the overhead panel will illuminate, and an increase in pedal resistance, will be felt when the the Service Brakes are applied.

For normal truck operation, Dynamic Retarding (lever or foot-operated pedal) should be used to slow and control the speed of the truck.

Service brakes should be applied only when dynamic retarding requires additional braking force to slow the truck speed quickly, or when bringing the truck to a COMPLETE stop.

ACCELERATOR (THROTTLE) PEDAL

The Accelerator Pedal/Throttle Pedal (4, Figure 3-1) is a foot-operated pedal which allows the operator to control engine RPM, depending on pedal depression.

It is used by the operator to request torque from the motors when in Forward or Reverse. In this mode, the propulsion system controller commands the correct engine speed for the power required. In Neutral, this pedal controls engine speed directly.

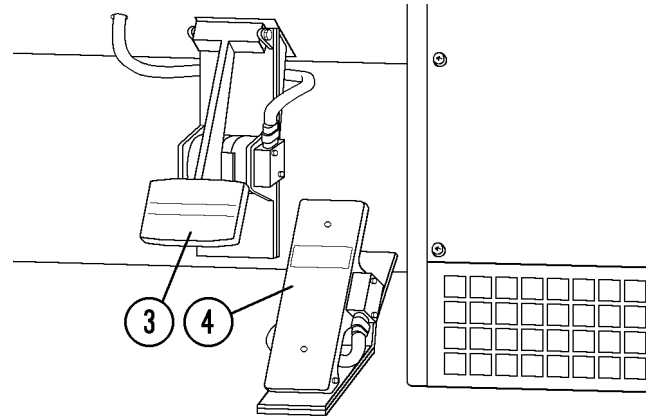

Starting On A Grade With A Loaded Truck

Initial propulsion with a loaded truck should begin from a level surface whenever possible, but when there are circumstances where the starting on a hill or grade cannot be avoided, use the following procedure:

1. Fully depress the foot-operated retarder/service brake pedal (do NOT use retarder lever) to hold the truck on the grade. With service brakes fully applied, move the selector switch to a drive position (Forward/Reverse) and increase engine RPM with throttle pedal.
2. As engine RPM approaches maximum, and operator senses propulsion effort working against the brakes, release the brakes and let truck movement start. Be sure to completely release the foot-operated retarder/service brake pedal. As truck speed increases above 3-5 MPH (5-8 KPH) the Propulsion System Control (PSC) will drop propulsion, if the retarder is still applied.

Releasing and reapplying dynamic retarding during a hill start operation will result in loss of propulsion and, if truck speed is above 1-2 mph, application of retarding effort.

HEATER / AIR CONDITIONER VENTS

Each heater/air conditioner vent (5, Figure 3-1) is a flapper type which may be opened or closed or rotated 360° for optimum air flow. There are four (three not shown) across the top of the panel, one each in the right and left panel modules, and four below the panel.

HEATER / AIR CONDITIONER COMPARTMENT AND CONTROLS

The heater/air conditioner compartment contains the heater/air conditioner controls (6, Figure 3-1) and some of the heater/air conditioner components, such as the blower motor assembly and heater coils. Optimum cab air climate can be selected by using the following controls in various combinations.

DEFROSTER VENT CONTROL SWITCH

The defroster control switch (1, Figure 3-3) directs heated air for windshield defrosting. "Down" position of the toggle switch is OFF. "Up" position of the toggle switch is On.

OUTSIDE/INSIDE AIR CONTROL SWITCH

The outside/inside air control switch (2, Figure 3-3) allows either outside or inside air to be circulated through the cab heater assembly.

Moving the switch "Up" directs outside air to be circulated through the heater assembly and through the cab.

Moving the switch "Down" directs inside air to be recirculated through the heater assembly.

HEAT VENT CONTROL SWITCH

The heater control (3, Figure 3-3) directs heated air to the cab floor for heating of the cab. "Down" position of the toggle switch is OFF. "Up" position of the toggle switch is On.

TEMPERATURE CONTROL KNOB

The temperature control knob (4, Figure 3-3) is provided for the operator to select a comfortable temperature.

Rotating the knob counter-clockwise (blue arrow) will select cooler temperatures.

Full counter-clockwise position is the coldest air setting.

Rotating the knob clockwise (red arrow) will select warmer temperatures. Full clockwise position is the warmest heater setting.

FAN CONTROL KNOB

The fan control knob (5, Figure 3-3) is provided to control the cab air fan motor. The fan motor is a 3-speed motor (low, medium and high). Speeds are selected by rotating the control knob clockwise to the desired position. "Off" is full counter-clockwise position.

HEATER/AIR CONDITIONER SELECTOR SWITCH

The selector switch (6, Figure 3-3) allows the operator to select heat or air conditioning, or neither. The left position of the switch activates the air conditioning and the right side of the switch activates the heater. The middle position is the "OFF" position. Neither the heat nor the air conditioning can be activated in this position.

HEATER/AIR CONDITIONER VENTS

These heater/air conditioner vents (7, Figure 3-3) may be rotated 360°. Air flow through the vents is controlled by manually opening/closing or turning the louvers.

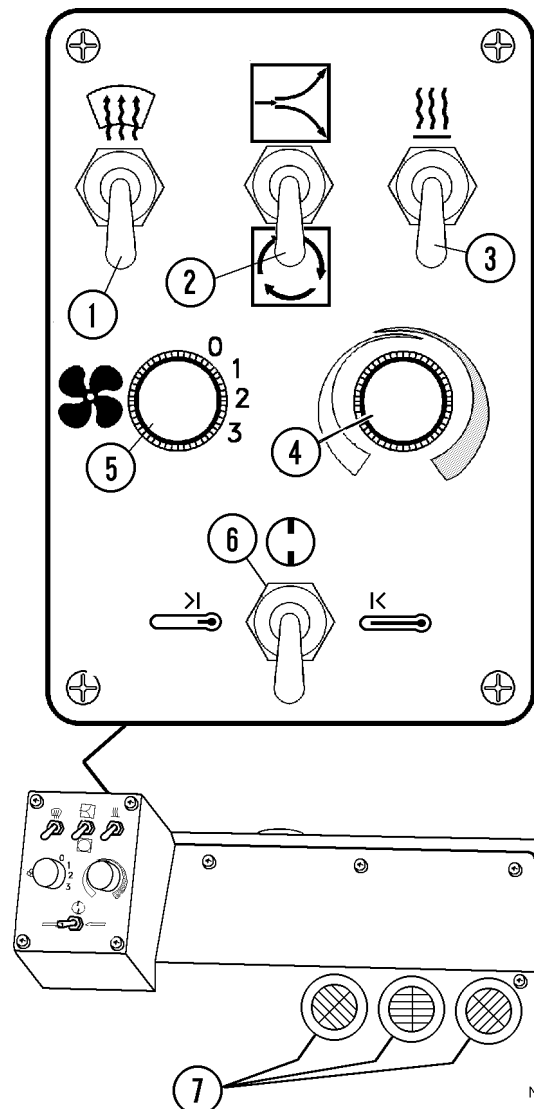

FIGURE 3-3. A/C & HEATER CONTROLS

INSTRUMENT PANEL

The Instrument Panel (7, Figure 3-1) includes a wide variety of switches, gauges, and indicators. Refer to INSTRUMENT PANEL AND INDICATOR LIGHTS, for a detailed description of function and location of these components.

GRADE/SPEED CHART

The Grade/Speed chart (8, Figure 3-1 & shown below) provides the recommended MAXIMUM truck speeds for descending various grades with a fully loaded truck.

The operator should reference this chart before descending any grade with a loaded truck. Proper use of Dynamic Retarding will maintain a safe speed.

NOTE: This decal may change with OPTIONAL truck equipment such as: wheelmotor drive train ratios, retarder grids, tire sizes, etc.

ALWAYS refer to this decal in the operator's cab, and follow recommendations for truck operation.

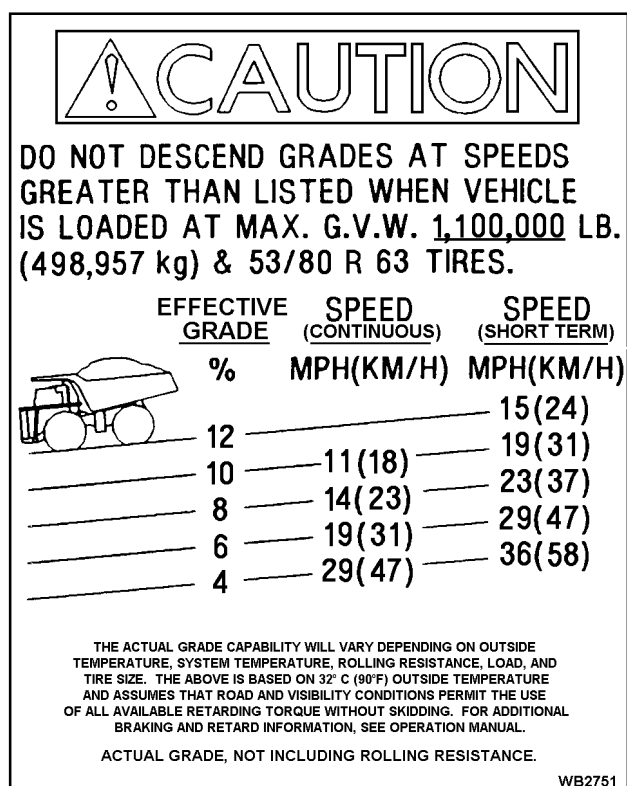

Two lists are provided, one a continuous rating and the second a short-term (3-minute) rating. Both lists are matched to a truck at maximum Gross Vehicle Weight.

The continuous numbers on the chart indicate the combination of speeds and grades which the vehicle can safely negotiate for unlimited time or distance.

The short-term (3-minute) numbers listed on the chart indicate the combination of speeds and grades which the vehicle can safely negotiate for three minutes. These speeds are faster than the continuous values, reflecting the thermal capacity of various system components. System components can accept heating at a

higher-than-continuous rate for a short period of time beyond which the system would become over-temperature.

If the vehicle is operated at short-term grade and speed limits for a period of time greater than three minutes, the retarding effort may begin to reduce, resulting in vehicle acceleration. The service brakes are available to slow the truck within the continuous level. This reduction in retarding effort will be gradual as the vehicle moves from the short-term limits to the continuous limits.

The “three-minute” curve is a minimum and the actual time limit could be greater. Ambient temperature, barometric pressure and recent motor power levels can affect this number.

The three-minute rating will successfully accommodate most downhill loaded hauls. It is necessary to divide haul road grade segment length by allowable speed to determine actual time on grade. If actual time on grade exceeds the allowable amount, the grade will need to be negotiated at the continuous speed.

DO NOT exceed these recommended MAXIMUM speeds when descending grades with a loaded truck.

RADIO SPEAKERS

Radio Speakers (9, Figure 3-1) for the AM/FM Stereo radio are located at the far left and right of the overhead panel.

WARNING ALARM BUZZER

This alarm (10, Figure 3-1) will sound when activated by any one of several truck functions. Refer to INSTRUMENT PANEL AND INDICATOR LIGHTS, for a detailed description of functions and indicators that will activate this alarm.

CAB RADIO

This panel will normally contain an AM/FM Stereo radio (11, Figure 3-1). Refer to Section 6, Optional Equipment, for a more complete description of the radio and its functions.

Individual customers may use this area for other purposes, such as a two-way communications radio.

Warning Lights Dimmer Control

This control knob (12, Figure 3-1) permits the operator to adjust the brightness of the Warning Indicator Lights.

STATUS / WARNING INDICATOR LIGHT PANEL

This panel (13, Figure 3-1) contains an array of indicator lights to provide the operator with important status messages concerning selected truck functions. Refer to INSTRUMENT PANEL AND INDICATOR LIGHTS, for a detailed description of these indicators.

AIR CLEANER VACUUM GAUGES

The Air Cleaner Vacuum Gauges (14, Figure 3-1) provide a continuous reading of maximum air cleaner restriction reached during operation.

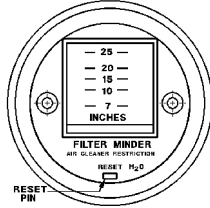

The air cleaner(s) should be serviced when the gauge(s) shows the following maximum recommended restriction:

Komatsu SSDA16V160 Engine: 25 inches of H₂O vacuum.

NOTE: After service, push the reset button on face of gauge to allow the gauge to return to zero.

WINDSHIELD WIPERS

The windshield wipers (15, Figure 3-1) are powered by an electric motor. Refer to INSTRUMENT PANEL AND INDICATOR LIGHTS, for a location and description of the windshield wiper and washer controls.

CENTER CONSOLE CONTROLS AND FEATURES

The Center Console (1, Figure 3-4) contains:

- (1) Center Console
- (2) F-N-R Selector Switch
- (3) Hoist Control Lever
- (4) Ash Tray
- (5) Cigar/Cigarette Lighter
- (6) L.H. Window Control Switch
- (7) R.H. Window Control Switch
- (8) Engine Shutdown Switch
- (9) Override/Fault Reset Switch
- (10) BLANK - NOT USED on this truck
- (11) RSC "Off/On" Switch
- (12) Retarder Speed Control Dial
- (13) Propulsion System Controller (PSC) Diagnostic Port (G.E.)
- (14) Engine Diagnostic Port (3 Pin) (Cense)
- (15) Truck Control Interface (TCI) Diagnostic Port
- (16) Passenger Seat (mounted on top of the right hand portion of the Console structure)
- (17) Engine Diagnostic Port (9 Pin) (Quantum)
- (18) Modular Mining Port (Optional)

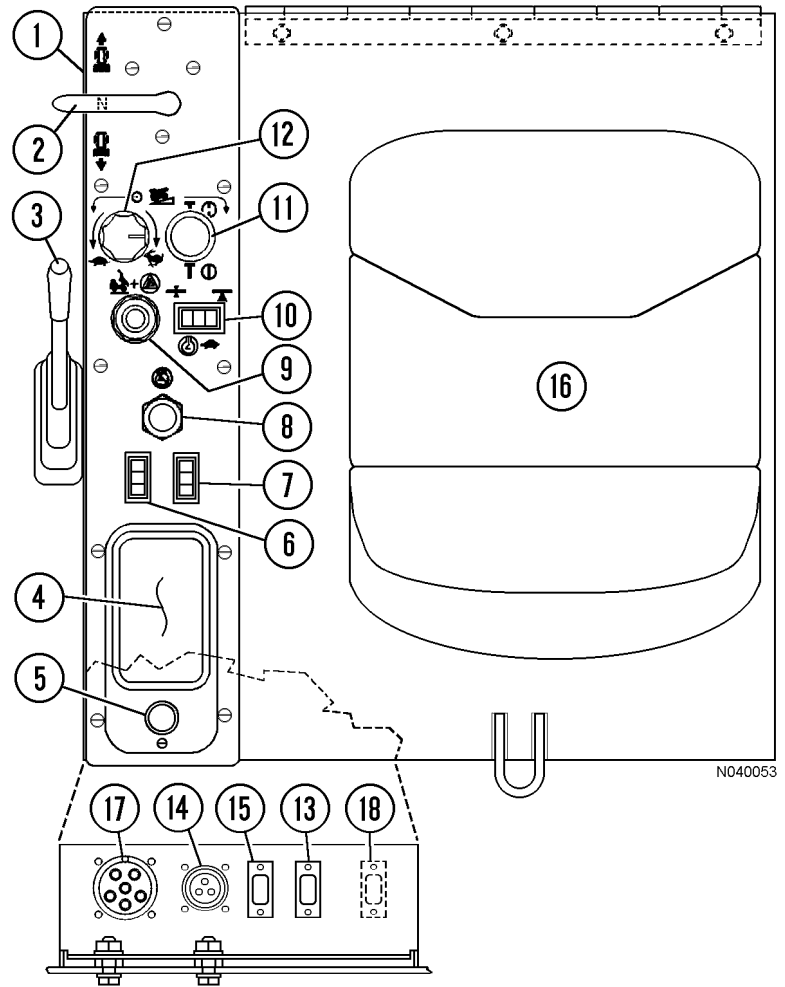

FIGURE 3-4. CENTER CONSOLE

F-N-R SELECTOR SWITCH

The Selector Switch (2, Figure 3-4) is mounted on a console to the right of the operator's seat. It is a three position switch which controls the Forward-Neutral-



Reverse motion of the truck. When the Selector Switch handle is in the center "N" position, it is in "Neutral".

The handle must be in Neutral to start the engine.

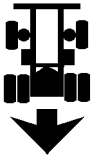

The operator can select **Forward** drive by moving the handle forward.

Reverse drive can be selected by moving the handle to the rear.

The truck should be stopped before the selector handle is moved to a drive position.

HOIST CONTROL LEVER

The hoist control (3, Figure 3-4) is a four position hand-operated lever located between the operator seat and the Center Console.

To Raise dump body:

1. Pull the lever to the rear to actuate hoist circuit. (Releasing the lever anywhere during “hoist up” will place the body in “hold” at that position.)
2. Raise engine RPM to increase hoist speed.
3. Reduce engine RPM as the last stage of the hoist cylinders begin to extend and then let the engine go to low idle as the last stage reaches half-extension.
4. Release hoist lever as the last stage reaches full extension.
5. After material being dumped clears the body, lower the body to frame.

Refer to “OPERATING INSTRUCTIONS, DUMPING” for more complete details concerning this control.

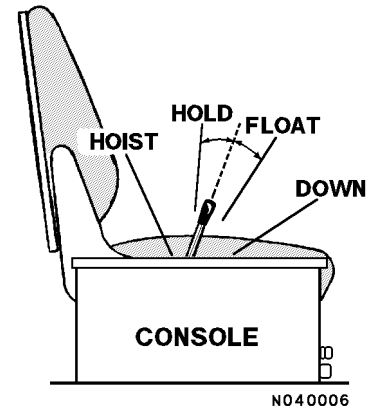

To lower body:

Move hoist lever forward to “down” position and release. Releasing the lever places hoist control valve in the “float” position allowing the body to return to frame.

ASH TRAY

The Ash Tray (4, Figure 3-4) is used for extinguishing and depositing smoking materials. DO NOT use for flammable materials, such as paper wrappers, etc.

Be certain that all fire ash is extinguished!

LIGHTER

The LIGHTER (5, Figure 3-4) may be used for lighting cigars/cigarettes.

Always use CAUTION with smoking materials!

This socket may also be used for a 12 VDC power supply.

L.H. WINDOW CONTROL SWITCH

This switch (6, Figure 3-4) is spring-loaded to the “OFF” position. Pushing the front of the switch raises the left side cab window. Pushing the rear of the switch lowers the window.

R.H. WINDOW CONTROL SWITCH

This switch (7, Figure 3-4) is spring-loaded to the “OFF” position. Pushing the front of the switch raises the right side cab window. Pushing the rear of the switch lowers the window.

ENGINE SHUTDOWN SWITCH

This switch (8, Figure 3-4) is used for engine shutdown by depressing this button and holding it until engine stops.



Use this switch to shutdown engine if engine does not shutdown by turning off keyswitch, or to shutdown engine without turning off 24 VDC electric circuits.

There is also a ground level engine shutdown switch on the left front frame rail behind the ladder.

OVERRIDE / FAULT RESET SWITCH

This push-button switch (9, Figure 3-4) is spring-loaded to the "OFF" position.

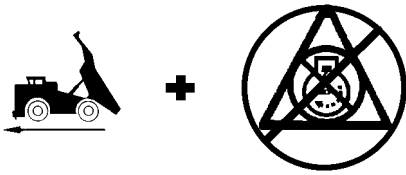

When pushed in and held, this switch may be used for several functions.

1. This switch permits the operator to override the "bodyup" switch and move the truck forward when the Selector Switch is in Forward, the dump body is raised, and the brakes are released.

! Use of the override switch for this purpose is intended for emergency situations only!

2. The override switch is also used to reset an electric system fault when indicated by a red warning light (Refer to "Instrument Panel And Indicator Lights", Overhead Warning / Status panel).

10, FIGURE 3-4 - BLANK

This position is not used for the 930E.

In some other truck models, this position is used for an Engine Idle Switch.

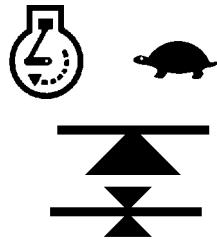

RETARD SPEED CONTROL (RSC) "OFF/ON" SWITCH

The Retard Speed Control Switch (11, Figure 3-4) turns the system "OFF" or "ON". Push the knob "IN" to turn "OFF" and pull the knob "OUT" to turn the system "ON".

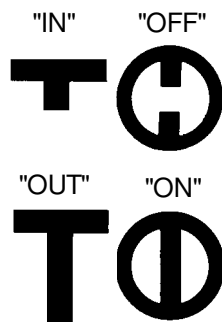
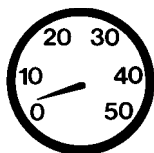

RETARD SPEED CONTROL (RSC) ADJUST DIAL

The RSC Adjust Dial (12, Figure 3-4) allows the operator to vary the downhill truck speed that the Retard Speed Control system will maintain when descending a grade. This function can be overridden by either the accelerator, retard lever, or retard pedal.

When the dial is rotated counterclockwise toward this symbol, the truck will descend a grade at lower speeds.



When the dial is rotated clockwise toward this symbol, the truck speed will increase.



ALWAYS refer to the Grade/Speed decal in the operator's cab, and follow the recommendations for truck operation. **DO NOT** exceed these recommended **MAXIMUM** speeds when descending grades with a loaded truck.

Throttle pedal position will override RSC setting. If operator depresses throttle pedal to increase truck speed, Dynamic Retarding will not come on unless truck overspeed setting is reached or foot operated retard pedal is used. When throttle pedal is released and RSC switch is "On", Dynamic Retarding will come on at, or above, the RSC dialed speed and will adjust truck speed to, and maintain, the dialed speed.

To adjust RSC control, pull switch (11) "On" and start with dial (12) rotated toward fastest speed while driving truck at desired maximum speed. Relax throttle pedal to let truck coast and turn RSC Adjusting Dial slowly counterclockwise until Dynamic Retarding is activated. Dynamic Retarding will now be activated automatically anytime the "set" speed is reached, the RSC switch is "On", and throttle pedal is released.

With RSC switch "On" and dial adjusted, the system will function as follows: As truck speed increases to the "set" speed and throttle pedal released, Dynamic Retarding will apply. As truck speed tries to increase, the amount of retarding effort will automatically adjust to keep the selected speed. When truck speed decreases, the retarding effort is reduced to maintain the selected speed. If truck speed continues to decrease to approximately 3 mph (4.8 kph) below "set" speed, Dynamic Retarding will turn off automatically. If truck speed must be reduced further, the operator can turn the Adjust Dial to a new setting or depress the foot operated retard pedal.

If the operator depresses the foot operated retard pedal and the retard effort called for is greater than that from the automatic system, the foot pedal retard will override RSC.

PSC DOWNLOAD PORT

This connector (13, Figure 3-4) is for use by qualified personnel to access diagnostic information for the Propulsion System Controller (PSC).

ENGINE DIAGNOSTICS DOWNLOAD PORT

This 3-PIN connector (14, Figure 3-4) is for use by qualified personnel to access the diagnostic information for the Engine Monitoring system. (CENSE).

TCI DOWNLOAD PORT

This connector (15, Figure 3-4) is for use by qualified personnel to access the Truck Control Interface (TCI) diagnostic information and data.

PASSENGER SEAT

The Passenger Seat (16, Figure 3-4) is mounted on top of the right hand portion of the Center Console structure.

The area beneath the passenger seat provides a cabinet for various 24 VDC electrical components.

Consult the Shop Manual for service involving any of these components.

ENGINE CONTROL SYSTEM

This 9-PIN connector (17, Figure 3-4) is for use by qualified personnel to access the diagnostic information for the Engine Control system. (QUANTUM)

MODULAR MINING SYSTEM

This connector (18, Figure 3-4) is for use by qualified personnel to access the Modular Mining System for diagnostic information and data.

PAYLOAD METER

The Payload Meter (1, Figure 3-5) and Download Connector (2) are used to provide management with operational data such as tonnage hauled and cycle times.

Refer to Section 6, Optional Equipment, for a more complete description of the payload meter and its functions.

Payload Meter Download Connector

This connector (2, Figure 3-5) is used with a special cable to allow the Payload Meter (1) to communicate with a Portable Computer.

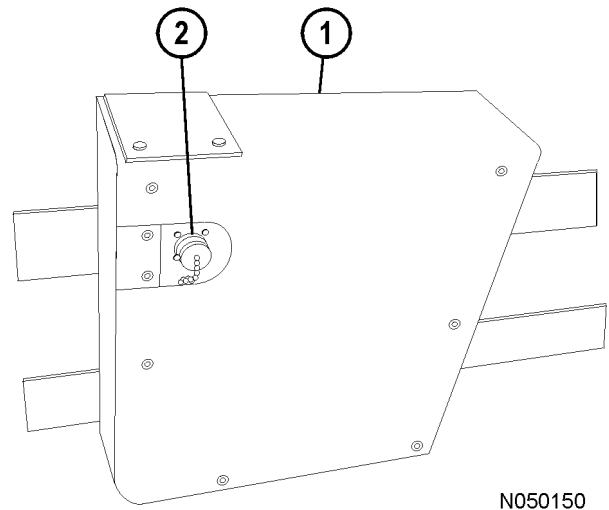

FIGURE 3-5. PAYLOAD METER 3
1. Payload Meter 3 2. Download Connector

OPERATOR COMFORT

OPERATOR SEAT

The operator's seat provides a fully adjustable cushioned ride for the driver's comfort and ease of operation.

Adjustment

The following adjustments must be made while sitting in the seat.

1. **Headrest:** headrest (1, Figure 3-6) will move up, down, fore, or aft by moving headrest to desired position.
2. **Armrests:** rotate adjusting knob until armrest is in desired position.
3. **Seat Belt:** Operator should always have seat belt buckled in place and properly adjusted whenever vehicle is in motion.
- 4 & 5. **Air Lumbar Support:** Each rocker switch (4 or 5) controls an air pillow. Switch (5) controls the lower air pillow and switch (4) controls the upper air pillow. To inflate, press on top of rocker switch and hold for desired support, then release. To deflate, press on bottom of rocker switch and hold for desired support, then release. Adjust each pillow for desired support.
6. **Seat Height:** Press rocker switch (6) on top to increase ride height. Press on lower part of rocker switch to lower ride height.
7. **Backrest:** Pull control (7) upward and hold, select backrest angle; release control handle.
8. **Fore/Aft Location of Seat:**
 - a. Raise adjustment lever (8).
 - b. Move seat to desired position; release lever.
9. **Front Height and Slope Adjustment of Seat Cushion:**
 - a. Front height and slope; lift control lever (9) and hold.
 - b. Bend knees to move seat to a comfortable position; release control lever to lock adjustment.

Seat Removal

1. Remove capscrews (10, Figure 3-6) and hardware that secures the seat base to the riser. Remove capscrews (11) that secures tether to floor.
2. Remove seat assembly from cab to clean work area for disassembly.

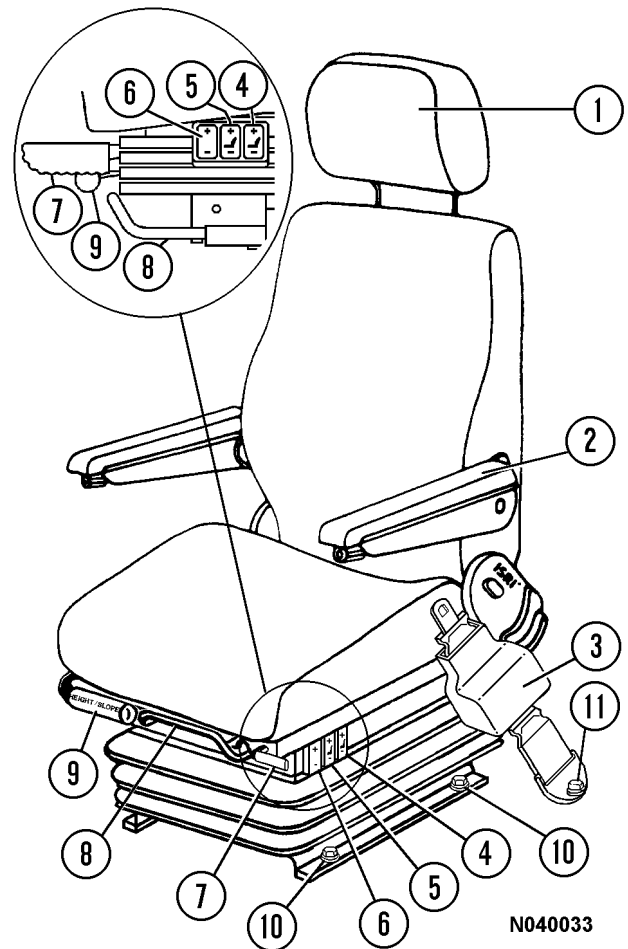

FIGURE 3-6. OPERATOR'S SEAT
ADJUSTMENT CONTROLS

1. Headrest
2. Armrest Adjustment
3. Seat Belt
4. Upper Air Pillow Lumbar Support
5. Lower Air Pillow Lumbar Support
6. Height Adjustment
7. Backrest Adjustment
8. Fore and Aft Adjustment
9. Front Height and Slope Adjustment
10. Mounting Capscrews and Hardware
11. Seat Tether Capscrew

Seat Installation

1. Mount seat assembly to seat riser. Install capscrews (10, Figure 3-6), lockwashers, flatwashers and nuts. Tighten capscrews to standard torque.
2. Fasten tether straps to floor with capscrews (11), flatwashers and lockwashers. Tighten capscrews to standard torque.

NOTES

INSTRUMENT PANEL AND INDICATOR LIGHTS

CONTROL SYMBOLS

Many control functions are identified with “International” symbols that the operator should learn to recognize immediately. The operator must understand the function and operation of each instrument and control. This knowledge is essential for proper and safe operation of the machine.

The following symbols are general indicators and may appear in multiple locations and combinations on the instrument panel.

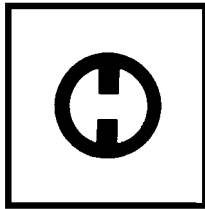

This symbol may be used alone or with another symbol. This symbol identifies the “Off” position of a switch or control.

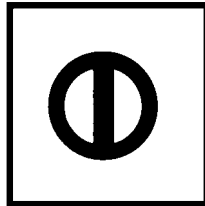

This symbol may be used alone or with another symbol. This symbol identifies the “On” position of a switch or control.

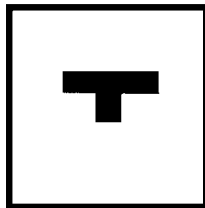

This symbol identifies the “Pushed-In” position of a push-pull switch or control.

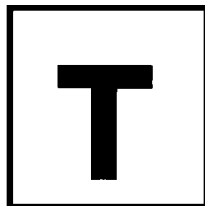

This symbol identifies the “Pulled-Out” position of a push-pull switch or control.

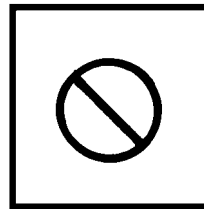

This symbol when it appears on an indicator or control identifies that this indicator or control is **NOT** used.

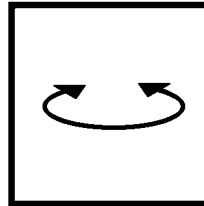

This symbol identifies a rotary control or switch. Rotate the knob clockwise or counterclockwise for functions.

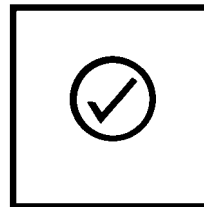

This symbol identifies a switch used to test or check a function. Press the switch on the side near the symbol to perform the test.

INSTRUMENT PANEL (Figure 3-7)

The operator must understand the function and operation of each instrument and control. Control functions are identified with “International” symbols that the operator should learn to recognize immediately. This knowledge is essential for proper and safe operation.

Items that are marked **OPTIONAL** do not apply to every truck.

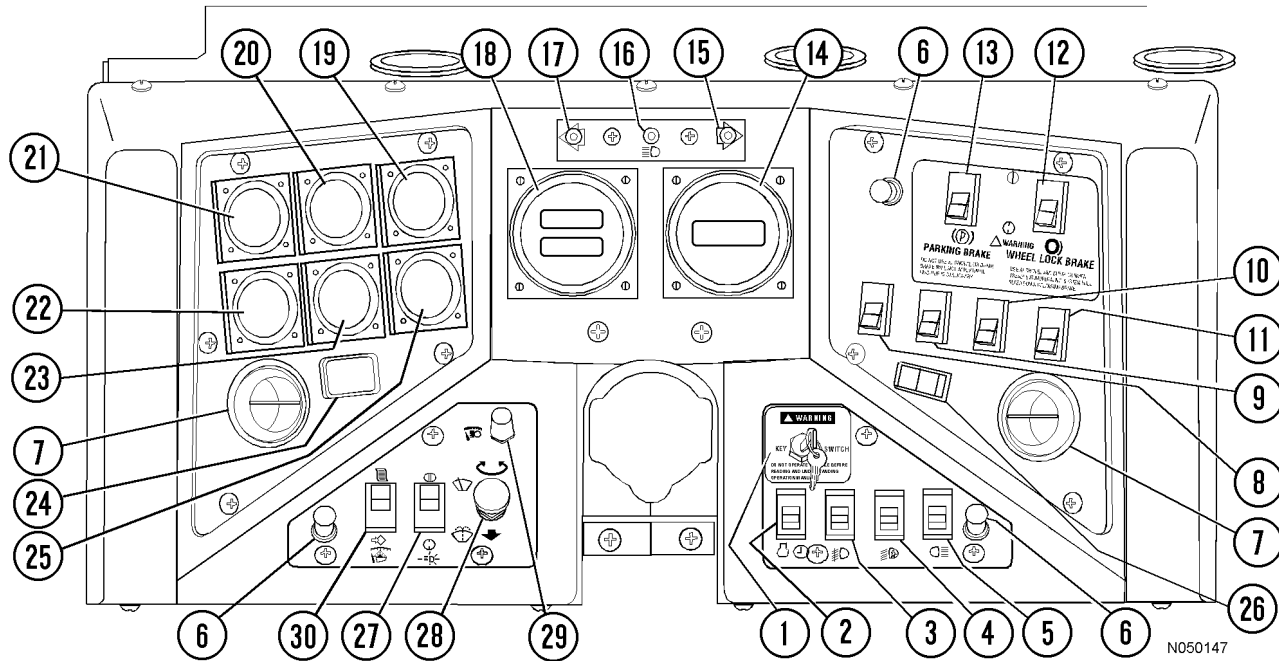

FIGURE 3-7. PANEL GAUGES, INDICATORS, AND CONTROLS

- | | |
|--|---|
| 1. Keyswitch | 16. High Beam Headlight Indicator Light |
| 2. Engine Shutdown Switch with Timer Delay | 17. Left Turn Signal Indicator Light |
| 3. Backup Light Switch (N./O.) | 18. Digital Speedometer |
| 4. Ladder Light Switch (3 - Way) | 19. Voltmeter Gauge |
| 5. Fog Light Switch (N./O.) | 20. Engine Oil Pressure Gauge |
| 6. Panel Illumination Light(s) | 21. Engine Water Temperature Gauge |
| 7. Vent(s) - Cab Air Conditioner/Heater | 22. Fuel Gauge |
| 8. Not used on 930E | 23. AC Drive System Temperature |
| 9. Rotating Beacon Light Switch (N./O.) (Optional) | 24. Engine Hourmeter |
| 10. Heated Mirror Switch (N./O.) (Optional) | 25. Hydraulic/Brake Oil Temperature |
| 11. Not used on 930E | 26. AC REST Switch |
| 12. Wheel Brake Lock Switch (N./O.) | 27. Headlights Switch (N./O.) |
| 13. Parking Brake Switch (N./O.) | 28. Wiper / Washer Switch |
| 14. Digital Tachometer | 29. Panel Illumination Lights Dimmer Rheostat |
| 15. Right Turn Signal Indicator Light | 30. Payload Meter Switch |

WIRE NUMBERS

- | | | |
|-------------------------------|--------------------------------|---|
| 1. 712/21PB/11S | 11. 71/79M/SPR55/79H/72F/SPR54 | 21. 712D/31TS/710/49 |
| 2. 11S/11TD/11R | 12. 712BL/52B/39H/710/SPR59 | 22. 712D/38G/710/49 |
| 3. 712/47S/47L/710 | 13. 71/52C/21PB/21 | 23. 15V/72MT/49/710 |
| 4. 11L/48A/48B | 14. 41TS/74X/74Z/710 | 24. 11L/36 |
| 5. 11L/48F | 15. 45R/710 | 25. 15V/34BT/710/49 |
| 6. 49/710 | 16. 41H/710 | 26. 710/72RQ |
| 7. No Wires | 17. 45L/710 | 27. 11D/41L/41TS |
| 8. 712/28E | 18. 41TS/77/77A/710 | 28. High 66S/Low 66L/710/66P Pulse/
712W / Washer 66 |
| 9. 11L/11RB | 19. 712D/710/49 | 29. 49/41TS |
| 10. 712/69M/SPR56/SPR57/SPR58 | 20. 712D/31PS/710/49 | |

PANEL GAUGES, INDICATORS, AND CONTROLS (Figure 3-7)

(1, Figure 3-7) KEY SWITCH

The key switch is a 3-position (Off, Run, Start) switch. When switch is rotated one position clockwise, it is in the "Run" position and all electrical circuits (except "Start") are activated. With Selector Switch in "Neutral", rotate keyswitch fully clockwise to "Start" position and hold this position until engine starts. "Start" position is spring loaded to return to "Run" when key is released. With truck stopped, turn keyswitch counterclockwise to "Off" for normal engine shutdown.

Use Engine Shutdown switch on center console, if engine does not shutdown with keyswitch.

NOTE: A ground level shutdown switch is located on lower front left side of truck.

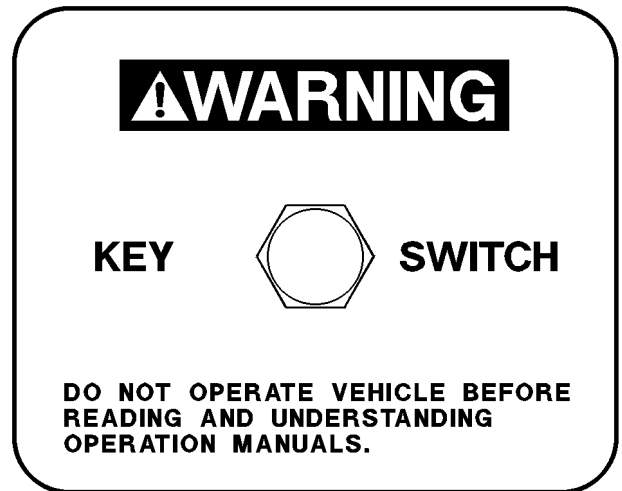

(2, Figure 3-7) ENGINE SHUTDOWN SWITCH with 5 MINUTE IDLE TIMER DELAY

This is a 3-position rocker-type switch (Off-On-Momentary). Refer to "OPERATING INSTRUCTIONS" section, "DELAYED ENGINE SHUTDOWN PROCEDURE", for a complete detailed operation of this switch.

1. Press top of switch to the "On" (center position), then press firmly to the "Momentary" (upper position) and hold this position briefly to activate the 5 Minute Idle Timer (switch is spring-loaded to return to "On" position when released).

At the SAME time while holding the "Momentary" switch position, turn the Keyswitch counterclockwise to the "Off" position.

When the engine stops after the 5 minute idle period, the hydraulic bleeddown timer will be activated and turn off the 24 VDC electric circuits controlled by the keyswitch.

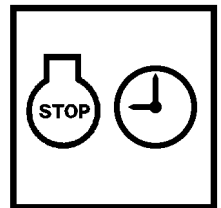

Engine WILL NOT SHUT DOWN, if keyswitch is not turned "Off" in this manner.

NOTE :

To cancel the 5 Minute Idle Timer sequence, press Timer Delay Shutdown switch to the "Off" (lower) position.

- *If keyswitch is in "Off" position, engine will stop.*
- *If keyswitch is in "On" position, engine will continue to run.*

If engine does not shutdown with keyswitch, use Engine Shutdown Switch (8, Figure 3-4) on operator cab center console, and hold this switch down until engine stops. The Ground Level Shutdown Switch will also stop the engine during this time-out.

2. When the Engine Shutdown Timer has been activated, the Timer Delay indicator light in the overhead display panel (C4, Figure 3-8) will illuminate to indicate that the shutdown timing sequence has been started. The engine will continue to run at Idle RPM for approximately 5 minutes to allow for proper engine cool-down before stopping.

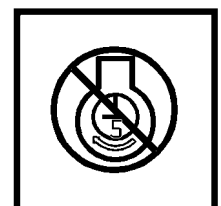

(3, Figure 3-7) FOG LIGHTS (OPTIONAL)

Fog Lights are optional equipment that are useful in foggy conditions and heavy rain. Pressing the top of the rocker switch turns the lights "On". Pressing the bottom of the switch turns the lights "Off".

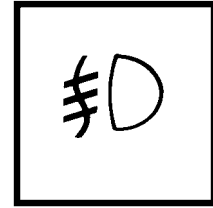

(4, Figure 3-7) LADDER LIGHT SWITCH

The switch turns the ladder lights "On" or "Off" after or before using ladder. Pressing the top of the rocker switch turns the lights "On". Pressing the bottom of the switch turns the lights "Off". Another switch is mounted at the front left of truck near the base of ladder.

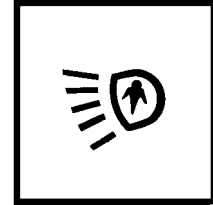

(5, Figure 3-7) MANUAL BACKUP SWITCH

The Manual Backup Switch allows backup lights to be turned "On" providing added visibility and safety when the Selector Switch (see OPERATOR CONTROLS) is not in "REV" position. When the SWITCH is pressed toward the "on" position, the MANUAL BACK UP LIGHT indicator (B4, Overhead Panel) will be illuminated.

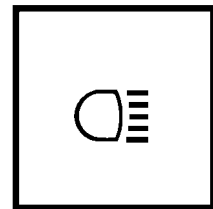

(6, Figure 3-7) PANEL ILLUMINATION LIGHTS

These lights provide illumination for the instrument panel. Brightness is controlled by the panel light dimmer switch (28).

(7, Figure 3-7) CAB AIR CONDITIONER / HEATER VENTS

These Vents are spherically mounted and may be directed by the operator to provide the most comfortable cabin air flow.

(8, Figure 3-7) NOT USED ON 930E

(9, Figure 3-7) ROTATING BEACON LIGHT SWITCH (OPTIONAL)

If truck is equipped with the OPTIONAL Rotating Beacon Light, it will be activated by this rocker-type switch when it is pressed toward the "on" position.

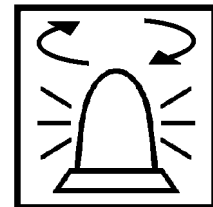

(10, Figure 3-7) HEATED MIRROR SWITCH (OPTIONAL)

If truck is equipped with the OPTIONAL Heated Mirror, it will be activated by this rocker-type switch when it is pressed toward the "on" position.

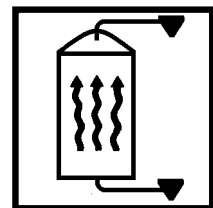

(11, Figure 3-7) NOT USED ON 930E

(12, Figure 3-7) WHEEL BRAKE LOCK CONTROL

 The Wheel Brake Lock should be used with engine running for dumping and loading operations only. The brake lock switch actuates the hydraulic brake system which locks the **rear wheel service brakes only**. When pulling into shovel or dump area, stop the truck using the foot-operated service brake pedal. When truck is completely stopped and in loading position, apply the brake lock by pressing the rocker switch toward the “On” symbol. To release, press the rocker switch toward the “Off” symbol.

Use at shovel and dump only to hold truck truck in position.

Do not use this switch to stop truck, unless foot-operated treadle valve is inoperative. Use of this switch applies rear service brakes at full, unmodulated pressure!

Do not use brake lock for parking. With engine stopped, hydraulic pressure will bleed down, allowing brakes to release!

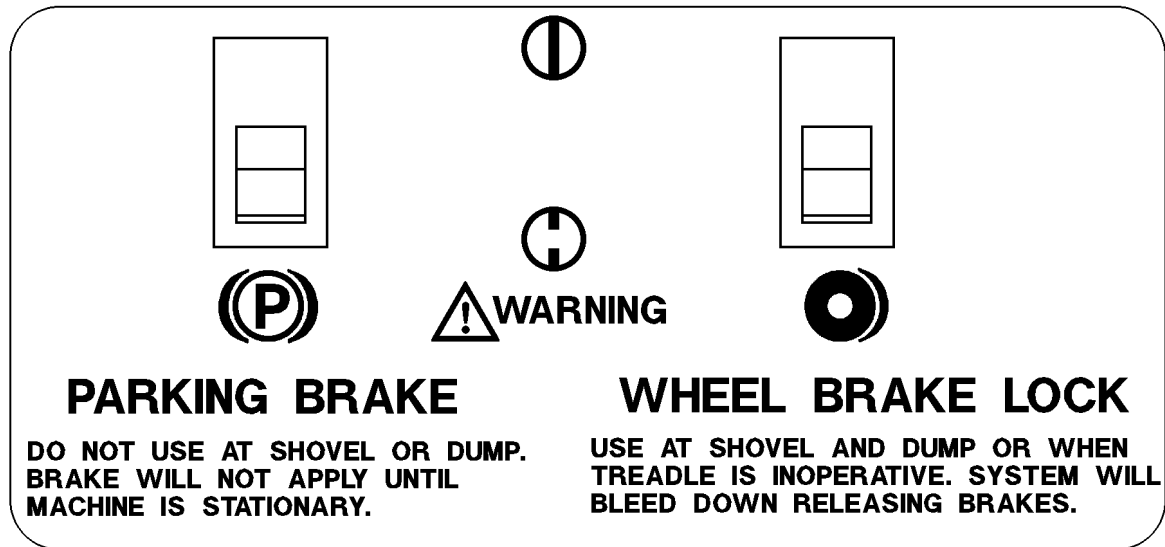

SM2729

(13, Figure 3-7) PARKING BRAKE CONTROL

 The Parking Brake is spring applied and hydraulically released. It is designed to hold a stationary truck when the engine is shutdown and keyswitch is turned “Off”. The truck must be completely stopped before applying the parking brake, or damage may occur to parking brake.

To apply the parking brake, press the rocker switch toward the “On” symbol. To release the parking brake, press the rocker switch toward the “Off” symbol. When the keyswitch is “On” and Parking Brake switch is applied, the Parking Brake indicator light (A3, Overhead Panel) will be illuminated.

NOTE: Do not use the parking brake at shovel or dump. With keyswitch “on” and engine running, sudden shock caused by loading or dumping could cause the system’s motion sensor to RELEASE the park brake.

(14, Figure 3-7) TACHOMETER

The tachometer registers engine crankshaft speed in hundreds of revolutions per minute (RPM).

Governed RPM (Komatsu SSSA16V160 Engine):

Low Idle - 600 RPM

Full Load - 1900 RPM

High Idle - 1910 RPM

(15, Figure 3-7) RIGHT TURN SIGNAL INDICATOR

This light illuminates to indicate the right turn signals are operating when the turn signal lever on the steering column is moved upward. Moving the lever to its center position will turn indicator "Off".

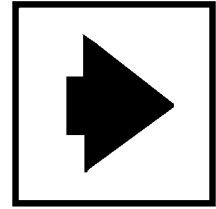

(16, Figure 3-7) HIGH BEAM INDICATOR

The high beam indicator when lit, indicates that the truck headlights are on "High" beam. To switch headlights to "High" beam, push the turn indicator lever away from steering wheel. For "Low" beam, pull lever toward the steering wheel.

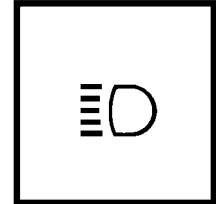

(17, Figure 3-7) LEFT TURN SIGNAL INDICATOR

This light illuminates to indicate the left turn signals are operating when the turn signal lever on the steering column is moved downward. Moving the lever to its center position will turn indicator "Off".

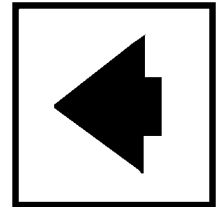

(18, Figure 3-7) SPEEDOMETER / PAYLOAD METER

The speedometer indicates the truck speed in miles per hour (MPH), or with OPTIONAL speedometer, it may indicate truck speed in kilometers per hour (KPH). The display also shows Payload Meter information. For more information, see Payload Meter in Index.

(19, Figure 3-7) VOLTMETER

The voltmeter indicates the voltage of the 24V battery system. Normal indicated voltage at high RPM is 27 to 28 volts with batteries in fully charged condition. When keyswitch (10) is "On" and engine is NOT running, voltmeter indicates battery charge condition.

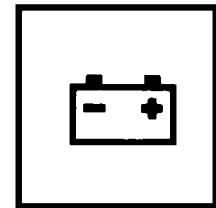

(20, Figure 3-7) ENGINE OIL PRESSURE GAUGE

The engine oil pressure gauge indicates pressure in the engine lubrication system in pounds per square inch (psi). Normal operating pressure after engine warm up should be:
Idle - 20 psi (138 kPa) (minimum)
Rated Speed - 45 - 70 psi (310 - 483 kPa)

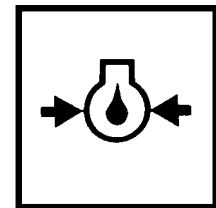

(21, Figure 3-7) WATER TEMPERATURE GAUGE

The water temperature gauge indicates the temperature of the coolant in the engine cooling system. The temperature range after engine warm-up and truck operating under normal conditions should be: 185°-207 °F (85°-97 °C)

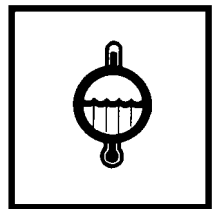

(22, Figure 3-7) FUEL GAUGE

The fuel gauge indicates how much diesel fuel is in the fuel tank. Fuel tank capacity is 1200 gallons (4542 liters).

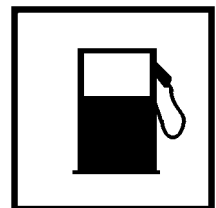

(23, Figure 3-7) AC DRIVE SYSTEM TEMPERATURE GAUGE

The Ac Drive System Temperature Gauge indicates the drive system temperature. There are three colored bands: Green; Yellow; and Red. Green indicates “Normal” operation.

Yellow indicates the system temperature is rising. There is also an amber (yellow) “temperature warning” light in the overhead panel (C5, Figure 3-8) that will illuminate when the temperature exceeds a certain level. When this condition occurs, the operator should consider changing truck operation in order to reduce system temperature.

If the Ac Drive System Temperature should reach the Red band, continued operation could damage components in the system.

Safely stop truck, shutdown engine, and notify maintenance personnel immediately.

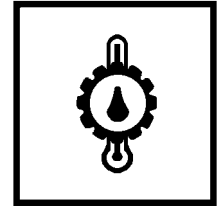

(24, Figure 3-7) HOURMETER

The hourmeter registers the total number of hours the engine has been in operation.

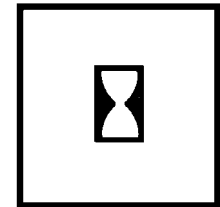

(25, Figure 3-7) HYDRAULIC OIL TEMPERATURE GAUGE

The Hydraulic Oil Temperature Gauge indicates oil temperature in the hydraulic tank. There are two colored bands: Green, and Red. Green indicates “Normal” operation.

Red indicates high oil temperature in the hydraulic tank. Continued operation could damage components in the hydraulic system. There is also a RED “temperature warning” light in the overhead panel (D5, Figure 3-8) that will illuminate when the temperature exceeds a certain level.

If this condition occurs, the operator should safely stop the truck, move Selector Switch to Neutral, apply the Park Brake, and operate engine at 1200 - 1500 RPM to reduce system temperature.

If temperature gauge does not move into the Green range after a few minutes, and the RED overhead indicator light does not go out, notify maintenance personnel immediately.

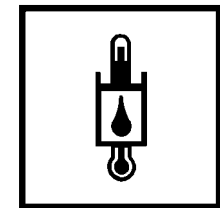

(26, Figure 3-7) REST SWITCH

The “REST” switch is a “rocker”-type switch with a locking device for the “Off” (left side) position. When the switch is in this position, a small black tab must be pushed to the left to “unlock” the switch, so that it can be depressed (rocked) to the “On” (right side) position. When the switch is in the “On” position, the switch is illuminated with a yellow/amber light.

An amber (yellow) indicator light in the overhead panel (B6, Figure 3-8) will also be illuminated when the “REST” state has been requested and entered.

The “REST” switch should be activated (turned “On”) to **de-energize the AC Drive System** whenever the engine is to be shutdown, or the truck parked for a length of time with the engine running.

The Selector Switch must be in neutral and the vehicle not moving to enable this function. This will allow the engine to continue running while the AC Drive System is de-energized.

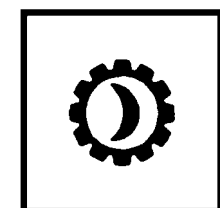
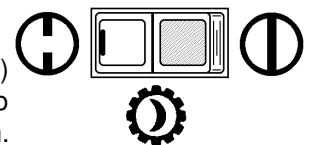

▲ WARNING *Activation of the “REST” switch alone does NOT completely ensure that the Drive System is safe to work on. Refer to Safety Procedures, and check all “LINK-ON”, or “LINK ENERGIZED”, indicator lights to verify the AC DRIVE system is DE-ENERGIZED before performing any maintenance on the Drive System.*

DO NOT ACTIVATE THE REST SWITCH WHILE THE TRUCK IS MOVING!
The truck may unintentionally enter the REST mode after stopping.

(27, Figure 3-7) LIGHT SWITCH

The instrument panel lights, clearance lights, and the headlights are controlled by this three position rocker type switch. "Off" is selected by pressing the bottom of the switch. Press the top of the switch until it reaches the first detent to select the panel, clearance, and tail lights only.

Press the top of the switch again, until it reaches the second detent to select headlights, as well as panel, clearance, and tail lights.

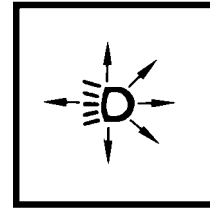

(28, Figure 3-7) WINDSHIELD WIPER and WASHER

The windshield wiper control switch is a four position rotary switch with intermittent wiper delay and wash feature. "Off" position is the detented position when the knob is rotated fully counterclockwise against the stop. The intermittent wiper position is located between "Off" and the first detent position, when rotating the knob clockwise.

Rotating the knob closer to the first detent position decreases the time interval between wiper strokes.

Rotate the knob clockwise to the first detent position for slow speed. Rotate the knob to the second detent position for fast speed.

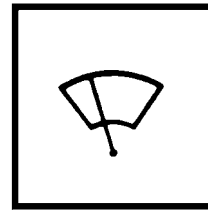

To use the windshield washer, press and hold the knob "in" to activate the windshield washer system.



(29, Figure 3-7) PANEL LIGHT DIMMER

The panel light dimmer control is a rheostat which allows the operator to vary the brightness of the instruments and panel lights. Rotating knob to the full counterclockwise position turns panel lights "On" to brightest condition. Rotating knob clockwise continually dims lights until "Off" position is reached at full clockwise rotation.

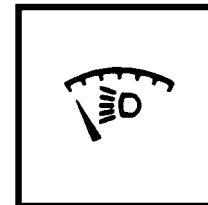

(30, Figure 3-7) PAYLOAD METER SWITCH

The Payload Meter switch is a two-way, momentary rocker switch. The top position is the select position. The Select position is used to step through the different displays. The lower position is the SET position. The SET position is used to set the Operator ID or clear the load and total ton counters. Refer to Section 6, Optional Equipment, for a more complete description of the Payload Meter System and its functions.

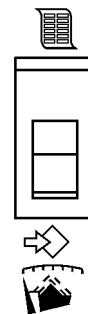

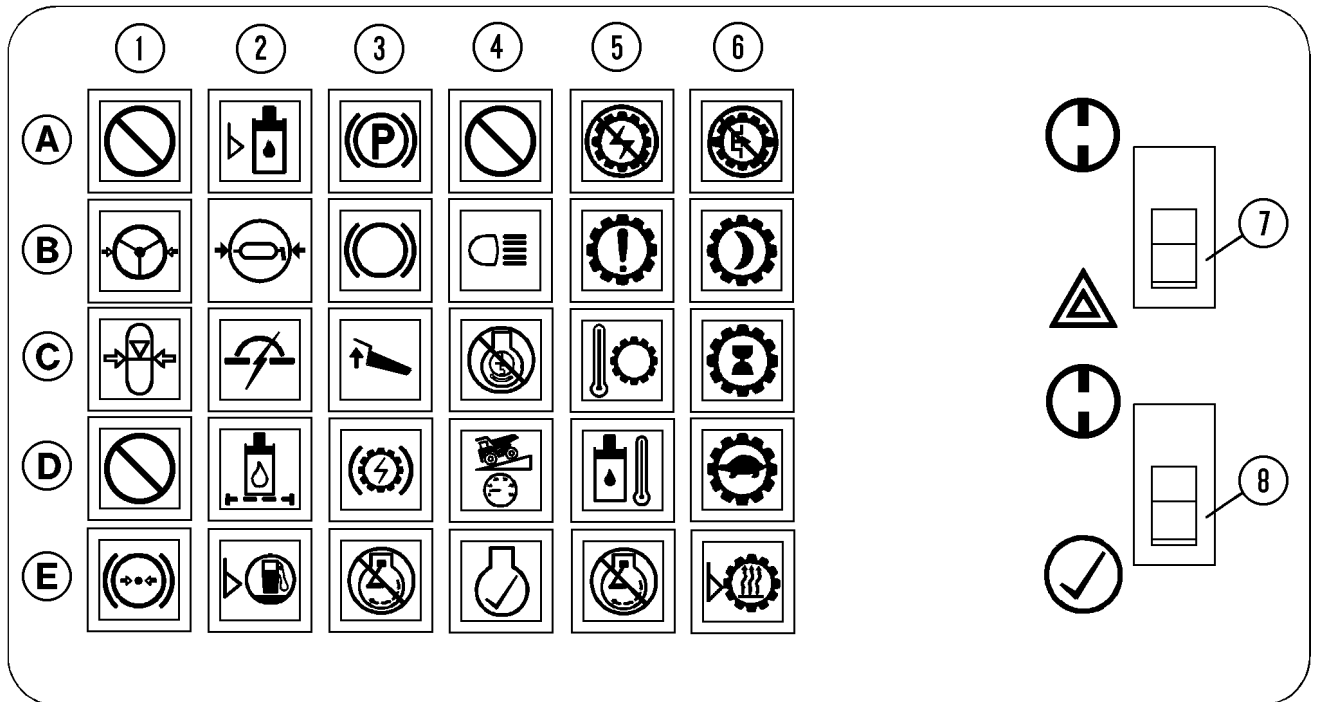

N050145

FIGURE 3-8. OVERHEAD STATUS / WARNING INDICATOR LIGHTS

Row / Column	Indicator Description	Indicator Color - Wire Index
A1*	NOT USED	12FD/34TL
B1*	Low Steering Pressure	RED-12FD/33A
C1	Low Accumulator Pr.	RED-12F/33K
D1	NOT USED	12F/79V
E1	Low Brake Pressure	RED-12F/33L
A2*	Hydraulic Tank Level	Red-12FD4/34LL
B2*	Low Automatic Lubrication Pressure	12FD8/68LLP
C2*	Circuit Breaker Tripped	Amber-12FD/31CB
D2*	Hydraulic Oil Filter	Amber-12MD/39
E2*	Low Fuel	Amber-12MD/38
A3*	Park Brake Applied	Amber-12MD/52A
B3*	Service Brake Applied	Amber-12MD/44L
C3*	Body Up	Amber-12MD6/63L
D3*	Dynamic Retarding	Amber-12MD/44 DL
E3	STOP ENGINE	RED-12M/509MA
A4*	NOT USED	12MD/SP2
B4*	Manual Back-Up Lights	Amber-12MD/47L
C4*	5 Min. Shutdown Timer	Amber-12MD/23L1
D4*	Retard Speed Control	Amber-12MD/31R
E4*	CHECK ENGINE	Amber-12MD7/419

Row / Column	Indicator Description	Indicator Color - Wire Index
A5	NO POWER	RED-12M/75-6PI
B5	PROPULSION SYS. WARNING	Amber-12F/79WI
C5	PROPULSION SYS. TEMPERATURE	Amber -12F/34TW
D5	HYDRAULIC OIL TEMP. HIGH	RED-12F/34TGI
E5	Stop Engine	12M/528AL
A6	NO PROPEL	RED-12M/75NPI
B6	PROPEL SYS.@ REST	Amber-12M/72PR
C6*	PROPEL SYS. NOT READY	Amber-12MD/72NR
D6*	REDUCED PROPULSION SYS.	Amber-12MD/72LP
E6*	RETARD @ CONTINUOUS LEVEL	Amber-12MD/76LR
- SWITCHES -		
7	Hazard Lights Switch N/O	11L/45L/45R
8	Lamp Check Switch N/O (Mom.)	33H/528/710/712

* NOTE: Brightness for these Indicator Lamps can be adjusted by using Dimmer Control (12, Figure 3-1).

STATUS / WARNING INDICATOR LIGHT SYMBOLS

Indicator Lights which are **AMBER** (Yellow) in color alert the operator that the indicated truck function requires some precaution when lighted.

Indicator Lights which are **RED** in color alert the operator that the indicated truck function requires **immediate action** by the operator. Safely stop the truck and shut down the engine.

DO NOT OPERATE THE TRUCK WITH A RED WARNING LIGHT ILLUMINATED.

Refer to Figure 3-8 and the descriptions below for explanations of the symbols.
Location of the symbols is described by rows (A-E) and columns (1 - 6).

A1. NOT USED

Not currently used. Reserved for future use or options.

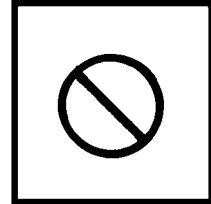

B1. Low Steering Pressure

When the keyswitch is turned "ON", the low steering pressure warning light will illuminate until the steering system hydraulic pressure reaches 2100 psi (14.7 MPa). The warning horn will also turn on, and both will remain on, until the accumulator has been charged.

During truck operation, the low steering pressure warning light and warning horn will turn sound if steering system hydraulic pressure drops below 2100 psi (14.7 MPa).

- If the light illuminates momentarily ("flickers") while turning the steering wheel at low truck speed and low engine RPM, this may be considered "normal", and truck operation may continue.
- If the indicator light illuminates at higher truck speed and high engine RPM, DO NOT OPERATE TRUCK.

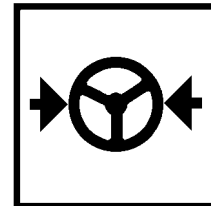

If the low steering warning light continues to illuminate and the alarm continues to sound, low steering pressure is indicated. The remaining pressure in the accumulators allows the operator to control the truck to a stop. Do not attempt further operation until the malfunction is located and corrected.

C1. Low Accumulator Precharge Pressure

The low accumulator precharge warning light, if illuminated, indicates low nitrogen precharge for the steering accumulator(s). To check for proper accumulator nitrogen precharge, engine must be stopped and hydraulic system completely bled down; then turn keyswitch to "Run" position. Warning light will NOT illuminate if system is properly charged. The warning light *will flash* if the nitrogen precharge within the accumulator(s) is below 1100 ± 45 psi (7585 ± 310 kPa).

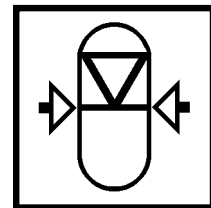

If low accumulator precharge warning light flashes, notify maintenance personnel. Do not attempt further operation until the accumulators have been recharged with nitrogen to 1400 psi (9653 kPa). Sufficient energy for emergency steering may not be available, if system is not properly charged.

D1. NOT USED

Not currently used. Reserved for future use or options.

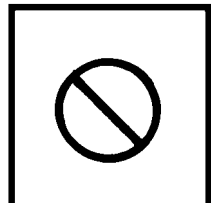

E1. Low Brake Pressure

This red indicator light indicates a malfunction within the hydraulic brake circuit. If this light comes on and buzzer sounds, **shut down truck operation** and notify maintenance personnel.

NOTE: Adequate hydraulic fluid is stored to allow the operator to safely stop the truck.

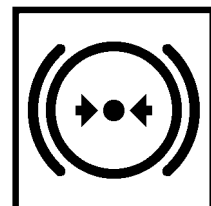

A2. Low Hydraulic Tank Level

This warning light indicates the oil level in the hydraulic tank is below recommended level. Damage to hydraulic pumps may occur if operation continues. Shut truck down and notify maintenance personnel immediately.

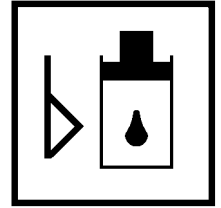

B2. Low Automatic Lubrication System Pressure

This amber light will illuminate if the Automatic Lubrication System fails to reach 2,200 PSI (at the junction block located on the rear axle housing) within one minute after the Lube Timer initiates a cycle of grease. To turn the light off, turn key switch off, then back on again. Notify maintenance personnel at earliest opportunity after light comes on.

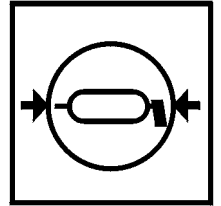

C2. Circuit Breaker Tripped

This light will illuminate if any of the circuit breakers in the relay circuit control boards are tripped. The relay circuit boards are located in the electrical control cabinet.

NOTE: Additional circuit breakers are in the operator cab behind the center console, however tripping of these circuit breakers should not activate this light.

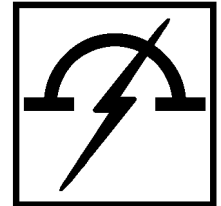

D2. Hydraulic Oil Filter Monitor

This light indicates a restriction in the high pressure filter assembly for either the steering or hoist circuit. This light will come on before filters start to bypass. Notify maintenance personnel at earliest opportunity after light comes on.

NOTE: The filter monitor warning light may also illuminate after the engine is initially started if the oil is cold. If the light turns off after the oil is warmed, filter maintenance is not required.



E2. Low Fuel

This amber low fuel indicator will illuminate when the usable fuel remaining in the tank is approximately 25 gallons (95 liters). A warning buzzer will also sound.

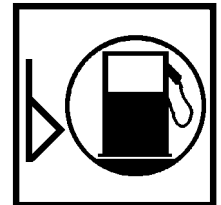

A3. Parking Brake

This amber parking brake indicator will illuminate when the parking brake is applied. Do not attempt to drive truck with parking brake applied.



B3. Service Brake

This amber service brake indicator light will illuminate when the service brake pedal is applied or when wheel brake lock or emergency brake is applied. Do not attempt to drive truck from stopped position with service brakes applied, except as noted in "Operating Instructions, Starting On A Grade With A Loaded Truck".

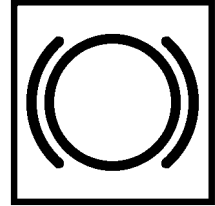

C3. Body Up

This amber Body Up indicator, when illuminated, shows that the body is not completely down on the frame. The truck should not be driven until body is down and light is off.



D3. Dynamic Retarding

This amber dynamic retarding indicator light illuminates whenever the retarder pedal (or retarder lever) is operated, RSC (Retarder Speed Control) is activated, or the automatic overspeed retarding circuit is energized, indicating the dynamic retarding function of the truck is operating.

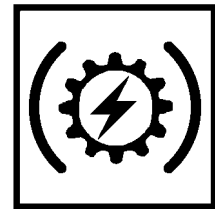

E3. Stop Engine

This **RED** engine monitor warning light will illuminate if a serious engine malfunction is detected in the electronic engine control system.

- Electric propulsion to the wheelmotors will be discontinued.
- Dynamic Retarding will still be available if needed to slow or stop the truck.

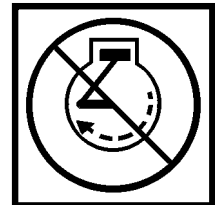

Stop the truck as quickly as possible in a safe area and apply parking brake.

SHUT DOWN THE ENGINE IMMEDIATELY.

Additional engine damage is likely to occur if operation is continued.

Listed below are a few conditions that could cause the Stop Engine light to illuminate:

- Low Oil Pressure - red warning light will illuminate, but engine does not shutdown.
- Low Coolant Level - red warning light will illuminate, but engine does not shutdown.
- Low Coolant Pressure - red warning light will illuminate, but engine does not shutdown.
- High Coolant Temperature - red warning light will illuminate, but engine does not shutdown.

A4. NOT USED

Reserved for future use or options.

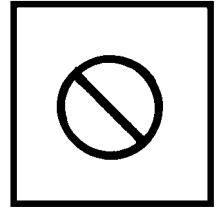

B4. Manual Backup Lights

This amber indicator will illuminate when the manually operated Manual Backup switch (3, Figure 3-7, Instrument Panel) is turned "on".

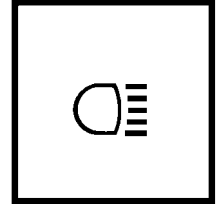

C4. Engine Shutdown Timer - 5 Minute Idle

When the Engine Shutdown Timer switch has been activated (2, Figure 3-7, Instrument Panel), this indicator light will illuminate to indicate that the shutdown timing sequence has started. Refer to Instrument panel for operation of this switch.

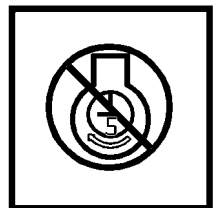

D4. Retard Speed Control Indicator

This amber light is illuminated when the RSC switch mounted on the console is pulled out to the "On" position. The light indicates the retarder is active. It is for feedback only and does not signal a problem.

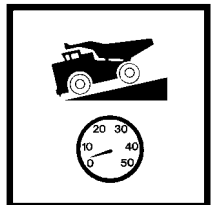

E4. Check Engine

This amber "Check Engine" indicator will illuminate if a malfunction is detected by the engine electronic control system.

If this indicator illuminates, truck operation may continue, but maintenance personnel should be alerted as soon as possible.

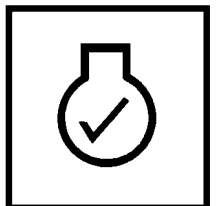

A5. NO POWER

This RED “No Retard/No Propel” indicator light indicates a fault has occurred which has eliminated the retarding and propulsion capability. A warning buzzer will also sound.

If this condition occurs, the operator should safely stop the truck, move Selector Switch to Neutral, apply the Park Brake, shutdown engine, and notify maintenance personnel immediately.

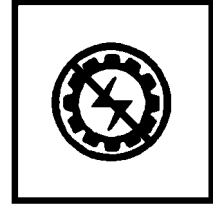

B5. PROPULSION SYSTEM WARNING

When this amber indicator is illuminated, the light indicates a “No Propel” or “No Retard” event may be about to occur. It is intended to provide advance notice of these events when possible. It does not require the operator to stop the truck, but may suggest that truck operation be appropriately modified, in case a red alarm does occur.

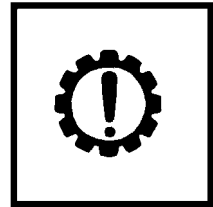

C5. PROPULSION SYSTEM TEMPERATURE

This amber AC Drive System “Temperature Warning” light indicates the drive system temperature is above a certain level. When this condition occurs, the operator should consider modifying truck operation in order to reduce system temperature. The operator is not required to stop the truck at this time.

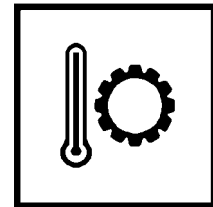

D5. HIGH HYDRAULIC OIL TEMPERATURE

This red warning light indicates high oil temperature in the hydraulic tank. Several things occur before the red light illuminates:

- If the truck is moving, and the oil temperature exceeds 221 °F (105 °C), the minimum idle speed will be 1200 RPM (normally 1050).
- If the truck is moving, and the oil temperature goes above 230 °F (110 °C), the minimum idle speed will be 1700 RPM (normally 1050).
- If the truck is stopped, and the oil temperature goes above 212 °F (100 °C) the minimum idle speed will be 1000 RPM (normally 750).

NOTE: Once the oil cools down to the normal operating range, the engine RPM will return to normal speed.

- The red warning light will illuminate if the oil temperature rises above 248 °F (120 °C). Continued operation could damage components in the hydraulic system.

If this condition occurs, the operator should safely stop the truck, move Selector Switch to Neutral, apply the Park Brake, and operate engine at 1200 - 1500 RPM to reduce system temperature.

If temperature gauge (25, Figure 3-7) does not move into the Green range after a few minutes, and the RED overhead indicator light does not go out, notify maintenance personnel immediately.

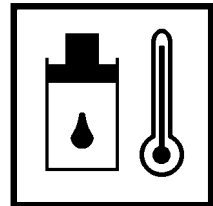

E5. STOP ENGINE

This **RED** engine monitor warning light will illuminate if a serious engine malfunction is detected in the electronic engine control system.

- Electric propulsion to the wheelmotors will still be available .
- Dynamic Retarding will still be available if needed to slow or stop the truck.

Stop the truck as quickly as possible in a safe area and apply parking brake.



***SHUT DOWN THE ENGINE IMMEDIATELY.
Additional engine damage is likely to occur if operation is continued.***

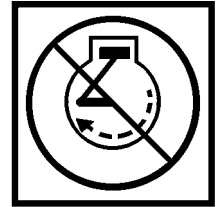

An example of a condition that could cause the Stop Engine light to illuminate:

- **If engine governor senses an overspeed condition, the ECM will close the fuel solenoid and stop the flow of fuel to the engine until engine speed is back within normal operating range.**

A6. NO PROPEL

The RED “No Propel” light indicates a fault has occurred which has eliminated the propulsion capability.

If this condition occurs, the operator should safely stop the truck, move Selector Switch to Neutral, apply the Park Brake, shutdown engine, and notify maintenance personnel immediately.

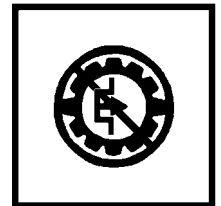

B6. PROPEL SYSTEM @ REST

The amber “Propel System @ REST” light is used to indicate that the AC Drive System is de-energized and propulsion is not available. This light is activated when the instrument panel REST switch is turned “On” and the AC Drive System is de-energized.

The three “LINK ENERGIZED” lights (one on rear wall of operator cab, and two on the deck-mounted control cabinets) should NOT be illuminated at this time.

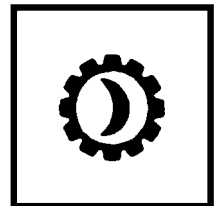

C6. PROPEL SYSTEM NOT READY

The amber “PROPEL SYSTEM NOT READY” indicator light functions during start-up much like the hourglass icon on a computer screen. This light indicates the computer is in the process of performing the self-diagnostics and set-up functions at start-up.

Propulsion will not be available at this time.

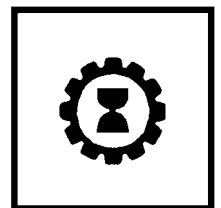

D6. REDUCED PROPULSION

The amber “Reduced Propulsion” light is used to indicate that the full AC Drive System performance in propulsion is not available. At this time, the only event that should activate this light is the use of “Limp Home Mode”. This mode of operation requires a technician to enable.

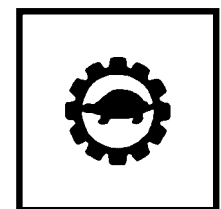

E6. RETARD AT CONTINUOUS LEVEL

The amber “Retard Continuous” light indicates the retarding effort is at the continuous level. For a limited period of time, the retarding effort can exceed this level.

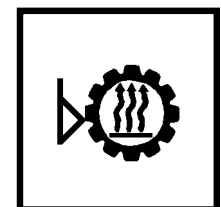

(7) HAZARD WARNING LIGHTS

The hazard warning light switch flashes all the turn signal lights. Pressing the bottom side of the rocker switch (toward the triangle) activates these lights. Pressing the top side of the rocker switch (toward the “OFF” symbol) turns these lights off.

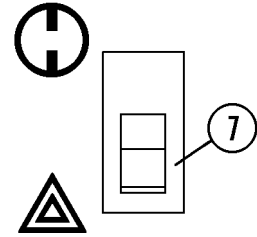

(8) LAMP TEST SWITCH

The Lamp Test switch is provided to allow the operator to test the indicator lamps prior to starting the engine. To test the lamps, and the warning horn, turn the key switch (1, Figure 3-7) to the “Run” position and press the bottom side of the rocker switch for the “Check” position. All lamps should illuminate, except those which are for “Optional” equipment that may not be installed. The warning horn should also sound. Any lamp bulbs which do not illuminate should be replaced before operating the truck.

Releasing the spring-loaded switch will allow the switch to return to the “Off” position.

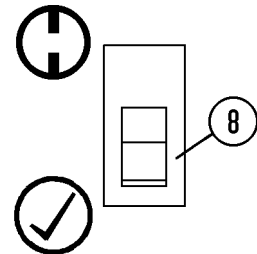

LINK-ON WARNING LIGHT

The “LINK-ON”, or “LINK ENERGIZED”, indicator light is located next to the D.I.D. display panel behind the passenger seat and indicates the AC DRIVE system is ENERGIZED.

The D.I.D. display panel is for use by maintenance personnel only, and is located out of the operator’s field of vision for that reason.

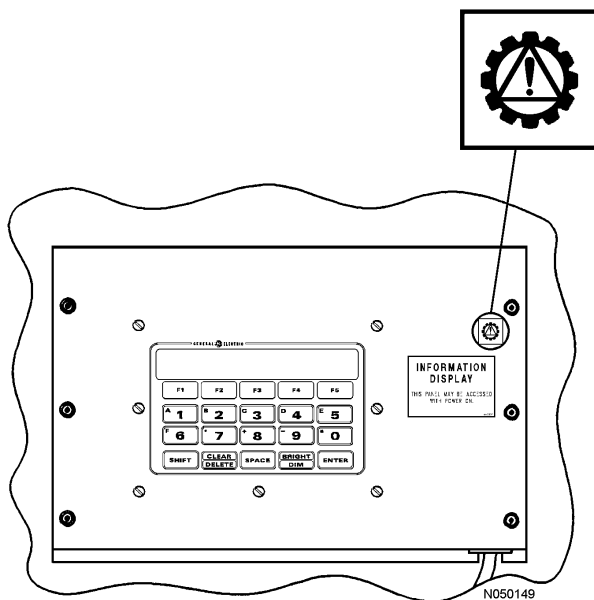
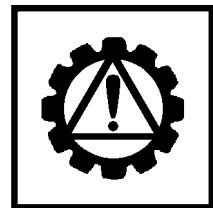

LUBRICATION AND SERVICE

Recommended Preventive Maintenance will contribute to the long life and dependability of the truck and its components. The use of proper lubricants and the performance of checks and adjustments at the recommended intervals is most important.

Lubrication requirements are referenced to the lube key found in the Truck Lubrication Specifications Chart (page 4-2). For detailed service requirements for specific components, refer to the Shop manual section for that component (i.e. Section "H" for Suspensions, Section "L" for Hydraulic System, etc.).

Refer to manufacturer's service manual when servicing any components of the General Electric System.

Refer to engine manufacturer's service manual when servicing the engine or any of its components.

The service intervals presented here are in hours of operation. **These intervals are recommended in lieu of an oil analysis program which may determine different intervals.** However, if the truck is being operated under extreme conditions, some or all, of the intervals may need to be shortened and the service performed more frequently.

The 930E Truck is equipped with a Lincoln Automatic Lubrication System. The initial setup for this system provides for nominal amounts of lubricant to be delivered to each serviced point. The lubrication injectors can be adjusted to vary the amount of lubricant delivered. In addition, the timer for lubrication intervals is normally adjustable. For adjustments to these devices, consult the "Lincoln Automatic Lubrication System" later in this section of the manual.

HYDRAULIC TANK SERVICE

There are two sight gauges on the side of the hydraulic tank. With engine stopped, keyswitch "off", hydraulic system bled down and body down, oil should be visible in the top sight gauge. If hydraulic oil is not visible in the top sight gauge, follow "Adding Oil" instructions below.

Adding Oil

Keep the system open to the atmosphere only as long as absolutely necessary to lessen chances of system contamination.

Service the tank with clean Type C-4 hydraulic oil only. All oil being put into the hydraulic tank should be filtered through 3 micron filters.

1. With engine stopped, keyswitch "off", hydraulic system bled down and body down, check to see that hydraulic oil is visible in the top sight gauge.
2. If hydraulic oil is not visible in the top sight gauge, remove the tank fill cap and add clean, filtered C-4 hydraulic oil (Lubrication Chart, Lube Key "B") until oil is visible in the top sight gauge.
3. Replace fill cap.
4. Start engine. Raise and lower the dump body three times.
5. Repeat steps 1 through 4 until oil is maintained in the top sight gauge with engine stopped, body down, and hydraulic system bled down.

930E SERVICE CAPACITIES		
	Liters	U.S. Gallons
Crankcase: (including 4 lube oil filters).		
Komatsu SSDA16V160 Engine	280	74
Cooling System: Komatsu SSDA16V160 Engine	594	157
Hydraulic System: Refer to "Hydraulic Tank Service".	1325	350
Wheel Motor Gear Box (each side)	76	20
Fuel Tank (Diesel Fuel Only)	4542	1200

COOLANT LEVEL CHECK

Inspect the coolant sight gauge. If coolant cannot be seen in the sight gauge, it is necessary to add coolant to the cooling system before truck operation. Refer to the procedure below for the proper filling procedure.

RADIATOR FILLING PROCEDURE



Cooling System is pressurized due to thermal expansion of coolant. DO NOT remove radiator cap while engine and coolant are hot. Severe burns may result.

1. With engine and coolant at ambient temperature, remove radiator cap.

Note: If coolant is added using the Wiggins quick fill system, the radiator cap MUST be removed prior to adding coolant.

2. Fill radiator with proper coolant mixture (as specified by the engine manufacturer) until coolant is visible in the sight gauge.
3. Install radiator cap.
4. Run engine for 5 minutes, check coolant level.
5. If coolant is not visible in the sight gauge, repeat steps 1 through 4. Any excess coolant will be discharged through the vent hose after the engine reaches normal operating temperature.

Engine coolant must always be visible in the sight gauge before truck operation.

COOLING SYSTEM ANTI - FREEZE RECOMMENDATIONS (Ethylene Glycol Permanent Type Anti-Freeze)		
Percentage of Anti-Freeze	Protection To	
10	+ 23°F	- 5°C
20	+ 16°F	- 9°C
25	+ 11°F	- 11°C
30	+ 4°F	- 16°C
35	- 3°F	- 19°C
40	- 12°F	- 24°C
45	- 23°F	- 30°C
50	- 34°F	- 36°C
55	- 48°F	- 44°C
60	- 62°F	- 52°C

Use only anti-freeze that is compatible with engine as specified by engine manufacturer.

Reserve Engine Oil System (Optional)

The reserve oil tank for the engine is designed to add more oil capacity to the engine to reduce the frequent servicing of the engine oil. The engine oil level must still be checked every shift using the dipstick. If engine oil level is not correct, check for proper operation of reserve oil system. Never add oil to engine unless it has been drained.

If the engine oil has been drained from the oil pan, the new oil must be added to the engine oil pan before starting. DO NOT use the oil in the reserve tank to fill an empty engine with oil. After an oil change, both engine and reserve tank must be full of oil before starting the engine.

Reserve Oil Tank Filling Procedure (Remote fill)

1. Connect the pressure supply hose from the new oil supply to the quick coupler on the truck. Open valve on supply hose to apply pressure.
2. Pull out on switch (2) to turn the fill system "ON".
3. Push the start switch (3). The "Valve Open" light (5) should illuminate and the filling process will begin.
4. When tank is full, the "Valve Open" light will turn "OFF" and the FULL light (4) will illuminate.
5. Close the oil supply valve in the fill hose.
6. Press and hold start switch (3) for a couple of seconds to relieve oil pressure in the line.
7. Disconnect the new oil supply hose.
8. Push switch (2) in to turn fill system power "OFF".

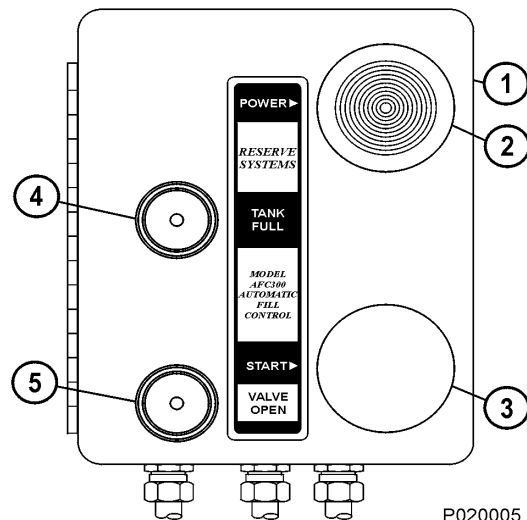

FIGURE 4-1. RESERVE OIL TANK REMOTE FILL

- | | |
|-----------------------|-----------------------|
| 1. Remote Control Box | 4. "Full" Light |
| 2. System Switch | 5. "Valve Open" light |
| 3. Start Switch | |

LUBRICATION CHART

LUBRICATION SPECIFICATIONS

LUBE KEY	TYPE LUBRICANT
A	ENGINE OIL SEE ENGINE MANUAL
B	HYDRAULIC OIL SAE 10W C-4 AUXILIARY HEATERS REQUIRED BELOW -10°F (-23°C)
C	HEAVY-DUTY SYNTHETIC GEAR OIL SEE DRIVE SYSTEM MANUAL
D	MULTI-PURPOSE EXTREME PRESSURE GREASE NLGI NO.2 (5% MIN. MOLY-DISULFIDE)
E	MULTI-PURPOSE GEAR OIL SAE 80W-90

SYM	DESCRIPTION	LUBE	PTS	10 HR	50 HR	100 HR	250 HR	500 HR	1000 HR	2000 HR	2500 HR
1	CRANKCASE OIL LEVEL	A	1	CHECK							
2	ENGINE LUBE OIL FILTERS										
3	FUEL FILTER										
4	FUEL SEPARATOR (DAYCO)										
5	FUEL TANK										
6	GE PREFILTER BREATHER	D	1						CLEAN		
7	FUEL TANK BREATHER		1						*CHANGE		
8	HYDRAULIC OIL LEVEL	B	1	CHECK					CLEAN		
9	HYDRAULIC STRAINER		2								
10	HYDRAULIC TANK BREATHER		2						CHANGE		
11	HYDRAULIC FILTERS		3	**	**	**	**	**	CHANGE		
12	MOTORIZED WHEEL OIL LEVEL	C	2						SEE DRIVE SYSTEM MANUAL		
13	HYD. PUMP DRIVE SHAFT	D	2						GREASE		
14	CHASSIS LUBE LEVEL	D	1						GREASE		
15	SEAT SLIDES & STEER SHAFT	D	4						GREASE		
16	WHEEL MOTOR BLOWER	D	2						GREASE		
17	FRONT WHEEL BEARINGS ***	E	2						CHECK		
18	FRONT TRUION	D	1						GREASE		CHANGE

SEE ENGINE MANUAL

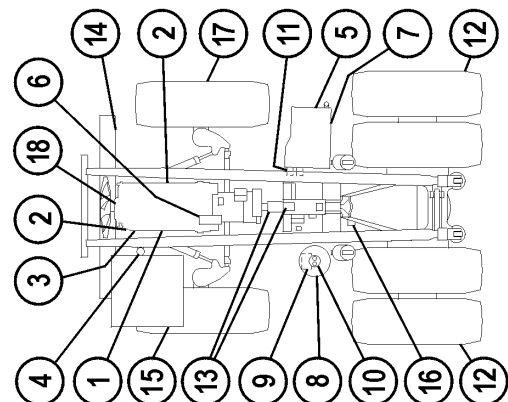

630E, 730E, 830E, & 930E

WB2790

* 1000 HR INTERVAL CAN BE EXTENDED TO 2500 HR PROVIDED OIL SAMPLING AND ANALYSIS IS CONDUCTED EVERY 250 HR.
 ** ONE TIME CHANGE AT 50, 100 AND 250 HR.
 *** NOT APPLICABLE FOR 930E

10 HOUR (DAILY) INSPECTION

Prior to each operating shift, a "walk around" inspection should be performed. Check the truck for general condition. Look for evidence of hydraulic leaks; check all lights and mirrors for clean and unbroken lenses; check operator's cab for clean and unbroken glass; check frame, sheet metal and body for cracks. Notify the proper maintenance authority if any discrepancies are found. Give particular attention to the following:

Truck Serial Number _____

Site Unit Number _____

Date: _____ Hour Meter _____

Name of Service person _____

NOTE: "Lube Key" references are to the Lubrication Specification Chart.

10 HOUR LUBRICATION AND MAINTENANCE CHECKS

1. FAN DRIVE AND TURBOCHARGERS -
Check for leaks, vibration or unusual noise.
Check alternator and fan belts for proper tension, condition and for alignment.
2. RADIATOR - Check coolant level and fill with proper mixture as shown in Cooling System Recommendation Chart. Refer to Engine Manual for proper coolant additives.
3. ENGINE - Check oil level on dipstick. Refer to engine manufacturer's shop manual for oil recommendations. (Lube Key "A").

NOTE: If truck is equipped with a reserve engine oil tank, the oil should be visible in the center (middle) sight gauge. If not, add oil to reserve tank until oil is visible in top sight gauge. Also, with engine running, check operation of the LED indicator light. See below for description of LED Light Signals.

Inspect exhaust piping for security.

4. FUEL FILTERS (Fuel Separators).-
Drain water from bottom of each filter housing.
5. HYDRAULIC TANK - Check oil level in tank, add oil if necessary. Refer to "Hydraulic Tank Service".
Oil should be visible in sight glass. -
DO NOT OVERFILL. Lube Key "B".
6. FUEL TANK - Fill as required.

COMMENTS	√'d	INITIALS

LED Light Signals:

- Steady - Pump 1 is withdrawing oil from the engine sump and bringing down the oil level.
- Regular Pulsing - Pump 2 is returning oil to the engine sump and raising the oil level.
- Irregular Pulsing - Oil is at the correct running level.

50 HOUR LUBRICATION AND MAINTENANCE CHECKS

MOTORIZED WHEELS - Check for correct oil level. Refer to G.E. Motorized Wheel Service & Maintenance Manual for the lubrication specifications and service intervals.

- *1. FUEL FILTERS - Change the Fuel Filters, (Fuel Separators).

Refer to engine manufacturer's maintenance manual for fuel filter replacement instructions.

- *2. HYDRAULIC SYSTEM FILTERS -
Replace filter elements only, after the initial 50, 100, and 250 hours of operation; then at each 500 hours of operation thereafter.

- *3. FAN DRIVE ASSEMBLY -
Check torque for the six fan mounting capscrews: **175 ft.lbs. (237 N.m)**.

* These checks are required **only after the initial hours of operation** (such as: the commissioning of a new truck, or after a new or rebuilt component installation).

Truck Serial Number _____		
Site Unit Number _____		
Date: _____ Hour Meter _____		
Name of Service person _____		
COMMENTS	√'d	INITIALS

100 HOUR LUBRICATION AND MAINTENANCE CHECKS

* These checks are required ***only after the initial hours of operation*** (such as: the commissioning of a new truck, or after a new or rebuilt component installation), check:

* 1. HYDRAULIC SYSTEM FILTERS -
Replace filter elements only, after the ***initial*** 100 and 250 hours of operation; then at each 500 hours of operation thereafter.

Truck Serial Number _____		
Site Unit Number _____		
Date: _____ Hour Meter _____		
Name of Service person _____		
COMMENTS	√'d	INITIALS

250 HOUR LUBRICATION AND MAINTENANCE CHECKS

Maintenance requirements for the 10 hour Lubrication and Maintenance Checks should also be carried out at this time.

NOTE: "Lube Key" references are to the Lubrication Specification Chart.

1. ENGINE - Refer to Cummins Operation & Maintenance manual for complete specifications regarding engine lube oil specifications.

NOTE: If engine is equipped with the CENTINEL™ oil system and/or the ELIMINATOR™ filter system, engine oil and filter change intervals are extended beyond 250 hours. Refer to Cummins Operation & Maintenance manual for specific oil & filter change intervals.*

- a. Change engine oil. Lube Key "A".
- b. Replace lube oil filters.
NOTE: When installing spin-on filter elements, follow the instructions as specified by the filter manufacturer. The tightening instructions are normally printed on the outside of the filter. Do not use a wrench or strap to tighten filter elements.
- c. If truck is equipped with a Reserve Engine Oil Tank, change the reserve tank oil filter.
- d. Check the fan belt tension.
Refer to Cummins Operation & Maintenance manual for specific fan belt adjustment instructions.

2. FUEL FILTERS - Change the Fuel Filters (Fuel Separators).
Refer to Cummins Operation & Maintenance manual for specific fuel filter replacement instructions.

3. HYDRAULIC PUMP DRIVESHAFT & U-JOINTS - Add one or two applications of grease to each grease fitting. Check that each bearing of the Cross & Bearing assembly is receiving grease. Lube Key "D".

* The Centinel™ system is a duty-cycle-dependent lubrication management system whereby oil is blended with the fuel and burned and an extension of oil change intervals can occur.

Truck Serial Number _____

Site Unit Number _____

Date: _____ Hour Meter _____

Name of Service person _____

COMMENTS	√'d	INITIALS

(CONTINUED NEXT PAGE)

1000 HOURS LUBRICATION AND MAINTENANCE CHECKS

Maintenance for every 10, 250, & 500 hour Lubrication and Maintenance Checks should also be carried out at this time.

NOTE: "Lube Key" references are to the Lubrication Specification Chart.

1. **HYDRAULIC TANK** - Drain hydraulic oil and clean inlet strainer. Refill tank with oil, approximate capacity 250 gal. (947 l). Use Lube Key "B".
2. **RADIATOR** - Clean cooling system with a quality cleaning compound. Flush with water. Refill system with anti-freeze and water solution. Check Cooling System Recommendation Chart for correct mixture. Refer to Engine manufacturer's manual for correct additive mixture.
3. **FUEL TANK** - Remove breather and clean in solvent. Dry with air pressure and reinstall.
4. **OPERATOR'S SEAT** - Apply grease to slide rails. Use Lube Key "D".
5. **AUTOMATIC BRAKE APPLICATION** - Check that brakes are automatically applied when hydraulic brake pressure decreases below specified limit. Refer to the shop manual for "Brake Check-out procedure".
6. **AUXILIARY BLOWER** - Apply a few applications of grease to auxiliary blower bearings. There are two grease zerks (1, Figure 4-2) located on the auxiliary blower (2).

Truck Serial Number _____		
Site Unit Number _____		
Date: _____ Hour Meter _____		
Name of Service person _____		
COMMENTS	√'d	INITIALS

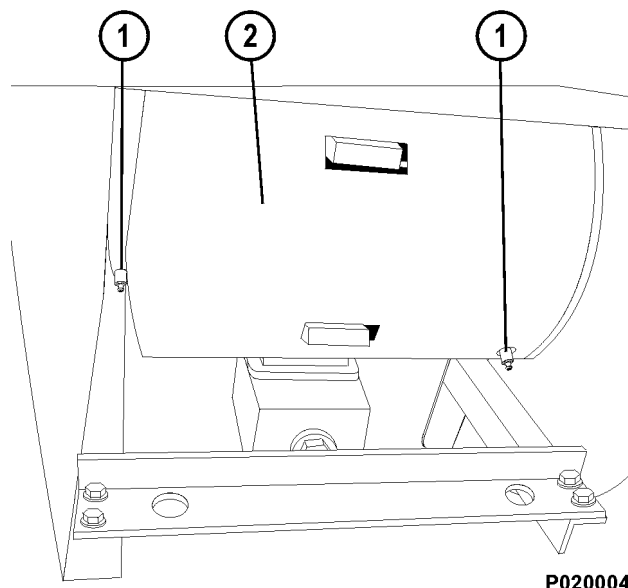

FIGURE 4-2. AUXILIARY BLOWER
 1. Grease Zerk 2. Auxiliary Blower

2500 HOUR MAINTENANCE CHECKS

MOTORIZED WHEELS - Drain and replace gear oil. Refer to G.E. Motorized Wheel Service & Maintenance Manual for lubrication specifications. Lube Key "C".

5000 HOUR MAINTENANCE CHECKS

1. AIR CLEANERS - Clean the Donaclone Tubes in the pre-cleaner section of the air filter. Use low pressure cold water or low pressure air to clean tubes. Refer to the Shop Manual, Section "C".

NOTE: Do not use a hot pressure washer or high pressure air to clean tubes, hot water/high pressure causes pre-cleaner tubes to distort.

Truck Serial Number _____		
Site Unit Number _____		
Date: _____ Hour Meter _____		
Name of Service person _____		
COMMENTS	√'d	INITIALS
COMMENTS	√'d	INITIALS

AUTOMATIC LUBRICATION SYSTEM

GENERAL DESCRIPTION

The Lincoln Automatic Lubrication System is a pressurized lubricant delivery system which delivers a controlled amount of lubricant to designated lube points. The system is controlled by an electric timer which signals a solenoid valve to operate a hydraulic motor powered grease pump. Hydraulic oil for pump operation is supplied by the truck steering circuit.

Grease output is proportional to the hydraulic motor input flow. A pump control manifold, mounted on top of the hydraulic motor, controls input flow and pressure. A 24VDC Solenoid mounted on the manifold turns the pump on and off.

The pump is driven by the rotary motion of the hydraulic motor, which is then converted to reciprocating motion through an eccentric crank mechanism. The reciprocating action causes the pump cylinder to move up and down. The pump is a positive displacement, double-acting type as grease output occurs on both the up and the down stroke.

During the down stroke, the pump cylinder is extended into the grease. Through the combination of shovel action and vacuum generated in the pump cylinder chamber, the grease is forced into the pump cylinder. Simultaneously, grease is discharged through the outlet of the pump. The volume of grease during intake is twice the amount of grease output during one cycle. During the upstroke, the inlet check valve closes, and one half the grease taken in during the previous stroke is transferred through the outlet check and discharged to the outlet port.

⚠ WARNING

Over-pressurizing of the system, modifying parts, using incompatible chemicals and fluids, or using worn or damaged parts, may result in equipment damage and/or serious personal injury.

- * ***DO NOT exceed the stated maximum working pressure of the pump, or of the lowest rated component in the system.***
- * ***Do not alter or modify any part of this system unless approved by factory authorization.***
- * ***Do not attempt to repair or disassemble the equipment while the system is pressurized.***
- * ***Make sure all fluid connections are securely tightened before using this equipment.***
- * ***Always read and follow the fluid manufacturer's recommendations regarding fluid compatibility, and the use of protective clothing and equipment.***
- * ***Check all equipment regularly and repair, or replace, worn or damaged parts immediately.***

This equipment generates very high grease pressure. Extreme caution should be used when operating this equipment as material leaks from loose or ruptured components can inject fluid through the skin and into the body causing serious bodily injury including possible need for amputation. Adequate protection is recommended to prevent splashing of material onto the skin or into the eyes.

If any fluid appears to penetrate the skin, get emergency medical care immediately! Do not treat as a simple cut. Tell attending physician exactly what fluid was injected.

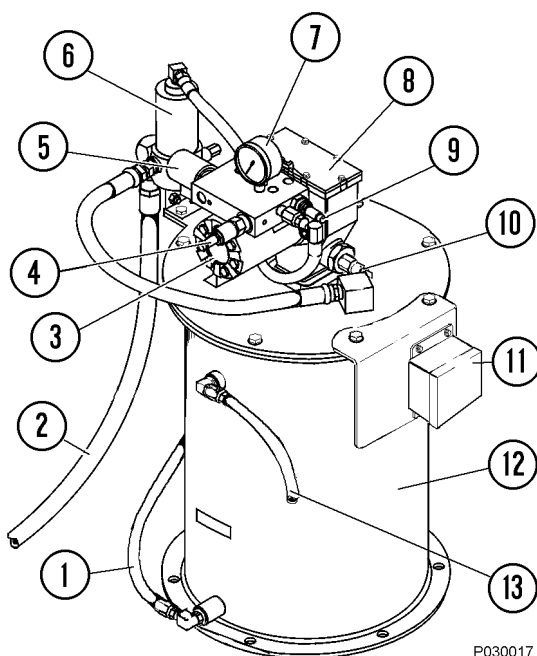
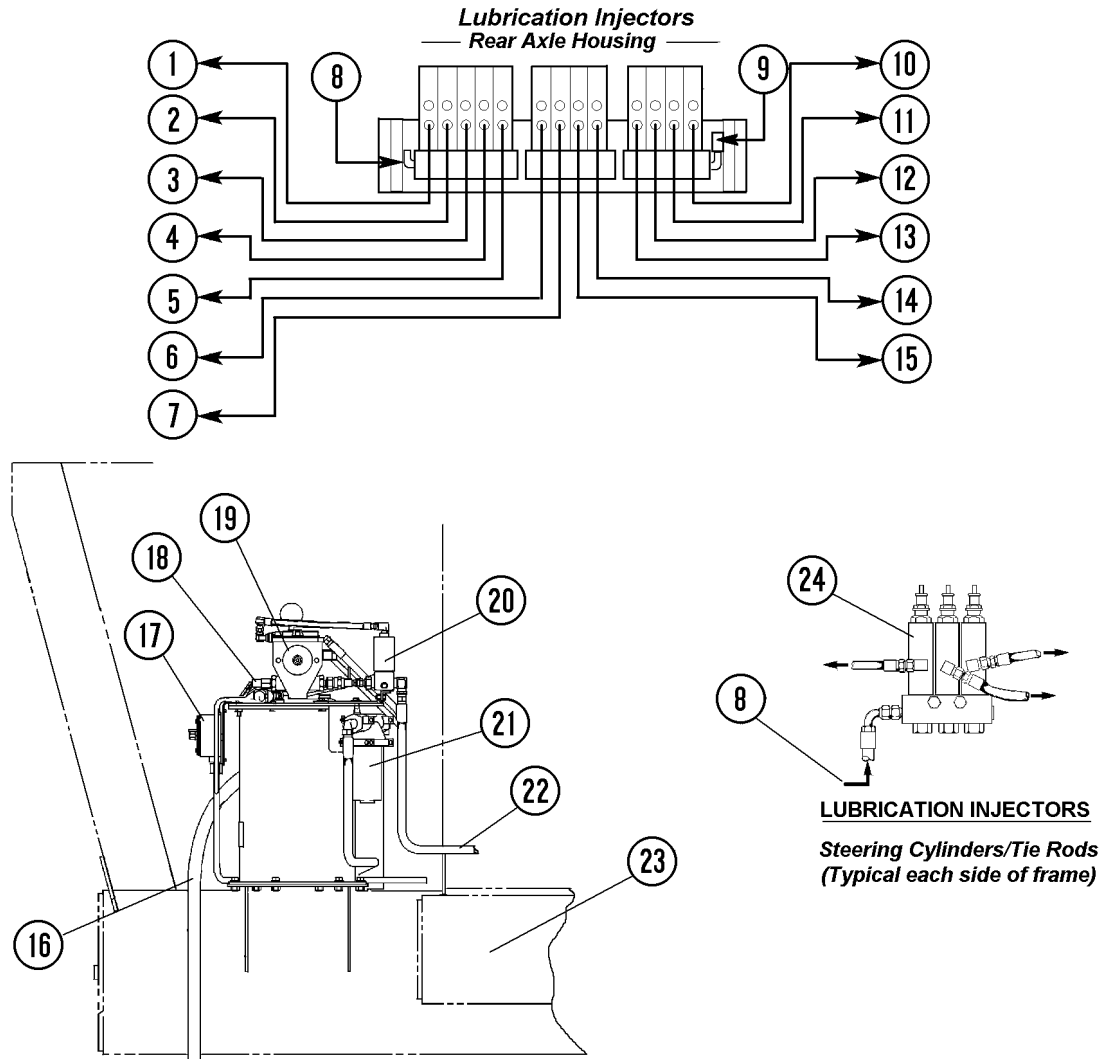

FIGURE 4-3. PUMP AND RESERVOIR COMPONENTS

- | | |
|----------------------------|-----------------------|
| 1. Hose From Filter | 7. Pressure Gauge |
| 2. Outlet to Injectors | 8. Pump Assembly |
| 3. Hydraulic Motor | 9. Flow Control Valve |
| 4. Pressure Reducing Valve | 10. Pressure Switch |
| 5. Solenoid Valve | 11. Relay Box |
| 6. Vent Valve | 12. Grease Reservoir |
| | 13. Vent Hose |



P030024

FIGURE 4-4. AUTO LUBE SYSTEM INSTALLATION

NOTE: The above illustration shows the standard location for the lube pump & reservoir (right platform). This assembly may be located on left platform on some models.

- | | |
|---|--|
| 1. L.H. Suspension, Top Bearing | 13. R.H. Hoist Cylinder, Top Bearing |
| 2. L.H. Suspension, Bottom Bearing | 14. R.H. Hoist Cylinder, Bottom Bearing |
| 3. L.H. Body Pivot Pin | 15. R.H. Anti-Sway Bar Bearing |
| 4. L.H. Hoist Cylinder, Top Bearing | 16. Vent Hose |
| 5. L.H. Hoist Cylinder, Bottom Bearing | 17. Junction Box |
| 6. L.H. Anti-Sway Bar Bearing | 18. Pressure Switch, N.O., 2500 psi (17 237 kPa) |
| 7. Rear Axle Pivot Pin | 19. Grease Pump |
| 8. Grease Supply From Pump | 20. Vent Valve |
| 9. Pressure Switch, N.O., 2000 psi (13 790 kPa) | 21. Filter |
| 10. R.H. Suspension, Top Bearing | 22. Grease Supply to Injectors |
| 11. R.H. Suspension, Bottom Bearing | 23. Truck Frame |
| 12. R.H. Body Pivot Pin | 24. Injector |

SYSTEM COMPONENTS

Filter (21, Figure 4-4)

A filter assembly mounted on the grease reservoir filters the grease prior to refilling the reservoir from the shop supply. A bypass indicator alerts service personnel when the filter requires replacement.

Hydraulic Motor and Pump (3 & 8, Figure 4-3)

The rotary hydraulic pump is a fully hydraulically operated grease pump. An integrated pump control manifold is incorporated with the motor to control input flow and pressure.

Note: The pump crankcase oil level must be maintained to the level of the pipe plug port. If necessary, refill with 10W-30 motor oil.



Hydraulic oil supply inlet pressure must not exceed 3000 psi (20 685 kPa). Exceeding the rated pressure may result in damage to the system components and personal injury.

Grease Reservoir (12, Figure 4-3)

The reservoir has an approximate capacity of 60 lbs. (27 kg) of grease. When the grease supply is replenished by filling the system at the service center, the grease is passed through the filter to remove contaminants before it flows into the reservoir.

Pressure Reducing Valve (4, Figure 4-3)

The pressure reducing valve, located on the manifold reduces the hydraulic supply pressure (from the truck steering circuit) to a suitable operating pressure, [325-350 psi (2 240-2 415 kPa)] for the hydraulic motor used to drive the lubricant pump.

Flow Control Valve (9, Figure 4-3)

The flow control valve mounted on the manifold, controls the amount of oil flow to the hydraulic motor.

The flow control valve has been factory adjusted and the setting should not be disturbed.

Solenoid Valve (5, Figure 4-3)

The solenoid valve, when energized, allows oil to flow to the hydraulic motor.

Vent Valve (6, Figure 4-3)

With the vent valve closed, the pump continues to operate until maximum grease pressure is achieved. As this occurs, the vent valve opens and allows the grease pressure to drop to 0, so the injectors can recharge for their next output cycle.

Lubrication Cycle Timer (1, Figure 4-6)

The solid state lubrication cycle timer provides a 24 VDC timed-interval signal to energize the solenoid valve (5, Figure 4-3), providing oil flow to operate the grease pump motor. This timer is mounted in the Electrical Interface Cabinet.

Delay Timer (11, Figure 4-6)

The delay timer, located in the Electrical Interface Cabinet, provides a one minute delay in the low pressure warning lamp circuit to allow a normally operating system to attain full grease system pressure without activating the warning lamp. If the system fails to reach 2000 psi (13 789 kPa) within this time period, the timer will apply 24VDC to several relays which will illuminate the low pressure warning lamp in the overhead display. An external 604K ohm resistor determines the delay period.

Pump Cutoff Pressure Switch (N.O. 2500 psi [17 237 kPa]) (10, Figure 4-3)

This pressure switch de-energizes the pump solenoid relay when the grease line pressure reaches the switch pressure setting, turning off the motor and pump.

Grease Pressure Failure Switch (N.O. 2000 psi [13 789 kPa]) (9, Figure 4-4)

This pressure switch monitors grease pressure in the injector bank on the rear axle housing. If the proper pressure is not sensed within 60 seconds (switch contacts do not close), several relays energize, actuating a warning lamp circuit to notify the operator a problem exists in the the lube system.

Pressure Gauge (7, Figure 4-3)

The pressure gauge monitors hydraulic oil pressure to the inlet of the hydraulic motor.

Injectors (24, Figure 4-4)

Each injector delivers a controlled amount of pressurized lubricant to a designated lube point. Refer to Figure 4-4 for locations.

System Operation

Normal Operation:

1. During truck operation, the lubrication cycle timer (1, Figure 4-6) will energize the system at a preset time interval.
2. The timer provides 24 VDC through the normally closed relay, RB7K5 (4) used to energize the pump solenoid valve (5), allowing hydraulic oil provided by the truck steering pump circuit to flow to the pump motor and initiate a pumping cycle.
3. The hydraulic oil pressure from the steering circuit is reduced to 325 to 350 psi (2 240 to 2 413 kPa) by the pressure reducing valve (4, Figure 4-5) before entering the motor. In addition, the amount of oil supplied to the pump is limited by the flow control valve (6). Pump pressure can be read using the gauge (5) mounted on the manifold.
4. With oil flowing into the hydraulic motor, the grease pump will operate, pumping grease from the reservoir to the injectors (13), through a check valve (10) and to the vent valve (11).
5. During this period, the injectors will meter the appropriate amount of grease to each lubrication point.
6. When grease pressure reaches the pressure switch (3, Figure 4-6) setting, the switch contacts will close and energize the relay RB7K5, removing power from the hydraulic motor/pump solenoid and the the pump will stop. The relay will remain energized until grease pressure drops and the pressure switch opens again or until the timer turns off.
7. After the pump solenoid valve is de-energized, hydraulic pressure in the manifold drops and the vent valve will open, releasing grease pressure in the lines to the injector banks. When this occurs, the injectors are then able to recharge for the next lubrication cycle.
8. The system will remain at rest until the lubrication cycle timer turns on and initiates a new grease cycle.

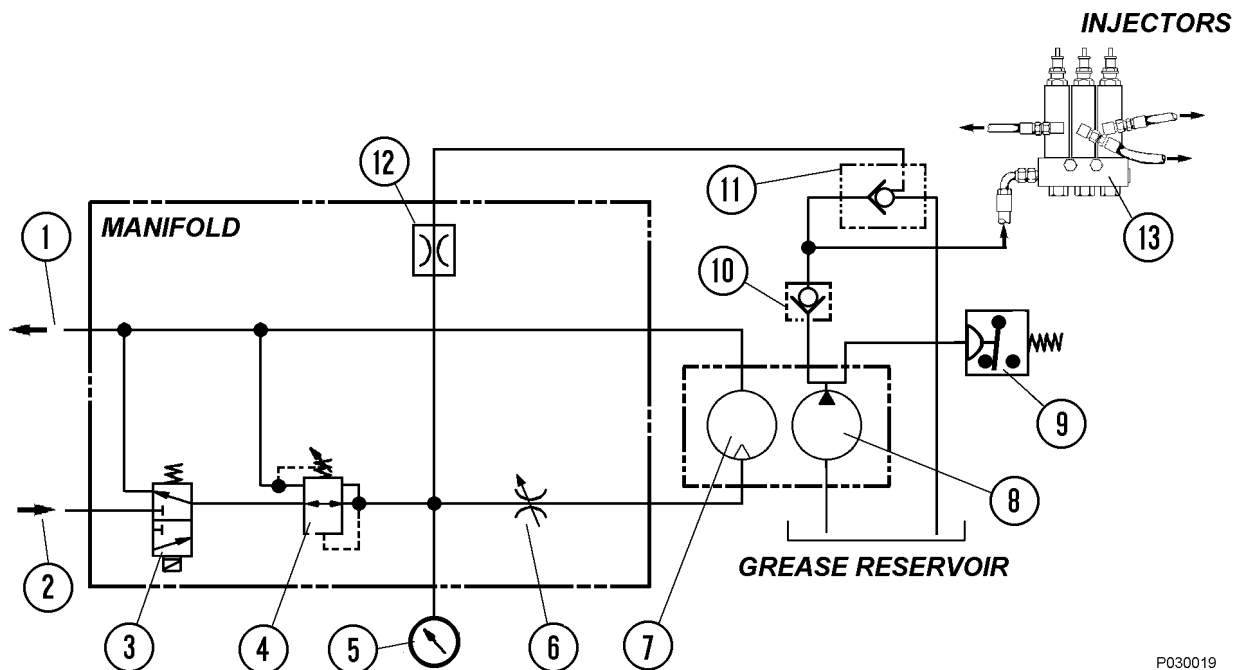

FIGURE 4-5. HYDRAULIC SCHEMATIC

- | | | |
|----------------------------|-------------------------|---------------------------|
| 1. Hydraulic Oil Return | 5. Motor Pressure Gauge | 9. Pressure Switch (N.O.) |
| 2. Hydraulic Oil Supply | 6. Flow Control Valve | 10. Check Valve |
| 3. Pump Solenoid Valve | 7. Hydraulic Motor | 11. Vent Valve |
| 4. Pressure Reducing Valve | 8. Grease Pump | 12. Orifice |
| | | 13. Injector Bank |

P030019

Pressure Failure Detection Circuits:

1. When the lubrication cycle is initiated, 24VDC flows through relay RB7K1 (7, Figure 4-6) N.C. contacts to a 1 minute delay timer (11).
2. If the system is operating normally, grease pressure at the rear axle injector bank will rise to pressure switch (6) setting of 2000 psi (13.8 MPa) and energize relay RB7K1 (7), removing 24VDC from the delay timer.

3. If a problem occurs and the system is not able to attain 2000 psi (13.8 MPa), the delay timer (11) will energize relay RB7K4 (12) after 60 seconds, turning on the "Low Lube System Pressure" warning lamp on the overhead display. After RB7K4 relay energizes, it will energize relay RB7K3 (10).
4. Once RB7K3 is energized, it will latch and remain energized as long as the keyswitch is on. In addition, RB7K4 will also remain energized and the Low Lube Pressure Warning lamp will remain on to notify the operator a problem exists and the system requires service.

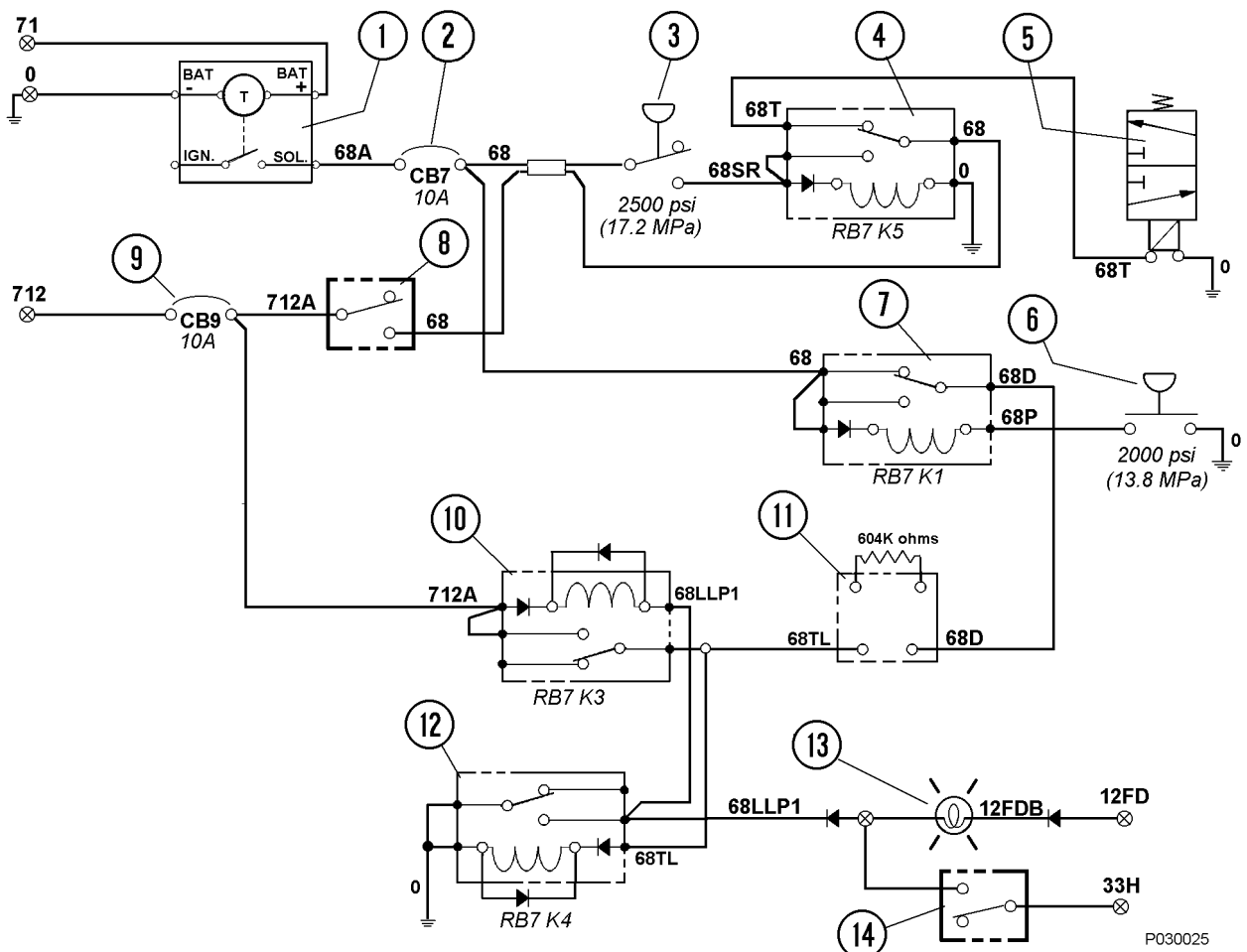

FIGURE 4-6. ELECTRICAL SCHEMATIC

- | | |
|--|--|
| 1. Lubrication Cycle Timer | 9. Circuit Breaker CB9 (In Electrical Interface Cabinet) |
| 2. Circuit Breaker CB7 (In Electrical Interface Cabinet) | 10. Relay K3 (On Relay Board RB7) |
| 3. Pressure Switch; N.O., 2500 psi (17 237 kPa) | 11. Circuit Time Delay Module |
| 4. Relay K5 (On Relay Board RB7) | 12. Relay K4 (On Relay Board RB7) |
| 5. Grease Pump Motor Solenoid Valve | 13. Low Grease Pressure Warning Lamp (On Overhead Display Panel) |
| 6. Pressure Switch; N.O. 2000 psi (13 790 kPa) | 14. Warning & Caution Lamp Test Switch (On Overhead Display Panel) |
| 7. Relay K1 (On Relay Board RB7) | |
| 8. Lube System Manual Test Switch | |

GENERAL INSTRUCTIONS

LUBRICANT REQUIRED FOR SYSTEM

Grease requirements will depend on ambient temperatures encountered during truck operation:

- Above 90°F (32°C) - Use NLGI No.2 multipurpose grease (MPG).
- -25° to 90°F (-32° to 32°C) - Use NLGI No. 1 multipurpose grease (MPG).
- Below -25°F (-32°C) - Refer to local supplier for extreme cold weather lubricant requirements.

SYSTEM PRIMING

The system must be full of grease and free of air pockets to function properly. After maintenance, if the primary or secondary lubrication lines were replaced, it will be necessary to reprime the system to eject all entrapped air.

1. Fill lube reservoir with lubricant, if necessary.
2. To purge air from the main supply line, remove the main supply line at the Lincoln Lube canister and connect an external grease supply to the line.
3. Remove plugs from each injector group in sequence (right front, left front, and rear axle).
4. Using the external grease source, pump grease until grease appears at the group of injectors and re-install the pipe plug. Repeat for remaining injector groups.
5. Remove the caps from each injector and connect an external grease supply to the zerk on the injector and pump until grease appears at the far end of the individual grease hose or the joint being greased.

FILTER ASSEMBLY

The filter assembly element (5, Figure 4-7) should be replaced if the bypass indicator (2) shows excessive element restriction.

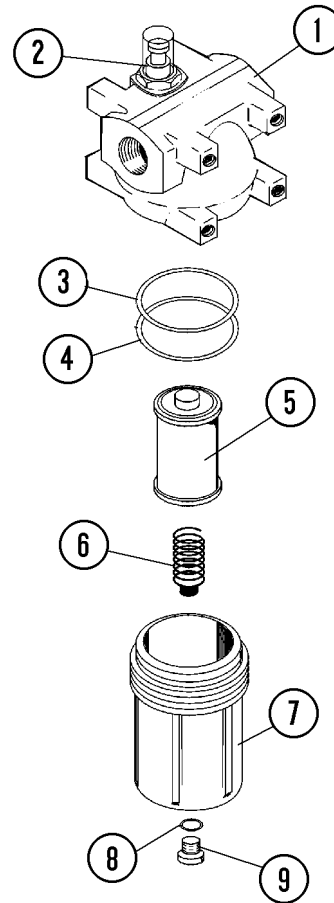

P030023

FIGURE 4-7. FILTER ASSEMBLY

- | | |
|---------------------|-----------|
| 1. Housing | 6. Spring |
| 2. Bypass Indicator | 7. Bowl |
| 3. O-Ring | 8. O-Ring |
| 4. Backup Ring | 9. Plug |
| 5. Element | |

LUBRICANT PUMP

Pump Housing Oil Level

The pump housing must be filled to the proper level with SAE 10W-30 motor oil. Oil level should be checked at 1000 hour intervals. To add oil, remove pipe plug (3, Figure 4-8) and fill housing to bottom of plug hole.

Pump Pressure Control

High pressure hydraulic fluid from the truck steering system is reduced to 325 to 350 psi (2 240 to 2 413 kPa) by the pressure reducing valve located on the manifold on top of the pump motor. This pressure can be read on the gauge installed on the manifold and should be checked occasionally to verify pressure is within the above limits.

Pressure Control Valve Adjustment

1. With the truck engine running, activate the lube system manual test switch to start the hydraulic motor and pump.
2. Loosen the locknut on the pressure control (1, Figure 4-8) by turning the nut counterclockwise.
3. Turn the valve stem counterclockwise until it no longer turns. (The valve stem will unscrew until it reaches the stop - it will not come off.)

Note: This is the minimum pressure setting, which is about 170 psi (1 172 kPa).

4. With the pump stalled against pressure, turn the pressure control valve stem clockwise until 325 to 350 psi (2 240 to 2 413 kPa) is attained on the manifold pressure gauge (2).
5. Tighten the locknut to lock the stem in position.

*Note: The flow control valve (4) is factory adjusted to 2.5 GPM (9.5 L/min.). **Do not change this setting.***

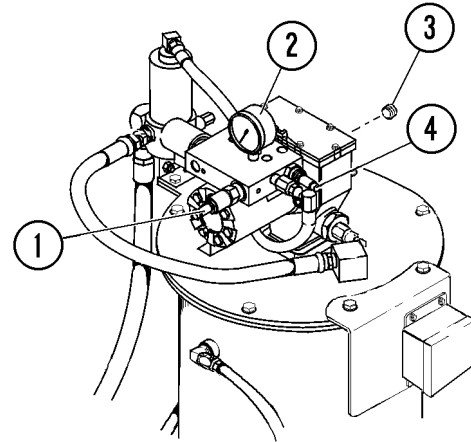

P030022

FIGURE 4-8. PUMP CONTROLS

- | | |
|--------------------------|-----------------------|
| 1. Pump Pressure Control | 3. Oil Level Plug |
| 2. Pressure Gauge | 4. Flow Control Valve |

INJECTOR OPERATION

STAGE 1

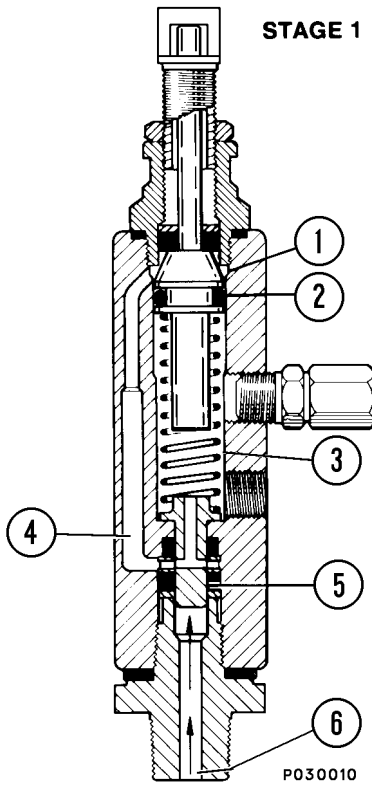

STAGE 1.

The injector piston (2) is in its normal or "rest" position. The discharge chamber (3) is filled with lubricant from the previous cycle. Under the pressure of incoming lubricant (6), the slide valve (5) is about to open the passage (4) leading to the measuring chamber (1) above the injector piston (2).

STAGE 2.

When the slide valve (5) uncovers the passage (4), lubricant (6) is admitted to the measuring chamber (1) above the injector piston (2) which forces lubricant from the discharge chamber (3) through the outlet port (7) to the bearing.

STAGE 2

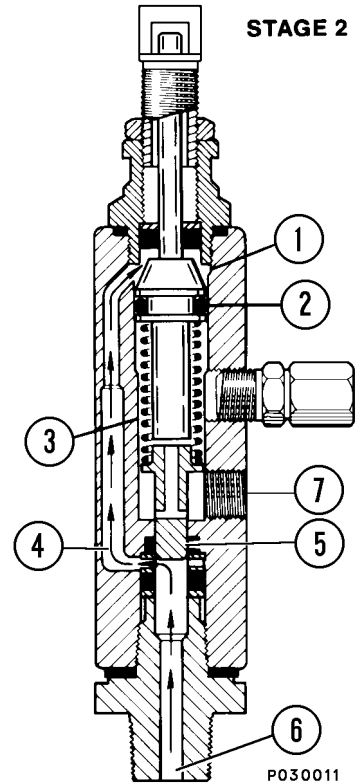

STAGE 3.

As the injector piston (2) completes its stroke, it pushes the slide valve (5) past the passage (4), cutting off further admission of lubricant (6) to the passage (4) and measuring chamber (1). The injector piston (2) and slide valve (5) remain in this position until lubricant pressure in the supply line (6) is vented.

STAGE 3

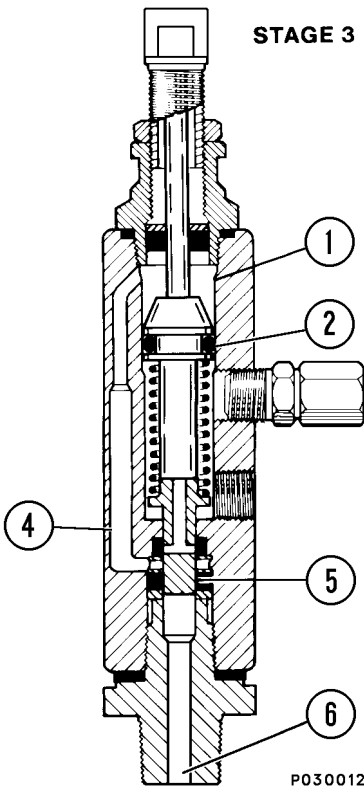

STAGE 4.

After venting, the injector spring expands, causing the slide valve (5) to move, so that the passage (4) and discharge chamber (3) are connected by a valve port (8). Further expansion of the spring causes the piston to move upward, forcing the lubricant in the measuring chamber (1) through the passage (4) and valve port (8) to refill the discharge chamber (3).

STAGE 4

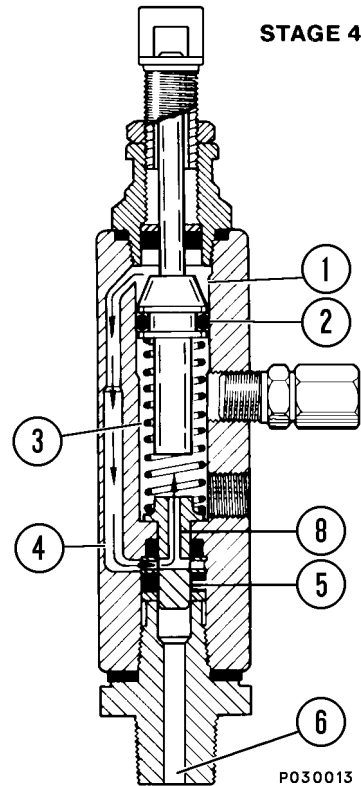

Injector is now ready for the next cycle.

INJECTORS (SL-1 Series "H")

Injector Specifications

- Each lube injector services only one grease point. In case of pump malfunction, each injector is equipped with a covered grease fitting to allow the use of external lubricating equipment.
- Injector output is adjustable:
Maximum output = 0.08 in³ (1.31 cc).
Minimum output = 0.008 in³ (0.13 cc).
- Operating Pressure:
Minimum - 1850 psi (12 755 kPa)
Maximum - 3500 psi (24 133 kPa)
Recommended - 2500 psi (17 238 kPa)
Maximum Vent Pressure - (Recharge)
600 psi (4 137 kPa)

Injector Adjustment

The injectors may be adjusted to supply from 0.008 in³ to 0.08 in³ (0.13 cc to 1.31 cc) of lubricant per injection cycle. The injector piston travel distance determines the amount of lubricant supplied. This travel is in turn controlled by an adjusting screw in the top of the injector housing.

Turn the adjusting screw (1, Figure 4-9) counterclockwise to increase lubricant amount delivered and clockwise to decrease the lubricant amount.

When the injector is not pressurized, maximum injector delivery volume is attained by turning the adjusting screw (1) fully counterclockwise until the indicating pin (8) just touches the adjusting screw. At the maximum delivery point, about 0.38 inch (9.7 mm) adjusting screw threads should be showing. Decrease the delivered lubricant amount by turning the adjusting screw clockwise to limit injector piston travel. If only half the lubricant is needed, turn the adjusting screw to the point where about 0.19 inch (4.8 mm) threads are showing. The injector will be set at minimum delivery point with about 0.009 inch (0.22 mm) thread showing.

NOTE: The above information concerns adjustment of injector delivery volume. The timer adjustment should also be changed, if overall lubricant delivery is too little or too much. Injector output should NOT be adjusted to less than one-fourth capacity.

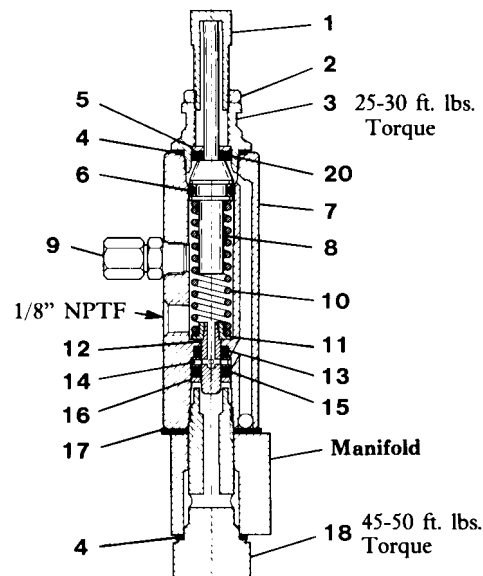

FIGURE 4-9. TYPE SL-1 INJECTOR

- | | |
|------------------------|-------------------|
| 1. Adjusting Screw | 11. Spring Seat |
| 2. Locknut | 12. Plunger |
| 3. Piston Stop Plug | 13. Viton Packing |
| 4. Gasket | 14. Inlet Disc |
| 5. Washer | 15. Viton Packing |
| 6. Viton O-Ring | 16. Washer |
| 7. Injector Body Assy. | 17. Gasket |
| 8. Piston Assembly | 18. Adapter Bolt |
| 9. Fitting Assembly | 19. Adapter |
| 10. Plunger Spring | 20. Viton Packing |

NOTE: The Piston Assembly (8) has a visible indicator pin at the top of the assembly to verify the injector operation.

SYSTEM CHECKOUT

To check system operation (not including timer), proceed as follows:

1. Turn keyswitch "ON" and start the engine.
2. Actuate the Lube System Test Switch at the reservoir/pump assembly on the front bumper.
3. The motor and pump should operate until the system attains 2500 psi (17 237 kPa).
4. Once the required pressure is achieved, the pump motor should turn off and the system should vent.
5. Check for pump, hose or injector damage or leakage with the system under pressure.
6. After checking system, shutdown engine, observing normal precautions regarding high voltage present in the propulsion system before attempting to repair lube system.

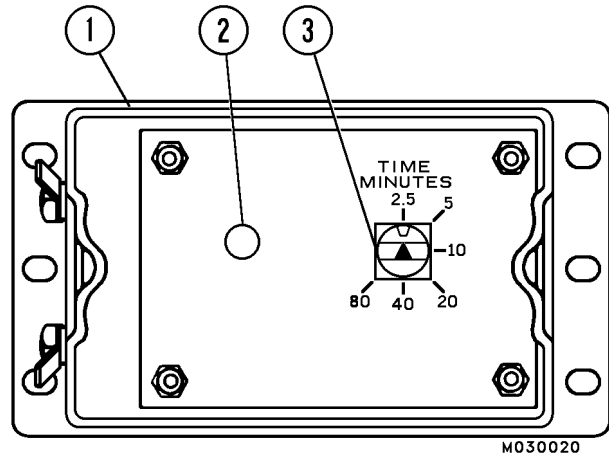

FIGURE 4-10. TIMER (TOP COVER REMOVED)

1. Timer Enclosure
2. Red LED (Light Emitting Diode)
3. Timer Selector

LUBRICATION CYCLE TIMER CHECK

To check the solid state timer operation without waiting for the normal timer setting, proceed as follows:

1. Remove timer dust cover.
NOTE: The timer incorporates a liquid and dust tight cover which must be in place and secured at all times during truck operation.
2. Adjust timer selector (3, Figure 4-10) to 5 minute interval setting.
3. The timer should cycle in five minutes if the truck is operating.

NOTE: If the timer check is being made on a cold start, the first cycle will be approximately double the nominal setting. All subsequent cycles should be within the selected time tolerance.

4. Voltage checks at the timer should be accomplished if the above checks do not identify the problem.
 - a. Insure timer ground connection is clean and tight.
 - b. Using a Volt-Ohm meter, read the voltage between positive and negative posts on the solid state timer with the truck keyswitch "ON".

Normal reading should be 18-26 VDC, depending upon whether or not the engine is running.

Lubrication Cycle Timer Adjustment

The timer is factory set for a nominal 2.5 minute (off time) interval. Dwell time is approximately 1 minute, 15 seconds. A longer interval (off time) is obtained by turning the Selector knob (3, Figure 4-10) to the desired position .

NOTE: Set timer by turning the Selector knob (3) to the 2.5 minute setting point. Then, turn the Selector clockwise, one detent at a time, to the desired setting, or until the maximum limit of eighty minutes is reached.

The timer is a sealed unit, do not attempt disassembly.

SYSTEM TROUBLESHOOTING CHART

If the following procedures do not correct the problem, contact a factory authorized service center.

POSSIBLE CAUSES

SUGGESTED CORRECTIVE ACTION

TROUBLE: Pump Does Not Operate

Lube system not grounded.

Correct grounding connections to pump assembly and truck chassis.

Electrical power loss.

Locate cause of power loss and repair. Check circuit breaker CB7. Be sure keyswitch is "ON".

Timer malfunction.

Replace timer assembly

Solenoid valve malfunctioning.

Replace the solenoid valve assembly

RB7K5 Relay malfunctioning

Replace relay

Motor or pump malfunction.

Replace motor and/or pump assembly

Pressure switch defective

Replace pressure switch

NOTE: On initial startup of the lube system, the timing capacitor will not contain a charge, therefore the first timing cycle will be about double in length compared to the normal interval. Subsequent timer cycles should be as specified.

TROUBLE: Pump Will Not Prime

Low lubricant supply.

Dirt in reservoir, pump inlet clogged, filter clogged.

TROUBLE: Pump Will Not Build Pressure

Air trapped in lubricant supply line.

Prime system to remove trapped air.

Lubricant supply line leaking.

Check lines and connections to repair leakage.

Vent valve leaking.

Clean or replace vent valve.

Pump worn or scored.

Repair or replace pump assembly.

TROUBLE: Injector Indicator Stem Does Not Operate

NOTE: Normally, during operation, the injector indicator stem will move into the body of the injector when pressure builds properly. When the system vents (pressure release) the indicator stem will again move out into the adjusting yoke.

Malfunctioning injector - usually indicated by the pump building pressure and then venting.

Replace individual injector assembly.

All injectors inoperative - pump build up not sufficient to cycle injectors.

Service and/or replace pump assembly.

POSSIBLE CAUSES

SUGGESTED CORRECTIVE ACTION

TROUBLE: Pressure Gauge Does Not Register Pressure

No system pressure to the pump motor.
No 24 VDC signal at pump solenoid.
Pressure reducing valve set too low.
Relay (RB7K5) may be defective.

Check hydraulic hose from steering system.
Determine problem in 24 VDC electric system.
Refer to "Pressure Control Valve Adjustment".
Replace relay.

TROUBLE: Pump Pressure Builds Very Slowly Or Not At All

No signal at RB7K5 relay.
Pressure switch may be defective
Pressure reducing valve may be set too low.
Grease viscosity may be too high for temperature at which pump is operating.

Check Timer and CB7.
Replace pressure switch.
Refer to "Pressure Control Valve Adjustment".
Replace grease with a lower viscosity lubricant.

Pump inlet check or outlet check may have foreign matter trapped causing leakage.

Remove, inspect and clean, if necessary.
Inspect sealing surfaces between checks. Replace if rough or pitted.

Lubricant supply line leaks or is broken.
Insufficient hydraulic oil supply.

Repair lubricant supply line
Check oil pressure and flow to motor.

TROUBLE: Lube Cycle Timer Not Operating

Timer BAT (-) connection is not on grounded member.
Timer BAT (+) connection not on circuit continuously connected to BAT (+) terminal during operation of vehicle.

Connect to good ground.
Establish direct connection between Timer BAT (+) connection and 24 V BAT (+) terminal.

Loose wire connections at any of the timer terminals.

Secure wire connections.

TROUBLE: Timer Stays Timed Out

Commutation failure in timer caused by damaged component.
Output relay contacts welded shut caused by extended short to ground.
Solenoid valve connected to "IGN" terminal of timer instead of terminal marked "SOL".

Replace Timer
Replace Timer.
Correct wiring hook-up.

POSSIBLE CAUSES

SUGGESTED CORRECTIVE ACTION

TROUBLE: Timer Turns On At Intervals Two (2) To Ten (10) Times More Often Than Set Time Interval

Electrical noise is being introduced into the power supply to the timer overcoming suppressor capacitor causing uncontrolled turn-on of its output relay.

IMPORTANT: In some instances, electrical noise may be generated into vehicle electrical system which may cause timer to turn on at random intervals, independent of timer setting.

If this occurs, a 250 to 1,000 MFD capacitor rated 150 to 350 VDC should be added across BAT (+) and BAT (-) terminals to suppress this noise and improve timer performance.

TROUBLE: Timer Turns On At Intervals Faster Than Allowable Tolerances Of Settings

Timer out of adjustment or damaged component.

Refer to "Timer Adjustment and re-adjust timer or replace timer.

Preventative Maintenance Procedures

The following maintenance procedures should be used to insure proper system operation.

Daily Lubrication System Inspection

1. Check grease reservoir level.

Inspect grease level height after each shift of operation. Grease usage should be consistent from day-to-day operations.

- Lack of lubricant usage would indicate an inoperative system. Excessive usage would indicate a broken supply line.

2. Check filter bypass indicator when filling reservoir. Replace element if bypassing.
3. Check all grease feed line hoses from the SL-1 Injectors to the lubrication points.
 - a. Repair or replace all damaged feed line hoses.
 - b. Make sure that all air is purged and all new feed line hoses are filled with grease before sending the truck back into service.
4. Inspect key lubrication points for a bead of lubricant around seal. If a lubrication point appears dry, troubleshoot and repair problem.

250 Hour Inspection

1. Check all grease feed line hoses from the SL-1 Injectors to the lubrication points (see, Figure 4-4).
 - a. Repair or replace all worn / broken feed line hoses.
 - b. Make sure that all air is purged and all new feed line hoses are filled with grease before sending the truck back into service.
2. Check all grease supply line hoses from the pump to the SL-1 injectors.
 - a. Repair or replace all worn / broken supply lines.
 - b. Make sure that all air is purged and all new supply line hoses are filled with grease before sending the truck back into service.
3. Check grease reservoir level.
 - a. Fill reservoir if low.
 - b. Check reservoir for contaminants. Clean, if required.

- c. Check that all filler plugs, covers and breather vents on the reservoir are intact and free of contaminants.

4. Inspect all bearing points for a bead of lubricant around the bearing seal.

It is good practice to manually lube each bearing point at the grease fitting provided on each Injector. This will indicate if there are any frozen or plugged bearings, and will help flush the bearings of contaminants.

5. System Checkout

- a. Remove all SL-1 injector cover caps to allow visual inspection of the injector cycle indicator pins during system operation.
- b. Start truck engine.
- c. Actuate the Lube System Test Switch. The hydraulic motor and grease pump should operate.
- d. With the grease under pressure, check each SL-1 injector assembly. The cycle indicator pin should be retracted inside the injector body.
- e. When the system attains 2500 psi (17 237 kPa), the pump should shut off and the pressure in the system should drop to zero, venting back to the grease reservoir.
- f. With the system vented, check all of the SL-1 injector indicator pins; all of the pins should be visible. Replace or repair injectors, if defective.
- g. Reinstall all injector cover caps.
- h. Check timer operation.

Note: With engine running, lube system should activate within 5 minutes. The system should build 2000 to 2500 psi within 25-40 seconds.

- i. If the system is working properly, the truck is ready for operation.
- j. If the system is malfunctioning, refer to the troubleshooting chart.

1000 Hour Inspection

1. Check pump housing oil level and correct if necessary.

MAJOR COMPONENT DESCRIPTION

Truck And Engine

The 930E Dump Truck is an off-highway, rear dump truck with AC Electric Drive. The gross vehicle weight is 1,100,000 lbs. (498 960 kg). The engine is a Komatsu SSDA16V160 rated @ 2700 HP (2014 kW).

Alternator (GE-GTA34)

The diesel engine drives an in-line alternator at engine speed. The alternator produces AC current which is rectified to DC within the main control cabinet. The rectified DC power is converted back to AC by groups of devices called “inverters”, also within the main control cabinet. Each inverter consists of six “phase modules” under the control of a “gate drive unit” (GDU). The GDU controls the operation of each phase module.

Each phase module contains an air-cooled solid-state switch referred to as a “gate turn-off thyristor” (GTO). The GTO cycles on and off at varying frequencies to create an AC power signal from the DC supply.

The AC power signal produced by each inverter is a variable-voltage, variable-frequency signal (VVVF). Frequency and voltage are changed to suit the operating conditions.

AC Induction Traction Motorized Wheels

The alternator output supplies electrical energy to the two wheel motors attached to the rear axle housing. The motorized wheels use three-phase AC induction motors with full-wave AC power.

The two wheel motors convert electrical energy back to mechanical energy through built-in gear trains within the wheel motor assembly. The direction of the wheel motors is controlled by a forward or reverse hand selector switch located on a console to the right side of the operator.

Blower

Both the inverters and the wheel motors produce heat while in operation and must be cooled. Cooling air is provided by a separate AC drive blower using rectified DC as its power source. Cooling air flow volume is modulated based on thermal requirements.

Suspension

HYDRAIR®II suspension cylinders located at each wheel provide a smooth and comfortable ride for the operator and dampens shock loads to the chassis during loading and operation.

Operator's Cab

The Operator's Cab has been engineered for operator comfort and to allow for efficient and safe operation of the truck. The cab provides for wide visibility, with an integral 4-post ROPS/FOPS structure, and an advanced analog operator environment. It includes a tinted safety-glass windshield and power-operated side windows, a deluxe interior with a fully adjustable seat with lumbar support, a fully adjustable/tilt steering wheel, controls mounted within easy reach of the operator, and an analog instrument panel which provides the operator with all instruments and gauges which are necessary to control and/or monitor the truck's operating systems.

Power Steering

The truck is equipped with a full time power steering system which provides positive steering control with minimum operator effort. The system includes nitrogen-charged accumulators which automatically provide emergency power if the steering hydraulic pressure is reduced below an established minimum.

Dynamic Retarding

The dynamic retarding is used to slow the truck during normal operation or control speed coming down a grade. The dynamic retarding ability of the electric system is controlled by the operator through the activation of the retarder pedal (or by operating a lever on the steering wheel) in the operators cab and by setting the RSC (Retarder Speed Control). Dynamic Retarding is automatically activated, if the truck speed goes to a preset overspeed setting.

Brake System

Service brakes at each wheel are oil-cooled multiple disc brakes applied by an all-hydraulic actuation system. Depressing the brake pedal actuates both front and rear brakes, after first applying the retarder. All wheel brakes will be applied automatically, if system pressure decreases below a preset minimum.

The parking brake is a dry disc type, mounted inboard on each rear wheel motor, and is spring-applied and hydraulically-released with wheel speed application protection (will not apply with truck moving).

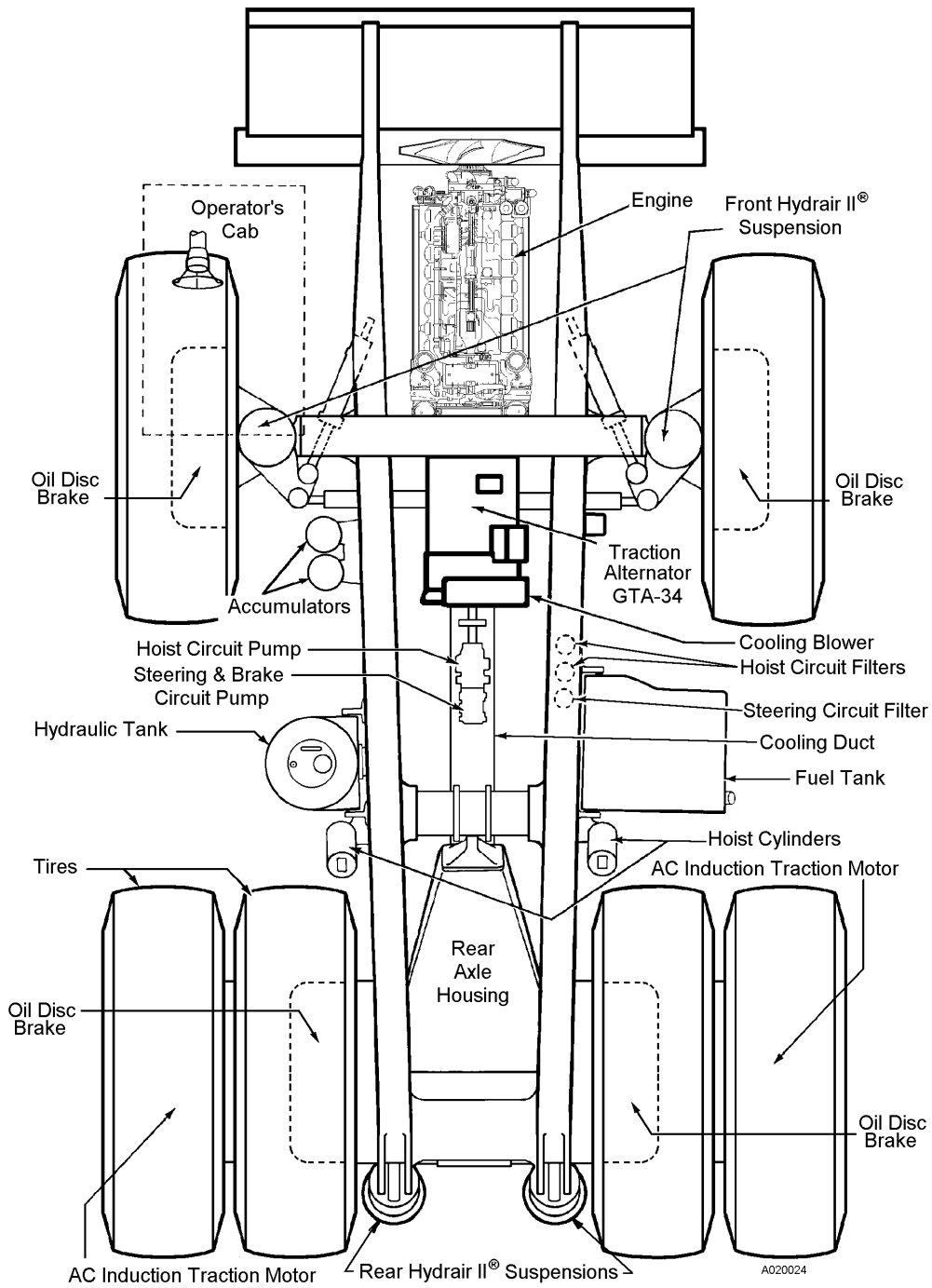

930E MAJOR COMPONENTS

SPECIFICATIONS

These specifications are for the standard 930E Truck. Customer Options may change this listing.

ENGINE

Komatsu SSDA16V160

Number of Cylinders 16
 Operating Cycle 4-Stroke
 Rated Brake HP . 2700HP (2014 kW) @ 1900 RPM
 Flywheel HP 2550HP (1879 kW)
 Weight (Wet)* 21,182 lbs. (9608 kg)
 * Weight does not include Radiator, Sub-frame, or Alternator

AC ELECTRIC DRIVE SYSTEM

AC/DC Current

Alternator General Electric GTA - 34
 Integral Cooling Fan . . . 2500 cfm (71 m³/min)
 AC Thermally Mod. Dual Fan
 12,000 cfm (340 m³/min)
 Motorized Wheels . . AC Induction Traction Motors
 Wheel Slip/Slide Control
 Standard Gear Ratio* 31.50:1
 Maximum Speed 40 MPH (64.5 km/h)
 * NOTE: Wheelmotor application depends upon GVW, haul
 road grade, haul road length, rolling resistance, and other pa-
 rameters.
 Komatsu & G.E. must analyze each job condition to assure
 proper application.

DYNAMIC RETARDING

Electric Dynamic Retarding Standard
 Maximum Retarding 5400 HP (4026 kW)
 Continuous 3300 HP (2460 kW)
 Continuously Rated High-density Blown Grids
 with Retard at Engine Idle and Retard in Reverse
 Propulsion.

BATTERY ELECTRIC SYSTEM

Batteries - bumper-mounted
 4 x 8D & 2 x 30H 12 Volt Batteries in Series/Parallel
 220 Ampere-Hour Capacity
 With Disconnect Switch
 Alternator 24 Volt, 240 Ampere Output
 Lighting 24 Volt
 Starters (2) 24 Volt

SERVICE CAPACITIES

	U.S. Gallons	Liters
Crankcase (Includes lube oil filters)		
SSDA16V160	74	280
Cooling System	157	594
Fuel	1200	4542
Hydraulic System	350	1325
Wheel Motor Gear Box . 20/Wheel		76/Wheel

HYDRAULIC SYSTEM

Hoist & Brake Cooling Pump: Tandem Gear
 Output . . . 270 GPM (1022 l/min) @ 1900 RPM
 and 2500 psi (17 237 kPa)
 Steering/Brake Pump: Press. Compensated Piston
 Output 65 GPM (246 l/min) @ 1900 RPM
 and 2750 psi (18 961 kPa)
 Relief Pressure- Hoist 2500 psi (17.2 MPa)
 Relief Pressure- Steering/Brake 2750 psi (22.4 MPa)
 Hoist Two 3-Stage Hydraulic Cylinders
 Tank Vertical - Cylindrical, Non-Pressurized
 Tank Capacity 250 U.S. Gal. (947 Liters)
 Filtration In-line replaceable elements
 Suction Single, Full Flow, 100 Mesh
 Hoist & Steering Filters . . . Beta 12 rating = 200
 Dual, In-Line, High Pressure

SERVICE BRAKES

All Hydraulic Actuation with Traction System
 Wheel Slip/Slide Control
 Front & Rear Oil-Cooled Multiple Discs
 at Each Wheel.
 Total Friction Area /Brake 15,038 in² (97 019 cm²)
 Maximum Apply Pressure . 2500 psi (17 238 kPa)

STEERING

Turning Circle (SAE) 98 ft. 1 in. (29.9 m)
 Twin hydraulic cylinders with accumulator assist to
 provide constant rate steering.
 Emergency Power Steering automatically provided by
 Accumulators

STANDARD DUMP BODY*

Capacity:
 Struck 224 yds³ 171 m³
 Heaped @ 2:1 (SAE) 276 yds³ 211 m³
 Width (Inside) 26 ft. 9 in. (8.15 m)
 Depth 10 ft. 3 in. (3.1 m)
 Loading Height 23 ft. (7.01 m)
 Dumping Angle 45°
 * OPTIONAL Capacity Dump Bodies are available.

WEIGHT DISTRIBUTION

	EMPTY	Pounds	Kilograms
Front Axle (49.3%)	220,319	999 351	
Rear Axle (50.7%)	225,527	102 297	
Total (50% Fuel)	445,846	202 232	
LOADED			
Front Axle (33.9%)	372,900	169 147	
Rear Axle (66.1%)	727,100	329 813	
Total	1,100,000	498 960	

Not to exceed 1,100,000 lbs. (498 960 kg), including options, fuel, and payload. Weights in excess of this amount require factory approval.

TIRES

Radial Tires (standard) 53/80 R63
 Rock Service, Deep Tread Tubeless
 Rims . (patented Phase II New Generation™ rims)

OVERALL TRUCK DIMENSIONS

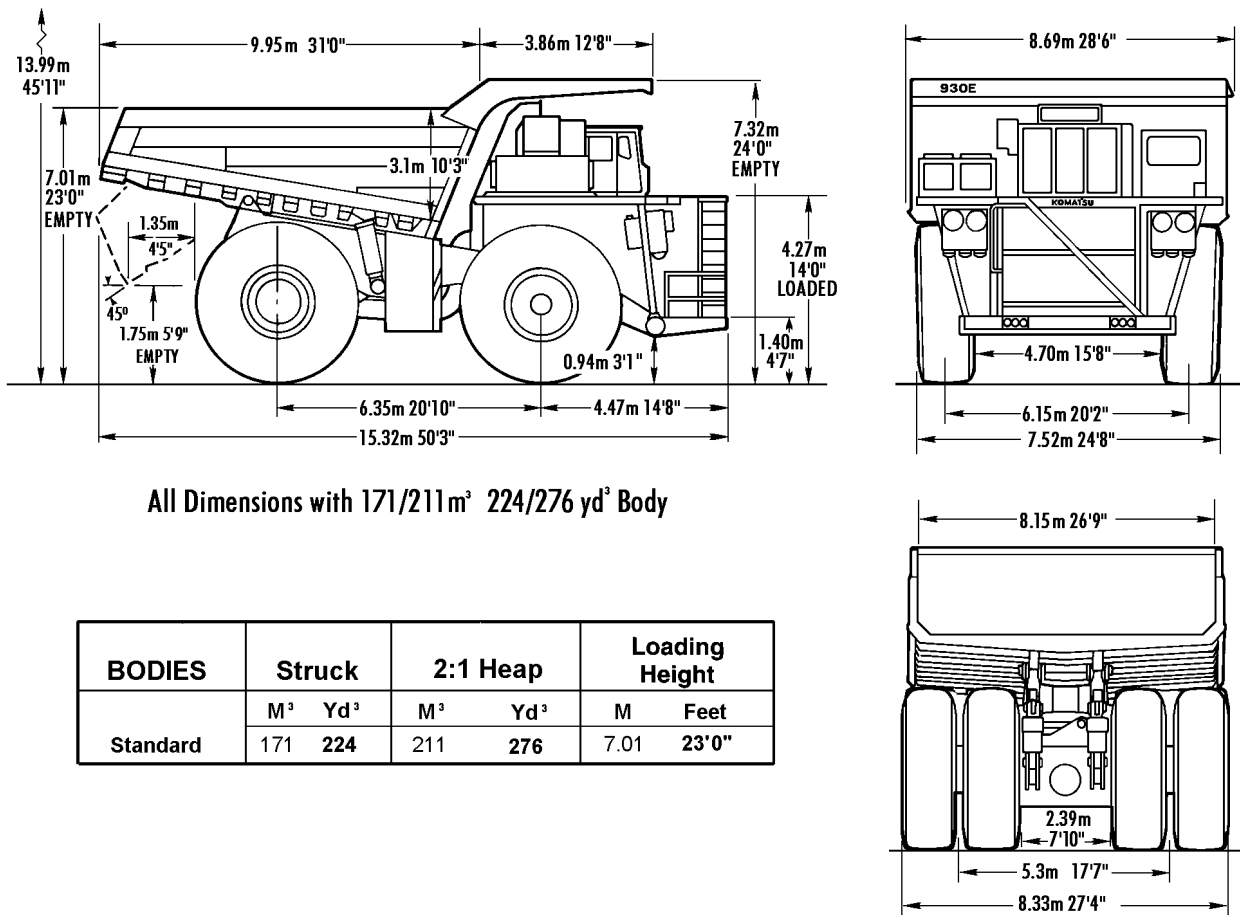

All Dimensions with 171/211 m³ 224/276 yd³ Body

BODIES	Struck		2:1 Heap		Loading Height	
	M ³	Yd ³	M ³	Yd ³	M	Feet
Standard	171	224	211	276	7.01	23'0"

PAYLOAD METER 3

INDEX

OPERATION SECTION	3
INTRODUCTION	3
DATA SUMMARY	3
DATA GATHERING	3
COMPONENT DESCRIPTION	4
System Diagram	4
Suspension Pressure Sensors	4
Inclinometer	4
Operator Display	4
Operator Switch	5
Speed Input	5
Body-up Switch	5
Brake Lock Switch	5
Payload Meter	5
Communications Ports	5
Keyswitch Input	6
Payload Meter Power	6
Load Lights	6
Wiring and Termination	7
TCI Outputs	7
OPERATOR'S DISPLAY AND SWITCH	8
Reading the Speedometer	8
Reading the Load Display	8
Using the Operator ID	8
Using the Load and Ton Counter	8
Total Ton Counter	8
Total Load Counter	9
Clearing the Counters	9
Viewing Live Sensor Data	9
Other Display Messages	9
PAYLOAD OPERATION & CALCULATION	10
Description of Haul Cycle States	10
"States" or stages of a typical haul cycle	10
Haul Cycle Description	10
Load Calculation	11
Carry Back	11
Measurement Accuracy	11
Sources for Payload Error	11
Payload Error	11
Loading Conditions	12
Pressure Sensors	12
Swingloads	12
Speed and Distance	12
HAUL CYCLE DATA	12
Haul Cycle Data	13
Haul Cycle Warning Flags	14
Alarm Records	15
Frame Torque Data	15
Sprung Weight Data	16
Maximum Speed Data	16

PC SOFTWARE OVERVIEW	16
PC Overview	16
System Configuration	16
Installing the Payload Meter 3 Software	16
DOWNLOADING DATA	17
PLM3 SYSTEM CONFIGURATION	18
Starting Communications	18
Displayed Payload Units.....	18
Time Units	18
Connection Menu	18
Connecting to the Payload Meter	19
Configure the Payload Meter	19
Setting the Date and Time	19
Setting the Truck Type	20
Setting the Gauge Display Units	20
Setting the Frame Serial Number	20
Setting the Truck Number	20
Setting the KMS Distributor	20
Setting the KMS Customer	20
Clean Truck Tare	21
Inclinometer Calibration	21
DATA ANALYSIS	22
Creating a Query	22
Sorting on Truck Unit Number	22
Sorting on Truck Type	22
Sorting on Date Range	23
Sorting on Time Range	23
Payload Detail Screen	24
Creating Reports	24
Summary - one page report	25
Detailed - multi-page report	25
Creating Graphs	26
Exporting Data	26
CSV Export	26
Compressed	27
Importing Data	28
Deleting Haul Cycle Records	28
Viewing Alarms	29
Deleting Alarm Records	29

OPERATION SECTION

INTRODUCTION

Payload Meter 3 (PLM3) measures, displays and records the weight of material being carried by an off-highway truck. The system generally consists of a payload meter, a gauge display, deck-mounted lights, and sensors. The primary sensors are four suspension pressures and an inclinometer. Other inputs include a body up signal, brake lock signal, and speed.

Data Summary

5208 haul cycles can be stored in memory. The following information is recorded for each haul cycle:

- Payload
- Operator ID number (0000-9999)
- Distance traveled loaded and empty
- The amount of time spent empty run/stop, loading, loaded run/stop, and dumping
- Maximum speed loaded and empty with time of day
- Average speed loaded and empty
- Empty carry-back load
- Haul-cycle, loading, dumping start time of day.
- Peak positive and peak negative frame torque with time of day
- Peak sprung load with time of day
- Tire ton-mph for each front and average per rear tires

The payload meter stores lifetime data that cannot be erased. This data includes:

- Top 5 maximum payloads and time stamps.
- Top 5 positive and negative frame torque and time stamps
- Top 5 maximum speeds and time stamps

Data Gathering

Windows 95/98/NT software is available to download, store and view payload and fault information. The PC software will download an entire truck fleet into one Paradox database file. Users can query the database by date, time, truck type and truck number to produce reports, graphs and export the data. The software can export the data in '.CSV' format that can be easily imported into most spreadsheet applications. The Windows software is not compatible with the Payload Meter 2 system.

It is important that each payload meter be configured for each truck using the PC software. The information for frame serial number and truck number is used by the database program to organize the payload data. In addition, the payload meter must be configured to make calculations for the proper truck model. Improper configuration can lead to data loss and inaccurate payload calculations.

Component Description

System Diagram

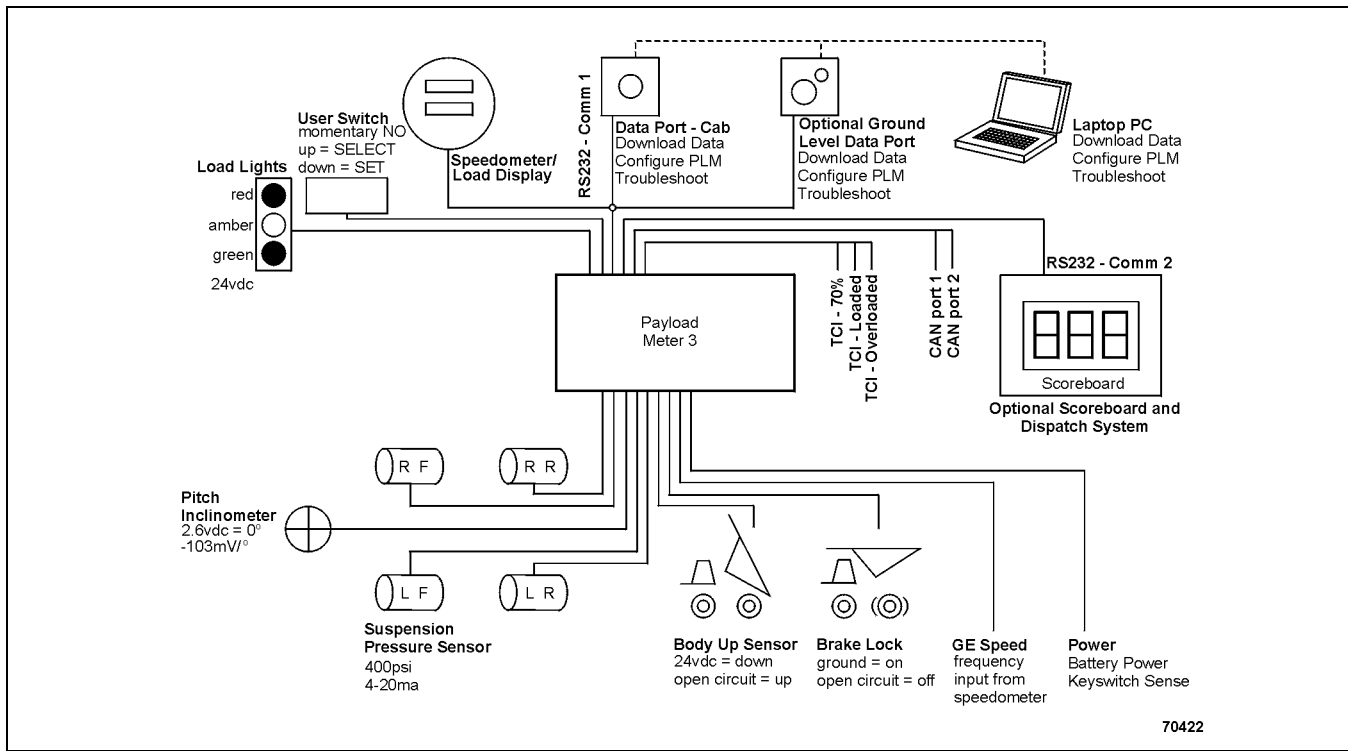

Suspension Pressure Sensors

PLM3 uses a two-wire pressure sensor. The range for the pressure sensor is 4000 psi (281 kg/cm²) and the overload limit is 10,000 psi (700 kg/cm²). One wire to the sensor is the supply voltage and the other is the signal. The 0-4000 psi range is converted into an electrical current between 4-20 ma. The supply voltage for the sensor is nominally +18vdc. Each pressure sensor has a 90" length of cable that is terminated with #10 ring terminals. The cable is specially shielded and reinforced to provide mechanical strength and electronic noise immunity. A typical part number for the pressure sensor is PC0328.

Inclinometer

The inclinometer is used to increase the accuracy of load calculations on an incline. The inclinometer uses three wires. For the sensor, red is the +18vdc supply voltage, black is ground and the white is the signal. The incline signal is a voltage between 1 and 4 volts. Zero degrees of incline is represented by 2.6vdc on the signal line. The voltage signal will be decreased by 0.103vdc for every degree of nose up incline. A typical part number for the inclinometer assembly is 7861-92-5330.

Operator Display

The speedometer/display gauge is used as a speedometer and payload display. The top display is used for speed and can display metric (km/h) or English (mph) units. Grounding terminal #4 on the back of the speedometer will switch the meter to display metric units. Leaving terminal #4 unconnected will cause the gauge to display English units. The speedometer can be adjusted using a calibration potentiometer in the back just like existing speedometers.

The payload meter uses the lower display for payload information. The normal display mode shows the current payload. The display can be changed to show the load and total tons counter or the Operator ID. Using the operator switch on the dash panel, the current suspension pressures and incline can be displayed. The units for display are set using the PC software. Payloads can be displayed in Short Tons, Long Tons or Metric Tons. A typical part number for this gauge is the PC0550.

Operator Switch

The payload operator switch is used to set, view and clear the Total Load Counter and Total Ton Counter. It is also used to enter the Operator ID number (0-9999). This switch can also be used to view the suspension pressures and inclinometer. The payload meter operator switch is located on the dashboard. It is a two-way momentary switch. The top position is the SELECT position. The SELECT position is used step through the different displays. The lower position is the SET position. The SET position is used to set the Operator ID or clear the load and total ton counters. Normally the inputs from the switch to the payload meter are open circuit. The switch momentarily connects the circuit to ground.

Speed Input

PLM3 uses a speed signal to calculate speed, distance, and other performance data. This input is critical to the proper operation of the system. PLM3 receives this signal from the speedometer/operator display on the dashboard. The same signal displayed to the operator is used by the system. Distance calculations are made based on the rolling radius of the tires for a particular truck.

Body-Up Switch

The Body-Up input signal is received from a magnetic switch located on the inside of the truck frame, forward the pivot pin of the truck body. This is the same switch typically used for input to the drive system. When the body is down, the switch closes and completes the circuit to 71-Control Power. 24vdc indicates the body is down. Open circuit indicates that the body is up.

Brake Lock Switch

The brake lock is used to lock the rear brakes on the truck. It is necessary for the accurate calculation of swingloads during the loading process. Without the brake lock applied, the payload meter will not calculate swingloads during the loading process. Without the brake lock, the payload meter will assume that the truck was loaded using a continuous loader and flag the haul cycle record. All other functions will be normal regardless of brake lock usage. The brake lock input comes from the switch located on the dash panel. The brake lock switch connects the circuit to ground. Open circuit indicates brake lock off. Ground indicates brake lock on.

Payload Meter

The payload meter is housed in a black aluminum housing. There is a small window on the face of the unit. Status and active alarm codes can be viewed through the window. During normal operation, a two-digit display flashes 0 back and forth. Active fault codes will be displayed for two seconds. These codes are typically viewed using the laptop computer connected to the serial communications port.

There is one 40-pin connector on the payload meter. A jack-screw is used to hold the payload meter and wire harness connector housings together. This screw requires a 4mm or 5/32 hex wrench. The correct tightening torque for this screw is 25 lb-in. Four bolts hold the payload meter housing to its mounting bracket in the cab.

The circuit board inside the payload meter housing is made from multi-layer, dual-sided surface-mount electronics. There are no field serviceable components inside. The electronics are designed to withstand the harsh operating environment of the mining industry. Opening the payload meter housing will result in voiding the warranty.

Communications Ports

The payload meter has two RS232 serial communications ports and two CAN ports. Connections for the two serial ports are available inside the payload meter junction box. The two CAN ports are available for future electronics systems.

Serial port #1 is used to communicate with the dashboard display. It is also used to connect to the laptop computer. The display gauge will remain blank when the PC is using the serial port. This port initially operates with serial settings at 9600,8,N,1. These settings change automatically to increase the communications rate when the PC is using the port. This serial port uses a 3-wire hardware connection.

Serial port #2 is used to communicate to other on-board electronics like Modular Mining's Dispatch® system or the Scoreboard from KMS. This port uses a 3-wire hardware connection. Connections to this serial port need to be approved by KMS. Several protocol options are available and detailed technical information is available depending on licensing.

Keyswitch Input

PLM3 monitors the status of the keyswitch. 24vdc indicates that the keyswitch is on, open indicates the keyswitch is off. The payload meter does not receive its electrical power from the keyswitch circuit. The payload meter will remain on for several seconds after keyswitch is removed. When the keyswitch power is removed, payload meter performs a series of internal memory operations before turning itself off. To allow for these operations, the keyswitch should be turned off for at least 15 seconds before turning the keyswitch back on. The payload meter will automatically reset itself without error if not enough time is given for these operations. The display may blink briefly.

Payload Meter Power

The payload meter receives its power from the battery circuit on the truck. Removing battery power from the payload meter before removing keyswitch and waiting 15 seconds may result in lost haul cycle data. The payload meter turns itself off approximately 15 seconds after the keyswitch power is removed. Some haul cycle data will be lost if battery power is removed before waiting 15 seconds. The payload meter system operates at a nominal voltage of 24vdc at 1 to 2 amps depending on options. The payload meter is designed to turn itself off if the supply voltage rises above 36vdc. The payload meter is also protected by a 5 amp circuit breaker located in the junction box.

Power to the load lights comes from the same battery circuit. The load lights are powered through a relay. The keyswitch circuit controls the relay. The load lights are also protected by a 15 amp circuit breaker in the junction box.

Load Lights

PLM3 uses load lights to indicate to the shovel operator the approximate weight of the material in the truck. The load lights are illuminated only when the brake lock is applied. The lights are controlled by the payload meter through a series of relays in the junction box. The payload meter controls the relays with 24vdc outputs. A 24vdc signal from the payload meter powers the relay coil and connects battery power to the load light. When the relay is not powered by the payload meter, a pre-warm resistor connects the load light to a reduced voltage. This circuit pre-warms the load light filaments and reduces the inrush current when the light is fully illuminated. This lengthens the operating life of the load lights.

The load lights progressively indicate to the shovel operator the approximate weight of the material in the truck.

A flashing green light indicates the next swingload will make the measured load greater than 50% of rated load. A solid green light indicates that the current load is greater than 50% of rated capacity.

A flashing amber light indicates the next swingload will make the measured load greater than 90% of rated load. A solid amber light indicates that the current load is greater than 90% of rated capacity.

A flashing red light indicates the next swingload will make the measured load greater than 105% of rated load. A solid red light indicates that the current load is greater than 105% of rated capacity.

The optimal loading target is a solid green and amber lights with a flashing red light. This indicates that the load is between 90% and 105% of rated load for the truck and the next swingload will load the truck over 105%.

Wiring and Termination

Most of the PLM3 truck connections use a heavy-duty cable. This yellow multi-conductor cable uses a 16awg, finely stranded wire designed for continuous motion operations. The conductors are protected by a foil and braided shield for electronic noise immunity and physical strength. A typical part number for this wire is LW086-63. This wire is typically terminated with a #10 ring terminal, part number VH2584. Most connections for the PLM3 system are made in the payload meter junction box.

TCI Outputs

The GE drive system on the 930E requires information from the payload meter regarding the loaded condition of the truck. There are three outputs from the payload meter to GE to indicate the relative load in the truck. 24 vdc on the 73MSL circuit indicates that the load is 70% of rated load. 24 vdc on the 73FSL circuit indicates the truck is 100% loaded. The 73OSL circuit is not currently used.

Operator's Display and Switch

Reading the Speedometer

The top window of the speedometer/display gauge is the speedometer section. The display shows the speed indicated by the frequency being received by the gauge. This can be adjusted using the potentiometer on the back of the gauge. In addition, the units for the display can be changed. Terminal #4 controls the displayed units. If #4 is grounded, the display will be metric. If terminal #4 is left open, the display will be in English units.

Reading the Load Display

The lower display on the speedometer/display gauge is used for payload information. The SELECT position on the operator switch allows the user to scroll through a number of useful displays. The order for the displays is as follows:

- **PL** = Payload
- **id** = Operator ID
- **tL** = Total Shift Tons
- **LC** = Shift Load Counter
- **LF** = Left Front Suspension Pressure
- **rF** = Right Front Suspension Pressure
- **Lr** = Left Rear Suspension Pressure
- **rr** = Right Rear Suspension Pressure
- **in** = Inclinometer

The display holds the displayed information until the SELECT switch is pressed again. The suspension pressures, inclinometer, and payload displays are based on current sensor inputs.

Communications to the display use the same serial link as the download connection. Whenever another computer is connected to serial port #1 to download or configure the system, the lower display will blank. This is not the same connection used by mine dispatch systems.

Using the Operator ID

The current Operator ID number is recorded with each haul cycle. The number can be between 0 and 9999.

To set the Operator ID:

1. Press the "SELECT" switch until **id:** is displayed.
2. Hold the "SET" button until **0000** is displayed. The first digit should be flashing.
3. Press the "SET" button again to change the digit.
4. Press the "SELECT" button once to adjust the second digit.
5. Use the "SET" button again to change the digit.
6. Press the "SELECT" button once to adjust the third digit.
7. Use the "SET" button again to change the digit.
8. Press the "SELECT" button once to adjust the fourth digit.
9. Use the "SET" button again to change the digit
10. Press the "SELECT" button one more time to enter the ID.

If no buttons are pressed for 30 seconds, the display will return to normal operation. The number being entered will be lost and the ID number returns to the previous ID number.

Using the Load and Ton Counter

PLM3 allows the truck operator to monitor and track the total tons hauled and the number of haul cycles during the shift. This display can be cleared at the beginning of each shift to allow the operator to record how many loads and tons have been hauled during the shift.

Total Ton Counter

The Total Ton Counter records the number of tons hauled since the last time it was cleared. This display is in 100's of tons. For example, if the display shows **432** the total tons is 43,200. This display can be cleared at the beginning of each shift to allow the operator to record how many tons have been hauled during the shift. The units are selected using the PC software.

- To view the Total Ton Counter press and release the "SELECT" switch until **tL:** is displayed on the gauge.

Total Load Counter

The Total Load Counter records the number of loads hauled since the last time it was cleared. This display can be cleared at the beginning of each shift to allow the operator to record how many loads have been hauled during the shift.

- To view the Total Load Counter press and release the "SELECT" switch until **LC=** is displayed on the gauge.

Clearing the Counters

Clearing the Total Ton Counter or Total Load Counter clears both records.

To clear the total ton and total load counter:

1. Press the "SELECT" switch until **TL=** or **LC=** is displayed.
2. Hold the "SET" button until the display clears.

Viewing Live Sensor Data

The display can also be used to quickly show the current readings from the four suspension pressure sensors and the inclinometer. This can be used during regularly scheduled service periods to check the state of the suspensions. These displays are live and will update as the values change.

The live displays cannot be cleared and the SET button will have no effect.

The units for the display are controlled by the configuration of the payload meter. If the payload meter is set to display metric units, the pressures will be displayed in tenths of kg/cm². For example, if the display shows **202** the actual value is 20.2 kg/cm². If the payload meter is set to display short tons, the pressures will be displayed in psi (lbs/in²). To convert from kg/cm² to psi, multiply by 14.2. 1 kg/cm² = 14.2 psi. There is no way to detect the units setting for the gauge without the PC software.

The inclinometer displays whole degrees of incline. Positive incline is truck nose up. The gauge will quickly display the type of information shown every 10 seconds. For example, if the left-front pressure is being displayed, **LF=** will flash on the display every minute. Only the payload display, **PL=** does not display this information.

- Left Front Pressure - To display the pressure in the left-front suspension, press and release the "SELECT" switch until **LF=** is displayed.
- Right Front Pressure - To display the pressure in the right-front suspension, press and release the "SELECT" switch until **RF=** is displayed.
- Left Rear Pressure - To display the pressure in the left-rear suspension, press and release the "SELECT" switch until **LR=** is displayed.
- Right Rear Pressure - To display the pressure in the right-rear suspension, press and release the "SELECT" switch until **RR=** is displayed.
- Inclinometer - To display the truck incline, press and release the "SELECT" switch until **in=** is displayed.

Other Display Messages

On startup of the payload meter system, the gauge display will scroll the truck type that the PLM3 is configured for. For example, on a 930E, the gauge will scroll, **---930E---**.

If the PLM3 encounters memory problems, it will display **E-88** where 88 is the specific memory error. In this very rare circumstance, the system should be turned off for 30 seconds and restarted.

Payload Operation & Calculation

Description of Haul Cycle States

The typical haul cycle can be broken down into eight distinct stages or states. Each state requires the payload meter to make different calculations and store different data.

"States" or stages of a typical haul cycle

1. Tare Zone
2. Empty
3. Loading
4. Maneuvering
5. Final Zone
6. Hauling
7. Dumping
8. After Dump

Haul Cycle Description

A new haul cycle is started after the load has been dumped from the previous cycle. The payload meter will stay in the after_dump state for 10 seconds to confirm that the load has actually been dumped. If the current payload is less than 20% of rated load, the payload meter will switch to the tare_zone and begin calculating a new empty tare. If, after dumping, the payload has not dropped below 20% of rated load the meter will return to the maneuvering or hauling states. In this case, the false_body_up flag will be recorded in the haul cycle record.

While in the tare_zone state, and moving faster than 5 km/h (3 mph), the payload meter calculates the empty sprung weight of the truck. This tare value will be subtracted from the loaded sprung weight to calculate the final payload. The payload meter will switch from the tare_zone or empty to the loading state if swingloads are detected. By raising the dump body while in the empty state the payload meter can be manually switched back to the tare_zone to calculate a new tare.

From the empty state, the payload meter will switch to the loading state through one of two means. If the brake lock is applied, the payload meter will be analyzing the suspension pressures to detect a swingload. If a swingload is detected, the meter will switch to the loading state. The minimum size for swingload detection is 10% of rated load. Swingload detection usually takes 4-6 seconds. The second

method to switch from empty to loading is through continuous loading. This can happen if the brake lock is not used during loading. If the load increases above 50% of rated load for 10 seconds without the brake lock applied, the meter will switch to loading and record the continuous_loading flag in the haul cycle.

The payload meter switches from loading to maneuvering as soon as the truck begins moving. The maneuvering zone is 160m and is designed to allow the operator to reposition the truck under the shovel. More payload can be added anytime within the maneuvering zone. Once the truck travels 160m (0.1 miles) the payload meter switches to the final_zone and begins calculating payload. If the body is raised while the payload meter is in the maneuvering state, the no_final_load flag will be recorded in the haul cycle record, no payload will be calculated, and the meter will switch to the dumping state.

While in the final_zone moving faster than 5 km/h (3 mph), the payload meter calculates the loaded sprung weight of the truck. The same advanced algorithm is used to calculate the empty and loaded sprung weights. The payload meter will switch from the final_zone to the dumping state if the Body-Up signal is received. If the truck has moved for less than 1 minute in the final_zone, the payload meter will calculate the final payload using an averaging technique which may be less accurate. If this happens, the average_load flag will be recorded in the haul cycle.

The payload meter switches to the dumping state when the dump body rises. The payload meter will switch from dumping to after_dump when the dump body comes back down.

From the after_dump, the payload meter will switch to one of three states:

1. If the average payload is greater than 20% of rated load and no final payload has been calculated, the payload meter will return to the maneuvering state. After the truck travels 160m (0.1 mile) the meter will switch to the final_zone and attempt to calculate the payload again. The false_body_up flag will be recorded in the haul cycle record.

2. If the average payload is greater than 20% of rated load and the final payload has been calculated, the payload meter will switch back to the hauling state. The `false_body_up` flag will be recorded in the haul cycle record.
3. If the average payload is less than 20% of rated load, the payload meter will switch to the `tare_zone` and begin to calculate a new empty tare.

Load Calculation

The final load calculation is different from the last swingload calculation. The accuracy of the swingload calculation depends on loading conditions and the position of the truck during loading. The last swingload calculation is not the value recorded in memory as the final load. The final load is determined by a series of calculations made while the truck is traveling to the dump site.

Carry Back

Carry back is calculated as the difference between the current truck tare and the clean truck tare. The clean truck tare is calculated using the PC software. When the suspensions are serviced or changes are made that may affect the sprung weight of the truck, a new clean truck tare should be calculated.

Measurement Accuracy

Payload measurements are typically repeatable within 1%. Accuracy for a particular scale test depends on specific combinations of pressure sensors and payload meters as well as the specifics of each scale test. Comparisons from different scale tests are often made without considering the differences introduced by the specific installation and operation of the scales for each test. In addition, each pressure sensor and payload meter introduces its own non-linearity. Each truck becomes an individual combination of sensors and payload meter. Errors from these sources can introduce up to a $\pm 7\%$ bias in the payload meter calculations for a specific scale test, for an individual truck.

Because the PLM3 calculates a new empty tare for each payload, a detailed scale test must weigh the trucks empty and loaded for each haul cycle. Using a simple average of 2 or 3 empty truck weights as an empty tare for the entire scale test will introduce significant error when comparing scale weights to PLM3 weights.

Sources for Payload Error

Payload Error

The number one source of error in payload calculation is improperly serviced suspensions. The payload meter calculates payload by measuring differences in the sprung weight of the truck when it is empty and when it is loaded. The sprung weight is the weight of the truck supported by the suspensions. The only method for determining sprung weight is by measuring the pressure of the nitrogen gas in the suspensions. If the suspensions are not properly maintained, the payload meter cannot determine an accurate value for payload. The two critical factors are proper oil height and proper nitrogen charge.

If the suspensions are overcharged, the payload meter will not be able to determine the empty sprung weight of the truck. The suspension cylinder must be able to travel up and down as the truck drives empty. The pressure in an overcharged suspension can push the suspension rod to full extension. In this case, the pressure inside the cylinder does not accurately represent the force necessary to support that portion of the truck.

If the suspensions are undercharged, the payload meter will not be able to determine the loaded sprung weight of the truck. The suspension cylinder must be able to travel up and down as the truck drives loaded. If the pressure in an undercharged suspension cannot support the load, the suspension will collapse and make metal-to-metal contact. In this case, the pressure inside the cylinder does not accurately represent the force necessary to support that portion of the truck.

Low oil height can also introduce errors by not correctly supporting a loaded truck. This is why the correct oil height and nitrogen charge are the most critical factors in the measurement of payload. If the suspensions are not properly maintained, accurate payload measurement is not possible. In addition, suspension maintenance is very important to the life of the truck.

Loading Conditions

The final load calculation of the PLM3 system is not sensitive to loading conditions. The final load is calculated as the truck travels away from the shovel. Variations in road conditions and slope are compensated for in the complex calculations performed by the payload meter.

Pressure Sensors

Small variations in sensors can also contribute to payload calculation error. Every pressure sensor is slightly different. The accuracy differences of individual sensors along the range from 0 to 4000 psi can add or subtract from payload measurements. This is also true of the sensor input circuitry within individual payload meters. These differences can stack up 7% in extreme cases. These errors will be consistent and repeatable for specific combinations of payload meters and sensors on a particular truck.

Swingloads

Swingload calculations can be affected by conditions at the loading site. Parking the truck against the berm or large debris can cause the payload meter to inaccurately calculate individual swingloads. While the PLM3 system uses an advanced calculation algorithms to determine swingloads, loading site conditions can affect the accuracy.

Speed and Distance

The payload meter receives the same speed signal as the speedometer. This signal is a frequency that represents the speed of the truck. The payload meter uses this frequency to calculate speeds and distances. The meter assumes a single value for the rolling radius of the tire. The rolling radius may change at difference speeds by growing larger at higher speeds. The actual rolling radius of the tire will also change between a loaded and empty truck. The payload meter does not compensate for these changes.

HAUL CYCLE DATA

PLM3 records and stores data in its on-board flash memory. This memory does not require a separate battery. The data is available through the download software.

PLM3 can store 5208 payload records. When the memory is full, the payload meter will erase the oldest 745 payload records and continue recording.

PLM3 can store 512 alarm records in memory. When the memory is full, the payload meter will erase the oldest 312 alarm records and continue recording. All data is calculated and stored in metric units within the payload meter. The data is downloaded and stored in metric units within the Paradox database on the PC. The analysis program converts units for displays, graphs and reports.

The units noted in the Table 1 are the actual units stored in the data file. The value for the haul cycle start time is the number of seconds since January 1, 1970 to the start of the haul cycle. All other event times are referenced in seconds since the haul cycle start time. The PC download and analysis program converts these numbers into dates and times for graphs and reports.

Haul Cycle Data

The following information is recorded for each haul cycle:

Table 1: Haul Cycle Data

Data	Unit	Remark
Truck #	alpha-numeric	Up to 22 characters can be stored in this field to identify the truck. Typically this field will be just the truck number.
Haul Cycle Start Date/Time	seconds	Number of seconds from 1/1/70 to the start of the haul cycle, haul cycle starts when the meter transitions from dumping to empty state after the previous haul cycle, download program converts seconds into date and time for display
Payload	tons	Stored as metric, download program allows for conversion to short or long tons.
Number of Swingloads	number	The number of swingloads detected by the payload meter
Operator ID	number	This is a 4 digit number that can be entered by the operator at the start of the shift.
Warning Flags	alpha	Each letter represents a particular warning message about the haul cycle, details are located on page 19.
Carry-back load	tons	The difference between the latest empty tare and the clean truck tare
Empty haul time	seconds	Number of seconds in the tare_zone and empty states with the truck moving
Empty stop time	seconds	Number of seconds in the tare_zone and empty states with the truck stopped
Loading time	seconds	Number of seconds in the loading state
Loaded haul time	seconds	Number of seconds in the maneuvering, final_zone and loaded states with the truck moving
Loaded stop time	seconds	Number of seconds in the maneuvering, final_zone and loaded states with the truck stopped
Dumping time	seconds	Number of seconds in the dumping state
Loading start time	seconds	Number of seconds from the start of the haul cycle to when the meter transitions from empty to loading state
Dump start time	seconds	Number of seconds from the start of the haul cycle to the time when the meter switches from loaded to dumping state
Loaded haul distance	m	Distance traveled while loaded
Empty haul distance	m	Distance traveled while empty
Loaded max speed	km/h	Maximum speed recorded while the truck is loaded
Loaded max speed time	seconds	Number of seconds from the start of the haul cycle to the time when the max speed occurred
Empty max speed	km/h	Maximum speed recorded while the truck is empty
Empty max speed time	seconds	Number of seconds from the start of the haul cycle to the time when the max speed occurred
Peak positive frame torque	ton-meter	Positive frame torque is measured as the frame twists in the clockwise direction as viewed from the operator's seat.
Peak frame torque time	seconds	Number of seconds from the start of the haul cycle to the peak torque, download program converts to time for display
Peak negative frame torque	ton-meter	Negative frame torque is measured as the frame twists in the counter-clockwise direction as viewed from the operator's seat.
Peak frame torque time	seconds	Number of seconds from the start of the haul cycle to the peak torque, download program converts to time for display
Peak sprung load	tons	Peak dynamic load calculation
Peak sprung load time	seconds	Number of seconds from the start of the haul cycle to the peak instantaneous load calculation
Front-left tire-ton-km/h	t-km/h	Tire ton-km/h for haul cycle
Front-right tire-ton-km/h	t-km/h	Tire ton-km/h for haul cycle
Average rear tire-ton-km/h	t-km/h	Tire ton-km/h for haul cycle
Truck Frame Serial Number	alpha	The truck serial number from the nameplate on the truck frame
Reserved 1-10	number	These values are internal calculations used in the continued development of the PLM3 system and should be ignored

Haul Cycle Warning Flags

The payload meter expects haul cycles to progress in a particular way. When something unexpected takes place, the system records a warning flag. Several events within the haul cycle can cause a warning flag to be generated. Each one indicates an unusual occurrence during the haul cycle. They do not necessarily indicate a problem with the payload meter or payload calculation.

A: Continuous Loading

This message is generated when the truck is loaded over 50% full without the payload meter sensing swingloads. This indicates that a continuous loading operation was used to load the truck. It may also indicate that the payload meter did not receive the Brake Lock input while the truck was being loaded. There may be a problem with the wiring or the Brake Lock was not used. The payload meter will not measure swingloads unless the Brake Lock is used during the loading process.

B: Loading to Dumping Transition

This message is generated when the payload meter senses a body up input during the loading process. This message is usually accompanied by a `no_final_load` flag.

C: No Final Load

This message is generated when the payload meter is unable to determine the final payload in the truck. Typically, this means that the payload meter switched from a loaded state to the dumping state before the load could be accurately measured.

D: Maneuvering to Dumping Transition

This message is generated when the payload meter senses a Body-Up input during the maneuvering or repositioning process indicating that the operator has dumped the load. It may also be generated if the Body-Up signal is not properly reaching the payload meter and the weight in the truck falls dramatically while the truck is maneuvering or repositioning.

E: Average Load or Tare Used

This message indicates that the recorded payload may not be as accurate as a typical final load calculation. Typically, this is recorded when loading begins before an accurate tare is calculated or the load is dumped before the load can be accurately measured.

F: Final Zone to Dumping Transition

This message is generated when the payload meter senses a Body-Up while it is calculating the final payload indicating that the operator has dumped the load. It may also be generated if the Body-Up signal is not properly reaching the payload meter and the weight in the truck falls dramatically while the truck is calculating the final payload.

G: False Body Up

This message indicates that the body was raised during the haul cycle without the load being dumped. The Body-Up signal indicated that the truck was dumping, but the weight of the truck did not fall below 20% of the rated load.

H: Body Up Signal Failed

This message indicates that the load was dumped without a Body-Up signal being received by the payload meter. The weight of the truck fell below 20%, but the payload meter did not receive a Body-Up signal from the sensor.

I: Speed Sensor Failed

This message indicates that the payload meter sensed the truck loading and dumping without receiving a speed signal.

J: New Tare Not Calculated

The payload meter was not able to accurately calculate a new empty sprung weight for the truck to use as the tare value for the haul cycle. The tare value from the last haul cycle was used to calculate payload.

K: Incomplete Haul Cycle

The payload meter did not have proper data to start the haul cycle with after powering up. When the PLM3 powers off, it records the data from the haul cycle in progress into memory. This flag indicates that this data was not recorded the last time the payload meter was shut down. This can happen when the main battery disconnect is used to shut the truck down instead of the keyswitch. A haul cycle with this warning flag should not be considered accurate. Haul cycles with this warning are displayed in red on the Payload Summary window and are not included in the summary statistics for reports or display.

L: Haul Cycle Too Long

The haul_cycle_too_long flag indicates that the haul cycle took longer than 18.2 hours to complete. The times stored for particular events may not be accurate. This does not affect the payload calculation.

M: Sensor Input Error

An alarm was set for one of the 5 critical sensor inputs during the haul cycle. The five critical sensors are the four pressure sensors and the inclinometer. Without these inputs, the payload meter cannot calculate payload. A haul cycle with this warning flag should not be considered accurate. Haul cycles with this warning are displayed in red on the Payload Summary window and are not included in the summary statistics for reports or display.

Alarm Records

The payload meter stores alarm records to give service personnel a working history of the system. All codes are viewed using the PC connected to the payload meter. Active codes are also displayed on the two-digit display on the meter itself. Each code has a specific cause and should lead to an investigation for correction. Some failures can be overcome by the payload meter. Haul cycle data will indicate if an alarm condition was present during the cycle. Failures with the suspension or inclinometer sensors cannot be overcome.

Table 2: Fault Code Data

Fault Code	Name	Description
1	Left front pressure high	Input current > 22 ma
2	Left front pressure low	Input current < 2 ma
3	Right front pressure high	Input current > 22 ma
4	Right front pressure low	Input current < 2 ma
5	Left rear pressure high	Input current > 22 ma
6	Left rear pressure low	Input current < 2 ma
7	Right rear pressure high	Input current > 22 ma
8	Right rear pressure low	Input current < 2 ma
9	Inclinometer high	Input voltage < 0.565 vdc
10	Inclinometer low	Input voltage > 5.08 vdc
13	Body-up input failure	Payload meter detected dumping activity without receiving a body up signal
16	Memory write failure	Indicates possible memory problem at power start up. Cycle power and recheck.
17	Memory read failure	Indicates possible memory problem at power start up. Cycle power and recheck.
24	System key-on status	Payload Meter failed to correctly start at power up. Cycle power and recheck.
26	User switch fault - SELECT	Select switch on for more than 2 minutes, may indicate short to ground
27	User switch fault - SET	Set switch on for more than 2 minutes, may indicate short to ground

Frame Torque Data

Payload meter records the top 5 peak positive and negative frame torque values and the time they occurred. The frame torque is a measure of the twisting action along the centerline of the truck. Positive frame torque is measured when the suspension forces on the front of the truck act to twist the frame in the clockwise direction as viewed from the operator's seat. Negative frame torque is measured when the forces from the suspensions act in the opposite direction.

For example, if the left front and right rear pressure rises as the right front and left rear pressure drops, the truck frame experiences a twisting motion along the longitudinal centerline. In this case, the payload meter will record a positive frame torque.

The 5 highest values in the positive and negative direction are stored in permanent memory within the payload meter.

Sprung Weight Data

The payload meter is constantly monitoring the live payload calculation. This value naturally rises and falls for a loaded truck depending on road and driving conditions. The payload meter records the top 5 highest payload calculations and the time they occurred. This information is stored in permanent memory inside the meter.

Maximum Speed Data

The payload meter records the top 5 highest speeds and the time they occurred. This information is stored in permanent memory inside the meter.

PC Software Overview

PC Overview

The PC software has several basic functions:

- Configure the PLM3 system on the truck.
- Troubleshoot and check the PLM3 system.
- Download data from the PLM3 system.
- Analyze data from the payload systems.

Configuration, troubleshooting and downloading require a serial connection to the payload meter on the truck. Analysis can be done at any time without a connection to the payload meter.

Payload data is downloaded from several trucks into one database on the PC. The database can be queried to look at the entire fleet, one truck or truck model. The data can be graphed, reported, imported or exported. The export feature can take payload data and save it in a format that spreadsheet programs like Excel or word processing programs can easily import.

System Configuration

PLM3 needs to be configured for operation when it is first installed on the truck. This process requires several steps and uses the laptop computer to make the necessary settings. The setup procedure can be broken down into several steps:

- Connecting the laptop to the PLM3 system.
- Starting communications
- Setting the time & date
- Setting the truck type
- Setting the truck ID
- Setting the speedometer/display gauge units

Installing the PLM3 Software

The CD ROM containing the Payload Data Management (PDM) Software will automatically begin installation when it is inserted into the drive on the PC. If this does not happen, the software can be installed by running the Setup.exe program on the CD ROM.

The minimum PC requirements for running the software is a Pentium 133Mhz with 64 MB of ram and at least 300 MB of free hard drive space available. For improved performance, the recommended PC would be a Celeron, AMD K6-2 or better processor with 128 MB of ram running at 400 Mhz. The PDM Software uses a powerful database to manipulate the large amounts of data gathered from the PLM3 system. Using a more powerful computer and added memory to run the software can result in a significant improvement in performance. The software is written to use a minimum 800x600 screen resolution.

Downloading Data

PLM3 records many types of data. The PLM3 PC software is designed to download the data from a whole truck fleet. Instead of creating one data file for each truck, the PC software combines all the data from many trucks into one database on the hard drive of the computer. The software then allows users to query the database to create custom reports and graphs. Data for individual trucks or groups of trucks can be easily analyzed. This same data can be exported for use in other software applications like word processors and spreadsheet applications.

As the database grows, performance of the PC software for analysis will slow down. It may be helpful to periodically export data. For example, query the database to show the oldest quarter, month, or half year and print out a summary report. Then export the data to a compressed format and save the file in a secure location. Once the data is exported, delete the entire query results from the database. If necessary, the data can easily be imported back into the main database for analysis at a future date. Removing this older data will improve performance.

To download the payload meter:

1. Connect to the payload meter and start the PC software.
2. From the main menu, select "Connect to Payload Meter". The PC will request the latest status information from the payload meter. The number of haul cycles and alarms will be displayed.
3. Select the "Begin Download" button. The PC will request the payload and alarm data from the payload meter and save it into the database. This may take several minutes. A progress bar at the bottom will show the approximate time left.



The PC software downloads the data from the payload meter into a single Paradox database. The data from all the trucks is added to the same database. Downloading the payload meter can take several minutes. The data is added to the database on the laptop used to download.

To move the data to another computer, a query must be run to isolate the particular data for export. Do not press the operator switch on the dashboard while downloading

PLM3 System Configuration

Starting Communications

The PDM software allows users to download and configure the system.

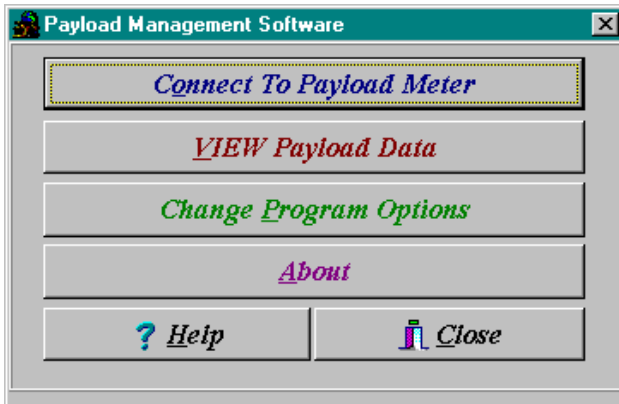

Before connecting to the payload meter, select "Change Program Options" and confirm that the program has selected the correct laptop serial port. Most laptops use Comm 1 for serial communications. The units displayed for reports and graphs by the PC software can be set on this form. Click "Done" to return to the main menu.

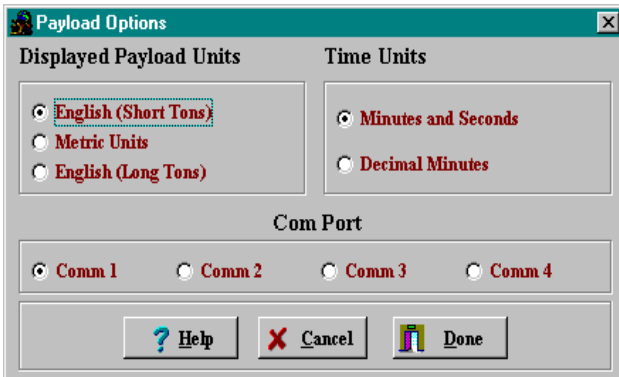

From the main menu, click the "Connect to Payload Meter" button. The PC will try to connect to the payload meter and request basic information from the system. In the event of communications trouble, the PC will try 3 times to connect before "timing-out". This may take several seconds.

Displayed Payload Units



Three options are available for the display of units in the PC software, reports, and graphs:

Short Tons: Payload is displayed in short tons, distances and speeds will be displayed in Miles

Metric Tons: Payload is displayed in metric tons, distances and speeds are displayed in Kilometers

Long Tons: Payload is displayed in long tons, distances and speeds are displayed in Miles

Time Units

Minutes and Seconds Example:

Five minutes and thirty-two seconds = 5:32

Decimal Minutes Example:

Five minutes and thirty-two seconds = 5.53

Connection Menu

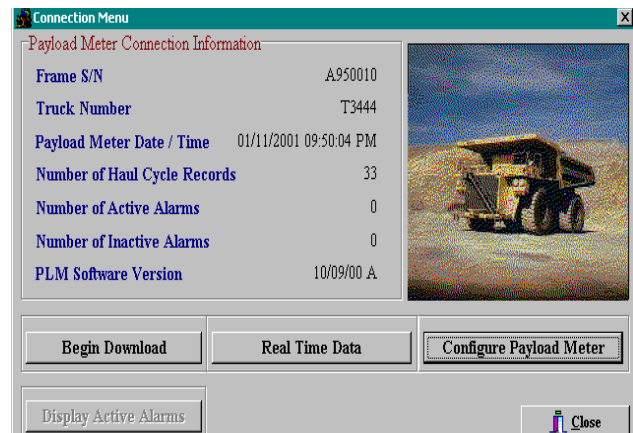

The connection screen displays basic system information to the user.

- Frame S/N should agree with the truck serial number from the serial plate located on the truck frame.
- Truck Number is an ID number assigned to the truck by the mine.
- The Payload Meter Date / Time values come from the payload meter at the moment of connection.
- Number of Haul Cycle Records is the number of haul cycles records stored in memory and available for download.
- Number of Active Alarms shows how many alarms are currently active in the system at the time of connection. If there are active alarms, the "Display Active Alarms" button is available.
- Number of Inactive Alarms shows how many alarms have been recorded in memory and are available for download.
- PLM Software Version displays the current version of software in the payload meter.

The information on the connection menu comes from the configuration of the payload meter system on the truck.

There are also many configuration and download options available from this screen. The Connection Menu is updated only when the connection is first made. It does not update automatically. To view changes made while connected, the user must close the window and reconnect to the payload meter.

The connection menu is displayed after a serial connection has been established and the PC software has connected to the payload meter.

Connecting to the Payload Meter

Communications to the PLM3 requires a laptop computer running the PDM software. The software connects to the payload meter through the meter's serial port #1. This is the same port used by the speedometer/display gauge. When the laptop is using the serial port, the lower display on the operator gauge on the dashboard will be blank. This does not affect the operation of the speedometer.

- Connect the laptop to the system using the EF9160 communications harness. The download connector is typically located on the housing mounted in the cab to the back wall. The PLM3 system uses the same connection as the Payload Meter 2 system.

Configure the Payload Meter

Configuration of the payload meter requires a serial connection to the PLM3 system. Clicking the "Configure Payload Meter" button will bring up the Truck Configuration screen and menu. This screen displays the latest configuration information stored on the payload meter.

When changes are made to the configuration, the "Save Changes" button must be pressed to save the changes into the payload meter. To confirm the changes, exit to the main menu and re-connect to the payload meter.

The screenshot shows the 'Truck Configuration' window. It has several sections:

- PLM Date and Time:** Includes a 'Change To' button, 'Edit Time' (10:59:58 AM), and 'Edit Date' (4/11/01).
- Gauge Units:** Radio buttons for Metric Tons (selected), Short Tons, and Long Tons.
- Truck Type:** A dropdown menu showing '930E'.
- Identification Fields:** Frame Serial Number (A950010), Truck Number (T611), KMS Distributor (RMS), and KMS Customer (Big Mine).
- Buttons:** 'Save Changes', 'Clean Truck Tare', 'Inclinometer', and 'Close'.

Setting the Date and Time

The screenshot shows a dialog box titled 'PLM Date and Time'. It has a 'Change To' button at the top. Below it are two fields: 'Edit Time' showing '9:51:36 PM' and 'Edit Date' showing '1/11/2001'.

The time shown on the form is the time transmitted from the payload when the connection was first established.

The screenshot shows a calendar for August 2000. The days of the week are Sun, Mon, Tue, Wed, Thu, Fri, Sat. The dates are arranged in a grid. The 28th is highlighted with a red circle and labeled 'Today: 10/17:00'.

The date and time are maintained by a special chip on the PLM3 circuit board. The memory for this chip is maintained by a very large capacitor when the power is removed from the payload meter. This will maintain the date and time settings for approximately 30 days. After this time, it is possible for the payload meter to lose the date and time setting. It is recommended that the system be powered every 20 days to maintain the date and time. If the date and time is lost, simply reset the information using this procedure. It takes approximately 90 minutes to recharge the capacitor.

Changing the date and time will affect the haul cycle in progress and may produce unexpected results in the statistical information for that one haul cycle.

To change the time:

1. Click on the digit that needs to be changed.
2. Use the up/down arrows to change or type in the correct value.
3. Press the "Save Changes" button to save the new time in the payload meter.

To change the date:

1. Click on the digit that needs to be changed.
2. Type in the correct value or use the pull-down calendar to select a date.
3. Press the "Save Changes" button to save the new time in the payload meter.

Setting the Truck Type



1. From the Truck Configuration screen, use the pull-down menu to select the truck type that the payload meter is installed on.
2. Press the "Save Changes" button to program the change into the meter.

Setting the Gauge Display Units

The Payload Meter Speedometer / Display Gauge displays the speed on the upper display. The units for the speed display are selected using a jumper on the rear of the case.

The payload units on the lower display can be changed from metric to short tons or long tons using the Truck Configuration screen. This selection also switches between metric (kg/cm²) and psi (lbs/in²) for the live display of pressure on the gauge.

1. From the Truck Configuration screen, select the payload units to be used on the lower display of the speedometer/display gauge.
2. Press the "Save Changes" button to program the change into the payload meter.

Setting the Frame Serial Number

Frame Serial Number	A950010
Truck Number	T3444
KMS Distributor	RMS
KMS Customer	Pit Mine

The frame serial number is located on the plate mounted to the truck frame. The plate is outboard on the lower right rail facing the right front tire. It is very important to enter the correct frame serial number. This number is one of the key fields used within the haul cycle database. The field will hold 20 alpha-numeric characters.

1. On the Truck Configuration screen, enter the truck frame serial number in the appropriate field.
2. Press the "Save Changes" button to program the change into the payload meter.

Setting the Truck Number

Most mining operations assign a number to each piece of equipment for quick identification. This number or name can be entered in the Truck Number field. It is very important to enter a unique truck number for each truck using the PLM3 system. This number is one of the key fields used within the haul cycle database. The field will hold 20 alpha-numeric characters.

1. On the Truck Configuration screen, enter the truck number in the appropriate field.
2. Press the "Save Changes" button to program the change into the payload meter.

Setting the KMS Distributor

This field in the haul cycle record can hold the name of the Komatsu Mining Systems distributor that helped install the system. KMS also assigns a distributor number to each distributor. This number is used on all warranty claims. This KMS distributor number can also be put into this field. The field will hold 20 alpha-numeric characters.

1. On the Truck Configuration screen, enter the distributor name or number in the appropriate field.
2. Press the "Save Changes" button to program the change into the payload meter.

Setting the KMS Customer

This field in the haul cycle record can hold the name of the mine or operation where the truck is in service. KMS also assigns a customer number to each customer. This number is used on all warranty claims. This KMS customer number can also be put into this field. The field will hold 20 alpha-numeric characters.

1. On the Truck Configuration screen, enter the customer name or number in the appropriate field.
2. Press the "Save Changes" button to program the change into the payload meter.

Clean Truck Tare

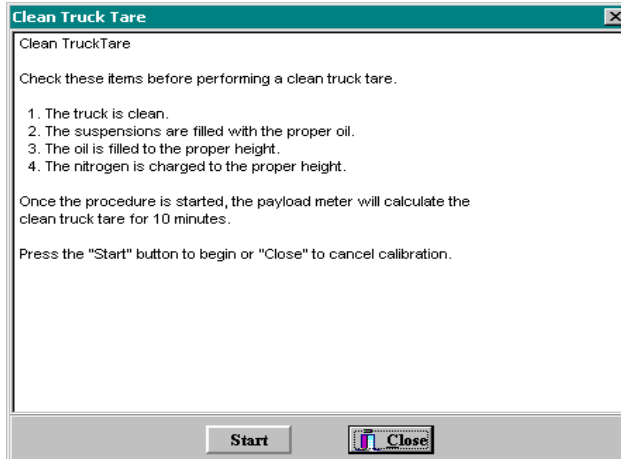

The payload meter uses the clean truck tare value to calculate carry-back load for each haul cycle. The carry-back stored in the haul cycle record is the new empty tare minus the clean truck tare.

This procedure should be performed after service to the suspensions or when significant changes are made to the sprung weight of the truck. Before performing this procedure, be sure the suspensions are properly filled with oil and charged. It is critical to payload measurement that the proper oil height and gas pressure be used.

Once the clean tare process is started, the payload meter will begin to calculate the clean empty sprung weight of the truck. This calculation continues while the truck drives to the next loading site. Once the procedure is started, there is no reason to continue to monitor the process with the PC. The truck does not need to be moving to start this procedure.

1. After cleaning debris from the truck and checking to see that the suspensions are properly serviced, use the PLM3 software to connect to the payload meter.
2. From the "Truck Configuration" screen, select "Clean Truck Tare".
3. Be sure to follow the screen instructions.

Inclinometer Calibration

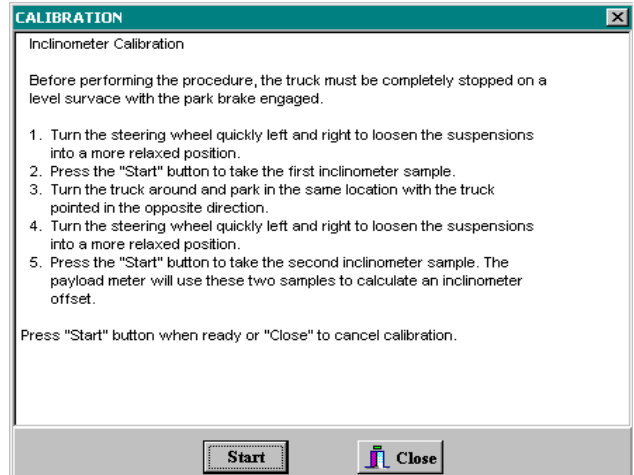

The inclinometer calibration procedure is designed to compensate for variations in the mounting attitude of the inclinometer. The inclinometer input is critical to the payload calculation.

This procedure should be performed on relatively flat ground. Often the maintenance area is an ideal location for this procedure.

1. After cleaning debris from the truck and checking to see that the suspensions are properly serviced, use the PLM3 software to connect to the payload meter.
2. From the "Truck Configuration" screen, select "Inclinometer".
3. With the truck stopped and the brake lock on, press the "Start" button. This instructs the payload meter to sample the inclinometer once.
4. Turn the truck around. Drive the truck around and park in the exact same spot as before, facing the other direction.
5. With the truck stopped and the brake lock on, press the "Start" button. This instructs the payload meter to sample the inclinometer again. The payload meter will average the two samples to determine the average offset.
6. Be sure to follow the screen instructions.

Data Analysis

The data analysis tools allow the user to monitor the performance of the payload systems across the fleet. Analysis begins when the "View Payload Data" button is pressed. This starts an "all trucks, all dates, all times" query of the database and displays the results in the Payload Summary Form.

The user can change the query by changing the dates, times, or trucks to include in the query for display.

Haul cycles in the data grid box at the bottom can be double-clicked to display the detailed results of that haul.

Sorting on Truck Unit Number

The truck unit number is the truck unit number entered into the payload meter when it was configured at installation. The query can be set to look for all trucks or one particular truck number. When the program begins, it searches through the database for all the unique truck numbers and creates a list to select from.

Choosing one particular truck number will limit the data in the displays, summaries and reports to the one selected truck. To create reports for truck number 374, select 374 from the pull-down menu and hit the "Query Database and Display" button.

Payload Summary Form

The screenshot shows the 'Payload Summary' window. At the top, there are 'Display Criteria' fields for Date (2/10/00 to 1/20/01), Daily Shift Time (00:00 to 24:00), Truck Number (ALL), and Truck Type (ALL). Below this is a 'Query Database and Display' button. The main area is divided into two summary sections: 'Payload Data Summary' and 'Cycle Time Summary'. The 'Payload Data Summary' includes metrics like Total Tons, Max. Payload, and Avg. Payload. The 'Cycle Time Summary' lists various time metrics in minutes and seconds. At the bottom is a 'Haul Cycle Records' table with columns for Truck Number, Date, Time, Payload, # Swings, and Total Time. A bottom toolbar contains buttons for Help, Report, Graph, Alarms, Export, Import, Delete, and Close.

Date: Sorts the data within a date range. eg. "Dec 1, 2000 through Dec 31, 2000"

Truck Number: Sorts the data by the truck unit number, eg. "374"

Time: Sorts the data within a time for each day within the data range. "8:00 AM to 5:00PM"

Truck Type: Sorts the data by the truck type, eg. "930E" or "830E"

Payload Data Summary: Summary statistical analysis of the payloads from the selected query.

Query Database & Display: Sorts the data by the selected query options (unit, type, date, time) and displays the results.

Output Options: Use to create reports, graphs and expert data from the selected query.

Cycle Summary: Cycle time summary from the selected query.

Haul Cycle Records: Summary view of the haul cycle records from the selected query. Double Click to view the details for individual haul cycle records. Haul cycles in red area are not included in the summary statistics..

Truck Number	Date	Time	Payload	# Swings	Total Time
351	07/10/2000	8:22:40 AM	323.8	5	7:09
351	07/10/2000	8:36:12 AM	323.8	5	5:23
351	07/10/2000	8:41:35 AM	323.8	5	5:24
351	07/10/2000	8:46:58 AM	321.5	1	30:11
351	07/10/2000	9:17:06 AM	321.9	0	0:32
351	07/10/2000	9:17:37 AM	318.0	0	0:32

Creating a Query

The program defaults to show all trucks, all types, all dates and all times for the initial query. The display can be narrowed by selecting which trucks or types to view and for what dates and times.

The query items are added in the "AND" condition. If the user selects a truck # and date range, the query will sort the data for that truck number AND the date range.

Sorting on Truck Type

The truck type is the size of the truck from the family of Komatsu trucks. This allows the user to quickly view results from different types of trucks on the property. For example, a separate report can be generated for 830E and 930E trucks.

Sorting on Date Range

The default query starts in 1995 and runs through the current date on the PC. To narrow the range to a specific date, change the "From" and "To" dates.

For example, to view the haul cycle reports from truck 374 for the month of July, 2000:

1. Select truck 374 from the Truck Unit pull-down menu.

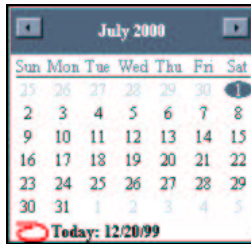

2. Change the "From" date to July 1, 2000.

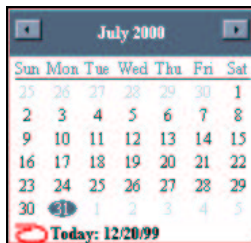

3. Change the "To" date to July 31, 2000.
4. Press the "Query Database and Display" to view the results.

Sorting on Time Range

The time range sorts the times of the day for valid dates. Changing the time range to 6:00AM to 6:00PM will limit the payloads displayed to the loads that occurred between those times for each day of the date range. Times are entered in 24:00 format. To view the haul cycle reports from the first shift for truck 374 from January 5, 2000 to January 8, 2000:

1. Select truck 374 from the Truck Unit pull-down menu.



2. Change the "From" date to July 1, 2000.



3. Change the "To" date to July 31, 2000.
4. Change the "From" time to 06:00.
5. Change the "To" time to 18:00.



6. Press the "Query Database and Display" to view the results.

This query will display haul cycles from January 5 to January 8, from 6:00 AM to 6:00 PM.

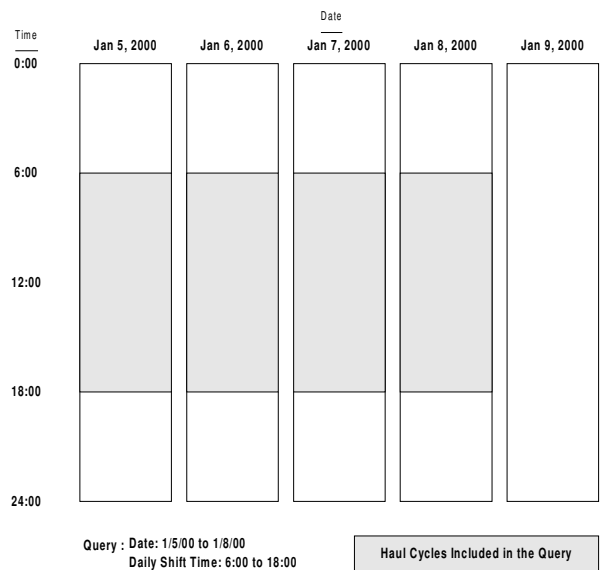

The shift times selected can extend the query past the original date. If the dates set for the query are January 5 to January 8 and the times were changed to query the 6:00 PM (18:00) to 6:00 AM (06:00) shift, the results would extend into the morning of the 9th. This can be seen in the following example:

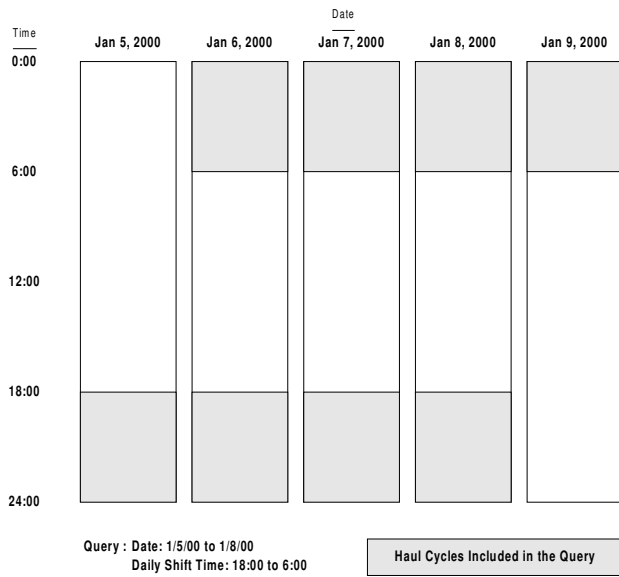

Creating Reports

Reports can be generated and viewed on the screen or printed. These reports are generated from the query displayed on the Payload Summary Screen. From the example in "Sorting on Time Range", the report printed would only contain data from truck 374 during the month of July 2000, from 8:00 AM to 5:00 PM.

It is important to carefully select the query data and press the "Query Database & Display" button before printing a report.

Payload Detail Screen

The Payload Detail screen gives the details for any individual haul cycle. From the "Payload Summary" screen, double-click on any haul cycle to display the detail.

PAYLOAD (Short tons)		CYCLE TIMES (Min:Sec)		START TIME (hh:mm:ss)	
Truck ID	374	Load Time	2:26	Payload Start Time	12:26:19
Operator ID	4200	Haul Time	12:03	Load Start Time	12:33:12
Payload Start Date	11/06/2000	Haul Stop Time	0:31	Dump Start Time	12:48:10
Dump Date	11/06/2000	Dump Time	0:49		
Carry Back	-0.77	ReturnTime	5:42		
Swingloads	5	Return Stop Time	1:23		
Final Payload	317	Total Operating Time	22:54		
Payload Est @ Shovel	322				
SPRUNG LOAD and TIRE TON MPH (hh:mm:ss)			CYCLE DISTANCE (mi)		
Peak Sprung Load	562.40 (Short Tons)	12:35:59	Haul Distance	1.76	
Left Front Tire	460.97 (Tire Short Ton MPH)		Return Distance	1.68	
Right Front Tire	507.54 (Tire Short Ton MPH)		Total Distance	3.44	
Rear Tire	374.66 (Tire Short Ton MPH)				
SPEEDS (mph)					
			LOADED TIME		
			Max Speed	25.02	12:44:50
			Avg Speed	8.43	
			EMPTY		
			Max Speed	28.03	12:27:20
			Avg Speed	14.21	

Buttons: ? Help, Warning Flags, Close

NOTE: Some haul cycles may contain the Sensor Input warning flag. This indicates that one of the four pressure sensors or inclinometer was not functioning properly during the haul cycle. Haul cycles with this warning are displayed in red on the Payload Summary window and are not included in the summary statistics for reports or display.

Summary - one page report

A summary of the queried data can be printed onto 1 page. The cycle data is summarized onto one sheet. Displayed is the speeds, cycle times, load statistics, frame and tire data.

Detailed - multi-page report

The detail report starts with the summary report and follows with pages of data for each haul cycle. The detailed report prints date, time, payload, cycle times, and cycle distances, speeds and the number of swing loads.

Payload Summary Report			
Report Date: April 11, 2001			
Query used for summary:			
Truck Number: ALL		Dates: 2/10/00 to 2/19/01	
Truck Type: ALL		Daily Shift Time: 00:00 to 24:00	

Time Period	Date	Time	Cycle Distance Averages (miles)	
First Load	02/10/2000	03:25:30 PM	Loaded	1.9
Last Load	02/19/2001	07:20:30 AM	Empty	2.0
			Avg Total Distance	3.9

Final Payload	Short Tons	Date	Time
Total, All Loads	1,495,086		
Maximum	421	01/24/2001	09:05:22 AM
Minimum	0	01/27/2001	04:11:24 AM
Average	321		
Standard Deviation	28.6		
Payload Estimate @ Shovel			
Total, All Loads	1,532,025		
Maximum	425	01/11/2001	06:45:58 PM
Minimum	250	02/11/2000	06:27:34 AM
Average	320		
Standard Deviation	36.3		
Number of Loads	4,654		
Avg Carry Back	2.2		

Cycle Time Averages (Min:Sec)	Avg Tire (Ton-MPH)
Load	Left Front 583
Haul Run	Right Front 576
Haul Stop	Rear 415
Empty Run	
Empty Stop	
Dump	
Avg Total Cycle Time	

Speed Data (mph)	
Loaded Max	37.32
Loaded Avg	10.57
Empty Max	37.97
Empty Avg	11.43

Payload Detail Report															Page 1			
Report Date: October 17, 2000																		
Query used for summary:																		
Truck Number: ALL																		
Truck Type: ALL																		
Dates: 8/28/00 to 10/3/00																		
Daily Shift Time: 00:00 to 24:00																		
No.	Date	Time	Payload S.Tons	#Swings	CYCLE Times(min:sec)							CYCLE DISTANCE(mi)			SPEEDS(mph)			
					Load	Haul	Haul Stop	Dump	Return	Return Stop	Total	Haul	Return	Total	Max	Haul Avg	Max	Return Avg
1	8/28/00	3:54P	347	7	4.40	11:11	0:06	0:52	7:54	14:28	39:11	1.9	2.0	4.0	21.99	10.14	31.03	5.48
2	8/28/00	5:18P	301	6	3.39	11:10	0:25	0:43	8:12	3:43	27:52	1.9	1.9	3.8	23.02	9.91	26.05	9.42
3	8/28/00	5:46P	300	6	3.32	11:32	2:32	0:56	7:07	0:09	25:48	1.9	1.9	3.8	23.02	8.30	25.02	15.49
4	8/28/00	6:11P	330	4	1.58	17:51	2:49	1:58	11:34	1:41	37:51	3.9	2.6	6.5	36.21	11.37	24.07	11.73
5	8/28/00	6:49P	344	4	1.54	18:26	13:04	1:50	11:20	0:24	46:58	4.0	3.9	7.9	34.97	7.56	37.06	20.15
6	8/28/00	7:36P	380	5	2.12	19:52	1:07	1:39	11:32	0:48	37:10	4.0	4.0	8.0	30.00	11.28	34.03	19.59
7	8/28/00	8:13P	352	4	2.26	18:17	0:23	1:54	11:54	1:56	36:50	3.9	4.0	8.0	31.97	12.62	34.07	17.49
8	8/28/00	8:50P	356	4	1.56	18:52	0:21	1:55	11:59	0:38	35:41	4.0	4.0	8.0	36.17	12.34	36.21	19.09
9	8/28/00	9:25P	370	5	2.18	16:17	2:18	0:53	12:25	0:25	34:36	2.7	4.1	6.7	34.97	8.55	36.17	19.14
10	8/28/00	10:00P	363	5	3.07	16:56	5:48	0:52	9:02	0:33	36:18	2.7	2.7	5.3	32.97	6.99	32.97	16.61
11	8/28/00	10:36P	341	7	3.58	12:23	0:23	0:53	7:26	0:57	26:00	2.0	2.0	3.9	21.03	9.20	32.00	14.10
12	8/28/00	11:02P	321	4	2.24	16:19	5:06	0:50	10:17	1:05	36:01	2.7	2.6	5.3	34.03	7.49	31.97	13.71
13	8/28/00	11:38P	316	5	2.49	15:21	7:06	0:58	13:01	13:11	52:26	3.9	4.0	7.9	40.12	10.30	40.12	9.16
14	8/29/00	12:56A	320	5	2.23	15:18	0:07	0:55	13:16	11:43	43:42	3.9	3.8	7.7	36.21	14.99	41.10	9.18
15	8/29/00	1:40A	302	4	1.55	14:12	0:08	0:54	10:34	0:11	27:54	3.9	3.9	7.7	40.12	16.15	41.10	21.64
16	8/29/00	2:08A	310	5	2.21	15:14	4:55	1:01	9:46	4:59	38:16	3.9	3.9	7.7	40.12	11.51	41.16	15.67
17	8/29/00	2:46A	318	5	2.25	14:44	0:15	0:54	10:36	0:19	29:13	3.9	3.9	7.7	41.10	15.50	41.10	21.28
18	8/29/00	3:15A	278	4	2.01	15:53	1:12	0:46	10:38	2:08	32:38	4.3	3.8	8.1	38.13	15.06	41.10	18.05
19	8/29/00	3:48A	328	5	2.25	17:38	3:08	0:57	10:07	0:20	34:35	4.3	3.9	8.2	34.03	12.41	41.10	22.19
20	8/29/00	4:22A	287	4	2.49	17:00	15:44	1:02	11:59	4:49	53:23	4.3	4.0	8.2	40.12	7.87	41.10	14.09
21	8/29/00	1:41P	285	4	2.15	16:08	6:14	5:21	9:02	0:16	20:13	1.8	1.8	3.6	27.05	10.98	30.02	18.98
22	8/29/00	2:50P	340	7	3.38	10:14	0:06	0:54	8:41	7:10	30:43	1.8	3.3	5.2	27.07	10.54	39.07	12.65
23	8/29/00	3:20P	326	5	3.32	9:47	0:08	1:09	5:21	0:16	20:13	1.8	1.8	3.6	27.05	10.98	30.02	18.98
24	8/29/00	3:41P	342	6	3.59	11:24	0:08	0:47	19:49	15:18	51:25	1.9	6.2	8.1	23.02	10.02	32.00	10.56
25	8/29/00	4:43P	349	7	4.46	11:12	0:18	0:57	7:32	3:12	27:57	1.8	1.9	3.8	23.02	9.50	27.07	10.87
26	8/29/00	5:11P	322	4	2.11	5:29	19:58	1:29	15:38	59:19	104:04	1.1	5.1	6.1	42.20	2.52	42.20	4.05
27	8/30/00	4:27A	330	7	4.27	10:33	0:09	1:02	21:08	159:27	196:46	1.7	4.3	6.0	23.02	9.69	28.01	1.42
28	8/30/00	4:55P	320	6	3.52	10:42	0:14	1:00	5:43	1:42	23:13	1.7	1.7	3.4	24.07	9.55	29.06	13.47
29	8/30/00	5:18P	338	6	3.16	10:45	0:51	0:58	6:00	2:34	24:24	1.7	1.6	3.3	23.02	8.71	29.04	11.36
30	8/30/00	5:42P	343	6	3.52	10:28	0:08	1:01	6:06	0:25	22:00	1.7	1.6	3.3	24.08	9.57	28.03	14.70

Creating Graphs

The PLM3 software can generate graphs that quickly summarize payload data. These graphs can be customized for printing. Just like the reports, the graphs are generated from the query displayed on the "Payload Summary" screen. From the "Sorting on Time Range" example, the graph that is printed would only contain data from truck 374 during the month of July 2000, from 8:00 AM to 5:00 PM.

It is important to carefully select the query data and press the "Query Database & Display" button before creating a graph.

1. From the Payload Summary Screen select the "Graph" button at the bottom. The Histogram Setup screen will display

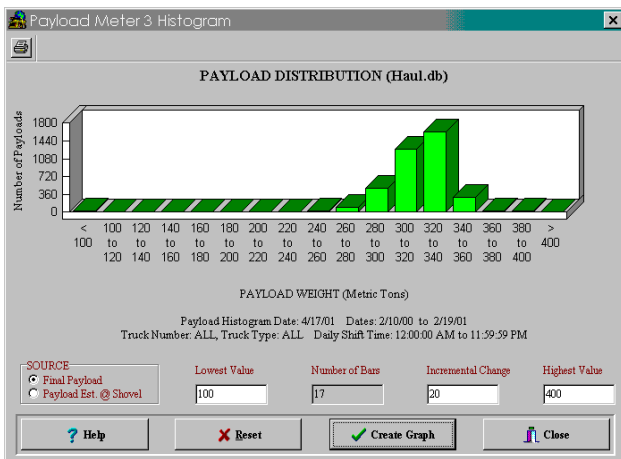

2. Enter the "Lowest Value". This will be the lowest payload on the graph. Any payloads less than this value will be summed in the first bar.
3. Enter the "Highest Value". This will be the highest value on the graph. Payloads over this value will be summed in the last bar.
4. Enter the "Incremental Change". This will determine the number of bars and the distance between them. The program limits the number of bars to 20. This allows graphs to fit on the screen and print onto 1 page.
5. Press the "Create Graph" button.

The graph will be displayed based on the query settings from the Payload Summary screen. The graph can be customized and printed.

Exporting Data

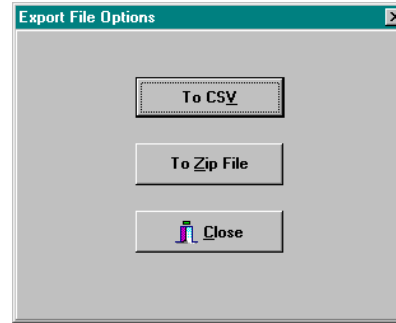

The data from the database can be exported for use with other software applications. The data is selected from the currently displayed query. The exported data can be put into a ".CSV" file or a compressed ".zip" file.

- The ".CSV" format allows data to be easily imported into spreadsheet applications and word processing applications.
- The ".Zip" format allows data to be transferred from one computer to the PDM Software database on another computer. This offers a compact way to transfer data from one computer to another.

CSV Export

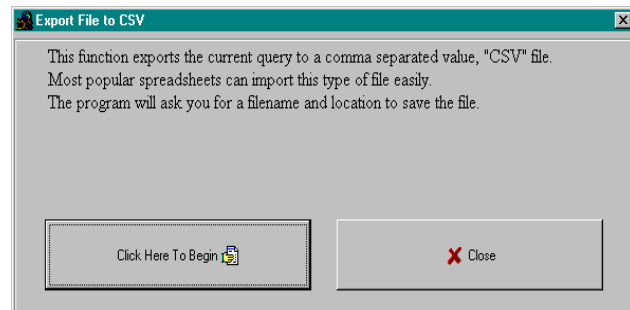

CSV stands for Comma Separated Value. This is an ASCII text file format that allows spreadsheet applications like Excel and Lotus 123 to import data easily. To export the data into a ".csv" file, press the "Export" button at the bottom of the payload summary screen and select "To CSV". The program will request a filename and location for the file.

Two sets of data are exported. At the top of the file will be the haul cycle data. The columns, left to right are:

- Truck number
- Haul cycle start date
- Haul cycle start time
- Payload
- Swingloads
- Operator ID
- Warning Flags
- Carry Back
- Total Haul Cycle time
- Empty Running Time
- Empty stop time
- Loading time
- Loaded running time
- Loaded stopped time
- Dumping time
- Loading start time
- Dumping start time
- Loaded haul distance
- Empty haul distance
- Loaded maximum speed
- Time when loaded maximum speed occurred
- Empty maximum speed
- Time when loaded maximum speed occurred
- Maximum + frame torque
- Time when the maximum + frame torque occurred
- Maximum - frame torque
- Time when the maximum - frame torque occurred
- Maximum sprung weight calculation
- Time when the maximum sprung weight calculation occurred
- Left Front Tire-kilometer-hour
- Right Front Tire-kilometer-hour
- Average Rear Tire-kilometer-hour
- Frame serial number

- Reserved 1-5, 7-10: These values are internal calculations used in the continued development of PLM3 and should be ignored.
- Reserved 6: This value is the payload estimate at the shovel just before the truck begins to move.

Alarm Type	Date Set	Time Set	Description	Date Cleared	Time Cleared
10	12/5/99	8:51:25 AM	INCL SENSOR LO	12/5/99	8:51:29 AM
10	12/5/99	8:56:07 AM	INCL SENSOR LO	12/5/99	8:56:12 AM
10	12/5/99	9:00:49 AM	INCL SENSOR LO	12/5/99	9:00:54 AM
10	12/5/99	9:05:31 AM	INCL SENSOR LO	12/5/99	9:05:36 AM
10	12/5/99	9:10:13 AM	INCL SENSOR LO	12/5/99	9:10:17 AM
10	12/5/99	9:14:54 AM	INCL SENSOR LO	12/5/99	9:14:59 AM
10	12/5/99	9:19:37 AM	INCL SENSOR LO	12/5/99	9:19:41 AM
10	12/5/99	9:24:19 AM	INCL SENSOR LO	12/5/99	9:24:24 AM
10	12/5/99	9:29:01 AM	INCL SENSOR LO	12/5/99	9:29:06 AM
10	12/5/99	9:33:44 AM	INCL SENSOR LO	12/5/99	9:33:48 AM
10	12/5/99	9:38:26 AM	INCL SENSOR LO	12/5/99	9:38:30 AM
10	12/5/99	9:43:08 AM	INCL SENSOR LO	12/5/99	9:43:13 AM
10	12/5/99	9:47:30 AM	INCL SENSOR LO	12/5/99	9:47:55 AM
10	12/5/99	9:52:32 AM	INCL SENSOR LO	12/5/99	9:52:37 AM
10	12/5/99	9:57:13 AM	INCL SENSOR LO	12/5/99	9:57:17 AM
10	12/5/99	10:01:55 AM	INCL SENSOR LO	12/5/99	10:01:59 AM

The second series of data below the haul cycle data is the alarms. The alarm columns, left to right are:

- The alarm type
- The date the alarm was set
- The time the alarm was set
- Alarm description
- The date the alarm was cleared
- The time the alarm was cleared

Compressed

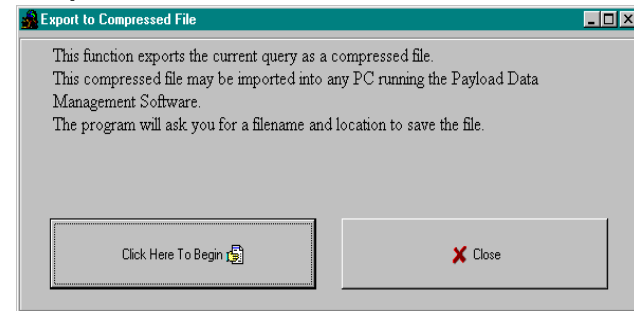

This export function allows the data from one laptop to be transferred to another computer. This can be useful when a service laptop is used to download multiple machines and transfer the data to a central computer for analysis. This can also be used to copy haul data from a particular truck onto a diskette for analysis.

The file format is a compressed binary form of the displayed query. The file can only be imported by another computer running the PDM Software.

To export data in ZIP format:

1. Confirm that the data displayed is the query data that needs to be exported.
2. From the payload summary screen, press the "EXPORT" button and select "To ZIP".
3. The program will ask for a filename and location.

Importing Data

This import function allows the data from one laptop to be transferred to another computer. This can be useful when a service laptop is used to download multiple machines and transfer the data to a central computer for analysis. This can also be used to copy haul data from a particular truck from a diskette into a database for analysis.

To import data, press the "IMPORT" button at the bottom of the "Payload Summary" screen. The program will ask for a ".zip" file to import, locate the file and press "Open". The program will only import ".zip" files created by another computer running the PDM Software.

Deleting Haul Cycle Records

To delete haul cycle records from the main database, press the "Delete" button at the bottom of the "Payload Summary" screen. The program will display a summary of the records from the displayed query. To delete a record, select one at a time and press the "Delete" button. It is recommended that records be exported to a zip file for archival purposes before deletion. Multiple records may be selected by holding down the Shift key. Pressing the "Delete All" button will select all the records from the current query and delete them.

NOTE: There is no recovery for records that have been deleted from the main database. It is highly recommended that all records be exported and archived in a compressed file format for future reference before being deleted.

Truck Number	Date	Time	Payload	# Swings	Total Time
374	08/28/2000	3:54:13 PM	346.7	7	39:11
374	08/28/2000	5:18:14 PM	301.5	6	27:52
374	08/28/2000	5:46:04 PM	300.0	6	25:48
374	08/28/2000	6:11:50 PM	330.5	4	37:51
374	08/28/2000	6:49:37 PM	343.7	4	46:58
374	08/28/2000	7:36:31 PM	379.9	5	37:10
374	08/28/2000	8:13:37 PM	351.6	4	36:50
374	08/28/2000	8:50:22 PM	356.3	4	35:41
374	08/28/2000	9:25:59 PM	369.6	5	34:36
374	08/28/2000	10:00:31 PM	362.6	5	36:18
374	08/28/2000	10:36:44 PM	340.5	7	26:00
374	08/28/2000	11:02:42 PM	320.9	4	36:01
374	08/28/2000	11:38:40 PM	316.5	5	52:26
374	08/29/2000	12:56:37 AM	319.7	5	43:42
374	08/29/2000	1:40:16 AM	301.6	4	27:54

Viewing Alarms

From the Payload Summary screen, click the "Alarms" button to display the alarm screen. The alarms are sorted by the query settings from the Payload Summary screen. Alarms can be displayed as Active or Inactive.

Truck Number	Type	Set Date	Set Time	Description	Cleared Date	Cleared Time
374	13	8/31/00	2:34:48 AM	ALARM BODY UP SWITCH	8/31/00	2:34:52 AM
374	13	9/11/00	2:36:57 PM	ALARM BODY UP SWITCH	9/11/00	2:37:01 PM
374	13	9/11/00	2:45:22 PM	ALARM BODY UP SWITCH	9/11/00	2:45:26 PM
374	13	9/13/00	9:19:43 PM	ALARM BODY UP SWITCH	9/13/00	9:19:48 PM
374	13	9/30/00	2:42:05 AM	ALARM BODY UP SWITCH	9/30/00	2:42:10 AM

Active Alarms Inactive Alarms All Alarms Delete Close

Deleting Alarm Records

To delete alarm records from the main database, press the "Delete" button at the bottom of the "Alarm Display" screen. The program will display a summary of the alarms from the query. To delete an alarm, select one at a time and press the "Delete" button. It is recommended that the query data be exported to a ".zip" file for archival purposes before deletion. Multiple records may be selected by holding down the Shift key. Pressing the "Delete All" button will select all the alarms from the current query and delete them.

NOTE: There is no recovery for alarms that have been deleted from the main database. It is highly recommended that all records be exported and archived in a compressed file format for future reference before being deleted.

Truck Number	Alarm Type	Set Date	Set Time	Description	Cleared Date	Cleared Time
374	13	8/31/00	2:34:48 AM	ALARM BODY UP SWITCH	8/31/00	2:34:52 AM
374	13	9/11/00	2:36:57 PM	ALARM BODY UP SWITCH	9/11/00	2:37:01 PM
374	13	9/11/00	2:45:22 PM	ALARM BODY UP SWITCH	9/11/00	2:45:26 PM
374	13	9/13/00	9:19:43 PM	ALARM BODY UP SWITCH	9/13/00	9:19:48 PM
374	13	9/30/00	2:42:05 AM	ALARM BODY UP SWITCH	9/30/00	2:42:10 AM

Help Delete All Delete Selection Close

NOTES:

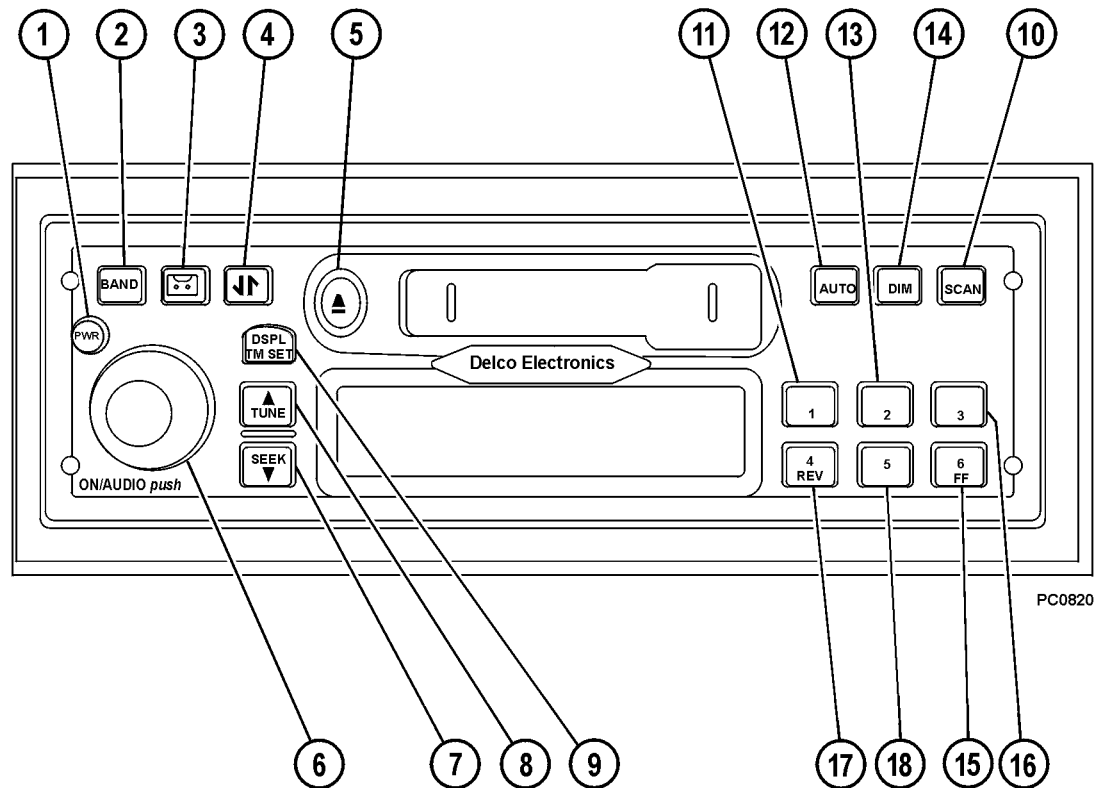

FIGURE 7-1. CAB RADIO

SETTING THE TIME

1. Turn the key switch "ON".
2. Press and hold DSPL/TM SET (9) for 2 seconds. When the number display flashes, time set mode is active.
3. Press TUNE / SEEK (7 & 8) to change the hour setting.
4. Press the DSPL/TM button to switch to minutes. The minute digits will flash when in this mode.
5. Press TUNE / SEEK to change the minute setting.

After 5 seconds of inactivity has elapsed, the display will return to the default mode. The clock will now display the correct time of day.

GENERAL RECEIVER FUNCTIONS

The receiver is equipped with two FM radio bands, FM1 and FM2. The two bands are identical, however, each one allows the operator to set 6 preset channels for a total of 12 FM presets overall.

TURNING THE POWER "ON" AND "OFF"

1. Turn the key switch to "ON".
2. Press PWR (1) to turn the receiver "ON" and "OFF". Pushing ON/AUDIO (6) may also be used to turn the receiver power "ON".

DISPLAY

With the receiver "OFF", the clock will be displayed. Momentarily pressing DSP/TM SET (9) with the receiver "ON" will allow the operator to toggle between displays.

- When the receiver is in AM, FM1, FM2, or WX, the display will toggle between the frequency and the clock.

- When the receiver is in the cassette mode, the display will toggle between TP SIDE 1 or TP SIDE 2, and the clock.

SETTING THE DEFAULT DISPLAY

1. Press and hold DSPL/TM (9) for 2 seconds until the hour digits flash.
2. Press push-button 6/FF (15) to change the default display.

After 5 seconds of inactivity has elapsed, the selected default will display.

ADJUSTING DISPLAY BRIGHTNESS

1. Press and hold DIM (14) until "DIM" appears on the display.
2. Rotate ON/AUDIO knob (6) clockwise or counterclockwise until the desired brightness is obtained.

OPERATING THE RADIO

BAND (2): Press Band (2) to switch between FM1, FM2, AM, and WX Weather (US).

TUNE / SEEK (7 & 8): Allows you to move up or down in frequency to other stations. There are two modes of operation for finding other stations, manual tuning and seek mode. Press and hold both TUNE (8) and BAND (2) for 2 seconds to toggle between the two modes. The display will read either "MANUAL" or "SEEK" to indicate the mode the receiver is in.

Manual Tuning: Press TUNE (8) to tune to the next higher frequency. Press SEEK (7) to tune to the next lower frequency. Holding either of the buttons for more than 0.5 seconds will activate fast tuning for increased speed.

Seek Mode: In seek mode, the receiver will only stop on stations that have a strong signal. To scroll through these stations, press TUNE (8) for at least 0.5 seconds to activate seek mode. The receiver will move to the next highest frequency and pause for 3 seconds. After 3 seconds, the receiver will move to the next higher frequency. This pattern will continue until the TUNE button is pressed again. Press SEEK (7) for at least 0.5 seconds to activate seek mode for the next lower frequency station. The receiver will momentarily stop on strong stations until the SEEK button is pressed again.

NOTE: *If the receiver can not find a strong enough signal after two band cycles, the seek mode will discontinue and the receiver will return to the initial station.*

SCAN (10): Press the SCAN button to scan all stations on the current band. When a strong frequency is found, the receiver will pause on that station for about 5 seconds and then continue scanning. Scan will appear on the display along with the frequency when this mode is active. To stop scanning, press the SCAN button again.

AUTO (12): AUTO allows the receiver to store the 6 strongest stations onto push-buttons 1 through 6. Press AUTO until "AUTO" and "AS" appear on the display. The presets on the current band only will now be programmed with the 6 strongest frequencies. Presets on the other bands will not be changed. Pressing AUTO again will delete the stations and default to the original preset stations.

PROGRAMMING PRESET STATIONS

Presets are stations that are stored on each of the 6 push-buttons. After a station has been programmed into one of the preset buttons, pushing the preset provides a quick return to that station. The six buttons can each store a preset channel per band.

Perform the following steps for programming presets:

1. Turn the receiver "ON".
2. Select the band and the desired station.
3. Press and hold one of the six push-buttons for at least 2 seconds. During the 2 second period, receiver output will be muted and the push-button number will show on the display. When the station has been committed to memory, the audio and the preset icon will return.
4. Repeat steps 1 through 3 for the remaining available presets.

NOTE: Six presets may be stored on AM, FM1, and FM2 for a total of 18 presets.

OPERATION OF THE WEATHERBAND (U.S.)

NOAA - Weather Radio is a service of the "Voice of the National Weather Service". It provides continuous broadcasts of the latest weather information directly from the National Weather Service offices. Taped weather messages are repeated every four to six minutes and are routinely revised every one to three hours, or more frequently if needed. Most of the stations operate 24 hours, daily.

The weather for the area you are in may be found on one of 7 stations. When in the Weatherband mode, the display will show the "WX" icon and "CHAN #" to indicate the channel. The channel may be adjusted through the TUNE /SEEK buttons, and may be preset as in the radio mode.

The frequency associated with each channel is as follows:

- | | |
|----------------|----------------|
| 1. 162.550 MHz | 5. 162.450 MHz |
| 2. 162.400 MHz | 6. 162.500 MHz |
| 3. 162.475 MHz | 7. 162.525 MHz |
| 4. 162.425 MHz | |

The National Weather Service operates approximately 372 stations. Close to 90 percent of the nation's population is within the listening range of a NOAA Weather Radio broadcast.

ADJUSTING THE RECEIVER SETTINGS

VOLUME: Rotate ON/AUDIO (6) knob clockwise to increase the volume and counter-clockwise to decrease the volume. "VOL" will be displayed along with the volume level.

BASS: Push and release ON/AUDIO (6) knob until "BASS" and the current bass level is displayed. Rotate the knob clockwise to increase the bass and counter-clockwise to decrease the bass.

TREBLE: Push and release ON/AUDIO (6) knob until "TREB" and the current treble level is displayed. Rotate the knob clockwise to increase the treble and counter-clockwise to decrease the treble.

FADE: Push and release ON/AUDIO (6) knob until "FADE" and the current level is displayed. Rotate the knob clockwise to move the sound to the front speakers and counter-clockwise to move the sound to the rear speakers.

BALANCE: Push and release ON/AUDIO (6) knob until "BAL" and the present level is displayed. Rotate the knob clockwise to move the sound to the front speakers and counter-clockwise to move the sound to the rear speakers.

SPEAKER: Push and release ON/AUDIO (6) knob until "SPKR" and the current setting is displayed. Rotate the ON/AUDIO knob to select 2-speaker or 4-speaker operation. When 2-speaker operation active, the rear speakers are muted and the FADE option will not appear on the menu.

PROGRAMMABLE EJECT DEFAULT

The cassette player has been pre-programmed to return to the radio after a tape has been ejected. This default may be changed to an "eject audio mute" mode. This mode will mute the radio after a cassette has been ejected. When this occurs, "NO TAPE" will appear on the display and the radio will remain muted until BAND (2) is pressed. Pressing this button will enable the radio.

Perform the following steps to change the eject default mode:

1. Press and hold DSP/TM SET (9) for at least 2 seconds until the hour digits flash.
2. Press  button (3) to toggle between "P.PLAY" and "EJMUTE". After 5 seconds of inactivity, the receiver will return to the default display.

CASSETTE PLAYER

The cassette player that the radio is equipped with works best with cassettes that range from 30 to 90 minutes long. Cassettes that are longer than 90 minutes have thinner tape, and do not work well in this model cassette player.

It is also important to only use cassettes that are in good condition. Cassettes that are dirty, damaged, or have been exposed to excessive heat and/or sunlight could cause damage to the cassette player and possible failure.

The cassette player is equipped with automatic equalization and metal tape sensing functions. An "M" will appear on the display when a metal tape is sensed.

Cleaning the cassette player is a recommended maintenance item. It should be performed at 35 hour (cassette play) intervals. Failure to clean the cassette player may diminish sound quality and cause cassette player failure.

PLAYING A CASSETTE

1. Turn the receiver "ON".
2. Insert a cassette into the player. The cassette icon will appear on the display. The tape will begin to play when the icon appears.

NOTE: Press  button (3) to change from the radio to a cassette. "TP SIDE 1" or "TP SIDE 2" will appear on the display depending on which side of the cassette is currently being played. If a cassette is not loaded in the player, "NO TAPE" will appear on the display.

CASSETTE FUNCTIONS

4/REV (17): This button rewinds the cassette. The cassette will continue to rewind until the button is pressed again, or until the cassette reaches the end of the tape. "<REW" will appear on the display as the cassette is rewinding.

6/FF (15): This button fast forwards the cassette. The cassette will continue to fast forward until the button is pressed again, or until the cassette reaches the end of the tape. "FWD>" will appear on the display as the cassette is fast forwarding.

▲ Eject (5): Press this button to eject the cassette from the player. When the eject button is held, it acts as a stop button.

↕ (4): This button causes the cassette player to reverse directions and play the opposite side of the cassette. Pressing the button a second time will reverse the cassette back to the original side.

NOTE: The cassette will automatically flip to the opposite side when the end of the tape is reached.

BAD TAPE DETECT

If the receiver detects a bad cassette, "BAD TAPE" will appear on the display, and the tape will be ejected. If this occurs, the cassette should be removed from the player and should not be re-inserted.

If it is desired to use a cleaning tape or a CD adapter in the cassette player, the bad tape detector must be turned "OFF". Perform the following steps in order to disable this mode:

1. Turn the receiver "OFF" and turn the key switch to "OFF".
2. Press and hold  button (3) for 5 seconds. "BAD TAPE DETECT OFF" will appear on the display. When this is displayed, the detector has been disabled.

Repeat this procedure to reactivate the bad tape detector. "BAD TAPE DETECT ON" will appear on the display after the detector has been activated.

CASSETTE PLAYER CLEANING

After 35 hours of cassette play, the display will read "TP CLEAN" for 5 seconds. This indicates that it is time to clean the cassette player.

1. Turn the key switch to "ON", and turn the receiver "OFF".
2. Disable "BAD TAPE DETECT" mode.
3. Turn the receiver "ON".
4. Insert a wet-type, non-abrasive, scrubbing cassette cleaner. Follow the instructions provided with the cleaner.
5. Reset the clean tape timer. With the receiver "ON", press and hold the eject button for 5 seconds. "TP CLEAN" will appear on the display and the tape icon will flash after 3 seconds has elapsed. After 5 seconds "CLN RST" will appear on the display. When this occurs, the clean tape timer will be reset to zero hours. If the button was released before "CLN RST" was displayed, the timer will not be reset.

NOTES

KOMATSU