

Operation & Maintenance Manual

CEAM007000



930E-2

DUMP TRUCK

SERIAL NUMBERS **930E A30181 thru A30223**
W/ Cummins QSK60 Engine

KOMATSU

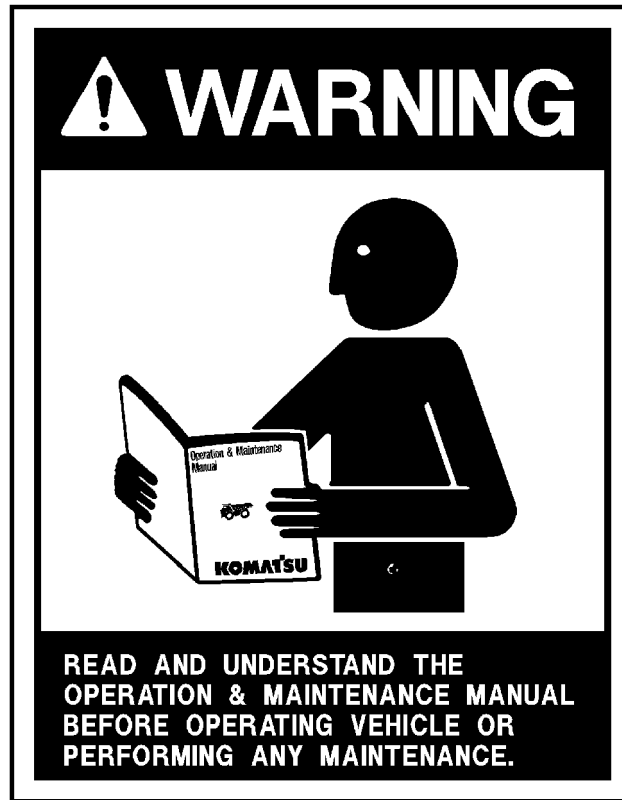

Unsafe use of this machine may cause serious injury or death. Operators and maintenance personnel must read and understand this manual before operating or maintaining this machine. This manual should be kept in or near the machine for reference, and periodically reviewed by all personnel who will come into contact with it.

This material is proprietary to Komatsu Mining Systems, Inc. and is not to be reproduced, used, or disclosed except in accordance with written authorization from Komatsu Mining Systems, Inc.

It is the policy of the Company to improve products whenever it is possible and practical to do so. The Company reserves the right to make changes or add improvements at any time without incurring any obligation to install such changes on products sold previously.

Because of continuous research and development, periodic revisions may be made to this publication. Customers should contact their local distributor for information on the latest revision.

**CALIFORNIA
Proposition 65 Warning**

Diesel engine exhaust, some of its constituents, and certain vehicle components contain or emit chemicals known to the State of California to cause cancer, birth defects or other reproductive harm.

**CALIFORNIA
Proposition 65 Warning**

Battery posts, terminals and related accessories contain lead and lead compounds, chemicals known to the State of California to cause cancer and birth defects or other reproductive harm. Wash hands after handling.

NOTES:

EMISSION CONTROL WARRANTY

EMISSION CONTROL WARRANTY STATEMENT (APPLIES TO CANADA ONLY)

1. Products Warranted

Komatsu America International Company, Komatsu Mining Systems Inc. and Komatsu Utility Corporation (collectively "Komatsu") produce and/or market products under brand names of Komatsu, Dresser, Dressta, Haulpak and Galion. This emissions warranty applies to new engines bearing the Komatsu name installed in these products and used in Canada in machines designed for industrial off-highway use. This warranty applies only to these engines produced on or after January 1, 2000. This warranty will be administered by Komatsu distribution in Canada.

2. Coverage

Komatsu warrants to the ultimate purchaser and each subsequent purchaser that the engine is designed, built and equipped so as to conform, at the time of sale by Komatsu, with all U.S. Federal emission regulations applicable at the time of manufacture and that it is free from defects in workmanship or material which would cause it not to meet these regulations within five years or 3,000 hours of operation, whichever occurs first, as measured from the date of delivery of the engine to the ultimate purchaser.

3. Limitations

Failures, other than those resulting from defects in materials or workmanship, are not covered by this warranty. Komatsu is not responsible for failures or damage resulting from what Komatsu determines to be abuse or neglect, including, but not limited to: operation without adequate coolant or lubricants; over fueling; over speeding; lack of maintenance of lubricating, cooling or intake systems; improper storage, starting, warm-up, run-in or shutdown practices; unauthorized modifications of the engine. Komatsu is also not responsible for failures caused by incorrect fuel or by water, dirt or other contaminants in the fuel. Komatsu is not responsible for non-engine repairs, "downtime" expense, related damage, fines, all business costs or other losses resulting from a warrantable failure.

KOMATSU IS NOT RESPONSIBLE FOR INCIDENTAL OR CONSEQUENTIAL DAMAGES.

This warranty, together with the express commercial warranties, are the sole warranties of Komatsu. **THERE ARE NO OTHER WARRANTIES, EXPRESS OR IMPLIED, OR OF MERCHANTABILITY OR FITNESS FOR A PARTICULAR PURPOSE.**

GARANTIE SUR LE CONTRÔLE DES ÉMISSIONS

ÉNONCÉ DE GARANTIE SUR LE CONTRÔLE DES ÉMISSIONS (APPLICABLE AU CANADA SEULEMENT):

1. Produits garantis:

Komatsu America International Company, Komatsu Mining Systems Inc. et Komatsu Utility Corporation (collectivement Komatsu) produisent et/ou font la mise en marché de produits portant les noms de marque Komatsu, Dresser, Dressta, Haulpak et Galion. Cette garantie sur les émissions s'applique à tous les nouveaux moteurs portant le nom Komatsu, installés dans ces produits et utilisés au Canada dans des machines conçues pour utilisation industrielle non-routière. Cette garantie s'applique seulement sur les moteurs produits à partir du 1er Janvier 2000. Cette garantie sera administrée par la distribution de Komatsu au Canada.

2. Couverture:

Komatsu garantit à l'acheteur ultime et chaque acheteur subséquent que le moteur est conçu, construit et équipé en toute conformité, au moment de la vente par Komatsu, avec toutes les Réglementations fédérales américaines sur les émissions applicables au moment de la fabrication et qu'il est exempt de défauts de construction ou de matériaux qui auraient pour effet de contrevenir à ces réglementations en dedans de 5 ans ou 3000 heures d'opération, mesuré à partir de la date de livraison du moteur au client ultime.

3. Limitations:

Les bris, autres que ceux résultant de défauts de matériaux ou de construction, ne sont pas couverts par cette Garantie. Komatsu n'est pas responsable pour bris ou dommages résultant de ce que Komatsu détermine comme étant de l'abus ou négligence, incluant mais ne se limitant pas à: l'opération sans lubrifiants ou agent refroidissants adéquats; la suralimentation d'essence; la survitesse; le manque d'entretien des systèmes de lubrification, de refroidissement ou d'entrée; de pratiques non-propices d'entreposage, de mise en marche, de réchauffement, de conditionnement ou d'arrêt; les modifications non-autorisées du moteur. De plus, Komatsu n'est pas responsable de bris causés par de l'essence inadéquate ou de l'eau, des saletés ou autres contaminants dans l'essence. Komatsu n'est pas responsable des réparations non-relées au moteur, des dépenses encourues suite aux temps d'arrêts, des dommages relatifs, amendes, et de tout autre coût d'affaires ou autres pertes résultant d'un bris couvert par la garantie.

KOMATSU N'EST PAS RESPONSABLE DES INCIDENTS OU DOMMAGES CONSÉQUENTS.

Cette garantie, ainsi que les garanties expresses commerciales, sont les seules garanties de Komatsu. **IL N'Y A AUCUNE AUTRE GARANTIE, EXPRESSE OU SOUS-ENTENDUE, MARCHANDABLE OU PROPICE A UNE UTILISATION PARTICULIÈRE.**

INFORMATION IMPORTANTE SUR LE MOTEUR
 CE MOTEUR EST CONFORME AUX NORMES AMÉRICAINES DEL'EPA (ANNÉE DU MODÈLE) ET DE LA CALIFORNIE POUR LES MOTEURS LARGES NON-ROUTIERS A IGNITION PAR COMPRESSION. CE MOTEUR EST CERTIFIÉ POUR OPERATION À ESSENCE DIÉSEL.

AVERTISSEMENT
 DES BLESSURES PEUVENT RÉsulTER ET LA GARANTIE S'ANNULER SI LES RPM DU TAUX D'ESSENCE OU L'ALTITUDE EXCÈDENT LES VALEURS MAXIMALES PUBLIÉES POUR CE MODÈLE ET SON APPLICATION.

IMPORTANT ENGINE INFORMATION
 THIS ENGINE CONFORMS TO YYYY MODEL YEAR U.S. EPA REGULATION AND THE CALIFORNIA REGULATIONS LARGE NON ROAD COMPRESSION IGNITION ENGINES. THIS ENGINE IS CERTIFIED TO OPERATE ON DIESEL FUEL.

WARNING
 INJURY MAY RESULT AND WARRANTY IS VOIDED IF FUEL RATE RPM OR ALTITUDES EXCEED PUBLISHED MAXIMUM VALUES FOR THIS MODEL AND APPLICATION.

ENGINE MODEL		SERIAL NO.	
ENGINE FAMILY		DISPLACEMENT	LITERS
EXHAUST EMISSION CONTROL SYSTEM		FIRING ORDER	1 - 5 - 3 - 6 - 2 - 4
ADV. LOAD OUTPUT	Kw (HP)	RPM
VALVE LASH COLD (mm)	IN.	EX.	FUEL RATE AT ADV. mm ³ /STROKE
IDLE SPEED		RPM	FAMILY EMISSION LIMIT
INITIAL INJECTION TIMING	DEG. BTDC	DATE OF MANUFACTURE	
		KOMATSU LTD. MADE IN JAPAN	KOMATSU

↓
**KOMATSU LTÉE
 FABRIQUÉ AU JAPON**

MODÈLE DU MOTEUR

FAMILLE DU MOTEUR

SYSTÈME DE CONTRÔLE DES ÉMISSIONS D'ÉCHAPPEMENT

CHARGE DE SORTIE ADV.

PORTÉE DE VALVE À FROID (mm)

VITESSE STATIQUE

RÉGLAGE DE L'ALLUMAGE - INJECTION INITIALE

DEG. BTDC

NO. SÉRIE

DÉPLACEMENT

LITRES

SÉQUENCE DE MISE À FEU

mm³/BATTEMENT

TAUX D'ESSENCE À ADV.

LIMITE D'ÉMISSION DE LA FAMILLE

DATE DE FABRICATION

ENGINE DATAPLATE - ENGLISH / FRENCH

FOREWORD

This manual is written for use by the operator and/or the service technician and is designed to help these persons to become fully knowledgeable of the truck and all its systems in order to keep it operating safely and efficiently.

All operators and maintenance personnel should read and understand the materials in this manual before operating the truck or performing maintenance and/or operational checks on the truck. All safety notices, warnings and cautions should be understood and followed when operating or accomplishing repairs on the truck.

The first section is an Introduction to the manual and contains a Table of Contents to locate specific areas of interest. Other sections include Safety, Operation, Maintenance, Specifications, and Optional Equipment.

The illustrations used in this manual are *TYPICAL* of the component shown and may not be an exact reproduction of what is found on the truck.

A product identification plate is located on the frame in front of the right side front wheel and designates the Truck Model Number, Product Identification Number (vehicle serial number), and Maximum G.V.W. (Gross Vehicle Weight) rating.

The KOMATSU Truck Model designation consists of three numbers and one letter (i.e. 930E).

The three numbers represent the basic truck model.

The letter "M", when present, designates a Mechanical drive system;

The letter "E", when present, designates an Electrical wheel motor drive system.

The Product Identification Number (vehicle serial number) contains information which will identify the original manufacturing bill of material for this unit. This complete number will be necessary for proper ordering of many service parts and/or warranty consideration.

The Gross Vehicle Weight (GVW) is what determines the load on the drive train, frame, tires, and other components. The vehicle design and application guidelines are sensitive to the total maximum **Gross Vehicle Weight (GVW)** and this means the **TOTAL WEIGHT: the Empty Vehicle Weight + the fuel & lubricants + the payload**.

To determine allowable payload:

Service all lubricants for proper level and fill fuel tank of empty truck (which includes all accessories, body liners, tailgates, etc.) and then weigh truck.

Record this value and subtract from the GVW rating. The result is the allowable payload.

NOTE: Accumulations of mud, frozen material, etc. become a part of the GVW and reduces allowable payload. To maximize payload and to keep from exceeding the GVW rating, these accumulations should be removed as often as practical.

Exceeding the allowable payload will reduce expected life of truck components.

⚠ WARNING

Unsafe use of this machine may cause serious injury or death. Operators and maintenance personnel must read this manual before operating or maintaining this machine. This manual should be kept in or near the machine for reference and periodically reviewed by all personnel who come in contact with it.



This “ALERT” symbol is used with the signal words, “CAUTION”, “DANGER”, and “WARNING” in this manual to alert the reader to hazards arising from improper operating and maintenance practices.



*“DANGER” identifies a specific potential hazard
WHICH WILL RESULT
in either INJURY OR DEATH
if proper precautions are not taken.*



*“WARNING” identifies a specific potential hazard
WHICH MAY RESULT
in either INJURY OR DEATH
if proper precautions are not taken.*



*“CAUTION” is used for general reminders
of proper safety practices
OR
to direct the reader’s attention to avoid unsafe
or improper practices which may result
in damage to the equipment.*

TABLE OF CONTENTS

SUBJECT SECTION / PAGE

INTRODUCTION SECTION 1

- Foreword 1-1
- ALERTS Page - a description of the DANGER, WARNING, and CAUTION symbols used in this manual. . . . 1-2
- TABLE OF CONTENTS 1-3
- Truck Model Illustration 1-6
- About This Manual 1-7
- STANDARD CHARTS and TABLES 1-9 through 1-14

SAFETY SECTION 2

Safety records of most organizations will show that the greatest percentage of accidents are caused by unsafe acts of persons. The remainder are caused by unsafe mechanical or physical conditions. Report all unsafe conditions to the proper authority. These safety rules are provided as a guide for the Komatsu truck operator. However, local conditions and regulations may add many more to this list.

- GENERAL SAFETY 2-1
- PRECAUTIONS DURING OPERATION 2-5
 - Operating Machine 2-6
 - Towing 2-9
 - Battery 2-10
- PRECAUTIONS FOR MAINTENANCE 2-11
 - Before Carrying Out Maintenance 2-11
 - During Maintenance 2-12
 - Tires 2-15
 - Additional Job Site Rules 2-16
- WHEN REPAIRS ARE NECESSARY 2-17
 - Special Precautions for Working on a 930E Truck 2-18
- WARNING, CAUTION, and Instruction Plates / Decals 2-21 through 2-30

OPERATION SECTION 3

This portion of the manual covers identification, location, and operation of the controls, switches, and indicators in the Operator's Cab and use / function of these controls, switches, and indicators.

- OPERATING INSTRUCTIONS
 - Preparing For Operation 3-1
 - Safety Is Thinking Ahead 3-1
 - At The Truck - Ground Level Walk-Around Inspection 3-1
- ENGINE START-UP SAFETY PRACTICES 3-4
- AFTER ENGINE HAS STARTED 3-5
- MACHINE OPERATION SAFETY PRECAUTIONS 3-6
- MACHINE OPERATION ON THE HAUL ROAD 3-6
- STARTING ON A GRADE WITH A LOADED TRUCK 3-7
- PASSING 3-7
- LOADING 3-7
- DUMPING 3-8
- TOWING 3-9
- SAFE PARKING PROCEDURES 3-10
- NORMAL ENGINE SHUTDOWN PROCEDURE 3-10

TABLE OF CONTENTS (Continued)

SUBJECT	SECTION / PAGE
OPERATION (Continued)	SECTION 3
DELAYED ENGINE SHUTDOWN PROCEDURE	3-11
OPERATOR CAB and CONTROLS	3-13
STEERING WHEEL AND CONTROLS	3-14
DYNAMIC RETARDER/SERVICE BRAKE PEDAL	3-15
ACCELERATOR (THROTTLE) PEDAL	3-15
HEATER / AIR CONDITIONER VENTS	3-15
HEATER / AIR CONDITIONER COMPARTMENT AND CONTROLS	3-16
OVER HEAD PANEL AND DISPLAYS	3-17
CENTER CONSOLE CONTROLS AND FEATURES	3-19
Hoist Control Lever	3-20
OPERATOR SEAT	3-23
INSTRUMENT PANEL AND INDICATOR LIGHTS	3-25
Control Symbols	3-25
INSTRUMENT PANEL (Figure 3-6)	3-26
PANEL GAUGES, INDICATORS, AND CONTROLS (Discussion of items 1 - 29, Figure 3-6)	3-27
OVERHEAD STATUS / WARNING INDICATOR LIGHT PANEL (Figure 3-7)	3-33
INDICATOR LIGHT SYMBOLS - Refer to Figure 3-7 by rows (A-E) and columns (1 - 6).	3-34
Hazard Warning Lights (7)	3-40
Lamp Test Switch (8)	3-40
LINK-ON WARNING LIGHT	3-40

MAINTENANCE **SECTION 4**

This portion of the manual pertains mainly to the periodic Lubrication and Service required to keep the truck operating at its design potential. Routine lubrication and maintenance procedures are provided in this section. For major repairs, refer to the appropriate section in the Truck Service Manual.
Refer to the engine manufacturer's service manual when servicing the engine.

Lubrication and Service	4-1
Service Capacities	4-1
Hydraulic Tank Service	4-1
Coolant Level Check	4-2
Radiator Filling Procedure	4-2
Cooling System Recommendations	4-2
Lubrication Chart	4-3
10 HOUR (SHIFT) Lubrication And Maintenance Checks	4-4
50 HOUR Lubrication And Maintenance Checks	4-6
100 HOUR Lubrication And Maintenance Checks	4-7
250 HOUR Lubrication And Maintenance Checks	4-8
500 HOUR Lubrication And Maintenance Checks	4-10
1000 HOUR Lubrication And Maintenance Checks	4-11
2500 HOUR Lubrication And Maintenance Checks	4-12
5000 HOUR Lubrication And Maintenance Checks	4-12
Lincoln Automatic Lubrication System (Rotary Pump)	4-13
General Description	4-13
System Components	4-15
System Operation	4-16
General Instructions	4-18
Lubricant Required	4-18

TABLE OF CONTENTS (Continued)

SUBJECT SECTION / PAGE

Lincoln Automatic Lubrication System (CONTINUED)

- System Priming 4-18
- Filter Assembly 4-18
- Lubricant Pump 4-19
- Injector Operation 4-20
- Injectors 4-21
- System Check-out 4-22
- Lubrication Cycle Timer Check 4-22
- System Troubleshooting Chart 4-23
- Preventative Maintenance Procedures 4-26

SPECIFICATIONS SECTION 5

This portion of the manual covers major component descriptions and truck specifications.

- Major Component Descriptions 5-1
- Specifications 5-3

OPTIONAL EQUIPMENT SECTION 6

This portion of the manual covers operation/maintenance of OPTIONAL EQUIPMENT.

- PAYLOAD METER II (Refer to separate PAYLOAD METER II Index) 6-1
- RADIO, AM/FM STEREO CASSETTE 6-35

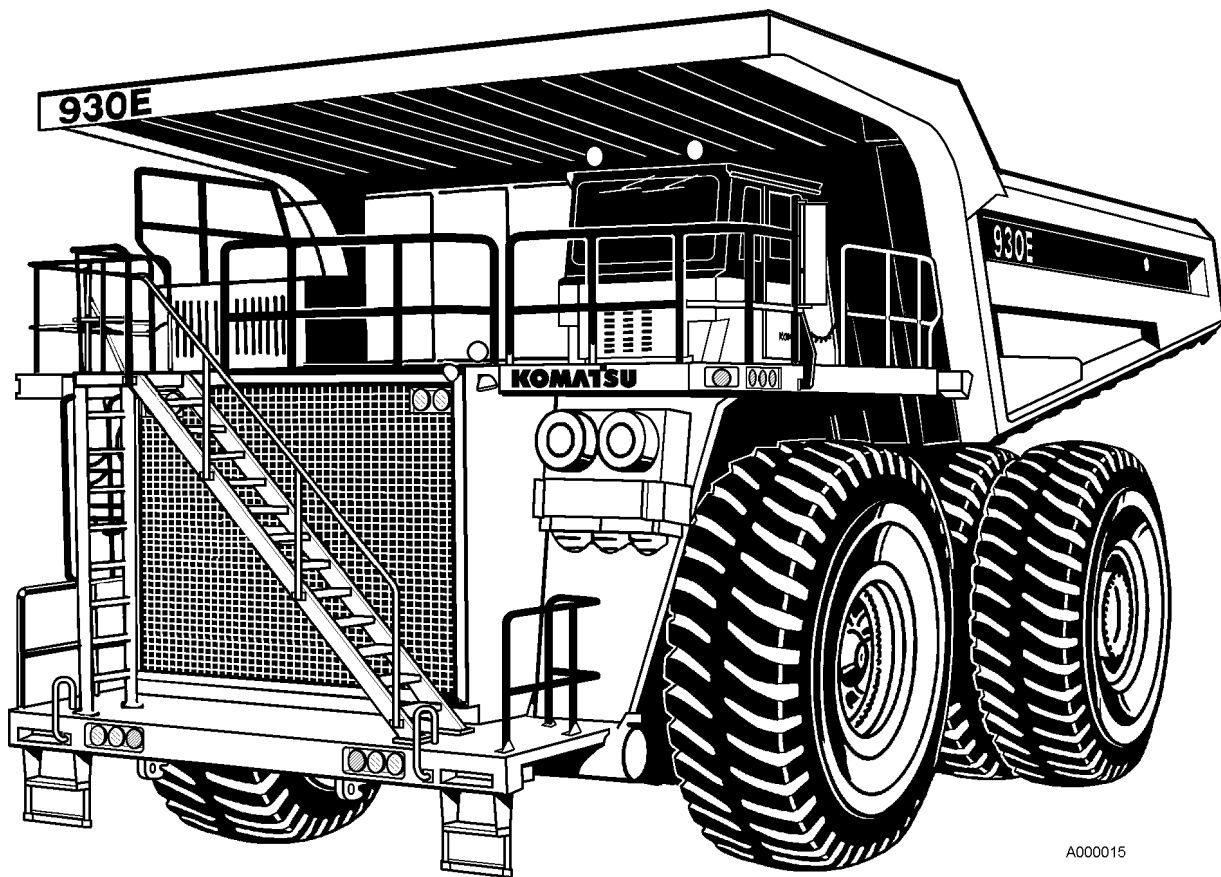

A000015

KOMATSU MODEL 930E Dump Truck

About This Manual

This Manual is written for use by the operator and/or the service technician and is designed to help these persons to become fully knowledgeable of the truck and all its systems in order to keep it operating safely and efficiently. All operators and maintenance personnel should read and understand the materials in this manual before operating the truck or performing maintenance and/or operational checks on the truck. All safety notices, warnings, and cautions should be understood and followed when operating or accomplishing repairs on the truck.

The front cover of this manual includes a Form Number. This Form No. should be referenced when ordering additional copies of this manual, or for any other correspondence regarding the coverage in this manual.

Direct all inquiries to:

Datakom Publishing Corporation
Peoria Operations
P.O. Box 240
Peoria, IL 61650-0240
(309)-672-7072 – FAX

This first section is an Introduction to the manual and contains a Table of Contents to locate specific areas of interest. Other sections include Safety, Operation, Maintenance, Specifications, and Optional Equipment.

When searching for a specific area of interest, go first to the Table of Contents to locate the Section in which the subject might generally be included. Then, go to that Section of the Table of Contents to find a Subject description that most closely describes the specific area of interest to find a page number and go to that page. Section Numbers and Page Numbers are located at the top, outside corner of the page. 

 At the top, inside corner of the page is a document (module) number. If there is ever a question regarding the information in a particular Section, refer to the document (module) number, the manual Form No., and use the address shown above to correspond. If there is a date (month/year) behind the document (module) number, that indicates the latest revision date of that page.

The illustrations used in this manual are *TYPICAL* of the component shown and *may not be an exact* reproduction of what is found on the truck.

This manual shows dimensioning of U.S. standard and metric (SI) units throughout. All references to “Right”, “Left”, “Front”, or “Rear” are made with respect to the operator’s normal seated position, unless specifically stated otherwise.

When assembly instructions are provided without references to torque values, standard torque values should be assumed. Standard torque requirements are shown in torque charts on the following pages of this section, and in the General Information section of the truck service manual. Individual torques when provided in the text are in bold face type, such as **100 ft.lbs. (135 N.m)** torque. All torque specifications have $\pm 10\%$ tolerance unless otherwise specified.

NOTES

STANDARD CHARTS AND TABLES

This manual provides dual dimensioning for most specifications. U.S. standard units are specified first, with metric (SI) units in parentheses. References throughout the manual to standard torques or other standard values will be to one of the following Charts or Tables. For values not shown in any of the charts or tables, standard conversion factors for most commonly used measurements are provided in TABLE XIII, page 1-14.

INDEX OF TABLES

TABLE I	Standard Torque Chart (SAE)	1-9
TABLE II	Standard Torque, 12-Point, Grade 9	1-10
TABLE III . .	Standard Metric Assembly Torque	1-10
TABLE IV	JIC Swivel Nuts Torque Chart	1-11
TABLE V	Pipe Thread Torque Chart	1-11
TABLE VI	O-Ring Boss Torque Chart	1-11
TABLE VII	O-Ring Face Seal Torque Chart	1-11
TABLE VIII . .	Torque Conversions (ft.lbs – N.m)	1-12
TABLE IX .	Torque Conversions (ft.lbs – kg.m)	1-12
TABLE X . .	Pressure Conversions (psi – kPa)	1-12
TABLE XI . .	Pressure Conversions (psi – MPa)	1-12
TABLE XII	Temperature Conversions	1-13
TABLE XIII . . .	Common Conversion Multipliers	1-14

EFFECT OF SPECIAL LUBRICANTS On Fasteners And Standard Torque Values

Komatsu Mining Systems, Inc., Peoria Operations, does NOT recommend the use of special “friction-reducing” lubricants such as, “Copper Coat”, “Never Seize”, and other similar products on the threads of standard fasteners where “standard torque” values are applied.

The use of special “friction-reducing” lubricants will significantly alter the clamping force being applied to fasteners during the tightening process. If special “friction-reducing” lubricants are used with the “Standard Torque” values listed below in Table I (and most Shop or Maintenance manuals), *excessive stress and possible breakage of the fasteners may result.*

Where Torque Tables specify “Lubricated Threads” for the Standard Torque values listed, **these standard torque values are to be used with simple lithium base chassis grease (multi-purpose EP NLGI) or a rust- preventive grease (see list, page 1-10) on the threads and seats**, unless specified otherwise.

NOTE: Always be sure threads of fasteners and tapped holes are free of burrs or other imperfections before assembling.

Standard Torque values are NOT to be used when “Turn-of-the-Nut” tightening procedures are recommended.

CAP-SCREW THREAD SIZE		TORQUE – GRADE 5			TORQUE – GRADE 8			CAPSCREW THREAD SIZE	TORQUE – GRADE 5			TORQUE – GRADE 8		
		ft. lbs.	kg.m	N.m	ft. lbs.	kg.m	N.m		ft. lbs.	kg.m	N.m	ft. lbs.	kg.m	N.m
1/4-20	7	0.97	9.5	10	1.38	13.6	3/4-16	235	32.5	319	335	46.3	454	
1/4-28	8	1.11	10.8	11	1.52	14.9	7/8-9	350	48.4	475	500	69.2	678	
5/16-18	15	2.07	20.3	21	2.90	28	7/8-14	375	51.9	508	530	73.3	719	
5/16-24	16	2.21	22	22	3.04	30	1.0-8	525	72.6	712	750	103.7	1017	
3/8-16	25	3.46	34	35	4.84	47	1.0-12	560	77.4	759	790	109.3	1071	
3/8-24	30	4.15	41	40	5.5	54	1.0-14	570	78.8	773	800	110.6	1085	
7/16-14	40	5.5	54	58	8.0	79	1 1/8-7	650	89.9	881	1050	145	1424	
7/16-20	45	6.2	61	62	8.57	84	1 1/8-12	700	96.8	949	1140	158	1546	
1/2-13	65	9	88	90	12.4	122	1 1/4-7	910	125.9	1234	1480	205	2007	
1/2-20	70	9.7	95	95	13.1	129	1 1/4-12	975	134.8	1322	1580	219	2142	
9/16-12	90	12.4	122	125	17.3	169	1 3/8-6	1200	166	1627	1940	268	2630	
9/16-18	95	13.1	129	135	18.7	183	1 3/8-12	1310	181	1776	2120	293	2874	
5/8-11	125	17.3	169	175	24.2	237	1 1/2-6	1580	219	2142	2560	354	3471	
5/8-18	135	18.7	183	190	26.2	258	1 1/2-12	1700	235	2305	2770	383	3756	
3/4-10	220	30.4	298	310	42.8	420								

1 ft. lbs. = 0.138 kg.m = 1.356 N.m

Standard Assembly Torques For 12-Point, Grade 9, Capscrews (SAE)

The following specifications apply to required assembly torques for all 12-Point, Grade 9 (170,000 psi minimum tensile), Capscrews.

- Capscrew threads and seats SHALL be lubricated when assembled.

Unless instructions specifically recommend otherwise, these standard torque values are to be used with simple lithium base chassis grease (multi-purpose EP NLGI) or a rust- preventive grease (see list, this page) on the threads.

- Torques are calculated to give a clamping force of approximately 75% of proof load.
- The maximum torque tolerance shall be $\pm 10\%$ of the torque value shown.

TABLE II - STANDARD ASSEMBLY TORQUE for 12-Point, Grade 9, Capscrews			
CAPSCREW SIZE*	TORQUE ft. lbs.	TORQUE N.m	TORQUE kg.m
0.250 - 20	12	16	1.7
0.312 - 18	24	33	3.3
0.375 - 16	42	57	5.8
0.438 - 14	70	95	9.7
0.500 - 13	105	142	14.5
0.562 - 12	150	203	20.7
0.625 - 11	205	278	28.3
0.750 - 10	360	488	49.7
0.875 - 9	575	780	79.4
1.000 - 8	860	1166	119
1.000 - 12	915	1240	126
1.125 - 7	1230	1670	170
1.125 - 12	1330	1800	184
1.250 - 7	1715	2325	237
1.250 - 12	1840	2495	254
1.375 - 6	2270	3080	313
1.375 - 12	2475	3355	342
1.500 - 6	2980	4040	411
1.500 - 12	3225	4375	445
* Shank Diameter (in.) - Threads per in.			
This Table represents standard values only. Do not use these values to replace torque values which are specified in assembly instructions.			

Standard Metric Assembly Torque For Class 10.9 Capscrews & Class 10 Nuts

The following specifications apply to required assembly torques for all metric Class 10.9 finished hexagon head capscrews and Class 10 nuts.

- Capscrews threads and seats SHALL NOT be lubricated when assembled. These specifications are based on all capscrews, nuts, and hardened washers being **phosphate and oil** coated.

NOTE: If zinc-plated hardware is used, each piece must be lubricated with a Rust Preventive Grease or Lithium-base grease to achieve the same clamping forces provided below.

- Torques are calculated to give a clamping force of approximately 75% of proof load.
- The maximum torque tolerance shall be within $\pm 10\%$ of the torque value shown.

TABLE III - STANDARD METRIC ASSEMBLY TORQUE			
CAPSCREW SIZE*	TORQUE N.m	TORQUE ft. lbs.	TORQUE kg.m
M 6 x 1	12	9	1.22
M 8 x 1.25	30	22	3.06
M10 x 1.5	55	40	5.61
M12 x 1.75	95	70	9.69
M14 x 2	155	114	15.81
M16 x 2	240	177	24.48
M20 x 2.5	465	343	47.43
M24 x 3	800	590	81.6
M30 x 3.5	1600	1180	163.2
M36 x 4	2750	2028	280.5
* Shank Diameter (mm) x Threads per mm.			
This Table represents standard values only. Do not use these values to replace torque values which are specified in assembly instructions.			

SUGGESTED* SOURCES FOR RUST PREVENTIVE GREASE:

- AMERICAN ANTI-RUST GREASE # 3-X from Standard Oil Company (also American Oil Co.)
- GULF NORUST # 3 from Gulf Oil Company.
- MOBILARMA 355, Product No. 66705 from Mobil Oil Corporation.
- RUST BAN 326 from Humble Oil Company.
- RUSTOLENE B GREASE from Sinclair Oil Company.
- RUST PREVENTIVE GREASE - CODE 312 from the Southwest Grease and Oil Company.

* NOTE: This list represents the current Engineering approved sources for use in KMS, Peoria Operations, manufacture. It is not exclusive. Other products may meet the same specifications of this list.

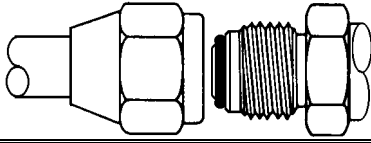

TABLE IV
TORQUE CHART FOR JIC 37° SWIVEL NUTS
WITH OR WITHOUT O-RING SEAL

SIZE CODE	TUBE SIZE (O.D.)	THREADS UNF - 2B	TORQUE FT. LBS.
-2	0.125	0.312-24	4 ± 1
-3	0.188	0.375-24	8 ± 3
-4	0.250	0.438-20	12 ± 3
-5	0.312	0.500-20	15 ± 3
-6	0.375	0.562-18	18 ± 5
-8	0.500	0.750-16	30 ± 5
-10	0.625	0.875-14	40 ± 5
-12	0.750	1.062-12	55 ± 5
-14	0.875	1.188-12	65 ± 5
-16	1.000	1.312-12	80 ± 5
-20	1.250	1.625-12	100 ± 10
-24	1.500	1.875-12	120 ± 10
-32	2.000	2.500-12	230 ± 20

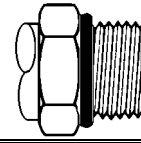

TABLE VI
TORQUE CHART FOR
O-RING BOSS FITTINGS

SIZE CODE	TUBE SIZE (O.D.)	THREADS UNF - 2B	TORQUE FT. LBS.
-2	0.125	0.312-24	4 ± 2
-3	0.188	0.375-24	5 ± 2
-4	0.250	0.438-20	8 ± 3
-5	0.312	0.500-20	10 ± 3
-6	0.375	0.562-18	13 ± 3
-8	0.500	0.750-16	24 ± 5
-10	0.625	0.875-14	32 ± 5
-12	0.750	1.062-12	48 ± 5
-14	0.875	1.188-12	54 ± 5
-16	1.000	1.312-12	72 ± 5
-20	1.250	1.625-12	80 ± 5
-24	1.500	1.875-12	80 ± 5
-32	2.000	2.500-12	96 ± 10

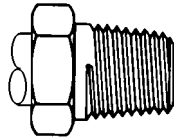

TABLE V
TORQUE CHART FOR
PIPE THREAD FITTINGS

SIZE CODE	PIPE THREAD SIZE	WITH SEALANT FT. LBS.	WITHOUT SEALANT FT. LBS.
-2	0.125-27	15 ± 3	20 ± 5
-4	0.250-18	20 ± 5	25 ± 5
-6	0.375-18	25 ± 5	35 ± 5
-8	0.500-14	35 ± 5	45 ± 5
-12	0.750-14	45 ± 5	55 ± 5
-16	1.000-11.50	55 ± 5	65 ± 5
-20	1.250-11.50	70 ± 5	80 ± 5
-24	1.500-11.50	80 ± 5	95 ± 10
-32	2.000-11.50	95 ± 10	120 ± 10

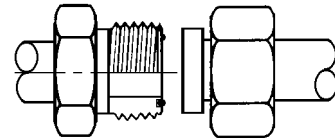

TABLE VII
TORQUE CHART FOR
O-RING FACE SEAL FITTINGS

SIZE CODE	TUBE SIZE (O.D.)	THREADS UNF - 2B	TORQUE FT. LBS.
-4	0.250	0.438-20	11 ± 1
-6	0.375	0.562-18	18 ± 2
-8	0.500	0.750-16	35 ± 4
-10	0.625	0.875-14	51 ± 5
-12	0.750	1.062-12	71 ± 7
-16	1.000	1.312-12	98 ± 6
-20	1.250	1.625-12	132 ± 7
-24	1.500	1.875-12	165 ± 15

TABLE VIII TORQUE CONVERSIONS										
Foot Pounds – ft. lbs. To Newton.meters (N.m)										
FT. LBS.	0	1	2	3	4	5	6	7	8	9
0	(N.m)	1.36	2.71	4.07	5.42	6.78	8.14	9.49	10.85	12.20
10	13.56	14.91	16.27	17.63	18.98	20.34	21.69	23.05	24.40	25.76
20	27.12	28.47	29.83	31.18	32.54	33.90	35.25	36.61	37.96	39.32
30	40.67	42.03	43.39	44.74	46.10	47.45	48.81	50.17	51.52	52.87
40	54.23	55.59	56.94	58.30	59.66	61.01	62.37	63.72	65.08	66.44
50	67.79	69.15	70.50	71.86	73.21	74.57	75.93	77.28	78.64	80.00
60	81.35	82.70	84.06	85.42	86.77	88.13	89.48	90.84	92.20	93.55
70	94.91	96.26	97.62	98.97	100.33	101.69	103.04	104.40	105.75	107.11
80	108.47	109.82	111.18	112.53	113.89	115.24	116.60	117.96	119.31	120.67
90	122.03	123.38	124.74	126.09	127.45	128.80	130.16	131.51	132.87	134.23

See NOTE on page 1-13

TABLE IX TORQUE CONVERSIONS										
Foot Pounds – ft. lbs. To kilogram.meter (kg.m)										
FT. LBS.	0	1	2	3	4	5	6	7	8	9
0	(kg.m)	0.138	0.277	0.415	0.553	0.692	0.830	0.968	1.106	1.245
10	1.38	1.52	1.66	1.80	1.94	2.07	2.21	2.35	2.49	2.63
20	2.77	2.90	3.04	3.18	3.32	3.46	3.60	3.73	3.87	4.01
30	4.15	4.29	4.43	4.56	4.70	4.84	4.98	5.12	5.26	5.39
40	5.53	5.67	5.81	5.95	6.09	6.22	6.36	6.50	6.64	6.78
50	6.92	7.05	7.19	7.33	7.47	7.61	7.74	7.88	8.02	8.16
60	8.30	8.44	8.57	8.71	8.85	8.99	9.13	9.27	9.40	9.54
70	9.68	9.82	9.96	10.10	10.23	10.37	10.51	10.65	10.79	10.93
80	11.06	11.20	11.34	11.48	11.62	11.76	11.89	12.03	12.17	12.30
90	12.45	12.59	12.72	12.86	13.00	13.14	13.28	13.42	13.55	13.69

See NOTE on page 1-13

TABLE X PRESSURE CONVERSIONS										
Pounds/sq. in. [psi] To kilopascals (kPa)										
Formula: psi x 6.895 = kPa										
PSI	0	1	2	3	4	5	6	7	8	9
0	(kPa)	6.895	13.79	20.68	27.58	34.47	41.37	48.26	55.16	62.05
10	68.95	75.84	82.74	89.63	96.53	103.42	110.32	117.21	124.1	131.0
20	137.9	144.8	151.7	158.6	165.5	172.4	179.3	186.2	193.1	200.0
30	206.8	213.7	220.6	227.5	234.4	241.3	248.2	255.1	262.0	268.9
40	275.8	282.7	289.6	296.5	303.4	310.3	317.2	324.1	331.0	337.9
50	344.7	351.6	358.5	365.4	372.3	379.2	386.1	393.0	399.9	406.8
60	413.7	420.6	427.5	434.4	441.3	448.2	455.1	462.0	468.9	475.8
70	482.6	489.5	496.4	503.3	510.2	517.1	524.0	530.9	537.8	544.7
80	551.6	558.5	565.4	572.3	579.2	586.1	593.0	599.9	606.8	613.7
90	620.5	627.4	634.3	641.2	648.1	655.0	661.9	668.8	675.7	682.6

See NOTE on page 1-13

TABLE XI PRESSURE CONVERSIONS										
Pounds/sq. in. [psi] To Megapascals (MPa)										
Formula: psi x 0.0069 = MPa										
PSI	0	10	20	30	40	50	60	70	80	90
0	(MPa)	0.069	0.14	0.21	0.28	0.34	0.41	0.48	0.55	0.62
100	0.69	0.76	0.83	0.90	0.97	1.03	1.10	1.17	1.24	1.31
200	1.38	1.45	1.52	1.59	1.65	1.72	1.79	1.86	1.93	2.00
300	2.07	2.14	2.21	2.28	2.34	2.41	2.48	2.55	2.62	2.69
400	2.76	2.83	2.90	2.96	3.03	3.10	3.17	3.24	3.31	3.38
500	3.45	3.52	3.59	3.65	3.72	3.79	3.86	3.93	4.00	4.07
600	4.14	4.21	4.27	4.34	4.41	4.48	4.55	4.62	4.69	4.76
700	4.83	4.90	4.96	5.03	5.10	5.17	5.24	5.31	5.38	5.45
800	5.52	5.58	5.65	5.72	5.79	5.86	5.93	6.00	6.07	6.14
900	6.21	6.27	6.34	6.41	6.48	6.55	6.62	6.69	6.76	6.83

See NOTE on page 1-13

NOTE: Tables such as Table VIII, IX, X, and XI may be used as in the following example:

Example: Convert 975 psi to kilopascals (kPa).

1. Select Table X.
2. Go to **PSI** row **90**, column **7**; read 668.8
97 psi = 668.8 kPa.
3. Multiply by 10:
970 psi = 6688 kPa.
4. Go to **PSI** row **0**, column **5**; read 34.47
5 psi = 34.47 kPa. Add to step 3.
5. 970 + 5 psi = 6688 + 34 = 6722 kPa.
975 psi = 6722 kPa.

TABLE XII TEMPERATURE CONVERSIONS								
FORMULA:			$F^{\circ} - 32 \div 1.8 = C^{\circ}$			$C^{\circ} \times 1.8 + 32 = F^{\circ}$		
CELSIUS C°		FAHRENHEIT F°	CELSIUS C°		FAHRENHEIT F°	CELSIUS C°		FAHRENHEIT F°
121	250	482	63	145	293	4	40	104
118	245	473	60	140	284	2	35	95
116	240	464	57	135	275	-1	30	86
113	235	455	54	130	266	-4	25	77
110	230	446	52	125	257	-7	20	68
107	225	437	49	120	248	-9	15	59
104	220	428	46	115	239	-12	10	50
102	215	419	43	110	230	-15	5	41
99	210	410	41	105	221	-18	0	32
96	205	401	38	100	212	-21	-5	23
93	200	392	35	95	203	-23	-10	14
91	195	383	32	90	194	-26	-15	5
88	190	374	29	85	185	-29	-20	-4
85	185	365	27	80	176	-32	-25	-13
82	180	356	24	75	167	-34	-30	-22
79	175	347	21	70	158	-37	-35	-31
77	170	338	18	65	149	-40	-40	-40
74	165	329	15	60	140	-43	-45	-49
71	160	320	13	55	131	-46	-50	-58
68	155	311	10	50	122	-48	-55	-67
66	150	302	7	45	113	-51	-60	-76

NOTE: The numbers in the unmarked columns refer to temperature in either degrees Celsius (C°) or Fahrenheit, F°. Select a number in this unmarked column and read to the left to convert to degrees Celsius (C°) or read to the right to convert to degrees Fahrenheit, F°. If starting with a known temperature (either C° or F°), find that temperature in the **marked** column and read the converted temperature in the center, **unmarked** column.

**TABLE XIII –
COMMON CONVERSION MULTIPLIERS**

COMMON CONVERSION MULTIPLIERS ENGLISH to METRIC		
TO CONVERT FROM	TO	MULTIPLY BY
inch – in.	millimeter (mm)	25.40
inch – in.	centimeter (cm)	2.54
foot – ft.	meter (m)	0.3048
yard – yd.	meter (m)	0.914
mile – mi.	kilometer (km)	1.61
sq. in. – in. ²	sq. centimeters (cm ²)	6.45
sq. ft. – ft. ²	sq. centimeters (cm ²)	929
cu. in. – in. ³	cu. centimeters (cm ³)	16.39
cu. in. – in. ³	liters (l)	0.016
cu. ft. – ft. ³	cu. meters (m ³)	0.028
cu. ft. – ft. ³	liters (l)	28.3
ounce – oz.	kilogram (kg)	0.028
fluid ounce – fl. oz.	milliliter (ml)	29.573
pound (mass)	kilogram (kg)	0.454
pound (force) – lbs.	Newton (N)	4.448
in. lbs. (force)	Newton.meters (N.m)	0.113
ft. lbs. (force)	Newton.meters (N.m)	1.356
ft. lbs. (force)	kilogram.meters (kg.m)	0.138
kilogram.meters (kg.m)	Newton.meters (N.m)	9.807
psi (pressure)	kilopascals (kPa)	6.895
psi (pressure)	megapascals (MPa)	0.007
psi (pressure)	kilograms/cm ² (kg/cm ²)	0.0704
ton (short)	kilogram (kg)	907.2
ton (short)	metric ton	0.907
quart – qt.	liters (l)	0.946
gallon – gal.	liters (l)	3.785
HP (horsepower)	Watts	745.7
HP (horsepower)	kilowatts (kW)	0.745

COMMON CONVERSION MULTIPLIERS METRIC to ENGLISH		
TO CONVERT FROM	TO	MULTIPLY BY
millimeter (mm)	inch – in.	0.0394
centimeter (cm)	inch – in.	0.3937
meter (m)	foot – ft.	3.2808
meter (m)	yard – yd.	1.0936
kilometer (km)	mile – mi.	0.6210
sq. centimeters (cm ²)	sq. in. – in. ²	0.1550
sq. centimeters (cm ²)	sq. ft. – ft. ²	0.001
cu. centimeters (cm ³)	cu. in. – in. ³	0.061
liters (l)	cu. in. – in. ³	61.02
cu. meters (m ³)	cu. ft. – ft. ³	35.314
liters (l)	cu. ft. – ft. ³	0.0353
grams (g)	ounce – oz.	0.0353
milliliter (ml)	fluid ounce – fl. oz.	0.0338
kilogram (kg)	pound (mass)	2.2046
Newton (N)	pound (force) – lbs.	0.2248
Newton.meters (N.m)	kilogram.meters (kg.m)	0.102
Newton.meters (N.m)	ft. lbs. (force)	0.7376
kilogram.meters (kg.m)	ft. lbs. (force)	7.2329
kilogram.meters (kg.m)	Newton.meters (N.m)	9.807
kilopascals (kPa)	psi (pressure)	0.1450
megapascals (MPa)	psi (pressure)	145.038
kilograms/cm ² (kg/cm ²)	psi (pressure)	14.2231
kilograms/cm ² (kg/cm ²)	kilopascals (kPa)	98.068
kilogram (kg)	ton (short)	0.0011
metric ton	ton (short)	1.1023
liters (l)	quart – qt.	1.0567
liters (l)	gallon – gal.	0.2642
Watts	HP (horsepower)	0.00134
kilowatts (kW)	HP (horsepower)	1.3410

GENERAL SAFETY

Safety records of most organizations will show that the greatest percentage of accidents are caused by unsafe acts of persons. The remainder are caused by unsafe mechanical or physical conditions. Report all unsafe conditions to the proper authority.

The following safety rules are provided as a guide for the operator. However, local conditions and regulations may add many more to this list.



Read and follow all safety precautions. Failure to do so may result in serious injury or death.

SAFETY RULES

- ONLY trained and authorized personnel can operate and maintain the machine.
- Follow all safety rules, precautions and instructions when operating or performing maintenance on the machine.
- When working with another operator or a person on worksite traffic duty, be sure all personnel understand all hand signals that are to be used.
-

SAFETY FEATURES

- Be sure all guards and covers are in their proper position. Have guards and covers repaired if damaged. (See Walk-Around Inspection, Operating Instructions - Section 3)
- Learn the proper use of safety features such as safety locks, safety pins, and seat belts, and use these safety features properly.
- NEVER remove any safety features. ALWAYS keep them in good operating condition.
- Improper use of safety features could result in serious bodily injury or death.
-

CLOTHING AND PERSONAL PROTECTIVE ITEMS

- Avoid loose clothing, jewelry, and loose long hair. They can catch on controls or in moving parts and cause serious injury or death. Also, do not wear oily clothes because they are flammable.
- Wear a hard hat, safety glasses, safety shoes, mask or gloves when operating or maintaining the machine. Always wear safety goggles, hard hat and heavy gloves if your job involves scattering metal chips or minute materials—this is so particularly when driving pins with a hammer and when cleaning the air cleaner element with compressed air. Check also that there is no one near the machine.

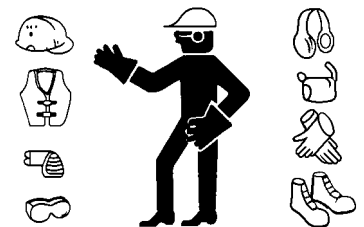

A0055010

UNAUTHORIZED MODIFICATION

- Any modification made to this vehicle without authorization from Komatsu Mining Systems, Inc. can possibly create hazards.
- Before making any modification, consult the authorized regional Komatsu Mining Systems, Inc. distributor. Komatsu will not be responsible for any injury or damage caused by any unauthorized modification.

LEAVING THE OPERATOR'S SEAT

- When preparing to leave the operator's seat, do not touch any control lever that is not locked. To prevent accidental operations from occurring, always carry out the following:
 - Move the shift control lever to the Neutral position (N) and set the parking lever/switch to the PARKING position.
 - Lower the dump body, set the dump lever to the FLOAT position.
 - Stop the engine. When leaving the machine, always lock everything. Always remember to take the key with you. If the machine should suddenly move or move in an unexpected way, this may result in serious bodily injury or death.

MOUNTING AND DISMOUNTING

- NEVER jump on or off the machine. NEVER get on or off a moving machine.
- When getting on or off the machine, face the machine and use the handhold and steps.
- Never hold any control levers when getting on or off the machine.
- Always maintain three-point contact with the handholds and steps to ensure that you support yourself.
- When bringing tools to the operator's compartment, always pass them by hand or pull them up by rope.
- If there is any oil, grease, or mud on the handholds or steps, wipe it off immediately. Always keep these parts clean. Repair any damage and tighten any loose bolts.
- Use the handrails and steps marked by arrows in the diagram below when getting on or off the machine.

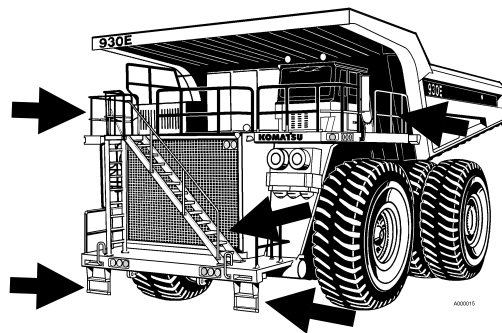

FIRE PREVENTION FOR FUEL AND OIL

- Fuel, oil, and antifreeze can be ignited by a flame. Fuel is particularly FLAMMABLE and can be HAZARDOUS.
- Keep flame away from flammable fluids.
- Stop the engine and do not smoke when refueling.
- Tighten all fuel and oil tank caps securely.
- Refueling and oiling should be made in well ventilated areas.
- Keep oil and fuel in the determined place and do not allow unauthorized persons to enter.



A0055020



A0055030



A0055040

PRECAUTIONS WHEN HANDLING AT HIGH TEMPERATURES

- Immediately after operations, the engine cooling water, engine oil, and hydraulic oil are at high temperature and are under pressure. If the cap is removed, or the oil or water is drained, or the filters are replaced, there is danger of serious burns. Always wait for the temperature to cool down, and carry out the operation according to the specified procedure.
- To prevent hot water from spurting out:
 - 1) Stop the engine.
 - 2) Wait for the water temperature to cool down.
 - 3) Turn the cap slowly to release the pressure before removing the cap.
- To prevent hot engine oil from spurting out:
 - 1) Stop the engine.
 - 2) Wait for the oil temperature to cool down.
 - 3) Turn the cap slowly to release the pressure before removing the cap.

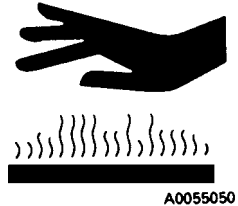

ASBESTOS DUST HAZARD PREVENTION

Asbestos dust can be HAZARDOUS to your health if it is inhaled.

If you handle materials containing asbestos fibers, follow these guidelines as given below:

- NEVER use compressed air for cleaning.
- Use water for cleaning to keep down the dust.
- Operate the machine with the wind to your back, whenever possible.
- Use an approved respirator if necessary.

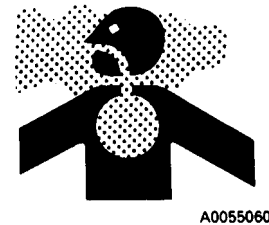

PREVENTION OF INJURY BY WORK EQUIPMENT

- Never enter or put your hand or arm or any other part of your body between movable parts such as the dump body and chassis or cylinders. If the work equipment is operated, the clearance will change and this may lead to serious bodily injury or death.

FIRE EXTINGUISHER AND FIRST AID KIT

- Be sure fire extinguishers have been provided and know how to use them.
- Provide a first aid kit at the storage point.
- Know what to do in the event of a fire.
- Be sure you know the phone numbers of persons you should contact in case of an emergency.

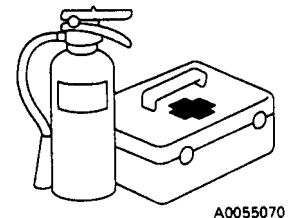

PRECAUTIONS WHEN USING ROPS

- If ROPS is installed, the ROPS must never be removed when operating the machine.
- The ROPS is installed to protect the operator if the machine should roll over. It is designed not only to support the load if the machine should roll over, but also to absorb the impact energy.
- The ROPS installed on equipment manufactured and designed by Komatsu Mining Systems, Inc. fulfills all of the regulations and standards for all countries, but if it is modified or repaired without authorization from Komatsu Mining Systems, Inc., or is damaged when the machine rolls over, the strength will drop and it will not be able to fulfill its function properly. It can only display its performance if it is repaired or modified in the specified way.
- When modifying or repairing the ROPS, always consult the authorized regional Komatsu Mining Systems, Inc. distributor.
- Even if the ROPS is installed, it cannot show its full effect if the operator does not fasten the seat belt properly. Always fasten the seat belt when operating.

PRECAUTIONS FOR ATTACHMENTS

- When installing and using optional equipment, read the instruction manual for the attachment and the information related to attachments in this manual.
- Do not use attachments that are not authorized by Komatsu Mining Systems, Inc., or the authorized regional Komatsu Mining Systems, Inc. distributor. Use of unauthorized attachments could create a safety problem and adversely affect the proper operation and useful life of the machine.
- Any injuries, accidents, and product failures resulting from the use of unauthorized attachments will not be the responsibility of Komatsu Mining Systems, Inc., or the authorized regional Komatsu Mining Systems, Inc. distributor.

PRECAUTIONS DURING OPERATION

SAFETY IS THINKING AHEAD

Prevention is the best safety program. Prevent a potential accident by knowing the employer's safety requirements and all necessary job site regulations. In addition, know the proper use and care of all the safety equipment on the truck. Only qualified operators or technicians should attempt to operate or maintain the Komatsu Truck.

Safe practices start before the operator gets to the equipment!

SAFETY AT WORKSITE

- When walking to and from the truck, maintain a safe distance from all machines even if the operator is visible.
- Before starting the engine, thoroughly check the area for any unusual conditions that could be dangerous.
- Examine the road surface in the jobsite and determine the best and safest method of operation.
- Choose an area where the ground is as horizontal and firm as possible before carrying out the operation.
- If you need to operate on a road, protect pedestrians and cars by designating a person for worksite traffic duty or by installing fences around the worksite.
- The operator must check personally the work position, roads to be used, and existence of obstacles before starting operations.
- Always determine the travel roads in the worksite and maintain them so that it is always safe for the machines to travel.
- If travel through wet areas is necessary, check the depth and flow of water before crossing the shallow parts. NEVER be in water which is in excess of the permissible water depth.

FIRE PREVENTION

- Thoroughly remove wood chips, leaves, paper and other flammable things accumulated in the engine compartment. These could cause a fire.
- Check fuel, lubrication, and hydraulic systems for leaks. Have any leaks repaired. Wipe up any excess oil, fuel or other flammable fluids.
- Be sure a fire extinguisher is present and working.
- Do not operate the machine near any flame.



A005502C

PREPARING FOR OPERATION

- Always mount and dismount facing the truck. Never attempt to mount or dismount the truck while it is in motion. Always use handrails and ladder when mounting or dismounting from the truck.
- Check the deck areas for debris, loose hardware or tools. Check for people and objects that might be in the way.
- Become familiar with and use all protective equipment devices on the truck and insure that these items (anti-skid material, grab bars, seat belts, etc.) are securely in place.

VENTILATION FOR ENCLOSED AREAS

- If it is necessary to start the engine within an enclosed area, provide adequate ventilation. Exhaust fumes from the engine can KILL.



A0055060

IN OPERATOR'S CAB - BEFORE STARTING ENGINE

- Do not leave tools or spare parts lying around in the operator's compartment or allow trash to accumulate in cab of truck. Keep all unauthorized reading material out of truck cab.
- Keep the cab floor, controls, steps, and handrails free of oil, grease, snow, and excess dirt.
- Check the seat belt, buckle and hardware for damage or wear. Replace any worn or damaged parts. Always use seat belts when operating your machine.
- Read and understand the contents of this manual. Read the Section 3 pertaining to safety and operating instructions with special attention. Become thoroughly acquainted with all gauges, instruments and controls before attempting operation of the truck.
- Read and understand the **WARNING** and **CAUTION** decals in the operator's cab.
- Insure steering wheel, horn, controls and pedals are free of any oil, grease or mud.
- Check operation of windshield wiper, condition of wiper blades, and check washer reservoir for fluid level.
- Be familiar with all steering and brake system controls and warning devices, road speeds and loading capabilities, before operating the truck.

KEEP MIRRORS, WINDOWS, AND LIGHTS CLEAN

- Remove any dirt from the surface of the windshield and all cab windows and lights. Good visibility may prevent an accident.
- Adjust the rear view mirror to a position where the operator can see best from the operator's seat, and keep the surface of the mirror clean. If any glass or light should break, replace it with a new part.
- Insure headlights, worklights and taillights are in proper working order. Check that the machine is equipped with the head lamps and working lamps needed for the operating conditions.

OPERATING THE MACHINE

WHEN STARTING ENGINE

- NEVER start the engine if a warning tag has been attached to the control.
- When starting the engine, sound the horn as an alert.
- Start and operate the machine only while seated.
- Do not allow any person other than the operator in the operator's compartment or any other place on the machine.

Truck Operation - General

- **WEAR SEAT BELTS AT ALL TIMES.**
- Only authorized persons are allowed to ride in truck. Riders should be in cab only and belted in passenger seat.
- Do not allow anyone to ride on decks or steps of truck.
- Do not allow anyone to get on or off truck while it is in motion.
- Do not move truck into or out of a building without a signal person present.
- Know and obey the hand signal communications between operator and spotter. When other machines and personnel are present, the operator should move in and out of buildings, loading areas and through traffic, under the direction of a signal person. **Courtesy at all times is a safety precaution!**
- Report immediately to supervisor any conditions on haul road, pit or dump area that may cause an operating hazard.

- Check for flat tires periodically during shift. If truck has been run on a “flat”, **it must not be parked in a building until the tire cools.**
If tire must be changed, do not stand in front of rim and locking ring when inflating tire mounted on the machine. Observers should not be permitted in the area and should be kept away from the side of such tires.

⚠ DANGER

Tire and rim assembly may explode if subjected to excessive heat. Personnel should move to a remote or protected location if sensing excessively hot brakes, smell of burning rubber or evidence of fire near tire and wheel area.

If the truck must be approached, such as to fight a fire, those personnel should do so only while facing the tread area of the tire (front or back), unless protected by use of large heavy equipment as a shield. Stay at least 50 ft. (15 m) from the tread of the tire.

In the event of fire in the tire and wheel area (including brake fires), stay away from the truck at least 8 hours or until the tire and wheel are cool.

- Keep serviceable fire fighting equipment at hand. Report used extinguishers for replacement or refilling.
- Always have parking brake applied when the truck is parked and unattended. **DO NOT** leave truck unattended while engine is running.
- When parking, park a safe distance from other vehicles as determined by supervisor.
- Stay alert at all times! In the event of an emergency, be prepared to react quickly and avoid accidents. If an emergency arises, know where to get prompt assistance.

CHECK WHEN TRAVELING IN REVERSE

Before operating the machine or work equipment, do as follows:

- Sound the horn to warn people in the area. For machines equipped with a back-up alarm, check that the alarm works properly.
- Check that there is no one near the machine. Be particularly careful to check behind the machine.
- If necessary, designate a person to check the safety. This is particularly necessary when traveling in reverse.
- When operating in areas that may be hazardous or have poor visibility, designate a person to direct worksite traffic.
- Do not allow any one to enter the line of travel of the machine. This rule must be strictly observed even on machines equipped with a back-up alarm or rear view mirror.

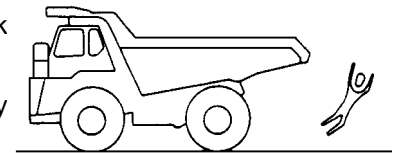

AE132050

TRAVELING

- When traveling on rough ground, travel at low speed. When changing direction, avoid turning suddenly.
- Lower the dump body and set the dump lever to the FLOAT position when traveling.
- If the engine should stop when the machine is traveling, the emergency steering system will be activated. Apply the brakes immediately and stop the machine as quickly and safely as possible, and off the haul road, if possible.

TRAVELING ON SLOPES

- Traveling on slopes could result in the machine tipping over or slipping.
- Do not change direction on slopes. To ensure safety, go down to level ground before turning.
- Do not travel up and down on grass, fallen leaves, or wet steel plates. These materials may make the machine slip on even the slightest slope. Take all possible steps to avoid traveling sideways, and always keep the travel speed low.
- When traveling downhill, use the retarder to reduce speed. Do not turn the steering wheel suddenly. Do not use the foot brake except in an emergency.
- If the engine should stop on a slope, apply the brakes fully and apply the parking brake to stop the machine.

ENSURE GOOD VISIBILITY

- When working in dark places, install working lamps and head lamps, and set up lighting in the work area if necessary.
- Stop operations if the visibility is poor, such as in mist, snow, or rain, and wait for the weather to improve to a condition that allows the operation to be carried out safely.

OPERATE CAREFULLY ON SNOW

- When working on snowy or icy roads, there is danger that the machine may slip to the side on even the slightest slope, so always travel slowly and avoid sudden starting, turning, or stopping.
- Be extremely careful when carrying out snow-clearing operations. The road shoulder and other objects are buried in the snow and cannot be seen. When traveling on snow-covered roads, always install tire chains.

AVOID DAMAGE TO DUMP BODY

- When working in tunnels, on bridges, under electric cables, or when entering a parking place or any other place where there are height limits, always drive extremely carefully and lower the dump body completely before driving the machine.

DO NOT GO CLOSE TO HIGH-VOLTAGE CABLES

- Going close to high-voltage cables can cause electric shock. Always maintain the safe distance given below between the machine and the electric cable.

Voltage	Min. Safety Distance	
6.6 kV	3 m	10 ft
33.0 kV	4 m	14 ft
66.0 kV	5 m	17 ft
154.0 kV	8 m	27 ft
275.0 kV	10 m	33 ft

- The following actions are effective in preventing accidents:
 - 1) Wear shoes with rubber or leather soles.
 - 2) Use a signalman to give warning if the machine approaches too close to the electric cable.
- If the work equipment should touch the electric cable, the operator should not leave the operator's compartment.
- When carrying out operations near high voltage cables, do not let anyone come close to the machine.
- Check with the electrical maintenance department about the voltage of the cables before starting operations.

WHEN DUMPING

- Before starting the dumping operation, check that there is no person or object behind the machine.
- Stop the machine in the correct position, and check again that there is no person or object behind the machine. Give the determined signal, then slowly operate the dump body. If necessary, use blocks for the wheels or position a flagman.
- When carrying out dumping operations on slopes, the machine stability will become poor and there is danger that it may tip over. Always carry out such operations extremely carefully.
- Do not travel with the dump body raised.

WORKING ON LOOSE GROUND

- Avoid operating the machine too close to the edge of cliffs, overhangs, and deep ditches. If these areas collapse, the machine could fall or tip over and result in serious injury or death. Remember that the soil after heavy rain or blasting is weakened in these areas.
- Earth laid on the ground and the soil near ditches is loose. It can collapse under the weight or vibration of the machine. Avoid these areas, if possible.

WHEN LOADING

- Check that the surrounding area is safe, stop the machine in the correct loading position, then load the body uniformly.
- Do not leave the operator's seat during the loading operation.

PARKING THE MACHINE

- Choose a horizontal road surface to park the machine. If the machine has to be parked on a slope, always put blocks under all the wheels to prevent the machine from moving.
- When parking on public roads, provide fences and signs, such as flags or lights, on the machine to warn pedestrians and other vehicles. Be sure that the machine, flags, or lights do not obstruct the traffic.
- Before leaving the machine, lower the dump body fully, set the parking lever to the PARKING position, stop the engine, then lock everything. Always take the key with you.

TOWING

WHEN TOWING, FIX WIRE TO HOOK

- Towing in the wrong way may lead to serious personal injury or damage.
- When using another machine to tow this machine, use a towing device with ample strength for the weight of this machine.
- Never tow a machine on a slope.
- Do not use any towing rope that has kinks or is twisted.
- Do not stand astride the towing cable or wire rope.
- When connecting a machine that is to be towed, do not let any one come between the towing machine and the machine that is being towed.
- Set the coupling of the machine being towed in a straight line with the towing portion of the machine, and secure it in position.
(For towing method, see Section 3, "Operating Instructions, TOWING".)

BATTERY

BATTERY HAZARD PREVENTION

- Battery electrolyte contains sulfuric acid and can quickly burn the skin and eat holes in clothing. If you spill acid on yourself, immediately flush the area with water.
- Battery acid could cause blindness if splashed into the eyes. If acid gets into the eyes, flush them immediately with large quantities of water and see a doctor at once.
- If you accidentally drink acid, drink a large quantity of water or milk, beaten egg or vegetable oil. Call a doctor or poison prevention center immediately.
- When working with batteries ALWAYS wear safety glasses or goggles.
- Batteries generate hydrogen gas. Hydrogen gas is very EXPLOSIVE, and is easily ignited with a small spark of flame.
- Before working with batteries, stop the engine and turn the starting switch to the OFF position.
- Avoid short-circuiting the battery terminals through accidental contact with metallic objects, such as tools, across the terminals.
- When removing or installing, check which is the positive (+) terminal and negative (-) terminal.
- Tighten the battery cap securely.
- Tighten the battery terminals securely. Loosened terminals can generate sparks and lead to an explosion.

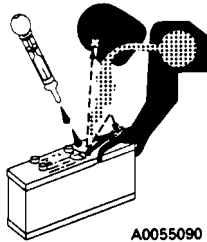

STARTING WITH BOOSTER CABLES

- ALWAYS wear safety glasses or goggles when starting the machine with booster cables.
- When starting from another machine, do not allow the two machines to touch.
- Be sure to connect the positive (+) cable first when installing the booster cables. Disconnect the ground or negative (-) cable first when removing them.
- If any tool touches between the positive (+) terminal and the chassis, it will cause sparks. This is dangerous, so be sure to work carefully.
- Connect the batteries in parallel: positive to positive and negative to negative.
- When connecting the ground cable to the frame of the machine to be started, be sure to connect it as far as possible from the battery.

INCORRECT

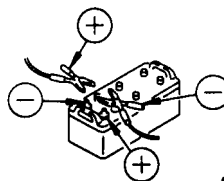

PRECAUTIONS FOR MAINTENANCE

BEFORE CARRYING OUT MAINTENANCE

WARNING TAG

- If others start the engine or operate the controls while you are performing service or lubrication, you could suffer serious injury or death.
- ALWAYS attach the WARNING TAG to the control lever in the operator's cab to alert others that you are working on the machine. Attach additional warning tags around the machine, if necessary.
- These tags are available from your Komatsu distributor. (Part No. 09963-03000)

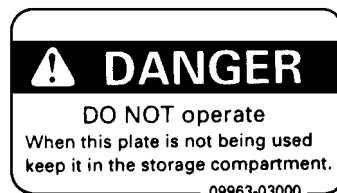

PROPER TOOLS

- Use only tools suited to the task.
Using damaged, low quality, faulty, or makeshift tools could cause personal injury.



A0055120

STOPPING THE ENGINE BEFORE SERVICE

- When carrying out inspection or maintenance, always stop the machine on firm flat ground, lower the dump body, then stop the engine.
- If the engine must be run during service, such as when cleaning the radiator, always move the shift control lever to the Neutral (N) position and set the parking brake lever to the PARKING position. Always carry out the work with two people. One person should sit on the operator's seat to stop the engine if necessary. NEVER move any controls not needed to operate.
- When servicing the machine, be careful not to touch any moving part or get clothing caught.
- Put blocks under the wheels.
- When carrying out service with the dump body raised, always place the dump lever at the HOLD position, and apply the lock (if equipped). Install the body-up safety pins (or cable) securely.

DURING MAINTENANCE

PERSONNEL

- Only authorized personnel can service and repair the machine. Extra precaution should be used when grinding, welding, and using a sledge-hammer.

ATTACHMENTS

- Place attachments that have been removed from the machine in a safe place so that they do not fall. If they fall on you or others, serious injury could result.

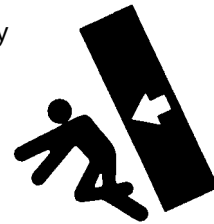

A0055130

WORK UNDER THE MACHINE

- Always lower all movable work equipment to the ground or to their lowest position before performing service or repairs under the machine.
- Always block the tires of the machine securely.
- Never work under the machine if the machine is poorly supported.

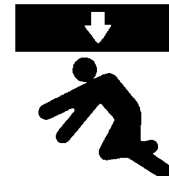

A0055140

KEEP THE MACHINE CLEAN

- Spilled oil or grease, or scattered tools or broken pieces are dangerous because they may cause you to slip or trip. Always keep your machine clean and tidy.
- If water gets into the electrical system, there is danger that the machine may not move or may move unexpectedly. Do not use water or steam to clean the sensors, connectors, or the inside of the operator's compartment.

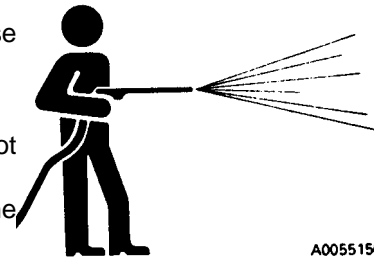

A0055150

RULES TO FOLLOW WHEN ADDING FUEL OR OIL

- Spilled fuel and oil may cause slipping. Always clean up spills immediately.
- Always tighten the cap of the fuel and oil fillers securely.
- Never use fuel for washing any parts.
- Always add fuel and oil in a well-ventilated place.



A0055020



A0055030



A0055040

RADIATOR WATER LEVEL

- If it is necessary to add water to the radiator, stop the engine and allow the engine and radiator to cool down before adding the water.
- Slowly loosen the cap to relieve pressure before removing the cap.

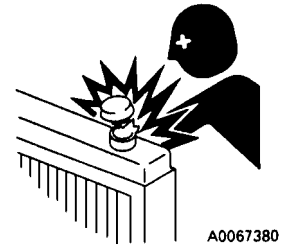

USE OF LIGHTING

When checking fuel, oil, coolant, or battery electrolyte, always use lighting with anti-explosion specifications. If such lighting equipment is not used, there is danger or explosion.



PRECAUTIONS WITH BATTERY

- When repairing the electrical system or when carrying out electrical welding, remove the negative (-) terminal of the battery to stop the flow of current.

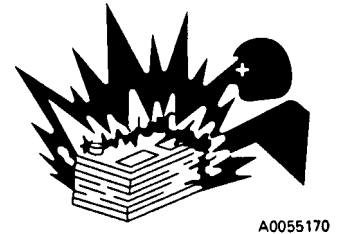

HANDLING HIGH-PRESSURE HOSES

- Do not bend high-pressure hoses or hit them with hard objects. Do not use any bent or cracked piping, tubes or hoses. They may burst during use.
- Always repair any loose or broken fuel hoses or oil hoses. If fuel or oil leaks, it may cause a fire.

PRECAUTIONS WITH HIGH PRESSURE OIL

- Do not forget that the work equipment circuits are always under pressure.
- Do not add oil, drain oil, or carry out maintenance or inspection before completely releasing the internal pressure.
- If oil is leaking under high pressure from small holes, it is dangerous if the jet of high-pressure oil hits the skin or enters the eyes. Always wear safety glasses and thick gloves, and use a piece of cardboard or a sheet of wood to check for oil leakage.
- If you are hit by a jet of high-pressure oil, consult a doctor immediately for medical attention.

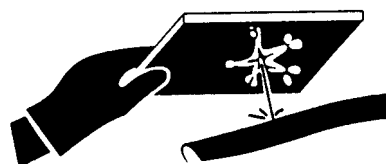

PRECAUTIONS WHEN CARRYING OUT MAINTENANCE AT HIGH TEMPERATURE OR HIGH PRESSURE

- Immediately after stopping operations, the engine cooling water and oil at all parts are at high temperature and under high pressure. In this condition, if the cap is removed, or the oil or water are drained, or the filters are replaced, it may result in burns or other injury. Wait for the temperature to go down, then carry out the inspection and maintenance in accordance with the procedures given in this manual.

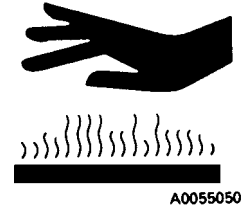

ROTATING FAN AND BELT

- Keep away from rotating parts and be careful not to let anything get caught in them.
- If your body or tools touch the fan blades or fan belt, they may be cut off or sent flying, so never touch any rotating parts.

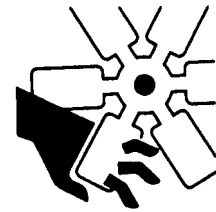

A0063830

WASTE MATERIALS

- Never dump waste oil in a sewer system, rivers, etc.
- Always put oil drained from your machine in containers. Never drain oil directly on the ground.
- Obey appropriate laws and regulations when disposing of harmful objects such as oil, fuel, coolant, solvent, filters, batteries, and others.

INCORRECT

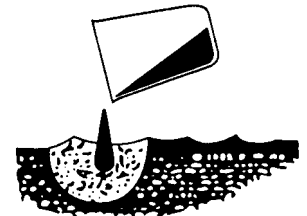

A0055220

TIRES

HANDLING TIRES

If tires are not used under the specified conditions, they may overheat and burst or be cut and burst by sharp stones on rough road surfaces. This may lead to serious injury or damage.

To maintain safety, always keep to the following conditions:

- Inflate the tires to the specified pressure. Abnormal heat is generated particularly when the inflation pressure is too low.
- Use the specified tires.

The tire inflation pressure and permissible speeds are general values. The actual values may differ depending on the type of tire and the condition under which they are used. For details, please consult the tire manufacturer.

If the tires become hot, a flammable gas is produced, and this may ignite. It is particularly dangerous if the tires become overheated when the tires are under pressure. If the gas generated inside the tire ignites, the internal pressure will suddenly rise, and the tire will explode, and this may lead to serious personal injury. Explosions differ from punctures or tire bursts, because the destructive force is extremely large. Therefore, the following operations are strictly prohibited when the tire is under high internal pressure:

- Welding the rim
- Building fires or carrying out welding near the wheel or tire.



A0055110

If the proper procedure for carrying out maintenance or replacement of the wheel or tire is not used, the wheel or tire may burst and cause serious injury or damage. When carrying out such maintenance, please consult the authorized regional Komatsu Mining Systems, Inc. distributor, or the tire manufacturer.

STORING TIRES AFTER REMOVAL

- As a basic rule, store the tires in a warehouse which unauthorized persons cannot enter. If the tires are stored outside, always erect a fence around the tires and put up "No Entry" and other warning signs that even young children can understand.
- Stand the tire on level ground, and block it securely so that it cannot roll or fall over.
- If the tire should fall over, get out of the way quickly. The tires for construction equipment are extremely heavy, so trying to hold the tire may lead to serious injury.

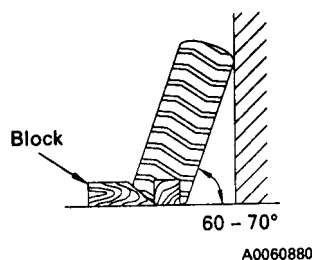

WHEN REPAIRS ARE NECESSARY

1. Only qualified maintenance personnel who understand the systems being repaired should accomplish repairs.
2. Many components on the Komatsu Truck are large and heavy. Insure that lifting equipment - hoists, slings, chains, lifting eyes - are of adequate capacity to handle the lift.
3. **DO NOT WORK** under a suspended load. Do not work under raised body unless body safety cables, props, or pins are in place to hold the body in up position.
4. Do not repair or service truck while engine is running, except when adjustments can only be made under such conditions. **Keep a safe distance from moving parts.**
5. When servicing any air conditioning system with refrigerant, wear a face shield and cold resistant gloves for protection against freezing. Be certain to follow all current regulations for handling and recycling refrigerants.
6. Follow package directions carefully when using cleaning solvents.
7. If an auxiliary battery assist is needed, first use one cable to connect the 24V positive (+) post of the disabled truck batteries to the 24V positive (+) post of the auxiliary assist. Use second cable to connect the 24V negative (-) post of the auxiliary assist battery to a **frame ground (-)** on the disabled truck *away from the battery*.
8. Always disconnect the positive and negative battery cables of the vehicle before doing any welding on the unit. Failure to do so may seriously damage the battery and electrical equipment. Disconnect battery charging alternator lead wire and isolate electronic control components before making welding repairs. (It is not necessary to disconnect or remove any control circuit cards on Electric Drive Dump Trucks or any of the "AID" circuit control cards.)

Always fasten the welding machine ground (-) lead to the piece being welded; **grounding clamp MUST BE ATTACHED AS NEAR AS POSSIBLE to the weld area**. Never allow welding current to pass through ball bearings, roller bearings, suspensions, or hydraulic cylinders. Always avoid laying welding cables over or near the vehicle electrical harnesses. Welding voltage could be induced into the electrical harness and possibly cause damage to components.
9. If truck is to be towed for any reason, use a rigid tow bar. Check truck cab for decal recommending special towing precautions. (Also refer to Towing Procedure in OPERATING INSTRUCTIONS.)
10. Drain, clean and ventilate fuel tanks and/or hydraulic tanks before making any welding repairs.

WARNING

Any operating fluid, such as hydraulic oil or brake fluid escaping under pressure, can have sufficient force to enter a person's body by penetrating the skin. Serious injury and possibly death may result if proper medical treatment by a physician familiar with this injury is not received immediately.

11. Relieve pressure in lines or hoses before making any disconnects.
12. After adjustments or repairs, replace all shields, screens and clamps.
13. Tire Care:

WARNING

Do not stand in front of rim and locking ring when inflating tire mounted on the machine. Observers should not be permitted in the area and should be kept away from the side of such tires.

Do not weld or apply heat on the rim assembly with the tire mounted on the rim. Resulting gases inside the tire may ignite, causing explosion of tire and rim.

14. Only a qualified operator or experienced maintenance personnel who are also qualified in operation should move the truck under its own power in the repair facility or during road testing after repairs are complete.

Special Precautions for Working on a 930E Truck

Preliminary Procedures before Welding or Performing Maintenance

Prior to welding and/or repairing the 930E Dump Truck, maintenance personnel should attempt to notify the Komatsu factory representative. Only qualified personnel, specifically trained for servicing the AC Drive System, should perform this service.

If it is necessary to perform welding or repair to the truck without the field engineer present, the following procedures should be followed to ensure that the truck is safe for maintenance personnel to work on and to reduce the chance for damage to equipment.



ANYTIME THE 930E ENGINE IS RUNNING:

- **Do not open any of the cabinet doors or remove any covers.**
- **Do not use any of the power cables for hand holds or foot steps.**
- **Do not touch the retarder grid elements.**



Before opening any cabinets or touching a grid element or a power cable, the engine must be shutdown.

Normal Engine Shutdown Procedure

1. Stop the truck out of the way of other traffic on a level surface (dry, if possible) and free of overhead power lines or other obstructions (in case dump body should need to be raised).
 - a. Reduce engine speed to idle.
Allow engine to cool gradually by running at low idle for 3 to 5 minutes.
 - b. Place the directional Selector Switch (2, Figure 3-4, Section 3 - Operation) in "Neutral".
 - c. Apply the Parking Brake switch (13, Figure 3-6, Section 3 - Operation).
Be sure the "Parking BrakeApplied" indicator light in the overhead display panel (A3, Figure 3-7, Section 3 - Operation) is illuminated.
2. Place REST switch (26, Figure 3-6, Section 3 - Operation) in "On" position to put AC Drive System in "REST" mode of operation. Be sure the "REST" indicator light in the overhead panel (B6, Figure 3-7, Section 3 - Operation) is illuminated.
3. With engine cooled down, turn keyswitch (1, Figure 3-6, Section 3 - Operation) counterclockwise to "Off" position for normal shutdown of engine.
If engine does not shutdown with keyswitch, use Engine Shutdown Switch (8, Figure 3-4, Section 3 - Operation) on operator cab center console, and hold this switch down until engine stops.
4. With keyswitch "Off", and engine stopped, wait at least 90 seconds. Insure steering circuit is completely bled down by turning steering wheel back and forth several times. No front wheel movement will occur when hydraulic pressure is relieved.
If the vehicle continues to steer after shutdown, notify maintenance personnel.
5. Verify that all the LINK VOLTAGE lights are OFF (one on back wall of operator cab, and two on deck control cabinets), and notify maintenance personnel, if any light remains illuminated longer than five minutes after engine shutdown.
6. Close and lock all windows, remove key from keyswitch and lock cab to prevent possible unauthorized truck operation. Dismount truck properly. Put wheel chocks in place.

Engine Shutdown Procedure before Welding or Performing Maintenance

Normal operation of the drive system at shutdown should leave the system safe to maintain. However, in the event of a system failure, performing the following procedure prior to any maintenance activities will ensure that no hazardous voltages are present in the AC Drive System.

1. Before shutting down the engine, verify the status of all the drive system warning lights on the overhead display panel (Figure 3-7, Section 3 - Operation). Use the Lamp Test Switch (8, Figure 3-7, Section 3 - Operation) to verify that all lamps are functioning properly.

If any of the RED Drive System warning lights remain ON, do not attempt to open any cabinets, disconnect any cables, or reach inside the retarder grid cabinet without a trained drive system technician present - even if engine is shut down.

Only qualified personnel, specifically trained for servicing the AC Drive System, should perform this service.

2. If all red drive system warning lights are off, follow the "Normal Engine Shutdown Procedure".
3. After the engine has been stopped for at least five (5) minutes, inspect the LINK VOLTAGE lights on the exterior of the main control cabinet and back wall of the operator's cab (DID panel). If all lights are OFF, the retard grids, wheel motors, alternator, and power cables connecting these devices are safe to work on.
4. Locate the "GF" Cut-out switch in the access panel on the left side of the main control cabinet. Place the switch in the "Alternator Cutout" position. This will prevent the alternator from re-energizing and creating system voltage, until the switch is returned to its former position.
5. The blower motors, control cabinet and power cables connecting these devices are still unsafe. To establish that these devices are safe, open the top control cabinet cover and inspect the red lights on the blower control panel.

If these lights are OFF, the blower system, blower power cables and remainder of the control cabinet is safe to work on.

If these lights are ON, refer to steps 11 – 12.
6. Before welding on the truck, disconnect all electrical harnesses from the Engine Control System (ECS) inside the electrical cabinet behind the operator's cab. Also, disconnect the ground strap from the ECS.
7. **Do not weld on the rear of the control cabinet!** The metal panels on the back of the cabinet are part of capacitors and cannot be heated.
8. **Do not weld on the retard grid exhaust louvers** - they are made of stainless steel.
Some power cable panels throughout the truck are also made of aluminum, or stainless steel. They must be repaired with the same material, or the power cables may be damaged.
9. Power cables must be cleated in wood or other non-ferrous materials. Do not repair cable cleats by encircling the power cables with metal clamps or hardware. Always inspect power cable insulation prior to servicing the cables and prior to returning the truck to service. Discard cables with broken insulation.
10. Power cables and wiring harnesses should be protected from weld spatter and heat.

Always fasten the welding machine ground (-) lead to the piece being welded; **the grounding clamp MUST BE ATTACHED AS NEAR AS POSSIBLE to the weld area.**

Always avoid laying welding cables over or near the vehicle electrical harnesses. Welding voltage could be induced into the electrical harness and possibly cause damage to components.

Before doing any welding on the truck, always disconnect the battery charging alternator lead wire and isolate electronic control components before making welding repairs.

In addition, always disconnect the positive and negative battery cables of the vehicle. Failure to do so may seriously damage the battery and electrical equipment.

Never allow welding current to pass through ball bearings, roller bearings, suspensions, or hydraulic cylinders.

11. If the red lights on the exterior of the control cabinet and/or the back wall of the operator's cab continue to be illuminated after following the above procedure, a fault has occurred.

Leave all cabinet doors in place, do not touch the rear grid elements, do not disconnect any power cables, or use them as hand or foot holds.

Notify the KMS factory representative immediately. Only qualified personnel, specifically trained for servicing the AC Drive System, should perform this service.

12. If the red lights on the blower control panel are illuminated after following the above procedure, a fault has occurred. Reinstall the control cabinet panel. Do not perform maintenance on the blower control panel, blower motor power cables.

Notify the KMS factory representative immediately. Only qualified personnel, specifically trained for servicing the AC Drive System, should perform this service.

13. Replace all covers and doors and place the "GF" cutout switch and battery disconnect switches in their original positions, and re-connect all harnesses prior to restarting the truck.

Leave the drive system in the REST position until the truck is to be moved.

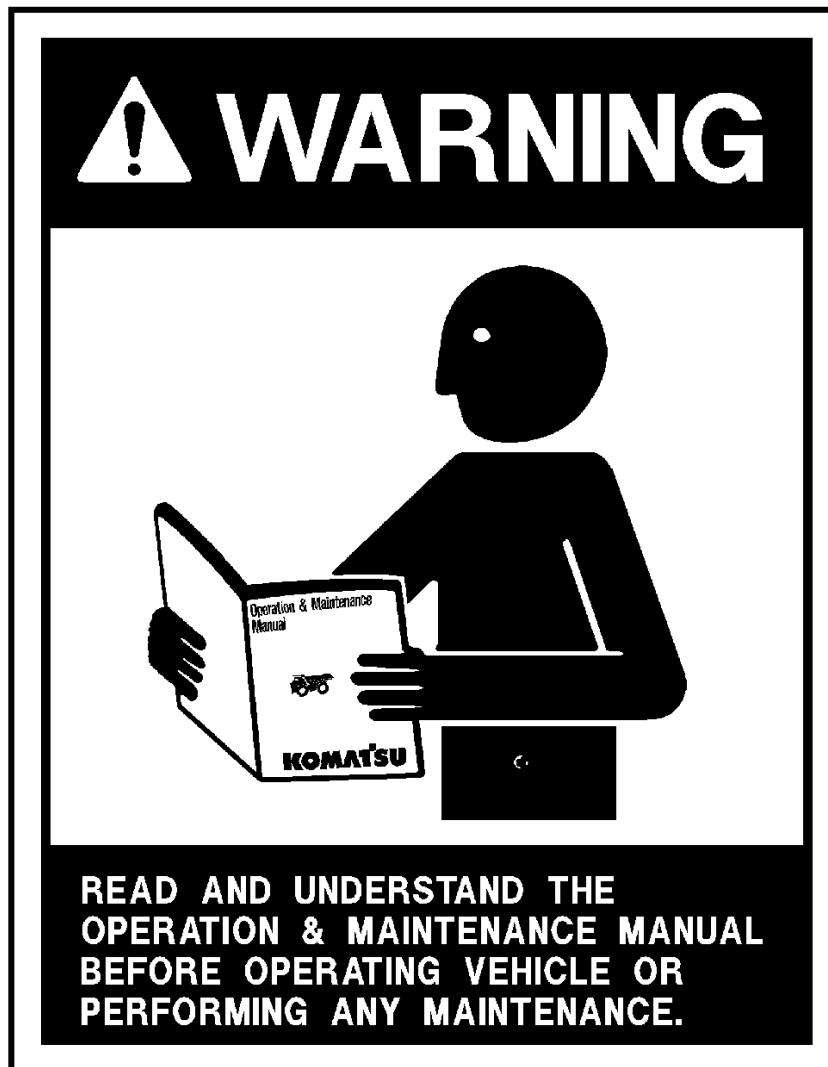

WARNINGS AND CAUTIONS

The following pages give an explanation of the Warning, Caution, and Service Instruction plates and decals attached to the truck. The plates and decals listed here are typical of this Komatsu model, but because of customer options, individual trucks may have plates and decals that are different from those shown here.

The plates and decals must be kept clean and legible. If any decal or plate becomes unable to be read or damaged, it should be replaced with a new one.

A warning decal surrounds the key switch located to the right of the steering column on the instrument panel. The warning stresses the importance of reading the operator's manual before operation.

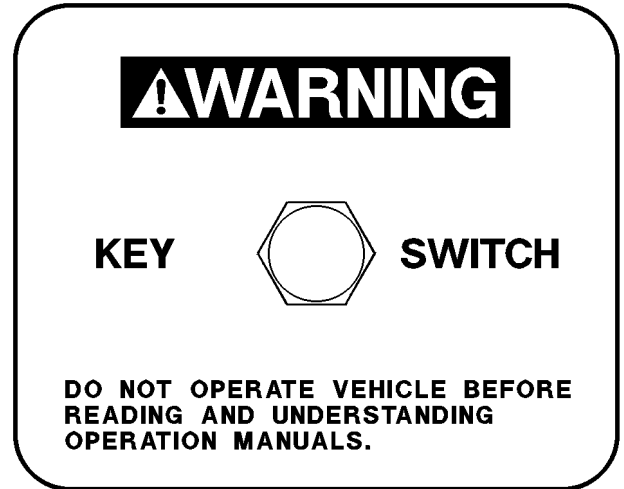

A Grade/Speed plate is located on the left front post of the operator's cab and provides the recommended MAXIMUM speeds to be used when descending various grades with a loaded truck.

Always refer to the decal in operator's cab. This decal may change with OPTIONAL truck equipment such as: wheelmotor drive train ratios, retarder grids, tire sizes, etc.

EFFECTIVE GRADE %	SPEED (CONTINUOUS)		SPEED (SHORT TERM)	
	MPH	(KM/H)	MPH	(KM/H)
12	11	(18)	15	(24)
10	14	(23)	19	(31)
8	19	(31)	23	(37)
6	29	(47)	29	(47)
4	29	(47)	36	(58)

WB2751

A plate attached to the right rear corner of the cab states the Rollover Protective Structure and Falling Object Protective Structure meets various SAE performance requirements.

! WARNING ! Do not make modifications to this structure, or attempt to repair damage without written approval from the Manufacturer. Unauthorized repairs will void certification.

ROPS/FOPS NO. **SM0460** MACHINE MODEL **930E**
 AS INSTALLED BY THE MANUFACTURER ON THIS DUMPER WITH EMPTY WEIGHT LESS THAN **180,532** kg. AND WEIGHT WITHOUT BODY LESS THAN **148,780** kg. THIS ROLLOVER PROTECTIVE STRUCTURE AND FALLING OBJECT PROTECTIVE STRUCTURE MEETS THE PERFORMANCE REQUIREMENTS OF SAE-J1040 APR88, SAE-J231 JAN 81, AND SAE-J1164 MAY 83.

! WARNING ! THE PROTECTION OFFERED MAY BE IMPAIRED IF SUBJECTED TO ANY MODIFICATIONS OR DAMAGE. TO MAINTAIN MANUFACTURERS CERTIFICATION, ANY REPAIR OR ALTERATION ON THIS STRUCTURE MUST HAVE WRITTEN APPROVAL.

Komatsu America International Co. Haulpak Division
 Peoria, Illinois U.S.A. SM2675

A warning instruction is applied below the Parking Brake and the Rear Wheel Brake Lock switches, which are located to the right of the steering column on the instrument panel. Pushing the top of the rocker-style switch turns the function ON, pushing the bottom, turns it OFF.

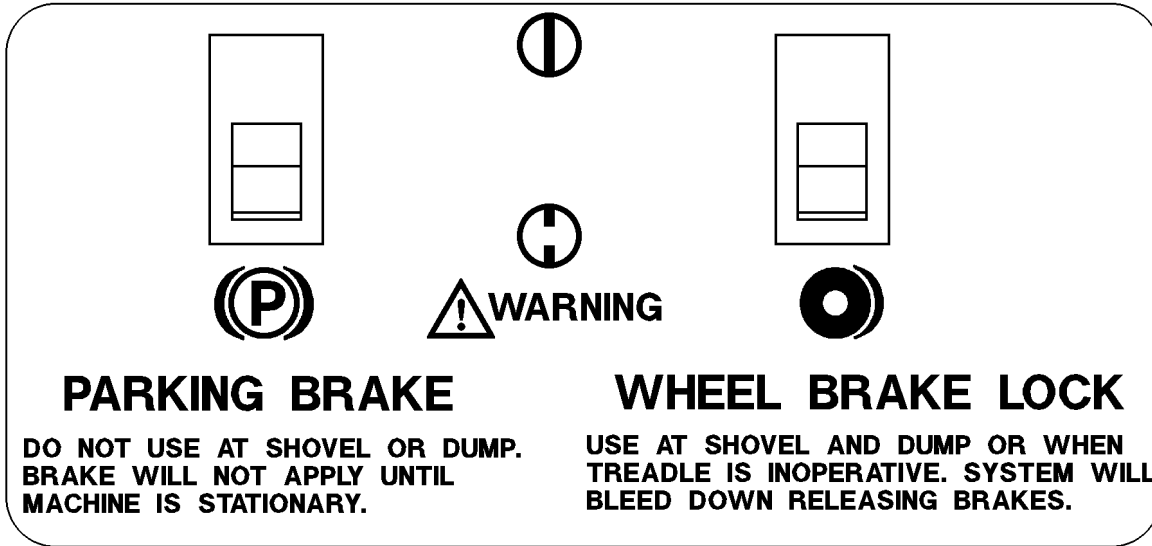

SM2729

 The **Parking Brake** is spring applied and hydraulically released. It is designed to hold a stationary truck when the engine is shutdown and keyswitch is turned "Off". The truck must be completely stopped before applying the parking brake, or damage may occur to parking brake.

To apply the parking brake, press the rocker switch toward the "On" symbol. To release the parking brake, press the rocker switch toward the "Off" symbol. When the keyswitch is "On" and Parking Brake switch is applied, the Parking Brake indicator light (A3, Overhead Panel) will be illuminated.

NOTE: Do not use the parking brake at shovel or dump. With keyswitch "on" and engine running, sudden shock caused by loading or dumping could cause the system's motion sensor to RELEASE the park brake.

 The **Wheel Brake Lock** switch is for holding the truck while parked at the shovel during loading, or while dumping. It applies the **rear service brakes only**. If the brake treadle valve does not operate, apply this brake to stop the truck. Do NOT use this brake as a parking brake when leaving the truck. With engine shut down, the hydraulic system will eventually bleed down, releasing the service brakes.

Attached to the exterior of both battery compartments is a danger plate. This plate stresses the need to keep from making any sparks near the battery. When another battery or 24VDC power source is used for auxiliary power, all switches must be "Off" prior to making any connections. When connecting auxiliary power cables, positively maintain correct polarity; connect the positive (+) posts together and then connect the negative (-) lead of the auxiliary power cable to a good frame ground. **Do not connect to the negative posts of the truck battery or near the battery box.** This hookup completes the circuit but minimizes danger of sparks near the batteries.

Sulfuric acid is corrosive and toxic. Use proper safety gear, goggles, rubber gloves and rubber apron when handling and servicing batteries. Get proper medical help immediately, if required.

This plate is placed on both battery boxes and near the battery disconnect switches to indicate that the battery system (24VDC) is a NEGATIVE (-) GROUND system.

These decals are placed above the battery disconnect switches on the right side of the front bumper to indicate "Off" and "On" positions of the switches.

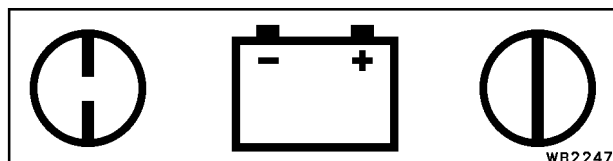
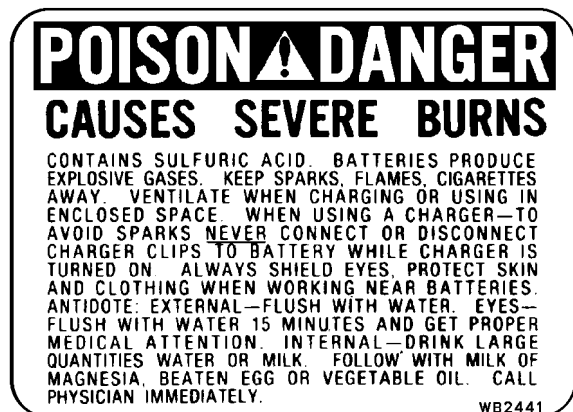

A warning plate is mounted on top of the radiator surge tank cover near the radiator cap.

The engine cooling system is pressurized. **Always turn the key switch off and allow the engine to cool before removing radiator cap.** Unless the pressure is first released, removing the radiator cap after the engine has been running for a time will result in the hot coolant being expelled from the radiator.

Serious scalding and burning can result.

Warning plates are mounted on the frame in front of, and to the rear, of both front tires. All personnel are warned that the clearances change when the truck is steered and could cause serious injury.

Warning plates are attached to both the hydraulic tank and fuel tank to alert technicians **not to work** on the truck **with the body in the raised position** unless body-up retention device (pins or cable) is in position.

These DANGER plates are mounted on the outside of each frame rail to alert technicians to read the warning labels attached to the side of each of the accumulators (see below) prior to releasing internal nitrogen pressure or disconnecting any hydraulic lines or hardware. There are similar decals mounted on top of each of the accumulators (both steering and brake) with the same DANGER message.

These WARNING decals are mounted on the side of each of the accumulators (both steering and brake) to alert technicians to discharge all gas and hydraulic pressure, and to read the maintenance/service manual prior to performing any service.

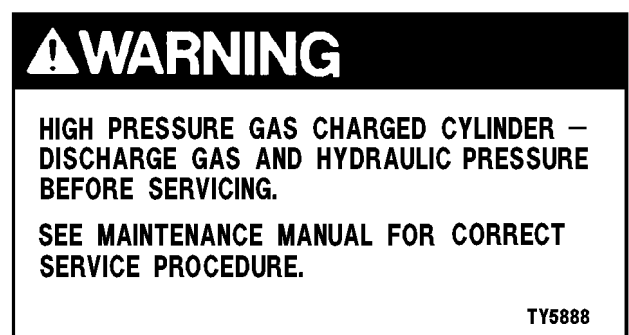
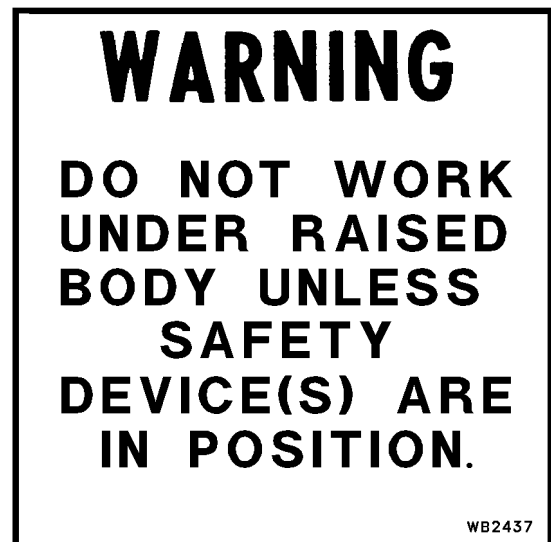
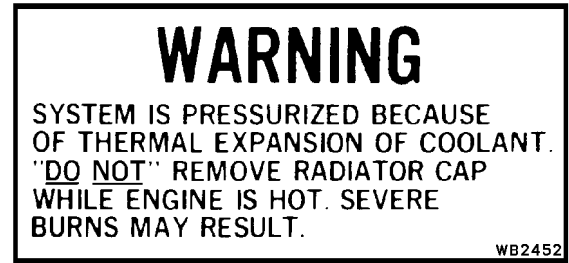

This Danger plate is attached to all four suspensions.

The plate contains instructions for releasing internal pressure before disconnecting any hardware.

Serious injury can occur if these directions are not followed.



DANGER

HIGH PRESSURE CYLINDER CHARGED WITH DRY NITROGEN

DO NOT REMOVE ANY HARDWARE INCLUDING CAPSCREWS, PLUGS, VALVE, OR VALVE CORE UNTIL ALL PRESSURE HAS BEEN RELEASED. REMOVAL OF ANY HARDWARE WHILE CYLINDER IS UNDER PRESSURE MAY RESULT IN HARDWARE FLYING VIOLENTLY FROM CYLINDER. TO RELEASE PRESSURE, REMOVE VALVE CAP, TURN TOP HEX ON VALVE THREE TURNS IN A COUNTERCLOCKWISE DIRECTION (DO NOT TURN MORE THAN THREE TURNS), THEN DEPRESS VALVE CORE. DO NOT TURN BOTTOM HEX UNTIL ALL PRESSURE HAS BEEN RELEASED.

1. CHECK OIL LEVEL ACCORDING TO INSTRUCTION MANUAL.
2. CHARGE CYLINDER WITH DRY NITROGEN GAS ONLY.

TO CHARGE CYLINDER: SEE YOUR HAULPAK® DISTRIBUTOR WHO HAS ALL TOOLS AND INFORMATION REQUIRED FOR CHARGING CYLINDERS.

WA2892

A plate on the side of the hydraulic tank furnishes instructions for filling the hydraulic tank.

Keep the system open to the atmosphere only as long as absolutely necessary to lessen chances of system contamination. Service the tank with clean Type C-4 hydraulic oil. All oil being put into the hydraulic tank should be filtered through 3 micron filters.

ATMOSPHERIC BREATHING SYSTEM

FILLING INSTRUCTIONS:

1. WITH ENGINE STOPPED, KEY SWITCH OFF AND BODY DOWN, FILL TANK TO TOP OF SIGHT GLASS.
2. RAISE AND LOWER BODY 3 TIMES.
3. REPEAT STEPS 1 AND 2 AND ADD OIL UNTIL LEVEL IS AGAIN AT TOP OF SIGHT GLASS.
4. OIL MUST BE VISIBLE IN UPPER SIGHT GLASS WITH ENGINE STOPPED, BODY DOWN AND KEY OFF FOR 90 SECONDS. OIL MUST BE VISIBLE IN LOWER SIGHT GLASS WITH ENGINE RUNNING AND BODY DOWN. REPEAT STEP 1 IF NECESSARY.

WB2724

A CAUTION decal is attached below the hydraulic tank oil level sight gauge. Check level with body down, engine stopped, and key switch "Off". Add oil per filling instructions, if oil level is below top of sight glass.



CAUTION

DO NOT ADD OIL UNLESS ENGINE IS STOPPED, KEY IS OFF, AND BODY IS DOWN

WA6628

A warning plate is attached to the hydraulic tank to inform technicians that high pressure hydraulic oil is present during operation. When it is necessary to open the hydraulic system, be sure engine is stopped and key switch is "Off" to bleed down hydraulic pressure. There is always a chance of residual pressure being present. Open fittings slowly to allow all pressure to bleed off before removing any connections.



WARNING

Any operating fluid, such as hydraulic oil, escaping under pressure can have sufficient force to enter a person's body by penetrating the skin. Serious injury and possibly death may result if proper medical treatment by a physician familiar with this injury is not received immediately.

WARNING

HIGH PRESSURE

DO NOT LOOSEN OR DISCONNECT ANY HYDRAULIC LINE OR COMPONENT UNTIL ENGINE IS STOPPED AND KEY SWITCH IS OFF.

WB2439

A wheel motor oil level decal is attached to the gear cover on both electric wheel motors. This decal stresses the fact that the truck must be on a level surface and parked for 20 minutes prior to checking the oil level. This is necessary in order to get an accurate reading.

A decal plate is located on the frame near the left hoist cylinder which provides the operator or technician with the hook-up procedure for dumping a loaded, disabled truck, by using a functional truck for hydraulic power.

Refer to the Service manual for additional instructions for using this procedure.

Warning decals are applied to both brake accumulators located inside the brake system cabinet behind the operator cab. These decals remind servicing technicians to be sure to close the accumulator drain valves after they have been opened to bleed brake pressure. It further warns not to over-tighten the drain valves to prevent damage to the valve seat(s).

This CAUTION decal is placed near the battery disconnect switches on the right side of the front bumper to alert servicing technicians that before doing any welding on the truck, always disconnect the battery charging alternator lead wire and isolate electronic control components before making welding repairs.

In addition, always disconnect the positive and negative battery cables of the vehicle. Failure to do so may seriously damage the battery and electrical equipment.

Always fasten the welding machine ground (-) lead to the piece being welded; **grounding clamp MUST BE ATTACHED AS NEAR AS POSSIBLE to the weld area**. Never allow welding current to pass through ball bearings, roller bearings, suspensions, or hydraulic cylinders. Always avoid laying welding cables over or near the vehicle electrical harnesses. Welding voltage could be induced into the electrical harness and possibly cause damage to components.

OIL FILL & CHECK PROCEDURE

**CHECK OIL LEVEL ONLY AFTER TRUCK HAS BEEN PARKED FOR 20 MINUTES. REMOVE LOWEST PLUG TO FILL AND CHECK LEVEL.
OIL LEVEL IS OK, IF OIL IS PRESENT.**

WB2444

EMERGENCY DUMP PROCEDURE

1. CONNECT A HYDRAULIC POWER SUPPLY CAPABLE OF 2500 PSI (17.2 MPa) WHICH HAS A RESERVE CAPACITY EXCEEDING 80 GAL. (303 l) TO THE QUICK DISCONNECTS ON L.H. HOIST CYLINDER.
2. PLACE HOIST VALVE IN HOLD POSITION.
3. DUMP LOAD AND LOWER BODY USING CONTROL VALVE ON HYDRAULIC POWER SUPPLY UNIT.

WB2246

WARNING

ALWAYS CLOSE DRAIN VALVES AFTER DISCHARGING ACCUMULATORS. DO NOT OVERTIGHTEN DRAIN VALVES.

WB2447

CAUTION

PRIOR TO WELDING ON TRUCK DISCONNECT LEAD WIRE ON BATTERY CHARGING ALTERNATOR

WB2442

A High Voltage Danger Plate is attached to the door of the rear hatch cover. HIGH VOLTAGE may be present!

Only authorized personnel should access this rear housing.



A CAUTION decal is also attached to the door of the rear hatch cover to alert personnel that HOT EXHAUST AIR is present and may cause injury.



This CAUTION decal is also placed around the Retarding Grid Cabinet.

These WARNING plates are mounted on all of the AC DRIVE CONTROL housings and cabinets. HIGH VOLTAGE may be present, with or without, the engine running! Only authorized personnel should access these cabinets.

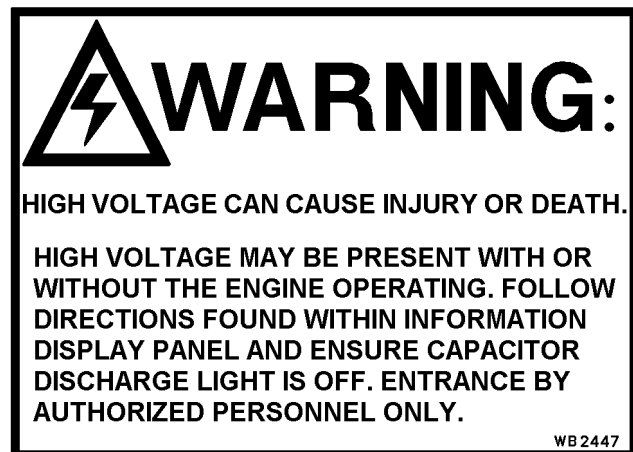

This CAUTION decal is placed on the back of the control cabinet to alert service technicians that this area contains capacitors and must not be disturbed in any manner.

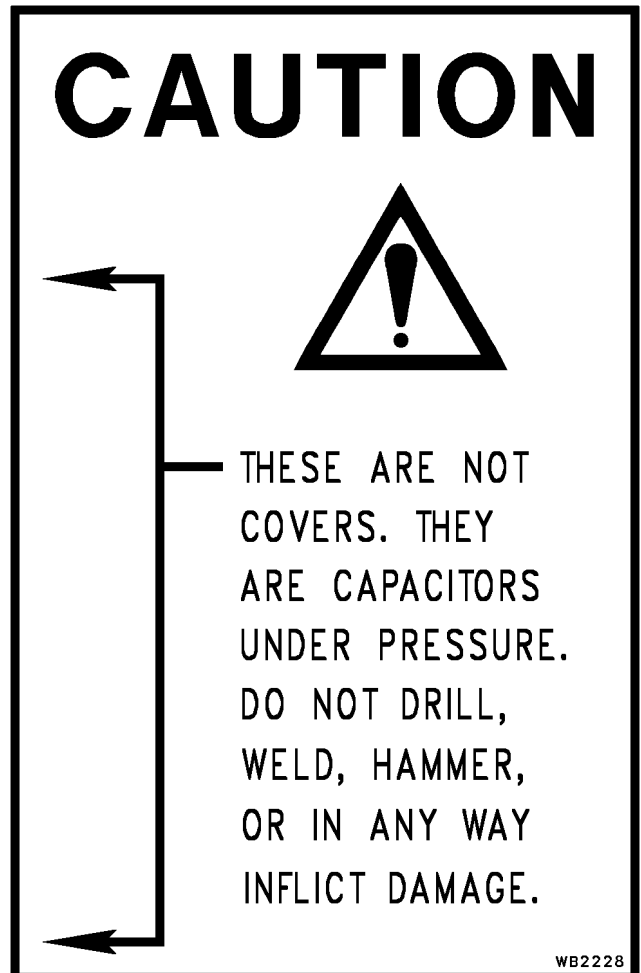

This INFORMATION decal is placed on the outside of the door panel on the control cabinet wall that faces the right side of the operator cab.

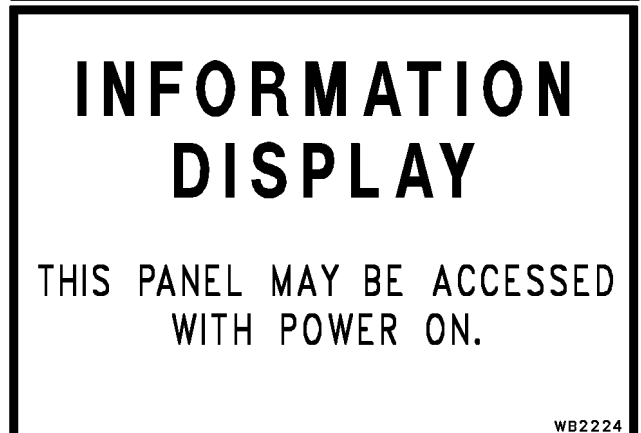

This decal is placed near three different indicator lights:

- In the operator cab, on the D.I.D. panel on the rear wall.
- On the front of the control box which is mounted on the right side of the main control cabinet.
- On the outside of the left control cabinet wall that faces the right side of the operator cab. (See also Information decal above.)

When any of these indicator lights are ON, High Voltage is present throughout the propulsion and retarding system. Extreme care should be exercised!

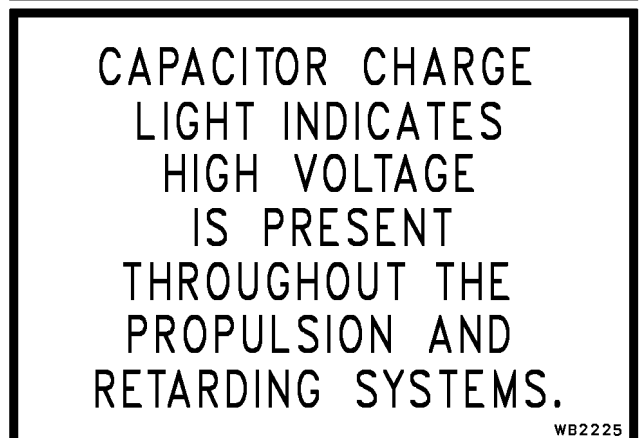

This decal is placed on the ground level engine shutdown switch which is mounted on the left side of the front bumper structure. It specifies that this switch is for emergency shutdown only.

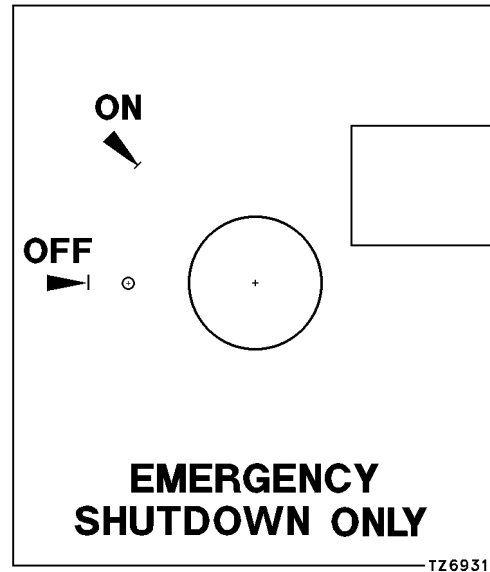

The following display illustrates a variety of decals which are mounted on deck mounted cabinets, housings, and structures which must be lifted in a specific manner, and from specific points, in order to safely move or lift any of these structures. If any of these decals are damaged or defaced, so that it is no longer legible, it should be replaced immediately. Maintenance personnel must follow these lifting instructions.

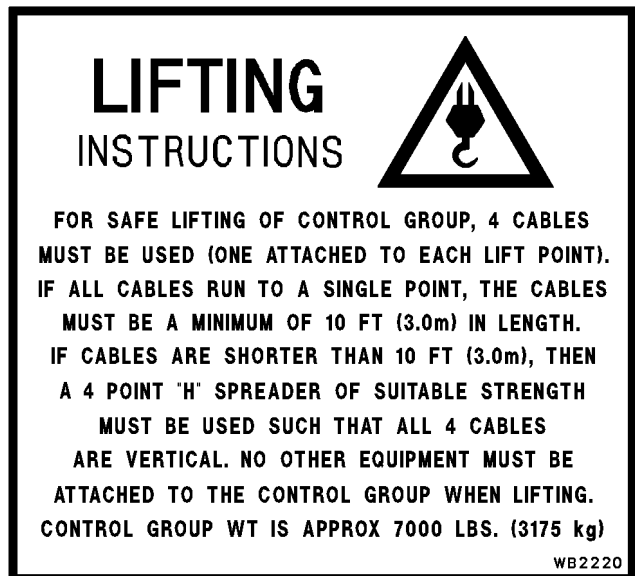
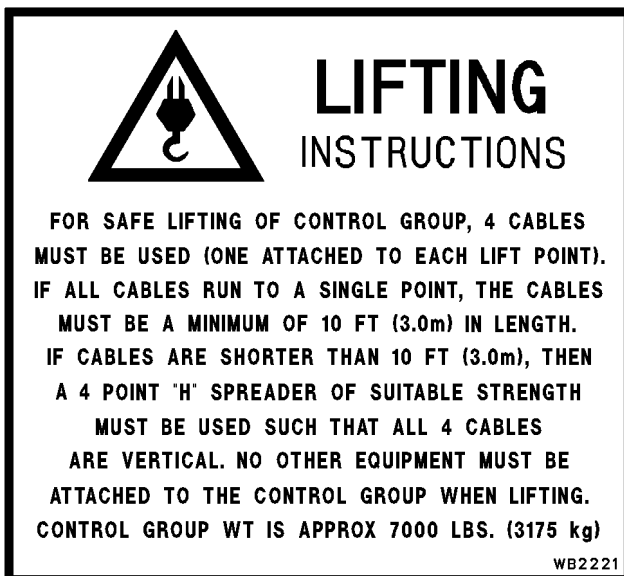
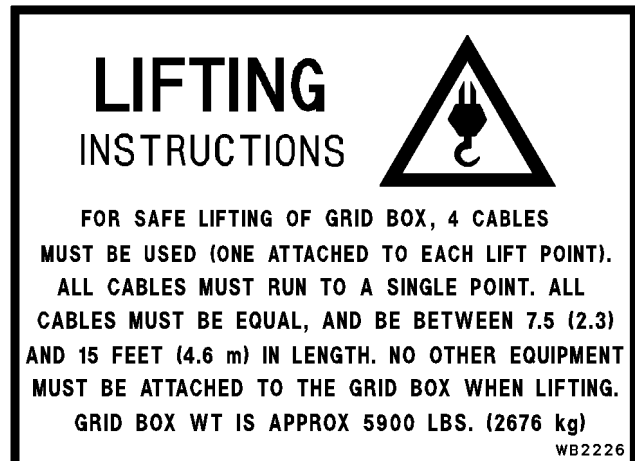
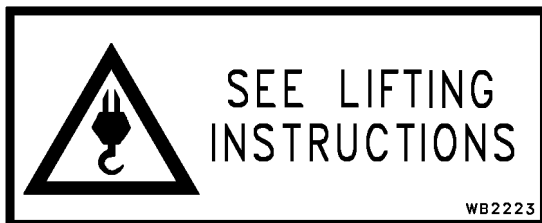
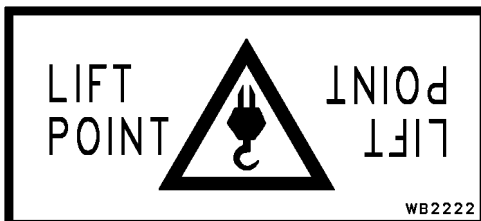

A product identification plate is located on the main frame in front of the right side front wheel and shows the Truck Model Number, Maximum G.V.W. and Product Identification Number (Truck Serial Number).

The Product Identification Number (Truck Serial Number) contains information which will identify the original manufacturing bill of material for this unit.

The complete truck serial number will be required for the proper ordering of many service parts and/or warranty consideration.

Komatsu Mining Systems, Inc.
 2300 NE Adams St
 Peoria, IL 61650-0240

KOMATSU

Product Identification Number

Model No. Max. G.V.W.

Product Identification Number

**MADE IN
 THE UNITED STATES OF AMERICA**
DO NOT DEFACE OR REMOVE THIS PLATE

WB2399

The Lubrication Chart is mounted on the right hand side of the radiator grille structure. Refer to the "Lubrication and Service" section in this manual for more complete lubrication instructions.

LUBRICATION CHART

LUBRICATION SPECIFICATIONS												
LUBE KEY	TYPE LUBRICANT											
A	ENGINE OIL - - - - SEE ENGINE MANUAL											
B	HYDRAULIC OIL - - - - SAE 10W C - 4 - - - - AUXILIARY HEATERS REQUIRED BELOW -10°F(-23°C)											
C	HEAVY-DUTY SYNTHETIC GEAR OIL - - - - SEE DRIVE SYSTEM MANUAL											
D	MULTI - PURPOSE EXTREME PRESSURE GREASE - - - - NLGI NO.2 (5% MIN. MOLY-DISULFIDE)											
E	MULTI - PURPOSE GEAR OIL - - - - SAE 80W - 90											
SYM	DESCRIPTION	PTS	LUBE KEY	10 HR	50 HR	100 HR	250 HR	500 HR	1000 HR	2000 HR	2500 HR	
1	CRANKCASE OIL LEVEL	1	A	CHECK	SEE ENGINE MANUAL							
2	ENGINE LUBE OIL FILTERS				SEE ENGINE MANUAL							
3	FUEL FILTER				SEE ENGINE MANUAL							
4	FUEL SEPERATOR (DAVCO)				SEE ENGINE MANUAL							
5	FUEL TANK	1										
6	GE PREFILTER BREATHER	1	D									
7	FUEL TANK BREATHER	1								CLEAN		
8	HYDRAULIC OIL LEVEL	1	B	CHECK						*CHANGE		
9	HYDRAULIC STRAINER	2								CLEAN		
10	HYDRAULIC TANK BREATHER	2								CHANGE		
11	HYDRAULIC FILTERS	3			**	**	**			CHANGE		
12	MOTORIZED WHEEL OIL LEVEL	2	C		SEE DRIVE SYSTEM MANUAL							
13	HYD. PUMP DRIVE SHAFT	2	D							GREASE		
14	CHASSIS LUBE LEVEL	1	D							GREASE		
15	SEAT SLIDES & STEER SHAFT	4	D							GREASE		
16	WHEEL MOTOR BLOWER	2	D							GREASE		
17	FRONT WHEEL BEARINGS ***	2	E							CHECK		
18	FRONT TRUNION	1	D							GREASE	CHANGE	

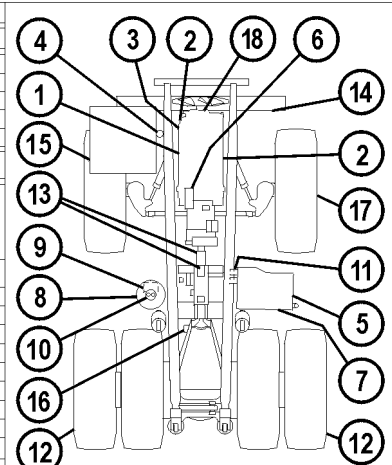

630E, 730E, 830E, & 930E

* 1000 HR INTERVAL CAN BE EXTENDED TO 2500 HR PROVIDED OIL SAMPLING AND ANALYSIS IS CONDUCTED EVERY 250 HR.

** ONE-TIME CHANGE AT 50, 100 AND 250 HR.

*** NOT APPLICABLE FOR 930E

WB2790

NOTES

OPERATING INSTRUCTIONS

PREPARING FOR OPERATION

The safest trucks are those which have been properly prepared for operation. At the beginning of each shift, a careful check of the truck should be made by the operator before attempting to start the engine.

SAFETY IS THINKING AHEAD

Prevention is the best safety program. Prevent a potential accident by knowing the employer's safety requirements, all necessary job site regulations, as well as use and care of the safety equipment on the truck.

Only qualified operators or technicians should attempt to operate or maintain the Komatsu Truck.

Safe practices start before the operator gets to the equipment!

- Wear the proper clothing. Loose fitting clothing, unbuttoned sleeves and jackets, jewelry, etc., can catch on a protrusion and cause a potential hazard.
- Always use the personal safety equipment provided for the operator such as hard hat, safety shoes, safety glasses or goggles. There are some conditions when protective hearing devices should also be worn for operator safety.
- When walking to and from the truck, maintain a safe distance from all machines even if the operator is visible.

At The Truck - Ground Level Walk Around Inspection

At the beginning of each shift, a careful walk around inspection of the truck should be made before the operator attempts engine start-up. A walk around inspection is a systematic ground level inspection of the truck and its components to insure that the truck is safe to operate before entering the operator's cab.

Start at the left front corner of the truck (see illustration, next page), and move in a counter-clockwise direction, front-to-rear, across the rear, and continuing forward up the opposite side of the truck to the original starting point.

If these steps are taken in sequence, and are repeated from the same point and in the same direction before every shift, many potential problems may be avoided, or scheduled for maintenance. UNSCHEDULED downtime and loss of production can be reduced.

Local work practices may prevent an operator from performing all tasks suggested here, but to the extent permitted, the operator should follow this or similar routine.

! DANGER ! HIGH VOLTAGE MAY BE PRESENT ON THIS TRUCK! DO NOT OPEN ANY ELECTRICAL CABINET DOORS ON THIS TRUCK WHEN THE ENGINE IS RUNNING! NEVER CLIMB ON ANY POWER CABLES OR USE POWER CABLES FOR HANDHOLDS OR FOOTHOLDS, UNLESS THE ENGINE HAS BEEN SHUT DOWN AND SYSTEM HAS BEEN VERIFIED AT "REST"!

1. Start at left front of truck. While performing the walk around inspection, visually inspect all lights and safety equipment for external damage from rocks or misuse. Make sure lenses are clean and unbroken.
Empty the dust pans on the left side air cleaner assemblies. Be sure battery box covers are in place and secure.
2. Move behind the front of the left front tire, inspect the hub and brake assemblies for leaks and any abnormal conditions.
Check that all suspension attaching hardware is secure and inspect mounting key area for evidence of wear. Check that the suspension extension (exposed piston rod) is correct, and that there are no leaks.
3. With engine stopped, check engine oil level. If dark, turn on service light.
4. Inspect air conditioner belts for correct tension, obvious wear, and tracking. Inspect fan guard for security and condition. When leaving this point, be sure to turn off service light, if used.
5. Inspect anchor end of steering cylinder for proper greasing and for security.

START HERE

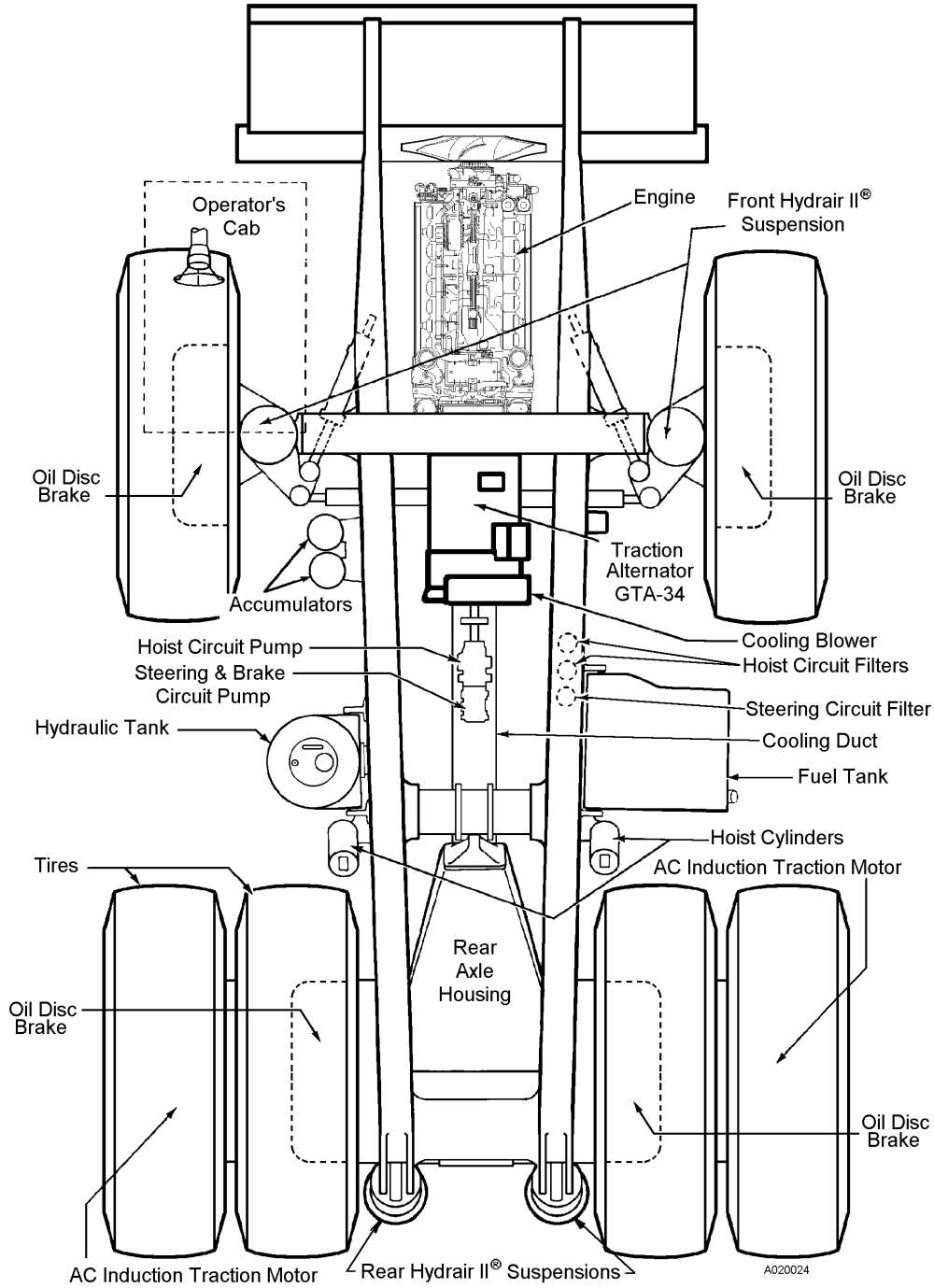

6. Move outboard of the front wheel, and inspect attaching nuts/studs to be sure all are tight and complete. Check tires for cuts, damage or "bubbles" and that inflation appears to be correct.
7. Move behind the rear of the front wheel, inspect for leaks at hub or brakes or any unusual conditions. Inspect wheel speed sensor and harness. Inspect suspension hardware to be sure it is all in place. Inspect live end of steering cylinder for proper greasing, and for security of all parts. Inspect for any hydraulic leaks.
8. Inspect sight glass on hydraulic tank. With engine stopped and body down, hydraulic fluid must be visible in lower sight glass.
9. Move on around the hydraulic tank and in front of the rear dual tires, inspect the hoist cylinder for any damage and leaks, also that lower guard is in place. Inspect both upper and lower hoist cylinder pins for security, and for proper greasing.
10. Before leaving this position, look under the lower edge of the chassis to be sure the flexible duct that carries the air from the main blower to the final drive housing is in good condition with no holes or breakage. Also look up at the main hydraulic pumps to see that there is no leakage or any other unusual condition with pumps or pump drive shafts.
11. Move on around the dual tires, check to see that all nuts/studs are in place and tight. Inspect wheel for any leakage that would indicate brake leakage, or wheel motor leakage.

Check dual tires for cuts, damage or "bubbles" and that inflation appears to be correct. If truck has been run on a "flat", **the tire must be cooled before parking truck inside**. Inspect for any rocks that might be lodged between dual tires, and that rock ejector is in good condition and straight so that it can not damage a tire.
12. Inspect left rear suspension for damage and for correct rod exposure, and that there are no leaks. See that covers over the chromed piston rod are in good condition and inspect for proper greasing.
13. Open rear hatch cover. Inspect for leaks around the parking brakes, and that there are no rags or tools left behind. Inspect condition of cooling air exhaust ductwork to be certain that it is intact and that there are no obstructions.
14. While standing in front of rear hatch, look up to see that rear lights are in good condition, along with dual backup horns. Look up at panhard rod to see that it is getting proper greasing. Also look at both body hinge pins for greasing and any abnormal condition. Check hoist limit switch and clear any mud/debris from contacts.
15. Perform the same inspection on the right rear suspension as done on the left.
16. Move on around the right dual tires, inspect between the tires for rocks, and for condition of the rock ejector, inspect the tires for cuts or damage, and for correct inflation.
17. Perform the same inspection for wheel nuts/studs and wheel leaks that was done on the left hand dual wheels.
18. Move in front of right dual tires, and inspect the hoist cylinder the same as was done on the left side.
Check security and condition of bodyup limit switch. Remove any mud/dirt accumulation from switch.
19. Move on around the fuel tank, inspect the fuel quantity gauge, (this should agree with what will show on the gauge in the cab). Inspect the attaching hardware for the fuel tank at the upper saddles, and then at the lower back of the tank for the security and condition of the mounts. Check hoist filters for leaks.
20. Move in behind the right front wheel, and inspect the steering cylinder, suspension attaching hardware and suspension extension, as well as greasing and attaching hardware for the steering cylinder. Inspect the hub and brakes for leaks and any unusual condition. Inspect wheel speed sensor and harness. Be sure the suspension protective boot is in good condition.
21. Move out and around the right front wheel, inspect that all nuts/studs are in place and tight.
22. Move in behind the front of the right front wheel, check hub and brakes for leaks and any unusual condition. Inspect wheel speed sensor and harness. Inspect steering cylinder for security and for proper greasing. Inspect the engine compartment for any leaks and unusual condition. Inspect the fan guard, and belts also for any rags or debris behind radiator. Turn work light off, if used, and secure the ladder up and latched.
23. Inspect auto lube system. See Maintenance Section 4 for specific details concerning auto lube system.
24. Move on around to the right front of the truck, drop the air cleaner pans to remove dirt, latch up and secure. Inspect battery box cover for damage and be sure it is in place and secure.

25. As you move in front of the radiator, inspect for any debris that might be stuck in front of the radiator and remove it. Check for any coolant leaks. Inspect all head and fog lights.
26. Before climbing ladder to first level, be sure ground level engine shutdown switch is "ON". Inspect fire control actuator to be sure safety pin is in place and plastic tie that prevents accidental actuation is in place and in good condition. Be sure battery disconnect switches are "ON". Always use grab rails and ladder when mounting or dismounting from the truck. Clean ladder and hand rails of any foreign material, such as ice, snow, oil or mud.

CAUTION

Always mount and dismount ladders facing the truck. Never attempt to mount or dismount while the truck is in motion.

27. Use stairs and handrails while climbing from first level to cab deck.
28. When checking coolant in radiator, use coolant level sight gauge (if equipped) or observe coolant level through opening in end of hood. If it is necessary to remove radiator cap, shut down engine (if running), and relieve coolant pressure SLOWLY, before removing radiator cap.

WARNING

If engine has been running, allow coolant to cool, before removing the fill cap or draining radiator. Serious burns may result if coolant is not allowed to cool.

29. Inspect covers over retarding grids to be sure latches are in place and secure. Inspect main air inlet to be sure it is clear. Be sure all cabinet door latches are secure.
30. Move on around the cab to the back, open the doors to the brake cabinet, inspect for leaks. Before latching doors, turn work lights off, if used.
31. Clean cab windows and mirrors; clean out cab floor as necessary. Insure steering wheel, controls and pedals are free of any oil, grease or mud.
32. Stow personal gear in cab so that it does not interfere with any operation of the truck. Dirt or trash buildup, specifically in the operator's cab, should be cleared. Do not carry tools or supplies in cab of truck or on the deck.
33. Adjust seat and steering wheel so that it is comfortable for use.
34. Read and understand the OPERATOR CONTROLS AND INSTRUMENT PANEL discussion in this section. Be familiar with all control locations and functions BEFORE operating truck.

ENGINE START-UP SAFETY PRACTICES

1. Insure all personnel are clear of truck before starting engine. Always sound the horn as a warning before actuating any operational controls. If the truck is in an enclosure, insure adequate ventilation before start-up.
Exhaust fumes are dangerous!
2. Be sure parking brake switch is in "On" position. Check and insure Selector Switch is in "Neutral" before starting.
Place REST switch in "On" position (put drive system in "REST" mode of operation).
Refer to discussion of REST SWITCH (26, Figure 3-6), in "Instrument Panel & Indicator Switches" section.
3. If truck is equipped with auxiliary cold weather heater system(s), do not attempt to start engine while heaters are in operation.
Damage to coolant heaters will result.

4. The keyswitch is a three position (Off, Run, Start) switch. When switch is rotated one position clockwise, it is in the "Run" position and all electrical circuits (except "Start") are activated.
 - a. Turn keyswitch to "Run" (not "Start") position.
 - b. With Selector Switch in "Neutral", rotate keyswitch fully clockwise to "Start" position, and HOLD this position until engine starts (see NOTE below). "Start" position is spring-loaded to return to "Run" when key is released.
 - c. After engine has started, place REST switch in "Off" position (de-activate the "REST" mode of operation). Refer to discussion of REST SWITCH (26, Figure 3-6), in "Instrument Panel & Indicator Switches" section.

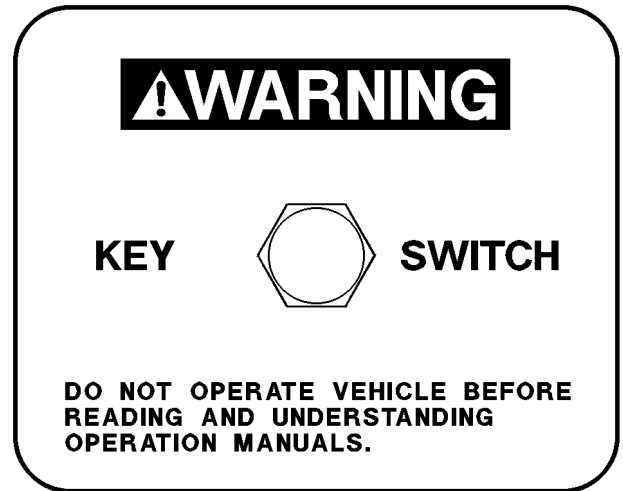

NOTE: This truck is equipped with an engine prelube system. With this feature, a noticeable time delay may occur (while engine lube oil passages are being filled and pressurized) before engine cranking will begin.

Cold Weather Starting

- Do not crank an electric starter for more than 30 seconds.
- Allow two minutes for cooling before attempting to start engine again.
- Severe damage to starter motor can result from overheating.*

AFTER ENGINE HAS STARTED

1. Become thoroughly familiar with steering and emergency controls. After engine has started and low pressure and warning systems are normal, test the truck steering in extreme right and left directions. If the steering system is not operating properly, shut engine down immediately. Determine the steering system problem and have repairs made before resuming operation.
2. Operate each of the truck's brake circuits at least twice prior to operating and moving the truck. These circuits include individual activation from the operator's cab of the service brake, parking brake, and brake lock. With the engine running and with the hydraulic circuit fully charged, activate each circuit individually. If any application or release of any brake circuit appears sluggish or improper, or if warning alarms are activated on application or release, shut the engine down and notify maintenance personnel. Do not operate truck until brake circuit in question is fully operational.
3. Check gauges, warning lights and instruments before moving the truck to insure proper system operation and proper instrument functioning. Give special attention to braking and steering circuit hydraulic warning lights. If warning lights come on, shut down the engine immediately and determine the cause.
4. Insure headlights, worklights and taillights are in proper working order. Good visibility may prevent an accident. Check operation of windshield wiper.
5. When truck body is in dump position, do not allow anyone beneath it unless body-up retaining pin or cable is in place.
6. Do not use the fire extinguisher for any purpose other than putting out a fire! If extinguisher is discharged, report the occurrence so the used unit can be refilled or replaced.
7. Do not allow unauthorized personnel to ride in the truck. Do not allow anyone to ride on the ladder of the truck.
8. Do not leave truck unattended while engine is running. Shut down engine and apply park brake before getting out of cab.

MACHINE OPERATION SAFETY PRECAUTIONS

After the truck engine is started and all systems are functioning properly, the operator must follow all local safety rules to insure safe machine operation.



If any of the red warning lights come “On” or if any gauge reads in the red area during truck operation, a malfunction is indicated. Stop truck as soon as safety permits, shut down engine if problem indicates and have problem corrected before resuming truck operation.



Truck is equipped with “Slip/Slide” control. If this function should become inoperative, operating truck with stalled or free spinning wheel motors may cause serious damage to wheel motors! If truck does not begin to move within 10 seconds after depressing throttle pedal (Selector Switch in a drive position), release throttle pedal and allow wheels to regain traction before accelerating engine again.

1. Always look to the rear before backing the truck. Watch for and obey ground spotter’s hand signals before making any reverse movements. Sound the warning horn (3 blasts). Spotter should have a clear view of the total area at the rear of the truck.
2. Operate the truck only while properly seated with seat belt fastened. Keep hands and feet inside the cab compartment while truck is in operation.
3. Check gauges and instruments frequently during operation for proper readings.
4. Observe all regulations pertaining to the job site’s traffic pattern. Be alert to any unusual traffic pattern. Obey the spotter’s signals.
5. Match the truck speed to haul road conditions and slow the truck in any congested area. Keep a firm grip on steering wheel at all times.
6. Do not allow engine to run at “Idle” for extended periods of time.
7. Check parking brake periodically during shift. Use parking brake **ONLY** for parking. Do not use park brake for loading / dumping.
Do not attempt to apply parking brake while truck is moving!



Do not use “Brake Lock” or “Emergency Brake” (if equipped) for parking. With engine stopped, hydraulic pressure will bleed down, allowing brakes to release!

8. Check brake lock performance periodically for safe loading and dump operation.
9. Proceed slowly on rough terrain to avoid deep ruts or large obstacles. Avoid traveling close to soft edges and the edge of fill area.
10. Truck operation requires concentrated effort by the driver. Avoid distractions of any kind while operating the truck.

MACHINE OPERATION ON THE HAUL ROAD

1. Always stay alert! If unfamiliar with the road, drive with extreme caution.
Cab doors should remain closed at all times if truck is in motion or unattended.
2. Obey all road signs. Operate truck so it is under control at all times. Govern truck speed by the road conditions, weather and visibility. Report haul road conditions immediately. Muddy or icy roads, pot holes or other obstructions can present hazards.
3. Initial propulsion with a loaded truck should begin from a level surface whenever possible, but when there are circumstances where starting on a hill or grade cannot be avoided, use the “**STARTING ON A GRADE WITH A LOADED TRUCK**” procedure (next page).
4. When backing the truck, give backup signal (three blasts on the horn); when starting forward, two blasts on the horn. These signals must be given each time the truck is moved forward or backward.

5. Use extreme caution when approaching a haul road intersection. Maintain a safe distance from oncoming vehicles.
6. Maintain a safe distance when following another vehicle. Never approach another vehicle from the rear, in the same lane, closer than 50 ft. (15 m). When driving on a down grade, this distance should not be less than 100 ft. (30 m).
7. Do not stop or park on a haul road unless unavoidable. If you must stop, move truck to a safe place, apply parking brake, and shut down engine before leaving cab. Block wheels securely and notify maintenance personnel for assistance.
8. Before starting up or down a grade, maintain a speed that will insure safe driving and provide effective retarding under all conditions. Refer to Grade/Speed decal in operator's cab.
9. When operating truck in darkness, or when visibility is poor, do not move truck unless all headlights, clearance lights, and tail lights are on. Do not back truck if backup horn or lights are inoperative. Always dim headlights when meeting oncoming vehicles.
10. If the "Emergency Steering" light and/or "Low Brake Pressure Warning" light (*if equipped*) illuminate during operation, steer the truck **immediately** to a safe stopping area, away from other traffic if possible. Refer to item 7 above.
11. Check tires for proper inflation periodically during shift. If truck has been run on a "flat", or under-inflated tire, **it must not be parked in a building until the tire cools.**

STARTING ON A GRADE WITH A LOADED TRUCK

Initial propulsion with a loaded truck should begin from a level surface whenever possible, but when there are circumstances where the starting on a hill or grade cannot be avoided, use the following procedure:

1. Fully depress the foot-operated retarder/service brake pedal (do NOT use retarder lever) to hold the truck on the grade. With service brakes fully applied, move the selector switch to a drive position (Forward/Reverse) and increase engine RPM with throttle pedal.
2. As engine RPM approaches maximum, and operator senses propulsion effort working against the brakes, release the brakes and let truck movement start. Be sure to completely release the foot-operated retarder/service brake pedal. As truck speed increases above 3-5 MPH (5-8 KPH) the Propulsion System Control (PSC) will drop propulsion, if the retarder is still applied. Releasing and reapplying dynamic retarding during a hill start operation will result in loss of propulsion.

PASSING

1. Do not pass another truck on a hill or blind curve!
2. Before passing, make sure the road ahead is clear. If a disabled truck is blocking your lane, slow down and pass with extreme caution.
3. Use only the areas designated for passing.

LOADING

1. Pull into the loading area with caution. Remain at a safe distance while truck ahead is being loaded.
2. Do not drive over unprotected power cables.
3. When approaching or leaving a loading area, watch out for other vehicles and for personnel working in the area.
4. When pulling in under a loader or shovel, follow "Spotter" or "Shovel Operator" signals. The truck operator may speed up loading operations by observing the location and loading cycle of the truck being loaded ahead, then follow a similar pattern.
5. When being loaded, operator should stay in truck cab with engine running. Place Selector Switch in "Neutral" and apply Wheel Brake Lock.
6. When loaded, pull away from shovel as quickly as possible but with extreme caution.

DUMPING

1. Pull into dump area with extreme caution. Make sure area is clear of persons and obstructions, including overhead utility lines. Obey signals directed by the spotter, if present.

Avoid unstable areas. Stay a safe distance from edge of dump area.

Position truck on a solid, level surface before dumping.

! DANGER

As body raises, the truck Center of Gravity (CG) will move. Truck must be on level surface to prevent tipping / rolling!

2. Carefully maneuver truck into dump position. When backing truck into dump position, use only the foot-operated brake pedal to stop and hold truck; DO NOT rely on Wheel Brake Lock to stop truck; this control is unmodulated and applies REAR SERVICE BRAKES ONLY.
3. When truck is stopped and in dump position, apply Wheel Brake Lock and move the Selector Switch to the "Neutral" position.

To Raise dump body:

! WARNING

The dumping of very large rocks (10% of payload, or greater) or sticky material (loads that do not flow freely from the body) may allow the material to move too fast and cause the body to move RAPIDLY and SUDDENLY. This sudden movement may jolt the truck violently and cause possible injury to the operator, and/or damage to the hoist cylinders, frame, and/or body hinge pins. If it is necessary to dump this kind of material, refer to the CAUTION in the following procedure:

4. Pull the lever to the rear to actuate hoist circuit. (Releasing the lever anywhere during "hoist up" will place the body in "hold" at that position.)
5. Raise engine RPM to accelerate hoist speed. Refer to the CAUTION below.

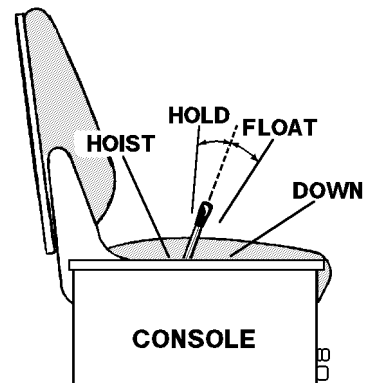

! CAUTION

If dumping very large rocks or sticky material as described in WARNING above, slowly accelerate engine RPM to raise body. When the material starts to move, release hoist lever to "HOLD" position. If material does not continue moving and clear body, repeat this procedure until material has cleared body.

6. Reduce engine RPM as last stage of hoist cylinder begins to extend and let engine go to low idle as last stage reaches half-extension.
7. Release hoist lever as last stage of hoist cylinder reaches full extension.
8. After material being dumped clears body, lower body to frame.

To Lower Body

(When dumping over a berm or into a crusher):

9. Move hoist lever forward to "down" position and release. Releasing the lever places hoist control valve in the "float" position allowing the body to return to frame.

NOTE: If dumped material builds up at the rear of the body and the body cannot be lowered, perform steps "a" & "b" below:

- a. Move hoist lever back to the "hoist" position to fully raise the dump body. Then release the hoist lever so it returns to the "hold" position.

NOTE: DO NOT drive forward if the tail of body will not clear the crusher wall in the fully raised position.

- b. Shift Selector Switch to "Forward", release Brake Lock, depress Override button and drive forward to clear the material. Stop, shift Selector Switch to "Neutral", apply Brake Lock and lower body again.

*NOTE: Failure to "hoist" the body after making an unsuccessful attempt at lowering the body may result in the dump body **suddenly lowering** after the truck has pulled ahead of the material that was previously preventing the body from lowering.*



CAUTION! The truck is not to be moved with the dump body raised except for emergency moves only. Failure to lower body before moving truck may cause damage to hoist cylinders, frame and/or body hinge pins.



To Lower Body

(When dumping on flat ground):

It is very likely when dumping on flat ground that the dumped material will build up enough to prevent the body from lowering. In this case, the truck will have to be driven forward a short distance (just enough to clear the material) before the body can be lowered.

- a. Shift Selector Switch to "Forward", release Brake Lock, depress Override button and drive just far enough forward for body to clear material. Stop, shift Selector Switch to "Neutral", apply Brake Lock.
- b. Move hoist lever forward to "down" position and release. Releasing the lever places hoist control valve in the "float" position allowing the body to return to frame.

NOTE: If dumped material builds up at the rear of the body and the body cannot be lowered, then perform steps "c" and "d" below:

- c. Move hoist lever back to the "hoist" position to fully raise the dump body. Then release the hoist lever so it returns to the "hold" position.
- d. Shift Selector Switch to "Forward", release Brake Lock, depress Override button and drive forward to clear the material. Stop, shift Selector Switch to "Neutral", apply Brake Lock and lower body again.

*NOTE: Failure to "hoist" the body after making an unsuccessful attempt at lowering the body may result in the dump body **suddenly lowering** after the truck has pulled ahead of the material that was previously preventing the body from lowering.*



CAUTION! The truck is not to be moved with the dump body raised except for emergency moves only. Failure to lower body before moving truck may cause damage to hoist cylinders, frame and/or body hinge pins.



10. With body returned to frame, move Selector Switch to "Forward", release Brake Lock, and leave dump area carefully.

TOWING

Prior to towing a truck, many factors must be carefully considered. Serious personal injury and/or significant property damage may result if important safety practices, procedures and preparation for moving heavy equipment are not observed.

Do not tow the truck any faster than 5 MPH (8 kph).

A disabled machine may be towed after the following MINIMUM precautions have been taken.

1. Shut down engine.
2. If truck is equipped, install hydraulic connections for steering and dumping between towing and towed vehicles. Check towed vehicle for braking system.
3. Inspect tow bar for adequacy (approximately 1.5 times the gross vehicle weight of truck being towed).
4. Determine that towing vehicle has adequate capacity to both move and stop the towed truck under all conditions.

TOWING - Continued

5. Protect both operators in the event of tow bar failure.
6. Block disabled truck to prevent movement while attaching tow bar.
7. Release disabled truck brakes and remove blocking.
8. Sudden movement may cause tow bar failure. Smooth and gradual truck movement is preferred.
9. Minimize tow angle at all times - NEVER EXCEED 30°. The towed truck must be steered in the direction of the tow bar.

SAFE PARKING PROCEDURES

The operator must continue the use of safety precautions when preparing for parking and engine shutdown.

In the event that the equipment is being worked in consecutive shifts, any questionable truck performance the operator may have noticed must be checked by maintenance personnel before the truck is released to another operator.

1. The truck should be parked on level ground, if at all possible. If parking must be done on a grade, the truck should be positioned at right angles to the grade.
2. The parking brake must be applied and/or chocks placed fore/aft of wheels so that the truck cannot roll. Each truck should be parked at a reasonable distance from another.
3. Haul roads are not safe parking areas. In an emergency, pick the safest spot most visible to other machines in the area. If the truck becomes disabled where traffic is heavy, mark the truck with warning flags in daylight or flares at night.

NORMAL ENGINE SHUTDOWN PROCEDURE

The following procedure should be followed at each engine shutdown.

1. Stop the truck out of the way of other traffic on a level surface and free of overhead power lines or other obstructions (in case dump body should need to be raised).
 - a. Reduce engine speed to idle. Allow engine to cool gradually by running at low idle for 3 to 5 minutes.
 - b. Place the directional Selector Switch (2, Figure 3-4) in "Neutral".
 - c. Apply the Parking Brake switch (13, Figure 3-6). Be sure the "Parking BrakeApplied" indicator light in the overhead display panel (A3, Figure 3-7) is illuminated.
2. Place REST switch (26, Figure 3-6) in "On" position to put AC Drive System in "REST" mode of operation. Be sure the "REST" indicator light in the overhead panel (B6, Figure 3-7) is illuminated.

NOTE: The truck is equipped with a Timer Delay to allow the engine to run at idle for 5 minutes before Engine Shutdown, if this option is desired, refer to DELAYED ENGINE SHUTDOWN PROCEDURE (next page).

3. With engine cooled down, turn keyswitch (1, Figure 3-6) counterclockwise to "Off" position for normal shutdown of engine.

If engine does not shutdown with keyswitch, use Engine Shutdown Switch (8, Figure 3-4) on operator cab center console, and hold this switch down until engine stops.

4. With keyswitch "Off", and engine stopped, wait at least 90 seconds. Insure steering circuit is completely bled down by turning steering wheel back and forth several times. No front wheel movement will occur when hydraulic pressure is relieved. If the vehicle continues to steer after shutdown, notify maintenance personnel.
5. Verify that all the LINK VOLTAGE lights are OFF (one on back wall of operator cab, and two on deck control cabinets), and notify maintenance personnel, if any light remains illuminated longer than five minutes after engine shutdown.
6. Close and lock all windows, remove key from keyswitch and lock cab to prevent possible unauthorized truck operation. Dismount truck properly. Put wheel chocks in place.

DELAYED ENGINE SHUTDOWN PROCEDURE

1. Stop the truck out of the way of other traffic on a level surface and free of overhead power lines or other obstructions (in case dump body should need to be raised).
 - a. Reduce engine speed to low idle.
 - b. Place the directional Selector Switch (2, Figure 3-4) in "Neutral".
 - c. Apply the Parking Brake switch (13, Figure 3-6). Be sure the "Parking BrakeApplied" indicator light in the overhead display panel (A3, Figure 3-7) is illuminated.
2. Place REST switch (26, Figure 3-6) in "On" position to put AC Drive System in "R ST" mode of operation. Be sure the "REST" indicator light in the overhead panel (B6, Figure 3-7) is illuminated.
3. Refer to INSTRUMENT PANEL AND INDICATOR LIGHTS section for location on instrument panel of **Engine Shutdown Switch with 5 Minute Idle Timer Delay** (2, Figure 3-6). This is a 3-position rocker-type switch (Off-On-Momentary).

- a. Press top of switch to the "On" (center position), then press firmly to the "Momentary" (upper position) and hold this position briefly to activate the 5 Minute Idle Timer (switch is spring-loaded to return to "On" position when released).

At the SAME time while holding the "Momentary" switch position, turn the Keyswitch counterclockwise to the "Off" position.

When the engine stops after the 5 minute idle period, the hydraulic bleddown timer will be activated and turn off the 24 VDC electric circuits controlled by the keyswitch.

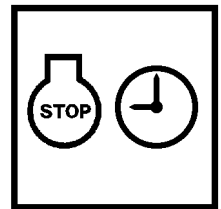

Engine WILL NOT SHUT DOWN, if keyswitch is not turned "Off" in this manner.

NOTE: To cancel the 5 Minute Idle Timer sequence, press Timer Delay Shutdown switch to the "Off" (lower) position.

- If keyswitch is in "Off" position, engine will stop.
- If keyswitch is in "On" position, engine will continue to run.

If engine does not shutdown with keyswitch, use Engine Shutdown Switch (8, Figure 3-4) on operator cab center console, and hold this switch down until engine stops. The Ground Level Shutdown Switch will also stop the engine during this time-out.

- b. When the Engine Shutdown Timer has been activated, the Timer Delay indicator light in the overhead display panel (C4, Figure 3-7) will illuminate to indicate that the shutdown timing sequence has been started. The engine will continue to run at Idle RPM for approximately 5 minutes to allow for proper engine cool-down before stopping.

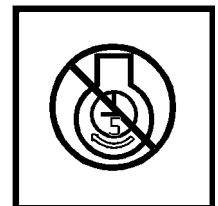

- c. After engine has stopped, perform steps 4, 5, and 6, in "NORMAL ENGINE SHUTDOWN PROCEDURE" above.

NOTES:

OPERATOR CAB AND CONTROLS

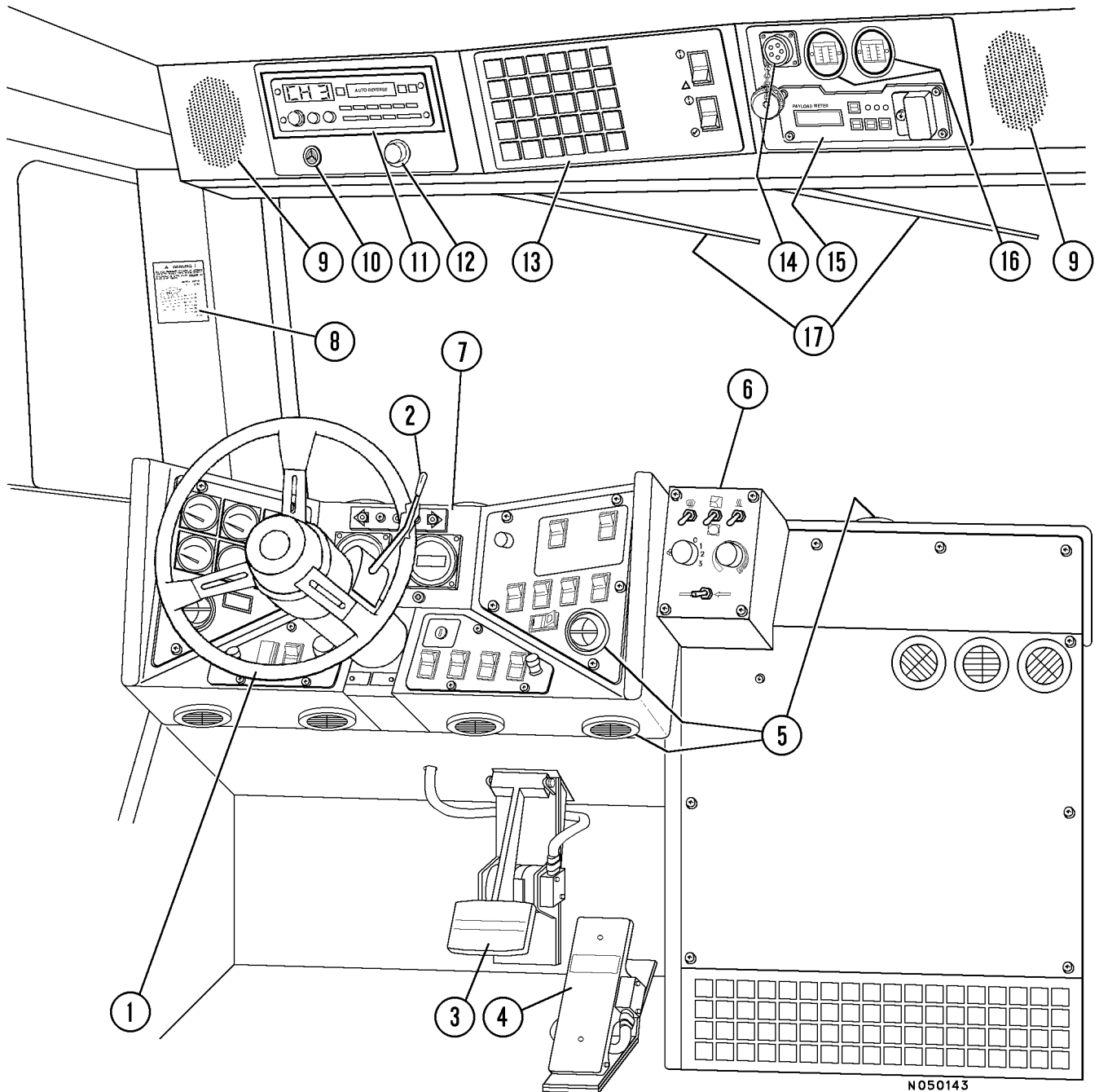

FIGURE 3-1. CAB INTERIOR - OPERATOR VIEW

- | | | |
|------------------------------------|-----------------------------------|--------------------------------------|
| 1. Steering Wheel | 7. Instrument Panel | 12. Warning Lights Dimmer Control |
| 2. Retarder Control Lever | 8. Grade / Speed Chart | 13. Warning/Status Indicator Lights |
| 3. Retarder / Service Brake Pedal | 9. Radio Speakers | 14. Payload Meter Download Connector |
| 4. Throttle / Accelerator Pedal | 10. Warning Alarm Buzzer | 15. Payload Meter II |
| 5. Heater/Air Conditioner Vents | 11. Radio, AM/FM Stereo, Cassette | 16. Air Cleaner Vacuum Gauges |
| 6. Heater/Air Conditioner Controls | | 17. Windshield Wipers |

STEERING WHEEL AND CONTROLS

The steering wheel (1, Figure 3-2) will telescope “in” and “out” and adjust through a tilt angle to provide a comfortable wheel position for most operators.

HORN BUTTON

The horn (2, Figure 3-2) is actuated by pushing the button in the center of the steering wheel. Operation of the horn should be verified before moving the truck. Observe all local safety rules regarding the use of the horn as a warning signal device before starting engine and moving the vehicle.

TELESCOPE LOCK RING

The Telescope Lock Ring (3, Figure 3-2) around the horn button locks/unlocks the telescoping function of the steering column. Rotating the ring (*) counter-clockwise (L.H. rotation), releases the column to move “in” or “out”. Rotating the ring clockwise (R.H. rotation), locks the column in the adjusted position.

(*) **DO NOT ROTATE RING MORE THAN 90°!**
Electrical ground wire may be cut!

TILT WHEEL LEVER

Adjust the tilt of the steering wheel by pulling the tilt adjustment lever (4, Figure 3-2) toward the steering wheel and moving the wheel to the desired angle. Releasing the lever will lock the wheel in the desired location.

TURN SIGNAL / HEADLIGHT DIMMER

The Turn Signal Lever (5, Figure 3-2) is used to activate turn signal lights and to select either high or low headlight beams.

Move the lever upward to signal a turn to the right.



An indicator in the top, center of the instrument panel will illuminate to indicate turn direction selected.

Refer to INSTRUMENT PANEL & INDICATOR LIGHTS.

Move the lever downward to signal a turn to the left.



Moving the lever toward the steering wheel changes Headlight beam.

When high beams are selected, the indicator in the top, center of the instrument panel will illuminate.

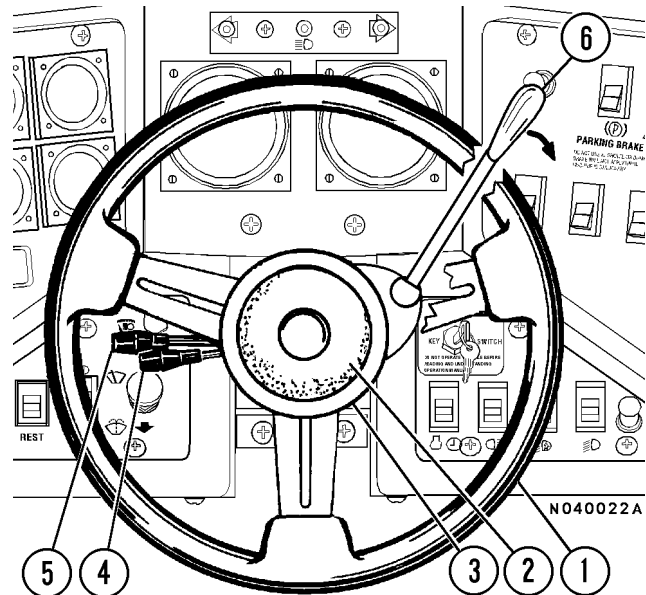

FIGURE 3-2. STEERING WHEEL AND CONTROLS

DYNAMIC RETARDING

Dynamic Retarding is a **braking torque** (not a brake) produced through electrical generation by the wheel-motors when the truck motion (momentum) is the propelling force. For normal truck operation, Dynamic Retarding should be used to slow and control the speed of the truck.

Dynamic Retarding is available in “Forward/Reverse” at all truck speeds above 0 mph/kph; however, as the truck speed slows below 3 mph (4.8 kph), the available retarding force may not be effective. Use the service brakes to bring the truck to a COMPLETE stop.

Dynamic Retarding will NOT hold a stationary truck on an incline; use the Parking Brake or Wheel Lock brake for this purpose.

Dynamic Retarding is available in “Neutral” only when truck speed is above 3 mph (4.8 kph).

When dynamic retarding is in operation, the engine RPM will automatically go to an advance RPM retard speed setting (usually 900 - 1000 RPM*).

* *NOTE: The exact engine speed in retarding may vary due to the temperature of certain components; this is controlled by the Propulsion System Controller.*

Dynamic retarding will be applied **automatically**, if the speed of the truck obtains the maximum truck speed of 40 MPH (64 KPH). Any application of the Dynamic retarding system (automatic, retarder lever, or foot pedal) will cause an indicator light to illuminate in the overhead display panel (D3, Figure 3-7).

The Grade/Speed Chart (8, Figure 3-1) should always be followed to determine MAXIMUM safe truck speeds for descending various grades with a loaded truck.

DYNAMIC RETARDER CONTROL LEVER

The Dynamic Retarder Control Lever (6, Figure 3-2) mounted on the right side of the steering column can be used to modulate retarding effort. The lever will command the full range of retarding and will remain at a fixed position when released.

- a. When the lever is rotated to full "Up" (counter-clockwise) position, it is in the "Off/No Retard" position.
- b. When the lever is rotated to full "Down" (clockwise) position, it is in the full "On/Retard" position.
- c. For long downhill hauls, the lever may be positioned to provide a desired retarding effort, and it will remain where it is positioned.

NOTE: The Retarder Control Lever must be rotated back to the "Off" position before the truck will resume the PROPEL mode of operation.

The lever and foot-operated Retarder/Service Brake pedal can be used simultaneously or independently. The Propulsion System Controller (PSC) will determine which device is requesting the most retarding effort and apply that amount.

DYNAMIC RETARDER/SERVICE BRAKE PEDAL

The Dynamic Retarder/Service Brake Pedal (3, Figure 3-1) is a single, foot-operated pedal which controls both retarding and service brake functions. The first portion of pedal travel commands retarding effort through a rotary potentiometer. The second portion of pedal travel modulates service brake pressure directly through a hydraulic valve. Thus, the operator must first apply, and maintain, full dynamic retarding in order to apply the service brakes. Releasing the pedal returns the brake and retarder to the "off" position.

When the pedal is partially depressed, the dynamic retarding is actuated. As the pedal is further depressed to where dynamic retarding is fully applied; the service brakes (while maintaining full retarding) are then actuated through a hydraulic valve, which modulates pressure to the service brakes. ***Completely depressing the pedal causes full application of both dynamic retarding AND the service brakes.*** An indicator light (B3, Figure 3-7) in the overhead panel will illuminate, and an increase in pedal resistance, will be felt when the the Service Brakes are applied.

For normal truck operation, Dynamic Retarding (lever or foot-operated pedal) should be used to slow and control the speed of the truck.

Service brakes should be applied only when dynamic retarding requires additional braking force to slow the truck speed quickly, or when bringing the truck to a COMPLETE stop.

ACCELERATOR (THROTTLE) PEDAL

The Accelerator Pedal/Throttle Pedal (4, Figure 3-1) is a foot-operated pedal which allows the operator to control engine RPM, depending on pedal depression.

It is used by the operator to request torque from the motors when in Forward or Reverse. In this mode, the propulsion system controller commands the correct engine speed for the power required. In Neutral, this pedal controls engine speed directly.

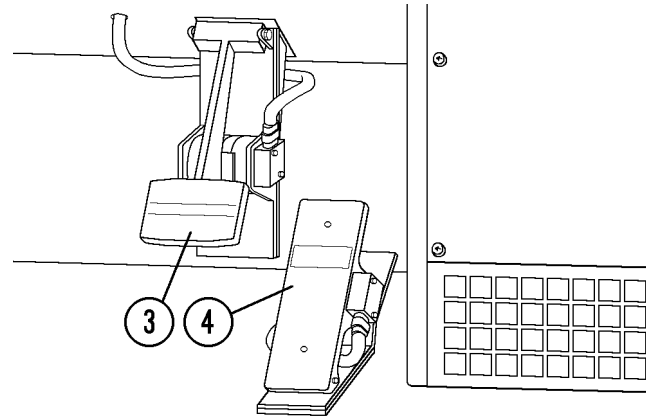

Starting On A Grade With A Loaded Truck

Initial propulsion with a loaded truck should begin from a level surface whenever possible, but when there are circumstances where the starting on a hill or grade cannot be avoided, use the following procedure:

1. Fully depress the foot-operated retarder/service brake pedal (do NOT use retarder lever) to hold the truck on the grade. With service brakes fully applied, move the selector switch to a drive position (Forward/Reverse) and increase engine RPM with throttle pedal.
2. As engine RPM approaches maximum, and operator senses propulsion effort working against the brakes, release the brakes and let truck movement start. Be sure to completely release the foot-operated retarder/service brake pedal. As truck speed increases above 3-5 MPH (5-8 KPH) the Propulsion System Control (PSC) will drop propulsion, if the retarder is still applied.

Releasing and reapplying dynamic retarding during a hill start operation will result in loss of propulsion and, if truck speed is above 1-2 mph, application of retarding effort.

HEATER / AIR CONDITIONER VENTS

Each heater/air conditioner vent (5, Figure 3-1) is a flapper type which may be opened or closed or rotated 360° for optimum air flow. There are four (three not shown) across the top of the panel, one each in the right and left panel modules, and four below the panel.

HEATER / AIR CONDITIONER COMPARTMENT AND CONTROLS

The heater/air conditioner compartment contains the heater/air conditioner controls (6, Figure 3-1) and some of the heater/air conditioner components, such as the blower motor assembly and heater coils. Optimum cab air climate can be selected by using the following controls in various combinations.

DEFROSTER VENT CONTROL SWITCH

The defroster control switch (1, Figure 3-3) directs heated air for windshield defrosting.

“Down” position of the toggle switch is OFF.

“Up” position of the toggle switch is On.

OUTSIDE/INSIDE AIR CONTROL SWITCH

The outside/inside air control switch (2, Figure 3-3) allows either outside or inside air to be circulated through the cab heater assembly.

Moving the switch “Up” directs outside air to be circulated through the heater assembly and through the cab.

Moving the switch “Down” directs inside air to be recirculated through the heater assembly.

HEAT VENT CONTROL SWITCH

The heater control (3, Figure 3-3) directs heated air to the cab floor for heating of the cab.

“Down” position of the toggle switch is OFF.

“Up” position of the toggle switch is On.

TEMPERATURE CONTROL KNOB

The temperature control knob (4, Figure 3-3) is provided for the operator to select a comfortable temperature.

Rotating the knob counter-clockwise (blue arrow) will select cooler temperatures.

Full counter-clockwise position is the coldest air setting.

Rotating the knob clockwise (red arrow) will select warmer temperatures. Full clockwise position is the warmest heater setting.

FAN CONTROL KNOB

The fan control knob (5, Figure 3-3) is provided to control the cab air fan motor. The fan motor is a 3-speed motor (low, medium and high). Speeds are selected by rotating the control knob clock-

wise to the desired position. “Off” is full counter-clockwise position.

HEATER/AIR CONDITIONER SELECTOR SWITCH

The selector switch (6, Figure 3-3) allows the operator to select heat or air conditioning, or neither. The left position of the switch activates the air conditioning and the right side of the switch activates the heater. The middle position is the “OFF” position. Neither the heat nor the air conditioning can be activated in this position.

HEATER/AIR CONDITIONER VENTS

These heater/air conditioner vents (7, Figure 3-3) may be rotated 360°. Air flow through the vents is controlled by manually opening/closing or turning the louvers.

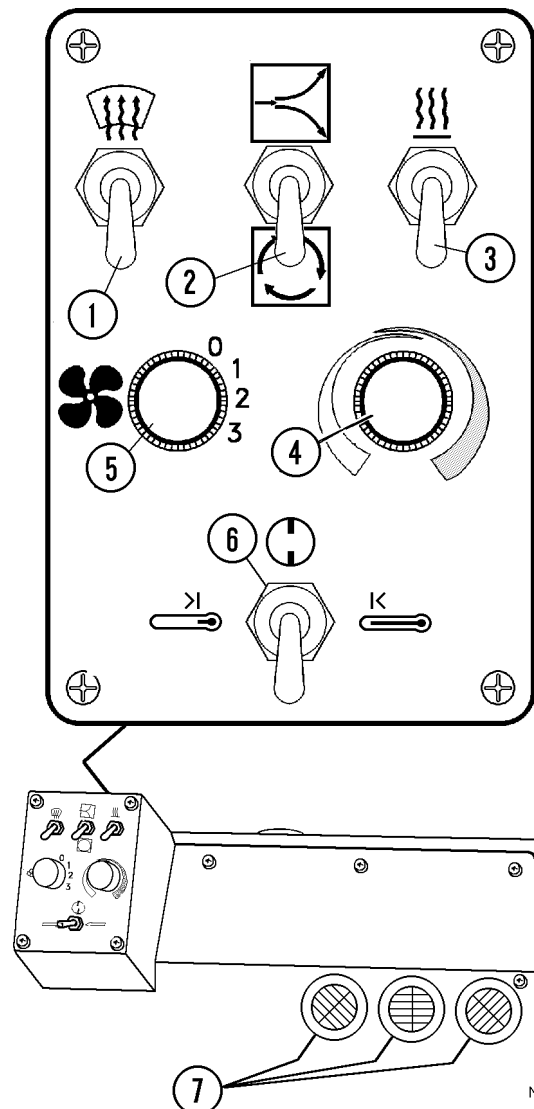

FIGURE 3-3. A/C & HEATER CONTROLS

N050139

INSTRUMENT PANEL

The Instrument Panel (7, Figure 3-1) includes a wide variety of switches, gauges, and indicators. Refer to INSTRUMENT PANEL AND INDICATOR LIGHTS, for a detailed description of function and location of these components.

GRADE/SPEED CHART

The Grade/Speed chart (8, Figure 3-1 & shown below) provides the recommended MAXIMUM truck speeds for descending various grades with a fully loaded truck.

The operator should reference this chart before descending any grade with a loaded truck. Proper use of Dynamic Retarding will maintain a safe speed.

NOTE: This decal may change with OPTIONAL truck equipment such as: wheelmotor drive train ratios, retarder grids, tire sizes, etc.

ALWAYS refer to this decal in the operator's cab, and follow recommendations for truck operation.

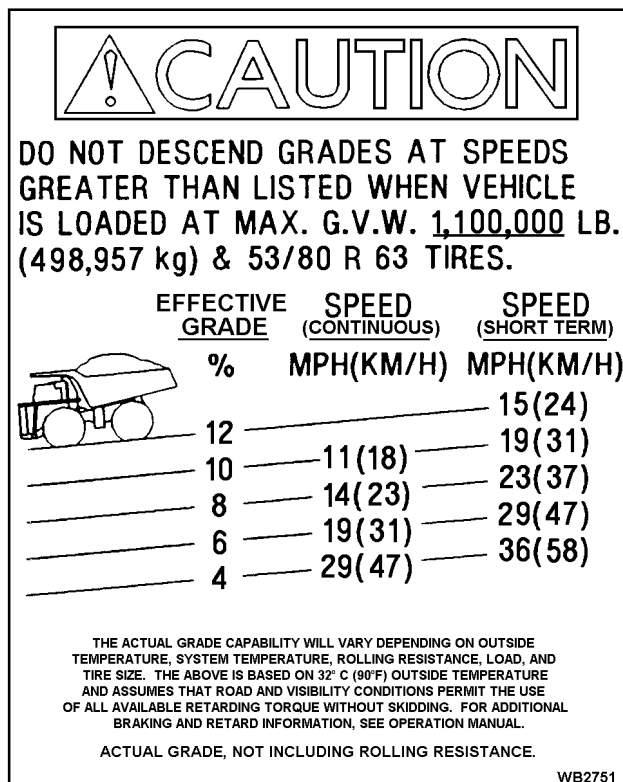

Two lists are provided, one a continuous rating and the second a short-term (3-minute) rating. Both lists are matched to a truck at maximum Gross Vehicle Weight.

The continuous numbers on the chart indicate the combination of speeds and grades which the vehicle can safely negotiate for unlimited time or distance.

The short-term (3-minute) numbers listed on the chart indicate the combination of speeds and grades which the vehicle can safely negotiate for three minutes. These speeds are faster than the continuous values, reflecting the thermal capacity of various system components. System components can accept heating at a

higher-than-continuous rate for a short period of time beyond which the system would become over-temperature.

If the vehicle is operated at short-term grade and speed limits for a period of time greater than three minutes, the retarding effort may begin to reduce, resulting in vehicle acceleration. The service brakes are available to slow the truck within the continuous level. This reduction in retarding effort will be gradual as the vehicle moves from the short-term limits to the continuous limits.

The “three-minute” curve is a minimum and the actual time limit could be greater. Ambient temperature, barometric pressure and recent motor power levels can affect this number.

The three-minute rating will successfully accommodate most downhill loaded hauls. It is necessary to divide haul road grade segment length by allowable speed to determine actual time on grade. If actual time on grade exceeds the allowable amount, the grade will need to be negotiated at the continuous speed.

DO NOT exceed these recommended MAXIMUM speeds when descending grades with a loaded truck.

RADIO SPEAKERS

Radio Speakers (9, Figure 3-1) for the AM/FM Stereo radio are located at the far left and right of the overhead panel.

WARNING ALARM BUZZER

This alarm (10, Figure 3-1) will sound when activated by any one of several truck functions. Refer to INSTRUMENT PANEL AND INDICATOR LIGHTS, for a detailed description of functions and indicators that will activate this alarm.

CAB RADIO

This panel will normally contain an AM/FM Stereo radio (11, Figure 3-1). Refer to Section 6, Optional Equipment, for a more complete description of the radio and its functions.

Individual customers may use this area for other purposes, such as a two-way communications radio.

Warning Lights Dimmer Control

This control knob (12, Figure 3-1) permits the operator to adjust the brightness of the Warning Indicator Lights.

STATUS / WARNING INDICATOR LIGHT PANEL

This panel (13, Figure 3-1) contains an array of indicator lights to provide the operator with important status messages concerning selected truck functions. Refer to INSTRUMENT PANEL AND INDICATOR LIGHTS, for a detailed description of these indicators.

Payload Meter Download Connector

This connector (14, Figure 3-1) is used with a special cable to allow the Payload Meter (15) to communicate with a Portable Computer.

PAYLOAD METER

The Payload Meter (15, Figure 3-1) and Download Connector (14) is used to provide management with operational data such as tonnage hauled and cycle times.

Refer to Section 6, Optional Equipment, for a more complete description of the payload meter and its functions.

AIR CLEANER VACUUM GAUGES

The Air Cleaner Vacuum Gauges (16, Figure 3-1) provide a continuous reading of maximum air cleaner restriction reached during operation.

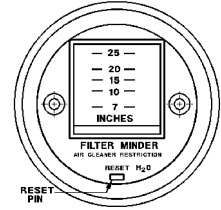

The air cleaner(s) should be serviced when the gauge(s) shows the following maximum recommended restriction:

Cummins QSK60 Engine: 25 inches of H₂O vacuum.

NOTE: After service, push the reset button on face of gauge to allow the gauge to return to zero.

WINDSHIELD WIPERS

The windshield wipers (17, Figure 3-1) are powered by an electric motor. Refer to INSTRUMENT PANEL AND INDICATOR LIGHTS, for a location and description of the windshield wiper and washer controls.

CENTER CONSOLE CONTROLS AND FEATURES

The Center Console (1, Figure 3-4) contains:

- (1) Center Console
- (2) F-N-R Selector Switch
- (3) Hoist Control Lever
- (4) Ash Tray
- (5) Cigar/Cigarette Lighter
- (6) L.H. Window Control Switch
- (7) R.H. Window Control Switch
- (8) Engine Shutdown Switch
- (9) Override/Fault Reset Switch
- (10) BLANK - NOT USED on this truck
- (11) RSC "Off/On" Switch
- (12) Retarder Speed Control Dial
- (13) Propulsion System Controller (PSC) Diagnostic Port
- (14) Engine Diagnostic Port (3 Pin)
- (15) Truck Control Interface (TCI) Diagnostic Port
- (16) Passenger Seat
(mounted on top of the right hand portion of the Console structure)
- (17) Engine Diagnostic Port (9 Pin)

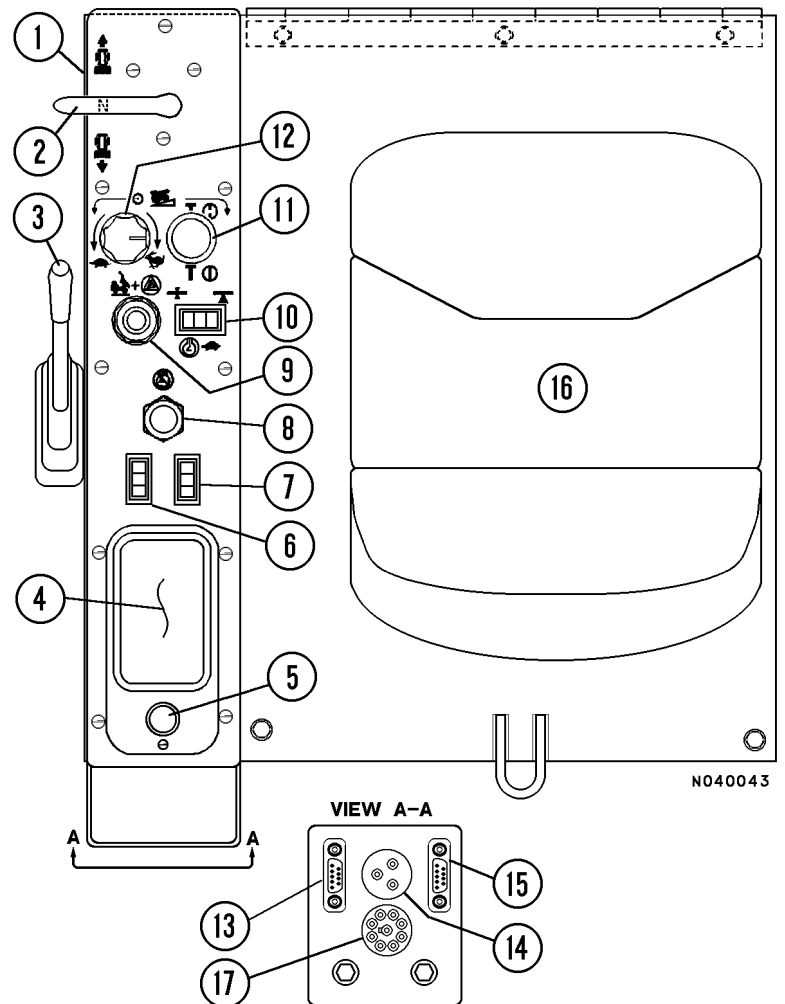

FIGURE 3-4. CENTER CONSOLE

F-N-R SELECTOR SWITCH

The Selector Switch (2, Figure 3-4) is mounted on a console to the right of the operator's seat. It is a three position switch which controls the Forward-Neutral-



Reverse motion of the truck. When the Selector Switch handle is in the center "N" position, it is in "Neutral".

The handle must be in Neutral to start the engine.

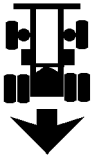

The operator can select **Forward** drive by moving the handle forward.

Reverse drive can be selected by moving the handle to the rear.

The truck should be stopped before the selector handle is moved to a drive position.

HOIST CONTROL LEVER

The hoist control (3, Figure 3-4) is a four position hand-operated lever located between the operator seat and the Center Console.

To Raise dump body:

1. Pull the lever to the rear to actuate hoist circuit. (Releasing the lever anywhere during “hoist up” will place the body in “hold” at that position.)
2. Raise engine RPM to increase hoist speed.
3. Reduce engine RPM as the last stage of the hoist cylinders begin to extend and then let the engine go to low idle as the last stage reaches half-extension.
4. Release hoist lever as the last stage reaches full extension.
5. After material being dumped clears the body, lower the body to frame.

Refer to “OPERATING INSTRUCTIONS, DUMPING” for more complete details concerning this control.

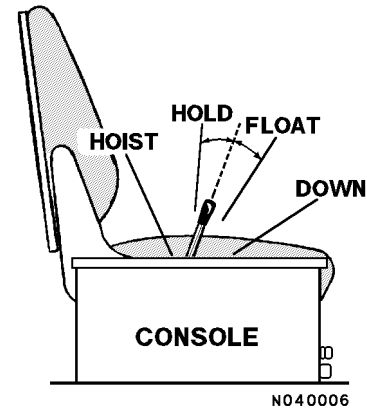

To lower body:

Move hoist lever forward to “down” position and release. Releasing the lever places hoist control valve in the “float” position allowing the body to return to frame.

ASH TRAY

The Ash Tray (4, Figure 3-4) is used for extinguishing and depositing smoking materials. DO NOT use for flammable materials, such as paper wrappers, etc.

Be certain that all fire ash is extinguished!

LIGHTER

The LIGHTER (5, Figure 3-4) may be used for lighting cigars/cigarettes.

Always use CAUTION with smoking materials!

This socket may also be used for a 12 VDC power supply.

L.H. WINDOW CONTROL SWITCH

This switch (6, Figure 3-4) is spring-loaded to the “OFF” position. Pushing the front of the switch raises the left side cab window. Pushing the rear of the switch lowers the window.

R.H. WINDOW CONTROL SWITCH

This switch (7, Figure 3-4) is spring-loaded to the “OFF” position. Pushing the front of the switch raises the right side cab window. Pushing the rear of the switch lowers the window.

ENGINE SHUTDOWN SWITCH

This switch (8, Figure 3-4) is used for engine shutdown by depressing this button and holding it until engine stops.



Use this switch to shutdown engine if engine does not shutdown by turning off keyswitch, or to shutdown engine without turning off 24 VDC electric circuits.

There is also a ground level engine shutdown switch on the left front frame rail behind the ladder.

VERRIDE / FAULT RESET SWITCH

This push-button switch (9, Figure 3-4) is spring-loaded to the "OFF" position.

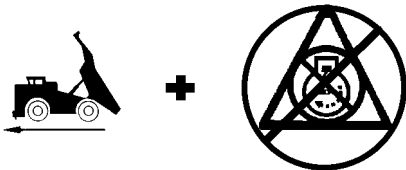

When pushed in and held, this switch may be used for several functions.

1. This switch permits the operator to override the "bodyup" switch and move the truck forward when the Selector Switch is in Forward, the dump body is raised, and the brakes are released.

! Use of the override switch for this purpose is intended for emergency situations only!

2. The override switch is also used to reset an electric system fault when indicated by a red warning light (Refer to "Instrument Panel And Indicator Lights", Overhead Warning / Status panel).

10, FIGURE 3-4 - BLANK

This position is not used for the 930E.

In some other truck models, this position is used for an Engine Idle Switch.

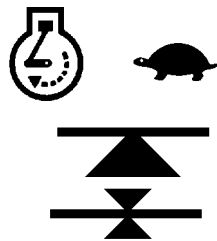

RETARD SPEED CONTROL (RSC) "OFF/ON" SWITCH

The Retard Speed Control Switch (11, Figure 3-4) turns the system "OFF" or "ON". Push the knob "IN" to turn "OFF" and pull the knob "OUT" to turn the system "ON".

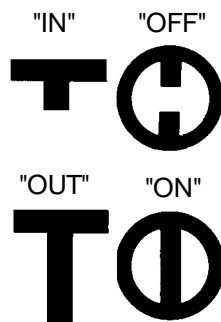

RETARD SPEED CONTROL (RSC) ADJUST DIAL

The RSC Adjust Dial (12, Figure 3-4) allows the operator to vary the downhill truck speed that the Retard Speed Control system will maintain when descending a grade. This function can be overridden by either the accelerator, retard lever, or retard pedal.

When the dial is rotated counterclockwise toward this symbol, the truck will descend a grade at lower speeds.



When the dial is rotated clockwise toward this symbol, the truck speed will increase.



ALWAYS refer to the Grade/Speed decal in the operator's cab, and follow the recommendations for truck operation. **DO NOT** exceed these recommended **MAXIMUM** speeds when descending grades with a loaded truck.

Throttle pedal position will override RSC setting. If operator depresses throttle pedal to increase truck speed, Dynamic Retarding will not come on unless truck overspeed setting is reached or foot operated retard pedal is used. When throttle pedal is released and RSC switch is "On", Dynamic Retarding will come on at, or above, the RSC dialed speed and will adjust truck speed to, and maintain, the dialed speed.

To adjust RSC control, pull switch (11) "On" and start with dial (12) rotated toward fastest speed while driving truck at desired maximum speed. Relax throttle pedal to let truck coast and turn RSC Adjusting Dial slowly counterclockwise until Dynamic Retarding is activated. Dynamic Retarding will now be activated automatically anytime the "set" speed is reached, the RSC switch is "On", and throttle pedal is released.

With RSC switch "On" and dial adjusted, the system will function as follows: As truck speed increases to the "set" speed and throttle pedal released, Dynamic Retarding will apply. As truck speed tries to increase, the amount of retarding effort will automatically adjust to keep the selected speed. When truck speed decreases, the retarding effort is reduced to maintain the selected speed. If truck speed continues to decrease to approximately 3 mph (4.8 kph) below "set" speed, Dynamic Retarding will turn off automatically. If truck speed must be reduced further, the operator can turn the Adjust Dial to a new setting or depress the foot operated retard pedal.

If the operator depresses the foot operated retard pedal and the retard effort called for is greater than that from the automatic system, the foot pedal retard will override RSC.

PSC DOWNLOAD PORT

This connector (13, Figure 3-4) is for use by qualified personnel to access diagnostic information for the Propulsion System Controller (PSC).

ENGINE DIAGNOSTICS DOWNLOAD PORT

This 3-PIN connector (14, Figure 3-4) is for use by qualified personnel to access the diagnostic information for the Engine Monitoring system. (CENSE).

TCI DOWNLOAD PORT

This connector (15, Figure 3-4) is for use by qualified personnel to access the Truck Control Interface (TCI) diagnostic information and data.

PASSENGER SEAT

The Passenger Seat (16, Figure 3-4) is mounted on top of the right hand portion of the Center Console structure.

The area beneath the passenger seat provides a cabinet for various 24 VDC electrical components.

Consult the Shop Manual for service involving any of these components.

ENGINE CONTROL SYSTEM

This 9-PIN connector (17, Figure 3-4) is for use by qualified personnel to access the diagnostic information for the Engine Control system. (QUANTUM)

OPERATOR COMFORT

OPERATOR SEAT

The operator's seat provides a fully adjustable cushioned ride for the driver's comfort and ease of operation.

Adjustment

The following adjustments must be made while sitting in the seat.

1. **Headrest:** headrest (1, Figure 3-5) will move up, down, fore, or aft by moving headrest to desired position.
2. **Armrests:** rotate adjusting knob until armrest is in desired position.
3. **Seat Belt:** Operator should always have seat belt buckled in place and properly adjusted whenever vehicle is in motion.
- 4 & 5. **Air Lumbar Support:** Each rocker switch (4 or 5) controls an air pillow. Switch (5) controls the lower air pillow and switch (4) controls the upper air pillow. To inflate, press on top of rocker switch and hold for desired support, then release. To deflate, press on bottom of rocker switch and hold for desired support, then release. Adjust each pillow for desired support.
6. **Seat Height:** Press rocker switch (6) on top to increase ride height. Press on lower part of rocker switch to lower ride height.
7. **Backrest:** Pull control (7) upward and hold, select backrest angle; release control handle.
8. **Fore/Aft Location of Seat:**
 - a. Raise adjustment lever (8).
 - b. Move seat to desired position; release lever.
9. **Front Height and Slope Adjustment of Seat Cushion:**
 - a. Front height and slope; lift control lever (9) and hold.
 - b. Bend knees to move seat to a comfortable position; release control lever to lock adjustment.

Seat Removal

1. Remove capscrews (10, Figure 3-5) and hardware that secures the seat base to the riser. Remove capscrews (11) that secures tether to floor.
2. Remove seat assembly from cab to clean work area for disassembly.

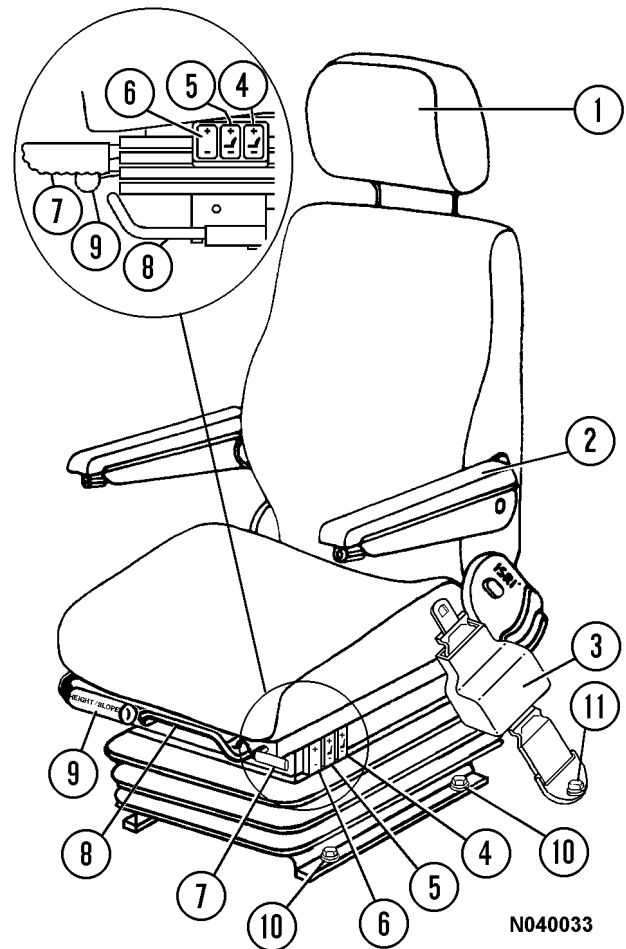

FIGURE 3-5. OPERATOR'S SEAT
ADJUSTMENT CONTROLS

1. Headrest
2. Armrest Adjustment
3. Seat Belt
4. Upper Air Pillow Lumbar Support
5. Lower Air Pillow Lumbar Support
6. Height Adjustment
7. Backrest Adjustment
8. Fore and Aft Adjustment
9. Front Height and Slope Adjustment
10. Mounting Capscrews and Hardware
11. Seat Tether Capscrew

Seat Installation

1. Mount seat assembly to seat riser. Install capscrews (10, Figure 3-5), lockwashers, flatwashers and nuts. Tighten capscrews to standard torque.
2. Fasten tether straps to floor with capscrews (11), flatwashers and lockwashers. Tighten capscrews to standard torque.

NOTES

INSTRUMENT PANEL AND INDICATOR LIGHTS

CONTROL SYMBOLS

Many control functions are identified with “International” symbols that the operator should learn to recognize immediately. The operator must understand the function and operation of each instrument and control. This knowledge is essential for proper and safe operation of the machine.

The following symbols are general indicators and may appear in multiple locations and combinations on the instrument panel.

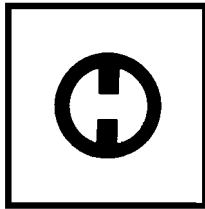

This symbol may be used alone or with another symbol. This symbol identifies the “Off” position of a switch or control.

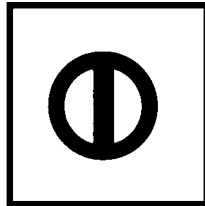

This symbol may be used alone or with another symbol. This symbol identifies the “On” position of a switch or control.

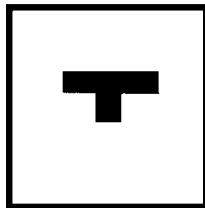

This symbol identifies the “Pushed-In” position of a push-pull switch or control.

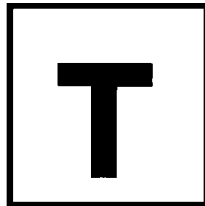

This symbol identifies the “Pulled-Out” position of a push-pull switch or control.

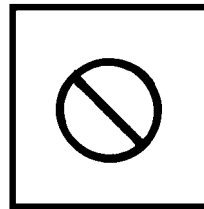

This symbol when it appears on an indicator or control identifies that this indicator or control is **NOT** used.

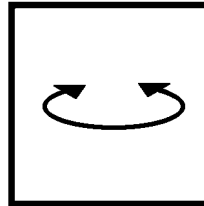

This symbol identifies a rotary control or switch. Rotate the knob clockwise or counterclockwise for functions.

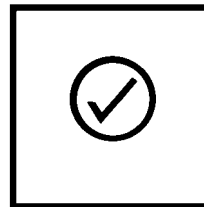

This symbol identifies a switch used to test or check a function. Press the switch on the side near the symbol to perform the test.

INSTRUMENT PANEL (Figure 3-6)

The operator must understand the function and operation of each instrument and control. Control functions are identified with “International” symbols that the operator should learn to recognize immediately. This knowledge is essential for proper and safe operation.

Items that are marked **OPTIONAL** do not apply to every truck.

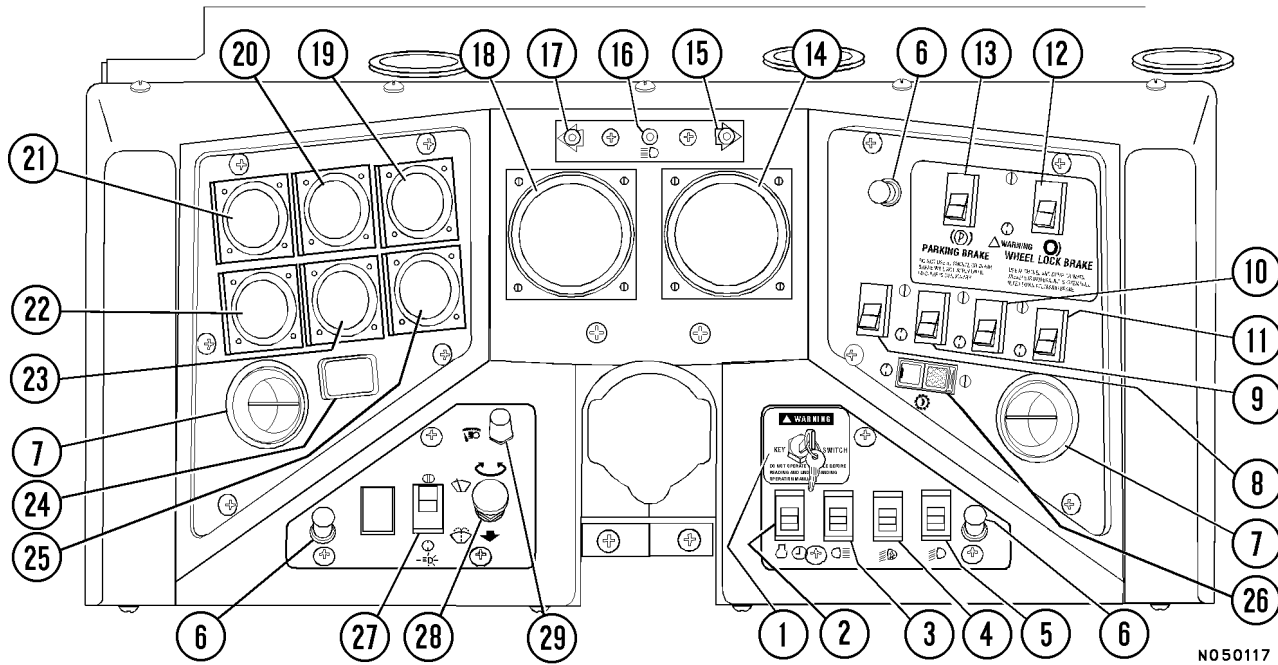

NO50117

FIGURE 3-6. PANEL GAUGES, INDICATORS, AND CONTROLS

- | | |
|--|---|
| 1. Keyswitch | 15. Right Turn Signal Indicator Light |
| 2. Engine Shutdown Switch with Timer Delay | 16. High Beam Headlight Indicator Light |
| 3. Backup Light Switch (N./O.) | 17. Left Turn Signal Indicator Light |
| 4. Ladder Light Switch (3 - Way) | 18. Digital Speedometer |
| 5. Fog Light Switch (N./O.) | 19. Voltmeter Gauge |
| 6. Panel Illumination Light(s) | 20. Engine Oil Pressure Gauge |
| 7. Vent(s) - Cab Air Conditioner/Heater | 21. Engine Water Temperature Gauge |
| 8. Not used on 930E | 22. Fuel Gauge |
| 9. Rotating Beacon Light Switch (N./O.) (Optional) | 23. AC Drive System Temperature |
| 10. Heated Mirror Switch (N./O.) (Optional) | 24. Engine Hourmeter |
| 11. Not used on 930E | 25. Hydraulic/Brake Oil Temperature |
| 12. Wheel Brake Lock Switch (N./O.) | 26. AC REST Switch |
| 13. Parking Brake Switch (N./O.) | 27. Headlights Switch (N./O.) |
| 14. Digital Tachometer | 28. Wiper / Washer Switch |
| | 29. Panel Illumination Lights Dimmer Rheostat |

WIRE NUMBERS

- | | | |
|-------------------------------|--------------------------------|---|
| 1. 712/21PB/11S | 11. 71/79M/SPR55/79H/72F/SPR54 | 21. 712D/31TS/710/49 |
| 2. 11S/11TD/11R | 12. 712BL/52B/39H/710/SPR59 | 22. 712D/38G/710/49 |
| 3. 712/47S/47L/710 | 13. 71/52C/21PB/21 | 23. 15V/72MT/49/710 |
| 4. 11L/48A/48B | 14. 41TS/74X/74Z/710 | 24. 11L/36 |
| 5. 11L/48F | 15. 45R/710 | 25. 15V/34BT/710/49 |
| 6. 49/710 | 16. 41H/710 | 26. 710/72RQ |
| 7. No Wires | 17. 45L/710 | 27. 11D/41L/41TS |
| 8. 712/28E | 18. 41TS/77/77A/710 | 28. High 66S/Low 66L/710/66P Pulse/
712W / Washer 66 |
| 9. 11L/11RB | 19. 712D/710/49 | 29. 49/41TS |
| 10. 712/69M/SPR56/SPR57/SPR58 | 20. 712D/31PS/710/49 | |

PANEL GAUGES, INDICATORS, AND CONTROLS (Figure 3-6)

(1, Figure 3-6) KEY SWITCH

The key switch is a 3-position (Off, Run, Start) switch. When switch is rotated one position clockwise, it is in the "Run" position and all electrical circuits (except "Start") are activated. With Selector Switch in "Neutral", rotate keyswitch fully clockwise to "Start" position and hold this position until engine starts. "Start" position is spring loaded to return to "Run" when key is released. With truck stopped, turn keyswitch counterclockwise to "Off" for normal engine shutdown. Use Engine Shutdown switch on center console, if engine does not shutdown with keyswitch.

NOTE: A ground level shutdown switch is located on lower front left side of truck.

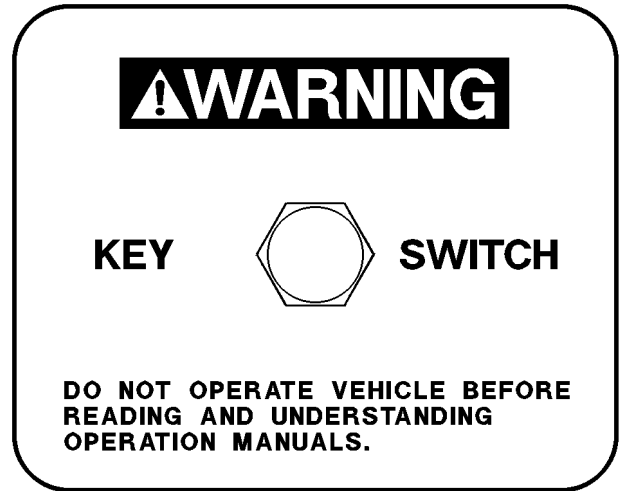

(2, Figure 3-6) ENGINE SHUTDOWN SWITCH with 5 MINUTE IDLE TIMER DELAY

This is a 3-position rocker-type switch (Off-On-Momentary). Refer to "OPERATING INSTRUCTIONS" section, "DELAYED ENGINE SHUTDOWN PROCEDURE", for a complete detailed operation of this switch.

1. Press top of switch to the "On" (center position), then press firmly to the "Momentary" (upper position) and hold this position briefly to activate the 5 Minute Idle Timer (switch is spring-loaded to return to "On" position when released).

At the SAME time while holding the "Momentary" switch position, turn the Keyswitch counterclockwise to the "Off" position.

When the engine stops after the 5 minute idle period, the hydraulic bleeddown timer will be activated and turn off the 24 VDC electric circuits controlled by the keyswitch.

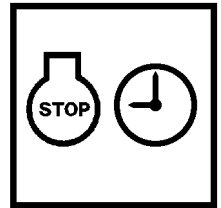

Engine WILL NOT SHUT DOWN, if keyswitch is not turned "Off" in this manner.

NOTE :

To cancel the 5 Minute Idle Timer sequence, press Timer Delay Shutdown switch to the "Off" (lower) position.

- *If keyswitch is in "Off" position, engine will stop.*
- *If keyswitch is in "On" position, engine will continue to run.*

If engine does not shutdown with keyswitch, use Engine Shutdown Switch (8, Figure 3-4) on operator cab center console, and hold this switch down until engine stops. The Ground Level Shutdown Switch will also stop the engine during this time-out.

2. When the Engine Shutdown Timer has been activated, the Timer Delay indicator light in the overhead display panel (C4, Figure 3-7) will illuminate to indicate that the shutdown timing sequence has been started. The engine will continue to run at Idle RPM for approximately 5 minutes to allow for proper engine cool-down before stopping.

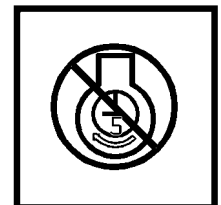

(3, Figure 3-6) MANUAL BACKUP SWITCH

The Manual Backup Switch allows backup lights to be turned “On” providing added visibility and safety when the Selector Switch (see OPERATOR CONTROLS) is not in “REV” position. When the SWITCH is pressed toward the “on” position, the MANUAL BACK UP LIGHT indicator (B4, Overhead Panel) will be illuminated.

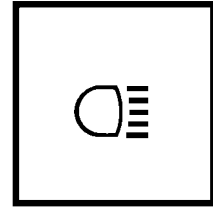

(4, Figure 3-6) LADDER LIGHT SWITCH

The switch turns the ladder lights “On” or “Off” after or before using ladder. Pressing the top of the rocker switch turns the lights “On”. Pressing the bottom of the switch turns the lights “Off”. Another switch is mounted at the front left of truck near the base of ladder.

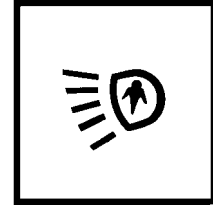

(5, Figure 3-6) FOG LIGHTS (OPTIONAL)

Fog Lights are optional equipment that are useful in foggy conditions and heavy rain. Pressing the top of the rocker switch turns the lights “On”. Pressing the bottom of the switch turns the lights “Off”.

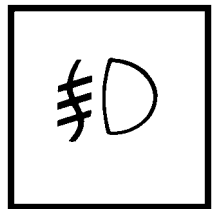

(6, Figure 3-6) PANEL ILLUMINATION LIGHTS

These lights provide illumination for the instrument panel. Brightness is controlled by the panel light dimmer switch (28).

(7, Figure 3-6) CAB AIR CONDITIONER / HEATER VENTS

These Vents are spherically mounted and may be directed by the operator to provide the most comfortable cabin air flow.

(8, Figure 3-6) NOT USED ON 930E

(9, Figure 3-6) ROTATING BEACON LIGHT SWITCH (OPTIONAL)

If truck is equipped with the OPTIONAL Rotating Beacon Light, it will be activated by this rocker-type switch when it is pressed toward the “on” position.

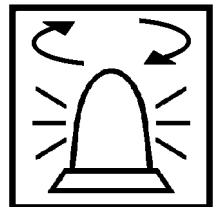

(10, Figure 3-6) HEATED MIRROR SWITCH (OPTIONAL)

If truck is equipped with the OPTIONAL Heated Mirror, it will be activated by this rocker-type switch when it is pressed toward the “on” position.

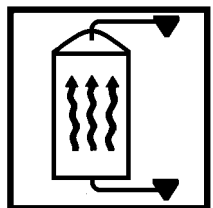

(11, Figure 3-6) NOT USED ON 930E

(12, Figure 3-6) WHEEL BRAKE LOCK CONTROL



The Wheel Brake Lock should be used with engine running for dumping and loading operations only. The brake lock switch actuates the hydraulic brake system which locks the **rear wheel service brakes only**. When pulling into shovel or dump area, stop the truck using the foot-operated service brake pedal. When truck is completely stopped and in loading position, apply the brake lock by pressing the rocker switch toward the “On” symbol. To release, press the rocker switch toward the “Off” symbol.

Use at shovel and dump only to hold truck in position.

Do not use this switch to stop truck, unless foot-operated treadle valve is inoperative. Use of this switch applies rear service brakes at full, unmodulated pressure!

Do not use brake lock for parking. With engine stopped, hydraulic pressure will bleed down, allowing brakes to release!

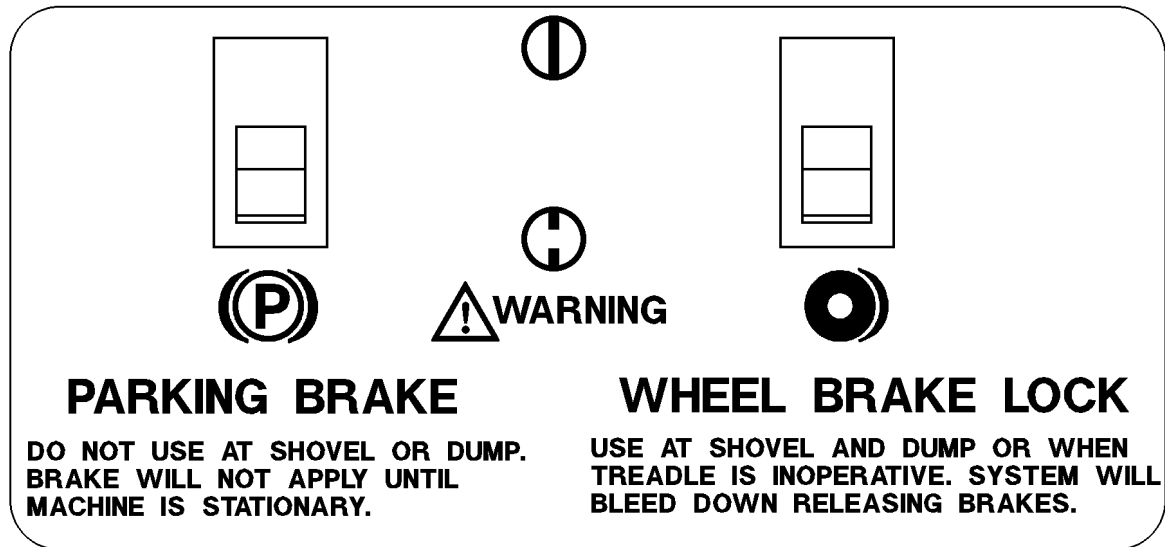

SM2729

(13, Figure 3-6) PARKING BRAKE CONTROL



The Parking Brake is spring applied and hydraulically released. It is designed to hold a stationary truck when the engine is shutdown and keyswitch is turned “Off”. The truck must be completely stopped before applying the parking brake, or damage may occur to parking brake.

To apply the parking brake, press the rocker switch toward the “On” symbol. To release the parking brake, press the rocker switch toward the “Off” symbol. When the keyswitch is “On” and Parking Brake switch is applied, the Parking Brake indicator light (A3, Overhead Panel) will be illuminated.

NOTE: Do not use the parking brake at shovel or dump. With keyswitch “on” and engine running, sudden shock caused by loading or dumping could cause the system’s motion sensor to RELEASE the park brake.

(14, Figure 3-6) TACHOMETER

The tachometer registers engine crankshaft speed in hundreds of revolutions per minute (RPM).

Governed RPM (Cummins QSK60-C Engine):

Low Idle - 600 RPM

Full Load - 1900 RPM

High Idle - 1910 RPM

(15, Figure 3-6) RIGHT TURN SIGNAL INDICATOR

This light illuminates to indicate the right turn signals are operating when the turn signal lever on the steering column is moved upward. Moving the lever to its center position will turn indicator "Off".

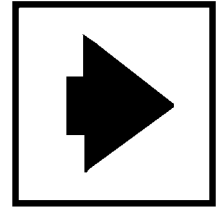

(16, Figure 3-6) HIGH BEAM INDICATOR

The high beam indicator when lit, indicates that the truck headlights are on "High" beam. To switch headlights to "High" beam, push the turn indicator lever away from steering wheel. For "Low" beam, pull lever toward the steering wheel.

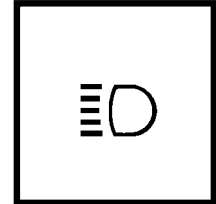

(17, Figure 3-6) LEFT TURN SIGNAL INDICATOR

This light illuminates to indicate the left turn signals are operating when the turn signal lever on the steering column is moved downward. Moving the lever to its center position will turn indicator "Off".

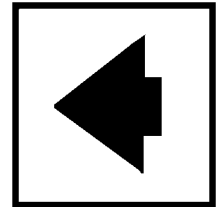

(18, Figure 3-6) SPEEDOMETER

The speedometer indicates the truck speed in miles per hour (MPH), or with OPTIONAL speedometer, it may indicate truck speed in kilometers per hour (KPH).

(19, Figure 3-6) VOLTMETER

The voltmeter indicates the voltage of the 24V battery system. Normal indicated voltage at high RPM is 27 to 28 volts with batteries in fully charged condition. When keyswitch (10) is "On" and engine is NOT running, voltmeter indicates battery charge condition.

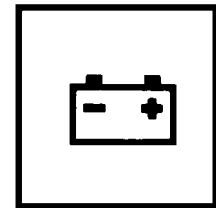

(20, Figure 3-6) ENGINE OIL PRESSURE GAUGE

The engine oil pressure gauge indicates pressure in the engine lubrication system in pounds per square inch (psi). Normal operating pressure after engine warm up should be:

- Idle - 20 psi (138 kPa) (minimum)
- Rated Speed - 45 - 70 psi (310 - 483 kPa)

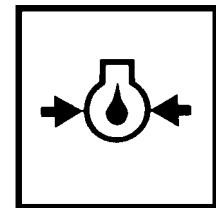

(21, Figure 3-6) WATER TEMPERATURE GAUGE

The water temperature gauge indicates the temperature of the coolant in the engine cooling system. The temperature range after engine warm-up and truck operating under normal conditions should be: 185°-207°F (85°-97°C)

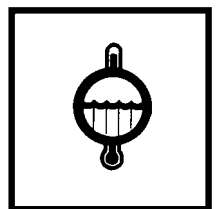

(22, Figure 3-6) FUEL GAUGE

The fuel gauge indicates how much diesel fuel is in the fuel tank. Fuel tank capacity is 1200 gallons (4542 liters).

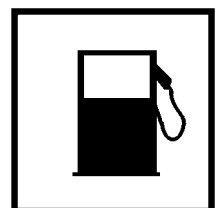

(23, Figure 3-6) AC DRIVE SYSTEM TEMPERATURE GAUGE

The Ac Drive System Temperature Gauge indicates the drive system temperature. There are three colored bands: Green; Yellow; and Red. Green indicates “Normal” operation.

Yellow indicates the system temperature is rising. There is also an amber (yellow) “temperature warning” light in the overhead panel (C5, Figure 3-7) that will illuminate when the temperature exceeds a certain level. When this condition occurs, the operator should consider changing truck operation in order to reduce system temperature.

If the Ac Drive System Temperature should reach the Red band, continued operation could damage components in the system.

Safely stop truck, shutdown engine, and notify maintenance personnel immediately.

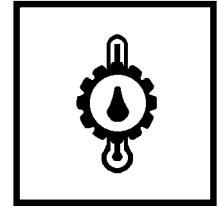

(24, Figure 3-6) HOURMETER

The hourmeter registers the total number of hours the engine has been in operation.

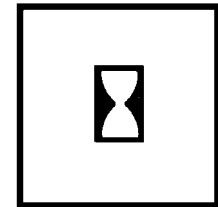

(25, Figure 3-6) HYDRAULIC OIL TEMPERATURE GAUGE

The Hydraulic Oil Temperature Gauge indicates oil temperature in the hydraulic tank. There are two colored bands: Green, and Red. Green indicates “Normal” operation.

Red indicates high oil temperature in the hydraulic tank. Continued operation could damage components in the hydraulic system. There is also a RED “temperature warning” light in the overhead panel (D5, Figure 3-7) that will illuminate when the temperature exceeds a certain level.

If this condition occurs, the operator should safely stop the truck, move Selector Switch to Neutral, apply the Park Brake, and operate engine at 1200 - 1500 RPM to reduce system temperature.

If temperature gauge does not move into the Green range after a few minutes, and the RED overhead indicator light does not go out, notify maintenance personnel immediately.

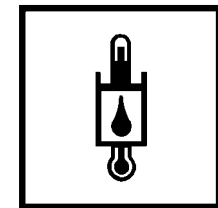

(26, Figure 3-6) REST SWITCH

The “REST” switch is a “rocker”-type switch with a locking device for the “Off” (left side) position. When the switch is in this position, a small black tab must be pushed to the left to “unlock” the switch, so that it can be depressed (rocked) to the “On” (right side) position. When the switch is in the “On” position, the switch is illuminated with a yellow/amber light.

An amber (yellow) indicator light in the overhead panel (B6, Figure 3-7) will also be illuminated when the “REST” state has been requested and entered.

The “REST” switch should be activated (turned “On”) to **de-energize the AC Drive System** whenever the engine is to be shutdown, or the truck parked for a length of time with the engine running.

The Selector Switch must be in neutral and the vehicle not moving to enable this function. This will allow the engine to continue running while the AC Drive System is de-energized.

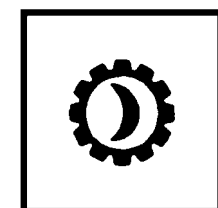
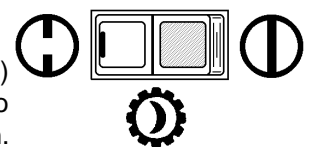

WARNING *Activation of the “REST” switch alone does NOT completely ensure that the Drive System is safe to work on. Refer to Safety Procedures, and check all “LINK-ON”, or “LINK ENERGIZED”, indicator lights to verify the AC DRIVE system is DE-ENERGIZED before performing any maintenance on the Drive System.*

DO NOT ACTIVATE THE REST SWITCH WHILE THE TRUCK IS MOVING!
The truck may unintentionally enter the REST mode after stopping.

(27, Figure 3-6) LIGHT SWITCH

The instrument panel lights, clearance lights, and the headlights are controlled by this three position rocker type switch. "Off" is selected by pressing the bottom of the switch. Press the top of the switch until it reaches the first detent to select the panel, clearance, and tail lights only.

Press the top of the switch again, until it reaches the second detent to select headlights, as well as panel, clearance, and tail lights.

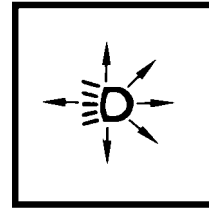

(28, Figure 3-6) WINDSHIELD WIPER and WASHER

The windshield wiper control switch is a four position rotary switch with intermittent wiper delay and wash feature. "Off" position is the detented position when the knob is rotated fully counterclockwise against the stop. The intermittent wiper position is located between "Off" and the first detent position, when rotating the knob clockwise.

Rotating the knob closer to the first detent position decreases the time interval between wiper strokes.

Rotate the knob clockwise to the first detent position for slow speed. Rotate the knob to the second detent position for fast speed.

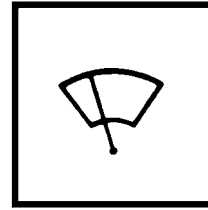

To use the windshield washer, press and hold the knob "in" to activate the windshield washer system.



(29, Figure 3-6) PANEL LIGHT DIMMER

The panel light dimmer control is a rheostat which allows the operator to vary the brightness of the instruments and panel lights. Rotating knob to the full counterclockwise position turns panel lights "On" to brightest condition. Rotating knob clockwise continually dims lights until "Off" position is reached at full clockwise rotation.

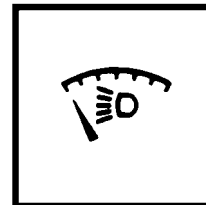

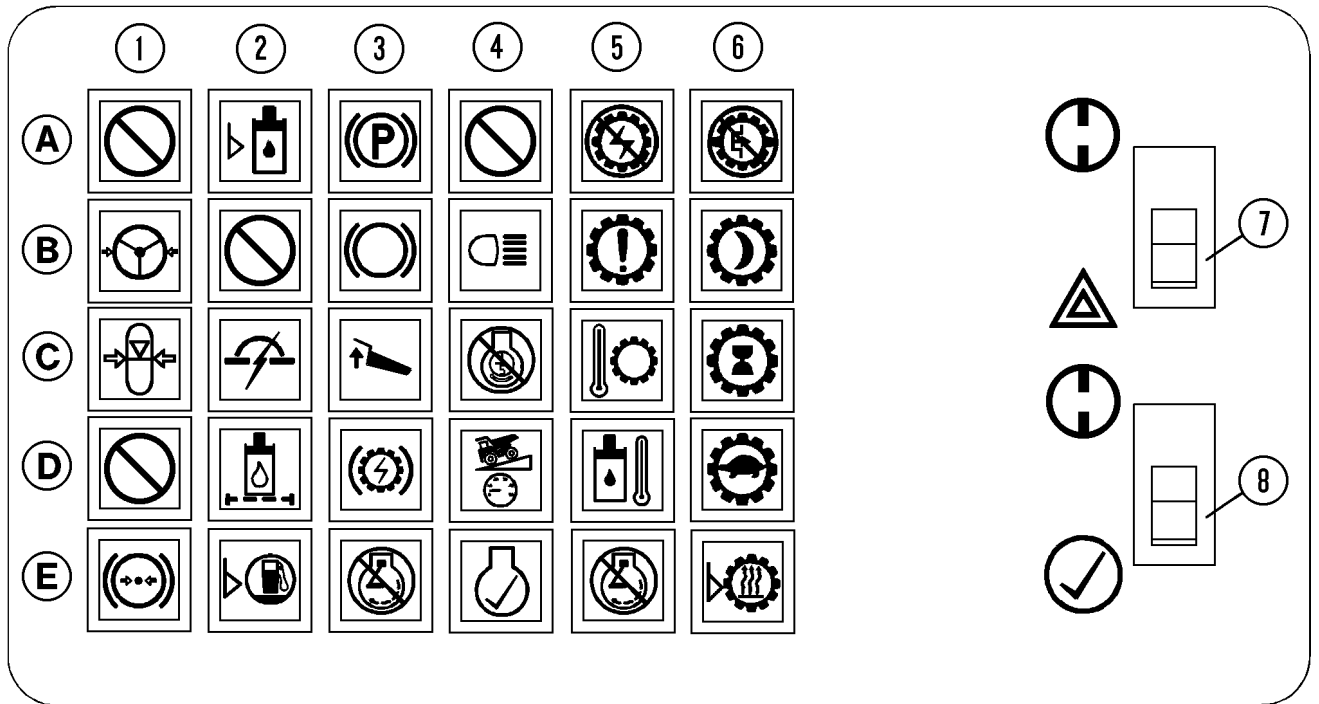

N050127

FIGURE 3-7. OVERHEAD STATUS / WARNING INDICATOR LIGHTS

Row / Column	Indicator Description	Indicator Color - Wire Index
A1*	NOT USED	12FD/34TL
B1	Low Steering Pressure	RED-12D/33A
C1	Low Accumulator Pr.	RED-12F/33K
D1	NOT USED	12F/79V
E1	Low Brake Pressure	RED-12F/33L
A2*	Hydraulic Tank Level	Red-12MD/34LL
B2*	NOT USED	12FD/SPR1
C2*	Circuit Breaker Tripped	Amber-12MD/31 CB
D2*	Hydraulic Oil Filter	Amber-12MD/39
E2*	Low Fuel	Amber-12MD/38
A3*	Park Brake Applied	Amber-12MD/52A
B3*	Service Brake Applied	Amber-12MD/44L
C3*	Body Up	Amber-12MD/63L
D3*	Dynamic Retarding	Amber-12MD/44 DL
E3	STOP ENGINE	RED-12M/509MA
A4*	NOT USED	12MD/SPR2
B4*	Manual Back-Up Lights	Amber-12MD/47L
C4*	5 Min. Shutdown Timer	Amber-12MD/23L1
D4*	Retard Speed Control	Amber-12MD/31R
E4*	CHECK ENGINE	Amber-12MD/419

Row / Column	Indicator Description	Indicator Color - Wire Index
A5	NO POWER	RED-12M/75-6PI
B5	PROPULSION SYS. WARNING	Amber-12F/79WI
C5	PROPULSION SYS. TEMPERATURE	Amber-12F/34TW
D5	HYDRAULIC OIL TEMP. HIGH	RED-12F/34TGI
E5*	Stop Engine	12FD/528AL
A6	NO PROPEL	RED-12M/75NPI
B6	PROPEL SYS. @ REST	Amber - 12M/72PR
C6*	PROPEL SYS. NOT READY	Amber-12MD/72NR
D6*	REDUCED PROPULSION SYS.	Amber-12MD/72LP
E6*	RETARD @ CONTINUOUS LEVEL	Amber-12MD/76LR
- SWITCHES -		
7	Hazard Lights Switch N/O	11L/45L/45R
8	Lamp Check Switch N/O (Mom.)	33H/710

* NOTE: Brightness for these Indicator Lamps can be adjusted by using Dimmer Control (12, Figure 3-1).

STATUS / WARNING INDICATOR LIGHT SYMBOLS

Indicator Lights which are **AMBER** (Yellow) in color alert the operator that the indicated truck function requires some precaution when lighted.

Indicator Lights which are **RED** in color alert the operator that the indicated truck function requires **immediate action** by the operator. Safely stop the truck and shut down the engine.

DO NOT OPERATE THE TRUCK WITH A RED WARNING LIGHT ILLUMINATED.

Refer to Figure 3-7 and the descriptions below for explanations of the symbols.
Location of the symbols is described by rows (A-E) and columns (1 - 6).

A1. NOT USED

Not currently used. Reserved for future use or options.

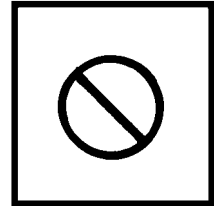

B1. Low Steering Pressure

When the keyswitch is turned "ON", the low steering pressure warning light will illuminate until the steering system hydraulic pressure reaches 2100 psi (14.7 MPa). The warning horn will also turn on, and both will remain on, until the accumulator has been charged.

During truck operation, the low steering pressure warning light and warning horn will turn sound if steering system hydraulic pressure drops below 2100 psi (14.7 MPa).

- If the light illuminates momentarily ("flickers") while turning the steering wheel at low truck speed and low engine RPM, this may be considered "normal", and truck operation may continue.
- If the indicator light illuminates at higher truck speed and high engine RPM, DO NOT OPERATE TRUCK.

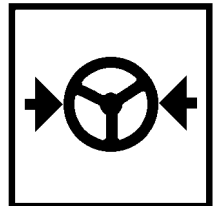

If the low steering warning light continues to illuminate and the alarm continues to sound, low steering pressure is indicated. The remaining pressure in the accumulators allows the operator to control the truck to a stop. Do not attempt further operation until the malfunction is located and corrected.

C1. Low Accumulator Precharge Pressure

The low accumulator precharge warning light, if illuminated, indicates low nitrogen precharge for the steering accumulator(s). To check for proper accumulator nitrogen precharge, engine must be stopped and hydraulic system completely bled down; then turn keyswitch to "Run" position. Warning light will NOT illuminate if system is properly charged. The warning light *will flash* if the nitrogen precharge within the accumulator(s) is below 1100 ± 45 psi (7585 ± 310 kPa).

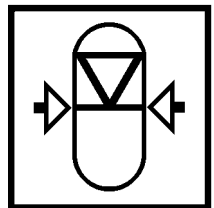

If low accumulator precharge warning light flashes, notify maintenance personnel. Do not attempt further operation until the accumulators have been recharged with nitrogen to 1400 psi (9653 kPa). Sufficient energy for emergency steering may not be available, if system is not properly charged.

D1. NOT USED

Not currently used. Reserved for future use or options.

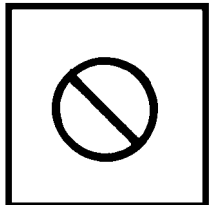

E1. Low Brake Pressure

This red indicator light indicates a malfunction within the hydraulic brake circuit. If this light comes on and buzzer sounds, **shut down truck operation** and notify maintenance personnel.

NOTE: Adequate hydraulic fluid is stored to allow the operator to safely stop the truck.

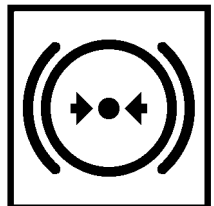

A2. Low Hydraulic Tank Level

This warning light indicates the oil level in the hydraulic tank is below recommended level. Damage to hydraulic pumps may occur if operation continues. Shut truck down and notify maintenance personnel immediately.

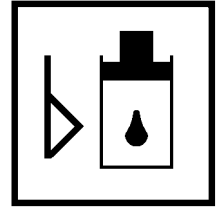

B2. NOT USED

Not currently used. Reserved for future use or options.

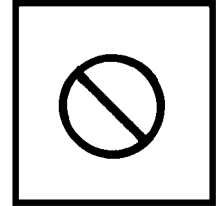

C2. Circuit Breaker Tripped

This light will illuminate if any of the circuit breakers in the relay circuit control boards are tripped. The relay circuit boards are located in the electrical control cabinet.

NOTE: Additional circuit breakers are in the operator cab behind the center console, however tripping of these circuit breakers should not activate this light.

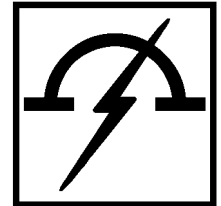

D2. Hydraulic Oil Filter Monitor

This light indicates a restriction in the high pressure filter assembly for either the steering or hoist circuit. This light will come on before filters start to bypass. Notify maintenance personnel at earliest opportunity after light comes on.

NOTE: The filter monitor warning light may also illuminate after the engine is initially started if the oil is cold. If the light turns off after the oil is warmed, filter maintenance is not required.



E2. Low Fuel

This amber low fuel indicator will illuminate when the usable fuel remaining in the tank is approximately 25 gallons (95 liters). A warning buzzer will also sound.

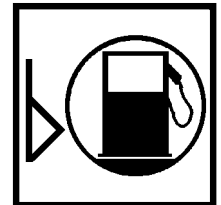

A3. Parking Brake

This amber parking brake indicator will illuminate when the parking brake is applied. Do not attempt to drive truck with parking brake applied.



B3. Service Brake

This amber service brake indicator light will illuminate when the service brake pedal is applied or when wheel brake lock or emergency brake is applied. Do not attempt to drive truck from stopped position with service brakes applied, except as noted in "Operating Instructions, Starting On A Grade With A Loaded Truck".

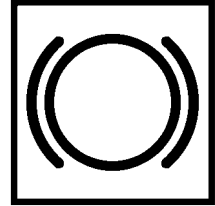

C3. Body Up

This amber Body Up indicator, when illuminated, shows that the body is not completely down on the frame. The truck should not be driven until body is down and light is off.



D3. Dynamic Retarding

This amber dynamic retarding indicator light illuminates whenever the retarder pedal (or retarder lever) is operated, RSC (Retarder Speed Control) is activated, or the automatic overspeed retarding circuit is energized, indicating the dynamic retarding function of the truck is operating.

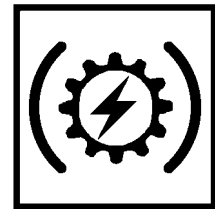

E3. Stop Engine

This **RED** engine monitor warning light will illuminate if a serious engine malfunction is detected in the electronic engine control system.

- Electric propulsion to the wheelmotors will be discontinued.
- Dynamic Retarding will still be available if needed to slow or stop the truck.

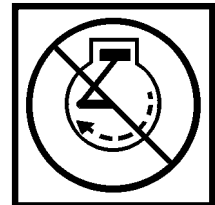

Stop the truck as quickly as possible in a safe area and apply parking brake.

SHUT DOWN THE ENGINE IMMEDIATELY.

Additional engine damage is likely to occur if operation is continued.

Listed below are a few conditions that could cause the Stop Engine light to illuminate:

- Low Oil Pressure - red warning light will illuminate, but engine does not shutdown.
- Low Coolant Level - red warning light will illuminate, but engine does not shutdown.
- Low Coolant Pressure - red warning light will illuminate, but engine does not shutdown.
- High Coolant Temperature - red warning light will illuminate, but engine does not shutdown.

A4. NOT USED

Reserved for future use or options.

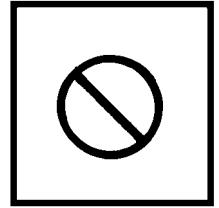

B4. Manual Backup Lights

This amber indicator will illuminate when the manually operated Manual Backup switch (3, Figure 3-6, Instrument Panel) is turned "on".

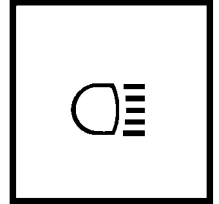

C4. Engine Shutdown Timer - 5 Minute Idle

When the Engine Shutdown Timer switch has been activated (2, Figure 3-6, Instrument Panel), this indicator light will illuminate to indicate that the shutdown timing sequence has started. Refer to Instrument panel for operation of this switch.



D4. Retard Speed Control Indicator

This amber light is illuminated when the RSC switch mounted on the console is pulled out to the "On" position. The light indicates the retarder is active. It is for feedback only and does not signal a problem.

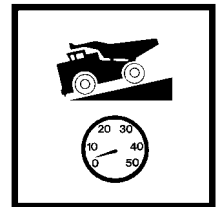

E4. Check Engine

This amber "Check Engine" indicator will illuminate if a malfunction is detected by the engine electronic control system.

If this indicator illuminates, truck operation may continue, but maintenance personnel should be alerted as soon as possible.

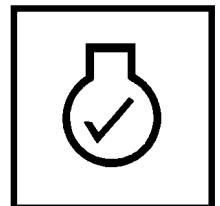

A5. NO POWER

This RED “No Retard/No Propel” indicator light indicates a fault has occurred which has eliminated the retarding and propulsion capability. A warning buzzer will also sound.

If this condition occurs, the operator should safely stop the truck, move Selector Switch to Neutral, apply the Park Brake, shutdown engine, and notify maintenance personnel immediately.

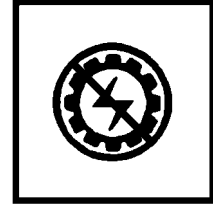

B5. PROPULSION SYSTEM WARNING

When this amber indicator is illuminated, the light indicates a “No Propel” or “No Retard” event may be about to occur. It is intended to provide advance notice of these events when possible. It does not require the operator to stop the truck, but may suggest that truck operation be appropriately modified, in case a red alarm does occur.

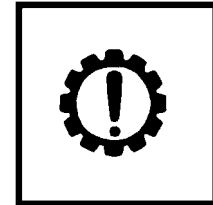

C5. PROPULSION SYSTEM TEMPERATURE

This amber AC Drive System “Temperature Warning” light indicates the drive system temperature is above a certain level. When this condition occurs, the operator should consider modifying truck operation in order to reduce system temperature. The operator is not required to stop the truck at this time.

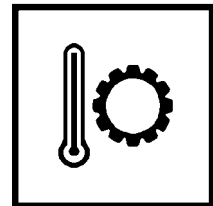

D5. HIGH HYDRAULIC OIL TEMPERATURE

This RED warning light indicates high oil temperature in the hydraulic tank. Continued operation could damage components in the hydraulic system.

If this condition occurs, the operator should safely stop the truck, move Selector Switch to Neutral, apply the Park Brake, and operate engine at 1200 - 1500 RPM to reduce system temperature.

If temperature gauge (25, Figure 3-6) does not move into the Green range after a few minutes, and the RED overhead indicator light does not go out, notify maintenance personnel immediately.

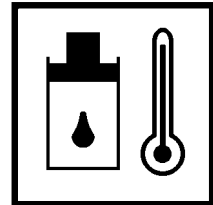

E5. STOP ENGINE

This RED engine monitor warning light will illuminate if a serious engine malfunction is detected in the electronic engine control system.

- Electric propulsion to the wheelmotors will still be available .
- Dynamic Retarding will still be available if needed to slow or stop the truck.

Stop the truck as quickly as possible in a safe area and apply parking brake.



***SHUT DOWN THE ENGINE IMMEDIATELY.
Additional engine damage is likely to occur if operation is continued.***

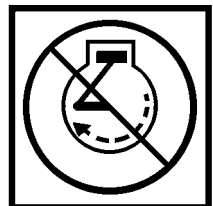

An example of a condition that could cause the Stop Engine light to illuminate:

- If engine governor senses an overspeed condition, the ECM will close the fuel solenoid and stop the flow of fuel to the engine until engine speed is back within normal operating range.

A6. NO PROPEL

The RED “No Propel” light indicates a fault has occurred which has eliminated the propulsion capability.

If this condition occurs, the operator should safely stop the truck, move Selector Switch to Neutral, apply the Park Brake, shutdown engine, and notify maintenance personnel immediately.

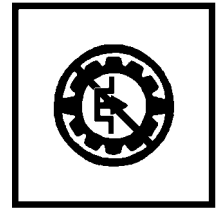

B6. PROPEL SYSTEM @ REST

The amber “Propel System @ REST” light is used to indicate that the AC Drive System is de-energized and propulsion is not available. This light is activated when the instrument panel REST switch is turned “On” and the AC Drive System is de-energized.

The three “LINK ENERGIZED” lights (one on rear wall of operator cab, and two on the deck-mounted control cabinets) should NOT be illuminated at this time.

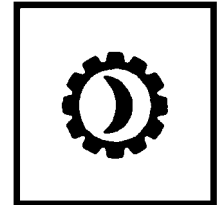

C6. PROPEL SYSTEM NOT READY

The amber “PROPEL SYSTEM NOT READY” indicator light functions during start-up much like the hourglass icon on a computer screen. This light indicates the computer is in the process of performing the self-diagnostics and set-up functions at start-up. Propulsion will not be available at this time.

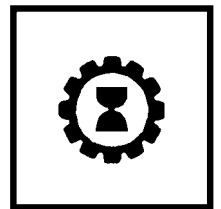

D6. REDUCED PROPULSION

The amber “Reduced Propulsion” light is used to indicate that the full AC Drive System performance in propulsion is not available. At this time, the only event that should activate this light is the use of “Limp Home Mode”. This mode of operation requires a technician to enable.

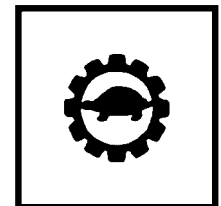

E6. RETARD AT CONTINUOUS LEVEL

The amber “Retard Continuous” light indicates the retarding effort is at the continuous level. For a limited period of time, the retarding effort can exceed this level.

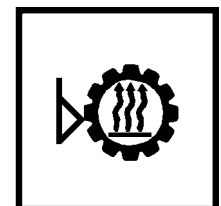

(7) HAZARD WARNING LIGHTS

The hazard warning light switch flashes all the turn signal lights. Pressing the bottom side of the rocker switch (toward the triangle) activates these lights. Pressing the top side of the rocker switch (toward the "OFF" symbol) turns these lights off.

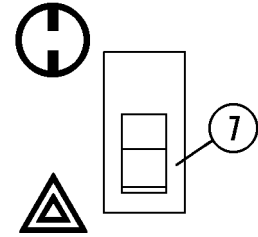

(8) LAMP TEST SWITCH

The Lamp Test switch is provided to allow the operator to test the indicator lamps prior to starting the engine. To test the lamps, and the warning horn, turn the key switch (1, Figure 3-6) to the "Run" position and press the bottom side of the rocker switch for the "Check" position. All lamps should illuminate, except those which are for "Optional" equipment that may not be installed. The warning horn should also sound. Any lamp bulbs which do not illuminate should be replaced before operating the truck. Releasing the spring-loaded switch will allow the switch to return to the "Off" position.

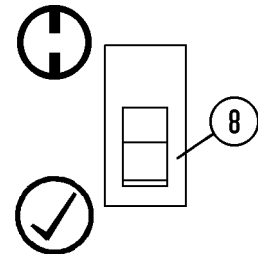

LINK-ON WARNING LIGHT

The "LINK-ON", or "LINK ENERGIZED", indicator light is located next to the D.I.D. display panel behind the passenger seat and indicates the AC DRIVE system is ENERGIZED.

The D.I.D. display panel is for use by maintenance personnel only, and is located out of the operator's field of vision for that reason.

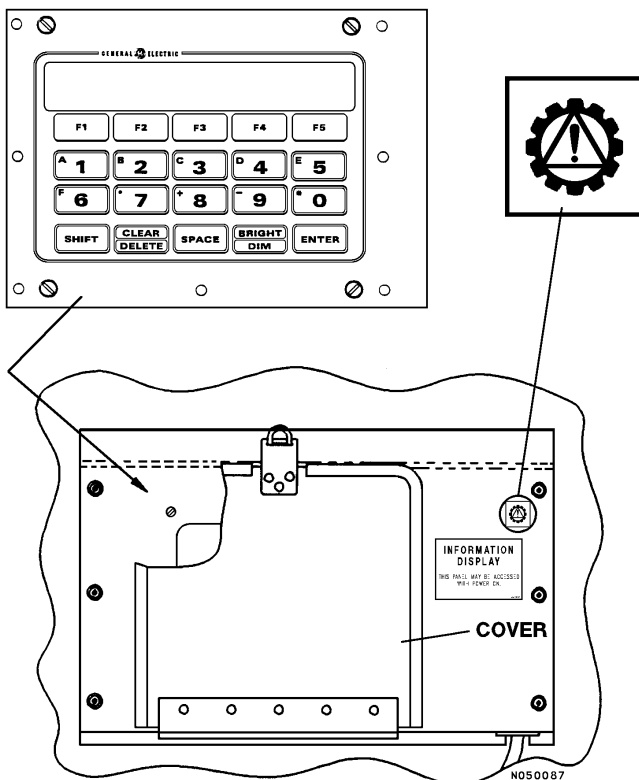
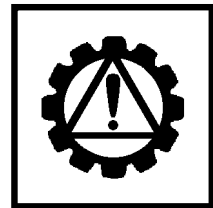

LUBRICATION AND SERVICE

Recommended Preventive Maintenance will contribute to the long life and dependability of the truck and its components. The use of proper lubricants and the performance of checks and adjustments at the recommended intervals is most important.

Lubrication requirements are referenced to the lube key found in the Truck Lubrication Specifications Chart (page 4-2). For detailed service requirements for specific components, refer to the Shop manual section for that component (i.e. Section "H" for Suspensions, Section "L" for Hydraulic System, etc.).

Refer to manufacturer's service manual when servicing any components of the General Electric System.

Refer to engine manufacturer's service manual when servicing the engine or any of its components.

The service intervals presented here are in hours of operation. **These intervals are recommended in lieu of an oil analysis program which may determine different intervals.** However, if the truck is being operated under extreme conditions, some or all, of the intervals may need to be shortened and the service performed more frequently.

The 930E Truck is equipped with a Lincoln Automatic Lubrication System. The initial setup for this system provides for nominal amounts of lubricant to be delivered to each serviced point. The lubrication injectors can be adjusted to vary the amount of lubricant delivered. In addition, the timer for lubrication intervals is normally adjustable. For adjustments to these devices, consult the "Lincoln Automatic Lubrication System" later in this section of the manual.

HYDRAULIC TANK SERVICE

There are two sight gauges on the side of the hydraulic tank. With engine stopped, keyswitch "off", hydraulic system bled down and body down, oil should be visible in the top sight gauge. If hydraulic oil is not visible in the top sight gauge, follow "Adding Oil" instructions below.

Adding Oil

Keep the system open to the atmosphere only as long as absolutely necessary to lessen chances of system contamination.

Service the tank with clean Type C-4 hydraulic oil only. All oil being put into the hydraulic tank should be filtered through 3 micron filters.

1. With engine stopped, keyswitch "off", hydraulic system bled down and body down, check to see that hydraulic oil is visible in the top sight gauge.
2. If hydraulic oil is not visible in the top sight gauge, remove the tank fill cap and add clean, filtered C-4 hydraulic oil (Lubrication Chart, Lube Key "B") until oil is visible in the top sight gauge.
3. Replace fill cap.
4. Start engine. Raise and lower the dump body three times.
5. Repeat steps 1 through 4 until oil is maintained in the top sight gauge with engine stopped, body down, and hydraulic system bled down.

930E SERVICE CAPACITIES		
	Liters	U.S. Gallons
Crankcase: (including 4 lube oil filters).		
Cummins QSK-60C Engine	280	74
Cooling System: Cummins QSK-60C Engine	594	157
Hydraulic System: Refer to "Hydraulic Tank Service".	1325	350
Wheel Motor Gear Box (each side)	76	20
Fuel Tank (Diesel Fuel Only)	4542	1200

COOLANT LEVEL CHECK

inspect the coolant sight gauge. If coolant cannot be seen in the sight gauge, it is necessary to add coolant to the cooling system before truck operation. Refer to the procedure below for the proper filling procedure.

RADIATOR FILLING PROCEDURE



Cooling System is pressurized due to thermal expansion of coolant. DO NOT remove radiator cap while engine and coolant are hot. Severe burns may result.

1. With engine and coolant at ambient temperature, remove radiator cap.

Note: If coolant is added using the Wiggins quick fill system, the radiator cap MUST be removed prior to adding coolant.

2. Fill radiator with proper coolant mixture (as specified by the engine manufacturer) until coolant is visible in the sight gauge.
3. Install radiator cap.
4. Run engine for 5 minutes, check coolant level.
5. If coolant is not visible in the sight gauge, repeat steps 1 through 4. Any excess coolant will be discharged through the vent hose after the engine reaches normal operating temperature.

Engine coolant must always be visible in the sight gauge before truck operation.

COOLING SYSTEM ANTI - FREEZE RECOMMENDATIONS (Ethylene Glycol Permanent Type Anti-Freeze)		
Percentage of Anti-Freeze	Protection To	
10	+ 23°F	- 5°C
20	+ 16°F	- 9°C
25	+ 11°F	- 11°C
30	+ 4°F	- 16°C
35	- 3°F	- 19°C
40	- 12°F	- 24°C
45	- 23°F	- 30°C
50	- 34°F	- 36°C
55	- 48°F	- 44°C
60	- 62°F	- 52°C

Use only anti-freeze that is compatible with engine as specified by engine manufacturer.

LUBRICATION CHART

LUBRICATION SPECIFICATIONS

LUBE KEY	TYPE LUBRICANT
A	ENGINE OIL SEE ENGINE MANUAL
B	HYDRAULIC OIL SAE 10W C-4 AUXILIARY HEATERS REQUIRED BELOW -10°F (-23°C)
C	HEAVY-DUTY SYNTHETIC GEAR OIL SEE DRIVE SYSTEM MANUAL
D	MULTI-PURPOSE EXTREME PRESSURE GREASE NLGI NO.2 (5% MIN. MOLY-DISULFIDE)
E	MULTI-PURPOSE GEAR OIL SAE 80W-90

SYM	DESCRIPTION	PTS	LUBE	10 HR	50 HR	100 HR	250 HR	500 HR	1000 HR	2000 HR	2500 HR
1	CRANKCASE OIL LEVEL	1	A	CHECK							
2	ENGINE LUBE OIL FILTERS										
3	FUEL FILTER										
4	FUEL SEPARATOR (DAYCO)										
5	FUEL TANK										
6	GE PREFILTER BREATHER	1	D						CLEAN		
7	FUEL TANK BREATHER	1							*CHANGE		
8	HYDRAULIC OIL LEVEL	1	B	CHECK					CLEAN		
9	HYDRAULIC STRAINER	2									
10	HYDRAULIC TANK BREATHER	2						CHANGE			
11	HYDRAULIC FILTERS	3		**	**	**	**	CHANGE			
12	MOTORIZED WHEEL OIL LEVEL	2	C								
13	HYD. PUMP DRIVE SHAFT	2	D								
14	CHASSIS LUBE LEVEL	1	D								
15	SEAT SLIDES & STEER SHAFT	4	D								
16	WHEEL MOTOR BLOWER	2	D								
17	FRONT WHEEL BEARINGS ***	2	E								
18	FRONT TRUION	1	D								CHANGE

SEE ENGINE MANUAL

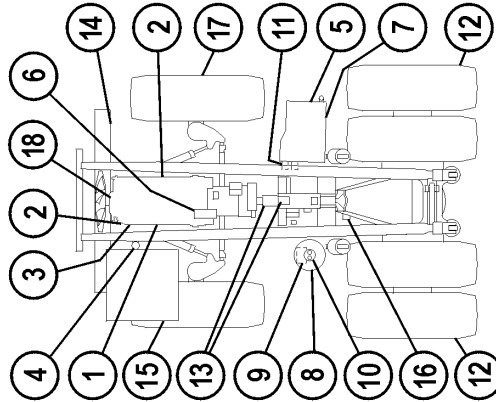

630E, 730E, 830E, & 930E

WB2790

* 1000 HR INTERVAL CAN BE EXTENDED TO 2500 HR PROVIDED OIL SAMPLING AND ANALYSIS IS CONDUCTED EVERY 250 HR.
 ** ONE TIME CHANGE AT 50, 100 AND 250 HR.
 *** NOT APPLICABLE FOR 930E

50 HOUR LUBRICATION AND MAINTENANCE CHECKS

MOTORIZED WHEELS - Check for correct oil level. Refer to G.E. Motorized Wheel Service & Maintenance Manual for the lubrication specifications and service intervals.

- *1. FUEL FILTERS - Change the Fuel Filters, (Fuel Separators).

Refer to engine manufacturer's maintenance manual for fuel filter replacement instructions.

- *2. HYDRAULIC SYSTEM FILTERS -
Replace filter elements only, after the initial 50, 100, and 250 hours of operation; then at each 500 hours of operation thereafter.

- *3. FAN DRIVE ASSEMBLY -
Check torque for the six fan mounting capscrews: **175 ft.lbs. (237 N.m)**.

* These checks are required **only after the initial hours of operation** (such as: the commissioning of a new truck, or after a new or rebuilt component installation).

Truck Serial Number _____		
Site Unit Number _____		
Date: _____ Hour Meter _____		
Name of Service person _____		
COMMENTS	√'d	INITIALS

100 HOUR LUBRICATION AND MAINTENANCE CHECKS

* These checks are required **only after the initial hours of operation** (such as: the commissioning of a new truck, or after a new or rebuilt component installation), check:

* 1. HYDRAULIC SYSTEM FILTERS -
Replace filter elements only, after the **initial** 100 and 250 hours of operation; then at each 500 hours of operation thereafter.

Truck Serial Number _____		
Site Unit Number _____		
Date: _____ Hour Meter _____		
Name of Service person _____		
COMMENTS	√'d	INITIALS

250 HOUR LUBRICATION AND MAINTENANCE CHECKS

Maintenance requirements for the 10 hour Lubrication and Maintenance Checks should also be carried out at this time.

NOTE: "Lube Key" references are to the Lubrication Specification Chart.

1. ENGINE - Refer to Cummins Operation & Maintenance manual for complete specifications regarding engine lube oil specifications.

NOTE: If engine is equipped with the CENTINEL oil system, engine oil and filter change intervals are extended beyond 250 hours. Refer to Cummins Operation & Maintenance manual for specific oil & filter change intervals.*

- a. Change engine oil. Lube Key "A".
 - b. Replace lube oil filters.
NOTE: When installing spin-on filter elements, follow the instructions as specified by the filter manufacturer. The tightening instructions are normally printed on the outside of the filter. Do not use a wrench or strap to tighten filter elements.
 - c. Check the fan belt tension.
Refer to Cummins Operation & Maintenance manual for specific fan belt adjustment instructions.
2. FUEL FILTERS - Change the Fuel Filters (Fuel Separators).
Refer to Cummins Operation & Maintenance manual for specific fuel filter replacement instructions.

* The Centinel™ system is a duty-cycle-dependent lubrication management system whereby oil is blended with the fuel and extension of oil change intervals can occur.

Truck Serial Number _____

Site Unit Number _____

Date: _____ Hour Meter _____

Name of Service person _____

COMMENTS	√'d	INITIALS

(CONTINUED NEXT PAGE)

3. HYDRAULIC PUMP DRIVESHAFT & U-JOINTS -
Add one or two applications of grease to each grease fitting. Check that each bearing of the Cross & Bearing assembly is receiving grease. Lube Key "D".
 4. COOLING SYSTEM -
 - a. Check cooling system for proper coolant mixture. Add coolant mixture as required.
 - b. COOLANT FILTERS - Change coolant filters. Refer to engine manufacturer's maintenance manual for coolant filter replacement instructions and proper coolant mixture instructions.
 5. REAR WHEEL MOUNTING - Using a mirror on a long rod and a flashlight, inspect where possible, all inner and outer wheel mounting nuts/studs for any evidence of looseness, damage, or missing hardware.

If wheel mounting nuts/studs must be secured or replaced, the outer wheel must be removed for access. Refer to the Shop manual, Section "G", for these procedures.
 6. REAR AXLE HOUSING - Check the rear axle housing for fluid leaks by removing the two drain plugs on the bottom of the axle housing. If fluid is present, the cause must be found and corrected before releasing truck to operation.
 7. STEERING LINKAGE - Check torque on pin retaining nuts (steering linkage), **525 ft.lbs. (712 N.m)** torque. Check torque on tie rod clamping cap-screws, **310 ft.lbs. (420 N.m)** torque.
 8. MAGNETIC PLUG - Remove magnetic plugs from front hub covers and inspect for debris. Clean the plugs and perform any necessary repairs.
- * These checks are required **only after the first 250 hours of operation** (such as: the commissioning of a new truck, or after a new or rebuilt component installation), check:
- *9. HYDRAULIC SYSTEM FILTERS -
Replace filter elements only after the **initial 250** hours of operation; then at each 500 hours of operation thereafter.
Check oil level. Add oil as necessary.
Lube Key "B".
 - *10. MOTORIZED WHEEL GEAR CASE - Refer to the G.E. planned maintenance manual and specific motorized wheel shop manual.

COMMENTS	√ ^d	INITIALS

1000 HOURS LUBRICATION AND MAINTENANCE CHECKS

Maintenance for every 10, 250, & 500 hour Lubrication and Maintenance Checks should also be carried out at this time.

NOTE: "Lube Key" references are to the Lubrication Specification Chart.

1. **HYDRAULIC TANK** - Drain hydraulic oil and clean inlet strainer. Refill tank with oil, approximate capacity 250 gal. (947 l). Use Lube Key "B".
2. **RADIATOR** - Clean cooling system with a quality cleaning compound. Flush with water. Refill system with anti-freeze and water solution. Check Cooling System Recommendation Chart for correct mixture. Refer to Engine manufacturer's manual for correct additive mixture.
3. **FUEL TANK** - Remove breather and clean in solvent. Dry with air pressure and reinstall.
4. **OPERATOR'S SEAT** - Apply grease to slide rails. Use Lube Key "D".
5. **AUTOMATIC BRAKE APPLICATION** - Check that brakes are automatically applied when hydraulic brake pressure decreases below specified limit. Refer to the shop manual for "Brake Checkout procedure".
6. **AUXILIARY BLOWER** - Apply a few pumps of grease to auxiliary blower bearings. There are two grease zerks (1, Figure 4-1) located on auxiliary blower (2).

Truck Serial Number _____		
Site Unit Number _____		
Date: _____ Hour Meter _____		
Name of Service person _____		
COMMENTS	√'d	INITIALS

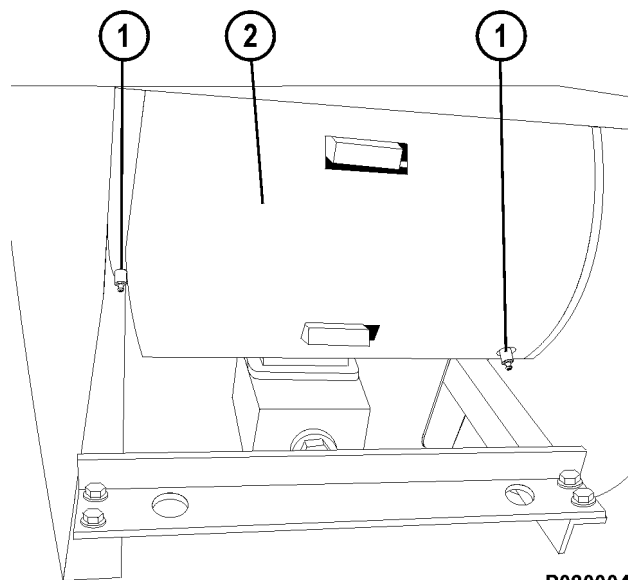

P020004

FIGURE 4-1. AUXILIARY BLOWER
1. Grease Zerk 2. Blower Motor

2500 HOUR MAINTENANCE CHECKS

MOTORIZED WHEELS - Drain and replace gear oil. Refer to G.E. Motorized Wheel Service & Maintenance Manual for lubrication specifications. Lube Key "C".

5000 HOUR MAINTENANCE CHECKS

AIR CLEANERS - Clean the Donaclone Tubes in the pre-cleaner section of the air filter. Use low pressure cold water or low pressure air to clean tubes. Refer to the Shop Manual, Section "C".

NOTE: Do not use a hot pressure washer or high pressure air to clean tubes, hot water/high pressure causes pre-cleaner tubes to distort.

Truck Serial Number _____		
Site Unit Number _____		
Date: _____ Hour Meter _____		
Name of Service person _____		
COMMENTS	√'d	INITIALS
COMMENTS	√'d	INITIALS

AUTOMATIC LUBRICATION SYSTEM

GENERAL DESCRIPTION

The Lincoln Automatic Lubrication System is a pressurized lubricant delivery system which delivers a controlled amount of lubricant to designated lube points. The system is controlled by an electric timer which signals a solenoid valve to operate a hydraulic motor powered grease pump. Hydraulic oil for pump operation is supplied by the truck steering circuit.

Grease output is proportional to the hydraulic motor input flow. A pump control manifold, mounted on top of the hydraulic motor, controls input flow and pressure. A 24VDC Solenoid mounted on the manifold turns the pump on and off.

The pump is driven by the rotary motion of the hydraulic motor, which is then converted to reciprocating motion through an eccentric crank mechanism. The reciprocating action causes the pump cylinder to move up and down. The pump is a positive displacement, double-acting type as grease output occurs on both the up and the down stroke.

During the down stroke, the pump cylinder is extended into the grease. Through the combination of shovel action and vacuum generated in the pump cylinder chamber, the grease is forced into the pump cylinder. Simultaneously, grease is discharged through the outlet of the pump. The volume of grease during intake is twice the amount of grease output during one cycle. During the upstroke, the inlet check valve closes, and one half the grease taken in during the previous stroke is transferred through the outlet check and discharged to the outlet port.

⚠ WARNING

Over-pressurizing of the system, modifying parts, using incompatible chemicals and fluids, or using worn or damaged parts, may result in equipment damage and/or serious personal injury.

- * ***DO NOT exceed the stated maximum working pressure of the pump, or of the lowest rated component in the system.***
- * ***Do not alter or modify any part of this system unless approved by factory authorization.***
- * ***Do not attempt to repair or disassemble the equipment while the system is pressurized.***
- * ***Make sure all fluid connections are securely tightened before using this equipment.***
- * ***Always read and follow the fluid manufacturer's recommendations regarding fluid compatibility, and the use of protective clothing and equipment.***
- * ***Check all equipment regularly and repair, or replace, worn or damaged parts immediately.***

This equipment generates very high grease pressure. Extreme caution should be used when operating this equipment as material leaks from loose or ruptured components can inject fluid through the skin and into the body causing serious bodily injury including possible need for amputation. Adequate protection is recommended to prevent splashing of material onto the skin or into the eyes.

If any fluid appears to penetrate the skin, get emergency medical care immediately! Do not treat as a simple cut. Tell attending physician exactly what fluid was injected.

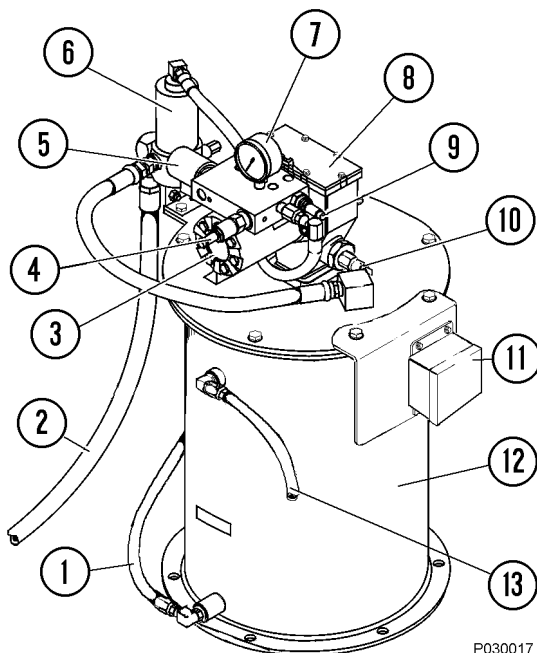
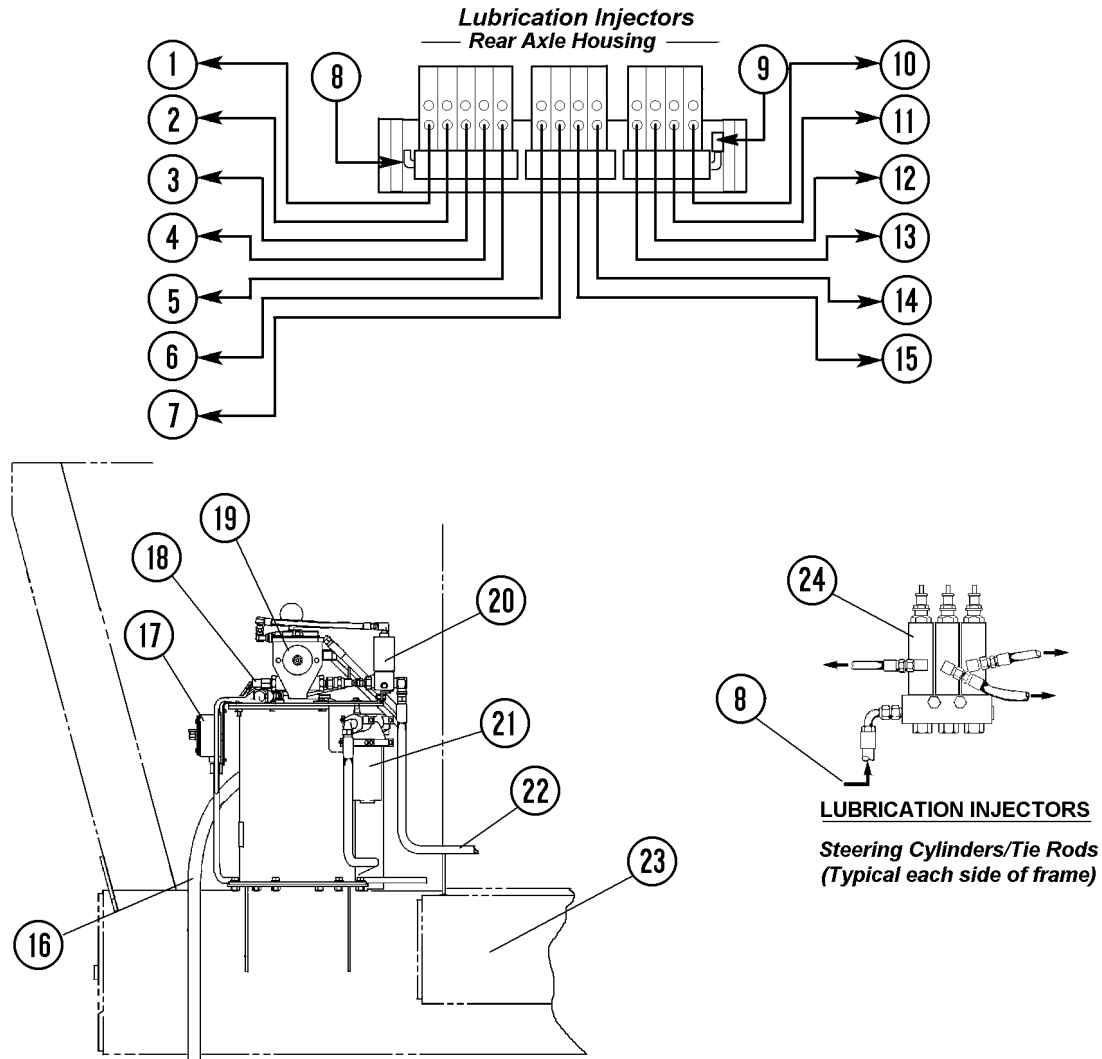

FIGURE 4-2. PUMP AND RESERVOIR COMPONENTS

- | | |
|----------------------------|-----------------------|
| 1. Hose From Filter | 7. Pressure Gauge |
| 2. Outlet to Injectors | 8. Pump Assembly |
| 3. Hydraulic Motor | 9. Flow Control Valve |
| 4. Pressure Reducing Valve | 10. Pressure Switch |
| 5. Solenoid Valve | 11. Relay Box |
| 6. Vent Valve | 12. Grease Reservoir |
| | 13. Vent Hose |

P030017



P030024

FIGURE 4-3. AUTO LUBE SYSTEM INSTALLATION

NOTE: The above illustration shows the standard location for the lube pump & reservoir (right platform). This assembly may be located on left platform on some models.

- | | |
|---|--|
| 1. L.H. Suspension, Top Bearing | 13. R.H. Hoist Cylinder, Top Bearing |
| 2. L.H. Suspension, Bottom Bearing | 14. R.H. Hoist Cylinder, Bottom Bearing |
| 3. L.H. Body Pivot Pin | 15. R.H. Anti-Sway Bar Bearing |
| 4. L.H. Hoist Cylinder, Top Bearing | 16. Vent Hose |
| 5. L.H. Hoist Cylinder, Bottom Bearing | 17. Junction Box |
| 6. L.H. Anti-Sway Bar Bearing | 18. Pressure Switch, N.O., 2500 psi (17 237 kPa) |
| 7. Rear Axle Pivot Pin | 19. Grease Pump |
| 8. Grease Supply From Pump | 20. Vent Valve |
| 9. Pressure Switch, N.O., 2000 psi (13 790 kPa) | 21. Filter |
| 10. R.H. Suspension, Top Bearing | 22. Grease Supply to Injectors |
| 11. R.H. Suspension, Bottom Bearing | 23. Truck Frame |
| 12. R.H. Body Pivot Pin | 24. Injector |

SYSTEM COMPONENTS

Filter (21, Figure 4-3)

A filter assembly mounted on the grease reservoir filters the grease prior to refilling the reservoir from the shop supply. A bypass indicator alerts service personnel when the filter requires replacement.

Hydraulic Motor and Pump (3 & 8, Figure 4-2)

The rotary hydraulic pump is a fully hydraulically operated grease pump. An integrated pump control manifold is incorporated with the motor to control input flow and pressure.

Note: The pump crankcase oil level must be maintained to the level of the pipe plug port. If necessary, refill with 10W-30 motor oil.



Hydraulic oil supply inlet pressure must not exceed 3000 psi (20 685 kPa). Exceeding the rated pressure may result in damage to the system components and personal injury.

Grease Reservoir (12, Figure 4-2)

The reservoir has an approximate capacity of 60 lbs. (27 kg) of grease. When the grease supply is replenished by filling the system at the service center, the grease is passed through the filter to remove contaminants before it flows into the reservoir.

Pressure Reducing Valve (4, Figure 4-2)

The pressure reducing valve, located on the manifold reduces the hydraulic supply pressure (from the truck steering circuit) to a suitable operating pressure, [325-350 psi (2 240-2 415 kPa)] for the hydraulic motor used to drive the lubricant pump.

Flow Control Valve (9, Figure 4-2)

The flow control valve mounted on the manifold, controls the amount of oil flow to the hydraulic motor.

The flow control valve has been factory adjusted and the setting should not be disturbed.

Solenoid Valve (5, Figure 4-2)

The solenoid valve, when energized, allows oil to flow to the hydraulic motor.

Vent Valve (6, Figure 4-2)

With the vent valve closed, the pump continues to operate until maximum grease pressure is achieved. As this occurs, the vent valve opens and allows the grease pressure to drop to 0, so the injectors can recharge for their next output cycle.

Lubrication Cycle Timer (1, Figure 4-5)

The solid state lubrication cycle timer provides a 24 VDC timed-interval signal to energize the solenoid valve (5, Figure 4-2), providing oil flow to operate the grease pump motor. This timer is mounted in the Electrical Interface Cabinet.

Delay Timer (11, Figure 4-5)

The delay timer, located in the Electrical Interface Cabinet, provides a one minute delay in the low pressure warning lamp circuit to allow a normally operating system to attain full grease system pressure without activating the warning lamp. If the system fails to reach 2000 psi (13 789 kPa) within this time period, the timer will apply 24VDC to several relays which will illuminate the low pressure warning lamp in the overhead display. An external 604K ohm resistor determines the delay period.

Pump Cutoff Pressure Switch (N.O. 2500 psi [17 237 kPa]) (10, Figure 4-2)

This pressure switch de-energizes the pump solenoid relay when the grease line pressure reaches the switch pressure setting, turning off the motor and pump.

Grease Pressure Failure Switch (N.O. 2000 psi [13 789 kPa]) (9, Figure 4-3)

This pressure switch monitors grease pressure in the injector bank on the rear axle housing. If the proper pressure is not sensed within 60 seconds (switch contacts do not close), several relays energize, actuating a warning lamp circuit to notify the operator a problem exists in the the lube system.

Pressure Gauge (7, Figure 4-2)

The pressure gauge monitors hydraulic oil pressure to the inlet of the hydraulic motor.

Injectors (24, Figure 4-3)

Each injector delivers a controlled amount of pressurized lubricant to a designated lube point. Refer to Figure 4-3 for locations.

System Operation

Normal Operation:

1. During truck operation, the lubrication cycle timer (1, Figure 4-5) will energize the system at a preset time interval.
2. The timer provides 24 VDC through the normally closed relay, RB7K5 (4) used to energize the pump solenoid valve (5), allowing hydraulic oil provided by the truck steering pump circuit to flow to the pump motor and initiate a pumping cycle.
3. The hydraulic oil pressure from the steering circuit is reduced to 325 to 350 psi (2 240 to 2 413 kPa) by the pressure reducing valve (4, Figure 4-4) before entering the motor. In addition, the amount of oil supplied to the pump is limited by the flow control valve (6). Pump pressure can be read using the gauge (5) mounted on the manifold.
4. With oil flowing into the hydraulic motor, the grease pump will operate, pumping grease from the reservoir to the injectors (13), through a check valve (10) and to the vent valve (11).
5. During this period, the injectors will meter the appropriate amount of grease to each lubrication point.
6. When grease pressure reaches the pressure switch (3, Figure 4-5) setting, the switch contacts will close and energize the relay RB7K5, removing power from the hydraulic motor/pump solenoid and the the pump will stop. The relay will remain energized until grease pressure drops and the pressure switch opens again or until the timer turns off.
7. After the pump solenoid valve is de-energized, hydraulic pressure in the manifold drops and the vent valve will open, releasing grease pressure in the lines to the injector banks. When this occurs, the injectors are then able to recharge for the next lubrication cycle.
8. The system will remain at rest until the lubrication cycle timer turns on and initiates a new grease cycle.

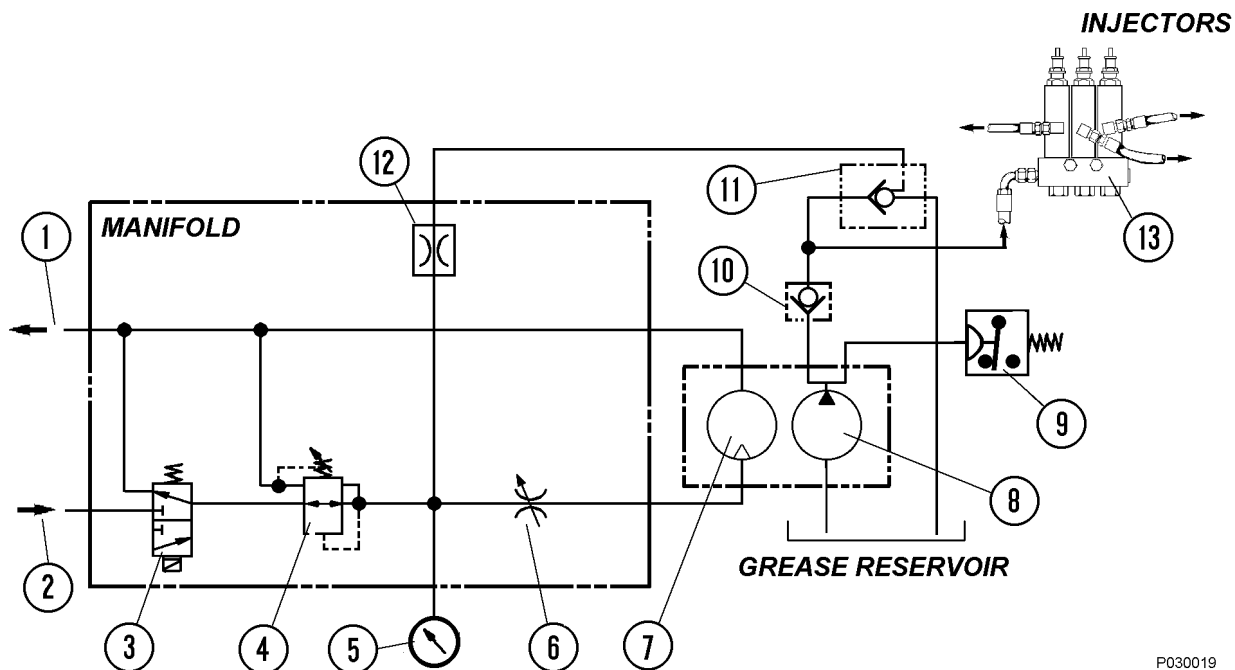

FIGURE 4-4. HYDRAULIC SCHEMATIC

- | | | |
|----------------------------|-------------------------|---------------------------|
| 1. Hydraulic Oil Return | 5. Motor Pressure Gauge | 9. Pressure Switch (N.O.) |
| 2. Hydraulic Oil Supply | 6. Flow Control Valve | 10. Check Valve |
| 3. Pump Solenoid Valve | 7. Hydraulic Motor | 11. Vent Valve |
| 4. Pressure Reducing Valve | 8. Grease Pump | 12. Orifice |
| | | 13. Injector Bank |

P030019

Pressure Failure Detection Circuits:

1. When the lubrication cycle is initiated, 24VDC flows through relay RB7K1 (7, Figure 4-5) N.C. contacts to a 1 minute delay timer (11).
2. If the system is operating normally, grease pressure at the rear axle injector bank will rise to pressure switch (6) setting of 2000 psi (13.8 MPa) and energize relay RB7K1 (7), removing 24VDC from the delay timer.

3. If a problem occurs and the system is not able to attain 2000 psi (13.8 MPa), the delay timer (11) will energize relay RB7K4 (12) after 60 seconds, turning on the "Low Lube System Pressure" warning lamp on the overhead display. After RB7K4 relay energizes, it will energize relay RB7K3 (10).
4. Once RB7K3 is energized, it will latch and remain energized as long as the keyswitch is on. In addition, RB7K4 will also remain energized and the Low Lube Pressure Warning lamp will remain on to notify the operator a problem exists and the system requires service.

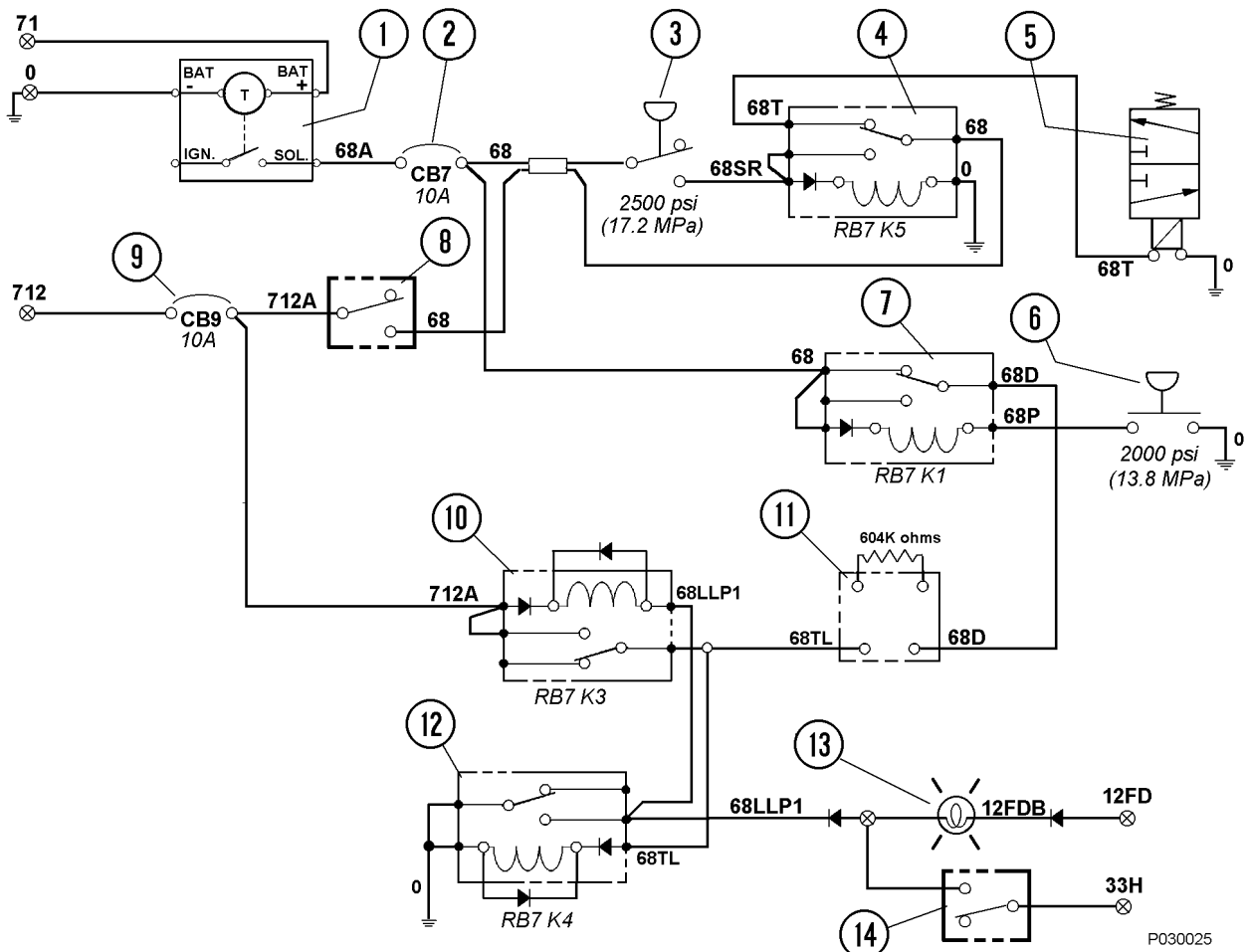

FIGURE 4-5. ELECTRICAL SCHEMATIC

- | | |
|--|--|
| 1. Lubrication Cycle Timer | 9. Circuit Breaker CB9 (In Electrical Interface Cabinet) |
| 2. Circuit Breaker CB7 (In Electrical Interface Cabinet) | 10. Relay K3 (On Relay Board RB7) |
| 3. Pressure Switch; N.O., 2500 psi (17 237 kPa) | 11. Circuit Time Delay Module |
| 4. Relay K5 (On Relay Board RB7) | 12. Relay K4 (On Relay Board RB7) |
| 5. Grease Pump Motor Solenoid Valve | 13. Low Grease Pressure Warning Lamp (On Overhead Display Panel) |
| 6. Pressure Switch; N.O. 2000 psi (13 790 kPa) | 14. Warning & Caution Lamp Test Switch (On Overhead Display Panel) |
| 7. Relay K1 (On Relay Board RB7) | |
| 8. Lube System Manual Test Switch | |

GENERAL INSTRUCTIONS

LUBRICANT REQUIRED FOR SYSTEM

Grease requirements will depend on ambient temperatures encountered during truck operation:

- Above 90°F (32°C) - Use NLGI No.2 multipurpose grease (MPG).
- -25° to 90°F (-32° to 32°C) - Use NLGI No. 1 multipurpose grease (MPG).
- Below -25°F (-32°C) - Refer to local supplier for extreme cold weather lubricant requirements.

SYSTEM PRIMING

The system must be full of grease and free of air pockets to function properly. After maintenance, if the primary or secondary lubrication lines were replaced, it will be necessary to reprime the system to eject all entrapped air.

1. Fill lube reservoir with lubricant, if necessary.
2. To purge air from the main supply line, remove the main supply line at the Lincoln Lube canister and connect an external grease supply to the line.
3. Remove plugs from each injector group in sequence (right front, left front, and rear axle).
4. Using the external grease source, pump grease until grease appears at the group of injectors and re-install the pipe plug. Repeat for remaining injector groups.
5. Remove the caps from each injector and connect an external grease supply to the zerk on the injector and pump until grease appears at the far end of the individual grease hose or the joint being greased.

FILTER ASSEMBLY

The filter assembly element (5, Figure 4-6) should be replaced if the bypass indicator (2) shows excessive element restriction.

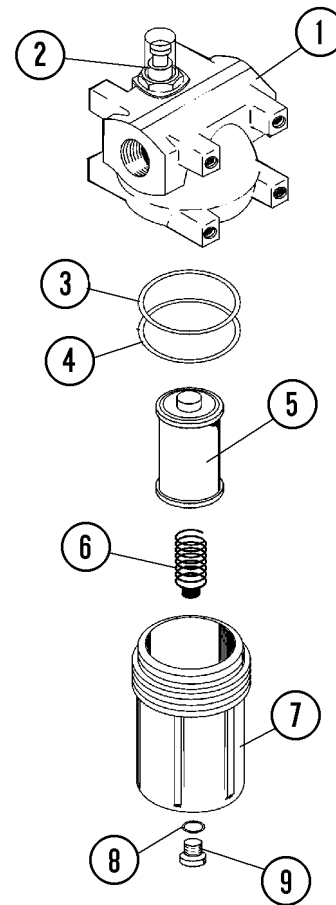

P030023

FIGURE 4-6. FILTER ASSEMBLY

- | | |
|---------------------|-----------|
| 1. Housing | 6. Spring |
| 2. Bypass Indicator | 7. Bowl |
| 3. O-Ring | 8. O-Ring |
| 4. Backup Ring | 9. Plug |
| 5. Element | |

LUBRICANT PUMP

Pump Housing Oil Level

The pump housing must be filled to the proper level with SAE 10W-30 motor oil. Oil level should be checked at 1000 hour intervals. To add oil, remove pipe plug (3, Figure 4-7) and fill housing to bottom of plug hole.

Pump Pressure Control

High pressure hydraulic fluid from the truck steering system is reduced to 325 to 350 psi (2 240 to 2 413 kPa) by the pressure reducing valve located on the manifold on top of the pump motor. This pressure can be read on the gauge installed on the manifold and should be checked occasionally to verify pressure is within the above limits.

Pressure Control Valve Adjustment

1. With the truck engine running, activate the lube system manual test switch to start the hydraulic motor and pump.
2. Loosen the locknut on the pressure control (1, Figure 4-7) by turning the nut counterclockwise.
3. Turn the valve stem counterclockwise until it no longer turns. (The valve stem will unscrew until it reaches the stop - it will not come off.)

Note: This is the minimum pressure setting, which is about 170 psi (1 172 kPa).

4. With the pump stalled against pressure, turn the pressure control valve stem clockwise until 325 to 350 psi (2 240 to 2 413 kPa) is attained on the manifold pressure gauge (2).
5. Tighten the locknut to lock the stem in position.

*Note: The flow control valve (4) is factory adjusted to 2.5 GPM (9.5 L/min.). **Do not change this setting.***

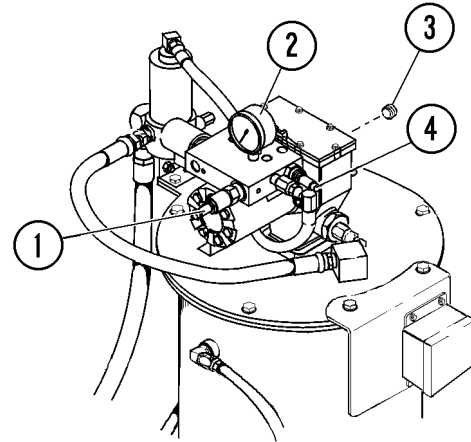

P030022

FIGURE 4-7. PUMP CONTROLS

- | | |
|--------------------------|-----------------------|
| 1. Pump Pressure Control | 3. Oil Level Plug |
| 2. Pressure Gauge | 4. Flow Control Valve |

INJECTOR OPERATION

STAGE 1

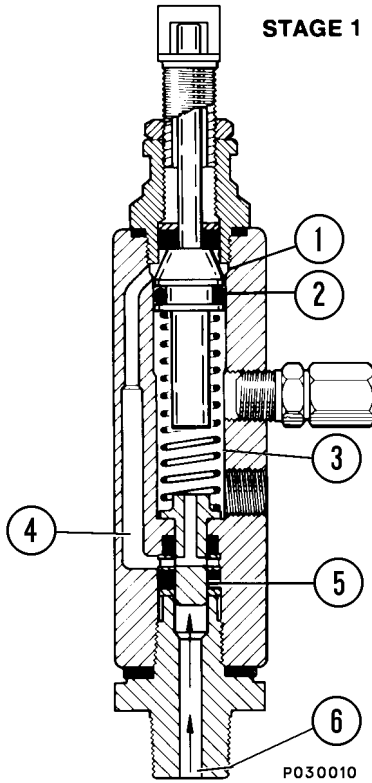

STAGE 1.

The injector piston (2) is in its normal or "rest" position. The discharge chamber (3) is filled with lubricant from the previous cycle. Under the pressure of incoming lubricant (6), the slide valve (5) is about to open the passage (4) leading to the measuring chamber (1) above the injector piston (2).

STAGE 2.

When the slide valve (5) uncovers the passage (4), lubricant (6) is admitted to the measuring chamber (1) above the injector piston (2) which forces lubricant from the discharge chamber (3) through the outlet port (7) to the bearing.

STAGE 2

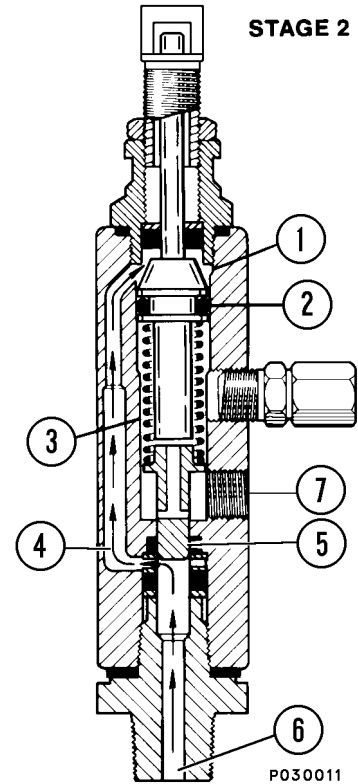

STAGE 3.

As the injector piston (2) completes its stroke, it pushes the slide valve (5) past the passage (4), cutting off further admission of lubricant (6) to the passage (4) and measuring chamber (1). The injector piston (2) and slide valve (5) remain in this position until lubricant pressure in the supply line (6) is vented.

STAGE 3

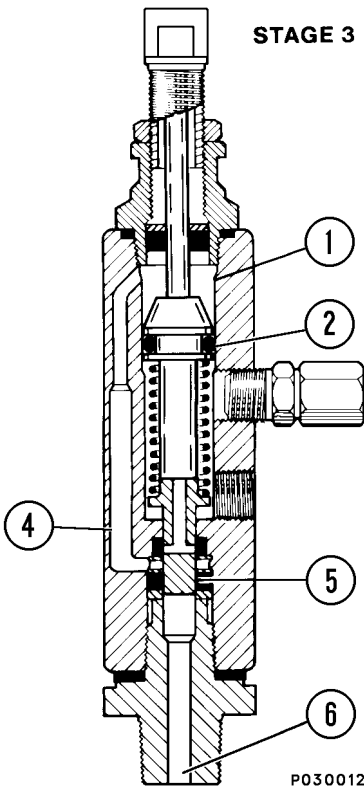

STAGE 4.

After venting, the injector spring expands, causing the slide valve (5) to move, so that the passage (4) and discharge chamber (3) are connected by a valve port (8). Further expansion of the spring causes the piston to move upward, forcing the lubricant in the measuring chamber (1) through the passage (4) and valve port (8) to refill the discharge chamber (3).

STAGE 4

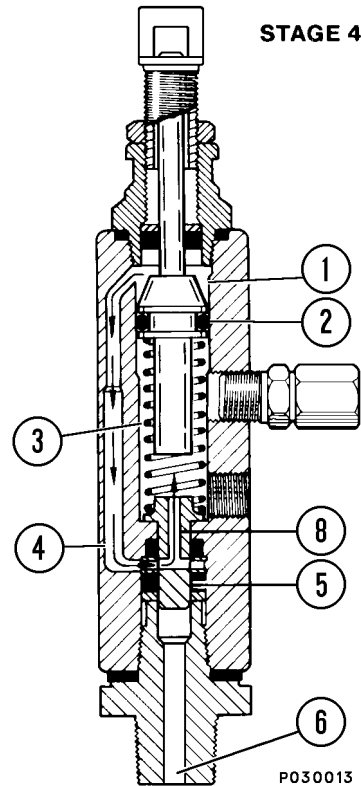

Injector is now ready for the next cycle.

INJECTORS (SL-1 Series "H")

Injector Specifications

- Each lube injector services only one grease point. In case of pump malfunction, each injector is equipped with a covered grease fitting to allow the use of external lubricating equipment.
- Injector output is adjustable:
Maximum output = 0.08 in³ (1.31 cc).
Minimum output = 0.008 in³ (0.13 cc).
- Operating Pressure:
Minimum - 1850 psi (12 755 kPa)
Maximum - 3500 psi (24 133 kPa)
Recommended - 2500 psi (17 238 kPa)
Maximum Vent Pressure - (Recharge)
600 psi (4 137 kPa)

Injector Adjustment

The injectors may be adjusted to supply from 0.008 in³ to 0.08 in³ (0.13 cc to 1.31 cc) of lubricant per injection cycle. The injector piston travel distance determines the amount of lubricant supplied. This travel is in turn controlled by an adjusting screw in the top of the injector housing.

Turn the adjusting screw (1, Figure 4-8) counterclockwise to increase lubricant amount delivered and clockwise to decrease the lubricant amount.

When the injector is not pressurized, maximum injector delivery volume is attained by turning the adjusting screw (1) fully counterclockwise until the indicating pin (8) just touches the adjusting screw. At the maximum delivery point, about 0.38 inch (9.7 mm) adjusting screw threads should be showing. Decrease the delivered lubricant amount by turning the adjusting screw clockwise to limit injector piston travel. If only half the lubricant is needed, turn the adjusting screw to the point where about 0.19 inch (4.8 mm) threads are showing. The injector will be set at minimum delivery point with about 0.009 inch (0.22 mm) thread showing.

NOTE: The above information concerns adjustment of injector delivery volume. The timer adjustment should also be changed, if overall lubricant delivery is too little or too much. Injector output should NOT be adjusted to less than one-fourth capacity.

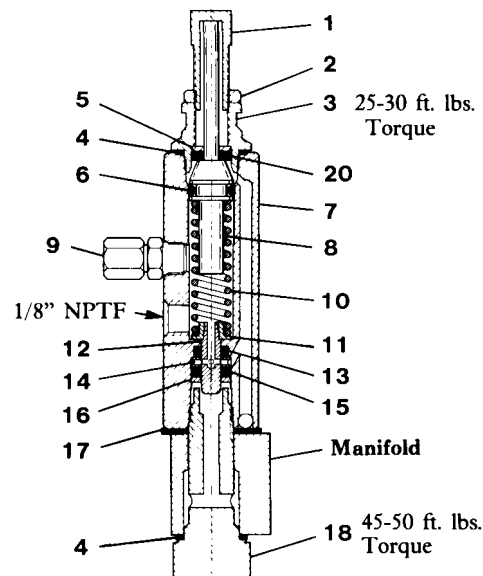

FIGURE 4-8. TYPE SL-1 INJECTOR

- | | |
|------------------------|-------------------|
| 1. Adjusting Screw | 11. Spring Seat |
| 2. Locknut | 12. Plunger |
| 3. Piston Stop Plug | 13. Viton Packing |
| 4. Gasket | 14. Inlet Disc |
| 5. Washer | 15. Viton Packing |
| 6. Viton O-Ring | 16. Washer |
| 7. Injector Body Assy. | 17. Gasket |
| 8. Piston Assembly | 18. Adapter Bolt |
| 9. Fitting Assembly | 19. Adapter |
| 10. Plunger Spring | 20. Viton Packing |

NOTE: The Piston Assembly (8) has a visible indicator pin at the top of the assembly to verify the injector operation.

SYSTEM CHECKOUT

To check system operation (not including timer), proceed as follows:

1. Turn keyswitch "ON" and start the engine.
2. Actuate the Lube System Test Switch at the reservoir/pump assembly on the front bumper.
3. The motor and pump should operate until the system attains 2500 psi (17 237 kPa).
4. Once the required pressure is achieved, the pump motor should turn off and the system should vent.
5. Check for pump, hose or injector damage or leakage with the system under pressure.
6. After checking system, shutdown engine, observing normal precautions regarding high voltage present in the propulsion system before attempting to repair lube system.

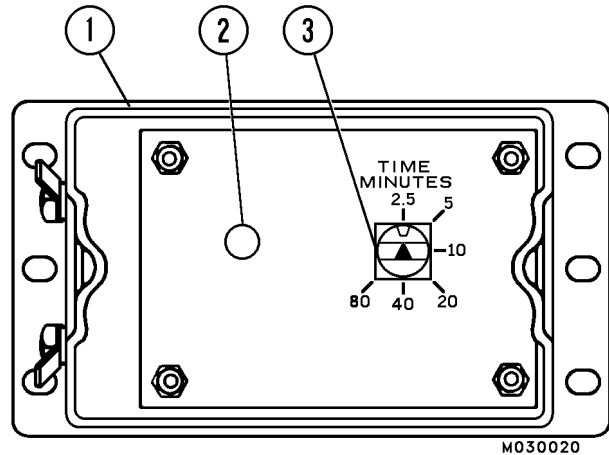

FIGURE 4-9. TIMER (TOP COVER REMOVED)

1. Timer Enclosure
2. Red LED (Light Emitting Diode)
3. Timer Selector

LUBRICATION CYCLE TIMER CHECK

To check the solid state timer operation without waiting for the normal timer setting, proceed as follows:

1. Remove timer dust cover.
NOTE: The timer incorporates a liquid and dust tight cover which must be in place and secured at all times during truck operation.
2. Adjust timer selector (3, Figure 4-9) to 5 minute interval setting.
3. The timer should cycle in five minutes if the truck is operating.

NOTE: If the timer check is being made on a cold start, the first cycle will be approximately double the nominal setting. All subsequent cycles should be within the selected time tolerance.

4. Voltage checks at the timer should be accomplished if the above checks do not identify the problem.
 - a. Insure timer ground connection is clean and tight.
 - b. Using a Volt-Ohm meter, read the voltage between positive and negative posts on the solid state timer with the truck keyswitch "ON".

Normal reading should be 18-26 VDC, depending upon whether or not the engine is running.

Lubrication Cycle Timer Adjustment

The timer is factory set for a nominal 2.5 minute (off time) interval. Dwell time is approximately 1 minute, 15 seconds. A longer interval (off time) is obtained by turning the Selector knob (3, Figure 4-9) to the desired position .

NOTE: Set timer by turning the Selector knob (3) to the 2.5 minute setting point. Then, turn the Selector clockwise, one detent at a time, to the desired setting, or until the maximum limit of eighty minutes is reached.

The timer is a sealed unit, do not attempt disassembly.

SYSTEM TROUBLESHOOTING CHART

If the following procedures do not correct the problem, contact a factory authorized service center.

POSSIBLE CAUSES

SUGGESTED CORRECTIVE ACTION

TROUBLE: Pump Does Not Operate

Lube system not grounded.

Correct grounding connections to pump assembly and truck chassis.

Electrical power loss.

Locate cause of power loss and repair. Check circuit breaker CB7. Be sure keyswitch is "ON".

Timer malfunction.

Replace timer assembly

Solenoid valve malfunctioning.

Replace the solenoid valve assembly

RB7K5 Relay malfunctioning

Replace relay

Motor or pump malfunction.

Replace motor and/or pump assembly

Pressure switch defective

Replace pressure switch

NOTE: On initial startup of the lube system, the timing capacitor will not contain a charge, therefore the first timing cycle will be about double in length compared to the normal interval. Subsequent timer cycles should be as specified.

TROUBLE: Pump Will Not Prime

Low lubricant supply.

Dirt in reservoir, pump inlet clogged, filter clogged.

TROUBLE: Pump Will Not Build Pressure

Air trapped in lubricant supply line.

Prime system to remove trapped air.

Lubricant supply line leaking.

Check lines and connections to repair leakage.

Vent valve leaking.

Clean or replace vent valve.

Pump worn or scored.

Repair or replace pump assembly.

TROUBLE: Injector Indicator Stem Does Not Operate

NOTE: Normally, during operation, the injector indicator stem will move into the body of the injector when pressure builds properly. When the system vents (pressure release) the indicator stem will again move out into the adjusting yoke.

Malfunctioning injector - usually indicated by the pump building pressure and then venting.

Replace individual injector assembly.

All injectors inoperative - pump build up not sufficient to cycle injectors.

Service and/or replace pump assembly.

POSSIBLE CAUSES

SUGGESTED CORRECTIVE ACTION

TROUBLE: Pressure Gauge Does Not Register Pressure

No system pressure to the pump motor.
No 24 VDC signal at pump solenoid.
Pressure reducing valve set too low.
Relay (RB7K5) may be defective.

Check hydraulic hose from steering system.
Determine problem in 24 VDC electric system.
Refer to "Pressure Control Valve Adjustment".
Replace relay.

TROUBLE: Pump Pressure Builds Very Slowly Or Not At All

No signal at RB7K5 relay.
Pressure switch may be defective
Pressure reducing valve may be set too low.
Grease viscosity may be too high for temperature at which pump is operating.

Check Timer and CB7.
Replace pressure switch.
Refer to "Pressure Control Valve Adjustment".
Replace grease with a lower viscosity lubricant.

Pump inlet check or outlet check may have foreign matter trapped causing leakage.

Remove, inspect and clean, if necessary.
Inspect sealing surfaces between checks. Replace if rough or pitted.

Lubricant supply line leaks or is broken.
Insufficient hydraulic oil supply.

Repair lubricant supply line
Check oil pressure and flow to motor.

TROUBLE: Lube Cycle Timer Not Operating

Timer BAT (-) connection is not on grounded member.
Timer BAT (+) connection not on circuit continuously connected to BAT (+) terminal during operation of vehicle.

Connect to good ground.
Establish direct connection between Timer BAT (+) connection and 24 V BAT (+) terminal.

Loose wire connections at any of the timer terminals.

Secure wire connections.

TROUBLE: Timer Stays Timed Out

Commutation failure in timer caused by damaged component.
Output relay contacts welded shut caused by extended short to ground.
Solenoid valve connected to "IGN" terminal of timer instead of terminal marked "SOL".

Replace Timer
Replace Timer.
Correct wiring hook-up.

POSSIBLE CAUSES

SUGGESTED CORRECTIVE ACTION

TROUBLE: Timer Turns On At Intervals Two (2) To Ten (10) Times More Often Than Set Time Interval

Electrical noise is being introduced into the power supply to the timer overcoming suppressor capacitor causing uncontrolled turn-on of its output relay.

IMPORTANT: In some instances, electrical noise may be generated into vehicle electrical system which may cause timer to turn on at random intervals, independent of timer setting.

If this occurs, a 250 to 1,000 MFD capacitor rated 150 to 350 VDC should be added across BAT (+) and BAT (-) terminals to suppress this noise and improve timer performance.

TROUBLE: Timer Turns On At Intervals Faster Than Allowable Tolerances Of Settings

Timer out of adjustment or damaged component.

Refer to "Timer Adjustment and re-adjust timer or replace timer.

Preventative Maintenance Procedures

The following maintenance procedures should be used to insure proper system operation.

Daily Lubrication System Inspection

1. Check grease reservoir level.

Inspect grease level height after each shift of operation. Grease usage should be consistent from day-to-day operations.

- Lack of lubricant usage would indicate an inoperative system. Excessive usage would indicate a broken supply line.

2. Check filter bypass indicator when filling reservoir. Replace element if bypassing.
3. Check all grease feed line hoses from the SL-1 Injectors to the lubrication points.
 - a. Repair or replace all damaged feed line hoses.
 - b. Make sure that all air is purged and all new feed line hoses are filled with grease before sending the truck back into service.
4. Inspect key lubrication points for a bead of lubricant around seal. If a lubrication point appears dry, troubleshoot and repair problem.

250 Hour Inspection

1. Check all grease feed line hoses from the SL-1 Injectors to the lubrication points (see, Figure 4-3).
 - a. Repair or replace all worn / broken feed line hoses.
 - b. Make sure that all air is purged and all new feed line hoses are filled with grease before sending the truck back into service.
2. Check all grease supply line hoses from the pump to the SL-1 injectors.
 - a. Repair or replace all worn / broken supply lines.
 - b. Make sure that all air is purged and all new supply line hoses are filled with grease before sending the truck back into service.
3. Check grease reservoir level.
 - a. Fill reservoir if low.
 - b. Check reservoir for contaminants. Clean, if required.

- c. Check that all filler plugs, covers and breather vents on the reservoir are intact and free of contaminants.

4. Inspect all bearing points for a bead of lubricant around the bearing seal.

It is good practice to manually lube each bearing point at the grease fitting provided on each Injector. This will indicate if there are any frozen or plugged bearings, and will help flush the bearings of contaminants.

5. System Checkout

- a. Remove all SL-1 injector cover caps to allow visual inspection of the injector cycle indicator pins during system operation.
- b. Start truck engine.
- c. Actuate the Lube System Test Switch. The hydraulic motor and grease pump should operate.
- d. With the grease under pressure, check each SL-1 injector assembly. The cycle indicator pin should be retracted inside the injector body.
- e. When the system attains 2500 psi (17 237 kPa), the pump should shut off and the pressure in the system should drop to zero, venting back to the grease reservoir.
- f. With the system vented, check all of the SL-1 injector indicator pins; all of the pins should be visible. Replace or repair injectors, if defective.
- g. Reinstall all injector cover caps.
- h. Check timer operation.

Note: With engine running, lube system should activate within 5 minutes. The system should build 2000 to 2500 psi within 25-40 seconds.

- i. If the system is working properly, the truck is ready for operation.
- j. If the system is malfunctioning, refer to the troubleshooting chart.

1000 Hour Inspection

1. Check pump housing oil level and correct if necessary.

MAJOR COMPONENT DESCRIPTION

Truck And Engine

The 930E Dump Truck is an off-highway, rear dump truck with AC Electric Drive. The gross vehicle weight is 1,100,000 lbs. (498 960 kg). The engine is a Cummins QSK60C rated @ 2700 HP (2014 kW).

Alternator (GE-GTA34)

The diesel engine drives an in-line alternator at engine speed. The alternator produces AC current which is rectified to DC within the main control cabinet. The rectified DC power is converted back to AC by groups of devices called "inverters", also within the main control cabinet. Each inverter consists of six "phase modules" under the control of a "gate drive unit" (GDU). The GDU controls the operation of each phase module.

Each phase module contains an air-cooled solid-state switch referred to as a "gate turn-off thyristor" (GTO). The GTO cycles on and off at varying frequencies to create an AC power signal from the DC supply.

The AC power signal produced by each inverter is a variable-voltage, variable-frequency signal (VVVF). Frequency and voltage are changed to suit the operating conditions.

AC Induction Traction Motorized Wheels

The alternator output supplies electrical energy to the two wheel motors attached to the rear axle housing. The motorized wheels use three-phase AC induction motors with full-wave AC power.

The two wheel motors convert electrical energy back to mechanical energy through built-in gear trains within the wheel motor assembly. The direction of the wheel motors is controlled by a forward or reverse hand selector switch located on a console to the right side of the operator.

Blower

Both the inverters and the wheel motors produce heat while in operation and must be cooled. Cooling air is provided by a separate AC drive blower using rectified DC as its power source. Cooling air flow volume is modulated based on thermal requirements.

Suspension

HYDRAIR®II suspension cylinders located at each wheel provide a smooth and comfortable ride for the operator and dampens shock loads to the chassis during loading and operation.

Operator's Cab

The Operator's Cab has been engineered for operator comfort and to allow for efficient and safe operation of the truck. The cab provides for wide visibility, with an integral 4-post ROPS/FOPS structure, and an advanced analog operator environment. It includes a tinted safety-glass windshield and power-operated side windows, a deluxe interior with a fully adjustable seat with lumbar support, a fully adjustable/tilt steering wheel, controls mounted within easy reach of the operator, and an analog instrument panel which provides the operator with all instruments and gauges which are necessary to control and/or monitor the truck's operating systems.

Power Steering

The truck is equipped with a full time power steering system which provides positive steering control with minimum operator effort. The system includes nitrogen-charged accumulators which automatically provide emergency power if the steering hydraulic pressure is reduced below an established minimum.

Dynamic Retarding

The dynamic retarding is used to slow the truck during normal operation or control speed coming down a grade. The dynamic retarding ability of the electric system is controlled by the operator through the activation of the retarder pedal (or by operating a lever on the steering wheel) in the operators cab and by setting the RSC (Retarder Speed Control). Dynamic Retarding is automatically activated, if the truck speed goes to a preset overspeed setting.

Brake System

Service brakes at each wheel are oil-cooled multiple disc brakes applied by an all-hydraulic actuation system. Depressing the brake pedal actuates both front and rear brakes, after first applying the retarder. All wheel brakes will be applied automatically, if system pressure decreases below a preset minimum.

The parking brake is a dry disc type, mounted inboard on each rear wheel motor, and is spring-applied and hydraulically-released with wheel speed application protection (will not apply with truck moving).

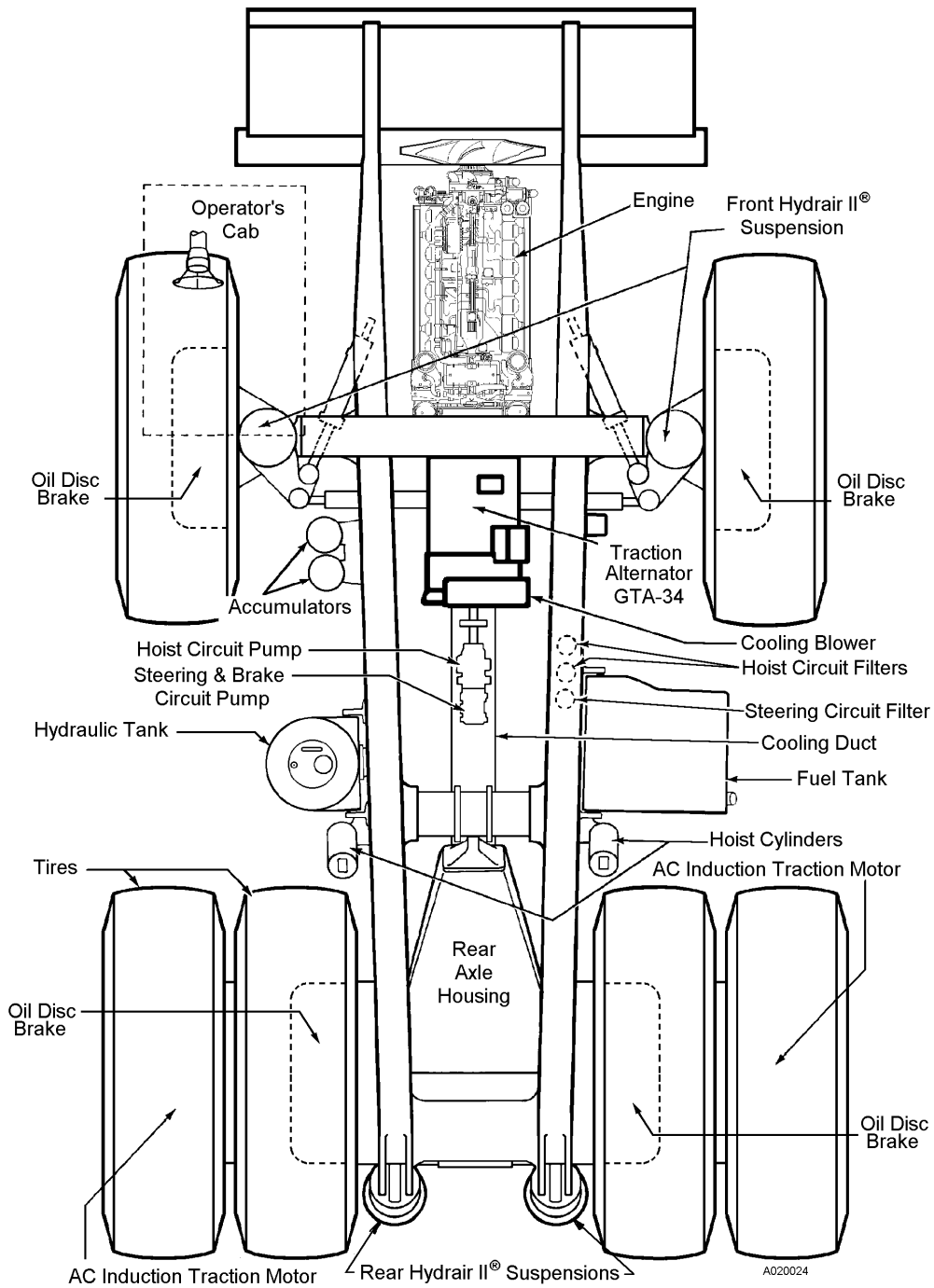

930E MAJOR COMPONENTS

SPECIFICATIONS

These specifications are for the standard 930E Truck. Customer Options may change this listing.

ENGINE

Cummins QSK60

Number of Cylinders 16
 Operating Cycle 4-Stroke
 Rated Brake HP . 2700HP (2014 kW) @ 1900 RPM
 Flywheel HP 2550HP (1879 kW)
 Weight (Dry)* 19,515 lbs. (8852 kg)

* Weight does not include Radiator, Sub-frame, or Alternator

AC ELECTRIC DRIVE SYSTEM

AC/DC Current

Alternator General Electric GTA - 34
 Integral Cooling Fan 2500 cfm (71 m³/min)
 AC Thermally Mod. Dual Fan
 12,000 cfm (340 m³/min)
 Motorized Wheels . . AC Induction Traction Motors
 Wheel Slip/Slide Control
 Standard Gear Ratio* 31.50:1
 Maximum Speed 40 MPH (64.5 km/h)

* NOTE: Wheelmotor application depends upon GVW, haul road grade, haul road length, rolling resistance, and other parameters.
 Komatsu & G.E. must analyze each job condition to assure proper application.

DYNAMIC RETARDING

Electric Dynamic Retarding Standard
 Maximum Retarding 5400 HP (4026 kW)
 Continuous 3300 HP (2460 kW)
 Continuously Rated High-density Blown Grids
 with Retard at Engine Idle and Retard in Reverse
 Propulsion.

BATTERY ELECTRIC SYSTEM

Batteries - bumper-mounted
 4 x 8D & 2 x 30H 12 Volt Batteries in Series/Parallel
 220 Ampere-Hour Capacity
 With Disconnect Switch
 Alternator 24 Volt, 240 Ampere Output
 Lighting 24 Volt
 Starters (2) 24 Volt

SERVICE CAPACITIES

	U.S. Gallons	Liters
Crankcase (Includes lube oil filters)		
QSK60-C	74	280
Cooling System	157	594
Fuel	1200	4542
Hydraulic System	350	1325
Wheel Motor Gear Box . 20/Wheel		76/Wheel

HYDRAULIC SYSTEM

Hoist & Brake Cooling Pump: Tandem Gear
 Output 270 GPM (1022 l/min) @ 1900 RPM
 and 2500 psi (17 237 kPa)
 Steering/Brake Pump: Press. Compensated Piston
 Output 65 GPM (246 l/min) @ 1900 RPM
 and 2750 psi (18 961 kPa)
 Relief Pressure- Hoist 2500 psi (17.2 MPa)
 Relief Pressure- Steering/Brake 2750 psi (22.4 MPa)
 Hoist Two 3-Stage Hydraulic Cylinders
 Tank Vertical - Cylindrical, Non-Pressurized
 Tank Capacity 250 U.S. Gal. (947 Liters)
 Filtration In-line replaceable elements
 Suction Single, Full Flow, 100 Mesh
 Hoist & Steering Filters . . . Beta 12 rating = 200
 Dual, In-Line, High Pressure

SERVICE BRAKES

All Hydraulic Actuation with Traction System
 Wheel Slip/Slide Control
 Front & Rear Oil-Cooled Multiple Discs
 at Each Wheel.
 Total Friction Area /Brake 15,038 in² (97 019 cm²)
 Maximum Apply Pressure . 2500 psi (17 238 kPa)

STEERING

Turning Circle (SAE) 97 ft. 4 in. (29.67 m)
 Twin hydraulic cylinders with accumulator assist to
 provide constant rate steering.
 Emergency Power Steering automatically provided by
 Accumulators

STANDARD DUMP BODY*

- Capacity:
 Struck 224 yds³ 171 m³
 Heaped @ 2:1 (SAE) 276 yds³ 211 m³
 Width (Inside) 26 ft. 9 in. (8.15 m)
 Depth 10 ft. 3 in. (3.1 m)
 Loading Height 23 ft. (7.01 m)
 Dumping Angle 45°
 * OPTIONAL Capacity Dump Bodies are available.

WEIGHT DISTRIBUTION

	EMPTY	Pounds	Kilograms
Front Axle (49.3%)	219,913	99 751	
Rear Axle (50.7%)	226,121	102 567	
Total (50% Fuel)	446,034	202 318	
LOADED			
Front Axle (33.9%)	372,727	169 069	
Rear Axle (66.1%)	727,273	329 891	
Total	1,100,000	498 960	

Not to exceed 1,100,000 lbs. (498 960 kg), including options, fuel, and payload. Weights in excess of this amount require factory approval.

TIRES

- Radial Tires (standard) 53/80 R63
 Rock Service, Deep Tread Tubeless
 Rims . (patented Phase II New Generation™ rims)

OVERALL TRUCK DIMENSIONS

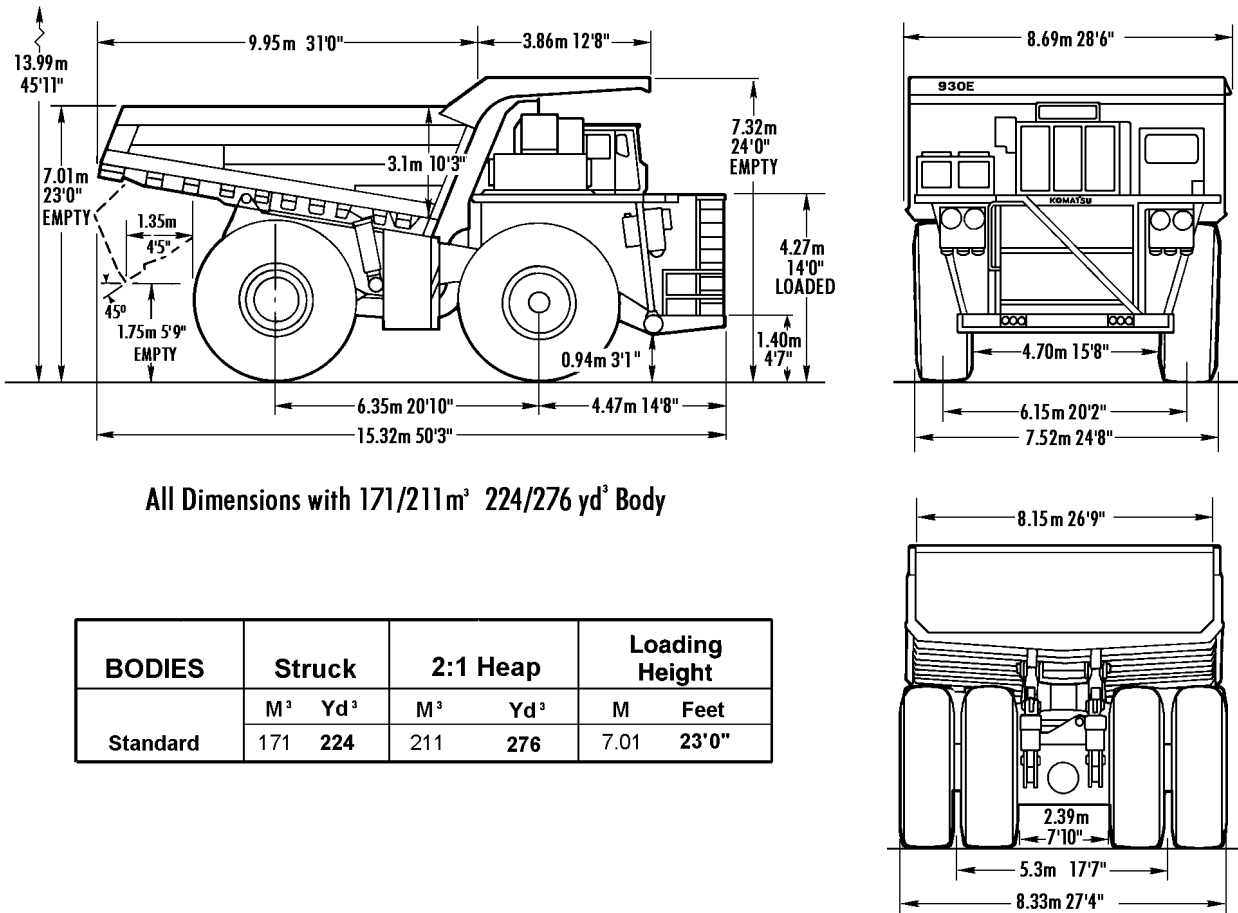

All Dimensions with 171/211 m³ 224/276 yd³ Body

BODIES	Struck		2:1 Heap		Loading Height	
	M ³	Yd ³	M ³	Yd ³	M	Feet
Standard	171	224	211	276	7.01	23'0"

PAYLOAD METER II ON BOARD WEIGHING SYSTEM (OBWS) INDEX

GENERAL INFORMATION	6-3
LIGHTS, SWITCHES, and COMPONENTS	6-4
TIPS FOR OPERATION	6-5
EXTERNAL DISPLAY LIGHTS	6-5
THEORY OF OPERATION	6-6
Basic Description	6-6
Linkage Factor	6-6
Brake Lock	6-7
Sources of Error	6-7
Typical Data From Service Check Mode	6-7
Example Calculation of Payload	6-8
Calculation of the Calibration Load	6-8
TYPES OF DATA STORED	6-9
Cycle data	6-9
Engine ON/OFF Data	6-10
Fault Codes and Warning Data	6-10
Engine Operation	6-11
Total Payload and Total Number of Cycles	6-11
Other Data	6-11
OPERATOR FUNCTIONS	6-12
Using the Operator Load Counter	6-12
Description	6-12
Viewing the Operator Load Counter	6-12
Clearing the Operator Load Counter	6-12
Dimming the Lights on the Display	6-12
INITIAL SETUP OF PAYLOAD METER	6-13
Switch Settings	6-13
Checking the Operator Check Mode	6-13
Checking the Service Check Mode	6-14
Setting "UP:00"	6-14
Setting "PL:00"	6-14
Checking the G_t Setting	6-14
Checking the Inclinometer Settings	6-15
Calibrating a Truck	6-15
DISPLAYS AT START-UP	6-16
SETUP AND MAINTENANCE	6-17
Setting the Speed Limit	6-17
Setting the Option Code	6-17
Setting The Machine I.D.	6-17
Setting The Operator I.D.	6-18
Setting The Time and Date	6-18

DOWNLOAD OF PAYLOAD AND FAULT CODES	6-18
DISPLAY OF FAULT CODES	6-19
CHARTS OF ERROR CODES AND OTHER INFORMATION	6 & 21
SERVICE CHECK MODE	6-22
Monitoring Input Signals	6-22
UP Factor - Payload Calculation Gain	6-23
PL Mode - Load Calculation Timing	6-23
FINAL GEAR RATIO SELECTION	6-24
BATTERY REPLACEMENT PROCEDURE	6-25
Replacing the Battery	6-25
After Replacing the Battery	6-26
SUSPENSION PRESSURE SENSOR	6-26
Removal	6-26
Installation	6-27
INCLINOMETER	6-27
Removal	6-27
Installation	6-27
SCOREBOARD	6-28
Description	6-28
Making Connections	6-28
Wiring Diagram	6-29
Normal Operation of the Scoreboard	6-30
PAYLOAD METER BACK PANEL	6-30
Connections (AMP Pin Identification)	6-31
PAYLOAD CIRCUIT NUMBERS	6-32
PAYLOAD METER II RE-INITIALIZATION PROCEDURE	6-33

PAYLOAD METER II ON BOARD WEIGHING SYSTEM (OBWS)

GENERAL INFORMATION

The Payload Meter II On Board Weighing System displays and records the payload weight along with other operating information. The system consists of a payload meter, pressure sensors, deck mounted lights and an inclinometer.

The payload meter (Figure 6-1) uses the four suspension pressures and an inclinometer to determine the load in the truck. The payload weight can be displayed in short tons or metric tons.

There are three external deck-mounted lights on each side of the truck. The lights indicate payload weight divided into three separate stages. A forecast feature will flash a deck mounted light predicting the payload weight if the next bucket of material is dropped into the body.

The payload meter stores in memory various operating data. This data includes:

- 1) The payload, time, distance, and travel speed for each cycle.
- 2) The date and time that the engine was started and stopped.
- 3) The date and time of each fault that occurred or was canceled.
- 4) The total payload and the overall number of cycles for a specific time period.

This data is retained even when the power is switched off. The stored data is backed up by an internal battery.

The data can be down loaded from the payload meter to a personal computer when a communication cable is connected to the port inside the cab.

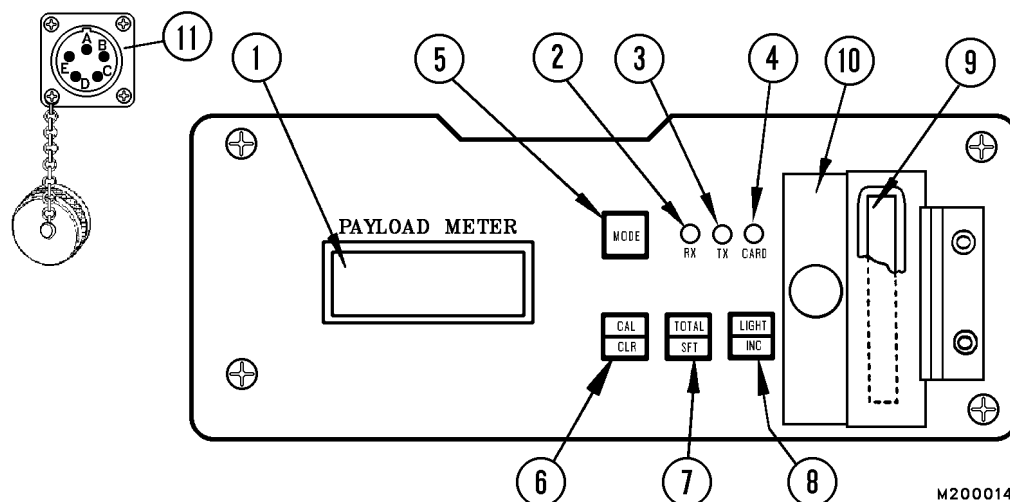

FIGURE 6-1. PAYLOAD METER II

- | | |
|---|---|
| 1. Display panel | 7. Total/shift switch [TOTAL] [SFT] |
| 2. Reception pilot lamp (Rx busy) | 8. Light/increment switch [LIGHT] [INC] |
| 3. Transmission pilot lamp (Tx busy) | 9. Memory card |
| 4. Memory card access lamp (CARD busy) | 10. Cover |
| 5. Mode switch [MODE] | 11. Diagnostic/Download Port |
| 6. Calibration/clear switch [CAL] [CLR] | |

WARNING - When not inserting or removing memory card (9), always keep the cover (10) closed)

LIGHTS, SWITCHES, and COMPONENTS On The Face Of The Payload Meter (Refer to Figure 6-1)

1. Display Panel

Digital display area for the data being recorded in memory. This will include items such as:

Payload

Date & Time

Cycles

Travel Distance

Fault Codes and Warnings

2. Reception Pilot Lamp (Rx Busy)

This light will illuminate for 3 seconds when the system is powered up. It will then be lit whenever the computer is communicating.

3. Transmission Pilot Lamp (Tx Busy)

This light will illuminate for 3 seconds when the system is powered up. It will then be lit whenever the memory is being downloaded to a personal computer.

4. Memory Card Access Lamp (CARD Busy)

This light will illuminate for 3 seconds when the system is powered up. It will also be lit whenever the memory data is being downloaded to the memory card.

5. Mode Switch

This switch is used to select the mode or system that will allow a function to be performed.

This may include:

Various settings or corrections to the display

Memory card downloading

Clearing data

Display of Abnormalities or Warnings

Setting the speed limit

Setting the date and time

6. Calibration/Clear Switch

Used to calibrate the machine when the conditions regulate this action.

Also used with the TOTAL/SFT switch to clear total payload and overall number of cycles.

7. Total/Shift Switch

Used to display payload and overall number of cycles each time the load is dumped. Will display the error codes. This switch is also used with the CALIBRATION/CLEAR switch to clear total payload and overall number of cycles.

8. Light/Increment Switch

Used to change the digital increments or units for the various displays. Also used to adjust the brightness of the lights on the monitor display.

9. Memory Card

Used to receive data from the payload meter memory to this card which can then be used to transfer the data into a personal computer. This enables the memory to be downloaded and saved when a personal computer is not available.

10. Cover

Protective cover for the Memory Card. Do not open or place foreign objects in slot.

11. Diagnostic/Download Port

Connector port that is used for downloading the memory data to a personal computer.

TIPS FOR OPERATION

To assure that the On Board Weighing System records the most accurate and consistent data, these important steps should be followed:

- * For most Komatsu Trucks:
Use **only the Brake Lock** switch to hold the truck stationary at the loading and dumping area.
For Komatsu 330M Trucks ONLY:
Use the **Park Brake switch** to hold the truck stationary at the loading and dumping area.
Any other method will not allow the payload system to register properly.
- * Do not activate the "Lamp Test" switch during loading. Inaccurate and inconsistent data may be stored.
- * At the loading area **do not release** the Brake Lock (or Park Brake switch) **until the loading is complete** and the load shock from the last load dumped has settled.
- * The loading area surface **must be** maintained as flat and level as possible. The On Board Weighing System can compensate for slight variations in grade and unevenness, but ruts, berms, rocks, etc. will cause the system to record inaccurate and inconsistent data.
- * Regularly remove "carryback" from the dump body.
- * Calibrate periodically.

EXTERNAL DISPLAY LIGHTS

The Payload Meter II controls three light relays. The relays operate three deck mounted lights on each side of the truck. There is one green light, one amber light, and one red light. (Figure 6-2)

While the truck is stopped being loaded and the hoist lever is in the float position, the appropriate lights will remain on according to the following schedule:

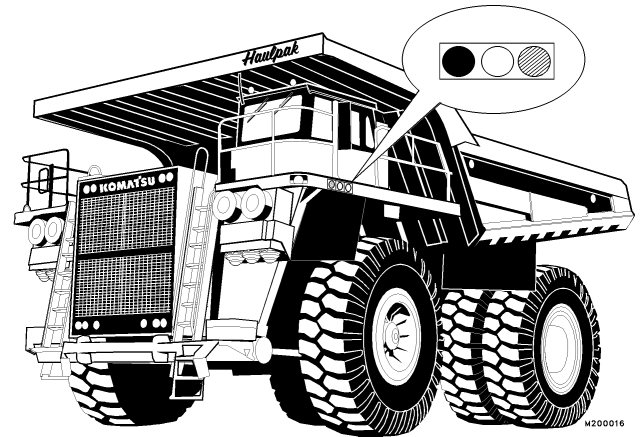

FIGURE 6-2. LOAD INDICATOR LIGHTS

INDICATOR LIGHTS			PAYLOAD WEIGHT
Off	Off	Green	50% and Greater
Off	Amber	Green	90% and Greater
RED	Amber	Green	105% and Greater

The shovel or loader operator can predict the payload weight by observing these lights. During the loading operation, a forecast feature flashes a deck mounted light predicting the payload weight after the next bucket of material is loaded into the body.

The logic is as follows:

1. If the measured payload is varying 3% or less of the rated load for more than 3 seconds, the current load is deemed a steady value.
2. If the difference between the previous steady value and the current steady value is greater than 15% of the rated load, the difference is taken to be the size of the current bucket.
3. The average size of previous buckets is added to the current load. One of the deck mounted lights will turn on, if another "average" size load is put in the body, and will blink at one second intervals.

THEORY OF OPERATION

Basic Description

The payload meter uses the four suspension pressures and the inclinometer to determine the load in the truck. These inputs are critical to the calculation of the load. The other inputs to the payload meter (Body Up, Speed, Brake Lock, Alternator R Terminal, and Engine Oil Pressure) are used to indicate where the truck is in the haul cycle. These inputs enable the payload meter to make time and distance measurements for the haul cycle.

The suspension pressures are the key ingredients in determining the sprung weight of the truck. These pressures are converted into forces using the formulas shown below. These forces are combined with the geometry of the truck to produce the load calculation. It is critical that the suspension pressure sensors are functioning properly.

$$\text{Sprung Weight} = \frac{\pi}{4} \text{Suspension Diameter}^2 (\text{Psi Left} + \text{Psi Right})$$

$$\text{Sprung Weight} = \text{Axle Weight}(\text{lbs})/2000$$

The inclinometer gives the payload meter information regarding the pitch angle of the truck. The front and rear incline factors are determined by the pitch angle. These two factors account for the load transfer that occurs when the truck is inclined nose up or nose down.

Linkage Factor

The linkage factor is part of the complex calculations performed by the payload meter to determine the load in the truck. The linkage factor is dependent on the load on the rear suspensions.

Figure 6-3 shows the side view of a truck. The nose pin is marked with a star and there are three arrows pointing to different spots of the rear tire. This figure shows how the support under the rear tire can affect the calculation of the load. The payload meter does not directly measure the load transferred to the frame through the nose pin. To account for portion of the load carried by the nose pin, the linkage factor is multiplied by the rear suspension force. It is assumed that the truck is supported under the center of the tire. In this case the payload meter uses L2 to help compute the linkage factor. If, however, the truck is backed into a berm and the rear tire is supported towards the back of the tire, the actual linkage factor calculation should use L3. Since the payload meter assumes L2 it will overestimate the load in the truck. The opposite is true in the case where the rear tires are supported toward the front of the tire. The linkage factor should use L1 but the payload meter assumes L2. This change in leverage will cause the payload meter to underestimate the load.

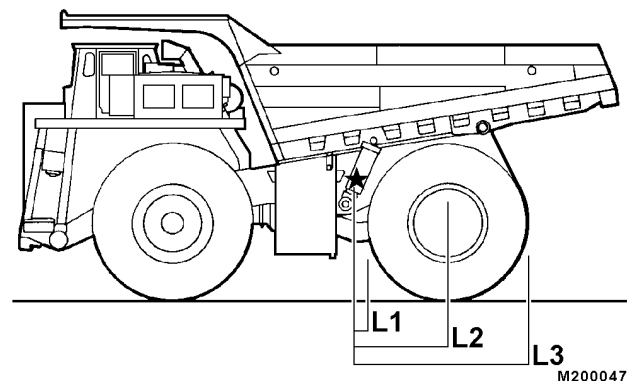

Figure 6-3.

Brake Lock

The Brake Lock only applies the rear brakes. This allows the front wheels to rotate slightly as the truck is being loaded. This is important because the payload meter assumes that the front wheels can rotate freely. As the truck is being loaded, it will begin to squat down on the suspensions. This will change the wheel base dimension of the truck. This freedom of movement prevents additional binding and friction in the front suspensions.

The incline of the grade on which the truck is loading is measured by the inclinometer. This helps determine the incline factors that are applied to the front and rear sprung weights. The tire forces on the road surface that hold the truck on grade affect the suspension pressures. If the front and rear brakes are locked, the effect on the suspension pressures cannot be determined. If only the rear brakes are applied the effect is predictable and the incline factors accurately account for the forces on the tires.

If the service brake or park brake is used and depending on the incline and other factors, the payload meter can overestimate or underestimate the load. **It is important that only the Brake Lock be used while loading the truck.**

Sources of Error

Suspensions

Poorly charged suspensions can lead to systematic error in the calculation of payload. The error is most obvious when the oil level is low. When there is too little oil in the suspensions, the cylinder may compress completely under load. The weight of the truck will be carried by the metal to metal contact within the suspension. Not only will the ride of the truck and the life of the tires be affected, but the pressure in the cylinder will not truly represent the load on the truck. In the under-charged condition the payload meter will typically weigh light and under report the load.

Typical Data From Service Check Mode

Number	Data	Description
1	13:09	Current Time
2	749.4	Front Left Pressure (Psi)
3	848.9	Front Right Pressure (Psi)
4	863.2	Rear Left Pressure (Psi)
5	1049.0	Rear Right Pressure (Psi)
6	106.0	Front Weight (Tons)
7	75.1	Rear Weight (Tons)
8	-1.85	Inclinometer (Degrees)
9	0.95	Incline Factor - Front Wheels
10	0.984	Incline Factor - Rear Wheels
11	1	Link Factor - Front Wheels
12	1.539	Link Factor - Rear Wheels
13	70.6	Calibration Sprung Weight (Tons)
14	1.000	Gain Adjustment
15	143.8	Current Load (Tons)
16	3.9	Battery Backup Voltage (Volts)

Figure 6-4.

A sample data set is shown in Figure 6-4. This data was taken in the laboratory and is used in Figure 6-5 to calculate the final load. Note that the front suspension pressures were converted into the front sprung weight using the formulas above Figure 6-5. The front sprung weight is then multiplied by the front incline factor and the front linkage factor. The same is done with the rear sprung weight. The front and rear sprung weights are then summed. This number is multiplied by the Gt gain potentiometer value. This value should be 1.000. The calibration load is subtracted from the total to produce the final load. The load displayed on the meter is this final load (item #15) multiplied by the UP gain factor.

Note - This screen is the only place that the value of the Gt gain potentiometer can be checked. THIS GAIN SHOULD BE SET TO 1.000. ANY OTHER SETTING CAN PRODUCE SYSTEMATIC ERRORS IN THE PAYLOAD MEASUREMENT.

Note - There are two gain factors that can be applied to the payload measurement. The first is the Gt gain factor and the other is the UP gain factor. They are not applied uniformly to all payload calculations. Both gain factors should be set to 1.000. See the warning on page 16 for more information.

If the Gt gain factor displayed in the Service Check Mode is not 1.000, adjust the gain to exactly 1.000.

In order to adjust this gain:

1. Start with the payload meter in normal operation mode.
2. Adjust the gain pot, left to reduce the value and right to increase the value.
3. Press and hold the LIGHT/INC and MODE switches until "CHEC" is flashing on the meter. **CHEC**
4. Press and hold the LIGHT/INC switch until "ALLO" is flashing on the display. "A.FUL" may also be displayed. **ALLO**
5. Press the LIGHT/INC switch 14 times. The number displayed will be the current Gt gain. This is not a "live" reading. Any time the potentiometer is changed, this cycle must be repeated to view the change.
6. Press MODE once and "CHEC" will flash on the display. **CHEC**
7. Press MODE once and the meter will return to normal operation.

These calculations used a 13" front suspension diameter and 10" rear suspension diameter.

$$\text{Sprung Weight} = \frac{\pi}{4} \text{Suspension Diameter}^2 (\text{Psi Left} + \text{Psi Right})$$

$$\text{Sprung Weight} = \text{Axle Weight}(\text{lbs})/2000$$

Example Calculation of Payload

Front Weight (6)	106.00	Rear Weight(7)	75.10
X Incline Factor (9)	0.95	X Incline Factor (10)	0.98
	100.70		73.90
X Link Factor (11)	1.00	X Link Factor (12)	1.53
Front Weight	100.70	Rear Weight	113.70
Front Weight	100.70		
Rear Weight	113.70		
Total Weight	214.40		
XGain Factor (14)	1.00		
	214.40		
- Calibration (13)	-70.60		
Current Load(15)	143.80		

Figure6-5.

Calculation of the Calibration Load

This procedure is similar to the manual calculation of load. This calibration load is used as item #13 from the manual calculation procedure.

1. Press and hold the LIGHT/INC and MODE switches until "CHEC" is flashing on the display. **CHEC**
2. Press and hold the CAL/CLR switch until "CALLO" is flashing on the display. **CALLO**
3. Press the CAL/CLR switch to cycle through the following data. The sequence repeats.

Item and Description	Units
1. Year of Calibration	Last 2 digits of year
2. Month:Day of Calibration	XX:XX
3. Hour:Minute of Calibration	XX:XX
4. Truck Model Setting	
5. Pressure Front Left	Psi
6. Pressure Front Right	Psi
7. Pressure Rear Left	Psi
8. Pressure Rear Right	Psi
9. Front Sprung Weight	Tons
10. Rear Sprung Weight	Tons
11. Degree of Incline	±° Nose Up Positive
12. Incline Factor - Front Axle	
13. Incline Factor - Rear Axle	
14. Link Factor Front Axle	
15. Link Factor Rear Axle	
16. Calibration Weight	Tons

4. Press MODE once and "CHEC" will flash on the display. **CHEC**
5. Press MODE once and the meter will return to normal operation.

TYPES OF DATA STORED

Cycle Data

One cycle is considered to be from the point where a load is dumped to the point where the next load is dumped. Data between these two points is recorded in memory. Examples of the data are shown below. The maximum number of cycles that can be stored in memory is 2900 cycles.

ITEM	UNIT	RANGE	REMARKS
Engine Operation Number	Number	1 - 65535	Advances by one each time the engine is started.
Month	Month	1 - 12	
Day	Day	1 - 31	
Time Hour	Hour	24 Hour Clock	These values are stored when the load is dumped.
Time Minute	Minute	1 - 59	
Payload	Metric tons Short tons	0 - 6553.5	
Travel Time When Empty	Minute	0 - 6553.5	
Travel Distance When Empty	Miles/Km	0 - 25.5	
Maximum Travel Speed When Empty	Mph/Kmh	0 - 99	
Average Travel Speed When Empty	Mph/Kmh	0 - 99	
Time Stopped When Empty	Minute	0 - 6553.5	
Time Stopped During Loading	Minute	0 - 6553.5	
Travel Time When Loaded	Minute	0 - 6553.5	
Travel Distance When Loaded	Miles/Km	0 - 25.5	
Maximum Travel Speed When Loaded	Mph/Kmh	0 - 99	
Average Travel Speed When Loaded	Mph/Kmh	0 - 99	
Time Stopped When Loaded	Minute	0 - 6553.5	
Dumping Time	Minute	0 - 6553.5	
Speed Limit	Mph/Kmh	0 - 99	
Warnings For Each Cycle	The fault codes that occur during each cycle		

Engine ON/OFF Data

When the engine is started or stopped, the following data is recorded.

ITEM	UNIT	RANGE	REMARKS
Engine Operation Number	Number	1 - 65535	Advances by one each time the engine is started.
Last Two Digits Of The Year	Year	0 - 99	Indicates when the engine was started.
Month	Month	1 - 12	
Day	Day	1 - 31	
Time Hour	Hour	24 Hour Clock	
Time Minute	Minute	0 - 59	
Last Two Digits Of The Year	Year	0 - 99	Indicates when the engine was shut off.
Month	Month	1 - 12	
Day	Day	1 - 31	
Time Hour	Hour	24 Hour Clock	
Time Minute	Minute	0 - 59	
Total Payload	Metric tons Short tons	0 - 999900.0	Total payload from the time when the engine was started until the time the engine was shut off.
Total Number Of Cycles	Number	0 - 9999	Totals for the time that the engine was running.
The engine operation numbers are included in the fault and warning data.			

Fault Codes and Warning Data

ITEM	UNIT	RANGE	REMARKS
Error Code	Displayed by a combination of letters and numbers representing a specific error code.		
Engine Operation Number At Time Of Occurrence	Number	1 - 65535	Every time the engine is started the number advances by one.
Number Of Times Of Occurrence Since The Engine Was Switched ON	Number	1 - 255	
Last Two Digits Of Year	Year	0 - 99	
Month	Month	1 - 12	
Day	Day	1 -31	
Time Hour	Hour	24 Hour Clock	
Time Minute	Minute	0 - 59	

Engine Operation

ITEM	UNIT	RANGE	REMARKS
Number when Canceled	Number	1 - 65535	Every time the engine is started the number advances by one.
Last Two Digits Of Year	Year	0 - 99	
Month	Month	1 - 12	
Day	Day	1 - 31	
Time Hour	Hour	24 Hour Clock	
Time Minute	Minute	0 - 59	

NOTE: If the engine operation number is a 0, this indicates that the problem occurred or was canceled (depends on the operation that was performed) when the key switch was in the ON position and the engine was not running.

Total Payload and Total Number of Cycles

The total payload and overall number of cycles can be displayed using the forced display operation. Both values start from a zero point whenever the memory has been cleared. The payload total is automatically displayed when the load is dumped.

ITEM	UNIT	RANGE	REMARKS
Total Payload	Metric Tons Short Tons	0 - 999900.0	The total payload since the unit was cleared.
Total Number Of Cycles	Digital Number	0 - 9999	The number of cycles since the unit was cleared.
Last Two Digits Of Year	Year	0 - 99	Date and time the unit was cleared.
Month	Month	1 - 12	
Day	Day	1 - 31	
Time Hour	Hour	24 Hour Clock	
Time Minute	Minute	0 - 59	

Other Data

CONTENT	ITEM	UNIT	RANGE	REMARKS
Set Up Data That The Operator Can Check	Speed Limit	Km/MPH	0 - 99	
	Option Code	Digital Number	0 - 13	Communication Mode
Calibration Data	Year	Year	0 - 99	Date and time when calibrated.
	Month	Month	1 - 12	
	Day	Day	1 - 31	
	Hour	Hour	24 Hour Clock	
	Minute	Minute	0 - 59	

OPERATOR FUNCTIONS

Using the Operator Load Counter

Description

The Payload Meter makes available to the operator a Total Load Counter and Haul Cycle Counter. This allows each operator to track the tons hauled during their shift. The total is displayed in hundreds of tons. For example, if 223 is displayed, this means that 22,300 tons have been hauled since the last time the cycle counter was cleared.

This memory location is separate from the main payload data storage. This memory is not cleared when the Data All Clear Operation is performed. Clearing this memory does not affect the main payload data storage.

Viewing the Operator Load Counter

1. Press the TOTAL/SFT switch once.

If there is a fault code present at this time:

2. The error code for that problem will be displayed. This will be a flashing display.
3. Press the TOTAL/SFT switch again. If additional faults or warnings exist, that fault code will be displayed as a flashing code.
4. Repeat step #3 until no fault codes are displayed. ":" will show when no additional faults exist. The display will then show total tons hauled since the last time the counter was cleared. The total is displayed in hundreds of tons.
5. Press the TOTAL/SFT switch again. The number displayed is the number of haul cycles since the last time the cycle counter was cleared.
6. Press the TOTAL/SFT switch again. ":" is displayed for 2 seconds before the display returns to normal operations.

Clearing the Operator Load Counter

1. Press the TOTAL/SFT switch once. The number displayed is the total tons hauled since the last time the counter was cleared. The total is displayed in hundreds of tons.
2. Press and hold the CAL/CLR switch until the display flashes.
3. Press the CAL/CLR switch until "0000" is displayed. After 2 seconds the meter will return to normal operation.

Clearing this memory **does not** affect the main payload data storage.

Dimming the Lights on the Display

There are a total of 10 brightness levels on the PLM display.

From the normal operation display:

1. Press the LIGHT/INC switch. The lighting will become one level dimmer. This will continue until the lighting has reached its lowest level.
2. After reaching the lowest level, the display will return to the brightest setting.

If the switch is held in the depressed position, the brightness will change continuously.

INITIAL SETUP OF PAYLOAD METER

There are several things that must be checked and programmed when a Payload Meter is first installed.

1. Check the Switch Settings on the side of the meter.
2. Check the Operator Check Mode settings
3. Check the Service Check Mode settings
4. Calibrate the clean truck.

The next few pages show the steps required to perform these checks. Only after all of these steps have been performed can the payload meter be released for service.

Switch Settings

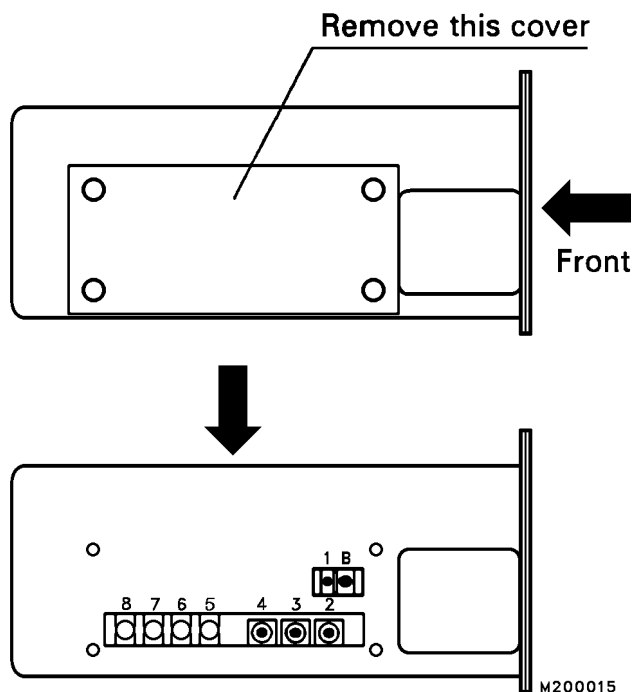

Figure 6-6.



There are nine switches located behind the panel on the left side of the payload meter. Figure 6-8 shows the switch numbers. The following switch positions should be confirmed before the meter is installed.





Switch	Position
1	Gt Gain - Do Not Adjust
B	Buzzer Volume - Do not Adjust
2	7
3	7
4*	4 - 685E
	5 - 630E
	B - 730E
	C - 930E
	D - 530M
	E - 330M
	F - 830E
5	DOWN
6	DOWN
7	DOWN - SHORT TONS UP - METRIC TONS
8	UP

* Set switch 4 for the appropriate model.

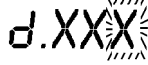

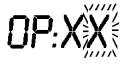

Checking the Operator Check Mode

The Operator Check Mode is used to check and change several settings. These should be checked before the payload meter is put into service.

1. Press and hold the MODE switch. The display will show. 
2. Press the MODE switch once. The display will show. Refer to "Data All Clear" on Page 17 to clear the haul cycle data. 
3. Press the MODE switch once. The display will show. Refer to "Display of Fault Codes" on Page 19 for viewing fault codes. 
4. Press the MODE switch once. The display will show. This is the truck ID number. Refer to "Setting The Machine ID" on Page 18 to change Machine ID. 

5. Press the MODE switch once. The display will show. Refer to "Setting The Operator ID" on Page 18 to change operator. 
6. Press the MODE switch once. The display will show. "SP:62" should be displayed. The speed limit should be set to 62 to avoid unnecessary faults and warnings. Refer to "Setting The Speed Limit" on Page 17 to make adjustments. 
7. Press the MODE switch once. The display will show. Refer to "Setting The Option Code" on Page 17 to change the option. 
8. Press the MODE switch once. The current time should be displayed with the minutes flashing. Refer to "Setting The Time And Date" on Page 18 to change the time and date. 
9. Push the MODE switch to return to normal operation.

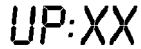
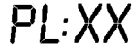
Setting "PL:00"





1. Press and hold the LIGHT/INC and MODE switches. The display will show. 
2. Press and hold the LIGHT/INC and TOTAL/SFT switches. The display will show. 
3. Press the CAL/CLR switch once. The display will show. 
4. Press the CAL/CLR switch once. The display will show. 
5. Press the LIGHT/INC switch until "PL:00" is displayed. **ONLY "PL:00" IS RECOMMENDED.** 
6. Press the MODE switch. The display will show. 
7. Press MODE and the meter will return to normal operation.

Checking the Service Check Mode

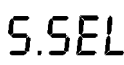

Refer to Pages 23 and 24 for additional information on UP Factor and PL Mode prior to setting these values.

Setting "UP:00"

1. Press and hold the LIGHT/INC and MODE switches. The display will show. 
2. Press and hold the LIGHT/INC and TOTAL/SFT switches. The display will show. 
3. Press the CAL/CLR switch once. The display will show. 
4. Press the LIGHT/INC switch until "UP: 0" is displayed. **ONLY "UP: 0" IS RECOMMENDED.** 
5. Press MODE. The display will show. 
6. Press MODE and the meter will return to normal operation.

Checking the G_T setting

The G_T value must be set = 1.000. Refer to "Calculation Method" on Page 8 for display and adjustment information.

Checking the Inclinator Settings

Refer to "Calculation Method" for instructions to display truck pitch angle. With truck on level ground, properly charged suspensions, and empty the display should indicate 0.0± 1.0. Remember this is not a live display. After adjustment, Service Check Mode must be entered again to obtain a new reading.

An alternative method is to use a Personal Computer running the Komatsu Payload Download Program for windows. The "Monitor Pressures" section of the program displays live inclinometer data. The inclinometer can be loosened and adjusted until the live display shows 0.0± 1.0 degrees with the truck on level ground, properly charged suspensions, and empty.

Another method is to use a voltmeter to read the voltage output of the inclinometer. With the truck on level ground, properly charged suspensions, and empty, the output voltage should be 2.6± .1 volts.

Calibrating a Truck

The payload meter should be calibrated whenever one of the following occurs:

1. When a new payload meter is installed.
2. When a suspension sensor has been changed.
3. Whenever the suspensions have been serviced or the Nitrogen levels have changed.
4. Once a month thereafter.

To calibrate the payload meter:

1. With the engine running and the truck stopped, press and hold the CAL/CLR switch until "CAL" is flashing on the display.
2. Drive the truck until the speed is approximately 6-10 MPH (10-15 Km/H)
3. Press the CAL/CLR switch once.
4. Drive until the display switches back to the time of day. This will take up to 30 seconds.
5. The payload meter is now calibrated and ready for normal operation.



Carry out this operation on flat level ground.

Travel in a straight line.

Maintain a steady speed, 6-10 MPH (10-15 Km/H)

DISPLAYS AT START-UP

POWER ON:

ALL external display lamps (Figure 6-2) will come on and stay on for approximately 27 seconds during the "Power-up Process".

The "Power-up Process" will display the PLM settings. Each display will occur for approximately 3 seconds:

1. The display will show: **88:88**
In addition, a buzzer will sound and the following lamps will light for 3 seconds:
 - Reception Pilot Lamp (2, Figure 6-1)
 - Transmission Pilot Lamp (3, Figure 6-1)
 - Memory Card Pilot Lamp (4, Figure 6-1)
2. The display will show: **CO:XX**
The "xx" indicates the Truck Model. Refer to "Initial Setup of Payload Meter" for code definitions.
3. The display will show: **Cd:--**
This display indicates the status of the Memory Card where: **Cd:oo**
"Cd : - -" indicates Card Not Used, and
"Cd : oo" indicates Card Is Used.
4. The display will show: **CL:--**
This display indicates the status of the Inclinometer for the PLM, where **CL:oo**
"CL : - -" indicates Inclinometer Not Used, and
"CL : oo" indicates Inclinometer Is Used.
5. The display will show: **US:--**
This display indicates method of measurement where: **US:oo**
"US : - -" indicates METRIC Tons.
"US : oo" indicates U.S. Tons.
6. The display will show: **SU:--**
This function is not used. **SU:oo**
"SU : - -" indicates Switch 8 is up.
"SU : oo" indicates Switch 8 is down.

7. The display will show: **d.XXX**
This display indicates the Machine ID code where "xxx" indicates a value between 0 and 200.
8. The display will show: **o.XXX**
This display indicates the Operator ID code where "xxx" indicates a value between 0 and 200.
9. The display will show: **SP:XX**
This display indicates the Speed Limit setting where "xx" indicates a value between 0 and 99 km/h.
10. The display will show: **OP:XX**
This display indicates the Option code setting. Refer to "Operator Check Mode, Setting the Option Code" and to "Method of Operation" for more information on this function.

NORMAL OPERATION

If the truck engine is started before the preceding "Power-up Process" is completed, the display will shift to normal operation.

If the engine is running when the payload meter starts up, only "o:XXX" and "d:XXX" will display before switching to normal operations.





SETUP AND MAINTENANCE

Speed Limit





A warning can be displayed if the machine exceeds a preset speed.

The available range is: 10 - 99 km/h (6 - 62 mph). It is recommended to set the speed limit to 99 km/h (62 mph).

Setting The Speed Limit

1. Press and hold the MODE switch until "Cd:dP" is flashing. 
2. Press the MODE switch once.
The display will show: 
3. Press the MODE switch once.
The display will show: 
4. Press the MODE switch repeatedly until "SP:XX" is displayed. 
5. Press the LIGHT/INC switch to change the "unit digit" to the desired number.
6. Press the TOTAL/SFT switch and the display will then indicate: 
7. Press the LIGHT/INC switch to change the "tens digit" to the desired number.
8. Press the MODE switch to return to normal operation.

Setting the Option Code

1. Press and hold the MODE switch until "Cd:dP" is displayed. 
2. Press the MODE switch once.
The display will show: 
3. Press the MODE switch once.
The display will show: 
4. Press the MODE switch repeatedly until "OP:XX" is displayed. 
5. Press the LIGHT/INC switch to change the "unit digit" to the desired number.
6. Press the TOTAL/SFT switch and the display will then indicate: 





7. Press the LIGHT/INC switch to change the "tens digit" to the desired number.
8. Press the MODE switch to return to normal operation.
9. The Option Code selects the PLM communication mode as follows:

Option Code	COMMUNICATION MODE
0	Stand Alone
10	PMC Mode (530M only)
12	Modular Mining Mode, Scoreboard and User Data Communication Mode

NOTES:

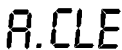





1. The Option Code is set to "0" for trucks not equipped with Modular Mining System (MMS) (Except 530M).
2. The 530M with Powertrain Management Control (PMC) system uses "10" as the setting for the Option Code.
3. For trucks with Modular Mining System (MMS) or Scoreboard, the Option Code is "12".

Setting The Machine I.D. Code





1. Press and hold the MODE switch until "Cd:dP" is displayed. 
2. Press the MODE switch once.
The display will show: 
3. Press the MODE switch once.
The display will show: 
4. Press the MODE switch once.
"d.XXX" is displayed. 
5. Press the LIGHT/INC switch to change the last digit to the desired number.
6. Press the TOTAL/SFT switch and the display will show: 
7. Press the LIGHT/INC switch to change the middle digit to the desired number.
8. Press the TOTAL/SFT switch and the display will show: 



9. Press the LIGHT/INC switch to change the first digit to the desired number.
10. Press the MODE switch to return to normal operation.

Setting The Operator I.D. Code

1. Press and hold the MODE switch until "Cd:dP" is displayed. 
2. Press the MODE switch once. The display will show: 
3. Press the MODE switch once. The display will show: 
4. Press the MODE switch repeatedly until "o.XXX" is displayed. 
5. Press the LIGHT/INC switch to change the last digit to the desired number.
6. Press the TOTAL/SFT switch and the display will then indicate: 
7. Press the LIGHT/INC switch to change the middle digit to the desired number.
8. Press the TOTAL/SFT switch and the display will show: 
9. Press the LIGHT/INC switch to change the first digit to the desired number.
10. Press the MODE switch to return to normal operation.

Setting The Time and Date

1. Press and hold the MODE switch until "Cd:dP" is displayed. 
2. Press the MODE switch once. The display will show: 
3. Press the MODE switch once. The display will show: 
4. Press the MODE switch repeatedly until "XX:XX" is displayed. 
5. Press the LIGHT/INC switch to change the minutes.
6. Press the TOTAL/SFT switch and the display will then indicate: 

7. Press the LIGHT/INC switch to change the hours. The clock is a 24 hour clock.
8. Press the TOTAL/SFT switch and the display will then indicate: 
9. Press the LIGHT/INC switch to change the day.
10. Press the TOTAL/SFT switch and the display will then indicate: 
11. Press the LIGHT/INC switch to change the month.
12. Press the TOTAL/SFT switch and the display will then indicate: 
13. Press the LIGHT/INC switch to change the year.
14. Press the MODE switch to return to normal operation.

DOWNLOAD OF INFORMATION



Payload information and fault codes recorded should be downloaded to a personal computer on a regular basis. The software required is available under part number AK4094. Detailed instructions for installing the software and downloading the data is provided with AK4094 PLM II download software.

Data All Clear

This function will erase all of the cycle data, engine ON/OFF data, and fault/warning data. Total payload and the overall number of cycles will not be cleared.

IMPORTANT - Before clearing the data, download the data to a personal computer.

To begin, the shift lever should be in the "N" position, the brake lock set, the hoist control lever should be in the "FLOAT" position and the body in the down position.

1. Press and hold the MODE switch until "Cd:dP" is displayed. 
2. Press the MODE switch once. The display will show: 
3. Press and hold the CAL/CLR switch until "A.CLE" is flashing. 
4. Press the CAL/CLR switch again and the memory will be cleared. The meter will then return to normal operation.

This does not clear the Operator Load Counter.

DISPLAY OF FAULT CODES

1. Press and hold the MODE switch until "Cd:dP" is displayed.



2. Press the MODE switch once. The display will show:



3. Press the MODE switch once. The display will show:



4. Press the TOTAL/SFT switch.

If there are no faults or warnings, the display will show for 6 seconds.



If there are current faults or warnings, the codes will be displayed in order of their priority, the highest priority first. Each code will flash for **6 seconds**.

5. After the current codes have been displayed, past history codes that have been reset will be displayed. Each code will flash for **3 seconds**.

If there are no history codes or after all history codes have been shown, the display will show for 3 seconds:

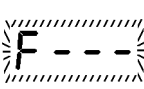

The system will then proceed to the following displays: Refer to Page 22 for details.

- Condition of the shift selector on mechanical trucks or brake lock on electric trucks.

The panel will display: "C1:XX" for 3 seconds, then indicate:

Mechanical trucks

"C1:00" Shift selector is in "N".

"C1:--" Shift selector is not in "N".

Electric trucks

"C1:00" Brake lock is on.

"C1:--" Brake lock is off.

- Condition of the Body Up Switch signal.

The panel will display: "C2:XX" for 3 seconds, then indicate:

"C2:00" Body up switch is in up position.

"C2:--" Body up switch is in down position.

- Condition of the Engine Oil Pressure signal.

The panel will display "C3:XX" for 3 seconds, then indicate:

"C3:00" Engine is running.

"C3:--" Engine is not running.

- Condition of Alternator 'R' terminal signal.

The panel will display "C4:XX" for 3 seconds, then indicate:

"C4:00" Engine is running.

"C4:--" Engine is not running.

- Condition of the Spare Analog Input 1 signal.

The panel will display "C5:XX" for 3 seconds with XX: as an input signal (V).

- Condition of the Spare Analog Input 2 signal.

The panel will display "C6:XX" for 3 seconds with XX: as an input signal (V).

- Condition of the Spare Digital Input 1 signal.

The panel will display "C7:XX" for 3 seconds, then:

"C7:00" High.

"C7:--" Low.

- Condition of the Spare Digital Input 2 signal.

The panel will display "C8:XX" for 3 seconds, then:

"C8:00" High.

"C8:--" Low.

4. Press the TOTAL/SFT switch to view faults again or press the MODE switch to return to normal operation.

FAULT CODES				
FAULT	CAUSE	CORRECTIVE ACTION	DECK LIGHTS	PRIORITY
b-FL Steady	Brake Lock On and Body is UP and not dumping.		Flash	1
b-FL Flashing	Brake Lock Off and Body is UP.			1
Cd Flashing	Remove memory card during download.			2
F-09	Internal battery voltage below 2.7 volts.	Open controller check internal battery and connections. Check voltage using Service Check Mode.		3
L.FUL Flashing	Less than 300 haul cycle data sets memory capacity remain.			4
L.FUL Steady	2900 Haul cycles have been stored and the oldest data is being overwritten.			4
E.FUL Flashing	Less than 10 engine start data sets memory capacity remain.			4
E.FUL Steady	115 engine start data sets have been stored and the oldest date is being overwritten.	Down load data to PC and clear memory. See Operator Check Mode; Clearing the haul cycle data memory.		4
F.FUL Flashing	Less than 10 fault data sets memory capacity remain.			4
F.FUL Steady	230 fault data sets have been stored and the oldest date is being overwritten.			4
H.FUL Flashing	Haul cycle counter or payload totalizer are near capacity.			
H.FUL Steady	Haul cycle counter exceeded 9999 or payload totalizer exceeded 999900.	Press TOTAL/SFT to display totals, then press CAL/CLR for at least 2 seconds, then press CAL/CLR again for at least 2 seconds.		4
F-18	Battery alternator R terminal is shorted or disconnected. The input to the PLM is less than 2V.	Trouble shoot wiring. Pin CN1-9, circuit # 21D.		5
F-20 Flashing	Sensor power is less than 15V or over 20V (18V normal).	Trouble shoot wiring, possible short.	Flash	6
F-21 Flashing	Left front pressure signal is less than 1V (1-5V normal).		Flash	7
F-22 Flashing	Right front pressure signal is less than 1V (1-5V normal).		Flash	8
F-23 Flashing	Left rear pressure signal is less than 1V (1-5V normal).		Flash	9
F-24 Flashing	Right rear pressure signal is less than 1V (1-5V normal).		Flash	10

M200051

FAULT CODES			
FAULT	CAUSE	CORRECTIVE ACTION	DECK LIGHTS PRIORITY
F-25 Flashing	Left front pressure signal is greater than 5V (1 - 5V normal).	Trouble shoot wiring, likely sensor wires are shorted together.	Flash 11
F-26 Flashing	Right front pressure signal is greater than 5V (1 - 5V normal).		Flash 12
F-27 Flashing	Left rear pressure signal is greater than 5V (1 - 5V normal).		Flash 13
F-28 Flashing	Right rear pressure signal is greater than 5V (1 - 5V normal).		Flash 14
F-31 Flashing	Inclinometer input less than 1.57V (more than + 10 degrees, nose up).	Trouble shoot wiring, likely an open circuit (Inclinometer output is 2.6V when horizontal, calibration: -103mV/degree)	Flash 15
F-32 Flashing	Inclinometer input greater than 3.63V (more than - 10 degrees, nose down).	Trouble shoot wiring, likely sensor wires are shorted together.	Flash 16
F-CAL	No calibration has been performed or cal data has been cleared.	Perform calibration.	Flash 17
F-41 Flashing	Light relay #1 driver short circuit.	Trouble shoot wiring, relay coil likely shorted.	Flash 18
F-42 Flashing	Light relay #2 driver short circuit.		Flash 19
F-43 Flashing	Light relay #3 driver short circuit.		Flash 20
F-44 Flashing	Light relay #4 driver short circuit.		Flash 21
F-45 Flashing	Light relay #5 driver short circuit.		Flash 22
L.bad Flashing	Payload measured while chassis is pitching.	Data ignored, error will clear for next load.	Flash 23
SP:SP Flashing	Speed limit setting is being exceeded.	Set the speed limit, using Operator Check Mode, to 62 mph or 99Km/h depending on the position of the unit selection switch (switch #7 behind the left side panel).	Flash 24
F-71 F-73 F-80 F-81 F-91 F-92 F-93 F-94 F-95 F-96 F-97 F-98 All Flashing	Communications port error.	Check communication wiring (RS-232) to Modular Mining Hub or to Scoreboard. Check OP setting.	Flash 25

Monitoring Input Signals

This procedure can be used to monitor the current input signals to the payload meter.

1. Press and hold the LIGHT/INC and MODE switches until "CHEC" is flashing.
2. Press and hold the CAL/CLR and TOTAL/SFT switches until "S.CHE" is flashing.
3. Press the CAL/CLR switch to cycle through the following information :

C1	Mechanical Trucks	C1:00 - Shift Selector in "N" C1:-- - Shift Selector not in "N"
C1	Electric Trucks	C1:00 - Brake Lock On C1:-- - Brake Lock Off
C2	Body Up	C2:00 - Body Down C2:-- - Body Up
C3	Engine Oil Pressure	C3:00 - Engine Run C3:-- - Engine Stopped
C4	Alternator R Terminal	C4:00 - Alternator Charging C4:-- - Alternator Stopped
C5	Analog 1 - Not Used	
C6	Analog 2 - Not Used	
C7	Digital 1 - Not Used	
C8	Digital 2 - Not Used	
C9	Speed	Vehicle Speed
C10	Travel Distance - under the current loaded or empty state	xx.xx Miles
C11	<u>Current Status</u> Note: Sample values are shown.	03:01 - Empty Stopped 01:02 - Empty Traveling 06:03 - Loading 02:04 - Loaded Traveling 04:05 - Loaded Stopped 05:06 - Dumping
C12(a)*	Time Empty Travel	S1:xx - Minutes*10
C12(b)	Time Empty Stopped	S2:xx - Minutes*10
C12(c)	Time Loaded Travel	S3:xx - Minutes*10
C12(d)	Time Loaded Stop	S4:xx - Minutes*10
C12(e)	Time Dumping	S5:xx - Minutes*10
C12(f)	Time Loading	S6:xx - Minutes*10

* After 9.9 minutes, "S1:--" will be displayed.

4. Press the MODE switch once and "CHEC" will flash.
5. Press the MODE switch once and the meter will return to normal operation.

Service Check Mode

1. Press and hold the LIGHT/INC and MODE switches until "CHEC" is flashing.
2. Press and hold the LIGHT/INC switch until "ALLO" is flashing. "A.FUL" may also be displayed.
3. Press the LIGHT/INC switch to cycle through the following data. The sequence repeats.

Item and Description	Units
1. Current Time	Hours:Minutes
2. Pressure Front Left	Psi
3. Pressure Front Right	Psi
4. Pressure Rear Left	Psi
5. Pressure Rear Right	Psi
6. Front Weight	Tons
7. Rear Weight	Tons
8. Degree of Incline	±° Nose Up Positive
9. Incline Factor - Front Axle	
10. Incline Factor - Rear Axle	
11. Link Factor - Front Axle	
12. Link Factor - Rear Axle	
13. Calibration Weight	Tons
14. Gt - Trimmer Gain	
15. Current Load	Tons
16. Backup Battery Voltage	Volts

4. Press MODE once and "CHEC" will flash on the display.
5. Press MODE once and the meter will return to normal operation.

UP Factor - Payload Calculation Gain

Description of UP Factor

The payload calculation gain, or UP factor is multiplied to the actual calculated load. From the example shown in Figure XX, the calculated load is 143.8 tons. If the UP factor is set to +5% the displayed load will be $143.8 \times 1.05 = 151$ tons. This factor can be used to minimize the effects of systematic error for a particular truck. The UP factor is not applied uniformly to all load calculations. There are three operating modes for the payload meter and the UP factor is applied differently to each mode. Therefore, it is recommended that this percentage be set to 0. There are significant differences in final calculated load that can be introduced by adjusting this gain.

Payload meters sent from the factory are typically set to "UP: 5" indicating a +5% gain in final load.

This should be checked on all new meters and changed to "UP: 0".

PL Mode - Load Calculation Timing

Load Calculation Timing

The PL mode controls when the payload meter takes a sample of the data and calculates the load. There are three modes available. There are two sets of data that are affected by the PL mode setting.

- Modular Mining Transmission
- Memory Storage



The PL mode setting can have a significant impact on the perceived accuracy of the payload meter.

PL:00 is the only recommended setting.

Use of settings other than PL:00 is NOT recommended.

Careful consideration must be given to the use of PL:01 and PL:10. These modes divide the data transmitted by Modular Mining and the data stored in the payload meter's memory. Additionally, each mode handles the UP factor differently and can calculate different loads for the same haul cycle. For these reasons **it is recommended that the payload meter be set to use PL:00 in all cases.**

PL:00

Modular Mining Transmission - The data is captured at the last transition from 0 to 1 MPH prior to traveling 160 meters from the shovel. The captured data is transmitted when the truck travels 160m from the shovel. This load calculation **will use** the UP factor percentage.

Memory Storage - Same as above, the data is captured at the last transition from 0 to 1 MPH prior to traveling 160 meters from the shovel. The captured data is stored into memory when the body rises at the dump. This load calculation **will use** the UP factor percentage.

PL:01

Modular Mining Transmission - The data is captured at the last transition from 0 to 1 MPH prior to traveling 160 meters from the shovel. The captured data is transmitted when the truck travels 160m from the shovel. This load calculation **will use** the UP factor percentage.

Memory Storage - The data is captured and stored when the body rises from the frame. This calculation **will not use** the UP factor percentage.

PL:10

Modular Mining Transmission - The data is captured and transmitted when the truck travels 160 meters from the shovel. This calculation **will not use** the UP factor percentage.

Memory Storage - The data is captured and stored when the body rises from the frame. This calculation **will not use** the UP factor percentage.

FINAL GEAR RATIO SELECTION

For an 830E truck, the proper gear ratio has to be selected.

1. Press and hold the MODE and LIGHT/INC switches until "CHEC" is displayed.

CHEC

2. Press and hold the TOTAL/SFT and LIGHT/INC switches until "S.SEL" is displayed.

S.SEL

3. Press the CAL/CLR switch repeatedly until "A.XX" is displayed, where "XX" is one of the following:

A.XX

"XX"	Gear Ratio	Remarks
00	31.875	Original
01	36.400	High Traction
02	28.125	Standard
03	26.625	High Speed

NOTE: The Payload Meter is originally set to "00".

4. Press the TOTAL/SFT switch and "XX" will flash.
5. Press the LIGHT/INC switch to select the desired gear ratio.
6. Press the MODE switch and "CHEC" will be displayed.

CHEC

7. Press the MODE switch and the meter will return to normal operation.

BATTERY REPLACEMENT PROCEDURE ERROR CODE, F-09, DISPLAYED

Replacing the Battery

The payload meter has an internal battery used to protect the memory from being erased when the key switch is turned to the OFF position. Battery life is approximately 2 years. The capacity of the battery is monitored by the payload meter. When the voltage of the memory battery does drop, error code, F-09, will be displayed.

When the F-09 error code appears, download the data within 48 hours; otherwise, the data may be lost. The Haul Cycle data may not be recorded properly while F-09 is displayed.

At this time it will be necessary to replace the battery. This should be performed when the truck is in an unloaded condition. The data stored in the payload meter should be downloaded to a personal computer or carry out the memory card dump operation. If this is not done, when the battery is disconnected all data will be lost.

All that is required is a phillips-head screwdriver and a new battery (P/N 581-86-55710)

1. Keyswitch in the ON position, download the data stored in the payload memory, or carry out the memory card dump operation.
2. Turn the keyswitch to the OFF position.
3. Remove the four mounting screws holding the payload meter in position and then pull the payload meter out, away from the instrument panel (Figure 6-7).

NOTICE - Be careful not to let dirt, metal or spare parts to drop inside the controller at any time.

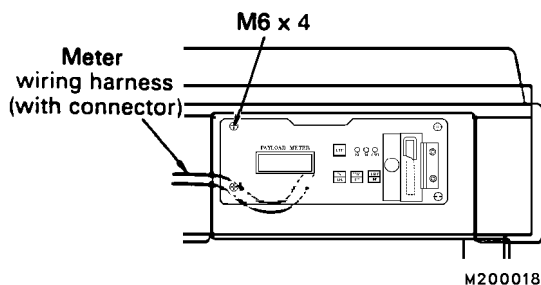

FIGURE 6-7. REMOVING PAYLOAD METER

4. Remove the electrical connector. Remove the screws on the top surface and the rear face. Remove the cover (Figure 6-8). This will expose the battery, its wires, and the connector.

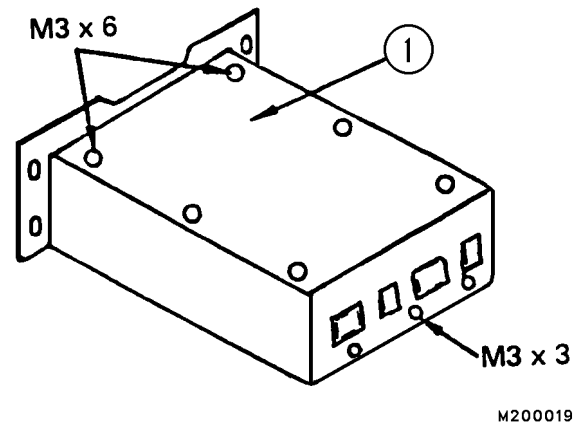

FIGURE 6-8. ACCESS TO BATTERY

5. Grasp the wires coming from the battery and pull out. By pulling perpendicular from the board, it will disconnect the connector from the board and pull the battery out of its holder all at the same time (Figure 6-9).

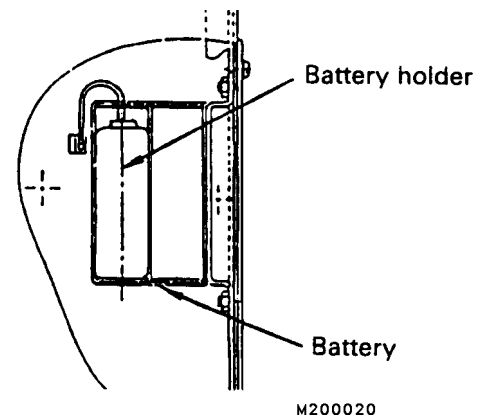

FIGURE 6-9. BATTERY INSTALLATION

6. Insert the connector of the new battery directly into the connector on the board (Figure 6-10). Place the battery in the battery holder, and pass the wiring through the notch. When doing this, insert the wiring into the bottom of the holder and pass it through the notch.
7. Install the controller cover, replace the electrical connector, and install the payload meter controller back into the instrument panel.

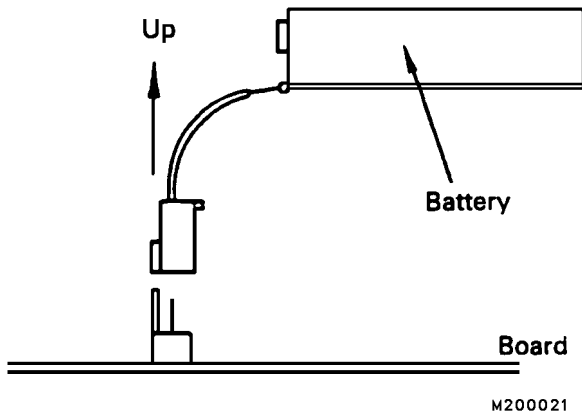

FIGURE 6-10. BATTERY CONNECTION

After Replacing the Battery

While replacing the battery, the backup power source for the memory inside the payload meter is momentarily disconnected.

This can allow unwanted data (garbage) to enter the memory and affect the meter's recognition procedures. The following will remove this unwanted data.

1. Turn the keyswitch to the ON position.

F-CAL may flash.

2. Using the Operator Check Mode, set the speed limit option code, time and date. (These were erased from memory when the battery was disconnected).
3. Without turning the keyswitch to the OFF position advance to the start position. With the engine running, the display: **F-CAL** may flash.
4. Perform the Calibration procedure.
Refer to Page 15.
5. Load the truck to the rated payload, or close to it.
Dump the load.
6. Move the truck to a safe area, wait at least 5 seconds after dumping the load, then shut the truck down.
7. Turn the keyswitch back to the ON position but do not start the engine.
8. Perform the Data All Clear in the Operator Check mode.

9. Forcibly clear the data for the total payload and overall number of cycles.
With this operation performed, all the unwanted data inside the payload meter is cleared. Except for the calibration data, all the data recorded in the previous steps is also erased.
10. After this procedure has been performed the system is ready for normal function.

SUSPENSION PRESSURE SENSOR

The pressure sensors are mounted on top of each suspension. The sensors produce a voltage signal from 1 – 5 volts output.

The pressure sensor is mounted to the suspension cylinder using a Schrader Valve assembly, adapter and sensor. The sensor can be replaced without releasing the pressure in the suspension by removing the sensor with the adapter.

Removal



Make certain the adapter and sensor are removed together from the valve assembly. Removing the complete valve assembly or just the sensor may result in the component being forced out of the suspension by the gas pressure inside.

1. Disconnect sensor from truck wiring harness.

*Note: The Schrader valve in the valve assembly will prevent gas from escaping **when adapter and sensor are removed together**. If entire valve assembly is turned allowing nitrogen gas to escape, recharging of the suspension will be required.*

2. Hold valve (2, Figure 6-11) with wrench while removing the **adapter/sensor assembly (3 & 4)**.
3. Remove sensor (4) from adapter (3).

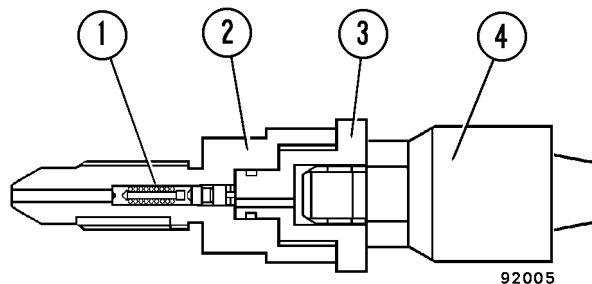

FIGURE 6-11. PRESSURE SENSOR.

- | | |
|-------------------|------------|
| 1. Schrader Valve | 3. Adapter |
| 2. Valve Assembly | 4. Sensor |

Installation

1. Install new O-ring on sensor (4, Figure 6-11) and install sensor into adapter (3). Tighten sensor to **22–29 ft.lbs. (30–39 N.m) torque.**
2. Install new O-ring on adapter (3) and install complete **adapter/sensor assembly** into valve (2). Hold valve body and tighten **adapter/sensor assembly** to **103 ft.lbs. (176 N.m) torque.**
3. Connect sensor wiring to truck wiring harness. The sensors have three wires. Be sure that wires are connected correctly. (Figure 6-12)

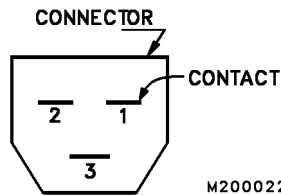

FIGURE 6-12. SENSOR SIDE CONNECTOR VIEW

Pin Number	Wire Color	Wire Function
1	Black	Ground (GND)
2	Red	+ Power
3	White	Signal

INCLINOMETER

As the truck is tilted fore or aft, the weight distribution between the front and rear axles changes. To compensate for this, the inclinometer measures the ground angle at which the truck rests. This data is then sent to the payload meter so it can calculate the correct payload weight. The inclinometer is located below the operator's center console (passenger seat structure).

Removal

1. Disconnect inclinometer wire lead from harness.
2. Remove the three capscrews, nuts and lockwashers (4, Figure 6-13) and inclinometer (3).

Installation

1. Install inclinometer (3, Figure 6-13) with cap-screws, nuts and lockwashers (4).

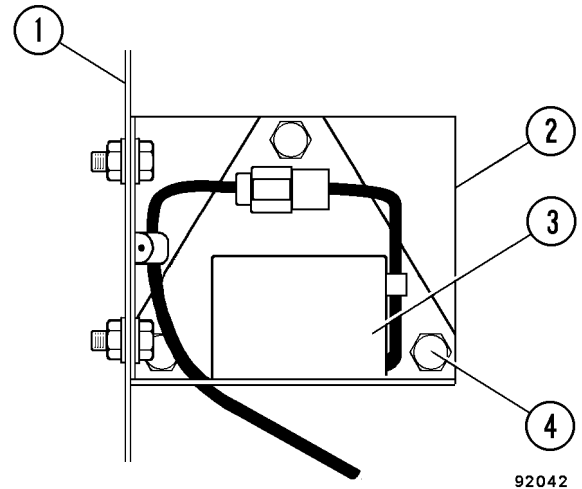

FIGURE 6-13. INCLINOMETER

- | | |
|------------------------------------|---------------------------------|
| 1. Operator's Center Console Frame | 3. Inclinometer |
| 2. Bracket | 4. Capscrew, Nut and Lockwasher |

2. Connect inclinometer wiring to the truck wiring harness. (Figure 6-14)
Be sure that wires are connected correctly.

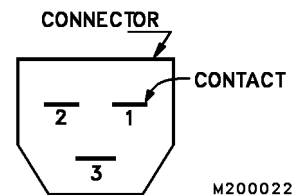

FIGURE 6-14. INCLINOMETER SIDE CONNECTOR VIEW

Pin Number	Wire Color	Wire Function
1	Black	Ground (GND)
2	White	Signal
3	Red	+ Power

Adjustment

1. Park the truck on a 0% grade.
2. Loosen the three Inclinometer mounting cap-screws (4, Figure 6-13) and rotate the Inclinometer until a voltage range of 2.6 ± 0.1 Volts can be measured (using a Volt/Ohm Meter) at pins 1 and 2 of the inclinometer electrical harness connector.
3. Tighten all cap-screws (4, Figure 6-13) to standard torque, after adjustment.

SCOREBOARD

Description

The Scoreboard from Komatsu Mining Systems uses information from the Payload Meter to display the current load. It uses ultra-high-brightness LED technology to form 3 digits. The sign is fully sunlight readable and housed in a rugged steel enclosure.

The Scoreboard displays each swing pass as the truck is being loaded. As the truck drives away, the sign will display the last swing pass until the final load calculation is made. It will then switch to display the final load calculation and hold it until the truck dumps. The sign will then clear for the empty ride back to the shovel.

Making Connections

The Scoreboard connects to the RS232 port on the Payload Meter. It must share this connection with other dispatch systems like Modular Mining as well as the PC download connection. This sharing of the single port creates special circumstances when using a Personal Computer or dispatch system.

The Scoreboard is in constant communications with the Payload Meter and must acknowledge every message from the meter. In addition, the Scoreboard must also signal the Payload Meter that it is ready to receive messages by supplying a 5vdc signal over the CTS line. Installations that include Modular Mining or other dispatch systems must take over the responsibility for acknowledging messages from the Payload Meter. To do this, the return communications line and the CTS line from the Scoreboard must be cut and taped back. When this is done, the Scoreboard simply monitors communications between the Payload Meter and Modular Mining. The Modular Mining system acknowledges each message from the meter.

Sharing this RS232 port with the Personal Computer for downloading can also create problems with communications. The Payload Meter can confuse messages from the Personal Computer and Scoreboard. To eliminate this problem, **the Scoreboard must be turned off during downloading of the Payload Meter.** Using the circuit breaker to turn off the main power to the Scoreboard is the best way to accomplish this. The power to the Scoreboard must be turned off before communications between a Personal Computer and the Payload Meter can start. Once the download process is finished, the power needs to be restored to the Scoreboard to keep from receiving F99 or F93 error codes.

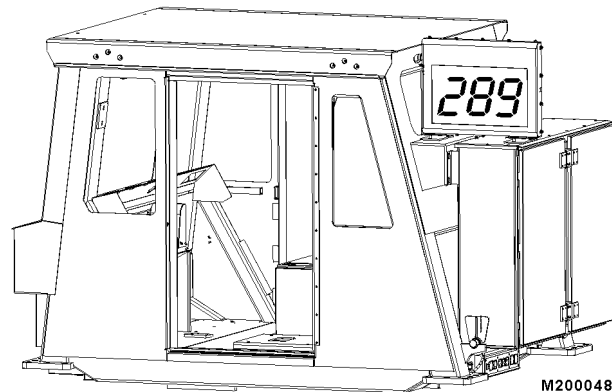

Figure 6-15. Scoreboard

The harness for the Scoreboard supplies two extra connections in the overhead compartment of the cab. One is for the existing PC port and the other is for Modular Mining.

When two Scoreboards are installed, the first sign transmits load information and power to the second sign. Note that the communications wire from the first sign connects to terminal 35L7. This is the retransmit terminal. This wire then connects to the 35L4 terminal in the second sign. This is the receive terminal of the second sign.

The Payload Meter must be set to use OP12. Refer to "Setting the Option Code" for instructions.

Once in this mode, the Payload Meter will look for the Scoreboard and attempt to communicate with it. If there are communications problems the Payload Meter may indicate a communications port error. Refer to "Fault Codes" for additional information.

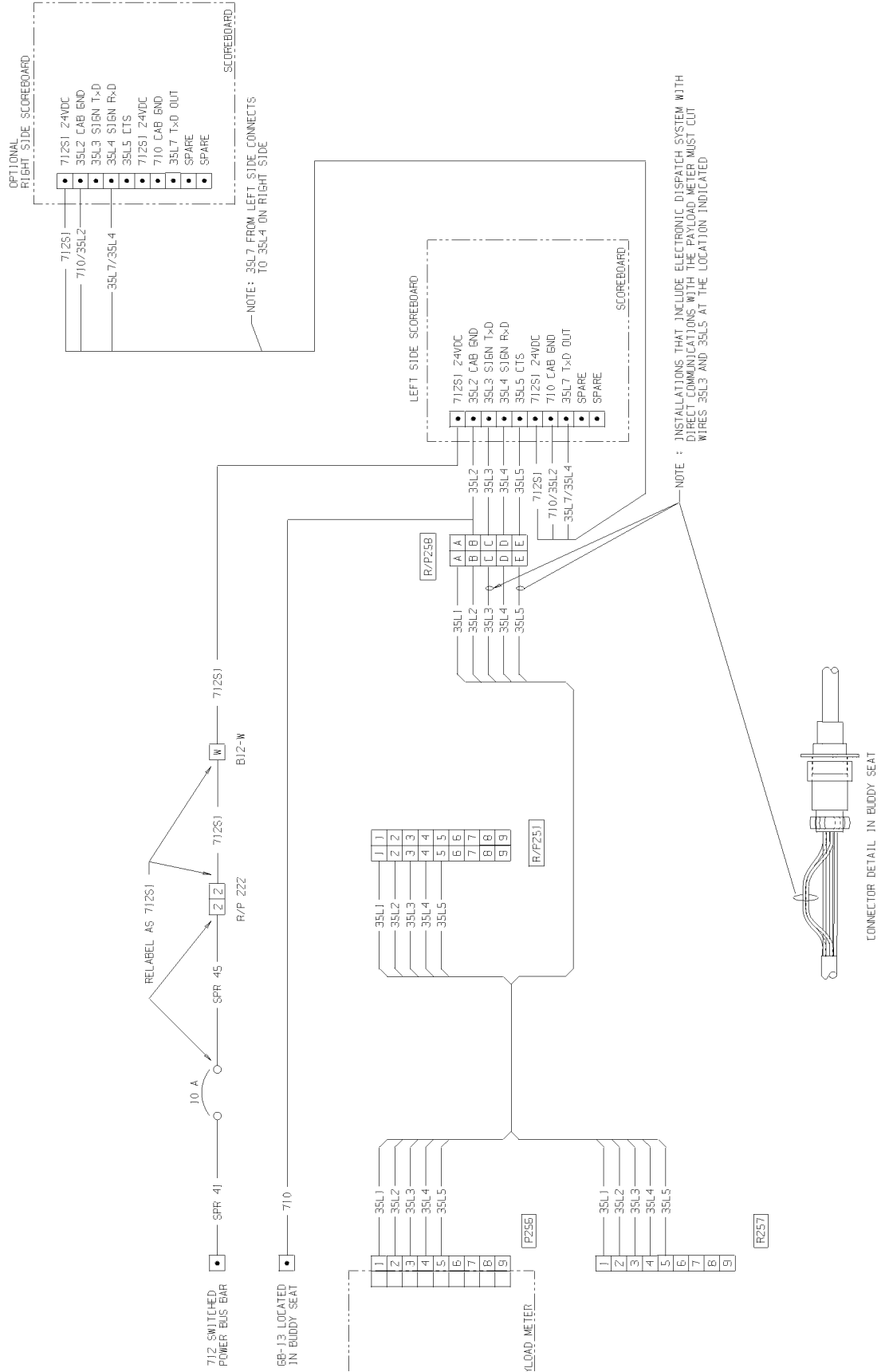

Normal Operation of the Scoreboard

On power up, the Scoreboard will display "888" and then display the current software version, "10". The sign will then go blank until the Payload Meter begins sending load information. There is also a small light that blinks once per second in the center of the top portion of the last digit that is visible by close inspection. This light indicates that the sign is powered and operating normally.

During the typical loading cycle there is a short delay from when a bucket load of material is dumped into the body and when the Scoreboard indicates the weight. This delay is caused by the Payload Meter waiting for the oscillations in the suspensions to settle out before calculating a current load. The Scoreboard will display the current load calculated by the Payload Meter after each swingload.

If the truck operator releases the brake lock and begins to drive before the last swingload calculation is made, the Scoreboard will never display the last swingload.

The Scoreboard will display the last load calculation made during the loading process until the final load calculation is made approximately 160 meters from the shovel. At this point the final load will be displayed. This number will remain until the truck dumps the load. There will typically be a difference between the last swingload and final load calculations.

PAYLOAD METER BACK PANEL

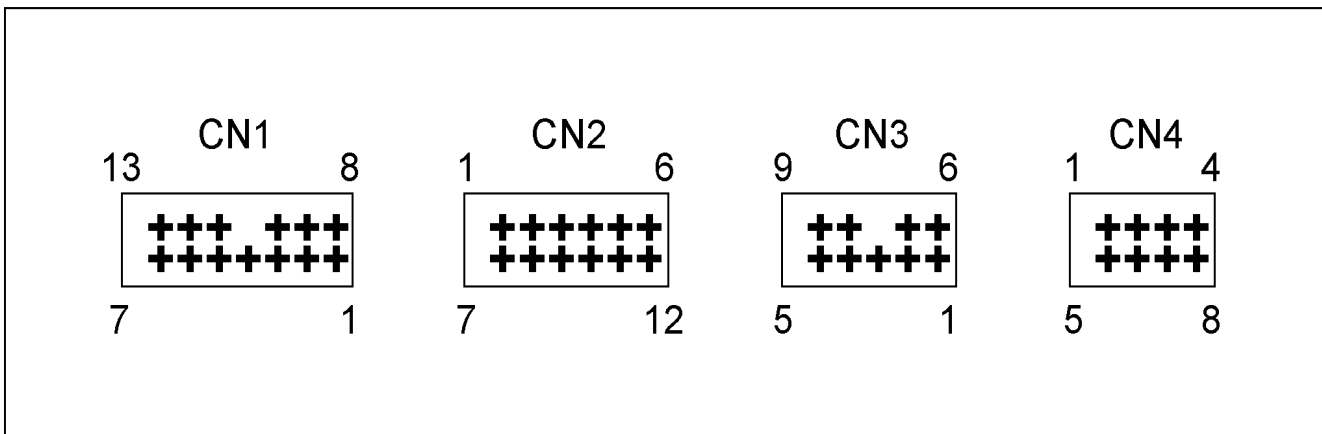

CONNECTIONS

CN1 - AMP MIC-MKII 13 Pins White Connector		
No.	Description	Comments
1	Power +24V (Battery)	
2	Lamp Relay 1	
3	Lamp Relay 2	
4	Lamp Relay 3	
5	Lamp Relay 4	
6	Lamp Relay 5	
7	Speed Sensor (Signal)	
8	Speed Sensor (GND)	
9	Alternator R Terminal (Charge Signal)	Running - 28VDC Off - 0VDC
10	Key Switch ACC Terminal (ACC Signal)	
11		
12		
13	GND (Power GND)	

CN3 - AMP MIC-MKII 9 Pins White (RS-232C Port)	
No.	Description
1	RTS
2	SG
3	RD
4	TX
5	CTS
6	DTR
7	DSR
8	

CN2 - AMP 040 12 Pins Black Connector		
No.	Description	Comments
1	Engine Oil Pressure Switch	Running Open Off - Closed
2	Sensor Power Out	+18V
3	Sensor GND	
4	Left Front Suspension Pressure Sensor	1-5VDC Normal
5	Right Front Suspension Pressure Sensor	1-5VDC Normal
6	Left Rear Suspension Pressure Sensor	1-5VDC Normal
7	Right Rear Suspension Pressure Sensor	1-5VDC Normal
8	Inclinometer	
9	Body Rise Signal	Body Down - Open Body Up - Gnd
10	Break Lock Signal/Neutral Signal	Lock Off - Open Lock On - Gnd
11		
12		

CN4 - AMP 040 8 Pins Black (Optional Input, Reserved)	
No.	Description
1	Optional Input GND
2	Analog Input 1
3	Analog Input 2
4	Digital Input 1
5	Digital Input 2
6	
7	

PAYLOAD CIRCUIT NUMBERS

Circuit Designation	Circuit Description
39F, 39F1...39F5	+18 volt sensor power supply
39FA	Pressure signal Right Rear
39FB	Pressure signal Left Rear
39FC	Pressure signal Right Front
39FD	Pressure signal Left Front
39FE	Inclinometer signal
39FG	Sensor ground
39A	PLM lamp output - green
39B	PLM lamp output - amber
39C	PLM lamp output - red
39D	PLM lamp output - unused
39E	PLM lamp output - unused
39G	+24 volt PLM power
39AA	Load light - green
39BA	Load light - amber
39CA	Load light - red
73FSL	TCI 100% load signal - 930E only
73MSL	TCI 70% load signal - 930E only
714A	Speed signal
714AT	Speed signal
63L	Body up (gnd = up, open = down)
39H	Brake lock (gnd = release, open = lock)
35L1	PLM RS232 RTS (request to send)
35L2	PLM RS232 signal ground
35L3	PLM RS232 receive
35L4	PLM RS232 transmit
35L5	PLM RS232 CTS (clear to send)
35L6	
35L7/35L4	Scoreboard 1 to scoreboard 2
35L8	PLM chan 2 TxD
35L9	PLM chan 2 RxD
21C	Engine oil pressure (gnd = off, open = run)
21D	Alternator R-Terminal (open = off, +24V = run)

PAYLOAD METER II RE-INITIALIZATION PROCEDURE

This procedure is designed to reset the Payload Meter II to clear repeated F.CAL errors.

This procedure is necessary to fix a rare condition in the operation of the meter. Indication for this procedure is a repeated display of **F.CAL** on the meter despite repeated calibration. If possible, download the Payload Meter before performing this procedure. This procedure will erase all memory and user settings.

NOTE:

This procedure should be performed before any Payload Meter is returned for warranty or repair.

Before performing this procedure, be sure that the engine inputs into the payload meter can be manipulated to indicate engine running and engine stopped. Some payload meter installations have hard-wired these inputs. These inputs must be accessible and able to produce the following input conditions:

Condition	21C Engine Oil Pressure	21D Alternator "R" Terminal
Engine Running	Open	24VDC
Engine Stopped	Ground	Open

1. Turn off all systems.
2. Turn on the Payload Meter but leave the engine off.
3. Hold **MODE** and **LIGHT** until CHEC flashes.
4. Hold the **CAL**, **TOTAL** and **LIGHT** buttons until 00:00 is displayed.
5. Press **CAL** for 2 seconds. 00 00 will flash and the meter will erase its memory and reset to its factory settings. This includes and OP, UP, PL, P.SEL, and E.SEL settings.
The meter will restart and display F.CAL.
6. Start the engine.

7. Set the time, date, OP, PL, and UP settings. All other user settings should be updated at this time.
8. Calibrate the Payload Meter by holding the **CAL** button until CAL flashes.
9. Release the Brake Lock (Park Brake for 330M) and begin driving 5-8 MPH on level ground and press **CAL**.
CAL should display until the meter finishes its calibration.
10. Load the truck to rated load and drive through one haul cycle.
11. After dumping the load, wait at least 15 seconds and drive the truck to a safe location.
12. Stop the truck and shut down the engine.
13. Turn on the Payload Meter but leave the engine off.
14. Hold **MODE** and **LIGHT** until CHEC flashes.
15. Hold **LIGHT** and **CAL** until A:CLE flashes.
16. Press **CAL** to clear the service memory.
17. When CHEC is displayed, press **MODE** to return to normal operation.
18. Clear the Haul Cycle Memory by holding **MODE** until Cd:dP is displayed.
19. Press **MODE** and A.CLE will be displayed.
20. Hold **CAL** until A.CLE flashed.
21. Press **CAL** once more to clear the haul cycle memory.
22. Clear the operator load counter by pressing the **TOTAL** button until ":" is displayed.
23. Hold the **CAL** button until the display flashes.
24. Hold the **CAL** button until 0000 is displayed to clear the memory.
25. The payload meter should now function normally.

NOTES

PORTIONS OF THIS PRODUCT RELATING TO PAYLOAD MEASURING SYSTEMS ARE
MANUFACTURED UNDER LICENSE FROM

L. G. HAGENBUCH holder of
U.S. Patent Numbers 4,831,539 and 4,839,835

CAB RADIO

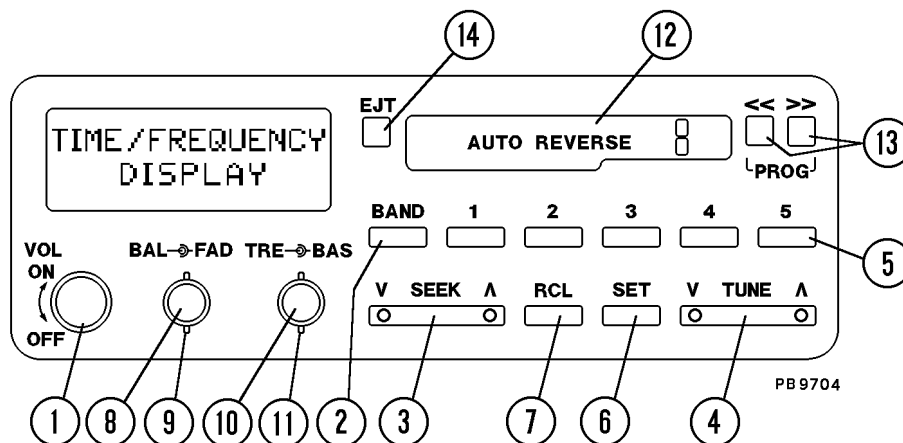

To operate the Radio

1. Rotate the **ON-OFF** control (1) clockwise to turn the radio ON; rotate CCW (counter-clockwise) to turn radio OFF. Rotate **VOL** control clockwise to increase volume. Rotate **VOL** control CCW to decrease volume.

2. **AM/FM** or **WX** - Press **BAND** switch (2) to select desired band. (AM/FM or optional WX*, will be displayed depending on band choice.)

NOTE: The last station heard on each band will be stored in memory. When switching back to that band, it will automatically return.

* WX not available on all models.

3. **SEEK** - Press **SEEK** ^ / v (3) to automatically search for the next higher / lower listenable station and stay there. It will find another station each time that the button is pressed.

4. **Manual Tuning** - Press and hold **TUNE** ^ button (4) to increase frequency. Release as the desired frequency is approached. Press **TUNE** v to decrease frequency.

5. **Pushbuttons** - Press one of the five pushbuttons (5) to recall a preset station.

6. The following procedure will set-up pushbuttons:

Locate a favorite station by using **SEEK** ^ / v or the **TUNE** ^ / v buttons.

Press **SET** pushbutton (6). The station frequency will flash 5 seconds or until set.

Press the button that is desired to be established for that station.

The radio will now return to that frequency each time that button is pressed and released.

NOTE: A total of fifteen stations can be preset - 5 AM, 5 FM, and 5 WX

7. **Clock** - If time-of-day is not on the display, press **RCL** (7).

Press and hold **SET** button and at the same time press and hold **TUNE** v until the correct **hour** appears.

Press and hold **SET** button and at the same time, press and hold **TUNE** ^ until the correct **minute** appears. (Seconds will set to 00 when adjusting minutes.)

Frequency - If radio is turned on and time is being displayed, press **RCL** to display frequency.

Stereo - The radio will automatically switch to stereo when tuned to an FM station broadcasting stereo, and the stereo indicator light **ST** will be displayed.

8. **Balance** - The left-right stereo balance is adjusted by rotating the **BALANCE** (8) control in the corresponding direction from the detent position.

9. **Fade** - Using the tab behind the **BAL** control, adjust the **FADE** control (9) to the right to **FADE** toward the rear speakers. Adjust it to the left to **FADE** toward the front speakers.

NOTE: BALANCE (8) and FADE (9) controls have a detent position at the center for a balance of front to rear and left to right.

10. & 11. **Tone**

Rotate **TRE** control (10) towards left to decrease treble; rotate **TRE** control towards right to increase treble.

Rotate **BAS** control (11) to the right to increase bass; rotate **BAS** control to the left to decrease bass.

NOTE: Both controls have a detent position at the center for a balance of treble and bass.

To Operate The Tape Player

12. Insert tape into door marked **AUTO REVERSE**. Raised portion of cassette cartridge should be to the right.

NOTE: The arrow points in the direction of tape direction.

13. **Program** - Press both direction buttons (13) simultaneously. The direction arrow will change in the graphic display and the player will change tracks.

Fast Forward - Viewing the arrow in the display, press button with arrow pointing in the same direction to activate fast forward; press other button lightly to cancel and return to playing speed.

Fast Reverse - Viewing the arrow in the display, press button with arrow pointing in the opposite direction to activate fast reverse; press other button lightly to cancel and return to speed.

14. **Eject** - Press **EJT** button (14) firmly to eject a tape.

NOTE: When tape is ejected, the radio becomes operative. It is not necessary to eject a tape when leaving the vehicle; a solenoid removes internal pressure automatically.

NOAA - Weather Radio is a service of the "Voice of the National Weather Service." It provides continuous broadcasts of the latest weather information directly from National Weather Service offices. Taped weather messages are repeated every four to six minutes and are routinely revised every one to three hours, or more frequently if need be.

Most of the stations operate 24 hours daily.

KOMATSU