

2016

OPERATOR MANUAL



Prowler[®]/HDX



This vehicle can be hazardous to operate.

A collision or rollover can occur quickly, even during what you think are routine maneuvers such as driving or turning on flat terrain, driving on hills, or crossing obstacles, if you fail to take proper precautions. For your safety, understand and follow all the warnings contained in this Operator's Manual and on the labels on this vehicle.

Keep this Operator's Manual with this vehicle at all times. If you lose your manual, contact Arctic Cat for a free replacement. The labels should be considered permanent parts of the Prowler/HDX. If a label comes off or becomes hard to read, contact Arctic Cat for a free replacement. Contact Arctic Cat Inc., Service Department, P.O. Box 810, Thief River Falls, MN 56701, for proper registration information.

FAILURE TO FOLLOW THE WARNINGS CONTAINED IN THIS MANUAL CAN RESULT IN SERIOUS INJURY OR DEATH.

Particularly important information is distinguished in this manual by the following notations:

	The Safety Alert Symbol means ATTENTION! BE ALERT! YOUR SAFETY IS INVOLVED.
	WARNING indicates a hazardous situation which, if not avoided, could result in death or serious injury.
	CAUTION , without the safety alert symbol, is used to address practices not related to personal injury.
■ NOTE:	A NOTE provides key information to make procedures easier or more clear.

FREE ROV TRAINING

Free training is available for Recreation Off-Highway Vehicles (ROV) operators and passengers from Recreational Off-Highway Vehicle Association (ROHVA). Arctic Cat recommends that you complete this course before you first use your new ROV.

This web-based course takes approximately two hours to complete and presents you with a certificate of accomplishment as soon as you complete the course. The course does not have to be completed all at one time. It will remember where you left off and bring you back to that point when you return.

To receive this free training, log on to www.arcticcat.com, proceed to the side by side site and click on the ROHVA "GET ROV CERTIFIED" link, sign in and complete the course or you could proceed directly to www.ROHVA.org.

California Proposition 65

This product contains or emits chemicals known to the State of California to cause cancer and birth defects or other reproductive harm.

Always use common sense when operating this vehicle.

Foreword

Congratulations and thank you from Arctic Cat Inc. for purchasing an ARCTIC CAT® Prowler/HDX. Built with American engineering and manufacturing know-how, it is designed to provide superior ride, comfort, utility, and dependable service.

This Operator's Manual is furnished to ensure that the operator is aware of safe operating procedures. It also includes information about the general care and maintenance of this vehicle.

Carefully read the following pages. If you have any questions regarding this vehicle, contact an authorized Arctic Cat dealer for assistance. Remember, only authorized Arctic Cat dealers have the knowledge and facilities to provide you with the best service possible.

Protect Your Sport

- Become familiar with all local and state/provincial laws governing ROV operation,
- Respect your vehicle,
- Respect the environment, and
- Respect private property and do not trespass.

We also advise you to strictly follow the recommended maintenance program as outlined. This preventive maintenance program is designed to ensure that all critical components on this vehicle are thoroughly inspected at various intervals.

All information in this manual is based on the latest product data and specifications available at the time of printing. Arctic Cat Inc. reserves the right to make product changes and improvements which may affect illustrations or explanations without notice.

You have chosen a quality Arctic Cat product designed and manufactured to give dependable service. Be sure, as the owner/operator of this vehicle, to become thoroughly familiar with its basic operation, maintenance, and storage procedures. Read and understand the entire Operator's Manual before operating this vehicle to ensure safe and proper use. Always operate the vehicle within your level of skill and current terrain conditions.

Division II of this manual covers operator-related maintenance, operating instructions, and storage instructions. If major repair or service is ever required, contact an authorized Arctic Cat dealer for professional service.

At the time of publication, all information and illustrations in this manual were technically correct. Some illustrations used in this manual are used for clarity purposes only and are not designed to depict actual conditions. Because Arctic Cat Inc. constantly refines and improves its products, no retroactive obligation is incurred.

Parts and Accessories

When in need of replacement parts, oil, or accessories for this vehicle, be sure to use only GENUINE ARCTIC CAT PARTS, OIL, AND ACCESSORIES. Only genuine Arctic Cat parts, oil, and accessories are engineered to meet the standards and requirements of this vehicle. For a complete list of accessories, refer to the current Arctic Cat ATV Accessory Catalog.

To aid in service and maintenance procedures on this vehicle, a Service Manual and an Illustrated Parts Manual are available through your local Arctic Cat dealer.

Operation of this vehicle is restricted to people 16 years of age and older who possess a valid driver's license. Passengers must be able to place both feet flat on the floor while keeping their back against the back of the seat and holding on to an available hand hold (outboard passenger only on HDX).

TREAD LIGHTLY! OFFICIAL SPONSOR®
ON PUBLIC AND PRIVATE LAND

Table of Contents

Foreword.....	1
Parts and Accessories	1

DIVISION I - SAFETY

Safety Alert.....	4
Warning Labels	5-6
Location of Parts and Controls	7
Warnings	8-16

DIVISION II - OPERATION/ MAINTENANCE

Specifications	17
Vehicle Operation	18-22
General Information.....	23-36
Control Locations and Functions	23
Occupant Side Restraints	25
Power Steering.....	29
Speedometer/LCD (Digital)	29
Diagnostic Trouble Codes.....	31
Oil Level Stick	32
Load Capacity Ratings Chart.....	33
Trailer and Towing	33
Transporting	34
Gasoline-Oil-Lubricant	34
Engine Break-In	36
Burnishing Brake Pads.....	36
General Maintenance.....	37-54
Maintenance Schedule	38
Liquid Cooling System	39
Oil Cooler (1000).....	39
Shock Absorbers.....	39

General Lubrication	40
Hydraulic Brake	42
Gas Hoses.....	43
Protective Rubber Boots	43
Battery	44
Spark Plug(s)	47
Air Filter/Housing Drain	48
Draining V-Belt Cover	49
Tires	49
Wheels	49
Muffler/Spark Arrester (Prowler).....	50
Light Bulb Replacement	51
Checking/Adjusting Headlight Aim	51
Fuses.....	52
Electrical Output Terminals	52
Storage Compartment/Tools	52
Seat Belts	53
Occupant Side Restraints.....	53
ROPS	53
Preparation For Storage.....	54
Preparation After Storage	55
Maintenance Record	56
Limited Warranty	57
Warranty Procedure/Owner Responsibility.....	58
U.S. EPA Emission Control Statement/ Warranty Coverage - ROV (U.S. Only)...	59
Change of Address, Ownership, or Warranty Transfer.....	61
Identification Numbers Record.... Inside Back Cover	

DIVISION I - SAFETY

This vehicle is not a toy and can be hazardous to operate.

- Always go slowly and be extra careful when operating on unfamiliar terrain. Always be alert to changing terrain conditions when operating this vehicle.
- Never operate on excessively rough, slippery, or loose terrain.
- Always follow proper procedures for turning as described in this manual. Practice turning at slow speeds before attempting to turn at faster speeds. Do not turn at excessive speed.
- Always have the vehicle checked by an authorized Arctic Cat dealer if it has been involved in an accident.
- Never operate on hills too steep for your abilities. Practice on smaller hills before attempting larger hills.
- Always follow proper procedures for climbing hills as described in this manual. Check the terrain carefully before you start up any hill. Never climb hills with slippery or loose surfaces. Never depress the accelerator suddenly or make gear changes while moving. Never go over the top of any hill at high speed.
- Always follow proper procedures for going down hills and for braking on hills as described in this manual. Check the terrain carefully before you start down any hill. Never go down a hill at high speed. Avoid going down a hill at an angle which would cause the vehicle to lean sharply to one side. Go straight down the hill where possible.
- Always be careful when you decide to climb or descend a hill and never turn on a hill. Drive straight up or down inclines and not across them. If you must cross the side of a hill, drive slowly and stop or turn downhill if you feel the vehicle may tip over.
- Always use proper procedures if you stall or roll backward when climbing a hill. To avoid stalling, maintain a steady speed when climbing a hill. If you stall or roll backwards, follow the special procedure for braking described in this manual.
- Always check for obstacles before operating in a new area. Never attempt to operate over large obstacles, such as large rocks or fallen trees. Always follow proper procedures when operating over obstacles as described in this manual.
- Always be careful of skidding or sliding. On slippery surfaces, such as ice, go slowly and be very cautious in order to reduce the chance of skidding or sliding out of control.
- Never operate this vehicle in fast flowing water or in water deeper than the floorboard. Remember that wet brakes may have reduced stopping capability. Test your brakes after leaving water. If necessary, apply them lightly several times to let friction dry out the pads.
- Always be sure there are no obstacles or people behind you when you operate in reverse. When it is safe to proceed in reverse, go slowly. Avoid turning at sharp angles in reverse.
- Always use the size and type tires specified in this manual. Always maintain proper tire pressure as described in this manual.
- Never improperly install or improperly use accessories on this vehicle.
- Never exceed the stated load capacity for this vehicle. Cargo should be properly distributed and securely attached. Reduce speed and follow instructions in this manual for carrying cargo or pulling a trailer and allow greater distance for braking.
- Operation of this vehicle is restricted to people 16 years of age and older who possess a valid driver's license. Passengers must be able to place both feet flat on the floor while keeping their back against the back of the seat and holding on to an available hand hold (outboard passenger only on HDX).



WARNING

Indicates a hazardous situation which, if not avoided, could result in death or serious injury. **3**

Safety Alert

You should be aware that THIS VEHICLE IS NOT A TOY AND CAN BE HAZARDOUS TO OPERATE. This vehicle handles differently from other vehicles, including motorcycles and cars. A collision or rollover can occur quickly, even during what you think are routine maneuvers such as turning, driving on hills, and going over obstacles, if you fail to take proper precautions.

TO AVOID SERIOUS INJURY OR DEATH:

- * Always read the Operator's Manual carefully and follow the operating procedures described. Pay special attention to the warnings contained in the manual and on all labels.
- * Always wear the seat belt when operating or riding in this vehicle.
- * Always follow these age recommendations:
 - Operation of this vehicle is restricted to people 16 years of age and older who possess a valid driver's license. Passengers must be able to place both feet flat on the floor while keeping their back against the back of the seat and holding on to the hand hold (outboard passenger only on HDX).
- * Never carry a passenger in the cargo box of this vehicle.
- * Never operate this vehicle on a public road, even a dirt or gravel one, because you may not be able to avoid colliding with other vehicles.
- * Never operate this vehicle without an approved motorcycle helmet, eye protection, boots, gloves, long pants and a long-sleeved shirt or jacket.
- * Never consume alcohol or drugs before or while operating this vehicle.
- * Never operate this vehicle at excessive speeds. Go at a speed which is proper for the terrain, visibility conditions, and your experience.
- * Never attempt to do wheelies, jumps, or other stunts.
- * Always be careful when operating this vehicle, especially when approaching hills, turns, and obstacles and when operating on unfamiliar or rough terrain.
- * Never operate this vehicle with the cargo box lifted or removed.
- * Never operate this vehicle in fast flowing water or in water deeper than the floorboard.
- * Never operate this vehicle with the ROPS removed. The ROPS provides a structure helping to limit intrusions by branches or other objects and may reduce your risk of injury in accidents.
- * Never put your hands or feet outside the vehicle for any reason while the vehicle is in motion. Do not hold onto the ROPS or hip restraint bar. If you think or feel the vehicle may tip, do not put your hands or feet outside the vehicle as they will not be able to prevent the vehicle from tipping. Any part of your body (arms, legs, or head) outside the vehicle can be crushed by passing objects, the vehicle, or ROPS.
- * Always fasten occupant side restraints prior to moving the vehicle.



Warning Labels

A

WARNING

Exceeding vehicle's towing limit could cause an accident. Reduce speed when towing a trailer. Read operator's manual for details.

MAXIMUM TONGUE WEIGHT:
150 lbs (68 kg)

MAXIMUM TOWING CAPACITY:
1500 lbs (680 kg)

4411-110

B

WARNING



- Keep hands, body and other persons away from closing cargo box.
- Do not operate the vehicle with cargo box up.

4411-883

D

WARNING

Vehicle rollover could cause **SERIOUS INJURY** or **DEATH**.

You must keep all parts of your body inside the vehicle.

DO NOT remove this **ROPS**.

This ROPS complies with ISO 3471.

3411-970

C

WARNING

Do not run engine without this shield in place or with drive belt removed.

Do not attempt any adjustment with engine running.

0411-426

E (Prowler)

WARNING

SEVERE INJURY or **DEATH** can result if you ignore the following:

- Never exceed the vehicle load capacity including weight of operator, passenger, cargo, accessories, and trailer tongue. Maximum load in cargo bed: 600 lbs (272 kg)
- When loaded or towing, reduce speed and allow more room to stop.
- Be sure cargo is secured, a loose load could shift and change handling unexpectedly.
- Keep weight in the cargo bed centered, low and forward. Top-heavy loads increase the risk of overturn.
- Never carry passengers in cargo bed. -Never tow or pull passengers.

WARNING

Improper tire pressure or overloading can cause loss of control. Loss of control can result in severe injury or death.

Cold tire pressure operator and passenger: Front: 12 psi (83 kPa) Rear: 12 psi (83 kPa)	Cold tire pressure operator and passenger with cargo: Front: 20 psi (138 kPa) Rear: 20 psi (138 kPa)
---	--

Maximum weight capacity: 1100 lbs (479 kg)



4411-118

F

WARNING



Watch hands while closing cargo box.

4411-882

E (700 HDX)

WARNING

SEVERE INJURY or **DEATH** can result if you ignore the following:

- Never exceed the vehicle load capacity including weight of operator, passenger, cargo, accessories, and trailer tongue. Maximum load in cargo bed: 1000 lbs (453 kg)
- When loaded or towing, reduce speed and allow more room to stop.
- Be sure cargo is secured, a loose load could shift and change handling unexpectedly.
- Keep weight in the cargo bed centered, low and forward. Top-heavy loads increase the risk of overturn.
- Never carry passengers in cargo bed. -Never tow or pull passengers.

WARNING

Improper tire pressure or overloading can cause loss of control. Loss of control can result in severe injury or death.

Cold tire pressure operator and passenger: Front: 12 psi (83 kPa) Rear: 12 psi (83 kPa)	Cold tire pressure operator and passenger with cargo: Front: 20 psi (138 kPa) Rear: 20 psi (138 kPa)
---	--

Maximum weight capacity: 1500 lbs (680 kg)



4411-055

E (500 HDX)

WARNING

SEVERE INJURY or **DEATH** can result if you ignore the following:

- Never exceed the vehicle load capacity including weight of operator, passenger, cargo, accessories, and trailer tongue. Maximum load in cargo bed: 600 lbs (272 kg)
- When loaded or towing, reduce speed and allow more room to stop.
- Be sure cargo is secured, a loose load could shift and change handling unexpectedly.
- Keep weight in the cargo bed centered, low and forward. Top-heavy loads increase the risk of overturn.
- Never carry passengers in cargo bed. -Never tow or pull passengers.

WARNING

Improper tire pressure or overloading can cause loss of control. Loss of control can result in severe injury or death.

Cold tire pressure operator and passenger: Front: 12 psi (83 kPa) Rear: 12 psi (83 kPa)	Cold tire pressure operator and passenger with cargo: Front: 20 psi (138 kPa) Rear: 20 psi (138 kPa)
---	--

Maximum weight capacity: 1100 lbs (479 kg)



4411-543



PR893C

Pour commander des Etiquettes de Mise en Garde gratuites, voyez votre détaillant de autorisé VTT Arctic Cat pour le numéro de pièce 1436-444.

WARNING Indicates a hazardous situation which, if not avoided, could result in death or serious injury. **5**

Warning Labels

A



B



PR878A

6



WARNING

Indicates a hazardous situation which, if not avoided, could result in death or serious injury.

Location of Parts and Controls



PR869A



PR893A

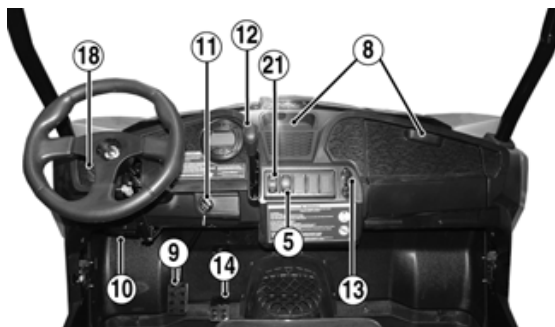

PR868A



PR892B



HDX184C

1. Battery
2. Headlights
3. Passenger Side Restraint Latch
4. Tailgate Latch
5. Reverse Override Switch
6. Seat Lock Lever
7. Under-Hood Storage Compartment
8. In-Dash Storage Compartment
9. Brake Pedal
10. Fuses
11. Ignition/Start Switch
12. Shift Lever
13. DC Power Outlets
14. Accelerator Pedal
15. Cargo Box Latch Handle
16. Taillight/Brakelight
17. Operator's Manual Location
18. Headlight Switch
19. Driver Seat Belt
20. Passenger Seat Belt (Prowler)
20. Passenger Seat Belt (Right) (HDX)
21. Drive Select Switch
22. Tilt Steering Lever
23. Tool Kit
24. Passenger Side Restraints
25. Driver Side Restraint
26. Driver Side Restraint Latch
27. Gas Tank Cap
28. Passenger Seat Belt (Center) (HDX)
29. Side Storage Compartment
30. Outboard Passenger Hand Hold
31. Hitch Receiver

Warnings

WARNING

POTENTIAL HAZARD

Operating this vehicle without proper instruction.

WHAT CAN HAPPEN

The risk of an accident is greatly increased if the operator does not know how to operate this vehicle properly in different situations and on different types of terrain.

HOW TO AVOID THE HAZARD

All operators of this vehicle must read and understand this Operator's Manual and all warning and instruction labels prior to operating this vehicle.

WARNING

POTENTIAL HAZARD

Allowing anyone under age 16 to operate this vehicle.

WHAT CAN HAPPEN

Use of this vehicle by children can lead to serious injury or death of the child. Children under the age of 16 may not have the skills, abilities, or judgment needed to operate this vehicle safely and may be involved in a serious accident.

HOW TO AVOID THE HAZARD

Only people 16 years of age or older with a valid driver's license should operate this vehicle.

WARNING

POTENTIAL HAZARD

Operating or riding in the vehicle without wearing a properly-secured seat belt.

WHAT CAN HAPPEN

Serious injury or death. Occupants can strike objects in the passenger compartment, fall out of the vehicle during maneuvers, or be crushed or otherwise injured in the event of an accident.

HOW TO AVOID THE HAZARD

ALWAYS WEAR YOUR SEAT BELT and require others to wear their seat belts. See the Operation/Maintenance section of this manual for more information on using your seat belt and both operator and passenger(s) wearing an approved helmet.

WARNING

POTENTIAL HAZARD

Operating this vehicle on public streets, roads, or highways.

WHAT CAN HAPPEN

You can collide with another vehicle.

HOW TO AVOID THE HAZARD

Never operate this vehicle on any public street, road, or highway. In many states it is illegal to operate a vehicle of this type on public streets, roads, or highways. Always check state and local laws and regulations.

⚠️ WARNING

POTENTIAL HAZARD

Operating or riding in this vehicle without wearing an approved helmet, eye protection, and protective clothing.

WHAT CAN HAPPEN

Operating or riding without an approved helmet increases your chances of a serious head injury or death in the event of an accident.

Operating or riding without eye protection can result in an accident and increases your chances of a serious injury in the event of an accident.

Operating or riding without protective clothing increases your chances of serious injury in the event of an accident.

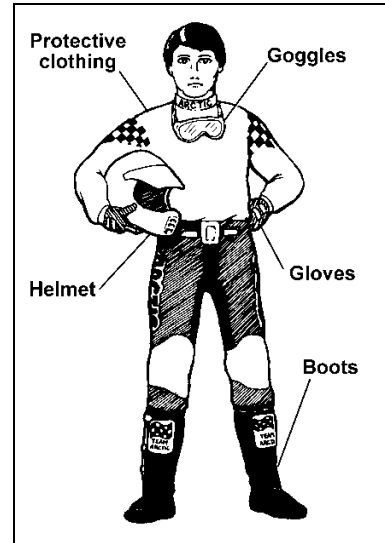

HOW TO AVOID THE HAZARD

Always wear an approved helmet that fits properly.

You should also wear:

Eye protection (goggles or face shield)

Gloves

Boots

Long sleeved shirt or jacket

Long pants

⚠️ WARNING

POTENTIAL HAZARD

Operating this vehicle after or while consuming alcohol or drugs.

WHAT CAN HAPPEN

Could seriously affect your judgment.

Could cause you to react more slowly.

Could affect your balance and perception.

Could result in an accident.

HOW TO AVOID THE HAZARD

Never consume alcohol or drugs before or while driving this vehicle.

⚠️ WARNING

POTENTIAL HAZARD

Allowing passengers to ride in the cargo bed.

WHAT CAN HAPPEN

Serious injury or death. This vehicle is not designed to carry passengers in the cargo bed. Passengers in the cargo bed can be thrown around or from the vehicle during operation or in an accident.

HOW TO AVOID THE HAZARD

Do not permit passengers to ride in the cargo bed. Do not install any seating in the cargo bed.

 **WARNING**

POTENTIAL HAZARD

Operating or riding in the vehicle without occupant side restraints properly secured.

WHAT CAN HAPPEN

Serious injury or death. Occupants or their body parts can strike objects outside the vehicle, be crushed by the vehicle, or fall out of the vehicle during maneuvers or in the event of an accident.

HOW TO AVOID THE HAZARD

Do not remove the occupant side restraints. Make sure both driver and passenger occupant side restraints are secure before operating or riding in the vehicle. Stay seated with your seat belt and helmet on and keep your body completely inside the vehicle during operation. See the Operation/Maintenance section of this manual for more information.

 **WARNING**

POTENTIAL HAZARD

Failing to keep all parts of your body inside the passenger compartment during operation.

WHAT CAN HAPPEN

Serious injury or death. Body parts could strike objects outside of vehicle or be crushed in the event of a rollover or accident.

HOW TO AVOID THE HAZARD

Do not place your head, arms, hands, legs, or feet outside of the passenger compartment during operation. Stay seated with your seat belt and helmet on and occupant side restraints properly secured. Keep your feet and legs inboard of the foot restraints at all times. Do not attempt to stop movement or tipping of the vehicle with your hands or feet. If you feel the vehicle tipping, brace your feet flat on the floor, keep hands firmly gripping the steering wheel and hand holds (outboard passenger only on HDX), and keep all body parts inside the passenger compartment.

 **WARNING**

POTENTIAL HAZARD

Operating this vehicle at excessive speeds.

WHAT CAN HAPPEN

Increases your chances of losing control of the vehicle, which can result in an accident.

HOW TO AVOID THE HAZARD

Always ride at a speed that is proper for the terrain, visibility, load, and operating conditions.



 **WARNING**

POTENTIAL HAZARD

Attempting abrupt maneuvers, sideways sliding, skidding, fishtailing, or donuts.

WHAT CAN HAPPEN

Increases the chance of an accident including a rollover.

HOW TO AVOID THE HAZARD

Never attempt abrupt maneuvers, sideways sliding, skidding, fishtailing, or donuts. Don't try to show off.

 **WARNING**

POTENTIAL HAZARD

Failure to inspect this vehicle before operating.

Failure to properly maintain this vehicle.

WHAT CAN HAPPEN

Increases the possibility of an accident or equipment damage.

HOW TO AVOID THE HAZARD

Always inspect this vehicle each time you use it to make sure it is in safe operating condition.

Always follow the inspection and maintenance procedures and schedules described in this Operator's Manual.

 **WARNING**

POTENTIAL HAZARD

Failure to use extra care when operating this vehicle on unfamiliar terrain.

WHAT CAN HAPPEN

You can come upon hidden rocks, bumps, or holes without enough time to react.

Could result in the vehicle overturning or going out of control.

HOW TO AVOID THE HAZARD

Go slowly and be extra careful when operating on unfamiliar terrain.

Always be alert to changing terrain conditions when operating this vehicle.

 **WARNING**

POTENTIAL HAZARD

Failure to use extra care when operating on rough, slippery, or loose terrain.

WHAT CAN HAPPEN

Could cause loss of traction or control, which could result in an accident including a rollover.

HOW TO AVOID THE HAZARD

Do not operate on rough, slippery, or loose terrain until you have learned and practiced the skills necessary to control this vehicle on such terrain.

Always be especially cautious on these kinds of terrain.

⚠ WARNING

POTENTIAL HAZARD

Failing to use care in turns; turning too sharply or aggressively.

WHAT CAN HAPPEN

The vehicle could go out of control causing a collision, tip over, or rollover.

HOW TO AVOID THE HAZARD

Always follow proper procedures for turning as described in this Operator's Manual. Practice turning at slow speeds before attempting to turn at faster speeds. Do not turn at excessive speed or too sharply for the conditions and for your experience level. See the Operation/Maintenance section of this manual for more information on turning on flat ground, hills, sand, ice, mud, or water.

⚠ WARNING

POTENTIAL HAZARD

Operating on steep hills.

WHAT CAN HAPPEN

This vehicle can overturn more easily on steep hills than on level surfaces or small hills.

HOW TO AVOID THE HAZARD

Never operate the vehicle on hills too steep for the vehicle or for your abilities. Practice on smaller hills before attempting larger hills.

⚠ WARNING

POTENTIAL HAZARD

Operating with the ROPS removed.

WHAT CAN HAPPEN

Could lead to serious injury or death.

HOW TO AVOID THE HAZARD

Never operate this vehicle with the ROPS removed.

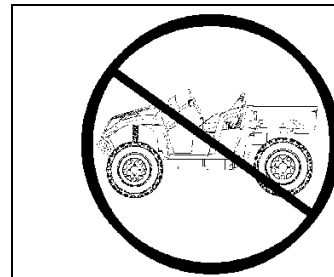

⚠ WARNING

POTENTIAL HAZARD

Going down a hill improperly.

WHAT CAN HAPPEN

Could cause loss of control or cause the vehicle to overturn.

HOW TO AVOID THE HAZARD

Always follow proper procedures for going down hills as described in this Operator's Manual.

Always check the terrain carefully before you start down any hill.

Never go down a hill at high speed.

Avoid going down a hill at an angle that would cause the vehicle to lean sharply to one side. Go straight down the hill where possible.

⚠ WARNING

POTENTIAL HAZARD

Climbing hills improperly.

WHAT CAN HAPPEN

Could cause loss of control or cause the vehicle to overturn.



HOW TO AVOID THE HAZARD

Always follow proper procedures for climbing hills as described in this Operator's Manual.

Always check the terrain carefully before you start up any hill.

Never climb hills with slippery or loose surfaces.

Never open the throttle suddenly or make sudden gear changes. The vehicle could flip over backwards.

Never go over the top of any hill at high speed. An obstacle, a sharp drop, or another vehicle or person could be on the other side of the hill.

**Never Operate Up Or
Down Hills Steeper
Than 15°**



⚠ WARNING

POTENTIAL HAZARD

Crossing hills or turning on hills.

WHAT CAN HAPPEN

Could cause loss of control or cause the vehicle to overturn.

HOW TO AVOID THE HAZARD

Avoid crossing the side of a hill or turning on a hill whenever possible. Never attempt to turn the vehicle around on any hill. If you must cross the side of a hill, drive slowly and stop or turn downhill if you feel the vehicle may tip.

⚠ WARNING

POTENTIAL HAZARD

Stalling, rolling backwards, or improperly dismounting while climbing a hill.

WHAT CAN HAPPEN

Could result in the vehicle overturning.

HOW TO AVOID THE HAZARD

Use proper gear and maintain steady speed when climbing a hill.

If you lose all forward speed:

Apply the brakes. Place the transmission in park after you are stopped.

If you begin rolling backwards:

Apply the brakes while rolling backwards.

When fully stopped, place the transmission in park.

WARNING

POTENTIAL HAZARD

Improperly operating over obstacles.

WHAT CAN HAPPEN

Could cause loss of control or a collision. Could cause the vehicle to overturn.

HOW TO AVOID THE HAZARD

Before operating in a new area, check for obstacles.

Never attempt to ride over large obstacles, such as large rocks or fallen trees.

When you go over obstacles, always follow proper procedures as described in this Operator's Manual.

WARNING

POTENTIAL HAZARD

Improperly operating in reverse.

WHAT CAN HAPPEN

You could hit an obstacle or person behind you, resulting in serious injury or death.

HOW TO AVOID THE HAZARD

Before you engage reverse gear, make sure there are no obstacles or people behind you. When it is safe to proceed, go slowly.

WARNING

POTENTIAL HAZARD

Skidding or sliding.

WHAT CAN HAPPEN

You could lose control of the vehicle.

You could also regain traction unexpectedly, which may cause the vehicle to overturn.

HOW TO AVOID THE HAZARD

Learn to safely control skidding or sliding by practicing at slow speeds and on level, smooth terrain.

On extremely slippery surfaces, such as ice, go slowly and be very cautious in order to reduce the chance of skidding or sliding out of control.

WARNING

POTENTIAL HAZARD

Overloading the vehicle or carrying or towing improperly.

WHAT CAN HAPPEN

Could cause changes in handling, which could lead to an accident.

HOW TO AVOID THE HAZARD

Never exceed the stated load capacity for this vehicle.

Cargo should be properly distributed and securely attached.

Reduce speed when carrying cargo or pulling a trailer. Allow greater distance for braking. Always follow the instructions in this Operator's Manual for carrying cargo or pulling a trailer.



 **WARNING**

POTENTIAL HAZARD

Operating this vehicle through deep or fast flowing water.

WHAT CAN HAPPEN

Tires may float, causing loss of traction and loss of control, which could lead to an accident.

HOW TO AVOID THE HAZARD

Never operate this vehicle in fast flowing water or in water deeper than the floorboard. Remember that wet brakes may have reduced stopping capability. Test the brakes after leaving water. If necessary, apply them several times to dry out the pads.

 **WARNING**

POTENTIAL HAZARD

Operating the vehicle with improper tires or with improper or uneven tire pressure.

WHAT CAN HAPPEN

Use of improper tires on the vehicle, or operating the vehicle with improper or uneven tire pressure, could cause loss of control increasing your risk of accident.

HOW TO AVOID THE HAZARD

Always use the size and type tires specified in this Operator's Manual for this vehicle. Always maintain proper tire pressure as described in this Operator's Manual.

 **WARNING**

POTENTIAL HAZARD

Operating this vehicle with improper modifications.

WHAT CAN HAPPEN

Improper installation of accessories or modification of the vehicle may cause changes in handling which could lead to an accident.

HOW TO AVOID THE HAZARD

Never modify this vehicle through improper installation or improper use of accessories. All parts and accessories added to this vehicle should be genuine Arctic Cat components designed for use on this vehicle and should be installed and used according to instructions. If you have questions, consult an authorized Arctic Cat dealer.

 **WARNING**

POTENTIAL HAZARD

Failing to avoid pinch-points when lowering the cargo box.

WHAT CAN HAPPEN

Fingers, hands, or arms could be seriously injured when lowering the cargo box.

HOW TO AVOID THE HAZARD

Always be aware of and avoid lowering cargo box until everyone is clear of pinch-points.

 **WARNING**

POTENTIAL HAZARD

Operating through or over thick or sharp brush, timber, debris, or rocks.

WHAT CAN HAPPEN

Serious injury or death. Brush, branches, debris, and rocks can enter or penetrate the passenger compartment and strike occupants. Running over sharp branches, rocks, or other large objects can also cause loss of control.

HOW TO AVOID THE HAZARD

Be alert. Slow down. Wear all recommended protective gear specified in this Operator's Manual. Avoid operating through or over thick brush, timber, debris, or large rocks whenever possible. Watch for and avoid sharp branches, rocks, or other large objects that could impede or impact the vehicle or enter the passenger compartment.

 **WARNING**

POTENTIAL HAZARD

Securing a person improperly in the vehicle due to physical size.

WHAT CAN HAPPEN

Serious injury or death. Occupant could strike objects in the passenger compartment, fall out of the vehicle during maneuvers, or be ejected and crushed in the event of an accident.

HOW TO AVOID THE HAZARD

Always make sure a passenger can sit with both feet flat on the floor and their back against the seat while being able to reach any provided hand holds.

 **WARNING**

POTENTIAL HAZARD

Operating this vehicle on paved surfaces.

WHAT CAN HAPPEN

The vehicle's tires are designed for off-road use only, not for use on pavement. Paved surfaces may seriously affect handling and control of the vehicle and may cause the vehicle to go out of control.

HOW TO AVOID THE HAZARD

Whenever possible, avoid operating the vehicle on any paved surfaces including sidewalks, driveways, parking lots, and streets. If operating on paved surfaces is unavoidable, travel slowly (less than 10 MPH) and avoid sudden turns and stops.

DIVISION II - OPERATION/ MAINTENANCE Specifications

ENGINE		
Type	(500/700) (1000)	Four-Cycle/Liquid Cooled Four-Cycle/Liquid Cooled V-Twin
Bore x Stroke	(500) (700) (1000)	89 mm x 71.12 mm (3.5 x 2.8 in.) 102 mm x 85 mm (4.01 x 3.4 in.) 92 mm x 71.6 mm (3.62 x 2.82 in.)
Displacement	(500) (700) (1000)	442 cc (27.0 cu in.) 695 cc (42.4 cu in.) 951 cc (58 cu in.)
Spark Plug Type	(500) (700/1000)	NGK CPR7E NGK CPR8E
Spark Plug Gap	(500) (700/1000)	0.7-0.8 mm (0.028-0.031 in.) 0.5-0.6 mm (0.019-0.024 in.)
Brake Type		Four Wheel Hydraulic
CHASSIS		
Length (Overall)	(Prowler) (HDX)	302.8 cm (119.25 in.) 328.9 cm (129.5 in.)
Height (Overall)		200.6 cm (79 in.)
Width (Overall)	(Prowler) (HDX)	154.9 cm (61 in.) 152.4 cm (60 in.)
Suspension Travel (Front/Rear)		25.4 cm (10 in.)
Tire Size (Front)	(500/700) (1000)	26 x 9R-14 27 x 9R-14
Tire Size (Rear)	(500/700) (1000)	26 x 11R-14 27 x 11R-14
Tire Inflation Pressure		0.84-1.41 kg/cm ² (12-20 psi)
MISCELLANY		
Dry Weight (Approx)	(500 HDX) (700) (700 HDX) (1000)	592 kg (1307 lb) 569 kg (1254 lb) 618 kg (1363 lb) 596 kg (1315 lb)
ROPS Tested Curb Weight	(HDX) (Prowler)	680 kg (1500 lb) 648 kg (1428 lb)
Gas Tank Capacity		31 L (8.2 U.S. gal.)
Coolant Capacity	(500/700) (1000)	2.9 L (3.0 U.S. qt) 3.3 L (3.5 U.S. qt)
Differential Capacity		275 ml (9.3 fl oz)
Rear Drive Capacity		250 ml (8.5 fl oz)
Engine Oil Capacity (Approx)	(500) (700/1000)	2.8 L (3.0 U.S. qt) 1.9 L (2.0 U.S. qt)
Gasoline (Recommended)		87 Octane Regular Unleaded
Engine Oil (Recommended)		Arctic Cat ACX All Weather (Synthetic)
Front Differential/Rear Drive Lubricant		SAE Approved 80W-90 Hypoid
Taillight/Brakelight		12V/60W/55W
Headlight		LED High Intensity w/Accent Bar
Starting System		Electric

Specifications subject to change without notice.

Vehicle Operation

Pre-Start/Pre-Operation Checklist	
Item	Remarks
Brake System	Pedal firm - near top of travel. Fluid at proper level. Check for fluid leaks.
Controls	Steering free - no binding - no excessive free-play. Shift lever in park. Accelerator free - no binding - returns to idle position.
Fluids	Coolant level to bottom of radiator neck. Check oil level. Gas tank full of recommended gasoline. Differential/rear drive at proper level. Check for fluid leaks.
Suspension	Ball joints/tie rod ends free - secure. Shocks not leaking - mountings secure. Shock spring pre-load equal on left and right. Components free of all debris.
Lights/Switches	Check headlight HI/LO beam - light switch to OFF. Check taillight/brakelight - light switch to OFF. Check drive select switch - set to 2WD.
Air Filter	Duck bill drains clear of all debris. Ducting secure - no holes or tears.
Tires/Wheels	Properly inflated - tread adequate. Check tires for cuts or tears. Wheels secure to hubs - hubs secure to axles. Check wheels for cracked or bent rims.
Seat Belts/Restraints	Check condition - proper operation - proper adjustment.
Nuts/Bolts/Fasteners	Check for loose nuts - bolts - tighten as necessary. Check fasteners - latches - ROPS. Secure hood, cargo box, seats.

Vehicle Operation

Starting the Vehicle

Always start with the vehicle on a flat, level surface. Carbon monoxide poisoning can kill you, so keep the vehicle outside while it's running. Follow these steps to start it up:

1. Step into the vehicle and sit down; then fasten the operator seat belt and the passenger seat belts (if applicable) and strap on your approved helmet and require your passenger(s) to do the same (if applicable). Check that the occupant side restraints are secured in place.

WARNING

Falling from a moving vehicle could result in serious injury or death. Always fasten your seat belt securely and ensure the passenger seat belt is properly and securely fastened prior to operating or riding in this vehicle.

2. Place the transmission in park; then depress the brake pedal.
3. Turn the ignition switch clockwise to the START position; then when the engine starts, release to the RUN position. Do not increase engine RPM above idle.

CAUTION

Increasing engine RPM above idle while in Park will cause belt damage.

CAUTION

Do not run the starter motor for more than eight seconds per starting attempt. The starter motor may overheat causing severe starter motor damage. Allow 15 seconds between starting attempts to allow the starter motor to cool.

4. Let the engine warm up.

Shifting

■ **NOTE:** The CVT is fully automatic and shifts as a function of engine RPM and vehicle loading.

CAUTION

Always come to a complete stop before attempting to shift from one range to the other or into reverse. Always shift on level ground.



PR878

1. To select reverse gear from park, move the shift lever downward one position until the letter "R" is displayed on the LCD gauge.
2. To select neutral from reverse, move the shift lever downward one position until the letter "N" is displayed on the LCD gauge.
3. To select high range from neutral, move the shift lever downward one position until the letter "H" is displayed on the LCD gauge.
4. To select low range from high range, move the shift lever downward one position until the letter "L" is displayed on the LCD gauge.

■ **NOTE:** The high range is for normal driving with light loads. The low range is for carrying heavy loads or trailer towing. Compared to HIGH range, the LOW range position provides slower speed and greater torque to the wheels.

CAUTION

Always shift into low range when operating on wet or uneven terrain, when towing or pushing heavy loads, and when using a plow. Failure to follow this caution may result in premature V-belt failure or in damage to related drive system components.

5. To select park, move the shift lever completely up until the letter "P" is displayed on the LCD gauge.

CAUTION

Never increase engine speed above idle RPM when in park or belt damage will occur.

Driving the Vehicle

Once the engine is warm, the vehicle is ready to be driven.

1. With the engine idling, press the foot brake pedal to apply the brake; then select the appropriate operating range and/or direction with the shift lever.
2. Release the foot brake pedal and press the accelerator to slowly add power to start moving.
3. To slow down or stop, release the accelerator and press the foot brake pedal as necessary to slow or stop the vehicle.

Braking/Stopping

Always allow plenty of room and time to stop smoothly. Sometimes quick stops are inevitable, so always be prepared. Whether you're stopping slowly or stopping quickly, do this:

1. Release the accelerator; then press the foot brake pedal to apply the brake.
2. If the wheels lock, release them for a second; then apply them again. On surfaces such as ice, mud, or loose gravel, pump the brake pedal rapidly.
3. Never "ride" the brake. Even maintaining minimal pressure on the brake pedal will cause the brake pads to drag on the disc and may overheat the brake fluid.

WARNING

Excessive repetitive use of the hydraulic brake for high speed stops will cause overheating of the brake fluid and premature brake pad wear which will result in an unexpected loss of brakes.

WARNING

Use only Arctic Cat approved brake fluid. Never substitute or mix different types or grades of brake fluid. Brake loss can result. Check brake fluid level and pad wear before each use. Brake loss can result in serious injury or death.

Parking

Parking involves following the previous rules for braking; then:

1. After the vehicle stops, shift into park.
2. Turn off the ignition.
3. If you have to park on a hill, block the wheels on the downhill side.

Basic Turns

Steering effort is at its lowest in two-wheel drive (2WD). Greater effort is needed when in four-wheel drive (4WD). The greatest effort is needed when in four-wheel drive and the differential (if equipped) is locked.

Slow down before entering a turn. The basic turning technique is to drive at low speed and gradually adjust the amount of steering to suit the driving surface. Do not make sudden sharp turns on any surface. Refer to the sub-sections Driving Uphill, Driving Downhill, Crossing Obstacles, Driving in Reverse, Skidding or Sliding, Crossing Water, or Crossing Roads for more information.

If your vehicle ever skids sideways during a turn, steer in the direction of the skid. Also, avoid hard braking or accelerating until you have regained directional control.

WARNING

Use care in turns - turning the steering wheel too far or too fast can result in loss of control or a rollover. Excessive speed, driving aggressively, or making abrupt maneuvers, even on flat, open areas, can cause loss of control, tipping, or rollover. Uneven terrain, rough terrain, soft surfaces, slippery surfaces, and paved surfaces can also cause a loss of control or rollover in a turn. On loose or soft surfaces, allow yourself more time and distance to turn and slow down.

Driving Uphill

Always drive straight up the hill and always avoid hills steeper than 15°.

1. Keep both hands on the wheel.

2. Prior to starting the climb, shift into low range, select four-wheel drive for traction, and gradually press the accelerator; then maintain a constant speed.

⚠ WARNING

Do not attempt to turn around on a hill.

⚠ WARNING

Driving up hills improperly can cause loss of control of the vehicle resulting in serious injury or death. Use extreme care when driving in hilly terrain.

3. If the vehicle stalls on a hill, press the foot brake pedal to apply the brake, shift into reverse, and slowly back down the hill. Do not attempt to turn around on a hill.

NEVER OPERATE UP OR DOWN HILLS STEEPER THAN 15°



Driving Downhill

Always drive straight down the hill and always avoid hills steeper than 15°.

1. Keep both hands on the wheel.
2. Prior to descending the hill, shift into low range and release the accelerator to allow maximum engine braking. Do not use four-wheel drive when descending a hill. Engine braking can cause the front wheels to slide reducing steering control.

■ **NOTE:** Use minimum braking (as necessary) to maintain a slow speed.

⚠ WARNING

Do not attempt to turn around on a hill.

⚠ WARNING

Driving down hills improperly can cause loss of control of the vehicle resulting in serious injury or death. Never drive downhill at a high rate of speed. Use extreme care when driving in hilly terrain.

Crossing Obstacles

Crossing obstacles can be hazardous. There is always the possibility of the vehicle tipping. If you cannot go around an obstacle, follow these guidelines:

1. Stop the vehicle and place the transmission in park. Go out to inspect the obstacle thoroughly from both your approach side and the exit side. If you believe you can cross the obstacle safely, select four-wheel drive (4WD).

■ **NOTE:** Selecting the LOCK position on the differential lock control may be beneficial; however, steering effort will be increased.

2. Approach the obstacle as close as possible to 90° to minimize vehicle tipping.
3. Keep speed slow enough to maintain control but fast enough to maintain momentum.
4. Use only enough power to cross the obstacle but still give yourself plenty of time to react to changes in conditions. Crawl over the obstacle.

⚠ WARNING

Striking hidden obstacles can cause serious injury or death. Reduce speed and proceed with care in unfamiliar terrain.

■ **NOTE:** If there is any question about your ability to cross the obstacle safely, you should turn around if the ground is flat and you have room or back up until you find a less difficult path.

Driving in Reverse

When operating in reverse, avoid sharp turns and backing down a hill. When using reverse, follow these guidelines:

1. Back up slowly. It's hard to see behind you.

■ NOTE: Avoid sudden braking while backing up.

2. If possible, it is advisable to have someone "spotting" for you while backing up.
3. If you are unsure of what is behind the vehicle, place the transmission in park and get out and inspect the area behind.

WARNING

Never activate the override while the throttle is open as a loss of control may result. Use caution when using the override switch as reverse speed can greatly increase.

Skidding or Sliding

If you lose control after hitting sand, ice, mud, or water, follow these guidelines:

1. Turn the steering wheel into the direction of the slide.
2. Keep your foot off the brake until you're out of the skid.
3. Stop and shift into four-wheel drive.

Crossing Water

This vehicle can only operate in water up to its floorboard. Stay away from fast moving rivers. This vehicle's tires can be buoyant. In deep water, the vehicle may lose traction due to floating.

1. Physically check the depth and current of the water, especially if you can't see the bottom. Also, check for boulders, logs, or any other hidden obstacles.

2. Keep speed slow while maintaining momentum.
3. Make sure you have a way out on the other side of the water.
4. Once you've cleared the water, briefly apply the brakes to make sure they work.

■ NOTE: Light pedal pressure or pumping the brakes for a short distance will aid in drying the brakes.

WARNING

Do not operate this vehicle on a frozen body of water unless you have first verified the ice is sufficiently thick to support the vehicle, cargo, and participants. The vehicle could break through the ice causing serious injury or death.

Crossing Roads

It may be necessary to cross a road or highway. If so, note the following guidelines.

1. Stop completely on the shoulder of the road.
2. Check both directions for traffic.
3. Crossing near a blind corner or intersection is dangerous; avoid it if at all possible.
4. Drive straight across to the opposite shoulder.
5. Take into account that this vehicle could stall while crossing; give yourself enough time to get off the road.
6. You have to assume that oncoming cars don't see you, and if they do, they won't be able to predict your actions.
7. It's illegal to cross public roads in some places. Know your local laws.

General Information

Control Locations and Functions

Ignition Switch Key

Two keys come with this vehicle. Keep the spare key in a safe place. An identifying number is stamped on each key. Use this number when ordering a replacement key.

Ignition Switch

The ignition switch has three positions.

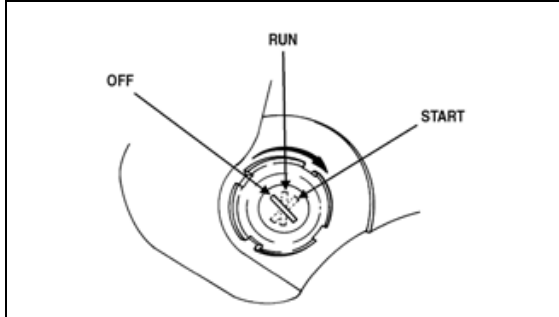

ATV-0056A

OFF position — All electrical circuits except the accessory are off. The engine will not start. The key can be removed in this position.

■ **NOTE: The accessory plugs are powered by the battery at all times.**

RUN position — The ignition circuit is complete and the engine can run. The key cannot be removed in this position.

START position — The ignition circuit is complete and the starter is engaged. When the key is released, the switch will return to the RUN position. The key cannot be removed in this position.

■ **NOTE: This vehicle has safety interlock switches which prevent the starter motor from activating when the transmission is not in neutral. Depress and hold the brake pedal to engage starter when the transmission is not in neutral.**

Shift Lever

This vehicle has a dual-range Constant Variable Transmission (CVT) with reverse and park.



PR878

Drive Select Switch



PR881A

This switch allows the operator to operate the vehicle in either two-wheel drive (rear wheels) or four-wheel drive (all wheels) as well as mechanically lock the differential (if equipped) to apply equal power to both front wheels. For normal riding on flat, dry, hard surfaces, two-wheel drive should be sufficient. In situations when additional traction is necessary, four-wheel drive would be the desired choice.

To select 2WD, depress the bottom of the switch. To select 4WD, move the switch to the middle position. To engage the differential lock, slide the switch latch slightly downward while pressing the top of the switch forward.

CAUTION

Do not attempt to either engage or disengage the front differential while the vehicle is moving.

■ **NOTE: When the differential lock is engaged on equipped models, the indicator light will be illuminated.**

■ **NOTE:** The differential lock is intended for use where minimum traction is available. Steering effort will increase with the front differential lock engaged. Maneuverability and handling characteristics will differ with the differential lock engaged.

Foot Brake

The foot brake is the only service brake, and it should be applied whenever braking is needed.

Apply the brake by pressing the brake pedal down.

Steering Wheel Tilt Latch

Pull on the lever located on the steering column and move the steering wheel to the desired position; then release the lever and make sure the steering wheel locks securely.

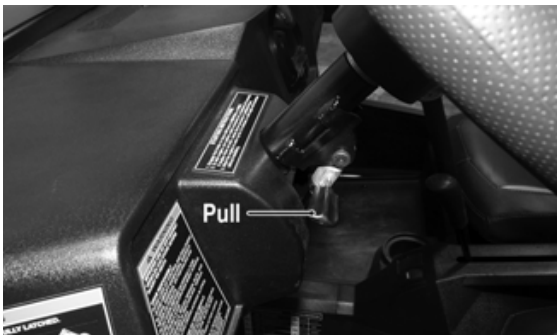

WT002A

WARNING

Make sure the steering wheel is locked securely in place before moving the vehicle, or steering wheel movement could occur causing loss of control.



PR880A

WARNING

Make sure the steering wheel is locked securely in place before moving the vehicle, or steering wheel movement could occur causing loss of control.

Headlight Switch



PR883A

With the ignition switch in the LIGHTS position, use the headlight switch to select light bar, light bar with low beam, or light bar with high beam.

Reverse Override Switch

This vehicle is equipped with a reverse speed limiter system. When additional RPM is needed in reverse, depress and hold the override switch located on the center console.

■ **NOTE:** The vehicle must be in 4WD to activate the reverse override.

WARNING

Never activate the override switch while the throttle is open as a loss of control could result. Use caution when using the override switch as reverse speed can greatly increase.

Accelerator Pedal

Press down on the pedal to increase engine RPM and vehicle speed; release the pedal to decrease engine RPM and vehicle speed.

■ **NOTE:** This vehicle is equipped with an RPM limiter that retards ignition timing when maximum RPM is approached. When the RPM limiter is activated, it could be misinterpreted as a high-speed misfire.

Seat (HDX)

1. To remove the seat, lift up on the front of the seat; then slide it forward.
2. To lock the seat into position, slide the rear of the seat into the seat retainers and push down firmly on the front of seat. The seat must engage the retainers and lock into position.

⚠ WARNING

Make sure the seat is secure before driving the vehicle. Serious injury or death could result if the seat is not properly secured.

Seat Latches (Prowler)

1. To remove the seat, lift up on the latch release (located at the front of the seat); then raise the front of the seat and slide it forward.
2. To lock the seat into position, slide the rear of the seat into the seat retainers and push down firmly on the front of seat. The seat should automatically lock into position.

⚠ WARNING

Make sure the seats are secure before driving the vehicle. Serious injury or death could result if the seats are not properly secured.

Seat Belts

This vehicle is equipped with seat belts for the operator and the passenger(s). To fasten and release the seat belt properly, use the following procedure.

1. Place the seat belt across your lap as low as possible without twisting the belt making sure the shoulder strap is below the neck and across the chest.

⚠ WARNING

Only appropriate-sized passengers may ride in this vehicle. Passengers must be able to place both feet flat on the floor while keeping their back against the back of the seat and holding on to the hand holds (outboard passenger only on HDX).

2. Push the latch-plate into the buckle slot until it “clicks” and latches securely. The belt will retract when the buckle is released.

⚠ WARNING

Falling outside a moving vehicle could result in serious injury or death. Always fasten your seat belt securely and ensure the passenger seat belt is properly and securely fastened prior to operating or riding in this vehicle.

Occupant Side Restraints

In addition to the seat belts, there are left- and right-side restraints to restrict arms or legs from extending outside the vehicle. The restraints should always be secured when the vehicle is moving.

To secure the restraint, connect the restraint handle to the foot restraint latch bracket. To release the restraint, press the lever on the foot restraint.



PR872A

Cargo Box (HDX)

The cargo box on this ROV can be converted to a “flat-bed” cargo platform. To convert your cargo box to a flat-bed, use the following procedure.

1. Remove all cargo from the box; then remove the left and right forward tie bolts.



HDX111A

2. Raise the cargo box; then loosen the four retaining bolts securing the side panels in the stake pockets; then lower the box.

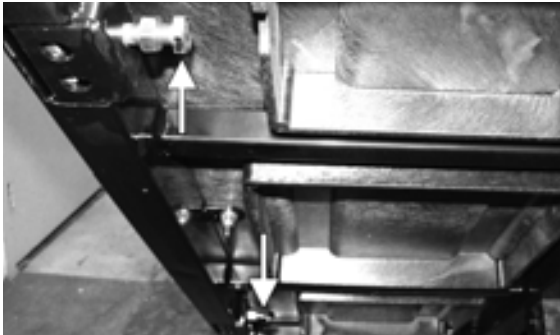

HDX112A

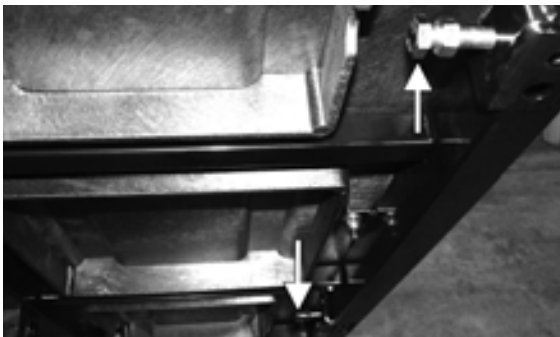

HDX113A

3. Open the tailgate and remove the machine screws securing the stop-cables to the tailgate. Note the correct orientation of the bushings to the cable ends and tailgate.

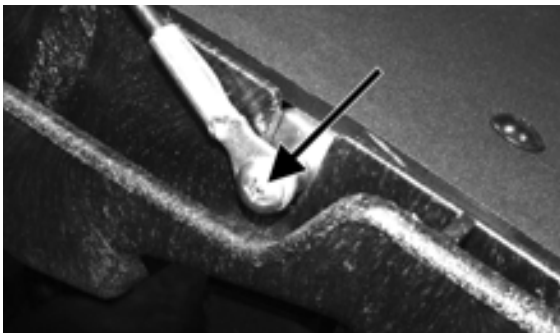

HDX114A

4. Lift off the left and right cargo box panels; then remove the tailgate from the cargo bed.

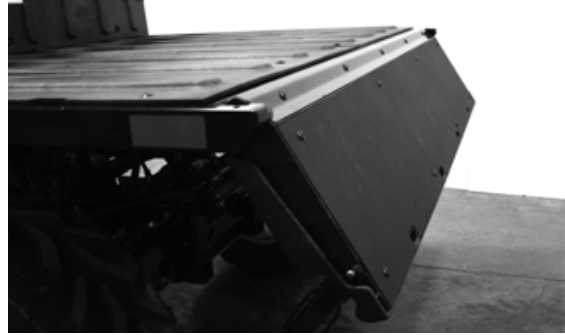

HDX117

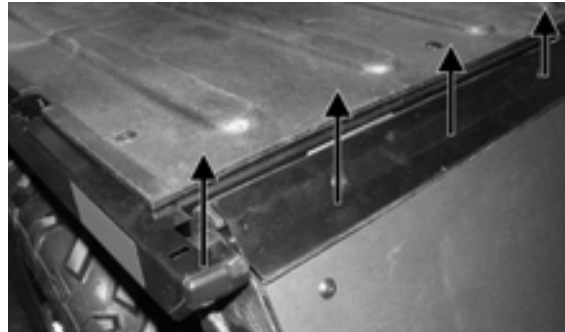

HDX115A

5. Remove the stake pocket retaining bolts, jam nuts, and forward tie bolt clip nuts and secure in a safe place with the machine screws and bushings from the tailgate.



HDX116A

To convert flat-bed to cargo box, use the following procedure.

1. Set the tailgate into position in the cargo bed; then lift the cargo bed making sure the tailgate clears any receiver hitch attachments.

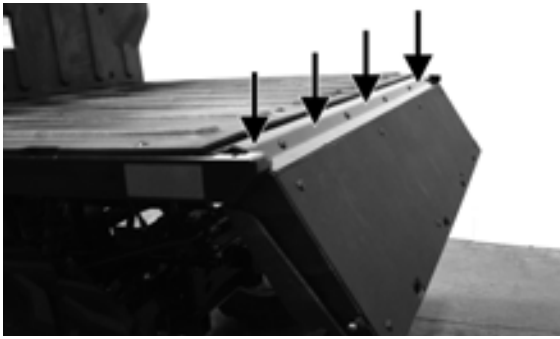

HDX117A

2. Install the stake pocket retaining bolts and jam nuts leaving clearance to install side panel stakes.

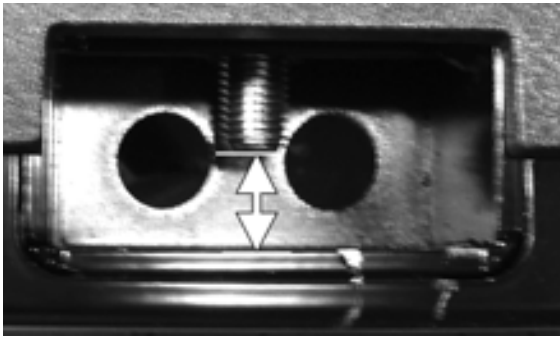

HDX118A

3. Set the left and right cargo box side panels into place on the cargo bed engaging the stakes into the side pockets.



HDX121

4. Install the left and right side clip nuts onto the frame; then install and tighten the forward tie bolts securely.

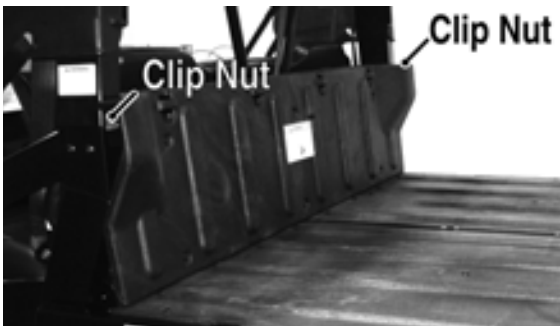

HDX116A

5. Tighten the four stake pocket retaining bolts to 25 ft-lb making sure the cargo box side panels are resting firmly on the cargo bed; then tighten the jam-nuts to 15 ft-lb. Lower the cargo box.

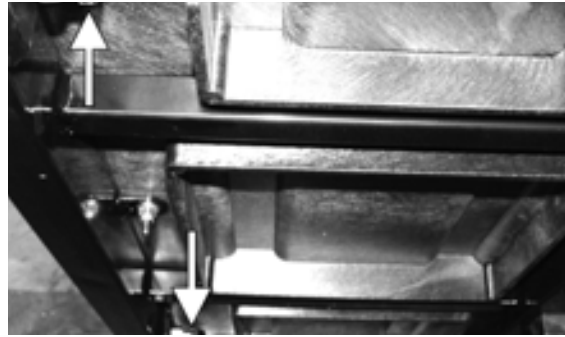

HDX112A

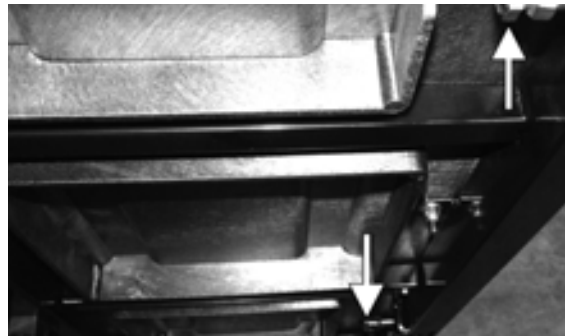

HDX113A



HDX122

6. Secure the tailgate stop-cables to the tailgate with the machine screws and bushings making sure the bushing engages the cable as shown. Tighten to 24 in.-lb.

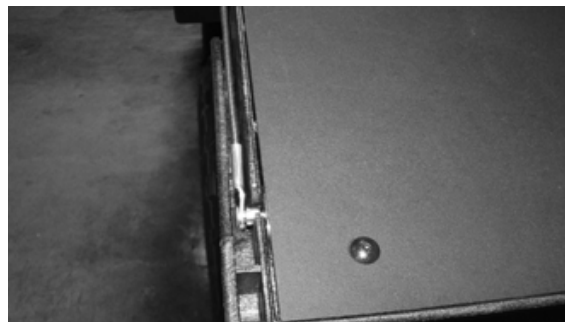

HDX123

Cargo Box Tie Downs (HDX)

The cargo box has numerous tie down locations around the top perimeter. Always secure cargo with tie down straps to avoid shifting or damage to cargo.

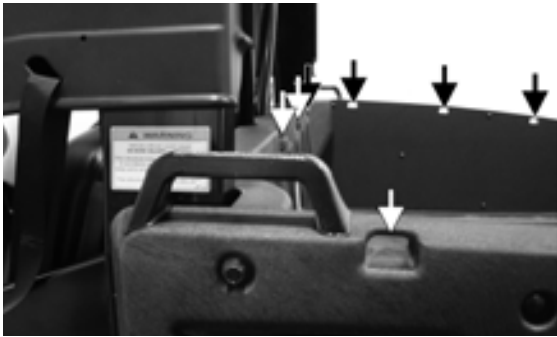

HDX094A

CAUTION

When using ratchet-type straps, do not over tighten or damage to the cargo box could occur.

■ **NOTE:** Always refer to the Load Capacity Ratings chart in this manual when loading and hauling cargo.

Tailgate Latch (Prowler)



PR039A

1. To open the tailgate, pull the latch (located at the center of the tailgate).
2. To close the tailgate, lift up and push forward firmly. The tailgate will latch automatically.

Tailgate Latches (HDX)



HDX184B

1. To open the tailgate, pull the latch handles (located on the end of the tailgate).
2. To close the tailgate, lift up and push forward firmly. Hook the latch bails and push the handles forward over center.

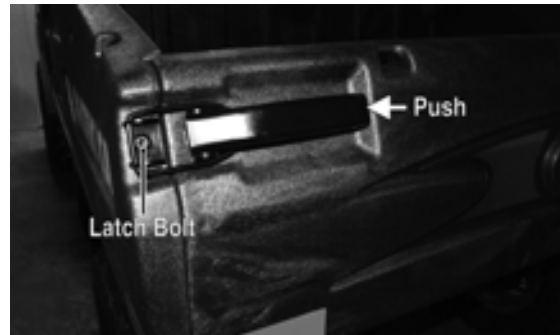

HDX012A

Cargo Box Latch Handles



Prowler

PR876A



HDX

HDX057A

1. To raise the cargo box, lift the handle upward; then raise the cargo box.
2. To lower the cargo box, push down firmly on the front of the box. The box will automatically lock into position.

Power Steering

Certain vehicles were produced with an Electronic Power Steering (EPS) system to reduce steering effort and driver fatigue over a broad range of operating conditions.

The EPS system engages when the ignition switch is turned to the ON position and disengages after approximately five minutes (to conserve battery power) if the engine is not running.

This system is entirely maintenance-free: no adjustment or servicing is required. There are no fluids to check or change, and the EPS system is entirely self-contained and sealed to protect it from the elements.

The EPS system is battery system powered; therefore, the battery must be in good condition and fully charged. Power delivery and overload protection is provided by an EPS relay and 30-amp fuse located under the passenger seat in the Power Distribution Module (PDM).

The system is self-monitored and will display a malfunction code on the LCD gauge/speedometer should an EPS system control circuit problem occur. Do not operate the vehicle with an EPS malfunction code displayed.

Code	Fault Description
C1301	Over Current
C1302	Excessive Current Error
C1303	Torque Sensor Range Fault
C1304	Torque Sensor Linearity Fault
C1305	Rotor Position Encoder
C1306	System Voltage Low
C1307	System Voltage High
C1308	Temperature Above 110° C
C1309	Temperature Above 120° C
C1310	Vehicle Speed High
C1311	Vehicle Speed Low
C1312	Vehicle Speed Faulty
C1313	Engine RPM High

Code	Fault Description
C1314	Engine RPM Low
C1315	Engine RPM Faulty
C1316	EEPROM Error
C1317	CAN Bus Error
C1318	Internal CRC Error
C1319	Boot Counter Exceeded
C1320	Incorrect Vehicle Speed-to-RPM Ratio
C1321	Vehicle Speed Erratic
C1322	Engine RPM Lost
C1323	"EPS OFF" Gauge Display
C1324	Loss of CAN communication with EPS unit
C1325	Dual Loss
C1326	Rotor Position Encoder
C1327	Voltage Converter Error (Low)
C1328	Voltage Converter Error (High)
C1329	Internal Data Error

■ **NOTE:** Turn the key switch to the OFF position then back to the ON position to reset the malfunction code. If the code continues to be displayed, take your vehicle to an authorized Arctic Cat Dealer for EPS system servicing before resuming operation.

CAUTION

Never operate this vehicle with an EPS code indicated on the LCD gauge/speedometer. This indicates a malfunction in the EPS system control circuit and could result in a loss of power steering assist.

In the event of electrical power failure, the EPS system becomes disabled (similar to an automobile with the engine shut off). Steering effort increases but steering control can be maintained.

Speedometer/LCD (Digital)

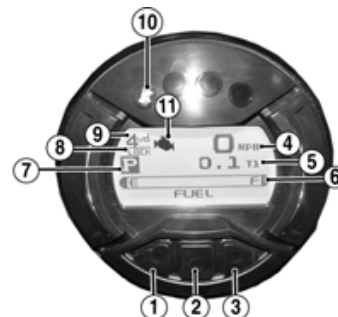

WT103B

1. Left Button - Shifts top display through speedometer, RPM, and clock.
2. Middle Button - Shifts middle display through speedometer, RPM, clock, odometer, trip 1, trip 2, and engine hours.
3. Right Button - Shifts bottom display through coolant temperature, battery voltage, intake air temperature, and fuel level.
4. Speedometer/Tachometer/Clock Display - Indicates approximate vehicle speed in MPH or KM/H when speedometer function is selected, RPM when tachometer function is selected, or time when clock is selected. Press the Left Button to change which parameter is being displayed. With speedometer selected, press and hold the Left Button to shift between standard (MPH/miles/Fahrenheit) and metric (km/h/kilometers/Celsius).

With the clock mode selected, press and hold the Left Button to set the clock. The option of selecting the 12-hour or 24-hour clock is available; press the Left Button to alternate between the two modes. Next, press the Middle Button to set the clock. Press the Left or Right to set the hours; then press the Middle Button to set the minutes. Press the Left or Right Button to set the minutes. When the proper time has been set, press the Middle Button to return to the main gauge display.

5. Engine Hour Meter/Odometer/Trip Meter/Speedometer/Tachometer/Clock Display - Displays engine hours, odometer, trip meter, speedometer, tachometer, or clock. Press the Middle Button to change which parameter is being displayed. The Engine Hour Meter and Odometer cannot be reset. To reset the trip meter, select the Trip Meter; then press and hold the Middle Button until the trip meter display reads 0.

NOTE: The engine hour meter will not activate until engine speed exceeds 500 RPM.

NOTE: An item can only be displayed in this position if it is not already being displayed in the top display. To set the clock when the clock is in this position, press and hold the Middle Button; then use the procedure found in 4.

6. Coolant Temperature/Battery Voltage/Intake Air Temperature/Fuel Level Display - Displays coolant temperature, battery voltage, intake air temperature, and fuel quantity. Press the Right Button to change which parameter is being displayed. Press and hold the Right Button to see the actual values associated with the mode selected.

CAUTION

Continued operation with high engine temperature may result in engine damage or premature wear.

NOTE: High engine RPM, low vehicle speed, or heavy load can raise engine temperature. Decreasing engine RPM, reducing load, and selecting an appropriate transmission gear can lower the temperature.

NOTE: Debris in the engine compartment (or packed between the cooling fins of the radiator) can reduce cooling capacity. Using a garden hose, wash the radiator and the engine to remove any debris preventing air flow.

CAUTION

Arctic Cat does not recommend using a pressure washer to clean the radiator core. The pressure may bend or flatten the fins causing restricted air flow, and electrical components on the radiator could be damaged. Use only a garden hose with spray nozzle at normal tap pressure.

7. Gear Position Indicator - Indicates which gear is selected.
8. Differential Lock Indicator - Displays LOCK when the differential lock has been engaged.

9. Drive Select Indicator - Displays 4WD when selected by the drive select switch or when the differential lock is engaged.
10. Seat Belt Reminder Indicator - Each time the ignition switch is turned ON, the indicator will illuminate on the speedometer for 8-10 seconds to remind occupants to secure their seat belts.

⚠ WARNING

The seat belt indicator is only a reminder and automatically extinguishes after 8-10 seconds. It does not indicate that seat belts are properly secured. It is the operator's responsibility to ensure all vehicle occupants are properly seated with seat belts secure and doors are properly latched. Serious injury or death could occur as a result of falling outside a moving vehicle.

11. EFI Malfunction Indicator - A diagnostic code (see list below) and engine icon will be displayed on the LCD whenever an EFI error is detected. The LCD will be normal, but the code and engine icon will continue to be displayed on the LCD until the error is corrected.



WT114A

■ NOTE: Take the vehicle to an authorized Arctic Cat dealer to have the error corrected and the system error reset as soon as possible.

Diagnostic Trouble Codes

Display	Fault Description
C0063	Tilt Sensor Circuit High
C0064	Tilt Sensor Circuit Low/SG/Open
C1263	Backup/Reverse-Light Circuit Open
C1264	Backup/Reverse-Light Circuit High
C1265	Backup/Reverse-Light Circuit Low/SG
C1400	Fuel Level Sender Open
C1418	Memory Power Failure
P0030	O2 Heater Intermittent/Open
P0031	O2 Heater Low/SG
P0032	O2 Heater High/SP
P0107	MAP Sensor Circuit Low/SG/Open
P0108	MAP Sensor Circuit High/SP
P0112	Intake Air Temp Sensor Circuit Low/SG
P0113	Intake Air Temp Sensor Circuit High/Open
P0114	Intake Air Temp Sensor Circuit Intermittent
P0116	Engine Coolant Temp Sensor Circuit Range/Performance
P0117	Engine Coolant Temp Sensor Circuit Low/SG
P0118	Engine Coolant Temp Sensor Circuit High/Open/SP
P0119	Engine Coolant Temp Sensor Circuit Intermittent
P0121	Throttle Position Sensor Range/Performance
P0122	Throttle Position Sensor Circuit Low/SG
P0123	Throttle Position Sensor Circuit High
P0130	O2 Sensor Intermittent/Open
P0131	O2 Sensor Low/SG or Air-Leak
P0132	O2 Sensor High/SP
P0171	O2 Feedback Below Minimum Correction
P0172	O2 Feedback Exceeds Maximum Correction
P0219	Engine Over-Speed Condition
P0231	Fuel Pump Relay Circuit Low/SG/Open
P0232	Fuel Pump Relay Circuit High
P0233	Fuel Pump Relay Circuit
P0261	Cylinder #1 Fuel injector Circuit Low/SG
P0262	Cylinder #1 Fuel injector Circuit High
P0263	Cylinder #1 Fuel injector Balance/Open
P0264	Cylinder #2 Fuel injector Circuit Low/SG
P0265	Cylinder #2 Fuel injector Circuit High

Display	Fault Description
P0266	Cylinder #2 Fuel injector Balance/Open
P0336	Crankshaft Angle Sensor Synchronization
P0337	Crankshaft Angle Sensor Circuit/SG
P0339	Crankshaft Angle Sensor Intermittent/Erratic
P0340	Camshaft Angle Sensor Synchronization
P0341	Camshaft Angle Sensor Circuit/SG
P0342	Camshaft Angle Sensor Intermittent/Erratic
P0480	Fan-Primary/Right Relay Control Circuit
P0481	Fan-Secondary/Left Relay Control Circuit High
P0482	Fan-Secondary/Left Relay Control Circuit Low/SG/Open
P0483	Fan-Secondary/Left Relay Control Circuit
P0484	Fan-Primary/Right Relay Control Circuit High
P0485	Fan-Primary/Right Relay Control Circuit Low/SG/Open
P0500	Vehicle Speed-Sensor
P0508	Idle Air Control System Circuit Low/SG
P0509	Idle Air Control System Circuit High/Open
P0520	Engine Oil Sensor/Switch
P0562	System Voltage Low
P0563	System Voltage High
P0601	ECM CAN Communication Shutdown
P0615	Starter Relay Circuit
P0616	Starter Relay Circuit Low
P0617	Starter Relay Circuit High
P0630	VIN Not Programmed or Incompatible
P0642	Sensor Power Circuit Low
P0643	Sensor Power Circuit High
P2300	Ignition Coil #1 Primary Circuit Low/SG/Open
P2301	Ignition Coil #1 Primary Circuit High
P2303	Ignition Coil #2 Primary Circuit Low/Open
P2304	Ignition Coil #2 Primary Circuit High
P2531	Ignition Switch Circuit Low
P2532	Ignition Switch Circuit High
FUEL OFF	Tilt Sensor Activation Code

Oil Level Stick

There is an oil level stick for checking the engine oil level. To check the oil level, use the following procedure.

■ **NOTE:** The vehicle should be on level ground when checking the engine oil level.

1. Remove the seats and center console (Prowler) or lift the cargo box (HDX).
2. Unscrew the oil level stick and wipe it with a clean cloth.
3. Install the oil level stick.

■ **NOTE:** The oil level stick should be threaded in for checking purposes.

4. Remove the oil level stick; the engine oil level should be within the operating range.



GZ461A

CAUTION

Do not overfill the engine with oil. Always make sure the oil level is within the operating range but not above the FULL mark.

5. On the 700 HDX to add oil, remove the seat, oil fill cap, and oil fill plug. After adding oil, install the fill plug and tighten securely; then install the cover and seat. On the 500 HDX/Prowler models, add oil to the oil level stick opening until proper operating level is achieved.



HDX234A



HDX022A

6. On the Prowler, install the center console; then install the seats making sure they are securely latched. On the HDX, lower the cargo box.

Load Capacity Ratings Chart

This vehicle must always be loaded in accordance with the Load Capacity Ratings chart. Under no circumstances should the Vehicle Load Capacity or the Gross Vehicle Weight (GVW) rating ever be exceeded.

⚠ WARNING
Overloading this vehicle could result in loss of control resulting in serious injury or death.

Item	Specifications	
	(lb)	(kg)
Vehicle Load Capacity (Prowler)	1180	535
Vehicle Load Capacity (GVW) (500 HDX)	1100	498
Vehicle Load Capacity (GVW) (700 HDX)	1500	680
Front Storage Compartment (max)	25	11
Tongue Weight	150	68
Side Storage Compartment (HDX)	15	6.8
Rear Tongue and Cargo Weight (max)	600	272
Rear Tongue, Cargo, and Side Storage Compartment Weight (max) (500 HDX)	600	272
Rear Tongue, Cargo, and Side Storage Compartment Weight (max) (700 HDX)	1000	454
Towing Capacity	1500	680

Vehicle Load Capacity - Total weight of operator, passenger(s), trailer tongue weight, accessories, cargo (GVW), and storage compartments. **On the HDX, GVW can be any combination of these must not exceed 1500 lb.**

Tongue Weight - Weight on trailer tongue.

Accessory Weight - Winch, gun scabbard brackets, snow plow, etc.

Rear Tongue and Cargo Weight - Total weight on trailer tongue and cargo box.

Rear Tongue, Cargo, and Side Storage Compartments Weight - Total weight on trailer tongue, cargo box, and side storage compartment.

Towing Capacity - Total weight of trailer and all cargo in the trailer.

Trailering and Towing



PR039B

This vehicle is equipped with a rear frame-mounted receiver for a standard 5.1 cm (2 in.) receiver hitch. The standard receiver hitch must be purchased separately.

⚠ WARNING
Make sure that the load in the trailer is properly secured and will not shift while moving. Also, do not overload the trailer.

When loading a trailer properly, two items are critical: Gross Trailer Weight (the weight of the trailer plus cargo) and Trailer Tongue Weight.

⚠ WARNING
Never exceed any of the vehicle weight restrictions.

Trailer Tongue Weight is the downward force exerted on the hitch by the trailer coupler when the trailer is fully loaded and the coupler is at its normal towing height. Refer to the Load Capacity Ratings chart for tongue weight information.

Always maintain a slow speed when trailering and towing and avoid sudden accelerations, quick maneuvers, and sudden stops. Braking distance will be affected when towing a trailer. When towing a trailer, always maintain slow speed and allow more stopping distance than when not towing a trailer.

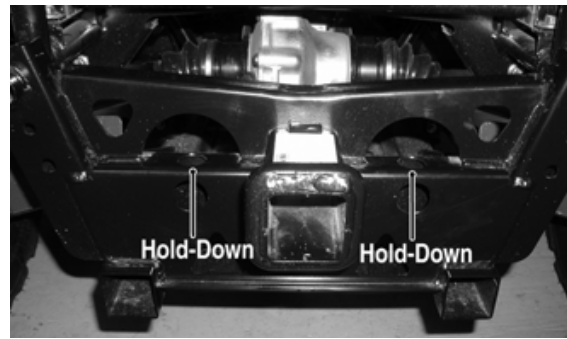

PR075A

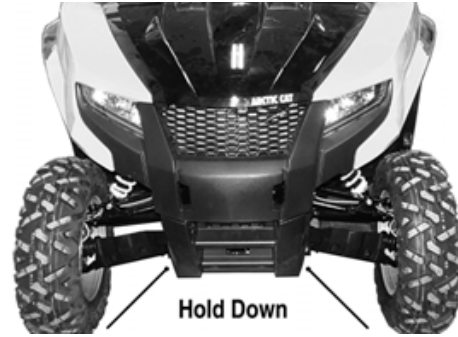

PR867A

⚠ WARNING
Driving this vehicle without extra caution when towing a trailer will be hazardous. Trailer towing can affect the handling and braking of the vehicle. Tow only at low speeds and never exceed 10 mph. Avoid sudden accelerations and stopping of the vehicle. Do not make quick maneuvers. Avoid uneven surfaces and do not tow on hills.

⚠ WARNING
Never tow people in or on any device except when towing a disabled vehicle with operable brakes and steering or on a trailer designed for passengers that has a rigid tow bar.

Transporting

When transporting, the vehicle must be in its normal operating position (on all four wheels) and the following procedure must be used.

1. Place the transmission in park.

CAUTION
Failure to place the transmission in park could allow the vehicle to roll off the trailer in the event of tie-down strap failure.

2. Secure the vehicle with load rated hold-down straps.

■ **NOTE:** Suitable hold-down straps are available from your Arctic Cat dealer. Ordinary rope is not recommended because it can stretch under load.

CAUTION
If using additional hold-down straps in any other areas, care must be taken not to damage the vehicle.

CAUTION
Always buckle the side restraints when transporting to prevent buckle damage to body panels.

Gasoline-Oil-Lubricant Filling Gas Tank

⚠ WARNING
Always fill the gas tank in a well-ventilated area. Never add gasoline to the gas tank near any open flames or with the engine running or hot. **DO NOT SMOKE** while filling the gas tank.

Since gasoline expands as its temperature increases, the gas tank must be filled to its rated capacity only. Expansion room must be maintained in the tank particularly if the tank is filled with cold gasoline and then moved to a warm area.

Allow the engine to cool before filling the gas tank. Care must be taken not to over-fill the tank. If overfilled, gas may leak onto the engine creating a fire hazard.



UTV-353A

⚠ WARNING

Do not over-flow gasoline when filling the gas tank. A fire hazard could materialize. Always allow the engine to cool before filling the gas tank.

Tighten the gas tank cap securely after filling the tank.

⚠ WARNING

Do not overfill the gas tank.

Recommended Gasoline

The recommended gasoline to use in this vehicle is 87 minimum octane regular unleaded. In many areas, oxygenates are added to the gasoline. Oxygenated gasolines containing up to 10% ethanol or 5% methane are acceptable gasolines.

When using ethanol blended gasoline, it is not necessary to add a gasoline antifreeze since ethanol will prevent the accumulation of moisture in the fuel system.

CAUTION

Do not use white gas. Only Arctic Cat approved gasoline additives should be used.

Recommended Engine/Transmission Oil

CAUTION

Any oil used in place of the recommended oil could cause serious engine damage. Do not use oils which contain graphite or molybdenum additives. These oils can adversely affect clutch operation. Also, not recommended are racing, vegetable, non-detergent, and castor-based oils.

The recommended oil to use is Arctic Cat ACX All Weather synthetic engine oil, which has been specifically formulated for use in this Arctic Cat engine. Although Arctic Cat ACX All Weather synthetic engine oil is the only oil recommended for use in this engine, use of any API certified SM 0W-40 oil is acceptable.

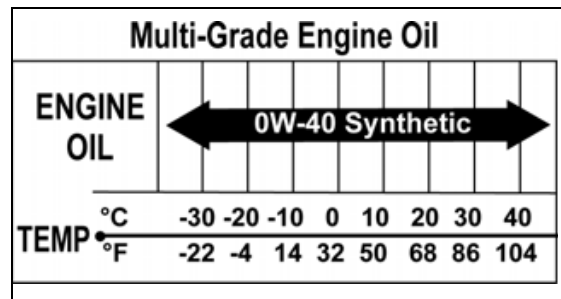

OILCHARTJ

■ **NOTE:** If the vehicle will be operated under severe conditions (heavy pulling or loading, extremely high ambient air temperatures, or extended high-speed operation), Arctic Cat recommends installing an engine oil cooler kit if not so equipped. For additional information, see your local authorized Arctic Cat dealer.

Recommended Front Differential/Rear Drive Lubricant

■ **NOTE:** Arctic Cat recommends the use of genuine Arctic Cat lubricants.

The recommended front differential/rear drive lubricant is SAE approved 80W-90 hypoid. This lubricant meets all of the lubrication requirements of this vehicle.

CAUTION

Any lubricant used in place of the recommended lubricant could cause serious front differential/rear drive damage.

Engine Break-In

After the completion of the break-in period, the engine oil and oil filter should be changed. Other maintenance after break-in should include checking of all prescribed adjustments and tightening of all fasteners. At the discretion and expense of the owner/operator, the vehicle may be taken to an authorized Arctic Cat dealer for this initial service.

New vehicles and engines require a “break-in” period. The first month is most critical to the life of this vehicle. Proper operation during this break-in period will help assure maximum life and performance from this vehicle.

During the first 10 hours of operation, always use less than ½ throttle. Varying the engine RPM during the break-in period allows the components to “load” (aiding the engine/transmission component mating process) and then “unload” (allowing components to cool). Although it is essential to place some stress on the engine components during break-in, care should be taken not to overload the engine too often. Do not pull a trailer during the break-in period.

When the engine starts, allow it to warm up properly. Idle the engine several minutes until the engine has reached normal operating temperature. Do not idle the engine for excessively long periods of time.

Burnishing Brake Pads

Brake pads must be burnished to achieve full braking effectiveness. Braking distance will be extended until brake pads are properly burnished.

WARNING

Do not attempt sudden stops or put yourself into a situation where a sudden stop will be required until the brake pads are properly burnished.

To properly burnish the brakes, use following procedure:

1. Choose an area sufficiently large to safely accelerate to 30 mph and to brake to a stop.
2. Accelerate to 30 mph; then release the accelerator pedal and press brake pedal to decelerate to 0-5 mph.
3. Repeat procedure twenty times.

General Maintenance

■ **NOTE:** Proper maintenance of this vehicle is important for optimum performance. Follow the Maintenance Schedule and all ensuing maintenance instructions/information.

If, at any time, abnormal noises, vibrations, or improper functioning of any component of this vehicle is detected, **DO NOT OPERATE THE VEHICLE.** Take the vehicle to an authorized Arctic Cat dealer for inspection and adjustment or repair.

If the owner/operator does not feel qualified to perform any of these maintenance procedures or checks, take the vehicle to an authorized Arctic Cat dealer for professional service.

■ **NOTE:** The following instructions and information refer to specific items in the maintenance and care of this vehicle.

Maintenance Schedule					
Item	Page	Initial 100 miles	Every 100 miles	Every 300 miles	Every 500 miles
Battery	44	I	I		
* Engine nuts and bolts	—	I			I
* Valve clearance	—	I			I
Spark plug(s)	47	I			I
	47	Replace every 4000 miles (6436 km) or 18 months			
Liquid cooling system	39	I	Inspect every time before operating		
Gas Hoses	32	I	Inspect every time before operating		
Engine/transmission oil and filter	40	R		R**	
Air filter	48	I		I	
Gear lubricant (front differential - rear drive)	41	R		I	I
V-belt	49	I			I
Spark arrester/muffler	50				C
Tires/air pressure	49/17	I	Inspect every time before operating		
* Brake components	42	I	Inspect every time before operating		
Brake fluid	42	I	Inspect every time before operating		
Brake hoses	43	I	Inspect every time before operating		
* Steering	—	I	Inspect every time before operating		
* Suspension (Ball joint boots, drive axle boots front and rear, tie rods, differential and rear drive bellows)	—	I	Inspect every time before operating		
* Chassis nuts and bolts	—	I	T		
Wheel lug nuts	49	T		T	
Frame/welds/racks	—	I			I
Electrical connections	—	I			I
Headlight/taillight-brakelight	51	I	Inspect every time before operating		
Air filter drains	—	I	Inspect every time before operating		
Accelerator pedal	24	I	Inspect every time before operating		
ROPS	53		Inspect every time before operating		
Occupant side restraints	53		Inspect every time before operating		
Wheel nuts	49	I	I		

I = Inspect and clean, adjust, lubricate, replace as necessary T = Tighten R = Replace

C = Clean

* = Dealer maintenance

**When using Arctic Cat ACX All Weather synthetic oil, oil change interval can be increased to every 1,000 miles or every year.

Liquid Cooling System

■ **NOTE:** Debris in the engine compartment or packed between the cooling fins of the radiator can reduce cooling capability. Using a garden hose, wash the radiator to remove any debris preventing air flow.

CAUTION

Arctic Cat does not recommend using a pressure washer to clean the radiator core. The pressure may bend or flatten the fins causing restricted air flow, and electrical components on the radiator could be damaged. Use only a garden hose with spray nozzle at normal tap pressure.

The cooling system capacity can be found in the specification chart. The cooling system should be inspected daily for leakage and damage. If leakage or damage is detected, take the vehicle to an authorized Arctic Cat dealer for service. Also, the coolant level should be checked periodically.

CAUTION

Continued operation of the vehicle with high engine temperature may result in engine damage or premature wear.

■ **NOTE:** High engine RPM, low vehicle speed, or heavy load can raise engine temperature. Decreasing engine RPM, reducing load, and selecting an appropriate transmission gear can lower the temperature.

When filling the cooling system, use a coolant/water mixture which will satisfy the coldest anticipated weather conditions of the area in accordance with the coolant manufacturer's recommendations.

While the cooling system is being filled, air pockets may develop; therefore, remove the bleed plug on the coolant pipe at the front of the engine allowing trapped air to escape. When pure coolant (no air) flows from the bleed hole, install the bleed plug, tighten securely, and then fill the cooling system to the bottom of the stand pipe in the radiator neck. Run the engine for five minutes after the initial fill; then shut off the engine and recheck coolant level.

■ **NOTE:** Use a good quality, biodegradable glycol-based, automotive-type antifreeze.

WARNING

Never check the coolant level when the engine is hot or the cooling system is under pressure.

CAUTION

After operating the vehicle for the initial 5-10 minutes, stop the engine, allow the engine to cool down, and check the coolant level. Add coolant as necessary.

Oil Cooler (1000)

■ **NOTE:** Dirt and debris must be cleaned from the cooling fins regularly to ensure proper engine oil cooling.

CAUTION

Continued operation of the ATV with high engine temperature may result in engine damage or premature wear.

■ **NOTE:** High engine RPM, low vehicle speed, or heavy load can raise engine temperature. Decreasing engine RPM, reducing load, and selecting an appropriate transmission gear can lower the temperature.

Shock Absorbers







Each shock absorber should be visibly checked weekly for excessive fluid leakage (some seal leakage may be observed but it does not indicate the shock is in need of replacement), cracks or breaks in the lower case, or a bent shock rod. If any one of these conditions is detected, replacement is necessary.

■ **NOTE:** When the vehicle is operated in extremely cold weather (-23° C/-10° F or colder), a small amount of leakage may be present. Unless the leakage is excessive, replacement is not necessary.

This vehicle is equipped with adjustable shock absorbers in the front and rear to allow for different driving and loading conditions.

The front shock absorbers (700 HDX) or front and rear shock absorbers (500 HDX/Prowler models) have an adjustment sleeve with five preload adjustment positions that can be turned with a special spanner wrench to increase or decrease coil spring tension.

To adjust the spring force on these shock absorbers, rotate the pre-load adjustment sleeve with a suitable spanner wrench until desired spring tension is achieved.

Position	Spring Force	Setting	Load
1		Soft	Light
2			
3			
4			
5		Stiff	Heavy

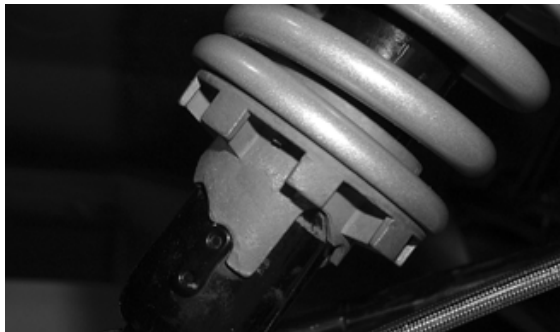

PR015

■ **NOTE:** Before attempting to adjust suspension, clean dirt and debris from the sleeve and remove load from the suspension; then use the spanner wrench to adjust the sleeve to the desired position.

On the 700 HDX, the rear shock absorbers combine fixed pre-load springs and a variable air assist to provide adjustment allowing for differing driving and loading conditions.

To adjust air pressure on these shock absorbers, connect the air pump to the valve fitting on the top of the shock absorber and pump (to increase pressure) or depress bleed valve (to decrease pressure) until desired pressure is achieved.

■ **NOTE:** For proper air pressure in rear shocks, use the following recommended settings. The vehicle must be on the ground with no load in cargo box. Do not rapidly fill shocks. Shocks may lose air over time. Check pressure periodically.

Payload	Pressure
0-250 lb	15 psi
250-500 lb	60 psi (min)
500-750 lb	90 psi (min)
750-1000 lb	150 psi



HDX087A

General Lubrication

Cables

None of the cables require lubrication; however, it is advisable to lubricate the ends of the cables periodically with a good cable lubricant.

Cargo Box Latches (HDX)

Periodically apply a light coat of grease to the latches and pins. Do not over grease.

Engine/Transmission Oil and Filter

■ **NOTE:** Refer to the recommended oil viscosity chart (on page 35) in this manual for the proper engine oil.

Change the engine oil and oil filter at the scheduled intervals. The engine should always be warm when the oil is changed so the oil will drain easily and completely.

1. Park the vehicle on level ground.
2. Remove the seat(s); then remove the center console (Prowler) or seat back and seat back (HDX).

- Loosen the oil fill cap (700 HDX) or level stick (500 HDX/Prowler models). Be careful not to allow contaminants to enter the opening.

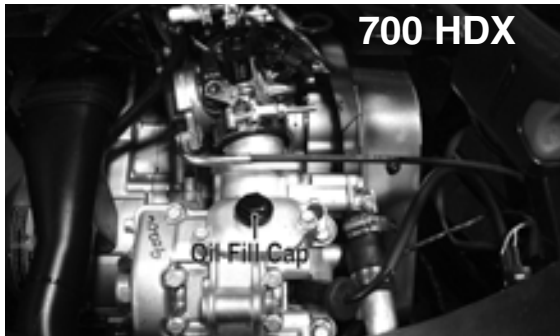

HDX042A

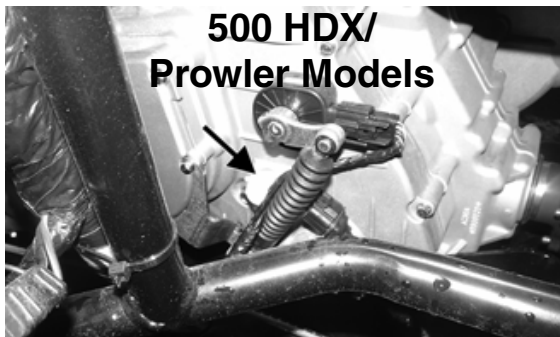

HDX234A

- Remove the drain plug from the bottom of the engine and drain the oil into a drain pan.
- Using the oil filter wrench and a ratchet handle (or a socket or box-end wrench), remove the old oil filter and dispose of properly. Do not re-use oil filter.

■ **NOTE: Clean up any excess oil after removing the filter.**

- Apply oil to the new filter O-ring and check to make sure it is positioned correctly; then install the new oil filter. Tighten securely.
- Install the engine drain plug and tighten it securely. Pour the recommended oil in the filler hole (700 HDX) or level stick opening (500 HDX/Prowler models). Install filler plug or level stick.
- Start the engine (while the vehicle is outside on level ground) and allow it to idle for a few minutes.
- Turn the engine off and wait approximately one minute. Recheck the oil level.

- Inspect the area around the drain plug and oil filter for leaks.
- Install the center console (Prowler) or seat base and seat back (HDX); then install the seat(s) making sure they are securely latched.

Front Differential/Rear Drive Gear Lubricant (Inspecting/Changing)

Inspect and change the gear lubricant in each according to the Maintenance Schedule. When changing the lubricant, use the appropriate hypoid oil and use the following procedure.

- Place the vehicle on level ground.
- Remove each oil fill plug.

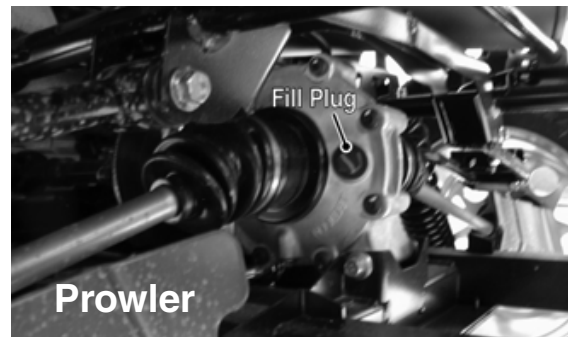

PR064A

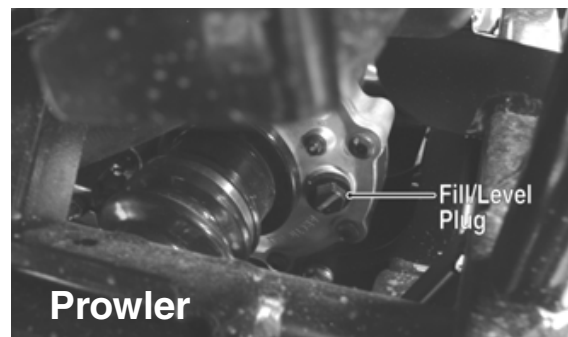

PR065A



HDX083A

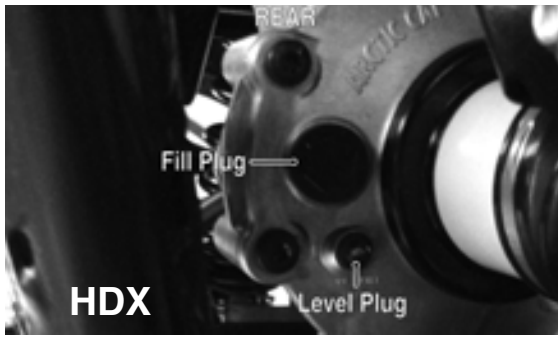

HDX084A

■ **NOTE:** On the Prowler front differential, the lubricant level should be within one inch of the plug. On the rear drive, the lubricant level should be visible at the plug threads.

3. Drain the oil into a drain pan by removing in turn the drain plug from each.

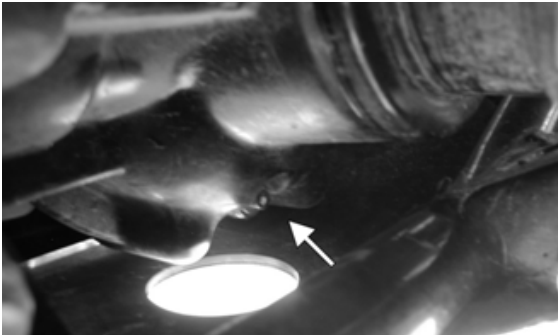

CF107A

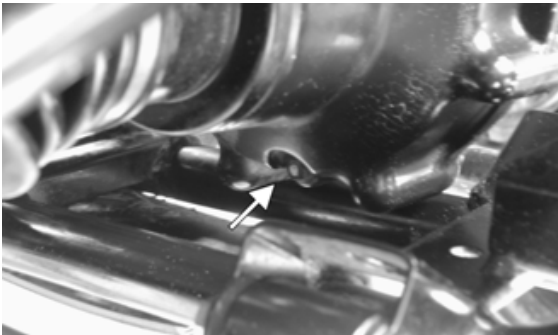

CF106A

4. After all the oil has been drained, install the drain plugs and tighten to 45 in.-lb.

CAUTION

Inspect the oil for any signs of metal filings or water. If found, take the vehicle to an authorized Arctic Cat dealer for servicing.

5. Pour recommended oil into each fill hole.

6. Install the fill plugs and tighten to 16 ft.-lb.

Hydraulic Brake

⚠ WARNING

Be sure to inspect the hydraulic brake system before each use. Always maintain brakes according to the Maintenance Schedule.

Brake Fluid

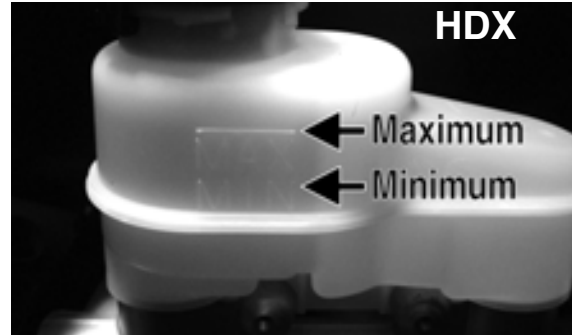

HDX081A

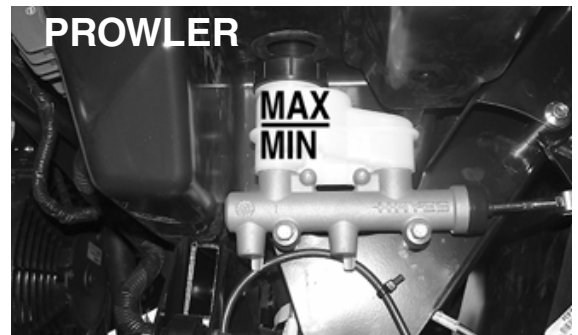

UTV-367A

1. Check the brake fluid level in the brake fluid reservoir. The fluid level must be maintained between the MAX and MIN level marks. If the level in the reservoir is low, add DOT 4 brake fluid.

■ **NOTE:** If fluid must be added, remove the rubber access plug beneath the hood.

■ **NOTE:** The brake fluid reservoir is located on top of the master cylinder under the hood.

2. Press the brake pedal several times to check for firmness.
3. If the pedal is not firm, the system must be bled.

■ **NOTE:** Take the vehicle to an authorized Arctic Cat dealer for this service.

CAUTION

Be careful not to spill any fluid when filling the brake fluid reservoir. Wipe away spilled fluid immediately.

Brake Hoses

Carefully inspect the hydraulic brake hoses for cracks or other damage. If found, take the vehicle to an authorized Arctic Cat dealer to have the brake hoses replaced.

Brake Pads

The clearance between the brake pads and brake discs is adjusted automatically as the brake pads wear. The only maintenance that is required is replacement of the brake pads when they show excessive wear. Check the thickness of each of the brake pads as follows:

1. Remove a front wheel.
2. Measure the thickness of each brake pad.
3. If thickness of either brake pad is less than 1.0 mm (0.039 in.), take the vehicle to an authorized Arctic Cat dealer to have brake pads replaced.

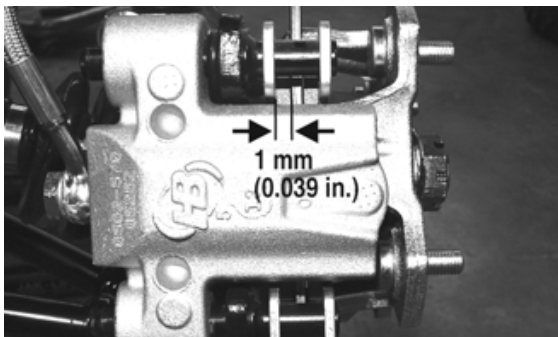

PR376B

4. Install the wheel and tighten the wheel nuts in 20 ft-lb increments to a final torque of 40 ft-lb (steel wheel), 60 ft-lb (aluminium wheel w/black nuts), or 80 ft-lb (aluminum wheel w/chrome nuts).

Gas Hoses

Inspect the gas hoses. Damage from aging may not always be visible.

Protective Rubber Boots

The protective boots should be inspected periodically according to the Maintenance Schedule.

Ball Joint Boots (Upper and Lower/Right and Left)



CC791

1. Secure the vehicle on a support stand to elevate the front wheels.
2. Remove both front wheels.
3. Inspect the four ball joint boots for cracks, tears, or perforations.
4. Check the ball joint for free-play by grasping the steering knuckle and turning it from side to side and up and down.
5. If boot damage is present or ball joint free-play seems excessive, contact an authorized Arctic Cat dealer for service.

Tie Rod Boots (Inner and Outer/Right and Left)

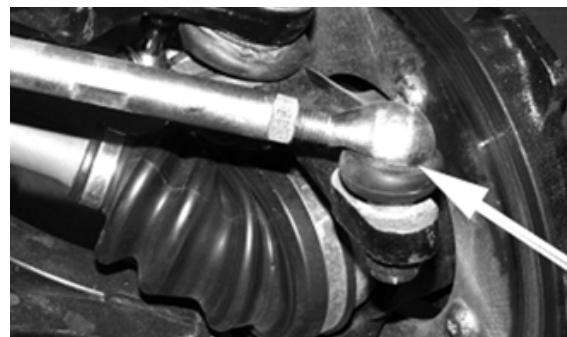

CC792

1. Secure the vehicle on a support stand to elevate the front wheels.
2. Remove both front wheels.
3. Inspect the four tie rod boots for cracks, tears, or perforations.

4. Check the tie rod end free-play by grasping the tie rod near the end and attempting to move it up and down.
5. If boot damage is present or tie rod end free-play seems excessive, contact an authorized Arctic Cat dealer for service.

Drive Axle Boots



CC793

1. Inspect all drive axle boots for cracks, tears, or perforations.
2. If boot damage is present, contact an authorized Arctic Cat dealer for service.

Battery

The battery is located in a compartment in front of the left-rear wheel under the driver seat.

After being in service, batteries require regular cleaning and recharging in order to deliver peak performance and maximum service life. The following procedures are recommended for cleaning and maintaining lead-acid batteries. Always read and follow instructions provided with battery chargers and battery products.

■ NOTE: Refer to all warnings and cautions provided with the battery or battery maintainer/charger.

Loss of battery charge may be caused by ambient temperature, ignition OFF current draw, corroded terminals, self discharge, frequent start/stops, and short engine run times. Frequent winch usage, snowplowing, extended low RPM operation, short trips, and high amperage accessory usage are also reasons for battery discharge.

Maintenance Charging

■ NOTE: Arctic Cat recommends the use of the CTEK Multi US 800 or the CTEK Multi US 3300 for battery maintenance charging. Maintenance charging is required on all batteries not used for more than two weeks or as required by battery drain.

1. When charging a battery in the vehicle, be sure the ignition switch is in the OFF position.

■ NOTE: Be sure to maintain the fluid of the battery at the UPPER LEVEL. Use only distilled water when adding fluid to these batteries.

2. Clean the battery terminals with a solution of baking soda and water.
3. Be sure the charger and battery are in a well-ventilated area and ensure the battery charger cables will not contact any battery acid. Be sure the charger is unplugged from the 110-volt electrical outlet.
4. Connect the red terminal lead from the charger to the positive terminal of the battery; then connect the black terminal lead of the charger to the negative terminal of the battery.

■ NOTE: Optional battery charging adapters are available from your authorized Arctic Cat dealer to connect directly to your vehicle from the recommended chargers to simplify the maintenance charging process. Check with your authorized Arctic Cat dealer for proper installation of these charging adapter connectors.

5. Plug the battery charger into a 110-volt electrical outlet.
6. If using the CTEK Multi US 800, there are no further buttons to push. If using the CTEK Multi US 3300, press the Mode button (A) at the left of the charger until the Maintenance Charge Icon (B) at the bottom illuminates. The Normal Charge Indicator (C) should illuminate on the upper portion of the battery charger.



800E

■ **NOTE:** The maintainer/charger will charge the battery to 95% capacity at which time the Maintenance Charge Indicator (D) will illuminate and the maintainer/charger will change to pulse/float maintenance. If the battery falls below 12.9 DC volts, the charger will automatically start again at the first step of the charge sequence.



3300A

■ **NOTE:** Not using a battery charger with the proper float maintenance will damage the battery if connected over extended periods.

Charging

■ **NOTE:** Arctic Cat recommends the use of the CTEK Multi US 800 or the CTEK Multi US 3300 for battery maintenance charging.

1. Be sure the battery and terminals have been cleaned with a baking soda and water solution.
2. Be sure the charger and battery are in a well-ventilated area and ensure the battery charger cables will not contact any battery acid. Be sure the charger is unplugged from the 110-volt electrical outlet.

3. Connect the red terminal lead from the charger to the positive terminal of the battery; then connect the black terminal lead of the charger to the negative terminal of the battery.

4. Plug the charger into a 110-volt electrical outlet.

5. By pushing the Mode button (A) on the left side of the charger, select the Normal Charge Icon (E). The Normal Charge Indicator (C) should illuminate on the upper left portion of the charger.

6. The battery will charge to 95% of its capacity at which time the Maintenance Charge Indicator (D) will illuminate.

■ **NOTE:** For optimal charge and performance, leave the charger connected to the battery for a minimum 1 hour after the Maintenance Charge Indicator (D) illuminates. If the battery becomes hot to the touch, stop charging. Resume after it has cooled.

7. Once the battery has reached full charge, unplug the charger from the 110-volt electrical outlet.

■ **NOTE:** If, after charging, the battery does not perform to operator expectations, bring the battery to an authorized Arctic Cat dealer for further troubleshooting.

Jump-Starting

■ **NOTE:** Arctic Cat does not recommend jump-starting a vehicle with a dead battery but rather to remove the battery, service it, and correctly charge it; however, in an emergency, it may be necessary to jump-start a vehicle. If so, use the following procedure to carefully and safely complete this procedure.

WARNING

Improper handling or connecting of a battery may result in serious injury including acid burns, electrical burns, or blindness as a result of an explosion. Always remove rings and watches.

1. On the vehicle to be jump-started, remove the battery cover and any terminal boots.

⚠ WARNING

Any time service is performed on a battery, the following must be observed: keep sparks, open flame, cigarettes, or any other flame away. Always wear safety glasses. Protect skin and clothing when handling a battery. When servicing battery in enclosed space, keep the area well-ventilated. Make sure battery venting is not obstructed.

2. Inspect the battery for any signs of electrolyte leaks, loose terminals, or bulging sides. Leaking or bulging battery cases may indicate a frozen or shorted battery.

⚠ WARNING

If any of these conditions exist, DO NOT attempt a jump-start, boost, or charge the battery. An explosion could occur causing serious injury or death.

3. Inspect the vehicle to be used for jump-starting to determine if voltage and ground polarity are compatible. The vehicle must have a 12-volt DC, negative ground electrical system.

CAUTION

Always make sure the electrical systems are of the same voltage and ground polarity prior to connecting jumper cables. If not, severe electrical damage could occur.

4. Move the vehicle to be used for the jump-start close enough to ensure the jumper cables easily reach; then shift into neutral, set and lock the brakes, shut off all electrical accessories, and turn the ignition switch OFF.

■ **NOTE:** Make sure all switches on the vehicle to be jump-started are turned OFF.

5. Disconnect all external accessories such as cell phones, GPS units, and radios on both vehicles.

CAUTION

Failure to disconnect electronic accessories during jump-starting may cause system damage due to power spikes.

6. Attach one clamp of the positive (red) jumper cable to the positive (+) terminal (1) of the dead battery (C) being careful not to touch any metal with the other clamp; then attach the other clamp of the positive (red) jumper cable to the positive (+) terminal (2) of the good battery (B).

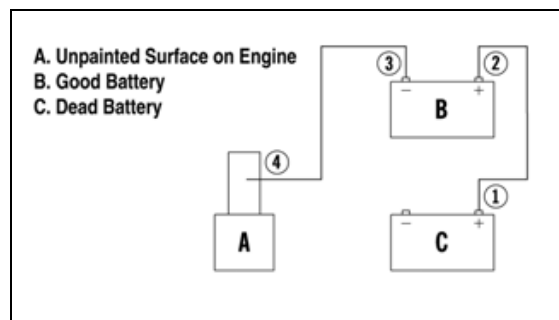

0744-527

■ **NOTE:** Some jumper cables may be the same color but the clamps or ends will be color-coded red and black.

7. Attach one clamp of the negative (black) jumper cable to the negative (-) terminal (3) of the good battery (B); then attach the other clamp of the negative (black) jumper cable (4) to an unpainted metal surface (A) on the engine or frame well away from the dead battery and fuel system components.

⚠ WARNING

Never make the final connection to a battery as a spark could ignite hydrogen gases causing an explosion of the battery resulting in acid burns or blindness.

8. Stand well away from the dead battery and start the vehicle with the good battery. Allow the vehicle to run for several minutes applying some charge to the dead battery.

9. Start the vehicle with the dead battery and allow it to run for several minutes before disconnecting the jumper cables.
10. Remove the jumper cables in opposite order of hook-up (4, 3, 2, 1). Be careful not to short cables against bare metal.

■ **NOTE:** Have the battery and electrical system checked prior to operating the vehicle again.

Spark Plug(s)

This vehicle comes equipped with a specified spark plug. See the specifications chart for the correct spark plug. A light brown insulator indicates that the plug is correct. A white or dark insulator indicates that the engine may need to be serviced. Consult an authorized Arctic Cat dealer if the plug insulator is not a light brown color. To help prevent cold weather fouling, make sure to thoroughly warm up the engine before operating.

To maintain a hot, strong spark, keep the plug free of carbon.

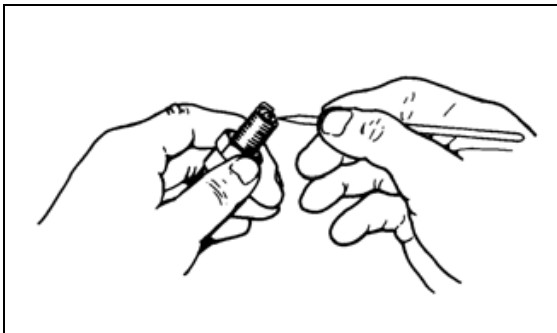

ATV-0051

Before removing the spark plug, be sure to clean the area around the spark plug. If you do not, dirt could enter engine when removing or installing the spark plug.

Adjust the gap (see specifications chart) for proper ignition. Use a feeler gauge to check the gap.

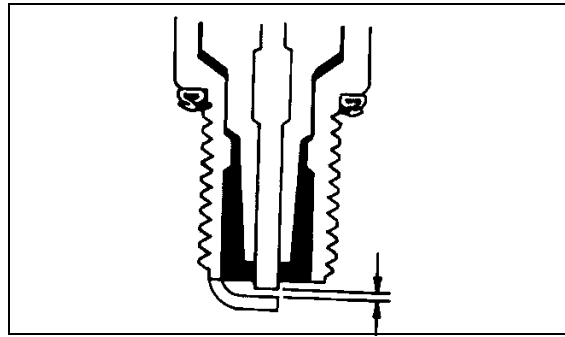

ATV-0052

A new spark plug should be tightened 1/2 turn once the washer contacts the cylinder head. A used spark plug should be tightened 1/8 - 1/4 turn once the washer contacts the cylinder head.

Air Inlet Pre-Filter (HDX)

This vehicle is equipped with a foam pre-filter to filter dirt from the inlet air prior to reaching the main air filter.

■ **NOTE:** To access the pre-filter, remove the seat and backrest; then remove the seat base.

1. Gently squeeze the pre-filter cover and lift it up to expose the pre-filter.



HDX237A

2. Loosen the clamp securing the pre-filter.



HDX235

2. Remove the pre-filter assembly and wash thoroughly in warm, soapy water; then rinse and dry.
3. Install and secure with the clamp. Tighten securely; then with the pre-filter cover installed, install the seat base, seat, and backrest.
6. Put the element in a plastic bag; then pour in air filter oil and work the oil into the element.
7. Squeeze the element to remove excess oil.

Air Filter/Housing Drain

The air filter inside the air filter housing must be kept clean to provide good engine power and gas mileage. If the vehicle is used under normal conditions, service the filter at the intervals specified. If operated in dusty, wet, or muddy conditions, inspect and service the filter more frequently. Use the following procedure to remove the filter and inspect and/or clean it.

CAUTION

Failure to inspect the air filter frequently if the vehicle is used in dusty, wet, or muddy conditions can damage the engine.

■ **NOTE:** To access the air filter, the seats and the center console must be removed (Prowler) or the cargo box must be raised (HDX).

1. Remove dirt and debris from around the filter housing.
2. Unsnap the four spring-clip fasteners and remove the air filter cover. On the HDX, remove the two screws securing the filter.
3. Fill a wash pan larger than the element with a non-flammable cleaning solvent; then dip the element in the solvent and wash it.

■ **NOTE:** Foam Air Filter Cleaner and Foam Air Filter Oil are available from Arctic Cat.

4. Squeeze the element by pressing it between the palms of both hands to remove excess solvent. Do not twist or ring the element or it will develop cracks.
5. Dry the element.

CAUTION

A torn air filter can cause damage to the engine. Dirt and dust may get inside the engine if the element is torn. Carefully examine the element for tears before and after cleaning it. Replace the element with a new one if it is torn.

8. Clean any dirt or debris from inside the filter housing.
9. Inspect the drain beneath the main housing for debris and for proper sealing.

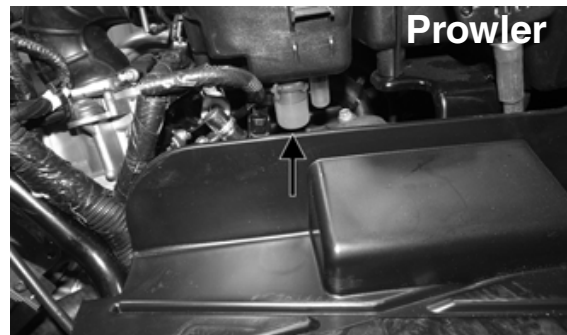

Prowler

PR882A

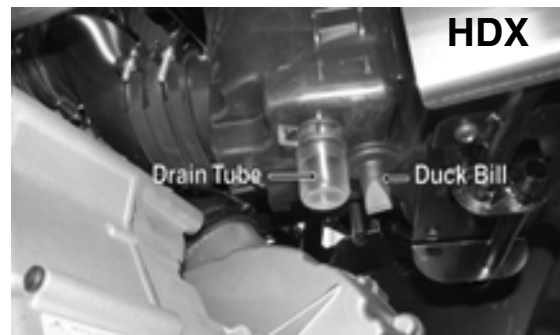

HDX

HDX089A

10. On the HDX, remove the tube drain and clean out any water, oil, or debris. Reinstall and secure with the clamp.
11. Install the air filter. On the HDX, secure the filter with the two screws and tighten to 12 ft-lb; then install the cover.
12. Install the center console (Prowler) or lower the cargo box (HDX); then install the seat(s) making sure they are securely latched.

Draining V-Belt Cover

■ **NOTE:** If the vehicle has been driven through water, the V-belt cover must be drained of any water.

1. Place the vehicle on a level surface.
2. Remove the drain bolt from the cover and allow the water to drain out.
3. Shift the range lever to the neutral position; then start the engine.

CAUTION

Do not attempt to clear water with the vehicle in park. The transmission is locked and belt or clutch damage could occur.

4. Increase and decrease engine RPM several times to “blow out” any water; then stop the engine.
5. Install the drain bolt and tighten securely.

■ **NOTE:** The V-belt and pulleys should be inspected every 500 miles and the belt replaced (if necessary).

Tires

⚠ WARNING

Always use the size and type of tires as specified. Refer to the specifications chart for proper tire inflation pressure, and always maintain proper tire inflation pressure.

Tire Tread Condition

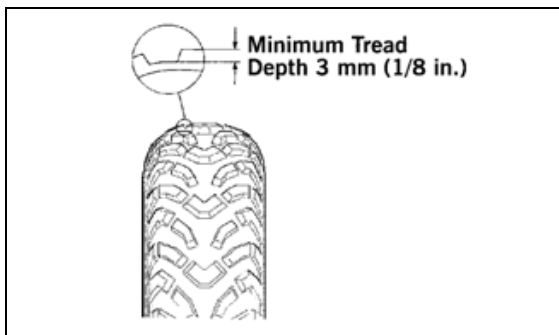

0732-649

The use of worn-out tires on this vehicle is very dangerous. A tire is considered to be worn out when the depth of the tread is less than 3 mm (1/8 in.). Be sure to replace the tires before reaching this minimum specification.

⚠ WARNING

The use of worn-out tires is dangerous and can increase the risk of an accident.

Tire Replacement

This vehicle has low-pressure tubeless tires. Air is sealed by the contact surfaces of the inner wheel rim and the tire bead. If either the inner wheel rim or tire bead is damaged, air may leak. Be extremely careful not to damage these areas when replacing tires.

It is very important to use the proper tools when repairing or replacing tires to prevent damage to the tire bead or wheel rims. If proper tools and related items are not available, have this maintenance performed by an authorized Arctic Cat dealer or a qualified tire repair station.

CAUTION

When breaking the tire bead loose from the wheel, be extremely careful not to damage the inner wheel surface or the tire bead.

⚠ WARNING

Use only Arctic Cat approved tires when replacing tires. Failure to do so could result in unstable operation.

Tubeless Tire Repair

Should a leak or flat tire occur due to a puncture, the tire may be repaired using a plug-type repair. If the damage is from a cut or if the puncture cannot be repaired using a plug, the tire must be replaced. When operating the vehicle in areas where transportation or service facilities are not readily available, it is strongly recommended to carry a plug-type repair kit and a tire pump along.

Wheels

1. Park the vehicle on level ground and engage the differential lock.
2. Loosen the lug nuts on the wheel to be removed.

3. Elevate the vehicle.
4. Remove the lug nuts.
5. Remove the wheel.
6. Install the wheel and install the lug nuts.
7. Install the wheel and tighten the wheel nuts in 20 ft-lb increments to a final torque of 40 ft-lb (steel wheel), 60 ft-lb (aluminium wheel w/black nuts), or 80 ft-lb (aluminum wheel w/ chrome nuts).
8. Remove the jack.

Muffler/Spark Arrester (Prowler)

The muffler has a spark arrester which must be periodically cleaned. At the intervals shown in the Maintenance Schedule, clean the spark arrester using the following procedure.

⚠ WARNING
Wait until the muffler cools to avoid burns.

1. Remove the cap screws securing the spark arrester assembly to the muffler.



PR879

2. Using a suitable brush, clean the carbon deposits from the screen taking care not to damage the screen.

■ **NOTE:** If the screen or gasket is damaged in any way, it must be replaced.

3. Install the spark arrester assembly and secure with the cap screws. Tighten to 60 in.-lb.

Muffler/Spark Arrester (HDX)

The muffler has a spark arrester which must be periodically cleaned. At the intervals shown in the Maintenance Schedule, clean the spark arrester using the following procedure.

⚠ WARNING
Wait until the muffler cools to avoid burns.

1. Open the cargo box and remove the two springs securing the muffler to the exhaust pipe.
2. Remove the muffler by pulling it rearward out of the vehicle.
3. Remove the three cap screws securing the spark arrester assembly to the muffler.



HDX243A

4. Using a suitable brush, clean the carbon deposits from the screen taking care not to damage the screen.



HDX242

■ **NOTE:** If the screen or gasket is damaged in any way, it must be replaced.

5. Install the spark arrester assembly and secure with the three cap screws. Tighten to 60 in.-lb.
6. Install the muffler and secure it to the exhaust pipe with the two springs.

Light Bulb Replacement

CAUTION

Use only specified bulbs indicated in the Specifications chart as replacement bulbs.

■ **NOTE:** The bulb portion of the headlight is fragile. **HANDLE WITH CARE.** When replacing the headlight bulb, do not touch the glass portion of the bulb. If the glass is touched, it must be cleaned with a dry cloth before installing. Skin oil residue on the bulb will shorten the life of the bulb.

To replace the headlight bulb, use the following procedure.

1. Rotate the back of the headlight bulb counterclockwise, disconnect the wiring harness, and discard the bulb.



XR065C

2. Connect the new headlight bulb to the wiring harness and insert into headlight assembly. Turn clockwise to secure the bulb.
3. Adjust the headlight (see Checking/Adjusting Headlight Aim in this subsection).

CAUTION

When replacing the headlight bulb, be careful not to touch the glass portion of the bulb. Grasp the new bulb with a clean cloth.

To replace the taillight/brakelight bulb, use the following procedure.

1. Remove the mounting screws securing the taillight/brakelight assembly to the rear ROPS tube.
2. Rotate the socket counterclockwise and remove it from the housing.
3. To remove the bulb from the socket, pull it straight out of the socket.
4. To install the bulb, push it straight into the socket.
5. Insert the socket into the housing and rotate it clockwise.
6. Position the taillight/brakelight assembly on the rear ROPS tube; then tighten the mounting screws securely.

Checking/Adjusting Headlight Aim

The headlights can be adjusted vertically and horizontally. The geometric center of the HIGH beam light zone is to be used for vertical and horizontal aiming.

1. Position the vehicle on a level floor so the headlights are approximately 6.1 m (20 ft) from an aiming surface (wall or similar aiming surface).

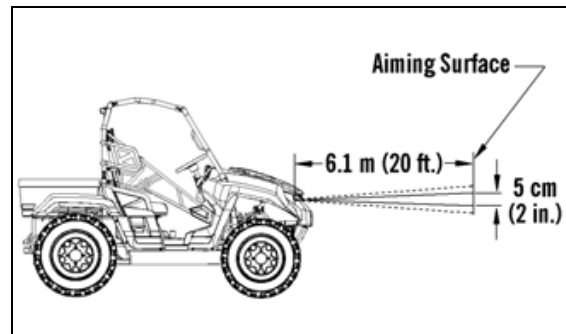

0748-733

■ **NOTE:** There should be an average operating load on the vehicle when adjusting the headlight aim.

2. Measure the distance from the floor to the mid-point of each headlight.
3. Using the measurements obtained in step 2, make horizontal marks on the aiming surface.
4. Make vertical marks which intersect the horizontal marks on the aiming surface directly in front of the headlights.

5. Switch on the lights. Make sure the HIGH beam is on. DO NOT USE LOW BEAM.
6. Observe each headlight beam aim. Proper aim is when the most intense beam is centered on the vertical mark 5 cm (2 in.) below the horizontal mark on the aiming surface.
7. Loosen the headlight adjustment screw; then adjust the headlight up or down as required. Tighten the headlight adjustment screw.

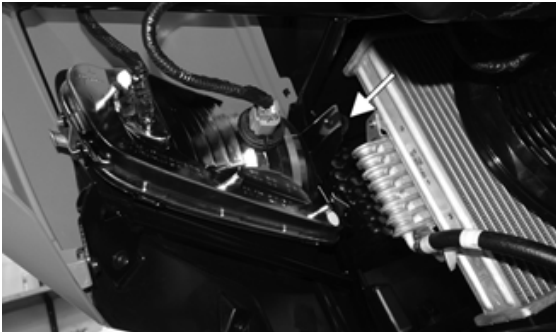

PR875A

Fuses

The fuses are located in a power distribution module under the dash below the headlight switch. If there is any type of electrical system failure, always check the fuses first.



PR895

■ **NOTE:** To remove the fuse, compress the locking tabs on either side of the fuse cover and lift out.

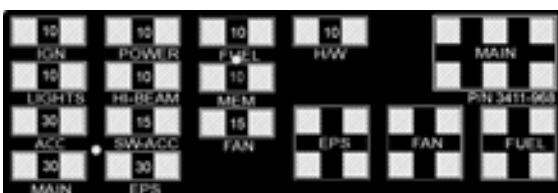

3411-968

CAUTION

Always replace a blown fuse with a fuse of the same type and rating. If the new fuse blows after a short period of use, consult an authorized Arctic Cat dealer immediately.

Electrical Output Terminals

Two output terminals for electrical accessories are located on the front and rear wiring harnesses. Two accessory plugs are located on the dash board.

■ **NOTE:** The rear output terminal is located beneath the center console near the right-side of the throttle body. The front output terminal is located beneath the dash board in front of the left-side accessory plug.

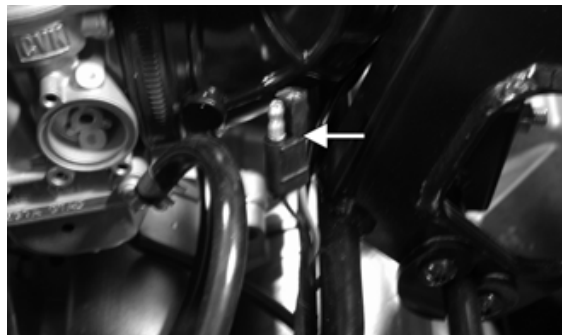

PR049A

CAUTION

Always use electrical accessories less than 180W.

Storage Compartment/Tools

A basic tool kit (located in the under hood storage) is provided with this vehicle. Maintain the tool kit with the vehicle at all times.

This vehicle has a storage compartment within the dashboard and a storage compartment beneath the hood. To access the compartment located under the hood, release the two hold-down straps at the rear of the hood and tilt the hood forward.

The HDX also has side storage compartments under each seat.

Seat Belts

Inspect the seat belts for frayed or torn edges. Check that the belts extend and retract smoothly and fully without binding or catching. Check that the latch plate locks securely in place in the buckle and releases when the button is pressed. Wash off any dirt and make sure the retractors are free of debris. Do not grease or oil the retractors.

Occupant Side Restraints

Inspect the occupant side restraints for frayed edges, cuts, or separation of seams. Wash off any dirt and make sure the latch straps lock securely into the foot restraints with straps taut.



PR872A

ROPS

Inspect the Rollover Protection Structure (ROPS) for any deformation, twisting, cracking, missing or damaged fasteners, loose fasteners, modification to the production form, missing ROPS label, unauthorized repair or welding, and/or improper installation. If any of these circumstances are discovered, do not operate and immediately bring the vehicle to an authorized Arctic Cat dealer for service.

Preparation For Storage

Arctic Cat recommends the following procedure to prepare the vehicle for storage. An authorized Arctic Cat dealer should perform this service; however, the owner/operator may perform this service if desired.

CAUTION

Prior to storing this vehicle, it must be properly serviced to prevent rusting and component deterioration.

1. Clean the seat cushions with a damp cloth and allow to dry.
2. Clean the vehicle thoroughly by washing dirt, oil, grass, and other foreign matter from the entire vehicle. Allow the vehicle to dry thoroughly. DO NOT get water into any part of the engine or air intake.
3. Either drain the gas tank or add a fuel stabilizer to the gas in the gas tank.
4. Clean the interior of the air filter housing.
5. Plug the hole in the exhaust system with a clean cloth.
6. Apply light oil to the upper steering shaft bushing and plungers of the shock absorbers.

7. Tighten all nuts, bolts, cap screws, and screws. Make sure rivets holding components together are tight. Replace all loose rivets. Care must be taken that all calibrated nuts, cap screws, and bolts are tightened to specifications.

8. Fill the cooling system to the bottom of the stand pipe in the radiator neck with properly mixed coolant.

9. Disconnect the battery cables (negative cable first); then remove the battery, clean the battery posts and cables, and store in a clean, dry area.

■ **NOTE: For storage, use a battery maintainer or make sure the battery is fully charged (see Battery section in this manual).**

10. Store the vehicle indoors in a level position.

CAUTION

Avoid storing outside in direct sunlight and avoid using a plastic cover as moisture will collect on the vehicle causing rusting.

Preparation After Storage

Taking this vehicle out of storage and correctly preparing it will assure many miles and hours of trouble-free riding. Arctic Cat recommends the following procedure.

1. Clean the vehicle thoroughly.
2. Clean the engine. Remove the cloth from the exhaust system.
3. Check all control wires and cables for signs of wear or fraying. Replace if necessary.
4. Change the engine/transmission oil and filter.
5. Check the coolant level and add properly mixed coolant as necessary.
6. Charge the battery; then install. Connect the battery cables making sure to connect the positive cable first.
7. Check the entire brake systems (fluid level, pads, etc.), all controls, headlights, taillight, brakelight, and headlight aim; adjust or replace if necessary.
8. Check the tire pressure. Inflate to recommended pressure as necessary.
9. Tighten all nuts, bolts, cap screws, and screws making sure all calibrated nuts, cap screws, and bolts are tightened to specifications.
10. Make sure the steering moves freely and does not bind.
11. Check the spark plug. Clean or replace as necessary.
12. Check the air filter and the air filter housing. Clean or replace as necessary.

CAUTION

Before installing the battery, make sure the ignition switch is in the OFF position.

Limited Warranty

Arctic Cat Inc. (hereinafter referred to as Arctic Cat) extends a limited warranty as described below on each new Arctic Cat ROV it assembles and on each genuine Arctic Cat ROV part and accessory assembled and sold by an authorized Arctic Cat ROV dealer. The limited warranty on an Arctic Cat ROV is extended to the original retail purchaser for the time periods described below; however, the balance of the remaining warranty may be transferred to another party unless the purchase is for commercial use (see below). Warranty coverage is only available in the country in which the original retail purchase occurs to the original retail purchaser resident in that country or to a transferee resident in that country of the balance of the remaining warranty.

Arctic Cat warrants only the products it assembles and/or sells and does not warrant that other products will function properly when used with an Arctic Cat ROV or will not damage the ROV. Arctic Cat does not assume any liability for incidental or consequential damages.

Arctic Cat will repair or replace, at its option, free of charge (including any related labor charges), any parts that are found to be warrantable in material or workmanship. This repair work **MUST** be done by an authorized Arctic Cat ROV dealer. No transportation charges, rental charges, or inconvenience costs will be paid by Arctic Cat. The warranty is validated upon examination of said parts by Arctic Cat or an authorized Arctic Cat ROV dealer. Arctic Cat reserves the right to inspect such parts at its factory for final determination if warranty should apply.

The warranty periods are as follows:

1. Six months from the date of sale - for an Arctic Cat ROV used for recreational purposes.
2. Ninety days from date of invoice - for an Arctic Cat ROV used for commercial purposes, including rental operations (non-transferable).
3. Thirty days from date of sale of ROV on Arctic Cat supplied batteries.

Exclusions to this warranty include normal wear, abuse, or corrosion and the following parts and items:

Tires	Drive/Driven Clutch Wear Parts
Oil Filter	Drive Belt
Air Filter	Torn or Punctured Upholstery
Brake Pads	Cracks or Gouges in Body Panels
Light Bulbs	Spark Plug(s)
CV Boots	Windshield
Shock Absorber(s)*	

* Limited to one (1) year of "normal" riding conditions - replace for defective or leaking shock, corroded or pitted shaft, peeling chrome.

■ **NOTE: ROVs that are factory equipped with Fox, Elka, or JRI shocks and experience a shock failure of workmanship or material within the factory warranty period must not be tampered with. Only the air pressure valve (p/n 2603-511 - Fox shocks only) is serviceable during the warranty period. Any other tampering with the shock will void warranty.**

The following will VOID Arctic Cat's warranty:

1. Failure to perform the proper break-in procedure and all related maintenance, storage procedures (if stored for extended periods), and/or service as recommended in the Operator's Manual.
2. Repairs and/or adjustments by anyone other than an authorized Arctic Cat ROV dealer.
3. Use of improper gasoline, lubricating oils, or spark plug(s).
4. An accident or subjecting the ROV to misuse, abuse, or negligent operation.
5. Any modification, addition, or removal of parts unless instructed to do so by Arctic Cat.
6. Use of the ROV in any way for racing purposes.
7. Removal of the engine for use in another vehicle.
8. Removal or mutilation of the Vehicle Identification Number or Engine Serial Number.
9. Use of parts not sold or approved by Arctic Cat.
10. Damage due to improper transportation.

Arctic Cat shall not be responsible for and this limited warranty excludes recovery of economic, punitive, consequential and incidental damages, lost profits, and loss of use. Some states or provinces do not allow the exclusion or limitation of incidental or consequential damages, so the above limitation may not apply to you. Arctic Cat's aggregate liability may not exceed the price of the product. The law of the State of Minnesota shall apply to all claims or disputes, exclusive of its conflicts of law provisions.

IMPLIED WARRANTY EXCLUSION AND DISCLAIMER

To the fullest extent permitted by law, Arctic Cat excludes and disclaims all implied warranties of merchantability and fitness for a particular purpose.

If you are not satisfied with warranty service or repairs, you should contact Arctic Cat at (U.S.) 1-218-681-9851 or (Canada) 1-204-982-1656.

Warranty Procedure/Owner Responsibility

At the time of sale, an ATV Rider Training Certificate and Owner Registration form is to be completed by the selling dealer and consumer. The receipt of the form by Arctic Cat is a condition precedent to warranty coverage. It is the selling dealer's responsibility to retain and/or submit appropriate copies of the form to the appropriate place(s) to initiate warranty coverage.

The dealer will furnish to the consumer a signed copy of the form which must be presented to the dealer when requesting warranty service. The registration form is the consumer's proof of ownership and warranty eligibility. The form is used by the dealer to validate the warranty claim. Retain your copy of the form and keep it in a safe place.

When warranty repair is suspected, the ROV should be taken to the selling dealer, who has the primary responsibility to perform warranty repairs. Subject to the limitations set forth in the Limited Warranty, in the event the selling dealer has ceased to do business, you have moved, or you are in a location away from your selling dealer, warranty may be performed by any authorized Arctic Cat dealer.

The authorized Arctic Cat ATV dealer will examine the ROV or part to determine if, in his opinion, a warrantable condition exists. If a warrantable condition appears to exist, the dealer will repair or replace, at Arctic Cat's option, free of charge, including any related labor costs, all parts that are found to be warrantable and any other parts which the warrantable part caused to be damaged. You, the owner, will then be asked to sign a warranty form to ensure Arctic Cat that the warranty work was actually performed.

It is the owner's responsibility to maintain and service the ROV in accordance with Arctic Cat's recommendations in the Operator's Manual. To protect yourself and your ROV, follow all safety and service tips. Arctic Cat will NOT warrant repairs required as a result of not performing standard operator maintenance, storage procedures, and service as outlined in the Operator's Manual.

Should you have any questions concerning the warranty, contact an authorized Arctic Cat ROV dealer.

U.S. EPA Emission Control Statement/Warranty Coverage - ROV (U.S. Only)

STATEMENT/WARRANTY

Arctic Cat warrants to the original retail purchaser, and each subsequent purchaser, that all U.S. EPA-certified Arctic Cat ROV's are designed, built, and equipped to conform to all U.S. EPA Emission Control Regulations. Please read the following information completely.

Your authorized Arctic Cat dealer will repair or replace any defective emission-related component at no cost to you during the warranty period. You may have non-warranty service performed by any repair establishment that uses equivalent components. The regulations provide significant civil penalties for tampering that causes your ROV to no longer meet U.S. EPA emission standards.

Arctic Cat further warrants that the engine and its emission-related components are free from defects in materials or workmanship that could cause the engine to fail to comply with applicable regulations during the warranty period.

If you have any questions about this information, or the emission warranty coverage statement, contact your local authorized Arctic Cat dealer.

WARRANTY PERIOD

The emission warranty period for this ROV begins on the same date as the standard warranty coverage and continues for 30 months or 3100 miles, whichever comes first.

COMPONENTS COVERED

The emissions warranty covers major emissions control components and emission-related components listed as follows:

Engine Management and Sensors

Barometric Pressure Sensor
Camshaft Position Sensor
Engine Control Module (ECM)
Engine Coolant Temperature Sensor
Intake Air Temperature Sensor
Manifold Absolute Pressure Sensor
Oxygen Sensor
Throttle Position Sensor
Crankshaft Position Sensor
Exhaust Temperature Sensor

Ignition System

Ignition Coil
Knock Sensor System
Spark Plugs
Capacitive Discharge Ignition (CDI) Module
Magneto Pick-Up

Fuel/Air System

Fuel Injectors
Fuel Pressure Regulator
Fuel Pump
Carburetor(s)
Turbocharger Assembly
Air Bypass Valve
Turbo Waste Gate Control Valve
Crankcase Ventilation System
ISC Valve

Miscellaneous Items Used in Aforementioned Systems

Connectors
Switches
Grommets
Clamps
Hoses
Ties
Gaskets
Wiring

OWNER'S RESPONSIBILITIES

The owner of any ROV warranted under this Arctic Cat Emission Control Statement is responsible for the proper maintenance and use of the ROV as stated in the Operator's Manual. Proper maintenance generally includes replacement and service, at the owner's choosing, such items as air filter, oil and oil filter, or any other part, item, or device related to emissions control as specified in the Operator's Manual. It is the owner's responsibility to ensure that the ROV is used in a manner for which it was designed.

NOTES

Change of Address, Ownership, or Warranty Transfer

Arctic Cat Inc. keeps on file the current name and address of the owner of this vehicle. This allows Arctic Cat to reach the current owner with any important safety information which may be necessary to protect customers from personal injury or property damage. Please make sure a copy of this form is completed and returned to Arctic Cat Inc. if you move or if the vehicle is sold to another party.

This form may also be used to transfer the unused portion of the original warranty to a second party. In order to transfer warranty, fill out this form completely; then return a copy of this form to Arctic Cat Inc. Arctic Cat will then process the application and issue warranty for the balance of the time remaining of the original warranty. Warranty coverage is only available in the country in which the original retail purchase occurs to the original retail purchaser resident in that country or to a transferee resident in that country of the balance of the remaining warranty.

- Address Change
- Ownership Change
- Warranty Transfer

CHANGE OF ADDRESS/OWNERSHIP/ WARRANTY TRANSFER TO:

Name _____

Address _____

City/State (Province)/Zip Code (Postal Code) _____

Phone # () _____

Email _____

Year and Model _____

Vehicle Identification Number (VIN) _____

Fold Back

CHANGE OF ADDRESS/OWNERSHIP

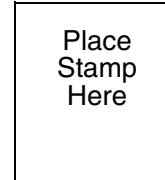

ARCTIC CAT INC.
PRODUCT SERVICE AND
WARRANTY DEPT.
P.O. BOX 810
THIEF RIVER FALLS, MN 56701

Identification Numbers Record

This vehicle has two identification numbers: Vehicle Identification Number (VIN) and Engine Serial Number (ESN). These numbers are required by the dealer to complete warranty claims properly. No warranty will be allowed by Arctic Cat if the VIN or ESN is removed or mutilated in any way.

Always provide the name, VIN, and ESN when contacting an authorized Arctic Cat dealer for parts, service, accessories, or warranty. If a complete engine must be replaced, ask the dealer to notify Arctic Cat for correct registration information.

Record the Vehicle Identification Number and Engine Serial Number in the spaces provided to assist you in ordering parts from your authorized Arctic Cat dealer or for reference in case this vehicle is stolen.

1. KEY IDENTIFICATION NUMBER:

The key identification number is stamped on the key as shown in the illustration. Record this number in the space provided for reference if you ever need a new key.



2. VEHICLE IDENTIFICATION NUMBER:

The VIN is located on the frame support rail.



PR877

3. ENGINE SERIAL NUMBER:

The ESN is located near the oil stick.

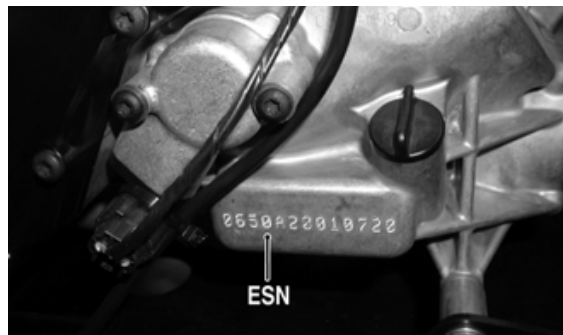

PR053A

WARNING

Improper Use of Off-Highway Vehicles Can Cause Severe Injury or Death

Be Prepared

- Fasten seat belts.
- Wear an approved helmet and protective gear.
- Latch all doors or side restraints
- Each rider must be able to sit with back against seat, feet flat on floor [and foot rests], and hands on steering wheel or handhold[s][where equipped]. Stay completely inside the vehicle.



Drive Responsibly

Avoid loss of control and rollovers:

- Avoid abrupt maneuvers, sideways sliding, skidding, or fishtailing, and never do donuts.
- Slow down before entering a turn.
- Avoid hard acceleration when turning, even from a stop.
- Plan for hills, rough terrain, ruts, and other changes in traction and terrain. Avoid paved surfaces.
- Avoid side hilling (riding across slopes).

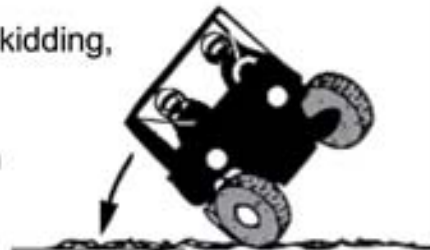

Rollovers have caused severe injuries and death, even on flat, open areas.

Be Sure Riders Pay Attention and Plan Ahead

If you think or feel the vehicle may tip or roll, reduce your risk to injury:

- Keep a firm grip on the steering wheel or handholds and brace yourself.
- Do not put any part of your body outside of the vehicle for any reason.

Require Proper Use of Your Vehicle

Do your part to prevent injuries:

- Do not allow careless or reckless driving.
- Make sure operators are 16 or older with a valid driver's license.
- Do not let people drive or ride after using alcohol or drugs.
- Do not allow operation on public roads (unless designated for off-highway vehicle access) -- collisions with cars and trucks can occur.
- Do not exceed seating capacity.



**[Locate and Read Operator's Manual]
Follow All Instruction and Warnings**

**Vehicle Capacity: 2 seat models, 1 Operator, 1 Passenger with seat belts
Vehicle Capacity: 3 seat models, 1 Operator, 2 Passengers with seat belts**