



**OWNER'S MANUAL**



**⚠ Read this manual carefully  
before operating this vehicle.**

***APEX***

**RX10GTY  
RX10LTGTY**

ESU10041

**⚠ WARNING**

**The engine exhaust from this product contains chemicals known to the State of California to cause cancer, birth defects or other reproductive harm.**

YAMAHA

LIT-CALIF-65-01

**⚠ Read this manual carefully before operating this vehicle. This manual should stay with this vehicle if it is sold.**

# Introduction

ESU10121

Congratulations on your purchase of a Yamaha snowmobile. This model is the result of Yamaha's vast experience in the production of fine sporting and touring snowmobiles. It represents the high degree of craftsmanship and reliability that have made Yamaha a leader in these fields.

This manual will give you an understanding of the operation, inspection, and basic maintenance of this snowmobile. If you have any questions concerning the operation or maintenance of your snowmobile, please consult a Yamaha dealer.

Yamaha continually seeks advancements in product design and quality. Therefore, while this manual contains the most current product information available at the time of printing, there may be minor discrepancies between your snowmobile and this manual. If there is any question concerning this manual, please consult a Yamaha dealer.

EWS00670

## **WARNING**

**Please read this manual carefully before operating this snowmobile. Do not attempt to operate this snowmobile until you have attained adequate knowledge of its controls and operating features.**

**Regular inspections and careful maintenance, along with good operating techniques, will help ensure that you safely enjoy the capabilities and reliability of this snowmobile.**

**RX10GTY  
RX10LTGTY  
OWNER'S MANUAL  
©2008 by Yamaha Motor Corporation,  
U.S.A.  
1st Edition, March 2008  
All rights reserved.  
Any reprinting or unauthorized use  
without the written permission of  
Yamaha Motor Corporation, U.S.A.  
is expressly prohibited.  
Printed in Japan.  
P/N LIT-12628-02-73**

# Important manual information

---

ESU10151

Particularly important information is distinguished in this manual by the following notations.

 This is the safety alert symbol. It is used to alert you to potential personal injury hazards. Obey all safety messages that follow this symbol to avoid possible injury or death.

EWS00021

## **WARNING**

---

**A WARNING indicates a hazardous situation which, if not avoided, could result in death or serious injury.**

---

ECS00011

## **NOTICE**

---

**A NOTICE indicates special precautions that must be taken to avoid damage to the snowmobile or other property.**

---

## **TIP**

---

A TIP provides key information to make procedures easier or clearer.

---

# Contents

<b>Location of the important labels</b> .....	1	Fuel .....	21
<b>Safety information</b> .....	3	Suspension .....	22
<b>Description</b> .....	5	<b>Pre-operation checks</b> .....	27
<b>Control functions</b> .....	8	Pre-operation check list .....	27
Main switch .....	8	<b>Operation</b> .....	29
Throttle lever .....	8	Starting the engine .....	29
Engine overheating prevention system .....	8	Break-in .....	30
Throttle override system (T.O.R.S.) .....	8	Riding your snowmobile .....	30
Speedometer unit .....	9	Maximizing drive track life .....	34
High beam indicator light .....	12	Driving .....	34
Low coolant temperature indicator light .....	12	Stopping the engine .....	35
Fuel meter, grip warmer level indicator, rear shock absorber compression damping level indicator, and thumb warmer level indicator .....	12	Transporting .....	36
Fuel level warning indicator .....	15	<b>Periodic maintenance and adjustment</b> .....	37
Oil level warning indicator .....	15	Periodic maintenance chart for the emission control system .....	37
Coolant temperature warning indicator .....	15	General maintenance and lubrication chart .....	39
Self-diagnosis device .....	16	Tool kit .....	41
Engine stop switch .....	16	Removing and installing the shroud and covers .....	41
Headlight beam switch “LIGHTS” .....	16	Checking the spark plugs .....	43
Grip warmer/rear shock absorber compression damping and thumb warmer adjustment switches .....	17	Adjusting the engine idling speed .....	44
Auxiliary DC jack .....	17	Adjusting the throttle cable free play .....	44
Brake lever .....	18	Checking the throttle override system (T.O.R.S.) .....	46
Parking brake lever .....	18	Checking the air filter .....	46
Shift lever .....	19	High-altitude settings .....	48
Shroud and covers .....	19	Valve clearance .....	48
Drive guard .....	20	Engine oil and oil filter cartridge ...	48
V-belt holders .....	20	Cooling system .....	52
Storage compartment .....	20	V-belt .....	53
		Drive chain housing .....	56
		Brake and parking brake .....	58
		Skis and ski runners .....	60
		Steering system .....	60
		Drive track and slide runners .....	61

# Contents

---

- Lubrication ..... 63
- Replacing a headlight bulb ..... 64
- Adjusting the headlight beams ..... 65
- Fittings and fasteners ..... 66
- Battery ..... 66
- Replacing a fuse ..... 67
  
- Troubleshooting ..... 70**
  
- Storage ..... 74**
  
- Specifications ..... 76**
  
- Consumer information..... 78**
  - Identification number records ..... 78
  - YAMAHA MOTOR  
CORPORATION, U.S.A.  
SNOWMOBILE LIMITED  
WARRANTY..... 79
  - YAMAHA EXTENDED SERVICE  
(Y.E.S.)..... 82

# Location of the important labels

ESU10213

Read and understand all of the labels on your vehicle. They contain important information for safe and proper operation of your vehicle. Never remove any labels from your vehicle. If a label becomes difficult to read or comes off, a replacement label is available from your Yamaha dealer.

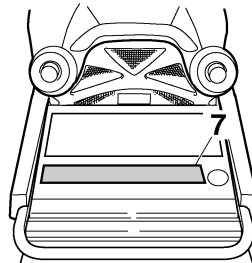
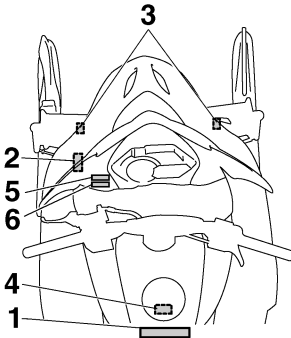

1

▲ WARNING	▲ AVERTISSEMENT
<p>SEVERE INJURY OR DEATH MAY RESULT IF YOU IGNORE ANY OF THE FOLLOWING:</p> <ul style="list-style-type: none"> <li>• Read the Owner's Manual and all labels before operating this vehicle.</li> <li>• This vehicle is a high performance machine. It should be operated by an experienced operator.</li> <li>• Check throttle, brake, and steering for proper operation before starting engine.</li> <li>• Set parking brake before attempting to start engine. Never run this vehicle with the parking brake applied.</li> <li>• To stop engine in an emergency, push the engine stop switch down.</li> <li>• Do not operate engine without drive belt or drive guard.</li> <li>• Make sure the fuel tank cap is closed securely after refueling.</li> <li>• Do not operate this vehicle on public roads. You could collide with another vehicle.</li> <li>• This vehicle is designed for operator only - no passengers.</li> <li>• Check lever position (Forward or Reverse) before moving.</li> <li>• Wear an approved helmet, eye protection, and adequate clothing for snowmobiling.</li> </ul>	<p>AFIN D'ÉVITER TOUT RISQUE DE BLESSURE SÉRIEUSE OU MÊME MORTELLE, VEUILLEZ SUIVRE LES RECOMMANDATIONS SUIVANTES:</p> <ul style="list-style-type: none"> <li>• Avant d'utiliser ce véhicule, lire le manuel du propriétaire et toutes les étiquettes. Ce véhicule est une machine à haute performance. Elle doit être conduite par un conducteur expérimenté.</li> <li>• Avant de démarrer le moteur, vérifier l'opération du frein, de l'accélérateur et de la direction.</li> <li>• Le frein de sécurité doit être appliqué lors du démarrage. Ne pas rouler avec le frein de sécurité actionné.</li> <li>• En cas d'urgence, utiliser l'interrupteur d'arrêt du moteur.</li> <li>• Ne pas laisser tourner le moteur sans la courroie ou sans son garde.</li> <li>• S'assurer que le bouchon du réservoir soit bien refermé après le remplissage.</li> <li>• Afin d'éviter tout risque de collision, ne pas rouler sur un chemin public.</li> <li>• Ce véhicule est conçu pour un conducteur seul - aucun passager.</li> <li>• Vérifier la position du levier (marche avant ou arrière) avant d'être en marche.</li> <li>• Toujours porter un casque approuvé et un habillement de motoneigiste. Prévoir une protection pour les yeux</li> </ul>

8FR-77761-E0

2

<p>▲ WARNING</p> <p>DO NOT OPERATE ENGINE WITHOUT V-BELT OR DRIVE GUARD.</p>
<p>▲ AVERTISSEMENT</p> <p>NE PAS FAIRE FONCTIONNER LE MOTEUR SANS COURROIE EN V OU PROTECTEUR D'EMBRAYAGE.</p>
<p>YAMAHA 88D-7776C-00</p>

# Location of the important labels

---

3

<b>⚠ WARNING</b>
This unit contains high pressure nitrogen gas. Mishandling can cause explosion. <ul style="list-style-type: none"><li>• Read owner's manual for instructions.</li><li>• Do not incinerate, puncture or open.</li></ul>
<b>⚠ AVERTISSEMENT</b>
Cette unité contient de l'azote à haute pression. Une mauvaise manipulation peut entraîner d'explosion. <ul style="list-style-type: none"><li>• Voir le manuel d'utilisateur pour les instructions.</li><li>• Ne pas brûler ni perforer ni ouvrir.</li></ul>
<small>4AA-22259-70</small>

4

<b>⚠ WARNING</b>
This unit contains high pressure nitrogen gas. Mishandling can cause explosion. <ul style="list-style-type: none"><li>• Read owner's manual for instructions.</li><li>• Do not incinerate, puncture or open.</li></ul>
<b>⚠ AVERTISSEMENT</b>
Cette unité contient de l'azote à haute pression. Une mauvaise manipulation peut entraîner d'explosion. <ul style="list-style-type: none"><li>• Voir le manuel d'utilisateur pour les instructions.</li><li>• Ne pas brûler ni perforer ni ouvrir.</li></ul>
<small>4AA-22259-60</small>

5

<b>NOTICE</b>
<ul style="list-style-type: none"><li>• Cleaning with alkaline or acid cleaner, gasoline or solvent will damage windshield.</li><li>• Use neutral detergent.</li></ul>
<small>8ET-2815K-00</small>

6

<b>ATTENTION</b>
<ul style="list-style-type: none"><li>• Éviter de nettoyer le pare-brise avec une solution alcaline ou acide ainsi qu'avec de l'essence ou un diluant.</li><li>• Utiliser un détergent neutre.</li></ul>
<small>8ET-2815K-10</small>

7 RX10LTGT

<b>⚠ WARNING</b>	<b>⚠ AVERTISSEMENT</b>
<b>NO PASSENGERS OR CARGO ON THIS TRACK COVER.</b> It was not designed to carry weight. It could bend or break under load. Anything placed here could block the view of the brake/tail light which could cause an accident.	<b>AUCUN PASSAGER OU MARCHANDISE SUR LE PROTECTEUR DE CHENILLE.</b> Ce protecteur n'a pas été conçu pour supporter un poids. Il pourrait s'incurver ou se briser sous la charge. Tout objet ou personne placé à cet endroit pourrait bloquer la vue des feux d'arrêt/arrière et ainsi causer un accident.
<small>8HA-77762-E0</small>	<small>8HA-77762-E0</small>



ESU10183

As the vehicle's owner, you are responsible for the safe and proper operation of your snowmobile. When you ride your snowmobile, you must know and use the following for your safety. Severe injury or death may result if you ignore any of the following.

## Before you operate your snowmobile

- Read the Owner's Manual and all labels. Become familiar with all of the operating controls and their function. Consult a Yamaha dealer about any control or function you do not understand.
- Wear protective clothing. Wear an approved helmet, and a face shield or goggles. Also, wear a good quality snowmobile suit, boots, and a pair of gloves or mittens that will permit use of your thumbs and fingers for operation of the controls.



- Do not operate the snowmobile after or while drinking alcohol or taking drugs. Your ability to operate the snowmobile is reduced by the influence of alcohol or drugs.

## Prepare your snowmobile

- Perform the pre-operation checks each time you use the vehicle to make sure it is in safe operating condition. Failure to inspect or maintain the vehicle properly increases the possibility of an accident or equipment damage. See page 27 for a list of pre-operation checks.

- Apply the parking brake before starting the engine. Never drive the snowmobile with the parking brake applied. This may overheat the brake disc and reduce braking ability.

## While using your snowmobile

- This snowmobile was not manufactured for use on public streets, roads, or highways. Such use is prohibited by law, and you could collide with another vehicle.
- This snowmobile is designed to carry the OPERATOR ONLY. Passengers are prohibited. Carrying a passenger can cause loss of control.

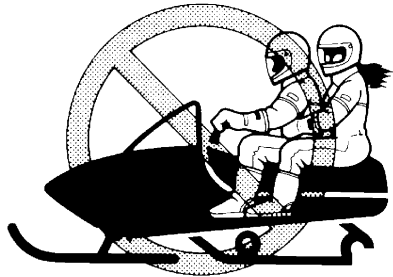

- Be careful where you ride. There may be obstacles hidden beneath the snow. Stay on established trails to minimize your exposure to hazards. Ride slowly and cautiously when you ride off of established trails. Hitting a rock or stump, or running into wires could cause an accident and injury.
- This snowmobile is not designed for use on surfaces other than snow or ice. Use on dirt, sand, grass, rocks, or bare pavement may cause loss of control and may damage the snowmobile.
- Always ride with other snowmobilers when going on a ride. You may need help if you run out of fuel, have an accident, or damage your snowmobile.

# Safety information

---

- Many surfaces such as ice and hardpacked snow require much longer stopping distances. Be alert, plan ahead and begin decelerating early. The best braking method on most surfaces is to release the throttle and apply the brake gently—not suddenly.

## **Avoid carbon monoxide poisoning**

All engine exhaust contains carbon monoxide, a deadly gas. Breathing carbon monoxide can cause headaches, dizziness, drowsiness, nausea, confusion, and eventually death. Carbon monoxide is a colorless, odorless, tasteless gas which may be present even if you do not see or smell any engine exhaust. Deadly levels of carbon monoxide can collect rapidly and you can quickly be overcome and be unable to save yourself. Also, deadly levels of carbon monoxide can linger for hours or days in enclosed or poorly-ventilated areas. If you experience any symptoms of carbon monoxide poisoning, leave the area immediately, get fresh air, and **SEEK MEDICAL TREATMENT.**

- Do not run the engine indoors. Even if you try to ventilate engine exhaust with fans or open windows and doors, carbon monoxide can rapidly reach dangerous levels.
- Do not run the engine in poorly ventilated or partially enclosed areas such as barns, garages, or carports.
- Do not run the engine outdoors where engine exhaust can be drawn into a building through openings such as windows and doors.

## **Genuine Yamaha Accessories**

Choosing accessories for your snowmobile is an important decision. Genuine Yamaha Accessories, which are available only from a Yamaha dealer, have been designed, tested, and approved by Yamaha for use on your snowmobile. Many companies with no connection to Yamaha manufacture parts and ac-

cessories or offer other modifications for Yamaha vehicles. Yamaha is not in a position to test the products that these aftermarket companies produce. Therefore, Yamaha can neither endorse nor recommend the use of accessories not sold by Yamaha or modifications not specifically recommended by Yamaha, even if sold and installed by a Yamaha dealer.

## **Maintenance and storage**

- When laying the snowmobile on its side for maintenance, use a suitable stand to keep it in a stable and level position.
- Do not leave the snowmobile on its left side for an extended period of time. Fuel may leak out from the fuel breather hose.
- Do not allow anyone to stand behind the snowmobile when starting, inspecting, or adjusting the snowmobile. A broken track, track fittings, or debris thrown by the track could be dangerous to the operator or bystanders.
- Modifications made to the snowmobile not approved by Yamaha, or the removal of original equipment may render your snowmobile unsafe for use, which may cause severe personal injury. Modifications may also make the snowmobile illegal to use.
- Never store the snowmobile with fuel in the fuel tank inside a building where ignition sources are present such as hot water and space heaters, an open flame, sparks, clothes dryers, and the like. Allow the engine to cool off before storing the snowmobile in an enclosed space.

ESU10260

## RX10GT

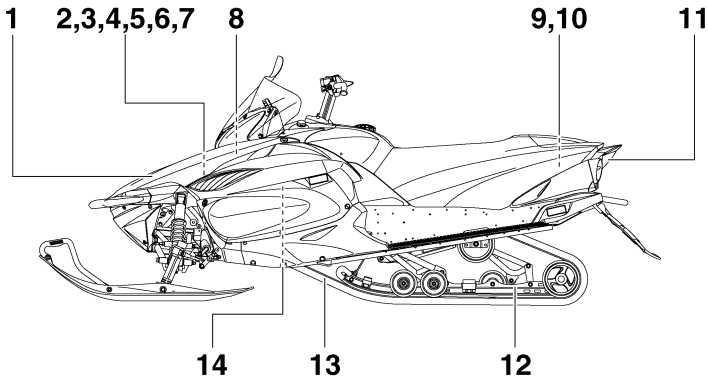

## RX10LTGT

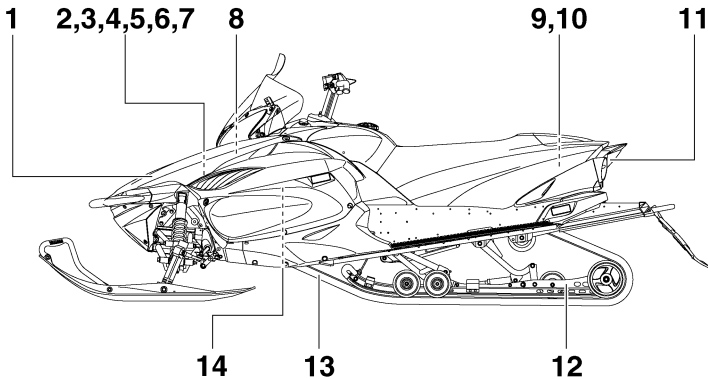

- |                          |                           |
|--------------------------|---------------------------|
| 1. Air filter            | 12. Slide rail suspension |
| 2. Battery               | 13. Drive track           |
| 3. Coolant recovery tank | 14. V-belt holder         |
| 4. Coolant reservoir     |                           |
| 5. Fuse box              |                           |
| 6. Main fuse             |                           |
| 7. Oil filler cap        |                           |
| 8. Idle adjusting screw  |                           |
| 9. Storage compartment   |                           |
| 10. Tool kit             |                           |
| 11. Tail/brake light     |                           |

# Description

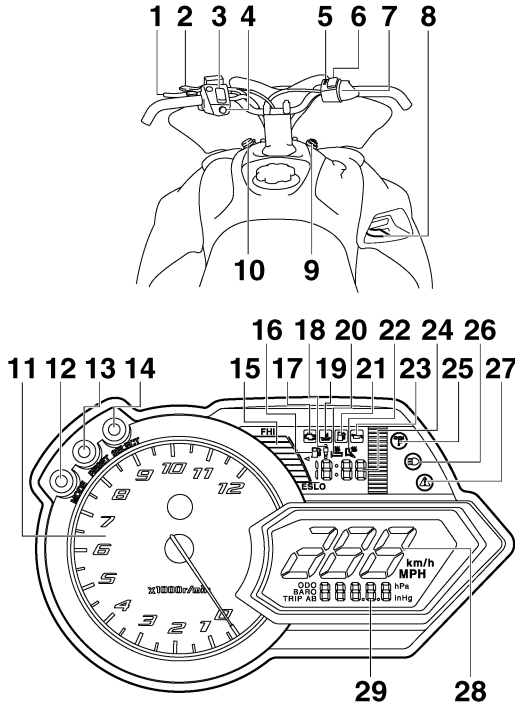

- |  |   |
|--|---|
| <ul style="list-style-type: none"> <li>1. Brake lever</li> <li>2. Parking brake lever</li> <li>3. Grip warmer/rear shock absorber compression damping adjustment switch</li> <li>4. Headlight beam switch</li> <li>5. Engine stop switch</li> <li>6. Thumb warmer adjustment switch</li> <li>7. Throttle lever</li> <li>8. Shift lever</li> <li>9. Main switch</li> <li>10. Auxiliary DC jack</li> <li>11. Tachometer</li> <li>12. "MODE" button</li> <li>13. "RESET" button</li> <li>14. "SELECT" button</li> <li>15. Fuel meter, grip warmer level indicator, rear shock absorber compression damping level indicator, and thumb warmer level indicator</li> <li>16. Fuel meter indicator</li> <li>17. Self-diagnosis warning indicator</li> <li>18. Rear shock absorber indicator</li> <li>19. Coolant temperature warning indicator</li> </ul> | <ul style="list-style-type: none"> <li>20. Grip warmer indicator</li> <li>21. Fuel level warning indicator</li> <li>22. Thumb warmer indicator</li> <li>23. Oil level warning indicator</li> <li>24. Clock</li> <li>25. Low coolant temperature indicator light</li> <li>26. High beam indicator light</li> <li>27. Warning light</li> <li>28. Speedometer</li> <li>29. Odometer/tripmeter/barometer</li> </ul> |
|--|---|

**TIP**

- The snowmobile you have purchased may differ slightly from those shown in the figures of this manual.
  - Design and specifications are subjected to change without notice.
-

# Control functions

ESU12691

## Main switch

The main switch controls the ignition and lighting systems. The various positions are described below.

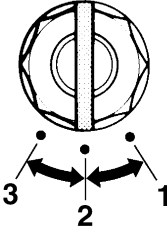

1. Off
2. On
3. Start

### Off

The ignition circuit is switched off.  
The key can be removed only in this position.

### On

The ignition circuit is switched on.

### Start

The starting circuit is switched on.  
The starter motor cranks the engine.

**NOTICE:** Release the switch immediately after the engine starts. [ECS00021]

### TIP

The headlights, meter lighting, and taillight come on after the engine is started.

ESU10312

## Throttle lever

Once the engine is running cleanly, squeezing the throttle lever will increase the engine speed and cause engagement of the drive train. Regulate the speed of the snowmobile by varying the throttle position. Because the throttle is spring-loaded, the snowmobile will decelerate, and the engine will return to idle when it is released.

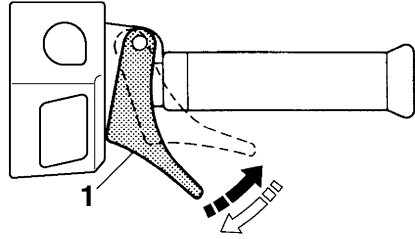

1. Throttle lever

ESU10321

## Engine overheating prevention system

This model is equipped with a system, which prevents overheating when the engine is idling.

When the engine has been idling for 3 minutes or longer and the coolant temperature has risen above 100 °C (212 °F), the engine automatically stops to prevent overheating.

### TIP

The engine can be started after it stops.

ESU10345

## Throttle override system (T.O.R.S.)

EWS00041

### WARNING

If the T.O.R.S. is activated, make sure that the cause of the malfunction has been corrected and that the engine can be operated without a problem before restarting the engine. Continuing to operate with a malfunction could cause loss of control or damage.

If the throttle bodies or throttle cable malfunctions during operation, the T.O.R.S. will operate when the throttle lever is released.

The T.O.R.S. is designed to override the fuel injection and limit the engine speed to less than the clutch engagement speed if the throt-

# Control functions

the valves fail to return to the idle position when the throttle lever is released. (See page 76 for the clutch engagement speed.)

	Idling / starting	Running	Trouble
<b>Throttle switch</b>	Off	On	Off
<b>Throttle position sensor</b>	Closed	Open	Open
<b>Engine</b>	Run	Run	T.O.R.S. will operate.

## Idling / starting

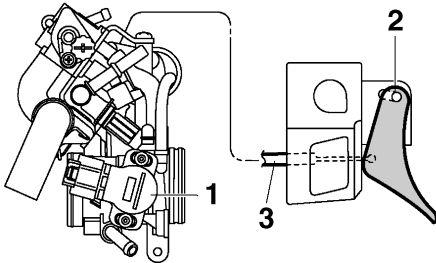

1. Throttle position sensor (throttle valve closed position)
2. Throttle switch (off)
3. Throttle cable

## Running

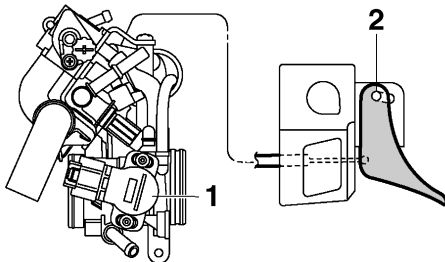

1. Throttle position sensor (throttle valve open position)
2. Throttle switch (on)

## Trouble

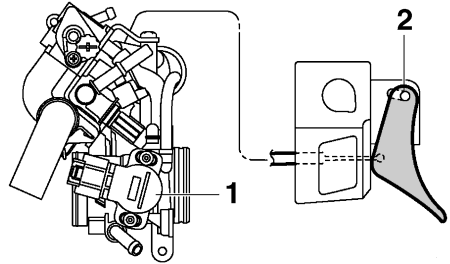

1. Throttle position sensor (throttle valve open position)
2. Throttle switch (off)

## TIP

- If the T.O.R.S. is activated, the warning light and self-diagnosis warning indicator will flash, and the two-digit code "84" will flash in the meter display.
- The T.O.R.S. monitors the condition of the throttle position sensor, speedometer assembly, and speed sensor, and will operate if any of the monitored items is disconnected or is malfunctioning.

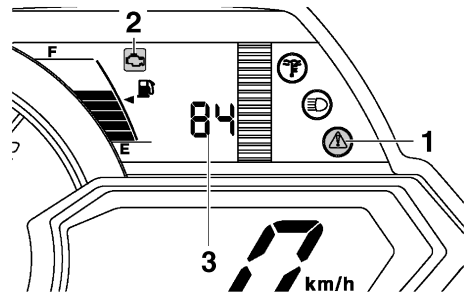

1. Warning light "⚠"
2. Self-diagnosis warning indicator "🔧"
3. Two-digit code "84"

ESU12603

## Speedometer unit



The speedometer unit is equipped with the following:

# Control functions

- a digital speedometer (which shows the riding speed)
- a tachometer (which shows engine speed)
- an odometer (which shows the total distance traveled)
- two tripmeters (which show the distance traveled since they were last set to zero)
- a barometer (which shows the ambient barometric pressure)
- a clock
- warning indicators (which show self-diagnosis, coolant temperature, fuel level, and oil level warnings)
- indicator lights (which show high beam and low coolant temperature conditions)
- a warning light (which shows warnings together with the warning indicators)
- a fuel meter (which shows the fuel remaining in the fuel tank)
- a grip/thumb warmer level indicator (which shows the grip warmer level or the thumb warmer level)
- a display brightness control function
- a rear shock absorber compression damping level indicator (which shows the compression damping force level of the electronically controlled rear shock absorber)

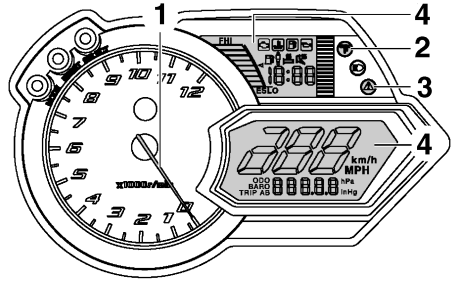
After the engine is started, the tachometer makes one sweep, and the low coolant temperature indicator light, the warning light, and all segments of the meter display turn on and off once.



1. Tachometer
2. Low coolant temperature indicator light “”
3. Warning light “”
4. Meter display

The grip warmer level or the rear shock absorber compression damping level is initially displayed for 5 seconds according to the selected mode, then the display switches to the fuel meter.

## Odometer, tripmeter, and barometer modes

Pushing the “SELECT” button switches the display between the odometer mode “ODO”, tripmeter modes “TRIP A” and “TRIP B”, and barometer mode “BARO”.

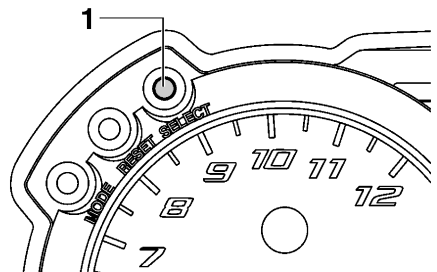

1. “SELECT” button

To reset a tripmeter, push the “RESET” button for at least 1 second while the tripmeter is displayed.



# Control functions

## TIP

- To switch the speedometer, odometer, and tripmeter displays between kilometers and miles, select the odometer mode “ODO”, and then push the “SELECT” button for at least 10 seconds while the snowmobile is stopped.
- To switch the barometer display between hectopascal “hPa” and inches of mercury “inHg”, select the barometer mode “BARO”, and then push the “SELECT” button for at least 3 seconds while the snowmobile is stopped.

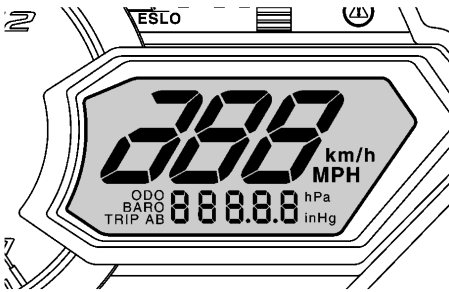

## Clock

To set the clock:

1. Push the “SELECT” button and “RESET” button simultaneously until the hour digits start flashing.

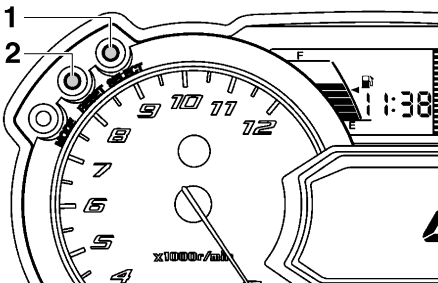

1. “SELECT” button
2. “RESET” button

2. Push the “RESET” button to change the hour setting, and then push the “SELECT” button. The minute digits will start flashing.
3. Push the “RESET” button to change the minute setting, and then push the “SELECT” button. The clock starts when the “SELECT” button is released.

## TIP

The clock must be set again when the battery is disconnected.

## Display brightness control

This function allows you to adjust the brightness of the meter display to suit the outdoor lighting conditions.

To adjust the display brightness

1. Turn the main switch to the off position.
2. Push and hold down the “SELECT” button.

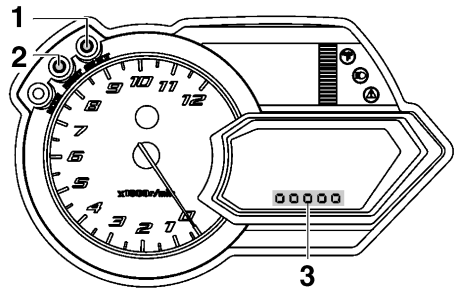

1. “SELECT” button
  2. “RESET” button
  3. Display brightness level
3. Turn the main switch to the on position, and then, after 5 seconds, release the “SELECT” button.
  4. Push the “RESET” button to select the desired display brightness level, and then push the “SELECT” button. The normal display returns when the “SELECT” button is released.

# Control functions

## TIP

If the main switch is turned to the off position or the engine is started before completing the procedure, the setting is not applied.

ESU10410

## High beam indicator light “”

The high beam indicator light comes on when the high beams of the headlights are switched on. (See page 16 for headlight beam switch operation.)

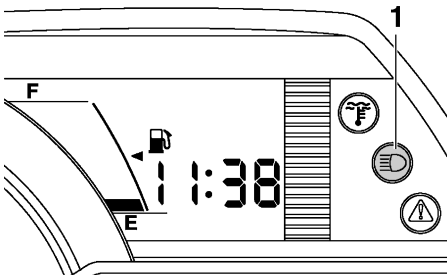



1. High beam indicator light “”

ESU10472

## Low coolant temperature indicator light “”

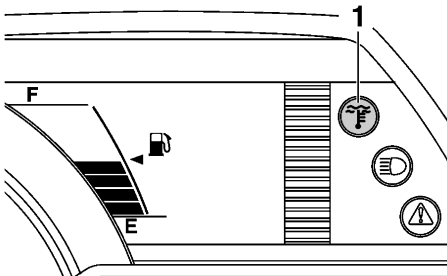
The low coolant temperature indicator light comes on when the coolant temperature is low and informs the rider that the snowmobile should be warmed up. After the engine is started, warm it up until the indicator light goes off.



1. Low coolant temperature indicator light “”

The snowmobile can be operated normally after the indicator light goes off.

## TIP

Drive the snowmobile at low speeds when the low coolant temperature indicator light is on. If the engine speed is too high, maximum engine speed is reduced to protect the engine.

ESU10442

## Fuel meter, grip warmer level indicator, rear shock absorber compression damping level indicator, and thumb warmer level indicator

The fuel meter, grip warmer level indicator, rear shock absorber compression damping level indicator, and thumb warmer level indicator have eight segments which show the amount of fuel remaining in the fuel tank, the grip warmer level or the thumb warmer level, and the compression damping force level of the electronically controlled rear shock absorber respectively.

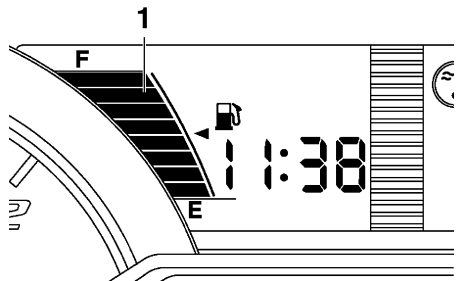



1. Fuel meter, grip warmer level indicator, rear shock absorber compression damping level indicator, and thumb warmer level indicator

## Fuel meter

The display segments of the fuel meter disappear towards “E” (Empty) as the fuel level decreases. When only one segment is left near “E”, the fuel level warning indicator and the warning light come on.

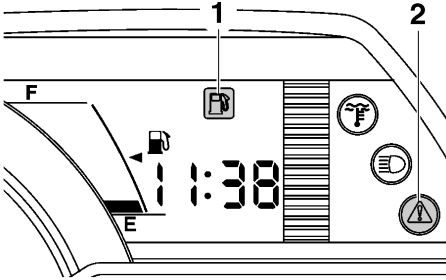
# Control functions



1. Fuel level warning indicator “”
2. Warning light “”

If the fuel level warning indicator and the warning light come on, refuel as soon as possible.



## TIP

The snowmobile must be stopped on a level surface to obtain an accurate fuel meter reading, since the reading changes according to the movement and inclination of the snowmobile.

## Grip warmer level indicator, rear shock absorber compression damping level indicator, and thumb warmer level indicator

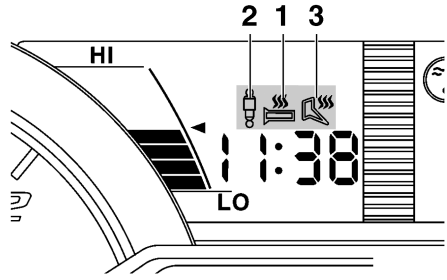
- To display the grip warmer level indicator or the rear shock absorber compression damping level indicator, press the grip warmer/rear shock absorber compression damping adjustment switch. To switch between the two level indicators, press the “MODE” button twice.
- To display the thumb warmer level indicator, press the thumb warmer adjustment switch.



1. Grip warmer indicator “”
2. Rear shock absorber indicator “”
3. Thumb warmer indicator “”

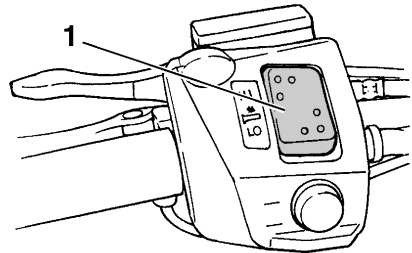

1. Grip warmer/rear shock absorber compression damping adjustment switch

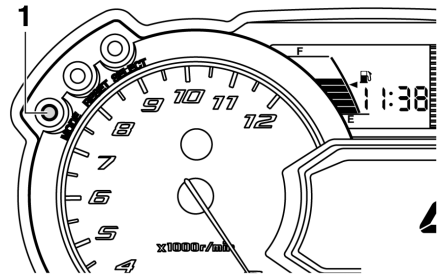

1. “MODE” button

# Control functions

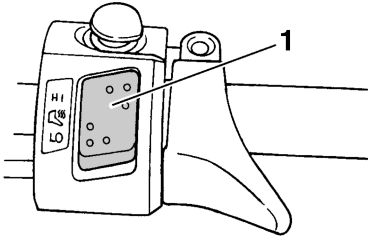

1. Thumb warmer adjustment switch

## TIP



- The grip warmer, rear shock absorber compression damping, and thumb warmer levels are displayed for 5 seconds after releasing the corresponding adjustment switch, then the display switches to the fuel meter.
- The top segment of the fuel meter, grip warmer level indicator, rear shock absorber compression damping level indicator, and thumb warmer level indicator flashes once when the corresponding adjustment reaches the maximum level. The bottom segment of the fuel meter, grip warmer level indicator, rear shock absorber compression damping level indicator, and thumb warmer level indicator flashes once when the corresponding adjustment reaches the minimum level.
- When the engine is started, the grip warmer, rear shock absorber compression damping, and thumb warmer levels are set to the levels selected when the engine was stopped.

### To adjust the grip warmer temperature

1. Push the “MODE” button and make sure that the grip warmer indicator is displayed. If the rear shock absorber indica-

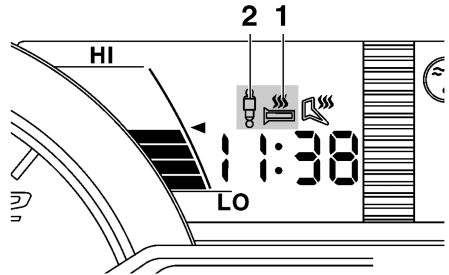
tor is displayed, push the “MODE” button again to display the grip warmer indicator.



1. Grip warmer indicator “”
  2. Rear shock absorber indicator “”
2. To raise the temperature, press the grip warmer/rear shock absorber compression damping adjustment switch to “HI”, and to lower it, press the switch to “LO”.

### To adjust the rear shock absorber compression damping level

1. Push the “MODE” button and make sure that the rear shock absorber indicator is displayed. If the grip warmer indicator is displayed, push the “MODE” button again to display the rear shock absorber indicator.

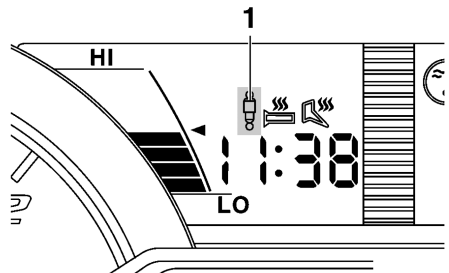

1. Rear shock absorber indicator “”

2. To increase the compression damping force, press the grip warmer/rear shock absorber compression damping adjustment switch to "HI", and to decrease it, press the switch to "LO".

## To adjust the thumb warmer temperature

To raise the temperature, press the thumb warmer adjustment switch to "HI", and to lower it, press the switch to "LO".

ESU10451

## Fuel level warning indicator "🛢️"

The fuel level warning indicator indicates a malfunctioning sensor, disconnected coupler, broken lead, or short circuit when detected by the self-diagnosis device of the snowmobile.

The fuel level warning indicator, warning light, and all segments of the fuel meter warn the rider of the above problems by flashing continuously.

If this occurs, have a Yamaha dealer inspect the snowmobile as soon as possible.

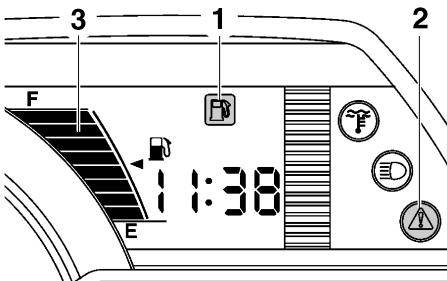

1. Fuel level warning indicator "🛢️"
2. Warning light "⚠️"
3. Fuel meter

ESU10460

## Oil level warning indicator "🛢️"

The oil level warning indicator and the warning light come on when the engine oil level is low.

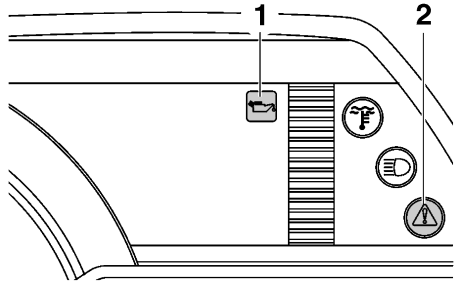

1. Oil level warning indicator "🛢️"
2. Warning light "⚠️"

If the oil level warning indicator and the warning light come on, place the snowmobile on a level surface and allow it to idle for one minute.

If the oil level warning indicator and the warning light go off, the engine oil level is sufficient, however it is getting low. Add engine oil as soon as possible.

If the oil level warning indicator and the warning light do not go off, check the engine oil level in the oil tank (see page 48 for engine oil level checking procedures), and add engine oil if necessary.



ESU10512

## Coolant temperature warning indicator "🌡️"

If the engine overheats, the coolant temperature warning indicator and the warning light come on. When this occurs, stop the engine immediately and allow the engine to cool down, and then check the coolant level in the coolant reservoir. (See page 52 for checking procedures.)

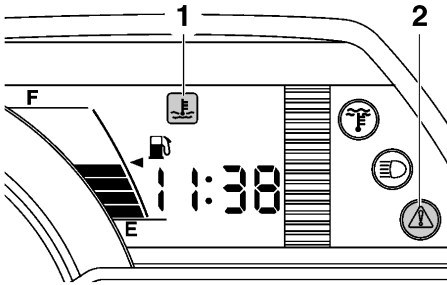
# Control functions



1. Coolant temperature warning indicator “”
2. Warning light “”

ECS00041

## NOTICE

**Do not continue to operate the engine if it is overheating.**

ESU12681



## Self-diagnosis device

This model is equipped with a self-diagnosis device for various electrical circuits.

If any of those circuits are not working correctly, the warning light and the self-diagnosis warning indicator will flash, and a two-digit error code will flash slowly in the tripmeter/odometer display. Note the error code, and then have a Yamaha dealer inspect the snowmobile as soon as possible. **NOTICE: Do not continue to operate the engine longer than necessary if there is an error code to avoid possible engine damage.**

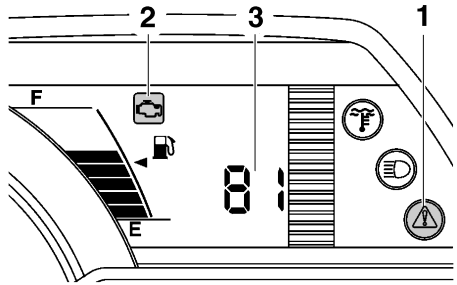
[ECS00820]



1. Warning light “”
2. Self-diagnosis warning indicator “”
3. Two-digit error code

ESU10530

## Engine stop switch “”

The engine stop switch is used to stop the engine in an emergency. Simply push the stop switch to stop the engine. To start the engine, pull the stop switch and proceed with starting the engine. (See pages 29 for engine starting procedures.)

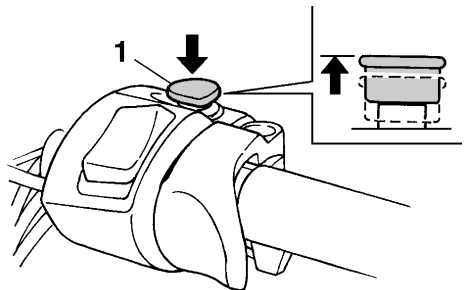

1. Engine stop switch “”

During the first few rides, practice using the stop switch so that you can react quickly in an emergency.

ESU10661

## Headlight beam switch “LIGHTS”

Push the headlight beam switch to change the headlight to high beam “HI” or to low beam “LO”.

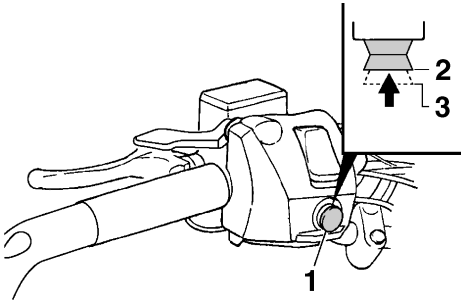

1. Headlight beam switch “LIGHTS”
2. High beam “HI”
3. Low beam “LO”

ESU12711

## Grip warmer/rear shock absorber compression damping and thumb warmer adjustment switches

These switches are used to adjust the grip warmer, rear shock absorber compression damping and thumb warmer levels.

See “Fuel meter, grip warmer level indicator, rear shock absorber compression damping level indicator, and thumb warmer level indicator” on page 12 for detailed information.

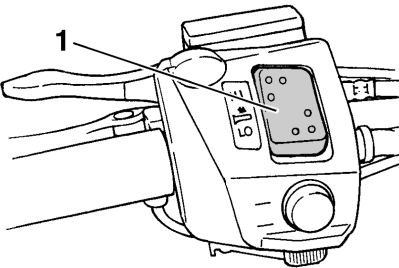

1. Grip warmer/rear shock absorber compression damping adjustment switch

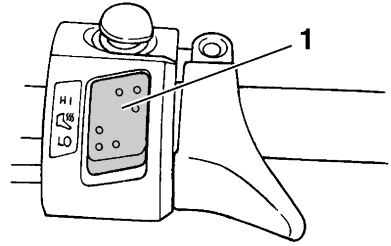

1. Thumb warmer adjustment switch

ESU10691

## Auxiliary DC jack

The auxiliary DC jack is located in the front panel and can be used for accessories.

### TIP

The auxiliary DC jack cannot be used if the engine is not running.

### To use the auxiliary DC jack

1. Start the engine.
2. Open the auxiliary DC jack cap, and then insert the accessory power plug into the jack.

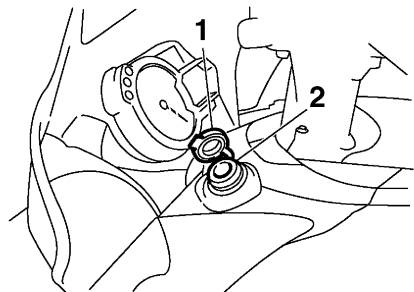

1. Auxiliary DC jack cap
2. Auxiliary DC jack
3. After using the auxiliary DC jack, be sure to remove the accessory power plug from the jack and to close the auxiliary DC jack cap.

# Control functions

ECS00120

## NOTICE

- Do not use accessories requiring more than the maximum rated capacity for the auxiliary DC jack. This may overload the circuit and cause the fuse to blow. (See page 67 for the specified amperage.)
- Do not use an automotive cigarette lighter or other accessory with a plug that gets hot because the jack can be damaged.

Maximum rated capacity:  
DC 12 V, 2.5 A (30 W)

ESU10560

## Brake lever

The snowmobile is stopped by braking the entire drive system.

Squeeze the brake lever towards the handlebar grip to stop the snowmobile.

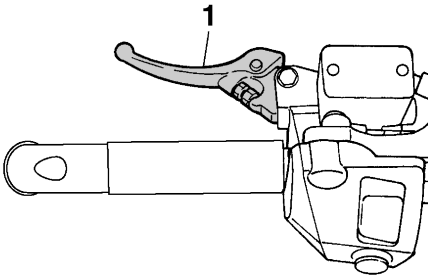

1. Brake lever

## TIP

When the brake lever is operated, the brake light will illuminate.

ECS00060

## NOTICE

Make sure that the brake lever end does not project out over the handlebar end. This will help prevent brake lever damage when the snowmobile is placed on its side for service.

The brake lever is equipped with a position adjuster.

To adjust the brake lever position:

1. Loosen the locknut.
2. While lightly pushing the brake lever in direction (a), finger tighten the adjusting bolt to set the brake lever to the desired position.

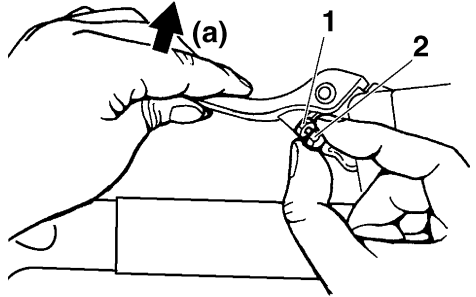

1. Locknut
2. Adjusting bolt
3. Tighten the locknut securely after adjusting the brake lever.

ESU10581

## Parking brake lever

When parking the snowmobile or starting the engine, apply the parking brake by moving the parking brake lever to the left.

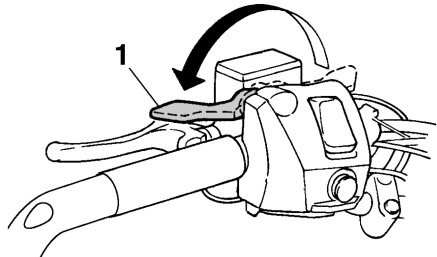

1. Parking brake lever

To release the parking brake, move the parking brake lever to the right.



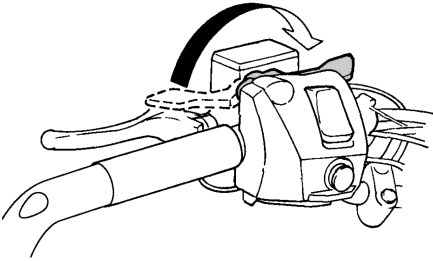

ESU10592

## Shift lever

The shift lever is used to put the snowmobile into forward or reverse. After coming to a complete stop, pull the shift lever out, slide it to “FWD” or to “REV” until it stops, and then release it.

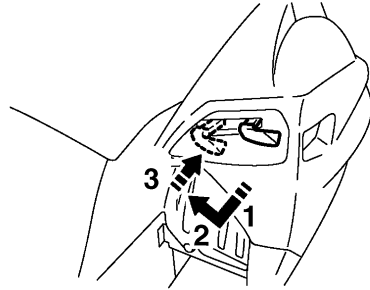

1. Pull out.
2. Slide to “REV” (reverse).
3. Release.

ECS00072

## NOTICE

**Do not use the shift lever while the snowmobile is moving, otherwise the drive train could be damaged.**

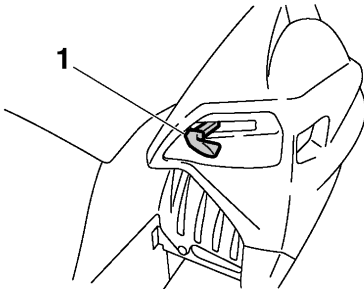

1. Shift lever

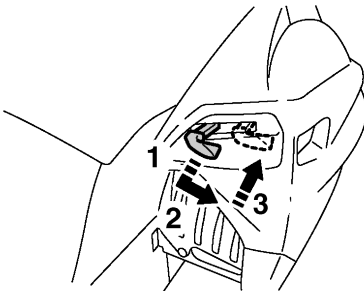

1. Pull out.
2. Slide to “FWD” (forward).
3. Release.

ESU10721

## Shroud and covers

Securely fasten the shroud and covers before operating the snowmobile. (See page 41 for removal and installation procedures.)



1. Shroud
2. Right side cover

# Control functions

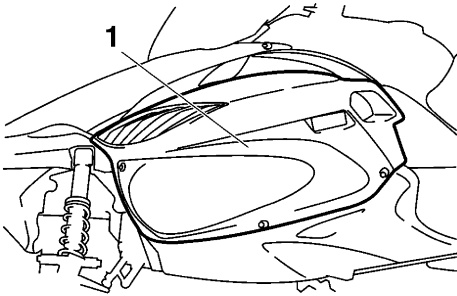

1. Left side cover

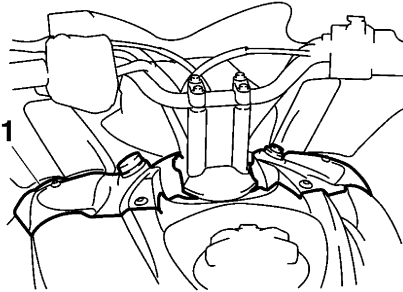

1. Top cover

ESU10751

## Drive guard

EWS00401

### WARNING

- Coming in contact with the rotating V-belt or clutch parts can cause severe injury or death. Never run the engine with the drive guard removed.
- Make sure that the drive guard is tightened securely before operating the snowmobile to protect against severe injury or death from a broken V-belt or other part should it come off the snowmobile while it is in operation.

ECS00830

### NOTICE

Never run the engine with the V-belt removed. Clutch components can be damaged.

The drive guard is designed to cover the V-belt clutch and V-belt in case parts break or come loose.

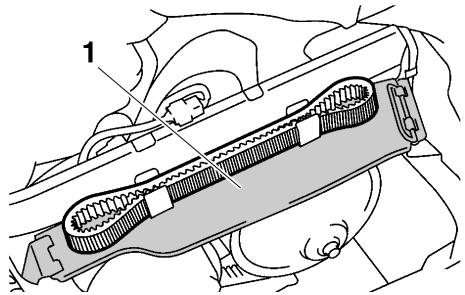

1. Drive guard

ESU10760

## V-belt holders

Keep a spare V-belt for emergency use by placing it into the V-belt holders provided.

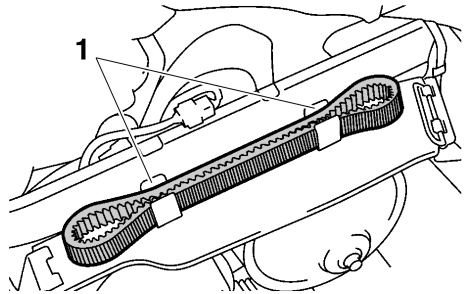

1. V-belt holder

ECS00180

### NOTICE

Make sure that the V-belt is installed securely in the holders.

ESU10810

## Storage compartment

Open the storage compartment to store the tool kit, spare parts, or other small items.

# Control functions

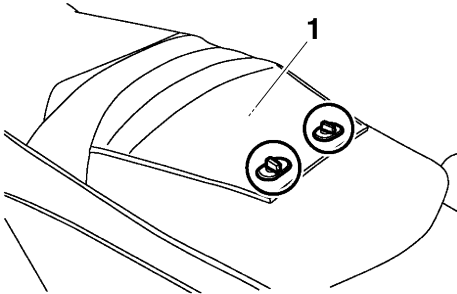

1. Storage compartment

ESU10601

## Fuel

Make sure there is sufficient gasoline in the tank.

EWS00071

### **WARNING**

**Gasoline and gasoline vapors are extremely flammable. To avoid fires and explosions and to reduce the risk of injury when refueling, follow these instructions.**

1. Before refueling, turn off the engine and be sure that nobody is on the snowmobile. Never refuel while smoking, or while in the vicinity of sparks, open flames, or other sources of ignition such as the pilot lights of water heaters and clothes dryers.
2. Do not overfill the fuel tank. Stop filling when the fuel reaches the bottom of the filler tube. Because fuel expands when it heats up, heat from the engine or the sun can cause fuel to spill out of the fuel tank.

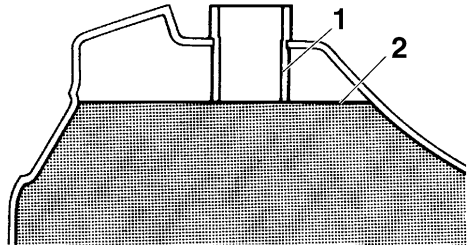
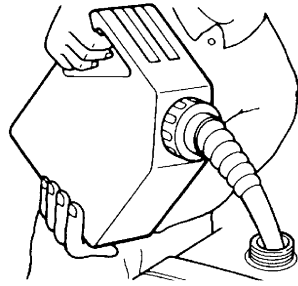

1. Filler tube
2. Fuel level

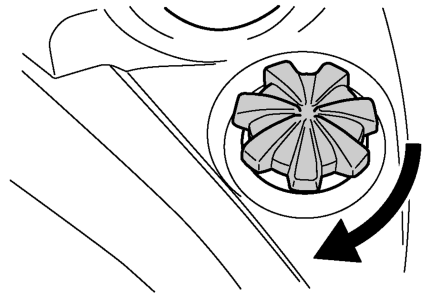

3. Wipe up any spilled fuel immediately.
4. Be sure the fuel tank cap is closed securely by turning it clockwise.

EWS00680

### **WARNING**

**Gasoline is poisonous and can cause injury or death. Handle gasoline with care. Never siphon gasoline by mouth. If you should swallow some gasoline or inhale a lot of gasoline vapor, or get some gasoline**

# Control functions

---

in your eyes, see your doctor immediately. If gasoline spills on your skin, wash with soap and water. If gasoline spills on your clothing, change your clothes.

Recommended fuel: REGULAR UNLEADED GASOLINE ONLY Fuel tank capacity: 35.6 L (9.41 US gal, 7.83 Imp.gal)
---

Your Yamaha engine has been designed to use regular unleaded gasoline with a pump octane number [(R+M)/2] of 86 or higher, or a research octane number of 91 or higher.

ECS00080

## NOTICE

- **Oxygenated fuels (gasohol) containing a maximum 5% of ethanol can be used, although richer jetting may be required to prevent engine damage. Consult a Yamaha dealer. Gasohol containing methanol is not recommended.**
- **Make sure that snow or ice does not enter the fuel tank when refueling.**
- **Do not use alcohol deicers or water absorbing additives with oxygenated fuel.**
- **The fuel tank should be filled with straight gasoline as specified.**

ESU10872

## Suspension

The suspension can be adjusted to suit rider preference. Softer settings, for example, may provide greater rider comfort, while harder settings may allow more precise handling and control over certain types of terrain or riding conditions.

If you are not familiar with suspension adjustments, have a Yamaha dealer make these adjustments.

EWS00151

## WARNING

Read and understand the following information before handling shock absorbers that contain highly pressurized nitrogen gas.

- **Do not tamper with or attempt to open the cylinder assemblies.**
- **Do not subject the shock absorbers to an open flame or other high heat source. This may cause the unit to explode due to excessive gas pressure.**
- **Do not deform or damage the cylinders in any way. Cylinder damage will result in poor damping performance.**
- **Do not dispose of a damaged or worn out shock absorber yourself. Take the shock absorber to a Yamaha dealer for any service.**

ESU10893

## Adjusting the spring preload of the front shock absorbers

EWS00720

## WARNING

The spring preload of the left and right shock absorbers must be adjusted to the same setting. Uneven settings can cause poor handling and loss of stability.

The spring preload can be adjusted by turning the adjusting nuts.

Adjust the spring preload as follows.

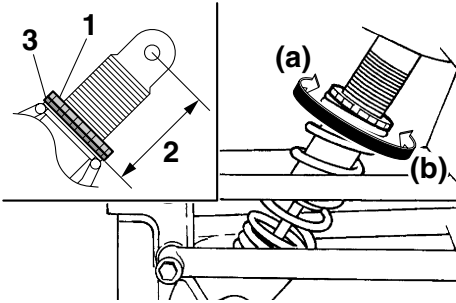

1. Locknut
2. Distance A
3. Spring preload adjusting nut

1. Loosen the locknut.
2. To increase the spring preload and thereby harden the suspension, turn the adjusting nut in direction (a). To decrease the spring preload and thereby soften the suspension, turn the adjusting nut in direction (b).

## TIP

The spring preload setting is determined by measuring distance A, shown in the illustration. The longer distance A is, the higher the spring preload; the shorter distance A is, the lower the spring preload.

### Spring preload setting\*:

Minimum (soft):

119.0 mm (4.69 in)

Standard:

119.0 mm (4.69 in)

Maximum (hard):

129.0 mm (5.08 in)

\* Distance A changes 1.5 mm (0.06 in) with each full turn of the adjusting nut.

3. Tighten the locknut to the specified torque. **NOTICE: Always tighten the locknut against the adjusting nut, and then tighten the locknut to the specified torque.** [ECS00860]

Tightening torque:

Locknut:

42 Nm (4.2 m·kgf, 30 ft·lbf)

ESU10924

## Adjusting the damping forces of the front shock absorbers

EWS00740

### ⚠ WARNING

The damping forces of the left and right shock absorbers must be adjusted to the same settings. Uneven settings can cause poor handling and loss of stability.

### Compression damping force

The compression damping force of each shock absorber can be adjusted by turning its compression damping force adjusting knob.

To increase the compression damping force, turn the adjusting knob in direction (a). To decrease the compression damping force, turn the adjusting knob in direction (b).

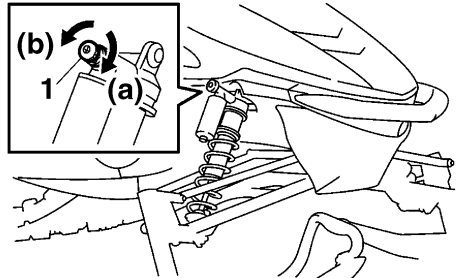

1. Compression damping force adjusting knob

### Compression damping setting:

Minimum (soft):

12 click(s) in direction (b)\*

Standard:

7 click(s) in direction (b)\*

Maximum (hard):

2 click(s) in direction (b)\*

\* With the adjusting knob fully turned in direction (a)

# Control functions

## Rebound damping force

The rebound damping force of each shock absorber can be adjusted by turning its rebound damping force adjusting knob.

To increase the rebound damping force, turn the adjusting knob in direction (a). To decrease the rebound damping force, turn the adjusting knob in direction (b).

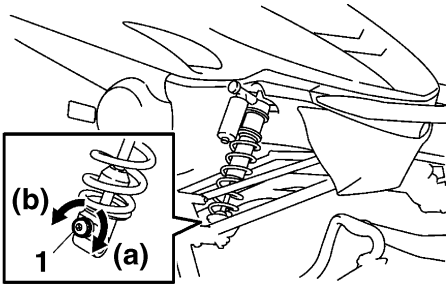

1. Rebound damping force adjusting knob

Rebound damping setting:

Minimum (soft):

20 click(s) in direction (b)\*

Standard:

12 click(s) in direction (b)\*

Maximum (hard):

3 click(s) in direction (b)\*

\* With the adjusting knob fully turned in direction (a)

## TIP

The damping forces will not decrease past the minimum levels even if the adjusting knobs are turned out more than the minimum settings.

ESU13082

## Adjusting the spring preload of the rear shock absorber

The spring preload can be adjusted by turning the adjusting nut on the rear shock absorber. Adjust the spring preload as follows.

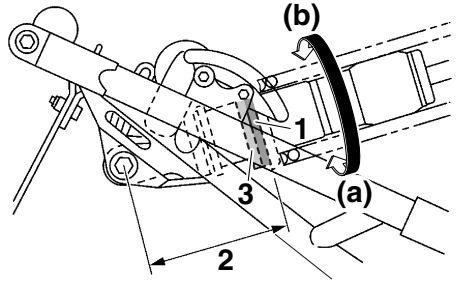

1. Spring preload adjusting nut
2. Distance A
3. Locknut

1. Loosen the locknut.
2. To increase the spring preload and thereby harden the suspension, turn the adjusting nut in direction (a). To decrease the spring preload and thereby soften the suspension, turn the adjusting nut in direction (b).

## TIP

The spring preload setting is determined by measuring distance A, shown in the illustration. The longer distance A is, the higher the spring preload; the shorter distance A is, the lower the spring preload.

Spring preload setting\*:

Minimum (soft):

120.5 mm (4.74 in)

Standard:

128.5 mm (5.06 in)

Maximum (hard):

RX10GT 145.5 mm (5.73 in)

RX10LTGT 138.5 mm (5.45 in)

\* Distance A changes 1.5 mm (0.06 in) with each full turn of the adjusting ring.

3. Tighten the locknut to the specified torque. **NOTICE: Always tighten the locknut against the adjusting nut, and then tighten the locknut to the specified torque.** [ECS00860]

Tightening torque:  
Locknut:  
25 Nm (2.5 m·kgf, 18 ft·lbf)

ESU11014

## Adjusting the damping forces of the rear shock absorber

### Adjusting the compression damping force

The compression damping force can be adjusted by pressing the grip warmer/rear shock absorber compression damping adjustment switch. (See page 12 for adjustment procedures.)

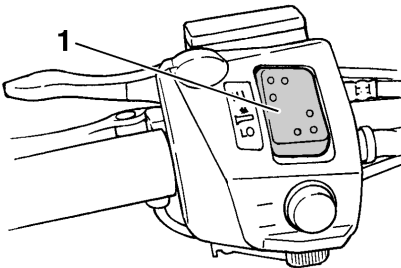

1. Grip warmer/rear shock absorber compression damping adjustment switch

### Adjusting the rebound damping force

The rebound damping force can be adjusted by turning the adjusting dial.

To increase the rebound damping force, turn the adjusting dial in direction (a). To decrease the rebound damping force, turn the adjusting dial in direction (b).

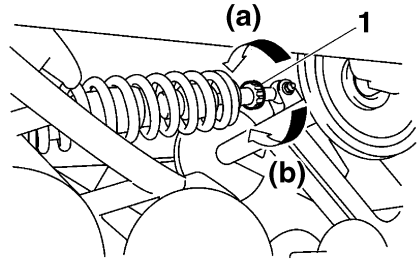

1. Rebound damping force adjusting dial

### Rebound damping setting:

Minimum (soft):

30 click(s) in direction (b)\*

Standard:

20 click(s) in direction (b)\*

Maximum (hard):

10 click(s) in direction (b)\*

\* With the adjusting dial fully turned in direction (a)

ESU11053

## Adjusting the control rod

The weight transfer can be adjusted by turning the adjuster on the control rod.

1. Check the control rod length using the scale on the special wrench as shown.

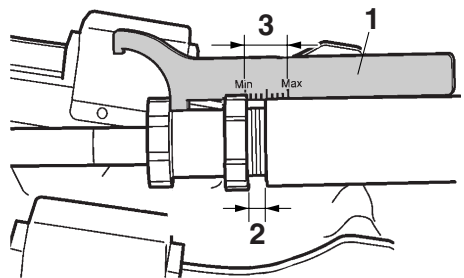

1. Special wrench
2. Control rod length
3. Scale range

### TIP

Use the special wrench in the owner's tool kit to make this adjustment.

# Control functions

---

2. Loosen the locknut.

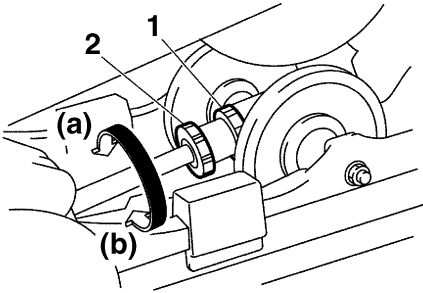

1. Locknut
  2. Control rod adjuster
3. To increase weight transfer, turn the adjuster in direction (a), and to decrease weight transfer, turn it in direction (b).  
**WARNING! Never adjust the control rod beyond the range of the scale on the special wrench, otherwise the control rod could be damaged, which could lead to an accident or injury.**

[EWS00181]

4. Tighten the locknut while holding the adjuster in place. **NOTICE: Make sure that the special wrench is positioned at a right angle to the control rod, and that it is tightly fitted on the locknut or the control rod adjuster.** [ECS00322]

Locknut tightening torque: 35 Nm (3.5 m-kgf, 25 ft-lbf)
--



# Pre-operation checks

ESU11071

Inspect your vehicle each time you use it to make sure the vehicle is in safe operating condition. Always follow the inspection and maintenance procedures and schedules described in the Owner's Manual.

EWS00191



**Failure to inspect or maintain the vehicle properly increases the possibility of an accident or equipment damage. Do not operate the vehicle if you find any problem. If a problem cannot be corrected by the procedures provided in this manual, have the vehicle inspected by a Yamaha dealer.**

ESU11080

## Pre-operation check list

ITEM	CHECKS	PAGE
<b>Fuel</b>	<ul style="list-style-type: none"><li>• Check fuel level.</li><li>• Refuel if necessary.</li><li>• Check fuel line for leakage.</li></ul>	21
<b>Engine oil</b>	<ul style="list-style-type: none"><li>• Check oil level in engine.</li><li>• If necessary, add recommended oil to specified level.</li><li>• Check vehicle for oil leakage.</li></ul>	48
<b>Coolant</b>	<ul style="list-style-type: none"><li>• Check coolant level.</li><li>• Add if necessary.</li></ul>	52
<b>V-belt</b>	<ul style="list-style-type: none"><li>• Check for wear and damage.</li><li>• Replace if necessary.</li></ul>	53
<b>Drive guard</b>	<ul style="list-style-type: none"><li>• Make sure that drive guard is tightened securely.</li><li>• Check the drive guard mounts for damage.</li></ul>	20
<b>Brake</b>	<ul style="list-style-type: none"><li>• Check operation.</li><li>• If soft or spongy, have Yamaha dealer bleed hydraulic system.</li><li>• Check brake pads for wear.</li><li>• Replace if necessary.</li><li>• Check fluid level in master cylinder.</li><li>• If necessary, add recommended brake fluid to specified level.</li><li>• Check hydraulic system for leakage.</li></ul>	58
<b>Air filter</b>	<ul style="list-style-type: none"><li>• Check that there is no snow under the air filter element.</li><li>• If necessary, brush off the snow.</li></ul>	46
<b>Tool kit and recommended equipment</b>	<ul style="list-style-type: none"><li>• Check for proper placement.</li></ul>	41
<b>Shroud and covers</b>	<ul style="list-style-type: none"><li>• Make sure that the shroud and covers are securely fastened.</li></ul>	19
<b>Skis and ski runners</b>	<ul style="list-style-type: none"><li>• Check for wear and damage.</li><li>• If necessary, have Yamaha dealer replace skis or ski runners.</li></ul>	60

# Pre-operation checks

---

ITEM	CHECKS	PAGE
<b>Drive track</b>	<ul style="list-style-type: none"><li>• Check for deflection, wear and damage.</li><li>• If necessary, have Yamaha dealer replace track.</li></ul>	61
<b>Slide runners</b>	<ul style="list-style-type: none"><li>• Check for wear and damage.</li><li>• If necessary, have Yamaha dealer replace slide runners.</li></ul>	61
<b>Steering</b>	<ul style="list-style-type: none"><li>• Check for excessive free play.</li></ul>	60
<b>Lights, signals and switches</b>	<ul style="list-style-type: none"><li>• Check operation.</li><li>• Correct if necessary.</li></ul>	16, 16, 64, 65
<b>Throttle lever</b>	<ul style="list-style-type: none"><li>• Make sure that operation is smooth and spring back to its home position when released.</li></ul>	8
<b>Throttle override system (T.O.R.S.)</b>	<ul style="list-style-type: none"><li>• Check the T.O.R.S. for proper operation.</li><li>• If system is defective, have Yamaha dealer check vehicle.</li></ul>	46

ESU13210

## TIP

This model is equipped with an engine oil pressure switch to stop the engine in case an engine oil pressure drop is detected. To start the engine after this system has stopped the engine, be sure to place the snowmobile on a level surface, and then turn the key in the main switch to the off position, and then to the on position. Failing to do so will prevent the engine from starting even though the engine will crank when turning the key to the start position. If the engine does not start or if it stops again, ask a Yamaha dealer to inspect the snowmobile.

ESU11302

## Starting the engine

Read the Owner's Manual carefully to become familiar with all controls. If there is a control or function you do not understand, ask your Yamaha dealer.

EWS00201

## WARNING

**Failure to familiarize yourself with the controls can lead to loss of control, which could cause an accident or injury.**

1. Apply the parking brake.

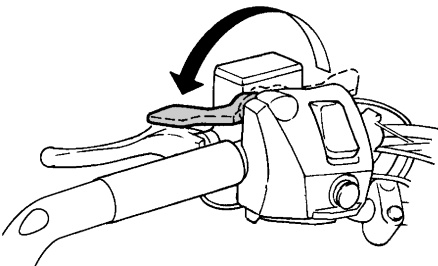

2. Be sure the engine stop switch is in the run position. The starter motor cannot be operated when the engine stop switch is in the off position.

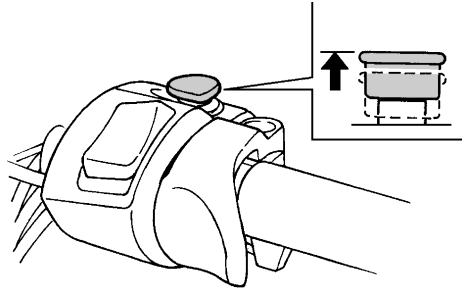

3. Turn the main switch to the start position and release it when the engine starts.  
**NOTICE: Release the switch immediately after the engine starts. If the engine fails to start, release the switch, wait a few seconds, then try again. Each attempt should be as short as possible to preserve the battery. Do not crank the engine more than 10 seconds on any one attempt.** [ECS00331]

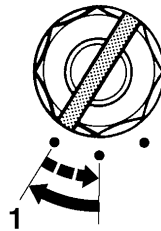

1. Start
4. Warm up the engine until it runs smoothly.
5. Be sure the low coolant temperature indicator light has gone out before operation. (See page 12 for detailed information about the indicator light.)

# Operation

---

ESU11310

## Break-in

There is never a more important period in the life of your engine than the period between 0 and 500 km (300 mi). For this reason, you should read the following material carefully.

Since the engine is brand new, do not put an excessive load on it for the first 500 km (300 mi). The various parts in the engine wear and polish themselves to the correct operating clearances. During this period, prolonged full-throttle operation or any condition that might result in engine overheating must be avoided.

### Operating your snowmobile for the first time

Start the engine and let it idle for 15 minutes.

#### 0–160 km (0–100 mi)

Avoid prolonged operation above 6000 r/min.

#### 160–500 km (100–300 mi)

Avoid prolonged operation above 8000 r/min.

#### 500 km (300 mi) and beyond

The snowmobile can now be operated normally.

ECS00340

### NOTICE

- After 800 km (500 mi) of operation, the engine oil must be changed and the oil filter cartridge replaced.
- If any engine trouble should occur during the engine break-in period, immediately have a Yamaha dealer check the snowmobile.

ESU11333

## Riding your snowmobile

### Getting to know your snowmobile

EWS00211



### WARNING

To avoid severe injury or death:

- Keep both hands on the handlebar during operation.
- Never put your feet outside the running boards.

- Avoid higher speeds or more difficult maneuvers until you have become thoroughly familiar with your snowmobile and all of its controls.

A snowmobile is a rider active vehicle, and your riding position and your balance are the two basic factors of maneuvering your snowmobile.

Riding your snowmobile requires skills acquired through practice over a period of time. Take the time to learn the basic techniques well before attempting more difficult maneuvers.

Riding your new snowmobile can be a very enjoyable activity, providing you with hours of pleasure. However, it is essential to familiarize yourself with the operation of the snowmobile to achieve the skill necessary to enjoy riding safely. Before operating the snowmobile, read this Owner's Manual completely and understand the operation of the controls. Pay particular attention to the safety information on page 3.

Please read all warning and notice labels on your snowmobile. Also, read the Snowmobiler's Safety Handbook that is supplied with your snowmobile.

### Learning to ride your snowmobile

Before you ride, always perform the pre-operation checks listed on page 27. The short time spent checking the condition of the snowmobile will be rewarded with added safety and a more reliable snowmobile. Always wear the proper clothing for both warmth and to help protect you from injury if an accident occurs. Become familiar with operating your snowmobile at low speeds, even if you are an experienced rider. Do not attempt to operate at maximum performance until you are totally familiar with the snowmobile's handling and performance characteristics.

The beginning operator should select a large flat area to become familiar with the snowmobile. Make sure that this area is free of obstacles and other traffic. You should practice control of the throttle and brake, and master turning techniques in this area before trying more difficult terrain.

Set the parking brake and follow the instructions on page 29 to start the engine. Once the engine has warmed up, you are ready to begin riding your snowmobile.

## To start out and accelerate

1. With the engine idling, release the parking brake.
2. Apply the throttle slowly and smoothly. The V-belt clutch will engage and you will start to accelerate. **WARNING! Do not allow anyone to stand behind the snowmobile when starting the engine. A broken track, track fittings, or debris thrown by the track could be dangerous to bystanders.** [EWS00690]

## Braking

EWS00220

### **WARNING**

- Many surfaces such as ice and hard-packed snow require much longer stopping distances. Be alert, plan ahead, and begin decelerating early.
- Improper use of the brake can cause the drive track to lose traction, reduce control, and increase the possibility of an accident.

When slowing down or stopping, release the throttle and apply the brake gently—not suddenly.

## Turning

For most snow surfaces, “body English” is the key to turning.

As you approach a curve, slow down and begin to turn the handlebar in the desired direction. As you do so, put your weight on the running board to the inside of the turn and lean your upper body into the turn.

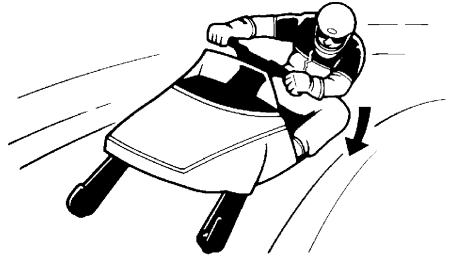

This procedure should be practiced at low speeds many times, in a large flat area with no obstacles. Once you have learned this technique, you should be able to perform it at higher speeds or in tighter curves. Lean more as the turn gets sharper or is made at higher speeds.

Improper riding techniques such as abrupt throttle changes, excessive braking, incorrect body movements, or too much speed for the sharpness of the turn may cause the snowmobile to tip.

If your snowmobile begins to tip while turning, lean more into the turn to regain balance. If necessary, gradually let off on the throttle and steer to the outside of the turn.

## Remember:

Avoid higher speeds until you are thoroughly familiar with the operation of your snowmobile.

## Riding uphill

EWS00231

### **WARNING**

**Operation on slopes can lead to loss of control if proper techniques are not used. Follow these instructions to reduce your**

# Operation

---

risk of an accident. Do not try steeper or more difficult inclines until you have developed your skill on gentle slopes.

You should practice first on gentle slopes. Try more difficult climbs only after you have developed your skill. As you approach a hill, accelerate before you start the climb, and then reduce the throttle to prevent track slippage. It is also important to keep your weight on the uphill side at all times. On climbs straight up the hill, this can be accomplished by leaning forward and, on steeper inclines, standing on the running boards and leaning forward over the handlebar. (Also see “Traversing a slope”.)

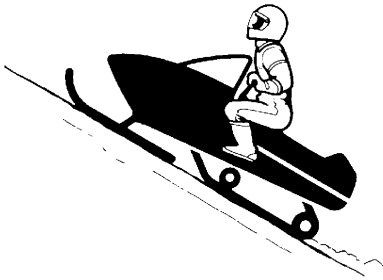

Slow down as you reach the crest of the hill, and be prepared to react to obstacles, sharp drops, or other vehicles or people which may be on the other side. If you are unable to continue up a hill, do not spin the track. Stop the engine and set the parking brake. Then pull the rear of the snowmobile around to point the snowmobile back down the hill. When the snowmobile is pointed downhill, mount your snowmobile from the uphill side. Restart the engine, release the parking brake, and descend the hill.

## Riding downhill

EWS00240



**WARNING**

**Use extra caution when applying the brake during a descent. Excessive braking will cause the drive track to lock, causing a loss of control.**

When riding downhill, keep speed to a minimum. It is important to apply just enough throttle to keep the clutch engaged while descending the hill. This will allow you to use engine compression to help slow the snowmobile, and to keep the snowmobile from rolling freely down the hill. Also apply the brake frequently, with light pressure.

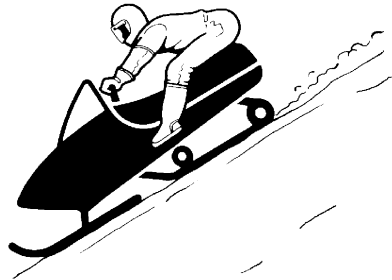

## Traversing a slope

EWS00251



**WARNING**

**Driving across the face of a slope (“side-hilling”) can lead to overturn or loss of control if proper techniques are not used. Follow these instructions to reduce your risk of an accident. Do not try steeper or more difficult inclines until you have developed your skill on gentle slopes.**

Traversing a slope requires you to properly position your weight to maintain proper balance. As you travel across the slope, lean your body to position your weight towards the uphill side. A recommended riding position is to kneel with the knee of your downhill leg on

the seat and the foot of your uphill leg on the running board. This position will make it easier for you to shift your body weight as needed.

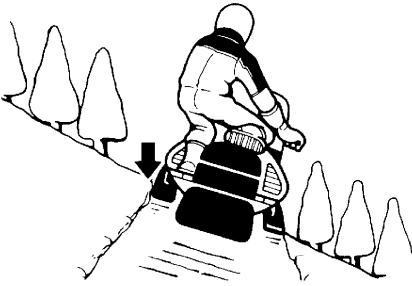

Snow and ice are slippery, so be prepared for the possibility that your snowmobile could begin to slip sideways on the slope. If this happens, steer in the direction of the slide if there are no obstacles in your path. As you regain proper balance, gradually steer again in the direction you wish to travel.

If your snowmobile starts to tip, steer down the hill to regain balance. **WARNING! If you are unable to maintain correct balance, and your snowmobile is going to tip over, dismount your snowmobile immediately on the uphill side to avoid being hit or caught under the snowmobile as it tips over.** [EWS00261]

## Ice or icy surface

EWS00270



**WARNING**

**When you have to operate on ice or icy surfaces, drive slowly and cautiously. Avoid accelerating, turning, and braking rapidly. Steering is minimal and uncontrolled spins are an ever-present danger.**

Operating on ice or icy surfaces can be very dangerous. Traction for turning, stopping, and starting is much less than that on snow.

## Hard-packed snow

It can be more difficult to negotiate on hard-packed snow as both the skis and drive track do not have as much traction as when the snowmobile is operated on fresh snow. Avoid rapid acceleration, turning, and braking.

## Operation on surfaces other than snow or ice

Operation of your snowmobile on surfaces other than snow or ice should be avoided. Operation under such conditions will damage or result in rapid wear of the ski runners, drive track, slide runners, and drive sprockets. Operation of the snowmobile on the following surfaces should be avoided at all times:

- Dirt
- Sand
- Rocks
- Grass
- Bare pavement

Other surfaces that should be avoided for the sake of drive track and slide runner life are:

- Glare ice surfaces
- Snow mixed with a lot of dirt and sand

All of the above surfaces have one thing in common in regard to drive track and slide runners: little or no lubricating ability. Drive track and all slide rail systems require lubrication (snow or water) between the slide runners and the slide metal. In the absence of lubrication, the slide runners will rapidly wear and in severe cases, literally melt away, and the drive track will be subject to damage or failure. Also traction aids such as studs, cleats, etc., may cause further track damage or failure.

EWS00280



**WARNING**

**Drive track damage or failure could result in loss of braking ability and snowmobile control, which could cause an accident.**

# Operation

---

- **Always check the drive track for damage or maladjustment before operating the snowmobile.**
  - **Do not operate the snowmobile if you find damage to the drive track.**
- 

ECS00350

## **NOTICE**

**Ride on fresh snow frequently. Operating on ice or hard-packed snow will rapidly wear the slide runners.**

---

ESU11350

## **Maximizing drive track life**

### **Recommendations**

#### **Track tension**

During initial break-in, the new drive track will tend to stretch quickly as the track settles. Be sure to correct the track tension and alignment frequently. (See page 61 for adjustment procedures.) A loose track can slip (ratchet), derail or catch on suspension parts causing severe damage. Do not overtighten the drive track, otherwise it may increase the friction between the track and the slide runners, resulting in the rapid wear of both components. Also, this may put an excessive load on the suspension components, resulting in component failure.

#### **Marginal snow**

The drive track and the slide runners are lubricated and cooled by snow and water. To prevent the drive track and slide runners from overheating, avoid sustained high-speed usage in areas such as icy trails, frozen lakes and rivers that have minimal snow coverage. An overheated track will be weakened internally, which may cause failure or damage.

#### **Off-trail riding**

Avoid off-trail riding until there is sufficient snow coverage. It generally takes several feet of snow to provide a good overall base to properly cover debris, such as rocks, logs,

etc. If snow coverage is not sufficient, stay on trails to avoid impact damage to the drive track.

#### **Studded track**

In general, track life will be shortened when studs are installed. Drilling stud holes into the drive track will cut the internal fibers, which weakens the track. Avoid spinning the drive track. Studs may catch on an object and pull out of the track, leaving tears and damage around the already weakened area. To minimize possible damage, consult your stud manufacturer for installation and stud pattern recommendations.

**Yamaha does not recommend track stud-ding.**

ESU11392

## **Driving**

EWS00300

### **⚠ WARNING**

**Be sure to read the “SAFETY INFORMATION” section on page 3 and the “Riding your snowmobile” section on page 30 carefully before operating the snowmobile.**

---

### **TIP**

Make sure that the engine is warmed up enough before riding.

---

EWS00310

### **⚠ WARNING**

- **Make sure that the throttle lever is fully released and the snowmobile is at a full stop before shifting.**
- **Be sure to slide the shift lever to “FWD” or “REV” until it stops completely and only while the engine is idling.**
- **Make sure that the area behind the snowmobile is clear before reversing. Watch behind.**



- Reduce speed and avoid sharp turning when operating the snowmobile in reverse.

1. To select the desired operating position, pull the shift lever out, slide it to “FWD” or to “REV” until it stops, and then release it.  
**NOTICE: Do not shift from “FWD” to “REV” or from “REV” to “FWD” while the snowmobile is moving, as the drive train could be damaged.** [ECS00811]

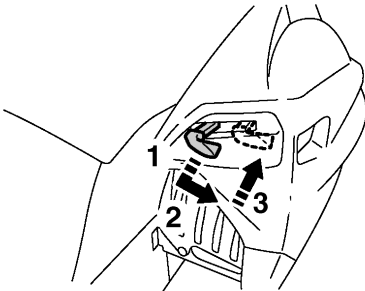

1. Pull out.
2. Slide to “FWD” (forward).
3. Release.

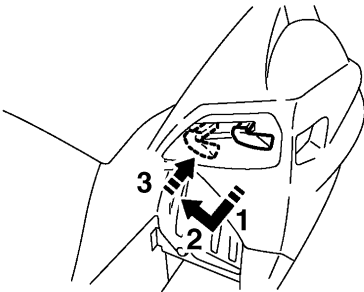

1. Pull out.
2. Slide to “REV” (reverse).
3. Release.

## TIP

The reverse buzzer beeps while the shift lever is in reverse.

2. Release the parking brake by moving the parking brake lever to the right.

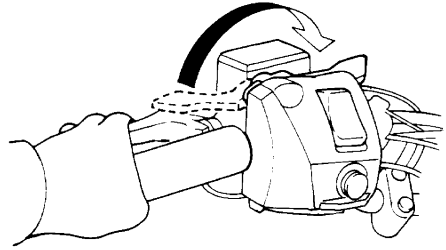

3. Press the throttle lever slowly to move the snowmobile.
4. Turn the handlebar in the desired direction.
5. Squeeze the brake lever to stop the snowmobile.
6. Apply the parking brake by moving the parking brake lever to the left.

ESU11411

## Stopping the engine

- Turn the main switch to the off position to stop the engine.

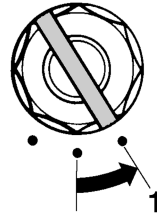

1. Off
- Push down the engine stop switch to stop the engine in an emergency.

# Operation

---

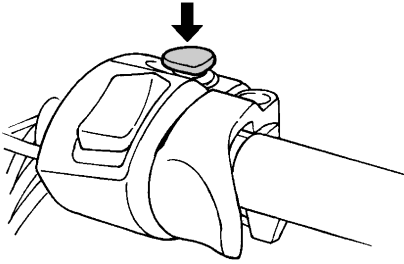

ESU11430

## Transporting

When transporting your snowmobile on a trailer or in a truck, observe the following recommendations to help protect it from damage:

- If transporting the snowmobile in an open trailer or truck, put a tight fitting cover on the snowmobile. A cover specifically designed for your snowmobile is best. This will help keep foreign objects out of the cooling vents, and also help protect the snowmobile against damage from debris on the road.
- If transporting the snowmobile in an open trailer or truck in areas where road salt is used, coat metal suspension surfaces lightly with oil or another protectant. This will help protect against corrosion. Be sure to clean the snowmobile when you get to your destination to remove any corrosive salts.

# Periodic maintenance and adjustment

ESU11451

Periodic inspection, adjustment, and lubrication will keep your snowmobile in the safest and most efficient condition possible. Safety is an obligation of the vehicle owner/operator. The most important points of vehicle inspection, adjustment, and lubrication are explained on the following pages.

EWS00341

## **WARNING**

**Failure to properly maintain the snowmobile or performing maintenance activities incorrectly may increase your risk of injury or death during service or while using the snowmobile. If you are not familiar with snowmobile service, have a Yamaha dealer perform service.**

EWS00700

## **WARNING**

**Turn off the engine when performing maintenance unless otherwise specified.**

- **A running engine has moving parts that can catch on body parts or clothing, and electrical parts that can cause shocks or fires.**
- **Running the engine while servicing can lead to eye injury, burns, fire, or carbon monoxide poisoning—possibly leading to death. See page 3 for more information about carbon monoxide.**

**Maintenance, replacement, or repair of the emission control devices and systems may be performed by any repair establishment or individual that is certified (if applicable).**

Proper periodic maintenance of your snowmobile is important in order to enjoy long, pleasurable use. Especially important are the maintenance services related to emission control. These controls not only function to ensure cleaner air, but are also vital to proper engine operation and maximum performance. In the following periodic maintenance charts, the services related to emission control are grouped separately. These services require specialized data, knowledge, and equipment. Yamaha dealers are trained and equipped to perform these particular services.

ESU11461

## **Periodic maintenance chart for the emission control system**

Items marked with an asterisk should be performed by a Yamaha dealer as they require special tools, data and technical skills.

	ITEM	REMARKS	INITIAL	EVERY	PAGE
			1 month or 800 km (500 mi) (40 hr)	Seasonally or 4000 km (2500 mi) (200 hr)	
	<b>Spark plugs</b>	<ul style="list-style-type: none"><li>• Check condition.</li><li>• Adjust gap and clean.</li><li>• Replace if necessary.</li></ul>		●	43
*	<b>Valve clearance</b>	<ul style="list-style-type: none"><li>• Check and adjust valve clearance when engine is cold.</li></ul>	Every 40000 km (25000 mi)		48

# Periodic maintenance and adjustment

	ITEM	REMARKS	INITIAL	EVERY	PAGE
			1 month or 800 km (500 mi) (40 hr)	Seasonally or 4000 km (2500 mi) (200 hr)	
*	<b>Crankcase breather system</b>	<ul style="list-style-type: none"> <li>• Check breather hose for cracks or damage.</li> <li>• Replace if necessary.</li> </ul>		●	—
*	<b>Fuel line</b>	<ul style="list-style-type: none"> <li>• Check fuel hose for cracks or damage.</li> <li>• Replace if necessary.</li> </ul>		●	—
*	<b>Idle speed</b>	<ul style="list-style-type: none"> <li>• Check and adjust idle speed.</li> </ul>	●	●	44
*	<b>Fuel injection</b>	<ul style="list-style-type: none"> <li>• Adjust synchronization.</li> </ul>	●	●	—
*	<b>Exhaust system</b>	<ul style="list-style-type: none"> <li>• Check for leakage.</li> <li>• Tighten or replace gasket if necessary.</li> </ul>		●	—

# Periodic maintenance and adjustment

ESU11561

## General maintenance and lubrication chart

	ITEM	REMARKS	INITIAL	EVERY	PAGE
			1 month or 800 km (500 mi) (40 hr)	Seasonally or 4000 km (2500 mi) (200 hr)	
	<b>Engine oil</b>	<ul style="list-style-type: none"> <li>• Change (warm engine before draining)</li> </ul>	●	●	48
*	<b>Engine oil filter cartridge</b>	<ul style="list-style-type: none"> <li>• Replace.</li> </ul>	●	Every 20000 km (12000 mi)	48
*	<b>Cooling system</b>	<ul style="list-style-type: none"> <li>• Check coolant level.</li> <li>• Air bleed the cooling system if necessary.</li> </ul>		●	52
*	<b>Primary and secondary clutches</b>	<ul style="list-style-type: none"> <li>• Check engagement and shift speed.</li> <li>• Adjust if necessary.</li> </ul>		●	—
			Whenever operating elevation is changed.		—
		<ul style="list-style-type: none"> <li>• Inspect sheaves for wear and damage.</li> <li>• Inspect weights/rollers and bushings for wear for primary.</li> <li>• Inspect ramp shoes/bushings for wear for secondary.</li> <li>• Replace if necessary.</li> </ul>		●	—
		<ul style="list-style-type: none"> <li>• Lubricate with specified grease.</li> </ul>		●	—
*	<b>Drive chain</b>	<ul style="list-style-type: none"> <li>• Check chain slack.</li> <li>• Adjust if necessary.</li> </ul>	Initial at 500 km (300 mi) and every 800 km (500 mi) thereafter.		56
*	<b>Drive chain oil</b>	<ul style="list-style-type: none"> <li>• Check oil level.</li> </ul>	●	●	56
		<ul style="list-style-type: none"> <li>• Change.</li> </ul>		●	56
*	<b>Brake and parking brake</b>	<ul style="list-style-type: none"> <li>• Adjust free play and/or replace pads if necessary.</li> </ul>		●	58
		<ul style="list-style-type: none"> <li>• Change brake fluid.</li> </ul>	See TIP following this chart.		58
	<b>Control cables</b>	<ul style="list-style-type: none"> <li>• Make sure that operation is smooth.</li> <li>• Lubricate if necessary.</li> </ul>		●	63
*	<b>Disc brake installation</b>	<ul style="list-style-type: none"> <li>• Check for slight free play.</li> <li>• Lubricate shaft with specified grease as required.</li> </ul>	Every 1600 km (1000 mi)		—
*	<b>Slide runners</b>	<ul style="list-style-type: none"> <li>• Check for wear and damage.</li> <li>• Replace if necessary.</li> </ul>		●	61
*	<b>Skis and ski runners</b>	<ul style="list-style-type: none"> <li>• Check for wear and damage.</li> <li>• Replace if necessary.</li> </ul>		●	60

# Periodic maintenance and adjustment

	ITEM	REMARKS	INITIAL	EVERY	PAGE
			1 month or 800 km (500 mi) (40 hr)	Seasonally or 4000 km (2500 mi) (200 hr)	
*	<b>Steering system</b>	<ul style="list-style-type: none"> <li>• Check toe-out.</li> <li>• Adjust if necessary.</li> </ul>		●	60
*	<b>Steering bearings</b>	<ul style="list-style-type: none"> <li>• Check bearing assemblies for looseness.</li> <li>• Lubricate with specified grease.</li> </ul>		●	—
*	<b>Skis and front shock absorbers</b>	<ul style="list-style-type: none"> <li>• Lubricate with specified grease.</li> </ul>		●	63
*	<b>Suspension component</b>	<ul style="list-style-type: none"> <li>• Lubricate with specified grease.</li> </ul>		●	63
	<b>Fittings and fasteners</b>	<ul style="list-style-type: none"> <li>• Make sure that all nuts, bolts and screws are properly tightened.</li> <li>• Tighten if necessary.</li> </ul>	●	●	66
*	<b>Battery</b>	<ul style="list-style-type: none"> <li>• Check condition.</li> <li>• Charge if necessary.</li> </ul>		●	66

## TIP

Brake system:

- After disassembling the master cylinder or caliper cylinder, always change the brake fluid. Regularly check the brake fluid level and add fluid if necessary.
- Replace the oil seals of the master cylinder and caliper cylinder every two years.
- Replace the brake hose every four years, or if cracked or damaged.

# Periodic maintenance and adjustment

ESU11740

## Tool kit

The owner's tool kit has the tools which are sufficient for most periodic maintenance and minor repairs. A torque wrench is also necessary to properly tighten nuts and bolts.

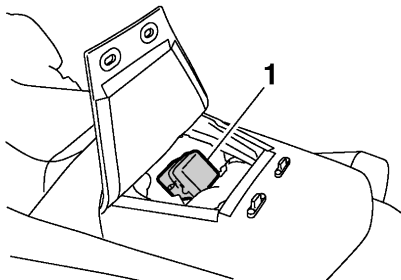

1. Tool kit

ECS00360

### **NOTICE**

**Before starting the engine, make sure that the tool kit is properly seated in its holder and is securely fastened.**

### **TIP**

If you do not have a torque wrench available during a service operation requiring one, take your snowmobile to a Yamaha dealer to check the torque settings and adjust them if necessary.

ESU12892

## Removing and installing the shroud and covers

EWS00091

### **WARNING**

**Be sure shroud and covers are secured before operation. A loose shroud or cover could move and cause loss of control.**

### **Shroud**

#### To remove the shroud

Loosen the fasteners, slowly raise the shroud, and then unhook the shroud from the shroud stay.

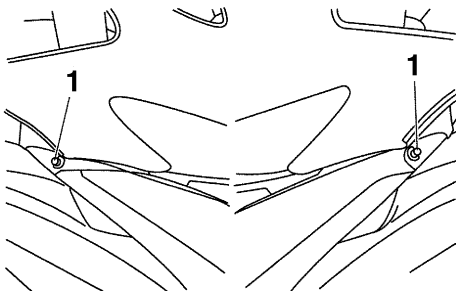

1. Fastener



1. Shroud

#### To install the shroud

Hook the end of the shroud onto the shroud stay, slowly lower it to the original position, and then tighten the fasteners.

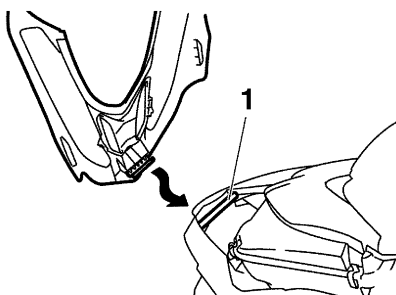

1. Shroud stay

### **Left and right side covers**

#### To remove a side cover

1. Remove the shroud. (See the above procedure.)

# Periodic maintenance and adjustment

2. Loosen the fasteners, and then remove the side cover.

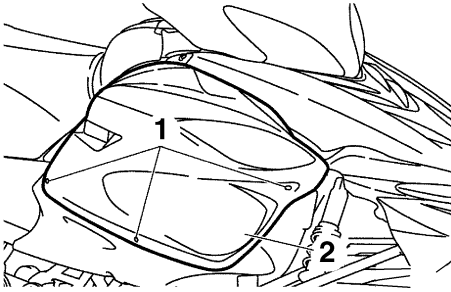

1. Fastener
2. Right side cover

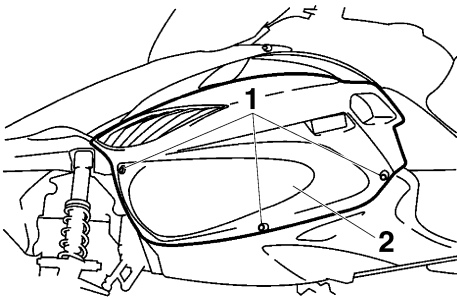

1. Fastener
2. Left side cover

## To install a side cover

1. Place the side cover in the original position, and then tighten the fasteners.
2. Install the shroud.

## **TIP**

Be sure to fit the projection on the rear of the side cover into the hole in the lower side cover.

## **Top cover**

### To remove the top cover

1. Remove the shroud. (See the above procedure.)
2. Remove the screws, and then remove the cable guide.

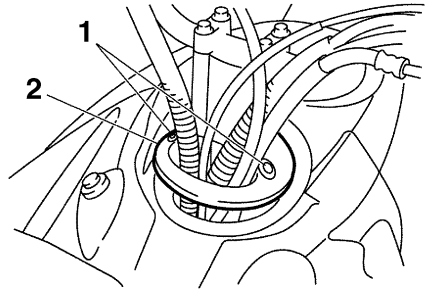

1. Screw
2. Cable guide

3. Loosen the quick fastener screws, disconnect the main switch coupler and auxiliary DC jack coupler, and then remove the top cover.

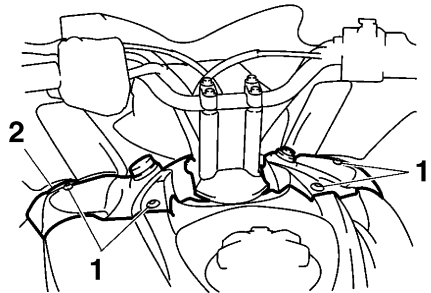

1. Quick fastener screw
2. Top cover

### To install the top cover

1. Connect the main switch coupler and auxiliary DC jack coupler, place the top cover in the original position, and then tighten the quick fastener screws.
2. Pass all of the cables, etc., through the cable guide, place the cable guide in the original position, and then install the screws.
3. Install the shroud.



# Periodic maintenance and adjustment

ECS00370

## NOTICE

Make sure that all cables, leads, etc., are routed properly before installing the shroud and covers.

## TIP

When installing the shroud and covers, be sure to tighten all fasteners securely.

ESU11782

## Checking the spark plugs

The spark plug is an important engine component and is easy to inspect. The condition of the spark plug can indicate the condition of the engine.

Check the coloration on the white porcelain insulator around the center electrode. The ideal coloration at this point is a medium to a light tan color for a snowmobile that is being ridden normally. If a spark plug shows a distinctly different color, there could be something wrong with the engine. For example, a very white center electrode porcelain color could indicate an intake track air leak or carburetion problem for that cylinder. Do not attempt to diagnose such problems yourself. Instead, take the snowmobile to a Yamaha dealer for inspection and possible repairs.

You should periodically remove and inspect the spark plug because heat and deposits will cause a spark plug to slowly break down and erode. Consult a Yamaha dealer before changing to a different type of spark plug.

Specified spark plug:

Manufacturer:

NGK

Model:

CR9EB

EWS00710

## WARNING

Be sure to use the specified spark plug and spark plug cap. Otherwise, the T.O.R.S. may not work properly.

Spark plugs are produced in several different thread lengths. The thread length or reach is the distance from the spark plug gasket seat to the end of the threaded portion. If the reach is too long, overheating and engine damage may result. If the reach is too short, spark plug fouling and poor performance may result. Also, if the reach is too short, carbon will form on the exposed threads resulting in combustion chamber hot spots and thread damage. Always use a spark plug with the specified reach.

Spark plug reach:  
19.0 mm (0.75 in)

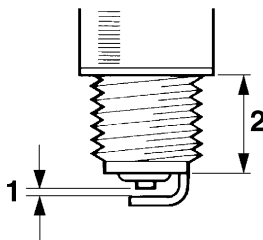

1. Spark plug gap
2. Spark plug reach

Before installing any spark plug, measure the electrode gap with a wire thickness gauge and adjust to specification.

Spark plug gap:  
0.7–0.8 mm (0.028–0.031 in)

# Periodic maintenance and adjustment

When installing the spark plug, always clean the gasket surface. Wipe off any grime from the threads and tighten the spark plug to the specified torque.

Spark plug tightening torque:  
12.5 Nm (1.25 m·kgf, 9 ft·lbf)

ECS00382

## NOTICE

**Make sure that the spark plug caps are securely installed. Otherwise the spark plug caps could be damaged due to engine vibration.**

ESU11802

## Adjusting the engine idling speed

1. Remove the shroud, the left and right side covers, and the top cover. (See page 41 for removal procedures.)
2. Start the engine and warm it up.
3. Remove the headlight unit bolts, and then lift up the headlight unit.

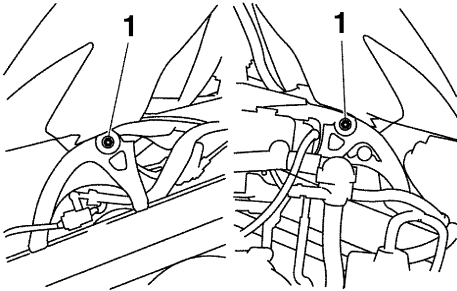

1. Headlight unit bolt
4. Turn the idle adjusting screw in or out to adjust the engine idling speed.

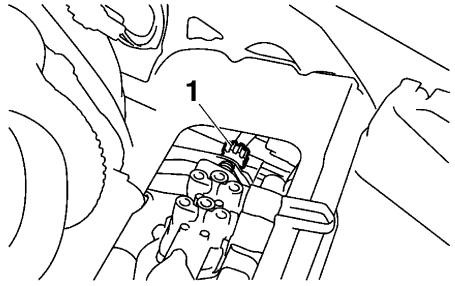

1. Idle adjusting screw

Standard engine idling speed:  
1400–1600 r/min

5. Install the headlight unit, making sure to insert the projections on the headlight unit stay into the slots on the bottom of the headlight unit.

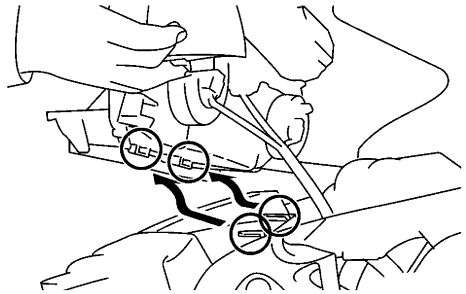

6. Install the headlight unit bolts, and then tighten them to the specified torque.

Headlight unit bolt tightening torque:  
3 Nm (0.3 m·kgf, 2.2 ft·lbf)

7. Install the top cover, the left and right side covers, and the shroud.

ESU11832

## Adjusting the throttle cable free play

1. Remove the shroud. (See page 41 for removal procedures.)

# Periodic maintenance and adjustment

2. Remove the headlight unit bolt on each side of the snowmobile and loosen the quick fastener screws shown on the top cover.

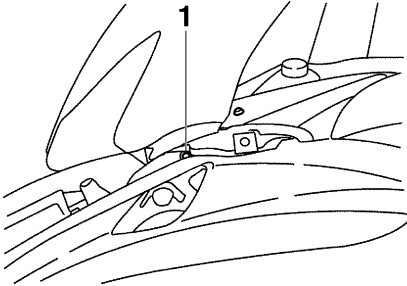

1. Headlight unit bolt

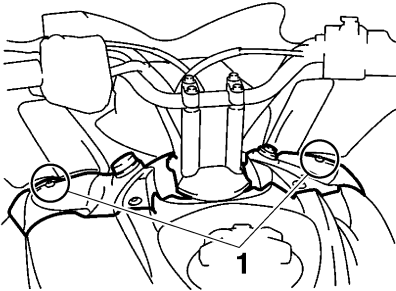

1. Quick fastener screw
3. Disconnect the speedometer coupler and headlight couplers, and then remove the headlight unit.
4. Loosen the locknut.
5. Turn the adjusting bolt in or out until the specified throttle cable free play is obtained.

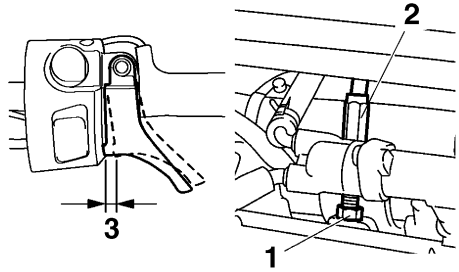

1. Locknut
2. Throttle cable free play adjusting bolt
3. Throttle cable free play

Throttle cable free play:  
2.0–3.0 mm (0.08–0.12 in)

6. Tighten the locknut.
7. Connect the speedometer coupler and headlight couplers, and then install the headlight unit, making sure to insert the projections on the headlight unit stay into the slots on the bottom of the headlight unit.

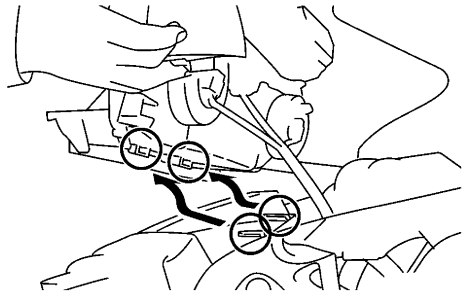

8. Install the headlight unit bolts, and then tighten them to the specified torque.

Headlight unit bolt tightening torque:  
3 Nm (0.3 m·kgf, 2.2 ft·lbf)

9. Tighten the quick fastener screws on the top cover.
10. Install the shroud.

# Periodic maintenance and adjustment

ESU11862

## Checking the throttle override system (T.O.R.S.)

Check the T.O.R.S. for proper operation.

EWS00352

### **WARNING**

When checking the T.O.R.S., take precautions to avoid snowmobile movement which could cause an accident:

- Make sure that the throttle lever moves smoothly with the engine off before checking the T.O.R.S.
- Make sure that the parking brake is applied.
- Do not rev the engine to the point that the clutch engages.

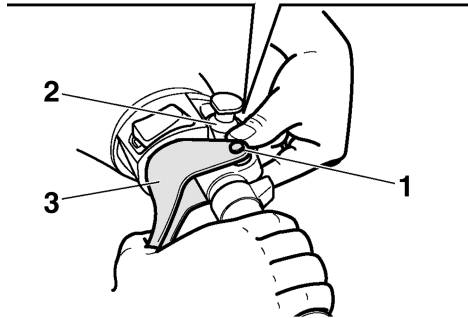
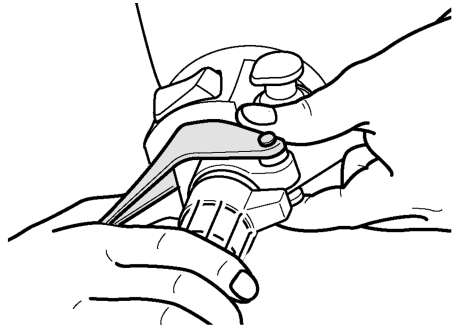

1. Throttle lever pivot
2. Engine stop switch housing
3. Throttle lever

The T.O.R.S. will be activated and the engine speed will be limited to less than the clutch engagement speed. (See page 76 for the clutch engagement speed.)

**WARNING! If the engine speed does not decrease to less than the clutch engagement speed, stop the engine by turning the main switch to the off position and consult a Yamaha dealer. Operating the snowmobile with a malfunctioning T.O.R.S. could result in loss of control.** [EWS00362]

ESU11882

## Checking the air filter

Always check that there is no snow under the air filter element frame.

1. Remove the shroud. (See page 41 for removal procedures.)
2. Unhook the air filter case cover fasteners.

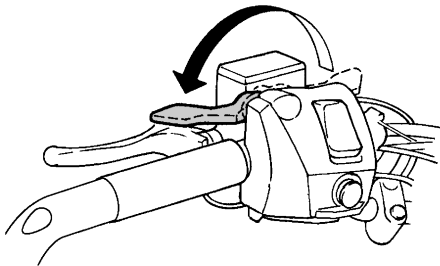

1. Start the engine.

### **TIP**

Refer to the "Starting the engine" section on page 29.

2. Hold the pivot point of the throttle lever away from the throttle switch by putting your thumb (above) and forefinger (below) between the throttle lever pivot and the engine stop switch housing.

While holding the pivot point as described above, press the throttle lever gradually.

# Periodic maintenance and adjustment

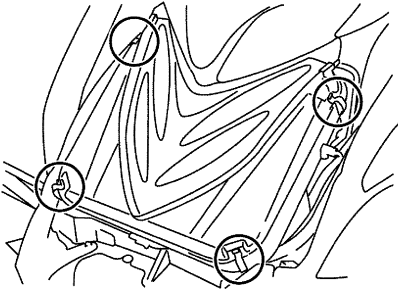

3. Remove the headlight unit bolt on each side of the snowmobile and loosen the quick fastener screws shown on the top cover.

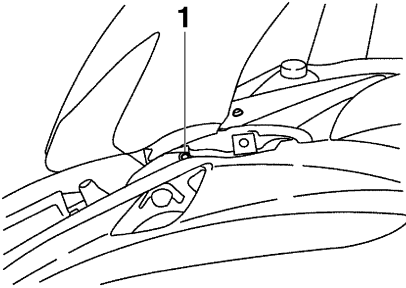

1. Headlight unit bolt

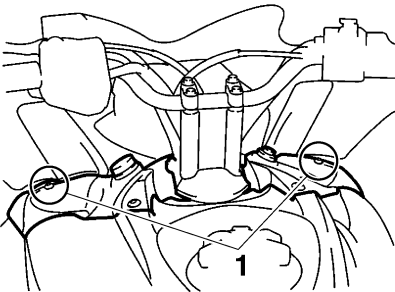

1. Quick fastener screw

4. Slightly lift up the headlight unit, and then remove the air filter case cover.

5. Lift up the air filter element frame and check the air filter element. If there is any snow on the air filter element, remove the element, brush off the snow, and then install the air filter element.

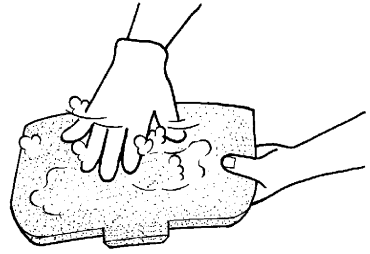
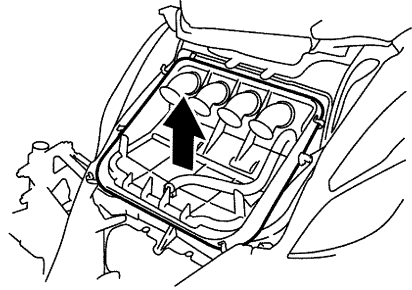

6. Place the air filter element frame in the original position, and then install the air filter case cover.
7. Install the air filter case cover by hooking the fasteners.
8. Install the headlight unit, making sure to insert the projections on the headlight unit stay into the slots on the bottom of the headlight unit.

# Periodic maintenance and adjustment

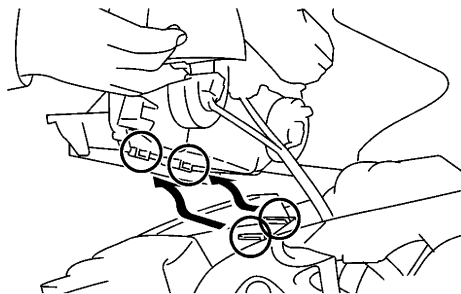

9. Install the headlight unit bolts, and then tighten them to the specified torque.

Headlight unit bolt tightening torque:  
3 Nm (0.3 m·kgf, 2.2 ft·lbf)

10. Tighten the quick fastener screws on the top cover.
11. Install the shroud.

## TIP

After riding the snowmobile, make sure that there is no snow under the air filter element frame.

ESU11931

## High-altitude settings

Operating at high altitude reduces the performance of a gasoline engine about 3% for every 305 m (1000 ft) of elevation. This is because there is less air as altitude increases. Less air means less oxygen available for combustion.

Your snowmobile utilizes an electronic fuel injection system that delivers the optimal air/fuel ratio required by the engine. Therefore, the fuel injection system does not need to be adjusted, even for operation at high altitude.

### Remember:

Less air at higher altitude means there is less horsepower available, even with the optimal air/fuel ratio. Expect acceleration and top speed to be reduced at higher altitudes.

To overcome operating with less power at high altitudes, your snowmobile may also require different settings for the drive chain gears and V-belt clutch to avoid poor performance and rapid wear. If you plan to operate your snowmobile at an altitude different from the area where you bought it, be sure to consult a Yamaha dealer. The dealer can tell you if there are any changes necessary for the altitude where you plan to ride. **NOTICE: The drive chain gears and V-belt clutch should be adjusted when operating above a high altitude of 900 m (3000 ft). Consult a Yamaha dealer.** [ECS00431]

ESU11950

## Valve clearance

The valve clearance changes with use, resulting in improper air-fuel mixture and/or engine noise. To prevent this from occurring, the valve clearance must be adjusted by a Yamaha dealer at the intervals specified in the periodic maintenance chart.

ESU11964

## Engine oil and oil filter cartridge

The engine oil level should be checked before each use. In addition, the oil must be changed and the oil filter cartridge replaced at the intervals specified in the periodic maintenance and lubrication chart.

EWS00370

## WARNING

**Engine oil is extremely hot immediately after the engine is turned off. Coming into contact with or getting any engine oil on your clothes could result in burns.**

ECS00440

## NOTICE

- Do not run the engine with too much or not enough oil in the oil tank. Oil could spray out or the engine could be damaged.

# Periodic maintenance and adjustment

- Be sure to change the engine oil after the first 800 km (500 mi) of operation, and every 4000 km (2500 mi) thereafter or at the start of a new season, otherwise the engine will wear quickly.
- The oil filter cartridge should be replaced every 20000 km (12000 mi) of operation. Have a Yamaha dealer replace the oil filter cartridge.

## To check the engine oil level

1. Place the snowmobile on a level surface and apply the parking brake.

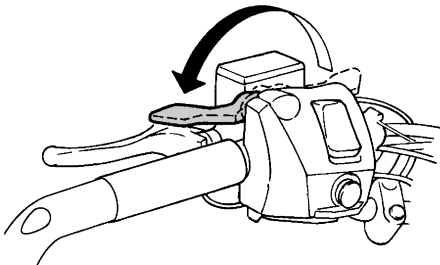

2. Start the engine, warm it up for 10–15 minutes, and then turn it off.

## TIP

- The engine can also be warmed up by operating the snowmobile for 10–15 minutes.
- After operating the snowmobile, allow the engine to idle for at least 10 seconds before turning it off.

3. Remove the shroud and the right side cover. (See page 41 for removal procedures.)
4. Disconnect the oil level gauge coupler.  
**NOTICE:** Disconnect the oil level gauge coupler before removing the oil filler cap, otherwise the cable could twist and break. [ECS00452]

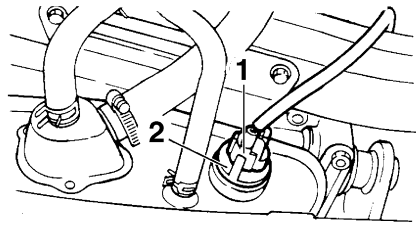

1. Oil level gauge coupler
  2. Oil filler cap
5. Remove the oil filler cap, wipe the dipstick clean, insert it back into the oil filler hole (without screwing it in), and then remove it again to check the oil level.

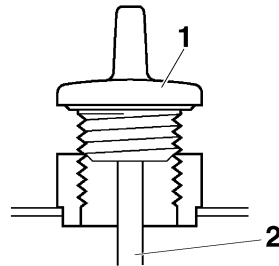

1. Oil filler cap
2. Dipstick

## TIP

The engine oil should be between the “H” and “L” level marks on the dipstick.

# Periodic maintenance and adjustment

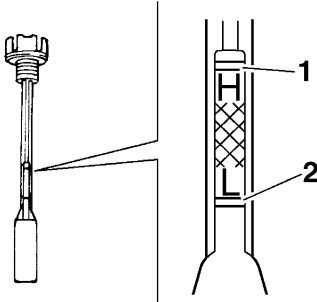

1. "H" level mark
2. "L" level mark

6. If the engine oil is below the "L" level mark, add sufficient oil of the recommended type to raise it to the "H" level mark. (See page 76 for the recommended oil.) **NOTICE: When adding the engine oil, be careful not to fill above the "H" level mark on the dipstick. Use only the recommended oil. (See page 76.) Make sure that no foreign material enters the engine oil tank.** [ECS00462]
7. Insert the dipstick into the oil filler hole, and then tighten the oil filler cap.
8. Connect the oil level gauge coupler.
9. Install the right side cover and the shroud.

## To change the engine oil (without oil filter cartridge replacement)

### TIP

It is recommended to have a Yamaha dealer change the engine oil.

1. Place the snowmobile on a level surface, and apply the parking brake.
2. Start the engine, warm it up for several minutes, and then turn it off.
3. Remove the shroud and the right side cover. (See page 41 for removal procedures.)
4. Remove the bottom panel and the right lower cover.

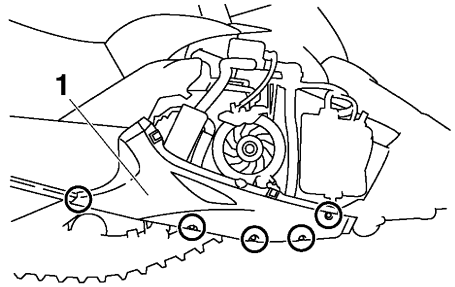

1. Right lower cover

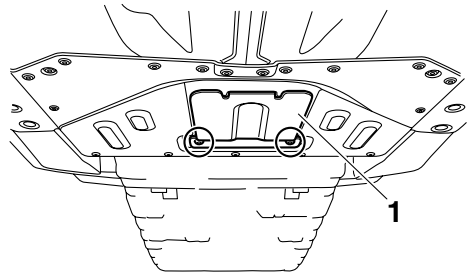

1. Bottom panel
5. Place an oil pan under the oil tank to collect the used oil.
6. Disconnect the oil level gauge coupler.

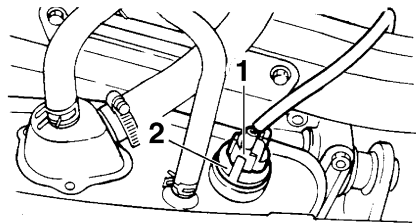

1. Oil level gauge coupler
2. Oil filler cap
7. Remove the oil filler cap and drain bolt to drain the oil from the oil tank.



# Periodic maintenance and adjustment

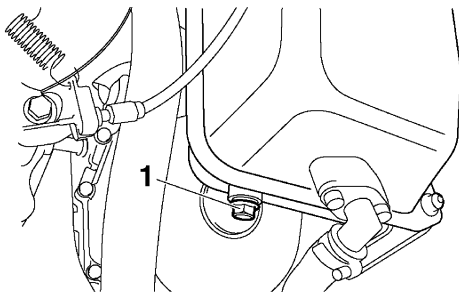

1. Engine oil drain bolt (oil tank)

8. Place an oil pan under the engine to collect the used oil.
9. Remove the engine oil drain bolt to drain the oil from the crankcase.

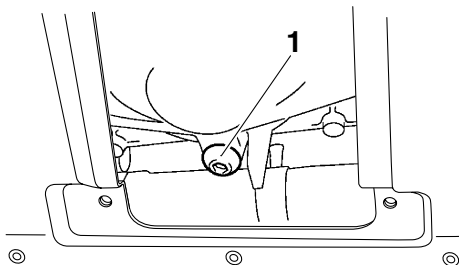

1. Engine oil drain bolt (crankcase)

## TIP

Dispose of used oil according to local regulations.

10. Install the engine oil drain bolts, and then tighten them to the specified torques.

### Tightening torques:

Engine oil drain bolt (crankcase):

30 Nm (3.0 m·kgf, 22 ft·lbf)

Engine oil drain bolt (oil tank):

16 Nm (1.6 m·kgf, 11 ft·lbf)

11. Add 2.0 L (2.11 US qt, 1.76 Imp.qt) of the recommended engine oil to the oil tank, and then install and tighten the oil filler cap.

12. Start the engine, warm it up for several minutes, and then turn it off.
13. Add sufficient oil of the recommended type to raise it to the "H" level mark on the dipstick. (See above for checking procedures.) **NOTICE: When adding the engine oil, be careful not to fill above the "H" level mark on the dipstick. Use only the recommended oil. (See page 76.) Make sure that no foreign material enters the engine oil tank.** [ECS00462]

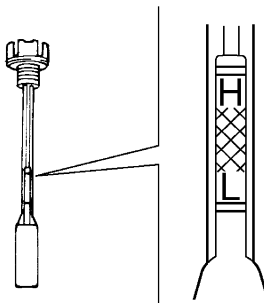

Recommended engine oil:

See page 76.

Oil quantity:

With oil filter cartridge replacement:

3.0 L (3.17 US qt, 2.64 Imp.qt)

Without oil filter cartridge replacement:

2.8 L (2.96 US qt, 2.46 Imp.qt)

Total amount:

3.8 L (4.02 US qt, 3.34 Imp.qt)

14. Start the engine, and then let it idle for several minutes while checking it for oil leakage. If oil is leaking, immediately turn the engine off and make sure that the engine oil drain bolt, oil tank drain bolt, and the oil filler cap are installed correctly.
15. Turn the engine off, and then connect the oil level gauge coupler.
16. Install the bottom panel and the right lower cover, and then install the right side cover and the shroud. **NOTICE: If oil is leaking or the oil level warning indica-**

# Periodic maintenance and adjustment

tor comes on when the engine is running, immediately turn the engine off and have a Yamaha dealer check the snowmobile. Continuing to operate the engine under such conditions could cause severe engine damage.

[ECS00471]

ESU12013

## Cooling system

The coolant level should be checked before each ride. In addition, the cooling system must be bled of air at the intervals specified in the periodic maintenance and lubrication chart.

EWS00380

### **WARNING**

**Do not remove the coolant reservoir cap when the engine is hot. Scalding hot fluid and steam may be blown out under pressure, which could cause serious injury.**

**When the engine has cooled, place a thick rag or towel over the coolant reservoir cap, and slowly rotate the cap counterclockwise to the detent. This procedure allows any residual pressure to escape. When the hissing sound has stopped, press down on the cap while turning counterclockwise and remove it.**

### To check the coolant level

1. Place the snowmobile on a level surface and apply the parking brake.
2. Remove the top cover. (See page 41 for removal procedures.)
3. Check the coolant level in the coolant recovery tank when the engine is cold. If the coolant level is below the “COLD LEVEL” mark, add soft water until it reaches the “COLD LEVEL” mark. (See the following section “Replenishing the coolant” for more details.) **NOTICE: Hard water or salt water is harmful to the engine parts. You may use boiled or distilled**

water, if soft water is not available. Tap water can be used temporarily in an emergency. [ECS00491]

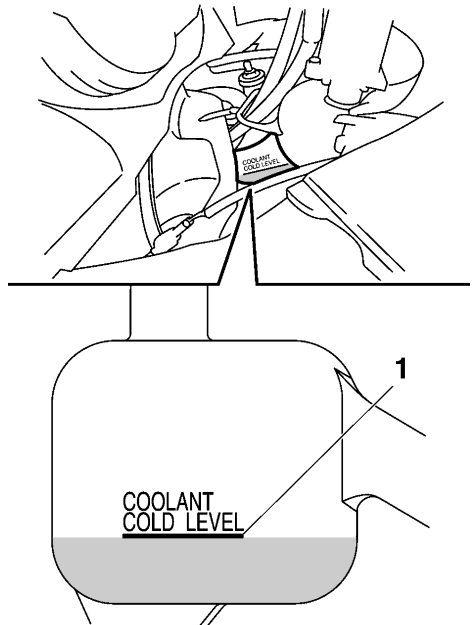

1. “COLD LEVEL” mark

## Bleeding the cooling system

The cooling system must be bled of air if the coolant reservoir becomes empty, if air can be seen in the cooling system, or if there is a cooling system leak. Consult a Yamaha dealer.

ECS00500

### **NOTICE**

**Operating the engine with an improperly bled cooling system can cause overheating and severe engine damage.**

## Replenishing the coolant

1. Remove the top cover. (See page 41 for removal procedures.)
2. Remove the coolant reservoir cap, fill the reservoir with the recommended coolant, and then install the cap.

# Periodic maintenance and adjustment

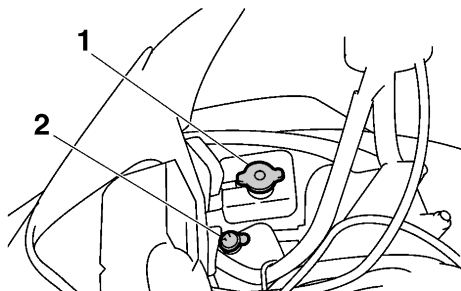

1. Coolant reservoir cap
2. Coolant recovery tank cap
3. Remove the coolant recovery tank cap, add the recommended coolant until it reaches the "COLD LEVEL" mark, and then install the cap.

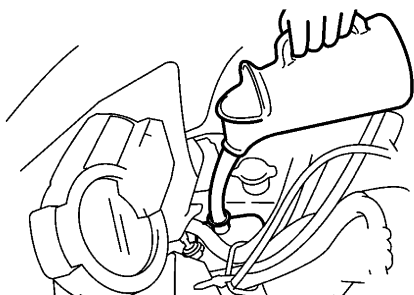

Recommended antifreeze:  
High-quality ethylene glycol antifreeze  
containing corrosion inhibitors  
Antifreeze and water mixing ratio:  
3:2  
Total amount:  
RX10GT 6.20 L (6.55 US qt,  
5.46 Imp.qt)  
RX10LTGT 6.80 L (7.19 US qt,  
5.98 Imp.qt)

4. Start the engine, allow it to idle for several minutes, and then turn it off.
5. Check the coolant level in the coolant reservoir. If it is not full, remove the coolant reservoir cap, fill the reservoir with the recommended coolant, and then install the cap.

6. Check for any coolant leakage.

## TIP

If you find any leaks, consult a Yamaha dealer.

7. Install the top cover.

ESU12062

## V-belt

EWS00401

### WARNING

- Coming in contact with the rotating V-belt or clutch parts can cause severe injury or death. Never run the engine with the drive guard removed.
- Make sure that the drive guard is tightened securely before operating the snowmobile to protect against severe injury or death from a broken V-belt or other part should it come off the snowmobile while it is in operation.

ECS00830

### NOTICE

Never run the engine with the V-belt removed. Clutch components can be damaged.

The V-belt should be checked before each ride.

#### To check the V-belt

1. Remove the shroud and the left side cover, and then remove the drive guard. (See page 41 for removal procedures.)
2. Check the V-belt for wear and damage. Replace if necessary.

# Periodic maintenance and adjustment

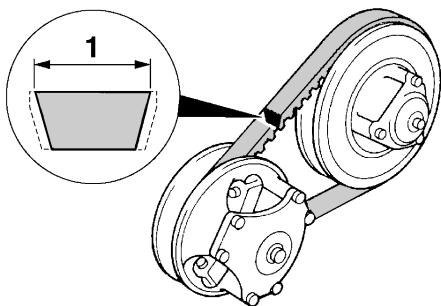

1. V-belt wear limit

New V-belt width:  
34.1 mm (1.34 in)  
V-belt wear limit width:  
32.5 mm (1.28 in)

3. Install the drive guard, and then install the left side cover and the shroud.

To replace and adjust the V-belt

EWS00411

## WARNING

When installing a new V-belt, make sure that it is positioned properly. Otherwise, the V-belt clutch engagement speed will be changed and the snowmobile may move unexpectedly when the engine is started, which could cause an accident.

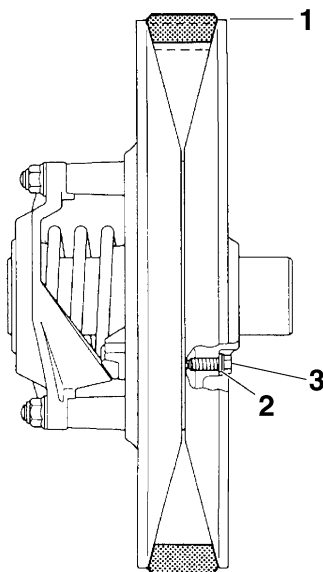

1. Edge of the secondary sheave assembly
2. Spacer
3. V-belt position adjusting bolt

ECS00510

## NOTICE

As the V-belt wears, adjustment may be necessary. To ensure proper clutch performance, the V-belt position should be adjusted by adding a spacer on each adjusting bolt when the V-belt position reaches 1.5 mm (0.06 in) below the edge of the secondary sheave assembly. Have a Yamaha dealer make this adjustment.

## TIP

Apply the parking brake before replacing the V-belt.

1. Remove the shroud and the left side cover, and then remove the drive guard. (See page 41 for removal procedures.)

# Periodic maintenance and adjustment

2. Rotate the secondary sliding sheave clockwise and push it so that it separates from the secondary fixed sheave.

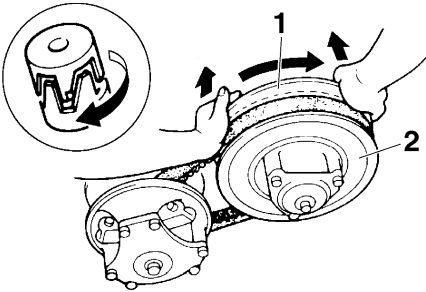

1. Secondary sliding sheave
  2. Secondary fixed sheave
3. Pull the V-belt up over the secondary fixed sheave.

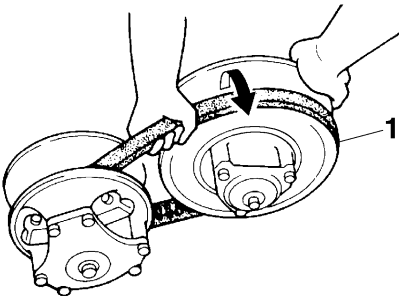

1. V-belt
4. Remove the V-belt from the secondary sheave assembly and primary sheave assembly.
  5. Temporarily install the new V-belt on the secondary sheave assembly only, and then measure the V-belt position. Do not force the V-belt between the sheaves; the secondary sliding and fixed sheaves must touch each other.

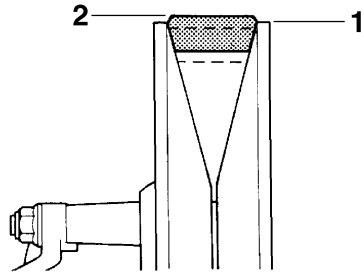
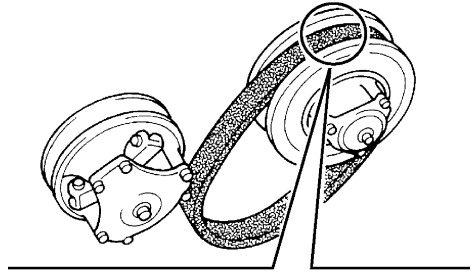

1. Edge of the secondary sheave assembly
2. V-belt position

## Standard V-belt position:

From 1.5 mm (0.06 in) above the edge of the secondary sheave assembly to 0.5 mm (0.02 in) below the edge

6. If the V-belt position is incorrect, adjust it by removing or adding a spacer on each V-belt position adjusting bolt.

# Periodic maintenance and adjustment

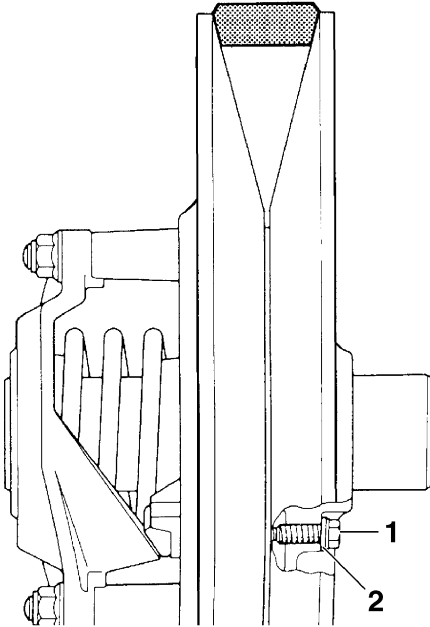

- 1. V-belt position adjusting bolt
- 2. Spacer

V-belt position	Adjustment
More than 1.5 mm (0.06 in) above the edge	Remove spacer
From 1.5 mm (0.06 in) above the edge to 0.5 mm (0.02 in) below the edge	Not necessary (It is correct.)
More than 0.5 mm (0.02 in) below the edge	Add spacer

- 7. Tighten the V-belt position adjusting bolts.

V-belt position adjusting bolt tightening torque:  
10 Nm (1.0 m·kgf, 7.2 ft·lbf)

- 8. Install the V-belt over the primary sheave assembly.

- 9. Rotate the secondary sliding sheave clockwise and push it so that it separates from the secondary fixed sheave.

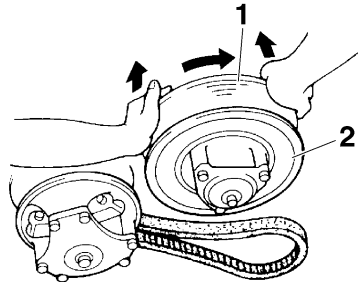

- 1. Secondary sliding sheave
- 2. Secondary fixed sheave

- 10. Install the V-belt between the secondary sliding and fixed sheaves.

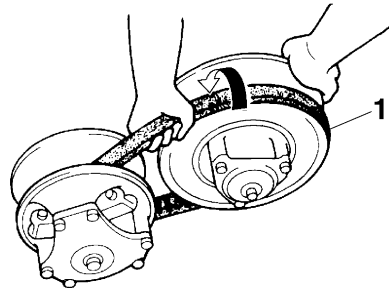

- 1. V-belt

- 11. Install the drive guard, and then install the left side cover and the shroud.

ESU12103

## Drive chain housing

To check the drive chain housing oil level

- 1. Place the snowmobile on a level surface and apply the parking brake.
- 2. Remove the shroud and the right side cover. (See page 41 for removal procedures.)
- 3. Remove the dipstick, wipe it off with a clean rag, and then insert it back into the filler hole.

# Periodic maintenance and adjustment

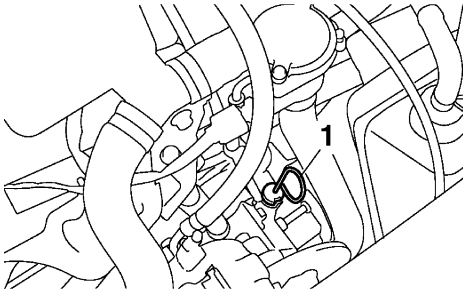

1. Dipstick

4. Remove the dipstick and check that the oil is between the maximum and minimum level marks. If the oil is below the minimum level mark, add sufficient oil of the recommended type to raise it to the maximum level mark. **NOTICE: Make sure that no foreign material enters the drive chain housing.** [ECS00531]



1. Maximum level mark
2. Minimum level mark

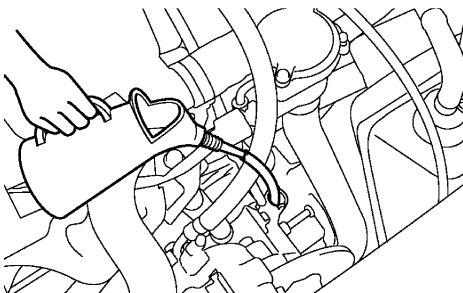

Recommended drive chain oil:  
SAE 75W or 80W API GL-3 Gear oil

5. Install the dipstick, making sure to align the notch in the dipstick handle with the projection on the drive chain housing.

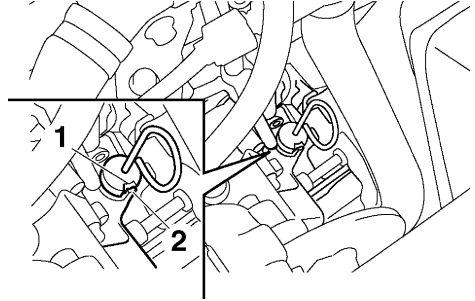

1. Notch
2. Projection

6. Install the right side cover and the shroud.  
To adjust the chain tension

1. Remove the shroud and the right side cover. (See page 41 for removal procedures.)
2. Loosen the locknut.
3. Turn the chain tension adjusting bolt clockwise until it is finger tight, and then loosen it 1/4 turn.
4. While holding the chain tension adjusting bolt with a wrench, tighten the locknut to the specified torque.

Tightening torque:

Locknut:

25 Nm (2.5 m·kgf, 18 ft·lbf)

# Periodic maintenance and adjustment

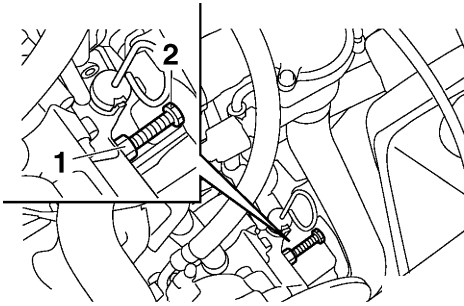

1. Locknut
2. Chain tension adjusting bolt

5. Install the right side cover and the shroud.

ESU12132

## Brake and parking brake

EWS00440

### **WARNING**

- A soft, spongy feeling in the brake lever indicates a failure in the brake system.
- Do not operate the snowmobile if you find any problems in the brake system. You could lose braking ability, which could lead to an accident. Ask a Yamaha dealer to inspect and repair the brake system.

ECS00060

### **NOTICE**

Make sure that the brake lever end does not project out over the handlebar end. This will help prevent brake lever damage when the snowmobile is placed on its side for service.

Test the brake at a low speed when starting out to make sure that it is working properly. If the brake does not provide proper braking performance, inspect the brake for wear or brake fluid leakage. (See the following section for more details.)

### Checking the brake pads

Check the brake pads for wear.

If the brake pads reach the wear limit, ask a Yamaha dealer to replace them.

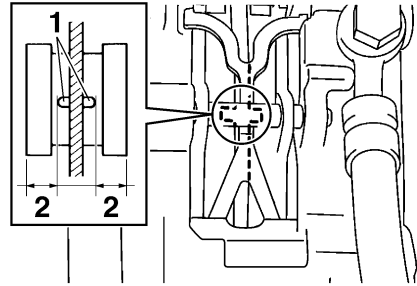

1. Brake pad wear indicator
2. Brake pad wear limit

Brake pad wear limit:  
4.7 mm (0.19 in)

### Checking the parking brake pads

Check the parking brake pads for wear by measuring the thickness of the pads. If the parking brake pads reach the wear limit, ask a Yamaha dealer to replace them.

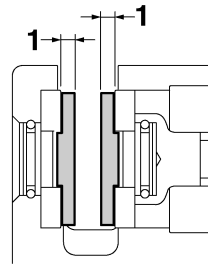

1. Parking brake pad wear limit

Parking brake pad wear limit:  
1.2 mm (0.047 in)

### To adjust the parking brake

As the parking brake pads wear, adjustment may be necessary to ensure proper brake performance.

1. Loosen the parking brake pad locknut and the parking brake pad adjusting bolt.
2. Loosen the parking brake cable locknut.



# Periodic maintenance and adjustment

- Turn the parking brake cable adjusting bolt in or out to adjust the cable length.

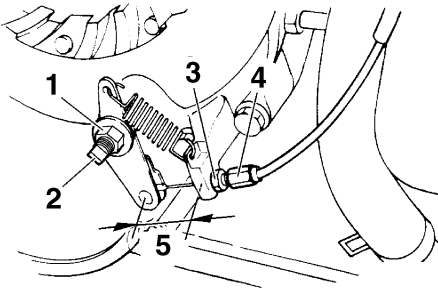

- Parking brake pad locknut
- Parking brake pad adjusting bolt
- Parking brake cable locknut
- Parking brake cable adjusting bolt
- Parking brake cable length

Parking brake cable length:  
43.5–46.5 mm (1.713–1.831 in)

- Tighten the parking brake cable locknut.
- Turn the parking brake pad adjusting bolt in or out to adjust the clearance between the parking brake pads and the brake disc.

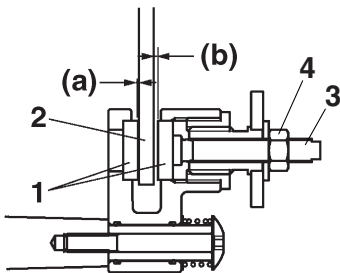

- Parking brake pad
- Brake disc

Parking brake pad to brake disc clearance (a) + (b):  
1.5–2.0 mm (0.059–0.079 in)

- Tighten the parking brake pad locknut.

## Checking the brake fluid level

EWS00460



**WARNING**

Be careful that water does not enter the master cylinder when refilling. Water will significantly lower the boiling point of the fluid and may result in vapor lock. If the brake fluid level goes down, consult a Yamaha dealer.

ECS00550

**NOTICE**

Brake fluid may deteriorate painted surfaces or plastic parts. Never spill any fluid. If any is spilled, clean it up immediately.

Place the snowmobile on a level surface. Check that the brake fluid is above the lower level and replenish when necessary.

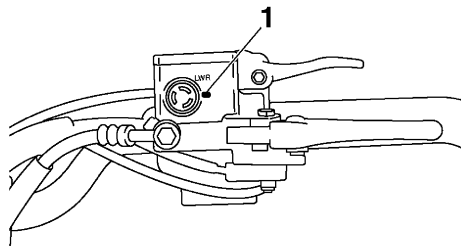

- Lower level

Specified brake fluid:  
DOT 4

## Changing the brake fluid

EWS00471



**WARNING**

Make sure that the brake fluid and the following parts are replaced by a Yamaha dealer.

Brake fluid replacement is necessary when the following components are replaced during the periodic maintenance or if they are damaged or leaking.

# Periodic maintenance and adjustment

- All oil seals of the master cylinder and caliper cylinder
- The brake hose

ESU12142

## Skis and ski runners

Check the skis and ski runners for wear and damage. Replace if necessary.

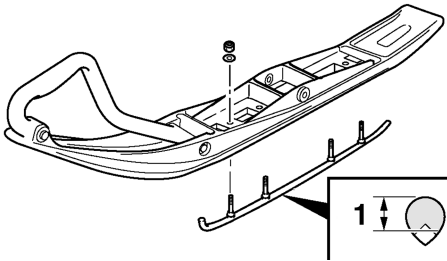

1. Ski runner wear limit

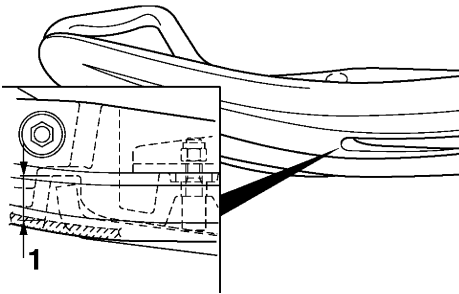

1. Ski wear limit

Ski runner wear limit:  
8 mm (0.3 in)  
Ski wear limit:  
12 mm (0.5 in)

ECS00560

### NOTICE

Avoid scratching the skis when loading and unloading the snowmobile, when riding in areas with little or no snow, or on sharp edges such as concrete, curbs, etc. This will wear or damage the skis.

## To align the skis

1. Turn the handlebar so the skis face straight ahead.
2. Check the following for ski alignment:
  - Skis are facing forward.
  - Ski toe-out (distance A – distance B) is within specification.

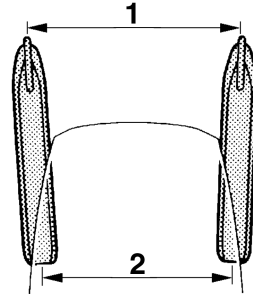

1. Distance A
2. Distance B

Ski toe-out (distance A – distance B):  
0.0–15.0 mm (0.00–0.59 in)

3. If the alignment is not correct, consult a Yamaha dealer.

ESU12151

## Steering system

Check the handlebar for excessive free play.

### To check the handlebar

1. Push the handlebar up and down and back and forth.
2. Turn the handlebar slightly to the right and left.

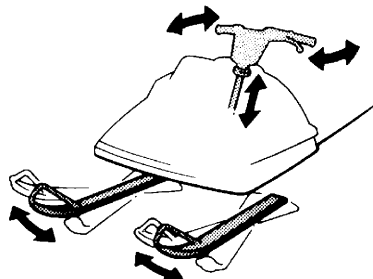

# Periodic maintenance and adjustment

If excessive free play is felt, consult a Yamaha dealer.

ESU12173

## Drive track and slide runners

### Drive track

EWS00480

#### **WARNING**

A broken track, track fittings or debris thrown by the drive track could be dangerous to an operator or bystanders. Observe the following precautions:

- Do not allow anyone to stand behind the snowmobile when the engine is running.
- When the rear of the snowmobile is raised to allow the drive track to spin, a suitable stand must be used to support the rear of the snowmobile. Never allow anyone to hold the rear of the snowmobile off the ground to allow the drive track to spin. Never allow anyone near a rotating drive track.
- Inspect the drive track condition frequently. Replace damaged slide metal. Replace the drive track if it is damaged to the depth where fabric reinforcement material is visible or support rods are broken. Otherwise, track damage or failure could result in loss of braking ability and snowmobile control, which could cause an accident.

### Checking the drive track

EWS00490

#### **WARNING**

Do not operate the snowmobile if you find damage to the drive track, or if it has been maladjusted. Drive track damage or failure could result in loss of braking ability and snowmobile control, which could cause an accident.

Check the drive track for deflection, wear, and damage.

Adjust or replace if necessary. (See the following section for more details.)

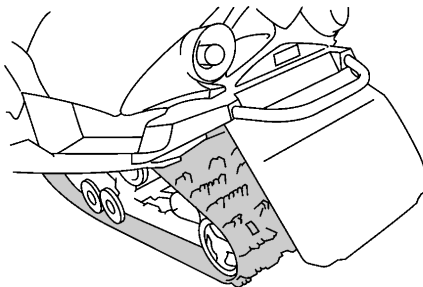

### Measuring the drive track deflection

1. Lay the snowmobile on its side.
2. Measure the drive track deflection with a spring scale. Pull at the center of the drive track with a force of 100 N (10 kgf, 22 lbf).

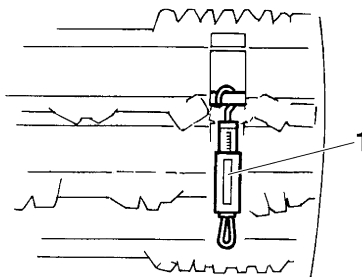

1. Spring scale

### TIP

Measure the gap between the slide runner and the edge of the track window. Measure both sides.

# Periodic maintenance and adjustment

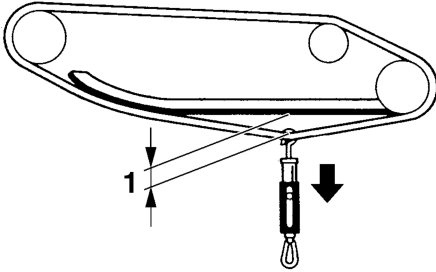

1. Drive track deflection

Standard drive track deflection:  
 RX10GT 30.0–35.0 mm (1.18–1.38 in)  
 RX10LTGT 25.0–30.0 mm (0.98–1.18 in)

3. If the deflection is incorrect, adjust the drive track.

## Adjusting the drive track

1. Lift the rear of the snowmobile onto a suitable stand to raise the drive track off the ground.
2. Loosen the rear axle nut.

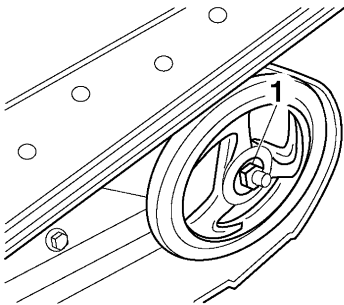

1. Rear axle nut

3. Start the engine and rotate the drive track one or two turns. Stop the engine.
4. Check the drive track alignment with the slide runners. If the alignment is incorrect, align the drive track by turning the left and right adjusting nuts.

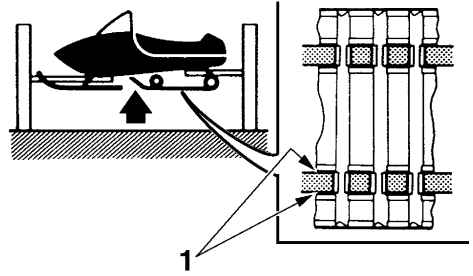

1. Slide runner

Drive track alignment	Shifted to right	Shifted to left
Left adjusting nut	Turn out	Turn in
Right adjusting nut	Turn in	Turn out

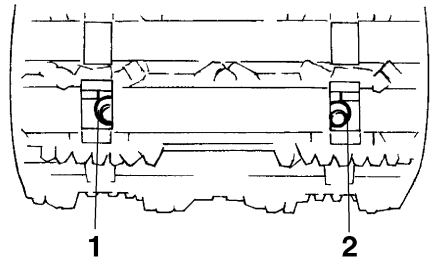

1. Left adjusting nut  
 2. Right adjusting nut

# Periodic maintenance and adjustment

## Shifted to right

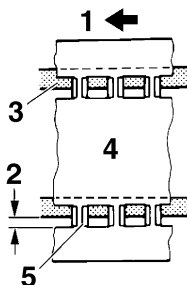

1. Forward
2. Gap
3. Slide runner
4. Drive track
5. Slide metal

## Shifted to left

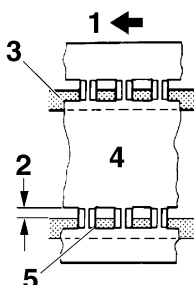

1. Forward
  2. Gap
  3. Slide runner
  4. Drive track
  5. Slide metal
5. Adjust the drive track deflection to specification. **NOTICE:** The right and left adjusting nuts should be turned an equal amount. [ECS00592]

Drive track deflection	More than specified	Less than specified
Left adjusting nut	Turn in	Turn out
Right adjusting nut	Turn in	Turn out

6. Recheck alignment and deflection. If necessary, repeat steps 3 to 5 until the proper adjustment is achieved.
7. Tighten the rear axle nut.

Rear axle nut tightening torque:  
75 Nm (7.5 m·kgf, 54 ft·lbf)

## Slide runners

Check the slide runners for wear and damage.

If the slide runners reach the wear limit, they should be replaced.

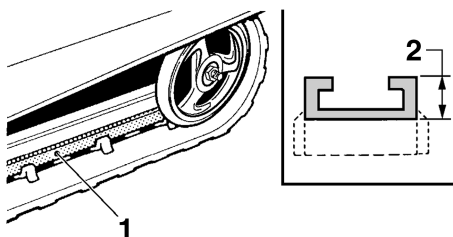

1. Slide runner
2. Wear limit height

Slide runner wear limit height:  
10.5 mm (0.41 in)

ECS00350

## NOTICE

**Ride on fresh snow frequently. Operating on ice or hard-packed snow will rapidly wear the slide runners.**

ESU12193

## Lubrication

Lubricate the following points with the specified grease.

# Periodic maintenance and adjustment

EWS00511

## **WARNING**

Do not grease the throttle cable because it could become frozen, which could cause loss of control. Apply a dab of grease onto the cable end only.

### Lubricants:

Brake lever:

Silicone grease

Other lubrication points:

Low-temperature grease

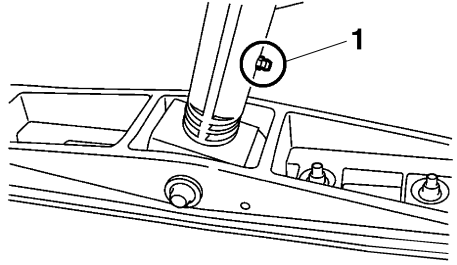

1. Lubrication point

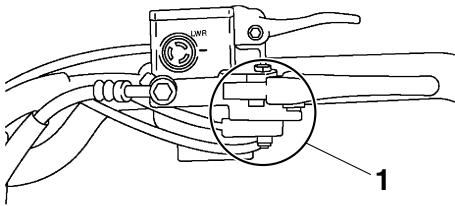

1. Lubrication point

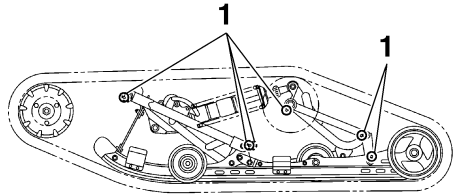

1. Lubrication point

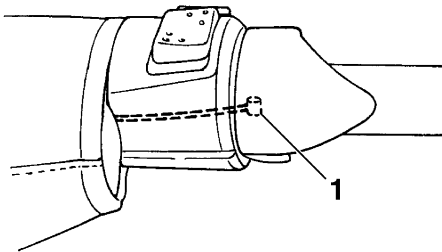

1. Throttle cable end

ESU12221

## Replacing a headlight bulb

1. Remove the top cover. (See page 41 for removal procedures.)
2. Remove the screws, and then remove the headlight access panel.

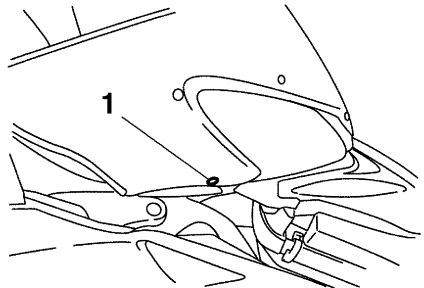

1. Screw

# Periodic maintenance and adjustment

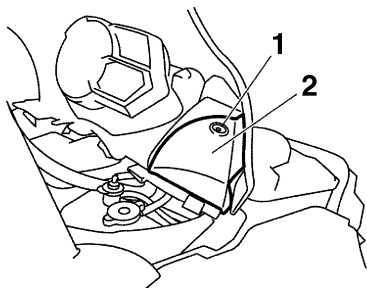

1. Screw
2. Headlight access panel
3. Disconnect the headlight coupler.
4. Remove the bulb holder cover.

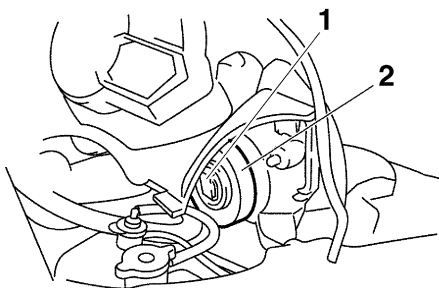

1. Headlight coupler
2. Bulb holder cover
5. Unhook the bulb holder by pushing it in, then clockwise.

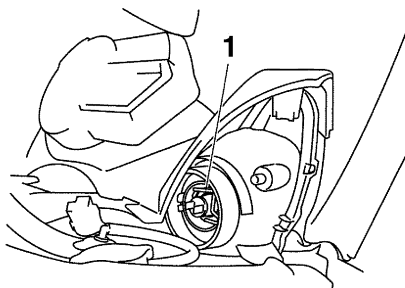

1. Bulb holder
6. Remove the bulb.

7. Install the new bulb, and then hook the bulb holder onto the headlight unit.  
**NOTICE:** Keep oil and your hands away from the glass part of the bulb or its life and illumination will be affected. If the glass is oil stained, thoroughly clean it with a cloth moistened with alcohol or lacquer thinner. [ECS00621]

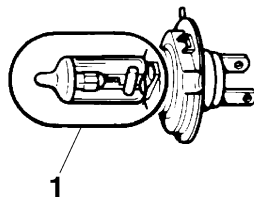

1. Do not touch the glass part of the bulb.

Bulb type:  
Halogen bulb

8. Install the bulb holder cover, and then connect the headlight coupler.
9. Install the headlight access panel and the top cover.

ESU12270

## Adjusting the headlight beams

1. Remove the top cover. (See page 41 for removal procedures.)
2. Use a Phillips screwdriver to turn the headlight beam adjusting screw and adjust the headlight beams. To lower the headlight beams, turn the headlight beam adjusting screw in direction (a). To raise the headlight beams, turn the headlight beam adjusting screw in direction (b).

# Periodic maintenance and adjustment

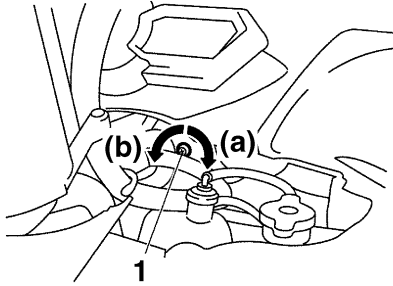

1. Headlight beam adjusting screw
3. Install the top cover.

ESU12290

## Fittings and fasteners

Check the tightness of the fittings and fasteners.

Tighten in proper sequence and torque if necessary.

ESU12303

## Battery

This model is equipped with a VRLA (Valve Regulated Lead Acid) battery. There is no need to check the electrolyte or to add distilled water. However, the battery lead connections need to be checked and, if necessary, tightened.

EWS00540

### **WARNING**

**Battery electrolyte is poisonous and dangerous. It contains sulfuric acid and can cause severe burns. Avoid contact with skin, eyes, or clothing.**

#### ANTIDOTE:

- **EXTERNAL:** Flush with water.
- **INTERNAL:** Drink large quantities of water or milk. Follow with milk of magnesia, beaten egg, or vegetable oil. Call physician immediately.
- **EYES:** Flush with water for 15 minutes and get prompt medical attention.

Batteries produce explosive gases. Keep sparks, flame, cigarettes, etc. away. Ventilate when charging or using in an enclosed space. Always shield your eyes when working near batteries.

**KEEP OUT OF THE REACH OF CHILDREN.**

Charge or have a Yamaha dealer charge the battery as soon as possible if it seems to have discharged. Keep in mind that the battery tends to discharge more quickly if the snowmobile is equipped with electrical accessories.

EWS00610

### **WARNING**

- **Never smoke around the battery while it is being charged. Sparks may ignite the hydrogen gas created by the battery.**
- **Disconnect the negative lead first, then the positive lead from the battery.**
- **Connect the positive lead first, then the negative lead to the battery when installing the battery.**
- **Never connect the battery to or disconnect it from the snowmobile while it is being charged. Sparks may ignite the hydrogen gas created by the battery.**
- **Make sure that the battery terminals are tight.**

ECS00842

### **NOTICE**

- **To charge a VRLA (Valve Regulated Lead Acid) battery, a special (constant-voltage) battery charger is required. If you do not have access to a constant-voltage battery charger, have a Yamaha dealer charge your battery. Using a conventional battery charger will damage the battery.**
- **Do not charge the battery quickly.**



# Periodic maintenance and adjustment

ESU12332

## Replacing a fuse

EWS00550

### **WARNING**

Be sure to use the specified fuse. A wrong fuse could cause electrical system damage or A FIRE HAZARD.

ECSS00631

### **NOTICE**

Be sure to turn the main switch to the off position and disconnect the negative battery lead to prevent accidental short-circuiting.

1. Remove the shroud, the left and right side covers, and the top cover. (See page 41 for removal procedures.)
2. Remove the headlight unit bolts, disconnect the headlight couplers and speedometer coupler, and then remove the headlight unit.

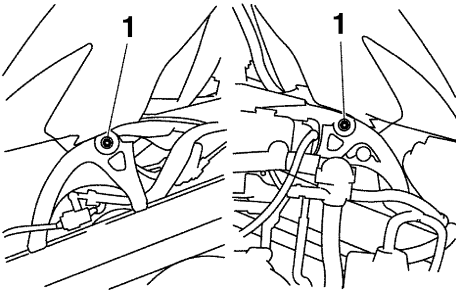

1. Headlight unit bolt
3. Unhook the air filter case fastener and disconnect the air temperature sensor coupler.

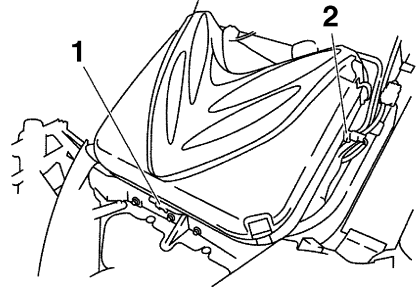

1. Fastener
2. Air temperature sensor coupler
4. Loosen the joint clamp bolts.

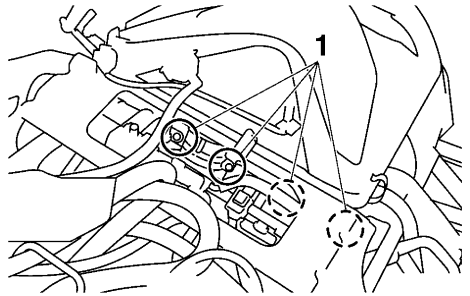

1. Joint clamp bolt
5. Slide the clamps away from the air filter case, and then disconnect the crankcase breather hose and the bypass air hose.

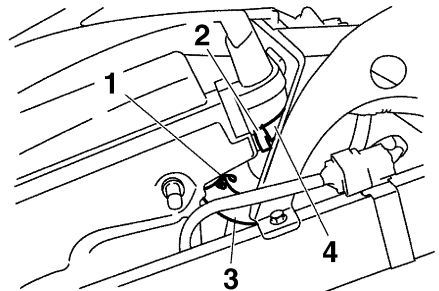

1. Crankcase breather hose clamp
2. Bypass air hose clamp
3. Crankcase breather hose
4. Bypass air hose
6. Slide the clamp down, and then disconnect the air filter case drain hose.

# Periodic maintenance and adjustment

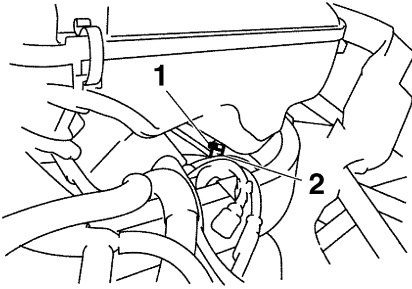

1. Air filter case drain hose clamp
2. Air filter case drain hose

7. Remove the air filter case.
8. Disconnect the negative battery lead.
9. Replace the blown fuse with one of the proper amperage.

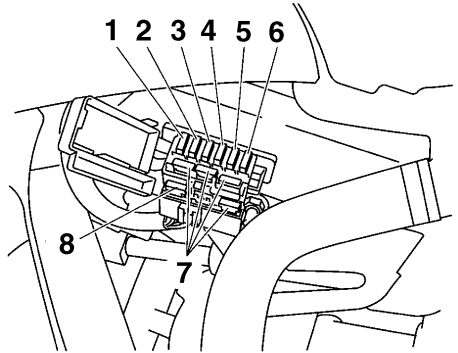
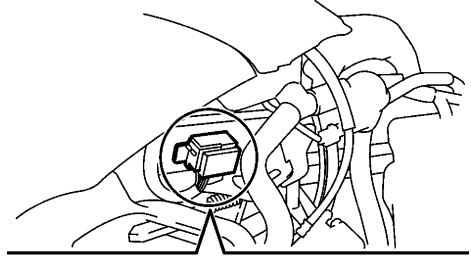

1. "HEAD" (headlight) fuse
2. "SIG" (signal) fuse
3. "DC TERM" (auxiliary DC jack) fuse
4. "IGN" (ignition) fuse
5. "BACK UP" (backup) fuse
6. "FAN" (radiator fan) fuse
7. Spare fuse
8. "ECS" (electronically controlled rear shock absorber) fuse

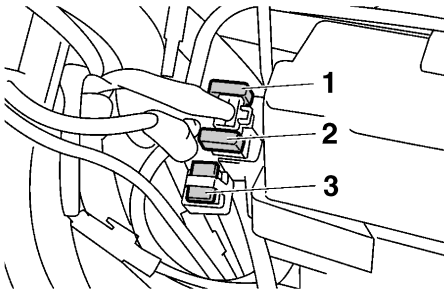

1. Spare fuse
2. Fuel injection system fuse
3. Main fuse

# Periodic maintenance and adjustment

## Specified fuses:

Main fuse:

40.0 A

Fuel injection system fuse:

10.0 A

“HEAD” (headlight) fuse:

20.0 A

“SIG” (signal) fuse:

10.0 A

“DC TERM” (auxiliary DC jack) fuse:

3.0 A

“IGN” (ignition) fuse:

20.0 A

“BACK UP” (backup) fuse:

3.0 A

“FAN” (radiator fan) fuse:

4.0 A

“ECS” (electronically controlled rear shock absorber) fuse:

10.0 A

Spare fuses:

20.0 A, 10.0 A, 4.0 A, 3.0 A

Headlight unit bolt tightening torque:

3 Nm (0.3 m·kgf, 2.2 ft·lbf)

14. Install the top cover, the left and right side covers, and the shroud.

## TIP

If the fuse immediately blows again, ask a Yamaha dealer to inspect the snowmobile.

10. Connect the negative battery lead.
11. Install the air filter case by reversing the removal steps.
12. Connect the headlight couplers and speedometer coupler, and then install the headlight unit, making sure to insert the projections on the headlight unit stay into the slots on the bottom of the headlight unit.

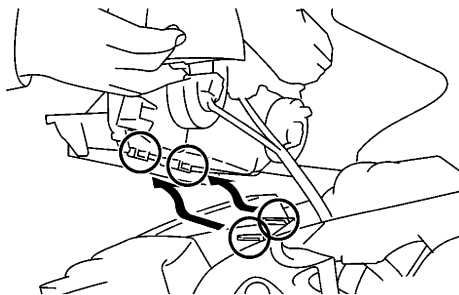

13. Install the headlight unit bolts, and then tighten them to the specified torque.

# Troubleshooting

ESU12384

## Engine turns over but does not start

### 1. Fuel system

- No fuel supplied to combustion chamber
  - No fuel in tank:  
Supply fuel.  
↓
  - Clogged fuel line:  
Clean fuel line.  
↓
  - Clogged injector:  
Ask a Yamaha dealer to inspect.
- Fuel supplied to combustion chamber
  - Flooded engine:  
Crank engine or wipe the spark plugs dry.

### 2. Electrical system

- Poor spark or no spark
  - Spark plugs are dirty with carbon or are wet:  
Remove carbon or wipe the spark plugs dry. Replace if necessary.  
↓
  - Faulty ignition system:  
Ask a Yamaha dealer to inspect.  
↓
  - T.O.R.S. malfunction:  
Disconnect the throttle switch connectors and connect the wire harness connectors together to bypass the T.O.R.S. **WARNING! Before bypassing the T.O.R.S., make sure that the throttle returns properly to the fully closed position. The T.O.R.S. is an important safety device; in the case of a malfunction, take the snowmobile to a Yamaha dealer immediately for repair.**

[EWS00561]

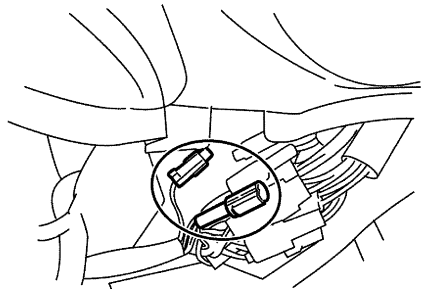

### 3. Compression

- Insufficient
  - Loose cylinder head nuts:  
Tighten nuts properly.  
↓
  - Worn or damaged gasket:  
Replace gasket.  
↓
  - Worn or damaged piston and cylinder:  
Ask a Yamaha dealer to inspect.

## Discharged battery

If the battery is discharged, the engine can be started using a fully-charged 12-volt battery and jumper cables. Two connecting leads have been provided for jump-starting the snowmobile. Due to the rubber engine mounting, the snowmobile frame is not a suitable grounding point for jump-starting the engine.

EWS00570

### **! WARNING**

- **Connect the jumper cables only to the connecting lead terminals. Do not connect them to the frame or any wire or other lead.**
- **When connecting the jumper cables, do not contact the jumper cables or connecting lead terminals to each other or to the frame or any metal part of the snowmobile. This can cause electrical system damage or A FIRE HAZARD.**

# Troubleshooting

- Be sure to pull the lead covers back over the terminals completely. If the terminals are exposed, they could come into contact with the frame or a metal part of the snowmobile and this can cause electrical system damage or A FIRE HAZARD.

ECS00650

## NOTICE

Use the connecting leads to jump-start the snowmobile only. Do not use the connecting leads for any other purpose.

### To start the engine using the booster battery

1. Apply the parking brake and turn the main switch to the off position.
2. Remove the shroud and the right side cover. (See page 41 for removal procedures.)
3. Remove the red (+) connecting lead from the lead holder and move it away from the black (-) connecting lead. **NOTICE: Be sure to connect the red (+) jumper cable to the red (+) connecting lead and the black (-) jumper cable to the black (-) connecting lead. Do not reverse the connections.** [ECS00661]

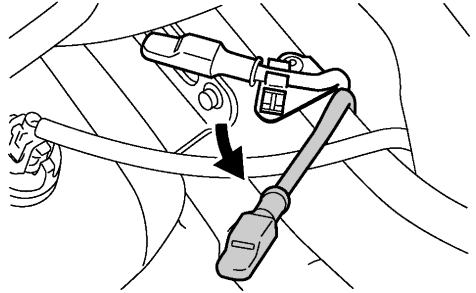
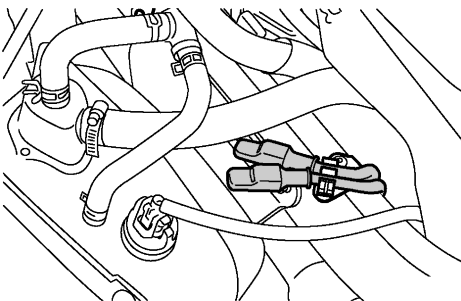

4. Pull the red (+) connecting lead cover to expose the terminal through the slit in the cover, and then connect the red (+) jumper cable to the red (+) connecting lead.

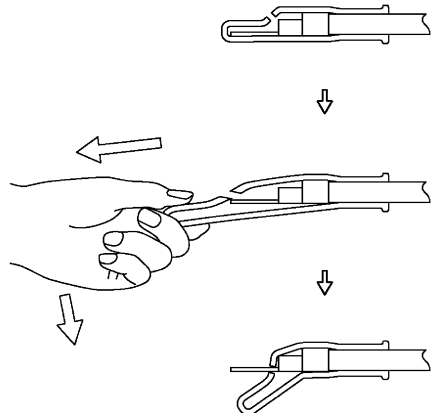

5. Connect the other end of the red (+) jumper cable to the positive (+) terminal of the booster battery.
6. Connect the black (-) jumper cable to the negative (-) terminal of the booster battery.

# Troubleshooting

- Pull the black (–) connecting lead cover to expose the terminal through the slit in the cover, and then connect the black (–) jumper cable to the black (–) connecting lead.

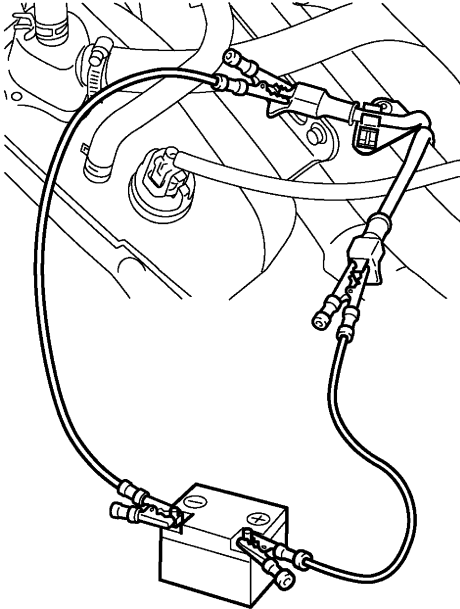

- Start the engine.
- Disconnect the black (–) jumper cable from the black (–) connecting lead, and then pull the cover completely over the lead terminal.
- Disconnect the black (–) jumper cable from the negative (–) terminal of the battery used to jump start the engine.
- Disconnect the red (+) jumper cable from the positive (+) terminal of the battery used to jump start the engine.
- Disconnect the red (+) jumper cable from the red (+) connecting lead, and then pull the cover completely over the lead terminal.

- Install the red (+) connecting lead into the lead holder.
- Install the right side cover and the shroud.

## TIP

Make sure that both the red (+) connecting lead and the black (–) connecting lead are seated securely in the lead holders.

## Electric starter does not operate or operates slowly

- Engine stop switch is pushed in: Pull it out.
- Faulty wire connections: Check connections or ask a Yamaha dealer to inspect.
- Discharged battery: Charge battery or see “Discharged battery” above.
- Seized engine: Seizure is caused by poor lubrication, inadequate fuel, or an air leak. Ask a Yamaha dealer to inspect.

## Engine power is low

- Low coolant temperature indicator light is flashing: Warm the engine up.
- Faulty spark plugs: Clean or replace the spark plugs.
- Improper fuel flow: See “Engine turns over but does not start–Fuel system” above.
- Incorrect V-belt clutch settings for altitude or conditions: Ask a Yamaha dealer to inspect.

## Engine constantly backfires or misfires

- Faulty spark plugs: Replace the spark plugs.
- Clogged fuel system: See “Engine turns over but does not start–Fuel system” above.
- Malfunctioning T.O.R.S.: See “Engine turns over but does not start–Electrical system” above.

## Engine overheats

- Insufficient coolant: Add coolant.
- Air in cooling system: Bleed the cooling system or ask a Yamaha dealer to inspect.

- Leaking coolant: Ask a Yamaha dealer to inspect.

## **Snowmobile does not move**

- Malfunctioning V-belt clutch: Ask a Yamaha dealer to inspect.
- Drive track does not move: Foreign object is caught in the drive track, or slide runners have melted to the slide metal due to lack of lubrication.
- Tight, loose, or broken drive chain: Ask a Yamaha dealer to inspect.

## **V-belt twists**

- Improper V-belt: Replace with the correct V-belt.
- Incorrect V-belt clutch offset: Ask a Yamaha dealer to inspect.
- Loose or broken engine mount(s): Ask a Yamaha dealer to inspect.

## **V-belt slips or becomes extremely hot**

- Oily or dirty V-belt or primary and secondary sheave assembly surfaces: Clean.
- Problem with the driveline: See “V-belt twists” above.

## **Engine does not upshift or downshift properly or engages harshly**

- Worn or damaged V-belt: Replace the V-belt or ask a Yamaha dealer to inspect.
- Incorrect V-belt clutch settings for altitude or conditions: Ask a Yamaha dealer to inspect.
- Worn or sticking primary sheave assembly: Ask a Yamaha dealer to inspect.
- Worn or sticking secondary sheave assembly: Ask a Yamaha dealer to inspect.

## **Noise or excessive vibration in drive chain and sprockets**

- Broken V-belt clutch components: Ask a Yamaha dealer to inspect.
- Worn or damaged bearings: Ask a Yamaha dealer to inspect.
- Worn or damaged V-belt with flat spots: Replace.

- Worn or damaged idler wheels or shafts: Ask a Yamaha dealer to inspect.
- Worn or damaged drive track: Ask a Yamaha dealer to inspect.

# Storage

---

ESU12433

Long-term storage requires some preventive procedures to guard against deterioration.

## Cleaning

Thoroughly clean the snowmobile, inside and out, to remove the corrosive salts and acids that can accumulate. Use Yamaha Mud, Grease, and Engine Cleaner, or an equivalent product, to loosen mud, grease, and grime. Wash with mild soap, then rinse and dry completely.

ECS00870

### **NOTICE**

- **Improper cleaning can damage plastic parts such as shroud, covers, windshields, headlight lenses, meter lenses, etc. Use only a soft, clean cloth or sponge with mild detergent and water to clean plastic.**
- **Do not use any harsh chemical products on plastic parts. Be sure to avoid using cloths or sponges which have been in contact with strong or abrasive cleaning products, solvent or thinner, fuel (gasoline), rust removers or inhibitors, brake fluid, antifreeze or electrolyte.**
- **Do not use high-pressure washers or steam-jet cleaners since they cause water seepage and deterioration in the following areas: seals (of the slide rail suspension, front suspension and brakes), electric components (couplers, connectors, instruments, switches and lights), breather hoses and vents.**
- **For snowmobiles equipped with a windshield: Do not use strong cleaners or hard sponges as they will cause dulling or scratching. Some cleaning compounds for plastic may leave scratches on the windshield. Test the product on a small hidden part of the windshield to make sure that it does not leave any**

**marks. If the windshield is scratched, use a quality plastic polishing compound after washing.**

---

## Lubrication

Lubricate moving parts, suspension linkage, and pivot points. Use the grease or lubricant specified in the MAINTENANCE section, or Yamaha Lube-Zall general-purpose lubricant. Proper lubrication fights corrosion while it reduces friction.

## Fuel system

Add Yamaha Fuel Stabilizer and Conditioner, or an equivalent stabilizer, to the fuel tank to help prevent fuel oxidation and gum and varnish deposits, and to inhibit corrosion in the fuel system and injectors. In areas where oxygenated fuel (gasohol) is used, consult a Yamaha dealer.

## Engine

Proper storage of the engine is essential to prevent costly rust and corrosion damage to internal engine components. This is more important in areas where oxygenated fuel (gasohol) is used, because the alcohol content in the fuel increases the chance for water to enter the engine. Use Yamaha Stor-Rite Engine Fogging Oil, or an equivalent fogging oil, to protect both the combustion chamber and crankshaft from corrosion. An alternate method is to remove the intake silencer and squirt oil into the throttle bodies while the engine is running. **NOTICE: Do not simply start the engine when in storage, starting the engine occasionally during the storage period can cause more harm than good. Moisture and acids form during combustion which can actually increase the chance for corrosion damage during the storage period.** [ECS00681]



## Surface protection

Apply a coat of wax to painted surfaces. Apply suitable protectants to the exterior of the engine, drive track, and to other metal, plastic, and rubber parts.

## Battery

Remove the battery from the snowmobile. Store it in a cool, dry place that is above 0 °C (32 °F), but less than 30 °C (90 °F). Check the condition of the battery once a month, and charge it as necessary. **NOTICE: Always keep the battery charged. Storing a discharged battery can cause permanent battery damage.** [ECS00691]

## Drive track

Loosen the drive track and block up the chassis so that the track is suspended above the ground.

## V-belt

Remove the V-belt and store separately.

## Storage

Store the snowmobile in a dry, well-ventilated place out of direct sunlight. Put a fabric cover over the snowmobile, preferably one that is designed for it. Do not use a plastic or vinyl cover—condensation could be trapped underneath which could increase the chances of rusting.

## Returning to service after storage

When returning your snowmobile to service, install the V-belt and battery and adjust the drive track.

Remove the spark plugs and clean or replace them if necessary. Perform all other pre-operation and seasonal maintenance checks listed in the periodic maintenance chart.

## TIP

---

Before installing the battery, have a Yamaha dealer inspect and fully charge it.

---

For peak performance, it is recommended that you have your snowmobile checked and tuned by a Yamaha dealer. The dealer has the experience and training to help you get the maximum performance and use out of your Yamaha snowmobile.

# Specifications

---

ESU12465

## Dimensions:

- Overall length:
  - RX10GT 2805 mm (110.4 in)
  - RX10LTGT 3000 mm (118.1 in)
- Overall width:
  - 1225 mm (48.2 in)
- Overall height:
  - 1160 mm (45.7 in)
- Dry weight:
  - RX10GT 261.0 kg (575 lb)
  - RX10LTGT 271.0 kg (597 lb)
- Ski stance:
  - 1086 mm (42.8 in)

## Engine:

- Type:
  - Liquid cooled 4-stroke, 20 valves
- Cylinder arrangement:
  - Backward-inclined parallel 4-cylinder
- Displacement:
  - 998.0 cm<sup>3</sup>
- Bore × stroke:
  - 74.0 × 58.0 mm (2.91 × 2.28 in)
- Idling speed:
  - 1400–1600 r/min
- Engine oil:
  - Recommended grade:
    - API service SG type or higher, JASO standard MA
  - Type:
    - YAMALUBE 4 0W-30, SAE 0W-30
- Fuel injection:
  - Model × quantity:
    - 39EIDW × 2
  - Manufacturer:
    - MIKUNI
- Fuel:
  - Type:
    - REGULAR UNLEADED GASOLINE ONLY
  - Minimum pump octane (R+M)/2:
    - 86
- Starting system:
  - Electric starter

## Chassis:

- Drive track:
  - Material:
    - Molded rubber, fiberglass-rod reinforced

## Type:

Internal drive type

## Width:

381 mm (15.0 in)

## Deflection:

RX10GT 30.0–35.0 mm (1.18–1.38 in)  
RX10LTGT 25.0–30.0 mm (0.98–1.18 in)

## Length on ground:

RX10GT 768 mm (30.2 in)  
RX10LTGT 960 mm (37.8 in)

## Rear suspension:

### Type:

Slide rail suspension

## Track sprocket wheel:

### Material:

Polyethylene

### Number of teeth:

9

## Transmission:

### Clutch type:

Automatic centrifugal engagement

### Overall reduction ratio:

RX10GT 6.02–1.58 :1  
RX10LTGT 6.28–1.65 :1

### Sheave distance:

267.0–270.0 mm (10.51–10.63 in)

### Sheave offset:

13.5–16.5 mm (0.53–0.65 in)

### Engagement speed (Subject to change according to elevation settings.):

3300–3700 r/min

### Shift speed [Subject to change according to elevation settings. Usually achieved after approximately 800 m (0.5 mi) traveled.]:

10250–10750 r/min

### Drive chain type:

Silent chain enclosed in oil bath

### Drive chain housing oil:

#### Type:

SAE 75W or 80W API GL-3 Gear oil

#### Capacity:

0.25 L (0.26 US qt, 0.22 Imp.qt)

### Reverse system:

Yes

### Primary reduction ratio:

3.80–1.00 :1

### Secondary reduction ratio:

RX10GT 38/24 (1.58)  
RX10LTGT 38/23 (1.65)

Secondary reduction ratio [R]:

RX10GT 2.08

RX10LTGT 2.17

Fuel tank capacity:

35.6 L (9.41 US gal, 7.83 Imp.gal)

Engine oil quantity:

With oil filter cartridge replacement:

3.0 L (3.17 US qt, 2.64 Imp.qt)

Without oil filter cartridge replacement:

2.8 L (2.96 US qt, 2.46 Imp.qt)

Total amount:

3.8 L (4.02 US qt, 3.34 Imp.qt)

Brake:

Type:

Hydraulic disc type (ventilated disc)

Operation:

Handle lever, left-hand operated

Throttle:

Operation:

Handle lever, right-hand operated

## Electrical system:

Ignition system:

T.C.I.

Spark plug:

Manufacturer:

NGK

Model:

CR9EB

Gap:

0.7–0.8 mm (0.028–0.031 in)

Battery:

Model:

YTX14-BS

Voltage, capacity:

12 V, 12.0 Ah

Ten-hour rate amperage:

1.2 A

Bulb voltage, wattage × quantity:

Headlight:

12 V, 60/55 W × 2

Headlight bulb type:

Halogen bulb

Tail/brake light:

LED

Meter lighting:

LED

High beam indicator light:

LED

Coolant temperature indicator light:

LED

Warning light:

LED

Low coolant temperature indicator light:

LED

# Consumer information

ESU12480

## Identification number records

Record the frame serial number, engine serial number (Primary ID), and key identification number in the spaces provided for assistance when ordering spare parts from a Yamaha dealer.

Also, record and keep the ID numbers in a separate place in case the snowmobile is stolen.

### Frame serial number

The frame serial number is the seventeen-digit number stamped on the frame of the snowmobile.

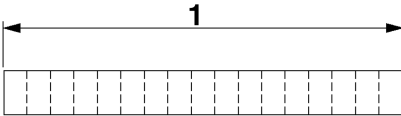
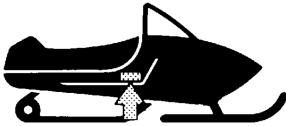

1. Frame serial number

### Engine serial number (Primary ID)

The engine serial number is stamped in the location as shown.

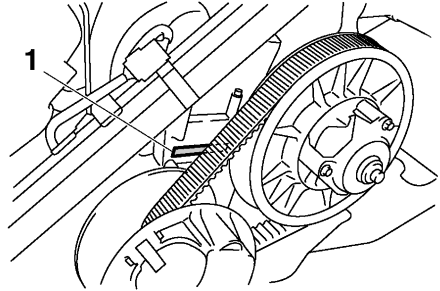

1. Engine serial number

### Key identification number

The key identification number is stamped in the location as shown.

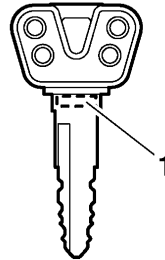

1. Key identification number

ESU12500

## YAMAHA MOTOR CORPORATION, U.S.A. SNOWMOBILE LIMITED WARRANTY

Yamaha Motor Corporation, U.S.A. hereby warrants that new Yamaha snowmobiles purchased from an authorized Yamaha snowmobile dealer in the continental United States will be free from defects in material and workmanship for the period of time stated herein, subject to certain stated limitations.

### WARRANTY PERIOD:

1. All Yamaha snowmobiles shall be warranted for a term of one (1) year from the date of purchase, plus a special early-season extension (if applicable).
2. All Yamaha snowmobile clutch components are warranted against abnormal wear for one (1) year from the date of purchase, plus a special early-season extension (if applicable).

**DURING THE PERIOD OF WARRANTY** any authorized Yamaha snowmobile dealer will, free of charge, repair or replace, at Yamaha's option, any part adjudged defective by Yamaha due to faulty workmanship or material from the factory. Parts used in warranty repairs will be warranted for the balance of the snowmobile's warranty period. All parts replaced under warranty become the property of Yamaha Motor Corporation, U.S.A.

**GENERAL EXCLUSIONS** from this warranty shall include any failures to the machine caused by:

1. Competition, racing, or non-Yamaha authorized rental use.
2. Operation on surfaces other than snow or ice.
3. Installation of parts or accessories that are not qualitatively equivalent to genuine Yamaha parts.
4. Abnormal strain, neglect, or abuse.
5. Lack of proper maintenance.
6. Accident or collision damage.
7. Modification to original parts.

**SPECIFIC EXCLUSIONS** from this warranty shall include parts replaced due to normal wear or routine maintenance including oil, spark plugs, clutch drive belts, slide runners, and track.

**THE CUSTOMER'S RESPONSIBILITY** under this warranty shall be to:

1. Operate and maintain the snowmobile as specified in the appropriate Owner's Manual.

2. Give notice to an authorized Yamaha snowmobile dealer of any and all apparent defects within ten (10) days after discovery, and make the machine available at that time for inspection and repairs at such dealer's place of business. You may locate your nearest authorized Yamaha dealer through your local telephone directory.

**WARRANTY TRANSFER:** To transfer any remaining warranty from the original purchaser to any subsequent purchaser, it is imperative that the machine be inspected and registered for warranty by an authorized Yamaha snowmobile dealer. In order for this warranty to remain in effect, this inspection and registration must take place within ten (10) days after ownership transfer. An inspection and registration fee will be charged for this service.

### EMISSION CONTROL SYSTEM WARRANTY

Yamaha Motor Corporation, USA also warrants to the ultimate purchaser and each subsequent purchaser of each 2006 and later model Yamaha snowmobile covered by this warranty that the vehicle is designed, built, and equipped so as to conform at the time of sale with all U.S. emissions standards applicable at the time of manufacture and that it is free from defects in materials and workmanship which would cause it not to meet these standards within the period listed immediately below. Failures other than those resulting from defects in material or workmanship which arise solely as a result of owner abuse and/or lack of proper maintenance are not covered by this warranty.

### All Models

Thirty (30) months from the original purchase date

# Consumer information

---

***YAMAHA MOTOR CORPORATION, U.S.A. MAKES NO OTHER WARRANTY OF ANY KIND, EXPRESSED OR IMPLIED. ALL IMPLIED WARRANTIES OF MERCHANTABILITY AND FITNESS FOR A PARTICULAR PURPOSE WHICH EXCEED THE OBLIGATIONS AND TIME LIMITS STATED IN THIS WARRANTY ARE HEREBY DISCLAIMED BY YAMAHA MOTOR CORPORATION, U.S.A. AND EXCLUDED FROM THIS WARRANTY.***

***SOME STATES DO NOT ALLOW LIMITATIONS ON HOW LONG AN IMPLIED WARRANTY LASTS, SO THE ABOVE LIMITATION MAY NOT APPLY TO YOU. ALSO EXCLUDED FROM THIS WARRANTY ARE ANY INCIDENTAL OR CONSEQUENTIAL DAMAGES INCLUDING LOSS OF USE. SOME STATES DO NOT ALLOW THE EXCLUSION OR LIMITATION OF INCIDENTAL OR CONSEQUENTIAL DAMAGES, SO THE ABOVE EXCLUSION MAY NOT APPLY TO YOU.***

***THIS WARRANTY GIVES YOU SPECIFIC LEGAL RIGHTS, AND YOU MAY ALSO HAVE OTHER RIGHTS WHICH VARY FROM STATE TO STATE.***

## **SPECIAL EARLY-SEASON WARRANTY EXTENSION**

A special warranty extension is available for all new Yamaha snowmobiles purchased between June 1 and December 1.

All new Yamaha snowmobiles purchased between June 1 and December 1 will have the warranty extended to November 30 of the following year.

**YAMAHA MOTOR CORPORATION, U.S.A.  
Post Office Box 6555  
Cypress, California 90630**

## **WARRANTY QUESTIONS AND ANSWERS**

- Q. What costs are my responsibility during the warranty period?
- A. The customer's responsibility includes all costs of normal maintenance services, non-warranty repairs, accident and collision damages, as well as oil, spark plugs, clutch drive belts, and slide runners.
- Q. What are some examples of "abnormal" strain, neglect, or abuse?
- A. These terms are general and overlap each other in areas. Specific examples include: Running the machine out of oil, hitting an object submerged under snow, operation on surfaces other than snow or ice, operating the machine with a broken or damaged part which causes another part to fail, and so on. If you have any specific questions on operation or maintenance, please contact your dealer for advice.
- Q. May I perform any or all of the recommended maintenance shown in the Owner's Manual instead of having the dealer do them?
- A. Yes, if you are a qualified snowmobile mechanic and follow the procedures specified in the Owner's and Service Manual. We do recommend, however, that items requiring special tools or equipment be done by a Yamaha snowmobile dealer.
- Q. Under what conditions is the clutch not covered by warranty?
- A. Clutches as well as clutch components wear with use. Normal wear is not covered under warranty such service is the customer's responsibility. Abnormal wear is, however, covered for one (1) year from the date of purchase. Your Yamaha snowmobile dealer possesses criteria as to what constitutes abnormal wear.
- Q. Will the warranty be void or canceled if I do not operate or maintain my new Yamaha exactly as specified in the Owner's Manual?
- A. No. The warranty on a new Yamaha cannot be "voided" or "canceled." However, if a particular failure is caused by operation or maintenance other than as shown in the Owner's Manual, that failure may not be covered under warranty.

# Consumer information

---

- Q. What responsibility does my dealer have under this warranty?
- A. Each Yamaha snowmobile dealer is expected to:
1. Completely set up every new machine before sale.
  2. Explain the operation, maintenance, and warranty requirements to your satisfaction at the time of sale, and upon your request at any later date.
  3. In addition, each Yamaha snowmobile dealer is held responsible for his setup, service and warranty repair work.
- Q. Whom should I contact if I have further questions about this warranty?
- A. Your Yamaha snowmobile dealer has the information and experience necessary to answer almost any questions about this warranty. If the dealer is not able to do so, he is expected to contact Yamaha Motor Corporation, U.S.A., for clarification or assistance.

## CUSTOMER SERVICE

If your machine requires warranty service, you must take it to any authorized Yamaha snowmobile dealer within the continental United States. Be sure to bring your warranty identification card or other valid proof of the original date of purchase. If a question or problem arises regarding warranty, first contact the owner of the dealership. Since all warranty matters are handled at the dealer level, this person is in the best position to help you. If you are still not satisfied and require additional assistance, please write:

**YAMAHA MOTOR CORPORATION, U.S.A.**  
**CUSTOMER RELATIONS**  
**DEPARTMENT**  
**P.O. Box 6555**  
**Cypress, California 90630**

When contacting Yamaha Motor Corporation, U.S.A. be sure to include the model, serial number, names, dates, and receipts.

## CHANGE OF ADDRESS

The federal government requires each manufacturer of a motor vehicle to maintain a complete, up-to-date list of all first purchasers against the possibility of a safety-related defect and recall. This list is compiled from the purchase registrations sent to Yamaha Motor Corporation, U.S.A. by the selling dealer at the time of your purchase.

If you should move after you have purchased your new snowmobile, please advise us of your new address by sending a postcard listing your snowmobile model name, engine serial number, dealer number (or dealer's name) as it is shown on your warranty registration identification, your name and new mailing address. Mail to:

**YAMAHA MOTOR CORPORATION, U.S.A.**  
**WARRANTY DEPARTMENT**  
**P.O. Box 6555**  
**Cypress, California 90630**

This will ensure that Yamaha Motor Corporation, U.S.A. has an up-to-date registration record in accordance with federal law.

# Consumer information

---

ESU12510

## YAMAHA EXTENDED SERVICE (Y.E.S.)

Keep your Yamaha protected even after your warranty expires with genuine Yamaha Extended Service (Y.E.S.).

- Y.E.S. is designed and administered by Yamaha Motor Corporation to provide maximum owner satisfaction. You get uninterrupted factory-backed coverage for extra peace of mind.
- Y.E.S. is flexible. You choose the plan that's right for you: 12 months, 24 months, 36 months, or every 48 months (on selected models) beyond your warranty period.
- Y.E.S. is designed and administered by the same Yamaha people who handle your warranty—and it shows in the comprehensive coverage benefits. There are no mileage limitations, and Y.E.S. covers manufacturing defects just like the warranty. See the sample contract at your Yamaha dealer to see how comforting uninterrupted factory-backed protection can be.
- You don't have to pay anything for covered repairs. There's no deductible to pay, and repairs aren't "pro-rated." You don't have any "out-of pocket" expenses for covered repairs.
- In addition, Travel and Recreation Interruption Protection (TRIP) is included at no extra cost. TRIP gives you up to \$150 reimbursement per occurrence for any reasonable expenses you incur because your Yamaha needs covered service: replacement vehicle rental, emergency towing, phone calls, even food and lodging when you are away from home. This superb coverage goes into effect when you purchase Y.E.S., so it applies to any warranty repairs as well as covered repairs during your entire Y.E.S. plan period.
- Y.E.S. coverage is honored at any authorized Yamaha dealer nationwide.
- Y.E.S. coverage is transferable to a new owner if you sell or trade-in. That can make your Yamaha much more valuable!

This excellent Y.E.S. plan coverage is only available to Yamaha owners like you, and only while your Yamaha is still within the Yamaha Limited Warranty period. So visit your authorized Yamaha dealer to get all the facts. He can show you how easy it is to protect your investment with Yamaha Extended Service.

We urge you to act now. You'll get the excellent benefits of TRIP coverage right away, and you'll rest easy knowing you'll have strong factory-backed protection even after your Yamaha Limited Warranty expires. See your dealer today!

A special note:

If visiting your dealer isn't convenient, contact Yamaha toll free at 1-866-937-3983 (866 YES-EXTD) or visit our web site. All you need to do is provide your vehicle's Primary ID number (your Tunnel number). We'll be happy to help you get the Y.E.S. coverage you need.

Yamaha Service Marketing  
P.O. Box 6555  
Cypress, CA 90630  
1-866-937-3983  
[www.yamaha-motor.com](http://www.yamaha-motor.com)



**YAMAHA EXTENDED SERVICE**



<b>A</b>		<b>L</b>	
Air filter, checking.....	46	Location of the important labels .....	1
Auxiliary DC jack .....	17	Low coolant temperature indicator light ...	12
<b>B</b>		Lubrication.....	63
Battery.....	66	<b>M</b>	
Brake and parking brake .....	58	Main switch .....	8
Brake lever .....	18	<b>O</b>	
Break-in.....	30	Oil level warning indicator .....	15
<b>C</b>		<b>P</b>	
Control rod, adjusting .....	25	Parking brake lever .....	18
Coolant temperature warning indicator ....	15	Part locations .....	5
Cooling system.....	52	Periodic maintenance chart for the emission control system .....	37
<b>D</b>		Pre-operation check list.....	27
Drive chain housing.....	56	<b>R</b>	
Drive guard.....	20	Riding your snowmobile .....	30
Drive track and slide runners .....	61	<b>S</b>	
Drive track life, maximizing .....	34	Safety information .....	3
Driving.....	34	Self-diagnosis device .....	16
<b>E</b>		Shift lever .....	19
Engine idling speed, adjusting .....	44	Shock absorber, rear, adjusting damping forces .....	25
Engine oil and oil filter cartridge .....	48	Shock absorber, rear, adjusting spring preload.....	24
Engine overheating prevention system .....	8	Shock absorbers, front, adjusting damping forces .....	23
Engine stop switch .....	16	Shock absorbers, front, adjusting spring preload.....	22
<b>F</b>		Shroud and covers .....	19
Fittings and fasteners.....	66	Shroud and covers, removing and installing.....	41
Fuel .....	21	Skis and ski runners.....	60
Fuel level warning indicator.....	15	Spark plugs, checking .....	43
Fuel meter, grip warmer level indicator, rear shock absorber compression damping level indicator, and thumb warmer level indicator .....	12	Specifications .....	76
Fuse, replacing.....	67	Speedometer unit.....	9
<b>G</b>		Starting the engine .....	29
General maintenance and lubrication chart.....	39	Steering system .....	60
Grip warmer/rear shock absorber compression damping and thumb warmer adjustment switches .....	17	Stopping the engine .....	35
<b>H</b>		Storage.....	74
Headlight beam switch.....	16	Storage compartment.....	20
Headlight beams, adjusting.....	65	Suspension .....	22
Headlight bulb, replacing.....	64	<b>T</b>	
High beam indicator light.....	12	Throttle cable free play, adjusting .....	44
High-altitude settings.....	48	Throttle lever .....	8
<b>I</b>		Throttle override system (T.O.R.S.) .....	8
Identification numbers .....	78		

# Index

---

- Throttle override system (T.O.R.S.),
  - checking..... 46
- Tool kit..... 41
- Transporting ..... 36
- Troubleshooting ..... 70
- V**
- Valve clearance..... 48
- V-belt..... 53
- V-belt holders ..... 20





PRINTED IN JAPAN  
2008.04-0.3x2 CR

PRINTED ON RECYCLED PAPER