

2012 ATV Operator's Manuals

Click on [blue](#) text to go.



[DVX 90/90 Utility](#)



[50](#)



[XC 450 I](#)

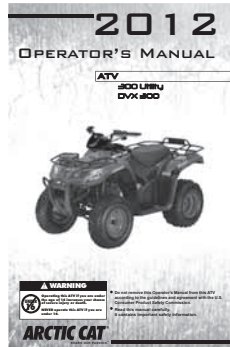

[300 Utility/DVX 300](#)



[350/425](#)



[650/650 Mud Pro](#)



[Generic](#)



[700 Diesel](#)



[TRV](#)

Your ATV can be hazardous to operate.

A collision or rollover can occur quickly, even during routine maneuvers such as turning and driving on hills or over obstacles, if you fail to take proper precautions.

For your safety, understand and follow all the warnings contained in this Operator's Manual and the labels on your ATV.



Keep this Operator's Manual with your ATV at all times.

FAILURE TO FOLLOW THE WARNINGS CONTAINED IN THIS MANUAL CAN RESULT IN SERIOUS INJURY OR DEATH.

Training is available: U.S. owners, call 800-887-2887; Canadian owners, call 613-739-1535.

Un cours d'instruction est disponible: pour les propriétaires canadiens, composez le 613-739-1535.

Particularly important information is distinguished in this manual by the following notations:

	The Safety Alert Symbol means ATTENTION! BE ALERT! YOUR SAFETY IS INVOLVED.
 WARNING	WARNING indicates a hazardous situation which, if not avoided, could result in death or serious injury.
 CAUTION	CAUTION, without the safety alert symbol, is used to address practices not related to personal injury.
■ NOTE:	A NOTE provides key information to make procedures easier or more clear.

California Proposition 65

 WARNING
This product contains or emits chemicals known to the State of California to cause cancer and birth defects or other reproductive harm.

Division I - Rider Awareness/ Responsibility

Foreword

Congratulations and thank you from Arctic Cat Inc. for purchasing an ARCTIC CAT® All-Terrain Vehicle (ATV). It is designed to provide superior ride, comfort, and utility.

This Operator's Manual is furnished to make the operator aware of proper operating procedures. It also includes information about the general care and maintenance of your ATV.

Children differ in skills, physical abilities, and judgment. Some children may not be able to operate an ATV safely. Parents should supervise their child's use of the ATV at all times. Parents should permit continued use only if they determine that the child has the ability to operate the ATV safely.

Carefully read the following pages. If you have any questions regarding this ATV, contact an authorized Arctic Cat ATV dealer for assistance. Remember, only authorized Arctic Cat ATV dealers have the knowledge and facilities to provide you with the best service possible.

Protect Your Sport

- Know all local, state/provincial riding laws,
- Respect your ATV,
- Respect the environment, and
- You will gain the respect of others.

We also advise you to strictly follow the recommended maintenance program as outlined. This preventive maintenance program is designed to ensure that all critical components on this ATV are thoroughly inspected at various intervals.

All information in this manual is based on the latest product data and specifications available at the time of printing. Arctic Cat Inc. reserves the right to make product changes and improvements which may affect illustrations or explanations without notice.

Arctic Cat and the ATV Safety Institute recommend that all ATV operators ride the appropriate-sized ATV according to age.

Category	Age (Years)	Speed Limitations (MPH)	NOTES
Y-12+	12 or Older	15 - Limited 30 - Maximum	Operate Under Adult Supervision
T-14	14 or Older	20 - Limited 30 - Limited 38 - Maximum	Operate Under Adult Supervision
G & S	16 or Older	According to Local Regulations	—

TREAD LIGHTLY! **OFFICIAL SPONSOR**®
ON PUBLIC AND PRIVATE LAND

Table of Contents

DIVISION I - RIDER AWARENESS/RESPONSIBILITY

Foreword.....	1
ATV Safety Alert.....	5
Rider Training Course.....	6
Hangtag & Warning Labels (DVX).....	7
Hangtag & Warning Labels (Utility).....	8
Warnings.....	9-15
Prevention.....	16-19
Clothing and Gear.....	16
Condition of the ATV.....	17
T-CLOC.....	17
First Aid and Survival.....	18
Active Riding.....	20
Sound Judgment.....	21-23
Those Around You.....	21
Environment.....	21
Equipment.....	22
Personal Choices.....	22
SIPDE.....	23
Load Capacity Ratings Chart (Utility).....	23
Supervision.....	24
Taking Responsibility.....	24
Inexperienced Riders.....	24
Experienced Riders.....	24

DIVISION II - OPERATION/ MAINTENANCE

Preface.....	25
Parts and Accessories.....	25
ATV Specifications.....	26
Location of Controls.....	27
ATV Operation.....	28-35
Basic Operating Maneuvers.....	28
Starting the Engine.....	28
BONE-C.....	28
Starting A Cold Engine.....	29
Handling the ATV (Active Riding Techniques).....	30
Tips.....	30

General Information.....	36-41
ATV Identification Numbers.....	36
Ignition Switch Key.....	36
Control Locations and Functions.....	36
Shift Lever.....	38
Gas/Vent Hoses.....	39
Carburetor Float Bowl Drain.....	39
Oil Level Stick.....	39
Seat Lock.....	39
Safety Flag/Bracket.....	39
Transporting ATV.....	40
Gasoline-Oil-Lubricant.....	40
Engine Break-In.....	41
General Maintenance.....	42-52
Maintenance Schedule.....	42
Shock Absorbers.....	43
General Lubrication.....	43
Hand Brake System.....	44
Brake Lever Lock.....	44
Adjusting Brakes.....	44
Protective Rubber Boots.....	45
Battery.....	45
Spark Plug.....	48
Engine Idle RPM Adjustment.....	49
Throttle Cable Adjustment.....	49
Air Filter.....	49
Tires.....	50
Wheels.....	51
Bulb Replacement.....	51
Fuse.....	52
Storage Compartment/Tools.....	52
Preparation For Storage.....	53
Preparation After Storage.....	54
Maintenance Record.....	55
Limited Warranty.....	56
Warranty Procedure/Owner Responsibility.....	57
Arctic Cat Emission Control System Limited Warranty.....	58
U.S. EPA Emission Control Statement/Warranty Coverage - ATV (U.S. Only).....	59
Declaration of Conformity.....	60
Change Of Address, Ownership, Or Warranty Transfer.....	61
Identification Numbers Record.....	Inside Back Cover

AN ATV IS NOT A TOY AND CAN BE HAZARDOUS TO OPERATE.

An ATV handles differently from other vehicles including motorcycles and cars. A collision or rollover can occur quickly, even during routine maneuvers such as turning and driving on hills or over obstacles, if you fail to take proper precautions.

SEVERE INJURY OR DEATH can result if you do not follow these instructions:

- Parents: It is very important that your child or children understand and follow the instructions and warnings contained in this manual before operating this ATV under adult supervision. Also, it is very important that you take time to watch the Safety DVD (included in the Owner's Packet) with your child or children. It contains important operating and safety instructions.
- Read this manual and all labels carefully and follow the operating procedures described.
- Never operate an ATV without proper instruction. Take a training course. Beginners should receive training from a certified instructor. Contact an authorized Arctic Cat ATV dealer or call the ATV Safety Institute at 1-800-887-2887 (U.S.) or 1-613-739-1535 (Canada) to find out about the training course nearest you.
- Never allow anyone under 12 years of age to operate this ATV.
- Never allow a child to operate a Y-12+ ATV without adult supervision and never allow continued use of an ATV by a child if the child does not have the abilities to operate it safely.
- Some operators, even at the age of 12, may not be able to operate an ATV safely; parents should supervise such operator of the ATV at all times. Parents should permit continued use only if they determine that the operator has the ability to operate the ATV safely.
- Never carry a passenger.
- Never permit a guest to operate this ATV unless the guest has read this manual and all product labels and has completed a certified training course.
- Never operate an ATV on any paved surfaces, including sidewalks, driveways, parking lots, and streets.
- Never operate this ATV on any public street, highway, or road (even a dirt or gravel one).

- Never operate an ATV without wearing an approved helmet that fits properly. You should also wear eye protection (goggles or face shield), gloves, boots, long-sleeved shirt or jacket, and long pants.
- Never consume alcohol or drugs before or while operating this ATV.
- Never operate at excessive speeds. Always travel at a speed which is proper for the terrain, visibility and operating conditions, and your experience.
- Never attempt wheelies, jumps, or other stunts.
- Always inspect this ATV each time you use it to make sure it is in safe operating condition. Always follow the inspection and maintenance procedures and schedules described in this manual.
- Always keep both hands on the handlebars and both feet on the footrests of the ATV during operation.
- Always go slowly and be extra careful when operating on unfamiliar terrain. Always be alert to changing terrain conditions when operating the ATV.
- Never operate on excessively rough, slippery, or loose terrain.
- Always follow proper procedures for turning as described in this manual. Practice turning at slow speeds before attempting to turn at faster speeds. Do not turn at excessive speed.
- Always have the ATV checked by an authorized Arctic Cat ATV dealer if it has been involved in an accident.
- Never operate the ATV on hills too steep for the ATV or for your abilities. Practice on smaller hills before attempting larger hills.
- Always follow proper procedures for climbing hills as described in this manual. Check the terrain carefully before you start up any hill. Never climb hills with slippery or loose surfaces. Shift your weight forward. Never open the throttle suddenly. Never go over the top of any hill at high speed. Always follow proper procedures for going down hills and for braking on hills as described in this manual. Check the terrain carefully before you start down any hill. Shift your weight backward. Never go down a hill at high speed. Avoid going down a hill at an angle which would cause the ATV to lean sharply to one side. Go straight down the hill where possible.
- Always follow proper procedures for crossing the side of a hill as described in this manual. Avoid hills with slippery or loose surfaces. Shift your weight to the uphill side of the ATV. Never attempt to turn the ATV around on any hill until you have mastered the turning techniques described in this manual on level ground. Avoid crossing the side of a steep hill if possible.

AN ATV IS NOT A TOY AND CAN BE HAZARDOUS TO OPERATE.

- Always use proper procedures if you stall or roll backward when climbing a hill. To avoid stalling, maintain a steady speed when climbing a hill. If you stall or roll backwards, follow the special procedure for braking described in this manual. Dismount on the uphill side or to either side if pointed straight uphill. Turn the ATV around and mount following the procedure described in this manual.
- Always check for obstacles before operating in a new area. Never attempt to operate over large obstacles, such as large rocks or fallen trees. Always follow proper procedures when operating over obstacles as described in this manual.

- Always be careful of skidding or sliding. On slippery surfaces, such as ice, go slowly and be very cautious in order to reduce the chance of skidding or sliding out of control.
- Never operate an ATV in fast flowing water or in water deeper than the footrests. Remember that wet brakes may have reduced stopping capability. Test your brakes after leaving water. If necessary, apply them lightly several times to let friction dry out the pads.
- Always use the size and type tires specified in this manual. Always maintain proper tire pressure as described in this manual.
- Never improperly install or improperly use accessories on your ATV.
- Never install a twist grip throttle on this ATV.
- Never exceed the stated load capacity for this ATV. One operator only. No cargo, passengers, or towing.
- Remove the speed limiting safety device on this ATV at your own risk.

FOR MORE INFORMATION ABOUT ATV SAFETY, call the ATV Safety Institute at 1-800-887-2887 (U.S.) or Canada Safety Council at 1-613-739-1535 (Canada).

ATV Safety Alert

The Consumer Product Safety Commission has concluded that ALL-TERRAIN VEHICLES (ATV's) may present a risk of DEATH or SEVERE INJURY in certain circumstances. While accidents may occur for many reasons:

- *** Over 2591 people, including many children, have died in accidents associated with ATV's since 2005.
- *** Many people have become severely paralyzed or suffered severe internal injuries as a result of accidents associated with ATV's.
- *** Every month thousands of people are treated in hospital emergency rooms for injuries received while riding an ATV.

You should be aware that AN ATV IS NOT A TOY AND CAN BE HAZARDOUS TO OPERATE. An ATV handles differently from other vehicles, including motorcycles and cars. A collision or rollover can occur quickly, even during routine maneuvers such as turning and driving on hills and over obstacles, if you fail to take proper precautions.

TO AVOID DEATH OR SEVERE PERSONAL INJURY:

- * NEVER ALLOW ANYONE UNDER 12 YEARS OLD TO OPERATE AN ARCTIC CAT Y-12+ ATV.
- * ALWAYS READ THE OPERATOR'S MANUAL CAREFULLY AND FOLLOW THE OPERATING PROCEDURES DESCRIBED. PAY SPECIAL ATTENTION TO THE WARNINGS CONTAINED IN THE MANUAL AND ON ALL LABELS.
- * NEVER OPERATE AN ATV WITHOUT PROPER INSTRUCTION. TAKE A TRAINING COURSE. BEGINNERS SHOULD COMPLETE THE TRAINING COURSE DESCRIBED ON PAGE 6.

- * NEVER CARRY A PASSENGER OR RIDE AS A PASSENGER ON AN ATV. CARRYING A PASSENGER MAY UPSET THE BALANCE OF THE ATV AND MAY CAUSE IT TO GO OUT OF CONTROL.
- * EVERY ARCTIC CAT BRAND ATV IS DESIGNED FOR A CERTAIN AGE GROUP. NEVER RIDE AN ATV THAT IS NOT DESIGNED FOR YOUR AGE GROUP. THE OPERATOR'S MANUAL AND LABELS CONTAIN THE AGE GROUP FOR EACH ARCTIC CAT BRAND ATV.
- * NEVER OPERATE AN ARCTIC CAT BRAND YOUTH ATV WITHOUT PARENTAL SUPERVISION.
- * NEVER OPERATE AN ATV ON PAVEMENT. THE VEHICLE IS NOT DESIGNED TO BE USED ON PAVED SURFACES AND MAY BE DIFFICULT TO CONTROL.
- * NEVER OPERATE AN ATV ON A PUBLIC ROAD, EVEN A DIRT OR GRAVEL ONE, BECAUSE YOU MAY NOT BE ABLE TO AVOID COLLIDING WITH OTHER VEHICLES. ALSO, OPERATING AN ATV ON A PUBLIC ROAD MAY BE AGAINST THE LAW.
- * NEVER OPERATE AN ATV WITHOUT AN APPROVED MOTORCYCLE HELMET, EYE PROTECTION, BOOTS, GLOVES, LONG PANTS, AND A LONG-SLEEVED SHIRT OR JACKET.
- * NEVER CONSUME ALCOHOL OR DRUGS BEFORE OR WHILE OPERATING AN ATV.
- * NEVER OPERATE AN ATV AT EXCESSIVE SPEEDS. GO AT A SPEED WHICH IS PROPER FOR THE TERRAIN, VISIBILITY CONDITIONS, AND YOUR EXPERIENCE.
- * NEVER ATTEMPT TO DO WHEELIES, JUMPS, OR OTHER STUNTS.
- * ALWAYS BE CAREFUL WHEN OPERATING AN ATV, ESPECIALLY WHEN APPROACHING HILLS, TURNS, AND OBSTACLES AND WHEN OPERATING ON UNFAMILIAR OR ROUGH TERRAIN.

* NEVER LEND YOUR ATV TO ANYONE WHO HAS NOT TAKEN A TRAINING COURSE OR HAS NOT BEEN DRIVING AN ATV FOR AT LEAST A YEAR.

Rider Training Course

Arctic Cat sponsors a free Rider Training Course to teach ATV riding skills or to reinforce current riding skills. First-time purchasers without any previous ATV riding experience will receive a \$100.00 coupon from Arctic Cat through the SVIA/ASI after completing the training course (U.S. owners only, one incentive). Arctic Cat provides free rider training courses to appropriate immediate family members per ATV purchase. Others can take the training course for a small fee. See an authorized Arctic Cat ATV dealer for details or call (800) 887-2887 for training course information.

**FOR MORE INFORMATION ABOUT
ATV SAFETY, call the Consumer
Product Safety Commission at (800)
638-2772 or the ATV Distributors'
Safety Hotline at (800) 852-5344.**

Visit the Arctic Cat Inc. website at www.arcticcat.com for additional product information.

Hangtag & Warning Labels (DVX)

Your Arctic Cat ATV comes with a hangtag and several labels containing important safety information. Anyone who rides the ATV should read and understand this information before riding.

The labels should be considered as permanent parts of the ATV. If a label comes off or becomes hard to read, contact your Arctic Cat ATV dealer for a replacement.

Pour commander des Etiquettes de Mise en Garde gratuites, voyez votre détaillant de autorisé VTT Arctic Cat pour le numéro de pièce 1436-344.

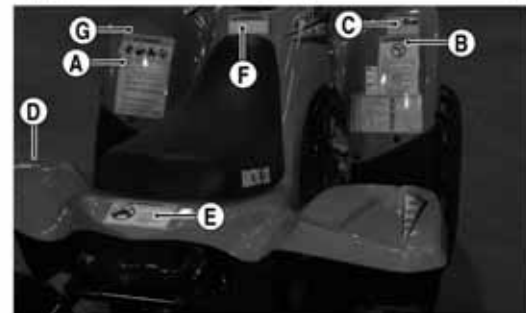

KM822D

DIVISION I - RIDER AWARENESS/ RESPONSIBILITY

Warnings

⚠ WARNING

POTENTIAL HAZARD

Operating this ATV without proper instruction and supervision.

WHAT CAN HAPPEN

The risk of an accident is greatly increased if the operator does not know how to operate the ATV properly in different situations and on different types of terrain.

HOW TO AVOID THE HAZARD

Beginning and inexperienced operators should complete the certified training course offered. They should then regularly practice the skills learned in the course and the operating techniques described in this Operator's Manual.

For more information about the training course, contact an authorized Arctic Cat ATV dealer or call 1-800-887-2887 (U.S.) or 1-613-739-1535 (Canada).

⚠ WARNING

POTENTIAL HAZARD

Allowing anyone under age 12 to operate this ATV.

WHAT CAN HAPPEN

Use of an ATV by children can lead to severe injury or death of the child. Children may not have the skills, abilities, or judgment needed to operate the ATV safely and may be involved in a serious accident.

HOW TO AVOID THE HAZARD

A child under 12 should never operate this ATV. A child lacking the skills, abilities, or judgment needed to operate the ATV safely should never operate this ATV. A child under the age of 16 should never operate this ATV without parental supervision.

⚠ WARNING

POTENTIAL HAZARD

Carrying a passenger on this ATV.

WHAT CAN HAPPEN

Greatly reduces your ability to balance and control this ATV. Could cause an accident, resulting in injury or death to you and/or your passenger.

HOW TO AVOID THE HAZARD

Never carry a passenger. The long seat is to allow the operator to shift positions as needed during operation. It is not for carrying passengers.

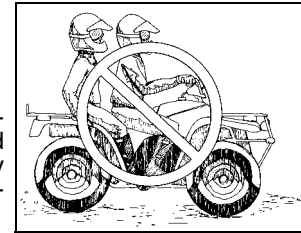

⚠ WARNING

POTENTIAL HAZARD

Operating this ATV on paved surfaces.

WHAT CAN HAPPEN

The ATV's tires are designed for off-road use only, not for use on pavement. Paved surfaces may seriously affect handling and control of the ATV and may cause the ATV to go out of control.

HOW TO AVOID THE HAZARD

Never operate the ATV on any paved surfaces, including sidewalks, driveways, parking lots, and streets.

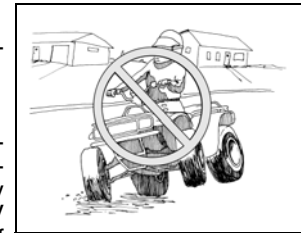

Warnings

⚠ WARNING

POTENTIAL HAZARD

Operating this ATV on public streets, roads, or highways.

WHAT CAN HAPPEN

You can collide with another vehicle.

HOW TO AVOID THE HAZARD

Never operate this ATV on any public street, road, or highway, even a dirt or gravel one. In many states it is illegal to operate an ATV on public streets, roads, or highways.

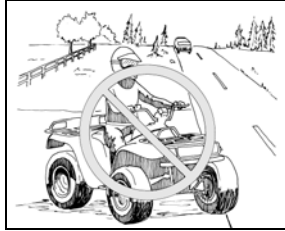

⚠ WARNING

POTENTIAL HAZARD

Operating this ATV after or while consuming alcohol or drugs.

WHAT CAN HAPPEN

Could seriously affect your judgment.
 Could cause you to react more slowly.
 Could affect your balance and perception.
 Could result in an accident.

HOW TO AVOID THE HAZARD

Never consume alcohol or drugs before or while driving this ATV.

⚠ WARNING

POTENTIAL HAZARD

Operating this ATV without wearing an approved motorcycle helmet, eye protection, and protective clothing.

WHAT CAN HAPPEN

Operating without an approved helmet increases your chances of a severe head injury or death in the event of an accident.

Operating without eye protection can result in an accident and increases your chances of a severe injury in the event of an accident.

Operating without protective clothing increases your chances of severe injury in the event of an accident.

HOW TO AVOID THE HAZARD

Always wear an approved helmet that fits properly.

You should also wear:

- Eye protection (goggles or face shield)
- Gloves
- Boots
- Long sleeved shirt or jacket
- Long pants

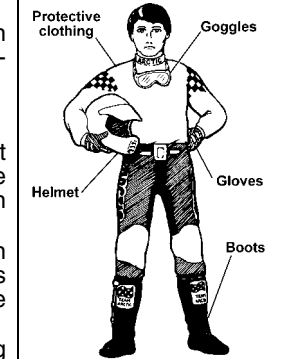

Warnings

⚠ WARNING

POTENTIAL HAZARD

Operating this ATV at excessive speeds or removing the speed limiting device from the ATV.

WHAT CAN HAPPEN

Increases your chances of losing control of the ATV, which can result in an accident.

HOW TO AVOID THE HAZARD

Always ride at a speed that is proper for the terrain, visibility and operating conditions, and your age and experience.

⚠ WARNING

POTENTIAL HAZARD

Attempting wheelies, jumps, and other stunts.

WHAT CAN HAPPEN

Increases the chance of an accident including an overturn.

HOW TO AVOID THE HAZARD

Never attempt stunts, such as wheelies or jumps. Don't try to show off.

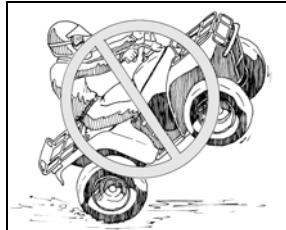

⚠ WARNING

POTENTIAL HAZARD

Failure to inspect the ATV before operating.
Failure to properly maintain the ATV.

WHAT CAN HAPPEN

Increases the possibility of an accident or equipment damage.

HOW TO AVOID THE HAZARD

Always inspect your ATV each time you use it to make sure the ATV is in safe operating condition.
Always follow the inspection and maintenance procedures and schedules described in this Operator's Manual.

⚠ WARNING

POTENTIAL HAZARD

Failure to use extra care when operating the ATV on unfamiliar terrain.

WHAT CAN HAPPEN

You can come upon hidden rocks, bumps, or holes without enough time to react.

Could result in the ATV overturning or going out of control.

HOW TO AVOID THE HAZARD

Go slowly and be extra careful when operating on unfamiliar terrain.
Always be alert to changing terrain conditions when operating the ATV.

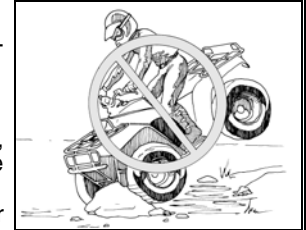

Warnings

⚠ WARNING

POTENTIAL HAZARD

Removing hands from handlebar or feet from footrests during operation.

WHAT CAN HAPPEN

Removing even one hand or foot can reduce your ability to control the ATV or could cause you to lose your balance and fall off the ATV. If you remove a foot from a footrest, your foot or leg may come into contact with the wheels, which could injure you or cause an accident.

HOW TO AVOID THE HAZARD

Always keep both hands on the handlebar and both feet on the footrests of your ATV during operation.

⚠ WARNING

POTENTIAL HAZARD

Operating on steep hills.

WHAT CAN HAPPEN

The ATV can overturn more easily on steep hills than on level surfaces or small hills.

HOW TO AVOID THE HAZARD

Never operate the ATV on hills too steep for the ATV or for your abilities.

Practice on smaller hills before attempting larger hills.

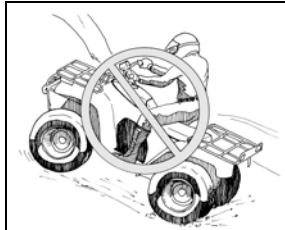

⚠ WARNING

POTENTIAL HAZARD

Turning improperly.

WHAT CAN HAPPEN

ATV could go out of control, causing a collision or rollover.

HOW TO AVOID THE HAZARD

Always follow proper procedures for turning as described in this Operator's Manual.

Practice turning at slow speeds before attempting to turn at faster speeds.

Do not turn at excessive speed.

⚠ WARNING

POTENTIAL HAZARD

Failure to use extra care when operating on rough, slippery, or loose terrain.

WHAT CAN HAPPEN

Could cause loss of traction or ATV control, which could result in an accident including an overturn.

HOW TO AVOID THE HAZARD

Do not operate on rough, slippery, or loose terrain until you have learned and practiced the skills necessary to control the ATV on such terrain.

Always be especially cautious on these kinds of terrain.

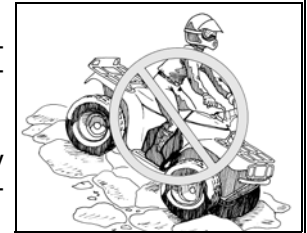

Warnings

WARNING

POTENTIAL HAZARD

Climbing hills improperly.

WHAT CAN HAPPEN

Could cause loss of control or cause the ATV to overturn.

HOW TO AVOID THE HAZARD

Always follow proper procedures for climbing hills as described in this Operator's Manual.

Always check the terrain carefully before you start up any hill.

Never climb hills with slippery or loose surfaces.

Shift your weight forward.

Never open the throttle suddenly. The ATV could flip over backwards.

Never go over the top of any hill at high speed. An obstacle, a sharp drop, or another vehicle or person could be on the other side of the hill.

NEVER OPERATE UP OR DOWN HILLS STEEPER THAN 15°

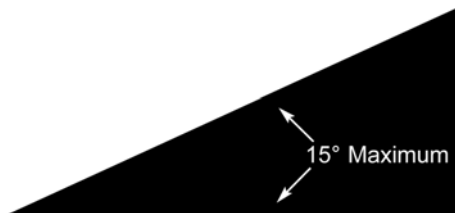
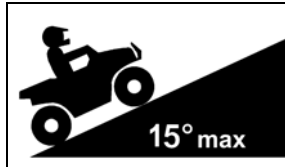

WARNING

POTENTIAL HAZARD

Going down a hill improperly.

WHAT CAN HAPPEN

Could cause loss of control or cause the ATV to overturn.

HOW TO AVOID THE HAZARD

Always follow proper procedures for going down hills as described in this Operator's Manual.

Always check the terrain carefully before you start down any hill.

Shift your weight backward.

Never go down a hill at high speed.

Avoid going down a hill at an angle that would cause the ATV to lean sharply to one side. Go straight down the hill where possible.

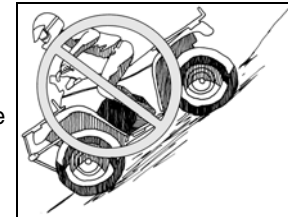

WARNING

POTENTIAL HAZARD

Operating the ATV through deep or fast flowing water.

WHAT CAN HAPPEN

Tires may float, causing loss of traction and loss of control, which could lead to an accident.

HOW TO AVOID THE HAZARD

Never operate the ATV in fast flowing water or in water deeper than the footrests.

Remember that wet brakes may have reduced stopping capability.

Test your brakes after leaving water. If necessary, apply them several times to dry out the brakes.

Warnings

⚠ WARNING

POTENTIAL HAZARD

Stalling, rolling backwards, or improperly dismounting while climbing a hill.

WHAT CAN HAPPEN

Could result in the ATV overturning.

HOW TO AVOID THE HAZARD

Use proper gear and maintain steady speed when climbing a hill.

If you lose all forward speed:

- Keep weight uphill.

- Apply the brakes.

- Engage the brake lever lock after you are stopped.

If you begin rolling backwards:

- Keep weight uphill.

- Apply the brakes while rolling backwards.

- When fully stopped, engage the brake lever lock.

Dismount on uphill side or to a side if pointed straight uphill.

Turn the ATV around and mount following the procedure described in this Operator's Manual.

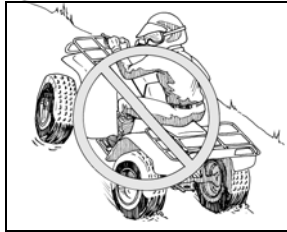

⚠ WARNING

POTENTIAL HAZARD

Operating the ATV with improper tires or with improper or uneven tire pressure.

WHAT CAN HAPPEN

Use of improper tires on the ATV, or operation of the ATV with improper or uneven tire pressure, may cause loss of control increasing your risk of accident.

HOW TO AVOID THE HAZARD

Always use the size and type tires specified in this Operator's Manual for this ATV.

Always maintain proper tire pressure as described in this Operator's Manual.

⚠ WARNING

POTENTIAL HAZARD

Skidding or sliding.

WHAT CAN HAPPEN

You may lose control of the ATV.

You may also regain traction unexpectedly, which may cause the ATV to overturn.

HOW TO AVOID THE HAZARD

Learn to safely control skidding or sliding by practicing at slow speeds and on level, smooth terrain.

On extremely slippery surfaces, such as ice, go slowly and be very cautious in order to reduce the chance of skidding or sliding out of control.

Warnings

⚠ WARNING

POTENTIAL HAZARD

Improperly operating over obstacles.

WHAT CAN HAPPEN

Could cause loss of control or a collision. Could cause the ATV to overturn.

HOW TO AVOID THE HAZARD

Before operating in a new area, check for obstacles.

Never attempt to ride over large obstacles, such as large rocks or fallen trees.

When you go over obstacles, always follow proper procedures as described in this Operator's Manual.

⚠ WARNING

POTENTIAL HAZARD

Operating the ATV with improper modifications.

WHAT CAN HAPPEN

Improper installation of accessories or modification of the ATV may cause changes in handling which, in some situations, could lead to an accident.

HOW TO AVOID THE HAZARD

Never modify the ATV through improper installation or improper use of accessories. All parts and accessories added to this ATV should be genuine Arctic Cat ATV components designed for use on the ATV and should be installed and used according to instructions. Never install a twist grip throttle. If you have questions, consult an authorized Arctic Cat ATV dealer.

⚠ WARNING

POTENTIAL HAZARD

Improperly crossing hills or turning on hills.

WHAT CAN HAPPEN

Could cause loss of control or cause the ATV to overturn.

HOW TO AVOID THE HAZARD

Never attempt to turn the ATV around on any hill until you have mastered the turning technique as described in this Operator's Manual. Practice first on level ground. Be very careful when turning on any hill.

Avoid crossing the side of a steep hill, if possible.

When crossing the side of a hill:

Always follow proper procedures as described in this Operator's Manual.

Avoid hills with slippery or loose surfaces.

Shift your weight to the uphill side of the ATV.

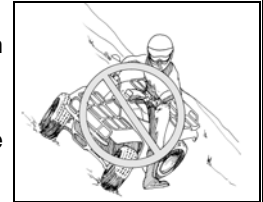

⚠ WARNING

POTENTIAL HAZARD

Failure to release the brake lever lock before driving the ATV.

WHAT CAN HAPPEN

Driving the ATV with the brake lever lock engaged could cause a change in handling or loss of brakes and cause an accident.

HOW TO AVOID THE HAZARD

Always release the brake lever lock before driving the ATV.

Prevention

Overview

When using an ATV, prevention is the name of the game. “Had you only known” something could go wrong, you would have prevented it. If you don’t notice your conditions and surroundings before riding your ATV, you give up control over the situation. Using ATV prevention techniques helps you forecast potential hazards before they injure you or damage your ATV.

Following the safety instructions and warnings in this manual will help you “P.A.S.S.” the safety test. P.A.S.S. stands for “Prevention,” “Active Riding,” “Sound Judgment,” and “Supervision.” Remembering P.A.S.S. and what it stands for will help you have a safe, predictable ride every time you go out on your ATV.

Clothing and Gear

You’ll find it important to dress correctly for ATV riding in order to prevent scraped skin and serious head injuries. It’s easy and could save you time in the long run not having to contend with an injury. This is the minimum protection you need to wear during every ride:

1. Helmet
2. Eye Protection
3. Long Pants
4. Long Sleeved Shirt
5. Gloves
6. Boots/Ankle Protection

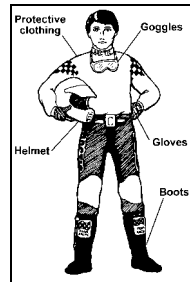

ATV-0004

Of course, it also makes sense to remember the seasons. Wear a hat under your helmet and a snowmobile suit in the winter and lighter, protective clothing in the summer.

Helmet

There are several types of helmets on the market, but make sure you wear a helmet that complies with the current standards of the U.S. Department of Transportation (DOT), The Snell Memorial Foundation, or the American National Standards Institute (ANSI). Helmets that comply with one or more of these agency’s standards have a sticker on the inside or outside of the helmet.

Helmets should have one of these:

1. DOT label
2. Snell label
3. ANSI Z90.1 label

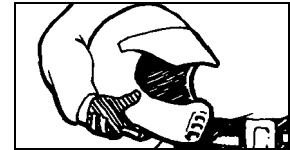

These helmets should provide full-face protection.

If you drop or damage your helmet, get a new one immediately. Your helmet may not protect your head from injury if it has cracks, fissures, or other damage to its outside or core padding.

Remember, your helmet won’t do you any good if the chin strap isn’t fastened.

Eye Protection

Wear eye protection, such as goggles, to completely surround your eyes to prevent getting dirt or other items in your eyes. Sunglasses are not recommended; they don’t prevent objects from flying in through the sides.

TESTIMONIAL

DOCUMENT#: N490117A1

CITY/STATE: N. HUNTINGDON, PA

SEX: M

AGE: 6

BODY PART: HEAD

DATE ACCIDENT: 06-14-94

DISPOSITION: DOA

SYNOPSIS: The 6 year old male victim died from blunt force trauma to the head when the 4-wheel ATV on which he was a passenger struck a rock on a hill connecting two roads and flipped over backwards onto the victim, shattering his bicycle helmet. The victim was life-flighted to the hospital and died that night. The driver of the ATV, the victim’s 29 year old father, sustained minor injuries, but wasn’t treated.

Prevention

Long Pants and Long Sleeved Shirt

The goal is to protect your body from branches, long grass, airborne objects, or anything else that could scrape your skin. The more thick and durable the material, the better protection it'll provide.

Gloves

Your hands are targets for flying objects and branches. Along with providing skin protection, gloves will shield your hands from harsh weather. Wear gloves that are weather resistant and have a gripping surface to keep them from sliding off the handlebar.

Boots/Ankle Protection

Wear a boot that covers the largest possible area of your leg (preferably up to your knee) and can handle significant impact. Choosing boots with low heels and a good tread will help prevent your feet from slipping off the footrests in wet or rugged conditions or getting hurt if they get hit by rocks, dirt, or branches.

Condition of the ATV

The second step in Prevention is checking the condition of your ATV. Chances are good that you'll be using your ATV in some rough terrain, and there's no way you want your brakes to go out when riding downhill. You need to check the following parts on your ATV before every ride.

1. Tires and Wheels
2. Controls and Cable
3. Lights and Electrical System
4. Oil and Fuel
5. Chassis
6. Miscellaneous Items

One easy way to remember what parts you need to check is by using the acronym "T-CLOC." It stands for:

T	C	L	O	C
TIRES AND WHEELS	CONTROLS AND CABLE	LIGHTS AND ELECTRICAL SYSTEM	OIL AND FUEL	CHASSIS

1. Tires and Wheels

Correct tire pressure is crucial. Consult the General Maintenance section of this Operator's Manual for tire pressure guidelines. Incorrect tire pressure can cause poor handling, instability, and a loss of ATV control.

Check:

1. Tire pressure
2. Tire surface (tread and sidewalls)

While checking the tire pressure, inspect the tread and sidewalls of the tires for cracks, cuts, or other damage that could indicate they need to be replaced.

2. Controls and Cable

A. Brakes

Squeeze your hand brake levers. If they feel soft or "squishy," the brakes may need adjustment. Check the maintenance section of this Operator's Manual for instructions. Don't use the ATV until the brakes are operating normally.

Check:

1. Hand brake levers
2. Brake lever lock

Test the brake lever lock and see if it locks the hand brake lever into position; then disengage it to release the brakes. Ensure that the hand brakes are working properly; your brakes could fail during a ride if they're not maintained.

Prevention

B. Throttle

The throttle should have a free, smooth range of motion. If it seems to “stick” at any point, refer to the General Maintenance section of this Operator’s Manual for instructions. Driving your ATV with a sticking throttle can turn your leisurely ride into an unwelcome accident. Don’t drive your ATV if the throttle sticks.

Check:

1. Free, smooth range of motion

3. Lights and Electrical System

Check that the brakelight and headlights work. Don’t drive the ATV unless all systems are working. Check the ignition switch and engine stop switch.

Check:

1. Brakelight
2. Headlights
3. Ignition switch
4. Engine stop switch

4. Oil and Fuel

Start with a full tank of gas and check engine oil before every ride. Don’t forget to check for fluid leaks around the ATV.

Check:

1. Gas
2. Oil
3. Fluid leaks

5. Chassis

Grass and leaves can gum-up your suspension and shocks. Clear and clean the suspension arms, shock springs, and fenders. Check smoothness by turning the handlebar full-left and full-right. Check that there is no binding, restrictions, free-play, or looseness in steering components. Check and clear the drive chain and sprockets of foreign materials and debris. Check drive chain adjustment.

Check:

1. Suspension arms
2. Shock springs
3. Fenders
4. Steering
5. Drive Chain

6. Miscellaneous Items

Inspect your air filter. Look for debris or damage that may indicate you need to replace it. A clogged filter can stop an engine. Check your battery terminals for corrosion. Also, be sure to tighten any loose parts, nuts, or bolts.

Check:

1. Air filter
2. Battery
3. Tighten parts, nuts, and bolts

First Aid and Survival

You need to prepare for the unexpected. Emergencies and accidents are traumatic enough, but they’re even worse when you’re not prepared for them. At the minimum during every ATV ride, you should have the following items on board:

- Tools
- Water
- Identification
- First Aid Kit

For rides that are longer in duration and distance, the following additional items are recommended:

- Cellular Phone
- Maps/GPS
- Emergency Kit *with Flashlight and First Aid Kit*

Tools

Routine maintenance will generally eliminate the need for emergency repairs. Riding on rough terrain could cause loosening of nuts, bolts, and fasteners. Especially on long rides, carrying the right tools can prevent an inconvenience from becoming a crisis.

Carry these items on your ATV:

1. Bulbs
2. Duct tape
3. Rope
4. Spark plugs
5. Spare parts
6. Tool Kit

Prevention

Water

Water is so important that you need to carry it regardless of the duration of your ride. Heat exhaustion and heat stroke can creep up suddenly and can take you out of commission. If you become dehydrated, you could find yourself physically unable to safely operate your ATV.

Identification

If something does happen to you, the emergency personnel will want to know who you are and whom to contact. It's possible you may be in no condition to give them that information. Put your I.D. in your pocket before you ride. Without it, you're anonymous.

Cellular Phone

It may be necessary to make an urgent phone call.

Maps/GPS (Global Positioning System)

Maps may be unnecessary when you're familiar with the area. But when you're riding on unfamiliar trails, it's good to know where you are, what's coming up, and how to get back.

Emergency Kit with Flashlight and First Aid Kit

You'll need several items in your Emergency Kit including a flashlight. The matches will come in handy if you need to start a fire to stay warm. Flares are appropriate for signaling help. A first aid kit is very important if an injury of some type should happen. A good First Aid Kit should include bandages, anti-septic spray, gauze, tape, etc.

Carry these items:

1. Flashlight
2. Matches
3. Flares
4. First Aid Kit
5. Money

Active Riding

Overview

“Active Riding” is the second part of “P.A.S.S.” It involves an understanding of how your body weight, balance, gravity, and physical forces affect the handling of the ATV. For example, when you drive a car quickly into a sharp turn, your body is pulled to the outside of the vehicle by centrifugal force. Although a car is relatively stable, enough centrifugal force can cause an ATV to overturn. Constantly shifting your weight is one major difference between driving a car and riding an ATV. Knowing how to shift your weight is necessary to avoid rolling or flipping the ATV.

For complete operating instructions, see ATV OPERATION section in this manual.

Sound Judgment

Those Around You

People do all kinds of things that you can't predict or control.

Riding Companions

Leave a lot of space between you and other riders, especially in dusty and dirty conditions, because it'll be difficult to see the riders in front of you stopping.

Riding with companions on several ATV's is not the same as riding one ATV with a passenger. Passengers are prohibited; it's unsafe. The extra weight on the seat makes the ATV difficult to control. About 50% of all ATV accidents involve passengers.

Other Vehicles

Depending on where you're riding, you might encounter other ATV's, bikes, or motor vehicles on public lands. Respect the presence of cars if you're crossing roads or riding in public areas and make yourself be seen. If you can't see other vehicles coming, that means you're invisible, too.

Environment

The environment you operate an ATV in is often harsh and sometimes dangerous if you don't take proper precautions.

Weather

You need to consider the weather. It is dangerous to ride your ATV when the weather is bad or potentially bad. Keep abreast with weather forecasts.

Terrain

Always pay close attention to the terrain you're on even if it is familiar to you. You can't assume that the landscape you're used to doesn't change. Changes to landscape can happen at nearly any time. Fences can be constructed and excavations dug in a short period of time. Weather, climate, and development take their toll.

The thing about terrain is that sometimes you don't know it's changed until you get there. Whether it's familiar or not, check out your surroundings before and during your ride.

Night Riding

Riding at night can be very hazardous. Obstacles and other hazards (that are easily identified during daytime) are much more difficult to see and avoid. When night riding, make sure the lights are properly adjusted and in good working order. Reduce speed; do not over-drive the headlights. Never travel in an unfamiliar area or blaze a new trail at night. Always carry a flashlight or flare for signaling an emergency.

Paved Surfaces

Don't do it! The ATV isn't designed for pavement. Its handling becomes more difficult on paved surfaces.

Hikers

With the renewed interest in hiking, camping, and other outdoor activities, people can show up in remote areas where you would never expect them. For their sake, keep your eyes open.

Animals and Nature

Respect the outdoors that you love. Don't use your ATV to chase animals or birds. Drive around young trees rather than over them. Keep clear of streams and ditches with standing water.

Tread Lightly and leave it as you found it.

Sound Judgment

Trail Riding

Use sound judgment when trail riding; that means riding on a trail that fits your ability level. If the trail is pretty rugged, standing up on your footrests will make it easier for you to endure the rough terrain.

Make yourself visible by using headlights and taillight and pull completely off the trail if you need to stop.

Outsloped trails (trails that slant to allow rain to run off) make trail riding a bit more challenging. Accepting that challenge means keeping your weight shifted into the slope. Denying the challenge means sliding off the trail.

It also helps to know which trails you can ride and who else might be on those same trails. These are signs currently used in some areas to designate trail types and restrictions.

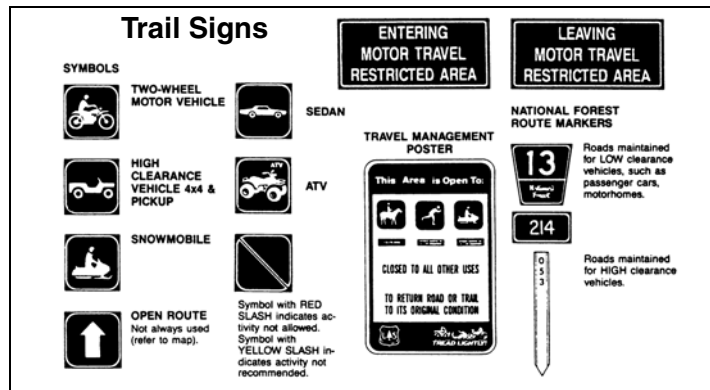

ATV-0068

Equipment

The last thing you expected was that your ATV would break down in the middle of the field... it's usually so reliable that sometimes you forget the ATV has its limits.

ATV Maintenance

You have to maintain your ATV. The General Maintenance section of this Operator's Manual tells you about taking care of your ATV. If, at any time, abnormal noises, vibrations, or improper functioning of any component of this ATV is detected, DO NOT OPERATE THE ATV. Take the ATV to an authorized Arctic Cat ATV dealer for inspection and adjustment or repair.

Personal Choices

A safe, enjoyable ride is dependent on many personal choices. An ATV, like all motorized vehicles, can be dangerous to operate if you choose to ignore safety precautions, take unnecessary chances, or ride beyond your ability or your vehicle's capability. Don't allow the thrill of freedom or adventure to affect your ability to make good, safe choices.

Your Physical Condition

Being physically exhausted is like being drunk. Try to do something that's detail-oriented when you're really tired, and you'll feel totally uncoordinated.

Don't ride:

1. When you're tired

Reckless Riding

If you are involved in an ATV accident when you're speeding, you have a 25% chance of landing yourself in the hospital. The faster you go, the more likely you are to destroy your head and internal organs, and skip the wheelies, jumps, stunts, and any other showboating.

Sound Judgment

Laws and Regulations

Any police officer will tell you that ignorance of the law is no defense. Your best defense is to check out your local, state, or provincial ATV laws before riding. It'll also make sure that you can continue to ride in your favorite areas. The quickest way to have a land area closed is by riding over the regulations.

Group Behavior

People occasionally do crazier and riskier things in a group than they would consider doing by themselves. When you're ATV riding with others and things start to get out of hand, decide whether you're willing to be injured or see your friends injured.

SIPDE

By themselves, none of these safe behaviors and sound judgments will go very far. But when you put them all together...when you're paying attention to how you feel, when you're monitoring the movements of your ATV, and when you're constantly evaluating your environment, then you're practicing SIPDE. SIPDE is an acronym that stands for:

S	I	P	D	E
SCAN/ SEARCH	IDENTIFY HAZARDS	PREDICT WHAT WILL HAPPEN	DECIDE WHAT TO DO	EXECUTE THE DECI- SION

Load Capacity Ratings Chart (Utility)

Arctic Cat ATV Load Capacity Ratings		
Item	Specifications	
	(lb)	(kg)
Max Load Capacity	175	79
Front Rack (max)	10	4.5
Rear Rack (max)	15	6.8

Max Load Capacity - Total weight of operator, accessories, and cargo on front and rear racks.

Supervision

Overview

You're responsible for supervising those who ride your ATV. Your wisdom is valuable... it'll bring them all back safely - your friends, your family, your relatives, and your ATV. It's crucial that you consider yourself a supervisor for all riders of your ATV. Whether you accept responsibility or not, the truth is that you are responsible for others riding your ATV.

Taking Responsibility

You're to the last letter in "PASS"... "Supervision." You've just gone through the manual, and you've seen what's involved. That puts you in a good position to be confident about what you know. So now it's time to use your knowledge and supervise others who ride your ATV.

Inexperienced/Untrained Riders

You can't let people ride your ATV who don't know what they're doing. Unless they've had over a year of experience with ATV riding or taken an ATV training course, it's your responsibility to keep them off your ATV. It can be dangerous (especially for underaged children) - all the more reason for you to be firm.

Experienced/Trained Riders

If anyone is going to borrow your ATV, you are responsible for their supervision. Before they ride, have them take the training course, have them watch the safety video, and have them read the Operator's Manual. You train them. It doesn't matter how you do it, as long as you do it.

ATV's are all a little different from the handling to the stability to the controls. So regardless of how much experience your family members have with ATV's, they don't have experience with *your* ATV. Let experienced riders get familiar with your ATV - show them the basics before they take off. You don't want it on your conscience that someone got hurt because you didn't tell them how to use your ATV.

Remember that regardless of experience, you should never let anyone under the age of 12 operate your ATV.

Arctic Cat and the ATV Safety Institute recommend that all ATV operators ride the appropriate-sized ATV according to age.

Category	Age (Years)	Speed Limitations (MPH)	NOTES
Y-12+	12 or Older	15 - Limited 30 - Maximum	Operate Under Adult Supervision
T-14	14 or Older	20 - Limited 30 - Limited 38 - Maximum	Operate Under Adult Supervision
G & S	16 or Older	According to Local Regulations	—

DIVISION II - OPERATION/ MAINTENANCE

Preface

This Arctic Cat ATV Operator's Manual should be considered a permanent part of the ATV and must remain with the ATV at the time of resale. If the ATV changes ownership more than once, contact Arctic Cat Inc., Service Department, P.O. Box 810, Thief River Falls, MN 56701, for proper registration information.

You have chosen a quality Arctic Cat ATV designed and manufactured to give dependable service. Be sure, as the owner/operator of an Arctic Cat ATV, to become thoroughly familiar with its basic operation, maintenance, and storage procedures. Read and understand the entire Operator's Manual before operating the ATV to ensure safe and proper use of your new Arctic Cat ATV. Always operate the ATV within your level of skill and current terrain conditions.

Division II of this manual covers important information, operator-related maintenance, and storage instructions. If major repair or service is ever required, contact an authorized Arctic Cat ATV dealer for professional service.

At the time of publication, all information and illustrations in Division II were technically correct. Some illustrations used in Division II are used for clarity purposes only and are not designed to depict actual conditions. Because Arctic Cat Inc. constantly refines and improves its products, no retroactive obligation is incurred.

Parts and Accessories

When in need of replacement parts, oil, or accessories for your Arctic Cat ATV, be sure to use only GENUINE ARCTIC CAT PARTS, OIL, AND ACCESSORIES. Only genuine Arctic Cat parts, oil, and accessories are engineered to meet the standards and requirements of your Arctic Cat ATV. For a complete list of accessories, refer to the current Arctic Cat ATV Accessory Catalog.

To aid in service and maintenance procedures on this ATV, a Service Manual and an Illustrated Parts Manual are available through your local Arctic Cat ATV dealer.

ATV Specifications

ENGINE AND DRIVE	
Type	Four-Cycle/OHC/Air Cooled
Bore x Stroke	47 x 51.8 mm (1.85 x 1.62 in.)
Displacement	89.9 cc (5.5 cu in.)
Spark Plug Type	CR7HSA
Spark Plug Gap	0.6 - 0.7 mm (0.024 - 0.028 in.)
Brake Type	Front Double Drum/Rear Hydraulic Disc w/Brake Lever Lock
CHASSIS	
Length (Overall)	1468.1 mm (57.8 in.)
Height (Overall)	962.6 mm (37.9 in.)
Width (Overall)	876.3 mm (34.5 in.)
Tire Size (Front)	AT20 x 7-8
Tire Size (Rear)	AT19 x 8-8
Tire Inflation Pressure	0.21 kg/cm ² (3.0 psi)

MISCELLANY	
Dry Weight (Approx)	118 kg (260 lb) - DVX 120 kg (265 lb) - Utility
Gas Tank Capacity (Rated)	5.7 L (1.5 U.S. gal.)
Reserve Capacity	1.3 L (0.34 U.S. gal.)
Transmission Lubricant (Recommended)	SAE 80W-90 Hypoid
Transmission Lubricant Capacity	250 ml (8.4 fl oz)
Engine Oil Capacity (Approx)	0.8 L (0.84 U.S. qt)
Gasoline (Recommended)	87 Octane Regular Unleaded
Engine Oil (Recommended)	Arctic Cat ACX All Weather (Synthetic)
Headlights	12V/35W
Brakelight	12V/5W
Starting System	Electric w/Kick Start (Emergency)

Specifications subject to change without notice.

Location of Controls

1. Battery
2. Front Brake Lever
3. Fuel Valve
4. Seat Lock Lever
5. Tool Storage
6. Brake Lever Lock
7. Key Switch
8. Throttle Limiter
9. Throttle Lever
10. Brakelight
11. Kick Start Lever
12. Engine Stop Switch
13. Starter Button
14. Rear Brake Lever
15. Oil Level Stick
16. Headlight HI/LO Switch
17. Shift Lever



KM916A



KM913A



KM911B

■ **NOTE:** The ATV you have purchased may differ slightly from those shown in the figures of this manual.

ATV Operation

Basic Operating Maneuvers

Active riding and basic maneuvers are the foundation of your ATV ride. Without basic skills, it's impossible to move to this level active riding. These are your basic maneuvers:

- Mounting the ATV
- Starting the Engine
- Emergency Starting
- Starting a Cold Engine
- Braking/Stopping
- Parking
- Dismounting the ATV

Mounting the ATV

1. From the left side, grab the left-side handlebar, apply the brake, and put your left foot on the footrest.
2. Grab the right-side handlebar.
3. Swing your leg over the seat and set your right foot down on the right-side footrest.
4. Get seated in a comfortable position.
5. Always keep your feet planted on the footrests.

Starting the Engine

Always start with the ATV on a flat, level surface. Carbon monoxide poisoning can kill you, so keep your ATV outside while it's running. Follow these steps to start it up:

1. Engage the brake lever lock.
2. Mount the ATV and sit down.
3. Turn on the fuel valve.
4. Turn on the ignition.
5. Shift into neutral.

6. Move the engine stop switch to RUN.

CAUTION

Do not run the starter motor for more than eight seconds per starting attempt. The starter motor may overheat causing severe starter motor damage. Allow 15 seconds between starting attempts to allow the starter motor to cool.

7. Press the starter button.
8. Let the engine warm up.

Another way to remember the starting procedure is by using the acronym "BONE-C." It stands for:

B	O	N	E	C
BRAKES LOCKED	ON FUEL VALVE	NEUTRAL AT IDLE	ENGINE SWITCH	CHOKE AUTOMATIC

Emergency Starting

This Arctic Cat ATV has an emergency kick starter to use if the electric starter becomes inoperative. To use the starter, follow this procedure.

WARNING

Be sure brake lever lock is engaged when using the emergency kick starter.

ATV Operation

1. Push down on the kick starter until resistance is felt; then with a short, quick, downward stroke, start engine.
2. Repeat until the engine starts.
3. After making sure that the engine is warm, apply the front brakes to release the brake lever lock.



KM002

Starting A Cold Engine

■ **NOTE: It is very important not to touch or compress the throttle lever during the starting procedures.**

1. Rotate the ignition switch key to the first position (ON).
2. Compress the left-hand brake lever; then press on the starter button.

CAUTION

Do not run the starter motor for more than eight seconds per starting attempt. The starter motor may overheat causing severe starter motor damage. Allow 15 seconds between starting attempts to allow the starter motor to cool.

3. Allow the engine to warm up for approximately 2-2 1/2 minutes. Do not touch the throttle lever until the engine has run for at least 3 minutes.
4. Run the engine for at least 10 minutes so it is thoroughly warmed up. If the engine is run for a shorter period of time, the spark plug may not have reached a high enough temperature to burn off the excess fuel in the combustion chamber.

CAUTION

If unburned fuel is collected in the combustion chamber due to lack of running time, spark plug fouling will occur more easily during the next starting attempt.

Braking/Stopping

Coming to a stop should be a slow, easy process. Always allow plenty of room and time to stop smoothly. Sometimes quick stops are inevitable, so always be prepared. Whether you're stopping slowly or stopping quickly, do this:

1. Compress both right and left brake levers on the handlebars to apply both the front and rear brakes.
2. If your wheels lock, release them for a second; then apply them again.
3. Never "ride" the brakes. Even maintaining minimal pressure on a brake lever will cause the brake shoes to drag on the drums and overheat the brake system.

Parking

Parking involves following the previous rules for braking; then:

1. After the ATV stops, shift into neutral.
2. Stop the engine using the engine stop switch.
3. Turn off the ignition.
4. If you have to park on a hill, shift the ATV into low gear; otherwise, try to park only on level surfaces.
5. Engage the brake lever lock.

Dismounting the ATV

After you've followed the procedure for parking, it's time to dismount.

ATV Operation

1. Double check that the brake lever lock is engaged.
2. Swing your right leg over to the left side of the seat.
3. Step to the ground on the left side of the ATV.

Handling the ATV (Active Riding Techniques)

Active riding involves moving your body. You must learn to lean and shift your weight into your turns to maintain control.

Your safety depends on using safe riding techniques. Statistics from the U.S. Consumer Product Safety Commission (CPSC) say that inexperienced riders who don't use safe riding techniques are **13 times more likely to have an ATV accident** than riders who have over 1 month of experience.

Tips

Safe riding techniques include:

- Riding
- Skidding or Sliding
- Leaning, Weight Shift, and Balance
- K-Turns
- Riding Uphill
- Sidehilling/Traversing
- Riding Downhill
- Wide Turns
- Sharp Turns
- Crossing Obstacles
- Crossing Water
- Crossing Roads
- Cold Weather Driving
- Stopping the ATV
- Stopping the Engine

Riding

Once the engine's warm, the ATV is ready to go.

1. Keep your feet on the footrests and both hands on the handlebar.
2. Hold the brake levers, and release the brake lever lock.
3. Release the brakes slowly and apply the throttle.

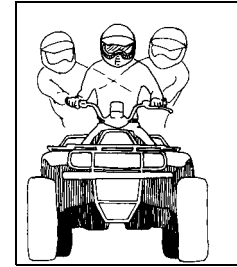

ATV-0012

Skidding or Sliding

If you lose control after hitting sand, ice, mud, or water:

1. Turn your handlebar into the direction of the slide.
2. Keep your hand off the brakes until you're out of the skid.
3. Shift your weight forward.

Sometimes your ATV may not respond and goes straight ahead instead of letting you turn. Here's how to handle it:

1. Slow down.
2. Move forward on the seat.
3. Lean to inside of turn.
4. Turn handlebar.

Leaning, Weight Shift, and Balance

When you turn, the trick is to move forward and slide over to the side of the seat that's on the inside of the turn. Support your body weight on the outside footrest. At the same time, lean your body to the inside of the turn. Pay attention to the handling—if you feel the tires coming off the ground, reduce speed, shift more of your body weight to the side that's lifting, and make the turn wider if possible.

ATV Operation



ATV-0013



ATV-0024



ATV-0025

K-Turns

Use K-turns if you accidentally stall while riding uphill; you need to take action before the ATV rolls backward down the hill.



ATV-0020

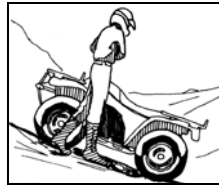

ATV-0034

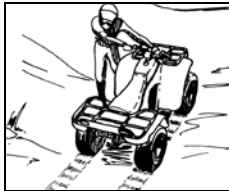

ATV-0035

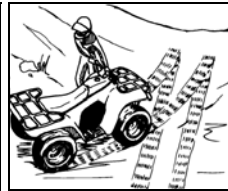

ATV-0036

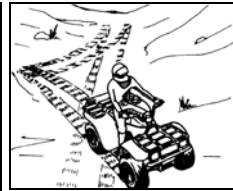

ATV-0037

1. Stop where you are, apply the brakes.
2. Shut off the engine.
3. Keep your body weight shifted forward.

4. Get off the ATV on the uphill side.
5. If you're to the left of the ATV, turn the handlebar all the way left.
6. Partially release the brake, but lightly hold the brake lever.
7. Let the ATV roll to your right side until it faces slightly downhill.
8. Reapply the brakes.
9. Get back on the ATV from the uphill side, and keep your weight shifted uphill when you sit down.
10. Start the engine and follow the method for riding downhill.

Riding Uphill

Roughly 20% of accidents happen while riding on hills and as a result of the ATV rolling or flipping. So, obviously, use extreme caution and follow this method for riding uphill.

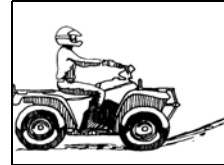

ATV-0019

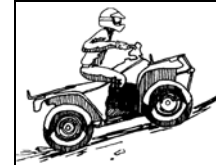

ATV-0032



ATV-0033

1. Accelerate before you start climbing; then maintain a steady pace.
2. Lean as far forward as possible. For steeper hills, come off your seat to stand and lean forward.
3. If you lose speed, quickly release the throttle (so your front tires don't lift), **OR**

ATV Operation

- If that doesn't work and you still have forward motion and the terrain permits, do a U-turn, go back down, and try climbing again, **OR**
- If you have lost all forward motion, follow the K-turn procedure.

NEVER OPERATE UP OR DOWN HILLS STEEPER THAN 15°

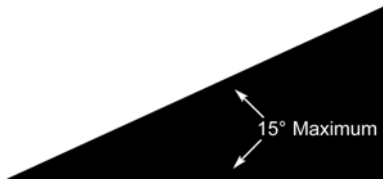

Sidehilling/Traversing

Sidehilling is considered an advanced skill; it's really tricky and unpredictable. So, whether your skills are advanced or not, try to avoid this kind of riding. If you're in a situation where you absolutely have to sidehill, follow this method:

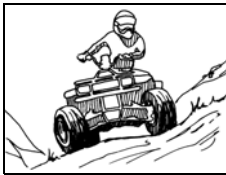

ATV-0017



ATV-0028



ATV-0029

- Keep your speed low and consistent.
- Shift all your body weight to the uphill side of the seat; also, support your weight on the uphill footrest.
- Steer like you're driving into the hill.

- If the ATV feels like it's tipping, turn the handlebar downhill. If that's not possible because of the terrain or other conditions or if it just doesn't work, stop and get off. Dismount the ATV on the uphill side.

Riding Downhill

Success in riding downhill depends on how well you know your brakes - take it easy on them, or you could flip over.

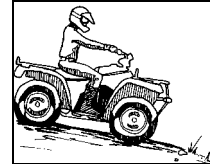

ATV-0018

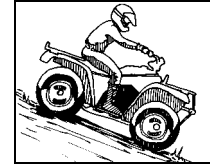

ATV-0030

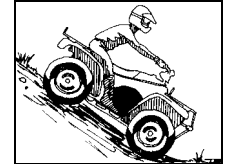

ATV-0031

- Shift your body weight as far back on the seat as possible.
- Lightly apply the brakes and ease up on the throttle.

Wide Turns

About 20% of ATV accidents happen during turns. If you don't understand turning techniques, it's easy for the ATV to get away from you by losing traction, plowing, or tipping.



ATV-0046

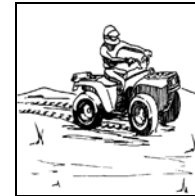

ATV-0045

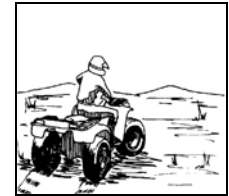

ATV-0044

- Ease off the throttle as you approach the turn to slow down.

ATV Operation

- Use the principles of leaning, weight shifting, and balancing - shift your body weight to the inside of the turn.
- Gradually increase your speed as you come out of the turn.

Sharp Turns

After mastering wide turns, practice the advanced skill of sharp turns.



ATV-0038

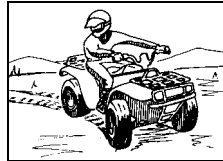

ATV-0039

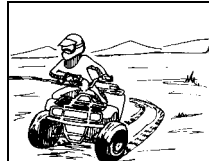

ATV-0040

- Ease off the throttle as you approach the turn to slow down.
- Use the principles of leaning, weight shifting, and balancing - shift your body weight to the inside of the turn.
- You might have to lean into the turn more than you do in a wide turn.
- If shifting your weight and balance aren't enough to keep the ATV tires on the ground, straighten out the handlebars as much as you can.
- Gradually increase your speed as you come out of the turn.

Crossing Obstacles

Crossing obstacles is risky; avoid it if possible. Riding over logs, rocks, and ruts means combining all the active riding skills into one big motion. Your ATV will respond differently for different obstacles (logs, ruts, etc.), but these are general guidelines for overcoming two-track (both tires contacting the obstacle at the same time) obstacles:

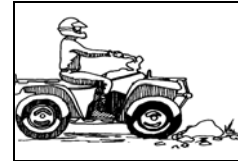

ATV-0016

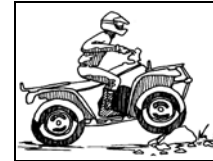

ATV-0026

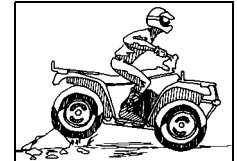

ATV-0027

- Keep your speed way down; less than 5 mph.
 - Approach the obstacle head-on.
 - Come up off the seat.
 - Keep your weight on the footrests.
 - Apply a little throttle when the front tires make contact with the obstacle.
 - Lean forward and release the throttle when the front tires clear the obstacle.
 - Keep your body loose to absorb any shock.
 - If the ATV starts tipping, shift your weight to keep it in balance.
- To clear a single-track (only one tire contacts) obstacle, follow the same rules except:

- Use the ATV's momentum to clear the obstacle.
- Don't pull up on the handlebar.
- Don't apply the throttle.

ATV Operation

Crossing Water

Your ATV can only handle water up to its footrests. Any more than that and you risk engine damage and/or personal injury. Stay away from fast moving rivers. ATV tires can be buoyant, so if the water is too deep, you might find the ATV suddenly afloat.

1. Physically check the depth and current of the water, especially if you can't see the bottom. You're also checking for boulders, logs, or any other hidden obstacles.
2. Keep your speed slow.
3. Make sure you have a way out on the other side of the water.
4. If you get stuck in the sludge or mud, try rocking the ATV from side to side.
5. Once you've cleared the water, briefly apply the brakes to make sure they work.

Crossing Roads

Crossing roads on your ATV is also a bad idea, so avoid it. If you can't:

1. Stop completely on the shoulder of the road.
2. Check both directions for traffic.
3. Crossing near a blind corner or intersection is dangerous; don't do it.
4. Drive straight across to the opposite shoulder.
5. Take into account that your ATV could stall while crossing; give yourself enough time to get off the road.
6. You have to assume that oncoming cars don't see you, and if they do, they won't be able to predict your actions.
7. It's illegal to cross public roads in some places. Know your local laws.

Cold Weather Driving

■ **NOTE:** Check that all control levers move freely. Make sure that the footrests are free of ice and snow.

WARNING

For your personal safety, it is very important to wear the type and amount of cold-weather clothing according to the coldest anticipated temperatures.

1. With the brake lever lock released, move the ATV forward and backward to check that the wheels roll freely. If the ATV will not roll, the tires may be frozen to the ground or the brake shoes may be frozen to the drums.
2. If the tires are frozen to the ground, pour warm water around them to melt the ice.

CAUTION

Before riding, manually move the ATV forward and backward to make certain that all wheels roll freely.

3. If the brakes are frozen, take the ATV to a warmer area to thaw out the brakes.

WARNING

Do not attempt to free frozen brakes by pouring warm water on the brakes.

■ **NOTE:** After the brakes thaw, dry them by applying them several times while riding slowly.

ATV Operation

■ **NOTE:** After riding through water, mud, snow, or slush, it is important to dry the brake system before parking the ATV.

WARNING

Go slowly and be extra careful when riding on snow-covered or ice-covered terrain. Always be alert to changing terrain conditions when operating the ATV.

4. Practice driving in an open snow-covered or ice-covered area at slow speeds before driving on snow-covered or ice-covered trails.
5. Learn how the ATV responds to steering and braking on the type of terrain to be encountered on the ride.

Stopping The ATV

To stop the ATV, first release the throttle lever. Next, apply the brake.

Stopping The Engine

To stop the engine, turn the ignition switch key to the OFF position or set the engine stop switch to the OFF position.

General Information

ATV Identification Numbers

The Arctic Cat ATV has two identification numbers: Vehicle Identification Number (VIN) and Engine Serial Number (ESN).

The VIN is located on the horizontal frame bar on the front fender frame.

The ESN is located on the left-side of the engine crankcase.

These numbers are required by the dealer to complete warranty claims properly. No warranty will be allowed by Arctic Cat if the VIN or ESN is removed or mutilated in any way.

Always provide the ATV name, VIN, and ESN when contacting an authorized Arctic Cat ATV dealer for parts, service, accessories, or warranty. If a complete engine must be replaced, ask the dealer to notify Arctic Cat for correct registration information.

Ignition Switch Key

Two keys come with the ATV. Keep the spare key in a safe place.



ATV-0055A



KM809A



KM037A

Control Locations and Functions

Ignition Switch

The ignition switch has two positions.

OFF position — All electrical circuits are off. The engine will not start. The key can be removed in this position.

ON position — The ignition circuit is complete, the engine can run, and the headlights and taillight are on. The key cannot be removed in this position.



MD0010

CAUTION

Leaving the ignition switch in the ON position for a long period of time when the engine is not running may cause the battery to discharge. Always leave the ignition switch in the OFF position when engine is not running.

Hand Brakes

The hand brakes should be applied whenever a braking situation is needed.

Apply the brakes by compressing the brake levers toward the handlebar.

Brake Lever Lock

To engage and release a brake lever lock, use the following procedure.

1. Compress the left brake lever.
2. Depress and hold the brake lever lock.
3. While holding the brake lever lock, release the brake lever.



KC333A

4. Release the brake lever lock by compressing the brake lever. It will return to its released position.

Check to make sure the brake lever lock engages properly and that the brake (when engaged) locks the wheels.

1. Engage the brake lever lock.
2. Attempt to push the ATV.

■ **NOTE: The brake lever lock must lock the rear wheels. If it doesn't, the rear brake system must be serviced.**

WARNING

Always check to be sure that the brake lever lock has been disengaged before operating the ATV. An accident could result if a brake lever lock is left engaged while the ATV is operated. The brake may relax if left engaged for a long period of time. This could cause an accident; therefore, do not leave the ATV on a hill depending on the brake lever lock. Always block the downhill side of the wheels if leaving the ATV on a hill or park the ATV in a sidehill position.

Headlight HI/LO Switch

Use the headlight HI/LO switch to select the high or low headlight beam when the ignition switch is in the ON position. When the switch is in the HI position, the high beam will illuminate. When the switch is in the LO position, the low beam will illuminate.

Engine Stop Switch

This switch will stop the engine. The engine can be started again by pressing the starter button.

STOP position — The ignition circuit is off. The engine cannot be started or will not run. If the engine stop switch is used to stop engine without turning off ignition switch, the battery may discharge.



KM063A

RUN position — The ignition circuit is on. The engine can start and run.

Electric Starter Button

Pushing in on this button activates the starter motor. Before starting the engine, make sure the ignition switch is in the ON position and the brake lever lock is engaged.



KM064A

Throttle Lever

Control engine RPM with the position of the throttle lever. Operate this lever with the thumb. Pushing it forward increases engine RPM and allowing it to retract decreases engine RPM.



KM027A

Throttle Limiter Screw

Throttle lever travel may be limited by adjusting the throttle limiter screw. The throttle limiter should be adjusted according to the operator's skill and experience. To adjust the throttle limiter, use the following procedure.

1. Loosen the jam nut (A).
2. Turn the throttle limiter screw (B) clockwise to decrease engine RPM maximum or counterclockwise to increase engine RPM maximum.
3. Tighten the jam nut (A) securely.

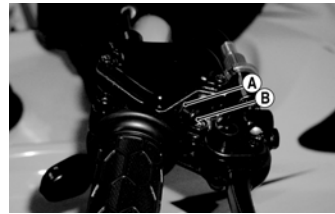

KM028A

Fuel Valve

The fuel valve is incorporated in the gas tank. There are three positions: ON, RES, and OFF.

In the OFF position, the valve will not allow gasoline to flow to the carburetor. In the ON position (the normal operating position), gasoline will flow from the tank to the carburetor. In this position, 1.3 L (0.34 U.S. gal.) will remain in the tank as a reserve quantity.

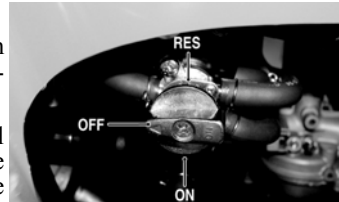

KM043A

Moving the valve to the reserve (RES) position will allow the operator to use the remaining gasoline in the tank. When turning the valve to any of the three positions, be sure the indicator is pointed directly at the position desired.

WARNING

Never leave the valve in the ON or RES position when the engine is not running.

Shift Lever

1. To shift into forward gear, pull out and upward on the shift lever until the transmission engages in the forward gear.
2. To shift into reverse gear, pull out and push downward on the shift lever until the transmission engages the reverse gear. When in reverse with the ignition switch in the ON position, the reverse indicator light will illuminate.
3. To shift into neutral from either forward or reverse gear, push or pull the lever to the center position. When in neutral with the ignition switch in the ON position, the neutral indicator light will illuminate.



KM914A

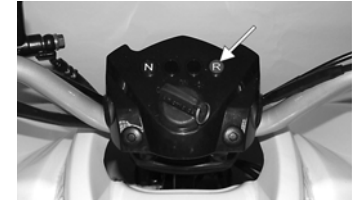

KM915A

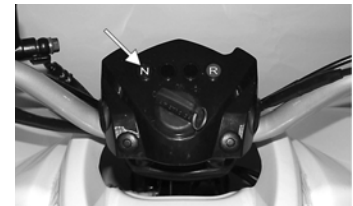

KM915B

WARNING

Always come to a complete stop with the engine at idle before moving the shift lever. Changing gears while moving or shifting from neutral with the engine above idle could cause sudden change of direction resulting in loss of control or being thrown from the ATV causing severe injury or death.

Gas/Vent Hoses

Replace the gas hose every two years. Damage from aging may not always be visible. Do not bend or obstruct the routing of the carburetor vent hose. Make certain that the vent hose is securely connected to the carburetor and hose holder and the opposite end is always open.

Carburetor Float Bowl Drain

Periodically, the float bowl should be drained to remove condensation. To drain the float bowl, use the following procedure.

1. Place a suitable container beneath the float bowl drain hose.
2. Loosen the drain screw and allow the gasoline and condensation to flow out.
3. Tighten the drain screw securely.



KM065

Oil Level Stick

There is an oil level stick for checking the engine oil level. To check the oil level, use the following procedure.

■ **NOTE:** The ATV should be on level ground when checking the engine oil level.

1. Unscrew the oil level stick and wipe it with a clean cloth.
2. Install the oil level stick completely into the engine crankcase.



KM021A

■ **NOTE:** The oil level stick should be threaded into the engine crankcase for checking purposes.

3. Remove the oil level stick; the engine oil level should be between the lower level and upper level on the stick.

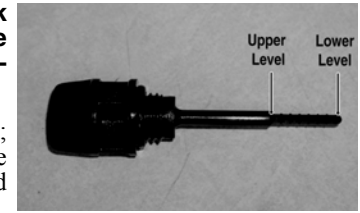

KM022A

CAUTION

Do not overfill the engine with oil. Always make sure the oil level is between the lower and upper levels on the stick.

Seat Lock

1. To remove the seat, push the seat lock lever rearward (located at the rear of the seat). Raise the rear end of the seat and slide it rearward.
2. To lock the seat into position, slide the front of the seat into the seat retainers and push down firmly on back of seat. The seat should automatically lock into position.



KM013A

⚠ WARNING

Make sure the seat is secure before mounting the ATV. Severe personal injury may result if the seat is not properly secured.

Safety Flag/Bracket

A bracket is provided for mounting a flag at the rear of the ATV. The flag should be displayed to make the ATV more visible.

Transporting ATV

When transporting the ATV, Arctic Cat recommends that the ATV be in its normal operating position (on all four wheels) and the following procedure be used.

1. Engage the brake lever lock and place the transmission in gear.

CAUTION

Failure to engage the brake lever lock and place the transmission in gear could result in the ATV rolling off the trailer in the event of tie-down strap failure.

2. Turn the fuel valve OFF.
3. Secure the ATV with load rated hold-down straps.

■ **NOTE: Suitable hold-down straps are available from your Arctic Cat ATV dealer. Ordinary rope is not recommended because it can stretch under load.**

CAUTION

When using hold-down straps, care must be taken not to damage the ATV.

Gasoline-Oil-Lubricant

Recommended Gasoline

The recommended gasoline to use in this ATV is 87 minimum octane regular unleaded. In many areas, oxygenates (either ethanol or MTBE) are added to the gasoline. Oxygenated gasolines containing up to 10% ethanol, 5% methane, or MTBE are acceptable gasolines.

When using ethanol blended gasoline, it is not necessary to add a gasoline antifreeze since ethanol will prevent the accumulation of moisture in the fuel system.

CAUTION

Do not use white gas. Only Arctic Cat approved gasoline additives should be used.

Recommended Engine Oil

CAUTION

Any oil used in place of the recommended oil could cause serious engine damage. Do not use oils which contain graphite or molybdenum additives. These oils can adversely affect clutch operation. Also, not recommended are racing, vegetable, non-detergent, and castor-based oils.

The recommended oil to use is Arctic Cat ACX All Weather synthetic engine oil, which has been specifically formulated for use in this Arctic Cat engine. Although Arctic Cat ACX All Weather synthetic engine oil is the only oil recommended for use in this engine, use of any API certified SM 0W-40 oil is acceptable.

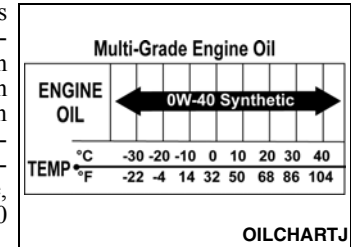

Recommended Transmission Lubricant

■ **NOTE: Arctic Cat recommends the use of genuine Arctic Cat lubricants.**

The recommended transmission lubricant to use is SAE 80W-90 hypoid.

CAUTION

Any lubricant used in place of the recommended one could cause serious transmission damage.

Filling Gas Tank

WARNING

Always fill the gas tank in a well-ventilated area. Never add gasoline to the ATV gas tank near any open flames or with the engine running or hot. DO NOT SMOKE while filling the gas tank.

Since gasoline expands as its temperature increases, the gas tank must be filled to its rated capacity only. Expansion room must be maintained in the tank particularly if the tank is filled with cold gasoline and then moved to a warm area.

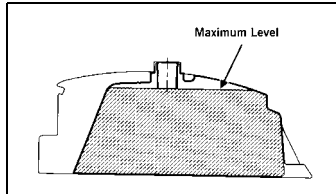

ATV-049B

Allow the engine to cool before filling the gas tank. Care must be taken not to overfill the tank. If overfilled, gas may leak onto the engine creating a fire hazard.

WARNING

Do not overfill or over-flow gasoline when filling the gas tank. A fire hazard could materialize. Always allow the engine to cool before filling the gas tank.

Tighten the gas tank cap securely after filling the tank.

Engine Break-In

New ATV's and renewed ATV engines require a "break-in" period. The first month is most critical to the life of this ATV. Proper operation during this break-in period will help assure maximum life and performance from the ATV.

During the first 3 hours of operation, always use less than ½ throttle. Varying the engine RPM during the break-in period allows the components to "load" (aiding the engine component mating process) and then "unload" (allowing components to cool). Although it is essential to place some stress on the engine components during break-in, care should be taken not to overload the engine too often.

When the engine starts, allow it to warm up properly. Idle the engine several minutes until the engine has reached normal operating temperature. Do not idle the engine for excessively long periods of time.

Maintenance after break-in should include checking of all prescribed adjustments and tightening of all fasteners. At the discretion and expense of the owner/operator, the ATV may be taken to an authorized Arctic Cat ATV dealer for this initial service.

General Maintenance

■ **NOTE: Proper maintenance of the ATV is important for optimum performance. Follow the Maintenance Schedule and all ensuing maintenance instructions/information.**

If, at any time, abnormal noises, vibrations, or improper functioning of any component of this ATV is detected, DO NOT OPERATE THE ATV. Take the ATV to an authorized Arctic Cat ATV dealer for inspection and adjustment or repair.

If the owner/operator does not feel qualified to perform any of these maintenance procedures or checks, take the ATV to an authorized Arctic Cat ATV dealer for professional service.

■ **NOTE: The following instructions and information refer to specific items in the maintenance and care of the ATV.**

Maintenance Schedule					
Item	Page	Initial Service (First Week)	Monthly	Quarterly	Annually
Air filter	49	I		I	
Battery	45	I	I	I	
*Brake components	44	I	Inspect every time before riding		
Brakelight/headlights	51	I	Inspect every time before riding		
Carburetor Float Bowl	39	I	C		
*Chassis nuts and bolts	—	I	T	T	T
*Drive chain	—	I		I	
Electrical connections	—	I			I
Transmission lubricant	43	R			I
Engine oil	43	R		R**	I
Fuel filter/tube	—	I		I	
Idle RPM	49	I			I
Chassis	—			C, L	I
Shock absorbers	43		I		
Spark plug	48			C	
*Steering	—	I	Inspect every time before riding		
*Suspension (Front tie rods/protective boots)	45	I	Inspect every time before riding		
Tires/air pressure	50/26	I	Inspect every time before riding		
Tire wear	50	I	I		
Throttle cable	49	I	Inspect every time before riding		

I = Inspect and clean, adjust, lubricate, replace as necessary

C = Clean L = Lubricate R = Replace T = Tighten

* = Dealer maintenance

** = When using Arctic Cat ACX All Weather synthetic oil, oil change interval can be increased to every 1,000 miles or every year.

Shock Absorbers

Each shock absorber should be visibly checked weekly for excessive fluid leakage (some seal leakage may be observed but it does not indicate the shock is in need of replacement), cracks or breaks in the lower case, or a bent shock rod. If any one of these conditions is detected, replacement is necessary.

■ **NOTE: When the ATV is operated in extremely cold weather (-23°C/-10°F or colder), a small amount of leakage may be present. Unless the leakage is excessive, replacement is not necessary.**

General Lubrication

Cables

None of the cables require lubrication; however, it is advisable to lubricate the ends of the cables periodically with a good cable lubricant.

Engine Oil

Change the engine oil at the scheduled intervals. The engine should always be warm so the oil will drain easily and completely.

1. Park the ATV on level ground.
2. Remove the oil level stick. Be careful not to allow contaminants to enter the opening.
3. Remove the oil drain plug from the left side of the engine; then remove the oil screen/filter cap from under the right-front of the engine and clean the screen.

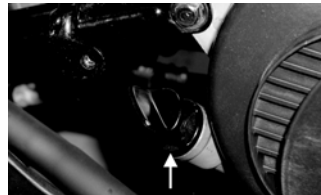

KM021A



KM041A

4. Install the screen/filter cap, spring, and screen. Tighten to 11 ft-lb.
5. Install the drain plug and tighten to 22 ft-lb. Pour the recommended oil in the fill hole. Install oil level stick.
6. Start the engine (while the ATV is outside on level ground) and allow it to idle for a few minutes.
7. Shut the engine off; then allow oil to drain into the crankcase for approximately three minutes. Remove the oil level stick and check for proper oil level.

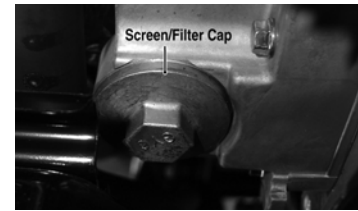

KM040A

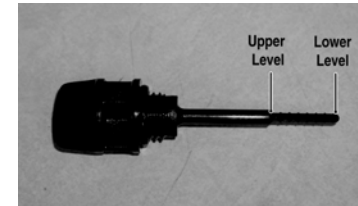

KM022A

Transmission Lubricant

Change the transmission lubricant at the scheduled intervals. The transmission should always be warm when the lubricant is changed so the lubricant will drain easily and completely.

1. Park the ATV on level ground.
2. Remove the fill/level plug. Be careful not to allow contaminants to enter the opening.



KM039A

- Remove the drain plug from the bottom of the transmission and drain the lubricant into a drain pan.
- Install the drain plug and tighten to 18 ft-lb. Pour the recommended lubricant in the fill hole. Install fill/level plug.
- Start the engine (while the ATV is outside on level ground) and allow it to idle for a few minutes.
- Turn the engine off and wait approximately one minute. Recheck the lubricant level. The level should be visible on the fill plug tip. If lubricant is not visible, add recommended lubricant until the level is visible at the threads of the fill/level plug.
- Inspect the area around the drain plug for leaks.



KM038A

Hand Brake System

WARNING

Be sure to inspect the hand brake system before each use. Always maintain brakes according to the Maintenance Schedule.

Brake Lever Lock

Check to make sure the brake lever lock engages properly and that the rear brake (when engaged) locks the wheels.

- Compress the left brake lever.
- Engage the brake lever lock.
- The rear brake should lock.
- Attempt to push the ATV.



KC333A

■ **NOTE:** The brake lever lock must lock the rear wheels. If not, take the ATV to an authorized Arctic Cat ATV dealer for service.

Adjusting Brakes

Checking/Adjusting Front Wheel Brake System

- Raise ATV enough to allow the wheels to spin freely.
- On the brake lever/cable assembly, loosen both jam nuts. Turn both cable adjusters counterclockwise until both front wheels do not spin freely.
- Turn both cable adjusters in 1/4 turn increments (clockwise) until wheels spin with a very slight amount of drag.
- Lower ATV, push ATV forward, and compress brake lever.
- If front wheels lock, adjustment is correct.
- If front wheels do not lock, additional adjustment is necessary.

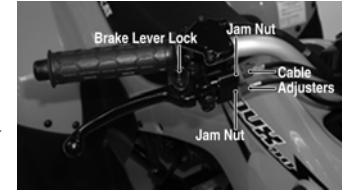

KM024B

Checking/Adjusting Rear Wheel Hydraulic Brake System

The rear wheel hydraulic brake system should be checked for proper operation before every time the ATV is ridden.

■ **NOTE:** The rear wheels should spin freely with the brake lever released.

CAUTION

Check through the rear brake reservoir sight glass that the fluid level is above the LOWER level line. If below the line, take the ATV to an authorized Arctic Cat ATV dealer for service.

1. Compress the left brake lever and engage the brake lever lock.
2. With engine turned off and with the brake lever locked, attempt to move the ATV.
3. If rear wheels are locked, brake is operating properly.



KC333A

4. If rear wheels are not locked, the hydraulic brake system must be serviced.

■ **NOTE:** The hydraulic brake must lock the rear wheels. If not, take the ATV to an authorized Arctic Cat ATV dealer for service.

Protective Rubber Boots

The protective boots should be inspected periodically.

Suspension/Steering Arm Assembly (Right and Left)

1. Secure the ATV on a support stand to elevate the front wheels.
2. Remove both front wheels.
3. Inspect the suspension/steering arm assembly boots for cracks, tears, or perforations.
4. Check the bushing for free-play by grasping the steering knuckle and turning it from side to side and up and down.
5. If boot damage is present or bushing free-play seems excessive, contact an authorized Arctic Cat ATV dealer for service.



MD0040

Tie Rod Boots (Inner and Outer/Right and Left)

1. Secure the ATV on a support stand to elevate the front wheels.
2. Remove both front wheels.
3. Inspect the four tie rod boots for cracks, tears, or perforations.
4. Check the tie rod end free-play by grasping the tie rod near the end and attempting to move it up and down.
5. If boot damage is present or tie rod end free-play seems excessive, contact an authorized Arctic Cat ATV dealer for service.



MD0041

Battery

The battery is located under the seat.

After being in service, batteries require regular cleaning and recharging in order to deliver peak performance and maximum service life. The following procedure is recommended for cleaning and maintaining a sealed battery. Always read and follow instructions provided with battery chargers and battery products.

■ **NOTE:** Refer to all warnings and cautions provided with the battery or battery maintainer/charger.

Loss of battery charge may be caused by ambient temperature, ignition OFF current draw, corroded terminals, self discharge, frequent start/stops, and short engine run times. Frequent winch usage, snowplowing, extended low RPM operation, short trips, and high amperage accessory usage are also reasons for battery discharge.

Maintenance Charging

■ **NOTE:** Arctic Cat recommends the use of the CTEK Multi US 800 or the CTEK Multi US 3300 for battery maintenance charging. Maintenance charging is required on all batteries not used for more than two weeks or as required by battery drain.

1. When charging a battery in the vehicle, be sure the ignition switch is in the OFF position.
2. Clean the battery terminals with a solution of baking soda and water.

■ **NOTE:** The sealing strip should NOT be removed and NO fluid should be added.

3. Be sure the charger and battery are in a well-ventilated area. Be sure the charger is unplugged from the 110-volt electrical outlet.
4. Connect the red terminal lead from the charger to the positive terminal of the battery; then connect the black terminal lead of the charger to the negative terminal of the battery.

■ **NOTE:** Optional battery charging adapters are available from your authorized Arctic Cat dealer to connect directly to your vehicle from the recommended chargers to simplify the maintenance charging process. Check with your authorized Arctic Cat dealer for proper installation of these charging adapter connectors.

5. Plug the battery charger into a 110-volt electrical outlet.
6. If using the CTEK Multi US 800, there are no further buttons to push. If using the CTEK Multi US 3300, press the Mode button (A) at the left of the charger until the Maintenance Charge Icon (B) at the bottom illuminates. The Normal Charge Indicator (C) should illuminate on the upper portion of the battery charger.

■ **NOTE:** The maintainer/charger will charge the battery to 95% capacity at which time the Maintenance Charge Indicator (D) will illuminate and the maintainer/charger will change to pulse/float maintenance. If the battery falls below 12.9 DC volts, the charger will automatically start again at the first step of the charge sequence.



800E

■ **NOTE:** Not using a battery charger with the proper float maintenance will damage the battery if connected over extended periods.



3300A

Charging

■ **NOTE:** Arctic Cat recommends the use of the CTEK Multi US 800 or the CTEK Multi US 3300 for battery maintenance charging.

1. Be sure the battery and terminals have been cleaned with a baking soda and water solution.

■ **NOTE:** The sealing strip should NOT be removed and NO fluid should be added.

2. Be sure the charger and battery are in a well-ventilated area. Be sure the charger is unplugged from the 110-volt electrical outlet.
3. Connect the red terminal lead from the charger to the positive terminal of the battery; then connect the black terminal lead of the charger to the negative terminal of the battery.
4. Plug the charger into a 110-volt electrical outlet.

5. By pushing the Mode button (A) on the left side of the charger, select the Normal Charge Icon (E). The Normal Charge Indicator (C) should illuminate on the upper left portion of the charger.
6. The battery will charge to 95% of its capacity at which time the Maintenance Charge Indicator (D) will illuminate.

■ **NOTE: For optimal charge and performance, leave the charger connected to the battery for a minimum 1 hour after the Maintenance Charge Indicator (D) illuminates. If the battery becomes hot to the touch, stop charging. Resume after it has cooled.**

7. Once the battery has reached full charge, unplug the charger from the 110-volt electrical outlet.

■ **NOTE: If, after charging, the battery does not perform to operator expectations, bring the battery to an authorized Arctic Cat dealer for further troubleshooting.**

Jump-Starting

■ **NOTE: Arctic Cat does not recommend jump-starting a vehicle with a dead battery but rather to remove the battery, service it, and correctly charge it; however, in an emergency, it may be necessary to jump-start a vehicle. If so, use the following procedure to carefully and safely complete this procedure.**

WARNING

Improper handling or connecting of a battery may result in severe injury including acid burns, electrical burns, or blindness as a result of an explosion. Always remove rings and watches.

1. On the vehicle to be jump-started, remove the battery cover and any terminal boots.

WARNING

Any time service is performed on a battery, the following must be observed: keep sparks, open flame, cigarettes, or any other flame away. Always wear safety glasses. Protect skin and clothing when handling a battery. When servicing battery in enclosed space, keep the area well-ventilated. Make sure battery venting is not obstructed.

2. Inspect the battery for any signs of electrolyte leaks, loose terminals, or bulging sides. Leaking or bulging battery cases may indicate a frozen or shorted battery.

WARNING

If any of these conditions exist, DO NOT attempt a jump-start, boost, or charge the battery. An explosion could occur causing serious injury.

3. Inspect the vehicle to be used for jump-starting to determine if voltage and ground polarity are compatible. The vehicle must have a 12-volt DC, negative ground electrical system.

CAUTION

Always make sure the electrical systems are of the same voltage and ground polarity prior to connecting jumper cables. If not, severe electrical damage may occur.

4. Move the vehicle to be used for the jump-start close enough to ensure the jumper cables easily reach; then shift into neutral, set and lock the brakes, shut off all electrical accessories, and turn the ignition switch OFF.

■ **NOTE: Make sure all switches on the vehicle to be jump-started are turned OFF.**

5. Disconnect all external accessories such as cell phones, GPS units, and radios on both vehicles.

CAUTION

Failure to disconnect electronic accessories during jump-starting may cause system damage due to power spikes.

- Attach one clamp of the positive (red) jumper cable to the positive (+) terminal (1) of the dead battery (C) being careful not to touch any metal with the other clamp; then attach the other clamp of the positive (red) jumper cable to the positive (+) terminal (2) of the good battery (B).

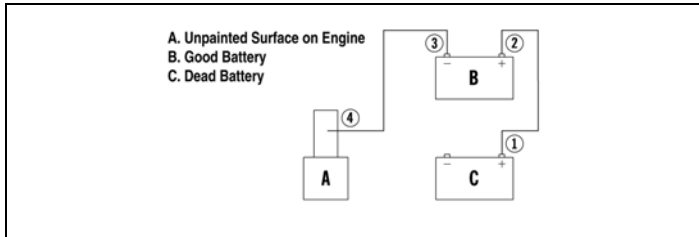

0744-527

■ **NOTE: Some jumper cables may be the same color but the clamps or ends will be color-coded red and black.**

- Attach one clamp of the negative (black) jumper cable to the negative (-) terminal (3) of the good battery (B); then attach the other clamp of the negative (black) jumper cable (4) to an unpainted metal surface (A) on the engine or frame well away from the dead battery and fuel system components.

⚠ WARNING

Never make the final connection to a battery as a spark could ignite hydrogen gases causing an explosion of the battery resulting in acid burns or blindness.

- Stand well away from the dead battery and start the vehicle with the good battery. Allow the vehicle to run for several minutes applying some charge to the dead battery.
- Start the vehicle with the dead battery and allow it to run for several minutes before disconnecting the jumper cables.
- Remove the jumper cables in opposite order of hook-up (4, 3, 2, 1). Be careful not to short cables against bare metal.

■ **NOTE: Have the battery and electrical system checked prior to operating the vehicle again.**

Spark Plug

The ATV comes equipped with a specified spark plug. See the specifications chart for the correct spark plug. A light brown insulator indicates that the plug is correct. A white or dark insulator indicates that the engine may need to be serviced or the carburetor may need to be adjusted.

Consult an authorized Arctic Cat ATV dealer if the plug insulator is not a light brown color. To help prevent cold weather fouling, make sure to thoroughly warm up the engine before operating.

To maintain a hot, strong spark, keep the plug free of carbon.

Before removing the spark plug, be sure to clean the area around the spark plug. If you do not, dirt could enter engine when removing or installing the spark plug.

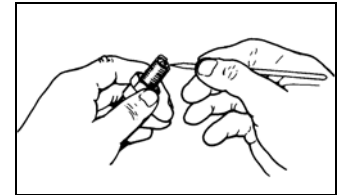

ATV-0051

Adjust the gap to 0.6-0.7 mm (0.024-0.028 in.) for proper ignition. Use a feeler gauge to check the gap.

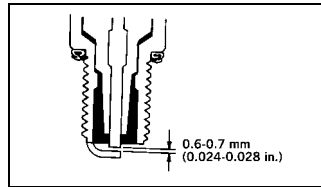

ATV0052A

When installing the spark plug, be sure to tighten it securely. A new spark plug should be tightened 1/2 turn once the washer contacts the cylinder head. A used spark plug should be tightened 1/8 - 1/4 turn once the washer contacts the cylinder head.

Engine Idle RPM Adjustment

To properly adjust the idle, a tachometer is necessary. If one is not available, take the ATV to an authorized Arctic Cat ATV dealer.

To adjust idle RPM:

1. Start the engine and warm it up to normal operating temperature.
2. Turn the idle adjustment screw in or out until the engine idles at 1700 RPM.



KM004A

WARNING

Adjust the idle to the correct RPM. Make sure the engine is at normal operating temperature before adjusting the idle RPM.

Throttle Cable Adjustment

The throttle has been adjusted at the factory, and no adjustment should be necessary. If adjustment is necessary, the following procedure should be followed:

1. Pull back rubber boots to access cable adjustment nut.
2. Loosen jam nut to allow cable adjustment nut to be adjusted.
3. Turn cable adjustment nut clockwise to increase free-play in the cable. Turn the adjustment nut counter-clockwise to decrease free-play in the cable.
4. There should be approximately 6 mm (1/4 in.) free-play in the cable.
5. Tighten the jam nut to secure the adjustment.



KM070A



KM071A

Air Filter

The air filter inside the air filter housing must be kept clean to provide good engine power and gas mileage. If the ATV is used under normal conditions, service the filter at the intervals specified. If operated in dusty, wet, or muddy conditions, inspect and service the filter more frequently. Use the following procedure to remove the filter and inspect and/or clean it.

CAUTION

Failure to inspect the air filter frequently if the ATV is used in dusty, wet, or muddy conditions can damage the engine.

1. Remove the seat; then remove the five screws securing the air filter housing cover.
2. Remove the air filter housing cover; then pull the filter out.
3. Fill a wash pan larger than the filter with a non-flammable cleaning solvent; then dip the filter in the solvent and wash it.

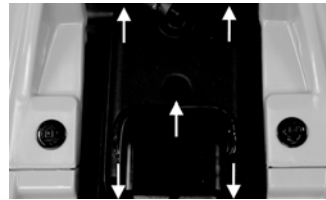

KM032A

■ NOTE: Foam Air Filter Cleaner and Foam Air Filter Oil are available from Arctic Cat.

4. Compress the filter by pressing it between the palms of both hands to remove excess solvent. Do not twist or wring the filter or it will develop cracks.
5. Dry the filter.
6. Put the filter in a plastic bag; then pour in air filter oil and work the oil into the filter.

CAUTION

A torn air filter can cause damage to the ATV engine. Dirt and dust may get inside the engine if the filter is torn. Carefully examine the filter for tears before and after cleaning it. Replace the filter with a new one if it is torn.

7. Clean any dirt or debris from inside the air cleaner. Be sure no dirt enters the carburetor.
8. Install the air filter and housing cover making sure the rubber seal is in place; then install the five screws and tighten securely (do not over-tighten the screws).
9. Install the seat making sure it locks securely.

Tires

⚠ WARNING

Always use the size and type of tires as specified. Refer to the specifications chart for proper tire inflation pressure, and always maintain proper tire inflation pressure.

Tire Tread Condition

The use of worn-out tires on an ATV is very dangerous. A tire is considered to be worn out when the depth of the tread is less than 3 mm (1/8 in.). Be sure to replace the tires before reaching this minimum specification.

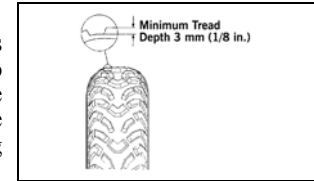

0732-649

⚠ WARNING

The use of worn-out tires can be dangerous and can increase the risk of an accident.

Tire Replacement

The ATV has low-pressure tubeless tires. Air is sealed by the contact surfaces of the inner wheel rim and the tire bead. If either the inner wheel rim or tire bead is damaged, air may leak. Be extremely careful not to damage these areas when replacing tires.

It is very important to use the proper tools when repairing or replacing tires to prevent damage to the tire bead or wheel rims. If proper tools and related items are not available, have this maintenance performed by an authorized Arctic Cat ATV dealer or a qualified tire repair station.

CAUTION

When breaking the tire bead loose from the wheel, be extremely careful not to damage the inner wheel surface or the tire bead.

⚠ WARNING

Use only Arctic Cat approved tires when replacing tires. Failure to do so could result in unstable ATV operation.

Tubeless Tire Repair

Should a leak or flat tire occur due to a puncture, the tire may be repaired using a plug-type repair. If the damage is from a cut or if the puncture cannot be repaired using a plug, the tire must be replaced. When operating the ATV in areas where transportation or service facilities are not readily available, it is strongly recommended to carry a plug-type repair kit and a tire pump along.

Wheels

1. Park the ATV on level ground and engage the front brake lever lock.
2. Loosen the wheel nuts on the wheel to be removed.
3. Elevate the ATV.
4. Remove the wheel nuts.
5. Remove the wheel.
6. Install the wheel and install wheel nuts.
7. Tighten in a crisscross pattern to 30 ft-lb.
8. Remove the jack.

Bulb Replacement

The wattage rating of the bulb is shown in the chart. When replacing a burned bulb, always use the same wattage rating.

Headlights	12V/35W
Brakelight	12V/5W

CAUTION

Use only specified bulb indicated in the chart as replacement bulb.

■ **NOTE:** The bulb portion of the headlight is fragile. **HANDLE WITH CARE.** When replacing the headlight bulb, do not touch the glass portion of the bulb. If the glass is touched, it must be cleaned with a dry cloth before installing. Skin oil residue on the bulb will shorten the life of the bulb.

To replace the headlight bulb, use the following procedure.

1. Remove the rubber boot from the back of the headlight housing; then remove the three-wire connector from the bulb.
2. Release the two ends of the springclip from the headlight housing taking care not to bend or deform the clip; then remove the bulb from the housing.
3. Install the new bulb into the housing; then secure with the spring clip.
4. Connect the three-wire connector to the bulb; then install the rubber boot.
5. Install the wiring harness connector.



KM194A



KM192A



KM192A



KM195

CAUTION

When replacing the headlight bulb, be careful not to touch the glass portion of the bulb. Grasp the new bulb with a clean cloth.

To replace the brakelight bulb, use the following procedure.

1. Remove the two screws and remove the lens cover.
2. Push the bulb in and turn it counterclockwise.
3. Install the new bulb by turning it clockwise while pushing in.
4. Install the lens cover.

CAUTION

Tighten the lens cover screws only until they are snug.

Fuse

The main (7 amp) fuse is located in a fuse holder near the battery under the seat.

■ **NOTE:** To replace the fuse, open the holder and remove the fuse; then install the new fuse. A spare fuse is located within the holder.

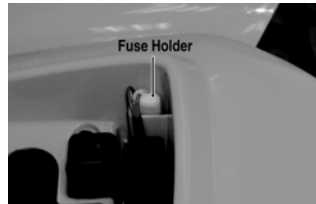

KM031A

If there is any type of electrical system failure, always check the fuse first.

CAUTION

Always replace a blown fuse with a fuse of the same type and rating. If the new fuse blows after a short period of use, consult an authorized Arctic Cat ATV dealer immediately.

Storage Compartment/Tools

A basic tool kit is provided with the ATV. It is located under the seat.

Maintain the tool kit with the ATV at all times.



KM029

Preparation For Storage

CAUTION

Prior to storing the ATV, it must be properly serviced to prevent rusting and component deterioration.

Arctic Cat recommends the following procedure to prepare the ATV for storage. An authorized Arctic Cat ATV dealer should perform this service; however, the owner/operator may perform this service if desired.

1. Clean the seat cushion (cover and base) with a damp cloth and allow to dry.
2. Clean the ATV thoroughly by washing dirt, oil, grass, and other foreign matter from the entire ATV. Allow the ATV to dry thoroughly. DO NOT get water into any part of the engine or air intake.
3. Either drain the gas tank or add a fuel stabilizer to the gas in the gas tank. Remove the air filter housing cover and air filter. Start the engine and allow it to idle; then using Arctic Cat Engine Preserver, rapidly inject the preserver into the air filter opening for a period of 10 to 20 seconds. Install the air filter and housing cover.

CAUTION

If the interior of the air filter housing is dirty, clean the area before starting the engine.

4. Drain the carburetor float chamber.
 5. Plug the hole in the exhaust system with a clean cloth.
 6. Apply light oil to the upper steering post bushing and plungers of the shock absorbers.
 7. Tighten all nuts, bolts, cap screws, and screws. Make sure rivets holding components together are tight. Replace all loose rivets. Care must be taken that all calibrated nuts, cap screws, and bolts are tightened to specifications.
 8. Clean the ATV thoroughly.
 9. Disconnect the battery cables (negative cable first); then remove the battery, clean the battery posts and cables, and store in a clean, dry area.
- **NOTE: For storage, use a battery maintainer or make sure the battery is fully charged (see Battery section in this manual).**
10. Store the ATV indoors in a level position.

CAUTION

Avoid storing outside in direct sunlight and avoid using a plastic cover as moisture will collect on the ATV causing rusting.

Preparation After Storage

Taking the ATV out of storage and correctly preparing it will assure many miles and hours of trouble-free riding. Arctic Cat recommends the following procedure to prepare the ATV.

1. Clean the ATV thoroughly.
2. Clean the engine. Remove the cloth from the exhaust system.
3. Check all control wires and cables for signs of wear or fraying. Replace if necessary.
4. Change the transmission lubricant.
5. Charge the battery; then install.
6. Connect the battery cables making sure to connect the positive cable first.
7. Check the entire brake system (cables, shoes, etc.), all controls, and brakelight; adjust or replace if necessary.
8. Check the tire pressure. Inflate to recommended pressure as necessary.
9. Tighten all nuts, bolts, cap screws, and screws making sure all calibrated nuts, cap screws, and bolts are tightened to specifications.
10. Make sure the steering moves freely and does not bind.
11. Check the spark plug. Clean or replace as necessary.

Limited Warranty

Arctic Cat Inc. (hereinafter referred to as Arctic Cat) extends a limited warranty on each new Arctic Cat ATV it assembles and on each genuine Arctic Cat ATV part and accessory assembled or sold by an authorized Arctic Cat ATV dealer. Warranty on an Arctic Cat ATV is extended to the original retail purchaser; however, the balance of the unused warranty may be transferred to another party. Warranty coverage is only available in the country in which the original retail purchase occurs to the original retail purchaser resident in that country or to a transferee resident in that country of the balance of the unused warranty.

Arctic Cat warrants only the products it assembles and/or sells and does not warrant that other products will function properly when used with an Arctic Cat ATV or will not damage the ATV. Arctic Cat does not assume any liability for incidental or consequential damages.

Arctic Cat will repair or replace, at its option, free of charge (including any related labor charges), any parts that are found to be warrantable in material or workmanship. This repair work MUST be done by an authorized Arctic Cat ATV dealer. No transportation charges, rental charges, or inconvenience costs will be paid by Arctic Cat. The warranty is validated upon examination of said parts by Arctic Cat or an authorized Arctic Cat ATV dealer. Arctic Cat reserves the right to inspect such parts at its factory for final determination if warranty should apply.

The warranty periods are as follows:

1. Six months from the date of sale — for an Arctic Cat ATV used for recreational purposes.
2. Ninety days from date of invoice — for an Arctic Cat ATV used for commercial purposes, including rental operations (non-transferable).
3. Thirty days from date of sale of ATV on Arctic Cat supplied batteries.
4. Thirty days from date of sale — for all dealer installed genuine Arctic Cat service parts and accessories.
5. Until expiration of the new product warranty (paragraphs 1 and 2 above) — for all eligible replacement parts on new product.

Exclusions to this warranty include normal wear, abuse, or corrosion and the following parts and items:

Tires	CV Boots Torn or Punctured Upholstery
Oil Filter	Drive Belt Cracks or Gouges in Body Panels
Air Filter	Brake Pads/Drive/Driven Clutch Wear Parts
Light Bulbs	Spark Plug(s)

The following will VOID Arctic Cat's warranty:

1. Failure to perform the proper break-in procedure and all related maintenance, storage procedures (if stored for extended periods), and/or service as recommended in the Operator's Manual.
2. Repairs and/or adjustments by anyone other than an authorized Arctic Cat ATV dealer.
3. Use of improper carburetor main jets.
4. Use of improper gasoline, lubricating oils, or spark plug.
5. An accident or subjecting the ATV to misuse, abuse, or negligent operation.
6. Any modification, addition, or removal of parts unless instructed to do so by Arctic Cat.
7. Use of the ATV in any way for racing purposes.
8. Removal of the engine for use in another vehicle.
9. Removal or mutilation of the Vehicle Identification Number or Engine Serial Number.
10. Use of parts not sold or approved by Arctic Cat.
11. Damage due to improper transportation.

In consideration of the foregoing, any implied warranty is limited in duration to the various warranty periods set forth. This warranty gives you specific legal rights, and you may also have other rights which vary from state/province to state/province or country to country. Some jurisdictions do not allow limitations on how long an implied warranty lasts, so the above limitations may not apply to you.

Warranty Procedure/Owner Responsibility

At the time of sale, an ATV Rider Training Certificate and Owner Registration form is to be completed by the selling dealer and consumer. The receipt of the form by Arctic Cat is a condition precedent to warranty coverage. It is the selling dealer's responsibility to retain and/or submit appropriate copies of the form to the appropriate place(s) to initiate warranty coverage.

The dealer will furnish to the consumer a signed copy of the form which must be presented to the dealer when requesting warranty service. The registration form is the consumer's proof of ownership and warranty eligibility. The form is used by the dealer to validate the warranty claim. Retain your copy of the form and keep it in a safe place.

When warranty repair is suspected, the ATV should be taken to the selling dealer, who has the primary responsibility to perform warranty repairs. Subject to the limitations set forth in the Limited Warranty, in the event the selling dealer has ceased to do business, you have moved, or you are in a location away from your selling dealer, warranty may be performed by any authorized Arctic Cat ATV dealer.

The authorized Arctic Cat ATV dealer will examine the ATV or part to determine if, in his opinion, a warrantable condition exists. If a warrantable condition appears to exist, the dealer will repair or replace, at Arctic Cat's option, free of charge, including any related labor costs, all parts that are found to be warrantable and any other parts which the warrantable part caused to be damaged. You, the owner, will then be asked to sign a warranty form to ensure Arctic Cat that the warranty work was actually performed.

It is the owner's responsibility to maintain and service the ATV in accordance with Arctic Cat's recommendations in the Operator's Manual. To protect yourself and your ATV, follow all safety and service tips. Arctic Cat will NOT warrant repairs required as a result of not performing standard operator maintenance, storage procedures, and service as outlined in the Operator's Manual.

Should you have any questions concerning the warranty, contact an authorized Arctic Cat ATV dealer.

Arctic Cat Emission Control System Limited Warranty

Arctic Cat Inc., P.O. Box 810, Thief River Falls, MN 56701 (hereinafter referred to as Arctic Cat) warrants that this new Arctic Cat ATV manufactured on or after January 1st, 1997:

- A. Is designed, built, and equipped so as to conform at the time of initial purchase with all applicable regulations of the California Air Resources Board and
- B. Is free from defects in material and workmanship which could cause such ATV to fail to conform with applicable regulations of the California Air Resources Board for a period of use of two (2) years from the date of initial retail delivery.

Coverage

Warranty defects shall be remedied during customary business hours at any authorized Arctic Cat ATV dealer located within the state of California in compliance with applicable regulations of the California Air Resources Board. Any component or components replaced under this warranty shall become the property of Arctic Cat.

In California, emission related warranted components are specifically defined by the state's Emission Warranty Parts List. These warranted components are carburetor and internal components, intake manifold, fuel injection system, spark advance mechanism, crankcase breather, air cutoff valve, fuel/vapor separator, canister, igniters, breaker governors, ignition coils, ignition wires, ignition points, condensers and spark plugs if failure occurs prior to the first scheduled replacement, and hoses, clamps, and fittings used directly in these parts. Since emission related components may vary from model to model, certain models may not contain all of these components, and certain models may contain functionally equivalent components.

In California, emission control system emergency repairs, as provided for in the California Administrative Code, may also be performed by other than an authorized Arctic Cat ATV dealer. An emergency situation occurs when an authorized Arctic Cat ATV dealer is not reasonably available, a component is not available within thirty (30) days, or a repair is not complete within thirty (30) days. Any replacement component can be used in an emergency repair. Arctic Cat will reimburse the owner for the expenses, including diagnosis, not to exceed suggested retail price as set forth by Arctic Cat for all warranted components replaced and labor charges based on the recommended time allowance set forth by Arctic Cat for the warranty repair and the geographically appropriate hourly labor rate. The owner may be required to keep receipts and failed components in order to receive compensation.

Limitations

This Emission Control System Warranty shall not cover any of the following:

- A. Repair or replacement required as a result of
 - (1) accident,
 - (2) misuse,
 - (3) lack of required maintenance,
 - (4) repairs improperly performed or replacements improperly installed,

- (5) use of replacement components or accessories not conforming to Arctic Cat specifications which adversely affect performance, and/or
- (6) use in competitive racing or related events.

- B. Inspections, replacement of components, and other services or adjustments necessary for required maintenance.

Limited Liability

The liability of Arctic Cat under this Emission Control System Warranty is limited solely to the remedying of defects in material and workmanship by an authorized Arctic Cat ATV dealer at its place of business during customary business hours. This warranty does not cover inconvenience or loss of use of the ATV or transportation of the ATV to or from the Arctic Cat ATV dealer.

ARCTIC CAT SHALL NOT BE LIABLE FOR ANY OTHER EXPENSES, LOSS, OR DAMAGE, WHETHER DIRECT, INCIDENTAL, CONSEQUENTIAL, OR EXEMPT, ARISING IN CONNECTION WITH THE SALE OR USE OF, OR INABILITY TO USE THE ARCTIC CAT ATV FOR ANY PURPOSE. SOME STATES DO NOT ALLOW THE EXCLUSION OR LIMITATION OF ANY INCIDENTAL OR CONSEQUENTIAL DAMAGES, SO THE ABOVE MAY NOT APPLY TO YOU.

NO EXPRESS EMISSION CONTROL SYSTEM WARRANTY IS GIVEN BY ARCTIC CAT EXCEPT AS SPECIFICALLY SET FORTH HEREIN. ANY EMISSION CONTROL SYSTEM WARRANTY IMPLIED BY LAW, INCLUDING ANY WARRANTY OF MERCHANTABILITY OR FITNESS FOR A PARTICULAR PURPOSE, IS LIMITED TO THE EXPRESS EMISSION CONTROL SYSTEM WARRANTY TERMS STATED IN THIS WARRANTY. THE FOREGOING STATEMENTS OF WARRANTY ARE EXCLUSIVE AND IN LIEU OF ALL OTHER REMEDIES.

No dealer is authorized to modify this Arctic Cat Inc. Limited Emission Control System Warranty.

Legal Rights

THIS WARRANTY GIVES YOU SPECIFIC LEGAL RIGHTS, AND YOU MAY ALSO HAVE OTHER RIGHTS WHICH VARY FROM STATE TO STATE.

THIS WARRANTY IS IN ADDITION TO THE ARCTIC CAT INC. LIMITED ATV WARRANTY.

Additional Information

Any replacement component that is equivalent in performance and durability may be used in the performance of any maintenance or repairs. However, Arctic Cat is not liable for these components. The owner is responsible for the performance of all required maintenance. Such maintenance may be performed at a service establishment or by any individual. The warranty period begins on the date the ATV is delivered to the owner.

U.S. EPA Emission Control Statement/Warranty Coverage - ATV (U.S. Only)

STATEMENT/WARRANTY

Arctic Cat warrants to the original retail purchaser, and each subsequent purchaser, that all U.S. EPA-certified Arctic Cat ATV's are designed, built, and equipped to conform to all U.S. EPA Emission Control Regulations. Please read the following information completely.

Your authorized Arctic Cat ATV dealer will repair or replace any defective emission-related component at no cost to you during the warranty period. You may have non-warranty service performed by any repair establishment that uses equivalent components. The regulations provide significant civil penalties for tampering that causes your ATV to no longer meet U.S. EPA emission standards.

Arctic Cat further warrants that the engine and its emission-related components are free from defects in materials or workmanship that could cause the engine to fail to comply with applicable regulations during the warranty period.

If you have any questions about this information, or the emission warranty coverage statement, contact your local authorized Arctic Cat ATV dealer.

WARRANTY PERIOD

The emission warranty period for this ATV begins on the same date as the standard warranty coverage and continues for 30 months or 3100 miles, whichever comes first.

COMPONENTS COVERED

The emissions warranty covers major emissions control components and emission-related components listed as follows

Engine Management and Sensors

Barometric Pressure Sensor
Camshaft Position Sensor
Engine Control Unit (ECU)
Engine Coolant Temperature Sensor
Intake Air Temperature Sensor
Manifold Absolute Pressure Sensor
Oxygen Sensor
Throttle Position Sensor
Crankshaft Position Sensor
Exhaust Temperature Sensor

Fuel/Air System

Fuel Injectors
Fuel Pressure Regulator
Fuel Pump
Carburetor(s)
Turbocharger Assembly
Air Bypass Valve
Turbo Waste Gate Control Valve
Crankcase Ventilation System
ISC Valve

Ignition System

Ignition Coil
Knock Sensor System
Spark Plugs
Capacitive Discharge Ignition (CDI) Module
Magneto Pick-Up

Miscellaneous Items Used in Aforementioned Systems

Connectors
Switches
Grommets
Clamps
Hoses
Ties
Gaskets
Wiring

OWNER'S RESPONSIBILITIES

The owner of any ATV warranted under this Arctic Cat Emission Control Statement is responsible for the proper maintenance and use of the ATV as stated in the Operator's Manual. Proper maintenance generally includes replacement and service, at the owner's choosing, such items as air filter, oil and oil filter, or any other part, item, or device related to emissions control as specified in the Operator's Manual. It is the owner's responsibility to ensure that the ATV is used in a manner for which it was designed.

Declaration of Conformity

Application of council directives: EMC Directive 97/24/EC
Date of Issue: June, 1997
EC Machinery Directive 2006/42/EC
Date of Issue: May, 2006

Issued by European Commission.

Type of Equipment: All-Terrain Vehicles

Brand Name: Arctic Cat

Model: 90 Utility
DVX 90

Standards to which conformity is declared: EN 61000-6-2:2005
EN 55012:2007

Manufacturer (if not issuing agent): Arctic Cat Inc.
601 Brooks Ave S.
Thief River Falls, MN
56701 USA

I, the undersigned, hereby declare that the equipment specified above conforms to the directive(s) and standard(s) as specified.

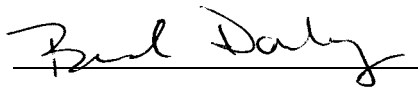

Brad Darling
Vice President/General Manager

Change Of Address, Ownership, Or Warranty Transfer

Arctic Cat Inc. keeps on file the current name and address of the owner of this ATV. This will allow Arctic Cat to reach the current owner with any important safety information which may be necessary to protect customers from personal injury or property damage. Please make sure a copy of this form is completed and returned to Arctic Cat Inc. if you move or if the ATV is sold to another party.

This form may also be used to transfer the unused portion of the original warranty to a second party. In order to transfer warranty, fill out this form completely; then return a copy of this form to Arctic Cat Inc. Arctic Cat will then process the application and issue warranty for the balance of the time remaining of the original warranty.

Address Change

Ownership Change

Warranty Transfer

CHANGE OF ADDRESS/OWNERSHIP/ WARRANTY TRANSFER TO:

Name _____

Address _____

City/State (Province)/Zip Code (Postal Code) _____

Phone # () _____

Year and Model ATV _____

Vehicle Identification Number (VIN) _____

Before operating, you should take an ATV Rider Course to learn ATV riding skills or reinforce your current good riding skills. In U.S.A., call 1-800-887-2887 to enroll in the half-day ATV Rider Course nearest you or ask your dealer for assistance. The course instructor will charge a small fee for each person taking the course. In Canada, call (613) 739-1535.

Fold Back

Place
Stamp
Here

CHANGE OF ADDRESS/OWNERSHIP

ARCTIC CAT INC.
PRODUCT SERVICE AND
WARRANTY DEPT.
P.O. BOX 810
THIEF RIVER FALLS, MN 56701

NOTES

NOTES

Identification Numbers Record

⚠ WARNING

Indicates a potential hazard that could result in serious injury or death.

1. VEHICLE IDENTIFICATION NUMBER:

2. ENGINE SERIAL NUMBER:

Record the Vehicle Identification Number and Engine Serial Number in the spaces provided to assist you in ordering parts from your authorized Arctic Cat ATV dealer or for reference in case the ATV is stolen.



[Previous](#)

[Main Table of Contents](#)

[Section Table of Contents](#)

[Next](#)



WARNING

Improper ATV use can result in SEVERE INJURY or DEATH



ALWAYS USE
AN APPROVED
HELMET AND
PROTECTIVE
GEAR



NEVER USE ON
PUBLIC ROADS



NEVER CARRY
PASSENGERS



NEVER USE
WITH DRUGS OR
ALCOHOL

NEVER operate:

- without proper training or instruction
- at speeds too fast for your skills or the conditions
- on public roads - a collision can occur with another vehicle
- with a passenger - passengers affect balance and steering and increase risk of losing control

ALWAYS:

- use proper riding techniques to avoid vehicle overturns on hills and rough terrain and in turns
- avoid paved surfaces - pavement may seriously affect handling and control

LOCATE AND READ OPERATOR'S MANUAL
FOLLOW ALL INSTRUCTIONS AND WARNINGS



©2011 Arctic Cat Inc. TM® Trademarks of Arctic Cat Inc., Thief River Falls, MN 56701
(218) 681-9851 - U.S. (204) 982-1656 - Canada p/n 2259-063

[Previous](#)

[Main Table of Contents](#)

[Section Table of Contents](#)

Your ATV can be hazardous to operate.

A collision or rollover can occur quickly, even during routine maneuvers such as turning and driving on hills or over obstacles, if you fail to take proper precautions.

For your safety, understand and follow all the warnings contained in this Operator's Manual and the labels on your ATV.



Keep this Operator's Manual with your ATV at all times.

FAILURE TO FOLLOW THE WARNINGS CONTAINED IN THIS MANUAL CAN RESULT IN SERIOUS INJURY OR DEATH.

Training is available: U.S. owners, call 800-887-2887; Canadian owners, call 613-739-1535.

Un cours d'instruction est disponible: pour les propriétaires canadiens, composez le 613-739-1535.

Particularly important information is distinguished in this manual by the following notations:

	The Safety Alert Symbol means ATTENTION! BE ALERT! YOUR SAFETY IS INVOLVED.
 WARNING	WARNING indicates a hazardous situation which, if not avoided, could result in death or serious injury.
CAUTION	CAUTION, without the safety alert symbol, is used to address practices not related to personal injury.
■ NOTE:	A NOTE provides key information to make procedures easier or more clear.

California Proposition 65

 WARNING
This product contains or emits chemicals known to the State of California to cause cancer and birth defects or other reproductive harm.

Foreword

Congratulations and thank you from Arctic Cat Inc. for purchasing an ARCTIC CAT® All-Terrain Vehicle (ATV). It is designed to provide superior ride, comfort, utility, and dependable service.

This Operator's Manual is furnished to make the operator aware of proper operating procedures. It also includes information about the general care and maintenance of your ATV.

This Arctic Cat ATV Operator's Manual should be considered a permanent part of the ATV and must remain with the ATV at the time of resale. If the ATV changes ownership more than once, contact Arctic Cat Inc., Service Department, P.O. Box 810, Thief River Falls, MN 56701, for proper registration information.

Children differ in skills, physical abilities, and judgment. Some children may not be able to operate an ATV safely. Parents should supervise their child's use of the ATV at all times. Parents should permit continued use only if they determine that the child has the ability to operate the ATV safely.

Carefully read the following pages. If you have any questions regarding this ATV, contact an authorized Arctic Cat ATV dealer for assistance. Remember, only authorized Arctic Cat ATV dealers have the knowledge and facilities to provide you with the best service possible.

Protect Your Sport

- Know all local, state/provincial riding laws,
- Respect your ATV,
- Respect the environment, and
- You will gain the respect of others.

We also advise you to strictly follow the recommended maintenance program as outlined. This preventive maintenance program is designed to ensure that all critical components on this ATV are thoroughly inspected at various intervals.

All information in this manual is based on the latest product data and specifications available at the time of printing. Arctic Cat Inc. reserves the right to make product changes and improvements which may affect illustrations or explanations without notice.

At the time of publication, all information and illustrations in this manual were technically correct. Some illustrations used in this manual are used for clarity purposes only and are not designed to depict actual conditions. Because Arctic Cat Inc. constantly refines and improves its products, no retroactive obligation is incurred.

Parts and Accessories

When in need of replacement parts, oil, or accessories for your Arctic Cat ATV, be sure to use only GENUINE ARCTIC CAT PARTS, OIL, AND ACCESSORIES. Only genuine Arctic Cat parts, oil, and accessories are engineered to meet the standards and requirements of your Arctic Cat ATV. For a complete list of accessories, refer to the current Arctic Cat ATV Accessory Catalog.

To aid in service and maintenance procedures on this ATV, a Service Manual and an Illustrated Parts Manual are available through your local Arctic Cat ATV dealer.

Arctic Cat and the ATV Safety Institute recommend that all ATV operators ride the appropriate-sized ATV according to age.

Category	Age (Years)	Speed Limitations (MPH)	NOTES
Y-12+	12 or Older	15 - Limited 30 - Maximum	Operate Under Adult Supervision
T-14	14 or Older	20 - Limited 30 - Limited 38 - Maximum	Operate Under Adult Supervision
G & S	16 or Older	According to Local Regulations	—

TREAD LIGHTLY! OFFICIAL SPONSOR®
ON PUBLIC AND PRIVATE LAND

Table of Contents

Foreword.....	1
Parts and Accessories	1
DIVISION I - RIDER AWARENESS/RESPONSIBILITY	
ATV Safety Alert.....	4
Rider Training Course	5
Hangtag & Warning Labels	6
Warnings	7-13
Prevention	14-17
Clothing and Gear	14
Condition of the ATV	15
T-CLOC	15
First Aid and Survival	16
Active Riding.....	18
Sound Judgment	19-22
Those Around You	19
Environment	19
Equipment	20
Load Capacity Ratings Chart	20
Personal Choices	21
SIPDE	22
Supervision	23
Taking Responsibility	23
Inexperienced Riders	23
Experienced Riders.....	23
DIVISION II - OPERATION/ MAINTENANCE	
ATV Specifications	24
Location of Controls.....	25
ATV Operation.....	26-32
Basic Operating Maneuvers	26
Starting the Engine	26
BONE-C	26
Starting A Cold Engine.....	27
Handling the ATV (Active Riding Techniques)	27
Tips.....	28
General Information.....	33-38
ATV Identification Numbers	33

Ignition Switch Key.....	33
Control Locations and Functions	33
LCD/Indicator Lights	35
Gas/Vent Hoses	36
Carburetor Float Bowl Drain	36
Oil Level Stick	36
Seat Lock.....	36
Safety Flag/Bracket.....	36
Transporting ATV	36
Gasoline-Oil-Lubricant.....	37
Engine Break-In	38
General Maintenance	39-49
Maintenance Schedule	39
Shock Absorbers	40
General Lubrication	40
Hand Brake Systems	41
Brake Lever Lock.....	41
Suspension/Steering Arm Bushings	42
Tie Rod Boots	42
Battery	42
Spark Plug	45
Engine Idle RPM Adjustment.....	45
Throttle Cable Adjustment	46
Air Filter	46
Drive Chain Condition/Adjustment.....	47
Tires.....	47
Wheels.....	48
Bulb Replacement	48
Fuse.....	49
Storage Compartment/Tools	49
Preparation For Storage.....	50
Preparation After Storage	51
Declaration of Conformity	52
Limited Warranty.....	53
Warranty Procedure/Owner Responsibility	54
Arctic Cat Emission Control System Limited Warranty	55
U.S. EPA Emission Control Statement/Warranty Coverage (U.S. Only)	56
Change Of Address, Ownership, or Warranty Transfer	57
Maintenance Record	59-60
Identification Numbers Record	Inside Back Cover

Division I - Rider Awareness/ Responsibility

An ATV Is Not A Toy And Can Be Hazardous To Operate.

An ATV handles differently from other vehicles including motorcycles and cars. A collision or rollover can occur quickly, even during routine maneuvers such as turning and driving on hills or over obstacles, if you fail to take proper precautions.

SEVERE INJURY OR DEATH can result if you do not follow these instructions:

- Parents: It is very important that your child or children understand and follow the instructions and warnings contained in this manual before operating this ATV under adult supervision. Also, it is very important that you take time to watch the Safety DVD (included in the Owner's Packet) with your child or children. It contains important operating and safety instructions.
- Read this manual and all labels carefully and follow the operating procedures described.
- Never operate an ATV without proper instruction. Take a training course. Beginners should receive training from a certified instructor. Contact an authorized Arctic Cat ATV dealer or call the ATV Safety Institute at 1-800-887-2887 (U.S.) or 1-613-739-1535 (Canada) to find out about the training course nearest you.
- Never allow anyone under 14 years of age to operate this ATV.
- Never allow a child to operate a T-14 ATV without adult supervision and never allow continued use of an ATV by a child if the child does not have the abilities to operate it safely.
- Some operators, even at the age of 14, may not be able to operate an ATV safely; parents should supervise such operator of the ATV at all times. Parents should permit continued use only if they determine that the operator has the ability to operate the ATV safely.
- Never carry a passenger.
- Never permit a guest to operate this ATV unless the guest has read this manual and all product labels and has completed a certified training course.
- Never operate an ATV on any paved surfaces, including sidewalks, driveways, parking lots, and streets.
- Never operate this ATV on any public street, highway, or road (even a dirt or gravel one).

- Never operate an ATV without wearing an approved helmet that fits properly. You should also wear eye protection (goggles or face shield), gloves, boots, long-sleeved shirt or jacket, and long pants.
- Never consume alcohol or drugs before or while operating this ATV.
- Never operate at excessive speeds. Always travel at a speed which is proper for the terrain, visibility and operating conditions, and your experience.
- Never attempt wheelies, jumps, or other stunts.
- Always inspect this ATV each time you use it to make sure it is in safe operating condition. Always follow the inspection and maintenance procedures and schedules described in this manual.
- Always keep both hands on the handlebars and both feet on the footrests of the ATV during operation.
- Always go slowly and be extra careful when operating on unfamiliar terrain. Always be alert to changing terrain conditions when operating the ATV.
- Never operate on excessively rough, slippery, or loose terrain.
- Always follow proper procedures for turning as described in this manual. Practice turning at slow speeds before attempting to turn at faster speeds. Do not turn at excessive speed.
- Always have the ATV checked by an authorized Arctic Cat ATV dealer if it has been involved in an accident.
- Never operate the ATV on hills too steep for the ATV or for your abilities. Practice on smaller hills before attempting larger hills.
- Always follow proper procedures for climbing hills as described in this manual. Check the terrain carefully before you start up any hill. Never climb hills with slippery or loose surfaces. Shift your weight forward. Never open the throttle suddenly. Never go over the top of any hill at high speed. Always follow proper procedures for going down hills and for braking on hills as described in this manual. Check the terrain carefully before you start down any hill. Shift your weight backward. Never go down a hill at high speed. Avoid going down a hill at an angle which would cause the ATV to lean sharply to one side. Go straight down the hill where possible.
- Always follow proper procedures for crossing the side of a hill as described in this manual. Avoid hills with slippery or loose surfaces. Shift your weight to the uphill side of the ATV. Never attempt to turn the ATV around on any hill until you have mastered the turning techniques described in this manual on level ground. Avoid crossing the side of a steep hill if possible.

An ATV Is Not A Toy And Can Be Hazardous To Operate.

- Always use proper procedures if you stall or roll backward when climbing a hill. To avoid stalling, maintain a steady speed when climbing a hill. If you stall or roll backwards, follow the special procedure for braking described in this manual. Dismount on the uphill side or to either side if pointed straight uphill. Turn the ATV around and mount following the procedure described in this manual.
- Always check for obstacles before operating in a new area. Never attempt to operate over large obstacles, such as large rocks or fallen trees. Always follow proper procedures when operating over obstacles as described in this manual.
- Always be careful of skidding or sliding. On slippery surfaces, such as ice, go slowly and be very cautious in order to reduce the chance of skidding or sliding out of control.
- Never operate an ATV in fast flowing water or in water deeper than the footrests. Remember that wet brakes may have reduced stopping capability. Test your brakes after leaving water. If necessary, apply them lightly several times to let friction dry out the pads.
- Always use the size and type tires specified in this manual. Always maintain proper tire pressure as described in this manual.
- Never improperly install or improperly use accessories on your ATV.
- Never install a twist grip throttle on this ATV.
- Never exceed the stated load capacity for this ATV. One operator only. No passengers.
- Remove the speed limiting safety device on this ATV at your own risk.

FOR MORE INFORMATION ABOUT ATV SAFETY, call the ATV Safety Institute at 1-800-887-2887 (U.S.) or Canada Safety Council at 1-613-739-1535 (Canada).

ATV Safety Alert

The Consumer Product Safety Commission has concluded that ALL-TERRAIN VEHICLES (ATV's) may present a risk of DEATH or SEVERE INJURY in certain circumstances. While accidents may occur for many reasons:

- *** Over 2591 people, including many children, have died in accidents associated with ATV's since 2005.
- *** Many people have become severely paralyzed or suffered severe internal injuries as a result of accidents associated with ATV's.
- *** Every month thousands of people are treated in hospital emergency rooms for injuries received while riding an ATV.

You should be aware that AN ATV IS NOT A TOY AND CAN BE HAZARDOUS TO OPERATE. An ATV handles differently from other vehicles, including motorcycles and cars. A collision or rollover can occur quickly, even during routine maneuvers such as turning and driving on hills and over obstacles, if you fail to take proper precautions.

To Avoid Death Or Severe Personal Injury:

- * **NEVER ALLOW ANYONE UNDER 14 YEARS OLD TO OPERATE AN ARCTIC CAT T-14 ATV.**
- * **ALWAYS** READ THE OPERATOR'S MANUAL CAREFULLY AND FOLLOW THE OPERATING PROCEDURES DESCRIBED. PAY SPECIAL ATTENTION TO THE WARNINGS CONTAINED IN THE MANUAL AND ON ALL LABELS.
- * **NEVER** OPERATE AN ATV WITHOUT PROPER INSTRUCTION. **TAKE A TRAINING COURSE.** BEGINNERS SHOULD COMPLETE THE TRAINING COURSE DESCRIBED ON THIS PAGE.
- * **NEVER** CARRY A PASSENGER OR RIDE AS A PASSENGER ON AN ATV. CARRYING A PASSENGER MAY UPSET THE BALANCE OF THE ATV AND MAY CAUSE IT TO GO OUT OF CONTROL.
- * EVERY ARCTIC CAT BRAND ATV IS DESIGNED FOR A CERTAIN AGE GROUP. NEVER RIDE AN ATV THAT IS NOT DESIGNED FOR YOUR AGE GROUP. THE OPERATOR'S MANUAL AND LABELS CONTAIN THE AGE GROUP FOR EACH ARCTIC CAT BRAND ATV.
- * **NEVER** OPERATE AN ARCTIC CAT BRAND TRANSITIONAL ATV WITHOUT PARENTAL SUPERVISION.
- * **NEVER** OPERATE AN ATV ON PAVEMENT. THE VEHICLE IS NOT DESIGNED TO BE USED ON PAVED SURFACES AND MAY BE DIFFICULT TO CONTROL.
- * **NEVER** OPERATE AN ATV ON A PUBLIC ROAD, EVEN A DIRT OR GRAVEL ONE, BECAUSE YOU MAY NOT BE ABLE TO AVOID COLLIDING WITH OTHER VEHICLES. ALSO, OPERATING AN ATV ON A PUBLIC ROAD MAY BE AGAINST THE LAW.
- * **NEVER** OPERATE AN ATV WITHOUT AN APPROVED MOTORCYCLE HELMET, EYE PROTECTION, BOOTS, GLOVES, LONG PANTS, AND A LONG-SLEEVED SHIRT OR JACKET.

- * **NEVER** CONSUME ALCOHOL OR DRUGS BEFORE OR WHILE OPERATING AN ATV.
- * **NEVER** OPERATE AN ATV AT EXCESSIVE SPEEDS. GO AT A SPEED WHICH IS PROPER FOR THE TERRAIN, VISIBILITY CONDITIONS, AND YOUR EXPERIENCE.
- * **NEVER** ATTEMPT TO DO WHEELIES, JUMPS, OR OTHER STUNTS.
- * **ALWAYS** BE CAREFUL WHEN OPERATING AN ATV, ESPECIALLY WHEN APPROACHING HILLS, TURNS, AND OBSTACLES AND WHEN OPERATING ON UNFAMILIAR OR ROUGH TERRAIN.
- * **NEVER** LEND YOUR ATV TO ANYONE WHO HAS NOT TAKEN A TRAINING COURSE OR HAS NOT BEEN DRIVING AN ATV FOR AT LEAST A YEAR.

Rider Training Course

Arctic Cat sponsors a free Rider Training Course to teach ATV riding skills or to reinforce current riding skills. First-time purchasers without any previous ATV riding experience will receive a \$100.00 coupon from Arctic Cat through the SVIA/ASI after completing the training course (U.S. owners only, one incentive). Arctic Cat provides free rider training courses to appropriate immediate family members per ATV purchase. Others can take the training course for a small fee. See an authorized Arctic Cat ATV dealer for details or call (800) 887-2887 for training course information.

FOR MORE INFORMATION ABOUT ATV SAFETY, call the Consumer Product Safety Commission at (800) 638-2772 or the ATV Distributors' Safety Hotline at (800) 852-5344.

Visit the Arctic Cat Inc. website at www.arcticcat.com for additional product information.

Hangtag & Warning Labels

Your Arctic Cat ATV comes with a hangtag and several labels containing important safety information. Anyone who rides the ATV should read and understand this information before riding.

The labels should be considered as permanent parts of the ATV. If a label comes off or becomes hard to read, contact your Arctic Cat ATV dealer for a replacement.

Pour commander des Etiquettes de Mise en Garde gratuites, voyez votre détaillant de autorisé VTT Arctic Cat pour le numéro de pièce 1436-344.



2258-135



KM881B



KM879D

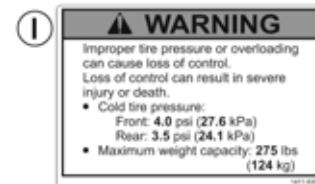
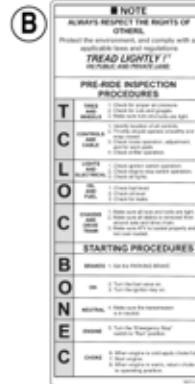

Warnings

⚠️ WARNING

POTENTIAL HAZARD

Operating this ATV without proper instruction and supervision.

WHAT CAN HAPPEN

The risk of an accident is greatly increased if the operator does not know how to operate the ATV properly in different situations and on different types of terrain.

HOW TO AVOID THE HAZARD

Beginning and inexperienced operators should complete the certified training course offered. They should then regularly practice the skills learned in the course and the operating techniques described in this Operator's Manual.

For more information about the training course, contact an authorized Arctic Cat ATV dealer or call 1-800-887-2887 (U.S.) or 1-613-739-1535 (Canada).

⚠️ WARNING

POTENTIAL HAZARD

Allowing anyone under age 14 to operate this ATV.

WHAT CAN HAPPEN

Use of an ATV by children can lead to severe injury or death of the child. Children may not have the skills, abilities, or judgment needed to operate the ATV safely and may be involved in a serious accident.

HOW TO AVOID THE HAZARD

A child under 14 should never operate this ATV. A child lacking the skills, abilities, or judgment needed to operate the ATV safely should never operate this ATV. A child under the age of 16 should never operate this ATV without parental supervision.

⚠️ WARNING

POTENTIAL HAZARD

Carrying a passenger on this ATV.

WHAT CAN HAPPEN

Greatly reduces your ability to balance and control this ATV. Could cause an accident, resulting in injury or death to you and/or your passenger.

HOW TO AVOID THE HAZARD

Never carry a passenger. The long seat is to allow the operator to shift positions as needed during operation. It is not for carrying passengers.

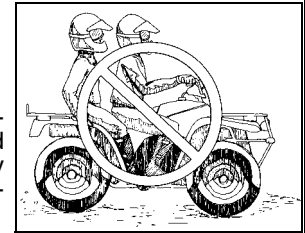

⚠️ WARNING

POTENTIAL HAZARD

Operating this ATV on paved surfaces.

WHAT CAN HAPPEN

The ATV's tires are designed for off-road use only, not for use on pavement. Paved surfaces may seriously affect handling and control of the ATV and may cause the ATV to go out of control.

HOW TO AVOID THE HAZARD

Never operate the ATV on any paved surfaces, including sidewalks, driveways, parking lots, and streets.

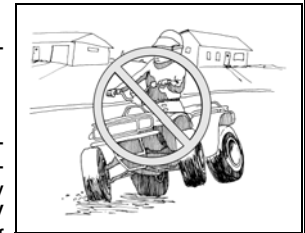

Warnings

⚠ WARNING

POTENTIAL HAZARD

Operating this ATV on public streets, roads, or highways.

WHAT CAN HAPPEN

You can collide with another vehicle.

HOW TO AVOID THE HAZARD

Never operate this ATV on any public street, road, or highway, even a dirt or gravel one. In many states it is illegal to operate an ATV on public streets, roads, or highways.

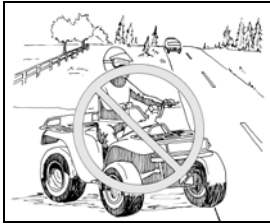

⚠ WARNING

POTENTIAL HAZARD

Failure to use extra care when operating the ATV on unfamiliar terrain.

WHAT CAN HAPPEN

You can come upon hidden rocks, bumps, or holes without enough time to react.

Could result in the ATV overturning or going out of control.

HOW TO AVOID THE HAZARD

Go slowly and be extra careful when operating on unfamiliar terrain. Always be alert to changing terrain conditions when operating the ATV.

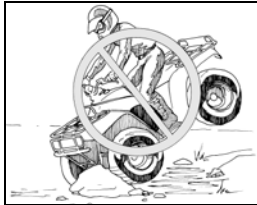

⚠ WARNING

POTENTIAL HAZARD

Operating this ATV without wearing an approved motorcycle helmet, eye protection, and protective clothing.

WHAT CAN HAPPEN

Operating without an approved helmet increases your chances of a severe head injury or death in the event of an accident.

Operating without eye protection can result in an accident and increases your chances of a severe injury in the event of an accident.

Operating without protective clothing increases your chances of severe injury in the event of an accident.

HOW TO AVOID THE HAZARD

Always wear an approved helmet that fits properly.

You should also wear:

- Eye protection (goggles or face shield)
- Gloves
- Boots
- Long sleeved shirt or jacket
- Long pants

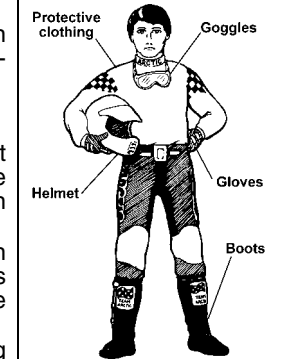

Warnings

⚠ WARNING

POTENTIAL HAZARD

Operating this ATV after or while consuming alcohol or drugs.

WHAT CAN HAPPEN

Could seriously affect your judgment.
 Could cause you to react more slowly.
 Could affect your balance and perception.
 Could result in an accident.

HOW TO AVOID THE HAZARD

Never consume alcohol or drugs before or while driving this ATV.

⚠ WARNING

POTENTIAL HAZARD

Operating this ATV at excessive speeds or removing the speed limiting device from the ATV.

WHAT CAN HAPPEN

Increases your chances of losing control of the ATV, which can result in an accident.

HOW TO AVOID THE HAZARD

Always ride at a speed that is proper for the terrain, visibility and operating conditions, and your age and experience.

⚠ WARNING

POTENTIAL HAZARD

Attempting wheelies, jumps, and other stunts.

WHAT CAN HAPPEN

Increases the chance of an accident including an overturn.

HOW TO AVOID THE HAZARD

Never attempt stunts, such as wheelies or jumps. Don't try to show off.

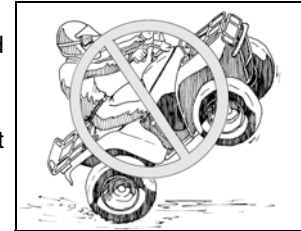

⚠ WARNING

POTENTIAL HAZARD

Failure to inspect the ATV before operating.
 Failure to properly maintain the ATV.

WHAT CAN HAPPEN

Increases the possibility of an accident or equipment damage.

HOW TO AVOID THE HAZARD

Always inspect your ATV each time you use it to make sure the ATV is in safe operating condition.
 Always follow the inspection and maintenance procedures and schedules described in this Operator's Manual.

Warnings

⚠ WARNING

POTENTIAL HAZARD

Removing hands from handlebar or feet from footrests during operation.

WHAT CAN HAPPEN

Removing even one hand or foot can reduce your ability to control the ATV or could cause you to lose your balance and fall off the ATV. If you remove a foot from a footrest, your foot or leg may come into contact with the wheels, which could injure you or cause an accident.

HOW TO AVOID THE HAZARD

Always keep both hands on the handlebar and both feet on the footrests of your ATV during operation.

⚠ WARNING

POTENTIAL HAZARD

Operating on steep hills.

WHAT CAN HAPPEN

The ATV can overturn more easily on steep hills than on level surfaces or small hills.

HOW TO AVOID THE HAZARD

Never operate the ATV on hills too steep for the ATV or for your abilities.

Practice on smaller hills before attempting larger hills.

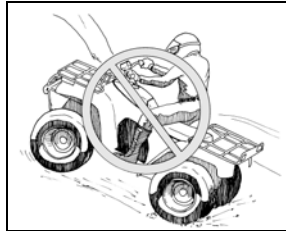

⚠ WARNING

POTENTIAL HAZARD

Turning improperly.

WHAT CAN HAPPEN

ATV could go out of control, causing a collision or rollover.

HOW TO AVOID THE HAZARD

Always follow proper procedures for turning as described in this Operator's Manual.

Practice turning at slow speeds before attempting to turn at faster speeds.

Do not turn at excessive speed.

⚠ WARNING

POTENTIAL HAZARD

Failure to use extra care when operating on rough, slippery, or loose terrain.

WHAT CAN HAPPEN

Could cause loss of traction or ATV control, which could result in an accident including an overturn.

HOW TO AVOID THE HAZARD

Do not operate on rough, slippery, or loose terrain until you have learned and practiced the skills necessary to control the ATV on such terrain.

Always be especially cautious on these kinds of terrain.

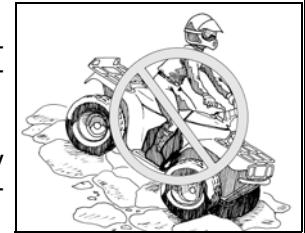

Warnings

WARNING

POTENTIAL HAZARD

Climbing hills improperly.

WHAT CAN HAPPEN

Could cause loss of control or cause the ATV to overturn.

HOW TO AVOID THE HAZARD

Always follow proper procedures for climbing hills as described in this Operator's Manual.

Always check the terrain carefully before you start up any hill.

Never climb hills with slippery or loose surfaces.

Shift your weight forward.

Never open the throttle suddenly. The ATV could flip over backwards.

Never go over the top of any hill at high speed. An obstacle, a sharp drop, or another vehicle or person could be on the other side of the hill.

NEVER OPERATE UP OR DOWN HILLS STEEPER THAN 15°

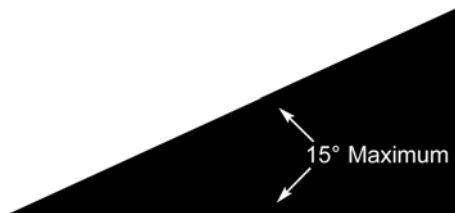
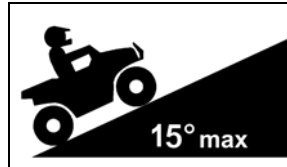

WARNING

POTENTIAL HAZARD

Stalling, rolling backwards, or improperly dismounting while climbing a hill.

WHAT CAN HAPPEN

Could result in the ATV overturning.

HOW TO AVOID THE HAZARD

Use proper gear and maintain steady speed when climbing a hill.

If you lose all forward speed:

Keep weight uphill.

Apply the brakes.

Engage the parking brake after you are stopped.

If you begin rolling backwards:

Keep weight uphill.

Apply the brakes while rolling backwards.

When fully stopped, engage the brake lever lock.

Dismount on uphill side or to a side if pointed straight uphill.

Turn the ATV around and mount following the procedure described in this Operator's Manual.

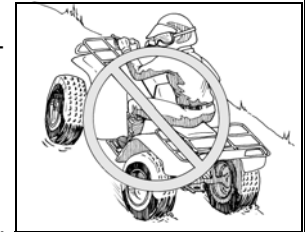

Warnings

⚠ WARNING

POTENTIAL HAZARD

Going down a hill improperly.

WHAT CAN HAPPEN

Could cause loss of control or cause the ATV to overturn.

HOW TO AVOID THE HAZARD

Always follow proper procedures for going down hills as described in this Operator's Manual.

Always check the terrain carefully before you start down any hill.

Shift your weight backward.

Never go down a hill at high speed.

Avoid going down a hill at an angle that would cause the ATV to lean sharply to one side. Go straight down the hill where possible.

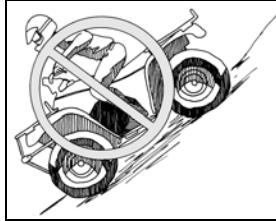

⚠ WARNING

POTENTIAL HAZARD

Improperly operating over obstacles.

WHAT CAN HAPPEN

Could cause loss of control or a collision. Could cause the ATV to overturn.

HOW TO AVOID THE HAZARD

Before operating in a new area, check for obstacles.

Never attempt to ride over large obstacles, such as large rocks or fallen trees.

When you go over obstacles, always follow proper procedures as described in this Operator's Manual.

⚠ WARNING

POTENTIAL HAZARD

Skidding or sliding.

WHAT CAN HAPPEN

You may lose control of the ATV.

You may also regain traction unexpectedly, which may cause the ATV to overturn.

HOW TO AVOID THE HAZARD

Learn to safely control skidding or sliding by practicing at slow speeds and on level, smooth terrain.

On extremely slippery surfaces, such as ice, go slowly and be very cautious in order to reduce the chance of skidding or sliding out of control.

⚠ WARNING

POTENTIAL HAZARD

Operating the ATV with improper modifications.

WHAT CAN HAPPEN

Improper installation of accessories or modification of the ATV may cause changes in handling which, in some situations, could lead to an accident.

HOW TO AVOID THE HAZARD

Never modify the ATV through improper installation or improper use of accessories. All parts and accessories added to this ATV should be genuine Arctic Cat ATV components designed for use on the ATV and should be installed and used according to instructions. Never install a twist grip throttle. If you have questions, consult an authorized Arctic Cat ATV dealer.

Warnings

⚠ WARNING

POTENTIAL HAZARD

Improperly crossing hills or turning on hills.

WHAT CAN HAPPEN

Could cause loss of control or cause the ATV to overturn.

HOW TO AVOID THE HAZARD

Never attempt to turn the ATV around on any hill until you have mastered the turning technique as described in this Operator's Manual. Practice first on level ground. Be very careful when turning on any hill.

Avoid crossing the side of a steep hill, if possible.

When crossing the side of a hill:

Always follow proper procedures as described in this Operator's Manual.

Avoid hills with slippery or loose surfaces.

Shift your weight to the uphill side of the ATV.

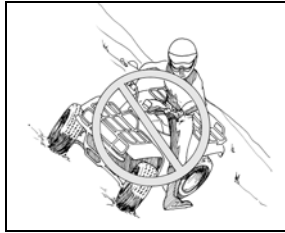

⚠ WARNING

POTENTIAL HAZARD

Failure to release the brake lever lock before driving the ATV.

WHAT CAN HAPPEN

Driving the ATV with the brake lever lock engaged could cause a change in handling or loss of brakes and cause an accident.

HOW TO AVOID THE HAZARD

Always release the brake lever lock before driving the ATV.

⚠ WARNING

POTENTIAL HAZARD

Operating the ATV through deep or fast flowing water.

WHAT CAN HAPPEN

Tires may float, causing loss of traction and loss of control, which could lead to an accident.

HOW TO AVOID THE HAZARD

Never operate the ATV in fast flowing water or in water deeper than the footrests.

Remember that wet brakes may have reduced stopping capability. Test your brakes after leaving water. If necessary, apply them several times to dry out the brakes.

⚠ WARNING

POTENTIAL HAZARD

Operating the ATV with improper tires or with improper or uneven tire pressure.

WHAT CAN HAPPEN

Use of improper tires on the ATV, or operation of the ATV with improper or uneven tire pressure, may cause loss of control increasing your risk of accident.

HOW TO AVOID THE HAZARD

Always use the size and type tires specified in this Operator's Manual for this ATV.

Always maintain proper tire pressure as described in this Operator's Manual.

Prevention

Overview

When using an ATV, prevention is the name of the game. “Had you only known” something could go wrong, you would have prevented it. If you don’t notice your conditions and surroundings before riding your ATV, you give up control over the situation. Using ATV prevention techniques helps you forecast potential hazards before they injure you or damage your ATV.

Following the safety instructions and warnings in this manual will help you “P.A.S.S.” the safety test. P.A.S.S. stands for “**P**revention,” “**A**ctive Riding,” “**S**ound Judgment,” and “**S**upervision.” Remembering P.A.S.S. and what it stands for will help you have a safe, predictable ride every time you go out on your ATV.

Clothing and Gear

You’ll find it important to dress correctly for ATV riding in order to prevent scraped skin and serious head injuries. It’s easy and could save you time in the long run not having to contend with an injury. This is the minimum protection you need to wear during every ride:

1. Helmet
2. Eye Protection
3. Long Pants
4. Long Sleeved Shirt
5. Gloves
6. Boots/Ankle Protection

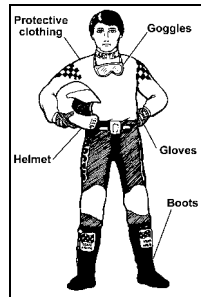

ATV-0004

Of course, it also makes sense to remember the seasons. Wear a hat under your helmet and a snowmobile suit in the winter and lighter, protective clothing in the summer.

Helmet

There are several types of helmets on the market, but make sure you wear a helmet that complies with the current standards of the U.S. Department of Transportation (DOT), The Snell Memorial Foundation, or the American National Standards Institute (ANSI). Helmets that comply with one or more of these agency’s standards have a sticker on the inside or outside of the helmet.

These helmets should provide full-face protection.

If you drop or damage your helmet, get a new one immediately. Your helmet may not protect your head from injury if it has cracks, fissures, or other damage to its outside or core padding.

Remember, your helmet won’t do you any good if the chin strap isn’t fastened.

Eye Protection

Wear eye protection, such as goggles, to completely surround your eyes to prevent getting dirt or other items in your eyes. Sunglasses are not recommended; they don’t prevent objects from flying in through the sides.

Helmets should have one of these:

1. DOT label
2. Snell label
3. ANSI Z90.1 label

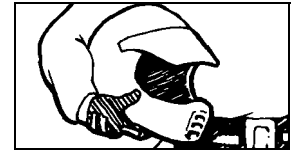

TESTIMONIAL

DOCUMENT#: N490117A1

CITY/STATE: N. HUNTINGDON, PA

SEX: M

AGE: 6

BODY PART: HEAD

DATE ACCIDENT: 06-14-94

DISPOSITION: DOA

SYNOPSIS: The 6 year old male victim died from blunt force trauma to the head when the 4-wheel ATV on which he was a passenger struck a rock on a hill connecting two roads and flipped over backwards onto the victim, shattering his bicycle helmet. The victim was life-flighted to the hospital and died that night. The driver of the ATV, the victim’s 29 year old father, sustained minor injuries, but wasn’t treated.

Prevention

Long Pants and Long Sleeved Shirt

The goal is to protect your body from branches, long grass, airborne objects, or anything else that could scrape your skin. The more thick and durable the material, the better protection it'll provide.

Gloves

Your hands are targets for flying objects and branches. Along with providing skin protection, gloves will shield your hands from harsh weather. Wear gloves that are weather resistant and have a gripping surface to keep them from sliding off the handlebar.

Boots/Ankle Protection

Wear a boot that covers the largest possible area of your leg (preferably up to your knee) and can handle significant impact. Choosing boots with low heels and a good tread will help prevent your feet from slipping off the footrests in wet or rugged conditions or getting hurt if they get hit by rocks, dirt, or branches.

Condition of the ATV

The second step in Prevention is checking the condition of your ATV. Chances are good that you'll be using your ATV in some rough terrain, and there's no way you want your brakes to go out when riding downhill. You need to check the following parts on your ATV before every ride.

1. Tires and Wheels
2. Controls and Cables
3. Lights and Electrical
4. Oil and Fuel
5. Chassis and Drive Train
6. Miscellaneous Items

One easy way to remember what parts you need to check is by using the acronym "T-CLOC." It stands for:

T	C	L	O	C
TIRES AND WHEELS	CONTROLS AND CABLES	LIGHTS AND ELECTRICAL	OIL AND FUEL	CHASSIS AND DRIVE TRAIN

1. Tires and Wheels

Correct tire pressure is crucial. Consult the General Maintenance section of this Operator's Manual for tire pressure guidelines. Incorrect tire pressure can cause poor handling, instability, and a loss of ATV control.

Check:

1. Tire pressure
2. Tire surface (tread and sidewalls)

While checking the tire pressure, inspect the tread and sidewalls of the tires for cracks, cuts, or other damage that could indicate they need to be replaced.

2. Controls and Cables

A. Brakes

Squeeze your hand brake levers. If they feel soft or "squishy," the brakes may need adjustment. Check the maintenance section of this Operator's Manual for instructions. Don't use the ATV until the brakes are operating normally.

Check:

1. Hand brake levers
2. Parking brake

Test the brake lever lock and see if it locks the hand brake lever into position; then disengage it to release the brakes. Ensure that the hand brakes are working properly; your brakes could fail during a ride if they're not maintained.

B. Throttle

The throttle should have a free, smooth range of motion. If it seems to "stick" at any point, refer to the General Maintenance section of this Operator's Manual for instructions. Driving your ATV with a sticking throttle can turn your leisurely ride into an unwelcome accident. Don't drive your ATV if the throttle sticks.

Check:

1. Free, smooth range of motion

Prevention

3. Lights and Electrical

Verify the brakelights, taillights, headlights, and parking lights work. Don't drive the ATV unless all systems are working. Check the ignition switch and engine stop switch.

Check:

1. Brakelights
2. Taillights
3. Headlights
4. Parking Lights
5. Ignition switch
6. Engine stop switch

Check:

1. Gas
2. Oil
3. Fluid leaks

4. Oil and Fuel

Start with a full tank of gas and check engine oil before every ride. Don't forget to check for fluid leaks around the ATV.

5. Chassis and Drive Train

Grass and leaves can gum-up your suspension and shocks. Clear and clean the suspension arms, shock springs, and fenders. Check smoothness by turning the handlebar full-left and full-right. Check that there is no binding, restrictions, free-play, or looseness in steering components. Check and clean the drive chain and sprockets of foreign material and debris. Check drive chain adjustment.

Check:

1. Suspension arms
2. Shock springs
3. Fenders
4. Steering
5. Drive Chain

6. Miscellaneous Items

Inspect your air filter. Look for debris or damage that may indicate you need to replace it. A clogged filter can stop an engine. Check your battery terminals for corrosion. Also, be sure to tighten any loose parts, nuts, or bolts.

Check:

1. Air filter
2. Battery
3. Tighten parts, nuts, and bolts

First Aid and Survival

You need to prepare for the unexpected. Emergencies and accidents are traumatic enough, but they're even worse when you're not prepared for them. At the minimum during every ATV ride, you should have the following items on board:

- Tools
- Water
- Identification
- First Aid Kit

For rides that are longer in duration and distance, the following additional items are recommended:

- Cellular Phone
- Maps/GPS
- Emergency Kit *with Flashlight and First Aid Kit*

Tools

Routine maintenance will generally eliminate the need for emergency repairs. Riding on rough terrain could cause loosening of nuts, bolts, and fasteners. Especially on long rides, carrying the right tools can prevent an inconvenience from becoming a crisis.

Carry these items on your ATV:

1. Bulbs
2. Duct tape
3. Rope
4. Spark plugs
5. Spare parts
6. Tool Kit

Water

Water is so important that you need to carry it regardless of the duration of your ride. Heat exhaustion and heat stroke can creep up suddenly and can take you out of commission. If you become dehydrated, you could find yourself physically unable to safely operate your ATV.

Prevention

Identification

If something does happen to you, the emergency personnel will want to know who you are and whom to contact. It's possible you may be in no condition to give them that information. Put your I.D. in your pocket before you ride. Without it, you're anonymous.

Cellular Phone

It may be necessary to make an urgent phone call.

Maps/GPS (Global Positioning System)

Maps may be unnecessary when you're familiar with the area. But when you're riding on unfamiliar trails, it's good to know where you are, what's coming up, and how to get back.

Emergency Kit with Flashlight and First Aid Kit

You'll need several items in your Emergency Kit including a flashlight. The matches will come in handy if you need to start a fire to stay warm. Flares are appropriate for signaling help. A first aid kit is very important if an injury of some type should happen. A good First Aid Kit should include bandages, anti-septic spray, gauze, tape, etc.

Carry these items:

1. Flashlight
2. Matches
3. Flares
4. First Aid Kit
5. Money

Active Riding

Overview

“Active Riding” is the second part of “P.A.S.S.” It involves an understanding of how your body weight, balance, gravity, and physical forces affect the handling of the ATV. For example, when you drive a car quickly into a sharp turn, your body is pulled to the outside of the vehicle by centrifugal force. Although a car is relatively stable, enough centrifugal force can cause an ATV to overturn. Constantly shifting your weight is one major difference between driving a car and riding an ATV. Knowing how to shift your weight is necessary to avoid rolling or flipping the ATV.

For complete operating instructions, see ATV OPERATION section in this manual.

Sound Judgment

Those Around You

People do all kinds of things that you can't predict or control.

Riding Companions

Leave a lot of space between you and other riders, especially in dusty and dirty conditions, because it'll be difficult to see the riders in front of you stopping.

Riding with companions on several ATV's is not the same as riding one ATV with a passenger. Passengers are prohibited; it's unsafe. The extra weight on the seat makes the ATV difficult to control. About 50% of all ATV accidents involve passengers.

Other Vehicles

Depending on where you're riding, you might encounter other ATV's, bikes, or motor vehicles on public lands. Respect the presence of cars if you're crossing roads or riding in public areas and make yourself be seen. If you can't see other vehicles coming, that means you're invisible, too.

Hikers

With the renewed interest in hiking, camping, and other outdoor activities, people can show up in remote areas where you would never expect them. For their sake, keep your eyes open.

Animals and Nature

Respect the outdoors that you love. Don't use your ATV to chase animals or birds. Drive around young trees rather than over them. Keep clear of streams and ditches with standing water.

Tread Lightly and leave it as you found it.

Environment

The environment you operate an ATV in is often harsh and sometimes dangerous if you don't take proper precautions.

Weather

You need to consider the weather. It is dangerous to ride your ATV when the weather is bad or potentially bad. Keep abreast with weather forecasts.

Terrain

Always pay close attention to the terrain you're on even if it is familiar to you. You can't assume that the landscape you're used to doesn't change. Changes to landscape can happen at nearly any time. Fences can be constructed and excavations dug in a short period of time. Weather, climate, and development take their toll.

The thing about terrain is that sometimes you don't know it's changed until you get there. Whether it's familiar or not, check out your surroundings before and during your ride.

Night Riding

Riding at night can be very hazardous. Obstacles and other hazards (that are easily identified during daytime) are much more difficult to see and avoid. When night riding, make sure the lights are properly adjusted and in good working order. Reduce speed; do not over-drive the headlights. Never travel in an unfamiliar area or blaze a new trail at night. Always carry a flashlight or flare for signaling an emergency.

Paved Surfaces

Don't do it! The ATV isn't designed for pavement. Its handling becomes more difficult on paved surfaces.

Trail Riding

Use sound judgment when trail riding; that means riding on a trail that fits your ability level. If the trail is pretty rugged, standing up on your footrests will make it easier for you to endure the rough terrain.

Make yourself visible by using headlights and taillight and pull completely off the trail if you need to stop.

Sound Judgment

Outsloped trails (trails that slant to allow rain to run off) make trail riding a bit more challenging. Accepting that challenge means keeping your weight shifted into the slope. Denying the challenge means sliding off the trail.

It also helps to know which trails you can ride and who else might be on those same trails. These are signs currently used in some areas to designate trail types and restrictions.

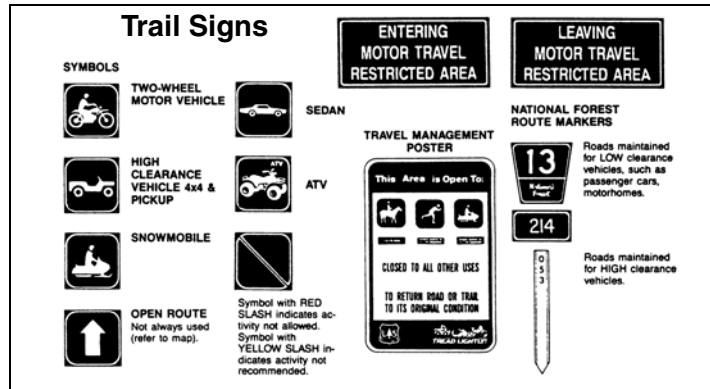

Equipment

The last thing you expected was that your ATV would break down in the middle of the field... it's usually so reliable that sometimes you forget the ATV has its limits.

ATV Maintenance

You have to maintain your ATV. The General Maintenance section of this Operator's Manual tells you about taking care of your ATV. If, at any time, abnormal noises, vibrations, or improper functioning of any component of this ATV is detected, **DO NOT OPERATE THE ATV**. Take the ATV to an authorized Arctic Cat ATV dealer for inspection and adjustment or repair.

Cargo Limitations

One reason why passengers are prohibited on this ATV is because their presence throws off the weight and balance of the ATV. Cargo can do the same. Limit the ATV to the specified load capacity rating. The combined weight limit, including you and your personal items, is a specified amount, so consult the ATV Load Capacity Ratings Chart and monitor it carefully.

Extra weight on the ATV will also throw you off balance if it's not distributed evenly.

Load Capacity Ratings Chart

Arctic Cat ATV Load Capacity Ratings		
Item	Specifications	
	(lb)	(kg)
Max Load Capacity	275	124
Front Rack (max)	25	11
Rear Rack (max)	50	23
Tongue Weight	35	16
Towing Capacity	300	136
Rear Rack and Tongue Weight (Max)	50	23

Max Load Capacity - Total weight of operator, tongue weight, accessories, and cargo on front and rear racks.

Tongue Weight - Weight on trailer tongue.

Sound Judgment

■ **NOTE:** Tongue and accessory weight (winch, gun scab-board, brackets, etc.) must be included as part of the front and rear rack weights.

WARNING

Operating this ATV with improper modifications can be hazardous. Improper installation of accessories or modification of the ATV may cause changes in handling which could lead to an accident. Never modify the ATV with improper installation or use of improper accessories. All parts and accessories installed on this ATV must be genuine Arctic Cat parts and accessories designed for use on this ATV. Install and use them according to instructions. If you have any questions, contact an authorized Arctic Cat ATV dealer.

■ **NOTE:** Use extra caution when operating an ATV with additional loads such as accessories and/or personal items. Handling of the ATV may be adversely affected. Reduce speed when adding additional loads.

WARNING

POTENTIAL HAZARD

Overloading the ATV or carrying personal items improperly.

WHAT CAN HAPPEN

Could cause changes in ATV handling, which could lead to an accident.

HOW TO AVOID THE HAZARD

Never exceed the stated load capacity for the ATV. Always follow the instructions in this Operator's Manual pertaining to ATV loading.

Personal Choices

A safe, enjoyable ride is dependent on many personal choices. An ATV, like all motorized vehicles, can be dangerous to operate if you choose to ignore safety precautions, take unnecessary chances, or ride beyond your ability or your vehicle's capability. Don't allow the thrill of freedom or adventure to affect your ability to make good, safe choices.

Your Physical Condition

Being physically exhausted is like being drunk. Try to do something that's detail-oriented when you're really tired, and you'll feel totally uncoordinated.

Don't ride:

1. When you're tired

Reckless Riding

If you are involved in an ATV accident when you're speeding, you have a 25% chance of landing yourself in the hospital. The faster you go, the more likely you are to destroy your head and internal organs, and skip the wheelies, jumps, stunts, and any other showboating.

Laws and Regulations

Any police officer will tell you that ignorance of the law is no defense. Your best defense is to check out your local, state, or provincial ATV laws before riding. It'll also make sure that you can continue to ride in your favorite areas. The quickest way to have a land area closed is by riding over the regulations.

Group Behavior

People occasionally do crazier and riskier things in a group than they would consider doing by themselves. When you're ATV riding with others and things start to get out of hand, decide whether you're willing to be injured or see your friends injured.

Sound Judgment

SIPDE

By themselves, none of these safe behaviors and sound judgments will go very far. But when you put them all together...when you're paying attention to how you feel, when you're monitoring the movements of your ATV, and when you're constantly evaluating your environment, then you're practicing SIPDE. SIPDE is an acronym that stands for:

S	I	P	D	E
SCAN/ SEARCH	IDENTIFY HAZARDS	PREDICT WHAT WILL HAPPEN	DECIDE WHAT TO DO	EXECUTE THE DECISION

Supervision

Overview

You're responsible for supervising those who ride your ATV. Your wisdom is valuable... it'll bring them all back safely - your friends, your family, your relatives, and your ATV. It's crucial that you consider yourself a supervisor for all riders of your ATV. Whether you accept responsibility or not, the truth is that you are responsible for others riding your ATV.

Taking Responsibility

You're to the last letter in "PASS"... "Supervision." You've just gone through the manual, and you've seen what's involved. That puts you in a good position to be confident about what you know. So now it's time to use your knowledge and supervise others who ride your ATV.

Inexperienced/Untrained Riders

You can't let people ride your ATV who don't know what they're doing. Unless they've had over a year of experience with ATV riding or taken an ATV training course, it's your responsibility to keep them off your ATV. It can be dangerous (especially for underaged children) - all the more reason for you to be firm.

Experienced/Trained Riders

If anyone is going to borrow your ATV, you are responsible for their supervision. Before they ride, have them take the training course, have them watch the safety video, and have them read the Operator's Manual. You train them. It doesn't matter how you do it, as long as you do it.

ATV's are all a little different from the handling to the stability to the controls. So regardless of how much experience your family members have with ATV's, they don't have experience with *your* ATV. Let experienced riders get familiar with your ATV - show them the basics before they take off. You don't want it on your conscience that someone got hurt because you didn't tell them how to use your ATV.

Remember that regardless of experience, you should never let anyone under the age of 14 operate your ATV.

Arctic Cat and the ATV Safety Institute recommend that all ATV operators ride the appropriate-sized ATV according to age.

Category	Age (Years)	Speed Limitations (MPH)	NOTES
Y-12+	12 or Older	15 - Limited 30 - Maximum	Operate Under Adult Supervision
T-14	14 or Older	20 - Limited 30 - Limited 38 - Maximum	Operate Under Adult Supervision
G & S	16 or Older	According to Local Regulations	—

Division II - Operation/ Maintenance ATV Specifications

ENGINE AND DRIVE	
Type	Four-Cycle/OHC/Air Cooled
Bore x Stroke	62 x 49.5 mm (2.44 x 1.95 in.)
Displacement	149 cc (9.1 cu in.)
Spark Plug Type	DR8EA
Spark Plug Gap	0.6 mm (0.024 in.)
Brake Type	Front Double Drum/Rear Hydraulic Disc w/Brake Lever Lock
CHASSIS	
Length (Overall)	177.8 cm (69.9 in.)
Height (Overall)	103.8 cm (40.9 in.)
Width (Overall)	95.0 cm (37.4 in.)
Tire Size (Front)	21 x 7-10
Tire Size (Rear)	22 x 10-10
Tire Inflation Pressure	(Front) 27.6 kPa (4.0 psi) (Rear) 24.1 kPa (3.5 psi)

MISCELLANY	
Dry Weight (Approx)	157.9 kg (349 lb)
Gas Tank Capacity (Rated)	8.7 L (2.3 U.S. gal.)
Transmission Lubricant (Recommended)	SAE 80W-90 Hypoid
Transmission Lubricant Capacity	300 ml (10 fl oz)
Engine Oil Capacity (Approx)	1.0 L (1.06 U.S. qt)
Gasoline (Recommended)	87 Octane Regular Unleaded
Engine Oil (Recommended)	Arctic Cat ACX All Weather (Synthetic)
Headlights	12V/35W/35W (2)
Parking Lights	12V/5W (2)
Brakelights/Taillights	12V/21W/5W (2)
Starting System	Electric w/Kick Start (Emergency)

Specifications subject to change without notice.

Location of Controls

1. Battery
2. Front Brake Lever
3. Fuel Valve
4. Seat Lock Lever
5. Tool Storage
6. Brake Lever Lock
7. Key Switch
8. Throttle Limiter
9. Throttle Lever
10. Brakelights/Taillights
11. Kick Start Lever
12. Engine Stop Switch
13. Starter Button
14. Rear Brake Lever
15. Oil Level Stick
16. Brake Fluid Sight Glass
17. Headlight Switch
18. Choke Lever
19. Shift Lever
20. Headlights/Parking Lights



KM882A



KM879A



KM884B

■ **NOTE:** The ATV you have purchased may differ slightly from those shown in the figures of this manual.

ATV Operation

Basic Operating Maneuvers

Active riding and basic maneuvers are the foundation of your ATV ride. Without basic skills, it's impossible to move to this level active riding. These are your basic maneuvers:

- Mounting the ATV
- Starting the Engine
- Emergency Starting
- Starting a Cold Engine
- Braking/Stopping
- Parking
- Dismounting the ATV

Mounting the ATV

1. From the left side, grab the left-side handlebar, apply the brake, and put your left foot on the footrest.
2. Grab the right-side handlebar.
3. Swing your leg over the seat and set your right foot down on the right-side footrest.
4. Get seated in a comfortable position.
5. Always keep your feet planted on the footrests.

Starting the Engine

Always start with the ATV on a flat, level surface. Carbon monoxide poisoning can kill you, so keep your ATV outside while it's running. Follow these steps to start it up:

1. Mount the ATV and sit down.
2. Engage the brake lever lock.
3. Turn on the fuel valve.
4. Turn on the ignition.
5. Move the engine stop switch to RUN.
6. Set the choke lever to the full-choke position (full left).
7. Press the starter button.

CAUTION

Do not run the starter motor for more than eight seconds per starting attempt. The starter motor may overheat causing severe starter motor damage. Allow 15 seconds between starting attempts to allow the starter motor to cool.

8. As the engine warms up, slowly slide the choke lever to the off position (full right).

Another way to remember the starting procedure is by using the acronym "BONE-C." It stands for:

B	O	N	E	C
BRAKES LOCKED	ON FUEL VALVE	NEUTRAL AT IDLE	ENGINE SWITCH	CHOKE

Emergency Starting

This Arctic Cat ATV has an emergency kick starter to use if the electric starter becomes inoperative. To use the starter, follow this procedure.

⚠ WARNING

Be sure the brake lever lock is engaged when using the emergency kick starter.

1. Push down on the kick starter until resistance is felt; then with a short, quick, downward stroke, start engine.
2. Repeat until the engine starts.
3. After making sure that the engine is warm, apply the front brakes to release the brake lever lock; then select the desired gear.



KM002

ATV Operation

Starting A Cold Engine

■ **NOTE: It is very important not to touch or compress the throttle lever during the starting procedures.**

1. Rotate the ignition switch key to the first position (ON).
2. Move the choke lever to the full-choke position (full left).
3. Compress the left-hand brake lever; then press on the starter button.

CAUTION

Do not run the starter motor for more than eight seconds per starting attempt. The starter motor may overheat causing severe starter motor damage. Allow 15 seconds between starting attempts to allow the starter motor to cool.

4. As the engine warms up (approximately 2-2 1/2 minutes), slowly move the choke lever to the off position (full right). Do not touch the throttle lever until the engine has run for at least 3 minutes.
5. Run the engine for at least 10 minutes so it is thoroughly warmed up. If the engine is run for a shorter period of time, the spark plug may not have reached a high enough temperature to burn off the excess fuel in the combustion chamber.

CAUTION

If unburned fuel is collected in the combustion chamber due to lack of running time, spark plug fouling will occur more easily during the next starting attempt.

Braking/Stopping

Coming to a stop should be a slow, easy process. Always allow plenty of room and time to stop smoothly. Sometimes quick stops are inevitable, so always be prepared. Whether you're stopping slowly or stopping quickly, do this:

1. Compress both right and left brake levers on the handlebars to apply both the front and rear brakes.
2. If your wheels lock, release them for a second; then apply them again.
3. Never "ride" the brakes. Even maintaining minimal pressure on a brake lever will cause the brake shoes to drag on the drums and overheat the brake system.

Parking

Parking involves following the previous rules for braking; then:

1. After the ATV stops, shift into neutral.
2. Stop the engine using the engine stop switch.
3. Turn off the ignition.
4. If you have to park on a hill, shift the ATV into low gear; otherwise, try to park only on level surfaces.
5. Engage the brake lever lock.

Dismounting the ATV

After you've followed the procedure for parking, it's time to dismount.

1. Double check the brake lever lock is engaged.
2. Swing your right leg over to the left side of the seat.
3. Step to the ground on the left side of the ATV.

Handling the ATV (Active Riding Techniques)

Active riding involves moving your body. You must learn to lean and shift your weight into your turns to maintain control.

ATV Operation

Your safety depends on using safe riding techniques. Statistics from the U.S. Consumer Product Safety Commission (CPSC) say that inexperienced riders who don't use safe riding techniques are **13 times more likely to have an ATV accident** than riders who have over 1 month of experience.

Tips

Safe riding techniques include:

- Riding
- Skidding or Sliding
- Leaning, Weight Shift, and Balance
- K-Turns
- Riding Uphill
- Sidehilling/Traversing
- Riding Downhill
- Wide Turns
- Sharp Turns
- Crossing Obstacles
- Crossing Water
- Crossing Roads
- Cold Weather Driving
- Stopping the ATV
- Stopping the Engine

Riding

Once the engine's warm, the ATV is ready to go.

1. Keep your feet on the footrests and both hands on the handlebar.
2. Hold the brake levers, and release the brake lever lock.
3. Release the brakes slowly and apply the throttle.

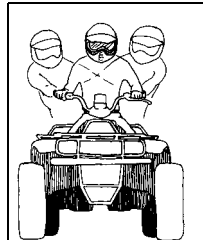

ATV-0012

Skidding or Sliding

If you lose control after hitting sand, ice, mud, or water:

1. Turn your handlebar into the direction of the slide.
2. Keep your hand off the brakes until you're out of the skid.
3. Shift your weight forward.

Sometimes your ATV may not respond and goes straight ahead instead of letting you turn. Here's how to handle it:

1. Slow down.
2. Move forward on the seat.
3. Lean to inside of turn.
4. Turn handlebar.

Leaning, Weight Shift, and Balance

When you turn, the trick is to move forward and slide over to the side of the seat that's on the inside of the turn. Support your body weight on the outside footrest. At the same time, lean your body to the inside of the turn. Pay attention to the handling—if you feel the tires coming off the ground, reduce speed, shift more of your body weight to the side that's lifting, and make the turn wider if possible.



ATV-0013



ATV-0024



ATV-0025

ATV Operation

K-Turns

Use K-turns if you accidentally stall while riding uphill; you need to take action before the ATV rolls backward down the hill.

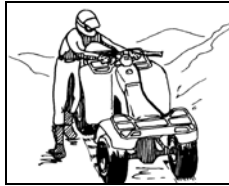

ATV-0020

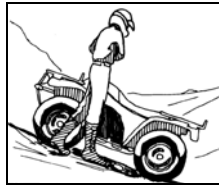

ATV-0034

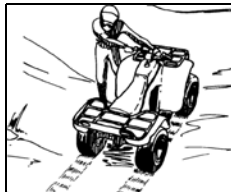

ATV-0035

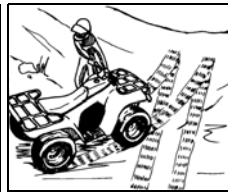

ATV-0036

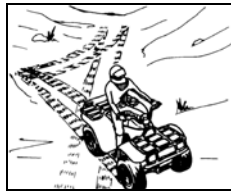

ATV-0037

1. Stop where you are; apply the brakes.
2. Shut off the engine.
3. Keep your body weight shifted forward.
4. Get off the ATV on the uphill side.
5. If you're to the left of the ATV, turn the handlebar all the way left.
6. Partially release the brake, but lightly hold the brake lever.
7. Let the ATV roll to your right side until it faces slightly downhill.
8. Reapply the brakes.

9. Get back on the ATV from the uphill side, and keep your weight shifted uphill when you sit down.
10. Start the engine and follow the method for riding downhill.

Riding Uphill

Roughly 20% of accidents happen while riding on hills and as a result of the ATV rolling or flipping. So, obviously, use extreme caution and follow this method for riding uphill.

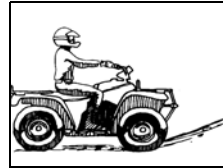

ATV-0019

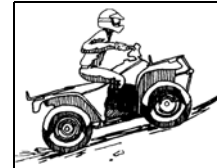

ATV-0032



ATV-0033

1. Accelerate before you start climbing; then maintain a steady pace.
2. Lean as far forward as possible. For steeper hills, come off your seat to stand and lean forward.
3. If you lose speed, quickly release the throttle (so your front tires don't lift), **OR**
4. If that doesn't work and you still have forward motion and the terrain permits, do a U-turn, go back down, and try climbing again, **OR**
5. If you have lost all forward motion, follow the K-turn procedure.

Never Operate Up Or Down Hills Steeper Than 15°

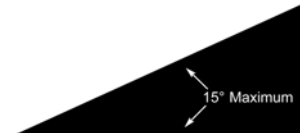

ATV Operation

Sidehilling/Traversing

Sidehilling is considered an advanced skill; it's really tricky and unpredictable. So, whether your skills are advanced or not, try to avoid this kind of riding. If you're in a situation where you absolutely have to sidehill, follow this method:

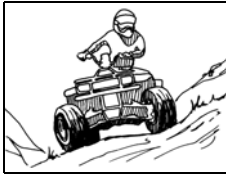

ATV-0017



ATV-0028



ATV-0029

1. Keep your speed low and consistent.
2. Shift all your body weight to the uphill side of the seat; also, support your weight on the uphill footrest.
3. Steer like you're driving into the hill.
4. If the ATV feels like it's tipping, turn the handlebar downhill. If that's not possible because of the terrain or other conditions or if it just doesn't work, stop and get off. Dismount the ATV on the uphill side.

Riding Downhill

Success in riding downhill depends on how well you know your brakes - take it easy on them, or you could flip over.

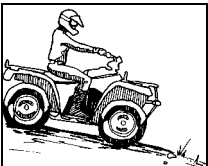

ATV-0018

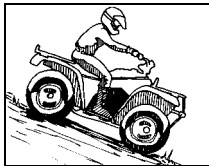

ATV-0030

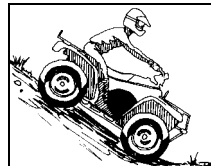

ATV-0031

1. Shift your body weight as far back on the seat as possible.
2. Lightly apply the brakes and ease up on the throttle.

Wide Turns

About 20% of ATV accidents happen during turns. If you don't understand turning techniques, it's easy for the ATV to get away from you by losing traction, plowing, or tipping.



ATV-0046

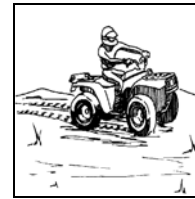

ATV-0045

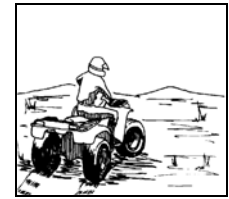

ATV-0044

1. Ease off the throttle as you approach the turn to slow down.
2. Use the principles of leaning, weight shifting, and balancing - shift your body weight to the inside of the turn.
3. Gradually increase your speed as you come out of the turn.

Sharp Turns

After mastering wide turns, practice the advanced skill of sharp turns.



ATV-0038

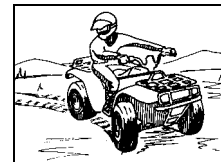

ATV-0039

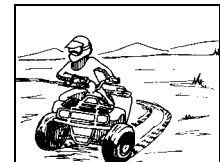

ATV-0040

1. Ease off the throttle as you approach the turn to slow down.
2. Use the principles of leaning, weight shifting, and balancing - shift your body weight to the inside of the turn.

ATV Operation

3. You might have to lean into the turn more than you do in a wide turn.
4. If shifting your weight and balance aren't enough to keep the ATV tires on the ground, straighten out the handlebars as much as you can.
5. Gradually increase your speed as you come out of the turn.

Crossing Obstacles

Crossing obstacles is risky; avoid it if possible. Riding over logs, rocks, and ruts means combining all the active riding skills into one big motion. Your ATV will respond differently for different obstacles (logs, ruts, etc.), but these are general guidelines for overcoming two-track (both tires contacting the obstacle at the same time) obstacles:

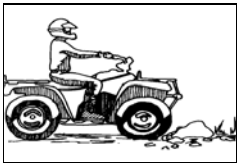

ATV-0016

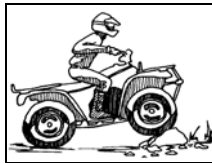

ATV-0026

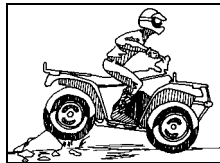

ATV-0027

1. Keep your speed way down; less than 5 mph.
2. Approach the obstacle head-on.
3. Come up off the seat.
4. Keep your weight on the footrests.
5. Apply a little throttle when the front tires make contact with the obstacle.
6. Lean forward and release the throttle when the front tires clear the obstacle.
7. Keep your body loose to absorb any shock.

8. If the ATV starts tipping, shift your weight to keep it in balance.

To clear a single-track (only one tire contacts) obstacle, follow the same rules except:

1. Use the ATV's momentum to clear the obstacle.
2. Don't pull up on the handlebar.
3. Don't apply the throttle.

Crossing Water

Your ATV can only handle water up to its footrests. Any more than that and you risk engine damage and/or personal injury. Stay away from fast moving rivers. ATV tires can be buoyant, so if the water is too deep, you might find the ATV suddenly afloat.

1. Physically check the depth and current of the water, especially if you can't see the bottom. You're also checking for boulders, logs, or any other hidden obstacles.
2. Keep your speed slow.
3. Make sure you have a way out on the other side of the water.
4. If you get stuck in the sludge or mud, try rocking the ATV from side to side.
5. Once you've cleared the water, briefly apply the brakes to make sure they work.

Crossing Roads

Crossing roads on your ATV is also a bad idea, so avoid it. If you can't:

1. Stop completely on the shoulder of the road.
2. Check both directions for traffic.
3. Crossing near a blind corner or intersection is dangerous; don't do it.
4. Drive straight across to the opposite shoulder.

ATV Operation

5. Take into account that your ATV could stall while crossing; give yourself enough time to get off the road.
6. You have to assume that oncoming cars don't see you, and if they do, they won't be able to predict your actions.
7. It's illegal to cross public roads in some places. Know your local laws.

Cold Weather Driving

■ **NOTE:** Check that all control levers move freely. Make sure that the footrests are free of ice and snow.

WARNING

For your personal safety, it is very important to wear the type and amount of cold-weather clothing according to the coldest anticipated temperatures.

1. With the brake lever lock released, move the ATV forward and backward to check that the wheels roll freely. If the ATV will not roll, the tires may be frozen to the ground or the brake shoes may be frozen to the drums.
2. If the tires are frozen to the ground, pour warm water around them to melt the ice.

CAUTION

Before riding, manually move the ATV forward and backward to make certain that all wheels roll freely.

3. If the brakes are frozen, take the ATV to a warmer area to thaw out the brakes.

WARNING

Do not attempt to free frozen brakes by pouring warm water on the brakes.

■ **NOTE:** After the brakes thaw, dry them by applying them several times while riding slowly.

■ **NOTE:** After riding through water, mud, snow, or slush, it is important to dry the brake system before parking the ATV.

WARNING

Go slowly and be extra careful when riding on snow-covered or ice-covered terrain. Always be alert to changing terrain conditions when operating the ATV.

4. Practice driving in an open snow-covered or ice-covered area at slow speeds before driving on snow-covered or ice-covered trails.
5. Learn how the ATV responds to steering and braking on the type of terrain to be encountered on the ride.

Stopping The ATV

To stop the ATV, first release the throttle lever. Next, apply the brake.

Stopping The Engine

To stop the engine, turn the ignition switch key to the OFF position or set the engine stop switch to the OFF position.

General Information

ATV Identification Numbers

The Arctic Cat ATV has two identification numbers: Vehicle Identification Number (VIN) and Engine Serial Number (ESN).

The VIN is located on the horizontal frame bar.

The ESN is located on the left-side of the engine crankcase near the lower front.

These numbers are required by the dealer to complete warranty claims properly. No warranty will be allowed by Arctic Cat if the VIN or ESN is removed or mutilated in any way.

Always provide the ATV name, VIN, and ESN when contacting an authorized Arctic Cat ATV dealer for parts, service, accessories, or warranty. If a complete engine must be replaced, ask the dealer to notify Arctic Cat for correct registration information.

Ignition Switch Key

Two keys come with the ATV. Keep the spare key in a safe place.



ATV-0055A

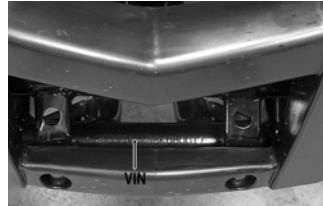

KM857A



KM849A

Control Locations and Functions

Ignition Switch

The ignition switch has three positions.

OFF position — All electrical circuits are off. The engine will not start. The key can be removed in this position.

ON position — The ignition circuit is complete, the engine can run. The key cannot be removed in this position.

LIGHTS position — The ignition circuit is complete and the parking lights and taillights are on. The headlight switch is active and the key cannot be removed in this position.



KM864

CAUTION

Leaving the ignition switch in the ON or LIGHTS position for a long period of time when the engine is not running may cause the battery to discharge. Always leave the ignition switch in the OFF position when engine is not running.

Hand Brakes

The hand brakes should be applied whenever a braking situation is needed.

Apply the brakes by compressing the brake levers toward the handlebar.

Brake Lever Lock

To engage and release the brake lever lock, use the following procedure.

1. Compress the left hand brake lever.
2. Depress and hold the brake lever lock.



KC333A

3. While holding the brake lever lock down, release the brake lever.

■ **NOTE: The brake lever will not return to its released position.**

4. Release the brake lever lock by compressing the brake lever. It will return to its released position.

Check to make sure the brake lever lock engages properly and that the brake (when engaged) locks the rear wheels.

1. Engage the brake lever lock.
2. Attempt to push the ATV.

■ **NOTE: The brake must lock the wheels. If it doesn't, the hydraulic brake system must be serviced.**

WARNING

Always check to be sure that the brake lever lock has been disengaged before operating the ATV. An accident could result if a brake is left engaged while the ATV is operated. Always block the downhill side of the wheels if leaving the ATV on a hill or park the ATV in a sidehill position.

Headlight Switch

Use the headlight switch to select the high or low headlight beam or parking lights when the ignition switch is in the LIGHTS position. When the switch is in the High Beam position, the high beam will illuminate. When the switch is in the Low Beam position, the low beam will illuminate. When the switch is in the Running Lights position, the running lights will illuminate.



KM850A

Engine Stop Switch

This switch will stop the engine. The engine can be started again by pressing the yellow starter button.

STOP position — The ignition circuit is off. The engine cannot be started or will not run. If the engine stop switch is used to stop engine without turning off ignition switch, the battery may discharge.

RUN position — The ignition circuit is on. The engine can start and run.

Electric Starter Button

Pushing in on this button activates the starter motor. Before starting the engine, make sure the ignition switch is in the ON position and the brake lever lock is engaged.

Throttle Lever

Control engine RPM with the position of the throttle lever. Operate this lever with the thumb. Pushing it forward increases engine RPM and allowing it to retract decreases engine RPM.



KM850B

Throttle Limiter Screw

Throttle lever travel may be limited by adjusting the throttle limiter screw. The throttle limiter should be adjusted according to the operator's skill and experience. To adjust the throttle limiter, use the following procedure.

1. Loosen the jam nut.



KM859

- Turn the throttle limiter screw clockwise to decrease engine RPM maximum or counterclockwise to increase engine RPM maximum.
- Tighten the jam nut securely.

Fuel Valve

The fuel valve is incorporated in the gas tank. There are three positions: ON, RES, and OFF.

In the OFF position, the valve will not allow gasoline to flow to the carburetor. In the ON position (the normal operating position), gasoline will flow from the tank to the carburetor.

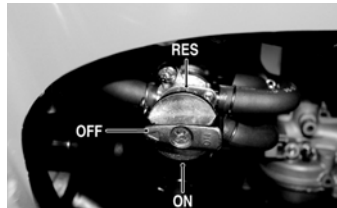

KM043A

Moving the valve to the reserve (RES) position will allow the operator to use the remaining gasoline in the tank. When turning the valve to any of the three positions, be sure the indicator is pointed directly at the position desired.

WARNING

Never leave the valve in the ON or RES position when the engine is not running.

LCD/Indicator Lights

■ **NOTE:** The LCD/indicator lights monitor several ATV functions. The gauge is backlit whenever the ignition switch is in the LIGHTS position.



KM842C

- Speedometer** - To select miles per hour (MPH) or kilometers per hour (KM/H), press and hold button A while watching the gauge. Release the button when the desired display is indicated.
- Odometer/Trip Meter** - To select odometer (ODO) or trip meter (TRIP), press and hold button B while watching the gauge. Release the button when the desired display is indicated. While in TRIP mode, depress and hold buttons A and B to reset the trip meter to zero.
- Clock** - To set the clock, use the following procedure.
 - Using button B, make sure the gauge is in the odometer (ODO) mode; then simultaneously depress and hold buttons A and B until the hour flashes in the clock window (approximately three seconds).
 - Depress button B to set the hour (24-hour clock only).
 - Momentarily depress button A until the minute flashes; then depress button B to set the minute. After ten seconds, the gauge will resume normal operation.
- Fuel Level Indicator** - Indicates approximate amount of gasoline in the gas tank.
- High Beam Indicator** - The high beam indicator will illuminate when the headlight high beam is selected and the ignition switch is in the LIGHTS position.
- Reverse Indicator** - The reverse indicator will illuminate when the reverse position is selected with the shift lever and the ignition switch is in the ON or Lights position.
- Neutral Indicator** - The neutral indicator will illuminate when the neutral position is selected with the shift lever and the ignition switch is in the ON or LIGHTS position.

Gas/Vent Hoses

Replace the gas hose every two years. Damage from aging may not always be visible. Do not bend or obstruct the routing of the carburetor vent hose. Make certain that the vent hose is securely connected to the carburetor and hose holder and the opposite end is always open.

Carburetor Float Bowl Drain

Periodically, the float bowl should be drained to remove condensation. To drain the float bowl, use the following procedure.

1. Place a suitable container beneath the float bowl drain hose.
2. Loosen the drain screw and allow the gasoline and condensation to flow out.
3. Tighten the drain screw securely.



KM846

Oil Level Stick

There is an oil level stick for checking the engine oil level. To check the oil level, use the following procedure.

■ **NOTE:** The ATV should be on level ground when checking the engine oil level.

1. Unscrew the oil level stick and wipe it with a clean cloth.
2. Install the oil level stick completely into the engine crankcase.



KM827A

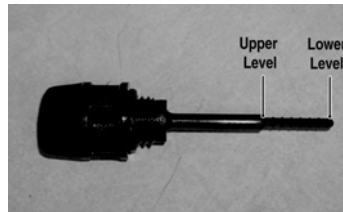

KM022A

■ **NOTE:** The oil level stick should be threaded into the engine crankcase for checking purposes.

3. Remove the oil level stick; the engine oil level should be between the lower level and upper level on the stick.

CAUTION

Do not overfill the engine with oil. Always make sure the oil level is between the lower and upper levels on the stick.

Seat Lock

1. To remove the seat, push the seat lock lever rearward (located at the rear of the ATV under the seat). Raise the rear end of the seat and slide it rearward.
2. To lock the seat into position, slide the front of the seat into the seat retainers and push down firmly on back of seat. The seat should automatically lock into position.

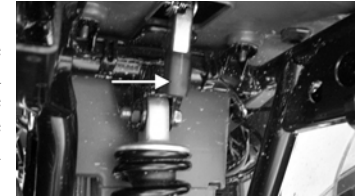

KM835A

⚠ WARNING

Make sure the seat is secure before mounting the ATV. Severe personal injury may result if the seat is not properly secured.

Safety Flag/Bracket

A bracket is provided for mounting a flag at the rear of the ATV. The flag should be displayed to make the ATV more visible.

Transporting ATV

When transporting the ATV, Arctic Cat recommends that the ATV be in its normal operating position (on all four wheels) and the following procedure be used.

1. Engage the brake lever lock and place the transmission in gear.

CAUTION

Failure to engage the brake lever lock and place the transmission in gear could result in the ATV rolling off the trailer in the event of tie-down strap failure.

2. Turn the fuel valve OFF.
3. Secure the ATV with load rated hold-down straps.

■ **NOTE:** Suitable hold-down straps are available from your Arctic Cat ATV dealer. Ordinary rope is not recommended because it can stretch under load.

CAUTION

When using hold-down straps, care must be taken not to damage the ATV.

Gasoline-Oil-Lubricant

Recommended Gasoline

The recommended gasoline to use in this ATV is 87 minimum octane regular unleaded. In many areas, oxygenates (either ethanol or MTBE) are added to the gasoline. Oxygenated gasolines containing up to 10% ethanol, 5% methane, or MTBE are acceptable gasolines.

When using ethanol blended gasoline, it is not necessary to add a gasoline antifreeze since ethanol will prevent the accumulation of moisture in the fuel system.

CAUTION

Do not use white gas. Only Arctic Cat approved gasoline additives should be used.

Recommended Engine Oil**CAUTION**

Any oil used in place of the recommended oil could cause serious engine damage. Do not use oils which contain graphite or molybdenum additives. These oils can adversely affect clutch operation. Also, not recommended are racing, vegetable, non-detergent, and castor-based oils.

The recommended oil to use is Arctic Cat ACX All Weather synthetic engine oil, which has been specifically formulated for use in this Arctic Cat engine. Although Arctic Cat ACX All Weather synthetic engine oil is the only oil recommended for use in this engine, use of any API certified SM 0W-40 oil is acceptable.

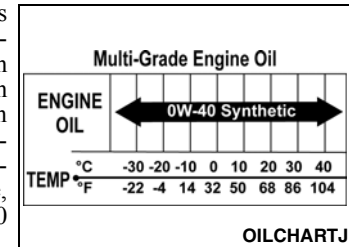
**Recommended Transmission Lubricant**

■ **NOTE:** Arctic Cat recommends the use of genuine Arctic Cat lubricants.

The recommended transmission lubricant to use is SAE 80W-90 hypoid.

CAUTION

Any lubricant used in place of the recommended one could cause serious transmission damage.

Filling Gas Tank

WARNING

Always fill the gas tank in a well-ventilated area. Never add gasoline to the ATV gas tank near any open flames or with the engine running or hot. DO NOT SMOKE while filling the gas tank.

Since gasoline expands as its temperature increases, the gas tank must be filled to its rated capacity only. Expansion room must be maintained in the tank particularly if the tank is filled with cold gasoline and then moved to a warm area.

Allow the engine to cool before filling the gas tank. Care must be taken not to overfill the tank. If overfilled, gas may leak onto the engine creating a fire hazard.

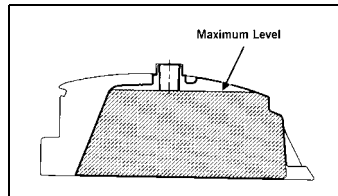

ATV-049B

WARNING

Do not overfill or over-flow gasoline when filling the gas tank. A fire hazard could materialize. Always allow the engine to cool before filling the gas tank.

Tighten the gas tank cap securely after filling the tank.

Engine Break-In

New ATV's and renewed ATV engines require a "break-in" period. The first month is most critical to the life of this ATV. Proper operation during this break-in period will help assure maximum life and performance from the ATV.

During the first 3 hours of operation, always use less than ½ throttle. Varying the engine RPM during the break-in period allows the components to "load" (aiding the engine component mating process) and then "unload" (allowing components to cool). Although it is essential to place some stress on the engine components during break-in, care should be taken not to overload the engine too often.

When the engine starts, allow it to warm up properly. Idle the engine several minutes until the engine has reached normal operating temperature. Do not idle the engine for excessively long periods of time.

Maintenance after break-in should include checking of all prescribed adjustments and tightening of all fasteners. At the discretion and expense of the owner/operator, the ATV may be taken to an authorized Arctic Cat ATV dealer for this initial service.

General Maintenance

■ **NOTE:** Proper maintenance of the ATV is important for optimum performance. Follow the Maintenance Schedule and all ensuing maintenance instructions/information.

If, at any time, abnormal noises, vibrations, or improper functioning of any component of this ATV is detected, DO NOT OPERATE THE ATV. Take the ATV to an authorized Arctic Cat ATV dealer for inspection and adjustment or repair.

If the owner/operator does not feel qualified to perform any of these maintenance procedures or checks, take the ATV to an authorized Arctic Cat ATV dealer for professional service.

■ **NOTE:** The following instructions and information refer to specific items in the maintenance and care of the ATV.

Maintenance Schedule					
Item	Page	Initial Service (First Week)	Monthly	Quarterly	Annually
Air filter	46	I		I	
Battery	42	I	I	I	
*Brake components	41	I	Inspect every time before riding		
Lights	48	I	Inspect every time before riding		
Carburetor float bowl	36	I	C		
*Chassis nuts and bolts	—	I	T	T	T
* Drive chain	47	I	Inspect every time before riding		
Electrical connections	—	I			I
Transmission lubricant	40	R			I
Engine oil	40	R		R**	I
Fuel filter	—	I		I	
Idle RPM	45	I			I
Chassis	—			C, L	I
Shock absorbers	40		I		
Spark plug	45			C	
*Steering	—	I	Inspect every time before riding		
*Suspension (Front tie rods/protective boots/bushings)	42	I	Inspect every time before riding		
Tire air pressure	24	I	Inspect every time before riding		
Tire wear	48	I	I		
Throttle cable	46	I	Inspect every time before riding		

I = Inspect and clean, adjust, lubricate, replace as necessary

* Dealer maintenance ** When using Arctic Cat ACX All Weather synthetic oil, oil change interval can be increased to every 1,000 miles or every year.

C = Clean L = Lubricate R = Replace T = Tighten

Shock Absorbers

Each shock absorber should be visibly checked weekly for excessive fluid leakage (some seal leakage may be observed but it does not indicate the shock is in need of replacement), cracks or breaks in the lower case, or a bent shock rod. If any one of these conditions is detected, replacement is necessary.

■ **NOTE:** When the ATV is operated in extremely cold weather (-23°C/-10°F or colder), a small amount of leakage may be present. Unless the leakage is excessive, replacement is not necessary.

General Lubrication

Cables

None of the cables require lubrication; however, it is advisable to lubricate the ends of the cables periodically with a good cable lubricant.

Engine Oil

Change the engine oil at the scheduled intervals. The engine should always be warm so the oil will drain easily and completely.

1. Park the ATV on level ground.
2. Loosen the oil level stick. Be careful not to allow contaminants to enter the opening.
3. Remove the oil drain plug from the left front of the engine; then remove the oil screen/filter cap from under the right-front of the engine and clean the screen.

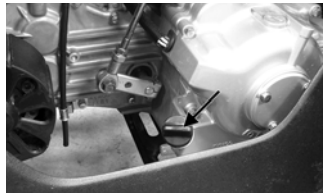

KM827A



KM041A

4. Install the screen/filter cap, spring, and screen. Tighten to 11 ft-lb.
5. Install the drain plug and tighten to 22 ft-lb. Pour the recommended oil in the fill hole. Install oil level stick.
6. Start the engine (while the ATV is outside on level ground) and allow it to idle for a few minutes.
7. Shut the engine off; then allow oil to drain into the crankcase for approximately three minutes. Remove the oil level stick and check for proper oil level.

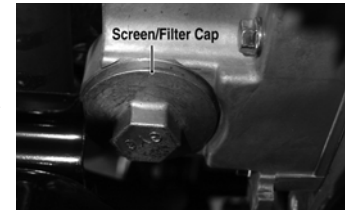

KM040A

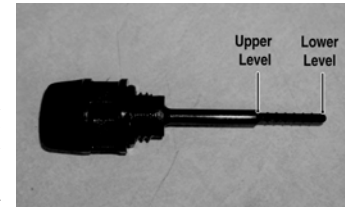

KM022A

Transmission Lubricant

Change the transmission lubricant at the scheduled intervals. The transmission should always be warm when the lubricant is changed so the lubricant will drain easily and completely.

1. Park the ATV on level ground.
2. Remove the fill plug. Be careful not to allow contaminants to enter the opening.
3. Remove the drain plug from the bottom of the transmission and drain the lubricant into a drain pan.

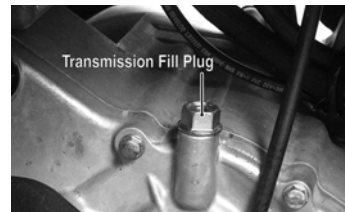

KM845A

4. Install the drain plug and tighten to 18 ft-lb. Pour the recommended lubricant in the fill hole. Install fill plug.
5. Start the engine (while the ATV is outside on level ground) and allow it to idle for a few minutes.
6. Turn the engine off and wait approximately one minute. Recheck the lubricant level. The level should be visible on the fill plug tip. If lubricant is not visible, add recommended lubricant until the level is visible at the threads of the fill/level plug.
7. Inspect the area around the drain plug for leaks.

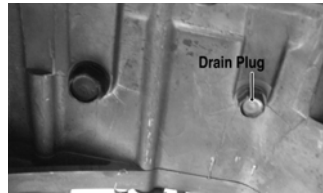

KM836B

Hand Brake Systems

WARNING

Be sure to inspect the hand brake systems before each use. Always maintain brakes according to the Maintenance Schedule.

Brake Lever Lock

Check to make sure the brake lever lock engages properly and that the rear brake (when engaged) locks the rear wheels.

1. Compress the left brake lever.
2. Engage the brake lever lock.
3. The rear brake should lock.
4. Attempt to push the ATV.



KC333A

■ **NOTE:** The brake must lock the wheels. If not, take the ATV to an authorized Arctic Cat ATV dealer for service.

Checking/Adjusting Front Wheel Brake System

1. Raise ATV enough to allow the wheels to spin freely.
2. On the brake lever/cable assembly, loosen both jam nuts. Turn both cable adjusters counterclockwise until both front wheels do not spin freely.
3. Turn both cable adjusters in 1/4 turn increments (clockwise) until wheels spin with a very slight amount of drag.
4. Lower ATV, push ATV forward, and compress brake lever.
5. If front wheels lock, adjustment is correct.
6. If front wheels do not lock, additional adjustment is necessary.

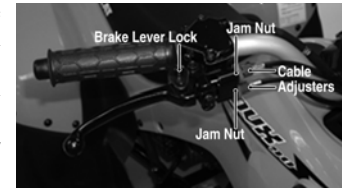

KM024B

Checking/Adjusting Rear Wheel Hydraulic Brake System

The rear wheel hydraulic brake system should be checked for proper operation before every time the ATV is ridden.

■ **NOTE:** The rear wheels should spin freely with the brake lever released.



KM026A

CAUTION

Check through the rear brake reservoir sight glass that the fluid level is above the LOWER level line. If below the line, take the ATV to an authorized Arctic Cat ATV dealer for service.

1. Compress the left brake lever and engage the brake lever lock.

2. With engine turned off and with the brake lever compressed, attempt to move the ATV.
3. If rear wheels are locked, brake is operating properly.
4. If rear wheels are not locked, the hydraulic brake system must be serviced.

■ **NOTE: The hydraulic brake must lock the rear wheels. If not, take the ATV to an authorized Arctic Cat ATV dealer for service.**

Suspension/Steering Arm Bushings

The bushings should be inspected periodically.

1. Secure the ATV on a support stand to elevate the front wheels.
2. Remove both front wheels.
3. Check the bushings for free-play by grasping the steering knuckle and turning it from side to side and up and down.
4. If bushing free-play seems excessive, contact an authorized Arctic Cat ATV dealer for service.



KM824

Tie Rod Boots

The protective boots should be inspected periodically.

1. Secure the ATV on a support stand to elevate the front wheels.
2. Remove both front wheels.
3. Inspect the four tie rod boots (inner and outer/right and left) for cracks, tears, or perforations.



MD0041

4. Check the tie rod end free-play by grasping the tie rod near the end and attempting to move it up and down.
5. If boot damage is present or tie rod end free-play seems excessive, contact an authorized Arctic Cat ATV dealer for service.

Battery

The battery is located under the seat.

After being in service, batteries require regular cleaning and recharging in order to deliver peak performance and maximum service life. The following procedure is recommended for cleaning and maintaining a sealed battery. Always read and follow instructions provided with battery chargers and battery products.

■ **NOTE: Refer to all warnings and cautions provided with the battery or battery maintainer/charger.**

Loss of battery charge may be caused by ambient temperature, ignition OFF current draw, corroded terminals, self discharge, frequent start/stops, and short engine run times. Frequent winch usage, snowplowing, extended low RPM operation, short trips, and high amperage accessory usage are also reasons for battery discharge.

Maintenance Charging

■ **NOTE: Arctic Cat recommends the use of the CTEK Multi US 800 or the CTEK Multi US 3300 for battery maintenance charging. Maintenance charging is required on all batteries not used for more than two weeks or as required by battery drain.**



800E

1. When charging a battery in the vehicle, be sure the ignition switch is in the OFF position.
2. Clean the battery terminals with a solution of baking soda and water.

■ **NOTE:** The sealing strip should NOT be removed and NO fluid should be added.

3. Be sure the charger and battery are in a well-ventilated area. Be sure the charger is unplugged from the 110-volt electrical outlet.
4. Connect the red terminal lead from the charger to the positive terminal of the battery; then connect the black terminal lead of the charger to the negative terminal of the battery.

■ **NOTE:** Optional battery charging adapters are available from your authorized Arctic Cat dealer to connect directly to your vehicle from the recommended chargers to simplify the maintenance charging process. Check with your authorized Arctic Cat dealer for proper installation of these charging adapter connectors.

5. Plug the battery charger into a 110-volt electrical outlet.
6. If using the CTEK Multi US 800, there are no further buttons to push. If using the CTEK Multi US 3300, press the Mode button (A) at the left of the charger until the Maintenance Charge Icon (B) at the bottom illuminates. The Normal Charge Indicator (C) should illuminate on the upper portion of the battery charger.



3300A

■ **NOTE:** The maintainer/charger will charge the battery to 95% capacity at which time the Maintenance Charge Indicator (D) will illuminate and the maintainer/charger will change to pulse/float maintenance. If the battery falls below 12.9 DC volts, the charger will automatically start again at the first step of the charge sequence.

■ **NOTE:** Not using a battery charger with the proper float maintenance will damage the battery if connected over extended periods.

Charging

■ **NOTE:** Arctic Cat recommends the use of the CTEK Multi US 800 or the CTEK Multi US 3300 for battery maintenance charging.

1. Be sure the battery and terminals have been cleaned with a baking soda and water solution.

■ **NOTE:** The sealing strip should NOT be removed and NO fluid should be added.

2. Be sure the charger and battery are in a well-ventilated area. Be sure the charger is unplugged from the 110-volt electrical outlet.
3. Connect the red terminal lead from the charger to the positive terminal of the battery; then connect the black terminal lead of the charger to the negative terminal of the battery.
4. Plug the charger into a 110-volt electrical outlet.
5. By pushing the Mode button (A) on the left side of the charger, select the Normal Charge Icon (E). The Normal Charge Indicator (C) should illuminate on the upper left portion of the charger.
6. The battery will charge to 95% of its capacity at which time the Maintenance Charge Indicator (D) will illuminate.

■ **NOTE:** For optimal charge and performance, leave the charger connected to the battery for a minimum 1 hour after the Maintenance Charge Indicator (D) illuminates. If the battery becomes hot to the touch, stop charging. Resume after it has cooled.

7. Once the battery has reached full charge, unplug the charger from the 110-volt electrical outlet.

■ **NOTE:** If, after charging, the battery does not perform to operator expectations, bring the battery to an authorized Arctic Cat dealer for further troubleshooting.

Jump-Starting

■ **NOTE:** Arctic Cat does not recommend jump-starting a vehicle with a dead battery but rather to remove the battery, service it, and correctly charge it; however, in an emergency, it may be necessary to jump-start a vehicle. If so, use the following procedure to carefully and safely complete this procedure.

WARNING

Improper handling or connecting of a battery may result in severe injury including acid burns, electrical burns, or blindness as a result of an explosion. Always remove rings and watches.

1. On the vehicle to be jump-started, remove the battery cover and any terminal boots.

WARNING

Any time service is performed on a battery, the following must be observed: keep sparks, open flame, cigarettes, or any other flame away. Always wear safety glasses. Protect skin and clothing when handling a battery. When servicing battery in enclosed space, keep the area well-ventilated. Make sure battery venting is not obstructed.

2. Inspect the battery for any signs of electrolyte leaks, loose terminals, or bulging sides. Leaking or bulging battery cases may indicate a frozen or shorted battery.

WARNING

If any of these conditions exist, **DO NOT** attempt a jump-start, boost, or charge the battery. An explosion could occur causing serious injury.

3. Inspect the vehicle to be used for jump-starting to determine if voltage and ground polarity are compatible. The vehicle must have a 12-volt DC, negative ground electrical system.

CAUTION

Always make sure the electrical systems are of the same voltage and ground polarity prior to connecting jumper cables. If not, severe electrical damage may occur.

4. Move the vehicle to be used for the jump-start close enough to ensure the jumper cables easily reach; then shift into neutral, set and lock the brakes, shut off all electrical accessories, and turn the ignition switch OFF.

■ **NOTE:** Make sure all switches on the vehicle to be jump-started are turned OFF.

5. Disconnect all external accessories such as cell phones, GPS units, and radios on both vehicles.

CAUTION

Failure to disconnect electronic accessories during jump-starting may cause system damage due to power spikes.

6. Attach one clamp of the positive (red) jumper cable to the positive (+) terminal (1) of the dead battery (C) being careful not to touch any metal with the other clamp; then attach the other clamp of the positive (red) jumper cable to the positive (+) terminal (2) of the good battery (B).

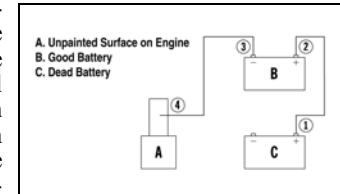

0744-527

■ **NOTE:** Some jumper cables may be the same color but the clamps or ends will be color-coded red and black.

- Attach one clamp of the negative (black) jumper cable to the negative (-) terminal (3) of the good battery (B); then attach the other clamp of the negative (black) jumper cable (4) to an unpainted metal surface (A) on the engine or frame well away from the dead battery and fuel system components.

WARNING

Never make the final connection to a battery as a spark could ignite hydrogen gases causing an explosion of the battery resulting in acid burns or blindness.

- Stand well away from the dead battery and start the vehicle with the good battery. Allow the vehicle to run for several minutes applying some charge to the dead battery.
- Start the vehicle with the dead battery and allow it to run for several minutes before disconnecting the jumper cables.
- Remove the jumper cables in opposite order of hook-up (4, 3, 2, 1). Be careful not to short cables against bare metal.

■ **NOTE:** Have the battery and electrical system checked prior to operating the vehicle again.

Spark Plug

The ATV comes equipped with a specified spark plug. See the ATV Specifications chart for the correct spark plug. A light brown insulator indicates that the plug is correct. A white or dark insulator indicates that the engine may need to be serviced or the carburetor may need to be adjusted.

Consult an authorized Arctic Cat ATV dealer if the plug insulator is not a light brown color. To help prevent cold weather fouling, make sure to thoroughly warm up the engine before operating.

To maintain a hot, strong spark, keep the plug free of carbon.

Before removing the spark plug, be sure to clean the area around the spark plug. If you do not, dirt could enter engine when removing or installing the spark plug.

Adjust the gap to 0.6 mm (0.024 in.) for proper ignition. Use a feeler gauge to check the gap.

When installing the spark plug, be sure to tighten it securely. A new spark plug should be tightened 1/2 turn once the washer contacts the cylinder head. A used spark plug should be tightened 1/8-1/4 turn once the washer contacts the cylinder head.

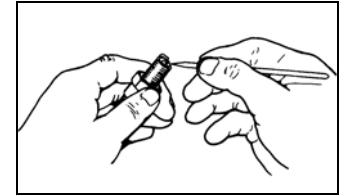

ATV-0051

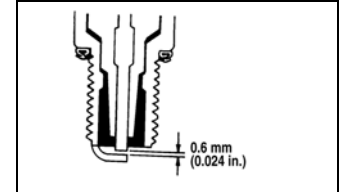

ATV0052D

Engine Idle RPM Adjustment

To properly adjust the idle, a tachometer is necessary. If one is not available, take the ATV to an authorized Arctic Cat ATV dealer.

- To adjust idle RPM, start the engine and warm it up to normal operating temperature.
- Turn the idle adjustment screw in or out until the engine idles at 1700 RPM.

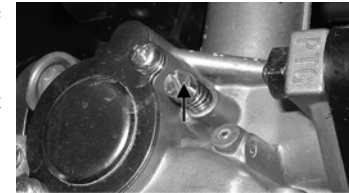

KM872A

WARNING

Adjust the idle to the correct RPM. Make sure the engine is at normal operating temperature before adjusting the idle RPM.

Throttle Cable Adjustment

The throttle has been adjusted at the factory, and no adjustment should be necessary. If adjustment is necessary, the following procedure should be followed:

1. Pull back rubber boots to access cable adjustment nut.
2. Loosen jam nut to allow cable adjustment nut to be adjusted.
3. Turn cable adjustment nut clockwise to increase free-play in the cable. Turn the adjustment nut counter-clockwise to decrease free-play in the cable.
4. There should be approximately 6 mm (1/4 in.) free-play in the cable.
5. Tighten the jam nut to secure the adjustment.

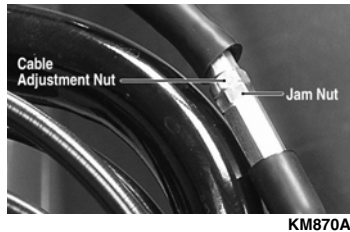

Air Filter

The air filter inside the air filter housing must be kept clean to provide good engine power and gas mileage. If the ATV is used under normal conditions, service the filter at the intervals specified. If operated in dusty, wet, or muddy conditions, inspect and service the filter more frequently. Use the following procedure to remove the filter and inspect and/or clean it.

CAUTION

Failure to inspect the air filter frequently if the ATV is used in dusty, wet, or muddy conditions can damage the engine.

1. Remove the seat; then remove the four screws securing the air filter housing cover.
2. Remove the air filter housing cover; then pull the filter out.
3. Fill a wash pan larger than the filter with a non-flammable cleaning solvent; then dip the filter in the solvent and wash it.



■ **NOTE: Foam Air Filter Cleaner and Foam Air Filter Oil are available from Arctic Cat.**

4. Compress the filter by pressing it between the palms of both hands to remove excess solvent. Do not twist or wring the filter or it will develop cracks.
5. Dry the filter.
6. Put the filter in a plastic bag; then pour in air filter oil and work the oil into the filter.

CAUTION

A torn air filter can cause damage to the ATV engine. Dirt and dust may get inside the engine if the filter is torn. Carefully examine the filter for tears before and after cleaning it. Replace the filter with a new one if it is torn.

7. Clean any dirt or debris from inside the air cleaner. Be sure no dirt enters the carburetor.
8. Install the air filter and housing cover making sure the rubber seal is in place; then install the four screws and tighten securely (do not over-tighten the screws).
9. Install the seat making sure it locks securely.

Drive Chain Condition/Adjustment

Drive chain condition and adjustment should be inspected each day before you ride. Always follow the guidelines below for inspecting and servicing the drive chain.

WARNING

Failure to inspect and maintain the drive chain can be hazardous. Operating the ATV with the drive chain in poor condition or improperly adjusted can cause an accident resulting in possible injury.

Inspecting Condition

Inspect the drive chain for any of the following conditions.

- Loose pins
- Loose or cracked rollers
- Dry or rusted links
- Kinked or binding links
- Excessive wear

The presence of any of the conditions requires drive chain replacement. Take the ATV to an authorized Arctic Cat ATV dealer for this service.

■ **NOTE:** If the drive chain is worn or damaged, the sprockets may also be worn or damaged. Inspect the sprockets for worn, broken, or damaged teeth. Always inspect the sprockets when a new drive chain is being installed.

Cleaning and Lubricating

The drive chain should be cleaned and lubricated frequently to prolong chain and sprocket life. Use the following procedure to clean and lubricate the chain.

■ **NOTE:** This ATV is equipped with an O-ring type roller chain. Each link incorporates small O-rings to seal out water and dirt. Care should be taken to choose cleaning solutions and lubricants that are suitable for O-ring chains.

1. Using a suitable, nonflammable cleaning solution, thoroughly wash the chain and sprockets.
2. Allow the chain to dry; then apply a dry, graphite-based lubricant to the chain.

The drive chain should be lubricated with a dry, graphite-based chain lubricant. By using a dry, graphite-based chain lubricant, dirt buildup on the drive chain will be minimized.

Adjusting Tension

1. Loosen the four cap screws (A) on the axle housing; then using adjuster nut (B), adjust chain “slack” (clockwise to tighten, counterclockwise to loosen) to 10-20 mm.
2. Tighten the four cap screws (A) to 50 ft-lb; then tighten adjuster nut (B) to 15 ft-lb.



KM831A

■ **NOTE:** Drive chain adjustments may be done by the ATV owner if qualified to do so. If the owner does not feel qualified, take the ATV to an authorized Arctic Cat ATV dealer for this service.

Tires

WARNING

Always use the size and type of tires as specified. Refer to the specifications chart for proper tire inflation pressure, and always maintain proper tire inflation pressure.

Tire Tread Condition

The use of worn-out tires on an ATV is very dangerous. A tire is considered to be worn out when the depth of the tread is less than 3 mm (1/8 in.). Be sure to replace the tires before reaching this minimum specification.

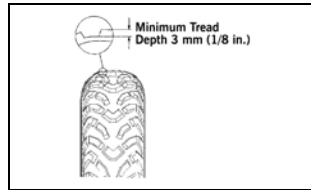

0732-649

WARNING

The use of worn-out tires can be dangerous and can increase the risk of an accident.

Tire Replacement

The ATV has low-pressure tubeless tires. Air is sealed by the contact surfaces of the inner wheel rim and the tire bead. If either the inner wheel rim or tire bead is damaged, air may leak. Be extremely careful not to damage these areas when replacing tires.

It is very important to use the proper tools when repairing or replacing tires to prevent damage to the tire bead or wheel rims. If proper tools and related items are not available, have this maintenance performed by an authorized Arctic Cat ATV dealer or a qualified tire repair station.

CAUTION

When breaking the tire bead loose from the wheel, be extremely careful not to damage the inner wheel surface or the tire bead.

WARNING

Use only Arctic Cat approved tires when replacing tires. Failure to do so could result in unstable ATV operation.

Tubeless Tire Repair

Should a leak or flat tire occur due to a puncture, the tire may be repaired using a plug-type repair. If the damage is from a cut or if the puncture cannot be repaired using a plug, the tire must be replaced. When operating the ATV in areas where transportation or service facilities are not readily available, it is strongly recommended to carry a plug-type repair kit and a tire pump along.

Wheels

1. Park the ATV on level ground and engage the brake lever lock.
2. Loosen the wheel nuts on the wheel to be removed.
3. Elevate the ATV.
4. Remove the wheel nuts.
5. Remove the wheel.
6. Install the wheel and install wheel nuts.
7. Tighten in a crisscross pattern to 30 ft-lb.
8. Remove the jack.

Bulb Replacement

The wattage rating of the bulb is shown in the chart. When replacing a burned bulb, always use the same wattage rating.

Headlights	12V/35W/35W (2)
Running Lights	12V/5W (2)
Brakelights/Taillights	12V/21W/5W (2)

CAUTION

Use only specified bulb indicated in the chart as replacement bulb.

■ **NOTE:** The bulb portion of the headlight is fragile. **HANDLE WITH CARE.** When replacing the headlight bulb, do not touch the glass portion of the bulb. If the glass is touched, it must be cleaned with a dry cloth before installing. Skin oil residue on the bulb will shorten the life of the bulb.

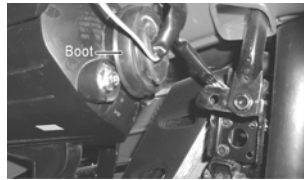

KM194A

To replace the headlight bulb, use the following procedure.

1. Remove the rubber boot from the back of the headlight housing; then remove the three-wire connector from the bulb.
2. Release the two ends of the spring clip from the headlight housing taking care not to bend or deform the clip; then remove the bulb from the housing.
3. Install the new bulb into the housing; then secure with the spring clip.
4. Connect the three-wire connector to the bulb; then install the rubber boot.
5. Install the wiring harness connector.



KM192A



KM195

CAUTION

When replacing the headlight bulb, be careful not to touch the glass portion of the bulb. Grasp the new bulb with a clean cloth.

To replace the running lights, use the following procedure.

1. Pull the bulb socket from the running light housing and remove the bulb by pulling it from the socket.

2. Push a new bulb into the socket and press the socket into the running light housing.

To replace the brakelight bulb, use the following procedure.

1. Turn the bulb socket counterclockwise to unlock and pull it out of the light housing.
2. Push the bulb in and turn it counterclockwise.
3. Install the new bulb by turning it clockwise while pushing in; then place the socket into the light housing and lock by turning it clockwise.

Fuse

The main (20 amp) fuse is located in a fuse holder near the battery under the seat.

■ **NOTE:** To replace the fuse, open the holder and remove the fuse; then install the new fuse. A spare fuse is located in the battery hold-down.

If there is any type of electrical system failure, always check the fuse first.

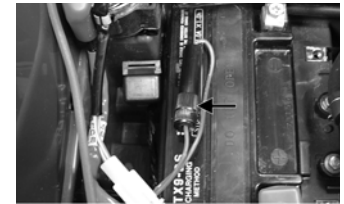

KM854A

CAUTION

Always replace a blown fuse with a fuse of the same type and rating. If the new fuse blows after a short period of use, consult an authorized Arctic Cat ATV dealer immediately.

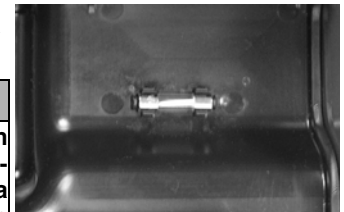

KM863

Storage Compartment/Tools

A basic tool kit is provided with the ATV. It is located under the seat.

Maintain the tool kit with the ATV at all times.

Preparation For Storage

CAUTION

Prior to storing the ATV, it must be properly serviced to prevent rusting and component deterioration.

Arctic Cat recommends the following procedure to prepare the ATV for storage. An authorized Arctic Cat ATV dealer should perform this service; however, the owner/operator may perform this service if desired.

1. Clean the seat cushion (cover and base) with a damp cloth and allow to dry.
2. Clean the ATV thoroughly by washing dirt, oil, grass, and other foreign matter from the entire ATV. Allow the ATV to dry thoroughly. DO NOT get water into any part of the engine or air intake.
3. Either drain the gas tank or add a fuel stabilizer to the gas in the gas tank. Remove the air filter housing cover and air filter. Start the engine and allow it to idle; then using Arctic Cat Engine Preserver, rapidly inject the preserver into the air filter opening for a period of 10 to 20 seconds. Install the air filter and housing cover.

CAUTION

If the interior of the air filter housing is dirty, clean the area before starting the engine.

4. Drain the carburetor float chamber.
 5. Plug the hole in the exhaust system with a clean cloth.
 6. Apply light oil to the upper steering post bushing and plungers of the shock absorbers.
 7. Tighten all nuts, bolts, cap screws, and screws. Make sure rivets holding components together are tight. Replace all loose rivets. Care must be taken that all calibrated nuts, cap screws, and bolts are tightened to specifications.
 8. Clean the ATV thoroughly.
 9. Disconnect the battery cables (negative cable first); then remove the battery, clean the battery posts and cables, and store in a clean, dry area.
- **NOTE: For storage, use a battery maintainer or make sure the battery is fully charged (see Battery section in this manual).**
10. Store the ATV indoors in a level position.

CAUTION

Avoid storing outside in direct sunlight and avoid using a plastic cover as moisture will collect on the ATV causing rusting.

Preparation After Storage

Taking the ATV out of storage and correctly preparing it will assure many miles and hours of trouble-free riding. Arctic Cat recommends the following procedure to prepare the ATV.

1. Clean the ATV thoroughly.
2. Clean the engine. Remove the cloth from the exhaust system.
3. Check all control wires and cables for signs of wear or fraying. Replace if necessary.
4. Change the transmission lubricant.
5. Charge the battery; then install.
6. Connect the battery cables making sure to connect the positive cable first.
7. Check the entire brake system (cables, shoes, etc.), all controls, and brakelight; adjust or replace if necessary.
8. Check the tire pressure. Inflate to recommended pressure as necessary.
9. Tighten all nuts, bolts, cap screws, and screws making sure all calibrated nuts, cap screws, and bolts are tightened to specifications.
10. Make sure the steering moves freely and does not bind.
11. Check the spark plug. Clean or replace as necessary.

Declaration of Conformity

Application of council directives: EMC Directive 97/24/EC
Date of Issue: June, 1997
EC Machinery Directive 2006/42/EC
Date of Issue: May, 2006

Issued by European Commission.

Type of Equipment: All-Terrain Vehicles

Brand Name: Arctic Cat

Model: 150 2x4

Standards to which conformity is declared: EN 61000-6-2:2005
EN 55012:2007

Manufacturer (if not issuing agent): Arctic Cat Inc.
601 Brooks Ave S.
Thief River Falls, MN
56701 USA

I, the undersigned, hereby declare that the equipment specified above conforms to the directive(s) and standard(s) as specified.

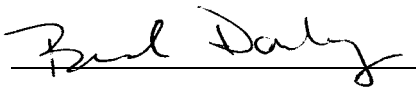

Brad Darling
Vice President/General Manager

Limited Warranty

Arctic Cat Inc. (hereinafter referred to as Arctic Cat) extends a limited warranty on each new Arctic Cat ATV it assembles and on each genuine Arctic Cat ATV part and accessory assembled or sold by an authorized Arctic Cat ATV dealer. Warranty on an Arctic Cat ATV is extended to the original retail purchaser; however, the balance of the unused warranty may be transferred to another party. Warranty coverage is only available in the country in which the original retail purchase occurs to the original retail purchaser resident in that country or to a transferee resident in that country of the balance of the unused warranty.

Arctic Cat warrants only the products it assembles and/or sells and does not warrant that other products will function properly when used with an Arctic Cat ATV or will not damage the ATV. Arctic Cat does not assume any liability for incidental or consequential damages.

Arctic Cat will repair or replace, at its option, free of charge (including any related labor charges), any parts that are found to be warrantable in material or workmanship. This repair work MUST be done by an authorized Arctic Cat ATV dealer. No transportation charges, rental charges, or inconvenience costs will be paid by Arctic Cat. The warranty is validated upon examination of said parts by Arctic Cat or an authorized Arctic Cat ATV dealer. Arctic Cat reserves the right to inspect such parts at its factory for final determination if warranty should apply.

The warranty periods are as follows:

1. Six months from the date of sale — for an Arctic Cat ATV used for recreational purposes.
2. Ninety days from date of invoice — for an Arctic Cat ATV used for commercial purposes, including rental operations (non-transferable).
3. Thirty days from date of sale of ATV on Arctic Cat supplied batteries.
4. Thirty days from date of sale — for all dealer installed genuine Arctic Cat service parts and accessories.
5. Until expiration of the new product warranty (paragraphs 1 and 2 above) — for all eligible replacement parts on new product.

Exclusions to this warranty include normal wear, abuse, or corrosion and the following parts and items:

Tires	CV Boots	Torn or Punctured Upholstery
Oil Filter	Drive Belt	Cracks or Gouges in Body
Panels		
Air Filter	Brake Pads	Drive/Driven Clutch Wear Parts
Light Bulbs	Spark Plug(s)	

The following will VOID Arctic Cat's warranty:

1. Failure to perform the proper break-in procedure and all related maintenance, storage procedures (if stored for extended periods), and/or service as recommended in the Operator's Manual.
2. Repairs and/or adjustments by anyone other than an authorized Arctic Cat ATV dealer.
3. Use of improper carburetor main jets.
4. Use of improper gasoline, lubricating oils, or spark plug.
5. An accident or subjecting the ATV to misuse, abuse, or negligent operation.
6. Any modification, addition, or removal of parts unless instructed to do so by Arctic Cat.
7. Use of the ATV in any way for racing purposes.
8. Removal of the engine for use in another vehicle.
9. Removal or mutilation of the Vehicle Identification Number or Engine Serial Number.
10. Use of parts not sold or approved by Arctic Cat.
11. Damage due to improper transportation.

In consideration of the foregoing, any implied warranty is limited in duration to the various warranty periods set forth. This warranty gives you specific legal rights, and you may also have other rights which vary from state/province to state/province or country to country. Some jurisdictions do not allow limitations on how long an implied warranty lasts, so the above limitations may not apply to you.

Warranty Procedure/Owner Responsibility

At the time of sale, an ATV Rider Training Certificate and Owner Registration form is to be completed by the selling dealer and consumer. The receipt of the form by Arctic Cat is a condition precedent to warranty coverage. It is the selling dealer's responsibility to retain and/or submit appropriate copies of the form to the appropriate place(s) to initiate warranty coverage.

The dealer will furnish to the consumer a signed copy of the form which must be presented to the dealer when requesting warranty service. The registration form is the consumer's proof of ownership and warranty eligibility. The form is used by the dealer to validate the warranty claim. Retain your copy of the form and keep it in a safe place.

When warranty repair is suspected, the ATV should be taken to the selling dealer, who has the primary responsibility to perform warranty repairs. Subject to the limitations set forth in the Limited Warranty, in the event the selling dealer has ceased to do business, you have moved, or you are in a location away from your selling dealer, warranty may be performed by any authorized Arctic Cat ATV dealer.

The authorized Arctic Cat ATV dealer will examine the ATV or part to determine if, in his opinion, a warrantable condition exists. If a warrantable condition appears to exist, the dealer will repair or replace, at Arctic Cat's option, free of charge, including any related labor costs, all parts that are found to be warrantable and any other parts which the warrantable part caused to be damaged. You, the owner, will then be asked to sign a warranty form to ensure Arctic Cat that the warranty work was actually performed.

It is the owner's responsibility to maintain and service the ATV in accordance with Arctic Cat's recommendations in the Operator's Manual. To protect yourself and your ATV, follow all safety and service tips. Arctic Cat will NOT warrant repairs required as a result of not performing standard operator maintenance, storage procedures, and service as outlined in the Operator's Manual.

Should you have any questions concerning the warranty, contact an authorized Arctic Cat ATV dealer.

Arctic Cat Emission Control System Limited Warranty

Arctic Cat Inc., P.O. Box 810, Thief River Falls, MN 56701 (hereinafter referred to as Arctic Cat) warrants that this new Arctic Cat ATV manufactured on or after January 1st, 1997:

- A. Is designed, built, and equipped so as to conform at the time of initial purchase with all applicable regulations of the California Air Resources Board and
- B. Is free from defects in material and workmanship which could cause such ATV to fail to conform with applicable regulations of the California Air Resources Board for a period of use of two (2) years from the date of initial retail delivery.

Coverage

Warranty defects shall be remedied during customary business hours at any authorized Arctic Cat ATV dealer located within the state of California in compliance with applicable regulations of the California Air Resources Board. Any component or components replaced under this warranty shall become the property of Arctic Cat.

In California, emission related warranted components are specifically defined by the state's Emission Warranty Parts List. These warranted components are carburetor and internal components, intake manifold, fuel injection system, spark advance mechanism, crankcase breather, air cutoff valve, fuel/vapor separator, canister, igniters, breaker governors, ignition coils, ignition wires, ignition points, condensers and spark plugs if failure occurs prior to the first scheduled replacement, and hoses, clamps, and fittings used directly in these parts. Since emission related components may vary from model to model, certain models may not contain all of these components, and certain models may contain functionally equivalent components.

In California, emission control system emergency repairs, as provided for in the California Administrative Code, may also be performed by other than an authorized Arctic Cat ATV dealer. An emergency situation occurs when an authorized Arctic Cat ATV dealer is not reasonably available, a component is not available within thirty (30) days, or a repair is not complete within thirty (30) days. Any replacement component can be used in an emergency repair. Arctic Cat will reimburse the owner for the expenses, including diagnosis, not to exceed suggested retail price as set forth by Arctic Cat for all warranted components replaced and labor charges based on the recommended time allowance set forth by Arctic Cat for the warranty repair and the geographically appropriate hourly labor rate. The owner may be required to keep receipts and failed components in order to receive compensation.

Limitations

This Emission Control System Warranty shall not cover any of the following:

- A. Repair or replacement required as a result of
 - (1) accident,
 - (2) misuse,
 - (3) lack of required maintenance,
 - (4) repairs improperly performed or replacements improperly installed,

- (5) use of replacement components or accessories not conforming to Arctic Cat specifications which adversely affect performance, and/or
- (6) use in competitive racing or related events.

- B. Inspections, replacement of components, and other services or adjustments necessary for required maintenance.

Limited Liability

The liability of Arctic Cat under this Emission Control System Warranty is limited solely to the remedying of defects in material and workmanship by an authorized Arctic Cat ATV dealer at its place of business during customary business hours. This warranty does not cover inconvenience or loss of use of the ATV or transportation of the ATV to or from the Arctic Cat ATV dealer.

ARCTIC CAT SHALL NOT BE LIABLE FOR ANY OTHER EXPENSES, LOSS, OR DAMAGE, WHETHER DIRECT, INCIDENTAL, CONSEQUENTIAL, OR EXEMPT, ARISING IN CONNECTION WITH THE SALE OR USE OF, OR INABILITY TO USE THE ARCTIC CAT ATV FOR ANY PURPOSE. SOME STATES DO NOT ALLOW THE EXCLUSION OR LIMITATION OF ANY INCIDENTAL OR CONSEQUENTIAL DAMAGES, SO THE ABOVE MAY NOT APPLY TO YOU.

NO EXPRESS EMISSION CONTROL SYSTEM WARRANTY IS GIVEN BY ARCTIC CAT EXCEPT AS SPECIFICALLY SET FORTH HEREIN. ANY EMISSION CONTROL SYSTEM WARRANTY IMPLIED BY LAW, INCLUDING ANY WARRANTY OF MERCHANTABILITY OR FITNESS FOR A PARTICULAR PURPOSE, IS LIMITED TO THE EXPRESS EMISSION CONTROL SYSTEM WARRANTY TERMS STATED IN THIS WARRANTY. THE FOREGOING STATEMENTS OF WARRANTY ARE EXCLUSIVE AND IN LIEU OF ALL OTHER REMEDIES.

No dealer is authorized to modify this Arctic Cat Inc. Limited Emission Control System Warranty.

Legal Rights

THIS WARRANTY GIVES YOU SPECIFIC LEGAL RIGHTS, AND YOU MAY ALSO HAVE OTHER RIGHTS WHICH VARY FROM STATE TO STATE.

THIS WARRANTY IS IN ADDITION TO THE ARCTIC CAT INC. LIMITED ATV WARRANTY.

Additional Information

Any replacement component that is equivalent in performance and durability may be used in the performance of any maintenance or repairs. However, Arctic Cat is not liable for these components. The owner is responsible for the performance of all required maintenance. Such maintenance may be performed at a service establishment or by any individual. The warranty period begins on the date the ATV is delivered to the owner.

U.S. EPA Emission Control Statement/Warranty Coverage (U.S. Only)

STATEMENT/WARRANTY

Arctic Cat warrants to the original retail purchaser, and each subsequent purchaser, that all U.S. EPA-certified Arctic Cat snowmobiles are designed, built, and equipped to conform to all U.S. EPA Emission Control Regulations. Please read the following information completely.

Your authorized Arctic Cat snowmobile dealer will repair or replace any defective emission-related component at no cost to you during the warranty period. You may have non-warranty service performed by any repair establishment that uses equivalent components. The regulations provide significant civil penalties for tampering that causes your snowmobile to no longer meet U.S. EPA emission standards.

Arctic Cat further warrants that the engine and its emission-related components are free from defects in materials or workmanship that could cause the engine to fail to comply with applicable regulations during the warranty period.

If you have any questions about this information, or the emission warranty coverage statement, contact your local authorized Arctic Cat snowmobile dealer.

WARRANTY PERIOD

The emission warranty period for this snowmobile begins on the same date as the standard warranty coverage and continues for 30 months or 2500 miles, whichever comes first.

COMPONENTS COVERED

The emissions warranty covers major emissions control components and emission-related components listed as follows:

Engine Management and Sensors	Fuel/Air System
Barometric Pressure Sensor	Fuel Injectors
Camshaft Position Sensor	Fuel Pressure Regulator
Engine Control Unit (ECU)	Fuel Pump
Engine Coolant Temperature Sensor	Carburetor(s)
Intake Air Temperature Sensor	Turbocharger Assembly
Manifold Absolute Pressure Sensor	Air Bypass Valve
Oxygen Sensor	Turbo Waste Gate Control Valve
Throttle Position Sensor	Crankcase Ventilation System
	ISC Valve

Ignition System

Ignition Coil
Knock Sensor System
Crankshaft Position Sensor
Exhaust Temperature Sensor
Capacitive Discharge Ignition (CDI) Module
Magneto Pick-Up

Miscellaneous Items Used in Aforementioned Systems

Connectors
Switches
Grommets
Clamps
Hoses
Ties
Gaskets
Wiring

OWNER'S RESPONSIBILITIES

The owner of any snowmobile warranted under this Arctic Cat Emission Control Statement is responsible for the proper maintenance and use of the snowmobile as stated in the Operator's Manual. Proper maintenance generally includes replacement and service, at the owner's choosing, such items as air filter, oil and oil filter, or any other part, item, or device related to emissions control as specified in the Operator's Manual. It is the owner's responsibility to ensure that the snowmobile is used in a manner for which it was designed.

Change Of Address, Ownership, or Warranty Transfer

Arctic Cat Inc. keeps on file the current name and address of the owner of this ATV. This will allow Arctic Cat to reach the current owner with any important safety information which may be necessary to protect customers from personal injury or property damage. Please make sure a copy of this form is completed and returned to Arctic Cat Inc. if you move or if the ATV is sold to another party.

This form may also be used to transfer the unused portion of the original warranty to a second party. In order to transfer warranty, fill out this form completely; then return a copy of this form to Arctic Cat Inc. Arctic Cat will then process the application and issue warranty for the balance of the time remaining of the original warranty.

Address Change

Ownership Change

Warranty Transfer

Change Of Address/Ownership/ Warranty Transfer To:

Name _____

Address _____

City/State (Province)/Zip Code (Postal Code) _____

Phone # () _____

Year and Model/ATV _____

Vehicle Identification Number (VIN) _____

Before operating, you should take an ATV Rider Course to learn ATV riding skills or reinforce your current good riding skills. In U.S.A., call 1-800-887-2887 to enroll in the half-day ATV Rider Course nearest you or ask your dealer for assistance. The course instructor will charge a small fee for each person taking the course. In Canada, call (613) 739-1535.

Fold Back

Place
Stamp
Here

CHANGE OF ADDRESS/OWNERSHIP

ARCTIC CAT INC.
PRODUCT SERVICE AND
WARRANTY DEPT.
P.O. BOX 810
THIEF RIVER FALLS, MN 56701

Identification Numbers Record

WARNING

Indicates a potential hazard that could result in serious injury or death.

1. VEHICLE IDENTIFICATION NUMBER:

2. ENGINE SERIAL NUMBER:

Record the Vehicle Identification Number and Engine Serial Number in the spaces provided to assist you in ordering parts from your authorized Arctic Cat ATV dealer or for reference in case the ATV is stolen.



[Previous](#)

[Main Table of Contents](#)

[Section Table of Contents](#)

[Next](#)



WARNING

Improper ATV use can result in SEVERE INJURY or DEATH



ALWAYS USE
AN APPROVED
HELMET AND
PROTECTIVE
GEAR



NEVER USE ON
PUBLIC ROADS



NEVER CARRY
PASSENGERS



NEVER USE
WITH DRUGS OR
ALCOHOL

NEVER operate:

- without proper training or instruction
- at speeds too fast for your skills or the conditions
- on public roads - a collision can occur with another vehicle
- with a passenger - passengers affect balance and steering and increase risk of losing control

ALWAYS:

- use proper riding techniques to avoid vehicle overturns on hills and rough terrain and in turns
- avoid paved surfaces - pavement may seriously affect handling and control

LOCATE AND READ OPERATOR'S MANUAL
FOLLOW ALL INSTRUCTIONS AND WARNINGS



©2011 Arctic Cat Inc. TM® Trademarks of Arctic Cat Inc., Thief River Falls, MN 56701
(218) 681-9851 - U.S. (204) 982-1656 - Canada p/n 2259-065

[Previous](#)

[Main Table of Contents](#)

[Section Table of Contents](#)

Your ATV can be hazardous to operate.

A collision or rollover can occur quickly, even during routine maneuvers such as turning and driving on hills or over obstacles, if you fail to take proper precautions.

For your safety, understand and follow all the warnings contained in this Operator's Manual and the labels on your ATV.



Keep this Operator's Manual with your ATV at all times. This Arctic Cat ATV Operator's Manual should be considered a permanent part of the ATV and must remain with the ATV at the time of resale. If the ATV changes ownership more than once, contact Arctic Cat Inc., Service Department, P.O. Box 810, Thief River Falls, MN 56701, for proper registration information.

FAILURE TO FOLLOW THE WARNINGS CONTAINED IN THIS MANUAL CAN RESULT IN SERIOUS INJURY OR DEATH.

Training is available: U.S. owners, call 800-887-2887; Canadian owners, call 613-739-1535.

Un cours d'instruction est disponible: pour les propriétaires canadiens, composez le 613-739-1535.

Particularly important information is distinguished in this manual by the following notations:

	The Safety Alert Symbol means ATTENTION! BE ALERT! YOUR SAFETY IS INVOLVED.
 WARNING	WARNING indicates a hazardous situation which, if not avoided, could result in death or serious injury.
CAUTION	CAUTION , without the safety alert symbol, is used to address practices not related to personal injury.
■ NOTE:	A NOTE provides key information to make procedures easier or more clear.

California Proposition 65

 WARNING
This product contains or emits chemicals known to the State of California to cause cancer and birth defects or other reproductive harm.

Foreword

Congratulations and thank you from Arctic Cat Inc. for purchasing an ARCTIC CAT® All-Terrain Vehicle (ATV). Built with American engineering and manufacturing know-how, it is designed to provide superior ride, comfort, utility, and dependable service.

This Operator's Manual is furnished to ensure that the operator is aware of safe operating procedures. It also includes information about the general care and maintenance of your ATV.

Carefully read the following pages. If you have any questions regarding this ATV, contact an authorized Arctic Cat ATV dealer for assistance. Remember, only authorized Arctic Cat ATV dealers have the knowledge and facilities to provide you with the best service possible.

Protect Your Sport

- Know all local, state/provincial riding laws,
- Respect your ATV,
- Respect the environment, and
- You will gain the respect of others.

We also advise you to strictly follow the recommended maintenance program as outlined. This preventive maintenance program is designed to ensure that all critical components on this ATV are thoroughly inspected at various intervals.

All information in this manual is based on the latest product data and specifications available at the time of printing. Arctic Cat Inc. reserves the right to make product changes and improvements which may affect illustrations or explanations without notice.

Division II of this manual covers operator-related maintenance, operating instructions, and storage instructions. If major repair or service is ever required, contact an authorized Arctic Cat ATV dealer for professional service.

At the time of publication, all information and illustrations in this manual were technically correct. Some illustrations used in this manual are used for clarity purposes only and are not designed to depict actual conditions. Because Arctic Cat Inc. constantly refines and improves its products, no retroactive obligation is incurred.

Parts and Accessories

When in need of replacement parts, oil, or accessories for your Arctic Cat ATV, be sure to use only GENUINE ARCTIC CAT PARTS, OIL, AND ACCESSORIES. Only genuine Arctic Cat parts, oil, and accessories are engineered to meet the standards and requirements of your Arctic Cat ATV. For a complete list of accessories, refer to the current Arctic Cat ATV Accessory Catalog.

To aid in service and maintenance procedures on this ATV, a Service Manual and an Illustrated Parts Manual are available through your local Arctic Cat ATV dealer.

Arctic Cat and the ATV Safety Institute recommend that all ATV operators ride the appropriate-sized ATV according to age.

Category	Age (Years)	Speed Limitations (MPH)	NOTES
Y-12+	12 or Older	15 - Limited 30 - Maximum	Operate Under Adult Supervision
T-14	14 or Older	20 - Limited 30 - Limited 38 - Maximum	Operate Under Adult Supervision
G & S	16 or Older	According to Local Regulations	—

TREAD LIGHTLY! OFFICIAL SPONSOR®
ON PUBLIC AND PRIVATE LAND

Table of Contents

Foreword	1
Parts and Accessories	1
DIVISION I - SAFETY	
ATV Safety Alert	4
Rider Training Course	5
Hangtags	6
Warning Labels & Information	7
Warnings	8-14
Prevention	15-18
Safe Riding Clothing and Gear	15
ATV Condition	16
T-CLOC	16
First Aid and Survival	17
Active Riding	19
Sound Judgment	20-24
Environment	20
Those Around You	21
Equipment	22
Load Capacity Ratings Chart	23
Personal Choices	23
SIPDE	24
Supervision	25
Taking Responsibility	25
Inexperienced Riders	25
Experienced Riders	25
DIVISION II - OPERATION/MAINTENANCE	
ATV Specifications	26
Location of Parts and Controls	27
ATV Operation	28-36
Basic Operating Maneuvers	28
Starting the Engine	28
BONE-C	28
Starting A Cold Engine	28
Handling the ATV (Active Riding Techniques)	30
Tips	34
General Information	37-45
ATV Identification Numbers	37
Ignition Switch Key	37
Control Locations and Functions	37
Speedometer/LCD (Digital)	40
Gas Hoses	41
Electric Fuel Pump	41

Oil Level Stick	42
Seat Latch	42
Safety Flag Bracket	42
Trailing and Towing	42
Transporting ATV	43
Gasoline-Oil-Lubricant	43
Engine Break-In	44
Burnishing Brake Pads	45
General Maintenance	46-57
Maintenance Schedule	46
Liquid Cooling System	47
Shock Absorbers	47
General Lubrication	48
Hydraulic Brakes	49
Brake Fluid	49
Brake Lever Lock (Right Hand Brake)	49
Brake Hoses	49
Brake Pads	49
Protective Rubber Boots	49
Battery	50
Spark Plug	53
Throttle Cable Adjustment	53
Air Filter	54
Air Filter Housing Drain	54
Draining V-Belt Cover	54
Tires	55
Wheels	55
Muffler/Spark Arrester	56
Light Bulb Replacement	56
Checking/Adjusting Headlight Aim	56
Fuses	57
Electrical Output Terminals	57
Tools	57
Preparation for Storage	58
Preparation after Storage	59
Maintenance Record	60
Limited Warranty	61
Warranty Procedure/Owner Responsibility	62
Arctic Cat ATV Emission Control Warranty Statement	63
Arctic Cat Emission Control System Limited Warranty	64
U.S. EPA Emission Control Statement/Warranty Coverage - ATV (U.S. Only)	65
Declaration of Conformity	66
Change Of Address, Ownership, Or Warranty Transfer	67
Identification Numbers Record	Inside Back Cover

DIVISION I - SAFETY

An ATV is not a toy and can be hazardous to operate.

- Always go slowly and be extra careful when operating on unfamiliar terrain. Always be alert to changing terrain conditions when operating the ATV.
- Never operate on excessively rough, slippery, or loose terrain.
- Always follow proper procedures for turning as described in this manual. Practice turning at slow speeds before attempting to turn at faster speeds. Do not turn at excessive speed.
- Always have the ATV checked by an authorized Arctic Cat ATV dealer if it has been involved in an accident.
- Never operate the ATV on hills too steep for the ATV or for your abilities. Practice on smaller hills before attempting larger hills.
- Always follow proper procedures for climbing hills as described in this manual. Check the terrain carefully before you start up any hill. Never climb hills with slippery or loose surfaces. Shift your weight forward. Never open the throttle suddenly or make sudden gear changes. Never go over the top of any hill at high speed.
- Always follow proper procedures for going down hills and for braking on hills as described in this manual. Check the terrain carefully before you start down any hill. Shift your weight backward. Never go down a hill at high speed. Avoid going down a hill at an angle which would cause the ATV to lean sharply to one side. Go straight down the hill where possible.
- Always be sure there are no obstacles or people behind you when you operate in reverse. When it is safe to proceed in reverse, go slowly. Avoid turning at sharp angles in reverse.
- Always follow proper procedures for crossing the side of a hill as described in this manual. Avoid hills with slippery or loose surfaces. Shift your weight to the uphill side of the ATV. Never attempt to turn the ATV around on any hill until you have mastered the turning techniques described in this manual on level ground. Avoid crossing the side of a steep hill if possible.

- Always use proper procedures if you stall or roll backward when climbing a hill. To avoid stalling, maintain a steady speed when climbing a hill. If you stall or roll backwards, follow the special procedure for braking described in this manual. Dismount on the uphill side or to either side if pointed straight uphill. Turn the ATV around and mount following the procedure described in this manual.
- Always check for obstacles before operating in a new area. Never attempt to operate over large obstacles, such as large rocks or fallen trees. Always follow proper procedures when operating over obstacles as described in this manual.
- Always be careful of skidding or sliding. On slippery surfaces, such as ice, go slowly and be very cautious in order to reduce the chance of skidding or sliding out of control.
- Never operate an ATV in fast flowing water or in water deeper than the footrests. Remember that wet brakes may have reduced stopping capability. Test your brakes after leaving water. If necessary, apply them lightly several times to let friction dry out the pads.
- Always use the size and type tires specified in this manual. Always maintain proper tire pressure as described in this manual.
- Never improperly install or improperly use accessories on this ATV.
- Never install a twist grip throttle on this ATV.
- Never exceed the stated load capacity for an ATV. Cargo should be properly distributed and securely attached. Reduce speed and follow instructions in this manual for carrying cargo or pulling a trailer and allow greater distance for braking.
- No one under the age of 16 should operate this ATV. Some operators at the age of 16 may not be able to operate an ATV safely. Parents should supervise the use of the ATV at all times. Parents should permit continued use only if they determine that the operator has the ability to operate the ATV safely.

FOR MORE INFORMATION ABOUT ATV SAFETY, call the ATV Safety Institute at 1-800-887-2887 (U.S.) or 1-613-739-1535 (Canada).

ATV Safety Alert

The Consumer Product Safety Commission has concluded that ALL-TERRAIN VEHICLES (ATV's) may present a risk of SERIOUS INJURY or DEATH in certain circumstances. Accidents may occur for many reasons:

- * Over 2591 people, including many children, have died in accidents associated with ATV's since 2005.
- * Many people have become severely paralyzed or suffered serious internal injuries as a result of accidents associated with ATV's.
- * Every month thousands of people are treated in hospital emergency rooms for injuries received while riding an ATV.

You should be aware that AN ATV IS NOT A TOY AND CAN BE HAZARDOUS TO OPERATE. An ATV handles differently from other vehicles, including motorcycles and cars. A collision or rollover can occur quickly, even during routine maneuvers such as turning and driving on hills and over obstacles, if you fail to take proper precautions.

TO AVOID SERIOUS INJURY OR DEATH:

- * Always read the Operator's Manual carefully and follow the operating procedures described. Pay special attention to the warnings contained in the manual and on all labels.
- * Never operate an ATV without proper instruction. Take a training course. Beginners should complete a training course.
- * Always follow these age recommendations:
 - A Y-12+ is intended for use by children age 12 or older, and a T-14 is intended for use by an operator age 14 or older.

- A child under 16 years old should never operate an ATV without adult supervision. Children need to be observed carefully because not all children have the strength, size, skills, or judgment to operate an ATV safely.
- * Never carry a passenger on an ATV. Carrying a passenger may upset the balance of the ATV and may cause it to go out of control.
- * Always avoid paved surfaces. ATV's are not designed to be used on paved surfaces and may seriously affect handling and control.
- * Never operate an ATV on a public road, even a dirt or gravel one, because you may not be able to avoid colliding with other vehicles. Also, operating an ATV on a public road may be against the law.
- * Never operate an ATV without an approved motorcycle helmet, eye protection, boots, gloves, long pants, and a long-sleeved shirt or jacket.
- * Never consume alcohol or drugs before or while operating an ATV.
- * Never operate an ATV at excessive speeds. Go at a speed which is proper for the terrain, visibility conditions, and your experience.
- * Never attempt to do wheelies, jumps, or other stunts.
- * Always be careful when operating an ATV, especially when approaching hills, turns, and obstacles and when operating on unfamiliar or rough terrain.
- * Never lend an ATV to anyone who has not taken a training course or has not been driving an ATV for at least a year.

Rider Training Course

Arctic Cat sponsors a free Rider Training Course to teach ATV riding skills or to reinforce current riding skills. First-time purchasers without any previous ATV riding experience will receive a \$100.00 coupon from Arctic Cat through the SVIA/ASI after completing the training course (U.S. owners only, one incentive, and free rider training courses for appropriate immediate family members per ATV purchase). See an authorized Arctic Cat ATV dealer for details or call (800) 887-2887 for training course information.

In Canada, the Canada Safety Council (CSC) provides an ATV Rider's Course to teach safe ATV operating skills. They also provide a special ATV Rider's Course for children under 14 years of age with parental supervision. Call the CSC at 1-613-739-1535 ext. 227 for more details. Also available is a bilingual computer-based safety training program on a CD-ROM from CATV - call toll-free at 1-877-470-2288.

Au Canada, le conseil canadien de la sécurité (CSC) offre un cours de conduite de VTT pour enseigner les habiletés d'opération sécuritaires de VTT. Un cours spécial de conduite de VTT est également offert aux enfants de moins de 14 ans avec la surveillance d'un parent. Communiquez avec le CSC en composant le: 1-613-739-1535, poste 227 pour de plus amples informations. Un programme de formation bilingue informatisé sur la sécurité est aussi disponible sur disque optique compact par CATV; composez sans frais le: 1-877-470-2288.



FOR MORE INFORMATION ABOUT ATV SAFETY, in the U.S., call the Consumer Product Safety Commission at (800) 638-2772 or the ATV Distributors' Safety Hotline at (800) 852-5344 or in Canada, call the Canada Safety Council at 1-613-739-1535 ext. 227.

Visit the Arctic Cat Inc. website at www.arcticcat.com for additional product information.

Hangtags

An Arctic Cat ATV comes with hangtags containing important safety information. Anyone who rides the ATV should read and understand this information before riding.



KC360



2258-714

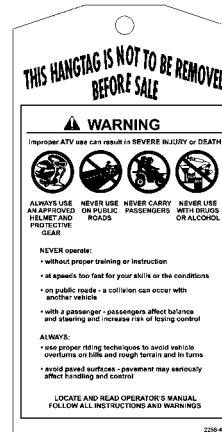

2258-432

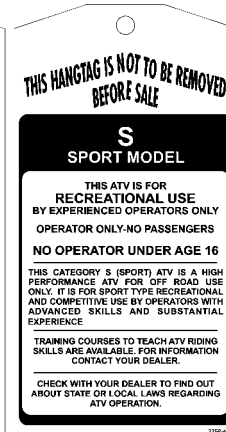

2258-432

Pour commander des Etiquettes de Mise en Garde gratuites, voyez votre détaillant de autorisé VTT Arctic Cat pour le numéro de pièce 1436-344.

Warning Labels & Information

An Arctic Cat ATV comes with several labels containing important safety information. Anyone who rides the ATV should read and understand this information before riding.

The labels should be considered as permanent parts of the ATV. If a label comes off or becomes hard to read, contact your Arctic Cat ATV dealer for a replacement.

■ **NOTE:** The location and content of labels on the ATV you have purchased may differ from those shown on this page.



Warnings

WARNING

POTENTIAL HAZARD

Operating this ATV without proper instruction.

WHAT CAN HAPPEN

The risk of an accident is greatly increased if the operator does not know how to operate the ATV properly in different situations and on different types of terrain.

HOW TO AVOID THE HAZARD

Beginning and inexperienced operators should complete the certified training course offered. They should then regularly practice the skills learned in the course and the operating techniques described in this Operator's Manual.

For more information about the training course, contact an authorized Arctic Cat ATV dealer or call 1-800-887-2887 (U.S.) or 1-613-739-1535 (Canada).

WARNING

POTENTIAL HAZARD

Allowing anyone under age 16 to operate this ATV.

WHAT CAN HAPPEN

Use of an ATV by children can lead to serious injury or death of the child.

Children under the age of 16 may not have the skills, abilities, or judgment needed to operate the ATV safely and may be involved in a serious accident.

HOW TO AVOID THE HAZARD

A child under 16 should never operate this ATV.

WARNING

POTENTIAL HAZARD

Carrying a passenger on this ATV.

WHAT CAN HAPPEN

Greatly reduces your ability to balance and control this ATV.

Could cause an accident, resulting in injury or death to you and/or your passenger.

HOW TO AVOID THE HAZARD

Never carry a passenger. The long seat is to allow the operator to shift positions as needed during operation. It is not for carrying passengers.

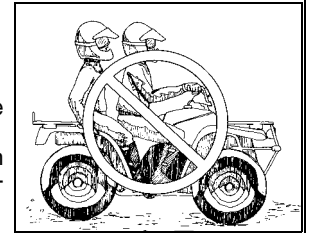

WARNING

POTENTIAL HAZARD

Operating this ATV on paved surfaces.

WHAT CAN HAPPEN

The ATV's tires are designed for off-road use only, not for use on pavement. Paved surfaces may seriously affect handling and control of the ATV and may cause the ATV to go out of control.

HOW TO AVOID THE HAZARD

Never operate the ATV on any paved surfaces, including sidewalks, driveways, parking lots, and streets.

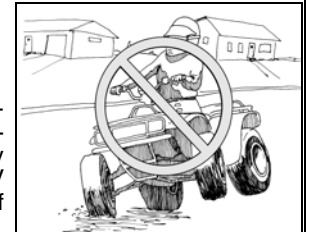

Warnings

⚠ WARNING

POTENTIAL HAZARD

Operating this ATV on public streets, roads, or highways.

WHAT CAN HAPPEN

You can collide with another vehicle.

HOW TO AVOID THE HAZARD

Never operate this ATV on any public street, road, or highway, even a dirt or gravel one.

In many states it is illegal to operate an ATV on public streets, roads, or highways.

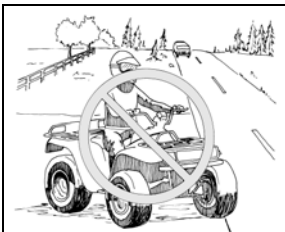

⚠ WARNING

POTENTIAL HAZARD

Going down a hill improperly.

WHAT CAN HAPPEN

Could cause loss of control or cause the ATV to overturn.

HOW TO AVOID THE HAZARD

Always follow proper procedures for going down hills as described in this Operator's Manual.

Always check the terrain carefully before you start down any hill.

Shift your weight backward.

Never go down a hill at high speed.

Avoid going down a hill at an angle that would cause the ATV to lean sharply to one side. Go straight down the hill where possible.

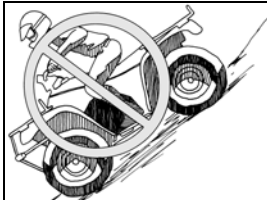

⚠ WARNING

POTENTIAL HAZARD

Operating this ATV without wearing an approved helmet, eye protection, and protective clothing.

WHAT CAN HAPPEN

Operating without an approved helmet increases your chances of a serious head injury or death in the event of an accident.

Operating without eye protection can result in an accident and increases your chances of a serious injury in the event of an accident.

Operating without protective clothing increases your chances of serious injury in the event of an accident.

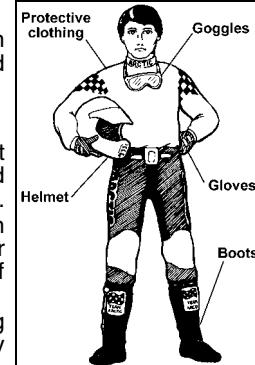

HOW TO AVOID THE HMAZARD

Always wear an approved helmet that fits properly.

You should also wear:

- Eye protection (goggles or face shield)

- Gloves

- Boots

- Long sleeved shirt or jacket

- Long pants

⚠ WARNING

POTENTIAL HAZARD

Operating this ATV at excessive speeds.

WHAT CAN HAPPEN

Increases your chances of losing control of the ATV, which can result in an accident.

HOW TO AVOID THE HAZARD

Always ride at a speed that is proper for the terrain, visibility and operating conditions, and your experience.

Warnings

⚠ WARNING

POTENTIAL HAZARD

Operating this ATV after or while consuming alcohol or drugs.

WHAT CAN HAPPEN

Could seriously affect your judgment.
 Could cause you to react more slowly.
 Could affect your balance and perception.
 Could result in an accident.

HOW TO AVOID THE HAZARD

Never consume alcohol or drugs before or while driving this ATV.

⚠ WARNING

POTENTIAL HAZARD

Attempting wheelies, jumps, and other stunts.

WHAT CAN HAPPEN

Increases the chance of an accident including a rollover.

HOW TO AVOID THE HAZARD

Never attempt stunts, such as wheelies or jumps. Don't try to show off.

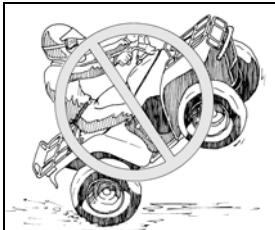

⚠ WARNING

POTENTIAL HAZARD

Failure to inspect the ATV before operating.
 Failure to properly maintain the ATV.

WHAT CAN HAPPEN

Increases the possibility of an accident or equipment damage.

HOW TO AVOID THE HAZARD

Always inspect your ATV each time you use it to make sure the ATV is in safe operating condition.
 Always follow the inspection and maintenance procedures and schedules described in this Operator's Manual.

⚠ WARNING

POTENTIAL HAZARD

Removing hands from handlebars or feet from footrests during operation.

WHAT CAN HAPPEN

Removing even one hand or foot can reduce your ability to control the ATV or could cause you to lose your balance and fall off the ATV. If you remove a foot from a footrest, your foot or leg may come into contact with the wheels, which could injure you or cause an accident.

HOW TO AVOID THE HAZARD

Always keep both hands on the handlebars and both feet on the footrests of your ATV during operation.

Warnings

⚠ WARNING

POTENTIAL HAZARD

Failure to use extra care when operating the ATV on unfamiliar terrain.

WHAT CAN HAPPEN

You can come upon hidden rocks, bumps, or holes without enough time to react.

Could result in the ATV overturning or going out of control.

HOW TO AVOID THE HAZARD

Go slowly and be extra careful when operating on unfamiliar terrain. Always be alert to changing terrain conditions when operating the ATV.

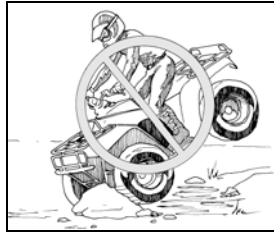

⚠ WARNING

POTENTIAL HAZARD

Failure to use extra care when operating on rough, slippery, or loose terrain.

WHAT CAN HAPPEN

Could cause loss of traction or ATV control, which could result in an accident including a rollover.

HOW TO AVOID THE HAZARD

Do not operate on rough, slippery, or loose terrain until you have learned and practiced the skills necessary to control the ATV on such terrain.

Always be especially cautious on these kinds of terrain.

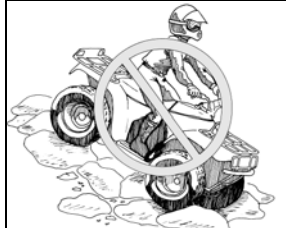

⚠ WARNING

POTENTIAL HAZARD

Turning improperly.

WHAT CAN HAPPEN

ATV could go out of control, causing a collision or rollover.

HOW TO AVOID THE HAZARD

Always follow proper procedures for turning as described in this Operator's Manual.

Practice turning at slow speeds before attempting to turn at faster speeds.

Do not turn at excessive speed.

⚠ WARNING

POTENTIAL HAZARD

Operating the ATV with improper modifications.

WHAT CAN HAPPEN

Improper installation of accessories or modification of the ATV may cause changes in handling which, in some situations, could lead to an accident.

HOW TO AVOID THE HAZARD

Never modify the ATV through improper installation or improper use of accessories. All parts and accessories added to this ATV should be genuine Arctic Cat ATV components designed for use on the ATV and should be installed and used according to instructions. Never install a twist grip throttle. If you have questions, consult an authorized Arctic Cat ATV dealer.

Warnings

⚠ WARNING

POTENTIAL HAZARD

Operating on steep hills.

WHAT CAN HAPPEN

The ATV can overturn more easily on steep hills than on level surfaces or small hills.

HOW TO AVOID THE HAZARD

Never operate the ATV on hills too steep for the ATV or for your abilities.

Practice on smaller hills before attempting larger hills.

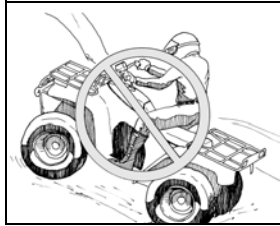

⚠ WARNING

POTENTIAL HAZARD

Overloading the ATV or carrying or towing cargo improperly.

WHAT CAN HAPPEN

Could cause changes in ATV handling, which could lead to an accident.

HOW TO AVOID THE HAZARD

Never exceed the stated load capacity for the ATV.

Cargo should be properly distributed and securely attached.

Reduce speed when carrying cargo or pulling a trailer. Allow greater distance for braking.

Always follow the instructions in this Operator's Manual for carrying cargo or pulling a trailer.

⚠ WARNING

POTENTIAL HAZARD

Improperly crossing hills or turning on hills.

WHAT CAN HAPPEN

Could cause loss of control or cause the ATV to overturn.

HOW TO AVOID THE HAZARD

Never attempt to turn the ATV around on any hill until you have mastered the turning technique as described in this Operator's Manual. Practice first on level ground. Be very careful when turning on any hill.

Avoid crossing the side of a steep hill, if possible.

When crossing the side of a hill:

Always follow proper procedures as described in this Operator's Manual.

Avoid hills with slippery or loose surfaces.

Shift your weight to the uphill side of the ATV.

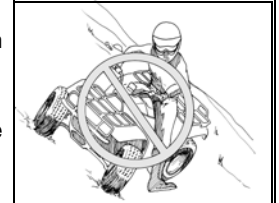

⚠ WARNING

POTENTIAL HAZARD

Improperly operating in reverse.

WHAT CAN HAPPEN

You could hit an obstacle or person behind you, resulting in serious injury.

HOW TO AVOID THE HAZARD

Before you engage reverse gear, make sure there are no obstacles or people behind you. When it is safe to proceed, go slowly.

Warnings

⚠ WARNING

POTENTIAL HAZARD

Climbing hills improperly.

WHAT CAN HAPPEN

Could cause loss of control or cause the ATV to overturn.

HOW TO AVOID THE HAZARD

Always follow proper procedures for climbing hills as described in this Operator's Manual.

Always check the terrain carefully before you start up any hill.

Never climb hills with slippery or loose surfaces.

Shift your weight forward.

Never open the throttle suddenly or make sudden gear changes. The ATV could flip over backwards.

Never go over the top of any hill at high speed. An obstacle, a sharp drop, or another vehicle or person could be on the other side of the hill.



Never Operate Up Or Down Hills Steeper Than 25°

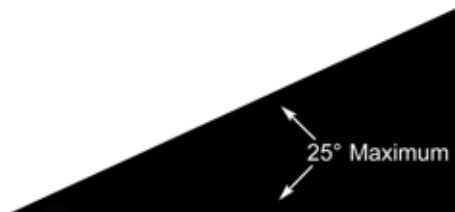

⚠ WARNING

POTENTIAL HAZARD

Stalling, rolling backwards, or improperly dismounting while climbing a hill.

WHAT CAN HAPPEN

Could result in the ATV overturning.

HOW TO AVOID THE HAZARD

Use proper gear and maintain steady speed when climbing a hill.

If you lose all forward speed:

- Keep weight uphill.

- Apply the brakes.

- Engage the brake lever lock after you are stopped.

If you begin rolling backwards:

- Keep weight uphill.

- Apply the brakes while rolling backwards.

- When fully stopped, engage the brake lever lock.

- Dismount on uphill side or to a side if pointed straight uphill.

- Turn the ATV around and mount following the procedure described in this Operator's Manual.

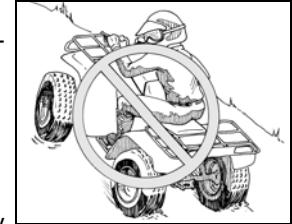

⚠ WARNING

POTENTIAL HAZARD

Failure to release the brake lever lock before driving the ATV.

WHAT CAN HAPPEN

Driving the ATV with the brake lever lock engaged could cause a change in handling or loss of brakes and cause an accident.

HOW TO AVOID THE HAZARD

Always release the brake lever lock before driving the ATV.

Warnings

WARNING

POTENTIAL HAZARD

Improperly operating over obstacles.

WHAT CAN HAPPEN

Could cause loss of control or a collision. Could cause the ATV to overturn.

HOW TO AVOID THE HAZARD

Before operating in a new area, check for obstacles.

Never attempt to ride over large obstacles, such as large rocks or fallen trees.

When you go over obstacles, always follow proper procedures as described in this Operator's Manual.

WARNING

POTENTIAL HAZARD

Skidding or sliding.

WHAT CAN HAPPEN

You may lose control of the ATV.

You may also regain traction unexpectedly, which may cause the ATV to overturn.

HOW TO AVOID THE HAZARD

Learn to safely control skidding or sliding by practicing at slow speeds and on level, smooth terrain.

On extremely slippery surfaces, such as ice, go slowly and be very cautious in order to reduce the chance of skidding or sliding out of control.

WARNING

POTENTIAL HAZARD

Operating the ATV through deep or fast flowing water.

WHAT CAN HAPPEN

Tires may float, causing loss of traction and loss of control, which could lead to an accident.

HOW TO AVOID THE HAZARD

Never operate the ATV in fast flowing water or in water deeper than the footrests.

Remember that wet brakes may have reduced stopping capability.

Test your brakes after leaving water. If necessary, apply them several times to dry out the pads.

WARNING

POTENTIAL HAZARD

Operating the ATV with improper tires or with improper or uneven tire pressure.

WHAT CAN HAPPEN

Use of improper tires on the ATV, or operation of the ATV with improper or uneven tire pressure, may cause loss of control increasing your risk of accident.

HOW TO AVOID THE HAZARD

Always use the size and type tires specified in this Operator's Manual for this ATV.

Always maintain proper tire pressure as described in this Operator's Manual.

Prevention

Overview

When using an ATV, prevention is the name of the game. “Had you only known” something could go wrong, you would have prevented it. If you don’t notice your conditions and surroundings before riding your ATV, you give up control over the situation. Using ATV prevention techniques helps you forecast potential hazards before they injure you or damage your ATV.

Following the safety instructions and warnings in this manual will help you “P.A.S.S.” the safety test. P.A.S.S. stands for “Prevention,” “Active Riding,” “Sound Judgment,” and “Supervision.” Remembering P.A.S.S. and what it stands for will help you have a safe, predictable ride every time you go out on your ATV.

Safe Riding Clothing and Gear

Always wear clothing suited to the type of riding you are doing. ATV riding requires special protective clothing which will make you feel more comfortable and reduce chances of injury.

You’ll find it important to dress correctly for ATV riding in order to prevent scraped skin and serious head injuries. It’s easy and could save you time in the long run not having to contend with an injury. Of course, it also makes sense to remember the seasons. Wear a hat under your helmet and a snowmobile suit in the winter and lighter, protective clothing in the summer. Following is the minimum protection you need to wear during every ride.

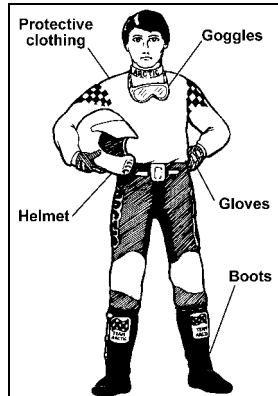

Gloves

Your hands are targets for flying objects and branches. Along with providing skin protection, gloves will shield your hands from harsh weather. Wear gloves that are weather resistant and have a gripping surface to keep them from sliding off the handlebar. Off-road style gloves with knuckle pads are the best for comfort and protection.

Boots/Ankle Protection

Wear a boot that covers the largest possible area of your leg (preferably up to your knee) and can handle significant impact. Choosing boots with low heels and a good tread will help prevent your feet from slipping off the footrests in wet or rugged conditions or getting hurt if they get hit by rocks, dirt, or branches.

Helmet

Your helmet is the most important piece of protective gear for safe riding. A helmet can prevent a serious head injury. There are several types of helmets on the market, but make sure you wear a helmet that complies with the current standards of the U.S. Department of Transportation (DOT), The Snell Memorial Foundation, or the American National Standards Institute (ANSI). Helmets that comply with one or more of these agency’s standards have a sticker on the inside or outside of the helmet.

TESTIMONIAL

DOCUMENT#: N490117A1
CITY/STATE: N. HUNTINGDON, PA
SEX: M
AGE: 6
BODY PART: HEAD
DATE ACCIDENT: 06-14-94
DISPOSITION: DOA
SYNOPSIS: The 6 year old male victim died from blunt force trauma to the head when the 4-wheel ATV on which he was a passenger struck a rock on a hill connecting two roads and flipped over backwards onto the victim, shattering his bicycle helmet. The victim was life-flighted to the hospital and died that night. The driver of the ATV, the victim’s 29 year old father, sustained minor injuries, but wasn’t treated.

Helmets should have one of these:

1. DOT label
2. Snell label
3. ANSI Z90.1 label

Prevention

These helmets should provide full-face protection.

If you drop or damage your helmet, get a new one immediately. Your helmet may not protect your head from injury if it has cracks, fissures, or other damage to its outside or core padding.

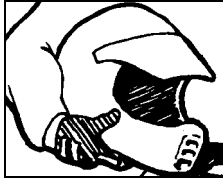

Remember, your helmet won't do you any good if the chin strap isn't fastened.

Eye Protection

Wear eye protection, such as goggles, to completely surround your eyes to prevent getting dirt or other items in your eyes. Do not depend on sunglasses for proper eye protection. Sunglasses are not recommended; they don't prevent objects from flying in through the sides.

Long Pants and Long Sleeved Shirt

The goal is to protect your body from branches, long grass, airborne objects, or anything else that could scrape your skin. The more thick and durable the material, the better protection it'll provide. Riding pants with kneepads, a jersey, and shoulder pads provide the best protection.

ATV Condition

The second step in Prevention is checking the condition of your ATV. Chances are good that you'll be using your ATV in some rough terrain, and there's no way you want your brakes to go out when riding downhill. You need to check the following parts on your ATV before every ride.

1. Tires and Wheels
2. Controls and Cables
3. Lights and Electric
4. Oil and Fuel

5. Chassis
6. Miscellaneous Items

One easy way to remember what parts you need to check is by using the acronym "T-CLOC." It stands for:

T	C	L	O	C
TIRES AND WHEELS	CONTROLS AND CABLES	LIGHTS AND ELECTRIC	OIL AND FUEL	CHASSIS

1. TIRES AND WHEELS

Correct tire pressure is crucial. Consult the Specifications section of this Operator's Manual for tire pressure guidelines. Incorrect tire pressure can cause poor handling, instability, and a loss of ATV control.

Check:

1. Tire pressure
2. Tire surface (tread and sidewalls)

While checking the tire pressure, inspect the tread and sidewalls of the tires for cracks, cuts, or other damage that could indicate they need to be replaced.

2. CONTROLS AND CABLES

With the engine running and brake applied, check all transmission positions: forward, neutral, and reverse.

Check:

1. Forward
2. Neutral
3. Reverse

A. Brakes

Squeeze the hand brake lever. If it feels soft or "squishy," it could be low on fluid or have a leak — refer to the General Maintenance section of this Operator's Manual for instructions. Don't use the ATV until the brakes are operating normally.

Check:

1. Hand brake lever
2. Brake pedal
3. Brake lever lock

Prevention

Test the brake lever lock and see if it locks the hand brake lever into position; then disengage it to release the brake. Be sure the brake pedal near the footrest is working; your brakes could fail during a ride if they're not maintained.

B. Throttle

The throttle should have a free, smooth range of motion. If it seems to "stick" at any point, refer to the General Maintenance section of this Operator's Manual for instructions. Driving your ATV with a sticking throttle can turn your leisurely ride into an unwelcome accident. Don't drive your ATV if the throttle sticks.

Check:

1. Free, smooth range of motion

3. LIGHTS AND ELECTRIC

Turn the hi-beam and lo-beam on and off to make sure they work. At the same time, verify the taillight and brakelight work. Also, check the status/warning indicators (reverse, neutral, and hi-lo beam) on the handlebars when you start the ATV. Don't drive the ATV unless all systems are working. Check the ignition switch and engine stop switch.

Check:

1. Hi-beam
2. Lo-beam
3. Taillight/brakelight
4. Status/warning indicators
5. Ignition switch
6. Engine stop switch

4. OIL AND FUEL

Start with a full tank of gas before every ride, and while you're at it, top off the oil. Don't forget to check for fluid leaks around the ATV. Watch the overheat indicator to ensure the engine coolant level is adequate.

Check:

1. Gas
2. Oil
3. Fluid leaks

5. CHASSIS

Grass and leaves can gum-up your suspension and shocks. Clear and clean the suspension arms, shock springs, and fenders. Check smoothness by turning the handlebar full-left and full-right. Check that there is no binding, restrictions, free-play, or looseness in steering components.

Check:

1. Suspension arms
2. Shock springs
3. Fenders
4. Steering

6. MISCELLANEOUS ITEMS

Inspect your air filter. Look for debris or damage that may indicate you need to replace it. A clogged filter can stop an engine. Check your battery terminals for corrosion. Also, be sure to tighten any loose parts, nuts, or bolts.

Check:

1. Air filter
2. Battery
3. Tighten parts, nuts, and bolts

First Aid and Survival

You need to prepare for the unexpected. Emergencies and accidents are traumatic enough, but they're even worse when you're not prepared for them. At the minimum during every ATV ride, you should have the following items on board:

- Tools
- Water
- Identification
- First Aid Kit

For rides that are longer in duration and distance, the following additional items are recommended:

- Cellular Phone
- Maps/GPS
- Emergency Kit *with Flashlight and First Aid Kit*

Prevention

Tools

Routine maintenance will generally eliminate the need for emergency repairs. Riding on rough terrain could cause loosening of nuts, bolts, and fasteners. Especially on long rides, carrying the right tools can prevent an inconvenience from becoming a crisis.

Carry these items on your ATV:

1. Bulbs
2. Duct tape
3. Rope
4. Spark plugs
5. Spare parts
6. Tool Kit

Water

Water is so important that you need to carry it regardless of the duration of your ride. Heat exhaustion and heat stroke can creep up suddenly and can take you out of commission. If you become dehydrated, you could find yourself physically unable to safely operate your ATV.

Identification

If something does happen to you, the emergency personnel will want to know who you are and whom to contact. It's possible you may be in no condition to give them that information. Put your I.D. in your pocket before you ride. Without it, you're anonymous.

Cellular Phone

It may be necessary to make an urgent phone call.

Maps/GPS (Global Positioning System)

Maps may be unnecessary when you're familiar with the area. But when you're riding on unfamiliar trails, it's good to know where you are, what's coming up, and how to get back.

Emergency Kit with Flashlight and First Aid Kit

You'll need several items in your Emergency Kit including a flashlight. The matches will come in handy if you need to start a fire to stay warm. Flares are appropriate for signaling help. A first aid kit is very important if an injury of some type should happen. A good First Aid Kit should include bandages, antiseptic spray, gauze, tape, etc.

Carry these items:

1. Flashlight
2. Matches
3. Flares
4. First Aid Kit
5. Money

Active Riding

Overview

“Active Riding” is the second part of “P.A.S.S.” It involves an understanding of how your body weight, balance, gravity, and physical forces affect the handling of the ATV. For example, when you drive a car quickly into a sharp turn, your body is pulled to the outside of the vehicle by centrifugal force. Although a car is relatively stable, enough centrifugal force can cause an ATV to overturn. Constantly shifting your weight is one major difference between driving a car and riding an ATV. Knowing how to shift your weight is necessary to avoid rolling or flipping the ATV.

For complete operating instructions, see ATV OPERATION section in this manual.

Sound Judgment

Overview

You are not invincible. Knowing that the first “S” in “P.A.S.S.” stands for “Sound Judgment” means you need to use yours.

Do you consider yourself to be pretty conservative, or are you a heavy risk-taker? Before continuing with this section on sound judgment, check your **Risk Factor** by doing this short survey:

1. Do you drive over the speed limit?

1	2	3
Never	Sometimes	Often

2. Are you more daring around your friends than you are when alone?

1	2	3
Never	Sometimes	Often

3. Do you drive your car when the gas gauge is on empty?

1	2	3
Never	Sometimes	Often

4. Do you feel that no matter what you do, you won't get hurt?

1	2	3
Never	Sometimes	Often

5. Do you drink or use drugs before you drive your car?

1	2	3
Never	Sometimes	Often

6. Do you drive your car even if it has a major problem with the brakes, tires, or engine?

1	2	3
Never	Sometimes	Often

7. Do you thrive on the adrenaline rush you get from speeding and dangerous situations?

1	2	3
Never	Sometimes	Often

8. Do you hurt yourself because you do things that are out of your ability range?

1	2	3
Never	Sometimes	Often

9. Do you tailgate other drivers when you think they're driving too slow?

1	2	3
Never	Sometimes	Often

10. Do you ignore weather reports before you do outside activities like swimming, camping, fishing, or boating?

1	2	3
Never	Sometimes	Often

Add the totals from lines 1-10. **YOUR RISK FACTOR IS:**

10-15: You're pretty conservative. Chances are good that the consistently safe choices you make will help you avoid hurting yourself and the people around you.

16-20: You're straddling the fence. Depending on your mood or whom you're with, the choices you make may help you or hurt you.

21-30: You're taking your chances. Time to reconsider a lot of the judgments you make. You're destined to put yourself in dangerous situations and potentially hurt yourself and the people around you.

Environment

The environment you operate an ATV in is often harsh and sometimes dangerous if you don't take proper precautions.

Sound Judgment

Weather

You need to consider the weather. It is dangerous to ride your ATV when the weather is bad or potentially bad. Keep abreast with weather forecasts.

Terrain

Always pay close attention to the terrain you're on, even if it is familiar to you. You can't assume that the landscape you're used to doesn't change. Changes to landscape can happen at nearly any time. Fences can be constructed and excavations dug in a short period of time. Weather, climate, and development take their toll.

The thing about terrain is that sometimes you don't know it's changed until you get there. Whether it's familiar or not, check out your surroundings before and during your ride.

Night Riding

Riding at night can be very hazardous. Obstacles and other hazards (that are easily identified during daytime) are much more difficult to see and avoid. When night riding, make sure the lights are properly adjusted and in good working order. Reduce speed; do not over-drive the headlights. Never travel in an unfamiliar area or blaze a new trail at night. Always carry a flashlight or flare for signaling an emergency.

Paved Surfaces

Don't do it! The ATV isn't designed for pavement. Its handling becomes more difficult on paved surfaces.

Trail Riding

Use sound judgment when trail riding; that means riding on a trail that fits your ability level. If the trail is pretty rugged, standing up on your footrests will make it easier for you to endure the rough terrain.

Make yourself visible by using headlights and taillights, and pull completely off the trail if you need to stop.

Outsloped trails (trails that slant to allow rain to run off) make trail riding a bit more challenging. Accepting that challenge means keeping your weight shifted into the slope. Denying the challenge means sliding off the trail.

It also helps to know which trails you can ride and who else might be on those same trails. These are signs currently used in some areas to designate trail types and restrictions.

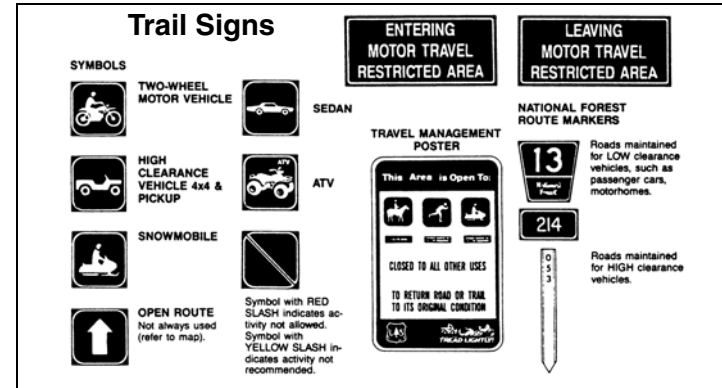

ATV-0068

Those Around You

People do all kinds of things that you can't predict or control.

Riding Companions

Leave a lot of space between you and other riders, especially in dusty and dirty conditions, because it'll be difficult to see the riders in front of you stopping.

Riding with companions on several ATV's is not the same as riding one ATV with a passenger. Passengers are prohibited; it's unsafe. The extra weight on the seat makes the ATV difficult to control. About 50% of all ATV accidents involve passengers.

Sound Judgment

Other Vehicles

Depending on where you're riding, you might encounter other ATV's, bikes, or motor vehicles on public lands. Respect the presence of cars if you're crossing roads or riding in public areas and make yourself be seen. If you can't see other vehicles coming, that means you're invisible, too.

Hikers

With the renewed interest in hiking, camping, and other outdoor activities, people can show up in remote areas where you would never expect them. For their sake, keep your eyes open.

Animals and Nature

Respect the outdoors that you love. Don't use your ATV to chase animals or birds. Drive around young trees rather than over them. Keep clear of streams and ditches with standing water.

Tread Lightly and leave it as you found it.

Equipment

The last thing you expected was that your ATV would break down in the middle of the field... it's usually so reliable that sometimes you forget the ATV has its limits.

TESTIMONIAL	
DOCUMENT#:	N380310A1
CITY/STATE:	NEW CUMBERLAND, WV
SEX:	M
AGE:	18
BODY PART:	HEAD
DATE ACCIDENT:	7-30-93
DISPOSITION:	DOA
SYNOPSIS:	An 18 year old male died as the result of injuries which he sustained in an accident while driving a 4-wheel ATV on a gravel public road. The victim lost control of the ATV when he suddenly applied the brakes to avoid a dog crossing the road. During the accident, the ATV's brake lever penetrated the victim's brain through his right eye resulting in death. The victim was not wearing a helmet.

ATV Maintenance

You have to maintain your ATV. The General Maintenance section of this Operator's Manual tells you about taking care of your ATV. If, at any time, abnormal noises, vibrations, or improper functioning of any component of this ATV is detected, **DO NOT OPERATE THE ATV**. Take the ATV to an authorized Arctic Cat ATV dealer for inspection and adjustment or repair.

Cargo Limitations

One reason why passengers are prohibited on ATV's is because their presence throws off the weight and balance of the ATV. Cargo can do the same if it weighs too much. Limit the ATV to the load capacity ratings identified in the following chart for the particular model being operated. So if you're weighing in at over 200 lb (91 kg) when you ride, leave some of that extra cargo at home. The combined weight limit, including you, your rack cargo, and your trailer, is a specified amount, so consult the ATV Load Capacity Ratings Chart and monitor it carefully.

Extra weight on the ATV will also throw you off balance if it's not distributed evenly, side-to-side and front-to-rear. If you have 150 lb (68 kg) on the rear rack only and you're heading up an incline, shifting your own weight forward isn't going to do enough to compensate for that cargo sitting over the back tires.

Cargo has such a huge affect on ATV handling that you need to pay a lot of attention to your speed. Even on really level areas, you should keep it under 10 mph (16 kph) if you've got a trailer attached. Avoid uneven terrain. Also, consider that your braking distance is going to increase with the more weight you carry.

Think about these when dealing with cargo:

1. Rack weight limit
2. Trailer weight limit
3. Weight distribution
4. ATV speed

Sound Judgment

Load Capacity Ratings Chart

Arctic Cat ATV Load Capacity Ratings		
Item	Specifications	
	(lb)	(kg)
Vehicle Load Capacity	285	129
Tongue Weight	35	16
Towing Capacity	1050	477

Vehicle Load Capacity - Total weight of operator, accessories, and tongue weight.

Tongue Weight - Weight on trailer tongue.

Towing Capacity - Total weight of trailer and all cargo in the trailer.

■ **NOTE: Tongue and accessory weight (winch, brackets, etc.) must be included as part of the weights.**

■ **NOTE: Use extra caution when operating an ATV with additional loads such as accessories and/or cargo. Handling of the ATV may be adversely affected. Reduce speed when adding additional loads.**

WARNING

POTENTIAL HAZARD

Overloading the ATV or carrying or towing cargo improperly.

WHAT CAN HAPPEN

Could cause changes in ATV handling, which could lead to an accident.

HOW TO AVOID THE HAZARD

Never exceed the stated load capacity for the ATV.

Cargo should be properly distributed and securely attached.

Reduce speed when carrying cargo or pulling a trailer. Allow greater distance for braking.

Always follow the instructions in this Operator's Manual for carrying cargo or pulling a trailer.

Personal Choices

A safe, enjoyable ride is dependent on many personal choices. An ATV, like all motorized vehicles, can be dangerous to operate if you choose to ignore safety precautions, take unnecessary chances, or ride beyond your ability or your machine's capability. Don't allow the thrill of freedom or adventure to affect your ability to make good, safe choices.

Alcohol and Drug Consumption

Alcohol is related to a high percentage of all hospital admissions due to ATV accidents in the U.S. This isn't an issue of morality.

It's extremely dangerous to drink alcoholic beverages and ride... it's also very foolish. When the alcohol starts kicking in and you're tearing along on your ATV, those odds can catch up to you.

Substances to avoid when riding:

1. Alcohol
2. Over-the-counter or prescription drugs

Sound Judgment

Be aware of prescription and over-the-counter medications. Drowsiness and impaired judgment can be caused by a wide variety of medications. The same is true of allergy, cold, flu, and headache medications. Your physical size and weight can't protect you... just one antihistamine tablet can affect your judgment.

If your sense of adventure persuades you to do illegal drugs when you're riding your ATV, this is a reality check. Something to think about—there can be legal consequences that will take away all that freedom you love. Don't use alcohol or drugs before or during your ATV ride.

THE EFFECTS OF ALCOHOL* <i>The Number of Drinks that Impair Mental and Physical Abilities</i>
1-2 DRINKS
Mental processes such as restraint, awareness, concentration, and judgment affected; reaction time slowed; inability to perform complicated tasks.
3-4 DRINKS
Depth perception, glare recovery, eye movement, and focus affected; decreased judgment and control.
5+ DRINKS
Coordination deteriorates, loss of critical judgment, and impaired memory and comprehension.
*According to the ATV Safety Institute.

Your Physical Condition

Being physically exhausted is like being drunk. Try to do something that's detail-oriented when you're really tired, and you'll feel totally uncoordinated.

Don't ride:

1. When you're tired

Reckless Riding

If you are involved in an ATV accident when you're speeding, you have a 25% chance of landing yourself in the hospital. The faster you go, the more likely you are to destroy your head and internal organs, and skip the wheelies, jumps, stunts, and any other showboating.

Laws and Regulations

Any police officer will tell you that ignorance of the law is no defense. Your best defense is to check out your local, state, or provincial ATV laws before riding. It'll also make sure that you can continue to ride in your favorite areas. The quickest way to have a land area closed is by riding over the regulations.

Group Behavior

People occasionally do crazier and riskier things in a group than they would consider doing by themselves. When you're ATV riding with others and things start to get out of hand, decide whether you're willing to be injured or see your friends injured.

SIPDE

By themselves, none of these safe behaviors and sound judgments will go very far. But when you put them all together... when you're paying attention to how you feel, when you're monitoring the movements of your ATV, and when you're constantly evaluating your environment, then you're practicing SIPDE. SIPDE is an acronym that stands for:

S	I	P	D	E
SCAN/ SEARCH	IDENTIFY HAZARDS	PREDICT WHAT WILL HAPPEN	DECIDE WHAT TO DO	EXECUTE THE DECISION

Supervision

Overview

You're responsible for supervising those who ride your ATV. Your wisdom is valuable... it'll bring them all back safely—your friends, your family, your relatives, and your ATV. It's crucial that you consider yourself a supervisor for all riders of your ATV. Whether you accept responsibility or not, the truth is that you are responsible for others riding your ATV.

Taking Responsibility

You're to the last letter in "PASS"... "Supervision." You've just gone through the manual, and you've seen what's involved. That puts you in a good position to be confident about what you know. So now it's time to use your knowledge and supervise others who ride your ATV.

Inexperienced/ Untrained Riders

You can't let people ride your ATV who don't know what they're doing. Unless they've had over a year of experience with ATV riding or taken an ATV training course, it's your responsibility to keep them off your ATV. It can be dangerous (especially for underaged children) — all the more reason for you to be firm.

TESTIMONIAL

DOCUMENT#: N37023A1
 CITY/STATE: MOOERSFORKS, NY
 SEX: F
 AGE: 5
 BODY PART: UPPER TRUNK
 DATE ACCIDENT: 6-29-93
 DISPOSITION: DOA
 SYNOPSIS: The victim of this incident, a five year old female, was operating a four wheeled all terrain vehicle (ATV) in the front yard of her parents' house, under the supervision of her father. The victim drove the ATV down an area where the only way to turn around was around a grain silo. The victim was executing a right hand turn when the vehicle tipped over to the right and fell onto her body. The victim was transported to a local hospital where she was pronounced dead on arrival. Photographs of the incident were not taken by law enforcement officials.

Experienced/Trained Riders

If anyone is going to borrow your ATV, you are responsible for their supervision. Before they ride, have them take the training course, have them watch the safety video, and have them read the Operator's Manual. You train them. It doesn't matter how you do it, as long as you do it.

ATV's are all a little different from the handling to the stability to the controls. So regardless of how much experience your family members have with ATV's, they don't have experience with *your* ATV. Let experienced riders get familiar with your ATV—show them the basics before they take off. You don't want it on your conscience that someone got hurt because you didn't tell them how to use your ATV.

Remember that regardless of experience, you should never let anyone under the age of 16 operate your ATV.

Arctic Cat and the ATV Safety Institute recommend that all ATV operators ride the appropriate-sized ATV according to age.

Category	Age (Years)	Speed Limitations (MPH)	NOTES
Y-12+	12 or Older	15 - Limited 30 - Maximum	Operate Under Adult Supervision
T-14	14 or Older	20 - Limited 30 - Limited 38 - Maximum	Operate Under Adult Supervision
G & S	16 or Older	According to Local Regulations	—

DIVISION II - OPERATION/ MAINTENANCE

ATV Specifications

ENGINE		450
Type	Four-Cycle/Liquid Cooled	
Bore x Stroke	89 mm x 71.12 mm (3.5 x 2.8 in.)	
Displacement	442.45 cc (27 cu in.)	
Spark Plug Type	NGK CR7E	
Spark Plug Gap	0.7-0.8 mm (0.028-0.031 in.)	
Brake Type	Dual lever, independent front & rear hydraulic brakes w/foot brake	
CHASSIS		
Length (Overall)	186.2 cm (73.3 in.)	
Height (Overall)	118.9 cm (46.8 in.)	
Width (Overall)	120.7 cm (47.5 in.)	
Suspension Travel (Front/Rear)	17.7 cm (7.0 in.)	
Tire Size (Front)	23 x 8-12	
Tire Size (Rear)	23 x 10-12	
Tire Inflation Pressure	40 kPa (5.7 psi)	

Specifications subject to change without notice.

MISCELLANY	
Dry Weight (Approx)	272.2 kg (600 lb)
Gas Tank Capacity	16.3 L (4.3 U.S. gal.)
Differential Capacity	275 ml (9.3 fl oz)
Coolant Capacity	1.8 L (1.9 U.S. qt)
Rear Drive Capacity	250 ml (8.5 fl oz)
Engine Oil Capacity (Approx)	2.8 L (3.0 U.S. qt)
Gasoline (Recommended)	87 Octane Regular Unleaded
Engine Oil (Recommended)	Arctic Cat ACX All Weather (Synthetic)
Differential/Rear Drive Lubricant	SAE Approved 80W-90 Hypoid
Taillight/Brakelight	12V/5W/21W
Headlight	12V/35W (4)
Running Light	5W
Starting System	Electric

Location of Parts and Controls



KC405A



KC401A



KC391A

1. Battery
2. Headlights
3. Rear Brake Lever
4. Power Distribution Module
5. Electrical Access Panel
6. Seat Latch
7. Storage Compartment
8. Reverse Override Switch
9. Foot Brake
10. Brake Lever Lock
11. Key Switch
12. Shift Lever
13. Throttle Limiter
14. Throttle Lever
15. Front Brake Lever
16. Taillight/Brakelight
17. Operator's Manual Location
18. Headlight HI/LO Switch
19. Starter Button
20. Engine Stop Switch
21. Drive Select Switch

■ **NOTE:** The ATV you have purchased may differ slightly from those shown in the figures of this manual.

ATV Operation

Basic Operating Maneuvers

Active riding and basic maneuvers are the foundation of your ATV ride. Without basic skills, it's impossible to move to this level—active riding. These are your basic maneuvers:

- Mounting the ATV
- Starting the Engine
- Starting a Cold Engine
- Braking/Stopping
- Shifting
- Parking
- Dismounting the ATV

Mounting the ATV

1. From the left side, grab the left-side handlebar, apply the brake, and put your left foot on the footrest.
2. Grab the right-side handlebar.
3. Swing your leg over the seat and set your right foot down on the right-side footrest.
4. Get seated in a comfortable position.
5. Always keep your feet planted on the footrests.

Starting the Engine

Always start with the ATV on a flat, level surface. Carbon monoxide poisoning can kill you, so keep your ATV outside while it's running. Follow these steps to start it up:

1. Mount the ATV and sit down.
2. Engage the brake lever lock.
3. Turn on the ignition.
4. Shift into neutral.
5. Move the engine stop switch to RUN.

6. Press the starter button.

CAUTION

Do not run the starter motor for more than eight seconds per starting attempt. The starter motor may overheat causing severe starter motor damage. Allow 15 seconds between starting attempts to allow the starter motor to cool.

7. Let the engine warm up.

Another way to remember the starting procedure is by using the acronym “BONE-C.” It stands for:

B	O	N	E	C
BRAKES LOCKED	IGNITION SWITCH ON	NEUTRAL TRANSMISSION	ENGINE SWITCH	AUTOMATIC CHOKE

Starting A Cold Engine

■ **NOTE: It is very important not to touch or compress the throttle lever during the starting procedures.**

1. Turn off all electrical accessories (hand warmer, lights, etc.); then rotate the ignition switch key to the first position (ON) leaving the headlights OFF. Note that the N is indicated on the LCD.
2. Press on the starter button.

CAUTION

Do not run the starter motor for more than eight seconds per starting attempt. The starter motor may overheat causing severe starter motor damage. Allow 15 seconds between starting attempts to allow the starter motor to cool.

■ **NOTE: Do not touch the throttle lever until the engine has run for at least 3 minutes.**

ATV Operation

3. Allow the engine to warm up for approximately 2-3 minutes or until the ATV will accelerate without hesitating.

Braking/Stopping

Always allow plenty of room and time to stop safely. Sometimes quick stops are inevitable, so always be prepared. Whether you're stopping slowly or stopping quickly, do this:

1. Squeeze the left brake lever or step on the brake pedal to apply the rear brakes, and squeeze the right brake lever to apply the front brakes.
2. If your wheels lock, release them for a second; then apply them again.
3. Never "ride" the brake. Even maintaining minimal pressure on the brake lever will cause the brake pads to drag on the disc and may overheat the brake fluid.

⚠ WARNING

Excessive repetitive use of the hydraulic brake for high speed stops will cause overheating of the brake fluid and premature brake pad wear which will result in an unexpected loss of brakes.

⚠ WARNING

Use only Arctic Cat approved brake fluid. Never substitute or mix different types or grades of brake fluid. Brake loss can result. Check brake fluid level and pad wear before each use. Brake loss can result in serious injury or death.

Shifting

The Arctic Cat ATV with an automatic transmission has a dual-range transmission with reverse. To shift the ATV, follow these steps:

1. To engage the high range from neutral, move the shift lever forward.
2. To engage the low range from high range, move the shift lever outward and forward.

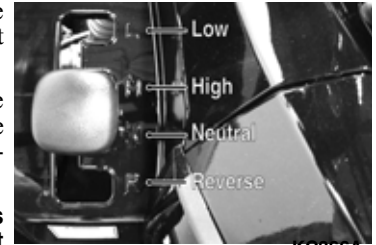

KC366A

■ NOTE: The high range is for normal riding with light loads. The low range is for carrying heavy loads or trailer towing. Compared to HIGH range, the LOW range position provides slower speed and greater torque to the wheels.

CAUTION

Always shift into low range when operating on wet or uneven terrain, when towing or pushing heavy loads, and when using a plow. Failure to follow this caution may result in premature V-belt failure or in damage to related drive system components.

3. To engage reverse gear from neutral, move the shift lever outward and rearward into the R position.

CAUTION

Always come to a complete stop before attempting to shift from one range to the other or into reverse. Always shift on level ground, or engage the brake lever lock before shifting into another range or into reverse.

⚠ WARNING

Do not start the engine or operate this ATV with the clutch shield removed. Serious injury could result.

ATV Operation

Parking

Parking involves following the previous rules for braking; then:

1. After the ATV stops, shift into neutral.
2. Stop the engine using the engine stop switch.
3. Turn off the ignition.
4. If you have to park on a hill, shift the ATV into low gear; otherwise, try to park only on level surfaces.
5. Engage the brake lever lock.

Dismounting the ATV

After you've followed the procedure for parking, it's time to dismount:

1. Double check that the brake lever lock is engaged.
2. Swing your right leg over to the left side of the seat.
3. Step to the ground on the left side of the ATV.

Handling the ATV (Active Riding Techniques)

Active riding involves moving your body. You must learn to lean and shift your weight into your turns to maintain control.

Your safety depends on using safe riding techniques. Statistics from the U.S. Consumer Product Safety Commission (CPSC) say that inexperienced riders who don't use safe riding techniques are **13 times more likely to have an ATV accident** than riders who have over 1 month of experience.

Safe riding techniques include:

- Riding
- Leaning, Weight Shift, and Balance
- Wide Turns

- Sharp Turns
- Quick Turns
- K-Turns
- Riding Uphill
- Riding Downhill
- Sidehilling/Traversing
- Swerving
- Crossing Obstacles

Riding

Once the engine's warm, the ATV is ready to go.

1. Keep your feet on the footrests and both hands on the handlebar.
2. Hold the brake lever, and release the brake lever lock.
3. Shift into gear.
4. Release the brake slowly and apply the throttle.

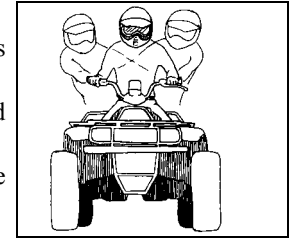

Leaning, Weight Shift, and Balance

When you turn, the trick is to move forward and slide over to the side of the seat that's on the inside of the turn. Support your body weight on the outside footrest. At the same time, lean your body to the inside of the turn. Pay attention to the handling—if you feel the tires coming off the ground, reduce speed, shift more of your body weight to the side that's lifting, and make the turn wider if possible.



ATV Operation

Wide Turns

About 20% of ATV accidents happen during turns. If you don't understand turning techniques, it's easy for the ATV to get away from you by losing traction, plowing, or tipping. Use this method for wide turns:

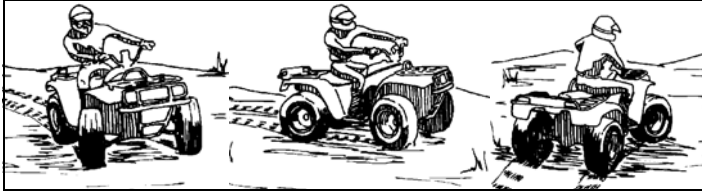

1. Ease off the throttle as you approach the turn to slow down.
2. Use the principles of leaning, weight shifting, and balancing—shift your body weight to the inside of the turn.
3. Gradually increase your speed as you come out of the turn.

Sharp Turns

After mastering wide turns, practice the advanced skill of sharp turns.

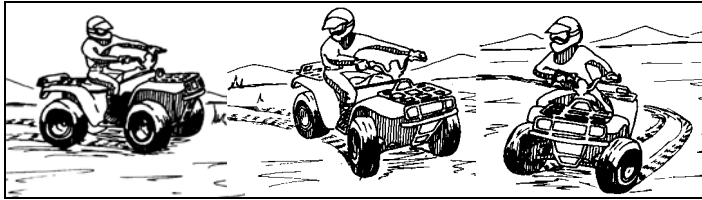

1. Ease off the throttle as you approach the turn to slow down.
2. Use the principles of leaning, weight shifting, and balancing—shift your body weight to the inside of the turn.
3. You might have to lean into the turn more than you do in a wide turn.

4. If shifting your weight and balance aren't enough to keep the ATV tires on the ground, straighten out the handlebar as much as you can.

5. Gradually increase your speed as you come out of the turn.

Quick Turns

Quick turns are the most difficult turns and should only be done after you are experienced with your ATV.

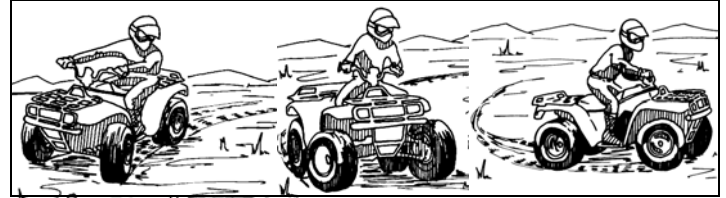

1. Ease off the throttle as you approach the turn to slow down.
2. Turn the handlebar, shift your weight, and balance at the same time as you enter the turn (use the principles of leaning, weight shifting, and balancing—shift your body weight to the inside of the turn).
3. Follow this with slight acceleration.
4. For multiple turns, repeat this movement as needed.
5. To make your turn quicker, try raising yourself off the seat a few inches as you shift your weight.

ATV Operation

K-Turns

Use K-turns if you accidentally stall while riding uphill; you need to take action before the ATV rolls backward down the hill.

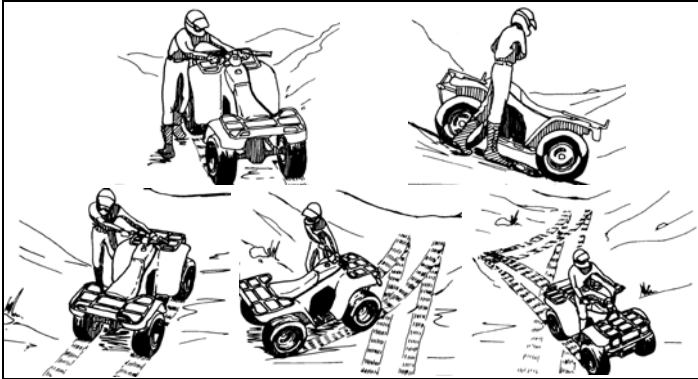

1. Stop where you are, apply the brakes, and shift to neutral.
2. Shut off the engine.
3. Keep your body weight shifted forward.
4. Get off the ATV on the uphill side.
5. If you're to the left of the ATV, turn the handlebar all the way left.
6. Partially release the brake, but lightly hold the brake lever.
7. Let the ATV roll to your right side until it faces slightly downhill.
8. Reapply the brakes.
9. Get back on the ATV from the uphill side, and keep your weight shifted uphill when you sit down.
10. Start the engine and follow the method for riding downhill.

Riding Uphill

Roughly 20% of accidents happen while riding on hills and as a result of the ATV rolling or flipping. So, obviously, use extreme caution and follow this method for riding uphill.

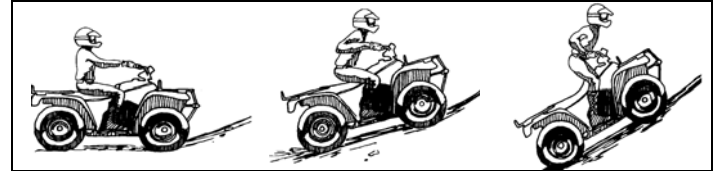

1. Shift down and accelerate before you start climbing; then maintain a steady pace.
2. Lean as far forward as possible. For steeper hills, come off your seat to stand and lean forward.
3. If you lose speed, quickly shift to low range. At the same time, release the throttle (so your front tires don't lift), **OR**
4. If that doesn't work and you still have forward motion and the terrain permits, do a U-turn, go back down, and try climbing again, **OR**
5. If you have lost all forward motion, follow the K-turn procedure.

Never Operate Up Or Down Hills Steeper Than 25°

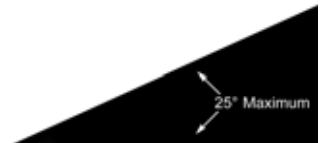

ATV Operation

Riding Downhill

Success in riding downhill depends on how well you know your brakes—take it easy on them, or you could flip over.

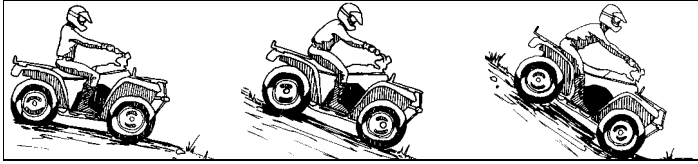

1. Shift your body weight as far back on the seat as possible.
2. Keep it in a low range; stay out of neutral.
3. Lightly apply the brake and ease up on the throttle.

Sidehilling/Traversing

Sidehilling is considered an advanced skill; it's really tricky and unpredictable. So, whether your skills are advanced or not, try to avoid this kind of riding. If you're in a situation where you absolutely have to sidehill, follow this method:

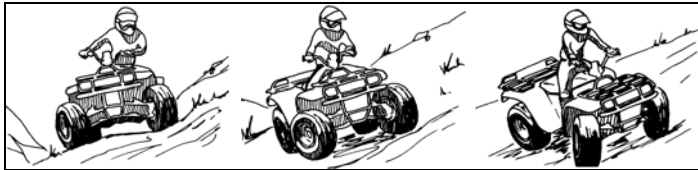

1. Keep your speed low and consistent.
2. Shift all your body weight to the uphill side of the seat; also, support your weight on the uphill footrest.
3. Steer like you're driving into the hill.

4. If the ATV feels like it's tipping, turn the handlebar downhill. If that's not possible because of the terrain or other conditions or if it just doesn't work, stop and get off. Dismount the ATV on the uphill side.

Swerving

Swerving is usually an emergency reaction to avoid an obstacle but is similar to quick turns. The difference is that quick turns involve slight acceleration in the turn; don't accelerate if you swerve.

1. Ease off the throttle as you approach the obstacle.
2. Turn the handlebar. At the same time, shift your weight and balance as you swerve. Use the principles of leaning, weight shifting, and balancing—shift your body weight to the inside of the turn.
3. Keep your hand off the brake until the emergency is over and you're back in control.



ATV Operation

Crossing Obstacles

Crossing obstacles is risky; avoid it if possible. Riding over logs, rocks, and ruts means combining all the active riding skills into one big motion. Your ATV will respond differently for different obstacles (logs, ruts, etc.), but these are general guidelines for overcoming two-track (both tires contacting the obstacle at the same time) obstacles:

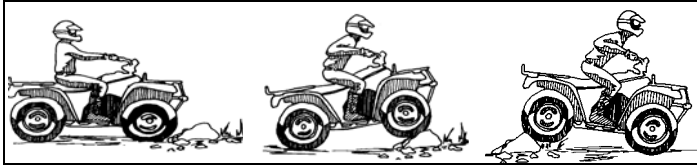

1. Keep your speed way down; less than 5 mph.
2. Approach the obstacle head-on.
3. Come up off the seat.
4. Keep your weight on the footrests.
5. Apply a little throttle when the front tires make contact with the obstacle.
6. Lean forward and release the throttle when the front tires clear the obstacle.
7. Keep your body loose to absorb any shock.
8. If the ATV starts tipping, shift your weight to keep it in balance.

To clear a single-track (only one tire contacts) obstacle, follow the same rules except:

1. Use the ATV's momentum to clear the obstacle.
2. Don't pull up on the handlebar.
3. Don't apply the throttle.

Tips

Driving an ATV and a car have some similarities; however, there are a few situations that require special attention:

- Reversing
- Skidding or Sliding
- Parking on a Hill
- Stalling on a Hill
- Crossing Water
- Crossing Roads
- Cold Weather Driving
- Stopping the ATV
- Stopping the Engine

Reversing

It's tough to see things behind you.

1. Go slowly. It's hard to see behind you.
2. Keep your handlebar straight.
3. Backing down hills is a bad idea; do a U-turn or K-turn instead to turn around.

Skidding or Sliding

If you lose control after hitting sand, ice, mud, or water:

1. Turn your handlebar into the direction of the slide.
2. Keep your hand off the brakes until you're out of the skid.
3. Shift your weight forward.

Sometimes your ATV may not respond and goes straight ahead instead of letting you turn. Here's how to handle it:

1. Slow down.
2. Move forward on the seat.

ATV Operation

3. Lean to inside of turn.
4. Turn handlebar.

Parking on a Hill

This shouldn't be necessary, but if it is:

1. Keep it in gear.
2. Engage the brake lever lock.
3. Find something to block the rear tires.

Stalling on a Hill

If you use the right method for riding uphill, this shouldn't happen. But if you have a problem, do this:

1. If the ATV hasn't started rolling backwards yet, follow the procedure for the K-Turn, **OR**
2. If the ATV is already rolling backward, lean as far forward as possible standing up on the footrests.
3. Nice and easy, apply the hand brake lever.
4. When you come to a stop, follow the procedure for the K-turn.
5. If the ATV continues to roll backward, dismount immediately on the uphill side.

Crossing Water

Your ATV can only handle water up to its footrests. Any more than that and you risk engine damage and/or injury. Stay away from fast moving rivers. ATV tires can be buoyant, so if the water is too deep, you might find the ATV suddenly afloat.

CAUTION

Riding through water deeper than the footrests may lead to severe engine damage due to water ingestion.

■ **NOTE:** Engine damage caused by water ingestion or immersion will not be covered by Arctic Cat warranty.

1. Physically check the depth and current of the water, especially if you can't see the bottom. You're also checking for boulders, logs, or any other hidden obstacles.
2. Keep your speed slow.
3. Make sure you have a way out on the other side of the water.
4. If you get stuck in the sludge or mud, try rocking the ATV from side to side.
5. Once you've cleared the water, briefly apply the brakes to make sure they work.

Crossing Roads

Crossing roads on your ATV is also a bad idea, so avoid it. If you can't:

1. Stop completely on the shoulder of the road.
2. Check both directions for traffic.
3. Crossing near a blind corner or intersection is dangerous; don't do it.
4. Drive straight across to the opposite shoulder.
5. Take into account that your ATV could stall while crossing; give yourself enough time to get off the road.
6. You have to assume that oncoming cars don't see you, and if they do, they won't be able to predict your actions.
7. It's illegal to cross public roads in some places. Know your local laws.

ATV Operation

Cold Weather Driving

■ **NOTE:** Check that all control levers move freely. Make sure that the footrest, shift lever, and brake pedal are free of ice and snow.

WARNING

For your personal safety, it is very important to wear the type and amount of cold-weather clothing according to the coldest anticipated temperatures.

1. With the transmission in neutral, move the ATV forward and backward to check that the wheels roll freely. If the ATV will not roll, the tires may be frozen to the ground or the brake pads may be frozen to the discs.
2. If the tires are frozen to the ground, pour warm water around them to melt the ice.

CAUTION

Before riding, manually move the ATV forward and backward to make certain that all wheels roll freely.

3. If the brakes are frozen, take the ATV to a warmer area to thaw out the brakes.

WARNING

Do not attempt to free frozen brakes by pouring warm water on the brake pads and housings.

■ **NOTE:** After the brakes thaw, dry them by applying them several times while riding slowly.

■ **NOTE:** After riding through water, mud, snow, or slush, it is important to dry both brake systems before parking the ATV.

WARNING

Go slowly and be extra careful when riding on snow-covered or ice-covered terrain. Always be alert to changing terrain conditions when operating the ATV.

4. Practice driving in an open snow-covered or ice-covered area at slow speeds before driving on snow-covered or ice-covered trails.
5. Learn how the ATV responds to steering and braking on the type of terrain to be encountered on the ride.

Stopping The ATV

To stop the ATV, first release the throttle lever. Next, apply the brake.

Stopping The Engine

To stop the engine, turn the ignition switch key to the OFF position or set the engine stop switch to the OFF position.

General Information

ATV Identification Numbers

The Arctic Cat ATV has two identification numbers: Vehicle Identification Number (VIN) and Engine Serial Number (ESN).

The VIN is located on the lower-front crossmember.



KC0055A

The ESN is located on the rear of the engine crankcase and is visible from the side.

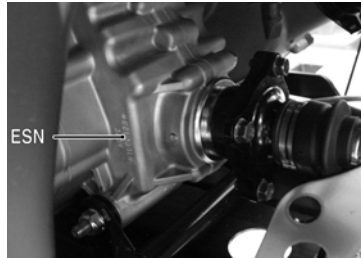

KC0055A

These numbers are required by the dealer to complete warranty claims properly. No warranty will be allowed by Arctic Cat if the VIN or ESN is removed or mutilated in any way.

Always provide the ATV name, Vehicle Identification Number, and Engine Serial Number when contacting an authorized Arctic Cat ATV dealer for parts, service, accessories, or warranty. If a complete engine must be replaced, ask the dealer to notify Arctic Cat for correct registration information.

Ignition Switch Key

Two keys come with the ATV. Keep the spare key in a safe place. An identifying number is stamped on each key. Use this number when ordering a replacement key.

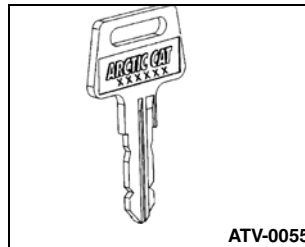

ATV-0055

Control Locations and Functions

Ignition Switch

The ignition switch has three positions.

OFF position — All electrical circuits except the accessory plug are off. The engine will not start. The key can be removed in this position.

■ **NOTE:** The accessory plug is powered by the battery at all times.

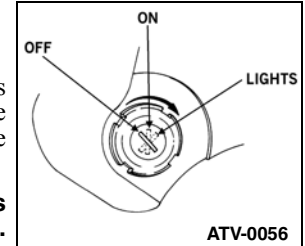

ATV-0056

ON position — The ignition circuit is complete and the engine can run. The key cannot be removed in this position.

LIGHTS position — The ignition circuit is complete and the running lights and taillights are on. The key cannot be removed in this position.

CAUTION

Leaving the ignition switch in the ON or LIGHTS position for a long period of time when the engine is not running may cause the battery to discharge. Always leave the ignition switch in the OFF position when engine is not running.

Shift Lever

This ATV has a dual-range automatic transmission with reverse.

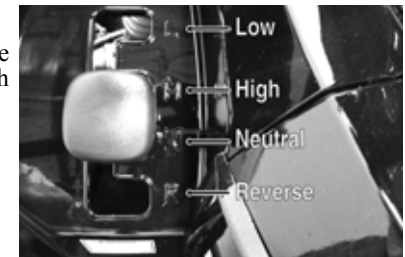

KC366A

Drive Select Switch

This switch allows the operator to operate the ATV in either two-wheel drive (rear wheels) or four-wheel drive (all wheels). For normal riding on flat, dry, hard surfaces, two-wheel drive should be sufficient. In situations of aggressive trail conditions, four-wheel drive would be the desired choice.



KC342B

To either engage or disengage the front wheels, move the switch to the 4WD position or to the 2WD position.

CAUTION

Do not attempt to either engage or disengage 4WD while the ATV is moving.

Hand Brake Levers/ Brake Lever Lock

The left hand brake is used to apply braking to the rear wheels when in two wheel drive; however, when operating in four wheel drive, braking will be applied to all four wheels.

Apply the brake by compressing the brake lever toward the handlebar.



KC377A

The right hand brake is used to apply braking to the front wheels when in two wheel drive; however, when operating in four wheel drive, braking will be applied to all four wheels.

The right hand brake also is equipped with a brake lever lock. To engage and release the brake lever lock, use the following procedure.

1. Squeeze the hand brake lever two or three times and release it.
2. Depress and hold the brake lever lock.
3. While holding in on the brake lever lock, squeeze the brake lever.

■ **NOTE:** It will click as it engages and the brake lever will not return to its released position.

4. Release the brake lever lock by squeezing the brake lever. It will return to its released position.

Check to make sure the brake lever lock engages properly and that the brake (when engaged) locks the wheels.

1. Pump the brake lever 2 or 3 times.
2. Engage the brake lever lock.
3. Attempt to push the ATV.

■ **NOTE:** The brake lever lock must lock the front wheels. If it doesn't, take the ATV to an authorized Arctic Cat ATV dealer for service.

⚠ WARNING

Always check to be sure that the brake lever lock has been disengaged before operating the ATV. An accident could result if the brake lever lock is left engaged while the ATV is operated. The brake may relax if left engaged for a long period of time. This could cause an accident; therefore, do not leave the ATV on a hill depending on the brake lever lock. Always block the downhill side of the wheels if leaving the ATV on a hill or park the ATV in a sidehill position.

■ **NOTE:** To lock all four wheel with the brake lever lock, turn the ignition switch to the ON position and select four wheel drive on the drive select switch (4WD); then engage the brake lever lock.

Rear Foot Brake

Pressing the rear foot brake downward will apply the brake to the rear wheels.

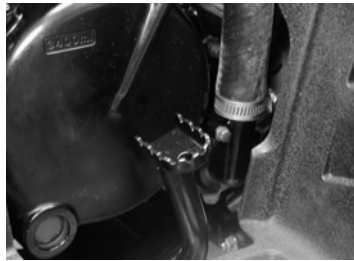

CF117

Headlight HI/LO Switch

Use the headlight HI/LO switch to select the running lights/tail-light and high or low headlight beam when the ignition switch is in the LIGHTS position. When the switch is in the HI position, the high beam will illuminate. When the switch is in the LO position, the low beam will illuminate. When the switch is in the Running Light position, the tail-lights and running lights will illuminate.



KM85

Engine Stop Switch

OFF position — The ignition circuit is off. The engine cannot be started or will not run. If the engine stop switch is used to stop engine without turning off ignition switch, the battery may discharge.

RUN position — The ignition circuit is on. The engine can start and run.

Starter Button

Pushing in on this button activates the starter motor. Before starting the engine, make sure the ignition switch is in the ON position, the transmission is in neutral, and the brake lever lock is engaged.

■ **NOTE:** This ATV has safety interlock switches which prevent the starter motor from activating when the transmission is not in neutral.

Reverse Override Switch

This ATV is equipped with a reverse speed limiter system. When additional RPM is needed in reverse, depress and hold the override switch.

WARNING

Never activate the override switch while the throttle is open as a loss of control may result.

Throttle Lever

Control engine RPM with the position of the throttle lever. Operate this lever with the thumb. Pushing it forward increases engine RPM and allowing it to retract decreases engine RPM.



KC342A

Throttle Limiter Screw

Throttle lever travel may be limited by adjusting the throttle limiter screw. The throttle limiter should be adjusted according to the operator's skill and experience. To adjust the throttle limiter, use the following procedure.

1. Loosen the jam nut.

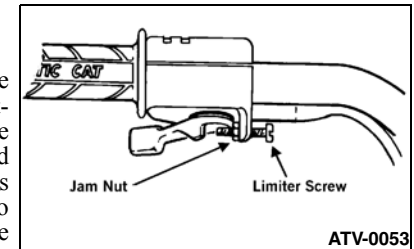

ATV-0053

- Turn the throttle limiter screw clockwise to decrease engine RPM maximum or counterclockwise to increase engine RPM maximum.
- Tighten the jam nut securely.

■ **NOTE:** The ATV is equipped with an RPM limiter that retards ignition timing when maximum RPM is approached. When the RPM limiter is activated, it could be misinterpreted as a high-speed misfire.

Speedometer/LCD (Digital)

■ **NOTE:** All segments of the LCD will activate for approximately two seconds when the ignition switch is rotated to the ON position.



- Clock/Engine Hour Meter - The clock function indicates time in the 12-hour mode; the hour meter indicates the total time the ATV has run and cannot be reset to zero. To set the clock, use the following procedure.
 - With the ignition switch ON, press and release the Mode Button (3) until the Clock/Engine Hour Meter (1) is displayed; then (if necessary) press and release the Set/Reset Button (4) to select the clock display.
 - Press and hold the Set/Reset Button (4) until the minutes stop scrolling and the hour display starts to scroll. Momentarily release when the correct hour is displayed; then repeatedly press and release the Set/Reset Button (4) until the correct minutes are displayed.

■ **NOTE:** Clock memory power is supplied through the 15-amp accessory fuse and verified during gauge “power-up” and reset. In the event of clock memory power failure (blown fuse, etc.), the gauge will “power-up,” reset, and shut down repeatedly until clock memory power is restored. Always check the 15-amp accessory fuse if this gauge condition is noted.

■ **NOTE:** The engine hour meter will not activate until engine speed exceeds 500 RPM.

- Temperature Indicator - If the engine coolant temperature exceeds the normal operating range, the temperature icon will begin flashing and the LCD will go blank for 30 seconds; then the LCD will return to normal. However, the temperature icon will continue to flash.

CAUTION

Continued operation with high engine temperature may result in engine damage or premature wear.

■ **NOTE:** High engine RPM, low vehicle speed, or heavy load can raise engine temperature. Decreasing engine RPM, reducing load, and selecting an appropriate transmission gear can lower the temperature.

■ **NOTE:** Debris in front of the engine (or packed between the cooling fins of the radiator) can reduce cooling capacity. Using a garden hose, wash the radiator and the engine to remove any debris restricting air flow.

CAUTION

Arctic Cat does not recommend using a pressure washer to clean the radiator core. The pressure may bend or flatten the fins causing restricted air flow, and electrical components on the radiator could be damaged. Use only a garden hose with spray nozzle at normal tap pressure.

3. Mode Button - Shifts the gauge through three set-up modes: speedometer/tachometer, distance, and time.

■ **NOTE: The Mode Button must be pressed and released to shift modes. Approximately two seconds after the Mode Button is released, the digital gauge will return to full display.**

4. Set/Reset Button - In conjunction with the Mode Button, sets and resets various displays on the digital gauge. Also used to shift from speedometer function to tachometer function on the speedometer/tachometer gauge.
5. Fuel Level Indicator - Indicates approximate amount of gasoline in the gas tank.

■ **NOTE: When the bottom segment flashes, approximately 3.5 L (0.92 U.S. gal.) of gasoline remains in the tank.**

6. Low Oil Pressure - Will be displayed during self-test at start-up. It will not be displayed during normal operation as oil pressure is not monitored on these models.
7. Odometer/Trip Meter - Odometer registers the total distance the vehicle has traveled. The trip meter is resettable and can be used to measure trip or trip legs. The odometer cannot be reset.

■ **NOTE: To shift between the odometer (ODO) or trip meter (TRIP), press the Mode Button (3) to select the distance mode; then press the Set/Reset Button (4) to select the desired display. Hold the Set/Reset Button down to reset the trip meter.**

8. Gear Position Indicator - Indicates which gear position is selected.
- R (reverse)/N (neutral)/L (low range)/H (high range)

■ **NOTE: An E will be displayed if there is an error caused by a no-shift position signal.**

9. High Beam Indicator - The High Beam icon will appear only when the headlights are on high beam.

10. Drive Select Indicator - Displays 4WD when selected by the drive select switch. The display is blank when in 2WD.

11. Speedometer - Indicates the approximate vehicle speed in miles per hour (MPH) or kilometers per hour (km/h).

■ **NOTE: To change mph/km/h display, press and release Mode Button (3) until the icon (MPH/km/h) appears; then press the Set Button (4) to change the display.**

Condition Warning Display - Uses odometer/trip meter display of the LCD to warn of a system error condition requiring attention.

- A. Volt - The LCD will go blank except the word VOLT will flash on the LCD whenever a low voltage (< 9 DC volts) or a high voltage (> 16 DC volts) is detected. When voltage returns to normal, the gauge must be reset by turning the ignition key to the OFF position and then to the ON position.
- B. EFI - The LCD will go blank except a diagnostic trouble code (DTC) will flash on the LCD and a wrench icon will be displayed whenever an electronic fuel injection malfunction is detected. After 30 seconds, the LCD will return to normal; however, the DTC and wrench icon will continue to be displayed until the malfunction is corrected.

■ **NOTE: Take the ATV to an authorized Arctic Cat ATV dealer to have the EFI error corrected and to have the ECU reset as soon as possible.**

Gas Hoses

Replace the gas hose every two years. Damage from aging may not always be visible.

Electric Fuel Pump

An electric fuel pump is incorporated in the gas tank to deliver gasoline to the fuel injector. The fuel pump is activated when the ignition switch is in the ON position.

■ **NOTE:** Both the ignition and fuel pump functions will be interrupted by the Tilt Sensor if the ATV tips over past 60°-70°. Righting the ATV will reactivate the ignition and fuel pump.

Oil Level Stick

There is an oil level stick for checking the engine oil level. To check the oil level, use the following procedure.

■ **NOTE:** The ATV should be on level ground when checking the engine oil level.

1. Unscrew the oil level stick and wipe it with a clean cloth.
2. Install the oil level stick and thread it into the engine case.
3. Remove the oil level stick; the engine oil level should be above the “L” mark but not higher than the “F” mark.

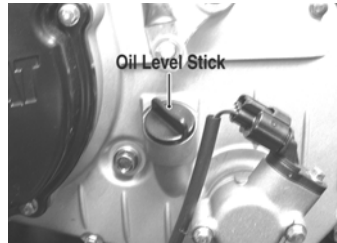

KC0051A

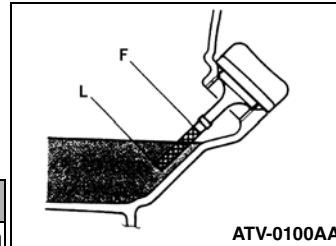

ATV-0100AA

CAUTION

Do not overfill the engine with oil. Always make sure the oil level is above the “L” mark but not higher than the “F” mark.

Seat Latch

1. To remove the seat, pull back on the latch release (located under the right rear of the seat); then raise the rear of the seat and slide it rearward.
2. To lock the seat into position, slide the front of the seat into the seat retainers and push down firmly on the rear of seat. The seat should automatically lock into position.



KC376A

⚠ WARNING

Make sure the seat is secure before mounting the ATV. Serious injury may result if the seat is not properly secured.

Safety Flag Bracket

A bracket is provided for mounting a flag at the rear of the ATV.

Trailering and Towing

⚠ WARNING

Never use the racks as a towing or trailering point.

Arctic Cat ATV's are equipped with a frame-mounted receiver for a standard 5.1 cm (2 in.) receiver hitch. The standard receiver hitch must be purchased separately.

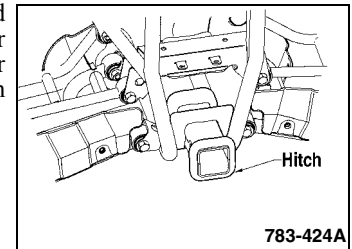

783-424A

When loading a trailer properly, two items are critical: Gross Trailer Weight (the weight of the trailer plus cargo) and Trailer Tongue Weight.

WARNING

Make sure that the load in the trailer is properly secured and will not shift while moving. Also, do not overload the trailer.

WARNING

Never exceed any of the ATV weight restrictions.

Trailer Tongue Weight is the downward force exerted on the hitch by the trailer coupler when the trailer is fully loaded and the coupler is at its normal towing height. Refer to the Load Capacity Ratings Chart for tongue weight information.

Always maintain a slow speed when trailering and towing and avoid sudden accelerations, quick maneuvers, and sudden stops. Braking distance will be affected when towing a trailer. When towing a trailer, always maintain slow speed and allow more stopping distance than when not towing a trailer.

WARNING

Riding an ATV without extra caution when towing a trailer will be hazardous. Trailer towing can affect the handling and braking of the ATV. Never tow a trailer without a rigid tongue and never exceed 10 mph. Avoid sudden accelerations and stopping of the ATV. Do not make quick maneuvers. Avoid uneven surfaces and do not tow on hills. Never carry passengers in a trailer unless the trailer is designed for such use. Allow more stopping distance than when not towing a trailer.

Transporting ATV

When transporting the ATV, Arctic Cat recommends that the ATV be in its normal operating position (on all four wheels) and the following procedure be used.

1. Engage the brake lever lock and place the transmission in gear.

CAUTION

Failure to engage the brake lever lock and place the transmission in gear could result in the ATV rolling off the trailer in the event of tie-down strap failure.

2. Secure the ATV with load rated hold-down straps.

NOTE: Suitable hold-down straps are available from your Arctic Cat ATV dealer. Ordinary rope is not recommended because it can stretch under load.

CAUTION

When using hold-down straps, care must be taken not to damage the ATV.

Gasoline-Oil-Lubricant Recommended Gasoline

The recommended gasoline to use in this ATV is 87 minimum octane regular unleaded. In many areas, oxygenates (either ethanol or MTBE) are added to the gasoline. Oxygenated gasolines containing up to 10% ethanol, 5% methane, or MTBE are acceptable gasolines.

When using ethanol blended gasoline, it is not necessary to add a gasoline antifreeze since ethanol will prevent the accumulation of moisture in the fuel system.

CAUTION

Do not use white gas. Only Arctic Cat approved gasoline additives should be used.

Recommended Engine/Transmission Oil

CAUTION

Any oil used in place of the recommended oil could cause serious engine damage. Do not use oils which contain graphite or molybdenum additives. These oils can adversely affect clutch operation. Also, not recommended are racing, vegetable, non-detergent, and castor-based oils.

The recommended oil to use is Arctic Cat ACX All Weather synthetic engine oil, which has been specifically formulated for use in this Arctic Cat engine. Although Arctic Cat ACX All Weather synthetic engine oil is the only oil recommended for use in this engine, use of any API certified SM 0W-40 oil is acceptable.

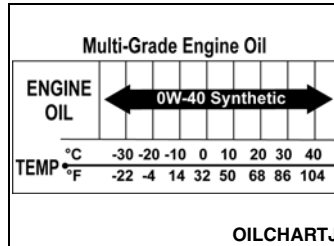

Recommended Front Differential/Rear Drive Lubricant

■ **NOTE:** Arctic Cat recommends the use of genuine Arctic Cat lubricants. The recommended lubricant (front differential and rear drive) is SAE approved 80W-90 hypoid. This lubricant meets all of the lubrication requirements of the Arctic Cat ATV.

CAUTION

Any lubricant used in place of the recommended lubricant could cause serious front differential/rear drive damage.

Filling Gas Tank

⚠ WARNING

Always fill the gas tank in a well-ventilated area. Never add gasoline to the ATV gas tank near any open flames or with the engine running or hot. **DO NOT SMOKE** while filling the gas tank.

Since gasoline expands as its temperature increases, the gas tank must be filled to its rated capacity only. Expansion room must be maintained in the tank particularly if the tank is filled with cold gasoline and then moved to a warm area.

Allow the engine to cool before filling the gas tank. Care must be taken not to overfill the tank. If overfilled, gas may leak onto the engine creating a fire hazard.

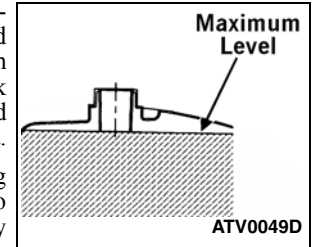

⚠ WARNING

Do not over-flow gasoline when filling the gas tank. A fire hazard could materialize. Always allow the engine to cool before filling the gas tank.

⚠ WARNING

Do not overfill the gas tank.

Tighten the gas tank cap securely after filling the tank.

Engine Break-In

After the completion of the break-in period, the engine oil and oil filter should be changed. Other maintenance after break-in should include checking of all prescribed adjustments and tightening of all fasteners. At the discretion and expense of the owner/operator, the ATV may be taken to an authorized Arctic Cat ATV dealer for this initial service.

New ATV's and renewed ATV engines require a "break-in" period. The first month is most critical to the life of this ATV. Proper operation during this break-in period will help assure maximum life and performance from the ATV.

During the first 10 hours of operation, always use less than ½ throttle. Varying the engine RPM during the break-in period allows the components to "load" (aiding the engine/transmission component mating process) and then "unload" (allowing components to cool). Although it is essential to place some stress on the engine components during break-in, care should be taken not to overload the engine too often. Do not pull a trailer during the break-in period.

When the engine starts, allow it to warm up properly. Idle the engine several minutes until the engine has reached normal operating temperature. Do not idle the engine for excessively long periods of time.

Burnishing Brake Pads

Brake pads must be burnished to achieve full braking effectiveness. Braking distance will be extended until brake pads are properly burnished.

To properly burnish the brakes, use following procedure:

1. Choose an area sufficiently large to safely accelerate ATV to 30 mph and to brake to a stop.
2. Accelerate to 30 mph; then compress brake lever to decelerate to 0-5 mph.
3. Repeat procedure twenty times.

WARNING

Do not attempt sudden stops or put yourself into a situation where a sudden stop will be required until the brake pads are properly burnished.

General Maintenance

■ **NOTE: Proper maintenance of the ATV is important for optimum performance. Follow the Maintenance Schedule and all ensuing maintenance instructions/information.**

If, at any time, abnormal noises, vibrations, or improper functioning of any component of this ATV is detected, DO NOT OPERATE THE ATV. Take the ATV to an authorized Arctic Cat ATV dealer for inspection and adjustment or repair.

If the owner/operator does not feel qualified to perform any of these maintenance procedures or checks, take the ATV to an authorized Arctic Cat ATV dealer for professional service.

■ **NOTE: The following instructions and information refer to specific items in the maintenance and care of the ATV.**

Maintenance Schedule					
Item	Page	Initial Service (1st Week)	Monthly	Quarterly	Annually
Battery	50	I	I		
* Engine nuts and bolts	-	I			I
* Valve clearance	-	I			I
Spark plug	53	I		I	I
	53	Replace every 4000 miles or 18 months			
Liquid Cooling System	47	I	Inspect every time before riding		
Throttle cable	53	I	Inspect every time before riding		
Gas hoses	41	I	Inspect every time before riding		
	41	Replace every 2 years			
Engine/transmission oil and filter	48	R		R**	
Air filter	54	I		I	
Air filter housing drain	54	I	Inspect every time before riding		
Gear lubricant (Front differential - rear drive)	48	I		I	
	48	Replace every 4 years			

Item	Page	Initial Service (1st Week)	Monthly	Quarterly	Annually
V-Belt	54	I			I
Muffler/spark arrester	56				C
Tires/air pressure	55/26	I	Inspect every time before riding		
* Brake components	49	I	Inspect every time before riding		
Brake fluid	49	I	*Replace every 2 years		
Brake hoses	49	I	*Replace every 4 years		
* Steering	-	I	Inspect every time before riding		
* Suspension (Ball joint boots, drive axle boots front and rear, tie rods, differential and rear drive bellows)	-	I	Inspect every time before riding		
* Chassis nuts and bolts	-	I	T		
Frame/welds/racks	-	I			I
Electrical connections	-	I			I
Headlight/taillight-brakelight	56	I	Inspect every time before riding		

I = Inspect and clean, adjust, lubricate, replace as necessary

T = Tighten R = Replace C = Clean * Dealer maintenance

** When using Arctic Cat ACX All Weather synthetic oil, oil change and strainer inspection interval can be increased to every 1000 miles or every year.

Liquid Cooling System

■ **NOTE:** Debris in front of the engine or packed between the cooling fins of the radiator can reduce cooling capability. Using a garden hose, wash the radiator to remove any debris preventing air flow.

CAUTION

Arctic Cat does not recommend using a pressure washer to clean the radiator core. The pressure may bend or flatten the fins causing restricted air flow, and electrical components on the radiator could be damaged. Use only a garden hose with spray nozzle at normal tap pressure.

The cooling system capacity can be found in the specifications chart. The cooling system should be inspected daily for leakage and damage. If leakage or damage is detected, take the ATV to an authorized Arctic Cat ATV dealer for service. Also, the coolant level should be checked periodically.

CAUTION

Continued operation of the ATV with high engine temperature may result in engine damage or premature wear.

■ **NOTE:** High engine RPM, low vehicle speed, or heavy load can raise engine temperature. Decreasing engine RPM, reducing load, and selecting an appropriate transmission gear can lower the temperature.

When filling the cooling system, use a coolant/water mixture which will satisfy the coldest anticipated weather conditions of the area in accordance with the coolant manufacturer's recommendations. While the cooling system is being filled, air pockets may develop; therefore, run the engine for five minutes after the initial fill, shut the engine off, and then fill the cooling system to the bottom of the stand pipe in the radiator neck.

Checking/Filling

1. Locate the coolant reservoir on the right side behind the radiator.
2. Remove the cap and fill with the appropriate coolant until coolant level is between the LOW and FULL lines. Do not overfill.
3. Install the cap on the reservoir.

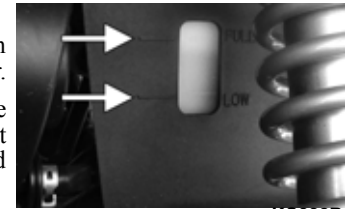

KC338B

Shock Absorbers

Each shock absorber should be visibly checked weekly for excessive fluid leakage (some seal leakage may be observed but it does not indicate the shock is in need of replacement), cracks or breaks in the lower case, or a bent shock rod. If any one of these conditions is detected, replacement is necessary.



KC0102

■ **NOTE:** When the ATV is operated in extremely cold weather (-23°C/-10°F or colder), a small amount of leakage may be present. Unless leakage is excessive, replacement is not necessary.

The shock absorber has a spring force adjustment sleeve with five adjustment positions to allow the spring to be adjusted for different riding and loading conditions. If the spring action is too soft or too stiff, adjust it according to the chart.

■ **NOTE:** Before attempting to adjust suspension, clean dirt and debris from sleeve and remove load from the suspension; then use the spanner wrench to adjust sleeve to desired position (clockwise for stiffer; counterclockwise for softer).

Position	Spring Force	Setting	Load
1	↓ Stronger	Soft	Light
2		↑ Stiff	↑ Heavy
3			
4			
5			

General Lubrication

Cables

None of the cables require lubrication; however, it is advisable to lubricate the ends of the cables periodically with a good cable lubricant.

Engine/Transmission Oil and Filter

■ **NOTE:** Refer to the recommended oil viscosity chart (on page 44) in this manual for the proper engine oil.

Change the engine oil and oil filter at the scheduled intervals. The engine should always be warm when the oil is changed so the oil will drain easily and completely.

1. Park the ATV on level ground.
 2. Remove the oil level stick. Be careful not to allow contaminants to enter the opening.
 3. Remove the drain plug from the bottom of the engine and drain the oil into a drain pan.
 4. Remove the oil filter plug from the filter mounting boss (located on the front-right side of the transmission case) and allow the filter to drain completely.
 5. Using the oil filter wrench and a ratchet handle (or a socket or box-end wrench), remove the old oil filter and dispose of properly. Do not re-use oil filter.
- **NOTE:** Clean up any excess oil after removing the filter.
6. Apply oil to the new filter O-ring and check to make sure it is positioned correctly; then install the new oil filter. Tighten securely.



KC0051A

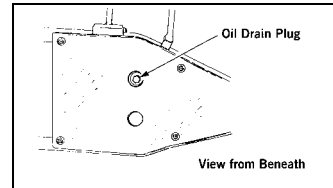

733-441A

7. Install the oil filter drain plug and tighten securely.
8. Install the engine drain plug and tighten it securely. Pour the recommended oil in the filler hole. Install filler plug.
9. Start the engine (while the ATV is outside on level ground) and allow it to idle for a few minutes.
10. Turn the engine off and wait approximately one minute. Recheck the oil level.
11. Inspect the area around the drain plug and oil filter for leaks.

Front Differential and Rear Drive Gear Lubricant (Inspecting/Changing)

Inspect and change the gear lubricant in each according to the Maintenance Schedule. When changing the lubricant, use approved SAE 80W-90 hypoid oil and use the following procedure.

1. With the ATV on level ground, remove each oil filler plug.
2. Drain the oil into a drain pan by removing in turn the drain plug from each.
3. After all the oil has been drained, install the drain plugs and tighten securely.

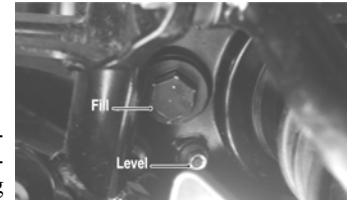

CF113A

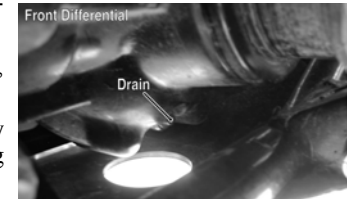

CF107B



CF106C

CAUTION

Inspect the oil for any signs of metal filings or water. If found, take the ATV to an authorized Arctic Cat ATV dealer for servicing.

4. Pour recommended oil into each filler hole.

■ **NOTE:** If the gear case has a level plug, fill to the threads of the level plug. If the gear case has only a fill plug, fill to within 1 in. of the threads of the fill plug.

■ **NOTE:** Arctic Cat recommends the use of genuine Arctic Cat lubricants.

5. Install the filler plugs and level plugs.

Hydraulic Brakes

WARNING

Be sure to inspect the hydraulic brake system before each use. Always maintain brakes according to the Maintenance Schedule.

Brake Fluid

Check the brake fluid level in the brake fluid reservoir. If the level in the reservoir is not visible in the sight glass, add DOT 4 brake fluid.

■ **NOTE:** If the sight glass windows appear dark, there is a sufficient amount of fluid in the reservoir.



KC387A

CAUTION

Be careful not to spill any fluid when filling the brake fluid reservoir. Wipe away spilled fluid immediately.

Brake Lever Lock (Right Hand Brake)

Check to make sure the brake lever lock engages properly and that the brake (when engaged) locks the front wheels.

1. Pump the brake lever 2 or 3 times.
2. Engage the brake lever lock.
3. Attempt to push the ATV.

■ **NOTE:** The brake lever lock must lock the wheels. If it doesn't, take the ATV to an authorized Arctic Cat ATV dealer for service.



KC377A

Brake Hoses

Carefully inspect the hydraulic brake hoses for cracks or other damage. If found, take the ATV to an authorized Arctic Cat ATV dealer to have the brake hoses replaced.

Brake Pads

The clearance between the brake pads and brake discs is adjusted automatically as the brake pads wear. The only maintenance that is required is replacement of the brake pads when they show excessive wear. Check the thickness of each of the brake pads as follows:

1. Remove the respective wheels.
2. Measure the thickness of each brake pad.
3. If thickness of any brake pad is less than 1.0 mm (0.039 in.), take the ATV to an authorized Arctic Cat ATV dealer to have brake pads replaced.

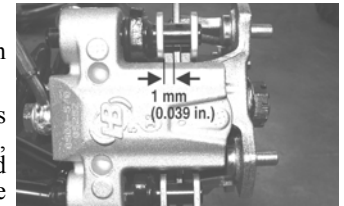

PR376B

4. Install the wheel and tighten using a crisscross pattern to 80 ft-lb.

Protective Rubber Boots

The protective boots should be inspected periodically according to the Maintenance Schedule.

Ball Joint Boots (Upper and Lower/ Right and Left)

1. Secure the ATV on a support stand to elevate the front wheels.
2. Remove both front wheels.
3. Inspect the four ball joint boots for cracks, tears, or perforations.
4. Check the ball joint for free-play by grasping the steering knuckle and turning it from side to side and up and down.
5. If boot damage is present or ball joint free-play seems excessive, contact an authorized Arctic Cat ATV dealer for service.



CC791

Tie Rod Boots (Inner and Outer/Right and Left)

1. Secure the ATV on a support stand to elevate the front wheels.
2. Remove both front wheels.
3. Inspect the four tie rod boots for cracks, tears, or perforations.
4. Check the tie rod end free-play by grasping the tie rod near the end and attempting to move it up and down.
5. If boot damage is present or tie rod end free-play seems excessive, contact an authorized Arctic Cat ATV dealer for service.

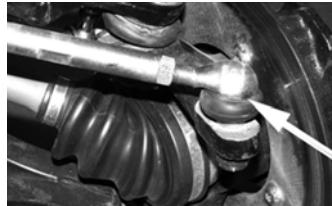

CC792

Drive Axle Boots

1. Inspect all drive axle boots for cracks, tears, or perforations.
2. If boot damage is present, contact an authorized Arctic Cat ATV dealer for service.



CC793

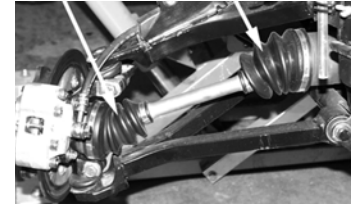

CF125A

Battery

The battery is located under the right rear fender.

After being in service, batteries require regular cleaning and recharging in order to deliver peak performance and maximum service life. The following procedures are recommended for cleaning and maintaining lead-acid batteries. Always read and follow instructions provided with battery chargers and battery products.



KC375A

■ **NOTE:** Refer to all warnings and cautions provided with the battery or battery maintainer/charger.

Loss of battery charge may be caused by ambient temperature, ignition OFF current draw, corroded terminals, self discharge, frequent start/stops, and short engine run times. Frequent winch usage, snowplowing, extended low RPM operation, short trips, and high amperage accessory usage are also reasons for battery discharge.

Maintenance Charging

■ **NOTE:** Arctic Cat recommends the use of the CTEK Multi US 800 or the CTEK Multi US 3300 for battery maintenance charging. Maintenance charging is required on all batteries not used for more than two weeks or as required by battery drain.

1. When charging a battery in the vehicle, be sure the ignition switch is in the OFF position.

■ **NOTE:** Be sure to maintain the fluid of the battery at the UPPER LEVEL. Use only distilled water when adding fluid to these batteries.

2. Clean the battery terminals with a solution of baking soda and water.
3. Be sure the charger and battery are in a well-ventilated area and ensure the battery charger cables will not contact any battery acid. Be sure the charger is unplugged from the 110-volt electrical outlet.
4. Connect the red terminal lead from the charger to the positive terminal of the battery; then connect the black terminal lead of the charger to the negative terminal of the battery.

■ **NOTE:** Optional battery charging adapters are available from your authorized Arctic Cat dealer to connect directly to your vehicle from the recommended chargers to simplify the maintenance charging process. Check with your authorized Arctic Cat dealer for proper installation of these charging adapter connectors.

5. Plug the battery charger into a 110-volt electrical outlet.



800E



3300A

6. If using the CTEK Multi US 800, there are no further buttons to push. If using the CTEK Multi US 3300, press the Mode button (A) at the left of the charger until the Maintenance Charge Icon (B) at the bottom illuminates. The Normal Charge Indicator (C) should illuminate on the upper portion of the battery charger.

■ **NOTE:** The maintainer/charger will charge the battery to 95% capacity at which time the Maintenance Charge Indicator (D) will illuminate and the maintainer/charger will change to pulse/float maintenance. If the battery falls below 12.9 DC volts, the charger will automatically start again at the first step of the charge sequence.

■ **NOTE:** Not using a battery charger with the proper float maintenance will damage the battery if connected over extended periods.

Charging

■ **NOTE:** Arctic Cat recommends the use of the CTEK Multi US 800 or the CTEK Multi US 3300 for battery maintenance charging.

1. Be sure the battery and terminals have been cleaned with a baking soda and water solution.
2. Be sure the charger and battery are in a well-ventilated area and ensure the battery charger cables will not contact any battery acid. Be sure the charger is unplugged from the 110-volt electrical outlet.
3. Connect the red terminal lead from the charger to the positive terminal of the battery; then connect the black terminal lead of the charger to the negative terminal of the battery.
4. Plug the charger into a 110-volt electrical outlet.
5. By pushing the Mode button (A) on the left side of the charger, select the Normal Charge Icon (E). The Normal Charge Indicator (C) should illuminate on the upper left portion of the charger.
6. The battery will charge to 95% of its capacity at which time the Maintenance Charge Indicator (D) will illuminate.

■ **NOTE:** For optimal charge and performance, leave the charger connected to the battery for a minimum 1 hour after the Maintenance Charge Indicator (D) illuminates. If the battery becomes hot to the touch, stop charging. Resume after it has cooled.

- Once the battery has reached full charge, unplug the charger from the 110-volt electrical outlet.

■ **NOTE:** If, after charging, the battery does not perform to operator expectations, bring the battery to an authorized Arctic Cat dealer for further troubleshooting.

Jump-Starting

■ **NOTE:** Arctic Cat does not recommend jump-starting a vehicle with a dead battery but rather to remove the battery, service it, and correctly charge it; however, in an emergency, it may be necessary to jump-start a vehicle. If so, use the following procedure to carefully and safely complete this procedure.

WARNING

Improper handling or connecting of a battery may result in serious injury including acid burns, electrical burns, or blindness as a result of an explosion. Always remove rings and watches.

- On the vehicle to be jump-started, remove the battery cover and any terminal boots.

WARNING

Any time service is performed on a battery, the following must be observed: keep sparks, open flame, cigarettes, or any other flame away. Always wear safety glasses. Protect skin and clothing when handling a battery. When servicing battery in enclosed space, keep the area well-ventilated. Make sure battery venting is not obstructed.

- Inspect the battery for any signs of electrolyte leaks, loose terminals, or bulging sides. Leaking or bulging battery cases may indicate a frozen or shorted battery.

WARNING

If any of these conditions exist, **DO NOT** attempt a jump-start, boost, or charge the battery. An explosion could occur causing serious injury.

- Inspect the vehicle to be used for jump-starting to determine if voltage and ground polarity are compatible. The vehicle must have a 12-volt DC, negative ground electrical system.

CAUTION

Always make sure the electrical systems are of the same voltage and ground polarity prior to connecting jumper cables. If not, severe electrical damage may occur.

- Move the vehicle to be used for the jump-start close enough to ensure the jumper cables easily reach; then shift into neutral, set and lock the brakes, shut off all electrical accessories, and turn the ignition switch OFF.

■ **NOTE:** Make sure all switches on the vehicle to be jump-started are turned OFF.

- Disconnect all external accessories such as cell phones, GPS units, and radios on both vehicles.

CAUTION

Failure to disconnect electronic accessories during jump-starting may cause system damage due to power spikes.

6. Attach one clamp of the positive (red) jumper cable to the positive (+) terminal (1) of the dead battery (C) being careful not to touch any metal with the other clamp; then attach the other clamp of the positive (red) jumper cable to the positive (+) terminal (2) of the good battery (B).

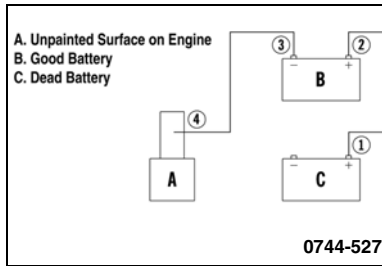

■ **NOTE:** Some jumper cables may be the same color but the clamps or ends will be color-coded red and black.

7. Attach one clamp of the negative (black) jumper cable to the negative (-) terminal (3) of the good battery (B); then attach the other clamp of the negative (black) jumper cable (4) to an unpainted metal surface (A) on the engine or frame well away from the dead battery and fuel system components.

⚠ WARNING

Never make the final connection to a battery as a spark could ignite hydrogen gases causing an explosion of the battery resulting in acid burns or blindness.

8. Stand well away from the dead battery and start the vehicle with the good battery. Allow the vehicle to run for several minutes applying some charge to the dead battery.
9. Start the vehicle with the dead battery and allow it to run for several minutes before disconnecting the jumper cables.
10. Remove the jumper cables in opposite order of hook-up (4, 3, 2, 1). Be careful not to short cables against bare metal.

■ **NOTE:** Have the battery and electrical system checked prior to operating the vehicle again.

Spark Plug

The ATV comes equipped with a specified spark plug. See the Specifications chart for the correct spark plug and the correct gap. A light brown insulator indicates that the plug is correct. A white or dark insulator indicates that the engine may need to be serviced. Consult an authorized Arctic Cat ATV dealer if the plug insulator is not a light brown color.

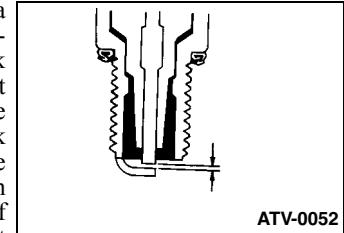

To help prevent cold weather fouling, make sure to thoroughly warm up the engine before operating. To maintain a hot, strong spark, keep the plug free of carbon.

Before removing the spark plug, be sure to clean the area around the spark plug. If you do not, dirt could enter engine when removing or installing the spark plug.

Adjust to the recommended gap for proper ignition. Use a wire-type feeler gauge to check the gap.

When installing the spark plug, be sure to tighten it securely. A new spark plug should be tightened 1/2 turn once the washer contacts the cylinder head. A used spark plug should be tightened 1/8-1/4 turn once the washer contacts the cylinder head.

Throttle Cable Adjustment

To adjust the throttle cable free-play:

1. Loosen the jam nut from the throttle cable adjuster.
2. Slide the rubber boot away and turn the adjuster until the throttle lever has the proper free-play of 3-6 mm (1/8-1/4 in.).

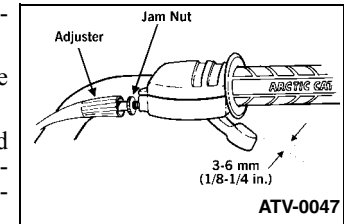

3. Tighten the knurled nut against the throttle cable adjuster securely; then slide the rubber boot over the adjuster.

Air Filter

The air filter inside the air filter housing must be kept clean to provide good engine power and gas mileage. If the ATV is used under normal conditions, service the filter at the intervals specified. If operated in dusty, wet, or muddy conditions, inspect and service the filter more frequently. Use the following procedure to remove the filter and inspect and/or clean it.

1. Rotate the three latches to release the filter housing cover; then loosen the inlet boot clamp.
2. Remove the filter housing cover and air filter element.
3. Fill a wash pan larger than the element with a non-flammable solvent; then dip the element in the solvent and wash it.
4. Squeeze the element by pressing it between the palms of both hands to remove excess solvent. Do not twist or ring the element or it will develop cracks.
5. Dry the element.
6. Put the element in a plastic bag; then pour in air filter oil and work the oil into the element.
7. Squeeze the element to remove excess oil.

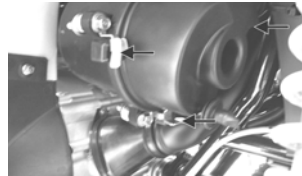

KC0056A



KC0056B

CAUTION

A torn air filter can cause damage to the ATV engine. Dirt and dust may get inside the engine if the element is torn. Carefully examine the element for tears before and after cleaning it. Replace the element with a new one if it is torn.

8. Clean any dirt or debris from inside the air cleaner. Be sure no dirt enters the throttle body.
9. Install the air filter and cover.
10. Connect the inlet boot and tighten the clamp securely.

Air Filter Housing Drain

Inspect the “duck bill” drain in front of the main housing for debris and for proper sealing.



KC0056C

Draining V-Belt Cover

NOTE: If the ATV has been driven through water, the V-belt cover must be drained of any water.

1. Place the ATV on a level surface.
2. Remove the drain bolt from the cover and allow water to drain out.
3. Shift the range lever to the neutral position; then start the engine.
4. Increase and decrease engine RPM several times to “blow out” any water; then stop the engine.

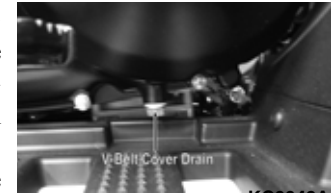

KC0049A

5. Install the drain bolt and tighten securely.

■ **NOTE:** The V-belt and pulleys should be inspected every 500 miles and the belt replaced (if necessary).

Tires

WARNING

Always use the size and type of tires as specified. Refer to the Specifications chart for proper tire inflation pressure, and always maintain proper tire inflation pressure.

Tire Tread Condition

The use of worn-out tires on an ATV is very dangerous. A tire is considered to be worn out when the depth of the tread is less than 3 mm (1/8 in.). Be sure to replace the tires before reaching this minimum specification.

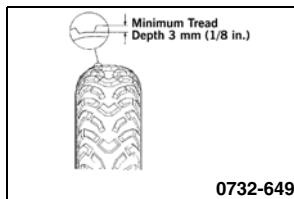

WARNING

The use of worn-out tires is dangerous and can increase the risk of an accident.

Tire Replacement

The ATV has low-pressure tubeless tires. Air is sealed by the contact surfaces of the inner wheel rim and the tire bead. If either the inner wheel rim or tire bead is damaged, air may leak. Be extremely careful not to damage these areas when replacing tires.

It is very important to use the proper tools when repairing or replacing tires to prevent damage to the tire bead or wheel rims. If proper tools and related items are not available, have this maintenance performed by an authorized Arctic Cat ATV dealer or a qualified tire repair station.

CAUTION

When breaking the tire bead loose from the wheel, be extremely careful not to damage the inner wheel surface or the tire bead.

WARNING

Use only Arctic Cat approved tires when replacing tires. Failure to do so could result in unstable ATV operation.

Tubeless Tire Repair

Should a leak or flat tire occur due to a puncture, the tire may be repaired using a plug-type repair. If the damage is from a cut or if the puncture cannot be repaired using a plug, the tire must be replaced. When operating the ATV in areas where transportation or service facilities are not readily available, it is strongly recommended to carry a plug-type repair kit and a tire pump along.

Wheels

1. Park the ATV on level ground and engage the brake lever lock.
2. Loosen the lug nuts on the wheel to be removed.
3. Elevate the ATV.
4. Remove the lug nuts.
5. Remove the wheel.
6. Install the wheel and install the lug nuts.
7. Tighten the nuts in a crisscross pattern to 80 ft-lb.
8. Remove the jack.

Muffler/Spark Arrester

The muffler has a spark arrester which must be periodically cleaned. At the intervals shown in the Maintenance Schedule, clean the spark arrester using the following procedure.

WARNING

Wait until the muffler cools to avoid burns.

1. Remove the cap screws securing the spark arrester assembly to the muffler; then remove the spark arrester.
2. Using a suitable brush, clean the carbon deposits from the screen taking care not to damage the screen.



KC374A

■ **NOTE: If the screen or gasket is damaged in any way, it must be replaced.**

3. Install the spark arrester assembly and secure with the cap screws. Tighten securely.

Light Bulb Replacement

The wattage rating of each bulb is shown in the chart. When replacing a burned bulb, always use the same wattage rating.

Headlight	12V/35W (4)
Taillight/Brakelight	12V/5W/21W

CAUTION

Use only specified bulbs indicated in the chart as replacement bulbs.

■ **NOTE: The bulb portion of the headlight is fragile. HANDLE WITH CARE. When replacing the headlight bulb, do not touch the glass portion of the bulb. If the glass is touched, it must be cleaned with a dry cloth before installing. Skin oil residue on the bulb will shorten the life of the bulb.**

To replace the headlight bulb, use the following procedure.

1. Remove the wiring harness connector from the back of the headlight.
2. Grasp the bulb housing, turn it counterclockwise, and remove the bulb.
3. Install the new bulb into the housing and rotate it completely clockwise.
4. Install the wiring harness connector.

CAUTION

When replacing the headlight bulb, be careful not to touch the glass portion of the bulb. Grasp the new bulb with a clean cloth.

To replace the taillight/brakelight bulb, use the following procedure.

1. Rotate the socket counterclockwise and remove it from the housing.
2. To remove the bulb from the socket, push in and rotate counterclockwise.
3. To install the bulb, push in and turn clockwise.
4. Insert the socket into the housing and rotate it clockwise.

Checking/Adjusting Headlight Aim

The headlights can be adjusted vertically and horizontally. The geometric center of the HIGH beam light zone is to be used for vertical and horizontal aiming.

1. Position the ATV on a level floor so the headlights are approximately 6.1 m (20 ft) from an aiming surface (wall or similar aiming surface).

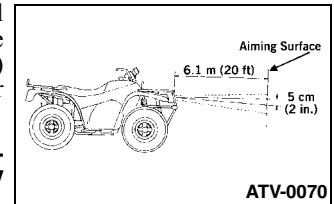

■ **NOTE: There should be an average operating load on the ATV when adjusting the headlight aim.**

ATV-0070

- Measure the distance from the floor to the mid-point of each headlight.
- Using the measurements obtained in step 2, make horizontal marks on the aiming surface.
- Make vertical marks which intersect the horizontal marks on the aiming surface directly in front of the headlights.
- Switch on the lights. Make sure the HIGH beam is on. DO NOT USE LOW BEAM.
- Observe each headlight beam aim. Proper aim is when the most intense beam is centered on the vertical mark 5 cm (2 in.) below the horizontal mark on the aiming surface.
- Adjust each headlight until correct aim is obtained by turning the adjuster clockwise to lower or counterclockwise to raise the beam.

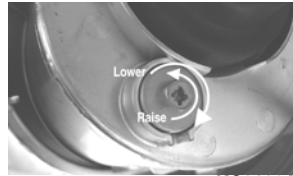

KC0108A

Fuses

The fuses are located in a power distribution module in front of the steering post under the electrical access panel. If there is any type of electrical system failure, always check the fuses first.

■ **NOTE:** To remove the fuse, compress the locking tabs on either side of the fuse cover and lift out.

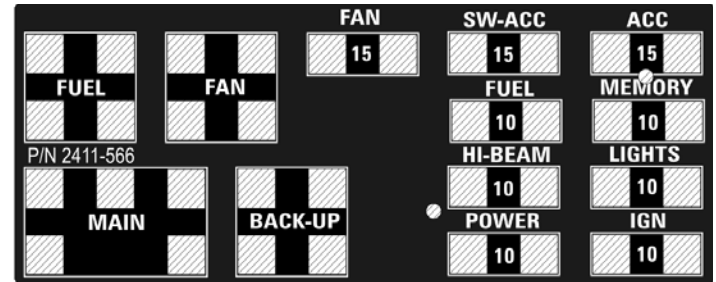

2411-566

CAUTION

Always replace a blown fuse with a fuse of the same type and rating. If the new fuse blows after a short period of use, consult an authorized Arctic Cat ATV dealer immediately.

Electrical Output Terminals

Two output terminals for electrical accessories are located on the front and rear wiring harnesses. The accessory plug is located on the front body panel.

CAUTION

Always use electrical accessories less than 180W.

Tools

A basic tool kit is provided with the ATV. Maintain the tool kit with the ATV at all times. The tool kit is located under the seat.

Preparation for Storage

CAUTION

Prior to storing the ATV, it must be properly serviced to prevent rusting and component deterioration.

Arctic Cat recommends the following procedure to prepare the ATV for storage. An authorized Arctic Cat ATV dealer should perform this service; however, the owner/operator may perform this service if desired.

1. Clean the seat cushion (cover and base) with a damp cloth and allow to dry.
2. Clean the ATV thoroughly by washing dirt, oil, grass, and other foreign matter from the entire ATV. Allow the ATV to dry thoroughly. DO NOT get water into any part of the engine or air intake.
3. Either drain the gas tank or add a fuel stabilizer to the gas in the gas tank. Remove the air filter housing cover and air filter. Start the engine and allow it to idle; then using Arctic Cat Engine Preserver, rapidly inject the preserver into the air filter opening for a period of 10 to 20 seconds. Install the air filter and housing cover.

CAUTION

If the interior of the air filter housing is dirty, clean the area before starting the engine.

4. Plug the hole in the exhaust system with a clean cloth.
 5. Apply light oil to the upper steering post bushing and plungers of the shock absorbers.
 6. Tighten all nuts, bolts, cap screws, and screws. Make sure rivets holding components together are tight. Replace all loose rivets. Care must be taken that all calibrated nuts, cap screws, and bolts are tightened to specifications.
 7. Fill the cooling system to the bottom of the stand pipe in the radiator neck with properly mixed coolant.
 8. Disconnect the battery cables (negative cable first); then remove the battery, clean the battery posts and cables, and store in a clean, dry area.
- **NOTE: For storage, use a battery maintainer or make sure the battery is fully charged (see Battery section in this manual).**
9. Store the ATV indoors in a level position.

CAUTION

Avoid storing outside in direct sunlight and avoid using a plastic cover as moisture will collect on the ATV causing rusting.

Preparation after Storage

Taking the ATV out of storage and correctly preparing it will assure many miles and hours of trouble-free riding. Arctic Cat recommends the following procedure to prepare the ATV.

1. Clean the ATV thoroughly.
2. Clean the engine. Remove the cloth from the exhaust system.
3. Check all control wires and cables for signs of wear or fraying. Replace if necessary.
4. Change the engine/transmission oil and filter.
5. Check the coolant level and add properly mixed coolant as necessary.
6. Charge the battery; then install. Connect the battery cables making sure to connect the positive cable first.
7. Check the entire brake systems (fluid level, pads, etc.), all controls, headlights, taillight, brakelight, and headlight aim; adjust or replace if necessary.
8. Check the tire pressure. Inflate to recommended pressure as necessary.
9. Tighten all nuts, bolts, cap screws, and screws making sure all calibrated nuts, cap screws, and bolts are tightened to specifications.
10. Make sure the steering moves freely and does not bind.
11. Check the spark plug. Clean or replace as necessary.
12. Follow the recommendations found in the pre-start inspection.

CAUTION

Before installing the battery, make sure the ignition switch is in the OFF position.

Limited Warranty

Arctic Cat Inc. (hereinafter referred to as Arctic Cat) extends a limited warranty on each new Arctic Cat ATV it assembles and on each genuine Arctic Cat ATV part and accessory assembled or sold by an authorized Arctic Cat ATV dealer. Warranty on an Arctic Cat ATV is extended to the original retail purchaser; however, the balance of the unused warranty may be transferred to another party. Warranty coverage is only available in the country in which the original retail purchase occurs to the original retail purchaser resident in that country or to a transferee resident in that country of the balance of the unused warranty.

Arctic Cat warrants only the products it assembles and/or sells and does not warrant that other products will function properly when used with an Arctic Cat ATV or will not damage the ATV. Arctic Cat does not assume any liability for incidental or consequential damages.

Arctic Cat will repair or replace, at its option, free of charge (including any related labor charges), any parts that are found to be warrantable in material or workmanship. This repair work MUST be done by an authorized Arctic Cat ATV dealer. No transportation charges, rental charges, or inconvenience costs will be paid by Arctic Cat. The warranty is validated upon examination of said parts by Arctic Cat or an authorized Arctic Cat ATV dealer. Arctic Cat reserves the right to inspect such parts at its factory for final determination if warranty should apply.

The warranty periods are as follows:

1. Six months from the date of sale — for an Arctic Cat ATV used for recreational purposes.
2. Ninety days from date of invoice — for an Arctic Cat ATV used for commercial purposes, including rental operations (non-transferable).
3. Thirty days from date of sale of ATV on Arctic Cat supplied batteries.
4. Thirty days from date of sale — for all dealer installed genuine Arctic Cat service parts and accessories.
5. Until expiration of the new product warranty (paragraphs 1 and 2 above) — for all eligible replacement parts on new product.

Exclusions to this warranty include normal wear, abuse, or corrosion and the following parts and items:

Tires	CV Boots	Torn or Punctured Upholstery
Oil Filter Panels	Drive Belt	Cracks or Gouges in Body
Air Filter	Brake Pads	Drive/Driven Clutch Wear Parts
Light Bulbs	Spark Plug(s)	

The following will VOID Arctic Cat's warranty:

1. Failure to perform the proper break-in procedure and all related maintenance, storage procedures (if stored for extended periods), and/or service as recommended in the Operator's Manual.
2. Repairs and/or adjustments by anyone other than an authorized Arctic Cat ATV dealer.
3. Use of improper carburetor main jets.
4. Use of improper gasoline, lubricating oils, or spark plug.
5. An accident or subjecting the ATV to misuse, abuse, or negligent operation.
6. Any modification, addition, or removal of parts unless instructed to do so by Arctic Cat.
7. Use of the ATV in any way for racing purposes.
8. Removal of the engine for use in another vehicle.
9. Removal or mutilation of the Vehicle Identification Number or Engine Serial Number.
10. Use of parts not sold or approved by Arctic Cat.
11. Damage due to improper transportation.

In consideration of the foregoing, any implied warranty is limited in duration to the various warranty periods set forth. This warranty gives you specific legal rights, and you may also have other rights which vary from state/province to state/province or country to country. Some jurisdictions do not allow limitations on how long an implied warranty lasts, so the above limitations may not apply to you.

Warranty Procedure/Owner Responsibility

At the time of sale, an ATV Rider Training Certificate and Owner Registration form is to be completed by the selling dealer and consumer. The receipt of the form by Arctic Cat is a condition precedent to warranty coverage. It is the selling dealer's responsibility to retain and/or submit appropriate copies of the form to the appropriate place(s) to initiate warranty coverage.

The dealer will furnish to the consumer a signed copy of the form which must be presented to the dealer when requesting warranty service. The registration form is the consumer's proof of ownership and warranty eligibility. The form is used by the dealer to validate the warranty claim. Retain your copy of the form and keep it in a safe place.

When warranty repair is suspected, the ATV should be taken to the selling dealer, who has the primary responsibility to perform warranty repairs. Subject to the limitations set forth in the Limited Warranty, in the event the selling dealer has ceased to do business, you have moved, or you are in a location away from your selling dealer, warranty may be performed by any authorized Arctic Cat ATV dealer.

The authorized Arctic Cat ATV dealer will examine the ATV or part to determine if, in his opinion, a warrantable condition exists. If a warrantable condition appears to exist, the dealer will repair or replace, at Arctic Cat's option, free of charge, including any related labor costs, all parts that are found to be warrantable and any other parts which the warrantable part caused to be damaged. You, the owner, will then be asked to sign a warranty form to ensure Arctic Cat that the warranty work was actually performed.

It is the owner's responsibility to maintain and service the ATV in accordance with Arctic Cat's recommendations in the Operator's Manual. To protect yourself and your ATV, follow all safety and service tips. Arctic Cat will NOT warrant repairs required as a result of not performing standard operator maintenance, storage procedures, and service as outlined in the Operator's Manual.

Should you have any questions concerning the warranty, contact an authorized Arctic Cat ATV dealer.

Arctic Cat ATV Emission Control Warranty Statement

Warranty Rights and Obligations

Arctic Cat Inc. (hereinafter referred to as Arctic Cat) and the California Air Resources Board are pleased to explain the emission control system warranty for each new Arctic Cat ATV sold in the state of California. In California, a new ATV must be designed, built, and equipped to meet the state's stringent anti-smog standards.

Arctic Cat warrants the emission control system on the Arctic Cat ATV for the periods listed below provided there has been no abuse, neglect, or improper maintenance of the ATV.

The emission control system may include components such as the carburetor, ignition system, and crankcase ventilation system. Also included may be hoses, belts, connectors, and other emission-related assemblies.

When a warrantable condition exists, Arctic Cat will repair the ATV at no cost to the owner, including diagnosis, parts, and labor.

Emission Control Warranty Coverage

A new Arctic Cat ATV manufactured after January 1, 1997 has a two (2) year warranty on its emissions control components.

If an emission-related component on the ATV is defective, the component will be repaired or replaced by any authorized Arctic Cat ATV dealer.

Owner's Emission Control Warranty Responsibilities

It is the owner's responsibility to perform the required maintenance listed in the Operator's Manual. Arctic Cat recommends the retention of all receipts covering maintenance performed on the ATV, but Arctic Cat cannot deny warranty solely for the lack of receipts or for failure to ensure the performance of all scheduled maintenance on the emission control system.

It is the owner's responsibility to present the ATV to an authorized Arctic Cat ATV dealer as soon as a problem exists. The undisputed warranty repairs should be completed within a reasonable period of time, not to exceed thirty days.

The ATV owner should be aware that Arctic Cat may deny warranty coverage if either the ATV or a component has failed due to abuse, neglect, improper maintenance, or any unapproved modifications.

If you have any questions regarding your warranty rights and responsibilities, contact either Arctic Cat Inc, P.O. Box 810, Thief River Falls, MN 56701, (218) 681-4999 or the California Air Resources Board, 9528 Telstar Avenue, El Monte, CA 91731, (818) 575-6800.

Arctic Cat Emission Control System Limited Warranty

Arctic Cat Inc., P.O. Box 810, Thief River Falls, MN 56701 (hereinafter referred to as Arctic Cat) warrants that this new Arctic Cat ATV manufactured on or after January 1st, 1997:

- A. Is designed, built, and equipped so as to conform at the time of initial purchase with all applicable regulations of the California Air Resources Board and
- B. Is free from defects in material and workmanship which could cause such ATV to fail to conform with applicable regulations of the California Air Resources Board for a period of use of two (2) years from the date of initial retail delivery.

Coverage

Warranty defects shall be remedied during customary business hours at any authorized Arctic Cat ATV dealer located within the state of California in compliance with applicable regulations of the California Air Resources Board. Any component or components replaced under this warranty shall become the property of Arctic Cat.

In California, emission related warranted components are specifically defined by the state's Emission Warranty Parts List. These warranted components are carburetor and internal components, intake manifold, fuel injection system, spark advance mechanism, crankcase breather, air cutoff valve, fuel/vapor separator, canister, igniters, breaker governors, ignition coils, ignition wires, ignition points, condensers and spark plugs if failure occurs prior to the first scheduled replacement, and hoses, clamps, and fittings used directly in these parts. Since emission related components may vary from model to model, certain models may not contain all of these components, and certain models may contain functionally equivalent components.

In California, emission control system emergency repairs, as provided for in the California Administrative Code, may also be performed by other than an authorized Arctic Cat ATV dealer. An emergency situation occurs when an authorized Arctic Cat ATV dealer is not reasonably available, a component is not available within thirty (30) days, or a repair is not complete within thirty (30) days. Any replacement component can be used in an emergency repair. Arctic Cat will reimburse the owner for the expenses, including diagnosis, not to exceed suggested retail price as set forth by Arctic Cat for all warranted components replaced and labor charges based on the recommended time allowance set forth by Arctic Cat for the warranty repair and the geographically appropriate hourly labor rate. The owner may be required to keep receipts and failed components in order to receive compensation.

Limitations

This Emission Control System Warranty shall not cover any of the following:

- A. Repair or replacement required as a result of
 - (1) accident,
 - (2) misuse,
 - (3) lack of required maintenance,
 - (4) repairs improperly performed or replacements improperly installed,

(5) use of replacement components or accessories not conforming to Arctic Cat specifications which adversely affect performance, and/or

(6) use in competitive racing or related events.

- B. Inspections, replacement of components, and other services or adjustments necessary for required maintenance.

Limited Liability

The liability of Arctic Cat under this Emission Control System Warranty is limited solely to the remedying of defects in material and workmanship by an authorized Arctic Cat ATV dealer at its place of business during customary business hours. This warranty does not cover inconvenience or loss of use of the ATV or transportation of the ATV to or from the Arctic Cat ATV dealer.

ARCTIC CAT SHALL NOT BE LIABLE FOR ANY OTHER EXPENSES, LOSS, OR DAMAGE, WHETHER DIRECT, INCIDENTAL, CONSEQUENTIAL, OR EXEMPLARY, ARISING IN CONNECTION WITH THE SALE OR USE OF, OR INABILITY TO USE THE ARCTIC CAT ATV FOR ANY PURPOSE. SOME STATES DO NOT ALLOW THE EXCLUSION OR LIMITATION OF ANY INCIDENTAL OR CONSEQUENTIAL DAMAGES, SO THE ABOVE MAY NOT APPLY TO YOU.

NO EXPRESS EMISSION CONTROL SYSTEM WARRANTY IS GIVEN BY ARCTIC CAT EXCEPT AS SPECIFICALLY SET FORTH HEREIN. ANY EMISSION CONTROL SYSTEM WARRANTY IMPLIED BY LAW, INCLUDING ANY WARRANTY OF MERCHANTABILITY OR FITNESS FOR A PARTICULAR PURPOSE, IS LIMITED TO THE EXPRESS EMISSION CONTROL SYSTEM WARRANTY TERMS STATED IN THIS WARRANTY. THE FOREGOING STATEMENTS OF WARRANTY ARE EXCLUSIVE AND IN LIEU OF ALL OTHER REMEDIES.

No dealer is authorized to modify this Arctic Cat Inc. Limited Emission Control System Warranty.

Legal Rights

THIS WARRANTY GIVES YOU SPECIFIC LEGAL RIGHTS, AND YOU MAY ALSO HAVE OTHER RIGHTS WHICH VARY FROM STATE TO STATE.

THIS WARRANTY IS IN ADDITION TO THE ARCTIC CAT INC. LIMITED ATV WARRANTY.

Additional Information

Any replacement component that is equivalent in performance and durability may be used in the performance of any maintenance or repairs. However, Arctic Cat is not liable for these components. The owner is responsible for the performance of all required maintenance. Such maintenance may be performed at a service establishment or by any individual. The warranty period begins on the date the ATV is delivered to the owner.

U.S. EPA Emission Control Statement/Warranty Coverage - ATV (U.S. Only)

STATEMENT/WARRANTY

Arctic Cat warrants to the original retail purchaser, and each subsequent purchaser, that all U.S. EPA-certified Arctic Cat ATV's are designed, built, and equipped to conform to all U.S. EPA Emission Control Regulations. Please read the following information completely.

Your authorized Arctic Cat ATV dealer will repair or replace any defective emission-related component at no cost to you during the warranty period. You may have non-warranty service performed by any repair establishment that uses equivalent components. The regulations provide significant civil penalties for tampering that causes your ATV to no longer meet U.S. EPA emission standards.

Arctic Cat further warrants that the engine and its emission-related components are free from defects in materials or workmanship that could cause the engine to fail to comply with applicable regulations during the warranty period.

If you have any questions about this information, or the emission warranty coverage statement, contact your local authorized Arctic Cat ATV dealer.

WARRANTY PERIOD

The emission warranty period for this ATV begins on the same date as the standard warranty coverage and continues for 30 months or 3100 miles, whichever comes first.

COMPONENTS COVERED

The emissions warranty covers major emissions control components and emission-related components listed as follows

Engine Management and Sensors

Barometric Pressure Sensor
Camshaft Position Sensor
Engine Control Unit (ECU)
Engine Coolant Temperature Sensor
Intake Air Temperature Sensor
Manifold Absolute Pressure Sensor
Oxygen Sensor
Throttle Position Sensor
Crankshaft Position Sensor
Exhaust Temperature Sensor

Ignition System

Ignition Coil
Knock Sensor System
Spark Plugs
Capacitive Discharge Ignition (CDI) Module
Magneto Pick-Up

Fuel/Air System

Fuel Injectors
Fuel Pressure Regulator
Fuel Pump
Carburetor(s)
Turbocharger Assembly
Air Bypass Valve
Turbo Waste Gate Control Valve
Crankcase Ventilation System
ISC Valve

Miscellaneous Items Used in

Aforementioned Systems

Connectors
Switches
Grommets
Clamps
Hoses
Ties
Gaskets
Wiring

OWNER'S RESPONSIBILITIES

The owner of any ATV warranted under this Arctic Cat Emission Control Statement is responsible for the proper maintenance and use of the ATV as stated in the Operator's Manual. Proper maintenance generally includes replacement and service, at the owner's choosing, such items as air filter, oil and oil filter, or any other part, item, or device related to emissions control as specified in the Operator's Manual. It is the owner's responsibility to ensure that the ATV is used in a manner for which it was designed.

Declaration Of Conformity

Application of council directives: EMC Directive 97/24/EC
Date of Issue: June, 1997
EC Machinery Directive 2006/42/EC
Date of Issue: May, 2006

Issued by European Commission.

Type of Equipment: All-Terrain Vehicles

Brand Name: Arctic Cat

Model: XC 450 i 4x4

Standards to which conformity is declared: EN 61000-6-2:2005
EN 55012:2007

Manufacturer (if not issuing agent): Arctic Cat Inc.
601 Brooks Ave S.
Thief River Falls, MN
56701 USA

I, the undersigned, hereby declare that the equipment specified above conforms to the directive(s) and standard(s) as specified.

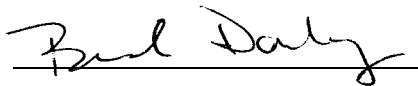

Brad Darling
Vice President/General Manager

Change Of Address, Ownership, Or Warranty Transfer

Arctic Cat Inc. keeps on file the current name and address of the owner of this ATV. This will allow Arctic Cat to reach the current owner with any important safety information which may be necessary to protect customers from personal injury or property damage. Please make sure a copy of this form is completed and returned to Arctic Cat Inc. if you move or if the ATV is sold to another party.

This form may also be used to transfer the unused portion of the original warranty to a second party. In order to transfer warranty, fill out this form completely; then return a copy of this form to Arctic Cat Inc. Arctic Cat will then process the application and issue warranty for the balance of the time remaining of the original warranty.

Address Change

Ownership Change

Warranty Transfer

CHANGE OF ADDRESS/OWNERSHIP/ WARRANTY TRANSFER TO:

Name _____
 Address _____
 City/State (Province)/Zip Code (Postal Code) _____
 Phone # () _____
 Year and Model ATV _____
 Vehicle Identification Number (VIN) _____

Before operating, you should take an ATV Rider Course to learn ATV riding skills or reinforce your current good riding skills. In U.S.A., call 1-800-887-2887 to enroll in the half-day ATV Rider Course nearest you or ask your dealer for assistance. The course instructor will charge a small fee for each person taking the course. In Canada, call (613) 739-1535.

Fold Back

Place
Stamp
Here

CHANGE OF ADDRESS/OWNERSHIP

ARCTIC CAT INC.
PRODUCT SERVICE AND
WARRANTY DEPT.
P.O. BOX 810
THIEF RIVER FALLS, MN 56701

[Previous](#)

[Main Table of Contents](#)

[Section Table of Contents](#)

[Next](#)

Identification Numbers Record

WARNING

Indicates a potential hazard that could result in serious injury or death.



1. KEY IDENTIFICATION NUMBER:

The key identification number is stamped on the key as shown in the illustration. Record this number in the space provided for reference if you ever need a new key.

2. VEHICLE IDENTIFICATION NUMBER:

3. ENGINE SERIAL NUMBER:

Record the Vehicle Identification Number and Engine Serial Number in the spaces provided to assist you in ordering parts from your authorized Arctic Cat ATV dealer or for reference in case the ATV is stolen.

[Previous](#)

[Main Table of Contents](#)

[Section Table of Contents](#)

[Next](#)



WARNING

2012 XC 450 i

Improper ATV use can result in SEVERE INJURY or DEATH



**ALWAYS USE
AN APPROVED
HELMET AND
PROTECTIVE
GEAR**



**NEVER USE ON
PUBLIC ROADS**



**NEVER CARRY
PASSENGERS**



**NEVER USE
WITH DRUGS
OR ALCOHOL**

NEVER operate:

- without proper training or instruction
- at speeds too fast for your skills or the conditions
- on public roads - a collision can occur with another vehicle
- with a passenger - passengers affect balance and steering and increase risk of losing control

ALWAYS:

- use proper riding techniques to avoid vehicle overturns on hills and rough terrain and in turns
- avoid paved surfaces - pavement may seriously affect handling and control

**LOCATE AND READ OPERATOR'S MANUAL
FOLLOW ALL INSTRUCTIONS AND WARNINGS**



©2010 Arctic Cat Inc. TM Trademarks of Arctic Cat Inc., Thief River Falls, MN 56701
(218) 681-9851 - U.S. (204) 982-1656 - Canada p/n 2258-848

[Previous](#)

[Main Table of Contents](#)

[Section Table of Contents](#)

Your ATV can be hazardous to operate.

A collision or rollover can occur quickly, even during routine maneuvers such as turning and driving on hills or over obstacles, if you fail to take proper precautions.

For your safety, understand and follow all the warnings contained in this Operator's Manual and the labels on your ATV.

This Arctic Cat ATV Operator's Manual should be considered a permanent part of the ATV and must remain with the ATV at the time of resale. If the ATV changes ownership more than once, contact Arctic Cat Inc., Service Department, P.O. Box 810, Thief River Falls, MN 56701, for proper registration information.

FAILURE TO FOLLOW THE WARNINGS CONTAINED IN THIS MANUAL CAN RESULT IN SERIOUS INJURY OR DEATH.

Training is available: U.S. owners, call 800-887-2887; Canadian owners, call 613-739-1535.

Un cours d'instruction est disponible: pour les propriétaires canadiens, composez le 613-739-1535.

Particularly important information is distinguished in this manual by the following notations:



The Safety Alert Symbol means ATTENTION! BE ALERT! YOUR SAFETY IS INVOLVED.



WARNING

WARNING indicates a hazardous situation which, if not avoided, could result in death or serious injury.

CAUTION

CAUTION, without the safety alert symbol, is used to address practices not related to personal injury.

■ **NOTE:**

A NOTE provides key information to make procedures easier or more clear.

California Proposition 65



WARNING

This product contains or emits chemicals known to the State of California to cause cancer and birth defects or other reproductive harm.

Foreword

Congratulations and thank you from Arctic Cat Inc. for purchasing an ARCTIC CAT® All-Terrain Vehicle (ATV). Built with American engineering and manufacturing know-how, it is designed to provide superior ride, comfort, utility, and dependable service.

You have chosen a quality Arctic Cat ATV designed and assembled to give dependable service. Be sure, as the owner/operator of an Arctic Cat ATV, to become thoroughly familiar with its basic operation, maintenance, and storage procedures. Read and understand the entire Operator's Manual before operating the ATV to ensure safe and proper use of your new Arctic Cat ATV. Always operate the ATV within your level of skill and current terrain conditions.

This Operator's Manual is furnished to ensure that the operator is aware of safe operating procedures. It also includes information about the general care and maintenance of your ATV.

Carefully read the following pages. If you have any questions regarding this ATV, contact an authorized Arctic Cat ATV dealer for assistance. Remember, only authorized Arctic Cat ATV dealers have the knowledge and facilities to provide you with the best service possible.

Protect Your Sport

- Know all local, state/provincial riding laws,
- Respect your ATV,
- Respect the environment, and
- You will gain the respect of others.

We also advise you to strictly follow the recommended maintenance program as outlined. This preventive maintenance program is designed to ensure that all critical components on this ATV are thoroughly inspected at various intervals.

All information in this manual is based on the latest product data and specifications available at the time of printing. Arctic Cat Inc. reserves the right to make product changes and improvements which may affect illustrations or explanations without notice.

Some illustrations used in this manual are used for clarity purposes only and are not designed to depict actual conditions. Because Arctic Cat Inc. constantly refines and improves its products, no retroactive obligation is incurred.

Parts and Accessories

When in need of replacement parts, oil, or accessories for your Arctic Cat ATV, be sure to use only GENUINE ARCTIC CAT PARTS, OIL, AND ACCESSORIES. **Only genuine Arctic Cat parts, oil, and accessories are engineered to meet the standards and requirements of your Arctic Cat ATV. For a complete list of accessories, refer to the current Arctic Cat ATV Accessory Catalog.**

To aid in service and maintenance procedures on this ATV, a Service Manual and an Illustrated Parts Manual are available through your local Arctic Cat ATV dealer.

Arctic Cat and the ATV Safety Institute recommend that all ATV operators ride the appropriate-sized ATV according to age.

Category	Age (Years)	Speed Limitations (MPH)	NOTES
Y-12+	12 or Older	15 - Limited 30 - Maximum	Operate Under Adult Supervision
T-14	14 or Older	20 - Limited 30 - Limited 38 - Maximum	Operate Under Adult Supervision
G & S	16 or Older	According to Local Regulations	—

TREAD LIGHTLY! OFFICIAL SPONSOR®
ON PUBLIC AND PRIVATE LAND

Table of Contents

Foreword.....	1	Oil Level Inspection Window.....	49
Parts and Accessories	1	Seat Latch.....	49
DIVISION I - SAFETY		Safety Flag Bracket.....	49
ATV Safety Alert.....	4	Rack Loading (Front and Rear) - Utility.....	50
Rider Training Course	5	Trailing and Towing (Utility).....	50
Hangtag & Warning Information.....	6	Transporting ATV.....	50
Warning Labels (Utility).....	7	Gasoline-Oil-Lubricant	50
Warning Labels (DVX)	8	Engine Break-In.....	52
Warnings	9-16	Burnishing Brake Pads	52
Prevention	17-21	General Maintenance.....	53-69
Safe Riding Clothing and Gear.....	17	Maintenance Schedule.....	54
Condition of the ATV.....	18	Cooling System.....	55
TCLOC.....	18	Shock Absorbers.....	55
First Aid and Survival.....	20	General Lubrication.....	56
Active Riding.....	22	Hydraulic Brakes.....	58
Sound Judgment	23-27	Brake Fluid.....	58
Environment.....	23	Brake Hoses.....	58
Those Around You.....	24	Brake Pads.....	58
Equipment.....	25	Brake Lever Lock.....	58
Load Capacity Ratings Chart.....	25	Protective Rubber Boots.....	59
Personal Choices.....	26	Battery.....	59
SIPDE.....	27	Spark Plug.....	62
Supervision	28	Engine Idle RPM Adjustment.....	63
Taking Responsibility.....	28	Throttle Cable Adjustment.....	63
Inexperienced Riders.....	28	Air Filter (V-Belt Housing) - Utility.....	63
Experienced Riders.....	28	Air Filter (V-Belt Housing) - DVX.....	63
DIVISION II -		Air Filter (Engine).....	64
OPERATION/		Air Filter Housing Drain Tube.....	65
MAINTENANCE		Drive Chain (DVX).....	65
ATV Specifications	29	Tires.....	66
Location of Parts and Controls (Utility).....	30	Wheels.....	67
Location of Parts and Controls (DVX).....	31	Muffler/Spark Arrester.....	67
ATV Operation	32-42	Light Bulb Replacement	67
Basic Operating Maneuvers.....	32	Fuses.....	68
Starting the Engine.....	32	Tools.....	69
BONEC.....	32	Preparation for Storage.....	70
Starting A Cold Engine.....	33	Preparation after Storage.....	71
Handling the ATV (Active Riding		Maintenance Record.....	72
Techniques).....	35	Limited Warranty.....	73
Tips.....	41	Warranty Procedure/Owner	
General Information.....	43-52	Responsibility.....	74
ATV Identification Numbers.....	43	Change of Address, Ownership, or	
Ignition Switch Key.....	43	Warranty Transfer.....	75
Control Locations and Functions.....	43	Arctic Cat ATV Emission Control	
Indicator Lights (Utility).....	46	Warranty Statement	77
Indicator Lights (DVX).....	47	U.S. EPA Emission Control Statement/	
Speedometer/LCD (Utility).....	47	Warranty Coverage - ATV (U.S. Only).....	78
Gas/Vent Hoses.....	49	Arctic Cat Emission Control System	
Carburetor Float Bowl Drain.....	49	Limited Warranty	79
		Declaration of Conformity	80
		Identification Numbers Record	
		Inside back cover	

DIVISION I - SAFETY

An ATV Is Not A Toy And Can Be Hazardous To Operate.

- Always go slowly and be extra careful when operating on unfamiliar terrain. Always be alert to changing terrain conditions when operating the ATV.
- Never operate on excessively rough, slippery, or loose terrain.
- Always follow proper procedures for turning as described in this manual. Practice turning at slow speeds before attempting to turn at faster speeds. Do not turn at excessive speed.
- Always have the ATV checked by an authorized Arctic Cat ATV dealer if it has been involved in an accident.
- Never operate the ATV on hills too steep for the ATV or for your abilities. Practice on smaller hills before attempting larger hills.
- Always follow proper procedures for climbing hills as described in this manual. Check the terrain carefully before you start up any hill. Never climb hills with slippery or loose surfaces. Shift your weight forward. Never open the throttle suddenly or make sudden gear changes. Never go over the top of any hill at high speed.
- Always follow proper procedures for going down hills and for braking on hills as described in this manual. Check the terrain carefully before you start down any hill. Shift your weight backward. Never go down a hill at high speed. Avoid going down a hill at an angle which would cause the ATV to lean sharply to one side. Go straight down the hill where possible.
- Always follow proper procedures for crossing the side of a hill as described in this manual. Avoid hills with slippery or loose surfaces. Shift your weight to the uphill side of the ATV. Never attempt to turn the ATV around on any hill until you have mastered the turning techniques described in this manual on level ground. Avoid crossing the side of a steep hill if possible.
- Always use proper procedures if you stall or roll backward when climbing a hill. To avoid stalling, maintain a steady speed when climbing a hill. If you stall or roll backwards, follow the special procedure for braking described in this manual. Dismount on the uphill side or to either side if pointed straight uphill. Turn the ATV around and mount following the procedure described in this manual.
- Always check for obstacles before operating in a new area. Never attempt to operate over large obstacles, such as large rocks or fallen trees. Always follow proper procedures when operating over obstacles as described in this manual.
- Always be careful of skidding or sliding. On slippery surfaces, such as ice, go slowly and be very cautious in order to reduce the chance of skidding or sliding out of control.
- Never operate an ATV in fast flowing water or in water deeper than the footrests. Remember that wet brakes may have reduced stopping capability. Test your brakes after leaving water. If necessary, apply them lightly several times to let friction dry out the pads.
- Always be sure there are no obstacles or people behind you when you operate in reverse. When it is safe to proceed in reverse, go slowly. Avoid turning at sharp angles in reverse.
- Always use the size and type tires specified in this manual. Always maintain proper tire pressure as described in this manual.
- Never improperly install or improperly use accessories on this ATV.
- Never install a twist grip throttle on this ATV.
- Never exceed the stated load capacity for an ATV. Cargo should be properly distributed and securely attached. Reduce speed and follow instructions in this manual for carrying cargo or pulling a trailer and allow greater distance for braking.
- No one under the age of 16 should operate this ATV. Some operators at the age of 16 may not be able to operate an ATV safely. Parents should supervise the use of the ATV at all times. Parents should permit continued use only if they determine that the operator has the ability to operate the ATV safely.

FOR MORE INFORMATION ABOUT ATV SAFETY, call the ATV Safety Institute at 1-800-887-2887 (U.S.) or 1-613-739-1535 (Canada).

ATV Safety Alert

The Consumer Product Safety Commission has concluded that ALL-TERRAIN VEHICLES (ATV's) may present a risk of DEATH or SEVERE INJURY in certain circumstances. Accidents may occur for many reasons:

- *** Over 2591 people, including many children, have died in accidents associated with ATV's since 2005.
- *** Many people have become severely paralyzed or suffered severe internal injuries as a result of accidents associated with ATV's.
- *** Every month thousands of people are treated in hospital emergency rooms for injuries received while riding an ATV.

You should be aware that AN ATV IS NOT A TOY AND CAN BE HAZARDOUS TO OPERATE. An ATV handles differently from other vehicles, including motorcycles and cars. A collision or roll-over can occur quickly, even during routine maneuvers such as turning and driving on hills and over obstacles, if you fail to take proper precautions.

TO AVOID DEATH OR SEVERE PERSONAL INJURY:

- * Always read the Operator's Manual carefully and follow the operating procedures described. Pay special attention to the warnings contained in the manual and on all labels.
- * Never operate an ATV without proper instruction. Take a training course.
- * Always follow these age recommendations:
 - A Y-12+ is intended for use by children age 12 or older, and a T-14 is intended for use by an operator age 14 or older.
 - A child under 16 years old should never operate an ATV without adult supervision. Children need to be observed carefully because not all children have the strength, size, skills, or judgment to operate an ATV safely.

- * Never carry a passenger on an ATV. Carrying a passenger may upset the balance of the ATV and may cause it to go out of control.
- * Always avoid paved surfaces. ATV's are not designed to be used on paved surfaces and may seriously affect handling and control.
- * Never operate an ATV on a public road, even a dirt or gravel one, because you may not be able to avoid colliding with other vehicles. Also, operating an ATV on a public road may be against the law.
- * Never operate an ATV without an approved motorcycle helmet, eye protection, boots, gloves, long pants, and a long-sleeved shirt or jacket.
- * Never consume alcohol or drugs before or while operating an ATV.
- * Never operate an ATV at excessive speeds. Go at a speed which is proper for the terrain, visibility conditions, and your experience.
- * Never attempt to do wheelies, jumps, or other stunts.
- * Always be careful when operating an ATV, especially when approaching hills, turns, and obstacles and when operating on unfamiliar or rough terrain.
- * Never lend the ATV to anyone who has not taken a training course or has not been driving an ATV for at least a year.

Rider Training Course

Arctic Cat sponsors a free Rider Training Course to teach ATV riding skills or to reinforce current riding skills. First-time purchasers without any previous ATV riding experience will receive a \$100.00 coupon from Arctic Cat through the SVIA/ASI after completing the training course (U.S. owners only, one incentive, and free rider training courses for appropriate immediate family members per ATV purchase). See an authorized Arctic Cat ATV dealer for details or call (800) 887-2887 for training course information.

In Canada, the Canada Safety Council (CSC) provides an ATV Rider's Course to teach safe ATV operating skills. They also provide a special ATV Rider's Course for children under 14 years of age with parental supervision. Call the CSC at 1-613-739-1535 ext. 227 for more details. Also available is a bilingual computer-based safety training program on a CD-ROM from CATV - call toll-free at 1-877-470-2288.

Au Canada, le conseil canadien de la sécurité (CSC) offre un cours de conduite de VTT pour enseigner les habiletés d'opération sécuritaires de VTT. Un cours spécial de conduite de VTT est également offert aux enfants de moins de 14 ans avec la surveillance d'un parent. Communiquez avec le CSC en composant le: 1-613-739-1535, poste 227 pour de plus amples informations. Un programme de formation bilingue informatisé sur la sécurité est aussi disponible sur disque optique compact par CATV; composez sans frais le: 1-877-470-2288.



FOR MORE INFORMATION ABOUT ATV SAFETY, in the U.S., call the Consumer Product Safety Commission at (800) 638-2772 or the ATV Distributors' Safety Hotline at (800) 852-5344 or in Canada, call the Canada Safety Council at 1-613-739-1535 ext. 227.

Visit the Arctic Cat Inc. website at www.arcticcat.com for additional product information.

Hangtag & Warning Information

This Arctic Cat ATV comes with a hangtag and several labels containing important safety information. Anyone who rides the ATV should read and understand this information before riding.

The labels should be considered as permanent parts of the ATV. If a label comes off or becomes hard to read, contact your Arctic Cat ATV dealer for a replacement.

Utility



2258-133



DVX

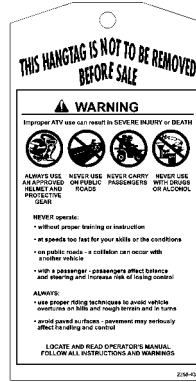

2258-432



Pour commander des Etiquettes de Mise en Garde gratuites, voyez votre détaillant de autorisé VTT Arctic Cat pour le numéro de pièce 1436-344.

Warning Labels (Utility)

A **WARNING**

Inflate tire pressure for overloading. Load causes loss of control. Loss of control can result in severe injury or death.

- Cold tire pressure:
 - Front: 4.0 psi (27.6 kPa)
 - Rear: 3.5 psi (24.1 kPa)
- Maximum weight capacity: 400 lbs (182 kg)

B

WARNING

Always use proper tie-down technique. Use proper tie-down technique. Use proper tie-down technique. Use proper tie-down technique.

NOTE

ALWAYS RESPECT THE RIGHTS OF OTHERS. Observe all applicable laws, regulations, and codes. Observe all applicable laws, regulations, and codes. Observe all applicable laws, regulations, and codes. Observe all applicable laws, regulations, and codes.

PRE-RIDE INSPECTION PROCEDURES/ STARTING PROCEDURES

T	Tire pressure	B	Brake
C	Controls	O	Oil
L	Lights	N	Noise
O	Operator	E	Engine
C	Chain	C	Clutch

C **WARNING**

Operator ATVs are not rated to SEVERE DUTY or DEPTD.

NEVER operate:

- without proper training or instruction
- at speeds too fast for your skills or the conditions
- on public roads - a vehicle can collide with another vehicle
- with a passenger-passenger affect balance and steering and increase risk of losing control

DO NOT:

- use power tilting techniques to avoid vehicle operation on hills and rough terrain and in turns
- avoid paved surfaces - pavement may seriously affect handling and control

LOCATE AND READ OPERATOR'S MANUAL. FOLLOW ALL INSTRUCTIONS AND WARNINGS.

D **WARNING**

UNDER 16

Operating this ATV if you are under the age of 16 increases your chance of serious injury or death.

NEVER operate this ATV if you are under age 16.

E **WARNING**

Exceeding vehicle's towing limit could cause an accident. Reduce speed when towing a trailer. Read operator's manual for details.

MAXIMUM TOWING WEIGHT: 25 lbs (11 kg)

MAXIMUM TOWING CAPACITY: 500 lbs (227 kg)

F **WARNING**

NEVER carry a passenger on this carrier. **MAXIMUM LOAD:** 50lb (23kg) evenly distributed.

G **WARNING**

NEVER ride as a passenger

Passengers can cause a loss of control, resulting in SEVERE INJURY or DEATH.

H **WARNING**

NEVER carry a passenger on this carrier. **MAXIMUM LOAD:** 100lb (45kg) evenly distributed.

I **WARNING/AVERTISSEMENT**

THIS VEHICLE IS AN ALL-TERRAIN VEHICLE AND IS NOT INTENDED FOR USE ON PUBLIC HIGHWAYS. CE VEHICULE EST UN VEHICULE TOUT TERRAIN QUI N'EST PAS DESTINE A ETRE UTILISE SUR LES CHEMINS PUBLICS.

J **WARNING**

Disengage brake lever lock before operating ATV.

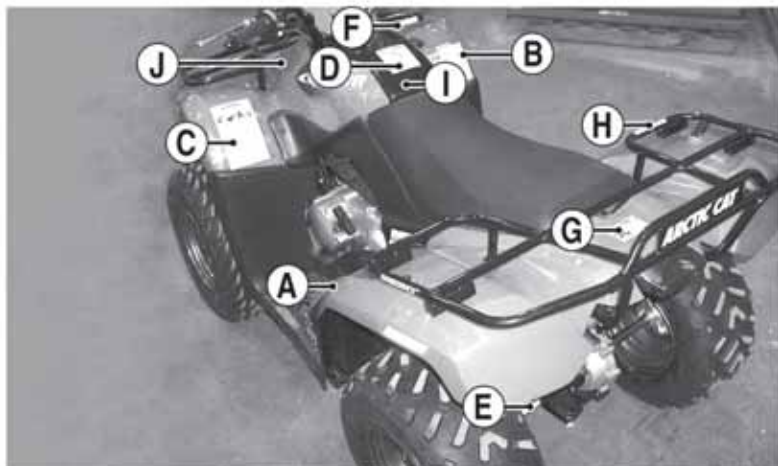

KM152C

Warning Labels (DVX)

A

<p>▲ WARNING</p> <p>Improper tire pressure or overloading can cause loss of control. Loss of control can result in severe injury or death.</p> <ul style="list-style-type: none"> • Call tire pressure: <ul style="list-style-type: none"> Front: 4.0 psi (27.6 kPa) Rear: 3.5 psi (24.1 kPa) • Maximum weight capacity: 250 lbs (113 kg) 	<p>▲ WARNING</p> <p>NEVER ride as a passenger. Passengers can cause a loss of control, resulting in SEVERE INJURY or DEATH.</p> 
---	---

B

<p>■ NOTE</p> <p>• ALWAYS RESPECT THE RIGHTS OF OTHERS, protect the environment, and comply with all applicable laws and regulations.</p> <p>TREAD LIGHTLY! ON PUBLIC AND PRIVATE LANDS</p>	<p>▲ WARNING</p> <p style="text-align: center;">UNDER 16</p> <p>Operating this ATV if you are under the age of 16 increases your chance of severe injury or death.</p> <p>NEVER operate this ATV if you are under age 16.</p>
---	--

PRE-RIDE INSPECTION PROCEDURES: STARTING PROCEDURES	
<p>T TIRES AND WHEELS</p> <ol style="list-style-type: none"> 1. Check for proper air pressure. 2. Check for cuts and gouges. 3. Make sure nuts and bolts are tight. 	<p>B BRAKES</p> <ol style="list-style-type: none"> 1. Set the PARKING BRAKE.
<p>C CONTROLS AND CABLE</p> <ol style="list-style-type: none"> 1. Identify location of all controls. 2. Throttle should operate smoothly and snap closed. 3. Check brake operation, adjustment, and for worn pads. 4. Check shifter operation. 	<p>O ON</p> <ol style="list-style-type: none"> 2. Turn the fuel valve on. 3. Turn the ignition key on.
<p>L LIGHTS AND ELECTRICAL</p> <ol style="list-style-type: none"> 1. Check ignition switch operation. 2. Check engine stop switch operation. 3. Check all lights. 	<p>N NEUTRAL</p> <ol style="list-style-type: none"> 4. Make sure the transmission is in neutral.
<p>O OIL AND FUEL</p> <ol style="list-style-type: none"> 1. Check fuel level. 2. Check oil level. 3. Check for leaks. 	<p>E ENGINE</p> <ol style="list-style-type: none"> 5. Turn the "Emergency Stop" switch to "Start" position.
<p>C CHASSIS AND DRIVE TRAIN</p> <ol style="list-style-type: none"> 1. Make sure all nuts and bolts are tight. 2. Make sure all debris is removed from around axle and drive chain. 3. Make sure ATV is loaded properly and not over loaded. 	<p>C CHOKE</p> <ol style="list-style-type: none"> 6. When engine is cold, spray choke fully. 7. Start engine. 8. When engine is warm, adjust choke to operating position.

D

▲ WARNING

Failure to stop vehicle completely before engaging reverse could result in you being thrown from the ATV.

TO ENGAGE REVERSE:

1. Stop vehicle completely.
2. Bring engine to idle. Apply brake.
3. Shift transmission to neutral.
4. Shift reverse lever fully toward rear while applying brakes.

Read operator's manual located under the seat for additional information. Write to Arctic Cat for free replacement if missing.

1411-109

C

▲ WARNING

Improper ATV use can result in SEVERE INJURY or DEATH



ALWAYS USE AN APPROVED HELMET AND PROTECTIVE GEAR

NEVER USE ON PUBLIC ROADS

NEVER CARRY PASSENGERS

NEVER USE WITH DRUGS OR ALCOHOL

NEVER operate:

- without proper training or instruction
- at speeds too fast for your skills or the conditions
- on public roads - a collision can occur with another vehicle
- with a passenger-passengers affect balance and steering and increase risk of losing control

ALWAYS:

- use proper riding techniques to avoid vehicle overruns on hills and rough terrain and in turns
- avoid paved surfaces - pavement may seriously affect handling and control

LOCATE AND READ OPERATOR'S MANUAL FOLLOW ALL INSTRUCTIONS AND WARNINGS

1411-105

E

▲ WARNING/AVERTISSEMENT

THIS VEHICLE IS AN ALL-TERRAIN VEHICLE AND IS NOT INTENDED FOR USE ON PUBLIC HIGHWAYS. CE VEHICULE EST UN VEHICULE TOUT TERRAIN QUI N'EST PAS DESTINE A ETRE UTILISE SUR LES CHEMINS PUBLICS.

1411-104

F

▲ WARNING

Disengage brake lever lock before operating ATV.

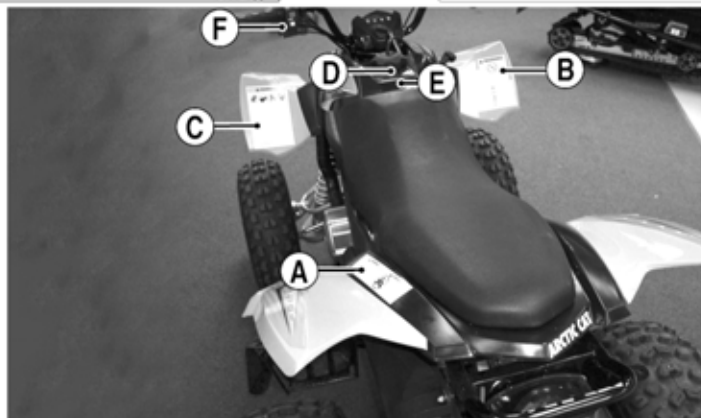

KM169E

Warnings

WARNING

POTENTIAL HAZARD

Operating this ATV without proper instruction.

WHAT CAN HAPPEN

The risk of an accident is greatly increased if the operator does not know how to operate the ATV properly in different situations and on different types of terrain.

HOW TO AVOID THE HAZARD

Beginning and inexperienced operators should complete the certified training course offered. They should then regularly practice the skills learned in the course and the operating techniques described in this Operator's Manual.

For more information about the training course, contact an authorized Arctic Cat ATV dealer or call 1-800-887-2887 (U.S.) or 1-613-739-1535 (Canada).

WARNING

POTENTIAL HAZARD

Allowing anyone under age 16 to operate this ATV.

WHAT CAN HAPPEN

Use of an ATV by children can lead to severe injury or death of the child. Children under the age of 16 may not have the skills, abilities, or judgment needed to operate the ATV safely and may be involved in a serious accident.

HOW TO AVOID THE HAZARD

A child under 16 should never operate this ATV.

WARNING

POTENTIAL HAZARD

Carrying a passenger on this ATV.

WHAT CAN HAPPEN

Greatly reduces your ability to balance and control this ATV.

Could cause an accident, resulting in injury or death to you and/or your passenger.

HOW TO AVOID THE HAZARD

Never carry a passenger. The long seat is to allow the operator to shift positions as needed during operation. It is not for carrying passengers.

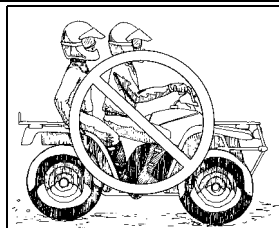

WARNING

POTENTIAL HAZARD

Operating this ATV on public streets, roads, or highways.

WHAT CAN HAPPEN

You can collide with another vehicle.

HOW TO AVOID THE HAZARD

Never operate this ATV on any public street, road, or highway, even a dirt or gravel one.

In many states it is illegal to operate an ATV on public streets, roads, or highways.



Warnings

WARNING

POTENTIAL HAZARD

Operating this ATV on paved surfaces.

WHAT CAN HAPPEN

The ATV's tires are designed for off-road use only, not for use on pavement. Paved surfaces may seriously affect handling and control of the ATV and may cause the ATV to go out of control.

HOW TO AVOID THE HAZARD

Never operate the ATV on any paved surfaces, including sidewalks, driveways, parking lots, and streets.



WARNING

POTENTIAL HAZARD

Operating this ATV without wearing an approved helmet, eye protection, and protective clothing.

WHAT CAN HAPPEN

Operating without an approved helmet increases your chances of a severe head injury or death in the event of an accident.

Operating without eye protection can result in an accident and increases your chances of a severe injury in the event of an accident.

Operating without protective clothing increases your chances of severe injury in the event of an accident.

HOW TO AVOID THE HAZARD

Always wear an approved helmet that fits properly.

You should also wear: Eye protection (goggles or face shield)

Gloves

Boots

Long sleeved shirt or jacket

Long pants

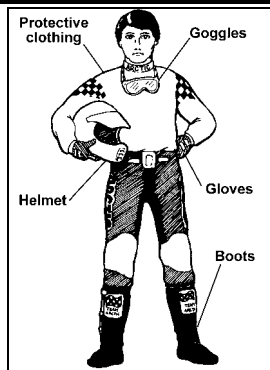

WARNING

POTENTIAL HAZARD

Operating on steep hills.

WHAT CAN HAPPEN

The ATV can overturn more easily on steep hills than on level surfaces or small hills.

HOW TO AVOID THE HAZARD

Never operate the ATV on hills too steep for the ATV or for your abilities.

Practice on smaller hills before attempting larger hills.

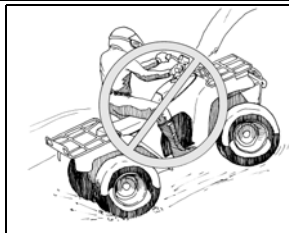

Warnings

WARNING

POTENTIAL HAZARD

Operating this ATV after or while consuming alcohol or drugs.

WHAT CAN HAPPEN

Could seriously affect your judgment.
 Could cause you to react more slowly.
 Could affect your balance and perception.
 Could result in an accident.

HOW TO AVOID THE HAZARD

Never consume alcohol or drugs before or while driving this ATV.

WARNING

POTENTIAL HAZARD

Operating this ATV at excessive speeds.

WHAT CAN HAPPEN

Increases your chances of losing control of the ATV, which can result in an accident.

HOW TO AVOID THE HAZARD

Always ride at a speed that is proper for the terrain, visibility and operating conditions, and your experience.

WARNING

POTENTIAL HAZARD

Attempting wheelies, jumps, and other stunts.

WHAT CAN HAPPEN

Increases the chance of an accident including a roll-over.

HOW TO AVOID THE HAZARD

Never attempt stunts, such as wheelies or jumps.
 Don't try to show off.

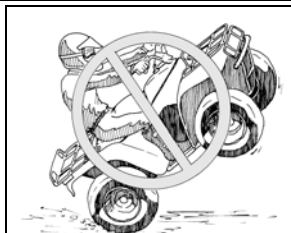

WARNING

POTENTIAL HAZARD

Failure to inspect the ATV before operating.
 Failure to properly maintain the ATV.

WHAT CAN HAPPEN

Increases the possibility of an accident or equipment damage.

HOW TO AVOID THE HAZARD

Always inspect your ATV each time you use it to make sure the ATV is in safe operating condition.
 Always follow the inspection and maintenance procedures and schedules described in this Operator's Manual.

Warnings

WARNING

POTENTIAL HAZARD

Removing hands from handlebars or feet from footrests during operation.

WHAT CAN HAPPEN

Removing even one hand or foot can reduce your ability to control the ATV or could cause you to lose your balance and fall off the ATV. If you remove a foot from a footrest, your foot or leg may come into contact with the wheels, which could injure you or cause an accident.

HOW TO AVOID THE HAZARD

Always keep both hands on the handlebars and both feet on the footrests of your ATV during operation.

WARNING

POTENTIAL HAZARD

Failure to use extra care when operating the ATV on unfamiliar terrain.

WHAT CAN HAPPEN

You can come upon hidden rocks, bumps, or holes without enough time to react.

Could result in the ATV overturning or going out of control.

HOW TO AVOID THE HAZARD

Go slowly and be extra careful when operating on unfamiliar terrain.

Always be alert to changing terrain conditions when operating the ATV.

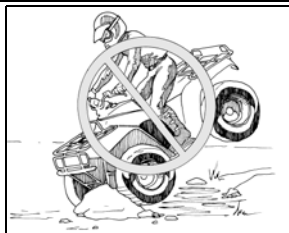

WARNING

POTENTIAL HAZARD

Failure to use extra care when operating on rough, slippery, or loose terrain.

WHAT CAN HAPPEN

Could cause loss of traction or ATV control, which could result in an accident including a rollover.

HOW TO AVOID THE HAZARD

Do not operate on rough, slippery, or loose terrain until you have learned and practiced the skills necessary to control the ATV on such terrain.

Always be especially cautious on these kinds of terrain.



WARNING

POTENTIAL HAZARD

Turning improperly.

WHAT CAN HAPPEN

ATV could go out of control, causing a collision or rollover.

HOW TO AVOID THE HAZARD

Always follow proper procedures for turning as described in this Operator's Manual.

Practice turning at slow speeds before attempting to turn at faster speeds.

Do not turn at excessive speed.

Warnings

WARNING

POTENTIAL HAZARD

Climbing hills improperly.

WHAT CAN HAPPEN

Could cause loss of control or cause the ATV to overturn.

HOW TO AVOID THE HAZARD

Always follow proper procedures for climbing hills as described in this Operator's Manual.

Always check the terrain carefully before you start up any hill.

Never climb hills with slippery or loose surfaces.

Shift your weight forward.

Never open the throttle suddenly or make sudden gear changes. The ATV could flip over backwards.

Never go over the top of any hill at high speed. An obstacle, a sharp drop, or another vehicle or person could be on the other side of the hill.

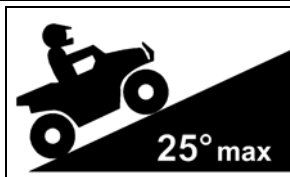

NEVER OPERATE UP OR DOWN HILLS STEEPER THAN 25°

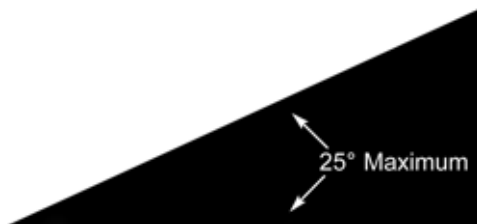

WARNING

POTENTIAL HAZARD

Going down a hill improperly.

WHAT CAN HAPPEN

Could cause loss of control or cause the ATV to overturn.

HOW TO AVOID THE HAZARD

Always follow proper procedures for going down hills as described in this Operator's Manual.

Always check the terrain carefully before you start down any hill.

Shift your weight backward.

Never go down a hill at high speed.

Avoid going down a hill at an angle that would cause the ATV to lean sharply to one side. Go straight down the hill where possible.

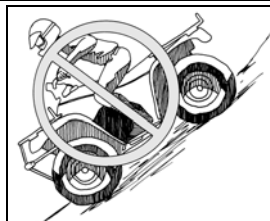

Warnings

WARNING

POTENTIAL HAZARD

Improperly crossing hills or turning on hills.

WHAT CAN HAPPEN

Could cause loss of control or cause the ATV to overturn.

HOW TO AVOID THE HAZARD

Never attempt to turn the ATV around on any hill until you have mastered the turning technique as described in this Operator's Manual. Practice first on level ground. Be very careful when turning on any hill.

Avoid crossing the side of a steep hill, if possible.

When crossing the side of a hill:

Always follow proper procedures as described in this Operator's Manual.

Avoid hills with slippery or loose surfaces.

Shift your weight to the uphill side of the ATV.

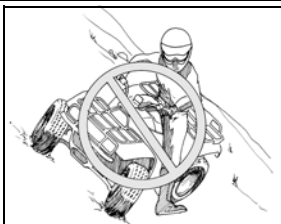

WARNING

POTENTIAL HAZARD

Stalling, rolling backwards, or improperly dismounting while climbing a hill.

WHAT CAN HAPPEN

Could result in the ATV overturning.

HOW TO AVOID THE HAZARD

Use proper gear and maintain steady speed when climbing a hill.

If you lose all forward speed:

- Keep weight uphill.

- Apply the brakes.

- Engage the brake lever lock after you are stopped.

If you begin rolling backwards:

- Keep weight uphill.

- Apply the brakes while rolling backwards.

- When fully stopped, engage the brake lever lock.

- Dismount on uphill side or to a side if pointed straight uphill.

- Turn the ATV around and mount following the procedure described in this Operator's Manual.

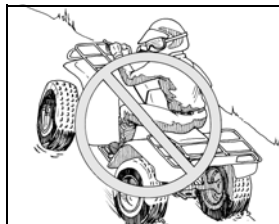

WARNING

POTENTIAL HAZARD

Improperly operating over obstacles.

WHAT CAN HAPPEN

Could cause loss of control or a collision. Could cause the ATV to overturn.

HOW TO AVOID THE HAZARD

Before operating in a new area, check for obstacles.

Never attempt to ride over large obstacles, such as large rocks or fallen trees.

When you go over obstacles, always follow proper procedures as described in this Operator's Manual.

Warnings

WARNING

POTENTIAL HAZARD

Skidding or sliding.

WHAT CAN HAPPEN

You may lose control of the ATV.

You may also regain traction unexpectedly, which may cause the ATV to overturn.

HOW TO AVOID THE HAZARD

Learn to safely control skidding or sliding by practicing at slow speeds and on level, smooth terrain.

On extremely slippery surfaces, such as ice, go slowly and be very cautious in order to reduce the chance of skidding or sliding out of control.

WARNING

POTENTIAL HAZARD

Operating the ATV through deep or fast flowing water.

WHAT CAN HAPPEN

Tires may float, causing loss of traction and loss of control, which could lead to an accident.

HOW TO AVOID THE HAZARD

Never operate the ATV in fast flowing water or in water deeper than the footrests.

Remember that wet brakes may have reduced stopping capability.

Test your brakes after leaving water. If necessary, apply them several times to dry out the pads.

WARNING

POTENTIAL HAZARD

Improperly operating in reverse.

WHAT CAN HAPPEN

You could hit an obstacle or person behind you, resulting in serious injury.

HOW TO AVOID THE HAZARD

Before you engage reverse gear, make sure there are no obstacles or people behind you. When it is safe to proceed, go slowly.

WARNING

POTENTIAL HAZARD

Operating the ATV with improper modifications.

WHAT CAN HAPPEN

Improper installation of accessories or modification of the ATV may cause changes in handling which, in some situations, could lead to an accident.

HOW TO AVOID THE HAZARD

Never modify the ATV through improper installation or improper use of accessories. All parts and accessories added to this ATV should be genuine Arctic Cat ATV components designed for use on the ATV and should be installed and used according to instructions. Never install a twist grip throttle. If you have questions, consult an authorized Arctic Cat ATV dealer.

Warnings

WARNING

POTENTIAL HAZARD

Operating the ATV with improper tires or with improper or uneven tire pressure.

WHAT CAN HAPPEN

Use of improper tires on the ATV, or operation of the ATV with improper or uneven tire pressure, may cause loss of control increasing your risk of accident.

HOW TO AVOID THE HAZARD

Always use the size and type tires specified in this Operator's Manual for this ATV. Always maintain proper tire pressure as described in this Operator's Manual.

WARNING

POTENTIAL HAZARD

Overloading the ATV or carrying or towing cargo improperly.

WHAT CAN HAPPEN

Could cause changes in ATV handling, which could lead to an accident.

HOW TO AVOID THE HAZARD

Never exceed the stated load capacity for the ATV.

Cargo should be properly distributed and securely attached.

Reduce speed when carrying cargo or pulling a trailer. Allow greater distance for braking.

Always follow the instructions in this Operator's Manual for carrying cargo or pulling a trailer.

WARNING

POTENTIAL HAZARD

Failure to release the brake lever lock before driving the ATV.

WHAT CAN HAPPEN

Driving the ATV with the brake lever lock engaged could cause a change in handling or loss of brakes and cause an accident.

HOW TO AVOID THE HAZARD

Always release the brake lever lock before driving the ATV.

Prevention

Overview

When using an ATV, prevention is the name of the game. “Had you only known” something could go wrong, you would have prevented it. If you don’t notice your conditions and surroundings before riding your ATV, you give up control over the situation. Using ATV prevention techniques helps you forecast potential hazards before they injure you or damage your ATV.

Following the safety instructions and warnings in this manual will help you “P.A.S.S.” the safety test. P.A.S.S. stands for “Prevention,” “Active Riding,” “Sound Judgment,” and “Supervision.” Remembering P.A.S.S. and what it stands for will help you have a safe, predictable ride every time you go out on your ATV.

Safe Riding Clothing and Gear

Always wear clothing suited to the type of riding you are doing. ATV riding requires special protective clothing which will make you feel more comfortable and reduce chances of injury.

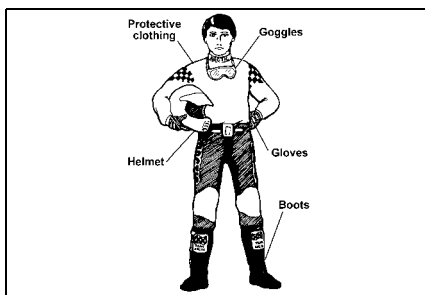

ATV-0004

You’ll find it important to dress correctly for ATV riding in order to prevent scraped skin and serious head injuries. It’s easy and could save you time in the long run not having to contend with an injury. Of course, it also makes sense to remember the seasons. Wear a hat under your helmet and a snowmobile suit in the winter and lighter, protective clothing in the summer. Following is the minimum protection you need to wear during every ride:

Gloves

Your hands are targets for flying objects and branches. Along with providing skin protection, gloves will shield your hands from harsh weather. Wear gloves that are weather resistant and have a gripping surface to keep them from sliding off the handlebar. Off-road style gloves with knuckle pads are the best for comfort and protection.

Boots/Ankle Protection

Wear a boot that covers the largest possible area of your leg (preferably up to your knee) and can handle significant impact. Choosing boots with low heels and a good tread will help prevent your feet from slipping off the footrests in wet or rugged conditions or getting hurt if they get hit by rocks, dirt, or branches.

Helmet

Your helmet is the most important piece of protective gear for safe riding. A helmet can prevent a severe head injury. There are several types of helmets on the market, but make sure you wear a helmet that complies with the current standards of the U.S. Department of Transportation (DOT), The Snell Memorial Foundation, or the American National Standards Institute (ANSI). Helmets that comply with one or more of these agency’s standards have a sticker on the inside or outside of the helmet.

Prevention

TESTIMONIAL

DOCUMENT#: N490117A1
 CITY/STATE: N. HUNTINGDON, PA
 SEX: M
 AGE: 6
 BODY PART: HEAD
 DATE ACCIDENT: 14-06-94
 DISPOSITION: DOA
SYNOPSIS: The 6 year old male victim died from blunt force trauma to the head when the 4-wheel ATV on which he was a passenger struck a rock on a hill connecting two roads and flipped over backwards onto the victim, shattering his bicycle helmet. The victim was life-flighted to the hospital and died that night. The driver of the ATV, the victim's 29 year old father, sustained minor injuries, but wasn't treated.

Helmets should have one of these:

1. DOT label
2. Snell label
3. ANSI Z90.1 label



These helmets should provide full-face protection.

If you drop or damage your helmet, get a new one immediately. Your helmet may not protect your head from injury if it has cracks, fissures, or other damage to its outside or core padding.

Remember, your helmet won't do you any good if the chin strap isn't fastened.

Eye Protection

Wear eye protection, such as goggles, to completely surround your eyes to prevent getting dirt or other items in your eyes. Do not depend on sunglasses for proper eye protection. Sunglasses are not recommended; they don't prevent objects from flying in through the sides.

Long Pants and Long Sleeved Shirt

The goal is to protect your body from branches, long grass, airborne objects, or anything else that could scrape your skin. The more thick and durable the material, the better protection it'll provide. Riding pants with kneepads, a jersey, and shoulder pads provide the best protection.

Condition of the ATV

The second step in Prevention is checking the condition of your ATV. Chances are good that you'll be using your ATV in some rough terrain, and there's no way you want your brakes to go out when riding downhill. You need to check the following parts on your ATV before every ride.

- | | |
|--------------------------|----------------------------|
| 1. Tires and Wheels | 4. Oil and Fuel |
| 2. Controls and Cable | 5. Chassis and Drive Train |
| 3. Lights and Electrical | 6. Miscellaneous Items |

One easy way to remember what parts you need to check is by using the acronym "T-CLOC." It stands for:

T	C	L	O	C
TIRES AND WHEELS	CONTROLS AND CABLE	LIGHTS AND ELECTRICAL	OIL AND FUEL	CHASSIS AND DRIVE TRAIN

Prevention

1. TIRES AND WHEELS

Correct tire pressure is crucial. Consult the General Maintenance section of this Operator's Manual for tire pressure guidelines. Incorrect tire pressure can cause poor handling, instability, and a loss of ATV control.

Check:

1. Tire pressure
2. Tire surface (tread and sidewalls)

While checking the tire pressure, inspect the tread and sidewalls of the tires for cracks, cuts, or other damage that could indicate they need to be replaced.

2. CONTROLS AND CABLE

With the engine running and brake applied, check all transmission positions: forward, neutral, and reverse.

Check:

1. Forward
2. Neutral
3. Reverse

A. Brakes

Squeeze your brake lever and depress the rear foot brake. If either feels soft or "squishy," it could be low on fluid or have a leak — refer to the General Maintenance section of this Operator's Manual for instructions. Don't use the ATV until the brakes are operating normally.

Check:

1. Hand brake lever
2. Rear foot brake
3. Brake lever lock

Test the brake lever lock and see if it locks the wheels; then disengage it to release the brake.

B. Throttle

The throttle should have a free, smooth range of motion. If it seems to "stick" at any point, refer to the General Maintenance section of this Operator's Manual for instructions. Driving your ATV with a sticking throttle can turn your leisurely ride into an unwelcome accident. Don't drive your ATV if the throttle sticks.

Check:

1. Free, smooth range of motion

3. LIGHTS AND ELECTRICAL

Turn the hi-beam and lo-beam on and off to make sure they work. At the same time, check that the taillight and brakelight work. Also, check the indicator/warning lights (reverse, neutral, and temperature) on your handlebar when you start the ATV. Don't drive the ATV unless all systems are working. Check the ignition switch and engine stop switch.

Check:

1. Hi-beam
2. Lo-beam
3. Taillight/brakelight
4. Indicator/warning lights
5. Ignition switch
6. Engine stop switch

4. OIL AND FUEL

Start with a full tank of gas before every ride, and while you're at it, top off the oil. Don't forget to check for fluid leaks around the ATV. Check the coolant tank to ensure the engine coolant level is adequate.

Check:

1. Gas
2. Oil
3. Fluid leaks

Prevention

5. CHASSIS AND DRIVE TRAIN

Grass and leaves can gum-up your suspension and shocks. Clear and clean the suspension arms, shock absorbers/springs, and fenders. Check smoothness by turning the handlebar full-left and full-right. Verify there is no binding, restrictions, free-play, or looseness in steering components. Check and clean the drive chain and sprockets of foreign material and debris. Check drive chain adjustment.

Check:

1. Suspension arms
2. Shock absorbers/springs
3. Fenders
4. Steering
5. Drive chain

6. MISCELLANEOUS ITEMS

Inspect your air filter. Look for debris or damage that may indicate you need to replace it. A clogged filter can stop an engine. Check your battery terminals for corrosion. Also, be sure to tighten any loose parts, nuts, or bolts.

Check

1. Air filter
2. Battery
3. Tighten parts, nuts, and bolts

First Aid and Survival

You need to prepare for the unexpected. Emergencies and accidents are traumatic enough, but they're even worse when you're not prepared for them. At the minimum during every ATV ride, you should have the following items on board:

- Tools
- Water
- Identification
- First Aid Kit

For rides that are longer in duration and distance, the following additional items are recommended:

- Cellular Phone
- Maps/GPS
- Emergency Kit *with Flashlight and First Aid Kit*

Tools

Routine maintenance will generally eliminate the need for emergency repairs. Riding on rough terrain could cause loosening of nuts, bolts, and fasteners. Especially on long rides, carrying the right tools can prevent an inconvenience from becoming a crisis.

Carry these items on your ATV:

1. Bulbs
2. Duct tape
3. Rope
4. Spark plugs
5. Spare parts
6. Tool Kit

Water

Water is so important that you need to carry it regardless of the duration of your ride. Heat exhaustion and heat stroke can creep up suddenly and can take you out of commission. If you become dehydrated, you could find yourself physically unable to safely operate your ATV.

Identification

If something does happen to you, the emergency personnel will want to know who you are and whom to contact. It's possible you may be in no condition to give them that information. Put your I.D. in your pocket before you ride. Without it, you're anonymous.

Cellular Phone

It may be necessary to make an urgent phone call.

Maps/GPS (Global Positioning System)

Maps may be unnecessary when you're familiar with the area. But when you're riding on unfamiliar trails, it's good to know where you are, what's coming up, and how to get back.

Prevention

Emergency Kit with Flashlight and First Aid Kit

You'll need several items in your Emergency Kit including a flashlight. The matches will come in handy if you need to start a fire to stay warm. Flares are appropriate for signaling help. A first aid kit is very important if an injury of some type should happen. A good First Aid Kit should include bandages, antiseptic spray, gauze, tape, etc.

Carry these items:

1. Flashlight
2. Matches
3. Flares
4. First Aid Kit
5. Money

Active Riding

Overview

“Active Riding” is the second part of “P.A.S.S.” It involves an understanding of how your body weight, balance, gravity, and physical forces affect the handling of the ATV. For example, when you drive a car quickly into a sharp turn, your body is pulled to the outside of the vehicle by centrifugal force. Although a car is relatively stable, enough centrifugal force can cause an ATV to overturn. Constantly shifting your weight is one major difference between driving a car and riding an ATV. Knowing how to shift your weight is necessary to avoid rolling or flipping the ATV.

For complete operating instructions, see ATV Operation sub-section in this manual.

Sound Judgment

Overview

You are not invincible. Knowing that the first “S” in “P.A.S.S.” stands for “Sound Judgment” means you need to use yours.

Do you consider yourself to be pretty conservative, or are you a heavy risk-taker? Before continuing with this section on sound judgment, check your **Risk Factor** by doing this short survey:

1. Do you drive over the speed limit?

1	2	3
Never	Sometimes	Often

2. Are you more daring around your friends than you are when alone?

1	2	3
Never	Sometimes	Often

3. Do you drive your car when the gas gauge is on empty?

1	2	3
Never	Sometimes	Often

4. Do you feel that no matter what you do, you won't get hurt?

1	2	3
Never	Sometimes	Often

5. Do you drink or use drugs before you drive your car?

1	2	3
Never	Sometimes	Often

6. Do you drive your car even if it has a major problem with the brakes, tires, or engine?

1	2	3
Never	Sometimes	Often

7. Do you thrive on the adrenaline rush you get from speeding and dangerous situations?

1	2	3
Never	Sometimes	Often

8. Do you hurt yourself because you do things that are out of your ability range?

1	2	3
Never	Sometimes	Often

9. Do you tailgate other drivers when you think they're driving too slow?

1	2	3
Never	Sometimes	Often

10. Do you ignore weather reports before you do outside activities like swimming, camping, fishing, or boating?

1	2	3
Never	Sometimes	Often

Add the totals from lines 1-10. **YOUR RISK FACTOR IS:**

10-15: You're pretty conservative. Chances are good that the consistently safe choices you make will help you avoid hurting yourself and the people around you.

16-20: You're straddling the fence. Depending on your mood or whom you're with, the choices you make may help you or hurt you.

21-30: You're taking your chances. Time to reconsider a lot of the judgments you make. You're destined to put yourself in dangerous situations and potentially hurt yourself and the people around you.

Environment

The environment you operate an ATV in is often harsh and sometimes dangerous if you don't take proper precautions.

Weather

You need to consider the weather. It is dangerous to ride your ATV when the weather is bad or potentially bad. Keep abreast with weather forecasts.

Terrain

Always pay close attention to the terrain you're on even if it is familiar to you. You can't assume that the landscape you're used to doesn't change. Changes to landscape can happen at nearly any time. Fences can be constructed and excavations dug in a short period of time. Weather, climate, and development take their toll.

Sound Judgment

The thing about terrain is that sometimes you don't know it's changed until you get there. Whether it's familiar or not, check out your surroundings before and during your ride.

Night Riding

Riding at night can be very hazardous. Obstacles and other hazards (that are easily identified during daytime) are much more difficult to see and avoid. When night riding, make sure the lights are properly adjusted and in good working order. Reduce speed; do not over-drive the headlight. Never travel in an unfamiliar area or blaze a new trail at night. Always carry a flashlight or flare for signaling an emergency.

Paved Surfaces

Don't do it! The ATV isn't designed for pavement. Its handling becomes more difficult on paved surfaces.

Trail Riding

Use sound judgment when trail riding; that means riding on a trail that fits your ability level. If the trail is pretty rugged, standing up on your footrests will make it easier for you to endure the rough terrain.

Make yourself visible by using headlights and taillights, and pull completely off the trail if you need to stop.

Outsloped trails (trails that slant to allow rain to run off) make trail riding a bit more challenging. Accepting that challenge means keeping your weight shifted into the slope. Denying the challenge means sliding off the trail.

It also helps to know which trails you can ride and who else might be on those same trails. These are signs currently used in some areas to designate trail types and restrictions.

Trail Signs

SYMBOLS



TWO-WHEEL
MOTOR VEHICLE



SEDAN



HIGH
CLEARANCE
VEHICLE 4x4 &
PICKUP



ATV



SNOWMOBILE



OPEN ROUTE
Not always used
(refer to map).

Symbol with RED
SLASH indicates activity
not allowed.
Symbol with
YELLOW SLASH
indicates activity not
recommended.



TRAVEL MANAGEMENT POSTER



NATIONAL FOREST ROUTE MARKERS



Roads maintained for
LOW clearance
vehicles, such as
passenger cars,
motorhomes.



Roads maintained for
HIGH clearance
vehicles.

ATV-0068A

Those Around You

People do all kinds of things that you can't predict or control.

Riding Companions

Leave a lot of space between you and other riders, especially in dusty and dirty conditions, because it'll be difficult to see the riders in front of you stopping.

Riding with companions on several ATV's is not the same as riding one ATV with a passenger. Passengers are prohibited; it's unsafe. The extra weight on the seat makes the ATV difficult to control. About 50% of all ATV accidents involve passengers.

Sound Judgment

Other Vehicles

Depending on where you're riding, you might encounter other ATV's, bikes, or motor vehicles on public lands. Respect the presence of cars if you're crossing roads or riding in public areas and make yourself be seen. If you can't see other vehicles coming, that means you're invisible, too.

Hikers

With the renewed interest in hiking, camping, and other outdoor activities, people can show up in remote areas where you would never expect them. For their sake, keep your eyes open.

Animals and Nature

Respect the outdoors that you love. Don't use your ATV to chase animals or birds. Drive around young trees rather than over them. Keep clear of streams and ditches with standing water.

TESTIMONIAL

DOCUMENT#: N380310A1
 CITY/STATE: NEW CUMBERLAND, WV
 SEX: M
 AGE: 18
 BODY PART: HEAD
 DATE ACCIDENT: 7-30-93
 DISPOSITION: DOA
 SYNOPSIS: An 18 year old male died as the result of injuries which he sustained in an accident while driving a 4-wheel ATV on a gravel public road. The victim lost control of the ATV when he suddenly applied the brakes to avoid a dog crossing the road. During the accident, the ATV's brake lever penetrated the victim's brain through his right eye resulting in death. The victim was not wearing a helmet.

Tread Lightly and leave it as you found it.

Equipment

The last thing you expected was that your ATV would break down in the middle of the field... it's usually so reliable that sometimes you forget the ATV has its limits.

ATV Maintenance

You have to maintain your ATV. The General Maintenance section of this Operator's Manual tells you about taking care of your ATV. If, at any time, abnormal noises, vibrations, or improper functioning of any component of this ATV is detected, **DO NOT OPERATE THE ATV**. Take the ATV to an authorized Arctic Cat ATV dealer for inspection and adjustment or repair.

Cargo Limitations

One reason why passengers are prohibited on this ATV is because their presence throws off the weight and balance of the ATV. Cargo can do the same. Limit the ATV to the specified load capacity rating. The combined weight limit, including you and your personal items, is a specified amount, so consult the Load Capacity Ratings Chart and monitor it carefully.

Extra weight on the ATV will also throw you off balance if it's not distributed evenly.

Think about these when dealing with weight:

1. Weight distribution
2. ATV speed

Load Capacity Ratings Chart

Arctic Cat ATV Load Capacity Ratings			
Item	Specifications		
	(lb)	(kg)	
Max Load Capacity			
	(Utility) (DVX)	400 250	181 113
Front Rack (max)	(Utility)	50	23
Rear Rack (max)	(Utility)	100	45
Tongue Weight		35	16
Rear Rack and Tongue Weight	(max)	100	45
Towing Capacity	(Utility)	500	227

Max Load Capacity - Total weight of operator, accessories, tongue weight, and cargo on front and rear racks.

Tongue Weight - Weight on trailer tongue.

Rear Rack and Tongue Weight - Total weight on trailer tongue and rear rack.

Sound Judgment

Towing Capacity - Total weight of trailer and all cargo in the trailer.

■ **NOTE:** Tongue and accessory weight (winch, gun scabbard brackets, etc.) must be included as part of the front and rear rack weights.

WARNING

Operating this ATV with improper modifications can be hazardous. Improper installation of accessories or modification of the ATV may cause changes in handling which could lead to an accident. Never modify the ATV with improper installation or use of improper accessories. All parts and accessories installed on this ATV must be genuine Arctic Cat parts and accessories designed for use on this ATV. Install and use them according to instructions. If you have any questions, contact an authorized Arctic Cat ATV dealer.

■ **NOTE:** Use extra caution when operating an ATV with additional loads such as accessories and/or personal items. Handling of the ATV may be adversely affected. Reduce speed when adding additional loads.

WARNING

POTENTIAL HAZARD

Overloading the ATV or carrying personal items improperly.

WHAT CAN HAPPEN

Could cause changes in ATV handling, which could lead to an accident.

HOW TO AVOID THE HAZARD

Never exceed the stated load capacity for the ATV.

Always follow the instructions in this Operator's Manual pertaining to ATV loading.

Personal Choices

A safe, enjoyable ride is dependent on many personal choices. An ATV, like all motorized vehicles, can be dangerous to operate if you choose to ignore safety precautions, take unnecessary chances, or ride beyond your ability or your vehicle's capability. Don't allow the thrill of freedom or adventure to affect your ability to make good, safe choices.

Alcohol and Drug Consumption

Alcohol is related to a high percentage of all hospital admissions due to ATV accidents in the U.S. This isn't an issue of morality. It's extremely dangerous to drink alcoholic beverages and ride... it's also very foolish. When the alcohol starts kicking in and you're tearing along on your ATV, those odds can catch up to you.

TESTIMONIAL

DOCUMENT#: X46481A1
 CITY/STATE: LAUREL, MS
 SEX: M
 AGE: 25
 BODY PART: ALL PARTS BODY
 DATE ACCIDENT: 6-25-93
 DISPOSITION: DOA
 SYNOPSIS: A 25 year old male died from drowning after the 4-wheeled ATV he was driving overturned and landed on the victim, pinning him face down in 6 inches of water in a drainage ditch. The victim had failed to make a right hand turn and drove off the side of the road. The victim was driving at an excessive speed, and under the influence of alcohol. He was pronounced dead at the scene. The victim was not wearing a helmet.

Substances to avoid when riding:

1. Alcohol
2. Over-the-counter or prescription drugs
3. Illegal/mood altering drugs

Be aware of prescription and over-the-counter medications. Drowsiness and impaired judgment can be caused by a wide variety of medications. The same is true of allergy, cold, flu, and headache medications. Your physical size and weight can't protect you... just one antihistamine tablet can affect your judgment.

Sound Judgment

If your sense of adventure persuades you to do illegal drugs when you're riding your ATV, this is a reality check. Something to think about—there can be legal consequences that will take away all that freedom you love. Don't use alcohol or drugs before or during your ATV ride.

THE EFFECTS OF ALCOHOL*

The Number of Drinks that Impair Mental and Physical Abilities

1-2 DRINKS

Mental processes such as restraint, awareness, concentration, and judgment affected; reaction time slowed; inability to perform complicated tasks.

3-4 DRINKS

Depth perception, glare recovery, eye movement, and focus affected; decreased judgment and control.

5+ DRINKS

Coordination deteriorates, loss of critical judgment, and impaired memory and comprehension.

*According to the ATV Safety Institute.

Your Physical Condition

Being physically exhausted is like being drunk. Try to do something that's detail-oriented when you're really tired, and you'll feel totally uncoordinated.

Don't ride:

1. When you're tired

Reckless Riding

If you are involved in an ATV accident when you're speeding, you have a 25% chance of landing yourself in the hospital. The faster you go, the more likely you are to destroy your head and internal organs, and skip the wheelies, jumps, stunts, and any other showboating.

Laws and Regulations

Any police officer will tell you that ignorance of the law is no defense. Your best defense is to check out your local, state, or provincial ATV laws before riding. It'll also make sure that you can continue to ride in your favorite areas. The quickest way to have a land area closed is by riding over the regulations.

Group Behavior

People occasionally do crazier and riskier things in a group than they would consider doing by themselves. When you're ATV riding with others and things start to get out of hand, decide whether you're willing to be injured or see your friends injured.

SIPDE

By themselves, none of these safe behaviors and sound judgments will go very far. But when you put them all together... when you're paying attention to how you feel, when you're monitoring the movements of your ATV, and when you're constantly evaluating your environment, then you're practicing SIPDE. SIPDE is an acronym that stands for:

S	I	P	D	E
SCAN/ SEARCH	IDENTIFY HAZARDS	PREDICT WHAT WILL HAPPEN	DECIDE WHAT TO DO	EXECUTE THE DECISION

Supervision

Overview

You're responsible for supervising those who ride your ATV. Your wisdom is valuable... it'll bring them all back safely—your friends, your family, your relatives, and your ATV. It's crucial that you consider yourself a supervisor for all riders of your ATV. Whether you accept responsibility or not, the truth is that you are responsible for others riding your ATV.

Taking Responsibility

You're to the last letter in "PASS"... "Supervision." You've just gone through the manual, and you've seen what's involved. That puts you in a good position to be confident about what you know. So now it's time to use your knowledge and supervise others who ride your ATV.

Inexperienced/ Untrained Riders

You can't let people ride your ATV who don't know what they're doing. Unless they've had over a year of experience with ATV riding or taken an ATV training course, it's your responsibility to keep them off your ATV. It can be dangerous (especially for under-aged children)—all the more reason for you to be firm.

TESTIMONIAL

DOCUMENT#: N37023A1

CITY/STATE: MOOERSFORKS, NY

SEX: F

AGE: 5

BODY PART: UPPER TRUNK

DATE ACCIDENT: 6-29-93

DISPOSITION: DOA

SYNOPSIS: The victim of this incident, a five year old female, was operating a four wheeled all terrain vehicle (ATV) in the front yard of her parents' house, under the supervision of her father. The victim drove the ATV down an area where the only way to turn around was around a grain silo. The victim was executing a right hand turn when the vehicle tipped over to the right and fell onto her body. The victim was transported to a local hospital where she was pronounced dead on arrival. Photographs of the incident were not taken by law enforcement officials.

Experienced/Trained Riders

If anyone is going to borrow your ATV, you are responsible for their supervision. Before they ride, have them take the training course, have them watch the safety video, and have them read the Operator's Manual. You train them. It doesn't matter how you do it, as long as you do it.

ATV's are all a little different from the handling to the stability to the controls. So regardless of how much experience your family members have with ATV's, they don't have experience with *your* ATV. Let experienced riders get familiar with your ATV—show them the basics before they take off. You don't want it on your conscience that someone got hurt because you didn't tell them how to use your ATV.

Remember that regardless of experience, you should never let anyone under the age of 16 operate your ATV.

Arctic Cat and the ATV Safety Institute recommend that all ATV operators ride the appropriate-sized ATV according to age.

Category	Age (Years)	Speed Limitations (MPH)	NOTES
Y-12+	12 or Older	15 - Limited 30 - Maximum	Operate Under Adult Supervision
T-14	14 or Older	20 - Limited 30 - Limited 38 - Maximum	Operate Under Adult Supervision
G & S	16 or Older	According to Local Regulations	—

DIVISION II - OPERATION/ MAINTENANCE

ATV Specifications

ENGINE AND DRIVE	UTILITY		DVX
Type	Four-Cycle/Liquid Cooled		
Bore x Stroke	72.7 x 65.2 mm (2.86 x 2.57 in.)		
Displacement	270 cc (16.5 cu in.)		
Ignition Type	CDI		
Spark Plug Type	NGK DPR7EA-9		
Spark Plug Gap	0.8-0.9 mm (0.032-0.036 in.)		
Brake Type	Hydraulic w/Brake Lever Lock and Rear Foot Brake		
CHASSIS			
Length (Overall)	186.9 cm (73.6 in.)	171.9 cm (67.7 in.)	
Height (Overall)	111.8 cm (44.0 in.)	113.5 cm (44.7 in.)	
Width (Overall)	105.1 cm (41.4 in.)	113.5 cm (44.7 in.)	
Suspension Travel (Front)	12.7 cm (5.0 in.)	15.5 cm (6.1 in.)	
Suspension Travel (Rear)	12.7 cm (5.0 in.)	16.5 cm (6.5 in.)	
Front Tire Size	AT22 x 7-10	AT21 x 7-10	
Rear Tire Size	AT22 x 10-10	AT20 x 11-9	
Tire Inflation Pressure (Front)	27.6 kPa (4.0 psi)		
Tire Inflation Pressure (Rear)	24.1 kPa (3.5 psi)		
MISCELLANY			
Dry Weight (Approx)	216.4 kg (477 lb)	192.8 kg (425 lb)	
Gas Tank Capacity	12.8 L (3.39 U.S. gal.)	12.8 L (3.39 U.S. gal.)	
Reserve Capacity	4.54 L (1.2 U.S. gal.)	4.54 L (1.2 U.S. gal.)	
Engine Oil Capacity (Approx)	1.4 L (1.5 U.S. qt)	1.6 L (1.69 U.S. qt)	
Transmission Lubricant Capacity	600 ml (20.3 fl oz) - Overhaul 500 ml (16.9 fl oz) - Change	400 ml (13.5 fl oz) - Overhaul 300 ml (10 fl oz) - Change	
Gasoline (Recommended)	87 Octane Regular Unleaded		
Engine Oil (Recommended)	Arctic Cat ACX All Weather (Synthetic)		
Transmission Lubricant (Recommended)	SAE Approved 80W-90 Hypoid		
Rear Drive Lubricant Capacity	150 ml (5 fl oz)	N/A	
Rear Drive Lubricant (Recommended)	SAE Approved 80W-90 Hypoid	N/A	
Cooling System Capacity	1.4 L (1.5 U.S. qt)		
Taillight/Brakelight	12V/5W/21W		
Headlight	12V/35W/35W (2)	12V/35W/35W	
Starting System	Electric w/Manual Recoil (Emergency)	Electric	

Specifications subject to change without notice.

Location of Parts and Controls (Utility)



KM091A



KM119A



KM120A

1. Battery
2. Headlights
3. Hand Brake Lever
4. Fuel Valve
5. Choke Lever
6. Seat Lock Lever
7. Rear Foot Brake
8. Kick Starter
9. Engine Stop Switch
10. Brake Lever Lock
11. Key Switch
12. Shift Lever
13. Throttle Limiter
14. Throttle Lever
15. Starter Button
16. Taillight/Brakelight
17. Operator's Manual Location
18. Headlight OFF/HI/LO Switch
19. Reverse Override Button
20. Tool Kit

Location of Parts and Controls (DVX)



KM186A



KM187A

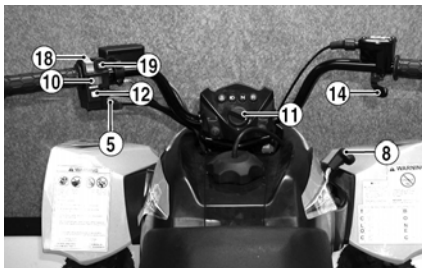

KM174A

1. Battery
2. Headlight
3. Hand Brake Lever
4. Fuel Valve
5. Choke Lever
6. Seat Lock Lever
7. Rear Foot Brake
8. Shift Lever
9. Brake Lever Lock
10. Engine Stop Switch
11. Key Switch
12. Reverse Override Button
13. Throttle Limiter
14. Throttle Lever
15. Tool Kit Location
16. Taillight/Brakelight
17. Operator's Manual Location
18. Headlight OFF/HI/LO Switch
19. Starter Button

ATV Operation

Basic Operating Maneuvers

Active riding and basic maneuvers are the foundation of your ATV ride. Without basic skills, it's impossible to move to this level— active riding. These are your basic maneuvers:

- Mounting the ATV
- Starting the Engine
- Starting a Cold Engine
- Shifting
- Braking/Stopping
- Parking
- Dismounting the ATV

Mounting the ATV

1. From the left side, grab the left-side handlebar and apply the hand brake; then put your left foot on the footrest.
2. Grab the right-side handlebar.
3. Swing your leg over the seat and set your right foot down on the right-side footrest.
4. Get seated in a comfortable position.
5. Always keep your feet planted on the footrests.

Starting the Engine

Always start with the ATV on a flat, level surface. Carbon monoxide poisoning can kill you, so keep your ATV outside while it's running. Follow these steps to start it up:

Another way to remember the starting procedure is by using the acronym "BONE-C." It stands for:

B	O	N	E	C
BRAKES	ON	NEUTRAL	ENGINE	CHOKE

1. Ensure that the fuel valve is in the ON position.
2. Mount the ATV and sit down.
3. Compress the hand brake; then engage the brake lever lock.
4. Shift the transmission into neutral.
5. Turn on the ignition.
6. Move the choke lever to the engaged position if starting the engine cold (if it's already warmed up, you shouldn't need to use the choke at all).
7. Move the engine stop switch to RUN.
8. Press the starter button.

CAUTION

Do not run the starter motor for more than eight seconds per starting attempt. The starter motor may overheat causing severe starter motor damage. Allow 15 seconds between starting attempts to allow the starter motor to cool.

9. Immediately after the engine starts, move the choke lever to the mid-position.
10. Let the engine warm up; then move the choke lever to the OFF position.

ATV Operation

Starting A Cold Engine

1. Turn off all electrical accessories (lights, etc.); then rotate the ignition switch key to the first position (ON) leaving the headlights OFF. Note that the Neutral light is illuminated.
2. Push the choke lever to the left.



KM121A

3. Press on the starter button.

CAUTION

Do not run the starter motor for more than eight seconds per starting attempt. The starter motor may overheat causing severe starter motor damage. Allow 15 seconds between starting attempts to allow the starter motor to cool.

4. When the engine starts, move the choke lever to the mid-position.
5. Allow the engine to warm up for approximately 2-2 1/2 minutes; then move the choke lever to the OFF position. Do not touch the throttle lever until the engine has run for at least 3 minutes.

■ **NOTE:** If the engine RPM starts to decrease or if the engine starts to stall, move the choke lever to the left until RPM increases; then as the RPM stabilizes, move the choke lever to the OFF position.

6. Run the engine for at least 10 minutes so it is thoroughly warmed up. If the engine is run for a shorter period of time, the spark plug may not have reached a high enough temperature to burn off the excess fuel in the combustion chamber.

Shifting (Utility)

This ATV has a dual-range automatic transmission with reverse. To shift the ATV, follow these steps:

1. To engage the high range from neutral, move the shift lever outward and forward.
2. To engage the low range from high range, come to a complete stop; then move the shift lever outward and forward.



KM124A

■ **NOTE:** The high range is for normal riding with light loads. The low range is for carrying heavy loads or trailer towing. Compared to HIGH range, the LOW range position provides slower speed and greater torque to the wheels.

CAUTION

Always shift into low range when operating on wet or uneven terrain, when towing or pushing heavy loads, and when using a plow. Failure to follow this caution may result in premature V-belt failure or in damage to related drive system components.

3. To engage reverse gear from neutral, move the shift lever outward and rearward into the R position.

CAUTION

Always come to a complete stop before attempting to shift from one range to the other or into reverse. Always shift on level ground, or engage the brake lever lock before shifting into another range or into reverse.

ATV Operation

Shifting (DVX)

This ATV has a single-range automatic transmission with reverse. To shift the ATV, follow these steps:

1. To engage the forward gear from neutral, move the shift lever outward and forward.
2. To engage reverse gear from neutral, move the shift lever outward and rearward into the R position.

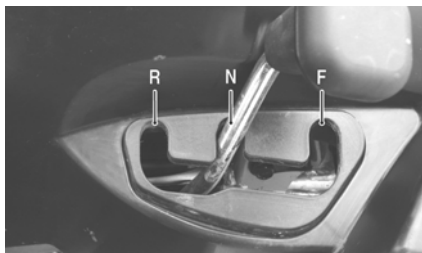

KM203A

CAUTION

Always come to a complete stop before attempting to shift from one gear to the other. Always shift on level ground, or engage the brake lever lock before shifting into forward gear or into reverse.

Braking/Stopping

Coming to a stop should be a slow, easy process. Always allow plenty of room and time to stop smoothly. Sometimes quick stops are inevitable, so always be prepared. Whether you're stopping slowly or stopping quickly, do this:

1. Release the throttle lever; then apply the hand brake.
2. If the wheels lock, release the brake for a second; then apply it again.
3. When coming to a complete stop, release the throttle lever completely.

4. Never "ride" the brake. Even maintaining minimal pressure on the brake lever or brake pedal will cause the brake pads to drag on the disc and may overheat the brake fluid, disc, and pads causing the brakes to "fade" or become "spongy."

WARNING

Excessive repetitive use of the hydraulic brake for high speed stops will cause overheating of the brake fluid and premature brake pad wear which will result in an unexpected loss of brakes.

WARNING

Use only Arctic Cat approved brake fluid. Never substitute or mix different types or grades of brake fluid. Brake loss can result. Check brake fluid level and pad wear before each use. Brake loss can result in severe injury or even death.

Parking

Parking involves following the previous rules for braking; then:

1. After the ATV stops, shift into neutral.
2. Stop the engine using the engine stop switch.
3. Turn off the ignition.
4. If you have to park on a hill, shift the ATV into low gear; otherwise, try to park only on level surfaces.
5. Engage the brake lever lock.

Dismounting the ATV

After you've followed the procedure for parking, it's time to dismount:

1. Double check that the brake lever lock is engaged.
2. Swing your right leg over to the left side of the seat.
3. Step to the ground on the left side of the ATV.

ATV Operation

Handling the ATV (Active Riding Techniques)

Active riding involves moving your body. You must learn to lean and shift your weight into your turns to maintain control.

Your safety depends on using safe riding techniques. Statistics from the U.S. Consumer Product Safety Commission (CPSC) say that inexperienced riders who don't use safe riding techniques are **13 times more likely to have an ATV accident** than riders who have over 1 month of experience.

Safe riding techniques include:

- Riding
- Leaning, Weight Shift, and Balance
- Wide Turns
- Sharp Turns
- Quick Turns
- K-Turns
- Riding Uphill
- Riding Downhill
- Sidehilling/Traversing
- Swerving
- Crossing Obstacles

Riding

Once the engine is warm, the ATV is ready to go.

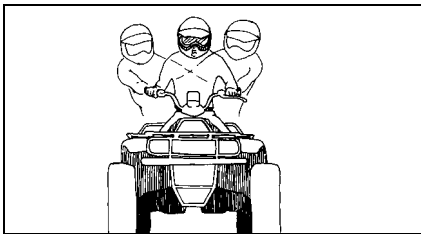

ATV-0012

1. Keep your feet on the footrests and both hands on the handlebar.
2. Compress the brake lever releasing the brake lever lock.
3. Move the shift lever from N and select a desired gear; then slowly compress the throttle lever while releasing the hand brake.

Leaning, Weight Shift, and Balance

When you turn, the trick is to move forward and slide over to the side of the seat that's on the inside of the turn. Support your body weight on the outside footrest. At the same time, lean your body to the inside of the turn. Pay attention to the handling—if you feel the tires coming off the ground, reduce speed, shift more of your body weight to the side that's lifting, and make the turn wider if possible.



ATV-0013

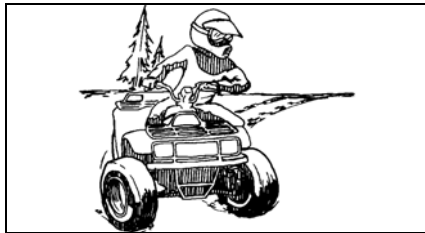

ATV-0024



ATV-0025

Wide Turns

About 20% of ATV accidents happen during turns. If you don't understand turning techniques, it's easy for the ATV to get away from you by losing traction, plowing, or tipping. Use this method for wide turns:

ATV Operation

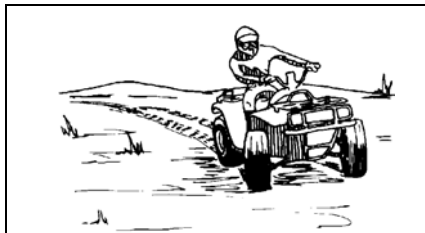

ATV-0046

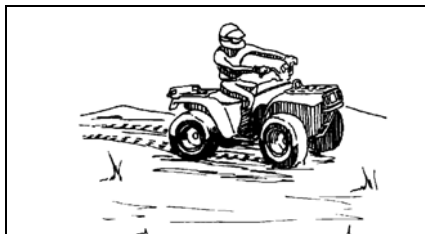

ATV-0045

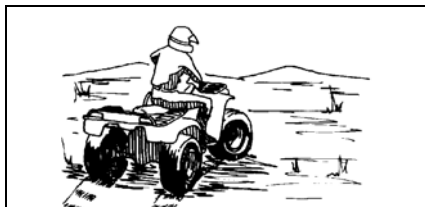

ATV-0044

1. Ease off the throttle as you approach the turn to slow down.
2. Use the principles of leaning, weight shifting, and balancing—shift your body weight to the inside of the turn.
3. Gradually increase your speed as you come out of the turn.

Sharp Turns

After mastering wide turns, practice the advanced skill of sharp turns.

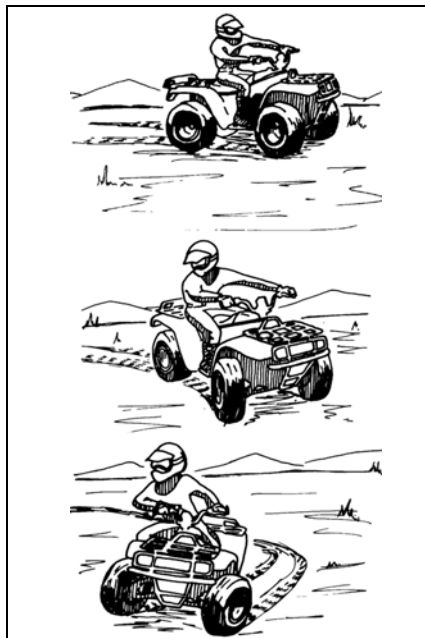

ATV-202

1. Ease off the throttle as you approach the turn to slow down.
2. Use the principles of leaning, weight shifting, and balancing—shift your body weight to the inside of the turn.
3. You might have to lean into the turn more than you do in a wide turn.
4. If shifting your weight and balance aren't enough to keep the ATV tires on the ground, straighten out the handlebars as much as you can.
5. Gradually increase your speed as you come out of the turn.

ATV Operation

Quick Turns

Quick turns are the most difficult turns and should only be done after you are experienced with your ATV.

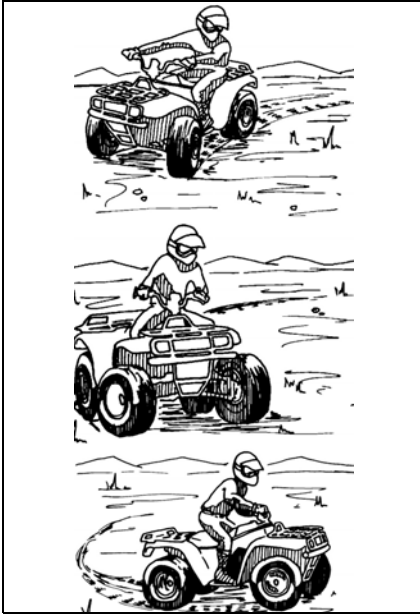

ATV-203

1. Ease off the throttle as you approach the turn to slow down.
2. Turn the handlebar and shift your weight and balance at the same time as you enter the turn (use the principles of leaning, weight shifting, and balancing—shift your body weight to the inside of the turn).
3. Follow this with slight acceleration.
4. For multiple turns, repeat this movement as needed.
5. To make your turn quicker, try raising yourself off the seat a few inches as you shift your weight.

K-Turns

Use K-turns if you accidentally stall while riding uphill; you need to take action before the ATV rolls backward down the hill.

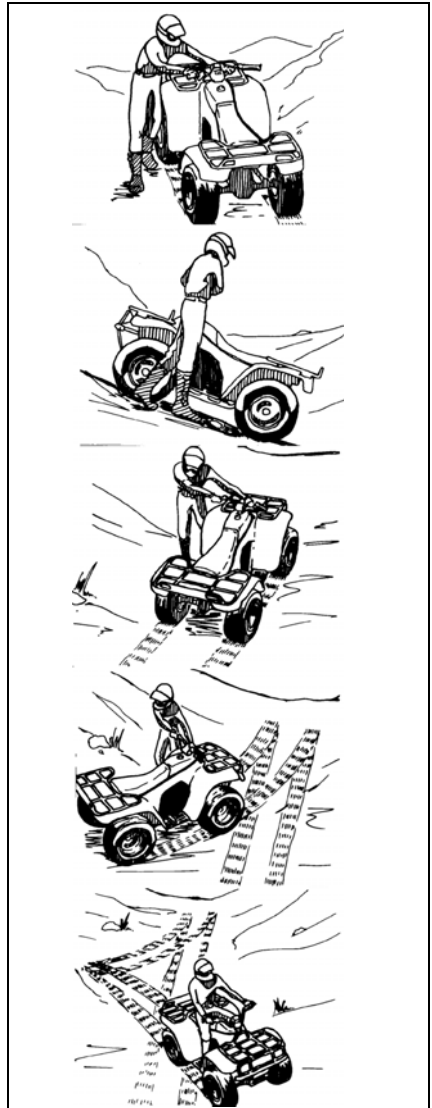

ATV-204

ATV Operation

1. Stop where you are, apply the brakes, and shift to neutral.
2. Shut off the engine.
3. Keep your body weight shifted forward.
4. Get off the ATV on the uphill side.
5. If you're to the left of the ATV, turn the handlebar all the way left.
6. Partially release the brake, but lightly hold the brake lever.
7. Let the ATV roll to your right side until it faces slightly downhill.
8. Reapply the brakes.
9. Get back on the ATV from the uphill side, and keep your weight shifted uphill when you sit down.
10. Start the engine and follow the method for riding downhill.

Riding Uphill

Roughly 20% of accidents happen while riding on hills and as a result of the ATV rolling or flipping. So, obviously, use extreme caution and follow this method for riding uphill.

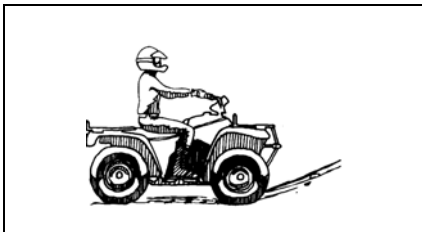

ATV-0019

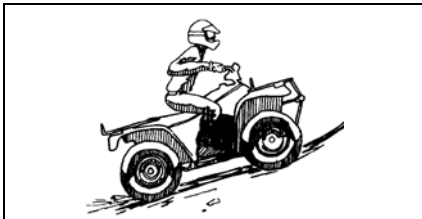

ATV-0032

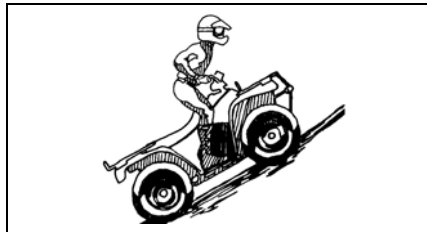

ATV-0033

1. Accelerate before you start climbing; then maintain a steady pace.
2. Lean as far forward as possible. For steeper hills, come off your seat to stand and lean forward.
3. If you lose speed, quickly shift to a lower gear. At the same time, release the throttle (so your front tires don't lift), **OR**
4. If that doesn't work and you still have forward motion and the terrain permits, do a U-turn, go back down, and try climbing again, **OR**
5. If you have lost all forward motion, follow the K-turn procedure.

Never Operate Up or Down Hills Steeper Than 25°

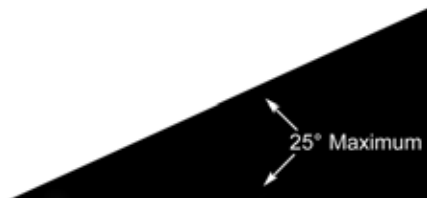

Riding Downhill

Success in riding downhill depends on how well you know your brakes—take it easy on them, or you could flip over.

ATV Operation

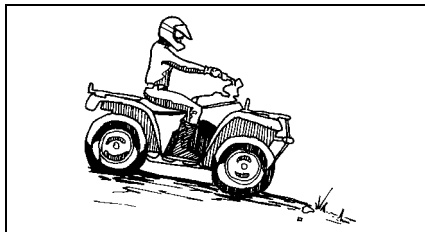

ATV-0018

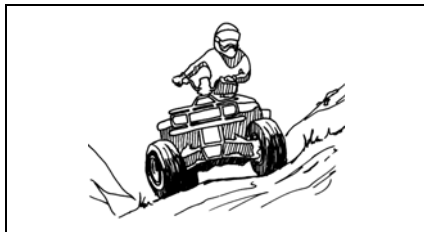

ATV-0017

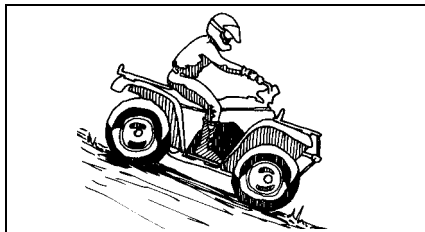

ATV-0030

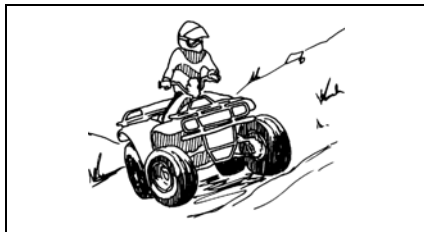

ATV-0028

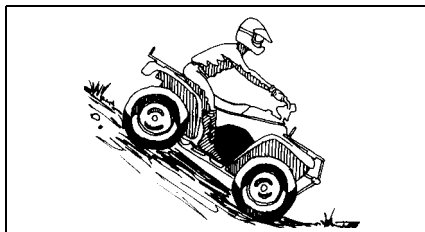

ATV-0031

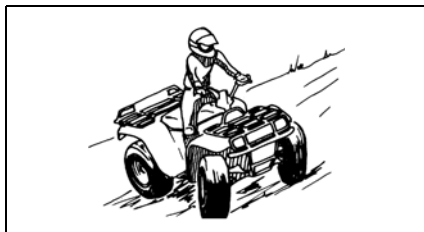

ATV-0029

1. Shift your body weight as far back on the seat as possible.
2. Shift into low range; stay out of neutral.
3. Lightly apply the brake and release the throttle lever completely.

Sidehilling/Traversing

Sidehilling is considered an advanced skill; it's really tricky and unpredictable. So, whether your skills are advanced or not, try to avoid this kind of riding. If you're in a situation where you absolutely have to sidehill, follow this method:

1. Keep your speed low and consistent.
2. Shift all your body weight to the uphill side of the seat; also, support your weight on the uphill footrest.
3. Steer like you're driving into the hill.
4. If the ATV feels like it's tipping, turn the handlebar downhill. If that's not possible because of the terrain or other conditions or if it just doesn't work, stop and get off. Dismount the ATV on the uphill side.

Swerving

Swerving is usually an emergency reaction to avoid an obstacle but is similar to quick turns. The difference is that quick turns involve slight acceleration in the turn; don't accelerate if you swerve.

ATV Operation

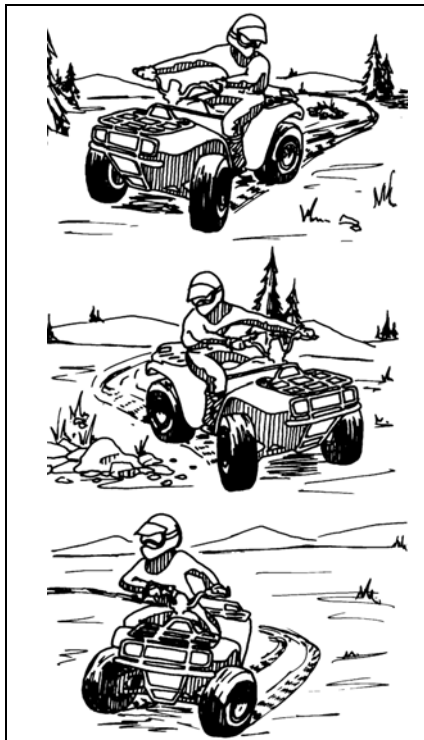

ATV-206

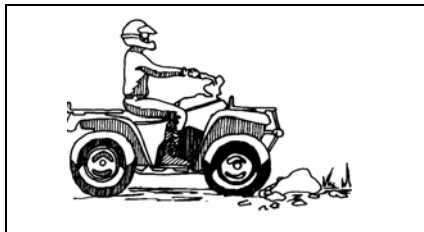

ATV-0016

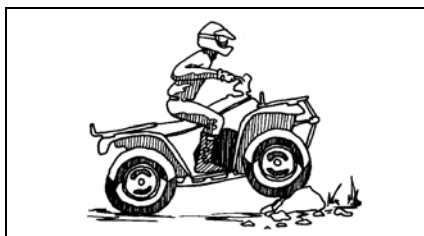

ATV-0026

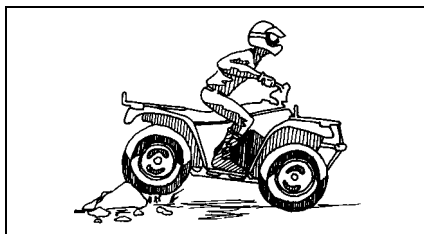

ATV-0027

1. Ease off the throttle as you approach the obstacle.
2. Turn the handlebar. At the same time, shift your weight and balance as you swerve. Use the principles of leaning, weight shifting, and balancing—shift your body weight to the inside of the turn.
3. Keep your hand off the brake until the emergency is over and you're back in control.

Crossing Obstacles

Crossing obstacles is risky; avoid it if possible. Riding over logs, rocks, and ruts means combining all the active riding skills into one big motion. Your ATV will respond differently for different obstacles (logs, ruts, etc.), but these are general guidelines for overcoming two-track (both tires contacting the obstacle at the same time) obstacles:

1. Keep your speed way down; less than 5 mph.
2. Approach the obstacle head-on.
3. Come up off the seat.
4. Keep your weight on the footrests.
5. Apply a little throttle when the front tires make contact with the obstacle.
6. Lean forward and release the throttle when the front tires clear the obstacle.
7. Keep your body loose to absorb any shock.
8. If the ATV starts tipping, shift your weight to keep it in balance.

To clear a single-track (only one tire contacting) obstacle, follow the same rules except:

ATV Operation

1. Use the ATV's momentum to clear the obstacle.
2. Don't pull up on the handlebar.
3. Don't apply the throttle.
2. Engage the brake lever lock.
3. Find something to block the rear tires.

Tips

Driving an ATV and a car have some similarities; however, there are a few situations that require special attention:

- Reversing
- Skidding or Sliding
- Parking on a Hill
- Stalling on a Hill
- Crossing Water
- Crossing Roads
- Cold Weather Driving
- Stopping the ATV
- Stopping the Engine

Reversing

It's tough to see things behind you.

1. Go slowly. It's hard to see behind you.
2. Keep your handlebar straight.
3. Backing down hills is a bad idea; do a U-turn or K-turn instead to turn around.

Skidding or Sliding

If you lose control after hitting sand, ice, mud, or water:

1. Turn your handlebar into the direction of the slide.
2. Keep your hand off the brakes until you're out of the skid.
3. Shift your weight forward.

Sometimes your ATV may not respond and goes straight ahead instead of letting you turn. Here's how to handle it:

1. Slow down.
2. Move forward on the seat.
3. Lean to inside of turn.
4. Turn handlebar.

Parking on a Hill

This shouldn't be necessary, but if it is:

1. Keep it in gear.

Stalling on a Hill

If you use the right method for riding uphill, this shouldn't happen. But if you have a problem, do this:

1. If the ATV hasn't started rolling backwards yet, follow the procedure for the K-Turn, **OR**
2. If the ATV is already rolling backward, lean as far forward as possible standing up on the footrests.
3. Nice and easy, apply the front and rear brakes.
4. When you come to a stop, follow the procedure for the K-turn.
5. If the ATV continues to roll backward, dismount immediately on the uphill side.

Crossing Water

Your ATV can only handle water up to its footrests. Any more than that and you risk engine damage and/or personal injury. Stay away from fast moving rivers. ATV tires can be buoyant, so if the water is too deep, you might find the ATV suddenly afloat.

1. Physically check the depth and current of the water, especially if you can't see the bottom. You're also checking for boulders, logs, or any other hidden obstacles.
2. Keep your speed slow.
3. Make sure you have a way out on the other side of the water.
4. If you get stuck in the sludge or mud, try rocking the ATV from side to side.
5. Once you've cleared the water, briefly apply the brakes to make sure they work.

Crossing Roads

Crossing roads on your ATV is also a bad idea, so avoid it. If you can't:

ATV Operation

1. Stop completely on the shoulder of the road.
2. Check both directions for traffic.
3. Crossing near a blind corner or intersection is dangerous; don't do it.
4. Drive straight across to the opposite shoulder.
5. Take into account that your ATV could stall while crossing; give yourself enough time to get off the road.
6. You have to assume that oncoming cars don't see you, and if they do, they won't be able to predict your actions.
7. It's illegal to cross public roads in some places. Know your local laws.

3. If the brakes are frozen, take the ATV to a warmer area to thaw out the brakes.

WARNING

Do not attempt to free frozen brakes by pouring warm water on the brake pads and housings.

■ **NOTE:** After the brakes thaw, dry them by applying them several times while riding slowly.

■ **NOTE:** After riding through water, mud, snow, or slush, it is important to dry both brake systems before parking the ATV.

WARNING

Go slowly and be extra careful when riding on snow-covered or ice-covered terrain. Always be alert to changing terrain conditions when operating the ATV.

Cold Weather Driving

■ **NOTE:** Check that all control levers move freely. Make sure that the foot-rest and rear foot brake are free of ice and snow.

WARNING

For your personal safety, it is very important to wear the type and amount of cold-weather clothing according to the coldest anticipated temperatures.

1. With the transmission in neutral, move the ATV forward and backward to check that the wheels roll freely. If the ATV will not roll, the tires may be frozen to the ground or the brake pads may be frozen to the discs.
2. If the tires are frozen to the ground, pour warm water around them to melt the ice.

4. Practice driving in an open snow-covered or ice-covered area at slow speeds before driving on snow-covered or ice-covered trails.

5. Learn how the ATV responds to steering and braking on the type of terrain to be encountered on the ride.

Stopping The ATV

To stop the ATV, first release the throttle lever. Next, apply the brakes.

Stopping The Engine

To stop the engine, turn the ignition switch key to the OFF position or set the engine stop switch to the OFF position.

CAUTION

Before riding, manually move the ATV forward and backward to make certain that all wheels roll freely.

General Information

ATV Identification Numbers

The Arctic Cat ATV has two identification numbers: Vehicle Identification Number (VIN) and Engine Serial Number (ESN).

The VIN is located on the front of the frame.



KM080A

The ESN is located on the lower left-side of the crankcase near the front of the engine.



KM082A

Ignition Switch Key

Two keys come with the ATV. Keep the spare key in a safe place. An identifying number is stamped on each key. Use this number when ordering a replacement key.



ATV-0055

Control Locations and Functions

Ignition Switch

The ignition switch has three positions.

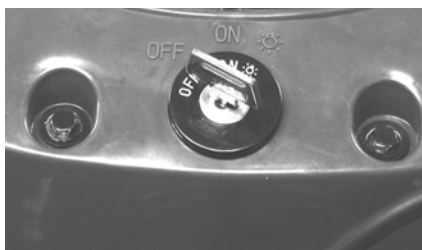

KM185

OFF position — All electrical circuits are off. The engine will not start. The key can be removed in this position.

ON position — The ignition circuit is complete and the engine can run. The key cannot be removed in this position.

LIGHTS position — The ignition circuit is complete and the taillight is on. The key cannot be removed in this position.

■ **NOTE:** To illuminate the headlight, the engine must be running and the headlight switch must be in the HI or LO position.

CAUTION

Leaving the ignition switch in the ON or LIGHTS position for a long period of time when the engine is not running may cause the battery to discharge. Always leave the ignition switch in the OFF position when engine is not running.

Shift Lever

The DVX model has a single-range automatic transmission with reverse. The Utility model has a dual-range automatic transmission with reverse.

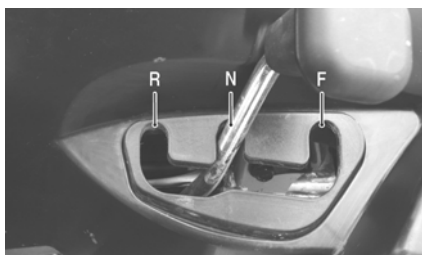

KM203A

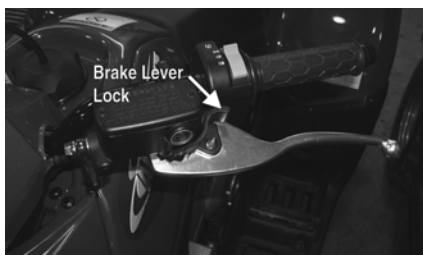

KM161B



KM124A

Hand Brake Lever

The hand brake is considered to be the normal operating (main) brake.

The hand brake should be applied whenever braking is needed.

Apply the brake by compressing the lever toward the handlebar.



KM161A

Brake Lever Lock

To engage and release the brake lever lock, use the following procedure.

1. Squeeze the hand brake two or three times and release it.
2. Push and hold the brake lever lock.
3. While pushing forward on the brake lever lock, squeeze the brake lever.

■ **NOTE:** It will click as it engages and the brake lever will not return to its released position.

4. Release the brake lever lock by squeezing the brake lever. It will return to its released position.

Check to make sure the brake lever lock engages properly and that the brake (when engaged) locks the wheels.

1. Pump the brake lever 2 or 3 times.
2. Engage the brake lever lock.
3. Attempt to push the ATV.

■ **NOTE:** The brake lever lock must lock the wheels. If it doesn't, take the ATV to an authorized Arctic Cat ATV dealer for service.

WARNING

Always check to be sure that the brake lever lock has been disengaged before operating the ATV. An accident could result if the brake lever lock is left engaged while the ATV is operated due to overheating of the brake system.

⚠ WARNING

Never use the brake lever lock as a parking brake or depend on it to hold the ATV when parking on a hill. The brake may relax if left engaged for a long period of time. This could cause an accident; therefore, do not leave the ATV on a hill depending on the brake lever lock. Always block the downhill side of the wheels if leaving the ATV on a hill or park the ATV in a sidehill position.

Rear Foot Brake

Pressing the rear foot brake downward will apply the brake to the rear wheels.

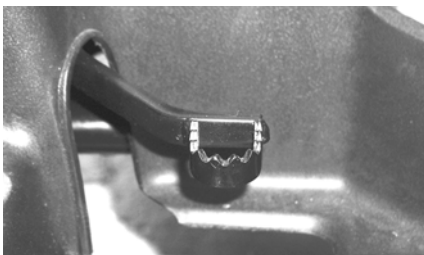

KM130

Headlight OFF/HI/LO Switch

Use the headlight OFF/HI/LO switch to select the high or low headlight beam when the ignition switch is in the LIGHTS position. When the switch is in the HI position, the high beam will illuminate. When the switch is in the LO position, the low beam will illuminate. When the switch is in the OFF position, only the taillight will illuminate.



KM161C

Engine Stop Switch

OFF position - The ignition circuit is off. The engine cannot be started or will not run. If the emergency stop switch is used to stop engine without turning off ignition switch, the battery may discharge.

RUN position - The ignition circuit is on. The engine can start and run.

Starter Button

Pushing in on this button activates the starter motor. Before starting the engine, make sure the ignition switch is in the ON position, the transmission is in neutral, and the parking brake lock is engaged.

■ **NOTE:** This ATV has a safety interlock switch which prevents the starter motor from activating when the transmission is not in neutral. The interlock will be bypassed if the hand brake lever is compressed or if the auxiliary brake pedal is depressed.

Reverse Override

These ATV's are equipped with a reverse speed limiter system. When additional RPM is needed in reverse, depress and hold the override button.



KM121C

⚠ WARNING

Never activate the override while the throttle is open as a loss of control may result.

Choke Lever

The choke lever is used to help start a cold engine. Move the lever to the left to activate the choke. Return the lever to the right position to de-activate the choke.

Throttle Lever

Control engine RPM with the position of the throttle lever. Operate this lever with the thumb. Pushing it forward increases engine RPM and allowing it to retract decreases engine RPM.

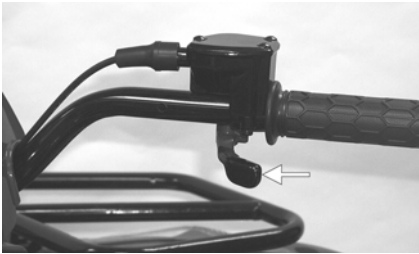

KM122A

Throttle Limiter Screw

Throttle lever travel may be limited by adjusting the throttle limiter screw. The throttle limiter should be adjusted according to the operator's skill and experience. To adjust the throttle limiter, use the following procedure.

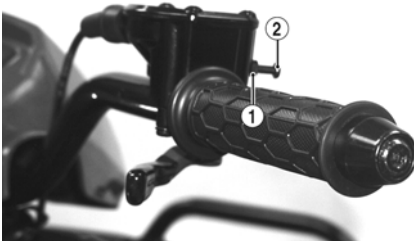

KM125A

1. Loosen the jam nut (1).
2. Turn the throttle limiter screw (2) clockwise to decrease engine RPM maximum or counterclockwise to increase engine RPM maximum.
3. Tighten the jam nut securely.

Fuel Valve

The fuel valve is incorporated in the gas tank. There are three positions: ON, RES (reserve), and OFF.

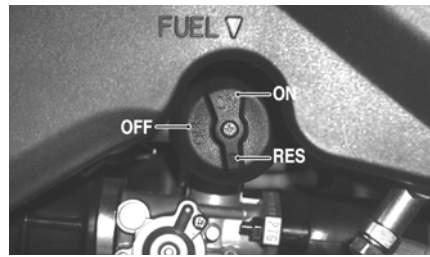

KM146A

In the OFF position, the valve will prevent gasoline flow to the carburetor. In the ON position (the normal operating position), gasoline will flow from the tank to the carburetor. In this position, 4.54 L (1.2 U.S. gal.) will remain in the tank as a reserve quantity.

Moving the valve to the reserve (RES) position will allow the operator to use the remaining gasoline in the tank. When turning the valve to any of the three positions, be sure the indicator is pointed directly at the position desired.

⚠ WARNING

Leaving the fuel valve in the ON or RES position when the engine is off can be hazardous. The carburetor may overflow and fuel may run into the engine. This can cause a fire or cause severe damage to the ATV when the engine is started. Always leave the fuel valve in the OFF position when the engine is not running.

Indicator Lights (Utility)



KM123A

1. **Low Range Indicator** - A white light will illuminate when the shift lever is in the "low range" position. The light will go out when the lever is moved to another position.

2. **High Beam Indicator** - A blue light will illuminate when the engine is running, the ignition switch is in the LIGHTS position, and the headlight switch is in the HI beam position.
3. **Neutral Indicator** - A green light will illuminate when the transmission is in neutral and the ignition switch is on. The light will go out when shifted into any gear other than neutral.
4. **Reverse Indicator** - A red light will illuminate when the transmission is shifted into reverse gear. The light will go off when shifted out of reverse.

Indicator Lights (DVX)

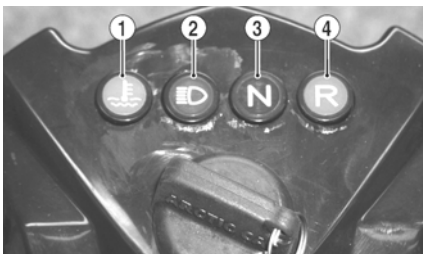

KM176A

1. **Temperature Indicator** - A red light will illuminate if the engine overheats. The light should be off during normal operation.

CAUTION

Continued operation of the ATV with high engine temperature may result in engine damage or premature wear.

■ **NOTE:** High engine RPM, low vehicle speed, or heavy load can raise engine temperature. Decreasing engine RPM, reducing load, and selecting an appropriate transmission gear can lower the temperature.

■ **NOTE:** Debris in front of the engine (or packed between the cooling fins of the radiator) can reduce cooling capability. Using a garden hose, wash the radiator and the engine to remove any debris restricting air flow.

CAUTION

Arctic Cat does not recommend using a pressure washer to clean the radiator core. The pressure may bend or flatten the fins causing restricted air flow, and electrical components on the radiator could be damaged. Use only a garden hose with spray nozzle at normal tap pressure.

2. **High Beam Indicator** - A blue light will illuminate when the engine is running, the ignition switch is in the LIGHTS position, and the headlight switch is in the HI beam position.
3. **Neutral Indicator** - A green light will illuminate when the transmission is in neutral and the ignition switch is on. The light will go out when shifted into any gear other than neutral.
4. **Reverse Indicator** - A red light will illuminate when the transmission is shifted into reverse gear. The light will go off when shifted out of reverse.

Speedometer/LCD (Utility)

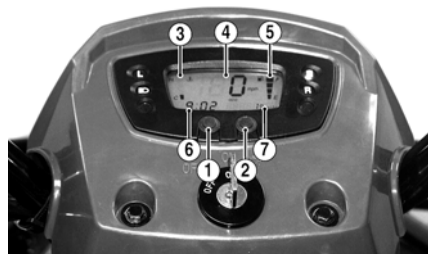

KM123B

1. **Mode/Set Button (1)** - In conjunction with Mode/Set Button (2), shifts the LCD through mode and reset operations.

2. **Mode/Set Button (2)** - In conjunction with Mode/Set Button (1), shifts the LCD through mode and reset operations.
3. **Coolant Temperature Indicator (3)** - Displays approximate engine coolant temperature.

■ **NOTE:** Normal operating range is from the bottom segment (C) up to but not including the top segment (H). In the event the top segment (H) is displayed, all segments of the display and the temperature icon will flash indicating high engine temperature.

CAUTION

Continued operation of the ATV with high engine temperature may result in engine damage or premature wear.

■ **NOTE:** High engine RPM, low vehicle speed, or heavy load can raise engine temperature. Decreasing engine RPM, reducing load, and selecting an appropriate transmission gear can lower the temperature.

■ **NOTE:** Debris in front of the engine (or packed between the cooling fins of the radiator) can reduce cooling capability. Using a garden hose, wash the radiator and the engine to remove any debris restricting air flow.

CAUTION

Arctic Cat does not recommend using a pressure washer to clean the radiator core. The pressure may bend or flatten the fins causing restricted air flow, and electrical components on the radiator could be damaged. Use only a garden hose with spray nozzle at normal tap pressure.

4. **Speedometer (4)** - Displays approximate vehicle speed in mph or km/h.

■ **NOTE:** To shift the display between mph and km/h, press the Mode/Set Button for two seconds. The LCD will display either mph or km/h on the right-side of the display. The Odometer/Trip Meter (7) will shift to correspond (miles/kilometers) with the speedometer.

5. **Fuel Level Indicator (5)** - Indicates approximate amount of gasoline in the gas tank.

■ **NOTE:** When the bottom segment flashes, gasoline quantity is low.

6. **Digital Clock (6)** - Displays time in hours and minutes when the ignition switch is turned to the ON position. To set the time, turn the ignition switch to the ON position; then use the following procedure.

■ **NOTE:** If the Hour Set or Minute Set operation is interrupted for more than 10 seconds, the clock will return to normal operation.

- A. **Hour Set:** Press and hold Mode/Set Buttons (1) and (2) until the hour display flashes; then release both buttons and again press Mode/Set Button (2) to select the desired hour. When the desired hour is displayed, release the button.

■ **NOTE:** The clock displays a sequential 24-hour time only. There is no 12-hour AM/PM designation.

- B. **Minute Set:** Press and hold Mode/Set Button (1) until the minute display flashes; then release the button and press Mode/Set Button (2) to select the desired minute. When the desired minute is displayed, release the button.

■ **NOTE:** When the button is released for more than 10 seconds, the clock will return to normal operation.

7. **Odometer/Trip Meter (7)** - Displays distance in miles or kilometers the vehicle has traveled. The odometer (ODO) displays total distance and cannot be reset to zero. The trip meter (TRIP) displays distance and can be reset to zero. The distance (miles/kilometers) will correspond to the speedometer. To shift between (ODO) and (TRIP), press and hold Mode/Set Button (2) for two seconds. To reset the (TRIP) display to zero, shift the display to (TRIP); then press and hold Mode/Set Button (2) and simultaneously press Mode/Set Button (1) until the display reads zero. Release the buttons.

Gas/Vent Hoses

Replace the gas hose every two years. Damage from aging may not always be visible. Do not bend or obstruct the routing of the carburetor vent hose. Make certain that the vent hose is securely connected to the carburetor and hose holder and the opposite end is always open.

Carburetor Float Bowl Drain

Periodically, the float bowl should be drained to remove condensation. To drain the float bowl, use the following procedure.

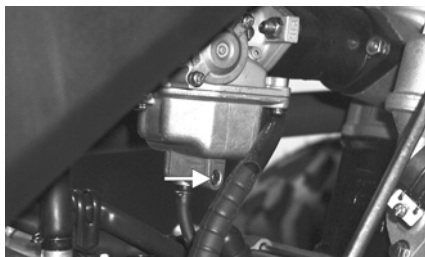

KM128A

1. Place a suitable container beneath the drain hose.
2. Loosen the drain screw and allow the gasoline and condensation to flow into the container.

3. Tighten the drain screw securely.

WARNING

Draining fuel from the carburetor can be hazardous. Fuel can catch on fire if not handled properly. When draining the carburetor, always shut the engine off. Do not smoke and never drain or refuel in an area where there are open flames or sparks. Dispose of drained fuel properly.

Oil Level Inspection Window

The oil level inspection window is located on the lower-right side of the engine. With the ATV on a level surface, the oil level should be visible at any point between the level marks.



KM180

Seat Latch

1. To remove the seat, push the seat latch lever to the left (located at the rear end of the seat). Raise the rear end of the seat and slide it backward.
2. To lock the seat into position, slide the front of the seat into the seat retainer and push down firmly on rear of seat. The seat should automatically lock into position.

WARNING

Make sure the seat is secure before mounting the ATV. Severe personal injury may result if the seat is not properly secured.

Safety Flag Bracket

A bracket is provided for mounting a flag at the rear of the ATV.



KM107

Rack Loading (Front and Rear) - Utility

The front rack and rear rack are designed to carry specified load capacities. Always refer to the ATV Load Capacity Ratings Chart for proper capacities.

WARNING

Make sure the loads on the front and rear racks will not interfere with the ATV controls or obstruct the view of the operator. Also, make sure the loads are evenly distributed, properly secured, and will not shift while operating the ATV.

Trailer and Towing (Utility)

WARNING

Never use the racks as a towing or trailering point.

Trailer Tongue Weight is the downward force exerted on the hitch by the trailer coupler when the trailer is fully loaded and the coupler is at its normal towing height. Refer to the Load Capacity Ratings Chart for tongue weight information.

Always maintain a slow speed when trailering and towing and avoid sudden accelerations, quick maneuvers, and sudden stops. Braking distance will be affected when towing a trailer. When towing a trailer, always maintain slow speed and allow more stopping distance than when not towing a trailer.

WARNING

Riding an ATV without extra caution when towing a trailer will be hazardous. Trailer towing can affect the handling and braking of the ATV. Never tow a trailer without a rigid tongue and never exceed 10 mph. Avoid sudden accelerations and stopping of the ATV. Do not make quick maneuvers. Avoid uneven surfaces and do not tow on hills. Never carry passengers in a trailer unless the trailer is designed for such use and has a rigid tow bar. Allow more stopping distance than when not towing a trailer.

Transporting ATV

When transporting the ATV, Arctic Cat recommends that the ATV be in its normal operating position (on all four wheels) and the following procedure be used.

1. Engage the brake lever lock and place the transmission in gear.

CAUTION

Failure to engage the brake lever lock and place the transmission in gear could result in the ATV rolling off the trailer in the event of tie-down strap failure.

2. Secure the ATV with load rated hold-down straps.

■ **NOTE: Suitable hold-down straps are available from your Arctic Cat ATV dealer. Ordinary rope is not recommended because it can stretch under load.**

Gasoline-Oil-Lubricant Recommended Gasoline

The recommended gasoline to use in this ATV is 87 minimum octane regular unleaded. In many areas, oxygenates (either ethanol or MTBE) are added to the gasoline. Oxygenated gasolines containing up to 10% ethanol, 5% methane, or MTBE are acceptable gasolines.

When using ethanol blended gasoline, it is not necessary to add a gasoline antifreeze since ethanol will prevent the accumulation of moisture in the fuel system.

CAUTION

Do not use white gas. Only Arctic Cat approved gasoline additives should be used.

Recommended Engine Oil

CAUTION

Any oil used in place of the recommended oil could cause serious engine damage. Do not use oils which contain graphite or molybdenum additives. These oils can adversely affect clutch operation. Also, not recommended are racing, vegetable, non-detergent, and castor-based oils.

The recommended oil to use is Arctic Cat ACX All Weather synthetic engine oil, which has been specifically formulated for use in this Arctic Cat engine. Although Arctic Cat ACX All Weather synthetic engine oil is the only oil recommended for use in this engine, use of any API certified SM 0W-40 oil is acceptable.

Multi-Grade Engine Oil	
ENGINE OIL	← 0W-40 Synthetic →
TEMP °C	-30 -20 -10 0 10 20 30 40
TEMP °F	-22 -4 14 32 50 68 86 104

OILCHARTJ

Recommended Transmission/Rear Drive Lubricant

■ **NOTE:** Arctic Cat recommends the use of genuine Arctic Cat lubricants.

The recommended lubricant (transmission and rear drive) is SAE approved 80W-90 hypoid. This lubricant meets all of the lubrication requirements of the Arctic Cat ATV.

CAUTION

Any lubricant used in place of the recommended lubricant could cause serious transmission or rear drive damage.

Filling Gas Tank

⚠ WARNING

Always fill the gas tank in a well-ventilated area. Never add gasoline to the ATV gas tank near any open flames or with the engine running or hot. **DO NOT SMOKE** while filling the gas tank.

Since gasoline expands as its temperature increases, the gas tank must be filled to its rated capacity only. Expansion room must be maintained in the tank particularly if the tank is filled with cold gasoline and then moved to a warm area.



KM099

Division II - Operation/
Maintenance

Allow the engine to cool before filling the gas tank. Care must be taken not to overfill the tank. If overfilled, gas may leak onto the engine creating a fire hazard.

To remove and install the tank cap, use the following procedure.

1. Remove the vent tube from the instrument pod.
2. Turn the cap counterclockwise and remove.

⚠ WARNING

Do not over-flow gasoline when filling the gas tank. A fire hazard could materialize. Always allow the engine to cool before filling the gas tank.

- Turn the cap clockwise to tighten the cap securely after filling the tank; then install the vent tube making sure it is properly routed.

 **WARNING**

Do not overfill the gas tank.

Engine Break-In

After the completion of the break-in period, the engine oil should be changed and the screen should be cleaned. Other maintenance after break-in should include checking of all prescribed adjustments and tightening of all fasteners. At the discretion and expense of the owner/operator, the ATV may be taken to an authorized Arctic Cat ATV dealer for this initial service.

New ATV's and renewed ATV engines require a "break-in" period. The first month is most critical to the life of this ATV. Proper operation during this break-in period will help assure maximum life and performance from the ATV.

During the first 10 hours of operation, always use less than ½ throttle. Varying the engine RPM during the break-in period allows the components to "load" (aiding the engine/transmission component mating process) and then "unload" (allowing components to cool). Although it is essential to place some stress on the engine components during break-in, care should be taken not to overload the engine too often.

When the engine starts, allow it to warm up properly. Idle the engine several minutes until the engine has reached normal operating temperature. Do not idle the engine for excessively long periods of time.

Burnishing Brake Pads

Brake pads must be burnished to achieve full braking effectiveness. Braking distance will be extended until brake pads are properly burnished.

To properly burnish the brakes, use following procedure:

- Choose an area sufficiently large to safely accelerate ATV to 30 mph and to brake to a stop.
- Accelerate to 30 mph; then compress brake lever to decelerate to 0-5 mph.
- Repeat procedure twenty times.

 **WARNING**

Do not attempt sudden stops or put yourself into a situation where a sudden stop will be required until the brake pads are properly burnished.

General Maintenance

■ **NOTE: Proper maintenance of the ATV is important for optimum performance. Follow the Maintenance Schedule and all ensuing maintenance instructions/information.**

If, at any time, abnormal noises, vibrations, or improper functioning of any component of this ATV is detected, DO NOT OPERATE THE ATV. Take the ATV to an authorized Arctic Cat ATV dealer for inspection and adjustment or repair.

If the owner/operator does not feel qualified to perform any of these maintenance procedures or checks, take the ATV to an authorized Arctic Cat ATV dealer for professional service.

■ **NOTE: The following instructions and information refer to specific items in the maintenance and care of the ATV.**

Maintenance Schedule					
Item	Page	After break-in	1 month	3 months	6 months
Air filter (Engine)	64	I		I	
Air filter (V-belt housing)	63	I			I
Battery	59	I	I		
* Brake components	58	I	Inspect every time before riding		
Brake fluid	58	I	*Replace every 2 years		
Brake hoses	58	I	*Replace every 4 years		
* Chassis nuts and bolts	—	I	T		
Cooling system	55	I	Inspect every time before riding		
Electrical connections	—	I			I
* Engine nuts and bolts	—	I			I
Engine oil	56	C		C	
Frame/welds/racks	—	I			I
Gas/vent hoses	49	I	Inspect every time before riding		
	49		Replace every 2 years		
Headlight/taillight-brakelight	67	I	Inspect every time before riding		
Idle RPM	63	I			I
Rear drive lubricant (Utility)	57		Replace every 12 months		
Drive Chain (DVX)	65	I	Inspect every time before riding		
Spark arrester/muffler	67				C
Spark plug	62	I		I	I
	62		Replace every 18 months		
* Steering	—	I	Inspect every time before riding		
* Suspension (Ball joint boots and tie rod boots)	—	I	Inspect every time before riding		
Throttle cable	63	I	Inspect every time before riding		
Tires/air pressure	66/29	I	Inspect every time before riding		
Transmission lubricant	57		Replace every 12 months		
* Valve clearance	—	I			I

I = Inspect and clean, adjust, lubricate, replace as necessary

* = Dealer maintenance

T = Tighten

C = Clean

Cooling System

■ **NOTE:** Debris in front of the engine or packed between the cooling fins of the radiator can reduce cooling capability. Using a garden hose, wash the radiator to remove any debris preventing air flow.

CAUTION

Arctic Cat does not recommend using a pressure washer to clean the radiator core. The pressure may bend or flatten the fins causing restricted air flow, and electrical components on the radiator could be damaged. Use only a garden hose with spray nozzle at normal tap pressure.

The cooling system capacity is approximately 1.4 L (1.5 U.S. qt). The cooling system should be inspected daily for leakage and damage. If leakage or damage is detected, take the ATV to an authorized Arctic Cat ATV dealer for service. Also, the coolant level should be checked periodically.

CAUTION

Continued operation of the ATV with high engine temperature may result in engine damage or premature wear.

■ **NOTE:** High engine RPM, low vehicle speed, or heavy load can raise engine temperature. Decreasing engine RPM, reducing load, and selecting an appropriate transmission gear can lower the temperature.

The engine coolant will expand in the radiator as the temperature increases. Excessive coolant will flow to the coolant overflow tank; then as the system cools, coolant will be drawn back into the radiator. The coolant level in the overflow tank should be maintained between low and full marks on the tank.



KM136

When filling the cooling system, use a coolant/water mixture which will satisfy the coldest anticipated weather conditions of the area in accordance with the coolant manufacturer's recommendations. While the cooling system is being filled, air pockets may develop; therefore, run the engine for five minutes after the initial fill, shut the engine off, and then fill the cooling system.

■ **NOTE:** Use a good quality, biodegradable glycol-based, automotive-type antifreeze.

⚠ WARNING

Never check the coolant level when the engine is hot or the cooling system is under pressure.

CAUTION

After operating the ATV for the initial 5-10 minutes, stop the engine, allow the engine to cool down, and check the coolant level. Add coolant as necessary.

Shock Absorbers

Each shock absorber should be visibly checked weekly for excessive fluid leakage (some seal leakage may be observed but it does not indicate the shock is in need of replacement), cracks or breaks in the lower case, or a bent shock rod. If any one of these conditions is detected, replacement is necessary.

■ **NOTE:** When the ATV is operated in extremely cold weather (-23°C/-10°F or colder), a small amount of leakage may be present. Unless the leakage is excessive, replacement is not necessary.

The shock absorber has a spring force adjustment sleeve with five adjustment positions to allow the spring to be adjusted for different riding and loading conditions. If the spring action is too soft or too stiff, adjust it according to the chart.



KM172



KM177

■ **NOTE:** Before attempting to adjust suspension, clean dirt and debris from the sleeve and remove a load from the suspension; then use the spanner wrench to adjust the sleeve to the desired position.

Position	Spring Force	Setting	Load
1	↓ Stronger	Soft	Light
2		↕	↕
3			
4			
5		Stiff	Heavy

General Lubrication

Cables

None of the cables require lubrication; however, it is advisable to lubricate the ends of the cables periodically with a good cable lubricant.

Engine Oil and Screen

■ **NOTE:** Refer to the recommended oil viscosity chart (on page 51) in this manual for the proper engine oil.

Change the engine oil and clean the engine screen at the scheduled intervals. The engine should always be warm when the oil is changed so the oil will drain easily and completely.

1. Park the ATV on level ground.
2. Loosen the oil fill plug. Be careful not to allow contaminants to enter the opening.

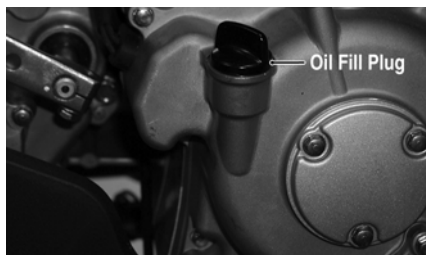

KM126A

3. Remove the screen/filter cap from the bottom of the crankcase. Drain the oil into a drain pan.

CAUTION

When the cap is removed, a compression spring, screen/filter, and an O-ring will fall into the drain pan. Take care to account for these components.

4. Using a brush and parts-cleaning solvent, clean the screen/filter; then clean the cap and inspect the O-ring.

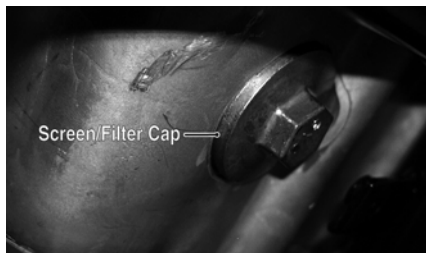

KM147A



CD628

5. Install the O-ring, screen/filter, compression spring, and the O-ring; then secure with the screen/filter cap. Tighten cap to 11 ft-lb.
6. Remove the oil fill plug; then pour recommended oil into the crankcase. Install fill plug.
7. Start the engine (while the ATV is outside on level ground) and allow it to idle for a few minutes.
8. Turn the engine off. Check the oil level in the oil level inspection window. The oil level should be between the low and high marks.
9. Inspect the area around the screen/filter cap for leaks.

Transmission Lubricant

Change the transmission lubricant at the scheduled intervals. The transmission should always be warm when the lubricant is changed so it will drain easily and completely.

1. Park the ATV on level ground.
2. Remove the fill plug. Be careful not to allow contaminants to enter the opening.

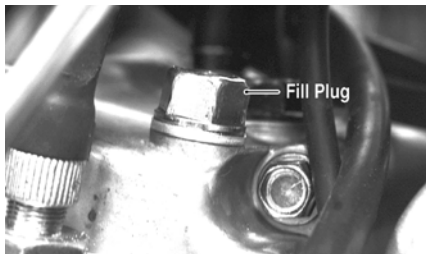

KM104A

3. Remove the drain plug and drain the lubricant into a drain pan.



KM106A

4. Install the drain plug and tighten to 22 ft-lb.
5. Pour correct amount of recommended lubricant (see specifications chart) into the fill plug hole; then install the fill plug and tighten securely.
6. Start the engine and drive the ATV to warm up the transmission; then check for any leaks around the drain and fill plugs.

Rear Drive Lubricant (Utility)

Change the rear drive lubricant at the scheduled intervals. The rear drive should always be warm when the lubricant is changed so it will drain easily and completely.

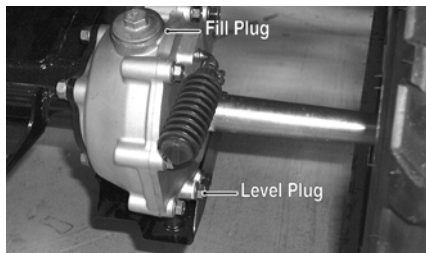

KM131A

1. Park the ATV on level ground.
2. Remove the fill plug. Be careful not to allow contaminants to enter the opening.
3. Remove the drain plug and drain the lubricant into a drain pan.
4. Install the drain plug and tighten to 15 ft-lb.

- Pour 150 ml (5 fl oz) of recommended lubricant into the fill plug hole; then install the fill plug and tighten securely.
- Start the engine and drive the ATV to warm up the rear drive; then check for any leaks around the drain and fill plugs.

Hydraulic Brakes

WARNING

Be sure to inspect the hydraulic brake system before each use. Always maintain brakes according to the Maintenance Schedule.

Brake Fluid

Check the brake fluid level in the hand brake fluid reservoir. If the level in the reservoir is below the lower mark in the sight glass, add DOT 4 brake fluid.



KM161D

Check the brake fluid level in the auxiliary brake fluid reservoir.

If the level in the reservoir is below the LOWER mark, add DOT 4 brake fluid.

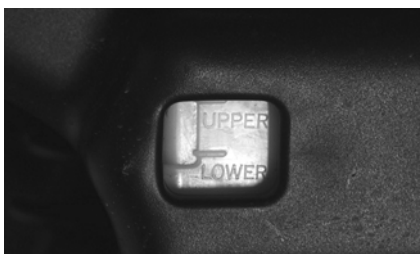

KM137

CAUTION

Be careful not to spill any fluid when filling the brake fluid reservoir. Wipe away spilled fluid immediately.

Brake Hoses

Carefully inspect the hydraulic brake hoses for cracks or other damage. If found, take the ATV to an authorized Arctic Cat ATV dealer to have the brake hoses replaced.

Brake Pads

The clearance between the brake pads and brake discs is adjusted automatically as the brake pads wear. The only maintenance that is required is replacement of the brake pads when they show excessive wear. Check the condition of each of the brake pads as follows:

- Remove a front wheel.
- Measure the thickness of each brake pad.
- If thickness of either brake pad is less than 1.0 mm (0.039 in.), take the ATV to an authorized Arctic Cat ATV dealer to have brake pads replaced.

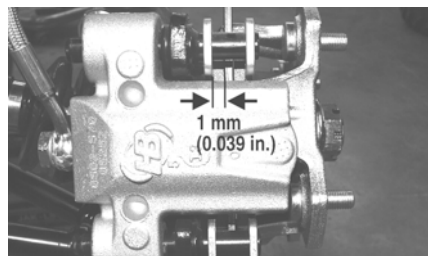

PR376B

- Install the wheel and tighten using a crisscross pattern to 40 ft-lb.

Brake Lever Lock

Check to make sure the brake lever lock engages properly and that the brake (when engaged) locks the wheels.

- Pump the brake lever 2 or 3 times.
- Engage the brake lever lock.

Tie Rod Boots (Inner and Outer/Right and Left)

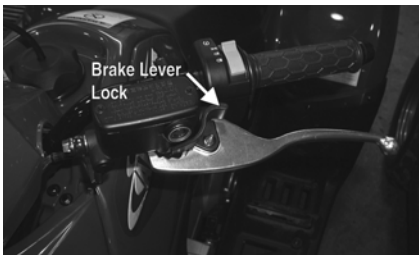

KM161B

3. Attempt to push the ATV.

■ **NOTE:** The brake lever lock must lock the wheels. If it doesn't, take the ATV to an authorized Arctic Cat ATV dealer for service.

Protective Rubber Boots

The protective boots should be inspected periodically according to the Maintenance Schedule.

Ball Joint Boots (Upper and Lower/Right and Left)



KM117A

1. Secure the ATV on a support stand to elevate the front wheels.
2. Remove both front wheels.
3. Inspect the four ball joint boots for cracks, tears, or perforations.
4. Check the ball joint for free-play by grasping the steering knuckle and turning it from side to side and up and down.
5. If boot damage is present or ball joint free-play seems excessive, contact an authorized Arctic Cat ATV dealer for service.

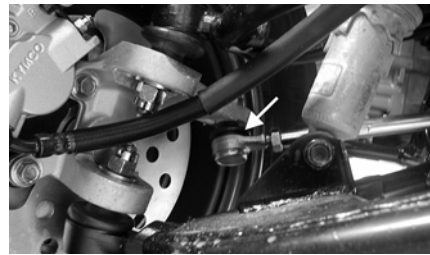

KM117B

1. Secure the ATV on a support stand to elevate the front wheels.
2. Remove both front wheels.
3. Inspect the four tie rod boots for cracks, tears, or perforations.
4. Check the tie rod end free-play by grasping the tie rod near the end and attempting to move it up and down.
5. If boot damage is present or tie rod end free-play seems excessive, contact an authorized Arctic Cat ATV dealer for service.

Battery

The battery is located under the seat.

After being in service, batteries require regular cleaning and recharging in order to deliver peak performance and maximum service life. The following procedure is recommended for cleaning and maintaining a sealed battery. Always read and follow instructions provided with battery chargers and battery products.

■ **NOTE:** Refer to all warnings and cautions provided with the battery or battery maintainer/charger.

Loss of battery charge may be caused by ambient temperature, ignition OFF current draw, corroded terminals, self discharge, frequent start/stops, and short engine run times. Frequent winch usage, snow plowing, extended low RPM operation, short trips, and high amperage accessory usage are also reasons for battery discharge.

Maintenance Charging

■ **NOTE:** Arctic Cat recommends the use of the CTEK Multi US 800 or the CTEK Multi US 3300 for battery maintenance charging. Maintenance charging is required on all batteries not used for more than two weeks or as required by battery drain.

1. When charging a battery in the vehicle, be sure the ignition switch is in the OFF position.
2. Clean the battery terminals with a solution of baking soda and water.

■ **NOTE:** The sealing strip should **NOT** be removed and **NO** fluid should be added.

3. Be sure the charger and battery are in a well-ventilated area. Be sure the charger is unplugged from the 110-volt electrical outlet.
4. Connect the red terminal lead from the charger to the positive terminal of the battery; then connect the black terminal lead of the charger to the negative terminal of the battery.

■ **NOTE:** Optional battery charging adapters are available from your authorized Arctic Cat dealer to connect directly to your vehicle from the recommended chargers to simplify the maintenance charging process. Check with your authorized Arctic Cat dealer for proper installation of these charging adapter connectors.

5. Plug the battery charger into a 110-volt electrical outlet.
6. If using the CTEK Multi US 800, there are no further buttons to push. If using the CTEK Multi US 3300, press the Mode button (A) at the left of the charger until the Maintenance Charge Icon (B) at the bottom illuminates. The Normal Charge Indicator (C) should illuminate on the upper portion of the battery charger.



800E

■ **NOTE:** The maintainer/charger will charge the battery to 95% capacity at which time the Maintenance Charge Indicator (D) will illuminate and the maintainer/charger will change to pulse/float maintenance. If the battery falls below 12.9 DC volts, the charger will automatically start again at the first step of the charge sequence.



3300A

■ **NOTE:** Not using a battery charger with the proper float maintenance will damage the battery if connected over extended periods.

Charging

■ **NOTE:** Arctic Cat recommends the use of the CTEK Multi US 800 or the CTEK Multi US 3300 for battery maintenance charging.

1. Be sure the battery and terminals have been cleaned with a baking soda and water solution.

■ **NOTE:** The sealing strip should **NOT** be removed and **NO** fluid should be added.

2. Be sure the charger and battery are in a well-ventilated area. Be sure the charger is unplugged from the 110-volt electrical outlet.

3. Connect the red terminal lead from the charger to the positive terminal of the battery; then connect the black terminal lead of the charger to the negative terminal of the battery.
4. Plug the charger into a 110-volt electrical outlet.
5. By pushing the Mode button (A) on the left side of the charger, select the Normal Charge Icon (E). The Normal Charge Indicator (C) should illuminate on the upper left portion of the charger.
6. The battery will charge to 95% of its capacity at which time the Maintenance Charge Indicator (D) will illuminate.

■ **NOTE:** For optimal charge and performance, leave the charger connected to the battery for a minimum 1 hour after the Maintenance Charge Indicator (D) illuminates. If the battery becomes hot to the touch, stop charging. Resume after it has cooled.

7. Once the battery has reached full charge, unplug the charger from the 110-volt electrical outlet.

■ **NOTE:** If, after charging, the battery does not perform to operator expectations, bring the battery to an authorized Arctic Cat dealer for further troubleshooting.

Jump-Starting

■ **NOTE:** Arctic Cat does not recommend jump-starting a vehicle with a dead battery but rather to remove the battery, service it, and correctly charge it; however, in an emergency, it may be necessary to jump-start a vehicle. If so, use the following procedure to carefully and safely complete this procedure.

WARNING

Improper handling or connecting of a battery may result in severe injury including acid burns, electrical burns, or blindness as a result of an explosion. Always remove rings and watches.

1. On the vehicle to be jump-started, remove the battery cover and any terminal boots.

WARNING

Any time service is performed on a battery, the following must be observed: keep sparks, open flame, cigarettes, or any other flame away. Always wear safety glasses. Protect skin and clothing when handling a battery. When servicing battery in enclosed space, keep the area well-ventilated. Make sure battery venting is not obstructed.

2. Inspect the battery for any signs of electrolyte leaks, loose terminals, or bulging sides. Leaking or bulging battery cases may indicate a frozen or shorted battery.

WARNING

If any of these conditions exist, DO NOT attempt a jump-start, boost, or charge the battery. An explosion could occur causing serious injury.

3. Inspect the vehicle to be used for jump-starting to determine if voltage and ground polarity are compatible. The vehicle must have a 12-volt DC, negative ground electrical system.

CAUTION

Always make sure the electrical systems are of the same voltage and ground polarity prior to connecting jumper cables. If not, severe electrical damage may occur.

4. Move the vehicle to be used for the jump-start close enough to ensure the jumper cables easily reach; then shift into neutral, set and lock the brakes, shut off all electrical accessories, and turn the ignition switch OFF.

■ **NOTE:** Make sure all switches on the vehicle to be jump-started are turned OFF.

5. Disconnect all external accessories such as cell phones, GPS units, and radios on both vehicles.

CAUTION

Failure to disconnect electronic accessories during jump-starting may cause system damage due to power spikes.

- Attach one clamp of the positive (red) jumper cable to the positive (+) terminal (1) of the dead battery (C) being careful not to touch any metal with the other clamp; then attach the other clamp of the positive (red) jumper cable to the positive (+) terminal (2) of the good battery (B).

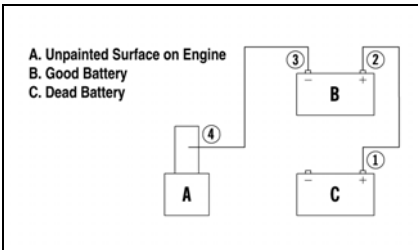

0744-527

NOTE: Some jumper cables may be the same color but the clamps or ends will be color-coded red and black.

- Attach one clamp of the negative (black) jumper cable to the negative (-) terminal (3) of the good battery (B); then attach the other clamp of the negative (black) jumper cable (4) to an unpainted metal surface (A) on the engine or frame well away from the dead battery and fuel system components.

WARNING

Never make the final connection to a battery as a spark could ignite hydrogen gases causing an explosion of the battery resulting in acid burns or blindness.

- Stand well away from the dead battery and start the vehicle with the good battery. Allow the vehicle to run for several minutes applying some charge to the dead battery.

- Start the vehicle with the dead battery and allow it to run for several minutes before disconnecting the jumper cables.
- Remove the jumper cables in opposite order of hook-up (4, 3, 2, 1). Be careful not to short cables against bare metal.

NOTE: Have the battery and electrical system checked prior to operating the vehicle again.

Spark Plug

The ATV comes equipped with a specified spark plug. See the specifications chart for the correct spark plug. A light brown insulator indicates that the plug is correct. A white or dark insulator indicates that the engine may need to be serviced or the carburetor may need to be adjusted. Consult an authorized Arctic Cat ATV dealer if the plug insulator is not a light brown color. To help prevent cold weather fouling, make sure to thoroughly warm up the engine before operating.

To maintain a hot, strong spark, keep the plug free of carbon.

Before removing the spark plug, be sure to clean the area around the spark plug. If you do not, dirt could enter engine when removing or installing the spark plug.

Adjust the gap to 0.8-0.9 mm (0.032-0.036 in.) for proper ignition. Use a feeler gauge to check the gap.

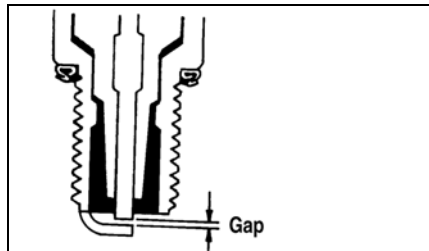

ATV-0052B

When installing the spark plug, be sure to tighten it securely. A new spark plug should be tightened 1/2 turn once the washer contacts the cylinder head. A used spark plug should be tightened 1/8-1/4 turn once the washer contacts the cylinder head.

Engine Idle RPM Adjustment

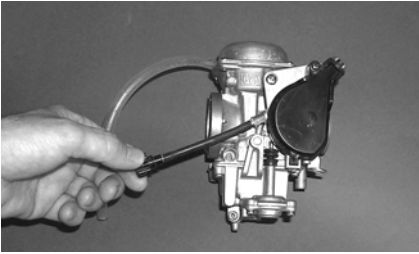

AF920

To properly adjust the idle, a tachometer is necessary. If one is not available, take the ATV to an authorized Arctic Cat ATV dealer.

To adjust idle RPM:

1. Start the engine and warm it up to normal operating temperature.
2. Turn the idle adjustment screw in or out until the engine idles at 1250-1350 RPM.

WARNING

Adjust the idle to the correct RPM. Make sure the engine is at normal operating temperature before adjusting the idle RPM.

Throttle Cable Adjustment

To adjust the throttle cable free-play:

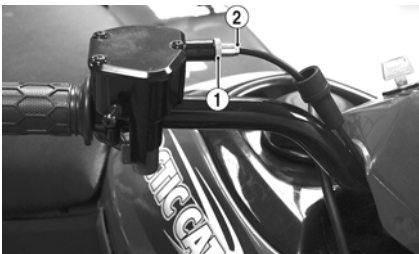

KM111A

1. Slide the rubber boot away; then loosen the jam nut (1) from the throttle housing.
2. Turn the throttle cable adjuster (2) until the throttle lever has proper free-play of 3-5 mm (1/8 - 1/5 in.).

3. Tighten the jam nut (1) against the throttle housing securely; then slide the rubber boot over the adjuster.

Air Filter (V-Belt Housing) - Utility

The air filter in the V-belt housing cooling inlet must be kept clean. If the ATV is used under normal conditions, service the filter at the intervals specified. If operated in dusty, wet, or muddy conditions, inspect and service the filter more frequently. Use the following procedure to remove the filter and inspect and/or clean it.

1. Remove the center cover from between the front fenders; then remove the two screws securing the filter housing to the front fender.
2. Remove the filter housing cover. Tap the filter lightly to remove dust and debris; then use compressed air to thoroughly clean the filter.

■ **NOTE: Inspect the filter element. If damaged or torn, it must be replaced.**

3. Install the filter housing cover onto the filter housing.
4. Place the filter housing into position on the front fender. Tighten the two screws securely; then place the center cover into position between the front fenders. Tighten the screws securely.

Air Filter (V-Belt Housing) - DVX

The air filter in the V-belt housing cooling inlet must be kept clean. If the ATV is used under normal conditions, service the filter at the intervals specified. If operated in dusty, wet, or muddy conditions, inspect and service the filter more frequently. Use the following procedure to remove the filter and inspect and/or clean it.

1. Remove the two screws securing the filter housing to the inside of the left-front fender.
2. Remove the filter housing cover. Tap the filter lightly to remove dust and debris; then use compressed air to thoroughly clean the filter.

■ **NOTE:** Inspect the filter element. If damaged or torn, it must be replaced.

3. Install the filter housing cover onto the filter housing.
4. Place the filter housing into position inside the left-front fender. Tighten the two screws securely.

Air Filter (Engine)

The air filter inside the air filter housing must be kept clean to provide good engine power and gas mileage. If the ATV is used under normal conditions, service the filter at the intervals specified. If operated in dusty, wet, or muddy conditions, inspect and service the filter more frequently. Use the following procedure to remove the filter and inspect and/or clean it.

CAUTION

Failure to inspect the air filter frequently if the ATV is used in dusty, wet, or muddy conditions can damage the engine.

1. Remove the seat.
2. Remove the air filter housing cover by unseating the two retaining clips; then lifting and removing the cover.



KM095A

3. Remove the air filter retaining nut (1); then remove the foam element (2) from its frame.

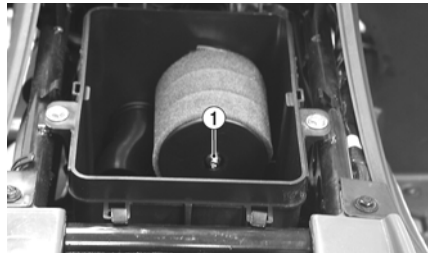

KM097A

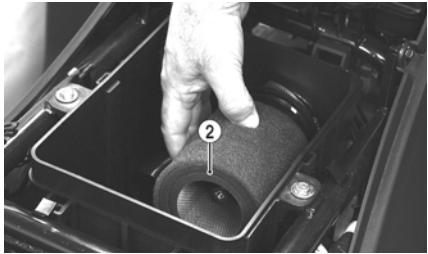

KM098A

4. Fill a wash pan larger than the element with a non-flammable cleaning solvent; then dip the element in the solvent and wash it.

■ **NOTE:** Foam Air Filter Cleaner and Foam Air Filter Oil are available from Arctic Cat.

5. Squeeze the element by pressing it between the palms of both hands to remove excess solvent. Do not twist or wring the element or it will develop cracks.
6. Dry the element.
7. Put the element in a plastic bag; then pour in air filter oil and work the oil into the element.
8. Squeeze the element to remove excess oil.

CAUTION

A torn air filter can cause damage to the ATV engine. Dirt and dust may get inside the engine if the element is torn. Carefully examine the element for tears before and after cleaning it. Replace the element with a new one if it is torn.

9. Clean any dirt or debris from inside the air cleaner. Be sure no dirt enters the carburetor.
10. Install the foam element into its frame; then place the assembly into position in the housing and secure with the retaining nut.
11. Install the cover and secure with the retaining clips.
12. Install the seat making sure it is properly secured.

Air Filter Housing Drain Tube

Periodically (weekly) check the drain tube for gasoline or oil accumulation. If noticed, remove the drain tube cap from beneath the housing, drain the gasoline or oil into a suitable container, and install and secure the tube cap.



KM114

Drive Chain (DVX)

Drive chain condition and adjustment should be inspected each day before you ride. Always follow the guidelines below for inspecting and servicing the drive chain.

WARNING

Failure to inspect and maintain the drive chain can be hazardous. Operating the ATV with the drive chain in poor condition or improperly adjusted can cause an accident resulting in possible injury.

Inspecting Condition

Inspect the drive chain for any of the following conditions.

- Loose pins
- Loose or cracked rollers
- Dry or rusted links

- Kinked or binding links
- Excessive wear

The presence of any of the conditions requires drive chain replacement. Take the ATV to an authorized Arctic Cat ATV dealer for this service.

NOTE: If the drive chain is worn or damaged, the sprockets may also be worn or damaged. Inspect the sprockets for worn, broken, or damaged teeth. Always inspect the sprockets when a new drive chain is being installed.

Cleaning and Lubricating

The drive chain should be cleaned and lubricated frequently to prolong chain and sprocket life. Use the following procedure to clean and lubricate the chain.

NOTE: This ATV is equipped with an O-ring type roller chain. Each link incorporates small O-rings to seal out water and dirt. Care should be taken to choose cleaning solutions and lubricants that are suitable for O-ring chains.

1. Using a suitable, nonflammable cleaning solution, thoroughly wash the chain and sprockets.
2. Allow the chain to dry; then apply a dry, graphite-based lubricant to the chain.

The drive chain should be lubricated with a dry, graphite-based chain lubricant. By using a dry, graphite-based chain lubricant, dirt buildup on the drive chain will be minimized.

Adjusting Tension

To adjust the drive chain tension, use the following procedure.

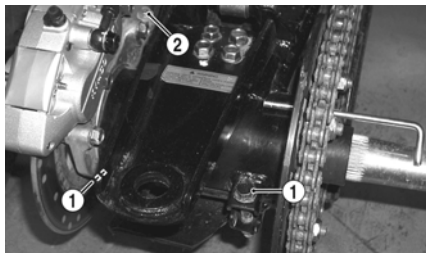

KM157A

1. Loosen the two cap screws (1) at the rear of the axle housing; then loosen the cap screw (2) on the front of the brake caliper.
2. Install an appropriate pin through the axle hub and rear sprocket.



KM158A

3. With a person seated on the ATV, check chain tension at the mid-point of the chain.

■ **NOTE:** Chain “slack” should be within a range of 30-40 mm (1.2-1.6 in.).

4. Push the ATV forward to tighten chain tension; push the ATV backward to loosen chain tension.
5. Tighten the two cap screws (1) to 28 ft-lb; tighten the cap screw (2) to 8 ft-lb.

■ **NOTE:** Drive chain adjustments may be done by the ATV owner if qualified to do so. If the owner does not feel qualified, take the ATV to an authorized Arctic Cat ATV dealer for this service.

Tires

WARNING

Always use the size and type of tires as specified. Refer to the specifications chart for proper tire inflation pressure, and always maintain proper tire inflation pressure.

Tire Tread Condition

The use of worn-out tires on an ATV is very dangerous. A tire is considered to be worn out when the depth of the tread is less than 4 mm (5/32 in.). Be sure to replace the tires before reaching this minimum specification.

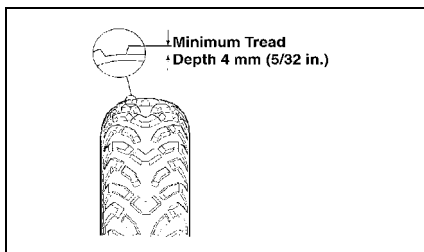

ATV-649A

WARNING

The use of worn-out tires can be dangerous and can increase the risk of an accident.

Tire Replacement

The ATV has low-pressure tubeless tires. Air is sealed by the contact surfaces of the inner wheel rim and the tire bead. If either the inner wheel rim or tire bead is damaged, air may leak. Be extremely careful not to damage these areas when replacing tires.

It is very important to use the proper tools when repairing or replacing tires to prevent damage to the tire bead or wheel rims. If proper tools and related items are not available, have this maintenance performed by an authorized Arctic Cat ATV dealer or a qualified tire repair station.

CAUTION

When breaking the tire bead loose from the wheel, be extremely careful not to damage the inner wheel surface or the tire bead.

WARNING

Use only Arctic Cat approved tires when replacing tires. Failure to do so could result in unstable ATV operation.

Tubeless Tire Repair

Should a leak or flat tire occur due to a puncture, the tire may be repaired using a plug-type repair. If the damage is from a cut or if the puncture cannot be repaired using a plug, the tire must be replaced. When operating the ATV in areas where transportation or service facilities are not readily available, it is strongly recommended to carry a plug-type repair kit and a tire pump along.

Wheels

1. Park the ATV on level ground and engage the brake lever lock.
2. Loosen the lug nuts on the wheel to be removed.
3. Elevate the ATV.
4. Remove the lug nuts.
5. Remove the wheel.
6. Install the wheel and install the lug nuts.
7. Tighten the nuts in a crisscross pattern to 32 ft-lb.

WARNING

Failure to tighten the wheel nuts to the specified torque value can be hazardous. If the wheel nuts are not properly tightened, the wheel can come off causing an accident and possible injury.

8. Remove the jack.

Muffler/Spark Arrester

The muffler has a spark arrester which must be periodically cleaned. At the intervals shown in the Maintenance Schedule, clean the spark arrester using the following procedure.

WARNING

Wait until the muffler cools to avoid burns.

1. Remove the cap screw (1) securing spark arrester; then remove the arrester (2).

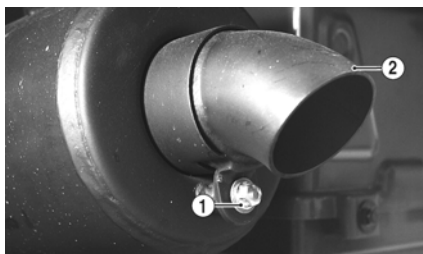

KM139A

2. Using a brush, clean the carbon deposits from the arrester screen (3) taking care not to damage the screen.

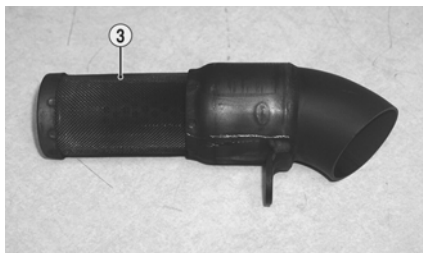

KM140B

■ **NOTE:** If the screen is damaged in any way, it must be replaced.

3. Install the spark arrester and secure with the cap screw.

Light Bulb Replacement

The wattage rating of each bulb is shown in the chart. When replacing a burned bulb, always use the same wattage rating.

Headlight	12V/35W/35W
Taillight/Brakelight	12V/5W/21W

CAUTION

Use only specified bulbs indicated in the chart as replacement bulbs.

■ **NOTE:** The bulb portion of the headlight is fragile. **HANDLE WITH CARE.** When replacing the headlight bulb, do not touch the glass portion of the bulb. If the glass is touched, it must be cleaned with a dry cloth before installing. Skin oil residue on the bulb will shorten the life of the bulb.

WARNING

Do not attempt to remove the bulb when it is hot. Severe burns may result.

To replace the headlight bulb, use the following procedure.

1. Remove the rubber boot from the back of the headlight housing; then remove the three-wire connector from the bulb.

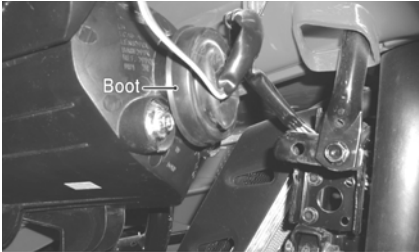

KM194A

2. Release the two ends of the spring clip from the headlight housing taking care not to bend or deform the clip; then remove the bulb from the housing.



KM192A

3. Install the new bulb into the housing; then secure with the spring clip.



KM195

4. Connect the three-wire connector to the bulb; then install the rubber boot.

CAUTION

When replacing the headlight bulb, be careful not to touch the glass portion of the bulb. Grasp the new bulb with a clean cloth.

To replace the taillight/brakelight bulb, use the following procedure.

1. Remove the two screws and remove the lens.



KM143B

2. Push the bulb in and turn it counter-clockwise.
3. Install the new bulb by turning it clockwise while pushing in.
4. Install the lens. Tighten the two screws securely.

Fuses

The fuse box (with three active fuses and one spare fuse) is located under the seat near the battery.



KM102

■ **NOTE:** To remove the fuse, compress the locking tabs on either side of the fuse cover and lift off; then remove and replace the fuse.

CAUTION

Always replace a blown fuse with a fuse of the same type and rating. If the new fuse blows after a short period of use, consult an authorized Arctic Cat ATV dealer immediately.

Tools

A basic tool kit, located under the seat, is provided with the ATV. Maintain the tool kit with the ATV at all times.

Preparation for Storage

CAUTION

Prior to storing the ATV, it must be properly serviced to prevent rusting and component deterioration.

Arctic Cat recommends the following procedure to prepare the ATV for storage. An authorized Arctic Cat ATV dealer should perform this service; however, the owner/operator may perform this service if desired.

1. Clean the seat cushion (cover and base) with a damp cloth and allow to dry.
2. Clean the ATV thoroughly by washing dirt, oil, grass, and other foreign matter from the entire ATV. Allow the ATV to dry thoroughly. DO NOT get water into any part of the engine or air intake.
3. Either drain the gas tank or add a fuel stabilizer to the gas in the gas tank. Remove the air filter housing cover and air filter. Start the engine and allow it to idle; then using Arctic Cat Engine Preserver, rapidly inject the preserver into the air filter opening for a period of 10 to 20 seconds. Install the air filter and housing cover.

CAUTION

If the interior of the air filter housing is dirty, clean the area before starting the engine.

4. Drain the carburetor float bowl.
5. Plug the hole in the exhaust system with a clean cloth.
6. Apply light oil to the upper steering post bushing, plungers of the shock absorbers, and drive chain.
7. Tighten all nuts, bolts, cap screws, and screws. Make sure rivets holding components together are tight. Replace all loose rivets. Care must be taken that all calibrated nuts, cap screws, and bolts are tightened to specifications.
8. Fill the cooling system with properly mixed coolant.
9. Disconnect the battery cables (negative cable first); then remove the battery, clean the battery posts and cables, and store in a clean, dry area.

■ NOTE: For storage, use a battery maintainer or make sure the battery is fully charged (see Battery section in this manual).

10. Store the ATV indoors in a level position.

CAUTION

Avoid storing outside in direct sunlight and avoid using a plastic cover as moisture will collect on the ATV causing rusting.

Preparation after Storage

Taking the ATV out of storage and correctly preparing it will assure many miles and hours of trouble-free riding. Arctic Cat recommends the following procedure to prepare the ATV.

1. Clean the ATV thoroughly.
2. Clean the engine. Remove the cloth from the exhaust system.
3. Check all control wires and cables for signs of wear or fraying. Replace if necessary.
4. Change the engine oil.
5. Check the coolant level and add properly mixed coolant as necessary.
6. Charge the battery; then install. Connect the battery cables making sure to connect the positive cable first.
7. Check the entire brake systems (fluid level, pads, etc.), all controls, headlights, taillight, brakelight, and headlight aim; adjust or replace if necessary.
8. Check the tire pressure. Inflate to recommended pressure as necessary.
9. Tighten all nuts, bolts, cap screws, and screws making sure all calibrated nuts, cap screws, and bolts are tightened to specifications.
10. Make sure the steering moves freely and does not bind.
11. Check the spark plug. Clean or replace as necessary.
12. Follow the recommendations found in the Starting the Engine sub-section in Division I of this manual.

Limited Warranty

Arctic Cat Inc. (hereinafter referred to as Arctic Cat) extends a limited warranty on each new Arctic Cat ATV it assembles and on each genuine Arctic Cat ATV part and accessory assembled or sold by an authorized Arctic Cat ATV dealer. Warranty on an Arctic Cat ATV is extended to the original retail purchaser; however, the balance of the unused warranty may be transferred to another party. Warranty coverage is only available in the country in which the original retail purchase occurs to the original retail purchaser resident in that country or to a transferee resident in that country of the balance of the unused warranty.

Arctic Cat warrants only the products it assembles and/or sells and does not warrant that other products will function properly when used with an Arctic Cat ATV or will not damage the ATV. Arctic Cat does not assume any liability for incidental or consequential damages.

Arctic Cat will repair or replace, at its option, free of charge (including any related labor charges), any parts that are found to be warrantable in material or workmanship. This repair work **MUST** be done by an authorized Arctic Cat ATV dealer. No transportation charges, rental charges, or inconvenience costs will be paid by Arctic Cat. The warranty is validated upon examination of said parts by Arctic Cat or an authorized Arctic Cat ATV dealer. Arctic Cat reserves the right to inspect such parts at its factory for final determination if warranty should apply.

The warranty periods are as follows:

1. Six months from the date of sale — for an Arctic Cat ATV used for recreational purposes.
2. Ninety days from date of invoice — for an Arctic Cat ATV used for commercial purposes, including rental operations (non-transferable).
3. Thirty days from date of sale of ATV on Arctic Cat supplied batteries.
4. Thirty days from date of sale — for all dealer installed genuine Arctic Cat service parts and accessories.
5. Until expiration of the new product warranty (paragraphs 1 and 2 above) — for all eligible replacement parts on new product.

Exclusions to this warranty include normal wear, abuse, or corrosion and the following parts and items:

Tires	CV Boots	Torn or Punctured Upholstery
Oil Filter	Drive Belt	Cracks or Gouges in Body Panels
Air Filter	Brake Pads	Drive/Driven Clutch Wear Parts
Light Bulbs	Spark Plug(s)	

The following will VOID Arctic Cat's warranty:

1. Failure to perform the proper break-in procedure and all related maintenance, storage procedures (if stored for extended periods), and/or service as recommended in the Operator's Manual.
2. Repairs and/or adjustments by anyone other than an authorized Arctic Cat ATV dealer.
3. Use of improper carburetor main jets.
4. Use of improper gasoline, lubricating oils, or spark plug.
5. An accident or subjecting the ATV to misuse, abuse, or negligent operation.
6. Any modification, addition, or removal of parts unless instructed to do so by Arctic Cat.
7. Use of the ATV in any way for racing purposes.
8. Removal of the engine for use in another vehicle.
9. Removal or mutilation of the Vehicle Identification Number or Engine Serial Number.
10. Use of parts not sold or approved by Arctic Cat.
11. Damage due to improper transportation.

In consideration of the foregoing, any implied warranty is limited in duration to the various warranty periods set forth. This warranty gives you specific legal rights, and you may also have other rights which vary from state/province to state/province or country to country. Some jurisdictions do not allow limitations on how long an implied warranty lasts, so the above limitations may not apply to you.

Warranty Procedure/Owner Responsibility

At the time of sale, an ATV Rider Training Certificate and Owner Registration form is to be completed by the selling dealer and consumer. The receipt of the form by Arctic Cat is a condition precedent to warranty coverage. It is the selling dealer's responsibility to retain and/or submit appropriate copies of the form to the appropriate place(s) to initiate warranty coverage.

The dealer will furnish to the consumer a signed copy of the form which must be presented to the dealer when requesting warranty service. The registration form is the consumer's proof of ownership and warranty eligibility. The form is used by the dealer to validate the warranty claim. Retain your copy of the form and keep it in a safe place.

When warranty repair is suspected, the ATV should be taken to the selling dealer, who has the primary responsibility to perform warranty repairs. Subject to the limitations set forth in the Limited Warranty, in the event the selling dealer has ceased to do business, you have moved, or you are in a location away from your selling dealer, warranty may be performed by any authorized Arctic Cat ATV dealer.

The authorized Arctic Cat ATV dealer will examine the ATV or part to determine if, in his opinion, a warrantable condition exists. If a warrantable condition appears to exist, the dealer will repair or replace, at Arctic Cat's option, free of charge, including any related labor costs, all parts that are found to be warrantable and any other parts which the warrantable part caused to be damaged. You, the owner, will then be asked to sign a warranty form to ensure Arctic Cat that the warranty work was actually performed.

It is the owner's responsibility to maintain and service the ATV in accordance with Arctic Cat's recommendations in the Operator's Manual. To protect yourself and your ATV, follow all safety and service tips. Arctic Cat will NOT warrant repairs required as a result of not performing standard operator maintenance, storage procedures, and service as outlined in the Operator's Manual.

Should you have any questions concerning the warranty, contact an authorized Arctic Cat ATV dealer.

Change of Address, Ownership, or Warranty Transfer

Arctic Cat Inc. keeps on file the current name and address of the owner of this ATV. This will allow Arctic Cat to reach the current owner with any important safety information which may be necessary to protect customers from personal injury or property damage. Please make sure a copy of this form is completed and returned to Arctic Cat Inc. if you move or if the ATV is sold to another party.

This form may also be used to transfer the unused portion of the original warranty to a second party. In order to transfer warranty, fill out this form completely; then return a copy of this form to Arctic Cat Inc. Arctic Cat will then process the application and issue warranty for the balance of the time remaining of the original warranty.

Address Change

Ownership Change

Warranty Transfer

CHANGE OF ADDRESS/OWNERSHIP/ WARRANTY TRANSFER TO:

Name _____

Address _____

City/State (Province)/Zip Code (Postal Code) _____

Phone # () _____

Year and Model ATV _____

Vehicle Identification Number (VIN) _____

Before operating, you should take an ATV Rider Course to learn ATV riding skills or reinforce your current good riding skills. In U.S.A., call 1-800-887-2887 to enroll in the half-day ATV Rider Course nearest you or ask your dealer for assistance. The course instructor will charge a small fee for each person taking the course. In Canada, call (613) 739-1535.

Fold Back

Place
Stamp
Here

CHANGE OF ADDRESS/OWNERSHIP

ARCTIC CAT INC.
PRODUCT SERVICE AND
WARRANTY DEPT.
P.O. BOX 810
THIEF RIVER FALLS, MN 56701

Arctic Cat ATV Emission Control Warranty Statement

Warranty Rights and Obligations

Arctic Cat Inc. (hereinafter referred to as Arctic Cat) and the California Air Resources Board are pleased to explain the emission control system warranty for each new Arctic Cat ATV sold in the state of California. In California, a new ATV must be designed, built, and equipped to meet the state's stringent anti-smog standards.

Arctic Cat warrants the emission control system on the Arctic Cat ATV for the periods listed below provided there has been no abuse, neglect, or improper maintenance of the ATV.

The emission control system may include components such as the carburetor, ignition system, and crankcase ventilation system. Also included may be hoses, belts, connectors, and other emission-related assemblies.

When a warrantable condition exists, Arctic Cat will repair the ATV at no cost to the owner, including diagnosis, parts, and labor.

Emission Control Warranty Coverage

A new Arctic Cat ATV manufactured after January 1, 1997 has a two (2) year warranty on its emissions control components.

If an emission-related component on the ATV is defective, the component will be repaired or replaced by any authorized Arctic Cat ATV dealer.

Owner's Emission Control Warranty Responsibilities

It is the owner's responsibility to perform the required maintenance listed in the Operator's Manual. Arctic Cat recommends the retention of all receipts covering maintenance performed on the ATV, but Arctic Cat cannot deny warranty solely for the lack of receipts or for failure to ensure the performance of all scheduled maintenance on the emission control system.

It is the owner's responsibility to present the ATV to an authorized Arctic Cat ATV dealer as soon as a problem exists. The undisputed warranty repairs should be completed within a reasonable period of time, not to exceed thirty days.

The ATV owner should be aware that Arctic Cat may deny warranty coverage if either the ATV or a component has failed due to abuse, neglect, improper maintenance, or any unapproved modifications.

If you have any questions regarding your warranty rights and responsibilities, contact either Arctic Cat Inc, P.O. Box 810, Thief River Falls, MN 56701, (218) 681-4999 or the California Air Resources Board, 9528 Telstar Avenue, El Monte, CA 91731, (818) 575-6800.

U.S. EPA Emission Control Statement/ Warranty Coverage - ATV (U.S. Only)

Statement/Warranty

Arctic Cat warrants to the original retail purchaser, and each subsequent purchaser, that all U.S. EPA-certified Arctic Cat ATV's are designed, built, and equipped to conform to all U.S. EPA Emission Control Regulations. Please read the following information completely.

Your authorized Arctic Cat ATV dealer will repair or replace any defective emission-related component at no cost to you during the warranty period. You may have non-warranty service performed by any repair establishment that uses equivalent components. The regulations provide significant civil penalties for tampering that causes your ATV to no longer meet U.S. EPA emission standards.

Arctic Cat further warrants that the engine and its emission-related components are free from defects in materials or workmanship that could cause the engine to fail to comply with applicable regulations during the warranty period.

If you have any questions about this information, or the emission warranty coverage statement, contact your local authorized Arctic Cat ATV dealer.

Warranty Period

The emission warranty period for this ATV begins on the same date as the standard warranty coverage and continues for 30 months or 3100 miles, whichever comes first.

Components Covered

The emissions warranty covers major emissions control components and emission-related components listed as follows:

Engine Management and Sensors

- Barometric Pressure Sensor
- Camshaft Position Sensor
- Engine Control Unit (ECU)
- Engine Coolant Temperature Sensor
- Intake Air Temperature Sensor
- Manifold Absolute Pressure Sensor
- Oxygen Sensor
- Throttle Position Sensor
- Crankshaft Position Sensor
- Exhaust Temperature Sensor
- Crankshaft Position Sensor

Ignition System

- Ignition Coil
- Knock Sensor System
- Spark Plugs
- Capacitive Discharge Ignition (CDI) Module
- Magneto Pick-Up

Fuel/Air System

- Fuel Injectors
- Fuel Pressure Regulator
- Fuel Pump
- Carburetor(s)
- Turbocharger Assembly
- Air Bypass Valve
- Turbo Waste Gate Control Valve
- Crankcase Ventilation System
- ISC Valve

Miscellaneous Items Used in Aforementioned Systems

- Connectors
- Switches
- Grommets
- Clamps
- Hoses
- Ties
- Gaskets
- Wiring

Owner's Responsibilities

The owner of any ATV warranted under this Arctic Cat Emission Control Statement is responsible for the proper maintenance and use of the ATV as stated in the Operator's Manual. Proper maintenance generally includes replacement and service, at the owner's choosing, such items as air filter, oil and oil filter, or any other part, item, or device related to emissions control as specified in the Operator's Manual. It is the owner's responsibility to ensure that the ATV is used in a manner for which it was designed.

Arctic Cat Emission Control System Limited Warranty

Arctic Cat Inc., P.O. Box 810, Thief River Falls, MN 56701 (hereinafter referred to as Arctic Cat) warrants that this new Arctic Cat ATV manufactured on or after January 1st, 1997:

- A. Is designed, built, and equipped so as to conform at the time of initial purchase with all applicable regulations of the California Air Resources Board and
- B. Is free from defects in material and workmanship which could cause such ATV to fail to conform with applicable regulations of the California Air Resources Board for a period of use of two (2) years from the date of initial retail delivery.

Coverage

Warranty defects shall be remedied during customary business hours at any authorized Arctic Cat ATV dealer located within the state of California in compliance with applicable regulations of the California Air Resources Board. Any component or components replaced under this warranty shall become the property of Arctic Cat.

In California, emission related warranted components are specifically defined by the state's Emission Warranty Parts List. These warranted components are carburetor and internal components, intake manifold, fuel injection system, spark advance mechanism, crankcase breather, air cutoff valve, fuel/vapor separator, canister, igniters, breaker governors, ignition coils, ignition wires, ignition points, condensers and spark plugs if failure occurs prior to the first scheduled replacement, and hoses, clamps, and fittings used directly in these parts. Since emission related components may vary from model to model, certain models may not contain all of these components, and certain models may contain functionally equivalent components.

In California, emission control system emergency repairs, as provided for in the California Administrative Code, may also be performed by other than an authorized Arctic Cat ATV dealer. An emergency situation occurs when an authorized Arctic Cat ATV dealer is not reasonably available, a component is not available within thirty (30) days, or a repair is not complete within thirty (30) days. Any replacement component can be used in an emergency repair. Arctic Cat will reimburse the owner for the expenses, including diagnosis, not to exceed suggested retail price as set forth by Arctic Cat for all warranted components replaced and labor charges based on the recommended time allowance set forth by Arctic Cat for the warranty repair and the geographically appropriate hourly labor rate. The owner may be required to keep receipts and failed components in order to receive compensation.

Limitations

This Emission Control System Warranty shall not cover any of the following:

- A. Repair or replacement required as a result of
 - (1) accident,
 - (2) misuse,
 - (3) lack of required maintenance,
 - (4) repairs improperly performed or replacements improperly installed,
 - (5) use of replacement components or accessories not conforming to Arctic Cat specifications which adversely affect performance, and/or
 - (6) use in competitive racing or related events.
- B. Inspections, replacement of components, and other services or adjustments necessary for required maintenance.

Limited Liability

The liability of Arctic Cat under this Emission Control System Warranty is limited solely to the remedying of defects in material and workmanship by an authorized Arctic Cat ATV dealer at its place of business during customary business hours. This warranty does not cover inconvenience or loss of use of the ATV or transportation of the ATV to or from the Arctic Cat ATV dealer.

ARCTIC CAT SHALL NOT BE LIABLE FOR ANY OTHER EXPENSES, LOSS, OR DAMAGE, WHETHER DIRECT, INCIDENTAL, CONSEQUENTIAL, OR EXEMPLARY, ARISING IN CONNECTION WITH THE SALE OR USE OF, OR INABILITY TO USE THE ARCTIC CAT ATV FOR ANY PURPOSE. SOME STATES DO NOT ALLOW THE EXCLUSION OR LIMITATION OF ANY INCIDENTAL OR CONSEQUENTIAL DAMAGES, SO THE ABOVE MAY NOT APPLY TO YOU.

NO EXPRESS EMISSION CONTROL SYSTEM WARRANTY IS GIVEN BY ARCTIC CAT EXCEPT AS SPECIFICALLY SET FORTH HEREIN. ANY EMISSION CONTROL SYSTEM WARRANTY IMPLIED BY LAW, INCLUDING ANY WARRANTY OF MERCHANTABILITY OR FITNESS FOR A PARTICULAR PURPOSE, IS LIMITED TO THE EXPRESS EMISSION CONTROL SYSTEM WARRANTY TERMS STATED IN THIS WARRANTY. THE FOREGOING STATEMENTS OF WARRANTY ARE EXCLUSIVE AND IN LIEU OF ALL OTHER REMEDIES.

No dealer is authorized to modify this Arctic Cat Inc. Limited Emission Control System Warranty.

Legal Rights

THIS WARRANTY GIVES YOU SPECIFIC LEGAL RIGHTS, AND YOU MAY ALSO HAVE OTHER RIGHTS WHICH VARY FROM STATE TO STATE.

THIS WARRANTY IS IN ADDITION TO THE ARCTIC CAT INC. LIMITED ATV WARRANTY.

Additional Information

Any replacement component that is equivalent in performance and durability may be used in the performance of any maintenance or repairs. However, Arctic Cat is not liable for these components. The owner is responsible for the performance of all required maintenance. Such maintenance may be performed at a service establishment or by any individual. The warranty period begins on the date the ATV is delivered to the owner.

Declaration of Conformity

Application of council directives:

EMC Directive 97/24/EC
Date of Issue: June, 1997
EC Machinery Directive 2006/42/EC
Date of Issue: May, 2006

Issued by European Commission.

Type of Equipment: All-Terrain Vehicles

Brand Name: Arctic Cat

Model:

DVX 300
300 Utility

Standards to which conformity is declared:

EN 61000-6-2:2005
EN 55012:2007

Manufacturer (if not issuing agent):

Arctic Cat Inc.
601 Brooks Ave S.
Thief River Falls, MN
56701 USA

I, the undersigned, hereby declare that the equipment specified above conforms to the directive(s) and standard(s) as specified.

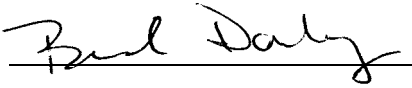

Brad Darling

Vice President/General Manager

Identification Numbers Record

WARNING

Indicates a potential hazard that could result in serious injury or death.



1. KEY IDENTIFICATION NUMBER:

The key identification number is stamped on the key as shown in the illustration. Record this number in the space provided for reference if you ever need a new key.

2. VEHICLE IDENTIFICATION NUMBER:

3. ENGINE SERIAL NUMBER:

Record the Vehicle Identification Number and Engine Serial Number in the spaces provided to assist you in ordering parts from your authorized Arctic Cat ATV dealer or for reference in case the ATV is stolen.



WARNING

Improper ATV use can result in SEVERE INJURY or DEATH



**ALWAYS USE
AN APPROVED
HELMET AND
PROTECTIVE
GEAR**



**NEVER USE
ON PUBLIC
ROADS**



**NEVER CARRY
PASSENGERS**



**NEVER USE
WITH DRUGS
OR ALCOHOL**

NEVER operate:

- without proper training or instruction
- at speeds too fast for your skills or the conditions
- on public roads - a collision can occur with another vehicle
- with a passenger - passengers affect balance and steering and increase risk of losing control

ALWAYS:

- use proper riding techniques to avoid vehicle overturns on hills and rough terrain and in turns
- avoid paved surfaces - pavement may seriously affect handling and control

**LOCATE AND READ OPERATOR'S MANUAL
FOLLOW ALL INSTRUCTIONS AND WARNINGS**

Your ATV can be hazardous to operate.

A collision or rollover can occur quickly, even during routine maneuvers such as turning and driving on hills or over obstacles, if you fail to take proper precautions.

For your safety, understand and follow all the warnings contained in this Operator's Manual and the labels on your ATV.

Keep this Operator's Manual with your ATV at all times. This Arctic Cat ATV Operator's Manual should be considered a permanent part of the ATV and must remain with the ATV at the time of resale. If the ATV changes ownership more than once, contact Arctic Cat Inc., Service Department, P.O. Box 810, Thief River Falls, MN 56701, for proper registration information.

FAILURE TO FOLLOW THE WARNINGS CONTAINED IN THIS MANUAL CAN RESULT IN SERIOUS INJURY OR DEATH.

Training is available: U.S. owners, call 800-887-2887; Canadian owners, call 613-739-1535.

Un cours d'instruction est disponible: pour les propriétaires canadiens, composez le 613-739-1535.

Particularly important information is distinguished in this manual by the following notations:



The Safety Alert Symbol means ATTENTION! BE ALERT! YOUR SAFETY IS INVOLVED.



WARNING

WARNING indicates a hazardous situation which, if not avoided, could result in death or serious injury.

CAUTION

CAUTION, without the safety alert symbol, is used to address practices not related to personal injury.

NOTE:

A NOTE provides key information to make procedures easier or more clear.

California Proposition 65



WARNING

This product contains or emits chemicals known to the State of California to cause cancer and birth defects or other reproductive harm.

Foreword

Congratulations and thank you from Arctic Cat Inc. for purchasing an ARCTIC CAT® All-Terrain Vehicle (ATV). Built with American engineering and manufacturing know-how, it is designed to provide superior ride, comfort, utility, and dependable service.

This Operator's Manual is furnished to ensure that the operator is aware of safe operating procedures. It also includes information about the general care and maintenance of your ATV.

Carefully read the following pages. If you have any questions regarding this ATV, contact an authorized Arctic Cat ATV dealer for assistance. Remember, only authorized Arctic Cat ATV dealers have the knowledge and facilities to provide you with the best service possible.

Protect Your Sport

- Know all local, state/provincial riding laws,
- Respect your ATV,
- Respect the environment, and
- You will gain the respect of others.

We also advise you to strictly follow the recommended maintenance program as outlined. This preventive maintenance program is designed to ensure that all critical components on this ATV are thoroughly inspected at various intervals.

All information in this manual is based on the latest product data and specifications available at the time of printing. Arctic Cat Inc. reserves the right to make product changes and improvements which may affect illustrations or explanations without notice.

Division II of this manual covers operator-related maintenance, operating instructions, and storage instructions. If major repair or service is ever required, contact an authorized Arctic Cat ATV dealer for professional service.

At the time of publication, all information and illustrations in this manual were technically correct. Some illustrations used in this manual are used for clarity purposes only and are not designed to depict actual conditions. Because Arctic Cat Inc. constantly refines and improves its products, no retroactive obligation is incurred.

Parts and Accessories

When in need of replacement parts, oil, or accessories for your Arctic Cat ATV, be sure to use only GENUINE ARCTIC CAT PARTS, OIL, AND ACCESSORIES. Only genuine Arctic Cat parts, oil, and accessories are engineered to meet the standards and requirements of your Arctic Cat ATV. For a complete list of accessories, refer to the current Arctic Cat ATV Accessory Catalog.

To aid in service and maintenance procedures on this ATV, a Service Manual and an Illustrated Parts Manual are available through your local Arctic Cat ATV dealer.

Arctic Cat and the ATV Safety Institute recommend that all ATV operators ride the appropriate-sized ATV according to age.

Category	Age (Years)	Speed Limitations (MPH)	NOTES
Y-12+	12 or Older	15 - Limited 30 - Maximum	Operate Under Adult Supervision
T-14	14 or Older	20 - Limited 30 - Limited 38 - Maximum	Operate Under Adult Supervision
G & S	16 or Older	According to Local Regulations	—

TREAD LIGHTLY! OFFICIAL SPONSOR®
ON PUBLIC AND PRIVATE LAND

Table of Contents

Foreword.....	1	Safety Flag Bracket.....	47
Parts and Accessories	1	Rack Loading (Front and Rear).....	47
DIVISION I - SAFETY		Trailing and Towing	47
ATV Safety Alert.....	4	Transporting ATV.....	48
Rider Training Course	5	Gasoline-Oil-Lubricant	48
Hangtags	6	Engine Break-In.....	49
Warning Labels & Information.....	7	Burnishing Brake Pads	49
Warnings	8-15	General Maintenance.....	51-65
Prevention	16-19	Maintenance Schedule	51
Safe Riding Clothing and Gear.....	16	Oil Cooler (350).....	52
Condition of the ATV.....	17	Liquid Cooling System (425)	52
T-CLOC.....	17	Shock Absorbers.....	53
First Aid and Survival.....	18	General Lubrication.....	53
Active Riding.....	20	Hydraulic Hand Brake.....	55
Sound Judgment	21-25	Brake Fluid.....	55
Environment.....	21	Brake Lever Lock.....	55
Those Around You.....	22	Brake Hoses.....	55
Equipment.....	23	Brake Pads	55
Load Capacity Ratings Chart.....	24	Rear Foot Brake	56
Speedrack.....	24	Protective Rubber Boots.....	56
Personal Choices.....	24	Battery.....	57
SIPDE.....	25	Spark Plug	60
Supervision	26	Engine Idle RPM Adjustment (350)	60
Taking Responsibility.....	26	Throttle Cable Adjustment.....	61
Inexperienced Riders.....	26	Air Filter.....	61
Experienced Riders	26	Air Filter Housing Drain.....	62
DIVISION II -		Draining V-Belt Cover.....	62
OPERATION/		Tires	62
MAINTENANCE		Wheels.....	63
ATV Specifications	27	Muffler/Spark Arrester.....	63
Location of Parts and Controls	28	Light Bulb Replacement	63
ATV Operation.....	29-39	Checking/Adjusting Headlight Aim.....	64
Basic Operating Maneuvers.....	29	Fuses	65
Starting the Engine	29	Tools.....	65
BONE-C	29	Preparation for Storage.....	66
Starting A Cold Engine (350).....	29	Preparation after Storage.....	67
Starting A Cold Engine (425).....	30	Maintenance Record.....	68
How to Handle the ATV (Active Riding		Limited Warranty.....	69
Techniques).....	31	Warranty Procedure/Owner	
Tips.....	37	Responsibility.....	70
General Information.....	40-50	Change of Address, Ownership, or	
ATV Identification Numbers.....	40	Warranty Transfer.....	71
Ignition Switch Key.....	40	Arctic Cat ATV Emission Control	
Control Locations and Functions.....	40	Warranty Statement	73
LCD Gauge.....	44	Arctic Cat Emission Control System	
Primer - Cold Start (350).....	45	Limited Warranty.....	74
Gas/Vent Hoses.....	45	U.S. EPA Emission Control	
Carburetor Float Bowl Drain (350).....	46	Statement/Warranty Coverage -	
Electric Fuel Pump (425).....	46	ATV (U.S. Only)	75
Oil Level Stick.....	46	Declaration Of Conformity	76
Seat Latch.....	47	Identification Numbers Record.... Inside	
		Back Cover	

DIVISION I - SAFETY

An ATV is not a toy and can be hazardous to operate.

- Always go slowly and be extra careful when operating on unfamiliar terrain. Always be alert to changing terrain conditions when operating the ATV.
- Never operate on excessively rough, slippery, or loose terrain.
- Always follow proper procedures for turning as described in this manual. Practice turning at slow speeds before attempting to turn at faster speeds. Do not turn at excessive speed.
- Always have the ATV checked by an authorized Arctic Cat ATV dealer if it has been involved in an accident.
- Never operate the ATV on hills too steep for the ATV or for your abilities. Practice on smaller hills before attempting larger hills.
- Always follow proper procedures for climbing hills as described in this manual. Check the terrain carefully before you start up any hill. Never climb hills with slippery or loose surfaces. Shift your weight forward. Never open the throttle suddenly or make sudden gear changes. Never go over the top of any hill at high speed.
- Always follow proper procedures for going down hills and for braking on hills as described in this manual. Check the terrain carefully before you start down any hill. Shift your weight backward. Never go down a hill at high speed. Avoid going down a hill at an angle which would cause the ATV to lean sharply to one side. Go straight down the hill where possible.
- Always be sure there are no obstacles or people behind you when you operate in reverse. When it is safe to proceed in reverse, go slowly. Avoid turning at sharp angles in reverse.
- Always follow proper procedures for crossing the side of a hill as described in this manual. Avoid hills with slippery or loose surfaces. Shift your weight to the uphill side of the ATV. Never attempt to turn the ATV around on any hill until you have mastered the turning techniques described in this manual on level ground. Avoid crossing the side of a steep hill if possible.
- Always use proper procedures if you stall or roll backward when climbing a hill. To avoid stalling, maintain a steady speed when climbing a hill. If you stall or roll backwards, follow the special procedure for braking described in this manual. Dismount on the uphill side or to either side if pointed straight uphill. Turn the ATV around and mount following the procedure described in this manual.
- Always check for obstacles before operating in a new area. Never attempt to operate over large obstacles, such as large rocks or fallen trees. Always follow proper procedures when operating over obstacles as described in this manual.
- Always be careful of skidding or sliding. On slippery surfaces, such as ice, go slowly and be very cautious in order to reduce the chance of skidding or sliding out of control.
- Never operate an ATV in fast flowing water or in water deeper than the footrests. Remember that wet brakes may have reduced stopping capability. Test your brakes after leaving water. If necessary, apply them lightly several times to let friction dry out the pads.
- Always use the size and type tires specified in this manual. Always maintain proper tire pressure as described in this manual.
- Never improperly install or improperly use accessories on this ATV.
- Never install a twist grip throttle on this ATV.
- Never exceed the stated load capacity for an ATV. Cargo should be properly distributed and securely attached. Reduce speed and follow instructions in this manual for carrying cargo or pulling a trailer and allow greater distance for braking.
- No one under the age of 16 should operate this ATV. Some operators at the age of 16 may not be able to operate an ATV safely. Parents should supervise the use of the ATV at all times. Parents should permit continued use only if they determine that the operator has the ability to operate the ATV safely.

FOR MORE INFORMATION ABOUT ATV SAFETY, call the ATV Safety Institute at 1-800-887-2887 (U.S.) or 1-613-739-1535 (Canada).

ATV Safety Alert

The Consumer Product Safety Commission has concluded that ALL-TERRAIN VEHICLES (ATV's) may present a risk of SERIOUS INJURY or DEATH in certain circumstances. Accidents may occur for many reasons:

- * Over 2591 people, including many children, have died in accidents associated with ATV's since 2005.
- * Many people have become severely paralyzed or suffered serious internal injuries as a result of accidents associated with ATV's.
- * Every month thousands of people are treated in hospital emergency rooms for injuries received while riding an ATV.

You should be aware that AN ATV IS NOT A TOY AND CAN BE HAZARDOUS TO OPERATE. An ATV handles differently from other vehicles, including motorcycles and cars. A collision or roll-over can occur quickly, even during routine maneuvers such as turning and driving on hills and over obstacles, if you fail to take proper precautions.

TO AVOID SERIOUS INJURY OR DEATH:

- * Always read the Operator's Manual carefully and follow the operating procedures described. Pay special attention to the warnings contained in the manual and on all labels.
- * Never operate an ATV without proper instruction. Take a training course. Beginners should complete a training course.
- * Always follow these age recommendations:
 - A Y-12+ is intended for use by children age 12 or older, and a T-14 is intended for use by an operator age 14 or older.
 - A child under 16 years old should never operate an ATV without adult supervision. Children need to be observed carefully because not all children have the strength, size, skills, or judgment to operate an ATV safely.

- * Never carry a passenger on an ATV. Carrying a passenger may upset the balance of the ATV and may cause it to go out of control.
- * Always avoid paved surfaces. ATV's are not designed to be used on paved surfaces and may seriously affect handling and control.
- * Never operate an ATV on a public road, even a dirt or gravel one, because you may not be able to avoid colliding with other vehicles. Also, operating an ATV on a public road may be against the law.
- * Never operate an ATV without an approved motorcycle helmet, eye protection, boots, gloves, long pants, and a long-sleeved shirt or jacket.
- * Never consume alcohol or drugs before or while operating an ATV.
- * Never operate an ATV at excessive speeds. Go at a speed which is proper for the terrain, visibility conditions, and your experience.
- * Never attempt to do wheelies, jumps, or other stunts.
- * Always be careful when operating an ATV, especially when approaching hills, turns, and obstacles and when operating on unfamiliar or rough terrain.
- * Never lend an ATV to anyone who has not taken a training course or has not been driving an ATV for at least a year.

Rider Training Course

Arctic Cat sponsors a free Rider Training Course to teach ATV riding skills or to reinforce current riding skills. First-time purchasers without any previous ATV riding experience will receive a \$100.00 coupon from Arctic Cat through the SVIA/ASI after completing the training course (U.S. owners only, one incentive, and free rider training courses for appropriate immediate family members per ATV purchase). See an authorized Arctic Cat ATV dealer for details or call (800) 887-2887 for training course information.

In Canada, the Canada Safety Council (CSC) provides an ATV Rider's Course to teach safe ATV operating skills. They also provide a special ATV Rider's Course for children under 14 years of age with parental supervision. Call the CSC at 1-613-739-1535 ext. 227 for more details. Also available is a bilingual computer-based safety training program on a CD-ROM from CATV - call toll-free at 1-877-470-2288.

Au Canada, le conseil canadien de la sécurité (CSC) offre un cours de conduite de VTT pour enseigner les habiletés d'opération sécuritaires de VTT. Un cours spécial de conduite de VTT est également offert aux enfants de moins de 14 ans avec la surveillance d'un parent. Communiquez avec le CSC en composant le: 1-613-739-1535, poste 227 pour de plus amples informations. Un programme de formation bilingue informatisé sur la sécurité est aussi disponible sur disque optique compact par CATV; composez sans frais le: 1-877-470-2288.



FOR MORE INFORMATION ABOUT ATV SAFETY, in the U.S., call the Consumer Product Safety Commission at (800) 638-2772 or the ATV Distributors' Safety Hotline at (800) 852-5344 or in Canada, call the Canada Safety Council at 1-613-739-1535 ext. 227.

Visit the Arctic Cat Inc. website at www.arcticcat.com for additional product information.

Hangtags

An Arctic Cat ATV comes with hangtags containing important safety information. Anyone who rides the ATV should read and understand this information before riding.



(350)



Pour commander des Etiquettes de Mise en Garde gratuites, voyez votre détaillant de autorisé VTT Arctic Cat pour le numéro de pièce 1436-344.

Warning Labels & Information

An Arctic Cat ATV comes with several labels containing important safety information. Anyone who rides the ATV should read and understand this information before riding.

The labels should be considered as permanent parts of the ATV. If a label comes off or becomes hard to read, contact your Arctic Cat ATV dealer for a replacement.

■ **NOTE:** The location and content of labels on the ATV you have purchased may differ from those shown on this page.

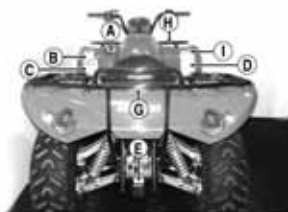

KC352A



KC344A



KC354A

Warnings

WARNING

POTENTIAL HAZARD

Operating this ATV without proper instruction.

WHAT CAN HAPPEN

The risk of an accident is greatly increased if the operator does not know how to operate the ATV properly in different situations and on different types of terrain.

HOW TO AVOID THE HAZARD

Beginning and inexperienced operators should complete the certified training course offered. They should then regularly practice the skills learned in the course and the operating techniques described in this Operator's Manual.

For more information about the training course, contact an authorized Arctic Cat ATV dealer or call 1-800-887-2887 (U.S.) or 1-613-739-1535 (Canada).

WARNING

POTENTIAL HAZARD

Allowing anyone under age 16 to operate this ATV.

WHAT CAN HAPPEN

Use of an ATV by children can lead to serious injury or death of the child.

Children under the age of 16 may not have the skills, abilities, or judgment needed to operate the ATV safely and may be involved in a serious accident.

HOW TO AVOID THE HAZARD

A child under 16 should never operate this ATV.

WARNING

POTENTIAL HAZARD

Carrying a passenger on this ATV.

WHAT CAN HAPPEN

Greatly reduces your ability to balance and control this ATV.

Could cause an accident, resulting in injury or death to you and/or your passenger.

HOW TO AVOID THE HAZARD

Never carry a passenger. The long seat is to allow the operator to shift positions as needed during operation. It is not for carrying passengers.

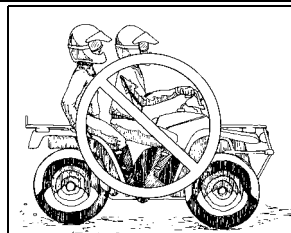

WARNING

POTENTIAL HAZARD

Operating this ATV on paved surfaces.

WHAT CAN HAPPEN

The ATV's tires are designed for off-road use only, not for use on pavement. Paved surfaces may seriously affect handling and control of the ATV and may cause the ATV to go out of control.

HOW TO AVOID THE HAZARD

Never operate the ATV on any paved surfaces, including sidewalks, driveways, parking lots, and streets.



Warnings

WARNING

POTENTIAL HAZARD

Operating this ATV on public streets, roads, or highways.

WHAT CAN HAPPEN

You can collide with another vehicle.

HOW TO AVOID THE HAZARD

Never operate this ATV on any public street, road, or highway, even a dirt or gravel one.

In many states it is illegal to operate an ATV on public streets, roads, or highways.

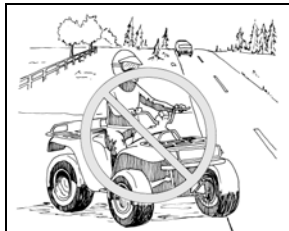

WARNING

POTENTIAL HAZARD

Operating this ATV without wearing an approved helmet, eye protection, and protective clothing.

WHAT CAN HAPPEN

Operating without an approved helmet increases your chances of a serious head injury or death in the event of an accident.

Operating without eye protection can result in an accident and increases your chances of a serious injury in the event of an accident.

Operating without protective clothing increases your chances of serious injury in the event of an accident.

HOW TO AVOID THE HMAZARD

Always wear an approved helmet that fits properly.

You should also wear:

- Eye protection (goggles or face shield)

- Gloves

- Boots

- Long sleeved shirt or jacket

- Long pants

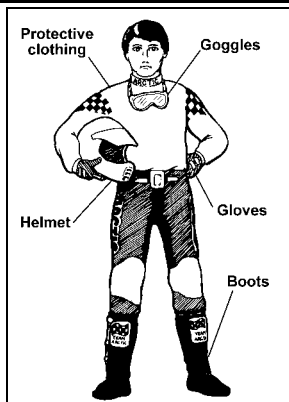

WARNING

POTENTIAL HAZARD

Going down a hill improperly.

WHAT CAN HAPPEN

Could cause loss of control or cause the ATV to overturn.

HOW TO AVOID THE HAZARD

Always follow proper procedures for going down hills as described in this Operator's Manual.

Always check the terrain carefully before you start down any hill.

Shift your weight backward.

Never go down a hill at high speed.

Avoid going down a hill at an angle that would cause the ATV to lean sharply to one side. Go straight down the hill where possible.

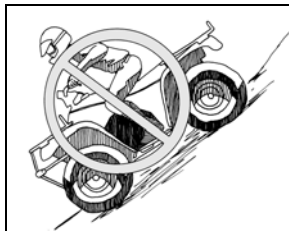

Warnings

WARNING

POTENTIAL HAZARD

Operating this ATV after or while consuming alcohol or drugs.

WHAT CAN HAPPEN

Could seriously affect your judgment.
 Could cause you to react more slowly.
 Could affect your balance and perception.
 Could result in an accident.

HOW TO AVOID THE HAZARD

Never consume alcohol or drugs before or while driving this ATV.

WARNING

POTENTIAL HAZARD

Operating this ATV at excessive speeds.

WHAT CAN HAPPEN

Increases your chances of losing control of the ATV, which can result in an accident.

HOW TO AVOID THE HAZARD

Always ride at a speed that is proper for the terrain, visibility and operating conditions, and your experience.

WARNING

POTENTIAL HAZARD

Attempting wheelies, jumps, and other stunts.

WHAT CAN HAPPEN

Increases the chance of an accident including a roll-over.

HOW TO AVOID THE HAZARD

Never attempt stunts, such as wheelies or jumps.
 Don't try to show off.

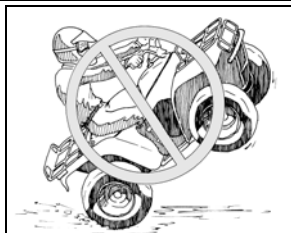

WARNING

POTENTIAL HAZARD

Failure to inspect the ATV before operating.
 Failure to properly maintain the ATV.

WHAT CAN HAPPEN

Increases the possibility of an accident or equipment damage.

HOW TO AVOID THE HAZARD

Always inspect your ATV each time you use it to make sure the ATV is in safe operating condition.
 Always follow the inspection and maintenance procedures and schedules described in this Operator's Manual.

Warnings

WARNING

POTENTIAL HAZARD

Removing hands from handlebars or feet from footrests during operation.

WHAT CAN HAPPEN

Removing even one hand or foot can reduce your ability to control the ATV or could cause you to lose your balance and fall off the ATV. If you remove a foot from a footrest, your foot or leg may come into contact with the wheels, which could injure you or cause an accident.

HOW TO AVOID THE HAZARD

Always keep both hands on the handlebars and both feet on the footrests of your ATV during operation.

WARNING

POTENTIAL HAZARD

Failure to use extra care when operating the ATV on unfamiliar terrain.

WHAT CAN HAPPEN

You can come upon hidden rocks, bumps, or holes without enough time to react.

Could result in the ATV overturning or going out of control.

HOW TO AVOID THE HAZARD

Go slowly and be extra careful when operating on unfamiliar terrain.

Always be alert to changing terrain conditions when operating the ATV.

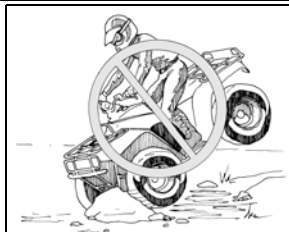

WARNING

POTENTIAL HAZARD

Failure to use extra care when operating on rough, slippery, or loose terrain.

WHAT CAN HAPPEN

Could cause loss of traction or ATV control, which could result in an accident including a rollover.

HOW TO AVOID THE HAZARD

Do not operate on rough, slippery, or loose terrain until you have learned and practiced the skills necessary to control the ATV on such terrain.

Always be especially cautious on these kinds of terrain.



WARNING

POTENTIAL HAZARD

Turning improperly.

WHAT CAN HAPPEN

ATV could go out of control, causing a collision or rollover.

HOW TO AVOID THE HAZARD

Always follow proper procedures for turning as described in this Operator's Manual.

Practice turning at slow speeds before attempting to turn at faster speeds.

Do not turn at excessive speed.

Warnings

WARNING

POTENTIAL HAZARD

Operating on steep hills.

WHAT CAN HAPPEN

The ATV can overturn more easily on steep hills than on level surfaces or small hills.

HOW TO AVOID THE HAZARD

Never operate the ATV on hills too steep for the ATV or for your abilities.

Practice on smaller hills before attempting larger hills.

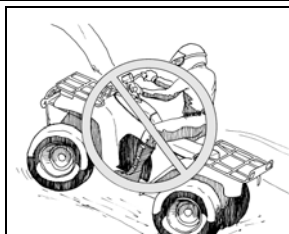

WARNING

POTENTIAL HAZARD

Overloading the ATV or carrying or towing cargo improperly.

WHAT CAN HAPPEN

Could cause changes in ATV handling, which could lead to an accident.

HOW TO AVOID THE HAZARD

Never exceed the stated load capacity for the ATV.

Cargo should be properly distributed and securely attached.

Reduce speed when carrying cargo or pulling a trailer. Allow greater distance for braking. Always follow the instructions in this Operator's Manual for carrying cargo or pulling a trailer.

WARNING

POTENTIAL HAZARD

Improperly crossing hills or turning on hills.

WHAT CAN HAPPEN

Could cause loss of control or cause the ATV to overturn.

HOW TO AVOID THE HAZARD

Never attempt to turn the ATV around on any hill until you have mastered the turning technique as described in this Operator's Manual. Practice first on level ground. Be very careful when turning on any hill.

Avoid crossing the side of a steep hill, if possible.

When crossing the side of a hill:

Always follow proper procedures as described in this Operator's Manual.

Avoid hills with slippery or loose surfaces.

Shift your weight to the uphill side of the ATV.

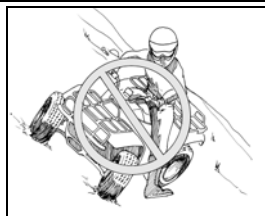

WARNING

POTENTIAL HAZARD

Improperly operating in reverse.

WHAT CAN HAPPEN

You could hit an obstacle or person behind you, resulting in serious injury.

HOW TO AVOID THE HAZARD

Before you engage reverse gear, make sure there are no obstacles or people behind you. When it is safe to proceed, go slowly.

Warnings

WARNING

POTENTIAL HAZARD

Climbing hills improperly.

WHAT CAN HAPPEN

Could cause loss of control or cause the ATV to overturn.

HOW TO AVOID THE HAZARD

Always follow proper procedures for climbing hills as described in this Operator's Manual.

Always check the terrain carefully before you start up any hill.

Never climb hills with slippery or loose surfaces.

Shift your weight forward.

Never open the throttle suddenly or make sudden gear changes. The ATV could flip over backwards.

Never go over the top of any hill at high speed. An obstacle, a sharp drop, or another vehicle or person could be on the other side of the hill.

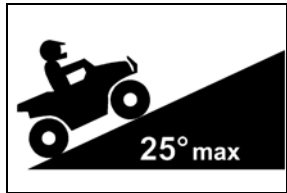

NEVER OPERATE UP OR DOWN HILLS STEEPER THAN 25°

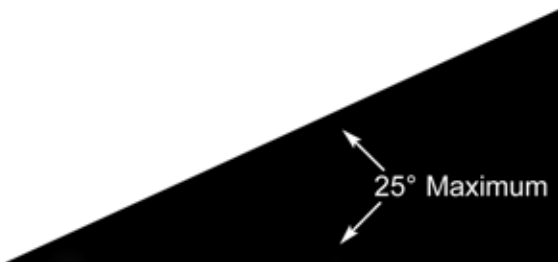

WARNING

POTENTIAL HAZARD

Stalling, rolling backwards, or improperly dismounting while climbing a hill.

WHAT CAN HAPPEN

Could result in the ATV overturning.

HOW TO AVOID THE HAZARD

Use proper gear and maintain steady speed when climbing a hill.

If you lose all forward speed:

Keep weight uphill.

Apply the brakes.

Engage the brake lever lock after you are stopped.

If you begin rolling backwards:

Keep weight uphill.

Apply the brakes while rolling backwards.

When fully stopped, engage the brake lever lock.

Dismount on uphill side or to a side if pointed straight uphill.

Turn the ATV around and mount following the procedure described in this Operator's Manual.

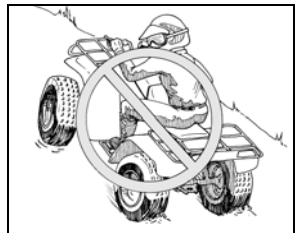

Warnings

WARNING

POTENTIAL HAZARD

Improperly operating over obstacles.

WHAT CAN HAPPEN

Could cause loss of control or a collision. Could cause the ATV to overturn.

HOW TO AVOID THE HAZARD

Before operating in a new area, check for obstacles.

Never attempt to ride over large obstacles, such as large rocks or fallen trees.

When you go over obstacles, always follow proper procedures as described in this Operator's Manual.

WARNING

POTENTIAL HAZARD

Skidding or sliding.

WHAT CAN HAPPEN

You may lose control of the ATV.

You may also regain traction unexpectedly, which may cause the ATV to overturn.

HOW TO AVOID THE HAZARD

Learn to safely control skidding or sliding by practicing at slow speeds and on level, smooth terrain.

On extremely slippery surfaces, such as ice, go slowly and be very cautious in order to reduce the chance of skidding or sliding out of control.

WARNING

POTENTIAL HAZARD

Operating the ATV through deep or fast flowing water.

WHAT CAN HAPPEN

Tires may float, causing loss of traction and loss of control, which could lead to an accident.

HOW TO AVOID THE HAZARD

Never operate the ATV in fast flowing water or in water deeper than the footrests.

Remember that wet brakes may have reduced stopping capability.

Test your brakes after leaving water. If necessary, apply them several times to dry out the pads.

WARNING

POTENTIAL HAZARD

Operating the ATV with improper tires or with improper or uneven tire pressure.

WHAT CAN HAPPEN

Use of improper tires on the ATV, or operation of the ATV with improper or uneven tire pressure, may cause loss of control increasing your risk of accident.

HOW TO AVOID THE HAZARD

Always use the size and type tires specified in this Operator's Manual for this ATV.

Always maintain proper tire pressure as described in this Operator's Manual.

Warnings

WARNING

POTENTIAL HAZARD

Operating the ATV with improper modifications.

WHAT CAN HAPPEN

Improper installation of accessories or modification of the ATV may cause changes in handling which, in some situations, could lead to an accident.

HOW TO AVOID THE HAZARD

Never modify the ATV through improper installation or improper use of accessories. All parts and accessories added to this ATV should be genuine Arctic Cat ATV components designed for use on the ATV and should be installed and used according to instructions. Never install a twist grip throttle. If you have questions, consult an authorized Arctic Cat ATV dealer.

WARNING

POTENTIAL HAZARD

Failure to release the brake lever lock before driving the ATV

WHAT CAN HAPPEN

Driving the ATV with the brake lever lock engaged could cause a change in handling or loss of brakes and cause an accident.

HOW TO AVOID THE HAZARD

Always release the brake lever lock before driving the ATV.

Prevention

Overview

When using an ATV, prevention is the name of the game. "Had you only known" something could go wrong, you would have prevented it. If you don't notice your conditions and surroundings before riding your ATV, you give up control over the situation. Using ATV prevention techniques helps you forecast potential hazards before they injure you or damage your ATV.

Following the safety instructions and warnings in this manual will help you "P.A.S.S." the safety test. P.A.S.S. stands for "Prevention," "Active Riding," "Sound Judgment," and "Supervision." Remembering P.A.S.S. and what it stands for will help you have a safe, predictable ride every time you go out on your ATV.

Safe Riding Clothing and Gear

Always wear clothing suited to the type of riding you are doing. ATV riding requires special protective clothing which will make you feel more comfortable and reduce chances of injury.

You'll find it important to dress correctly for ATV riding in order to prevent scraped skin and serious head injuries. It's easy and could save you time in the long run not having to contend with an injury. Of course, it also makes sense to remember the seasons. Wear a hat under your helmet and a snowmobile suit in the winter and lighter, protective clothing in the summer. Following is the minimum protection you need to wear during every ride.

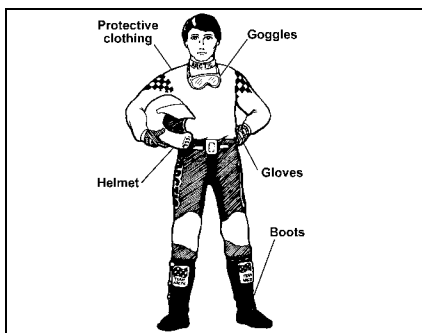

ATV-0004

Gloves

Your hands are targets for flying objects and branches. Along with providing skin protection, gloves will shield your hands from harsh weather. Wear gloves that are weather resistant and have a gripping surface to keep them from sliding off the handlebar. Off-road style gloves with knuckle pads are the best for comfort and protection.

Boots/Ankle Protection

Wear a boot that covers the largest possible area of your leg (preferably up to your knee) and can handle significant impact. Choosing boots with low heels and a good tread will help prevent your feet from slipping off the footrests in wet or rugged conditions or getting hurt if they get hit by rocks, dirt, or branches.

Helmet

Your helmet is the most important piece of protective gear for safe riding. A helmet can prevent a serious head injury. There are several types of helmets on the market, but make sure you wear a helmet that complies with the current standards of the U.S. Department of Transportation (DOT), The Snell Memorial Foundation, or the American National Standards Institute (ANSI). Helmets that comply with one or more of these agency's standards have a sticker on the inside or outside of the helmet.

TESTIMONIAL

DOCUMENT#: N490117A1
CITY/STATE: N. HUNTINGDON, PA
SEX: M
AGE: 6
BODY PART: HEAD
DATE ACCIDENT: 06-14-94
DISPOSITION: DOA
SYNOPSIS: The 6 year old male victim died from blunt force trauma to the head when the 4-wheel ATV on which he was a passenger struck a rock on a hill connecting two roads and flipped over backwards onto the victim, shattering his bicycle helmet. The victim was life-flighted to the hospital and died that night. The driver of the ATV, the victim's 29 year old father, sustained minor injuries, but wasn't treated.

Helmets should have one of these:

1. DOT label
2. Snell label
3. ANSI Z90.1 label

Prevention

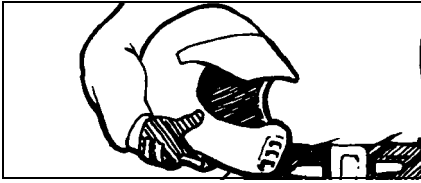

These helmets should provide full-face protection.

If you drop or damage your helmet, get a new one immediately. Your helmet may not protect your head from injury if it has cracks, fissures, or other damage to its outside or core padding.

Remember, your helmet won't do you any good if the chin strap isn't fastened.

Eye Protection

Wear eye protection, such as goggles, to completely surround your eyes to prevent getting dirt or other items in your eyes. Do not depend on sunglasses for proper eye protection. Sunglasses are not recommended; they don't prevent objects from flying in through the sides.

Long Pants and Long Sleeved Shirt

The goal is to protect your body from branches, long grass, airborne objects, or anything else that could scrape your skin. The more thick and durable the material, the better protection it'll provide. Riding pants with kneepads, a jersey, and shoulder pads provide the best protection.

Condition of the ATV

The second step in Prevention is checking the condition of your ATV. Chances are good that you'll be using your ATV in some rough terrain, and there's no way you want your brakes to go out when riding downhill. You need to check the following parts on your ATV before every ride.

1. Tires and Wheels
2. Controls and Cables
3. Lights and Electric
4. Oil and Fuel
5. Chassis
6. Miscellaneous Items

One easy way to remember what parts you need to check is by using the acronym "T-CLOC." It stands for:

T	C	L	O	C
TIRES AND WHEELS	CONTROLS AND CABLES	LIGHTS AND ELECTRIC	OIL AND FUEL	CHASSIS

1. TIRES AND WHEELS

Correct tire pressure is crucial. Consult the Specifications section of this Operator's Manual for tire pressure guidelines. Incorrect tire pressure can cause poor handling, instability, and a loss of ATV control.

Check:

1. Tire pressure
2. Tire surface (tread and sidewalls)

While checking the tire pressure, inspect the tread and sidewalls of the tires for cracks, cuts, or other damage that could indicate they need to be replaced.

2. CONTROLS AND CABLES

With the engine running and brake applied, check all transmission positions: forward, neutral, and reverse.

Check:

1. Forward
2. Neutral
3. Reverse

Prevention

A. Brakes

Squeeze the hand brake lever. If it feels soft or “squishy,” it could be low on fluid or have a leak — refer to the General Maintenance section of this Operator’s Manual for instructions. Don’t use the ATV until the brakes are operating normally.

Test the brake lever lock and see if it locks the hand brake lever into position; then disengage it to release the brake. Be sure the rear foot brake near the footrest is working; your brakes could fail during a ride if they’re not maintained.

Check:

1. Hand brake lever
2. Rear foot brake
3. Brake lever lock

B. Throttle

The throttle should have a free, smooth range of motion. If it seems to “stick” at any point, refer to the General Maintenance section of this Operator’s Manual for instructions. Driving your ATV with a sticking throttle can turn your leisurely ride into an unwelcome accident. Don’t drive your ATV if the throttle sticks.

Check:

1. Free, smooth range of motion

3. LIGHTS AND ELECTRIC

Turn the hi-beam and lo-beam on and off to make sure they work. At the same time, check that the taillight and brake-light work. Also, check the status/warning indicators (reverse, neutral, and hi-lo beam) on the handlebars when you start the ATV. Don’t drive the ATV unless all systems are working. Check the ignition switch and engine stop switch.

Check:

1. Hi-beam
2. Lo-beam
3. Taillight/brakelight
4. Status/warning indicators
5. Ignition switch
6. Engine stop switch

4. OIL AND FUEL

Start with a full tank of gas before every ride, and while you’re at it, top off the oil. Don’t forget to check for fluid leaks around the ATV. Watch the overheat indicator to ensure the engine coolant level is adequate.

Check:

1. Gas
2. Oil
3. Fluid leaks

5. CHASSIS

Grass and leaves can gum-up your suspension and shocks. Clear and clean the suspension arms, shock springs, and fenders. Check smoothness by turning the handlebar full-left and full-right. Check that there is no binding, restrictions, free-play, or looseness in steering components.

Check:

1. Suspension arms
2. Shock springs
3. Fenders
4. Steering

6. MISCELLANEOUS ITEMS

Inspect your air filter. Look for debris or damage that may indicate you need to replace it. A clogged filter can stop an engine. Check your battery terminals for corrosion. Also, be sure to tighten any loose parts, nuts, or bolts.

Check:

1. Air filter
2. Battery
3. Tighten parts, nuts, and bolts

First Aid and Survival

You need to prepare for the unexpected. Emergencies and accidents are traumatic enough, but they’re even worse when you’re not prepared for them. At the minimum during every ATV ride, you should have the following items on board:

Prevention

- Tools
- Water
- Identification
- First Aid Kit

For rides that are longer in duration and distance, the following additional items are recommended:

- Cellular Phone
- Maps/GPS
- Emergency Kit *with Flashlight and First Aid Kit*

Tools

Routine maintenance will generally eliminate the need for emergency repairs. Riding on rough terrain could cause loosening of nuts, bolts, and fasteners. Especially on long rides, carrying the right tools can prevent an inconvenience from becoming a crisis.

Carry these items on your ATV:

1. Bulbs
2. Duct tape
3. Rope
4. Spark plugs
5. Spare parts
6. Tool Kit

Water

Water is so important that you need to carry it regardless of the duration of your ride. Heat exhaustion and heat stroke can creep up suddenly and can take you out of commission. If you become dehydrated, you could find yourself physically unable to safely operate your ATV.

Identification

If something does happen to you, the emergency personnel will want to know who you are and whom to contact. It's possible you may be in no condition to give them that information. Put your I.D. in your pocket before you ride. Without it, you're anonymous.

Cellular Phone

It may be necessary to make an urgent phone call.

Maps/GPS (Global Positioning System)

Maps may be unnecessary when you're familiar with the area. But when you're riding on unfamiliar trails, it's good to know where you are, what's coming up, and how to get back.

Emergency Kit with Flashlight and First Aid Kit

You'll need several items in your Emergency Kit including a flashlight. The matches will come in handy if you need to start a fire to stay warm. Flares are appropriate for signaling help. A first aid kit is very important if an injury of some type should happen. A good First Aid Kit should include bandages, antiseptic spray, gauze, tape, etc.

Carry these items:

1. Flashlight
2. Matches
3. Flares
4. First Aid Kit
5. Money

Active Riding

Overview

“Active Riding” is the second part of “P.A.S.S.” It involves an understanding of how your body weight, balance, gravity, and physical forces affect the handling of the ATV. For example, when you drive a car quickly into a sharp turn, your body is pulled to the outside of the vehicle by centrifugal force. Although a car is relatively stable, enough centrifugal force can cause an ATV to overturn. Constantly shifting your weight is one major difference between driving a car and riding an ATV. Knowing how to shift your weight is necessary to avoid rolling or flipping the ATV.

For complete operating instructions, see ATV OPERATION section in this manual.

Sound Judgment

Overview

You are not invincible. Knowing that the first “S” in “P.A.S.S.” stands for “Sound Judgment” means you need to use yours.

Do you consider yourself to be pretty conservative, or are you a heavy risk-taker? Before continuing with this section on sound judgment, check your **Risk Factor** by doing this short survey:

1. Do you drive over the speed limit?

1	2	3
Never	Sometimes	Often

2. Are you more daring around your friends than you are when alone?

1	2	3
Never	Sometimes	Often

3. Do you drive your car when the gas gauge is on empty?

1	2	3
Never	Sometimes	Often

4. Do you feel that no matter what you do, you won't get hurt?

1	2	3
Never	Sometimes	Often

5. Do you drink or use drugs before you drive your car?

1	2	3
Never	Sometimes	Often

6. Do you drive your car even if it has a major problem with the brakes, tires, or engine?

1	2	3
Never	Sometimes	Often

7. Do you thrive on the adrenaline rush you get from speeding and dangerous situations?

1	2	3
Never	Sometimes	Often

8. Do you hurt yourself because you do things that are out of your ability range?

1	2	3
Never	Sometimes	Often

9. Do you tailgate other drivers when you think they're driving too slow?

1	2	3
Never	Sometimes	Often

10. Do you ignore weather reports before you do outside activities like swimming, camping, fishing, or boating?

1	2	3
Never	Sometimes	Often

Add the totals from lines 1-10. **YOUR RISK FACTOR IS:**

10-15: You're pretty conservative. Chances are good that the consistently safe choices you make will help you avoid hurting yourself and the people around you.

16-20: You're straddling the fence. Depending on your mood or whom you're with, the choices you make may help you or hurt you.

21-30: You're taking your chances. Time to reconsider a lot of the judgments you make. You're destined to put yourself in dangerous situations and potentially hurt yourself and the people around you.

Environment

The environment you operate an ATV in is often harsh and sometimes dangerous if you don't take proper precautions.

Weather

You need to consider the weather. It is dangerous to ride your ATV when the weather is bad or potentially bad. Keep abreast with weather forecasts.

Terrain

Always pay close attention to the terrain you're on, even if it is familiar to you. You can't assume that the landscape you're used to doesn't change. Changes to landscape can happen at nearly any time. Fences can be constructed and excavations dug in a short period of time. Weather, climate, and development take their toll.

Sound Judgment

The thing about terrain is that sometimes you don't know it's changed until you get there. Whether it's familiar or not, check out your surroundings before and during your ride.

Night Riding

Riding at night can be very hazardous. Obstacles and other hazards (that are easily identified during daytime) are much more difficult to see and avoid. When night riding, make sure the lights are properly adjusted and in good working order. Reduce speed; do not over-drive the headlights. Never travel in an unfamiliar area or blaze a new trail at night. Always carry a flashlight or flare for signaling an emergency.

Paved Surfaces

Don't do it! The ATV isn't designed for pavement. Its handling becomes more difficult on paved surfaces.

Trail Riding

Use sound judgment when trail riding; that means riding on a trail that fits your ability level. If the trail is pretty rugged, standing up on your footrests will make it easier for you to endure the rough terrain.

Make yourself visible by using headlights and taillights, and pull completely off the trail if you need to stop.

Outsloped trails (trails that slant to allow rain to run off) make trail riding a bit more challenging. Accepting that challenge means keeping your weight shifted into the slope. Denying the challenge means sliding off the trail.

It also helps to know which trails you can ride and who else might be on those same trails. These are signs currently used in some areas to designate trail types and restrictions.



ATV-0068

Those Around You

People do all kinds of things that you can't predict or control.

Riding Companions

Leave a lot of space between you and other riders, especially in dusty and dirty conditions, because it'll be difficult to see the riders in front of you stopping.

Riding with companions on several ATV's is not the same as riding one ATV with a passenger. Passengers are prohibited; it's unsafe. The extra weight on the seat makes the ATV difficult to control. About 50% of all ATV accidents involve passengers.

Sound Judgment

Other Vehicles

Depending on where you're riding, you might encounter other ATV's, bikes, or motor vehicles on public lands. Respect the presence of cars if you're crossing roads or riding in public areas and make yourself be seen. If you can't see other vehicles coming, that means you're invisible, too.

Hikers

With the renewed interest in hiking, camping, and other outdoor activities, people can show up in remote areas where you would never expect them. For their sake, keep your eyes open.

Animals and Nature

Respect the outdoors that you love. Don't use your ATV to chase animals or birds. Drive around young trees rather than over them. Keep clear of streams and ditches with standing water.

TESTIMONIAL

DOCUMENT#: N380310A1
 CITY/STATE: NEW CUMBERLAND, WV
 SEX: M
 AGE: 18
 BODY PART: HEAD
 DATE ACCIDENT: 7-30-93
 DISPOSITION: DOA
 SYNOPSIS: An 18 year old male died as the result of injuries which he sustained in an accident while driving a 4-wheel ATV on a gravel public road. The victim lost control of the ATV when he suddenly applied the brakes to avoid a dog crossing the road. During the accident, the ATV's brake lever penetrated the victim's brain through his right eye resulting in death. The victim was not wearing a helmet.

Tread Lightly and leave it as you found it.

Equipment

The last thing you expected was that your ATV would break down in the middle of the field... it's usually so reliable that sometimes you forget the ATV has its limits.

ATV Maintenance

You have to maintain your ATV. The General Maintenance section of this Operator's Manual tells you about taking care of your ATV. If, at any time, abnormal noises, vibrations, or improper functioning of any component of this ATV is detected, **DO NOT OPERATE THE ATV.** Take the ATV to an authorized Arctic Cat ATV dealer for inspection and adjustment or repair.

Cargo Limitations

One reason why passengers are prohibited on ATV's is because their presence throws off the weight and balance of the ATV. Cargo can do the same if it weighs too much. Limit the ATV to the load capacity ratings identified in the following chart for the particular model being operated. So if you're weighing in at over 200 lb (91 kg) when you ride, leave some of that extra cargo at home. The combined weight limit, including you, your rack cargo, and your trailer, is a specified amount, so consult the ATV Load Capacity Ratings Chart and monitor it carefully.

Extra weight on the ATV will also throw you off balance if it's not distributed evenly, side-to-side and front-to-rear. If you have 150 lb (68 kg) on the rear rack only and you're heading up an incline, shifting your own weight forward isn't going to do enough to compensate for that cargo sitting over the back tires.

Cargo has such a huge affect on ATV handling that you need to pay a lot of attention to your speed. Even on really level areas, you should keep it under 10 mph (16 kph) if you've got a trailer attached. Avoid uneven terrain. Also, consider that your braking distance is going to increase with the more weight you carry.

Think about these when dealing with cargo:

1. Rack weight limit
2. Trailer weight limit
3. Weight distribution
4. ATV speed

Sound Judgment

Load Capacity Ratings Chart

Arctic Cat ATV Load Capacity Ratings			
Item	Specifications		
		(lb)	(kg)
Vehicle Load Capacity		450	204
Front Rack	(max)	75	34
Rear Rack	(max)	150	68
Tongue Weight		35	16
Rear Rack and Tongue Weight	(max)	150	68
Towing Capacity		1050	477

Vehicle Load Capacity - Total weight of operator, accessories, tongue weight, and cargo on front and rear racks.

Tongue Weight - Weight on trailer tongue.

Rear Rack and Tongue Weight - Total weight on trailer tongue and rear rack.

Towing Capacity - Total weight of trailer and all cargo in the trailer.

■ **NOTE: Tongue and accessory weight (winch, gun scabbard, brackets, etc.) must be included as part of the front and rear rack weights.**

Speedrack

When installing Speedrack accessories, make sure to read and carefully follow the instructions provided in each kit.

■ **NOTE: Use extra caution when operating an ATV with additional loads such as accessories and/or cargo. Handling of the ATV may be adversely affected. Reduce speed when adding additional loads.**

WARNING

POTENTIAL HAZARD

Overloading the ATV or carrying or towing cargo improperly.

WHAT CAN HAPPEN

Could cause changes in ATV handling, which could lead to an accident.

HOW TO AVOID THE HAZARD

Never exceed the stated load capacity for the ATV.

Cargo should be properly distributed and securely attached.

Reduce speed when carrying cargo or pulling a trailer. Allow greater distance for braking.

Always follow the instructions in this Operator's Manual for carrying cargo or pulling a trailer.

Personal Choices

A safe, enjoyable ride is dependent on many personal choices. An ATV, like all motorized vehicles, can be dangerous to operate if you choose to ignore safety precautions, take unnecessary chances, or ride beyond your ability or your machine's capability. Don't allow the thrill of freedom or adventure to affect your ability to make good, safe choices.

Alcohol and Drug Consumption

Alcohol is related to a high percentage of all hospital admissions due to ATV accidents in the U.S. This isn't an issue of morality. It's extremely dangerous to drink alcoholic beverages and ride... it's also very foolish. When the alcohol starts kicking in and you're tearing along on your ATV, those odds can catch up to you.

Substances to avoid when riding:

1. Alcohol
2. Over-the-counter or prescription drugs

Sound Judgment

Be aware of prescription and over-the-counter medications. Drowsiness and impaired judgment can be caused by a wide variety of medications. The same is true of allergy, cold, flu, and headache medications. Your physical size and weight can't protect you... just one anti-histamine tablet can affect your judgment.

If your sense of adventure persuades you to do illegal drugs when you're riding your ATV, this is a reality check. Something to think about—there can be legal consequences that will take away all that freedom you love. Don't use alcohol or drugs before or during your ATV ride.

THE EFFECTS OF ALCOHOL*

The Number of Drinks that Impair Mental and Physical Abilities

1-2 DRINKS

Mental processes such as restraint, awareness, concentration, and judgment affected; reaction time slowed; inability to perform complicated tasks.

3-4 DRINKS

Depth perception, glare recovery, eye movement, and focus affected; decreased judgment and control.

5+ DRINKS

Coordination deteriorates, loss of critical judgment, and impaired memory and comprehension.

*According to the ATV Safety Institute.

Your Physical Condition

Being physically exhausted is like being drunk. Try to do something that's detail-oriented when you're really tired, and you'll feel totally uncoordinated.

Don't ride:

1. When you're tired

Reckless Riding

If you are involved in an ATV accident when you're speeding, you have a 25% chance of landing yourself in the hospital. The faster you go, the more likely you are to destroy your head and internal organs, and skip the wheelies, jumps, stunts, and any other showboating.

Laws and Regulations

Any police officer will tell you that ignorance of the law is no defense. Your best defense is to check out your local, state, or provincial ATV laws before riding. It'll also make sure that you can continue to ride in your favorite areas. The quickest way to have a land area closed is by riding over the regulations.

Group Behavior

People always do crazier and riskier things in a group than they would consider doing by themselves. When you're ATV riding with others and things start to get out of hand, decide whether you're willing to be injured or see your friends injured.

SIPDE

By themselves, none of these safe behaviors and sound judgments will go very far. But when you put them all together... when you're paying attention to how you feel, when you're monitoring the movements of your ATV, and when you're constantly evaluating your environment, then you're practicing SIPDE. SIPDE is an acronym that stands for:

S	I	P	D	E
SCAN/ SEARCH	IDENTIFY HAZARDS	PREDICT WHAT WILL HAPPEN	DECIDE WHAT TO DO	EXECUTE THE DECISION

Supervision

Overview

You're responsible for supervising those who ride your ATV. Your wisdom is valuable... it'll bring them all back safely—your friends, your family, your relatives, and your ATV. It's crucial that you consider yourself a supervisor for all riders of your ATV. Whether you accept responsibility or not, the truth is that you are responsible for others riding your ATV.

Taking Responsibility

You're to the last letter in "PASS"... "Supervision." You've just gone through the manual, and you've seen what's involved. That puts you in a good position to be confident about what you know. So now it's time to use your knowledge and supervise others who ride your ATV.

Inexperienced/Untrained Riders

You can't let people ride your ATV who don't know what they're doing. Unless they've had over a year of experience with ATV riding or taken an ATV training course, it's your responsibility to keep them off your ATV. It can be dangerous (especially for underaged children) — all the more reason for you to be firm.

Experienced/Trained Riders

If anyone is going to borrow your ATV, you are responsible for their supervision. Before they ride, have them take the training course, have them watch the safety video, and have them read the Operator's Manual. You train them. It doesn't matter how you do it, as long as you do it.

ATV's are all a little different from the handling to the stability to the controls. So regardless of how much experience your family members have with ATV's, they don't have experience with *your* ATV. Let experienced riders get familiar with your ATV—show them the basics before they take off. You don't want it on your conscience that someone got hurt because you didn't tell them how to use your ATV.

Remember that regardless of experience, you should never let anyone under the age of 16 operate your ATV.

Arctic Cat and the ATV Safety Institute recommend that all ATV operators ride the appropriate-sized ATV according to age.

TESTIMONIAL	
DOCUMENT#:	N37023A1
CITY/STATE:	MOOERSFORKS, NY
SEX:	F
AGE:	5
BODY PART:	UPPER TRUNK
DATE ACCIDENT:	6-29-93
DISPOSITION:	DOA
SYNOPSIS:	The victim of this incident, a five year old female, was operating a four wheeled all terrain vehicle (ATV) in the front yard of her parents' house, under the supervision of her father. The victim drove the ATV down an area where the only way to turn around was around a grain silo. The victim was executing a right hand turn when the vehicle tipped over to the right and fell onto her body. The victim was transported to a local hospital where she was pronounced dead on arrival. Photographs of the incident were not taken by law enforcement officials.

Category	Age (Years)	Speed Limitations (MPH)	NOTES
Y-12+	12 or Older	15 - Limited 30 - Maximum	Operate Under Adult Supervision
T-14	14 or Older	20 - Limited 30 - Limited 38 - Maximum	Operate Under Adult Supervision
G & S	16 or Older	According to Local Regulations	—

DIVISION II - OPERATION/ MAINTENANCE

ATV Specifications

ENGINE	350	425
Type	Four-Cycle/Oil Cooled	Four-Cycle/Liquid Cooled
Bore x Stroke	81 mm x 71.2 mm (3.19 x 2.80 in.)	89 mm x 71.12 mm (3.5 x 2.8 in.)
Displacement	366 cc (22.33 cu in.)	442 cc (27 cu in.)
Spark Plug Type	NGK CPR8E	NGK CR7E
Spark Plug Gap	0.5-0.6 mm (0.019-0.024 in.)	0.7-0.8 mm (0.028-0.031 in.)
Brake Type	Hydraulic w/Brake Lever Lock and Rear Foot Brake	
CHASSIS		
Length (Overall)	211.6 cm (83.3 in.)	
Height (Overall)	116.8 cm (46.0 in.)	117.6 cm (46.3 in.)
Width (Overall)	111.7 cm (44.0 in.)	
Suspension Travel (Front/Rear)	17.7 cm (7.0 in.)	
Tire Size (Front)	24 x 8-12	25 x 8-12
Tire Size (Rear)	24 x 10-12	25 x 10-12
Tire Inflation Pressure	27.6 kPa (4.0 psi)	
MISCELLANY		
Dry Weight (Approx)	265.4 kg (585 lb)	276.7 kg (610 lb)
Gas Tank Capacity (Rated)	15.1 L (4.0 U.S. gal.)	
Differential Capacity	275 ml (9.3 fl oz)	
Coolant Capacity	N/A	2.9 L (3.0 U.S. qt)
Rear Drive Capacity	250 ml (8.5 fl oz)	
Engine Oil Capacity (Approx)	2.8 L (3.0 U.S. qt)	
Gasoline (Recommended)	87 Octane Regular Unleaded	
Engine Oil (Recommended)	Arctic Cat ACX All Weather (Synthetic)	
Differential/Rear Drive Lubricant	SAE Approved 80W-90 Hypoid	
Taillight/Brakelight	12V/5W/21W	
Headlight	12V/35W (4)	
Starting System	Electric	

Specifications subject to change without notice.

Location of Parts and Controls



KC344B



KC354B



KC353A

1. Battery
2. Headlights
3. Hand Brake Lever
4. Power Distribution Module
5. Electrical Access Panel
6. Seat Latch
7. Storage Compartment
8. Reverse Override Switch
9. Rear Foot Brake
10. Brake Lever Lock
11. Key Switch
12. Shift Lever
13. Throttle Limiter
14. Throttle Lever
15. DC Power Outlet
16. Taillight/Brakelight
17. Operator's Manual Location
18. Headlight HI/LO Switch
19. Starter Button
20. Engine Stop Switch
21. Drive Select Switch (425)
22. Gas Tank Valve (350)

■ **NOTE:** The ATV you have purchased may differ slightly from those shown in the figures of this manual.

ATV Operation

Basic Operating Maneuvers

Active riding and basic maneuvers are the foundation of your ATV ride. Without basic skills, it's impossible to move to this level— active riding. These are your basic maneuvers:

- Mounting the ATV
- Starting the Engine
- Starting a Cold Engine
- Braking/Stopping
- Shifting
- Parking
- Dismounting the ATV

Mounting the ATV

1. From the left side, grab the left-side handlebar, apply the brake, and put your left foot on the footrest.
2. Grab the right-side handlebar.
3. Swing your leg over the seat and set your right foot down on the right-side footrest.
4. Get seated in a comfortable position.
5. Always keep your feet planted on the footrests.

Another way to remember the starting procedure is by using the acronym “BONE-C.” It stands for:

B	O	N	E	C
BRAKES LOCKED	IGNITION SWITCH ON	NEUTRAL TRANSMISSION	ENGINE SWITCH	AUTOMATIC CHOKE

Starting A Cold Engine (350)

■ **NOTE:** It is very important not to touch or compress the throttle lever during the starting procedures.

1. Turn off all electrical accessories (hand warmer, lights, etc.); then rotate the ignition switch key to the first position (ON) leaving the headlights OFF. Note that the N is indicated on the LCD.

■ **NOTE:** Pump the primer three times when the temperature is at 0° C (32° F) or colder. To access the primer, the seat and right-side heat shield must be removed.

Starting the Engine

Always start with the ATV on a flat, level surface. Carbon monoxide poisoning can kill you, so keep your ATV outside while it's running. Follow these steps to start it up:

1. Mount the ATV and sit down.
2. Engage the brake lever lock.
3. Turn on the ignition.
4. Shift into neutral.
5. Move the engine stop switch to RUN.
6. Press the starter button.

CAUTION

Do not run the starter motor for more than eight seconds per starting attempt. The starter motor may overheat causing severe starter motor damage. Allow 15 seconds between starting attempts to allow the starter motor to cool.

7. Let the engine warm up.

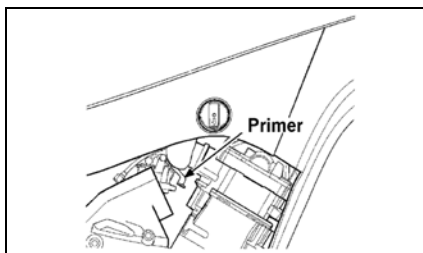

735-887C

ATV Operation

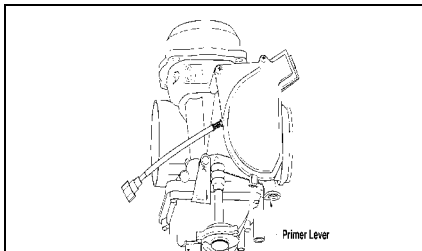

738-436A

2. Press the starter button.

CAUTION

Do not run the starter motor for more than eight seconds per starting attempt. The starter motor may overheat causing severe starter motor damage. Allow 15 seconds between starting attempts to allow the starter motor to cool.

3. If the engine does not start, press the starter button again for eight seconds.

NOTE: At this point if the engine does not start, pump the primer three more times; then press the starter button again.

4. Allow the engine to warm up for approximately 2-3 minutes or until the ATV will accelerate without hesitating.

Starting A Cold Engine (425)

NOTE: It is very important not to touch or compress the throttle lever during the starting procedures.

1. Turn off all electrical accessories (hand warmer, lights, etc.); then rotate the ignition switch key to the first position (ON) leaving the headlights OFF. Note that the N is indicated on the LCD.
2. Press on the starter button.

CAUTION

Do not run the starter motor for more than eight seconds per starting attempt. The starter motor may overheat causing severe starter motor damage. Allow 15 seconds between starting attempts to allow the starter motor to cool.

NOTE: Do not touch the throttle lever until the engine has run for at least 3 minutes.

3. Allow the engine to warm up for approximately 2-3 minutes or until the ATV will accelerate without hesitating.

Braking/Stopping

Always allow plenty of room and time to stop safely. Sometimes quick stops are inevitable, so always be prepared. Whether you're stopping slowly or stopping quickly, do this:

1. Squeeze the brake lever on the left handlebar to apply both the front and rear brakes.
2. If your wheels lock, release them for a second; then apply them again.
3. Never "ride" the brake. Even maintaining minimal pressure on the brake lever will cause the brake pads to drag on the disc and may overheat the brake fluid.

⚠ WARNING

Excessive repetitive use of the hydraulic brake for high speed stops will cause overheating of the brake fluid and premature brake pad wear which will result in an unexpected loss of brakes.

⚠ WARNING

Use only Arctic Cat approved brake fluid. Never substitute or mix different types or grades of brake fluid. Brake loss can result. Check brake fluid level and pad wear before each use. Brake loss can result in serious injury or death.

ATV Operation

Shifting

The Arctic Cat ATV with an automatic transmission has a dual-range transmission with reverse. To shift the ATV, follow these steps:

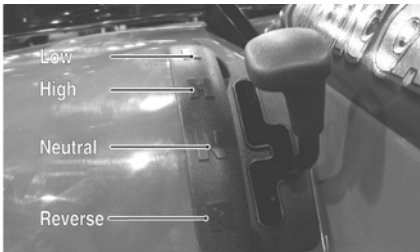

CF130B

1. To engage the high range from neutral, move the shift lever forward.
2. To engage the low range from high range, move the shift lever outward and forward.

■ **NOTE:** The high range is for normal riding with light loads. The low range is for carrying heavy loads or trailer towing. Compared to HIGH range, the LOW range position provides slower speed and greater torque to the wheels.

CAUTION

Always shift into low range when operating on wet or uneven terrain, when towing or pushing heavy loads, and when using a plow. Failure to follow this caution may result in premature V-belt failure or in damage to related drive system components.

3. To engage reverse gear from neutral, move the shift lever outward and rearward into the R position.

CAUTION

Always come to a complete stop before attempting to shift from one range to the other or into reverse. Always shift on level ground, or engage the brake lever lock before shifting into another range or into reverse.

WARNING

Do not start the engine or operate this ATV with the clutch shield removed. Serious injury could result.

Parking

Parking involves following the previous rules for braking; then:

1. After the ATV stops, shift into neutral.
2. Stop the engine using the engine stop switch.
3. Turn off the ignition.
4. If you have to park on a hill, shift the ATV into low gear; otherwise, try to park only on level surfaces.
5. Engage the brake lever lock.

Dismounting the ATV

After you've followed the procedure for parking, it's time to dismount:

1. Double check that the brake lever lock is engaged.
2. Swing your right leg over to the left side of the seat.
3. Step to the ground on the left side of the ATV.

How to Handle the ATV (Active Riding Techniques)

Active riding involves moving your body. You must learn to lean and shift your weight into your turns to maintain control.

Your safety depends on using safe riding techniques. Statistics from the U.S. Consumer Product Safety Commission (CPSC) say that inexperienced riders who don't use safe riding techniques are **13 times more likely to have an ATV accident** than riders who have over 1 month of experience.

ATV Operation

Safe riding techniques include:

- Riding
- Leaning, Weight Shift, and Balance
- Wide Turns
- Sharp Turns
- Quick Turns
- K-Turns
- Riding Uphill
- Riding Downhill
- Sidehilling/Traversing
- Swerving
- Crossing Obstacles

Riding

Once the engine's warm, the ATV is ready to go.

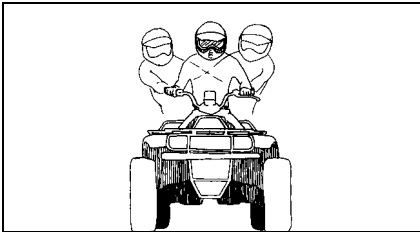

ATV-0012

1. Keep your feet on the footrests and both hands on the handlebar.
2. Hold the brake lever, and release the brake lever lock.
3. Shift into gear.
4. Release the brake slowly and apply the throttle.

Leaning, Weight Shift, and Balance

When you turn, the trick is to move forward and slide over to the side of the seat that's on the inside of the turn. Support your body weight on the outside footrest. At the same time, lean your body to the inside of the turn. Pay attention to the handling—if you feel the tires coming off the ground, reduce speed, shift more of your body weight to the side that's lifting, and make the turn wider if possible.

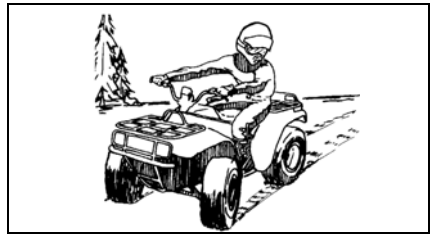

ATV-0013



ATV-0024



ATV-0025

Wide Turns

About 20% of ATV accidents happen during turns. If you don't understand turning techniques, it's easy for the ATV to get away from you by losing traction, plowing, or tipping. Use this method for wide turns:



ATV-0046

ATV Operation

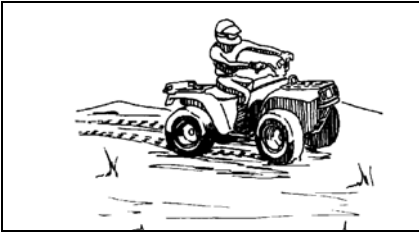

ATV-0045

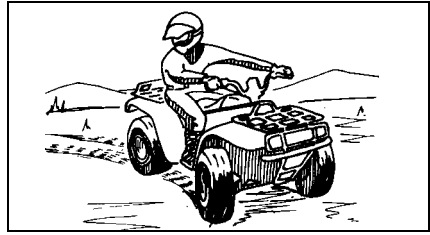

ATV-0039

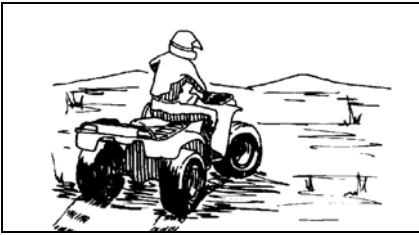

ATV-0044

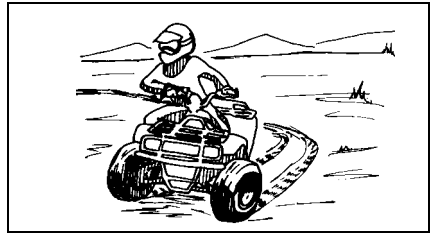

ATV-0040

1. Ease off the throttle as you approach the turn to slow down.
2. Use the principles of leaning, weight shifting, and balancing—shift your body weight to the inside of the turn.
3. Gradually increase your speed as you come out of the turn.

Sharp Turns

After mastering wide turns, practice the advanced skill of sharp turns.

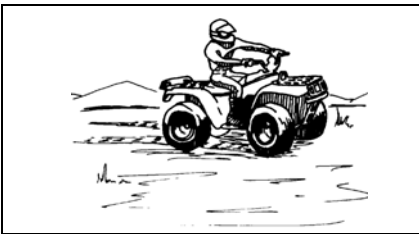

ATV-0038

1. Ease off the throttle as you approach the turn to slow down.
2. Use the principles of leaning, weight shifting, and balancing—shift your body weight to the inside of the turn.
3. You might have to lean into the turn more than you do in a wide turn.
4. If shifting your weight and balance aren't enough to keep the ATV tires on the ground, straighten out the handlebar as much as you can.
5. Gradually increase your speed as you come out of the turn.

Quick Turns

Quick turns are the most difficult turns and should only be done after you are experienced with your ATV.

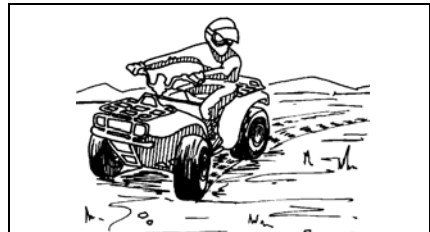

ATV-0021

ATV Operation

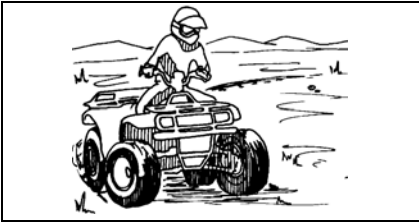

ATV-0022

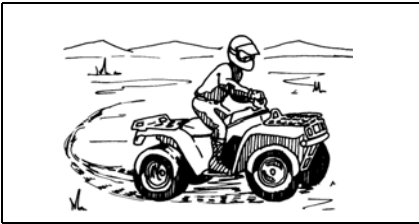

ATV-0023

1. Ease off the throttle as you approach the turn to slow down.
2. Turn the handlebar, shift your weight, and balance at the same time as you enter the turn (use the principles of leaning, weight shifting, and balancing—shift your body weight to the inside of the turn).
3. Follow this with slight acceleration.
4. For multiple turns, repeat this movement as needed.
5. To make your turn quicker, try raising yourself off the seat a few inches as you shift your weight.

K-Turns

Use K-turns if you accidentally stall while riding uphill; you need to take action before the ATV rolls backward down the hill.

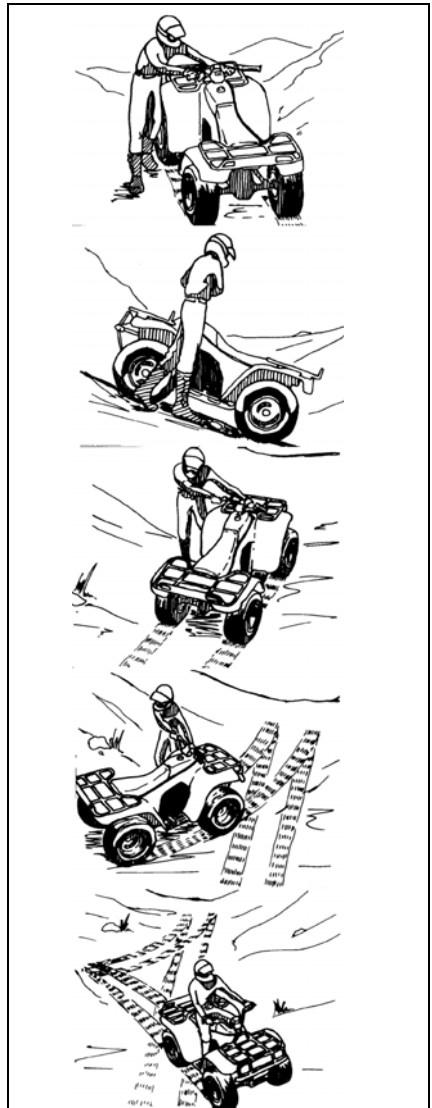

ATV-204

1. Stop where you are, apply the brakes, and shift to neutral.
2. Shut off the engine.
3. Keep your body weight shifted forward.
4. Get off the ATV on the uphill side.

ATV Operation

- If you're to the left of the ATV, turn the handlebar all the way left.
- Partially release the brake, but lightly hold the brake lever.
- Let the ATV roll to your right side until it faces slightly downhill.
- Reapply the brakes.
- Get back on the ATV from the uphill side, and keep your weight shifted uphill when you sit down.
- Start the engine and follow the method for riding downhill.
- Lean as far forward as possible. For steeper hills, come off your seat to stand and lean forward.
- If you lose speed, quickly shift to low range. At the same time, release the throttle (so your front tires don't lift), **OR**
- If that doesn't work and you still have forward motion and the terrain permits, do a U-turn, go back down, and try climbing again, **OR**
- If you have lost all forward motion, follow the K-turn procedure.

Riding Uphill

Roughly 20% of accidents happen while riding on hills and as a result of the ATV rolling or flipping. So, obviously, use extreme caution and follow this method for riding uphill.

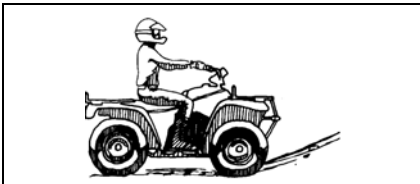

ATV-0019

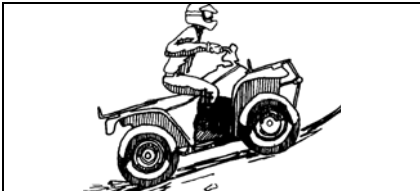

ATV-0032

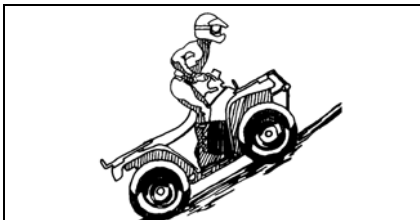

ATV-0033

- Shift down and accelerate before you start climbing; then maintain a steady pace.

Never Operate Up Or Down Hills Steeper Than 25°

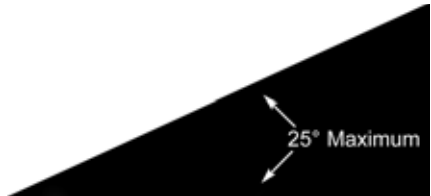

Riding Downhill

Success in riding downhill depends on how well you know your brakes—take it easy on them, or you could flip over.

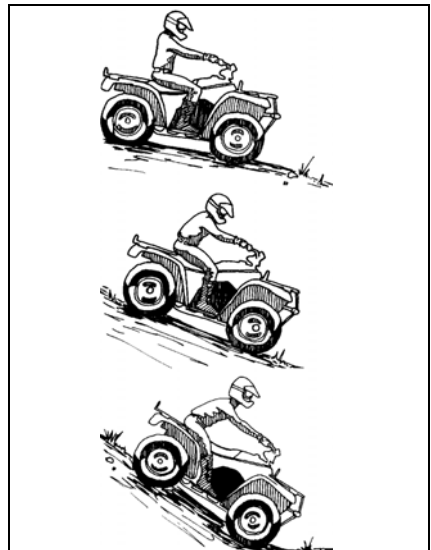

ATV-205

ATV Operation

1. Shift your body weight as far back on the seat as possible.
2. Keep it in a low range; stay out of neutral.
3. Lightly apply the brake and ease up on the throttle.

Sidehilling/Traversing

Sidehilling is considered an advanced skill; it's really tricky and unpredictable. So, whether your skills are advanced or not, try to avoid this kind of riding. If you're in a situation where you absolutely have to sidehill, follow this method:

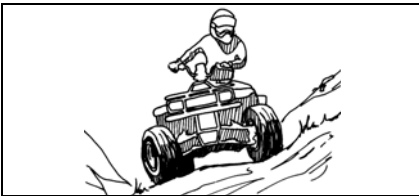

ATV-0017

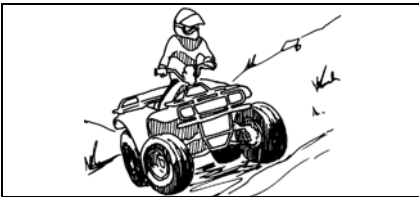

ATV-0028

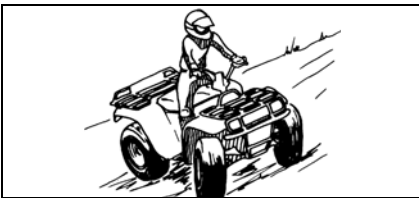

ATV-0029

1. Keep your speed low and consistent.
2. Shift all your body weight to the uphill side of the seat; also, support your weight on the uphill footrest.
3. Steer like you're driving into the hill.

4. If the ATV feels like it's tipping, turn the handlebar downhill. If that's not possible because of the terrain or other conditions or if it just doesn't work, stop and get off. Dismount the ATV on the uphill side.

Swerving

Swerving is usually an emergency reaction to avoid an obstacle but is similar to quick turns. The difference is that quick turns involve slight acceleration in the turn; don't accelerate if you swerve.

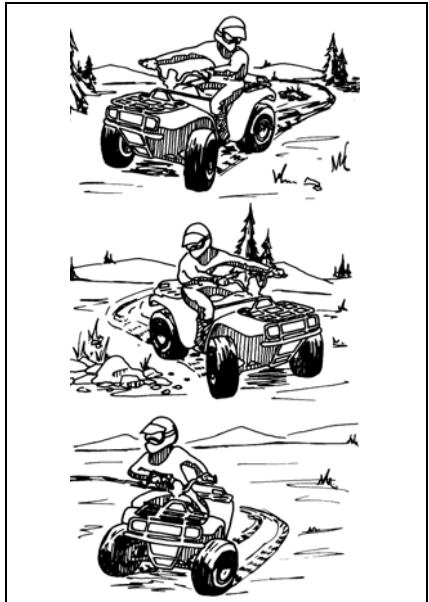

ATV-206

1. Ease off the throttle as you approach the obstacle.
2. Turn the handlebar. At the same time, shift your weight and balance as you swerve. Use the principles of leaning, weight shifting, and balancing—shift your body weight to the inside of the turn.
3. Keep your hand off the brake until the emergency is over and you're back in control.

ATV Operation

Crossing Obstacles

Crossing obstacles is risky; avoid it if possible. Riding over logs, rocks, and ruts means combining all the active riding skills into one big motion. Your ATV will respond differently for different obstacles (logs, ruts, etc.), but these are general guidelines for overcoming two-track (both tires contacting the obstacle at the same time) obstacles:

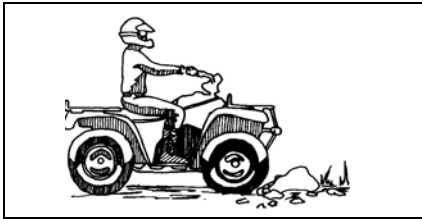

ATV-0016

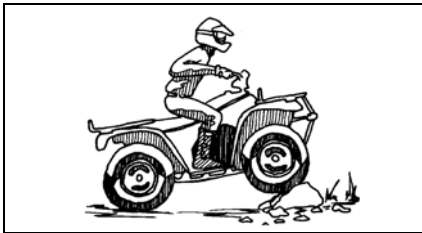

ATV-0026

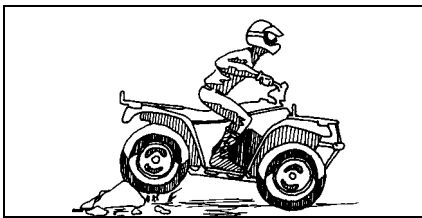

ATV-0027

1. Keep your speed way down; less than 5 mph.
2. Approach the obstacle head-on.
3. Come up off the seat.
4. Keep your weight on the footrests.
5. Apply a little throttle when the front tires make contact with the obstacle.
6. Lean forward and release the throttle when the front tires clear the obstacle.

7. Keep your body loose to absorb any shock.
8. If the ATV starts tipping, shift your weight to keep it in balance.

To clear a single-track (only one tire contacts) obstacle, follow the same rules except:

1. Use the ATV's momentum to clear the obstacle.
2. Don't pull up on the handlebar.
3. Don't apply the throttle.

Tips

Driving an ATV and a car have some similarities; however, there are a few situations that require special attention:

- Reversing
- Skidding or Sliding
- Parking on a Hill
- Stalling on a Hill
- Crossing Water
- Crossing Roads
- Driving in Cold Weather
- Stopping the ATV
- Stopping the Engine

Reversing

It's tough to see things behind you.

1. Go slowly. It's hard to see behind you.
2. Keep your handlebar straight.
3. Backing down hills is a bad idea; do a U-turn or K-turn instead to turn around.

Skidding or Sliding

If you lose control after hitting sand, ice, mud, or water:

1. Turn your handlebar into the direction of the slide.
2. Keep your hand off the brakes until you're out of the skid.
3. Shift your weight forward.

Sometimes your ATV may not respond and goes straight ahead instead of letting you turn. Here's how to handle it:

ATV Operation

1. Slow down.
2. Move forward on the seat.
3. Lean to inside of turn.
4. Turn handlebar.

Parking on a Hill

This shouldn't be necessary, but if it is:

1. Keep it in gear.
2. Engage the brake lever lock.
3. Find something to block the rear tires.

Stalling on a Hill

If you use the right method for riding uphill, this shouldn't happen. But if you have a problem, do this:

1. If the ATV hasn't started rolling backwards yet, follow the procedure for the K-Turn, **OR**
2. If the ATV is already rolling backward, lean as far forward as possible standing up on the footrests.
3. Nice and easy, apply the hand brake lever.
4. When you come to a stop, follow the procedure for the K-turn.
5. If the ATV continues to roll backward, dismount immediately on the uphill side.

Crossing Water

Your ATV can only handle water up to its footrests. Any more than that and you risk engine damage and/or injury. Stay away from fast moving rivers. ATV tires can be buoyant, so if the water is too deep, you might find the ATV suddenly afloat.

CAUTION

Riding through water deeper than the footrests may lead to severe engine damage due to water ingestion.

■ **NOTE: Engine damage caused by water ingestion or immersion will not be covered by Arctic Cat warranty.**

1. Physically check the depth and current of the water, especially if you can't see the bottom. You're also checking for boulders, logs, or any other hidden obstacles.
2. Keep your speed slow.
3. Make sure you have a way out on the other side of the water.
4. If you get stuck in the sludge or mud, try rocking the ATV from side to side.
5. Once you've cleared the water, briefly apply the brakes to make sure they work.

Crossing Roads

Crossing roads on your ATV is also a bad idea, so avoid it. If you can't:

1. Stop completely on the shoulder of the road.
2. Check both directions for traffic.
3. Crossing near a blind corner or intersection is dangerous; don't do it.
4. Drive straight across to the opposite shoulder.
5. Take into account that your ATV could stall while crossing; give yourself enough time to get off the road.
6. You have to assume that oncoming cars don't see you, and if they do, they won't be able to predict your actions.
7. It's illegal to cross public roads in some places. Know your local laws.

ATV Operation

Driving In Cold Weather

■ **NOTE:** Check that all control levers move freely. Make sure that the footrest, shift lever, and rear foot brake are free of ice and snow.

WARNING

For your personal safety, it is very important to wear the type and amount of cold-weather clothing according to the coldest anticipated temperatures.

1. With the transmission in neutral, move the ATV forward and backward to check that the wheels roll freely. If the ATV will not roll, the tires may be frozen to the ground or the brake pads may be frozen to the discs.
2. If the tires are frozen to the ground, pour warm water around them to melt the ice.

CAUTION

Before riding, manually move the ATV forward and backward to make certain that all wheels roll freely.

3. If the brakes are frozen, take the ATV to a warmer area to thaw out the brakes.

WARNING

Do not attempt to free frozen brakes by pouring warm water on the brake pads and housings.

■ **NOTE:** After the brakes thaw, dry them by applying them several times while riding slowly.

■ **NOTE:** After riding through water, mud, snow, or slush, it is important to dry both brake systems before parking the ATV.

WARNING

Go slowly and be extra careful when riding on snow-covered or ice-covered terrain. Always be alert to changing terrain conditions when operating the ATV.

4. Practice driving in an open snow-covered or ice-covered area at slow speeds before driving on snow-covered or ice-covered trails.
5. Learn how the ATV responds to steering and braking on the type of terrain to be encountered on the ride.

Stopping The ATV

To stop the ATV, first release the throttle lever. Next, apply the brake.

Stopping The Engine

To stop the engine, turn the ignition switch key to the OFF position or set the engine stop switch to the OFF position.

General Information

ATV Identification Numbers

The Arctic Cat ATV has two identification numbers: Vehicle Identification Number (VIN) and Engine Serial Number (ESN).

The VIN is located on the lower-front crossmember.



KC0055A

The ESN is located on the rear of the engine crankcase and is visible from the side.



KC287B

These numbers are required by the dealer to complete warranty claims properly. No warranty will be allowed by Arctic Cat if the VIN or ESN is removed or mutilated in any way.

Always provide the ATV name, Vehicle Identification Number, and Engine Serial Number when contacting an authorized Arctic Cat ATV dealer for parts, service, accessories, or warranty. If a complete engine must be replaced, ask the dealer to notify Arctic Cat for correct registration information.

Ignition Switch Key

Two keys come with the ATV. Keep the spare key in a safe place. An identifying number is stamped on each key. Use this number when ordering a replacement key.

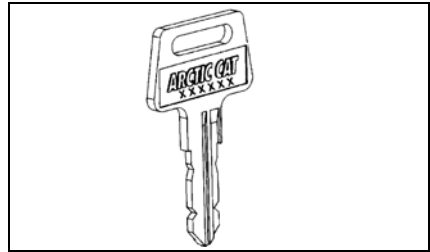

ATV-0055

Control Locations and Functions

Ignition Switch

The ignition switch has three positions.

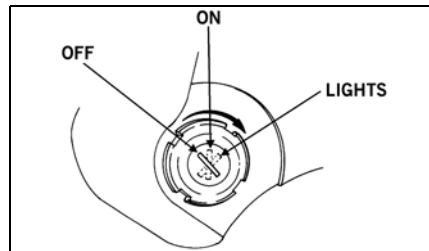

ATV-0056

OFF position — All electrical circuits except the accessory plug are off. The engine will not start. The key can be removed in this position.

■ **NOTE:** The accessory plug is powered by the battery at all times.

ON position — The ignition circuit is complete and the engine can run. The key cannot be removed in this position.

LIGHTS position — The ignition circuit is complete and the headlights and tail-light are on. The key cannot be removed in this position.

CAUTION

Leaving the ignition switch in the ON or LIGHTS position for a long period of time when the engine is not running may cause the battery to discharge. Always leave the ignition switch in the OFF position when engine is not running.

Gas Tank Valve (350)

The gas tank valve is incorporated in the gas tank. There are three positions: ON, RES, and OFF.

In the OFF position, the valve will not allow gasoline to flow to the carburetor. In the ON position (the normal operating position), gasoline will flow from the tank to the carburetor. In this position, 2.46 L (0.65 U.S. gal.) will remain in the tank as a reserve quantity.

Moving the valve to the reserve (RES) position will allow the operator to use the remaining gasoline in the tank. When turning the valve to any of the three positions, be sure the indicator is pointed directly at the position desired.

WARNING

Never leave the valve in the ON or RES position when the engine is not running.

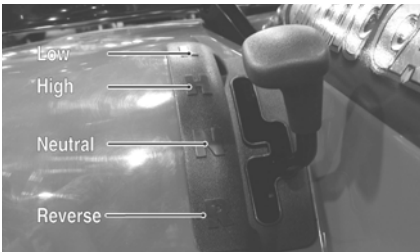
Shifting

CF130B

This ATV has a dual-range automatic transmission with reverse. To shift the ATV, follow these steps:

1. To engage the high range from neutral, move the shift lever forward.

2. To engage the low range from high range, move the shift lever outward and forward.

■ **NOTE:** The high range is for normal riding with light loads. The low range is for carrying heavy loads or trailer towing. Compared to HIGH range, the LOW range position provides slower speed and greater torque to the wheels.

CAUTION

Always shift into low range when operating on wet or uneven terrain, when towing or pushing heavy loads, and when using a plow. Failure to follow this caution may result in premature V-belt failure or in damage to related drive system components.

3. To engage reverse gear from neutral, move the shift lever outward and rearward into the R position.

CAUTION

Always come to a complete stop before attempting to shift from one range to the other or into reverse. Always shift on level ground, or engage the brake lever lock before shifting into another range or into reverse.

Drive Select Switch (425)

KC342B

This switch allows the operator to operate the ATV in either two-wheel drive (rear wheels) or four-wheel drive (all wheels). For normal riding on flat, dry, hard surfaces, two-wheel drive should be sufficient. In situations of aggressive trail conditions, four-wheel drive would be the desired choice.

To either engage or disengage the front wheels, move the switch to the 4WD position or to the 2WD position.

CAUTION

Do not attempt to either engage or disengage 4WD while the ATV is moving.

Hand Brake Lever/Brake Lever Lock

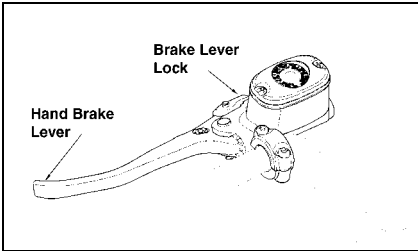

738-420B

The hand brake is considered to be the normal operating (main) brake. It should be applied whenever a braking situation is needed.

Apply the brake by compressing the brake lever toward the handlebar.

To engage and release the brake lever lock, use the following procedure.

1. Squeeze the hand brake lever two or three times and release it.
2. Depress and hold the brake lever lock.
3. While holding in on the brake lever lock, squeeze the brake lever.

■ **NOTE: It will click as it engages and the brake lever will not return to its released position.**

4. Release the brake lever lock by squeezing the brake lever. It will return to its released position.

Check to make sure the brake lever lock engages properly and that the brake (when engaged) locks the wheels.

1. Pump the brake lever 2 or 3 times.
2. Engage the brake lever lock.
3. Attempt to push the ATV.

■ **NOTE: The brake lever lock must lock the wheels. If it doesn't, take the ATV to an authorized Arctic Cat ATV dealer for service.**

WARNING

Always check to be sure that the brake lever lock has been disengaged before operating the ATV. An accident could result if the brake lever lock is left engaged while the ATV is operated. The brake may relax if left engaged for a long period of time. This could cause an accident; therefore, do not leave the ATV on a hill depending on the brake lever lock. Always block the downhill side of the wheels if leaving the ATV on a hill or park the ATV in a sidehill position.

Rear Foot Brake



CF117

Pressing the rear foot brake downward will apply the brake to the rear wheels.

Headlight HI/LO Switch



KM850A

Use the headlight HI/LO switch to select the high or low headlight beam when the ignition switch is in the LIGHTS position. When the switch is in the HI position, the high beam will illuminate. When the switch is in the LO position, the low beam will illuminate. When the switch is in the Running Light position, the tail-lights and running lights will illuminate.

Engine Stop Switch

OFF position — The ignition circuit is off. The engine cannot be started or will not run. If the engine stop switch is used to stop engine without turning off ignition switch, the battery may discharge.

RUN position — The ignition circuit is on. The engine can start and run.

Starter Button

Pushing in on this button activates the starter motor. Before starting the engine, make sure the ignition switch is in the ON position, the transmission is in neutral, and the brake lever lock is engaged.

■ **NOTE:** This ATV has safety interlock switches which prevent the starter motor from activating when the transmission is not in neutral.

Reverse Override Switch

This ATV is equipped with a reverse speed limiter system. When additional RPM is needed in reverse, depress and hold the override switch

■ **NOTE:** On the 425, the reverse override switch is active in 4WD only.

WARNING

Never activate the override switch while the throttle is open as a loss of control may result.

Throttle Lever



KC342A

Control engine RPM with the position of the throttle lever. Operate this lever with the thumb. Pushing it forward increases engine RPM and allowing it to retract decreases engine RPM.

Throttle Limiter Screw

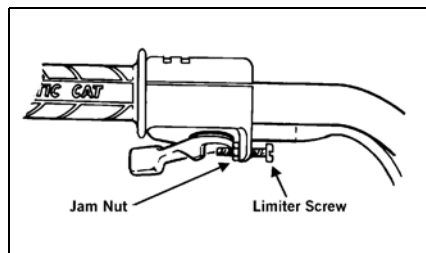

ATV-0053

Throttle lever travel may be limited by adjusting the throttle limiter screw. The throttle limiter should be adjusted according to the operator's skill and experience. To adjust the throttle limiter, use the following procedure.

1. Loosen the jam nut.
2. Turn the throttle limiter screw clockwise to decrease engine RPM maximum or counterclockwise to increase engine RPM maximum.
3. Tighten the jam nut securely.

■ **NOTE:** The ATV is equipped with an RPM limiter that retards ignition timing when maximum RPM is approached. When the RPM limiter is activated, it could be misinterpreted as a high-speed misfire.

LCD Gauge

■ **NOTE:** All segments of the LCD will activate for approximately two seconds when the ignition switch is rotated to the ON position.



CF236B

1. Clock/Engine Hour Meter - The clock function indicates time in the 12-hour mode; the hour meter indicates the total time the ATV has run and cannot be reset to zero. To set the clock, use the following procedure.

A. With the ignition switch ON, press and release the Mode Button (3) until the Clock/Engine Hour Meter (1) is displayed; then (if necessary) press and release the Set/Reset Button (4) to select the clock display.

B. Press and hold the Set/Reset Button (4) until the minutes stop scrolling and the hour display starts to scroll. Momentarily release when the correct hour is displayed; then repeatedly press and release the Set/Reset Button (4) until the correct minutes are displayed.

■ **NOTE:** Clock memory power is supplied through the 15-amp accessory fuse and verified during gauge “power-up” and reset. In the event of clock memory power failure (blown fuse, etc.), the gauge will “power-up,” reset, and shut down repeatedly until clock memory power is restored. Always check the 15-amp accessory fuse if this gauge condition is noted.

■ **NOTE:** The engine hour meter will not activate until engine speed exceeds 500 RPM.

2. Temperature Indicator - If the engine coolant temperature exceeds the normal operating range, the temperature icon will begin flashing and the LCD will go blank for 30 seconds; then the LCD will return to normal. However, the temperature icon will continue to flash.

CAUTION

Continued operation with high engine temperature may result in engine damage or premature wear.

■ **NOTE:** High engine RPM, low vehicle speed, or heavy load can raise engine temperature. Decreasing engine RPM, reducing load, and selecting an appropriate transmission gear can lower the temperature.

■ **NOTE:** Debris in front of the engine (or packed between the cooling fins of the radiator) can reduce cooling capacity. Using a garden hose, wash the radiator and the engine to remove any debris restricting air flow.

CAUTION

Arctic Cat does not recommend using a pressure washer to clean the radiator core. The pressure may bend or flatten the fins causing restricted air flow, and electrical components on the radiator could be damaged. Use only a garden hose with spray nozzle at normal tap pressure.

3. Mode Button - Shifts the gauge through three set-up modes: speedometer/tachometer, distance, and time.

■ **NOTE:** The Mode Button must be pressed and released to shift modes. Approximately two seconds after the Mode Button is released, the digital gauge will return to full display.

4. Set/Reset Button - In conjunction with the Mode Button, sets and resets various displays on the digital gauge. Also used to shift from speedometer function to tachometer function on the speedometer/tachometer gauge.

5. Fuel Level Indicator - Indicates approximate amount of gasoline in the gas tank.

NOTE: When the bottom segment flashes, approximately 3.5 L (0.92 U.S. gal.) of gasoline remains in the tank.

6. Low Oil Pressure - Will be displayed during self-test at start-up. It will not be displayed during normal operation as oil pressure is not monitored on these models.
7. Odometer/Trip Meter - Odometer registers the total distance the vehicle has traveled. The trip meter is resettable and can be used to measure trip or trip legs. The odometer cannot be reset.

NOTE: To shift between the odometer (ODO) or trip meter (TRIP), press the Mode Button (3) to select the distance mode; then press the Set/Reset Button (4) to select the desired display. Hold the Set/Reset Button down to reset the trip meter.

8. Gear Position Indicator - Indicates which gear position is selected.
- R (reverse)/N (neutral)/L (low range)/H (high range)

NOTE: An E will be displayed if there is an error caused by a no-shift position signal.

9. High Beam Indicator - The High Beam icon will appear only when the headlights are on high beam.
10. Drive Select Indicator - Displays 4WD when selected by the drive select switch. The display is blank when in 2WD.
11. Speedometer - Indicates the approximate vehicle speed in miles per hour (MPH) or kilometers per hour (km/h).

NOTE: To change mph/km/h display, press and release Mode Button (3) until the icon (MPH/km/h) appears; then press the Set Button (4) to change the display.

Condition Warning Display (425) - Uses odometer/trip meter display of the LCD to warn of a system error condition requiring attention.

- A. Volt - The LCD will go blank except the word VOLT will flash on the LCD whenever a low voltage (< 9 DC volts) or a high voltage (> 16 DC volts) is detected. When voltage returns to normal, the gauge must be reset by turning the ignition key to the OFF position and then to the ON position.

- B. EFI - The LCD will go blank except a diagnostic trouble code (DTC) will flash on the LCD and a wrench icon will be displayed whenever an electronic fuel injection malfunction is detected. After 30 seconds, the LCD will return to normal; however, the DTC and wrench icon will continue to be displayed until the malfunction is corrected.

NOTE: Take the ATV to an authorized Arctic Cat ATV dealer to have the EFI error corrected and to have the ECU reset as soon as possible.

Primer - Cold Start (350)

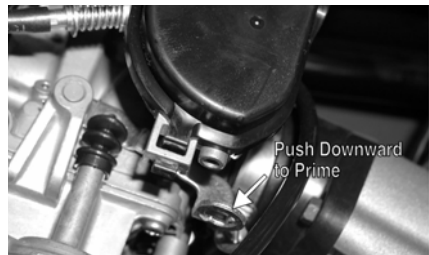

CF123A

The primer is located on the carburetor. Depress and release the lever several times prior to attempting to start a cold engine.

Gas/Vent Hoses

Replace the gas hose every two years. Damage from aging may not always be visible.

On the 350, do not bend or obstruct the routing of the carburetor vent hose. Make certain that the vent hose is securely connected to the carburetor and hose holder and the opposite end is always open.

Carburetor Float Bowl Drain (350)

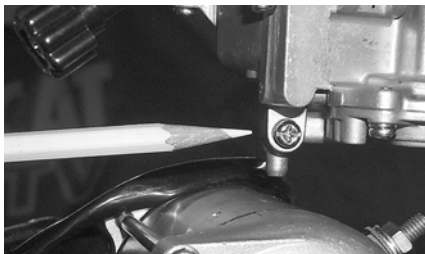

AF925

Periodically, the float bowl should be drained to remove condensation. To drain the float bowl, use the following procedure.

1. Direct the hose from the float bowl drain into a container.

WARNING

Do not drain float bowl contents directly onto the engine. Gasoline is highly flammable and could ignite. Use a hose.

2. Loosen the drain screw and allow the gasoline and condensation to flow out.
3. Tighten the drain screw securely and remove the hose.

WARNING

It is very important that the drain screw be tightened securely. If it is not tightened securely, gasoline could drip onto the engine.

Electric Fuel Pump (425)

An electric fuel pump is incorporated in the gas tank to deliver gasoline to the fuel injector. The fuel pump is activated when the ignition switch is in the ON position.

■ **NOTE:** Both the ignition and fuel pump functions will be interrupted by the Tilt Sensor if the ATV tips over past 60°-70°. Righting the ATV will reactivate the ignition and fuel pump.

Oil Level Stick

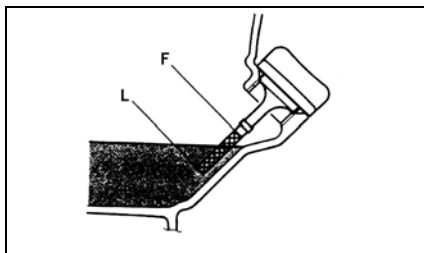

ATV-0100AA



KC0051A

There is an oil level stick for checking the engine oil level. To check the oil level, use the following procedure.

■ **NOTE:** The ATV should be on level ground when checking the engine oil level.

1. Unscrew the oil level stick and wipe it with a clean cloth.
2. Install the oil level stick and thread it into the engine case.
3. Remove the oil level stick; the engine oil level should be above the "L" mark but not higher than the "F" mark.

CAUTION

Do not overfill the engine with oil. Always make sure the oil level is above the "L" mark but not higher than the "F" mark.

Seat Latch

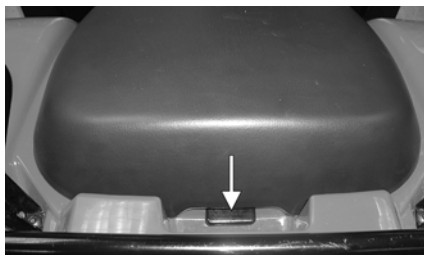

AL676A

1. To remove the seat, lift up on the latch release (located at the rear of the seat); then raise the rear of the seat and slide it rearward.
2. To lock the seat into position, slide the front of the seat into the seat retainers and push down firmly on the rear of seat. The seat should automatically lock into position.

⚠ WARNING

Make sure the seat is secure before mounting the ATV. Serious injury may result if the seat is not properly secured.

Safety Flag Bracket

A bracket is provided for mounting a flag at the rear of the ATV.

Rack Loading (Front and Rear)

The front rack and rear rack are designed to carry specified load capacities. Always refer to the ATV Load Capacity Ratings Chart for proper capacities.

⚠ WARNING

Make sure the loads on the front and rear racks will not interfere with the ATV controls or obstruct the view of the operator. Also, make sure the loads are evenly distributed, properly secured, and will not shift while operating the ATV.

Trailing and Towing

⚠ WARNING

Never use the racks as a towing or trailering point.

Arctic Cat ATV's are equipped with a frame-mounted receiver for a standard 5.1 cm (2 in.) receiver hitch. The standard receiver hitch must be purchased separately.

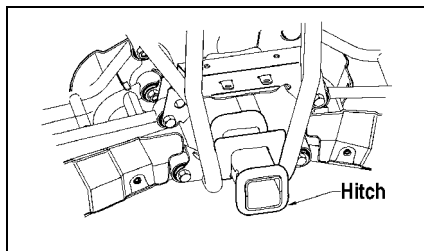

738-424A

When loading a trailer properly, two items are critical: Gross Trailer Weight (the weight of the trailer plus cargo) and Trailer Tongue Weight.

⚠ WARNING

Make sure that the load in the trailer is properly secured and will not shift while moving. Also, do not overload the trailer.

⚠ WARNING

Never exceed any of the ATV weight restrictions.

Trailer Tongue Weight is the downward force exerted on the hitch by the trailer coupler when the trailer is fully loaded and the coupler is at its normal towing height. Refer to the Load Capacity Ratings Chart for tongue weight information.

Always maintain a slow speed when trailering and towing and avoid sudden accelerations, quick maneuvers, and sudden stops. Braking distance will be affected when towing a trailer. When towing a trailer, always maintain slow speed and allow more stopping distance than when not towing a trailer.

⚠ WARNING

Riding an ATV without extra caution when towing a trailer will be hazardous. Trailer towing can affect the handling and braking of the ATV. Never tow a trailer without a rigid tongue and never exceed 10 mph. Avoid sudden accelerations and stopping of the ATV. Do not make quick maneuvers. Avoid uneven surfaces and do not tow on hills. Never carry passengers in a trailer unless the trailer is designed for such use. Allow more stopping distance than when not towing a trailer.

Transporting ATV

When transporting the ATV, Arctic Cat recommends that the ATV be in its normal operating position (on all four wheels) and the following procedure be used.

1. Engage the brake lever lock and place the transmission in gear.

CAUTION

Failure to engage the brake lever lock and place the transmission in gear could result in the ATV rolling off the trailer in the event of tie-down strap failure.

2. Secure the ATV with load rated hold-down straps.

■ **NOTE:** Suitable hold-down straps are available from your Arctic Cat ATV dealer. Ordinary rope is not recommended because it can stretch under load.

CAUTION

When using hold-down straps, care must be taken not to damage the ATV.

**Gasoline-Oil-Lubricant
Recommended Gasoline**

The recommended gasoline to use in this ATV is 87 minimum octane regular unleaded. In many areas, oxygenates (either ethanol or MTBE) are added to the gasoline. Oxygenated gasolines containing up to 10% ethanol, 5% methane, or MTBE are acceptable gasolines.

When using ethanol blended gasoline, it is not necessary to add a gasoline antifreeze since ethanol will prevent the accumulation of moisture in the fuel system.

CAUTION

Do not use white gas. Only Arctic Cat approved gasoline additives should be used.

**Recommended Engine/
Transmission Oil****CAUTION**

Any oil used in place of the recommended oil could cause serious engine damage. Do not use oils which contain graphite or molybdenum additives. These oils can adversely affect clutch operation. Also, not recommended are racing, vegetable, non-detergent, and castor-based oils.

The recommended oil to use is Arctic Cat ACX All Weather synthetic engine oil, which has been specifically formulated for use in this Arctic Cat engine. Although Arctic Cat ACX All Weather synthetic engine oil is the only oil recommended for use in this engine, use of any API certified SM 0W-40 oil is acceptable.

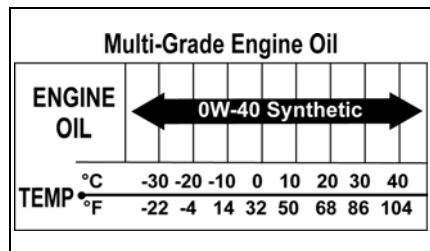

OILCHART J

Recommended Front Differential/Rear Drive Lubricant

■ **NOTE:** Arctic Cat recommends the use of genuine Arctic Cat lubricants. The recommended lubricant (front differential and rear drive) is SAE approved 80W-90 hypoid. This lubricant meets all of the lubrication requirements of the Arctic Cat ATV.

CAUTION

Any lubricant used in place of the recommended lubricant could cause serious front differential/rear drive damage.

Filling Gas Tank

WARNING

Always fill the gas tank in a well-ventilated area. Never add gasoline to the ATV gas tank near any open flames or with the engine running or hot. **DO NOT SMOKE** while filling the gas tank.

Since gasoline expands as its temperature increases, the gas tank must be filled to its rated capacity only. Expansion room must be maintained in the tank particularly if the tank is filled with cold gasoline and then moved to a warm area.

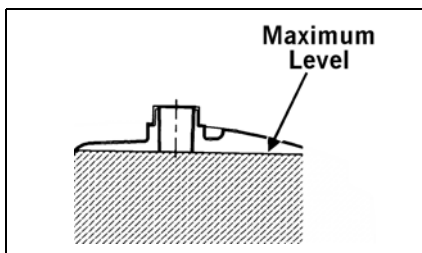

ATV0049D

Allow the engine to cool before filling the gas tank. Care must be taken not to overfill the tank. If overfilled, gas may leak onto the engine creating a fire hazard.

WARNING

Do not over-flow gasoline when filling the gas tank. A fire hazard could materialize. Always allow the engine to cool before filling the gas tank.

WARNING

Do not overfill the gas tank.

Tighten the gas tank cap securely after filling the tank.

Engine Break-In

After the completion of the break-in period, the engine oil and oil filter should be changed. Other maintenance after break-in should include checking of all prescribed adjustments and tightening of all fasteners. At the discretion and expense of the owner/operator, the ATV may be taken to an authorized Arctic Cat ATV dealer for this initial service.

New ATV's and renewed ATV engines require a "break-in" period. The first month is most critical to the life of this ATV. Proper operation during this break-in period will help assure maximum life and performance from the ATV.

During the first 10 hours of operation, always use less than ½ throttle. Varying the engine RPM during the break-in period allows the components to "load" (aiding the engine/transmission component mating process) and then "unload" (allowing components to cool). Although it is essential to place some stress on the engine components during break-in, care should be taken not to overload the engine too often. Do not pull a trailer during the break-in period.

When the engine starts, allow it to warm up properly. Idle the engine several minutes until the engine has reached normal operating temperature. Do not idle the engine for excessively long periods of time.

Burnishing Brake Pads

Brake pads must be burnished to achieve full braking effectiveness. Braking distance will be extended until brake pads are properly burnished.

To properly burnish the brakes, use following procedure:

1. Choose an area sufficiently large to safely accelerate ATV to 30 mph and to brake to a stop.

2. Accelerate to 30 mph; then compress brake lever to decelerate to 0-5 mph.
3. Repeat procedure twenty times.

**WARNING**

Do not attempt sudden stops or put yourself into a situation where a sudden stop will be required until the brake pads are properly bur-nished.

General Maintenance

■ **NOTE: Proper maintenance of the ATV is important for optimum performance. Follow the Maintenance Schedule and all ensuing maintenance instructions/information.**

If, at any time, abnormal noises, vibrations, or improper functioning of any component of this ATV is detected, DO NOT OPERATE THE ATV. Take the ATV to an authorized Arctic Cat ATV dealer for inspection and adjustment or repair.

If the owner/operator does not feel qualified to perform any of these maintenance procedures or checks, take the ATV to an authorized Arctic Cat ATV dealer for professional service.

■ **NOTE: The following instructions and information refer to specific items in the maintenance and care of the ATV.**

Maintenance Schedule					
Item	Page	Initial 100 miles after break-in	Every 100 miles or 1 month	Every 300 miles or 3 months	Every 500 miles or 6 months
Battery	57	I	I		
* Engine nuts and bolts	-	I			I
* Valve clearance	-	I			I
Spark plug	60	I		I	I
	60	Replace every 4000 miles or 18 months			
Oil cooler (350)	52	I		I	I
Liquid Cooling System (425)	52	I	Inspect every time before riding		
Idle RPM (350)	60	I			I
Throttle cable	61	I	Inspect every time before riding		
Gas/vent hoses	45	I	Inspect every time before riding		
	45	Replace every 2 years			
Engine/transmission oil and filter	53	R		R**	
Air filter	61	I		I	
Air filter housing drain	62	I	Inspect every time before riding		
Gear lubricant (Front differential - rear drive)	54	I		I	
	54	Replace every 4 years			
V-Belt	62	I			I
Muffler/spark arrester	63				C
Tires/air pressure	62/27	I	Inspect every time before riding		
* Brake components	55/56	I	Inspect every time before riding		
Brake fluid	55	I	*Replace every 2 years		
Brake hoses	55	I	*Replace every 4 years		
* Steering	-	I	Inspect every time before riding		
* Suspension (Ball joint boots, drive axle boots front and rear, tie rods, differential and rear drive bellows)	-	I	Inspect every time before riding		
* Chassis nuts and bolts	-	I	T		
Frame/welds/racks	-	I			I
Electrical connections	-	I			I
Headlight/taillight-brakelight	63	I	Inspect every time before riding		

I = Inspect and clean, adjust, lubricate, replace as necessary * = Dealer maintenance T = Tighten R = Replace C = Clean
 ** = When using Arctic Cat ACX All Weather synthetic oil, oil change interval can be increased to every 1,000 miles or every year.

Oil Cooler (350)

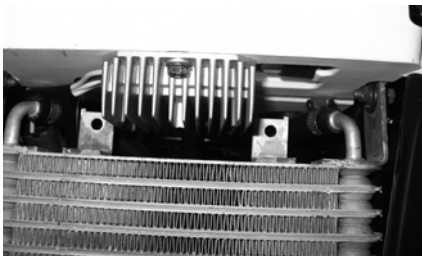

KC0083

■ **NOTE:** Dirt and debris must be cleaned from the cooling fins regularly to ensure proper engine oil cooling.

CAUTION

Continued operation of the ATV with high engine temperature may result in engine damage or premature wear.

■ **NOTE:** High engine RPM, low vehicle speed, or heavy load can raise engine temperature. Decreasing engine RPM, reducing load, and selecting an appropriate transmission gear can lower the temperature.

Liquid Cooling System (425)

■ **NOTE:** Debris in front of the engine or packed between the cooling fins of the radiator can reduce cooling capability. Using a garden hose, wash the radiator to remove any debris preventing air flow.

CAUTION

Arctic Cat does not recommend using a pressure washer to clean the radiator core. The pressure may bend or flatten the fins causing restricted air flow, and electrical components on the radiator could be damaged. Use only a garden hose with spray nozzle at normal tap pressure.

The cooling system capacity can be found in the specifications chart. The cooling system should be inspected daily for leakage and damage. If leakage or damage is detected, take the ATV to an authorized Arctic Cat ATV dealer for service. Also, the coolant level should be checked periodically.

CAUTION

Continued operation of the ATV with high engine temperature may result in engine damage or premature wear.

■ **NOTE:** High engine RPM, low vehicle speed, or heavy load can raise engine temperature. Decreasing engine RPM, reducing load, and selecting an appropriate transmission gear can lower the temperature.

When filling the cooling system, use a coolant/water mixture which will satisfy the coldest anticipated weather conditions of the area in accordance with the coolant manufacturer's recommendations. While the cooling system is being filled, air pockets may develop; therefore, run the engine for five minutes after the initial fill, shut the engine off, and then fill the cooling system to the bottom of the stand pipe in the radiator neck.

Checking/Filling

1. Locate the coolant reservoir on the right side behind the radiator.

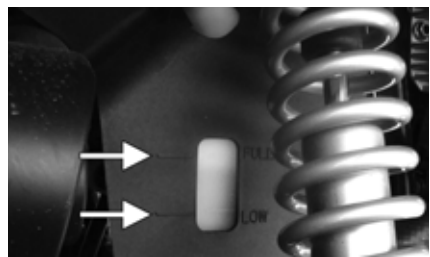

KC338B

2. Remove the cap and fill with the appropriate coolant until coolant level is between the LOW and FULL lines. Do not overfill.
3. Install the cap on the reservoir.

- Remove the radiator access panel; then remove the radiator cap and add coolant as necessary until coolant is visible in the fill tank.



KC339A

- Install the radiator cap and access panel.

Shock Absorbers

Each shock absorber should be visibly checked weekly for excessive fluid leakage (some seal leakage may be observed but it does not indicate the shock is in need of replacement), cracks or breaks in the lower case, or a bent shock rod. If any one of these conditions is detected, replacement is necessary.

■ **NOTE:** When the ATV is operated in extremely cold weather (-23°C/-10°F or colder), a small amount of leakage may be present. Unless the leakage is excessive, replacement is not necessary.

The shock absorber has a spring force adjustment sleeve with five adjustment positions to allow the spring to be adjusted for different riding and loading conditions. If the spring action is too soft or too stiff, adjust it according to the chart.

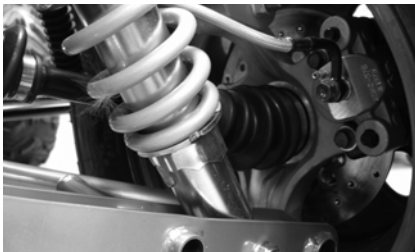

KC0102

■ **NOTE:** Before attempting to adjust suspension, clean dirt and debris from the sleeve and remove load from the suspension; then use the spanner wrench to adjust the sleeve to the desired position.

Position	Spring Force	Setting	Load
1	↓ Stronger	Soft	Light
2		↑	↑
3		↕	↕
4		↓	↓
5		Stiff	Heavy

General Lubrication

Cables

None of the cables require lubrication; however, it is advisable to lubricate the ends of the cables periodically with a good cable lubricant.

Engine/Transmission Oil and Filter

■ **NOTE:** Refer to the recommended oil viscosity chart (on page 48) in this manual for the proper engine oil.

Change the engine oil and oil filter at the scheduled intervals. The engine should always be warm when the oil is changed so the oil will drain easily and completely.

- Park the ATV on level ground.
- Remove the oil level stick. Be careful not to allow contaminants to enter the opening.



KC0051A

- Remove the drain plug from the bottom of the engine and drain the oil into a drain pan.

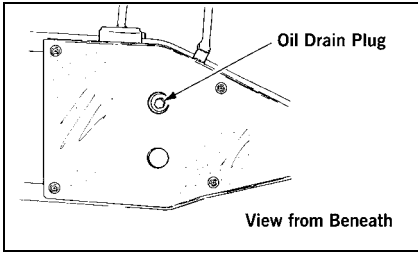

733-441A

- Remove the oil filter plug from the filter mounting boss (located on the front-right side of the transmission case) and allow the filter to drain completely.
- Using the oil filter wrench and a ratchet handle (or a socket or box-end wrench), remove the old oil filter and dispose of properly. Do not re-use oil filter.

■ **NOTE:** Clean up any excess oil after removing the filter.

- Apply oil to the new filter O-ring and check to make sure it is positioned correctly; then install the new oil filter. Tighten securely.
- Install the oil filter drain plug and tighten securely.
- Install the engine drain plug and tighten it securely. Pour the recommended oil in the filler hole. Install filler plug.
- Start the engine (while the ATV is outside on level ground) and allow it to idle for a few minutes.
- Turn the engine off and wait approximately one minute. Recheck the oil level.
- Inspect the area around the drain plug and oil filter for leaks.

Front Differential and Rear Drive Gear Lubricant (Inspecting/Changing)

Inspect and change the gear lubricant in each according to the Maintenance Schedule. When changing the lubricant, use approved SAE 80W-90 hypoid oil and use the following procedure.

- Place the ATV on level ground.
- Remove each oil filler plug.
- Drain the oil into a drain pan by removing in turn the drain plug from each.

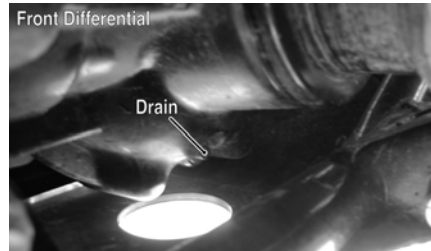

CF107B

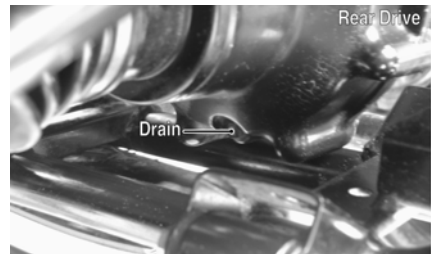

CF106C

- After all the oil has been drained, install the drain plugs and tighten securely.

CAUTION

Inspect the oil for any signs of metal filings or water. If found, take the ATV to an authorized Arctic Cat ATV dealer for servicing.

- Pour recommended oil into each filler hole.

■ **NOTE:** If the gear case has a level plug, fill to the threads of the level plug. If the gear case has only a fill plug, fill to within 1 in. of the threads of the fill plug.

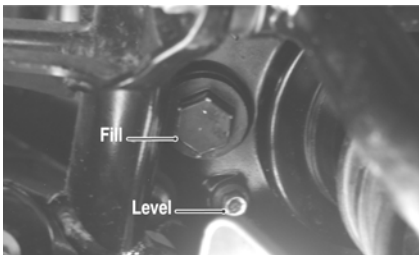

CF113A

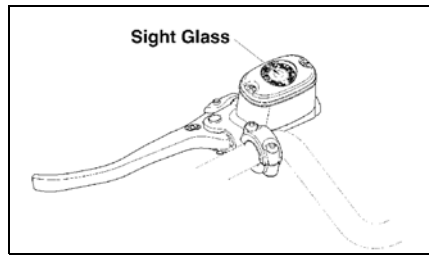

738-420A

■ **NOTE:** If the sight glass appears dark, there is a sufficient amount of fluid in the reservoir.

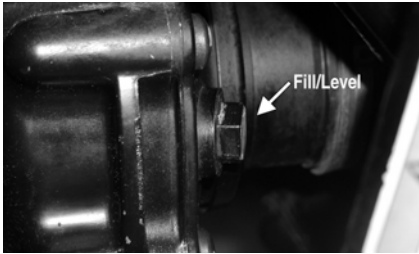

CF116A

■ **NOTE:** Arctic Cat recommends the use of genuine Arctic Cat lubricants.

6. Install the filler plugs and level plugs.

Hydraulic Hand Brake

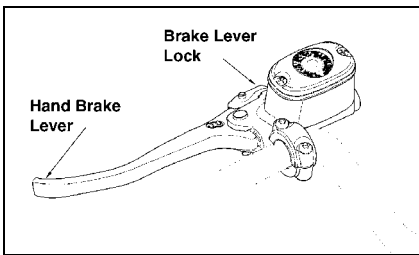

738-420B

WARNING

Be sure to inspect the hydraulic brake system before each use. Always maintain brakes according to the Maintenance Schedule.

Brake Fluid

Check the brake fluid level in the brake fluid reservoir. If the level in the reservoir is not visible in the sight glass, add DOT 4 brake fluid.

CAUTION

Be careful not to spill any fluid when filling the brake fluid reservoir. Wipe away spilled fluid immediately.

Brake Lever Lock

Check to make sure the brake lever lock engages properly and that the brake (when engaged) locks the wheels.

1. Pump the brake lever 2 or 3 times.
2. Engage the brake lever lock.
3. Attempt to push the ATV.

■ **NOTE:** The brake lever lock must lock the wheels. If it doesn't, take the ATV to an authorized Arctic Cat ATV dealer for service.

Brake Hoses

Carefully inspect the hydraulic brake hoses for cracks or other damage. If found, take the ATV to an authorized Arctic Cat ATV dealer to have the brake hoses replaced.

Brake Pads

The clearance between the brake pads and brake discs is adjusted automatically as the brake pads wear. The only maintenance that is required is replacement of the brake pads when they show excessive wear. Check the thickness of each of the brake pads as follows:

1. Remove a front wheel.
2. Measure the thickness of each brake pad.

- If thickness of either brake pad is less than 1.0 mm (0.039 in.), take the ATV to an authorized Arctic Cat ATV dealer to have brake pads replaced.

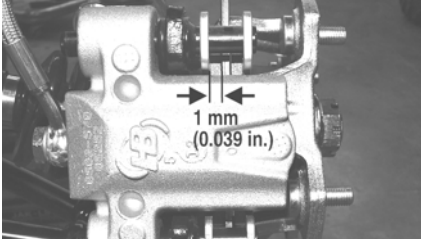

PR376B

- Install the wheel and tighten using a crisscross pattern to 40 ft-lb (steel wheels) or 80 ft-lb (aluminum wheels).

Rear Foot Brake

The rear foot brake must be maintained to be fully functional.

WARNING

Be sure to inspect the rear foot brake system before each use. Always maintain brakes according to the Maintenance Schedule.

- Check the brake fluid level in the reservoir. The fluid level must be maintained between the MAX and MIN level marks. If the level in the reservoir is low, add DOT 4 brake fluid.

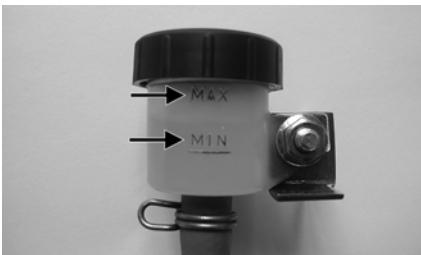

CD474A

■ **NOTE:** The brake fluid reservoir is located under the seat.

- Press the rear foot brake pedal several times to check for firmness.

- If the brake is not firm, the system must be bled.

■ **NOTE:** Take the ATV to an authorized Arctic Cat ATV dealer for this service.

Protective Rubber Boots

The protective boots should be inspected periodically according to the Maintenance Schedule.

Ball Joint Boots (Upper and Lower/Right and Left)

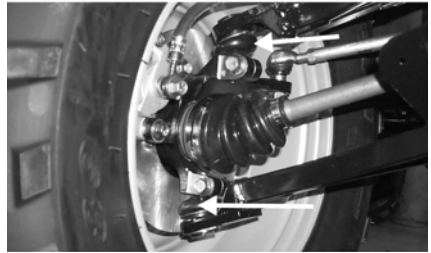

CC791

- Secure the ATV on a support stand to elevate the front wheels.
- Remove both front wheels.
- Inspect the four ball joint boots for cracks, tears, or perforations.
- Check the ball joint for free-play by grasping the steering knuckle and turning it from side to side and up and down.
- If boot damage is present or ball joint free-play seems excessive, contact an authorized Arctic Cat ATV dealer for service.

Tie Rod Boots (Inner and Outer/Right and Left)

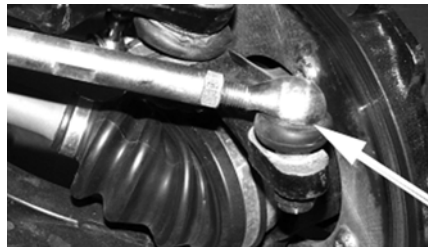

CC792

1. Secure the ATV on a support stand to elevate the front wheels.
2. Remove both front wheels.
3. Inspect the four tie rod boots for cracks, tears, or perforations.
4. Check the tie rod end free-play by grasping the tie rod near the end and attempting to move it up and down.
5. If boot damage is present or tie rod end free-play seems excessive, contact an authorized Arctic Cat ATV dealer for service.

Drive Axle Boots

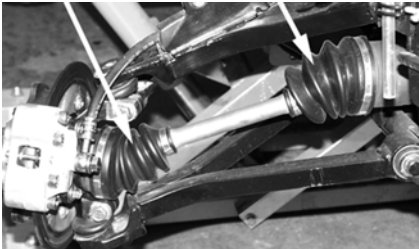

CC793

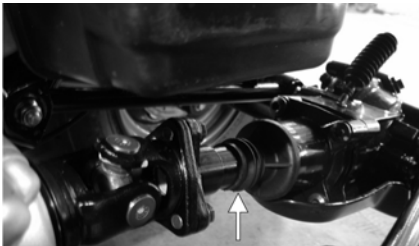

CF125A

1. Inspect all drive axle boots for cracks, tears, or perforations.
2. If boot damage is present, contact an authorized Arctic Cat ATV dealer for service.

Battery

The battery is located under the seat.

After being in service, batteries require regular cleaning and recharging in order to deliver peak performance and maximum service life. The following procedures are recommended for cleaning and maintaining lead-acid batteries. Always read and follow instructions provided with battery chargers and battery products.

■ **NOTE: Refer to all warnings and cautions provided with the battery or battery maintainer/charger.**

Loss of battery charge may be caused by ambient temperature, ignition OFF current draw, corroded terminals, self discharge, frequent start/stops, and short engine run times. Frequent winch usage, snowplowing, extended low RPM operation, short trips, and high amperage accessory usage are also reasons for battery discharge.

Maintenance Charging

■ **NOTE: Arctic Cat recommends the use of the CTEK Multi US 800 or the CTEK Multi US 3300 for battery maintenance charging. Maintenance charging is required on all batteries not used for more than two weeks or as required by battery drain.**

1. When charging a battery in the vehicle, be sure the ignition switch is in the OFF position.
2. Clean the battery terminals with a solution of baking soda and water.

■ **NOTE: The sealing strip should NOT be removed and NO fluid should be added.**

3. Be sure the charger and battery are in a well-ventilated area. Be sure the charger is unplugged from the 110-volt electrical outlet.
4. Connect the red terminal lead from the charger to the positive terminal of the battery; then connect the black terminal lead of the charger to the negative terminal of the battery.

■ **NOTE:** Optional battery charging adapters are available from your authorized Arctic Cat dealer to connect directly to your vehicle from the recommended chargers to simplify the maintenance charging process. Check with your authorized Arctic Cat dealer for proper installation of these charging adapter connectors.

5. Plug the battery charger into a 110-volt electrical outlet.
6. If using the CTEK Multi US 800, there are no further buttons to push. If using the CTEK Multi US 3300, press the Mode button (A) at the left of the charger until the Maintenance Charge Icon (B) at the bottom illuminates. The Normal Charge Indicator (C) should illuminate on the upper portion of the battery charger.



800E

■ **NOTE:** The maintainer/charger will charge the battery to 95% capacity at which time the Maintenance Charge Indicator (D) will illuminate and the maintainer/charger will change to pulse/float maintenance. If the battery falls below 12.9 DC volts, the charger will automatically start again at the first step of the charge sequence.



3300A

■ **NOTE:** Not using a battery charger with the proper float maintenance will damage the battery if connected over extended periods.

Charging

■ **NOTE:** Arctic Cat recommends the use of the CTEK Multi US 800 or the CTEK Multi US 3300 for battery maintenance charging.

1. Be sure the battery and terminals have been cleaned with a baking soda and water solution.

■ **NOTE:** The sealing strip should **NOT** be removed and **NO** fluid should be added.

2. Be sure the charger and battery are in a well-ventilated area. Be sure the charger is unplugged from the 110-volt electrical outlet.
3. Connect the red terminal lead from the charger to the positive terminal of the battery; then connect the black terminal lead of the charger to the negative terminal of the battery.
4. Plug the charger into a 110-volt electrical outlet.
5. By pushing the Mode button (A) on the left side of the charger, select the Normal Charge Icon (E). The Normal Charge Indicator (C) should illuminate on the upper left portion of the charger.
6. The battery will charge to 95% of its capacity at which time the Maintenance Charge Indicator (D) will illuminate.

■ **NOTE:** For optimal charge and performance, leave the charger connected to the battery for a minimum 1 hour after the Maintenance Charge Indicator (D) illuminates. If the battery becomes hot to the touch, stop charging. Resume after it has cooled.

7. Once the battery has reached full charge, unplug the charger from the 110-volt electrical outlet.

■ **NOTE:** If, after charging, the battery does not perform to operator expectations, bring the battery to an authorized Arctic Cat dealer for further troubleshooting.

Jump-Starting

■ **NOTE:** Arctic Cat does not recommend jump-starting a vehicle with a dead battery but rather to remove the battery, service it, and correctly charge it; however, in an emergency, it may be necessary to jump-start a vehicle. If so, use the following procedure to carefully and safely complete this procedure.

WARNING

Improper handling or connecting of a battery may result in serious injury including acid burns, electrical burns, or blindness as a result of an explosion. Always remove rings and watches.

1. On the vehicle to be jump-started, remove the battery cover and any terminal boots.

WARNING

Any time service is performed on a battery, the following must be observed: keep sparks, open flame, cigarettes, or any other flame away. Always wear safety glasses. Protect skin and clothing when handling a battery. When servicing battery in enclosed space, keep the area well-ventilated. Make sure battery venting is not obstructed.

2. Inspect the battery for any signs of electrolyte leaks, loose terminals, or bulging sides. Leaking or bulging battery cases may indicate a frozen or shorted battery.

WARNING

If any of these conditions exist, DO NOT attempt a jump-start, boost, or charge the battery. An explosion could occur causing serious injury.

3. Inspect the vehicle to be used for jump-starting to determine if voltage and ground polarity are compatible. The vehicle must have a 12-volt DC, negative ground electrical system.

CAUTION

Always make sure the electrical systems are of the same voltage and ground polarity prior to connecting jumper cables. If not, severe electrical damage may occur.

4. Move the vehicle to be used for the jump-start close enough to ensure the jumper cables easily reach; then shift into neutral, set and lock the brakes, shut off all electrical accessories, and turn the ignition switch OFF.

■ **NOTE:** Make sure all switches on the vehicle to be jump-started are turned OFF.

5. Disconnect all external accessories such as cell phones, GPS units, and radios on both vehicles.

CAUTION

Failure to disconnect electronic accessories during jump-starting may cause system damage due to power spikes.

6. Attach one clamp of the positive (red) jumper cable to the positive (+) terminal (1) of the dead battery (C) being careful not to touch any metal with the other clamp; then attach the other clamp of the positive (red) jumper cable to the positive (+) terminal (2) of the good battery (B).

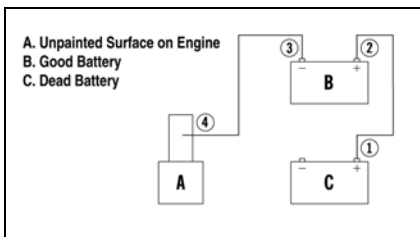

0744-527

■ **NOTE:** Some jumper cables may be the same color but the clamps or ends will be color-coded red and black.

- Attach one clamp of the negative (black) jumper cable to the negative (-) terminal (3) of the good battery (B); then attach the other clamp of the negative (black) jumper cable (4) to an unpainted metal surface (A) on the engine or frame well away from the dead battery and fuel system components.

WARNING

Never make the final connection to a battery as a spark could ignite hydrogen gases causing an explosion of the battery resulting in acid burns or blindness.

- Stand well away from the dead battery and start the vehicle with the good battery. Allow the vehicle to run for several minutes applying some charge to the dead battery.
- Start the vehicle with the dead battery and allow it to run for several minutes before disconnecting the jumper cables.
- Remove the jumper cables in opposite order of hook-up (4, 3, 2, 1). Be careful not to short cables against bare metal.

■ **NOTE:** Have the battery and electrical system checked prior to operating the vehicle again.

Spark Plug

The ATV comes equipped with a specified spark plug. See the Specifications chart for the correct spark plug and the correct gap. A light brown insulator indicates that the plug is correct. A white or dark insulator indicates that the engine may need to be serviced or the carburetor (on the 350) may need to be adjusted. Consult an authorized Arctic Cat ATV dealer if the plug insulator is not a light brown color.

To help prevent cold weather fouling, make sure to thoroughly warm up the engine before operating. To maintain a hot, strong spark, keep the plug free of carbon.

Before removing the spark plug, be sure to clean the area around the spark plug. If you do not, dirt could enter engine when removing or installing the spark plug.

Adjust to the recommended gap for proper ignition. Use a wire-type feeler gauge to check the gap.

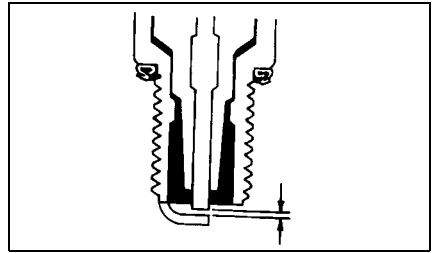

ATV-0052

When installing the spark plug, be sure to tighten it securely. A new spark plug should be tightened 1/2 turn once the washer contacts the cylinder head. A used spark plug should be tightened 1/8-1/4 turn once the washer contacts the cylinder head.

Engine Idle RPM Adjustment (350)

To properly adjust the idle, a tachometer is necessary. If one is not available, take the ATV to an authorized Arctic Cat ATV dealer.

- Start the engine and warm it up to normal operating temperature.
- Remove the seat; then turn the idle adjustment screw in or out until the engine idles at 1250-1350 RPM.



KC356A

⚠ WARNING

Adjust the idle to the correct RPM. Make sure the engine is at normal operating temperature before adjusting the idle RPM.

Throttle Cable Adjustment

To adjust the throttle cable free-play:

1. Loosen the jam nut from the throttle cable adjuster.
2. Slide the rubber boot away and turn the adjuster until the throttle lever has the proper free-play of 3-6 mm (1/8-1/4 in.).

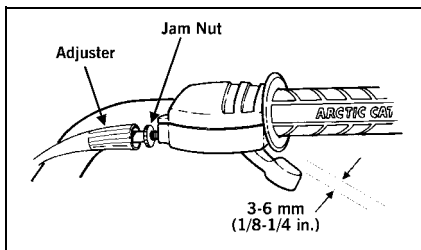

ATV-0047

3. Tighten the knurled nut against the throttle cable adjuster securely; then slide the rubber boot over the adjuster.

Air Filter

The air filter inside the air filter housing must be kept clean to provide good engine power and gas mileage. If the ATV is used under normal conditions, service the filter at the intervals specified. If operated in dusty, wet, or muddy conditions, inspect and service the filter more frequently. Use the following procedure to remove the filter and inspect and/or clean it.

1. Rotate the three latches to release the filter housing cover; then loosen the inlet boot clamp.

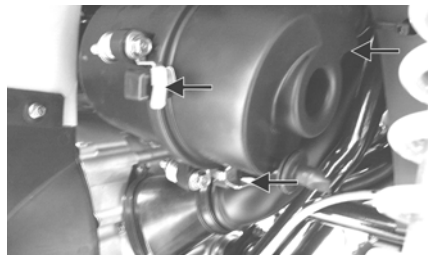

KC0056A



KC0056B

2. Remove the filter housing cover and air filter element.
3. Fill a wash pan larger than the element with a non-flammable solvent; then dip the element in the solvent and wash it.
4. Squeeze the element by pressing it between the palms of both hands to remove excess solvent. Do not twist or ring the element or it will develop cracks.
5. Dry the element.
6. Put the element in a plastic bag; then pour in air filter oil and work the oil into the element.
7. Squeeze the element to remove excess oil.

CAUTION

A torn air filter can cause damage to the ATV engine. Dirt and dust may get inside the engine if the element is torn. Carefully examine the element for tears before and after cleaning it. Replace the element with a new one if it is torn.

- Clean any dirt or debris from inside the air cleaner. Be sure no dirt enters the carburetor.
- Install the air filter and cover.
- Connect the inlet boot and tighten the clamp securely.



KC0056B

Air Filter Housing Drain

Inspect the “duck bill” drain in front of the main housing for debris and for proper sealing.

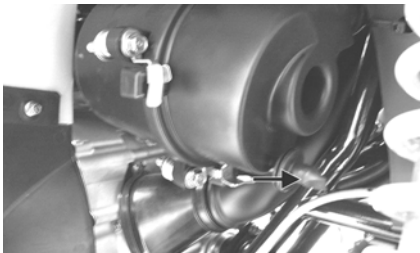

KC0056C

Draining V-Belt Cover

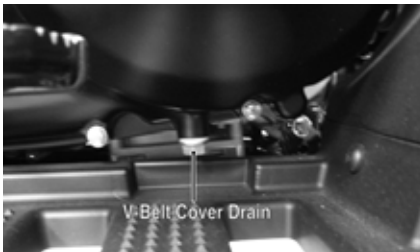

KC0049A

■ **NOTE:** If the ATV has been driven through water, the V-belt cover must be drained of any water.

- Place the ATV on a level surface.

- Remove the drain bolt from the cover and allow the water to drain out.
- Shift the range lever to the neutral position; then start the engine.
- Increase and decrease engine RPM several times to “blow out” any water; then stop the engine.
- Install the drain bolt and tighten securely.

■ **NOTE:** The V-belt and pulleys should be inspected every 500 miles and the belt replaced (if necessary).

Tires

WARNING

Always use the size and type of tires as specified. Refer to the Specifications chart for proper tire inflation pressure, and always maintain proper tire inflation pressure.

Tire Tread Condition

The use of worn-out tires on an ATV is very dangerous. A tire is considered to be worn out when the depth of the tread is less than 3 mm (1/8 in.). Be sure to replace the tires before reaching this minimum specification.

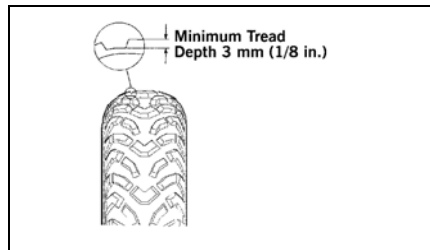

0732-649

WARNING

The use of worn-out tires is dangerous and can increase the risk of an accident.

Tire Replacement

The ATV has low-pressure tubeless tires. Air is sealed by the contact surfaces of the inner wheel rim and the tire bead. If either the inner wheel rim or tire bead is damaged, air may leak. Be extremely careful not to damage these areas when replacing tires.

It is very important to use the proper tools when repairing or replacing tires to prevent damage to the tire bead or wheel rims. If proper tools and related items are not available, have this maintenance performed by an authorized Arctic Cat ATV dealer or a qualified tire repair station.

CAUTION

When breaking the tire bead loose from the wheel, be extremely careful not to damage the inner wheel surface or the tire bead.

WARNING

Use only Arctic Cat approved tires when replacing tires. Failure to do so could result in unstable ATV operation.

Tubeless Tire Repair

Should a leak or flat tire occur due to a puncture, the tire may be repaired using a plug-type repair. If the damage is from a cut or if the puncture cannot be repaired using a plug, the tire must be replaced. When operating the ATV in areas where transportation or service facilities are not readily available, it is strongly recommended to carry a plug-type repair kit and a tire pump along.

Wheels

1. Park the ATV on level ground and engage the brake lever lock.
2. Loosen the lug nuts on the wheel to be removed.
3. Elevate the ATV.
4. Remove the lug nuts.
5. Remove the wheel.
6. Install the wheel and install the lug nuts.

7. Tighten the nuts in a crisscross pattern to 40 ft-lb (steel wheels) or 80 ft-lb (aluminum wheels).
8. Remove the jack.

Muffler/Spark Arrester

The muffler has a spark arrester which must be periodically cleaned. At the intervals shown in the Maintenance Schedule, clean the spark arrester using the following procedure.

WARNING

Wait until the muffler cools to avoid burns.

1. Remove the cap screws securing the spark arrester assembly to the muffler; then remove the spark arrester.

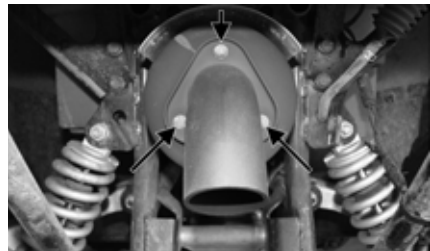

KC334A

2. Using a suitable brush, clean the carbon deposits from the screen taking care not to damage the screen.

■ **NOTE:** If the screen or gasket is damaged in any way, it must be replaced.

3. Install the spark arrester assembly and secure with the cap screws. Tighten securely.

Light Bulb Replacement

The wattage rating of each bulb is shown in the chart. When replacing a burned bulb, always use the same wattage rating.

Headlight	12V/35W (4)
Taillight/Brakelight	12V/5W/21W

CAUTION

Use only specified bulbs indicated in the chart as replacement bulbs.

■ **NOTE:** The bulb portion of the headlight is fragile. **HANDLE WITH CARE.** When replacing the headlight bulb, do not touch the glass portion of the bulb. If the glass is touched, it must be cleaned with a dry cloth before installing. Skin oil residue on the bulb will shorten the life of the bulb.

To replace the headlight bulb, use the following procedure.

1. Remove the wiring harness connector from the back of the headlight.
2. Grasp the bulb housing, turn it counterclockwise, and remove the bulb.
3. Install the new bulb into the housing and rotate it completely clockwise.
4. Install the wiring harness connector.

CAUTION

When replacing the headlight bulb, be careful not to touch the glass portion of the bulb. Grasp the new bulb with a clean cloth.

To replace the taillight/brakelight bulb, use the following procedure.

1. Rotate the socket counterclockwise and remove it from the housing.
2. To remove the bulb from the socket, push in and rotate counterclockwise.
3. To install the bulb, push in and turn clockwise.
4. Insert the socket into the housing and rotate it clockwise.

To replace the running lights, use the following procedure.

1. Pull the bulb socket from the running light housing and remove the bulb by pulling it from the socket.
2. Push a new bulb into the socket and press the socket into the running light housing.

Checking/Adjusting Headlight Aim

The headlights can be adjusted vertically and horizontally. The geometric center of the HIGH beam light zone is to be used for vertical and horizontal aiming.

1. Position the ATV on a level floor so the headlights are approximately 6.1 m (20 ft) from an aiming surface (wall or similar aiming surface).

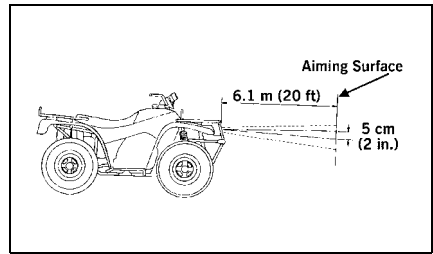

ATV-0070

■ **NOTE:** There should be an average operating load on the ATV when adjusting the headlight aim.

2. Measure the distance from the floor to the mid-point of each headlight.
3. Using the measurements obtained in step 2, make horizontal marks on the aiming surface.
4. Make vertical marks which intersect the horizontal marks on the aiming surface directly in front of the headlights.
5. Switch on the lights. Make sure the HIGH beam is on. **DO NOT USE LOW BEAM.**
6. Observe each headlight beam aim. Proper aim is when the most intense beam is centered on the vertical mark 5 cm (2 in.) below the horizontal mark on the aiming surface.
7. Adjust each headlight until correct aim is obtained by turning the adjuster clockwise to lower or counterclockwise to raise the beam.

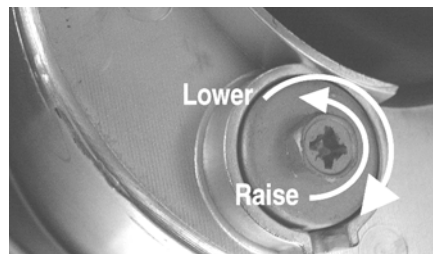

KC0108A

Fuses

The fuses are located in a power distribution module in front of the steering post under the electrical access panel. If there is any type of electrical system failure, always check the fuses first.

■ **NOTE:** To remove the fuse, compress the locking tabs on either side of the fuse cover and lift out.

350

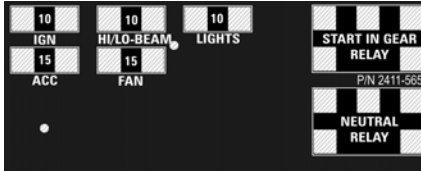

2411-565

425

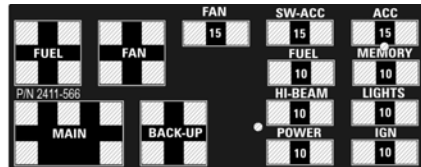

2411-566

CAUTION

Always replace a blown fuse with a fuse of the same type and rating. If the new fuse blows after a short period of use, consult an authorized Arctic Cat ATV dealer immediately.

Tools

A basic tool kit is provided with the ATV. Maintain the tool kit with the ATV at all times.



KC0042B

Preparation for Storage

CAUTION

Prior to storing the ATV, it must be properly serviced to prevent rusting and component deterioration.

Arctic Cat recommends the following procedure to prepare the ATV for storage. An authorized Arctic Cat ATV dealer should perform this service; however, the owner/operator may perform this service if desired.

1. Clean the seat cushion (cover and base) with a damp cloth and allow to dry.
2. Clean the ATV thoroughly by washing dirt, oil, grass, and other foreign matter from the entire ATV. Allow the ATV to dry thoroughly. DO NOT get water into any part of the engine or air intake.
3. Either drain the gas tank or add a fuel stabilizer to the gas in the gas tank. Remove the air filter housing cover and air filter. Start the engine and allow it to idle; then using Arctic Cat Engine Preserver, rapidly inject the preserver into the air filter opening for a period of 10 to 20 seconds. Install the air filter and housing cover.

CAUTION

If the interior of the air filter housing is dirty, clean the area before starting the engine.

4. On the 350, drain the carburetor float bowl.
5. Plug the hole in the exhaust system with a clean cloth.
6. Apply light oil to the upper steering post bushing and plungers of the shock absorbers.
7. Tighten all nuts, bolts, cap screws, and screws. Make sure rivets holding components together are tight. Replace all loose rivets. Care must be taken that all calibrated nuts, cap screws, and bolts are tightened to specifications.
8. On the 425, fill the cooling system to the bottom of the stand pipe in the radiator neck with properly mixed coolant.

■ NOTE: For storage, use a battery maintainer or make sure the battery is fully charged (see Battery section in this manual).

9. Disconnect the battery cables (negative cable first); then remove the battery, clean the battery posts and cables, and store in a clean, dry area.
10. Store the ATV indoors in a level position.

CAUTION

Avoid storing outside in direct sunlight and avoid using a plastic cover as moisture will collect on the ATV causing rusting.

Preparation after Storage

Taking the ATV out of storage and correctly preparing it will assure many miles and hours of trouble-free riding. Arctic Cat recommends the following procedure to prepare the ATV.

1. Clean the ATV thoroughly.
2. Clean the engine. Remove the cloth from the exhaust system.
3. Check all control wires and cables for signs of wear or fraying. Replace if necessary.
4. Change the engine/transmission oil and filter.
5. On the 425, check the coolant level and add properly mixed coolant as necessary.
6. Charge the battery; then install. Connect the battery cables making sure to connect the positive cable first.
7. Check the entire brake systems (fluid level, pads, etc.), all controls, headlights, taillight, brakelight, and headlight aim; adjust or replace if necessary.
8. Check the tire pressure. Inflate to recommended pressure as necessary.
9. Tighten all nuts, bolts, cap screws, and screws making sure all calibrated nuts, cap screws, and bolts are tightened to specifications.
10. Make sure the steering moves freely and does not bind.
11. Check the spark plug. Clean or replace as necessary.
12. Follow the recommendations found in the pre-start inspection.

CAUTION

Before installing the battery, make sure the ignition switch is in the OFF position.

Maintenance Record

DATE	MILEAGE	SERVICE PERFORMED/NOTES

Limited Warranty

Arctic Cat Inc. (hereinafter referred to as Arctic Cat) extends a limited warranty on each new Arctic Cat ATV it assembles and on each genuine Arctic Cat ATV part and accessory assembled or sold by an authorized Arctic Cat ATV dealer. Warranty on an Arctic Cat ATV is extended to the original retail purchaser; however, the balance of the unused warranty may be transferred to another party. Warranty coverage is only available in the country in which the original retail purchase occurs to the original retail purchaser resident in that country or to a transferee resident in that country of the balance of the unused warranty.

Arctic Cat warrants only the products it assembles and/or sells and does not warrant that other products will function properly when used with an Arctic Cat ATV or will not damage the ATV. Arctic Cat does not assume any liability for incidental or consequential damages.

Arctic Cat will repair or replace, at its option, free of charge (including any related labor charges), any parts that are found to be warrantable in material or workmanship. This repair work **MUST** be done by an authorized Arctic Cat ATV dealer. No transportation charges, rental charges, or inconvenience costs will be paid by Arctic Cat. The warranty is validated upon examination of said parts by Arctic Cat or an authorized Arctic Cat ATV dealer. Arctic Cat reserves the right to inspect such parts at its factory for final determination if warranty should apply.

The warranty periods are as follows:

1. Six months from the date of sale — for an Arctic Cat ATV used for recreational purposes.
2. Ninety days from date of invoice — for an Arctic Cat ATV used for commercial purposes, including rental operations (non-transferable).
3. Thirty days from date of sale of ATV on Arctic Cat supplied batteries.
4. Thirty days from date of sale — for all dealer installed genuine Arctic Cat service parts and accessories.
5. Until expiration of the new product warranty (paragraphs 1 and 2 above) — for all eligible replacement parts on new product.

Exclusions to this warranty include normal wear, abuse, or corrosion and the following parts and items:

Tires	CV Boots	Torn or Punctured Upholstery
Oil Filter	Drive Belt	Cracks or Gouges in Body Panels
Air Filter	Brake Pads	Drive/Driven Clutch Wear Parts
Light Bulbs	Spark Plug(s)	

The following will VOID Arctic Cat's warranty:

1. Failure to perform the proper break-in procedure and all related maintenance, storage procedures (if stored for extended periods), and/or service as recommended in the Operator's Manual.
2. Repairs and/or adjustments by anyone other than an authorized Arctic Cat ATV dealer.
3. Use of improper carburetor main jets.
4. Use of improper gasoline, lubricating oils, or spark plug.
5. An accident or subjecting the ATV to misuse, abuse, or negligent operation.
6. Any modification, addition, or removal of parts unless instructed to do so by Arctic Cat.
7. Use of the ATV in any way for racing purposes.
8. Removal of the engine for use in another vehicle.
9. Removal or mutilation of the Vehicle Identification Number or Engine Serial Number.
10. Use of parts not sold or approved by Arctic Cat.
11. Damage due to improper transportation.

In consideration of the foregoing, any implied warranty is limited in duration to the various warranty periods set forth. This warranty gives you specific legal rights, and you may also have other rights which vary from state/province to state/province or country to country. Some jurisdictions do not allow limitations on how long an implied warranty lasts, so the above limitations may not apply to you.

Warranty Procedure/Owner Responsibility

At the time of sale, an ATV Rider Training Certificate and Owner Registration form is to be completed by the selling dealer and consumer. The receipt of the form by Arctic Cat is a condition precedent to warranty coverage. It is the selling dealer's responsibility to retain and/or submit appropriate copies of the form to the appropriate place(s) to initiate warranty coverage.

The dealer will furnish to the consumer a signed copy of the form which must be presented to the dealer when requesting warranty service. The registration form is the consumer's proof of ownership and warranty eligibility. The form is used by the dealer to validate the warranty claim. Retain your copy of the form and keep it in a safe place.

When warranty repair is suspected, the ATV should be taken to the selling dealer, who has the primary responsibility to perform warranty repairs. Subject to the limitations set forth in the Limited Warranty, in the event the selling dealer has ceased to do business, you have moved, or you are in a location away from your selling dealer, warranty may be performed by any authorized Arctic Cat ATV dealer.

The authorized Arctic Cat ATV dealer will examine the ATV or part to determine if, in his opinion, a warrantable condition exists. If a warrantable condition appears to exist, the dealer will repair or replace, at Arctic Cat's option, free of charge, including any related labor costs, all parts that are found to be warrantable and any other parts which the warrantable part caused to be damaged. You, the owner, will then be asked to sign a warranty form to ensure Arctic Cat that the warranty work was actually performed.

It is the owner's responsibility to maintain and service the ATV in accordance with Arctic Cat's recommendations in the Operator's Manual. To protect yourself and your ATV, follow all safety and service tips. Arctic Cat will NOT warrant repairs required as a result of not performing standard operator maintenance, storage procedures, and service as outlined in the Operator's Manual.

Should you have any questions concerning the warranty, contact an authorized Arctic Cat ATV dealer.

Change of Address, Ownership, or Warranty Transfer

Arctic Cat Inc. keeps on file the current name and address of the owner of this ATV. This will allow Arctic Cat to reach the current owner with any important safety information which may be necessary to protect customers from injury or property damage. Please make sure a copy of this form is completed and returned to Arctic Cat Inc. if you move or if the ATV is sold to another party.

This form may also be used to transfer the unused portion of the original warranty to a second party. In order to transfer warranty, fill out this form completely; then return a copy of this form to Arctic Cat Inc. Arctic Cat will then process the application and issue warranty for the balance of the time remaining of the original warranty.

Address Change

Ownership Change

Warranty Transfer

CHANGE OF ADDRESS/OWNERSHIP/ WARRANTY TRANSFER TO:

Name _____

Address _____

City/State (Province)/Zip Code (Postal Code) _____

Phone # () _____

Year and Model ATV _____

Vehicle Identification Number (VIN) _____

Before operating, you should take an ATV Rider Course to learn ATV riding skills or reinforce your current good riding skills. In U.S.A., call 1-800-887-2887 to enroll in the half-day ATV Rider Course nearest you or ask your dealer for assistance. The course instructor will charge a small fee for each person taking the course. In Canada, call (613) 739-1535.

Fold Back

Place
Stamp
Here

CHANGE OF ADDRESS/OWNERSHIP

ARCTIC CAT INC.
PRODUCT SERVICE AND
WARRANTY DEPT.
P.O. BOX 810
THIEF RIVER FALLS, MN 56701

Arctic Cat ATV Emission Control Warranty Statement

Warranty Rights and Obligations

Arctic Cat Inc. (hereinafter referred to as Arctic Cat) and the California Air Resources Board are pleased to explain the emission control system warranty for each new Arctic Cat ATV sold in the state of California. In California, a new ATV must be designed, built, and equipped to meet the state's stringent anti-smog standards.

Arctic Cat warrants the emission control system on the Arctic Cat ATV for the periods listed below provided there has been no abuse, neglect, or improper maintenance of the ATV.

The emission control system may include components such as the carburetor, ignition system, and crankcase ventilation system. Also included may be hoses, belts, connectors, and other emission-related assemblies.

When a warrantable condition exists, Arctic Cat will repair the ATV at no cost to the owner, including diagnosis, parts, and labor.

Emission Control Warranty Coverage

A new Arctic Cat ATV manufactured after January 1, 1997 has a two (2) year warranty on its emissions control components.

If an emission-related component on the ATV is defective, the component will be repaired or replaced by any authorized Arctic Cat ATV dealer.

Owner's Emission Control Warranty Responsibilities

It is the owner's responsibility to perform the required maintenance listed in the Operator's Manual. Arctic Cat recommends the retention of all receipts covering maintenance performed on the ATV, but Arctic Cat cannot deny warranty solely for the lack of receipts or for failure to ensure the performance of all scheduled maintenance on the emission control system.

It is the owner's responsibility to present the ATV to an authorized Arctic Cat ATV dealer as soon as a problem exists. The undisputed warranty repairs should be completed within a reasonable period of time, not to exceed thirty days.

The ATV owner should be aware that Arctic Cat may deny warranty coverage if either the ATV or a component has failed due to abuse, neglect, improper maintenance, or any unapproved modifications.

If you have any questions regarding your warranty rights and responsibilities, contact either Arctic Cat Inc, P.O. Box 810, Thief River Falls, MN 56701, (218) 681-4999 or the California Air Resources Board, 9528 Telstar Avenue, El Monte, CA 91731, (818) 575-6800.

Arctic Cat Emission Control System Limited Warranty

Arctic Cat Inc., P.O. Box 810, Thief River Falls, MN 56701 (hereinafter referred to as Arctic Cat) warrants that this new Arctic Cat ATV manufactured on or after January 1st, 1997:

- A. Is designed, built, and equipped so as to conform at the time of initial purchase with all applicable regulations of the California Air Resources Board and
- B. Is free from defects in material and workmanship which could cause such ATV to fail to conform with applicable regulations of the California Air Resources Board for a period of use of two (2) years from the date of initial retail delivery.

Coverage

Warranty defects shall be remedied during customary business hours at any authorized Arctic Cat ATV dealer located within the state of California in compliance with applicable regulations of the California Air Resources Board. Any component or components replaced under this warranty shall become the property of Arctic Cat.

In California, emission related warranted components are specifically defined by the state's Emission Warranty Parts List. These warranted components are carburetor and internal components, intake manifold, fuel injection system, spark advance mechanism, crankcase breather, air cutoff valve, fuel/vapor separator, canister, igniters, breaker governors, ignition coils, ignition wires, ignition points, condensers and spark plugs if failure occurs prior to the first scheduled replacement, and hoses, clamps, and fittings used directly in these parts. Since emission related components may vary from model to model, certain models may not contain all of these components, and certain models may contain functionally equivalent components.

In California, emission control system emergency repairs, as provided for in the California Administrative Code, may also be performed by other than an authorized Arctic Cat ATV dealer. An emergency situation occurs when an authorized Arctic Cat ATV dealer is not reasonably available, a component is not available within thirty (30) days, or a repair is not complete within thirty (30) days. Any replacement component can be used in an emergency repair. Arctic Cat will reimburse the owner for the expenses, including diagnosis, not to exceed suggested retail price as set forth by Arctic Cat for all warranted components replaced and labor charges based on the recommended time allowance set forth by Arctic Cat for the warranty repair and the geographically appropriate hourly labor rate. The owner may be required to keep receipts and failed components in order to receive compensation.

Limitations

This Emission Control System Warranty shall not cover any of the following:

- A. Repair or replacement required as a result of
 - (1) accident,
 - (2) misuse,
 - (3) lack of required maintenance,
 - (4) repairs improperly performed or replacements improperly installed,
 - (5) use of replacement components or accessories not conforming to Arctic Cat specifications which adversely affect performance, and/or
 - (6) use in competitive racing or related events.
- B. Inspections, replacement of components, and other services or adjustments necessary for required maintenance.

Limited Liability

The liability of Arctic Cat under this Emission Control System Warranty is limited solely to the remedying of defects in material and workmanship by an authorized Arctic Cat ATV dealer at its place of business during customary business hours. This warranty does not cover inconvenience or loss of use of the ATV or transportation of the ATV to or from the Arctic Cat ATV dealer.

ARCTIC CAT SHALL NOT BE LIABLE FOR ANY OTHER EXPENSES, LOSS, OR DAMAGE, WHETHER DIRECT, INCIDENTAL, CONSEQUENTIAL, OR EXEMPLARY, ARISING IN CONNECTION WITH THE SALE OR USE OF, OR INABILITY TO USE THE ARCTIC CAT ATV FOR ANY PURPOSE. SOME STATES DO NOT ALLOW THE EXCLUSION OR LIMITATION OF ANY INCIDENTAL OR CONSEQUENTIAL DAMAGES, SO THE ABOVE MAY NOT APPLY TO YOU.

NO EXPRESS EMISSION CONTROL SYSTEM WARRANTY IS GIVEN BY ARCTIC CAT EXCEPT AS SPECIFICALLY SET FORTH HEREIN. ANY EMISSION CONTROL SYSTEM WARRANTY IMPLIED BY LAW, INCLUDING ANY WARRANTY OF MERCHANTABILITY OR FITNESS FOR A PARTICULAR PURPOSE, IS LIMITED TO THE EXPRESS EMISSION CONTROL SYSTEM WARRANTY TERMS STATED IN THIS WARRANTY. THE FOREGOING STATEMENTS OF WARRANTY ARE EXCLUSIVE AND IN LIEU OF ALL OTHER REMEDIES.

No dealer is authorized to modify this Arctic Cat Inc. Limited Emission Control System Warranty.

Legal Rights

THIS WARRANTY GIVES YOU SPECIFIC LEGAL RIGHTS, AND YOU MAY ALSO HAVE OTHER RIGHTS WHICH VARY FROM STATE TO STATE.

THIS WARRANTY IS IN ADDITION TO THE ARCTIC CAT INC. LIMITED ATV WARRANTY.

Additional Information

Any replacement component that is equivalent in performance and durability may be used in the performance of any maintenance or repairs. However, Arctic Cat is not liable for these components. The owner is responsible for the performance of all required maintenance. Such maintenance may be performed at a service establishment or by any individual. The warranty period begins on the date the ATV is delivered to the owner.

U.S. EPA Emission Control Statement/ Warranty Coverage - ATV (U.S. Only)

Statement/Warranty

Arctic Cat warrants to the original retail purchaser, and each subsequent purchaser, that all U.S. EPA-certified Arctic Cat ATV's are designed, built, and equipped to conform to all U.S. EPA Emission Control Regulations. Please read the following information completely.

Your authorized Arctic Cat ATV dealer will repair or replace any defective emission-related component at no cost to you during the warranty period. You may have non-warranty service performed by any repair establishment that uses equivalent components. The regulations provide significant civil penalties for tampering that causes your ATV to no longer meet U.S. EPA emission standards.

Arctic Cat further warrants that the engine and its emission-related components are free from defects in materials or workmanship that could cause the engine to fail to comply with applicable regulations during the warranty period.

If you have any questions about this information, or the emission warranty coverage statement, contact your local authorized Arctic Cat ATV dealer.

Warranty Period

The emission warranty period for this ATV begins on the same date as the standard warranty coverage and continues for 30 months or 3100 miles, whichever comes first.

Components Covered

The emissions warranty covers major emissions control components and emission-related components listed as follows:

Engine Management and Sensors

- Barometric Pressure Sensor
- Camshaft Position Sensor
- Engine Control Unit (ECU)
- Engine Coolant Temperature Sensor
- Intake Air Temperature Sensor
- Manifold Absolute Pressure Sensor
- Oxygen Sensor
- Throttle Position Sensor
- Crankshaft Position Sensor
- Exhaust Temperature Sensor
- Crankshaft Position Sensor

Ignition System

- Ignition Coil
- Knock Sensor System
- Spark Plugs
- Capacitive Discharge Ignition (CDI) Module
- Magneto Pick-Up

Fuel/Air System

- Fuel Injectors
- Fuel Pressure Regulator
- Fuel Pump
- Carburetor(s)
- Turbocharger Assembly
- Air Bypass Valve
- Turbo Waste Gate Control Valve
- Crankcase Ventilation System
- ISC Valve

Miscellaneous Items Used in Aforementioned Systems

- Connectors
- Switches
- Grommets
- Clamps
- Hoses
- Ties
- Gaskets
- Wiring

Owner's Responsibilities

The owner of any ATV warranted under this Arctic Cat Emission Control Statement is responsible for the proper maintenance and use of the ATV as stated in the Operator's Manual. Proper maintenance generally includes replacement and service, at the owner's choosing, such items as air filter, oil and oil filter, or any other part, item, or device related to emissions control as specified in the Operator's Manual. It is the owner's responsibility to ensure that the ATV is used in a manner for which it was designed.

Declaration Of Conformity

Application of council directives:

EMC Directive 97/24/EC
Date of Issue: June, 1997
EC Machinery Directive 2006/42/EC
Date of Issue: May, 2006

Issued by European Commission.

Type of Equipment: All-Terrain Vehicles

Brand Name: Arctic Cat

Model: 350 4x4 425 4x4

Standards to which conformity is declared:

EN 61000-6-2:2005
EN 55012:2007

Manufacturer (if not issuing agent):

Arctic Cat Inc.
601 Brooks Ave S.
Thief River Falls, MN
56701 USA

I, the undersigned, hereby declare that the equipment specified above conforms to the directive(s) and standard(s) as specified.

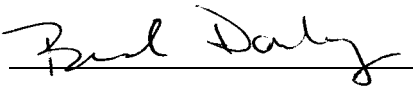

Brad Darling

Vice President/General Manager

Identification Numbers Record

WARNING

Indicates a potential hazard that could result in serious injury or death.



1. KEY IDENTIFICATION NUMBER:

The key identification number is stamped on the key as shown in the illustration. Record this number in the space provided for reference if you ever need a new key.

2. VEHICLE IDENTIFICATION NUMBER:

3. ENGINE SERIAL NUMBER:

Record the Vehicle Identification Number and Engine Serial Number in the spaces provided to assist you in ordering parts from your authorized Arctic Cat ATV dealer or for reference in case the ATV is stolen.



WARNING

Improper ATV use can result in SEVERE INJURY or DEATH



**ALWAYS USE
AN APPROVED
HELMET AND
PROTECTIVE
GEAR**



**NEVER USE
ON PUBLIC
ROADS**



**NEVER CARRY
PASSENGERS**



**NEVER USE
WITH DRUGS
OR ALCOHOL**

NEVER operate:

- without proper training or instruction
- at speeds too fast for your skills or the conditions
- on public roads - a collision can occur with another vehicle
- with a passenger - passengers affect balance and steering and increase risk of losing control

ALWAYS:

- use proper riding techniques to avoid vehicle overturns on hills and rough terrain and in turns
- avoid paved surfaces - pavement may seriously affect handling and control

**LOCATE AND READ OPERATOR'S MANUAL
FOLLOW ALL INSTRUCTIONS AND WARNINGS**

■ **NOTE: High altitude and temperature adversely affect the power output of this diesel engine. Operation above 5500 ft is not recommended.**

This Arctic Cat ATV is equipped with a rear rack. An optional Passenger Seat (p/n 1436-028) is available from an authorized Arctic Cat ATV dealer.

 **WARNING**

Never carry a passenger without the optional passenger seat installed.

Your 2-Up ATV can be hazardous to operate.

A collision or rollover can occur quickly, even during routine maneuvers such as turning and driving on hills or over obstacles, if you fail to take proper precautions.

For your safety and the safety of a passenger, understand and follow all the warnings contained in this Operator's Manual and the labels on your ATV.

Keep this Operator's Manual with your ATV at all times. This Arctic Cat 700 Diesel Operator's Manual should be considered a permanent part of the ATV and must remain with the ATV at the time of resale. If the ATV changes ownership more than once, contact Arctic Cat Inc., Service Department, P.O. Box 810, Thief River Falls, MN 56701, for proper registration information.

FAILURE TO FOLLOW THE WARNINGS CONTAINED IN THIS MANUAL CAN RESULT IN SERIOUS INJURY OR DEATH.

Training is available: U.S. owners, call 800-887-2887; Canadian owners, call 613-739-1535.

Un cours d'instruction est disponible: pour les propriétaires canadiens, composez le 613-739-1535.

Particularly important information is distinguished in this manual by the following notations:



The Safety Alert Symbol means ATTENTION! BE ALERT! YOUR SAFETY IS INVOLVED.

 **WARNING**

WARNING indicates a hazardous situation which, if not avoided, could result in death or serious injury.

CAUTION

CAUTION, without the safety alert symbol, is used to address practices not related to personal injury.

■ **NOTE:**

A NOTE provides key information to make procedures easier or more clear.

California Proposition 65

 **WARNING**

This product contains or emits chemicals known to the State of California to cause cancer and birth defects or other reproductive harm.

Foreword

Congratulations and thank you from Arctic Cat Inc. for purchasing an ARCTIC CAT® 700 Diesel. Built with American engineering and manufacturing know-how, it is designed to provide superior ride, comfort, utility, and dependable service.

This Operator's Manual is furnished to make sure that the operator is aware of safe operating procedures. It also includes information about the general care and maintenance of your ATV.

Carefully read the following pages. If you have any questions regarding this ATV, contact an authorized Arctic Cat ATV dealer for assistance. Remember, only authorized Arctic Cat ATV dealers have the knowledge and facilities to provide you with the best service possible.

Protect Your Sport

- Know all local, state/provincial riding laws,
- Respect your ATV, and
- Respect the environment, and
- You will gain respect of others.

We also advise you to strictly follow the recommended maintenance program as outlined. This preventive maintenance program is designed to ensure that all critical components on this ATV are thoroughly inspected at various intervals.

All information in this manual is based on the latest product data and specifications available at the time of printing. Arctic Cat Inc. reserves the right to make product changes and improvements which may affect illustrations or explanations without notice.

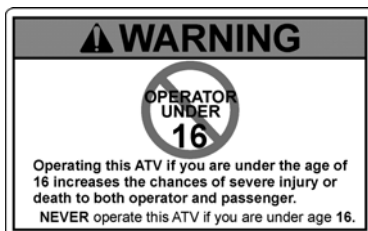

1411-930A

Division II of this manual covers operator-related maintenance, operating instructions, and storage instructions. If major repair or service is ever required, contact an authorized Arctic Cat ATV dealer for professional service.

At the time of publication, all information and illustrations in Division II were technically correct. Some illustrations used in Division II are used for clarity purposes only and are not designed to depict actual conditions. Because Arctic Cat Inc. constantly refines and improves its products, no retroactive obligation is incurred.

Parts and Accessories

When in need of replacement parts, oil, or accessories for your Arctic Cat TRV, be sure to use only GENUINE ARCTIC CAT PARTS, OIL, AND ACCESSORIES. Only genuine Arctic Cat parts, oil, and accessories are engineered to meet the standards and requirements of your Arctic Cat TRV. For a complete list of accessories, refer to the current Arctic Cat Accessory Catalog.

To aid in service and maintenance procedures on this ATV, a Service Manual and an Illustrated Parts Manual are available through your local Arctic Cat ATV dealer.

TREAD LIGHTLY! OFFICIAL SPONSOR®
ON PUBLIC AND PRIVATE LAND

Table of Contents

Foreword.....	1	Rack Loading (Front and Rear)	50
Parts and Accessories	1	Rear Seat (Optional).....	50
DIVISION 1 - SAFETY		Front Seat Lock	51
2-Up ATV Safety Alert.....	5	Trailering and Towing.....	51
Hangtags & Warning Information.....	6	Transporting TRV.....	51
Rider Training Course	7	Fuel-Oil-Lubricant.....	52
Warning Labels	8-9	Engine Break-in.....	53
Warnings	10-18	Burnishing Brake Pads.....	53
Prevention	19-23	General Maintenance.....	54-70
Safe Riding Clothing and Gear		Maintenance Schedule.....	55
(Operator and Passenger)	19	Liquid Cooling System.....	56
Condition of the ATV.....	20	Shock Absorbers.....	56
T-CLOC	20	General Lubrication	57
First Aid and Survival	22	Hydraulic Hand Brake.....	59
Active Riding.....	24	Brake Fluid.....	59
Sound Judgment	25-30	Brake Lever Lock	59
Environment	25	Brake Hoses.....	60
Those Around You	26	Brake Pads.....	60
Equipment	27	Rear Foot Brake	60
Load Capacity Ratings Chart	28	Protective Rubber Boots.....	60
Speedrack	28	Battery.....	61
Personal Choices	28	Fuel Filter.....	64
SIPDE	30	Idle RPM.....	65
Supervision	31	Throttle Cable Adjustment.....	65
Taking Responsibility	31	Air Filter	65
Inexperienced Riders	31	Draining V-Belt Cover	66
Experienced Riders.....	31	Tires.....	67
DIVISION II -		Wheel Removal	67
OPERATION/		Muffler/Spark Arrester	67
MAINTENANCE		Light Bulb Replacement	68
Specifications	32	Checking/Adjusting Headlight Aim	68
Location of Parts and Controls	33	Fuses.....	69
ATV Operation.....	34-43	Electrical Output Terminals.....	69
Basic Operating Maneuvers	34	Tool Storage Tray/Storage	
Starting the Engine	34	Compartment.....	70
Starting A Cold Engine	34	Preparation For Storage.....	71
Handling the ATV (Active Riding		Preparation After Storage	72
Techniques).....	36	Limited Warranty.....	73
Tips.....	42	Warranty Procedure/Owner	
General Information.....	44-53	Responsibility.....	74
TRV Identification Numbers.....	44	Change Of Address, Ownership, Or	
Ignition Switch/key.....	44	Warranty Transfer.....	75
Control Locations and Functions.....	44	Arctic Cat ATV Emission Control	
Indicator Lights	47	Warranty Statement (California	
Speedometer/LCD.....	47	Only)	77
Fuel/Vent Hoses	48	U.S. EPA Diesel Emission Control	
Level Stick (Engine Oil)	48	Statement/Warranty Coverage (U.S.	
Level Stick (Transmission Lubricant) ..	49	Only).....	78
Safety Flag Bracket	49	Declaration of Conformity	79
Rear Rack.....	49	Maintenance Record	80
		Identification Numbers Record.... Inside	
		Back Cover	

Division I - Safety

A 2-Up ATV Is Not A Toy And Can Be Hazardous To Operate.

- Always go slowly and be extra careful when operating on unfamiliar terrain. Always be alert to changing terrain conditions when operating the ATV.
- Never operate on excessively rough, slippery, or loose terrain.
- Always follow proper procedures for turning as described in this manual. Practice turning at slow speeds before attempting to turn at faster speeds. Do not turn at excessive speed.
- Always have the ATV checked by an authorized Arctic Cat ATV dealer if it has been involved in an accident.
- Never operate the ATV on hills too steep for the ATV or for your abilities. Practice on smaller hills before attempting larger hills. Never operate up or down hills steeper than 25°.
- Always follow proper procedures for climbing hills as described in this manual. Check the terrain carefully before you start up any hill. Never climb hills with slippery or loose surfaces. Shift your weight forward. Never open the throttle suddenly or make sudden gear changes. Never go over the top of any hill at high speed.
- Always follow proper procedures for going down hills and for braking on hills as described in this manual. Check the terrain carefully before you start down any hill. Shift your weight backward. Never go down a hill at high speed. Avoid going down a hill at an angle which would cause the ATV to lean sharply to one side. Go straight down the hill where possible.
- Always follow proper procedures for crossing the side of a hill as described in this manual. Avoid hills with slippery or loose surfaces. Shift your weight to the uphill side of the ATV. Never attempt to turn the ATV around on any hill until you have mastered the turning techniques described in this manual on level ground. Avoid crossing the side of a steep hill if possible.
- Always use proper procedures if you stall or roll backward when climbing a hill. To avoid stalling, maintain a steady speed when climbing a hill. If you stall or roll backwards, follow the special procedure for braking described in this manual. Dismount on the uphill side or to either side if pointed straight uphill. Turn the ATV around and mount following the procedure described in this manual.
- Always check for obstacles before operating in a new area. Never attempt to operate over large obstacles, such as large rocks or fallen trees. Always follow proper procedures when operating over obstacles as described in this manual.
- Always be careful of skidding or sliding. On slippery surfaces, such as ice, go slowly and be very cautious in order to reduce the chance of skidding or sliding out of control.
- Never operate the ATV in fast flowing water or in water deeper than the footrests. Remember that wet brakes may have reduced stopping capability. Test your brakes after leaving water. If necessary, apply them lightly several times to let friction dry out the pads.
- Always be sure there are no obstacles or people behind you when you operate in reverse. When it is safe to proceed in reverse, go slowly. Avoid turning at sharp angles in reverse.
- Always use the size and type tires specified in this manual. Always maintain proper tire pressure as described in this manual.
- Never improperly install or improperly use accessories on this ATV.
- Never install a twist grip throttle on this ATV.
- Never exceed the stated load capacity for this ATV. Cargo should be properly distributed and securely attached. Reduce speed and follow instructions in this manual for carrying cargo or pulling a trailer and allow greater distance for braking.
- No one under the age of 16 should operate this ATV. Some operators at the age of 16 may not be able to operate the ATV safely. Parents should supervise the use of the ATV at all times. Parents should permit continued use only if they determine that the operator has the ability to operate the ATV safely.
- Never carry a passenger under the age of 12.
- Never carry a passenger who cannot place both feet on the footrests and who cannot securely hold onto the handholds.

A 2-Up ATV Is Not A Toy And Can Be Hazardous To Operate.

FOR MORE INFORMATION ABOUT TRV SAFETY, contact your local Arctic Cat ATV dealer or 1-613-739-1535 (Canada).

TRV Passenger Instructions

Operator, tell your passenger to:

- Hold firmly onto the handholds.
- Keep both feet on the footrests even when stopped.
- Stay directly behind you leaning as you lean.

2-Up ATV Safety Alert

You should be aware that A 2-Up ATV IS NOT A TOY AND CAN BE HAZARDOUS TO OPERATE. A TRV handles differently from other vehicles, including motorcycles and cars. A collision or roll-over can occur quickly, even during routine maneuvers such as turning and driving on hills and over obstacles, if you fail to take proper precautions.

To Avoid Death Or Severe Personal Injury:

- * Always read the Operator's Manual carefully and follow the operating procedures described. Pay special attention to the warnings contained in the manual and on all labels.
- * Never operate the ATV without proper instruction. Take a training course. Beginners should complete a training course.
- * Never allow anyone under 16 years old to operate an Arctic Cat TRV.
- * Never operate the ATV on pavement. The ATV is not designed to be used on paved surfaces and may be difficult to control.
- * Never operate the ATV on a public road, even a dirt or gravel one, because you may not be able to avoid colliding with another ATV. Also, operating the ATV on a public road may be against the law.
- * Never operate the ATV without an approved motorcycle helmet, eye protection, boots, gloves, long pants, and a long-sleeved shirt or jacket.
- * Never consume alcohol or drugs before or while operating the ATV.
- * Never operate the ATV at excessive speeds. Go at a speed which is proper for the terrain, visibility conditions, and your experience.
- * Never attempt to do wheelies, jumps, or other stunts.
- * Always be careful when operating the ATV, especially when approaching hills, turns, and obstacles and when operating on unfamiliar or rough terrain.
- * Never lend the ATV to anyone who has not taken a training course.
- * Always inspect the ATV each time you use it to make sure it is in safe operating condition. Always follow the inspection and maintenance procedures and schedules described in this manual.
- * Always keep both hands on the handlebar grips (operator)/handholds (passenger) and both feet firmly planted on the footrests of the ATV during operation.

Hangtags & Warning Information

This Arctic Cat TRV comes with hangtags and several labels containing important safety information. Anyone who rides the ATV should read and understand this information before riding.

The labels should be considered as permanent parts of the ATV. If a label comes off or becomes hard to read, contact your Arctic Cat ATV dealer for a replacement.



THIS HANGTAG IS NOT TO BE REMOVED BEFORE SALE

▲ WARNING

Improper use can result in SEVERE INJURY or DEATH

ALWAYS USE ALWAYS USE NEVER CARRY NEVER USE
 APPROVED OFF-PUBLIC ROADS ROADS WITH HELMS
 HELMET AND PROTECTIVE GEAR FOR DRIVER AND PASSENGER

NEVER operate:

- without proper ATV training or instruction
- at speeds too fast for your skills or the conditions
- on public roads - a collision can occur with another vehicle
- with a passenger unless passenger seat is securely in place

THE OPERATOR MUST ALWAYS:

- use proper riding techniques to avoid overturns on this and rough terrain and in turns
- avoid paved surfaces - pavement may seriously affect handling and control
- reduce speed and use extra caution at all times when carrying a passenger - diamond passenger when conditions require
- make sure passenger reads and understands this label and passenger safety label

LOCATE AND READ OPERATOR'S MANUAL FOLLOW ALL INSTRUCTIONS AND WARNINGS

2258-417

THIS HANGTAG IS NOT TO BE REMOVED BEFORE SALE

2-UP ATV

**NO OPERATOR UNDER AGE 16
 NO PASSENGER UNDER AGE 12**

NEVER CARRY MORE THAN ONE PASSENGER

THIS ATV IS FOR OFF-HIGHWAY USE ONLY.

TRAINING COURSES TO TEACH ATV RIDING SKILLS ARE AVAILABLE. FOR INFORMATION CONTACT YOUR DEALER. MAKE SURE TO WATCH THE SAFETY VIDEO. READ AND UNDERSTAND THE OPERATORS MANUAL AND ALL OF THE WARNING LABELS ON THIS VEHICLE BEFORE OPERATING.

CHECK WITH YOUR DEALER TO FIND OUT ABOUT STATE OR LOCAL LAWS REGARDING VEHICLE OPERATION.

2258-417

THIS HANGTAG IS NOT TO BE REMOVED BEFORE SALE

RECOMMENDED FUELS FOR ARCTIC CAT 700 DIESEL ATV

FUEL TYPE / GRADE	COMMENTS
No 2 Diesel Fuel (DF-2)	Recommended fuel type for normal ambient operation. Biodiesel 20% max Methyl Ester. Use above -10°C (14°F). Recommended fuel type for normal ambient operation. Use above -10°C (14°F).
No 1 Diesel Fuel (DF-1)	Recommended fuel type for cold weather operation. Use at or below -10°C (14°F).
DF A Arctic	Acceptable fuel for use in areas with sub-zero ambient temperatures only.
JP 8 Turbine Fuel	5-12% reduction in power.
JP 5 Turbine Fuel	5-12% reduction in power.

P/N 2257-873

2258-417

2257-873

Pour commander des Etiquettes de Mise en Garde gratuites, voyez votre détaillant de autorisé VTT Arctic Cat pour le numéro de pièce 1436-426.

Rider Training Course

Arctic Cat sponsors a free Rider Training Course to teach ATV riding skills or to reinforce current riding skills. First-time purchasers without any previous ATV riding experience will receive a \$100.00 coupon from Arctic Cat through the SVIA/ASI after completing the training course (U.S. owners only, one incentive, and free rider training courses for appropriate immediate family members per ATV purchase). See an authorized Arctic Cat ATV dealer for details or call (800) 887-2887 for training course information.

In Canada, the Canada Safety Council (CSC) provides an ATV Rider's Course to teach safe ATV operating skills. They also provide a special ATV Rider's Course for children under 14 years of age with parental supervision. Call the CSC at 1-613-739-1535 ext. 227 for more details. Also available is a bilingual computer-based safety training program on a CD-ROM from CATV - call toll-free at 1-877-470-2288.

Au Canada, le conseil canadien de la sécurité (CSC) offre un cours de conduite de VTT pour enseigner les habiletés d'opération sécuritaires de VTT. Un cours spécial de conduite de VTT est également offert aux enfants de moins de 14 ans avec la surveillance d'un parent. Communiquez avec le CSC en composant le : 1-613-739-1535, poste 227 pour de plus amples informations. Un programme de formation bilingue informatisé sur la sécurité est aussi disponible sur disque optique compact par CATV; composez sans frais le: 1-877-470-2288.



FOR MORE INFORMATION ABOUT ATV SAFETY, in the U.S., call the Consumer Product Safety Commission at (800) 638-2772 or the ATV Distributors' Safety Hotline at (800) 852-5344 or in Canada, call the Canada Safety Council at 1-613-739-1535 ext. 227.

Visit the Arctic Cat Inc. website at www.arcticcat.com for additional product information.

Warning Labels

An Arctic Cat ATV comes with several labels containing important safety information. Anyone who rides the ATV should read and understand this information before riding.

The labels should be considered as permanent parts of the ATV. If a label comes off or becomes hard to read, contact your Arctic Cat ATV dealer for a replacement.

■ **NOTE:** The location and content of labels on the ATV you have purchased may differ from those shown on this page.

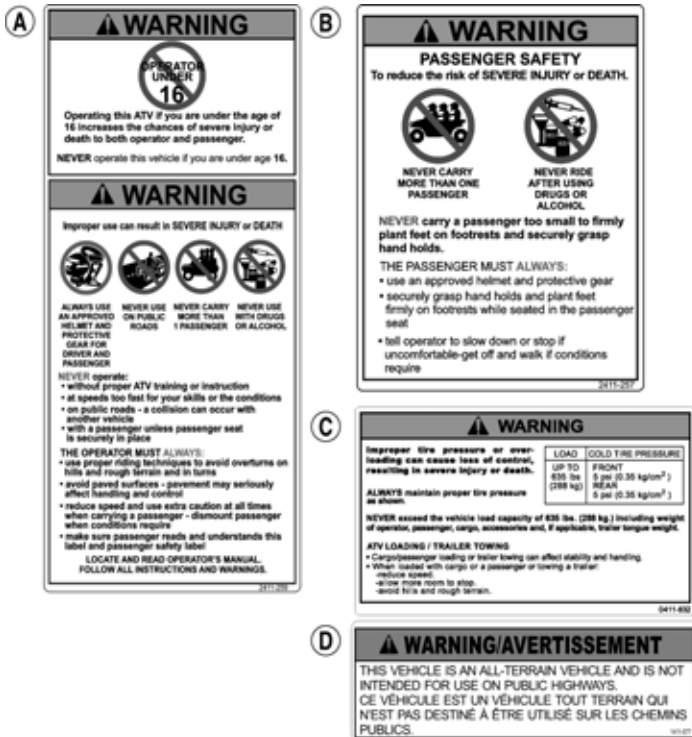

DE053C

Warning Labels

G

WARNING

Do not run engine without this shield in place or with drive belt removed.
Do not attempt any adjustment with engine running.

0411-428

H

WARNING

Exceeding vehicle's towing limit could cause an accident. Reduce speed when towing a trailer. Read operator's manual for details.

MAXIMUM TONGUE WEIGHT:
35 lbs. (16 kg)

MAXIMUM TOWING CAPACITY:
1050 lbs. (477 kg)

1411-477

I

WARNING

NEVER operate up or down hills greater than 25°

 25° MAX.

Riding on hills steeper than 25° can cause the vehicle to overturn and result in severe injury or death.

0411-894

J

WARNING

 NEVER ride as a passenger unless passenger's seat is installed and mounting pins are properly engaged.

1411-209

K

WARNING

NEVER operate with a passenger unless passenger's seat is installed and mounting pins are properly engaged. Failure to secure pins can result in SEVERE INJURY or DEATH.

1411-251

L

WARNING		NOTE
Failure to stop vehicle completely before engaging reverse could result in your being thrown from the ATV.		<ul style="list-style-type: none"> ALWAYS RESPECT THE RIGHTS OF OTHERS. Protect the environment, and comply with all applicable laws and regulations.
TO ENGAGE REVERSE: 1. Stop vehicle completely. 2. Bring engine to idle. Apply brake. 3. Shift transmission to neutral. 4. Shift reverse lever fully toward rear while applying brakes.		
Read operator's manual located under the seat for additional information. Write to Arctic Cat for free replacement if missing.		TREAD LIGHTLY! <small>ON PUBLIC AND PRIVATE LAND</small>
PRE-RIDE INSPECTION PROCEDURE		
T TIRES AND WHEELS	1. Check for proper air pressure. 2. Check for cuts and gouges. 3. Make sure nuts and bolts are tight.	
C CONTROLS AND CABLE	1. Identify location of all controls. 2. Throttle should operate smoothly and snap closed. 3. Check brake operation, adjustment, and for worn pads. 4. Check shifter operation.	
L LIGHTS AND ELECTRICAL	1. Check ignition switch operation. 2. Check engine stop switch operation. 3. Check all lights.	
O OIL AND FUEL	1. Check fuel level. 2. Check oil level. 3. Check for leaks.	
C CHASSIS AND DRIVE TRAIN	1. Make sure all nuts and bolts are tight. 2. Make sure all debris is removed from around axles and driveshaft. 3. Make sure ATV is loaded properly and not overloaded.	
DIESEL STARTING PROCEDURE		
CAUTION: Engine exhaust fumes can cause serious illness or death. Do not run the engine in an enclosed area without adequate ventilation.		
1. Set the PARKING BRAKE. 2. Move transmission to NEUTRAL position. 3. Turn "Emergency Stop" switch to RUN position. 4. Turn ignition key switch to ON position. 5. Check instrument panel: Green Glow Plug indicator will automatically shut off in 0-28 seconds. 6. Press Starter Button. Release button when engine starts. Use throttle as necessary to attain smooth idle. 7. Warm up engine for 1 minute before operating.		
IMPORTANT: Avoid Damage! Do not operate starter more than 5 seconds. If engine does not start, wait 5 seconds before trying again or starter may be damaged. If engine does not start after 5 tries, pause 5 minutes before repeating starting procedure.		
1411-490		

M

WARNING

NEVER carry a passenger on this carrier
MAXIMUM LOAD: 200lb (91kg)
evenly distributed

0411-648

N

WARNING

NEVER carry a passenger on this carrier
MAXIMUM LOAD: 100lb (45kg)
evenly distributed

0411-076

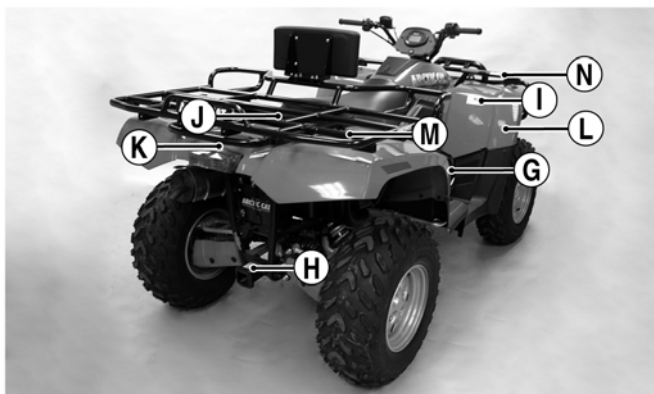

DE052B

Warnings

■ **NOTE:** The illustrations in this Warnings sub-section apply to an operator and a passenger even though some may show only the operator.

WARNING

POTENTIAL HAZARD

Operating this ATV without proper instruction.

WHAT CAN HAPPEN

The risk of an accident is greatly increased if the operator does not know how to operate the ATV properly in different situations and on different types of terrain.

HOW TO AVOID THE HAZARD

Beginning and inexperienced operators should complete the certified training course offered. They should then regularly practice the skills learned in the course and the operating techniques described in this Operator's Manual.

WARNING

POTENTIAL HAZARD

Allowing anyone under age 16 to operate this ATV.

WHAT CAN HAPPEN

Use of the ATV by children can lead to severe injury or death of the child.

Children under the age of 16 may not have the skills, abilities, or judgment needed to operate the ATV safely and may be involved in a serious accident.

HOW TO AVOID THE HAZARD

A child under 16 should never operate this ATV.

WARNING

POTENTIAL HAZARD

Operating this ATV on paved surfaces.

WHAT CAN HAPPEN

The ATV's tires are designed for off-road use only, not for use on pavement. Paved surfaces may seriously affect handling and control of the ATV and may cause the ATV to go out of control.



HOW TO AVOID THE HAZARD

Never operate the ATV on any paved surfaces, including sidewalks, driveways, parking lots, and streets.

WARNING

POTENTIAL HAZARD

Attempting wheelies, jumps, and other stunts.

WHAT CAN HAPPEN

Increases the chance of an accident including a roll-over.

HOW TO AVOID THE HAZARD

Never attempt stunts, such as wheelies or jumps. Don't try to show off.

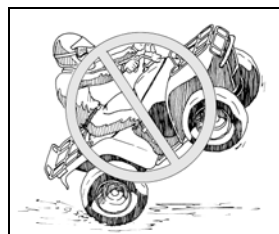

Warnings

WARNING

POTENTIAL HAZARD

Carrying a passenger under the age of 12 on this ATV.

WHAT CAN HAPPEN

Could cause an accident, resulting in injury or death to you and/or your passenger.

HOW TO AVOID THE HAZARD

Never carry a passenger under the age of 12. The passenger must allow the operator to shift positions as needed during operation, must always keep feet on the footrests, and must always keep hands on handholds.

 WARNING

PASSENGER SAFETY
To reduce the risk of SEVERE INJURY or DEATH.



NEVER CARRY MORE THAN ONE PASSENGER



NEVER RIDE AFTER USING DRUGS OR ALCOHOL

NEVER carry a passenger too small to firmly plant feet on footrests and securely grasp hand holds.

THE PASSENGER MUST ALWAYS:

- use an approved helmet and protective gear
- securely grasp hand holds and plant feet firmly on footrests while seated in the passenger seat
- tell operator to slow down or stop if uncomfortable-get off and walk if conditions require

2411-257

Never Carry More Than One Passenger.

WARNING

POTENTIAL HAZARD

Operating this ATV on public streets, roads, or highways.

WHAT CAN HAPPEN

You can collide with another vehicle.

HOW TO AVOID THE HAZARD

Never operate this ATV on any public street, road, or highway, even a dirt or gravel one.

In many states it is illegal to operate the ATV on public streets, roads, or highways.

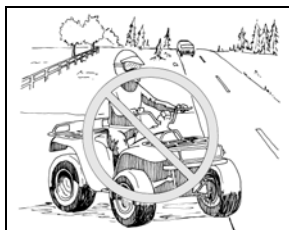

WARNING

POTENTIAL HAZARD

Going down a hill improperly.

WHAT CAN HAPPEN

Could cause loss of control or cause the ATV to overturn.

HOW TO AVOID THE HAZARD

Always follow proper procedures for going down hills as described in this Operator's Manual.

Always check the terrain carefully before you start down any hill.

Shift your weight backward.

Never go down a hill at high speed.

Avoid going down a hill at an angle that would cause the ATV to lean sharply to one side. Go straight down the hill where possible.

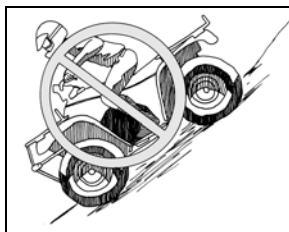

Warnings

WARNING

POTENTIAL HAZARD

Operating this ATV after or while consuming alcohol or drugs.

WHAT CAN HAPPEN

- Could seriously affect your judgment.
- Could cause you to react more slowly.
- Could affect your balance and perception.
- Could result in an accident.

HOW TO AVOID THE HAZARD

Never consume alcohol or drugs before or while driving this ATV.

WARNING

POTENTIAL HAZARD

Operating or riding as a passenger on this ATV without wearing an approved helmet, eye protection, and protective clothing.

WHAT CAN HAPPEN

- Operating or riding as a passenger on this ATV without an approved helmet increases your chances of a severe head injury or death in the event of an accident.
- Operating or riding as a passenger on this ATV without eye protection can result in an accident and increases your chances of a severe injury in the event of an accident.
- Operating or riding as a passenger on this ATV without protective clothing increases your chances of severe injury in the event of an accident.

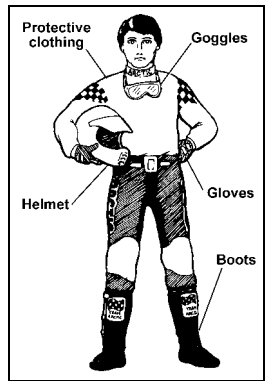

HOW TO AVOID THE HAZARD

Always wear an approved helmet that fits properly.

- You should also wear:
- Eye protection (goggles or face shield)
 - Gloves
 - Boots
 - Long sleeved shirt or jacket
 - Long pants

WARNING

POTENTIAL HAZARD

Turning improperly.

WHAT CAN HAPPEN

The ATV could go out of control, causing a collision or rollover.

HOW TO AVOID THE HAZARD

- Always follow proper procedures for turning as described in this Operator's Manual.
- Practice turning at slow speeds before attempting to turn at faster speeds.
- Do not turn at excessive speed.

Warnings

WARNING

POTENTIAL HAZARD

Failure to inspect the ATV before operating.
Failure to properly maintain the ATV.

WHAT CAN HAPPEN

Increases the possibility of an accident or equipment damage.

HOW TO AVOID THE HAZARD

Always inspect your ATV each time you use it to make sure the ATV is in safe operating condition.

Always follow the inspection and maintenance procedures and schedules described in this Operator's Manual.

WARNING

POTENTIAL HAZARD

Removing hands from handlebar grips (operator)/handholds (passenger) or feet from the footrests during operation.

WHAT CAN HAPPEN

Removing even one hand or foot can reduce your ability to control the ATV or could cause you to lose your balance and fall off the ATV. If you remove a foot from the footrest, your foot or leg may come into contact with the wheels, which could injure you or cause an accident.

HOW TO AVOID THE HAZARD

Always keep both hands on the handlebar grips (operator)/handholds (passenger) and both feet on the footrests of your ATV during operation.

WARNING

POTENTIAL HAZARD

Improperly operating in reverse.

WHAT CAN HAPPEN

You could hit an obstacle or person behind you, resulting in serious injury.

HOW TO AVOID THE HAZARD

Before you engage reverse gear, make sure there are no obstacles or people behind you. When it is safe to proceed, go slowly.

WARNING

POTENTIAL HAZARD

Improperly operating over obstacles.

WHAT CAN HAPPEN

Could cause loss of control or a collision. Could cause the ATV to overturn.

HOW TO AVOID THE HAZARD

Before operating in a new area, check for obstacles.

Never attempt to ride over large obstacles, such as large rocks or fallen trees.

When you go over obstacles, always follow proper procedures as described in this Operator's Manual.

Warnings

WARNING

POTENTIAL HAZARD

Failure to use extra care when operating the ATV on unfamiliar terrain.

WHAT CAN HAPPEN

You can come upon hidden rocks, bumps, or holes without enough time to react.

Could result in the ATV overturning or going out of control.

HOW TO AVOID THE HAZARD

Go slowly and be extra careful when operating on unfamiliar terrain.

Always be alert to changing terrain conditions when operating the ATV.

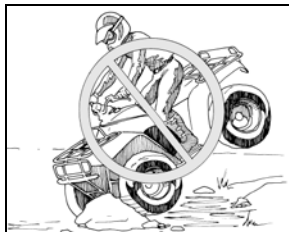

WARNING

POTENTIAL HAZARD

Failure to use extra care when operating on rough, slippery, or loose terrain.

WHAT CAN HAPPEN

Could cause loss of traction or control, which could result in an accident including a rollover.

HOW TO AVOID THE HAZARD

Do not operate on rough, slippery, or loose terrain until you have learned and practiced the skills necessary to control the ATV on such terrain.

Always be especially cautious on these kinds of terrain.



WARNING

POTENTIAL HAZARD

Improperly crossing hills or turning on hills.

WHAT CAN HAPPEN

Could cause loss of control or cause the ATV to overturn.

HOW TO AVOID THE HAZARD

Never attempt to turn the ATV around on any hill until you have mastered the turning technique as described in this Operator's Manual. Practice first on level ground. Be very careful when turning on any hill.

Avoid crossing the side of a steep hill, if possible.

When crossing the side of a hill:

Always follow proper procedures as described in this Operator's Manual.

Avoid hills with slippery or loose surfaces.

Shift your weight to the uphill side of the ATV.

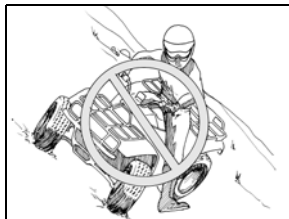

Warnings

WARNING

POTENTIAL HAZARD

Operating on steep hills.

WHAT CAN HAPPEN

The ATV can overturn more easily on steep hills than on level surfaces or small hills.

HOW TO AVOID THE HAZARD

Never operate the ATV on hills too steep for the ATV or for your abilities.

Practice on smaller hills before attempting larger hills.

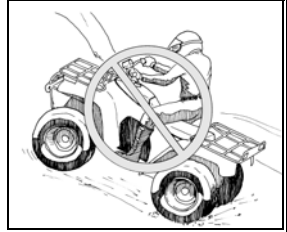

WARNING

POTENTIAL HAZARD

Climbing hills improperly.

WHAT CAN HAPPEN

Could cause loss of control or cause the ATV to overturn.

HOW TO AVOID THE HAZARD

Always follow proper procedures for climbing hills as described in this Operator's Manual.

Always check the terrain carefully before you start up any hill.

Never climb hills with slippery or loose surfaces.

Shift your weight forward.

Never open the throttle suddenly or make sudden gear changes. The ATV could flip over backwards.

Never go over the top of any hill at high speed. An obstacle, a sharp drop, or another ATV or person could be on the other side of the hill.

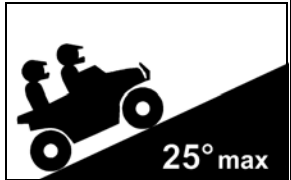

Never operate up or down hills steeper than 25°.

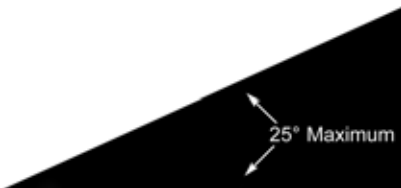

Warnings

WARNING

POTENTIAL HAZARD

Operating the ATV with improper tires or with improper or uneven tire pressure.

WHAT CAN HAPPEN

Use of improper tires on the ATV, or operation of the ATV with improper or uneven tire pressure, may cause loss of control increasing your risk of accident.

HOW TO AVOID THE HAZARD

Always use the size and type tires specified in this Operator's Manual for this ATV. Always maintain proper tire pressure as described in this Operator's Manual.

WARNING

POTENTIAL HAZARD

Skidding or sliding.

WHAT CAN HAPPEN

You may lose control of the ATV.

You may also regain traction unexpectedly, which may cause the ATV to overturn.

HOW TO AVOID THE HAZARD

Learn to safely control skidding or sliding by practicing at slow speeds and on level, smooth terrain.

On extremely slippery surfaces, such as ice, go slowly and be very cautious in order to reduce the chance of skidding or sliding out of control.

WARNING

POTENTIAL HAZARD

Operating the ATV through deep or fast flowing water.

WHAT CAN HAPPEN

Tires may float, causing loss of traction and loss of control, which could lead to an accident.

HOW TO AVOID THE HAZARD

Never operate the ATV in fast flowing water or in water deeper than the footrests.

Remember that wet brakes may have reduced stopping capability.

Test your brakes after leaving water. If necessary, apply them several times to dry out the pads.

WARNING

POTENTIAL HAZARD

Operating this ATV at excessive speeds.

WHAT CAN HAPPEN

Increases your chances of losing control of the ATV, which can result in an accident.

HOW TO AVOID THE HAZARD

Always ride at a speed that is proper for the terrain, visibility and operating conditions, and your experience.

Warnings

WARNING

POTENTIAL HAZARD

Stalling, rolling backwards, or improperly dismounting while climbing a hill.

WHAT CAN HAPPEN

Could result in the ATV overturning.

HOW TO AVOID THE HAZARD

Use proper gear and maintain steady speed when climbing a hill.

If you lose all forward speed:

Keep weight uphill.

Apply the brakes.

Engage the brake lever lock after you are stopped.

If you begin rolling backwards:

Keep weight uphill.

Apply the brakes while rolling backwards.

When fully stopped, engage the brake lever lock.

Have the passenger dismount on uphill side or to a side if pointed straight uphill; then the operator should dismount on uphill side or to a side if pointed straight uphill.

Turn the ATV around and mount following the procedure described in this Operator's Manual.

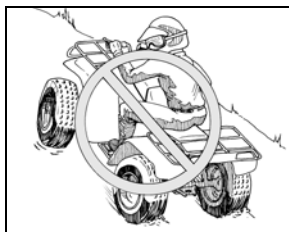

WARNING

POTENTIAL HAZARD

Overloading the ATV or carrying or towing cargo improperly.

WHAT CAN HAPPEN

Could cause changes in handling, which could lead to an accident.

HOW TO AVOID THE HAZARD

Never exceed the stated load capacity for the ATV.

Cargo should be properly distributed and securely attached.

Reduce speed when carrying cargo or pulling a trailer. Allow greater distance for braking.

Always follow the instructions in this Operator's Manual for carrying cargo or pulling a trailer.

Warnings

WARNING

POTENTIAL HAZARD

Operating the ATV with improper modifications.

WHAT CAN HAPPEN

Improper installation of accessories or modification of the ATV may cause changes in handling which, in some situations, could lead to an accident.

HOW TO AVOID THE HAZARD

Never modify the ATV through improper installation or improper use of accessories. All parts and accessories added to this ATV should be genuine Arctic Cat components designed for use on the ATV and should be installed and used according to instructions. Never install a twist grip throttle. If you have questions, consult an authorized Arctic Cat ATV dealer.

WARNING

POTENTIAL HAZARD

Operating the ATV with improperly installed passenger seat.

WHAT CAN HAPPEN

The passenger seat could shift or separate from the ATV causing the passenger to fall from the vehicle resulting in serious injury or death.

HOW TO AVOID THE HAZARD

Always check the seat latches to make sure they are properly engaged and locked before operating the ATV.

WARNING

POTENTIAL HAZARD

Operating the ATV with differential lock engaged.

WHAT CAN HAPPEN

The increased steering effort and reduced maneuverability caused by the locked differential could result in loss of control and an accident.

HOW TO AVOID THE HAZARD

Never exceed 10 MPH (16 KPH) with the differential lock engaged. Always disengage the differential lock as soon as not needed for additional traction.

WARNING

POTENTIAL HAZARD

Failure to release the brake lever lock before driving the ATV.

WHAT CAN HAPPEN

Driving the ATV with the brake lever lock engaged could cause a change in handling or loss of brakes and cause an accident.

HOW TO AVOID THE HAZARD

Always release the brake lever lock before driving the ATV.

Prevention

Overview

When using this ATV, prevention is the name of the game. “Had you only known” something could go wrong, you would have prevented it. If you don’t notice your conditions and surroundings before riding your ATV, you give up control over the situation. Using ATV prevention techniques helps you forecast potential hazards before they injure you or damage your ATV.

Following the safety instructions and warnings in this manual will help you “P.A.S.S.” the safety test. P.A.S.S. stands for “Prevention,” “Active Riding,” “Sound Judgment,” and “Supervision.” Remembering P.A.S.S. and what it stands for will help you have a safe, predictable ride every time you go out on your ATV.

Safe Riding Clothing and Gear (Operator and Passenger)

Always wear clothing suited to the type of riding you are doing. TRV riding requires special protective clothing which will make you feel more comfortable and reduce chances of injury.

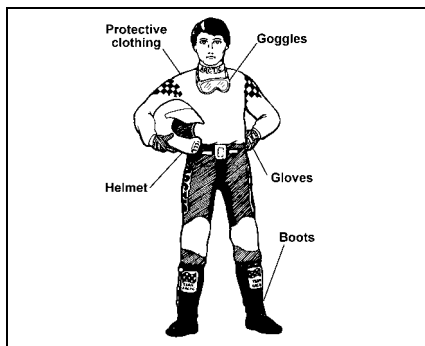

ATV-0004

You’ll find it important to dress correctly for riding in order to prevent scraped skin and serious head injuries. It’s easy and could save you time in the long run not having to contend with an injury. Of course, it also makes sense to remember the seasons. Wear a hat under your helmet and a snowmobile suit in the winter and lighter, protective clothing in the summer. Following is the minimum protection you need to wear during every ride:

Gloves

Your hands are targets for flying objects and branches. Along with providing skin protection, gloves will shield your hands from harsh weather. Wear gloves that are weather resistant and have a gripping surface to keep them from sliding off the handlebars. Off-road style gloves with knuckle pads are the best for comfort and protection.

Boots/Ankle Protection

Wear a boot that covers the largest possible area of your leg (preferably up to your knee) and can handle significant impact. Choosing boots with low heels and a good tread will help prevent your feet from slipping off the footrests in wet or rugged conditions or getting hurt if they get hit by rocks, dirt, or branches.

Helmet

Your helmet is the most important piece of protective gear for safe riding. A helmet can prevent a severe head injury. There are several types of helmets on the market, but make sure you wear a helmet that complies with the standards of the U.S. Department of Transportation (DOT), The Snell Memorial Foundation, or the American National Standards Institute (ANSI). Helmets that comply with one or more of these agency’s standards have a sticker on the inside or outside of the helmet.

Prevention

TESTIMONIAL

DOCUMENT#: N490117A1
 CITY/STATE: N. HUNTINGDON, PA
 SEX: M
 AGE: 6
 BODY PART: HEAD
 DATE ACCIDENT: 14-06-94
 DISPOSITION: DOA
 SYNOPSIS: The 6 year old male victim died from blunt force trauma to the head when the 4-wheel ATV on which he was a passenger struck a rock on a hill connecting two roads and flipped over backwards onto the victim, shattering his bicycle helmet. The victim was life-flighted to the hospital and died that night. The driver of the ATV, the victim's 29 year old father, sustained minor injuries, but wasn't treated.

Helmets should have one of these:

1. DOT label
2. Snell label
3. ANSI Z90.1 label

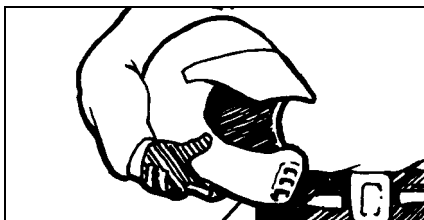

These helmets should provide full-face protection.

Condition of the ATV

The second step in Prevention is checking the condition of your ATV. Chances are good that you'll be using your ATV in some rough terrain, and there's no way you want your brakes to go out when riding downhill. You need to check the following parts on your ATV before every ride.

- | | |
|------------------------|------------------------|
| 1. Tires and Wheels | 4. Oil and Fuel |
| 2. Controls and Cables | 5. Chassis |
| 3. Lights and Electric | 6. Miscellaneous Items |

One easy way to remember what parts you need to check is by using the acronym "T-CLOC." It stands for:

T	C	L	O	C
TIRES AND WHEELS	CONTROLS AND CABLES	LIGHTS AND ELECTRIC	OIL AND FUEL	CHASSIS

If you drop or damage your helmet, get a new one immediately. Your helmet may not protect your head from injury if it has cracks, fissures, or other damage to its outside or core padding.

Remember, your helmet won't do you any good if the chin strap isn't fastened.

Eye Protection

Wear eye protection, such as goggles, to completely surround your eyes to prevent getting dirt or other items in your eyes. Do not depend on sunglasses for proper eye protection. Sunglasses are not recommended; they don't prevent objects from flying in through the sides.

Long Pants and Long Sleeved Shirt

The goal is to protect your body from branches, long grass, airborne objects, or anything else that could scrape your skin. The more thick and durable the material, the better protection it'll provide. Riding pants with kneepads, a jersey, and shoulder pads provide the best protection.

Prevention

1. Tires And Wheels

Correct tire pressure is crucial. Consult the General Maintenance section of this Operator's Manual for tire pressure guidelines. Incorrect tire pressure can cause poor handling, instability, and a loss of ATV control.

Check:

1. Tire pressure
2. Tire surface (tread and sidewalls)

While checking the tire pressure, inspect the tread and sidewalls of the tires for cracks, cuts, or other damage that could indicate they need to be replaced.

2. Controls and Cables

With the engine running and brake applied, check all transmission positions: forward, neutral, and reverse.

Check:

1. Forward
2. Neutral
3. Reverse

A. Brakes

Squeeze your hand brake lever. If it feels soft or "squishy," it could be low on fluid or have a leak — refer to the General Maintenance section of this Operator's Manual for instructions. Don't use the ATV until the brakes are operating normally.

Check:

1. Hand brake lever
2. Rear foot brake
3. Brake lever lock

Test the brake lever lock and see if it locks the hand brake lever into position; then disengage it to release the brake. Be sure the rear foot brake near the footrest is working; your brakes could fail during a ride if they're not maintained.

B. Throttle

The throttle should have a free, smooth range of motion. If it seems to "stick" at any point, refer to the General Maintenance section of this Operator's Manual for instructions. Driving your ATV with a sticking throttle can turn your leisurely ride into an unwelcome accident. Don't drive your ATV if the throttle sticks.

Check:

1. Free, smooth range of motion

3. Lights and Electric

Turn the hi-beam and lo-beam on and off to make sure they work. At the same time, verify the taillight and brakelight work. Also, check the status/warning indicators (reverse, neutral, and hi-lo beam) on the LCD when you start the ATV. Don't drive the ATV unless all systems are working. Check the ignition switch and engine stop switch.

Check:

1. Hi-beam
2. Lo-beam
3. Taillight/brakelight
4. Status/warning indicators
5. Ignition switch
6. Engine stop switch

4. Oil and Fuel

Start with a full tank of fuel before every ride, and while you're at it, top off the oil. Don't forget to check for fluid leaks around the ATV. Watch the overheat lamp to ensure the engine coolant level is adequate.

Check:

1. Fuel
2. Oil
3. Fluid leaks

Prevention

5. Chassis

Grass and leaves can gum-up your suspension and shocks. Clear and clean the suspension arms, shock springs, and fenders. Check smoothness by turning the handlebar full-left and full-right. Verify there is no binding, restrictions, free-play, or looseness in steering components.

Check:

1. Suspension arms
2. Shock springs
3. Fenders
4. Steering

6. Miscellaneous Items

Inspect your air filter. Look for debris or damage that may indicate you need to replace it. A clogged filter can stop an engine. Check your battery terminals for corrosion. Also, be sure to tighten any loose parts, nuts, or bolts.

Check:

1. Air filter
2. Battery
3. Tighten parts, nuts, and bolts

First Aid and Survival

You need to prepare for the unexpected. Emergencies and accidents are traumatic enough, but they're even worse when you're not prepared for them. At the minimum during every ATV ride, you should have the following items on board:

- Tools
- Water
- Identification
- First Aid Kit

For rides that are longer in duration and distance, the following additional items are recommended:

- Cellular Phone
- Maps/GPS
- Emergency Kit with *Flashlight and First Aid Kit*

Tools

Routine maintenance will generally eliminate the need for emergency repairs. Riding on rough terrain could cause loosening of nuts, bolts, and fasteners. Especially on long rides, carrying the right tools can prevent an inconvenience from becoming a crisis.

Carry these items on your ATV:

1. Bulbs
2. Duct tape
3. Rope
4. Spare parts
5. Tool Kit

Water

Water is so important that you need to carry it regardless of the duration of your ride. Heat exhaustion and heat stroke can creep up suddenly and can take you out of commission. If you become dehydrated, you could find yourself physically unable to safely operate your ATV.

Identification

If something does happen to you, the emergency personnel will want to know who you are and whom to contact. It's possible you may be in no condition to give them that information. Put your I.D. in your pocket before you ride. Without it, you're anonymous.

Cellular Phone

It may be necessary to make an urgent phone call.

Maps/GPS (Global Positioning System)

Maps may be unnecessary when you're familiar with the area. But when you're riding on unfamiliar trails, it's good to know where you are, what's coming up, and how to get back.

Prevention

Emergency Kit with Flashlight and First Aid Kit

You'll need several items in your Emergency Kit including a flashlight. The matches will come in handy if you need to start a fire to stay warm. Flares are appropriate for signaling help. A first aid kit is very important if an injury of some type should happen. A good First Aid Kit should include bandages, antiseptic spray, gauze, tape, etc.

Carry these items:

1. Flashlight
2. Matches
3. Flares
4. First Aid Kit
5. Money

Active Riding

Overview

“Active Riding” is the second part of “P.A.S.S.” It involves an understanding of how your body weight, balance, gravity, and physical forces affect the handling of the ATV. For example, when you drive a car quickly into a sharp turn, your body is pulled to the outside of the turn by centrifugal force. Although a car is relatively stable, enough centrifugal force can cause the ATV to overturn. Constantly shifting operator weight is one major difference between driving a car and riding the ATV. Knowing how to shift your weight is necessary to avoid rolling or flipping the ATV.

For complete operating instructions, see ATV OPERATION section in this manual.

Sound Judgment

Overview

You are not invincible. Knowing that the first “S” in “P.A.S.S.” stands for “Sound Judgment” means you need to use yours.

Do you consider yourself to be pretty conservative, or are you a heavy risk-taker? Before continuing with this section on sound judgment, check your **Risk Factor** by doing this short survey:

1. Do you drive over the speed limit?

1 2 3

Never Sometimes Often

2. Are you more daring around your friends than you are when alone?

1 2 3

Never Sometimes Often

3. Do you drive your car when the gas gauge is on empty?

1 2 3

Never Sometimes Often

4. Do you feel that no matter what you do, you won't get hurt?

1 2 3

Never Sometimes Often

5. Do you drink or use drugs before you drive your car?

1 2 3

Never Sometimes Often

6. Do you drive your car even if it has a major problem with the brakes, tires, or engine?

1 2 3

Never Sometimes Often

7. Do you thrive on the adrenaline rush you get from speeding and dangerous situations?

1 2 3

Never Sometimes Often

8. Do you hurt yourself because you do things that are out of your ability range?

1 2 3

Never Sometimes Often

9. Do you tailgate other drivers when you think they're driving too slow?

1 2 3

Never Sometimes Often

10. Do you ignore weather reports before you do outside activities like swimming, camping, fishing, or boating?

1 2 3

Never Sometimes Often

Add the totals from lines 1-10. **YOUR RISK FACTOR IS:**

10-15: You're pretty conservative. Chances are good that the consistently safe choices you make will help you avoid hurting yourself and the people around you.

16-20: You're straddling the fence. Depending on your mood or whom you're with, the choices you make may help you or hurt you.

21-30: You're taking your chances. Time to reconsider a lot of the judgments you make. You're destined to put yourself in dangerous situations and potentially hurt yourself and the people around you.

Environment

The environment you operate an ATV in is often harsh and sometimes dangerous if you don't take proper precautions.

Weather

You need to consider the weather. It is dangerous to ride your ATV when the weather is bad or potentially bad. Keep abreast with weather forecasts.

Sound Judgment

Terrain

Always pay close attention to the terrain you're on, even if it is familiar to you. You can't assume that the landscape you're used to doesn't change. Changes to landscape can happen at nearly any time. Fences can be constructed and excavations dug in a short period of time. Weather, climate, and development take their toll.

Night Riding

Riding at night can be very hazardous. Obstacles and other hazards (that are easily identified during daytime) are much more difficult to see and avoid. When night riding, make sure the lights are properly adjusted and in good working order. Reduce speed; do not over-drive the headlights. Never travel in an unfamiliar area or blaze a new trail at night. Always carry a flashlight or flare for signaling an emergency.

Paved Surfaces

Don't do it! The ATV isn't designed for pavement. Its handling becomes more difficult on paved surfaces.

Trail Riding

Use sound judgment when trail riding; that means riding on a trail that fits your ability level. If the trail is pretty rugged, standing up on your footrests will make it easier for you to endure the rough terrain.

Make yourself visible by using headlights and taillight, and pull completely off the trail if you need to stop.

Outsloped trails (trails that slant to allow rain to run off) make trail riding a bit more challenging.

It also helps to know which trails you can ride and who else might be on those same trails. These are signs currently used in some areas to designate trail types and restrictions.

Trail Signs

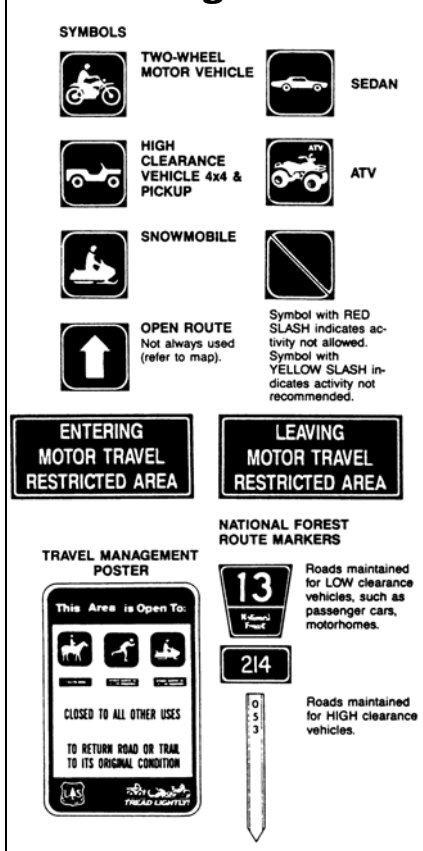

ATV-0068

Those Around You

People do all kinds of things that you can't predict or control.

Passenger

Never carry a passenger under the age of 12. Never carry a passenger who cannot place both feet on the footrests and who cannot securely hold onto the handholds.

You are responsible for the passenger and you must instruct the passenger on the correct procedures for riding.

Sound Judgment

Riding Companions

Leave a lot of space between you and other riders, especially in dusty and dirty conditions, because it'll be difficult to see the riders in front of you stopping.

Riding with companions on several vehicles is not the same as riding one ATV with a passenger.

Other Vehicles

Depending on where you're riding, you might encounter ATV's, bikes, or motor vehicles on public lands. Respect the presence of cars if you're crossing roads or riding in public areas and make yourself be seen. If you can't see other vehicles coming, that means you're invisible, too.

Hikers

With the renewed interest in hiking, camping, and other outdoor activities, people can show up in remote areas where you would never expect them. For their sake, keep your eyes open.

Animals and Nature

Respect the outdoors that you love. Don't use your ATV to chase animals or birds. Drive around young trees rather than over them. Keep clear of streams and ditches with standing water.

TESTIMONIAL

DOCUMENT#: N380310A1
CITY/STATE: NEW CUMBERLAND, WV
SEX: M
AGE: 18
BODY PART: HEAD
DATE ACCIDENT: 7-30-93
DISPOSITION: DOA
SYNOPSIS: An 18 year old male died as the result of injuries which he sustained in an accident while driving a 4-wheel ATV on a gravel public road. The victim lost control of the ATV when he suddenly applied the brakes to avoid a dog crossing the road. During the accident, the ATV's brake lever penetrated the victim's brain through his right eye resulting in death. The victim was not wearing a helmet.

Tread Lightly and leave it as you found it.

Equipment

The last thing you expected was that your ATV would break down in the middle of the field . . . it's usually so reliable that sometimes you forget the ATV has its limits.

Maintenance

You have to maintain your ATV. The General Maintenance section of this Operator's Manual tells you about taking care of your ATV. If, at any time, abnormal noises, vibrations, or improper functioning of any component of this ATV is detected, **DO NOT OPERATE THE ATV.** Take the ATV to an authorized Arctic Cat ATV dealer for inspection and adjustment or repair.

Cargo Limitations

Limit the ATV to the load capacity ratings identified in the Load Capacity Ratings chart. So if you and your passenger combined weigh in at over 500 lb (226 kg), leave some of that extra cargo at home. The combined weight limit, including you, your passenger, your rack cargo, and your trailer, is a specified amount, so consult the chart and monitor it carefully.

Extra weight on the ATV will also throw you off balance if it's not distributed evenly, side-to-side and front-to-rear.

Cargo has such a huge affect on handling that you need to pay a lot of attention to your speed. Even on really level areas, you should keep it under 10 mph (16 kph) if you've got a trailer attached. Avoid uneven terrain. Also, consider that your braking distance is going to increase with the more weight you carry.

Think about these when dealing with cargo:

1. Rack weight limit
2. Trailer weight limit
3. Weight distribution
4. Speed

Sound Judgment

Load Capacity Ratings Chart

ARCTIC CAT LOAD CAPACITY RATINGS		
Item	Specification	
	(lb)	(kg)
Max Load Capacity	600	272
Front Rack (max)	100	45
Rear Rack (max)	200	91
Rear Box - Optional (max)	200	91
Rear Rack and Tongue Weight	35	16
Towing Capacity (max)	1050	477

Max Load Capacity - Total weight of operator and passenger, accessory weight, tongue weight, and cargo on the front and rear rack.

Tongue Weight - Weight on trailer tongue.

Towing Capacity - Total weight of trailer and all cargo in the trailer.

Speedrack

When installing Speedrack accessories, make sure to read and carefully follow the instructions provided in each kit including all weight restrictions as noted on placards and decals.

■ **NOTE:** Use extra caution when operating this ATV with additional loads such as passenger, accessories, and/or cargo. Handling of the ATV may be adversely affected. Reduce speed when adding additional loads.

WARNING

POTENTIAL HAZARD

Overloading the ATV or carrying or towing cargo improperly.

WHAT CAN HAPPEN

Could cause changes in handling, which could lead to an accident.

HOW TO AVOID THE HAZARD

Never exceed the stated load capacity. Cargo should be properly distributed and securely attached.

Reduce speed when carrying cargo or pulling a trailer. Allow greater distance for braking.

Always follow the instructions in this Operator's Manual for carrying cargo or pulling a trailer.

Personal Choices

A safe, enjoyable ride is dependent on many personal choices. An ATV, like all motorized vehicles, can be dangerous to operate if you choose to ignore safety precautions, take unnecessary chances, or ride beyond your ability or your vehicle's capability. Don't allow the thrill of freedom or adventure to affect your ability to make good, safe choices.

Alcohol and Drug Consumption (Operator and/or Passenger)

Alcohol is related to a high percentage of all hospital admissions due to accidents in the U.S. It's extremely dangerous to drink alcoholic beverages and ride . . . it's also very foolish.

Sound Judgment

TESTIMONIAL

DOCUMENT#: X46481A1
 CITY/STATE: LAUREL, MS
 SEX: M
 AGE: 25
 BODY PART: ALL PARTS BODY
 DATE ACCIDENT: 6-25-93
 DISPOSITION: DOA
 SYNOPSIS: A 25 year old male died from drowning after the 4-wheeled ATV he was driving overturned and landed on the victim, pinning him face down in 6 inches of water in a drainage ditch. The victim had failed to make a right hand turn and drove off the side of the road. The victim was driving at an excessive speed, and under the influence of alcohol. He was pronounced dead at the scene. The victim was not wearing a helmet.

Substances to avoid when riding:

1. Alcohol
2. Over-the-counter or prescription drugs
3. Illegal/mood altering drugs

Be aware of prescription and over-the-counter medications. Drowsiness and impaired judgment can be caused by a wide variety of medications. The same is true of allergy, cold, flu, and headache medications. Your physical size and weight can't protect you . . . just one anti-histamine tablet can affect your judgment.

If your sense of adventure persuades you to do illegal drugs when you're riding your ATV, this is a reality check. Something to think about—there can be legal consequences that will take away all that freedom you love. Don't use alcohol or drugs before or during your ride.

THE EFFECTS OF ALCOHOL*

The Number of Drinks that Impair Mental and Physical Abilities

1-2 DRINKS

Mental processes such as restraint, awareness, concentration, and judgment affected; reaction time slowed; inability to perform complicated tasks.

3-4 DRINKS

Depth perception, glare recovery, eye movement, and focus affected; decreased judgment and control.

5+ DRINKS

Coordination deteriorates, loss of critical judgment, and impaired memory and comprehension.

*According to the ATV Safety Institute.

Your Physical Condition

Being physically exhausted is like being drunk. Try to do something that's detail-oriented when you're really tired, and you'll feel totally uncoordinated.

Don't ride:

1. When you're tired

Reckless Riding

If you are involved in an accident when you're speeding, you have a 25% chance of landing yourself in the hospital. The faster you go, the more likely you are to destroy your head and internal organs, and skip the wheelies, jumps, stunts, and any other showboating.

Laws and Regulations

Any police officer will tell you that ignorance of the law is no defense. Your best defense is to check out your local, state, or provincial laws before riding. It'll also make sure that you can continue to ride in your favorite areas. The quickest way to have a land area closed is by riding over the regulations.

Sound Judgment

Group Behavior

People occasionally do crazier and riskier things in a group than they would consider doing by themselves. When you're riding with others and things start to get out of hand, decide whether you're willing to be injured or see your friends injured.

SIPDE

By themselves, none of these safe behaviors and sound judgments will go very far. But when you put them all together . . . when you're paying attention to how you feel, when you're monitoring the movements of your ATV, and when you're constantly evaluating your environment, then you're practicing SIPDE. SIPDE is an acronym that stands for:

S	I	P	D	E
SCAN/ SEARCH	IDENTIFY HAZARDS	PREDICT WHAT WILL HAPPEN	DECIDE WHAT TO DO	EXECUTE THE DECISION

Supervision

Overview

You're responsible for supervising those who ride your ATV. Your wisdom is valuable . . . it'll bring them all back safely — your friends, your family, your relatives, and your ATV. It's crucial you consider yourself a supervisor for all riders of your ATV. Whether you accept responsibility or not, the truth is you are responsible for others riding your ATV.

Taking Responsibility

You're the last letter in "PASS" . . . "Supervision." You've just gone through Division 1 of this manual, and you've seen what's involved. That puts you in a good position to be confident about what you know. So now it's time to use your knowledge and supervise others who ride your ATV.

Inexperienced/ Untrained Riders

You can't let people ride your ATV who don't know what they're doing. Unless they've had over a year of experience with riding an all-terrain vehicle or taken a training course, it's your responsibility to keep them off your ATV. It can be dangerous (especially for underaged children) — all the more reason for you to be firm.

Experienced/Trained Riders

If anyone is going to borrow your ATV, you are responsible for their supervision. Before they ride, have them take the training course, have them watch the safety video, and have them read the Operator's Manual. You train them. It doesn't matter how you do it, as long as you do it.

TRV's are a little different from the handling to the stability to the controls. So regardless of how much experience your family members have, they don't have experience with *your* ATV. Let experienced riders get familiar with your ATV — show them the basics before they take off. You don't want it on your conscience that someone got hurt because you didn't tell them how to use your ATV.

Remember that regardless of experience, you should never let anyone under the age of 16 operate your ATV.



2411-257

Division II - Operation/Maintenance Specifications

ENGINE AND DRIVE	
Type	Four-Cycle Liquid-Cooled Vertical Twin
Bore x Stroke	75 mm x 77.6 mm (2.95 x 3.05 in.)
Displacement	686 cc (41.8 cu in.)
Ignition Type	Compression Ignition
Timing	14° BTDC Static
Brake Types	Hydraulic w/Brake Lever Lock and Rear Foot Brake
Fuel Injection Type	Lombardini Unit Injectors
CHASSIS	
Length (Overall)	336.2 cm (93.0 in.)
Height (Overall)	125.2 cm (49.3 in.)
Width (Overall)	120.7 cm (47.5 in.)
Suspension Travel (Front/Rear)	20 cm (8.0 in.)
Wheelbase	147 cm (58 in.)
Front Tire Size	AT25 x 8-12
Rear Tire Size	AT25 x 10-12
Tire Inflation Pressure	0.35 kg/cm ² (5.0 psi)
MISCELLANY	
Dry Weight (Approx)	373 kg (823 lb)
Fuel Tank Capacity (Rated)	20.81 L (5.5 U.S. gal.)
Coolant Capacity	5.6 L (5.9 U.S. qt)
Differential Capacity	275 ml (9.3 fl oz)
Rear Drive Capacity	250 ml (8.5 fl oz)
Transmission Capacity	600 ml (20.3 fl oz)
Engine Oil Capacity (With Filter)	2.0 L (2.1 U.S. qt)
Engine Oil Capacity (Without Filter)	1.9 L (2.0 U.S. qt)
Fuel (Recommended)	Biodiesel Blend up to 20% (B20)/42-50 Cetane Diesel - #1 or #2/JP 5 or JP 8 Turbine
Engine Oil (Recommended)	SAE 10W-40
Differential/Rear Drive Lubricant	SAE Approved 80W-90 Hypoid
Transmission Lubricant	SAE Approved 80W-90 Hypoid
Taillight/Brakelight	12V/8W/27W
Headlight	12V/27W (4)
Starting System	Electric w/Glow Plug Preheat

Specifications subject to change without notice.

Location of Parts and Controls



DE043B



DE042A



CF214C

1. Battery
2. Headlights
3. Hand Brake Lever
4. Rear Rack Latch Handle
5. Storage Compartment
6. Seat Lock Lever
7. Engine Access Cover
8. Rear Foot Brake
9. Taillight/Brakelight
10. Brake Lever Lock
11. Key Switch
12. Shift Lever
13. Throttle Limiter
14. Throttle Lever
15. Operator's Manual Location
16. Drive Select Switch
17. Speedometer/LCD
18. Headlight HI/LO Switch
19. Starter Button
20. Engine Stop Switch

ATV Operation

Basic Operating Maneuvers

Active riding and basic maneuvers are the foundation of your ride. Without basic skills, it's impossible to move to this level — active riding. These are your basic maneuvers:

- Mounting the TRV (Operator)
- Mounting the TRV (Passenger)
- Starting the Engine
- Starting a Cold Engine
- Shifting
- Braking/Stopping
- Parking
- Dismounting the TRV

Mounting the TRV (Operator)

1. From the left side, grab the left-side handlebar, apply the brake, and put your left foot on the footrest.
2. Grab the right-side handlebar.
3. Swing your leg over the seat and set your right foot down on the right-side footrest.
4. Get seated in a comfortable position.
5. Always keep your feet planted on the footrests.

Mounting the TRV (Passenger)

1. After the operator is seated and has the brake firmly applied, with your left hand, grasp the left shoulder of the operator, and with your right hand grasp the backrest; then swing your leg over the seat and set your right foot down on the right-side footrest.
2. Get seated in a comfortable position and keep hands firmly on the handholds.
3. Always keep your feet planted on the footrests.

Starting the Engine

Always start with the ATV on a flat, level surface. Carbon monoxide poisoning can kill you, so keep your ATV outside while it's running. Follow these steps to start it up:

1. Mount the ATV and sit down.
2. Engage the brake lever lock.
3. Turn on the ignition.
4. Shift into neutral.
5. Move the engine stop switch to RUN.
6. When the glow plug indicator light goes off, press the starter button.

CAUTION

Do not run the starter motor for more than eight seconds per starting attempt. The starter motor may overheat causing severe starter motor damage. Allow 15 seconds between starting attempts to allow the starter motor to cool.

7. Let the engine warm up.

Starting A Cold Engine

1. Turn off all electrical accessories (hand warmer, lights, etc.); then rotate the ignition switch key to the first position (ON) leaving the headlights OFF. Note that the N is indicated on the LCD and the glow plug indicator light is illuminated.
2. When the glow plug indicator light goes off, press the starter button.

CAUTION

Do not run the starter motor for more than eight seconds per starting attempt. The starter motor may overheat causing severe starter motor damage. Allow 15 seconds between starting attempts to allow the starter motor to cool.

■ NOTE: At temperatures below -10°C (14°F), turn the ignition key off and then on to recycle the glow plug. This will simplify starting in cold weather.

CAUTION

Allow 30 seconds between starting attempts for the starter motor to cool. Continuous starter motor operation can result in overheating the starter motor.

ATV Operation

- If the engine does not start, turn the ignition key off and then on to recycle the glow plug timer; then when the glow plug indicator light goes off, press the starter button again for eight seconds.
- Allow the engine to warm up for at least 10 minutes or until it is thoroughly warmed up.

CAUTION

Never use starting fluid in a diesel engine equipped with a glow plug. Severe engine damage will occur.

Shifting

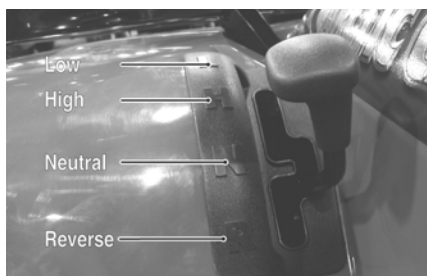

CF130B

The automatic transmission has a dual-range transmission with reverse. To shift the transmission, follow these steps:

- To engage the high range from neutral, move the shift lever forward and inward.
- To engage the low range from high range, move the shift lever forward.

■ **NOTE:** The high range is for normal riding with light loads. The low range is for carrying heavy loads or trailer towing. Compared to HIGH range, the LOW range position provides slower speed and greater torque to the wheels.

CAUTION

Always shift into low range when operating on wet or uneven terrain, when towing or pushing heavy loads, and when using a plow. Failure to follow this caution may result in premature V-belt failure or in damage to related drive system components.

- To engage reverse gear from neutral, move the shift lever outward and rearward into the R position.

CAUTION

Always come to a complete stop before attempting to shift from one range to the other or into reverse. Always shift on level ground, or engage the brake lever lock before shifting into another range or into reverse.

⚠ WARNING

Do not start the engine or operate this ATV with the clutch shield removed. Severe injury could result.

Braking/Stopping

Coming to a stop should be a slow, easy process. Always allow plenty of room and time to stop smoothly. Sometimes quick stops are inevitable, so always be prepared. Whether you're stopping slowly or stopping quickly, do this:

- Squeeze the brake lever on the left handlebar to apply both the front and rear brakes.
- If your wheels lock, release them for a second; then apply them again.
- Never "ride" the brake. Even maintaining minimal pressure on the brake lever will cause the brake pads to drag on the disc and may overheat the brake fluid.

⚠ WARNING

Excessive repetitive use of the hydraulic brake for high speed stops will cause overheating of the brake fluid and premature brake pad wear which will result in an unexpected loss of brakes.

ATV Operation

WARNING

Use only Arctic Cat approved brake fluid. Never substitute or mix different types or grades of brake fluid. Brake loss can result. Check brake fluid level and pad wear before each use. Brake loss can result in severe injury or even death.

Parking

Parking involves following the previous rules for braking; then:

1. After the ATV stops, shift into neutral.
2. Stop the engine using the ignition switch.
3. Turn off the engine stop switch.
4. If you have to park on a hill, shift the ATV into low gear; otherwise, try to park only on level surfaces.
5. Engage the brake lever lock.

Dismounting the TRV

After you've followed the procedure for parking, it's time to dismount:

1. The operator should double check that the brake lever lock is engaged.
2. The passenger should grasp the left shoulder of the operator with the right hand and with the left hand grasp the left-side handhold; then swing the right leg over the seat and step to the ground on the left side of the ATV.
3. The operator should swing the right leg over to the left side of the seat.
4. The operator should step to the ground on the left side of the ATV.

Handling the ATV (Active Riding Techniques)

Active riding involves moving your body. You and your passenger must learn to lean and shift body weight into turns to maintain control.

Safe riding techniques include:

- Riding
- Leaning, Weight Shift, and Balance
- Wide Turns
- Sharp Turns
- Quick Turns
- K-Turns
- Riding Uphill
- Riding Downhill
- Sidehilling/Traversing
- Swerving
- Crossing Obstacles

Riding

Once the engine's warm, the ATV is ready to go.

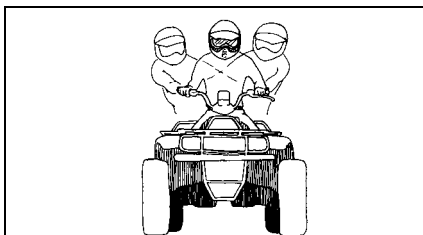

ATV-0012

1. Keep your feet on the footrests and both hands on the handlebar.
2. Hold the brake lever, and release the brake lever lock.
3. Shift into gear.
4. Release the brake slowly and apply the throttle.

Leaning, Weight Shift, and Balance

When you turn, the trick is to move forward and slide over to the side of the seat that's on the inside of the turn. Support your body weight on the outside footrest. At the same time, lean your body and the passenger body to the inside of the turn. Pay attention to the handling—if you feel the tires coming off the ground, reduce speed, shift more of your body weight to the side that's lifting, and make the turn wider if possible.

ATV Operation

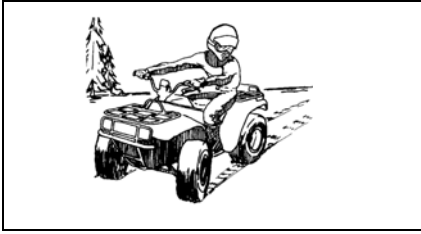

ATV-0013

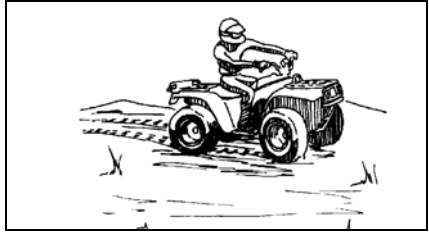

ATV-0045

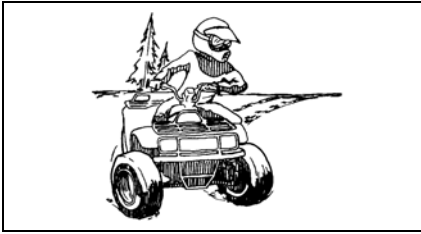

ATV-0024

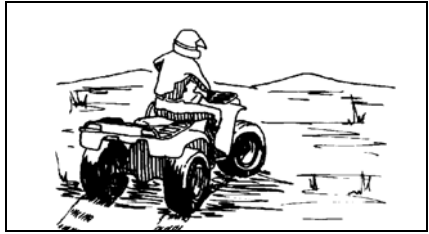

ATV-0044



ATV-0025

1. Ease off the throttle as you approach the turn to slow down.
2. Use the principles of leaning, weight shifting, and balancing — shift your body weight to the inside of the turn.
3. Gradually increase your speed as you come out of the turn.

Sharp Turns

After mastering wide turns, practice the advanced skill of sharp turns.

Wide Turns

Many accidents happen during turns. If you don't understand turning techniques, it's easy for the ATV to get away from you by losing traction, plowing, or tipping. Use this method for wide turns:



ATV-0046

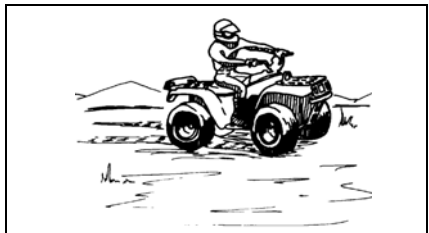

ATV-0038

ATV Operation

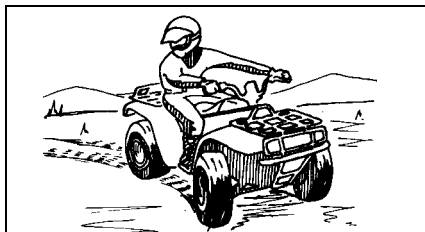

ATV-0039

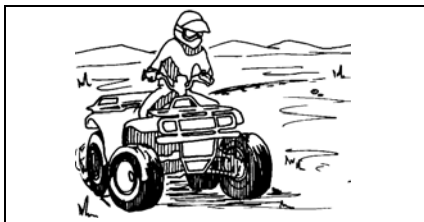

ATV-0022

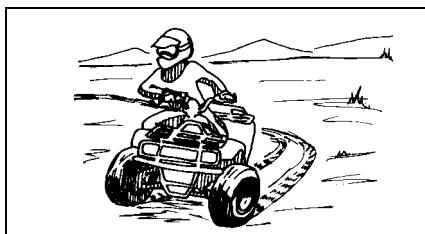

ATV-0040

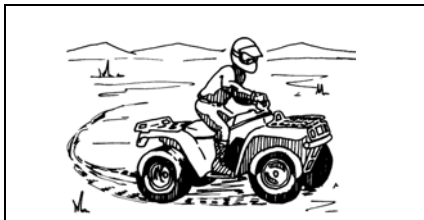

ATV-0023

1. Ease off the throttle as you approach the turn to slow down.
2. Use the principles of leaning, weight shifting, and balancing — shift your body weight to the inside of the turn.
3. You might have to lean into the turn more than you do in a wide turn.
4. If shifting weight and balance aren't enough to keep the tires on the ground, straighten out the handlebars as much as you can.
5. Gradually increase your speed as you come out of the turn.

Quick Turns

Quick turns are the most difficult turns and should only be done after you are experienced with your ATV.

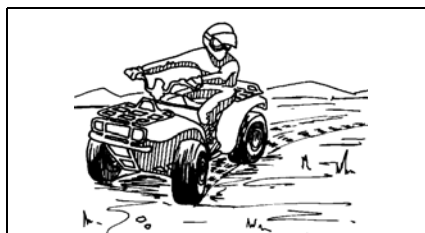

ATV-0021

1. Ease off the throttle as you approach the turn to slow down.
2. Turn the handlebars and shift weight and balance at the same time as you enter the turn (use the principles of leaning, weight shifting, and balancing — shift your body weight to the inside of the turn).
3. Follow this with slight acceleration.
4. For multiple turns, repeat this movement as needed.
5. To make your turn quicker, try raising yourself off the seat a few inches as you shift your weight.

K-Turns

Use K-turns if you accidentally stall while riding uphill; you need to take action before the ATV rolls backward down the hill.



ATV-0020

ATV Operation

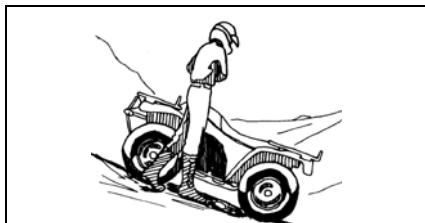

ATV-0034

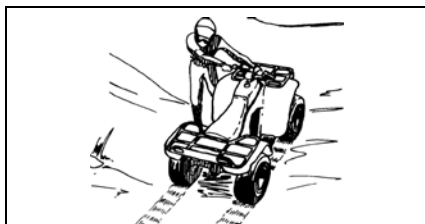

ATV-0035

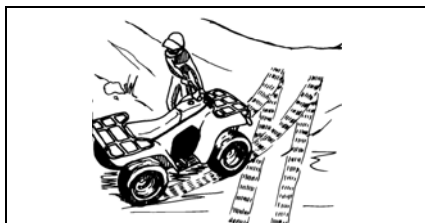

ATV-0036

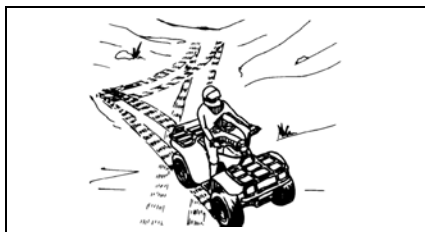

ATV-0037

1. Stop where you are, apply the brakes, and shift to neutral.
2. Shut off the engine.
3. Keep your body weight shifted forward.
4. Ask the passenger to dismount.
5. Get off the ATV on the uphill side.
6. If you're to the left of the ATV, turn the handlebar all the way left.

7. Partially release the brake, but lightly hold the brake lever.
8. Let the ATV roll to your right side until it faces slightly downhill.
9. Reapply the brakes.
10. Get back on the ATV from the uphill side, have your passenger mount the ATV from the uphill side, and keep your body weight and the passenger's body weight shifted uphill when you sit down.
11. Start the engine and follow the method for riding downhill.

Riding Uphill

Many accidents happen while riding on hills and as a result of the ATV rolling or flipping. So, obviously, use extreme caution and follow this method for riding uphill.

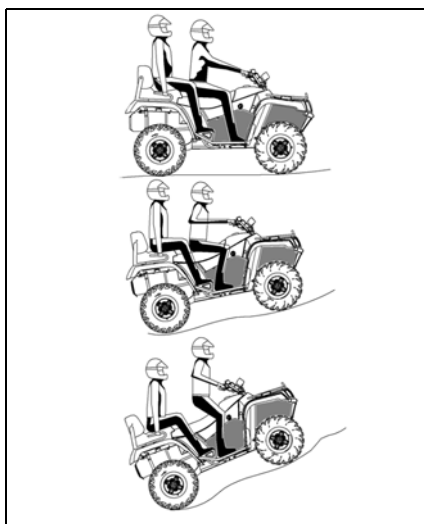

ATV-207

1. Accelerate before you start climbing; then maintain a steady pace.
2. Both the operator and the passenger should lean as far forward as possible. For steeper hills, the operator should come off the seat to stand and lean forward.
3. If you lose speed, release the throttle (so your front tires don't lift), **OR**

ATV Operation

- If that doesn't work and you still have forward motion and the terrain permits, do a U-turn, go back down, and try climbing again, **OR**
- If you have lost all forward motion, follow the K-turn procedure.

Never Operate Up Or Down Hills Steeper Than 25°

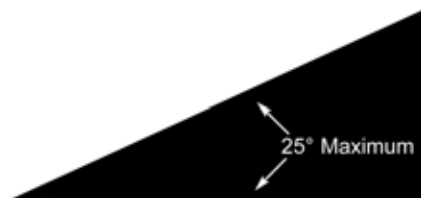

Riding Downhill

Success in riding downhill depends on how well you know your brakes—take it easy on them, or you could flip over.

- Shift your body weight and passenger's body weight as far back on the seat as possible.
- Keep it in a gear; stay out of neutral.
- Lightly apply the brake and ease up on the throttle.

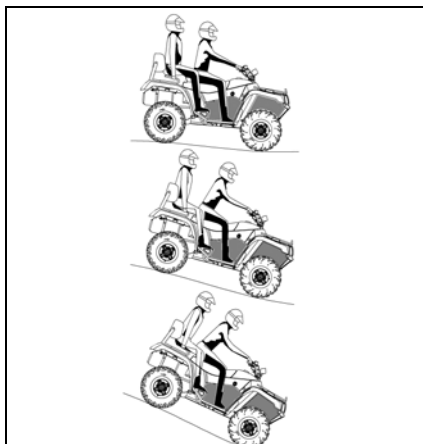

ATV-208

Sidehilling/Traversing

Sidehilling is considered an advanced skill; it's really tricky and unpredictable. So, whether your skills are advanced or not, try to avoid this kind of riding. If you're in a situation where you absolutely have to sidehill, follow this method:



ATV-0017

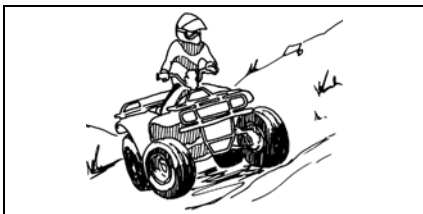

ATV-0028

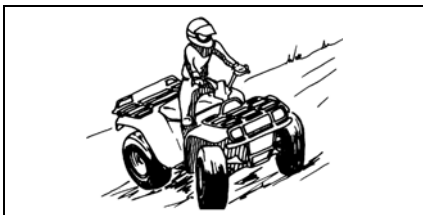

ATV-0029

- Keep your speed low and consistent.
- Shift all your body weight and passenger's body weight to the uphill side of the seat; also, support weight on the uphill footrest.
- Steer like you're driving into the hill.
- If the ATV feels like it's tipping, turn the handlebar downhill. If that's not possible because of the terrain or other conditions or if it just doesn't work, stop and get off. Have the passenger dismount on the uphill side first; then you should dismount on the uphill side.

ATV Operation

Swerving

Swerving is usually an emergency reaction to avoid an obstacle but is similar to quick turns. The difference is that quick turns involve slight acceleration in the turn; don't accelerate if you swerve.

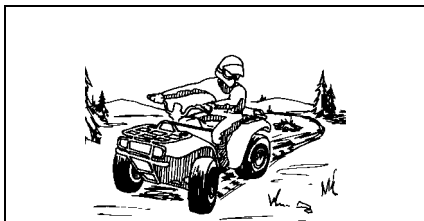

ATV-0043

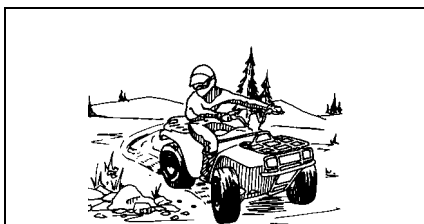

ATV-0042

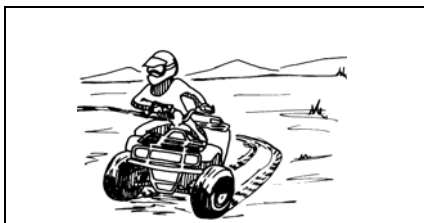

ATV-0041

1. Ease off the throttle as you approach the obstacle.
2. Turn the handlebar. At the same time, shift weight and balance as you swerve. Use the principles of leaning, weight shifting, and balancing — shift your body weight to the inside of the turn.
3. Keep your hand off the brake until the emergency is over and you're back in control.

Crossing Obstacles

Crossing obstacles is risky; avoid it if possible. Riding over logs, rocks, and ruts means combining all the active riding skills into one big motion. Your ATV will respond differently for different obstacles (logs, ruts, etc.), but these are general guidelines for overcoming two-track (both tires contacting the obstacle at the same time) obstacles:

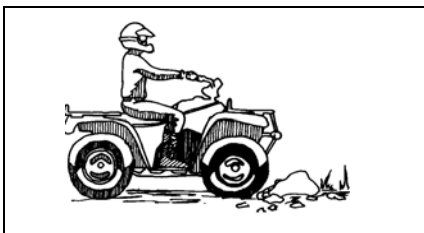

ATV-0016

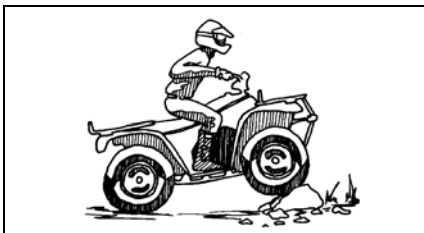

ATV-0026

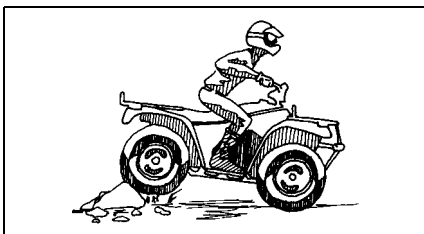

ATV-0027

1. Stop the ATV.
2. Have the passenger dismount.
3. Keep your speed way down; less than 5 mph.
4. Approach the obstacle head-on.
5. Come up off the seat.
6. Keep your weight on the footrests.

ATV Operation

7. Apply a little throttle when the front tires make contact with the obstacle.
8. Lean forward and release the throttle when the front tires clear the obstacle.
9. Keep your body loose to absorb any shock.
10. If the ATV starts tipping, shift your body weight to keep it in balance.

To clear a single-track (only one tire contacts) obstacle, follow the same rules except:

1. Use the ATV's momentum to clear the obstacle.
2. Don't pull up on the handlebar.
3. Don't apply the throttle.

Tips

Driving an ATV and a car have some similarities; however, there are a few situations that require special attention:

- Reversing
- Skidding or Sliding
- Parking on a Hill
- Stalling on a Hill
- Crossing Water
- Crossing Roads
- Cold Weather Driving
- Stopping the ATV
- Stopping the Engine

Reversing

It's tough to see things behind you.

1. Go slowly. It's hard to see behind you.
2. Keep your handlebar straight.
3. Backing down hills is a bad idea; do a U-turn or K-turn instead to turn around.

Skidding or Sliding

If you lose control after hitting sand, ice, mud, or water:

1. Turn your handlebar into the direction of the slide.
2. Keep your hand off the brakes until you're out of the skid.

3. Shift your weight forward.

Sometimes your ATV may not respond and goes straight ahead instead of letting you turn. Here's how to handle it:

1. Slow down.
2. Move forward on the seat.
3. Lean to inside of turn and have your passenger lean to the inside of the turn.
4. Turn handlebar.

Parking on a Hill

This shouldn't be necessary, but if it is:

1. Keep it in gear.
2. Engage the brake lever lock.
3. Find something to block the rear tires.

Stalling on a Hill

If you use the right method for riding uphill, this shouldn't happen. But if you have a problem, do this:

1. If the ATV hasn't started rolling backwards yet, follow the procedure for the K-Turn, **OR**
2. If the ATV is already rolling backward, both the operator and the passenger should lean as far forward as possible and the operator can be standing up on the footrests.
3. Nice and easy, apply the hand brake lever.
4. When you come to a stop, follow the procedure for the K-turn.

Crossing Water

This ATV can only handle water up to its footrests. Any more than that and you risk engine damage and/or personal injury. Stay away from fast moving rivers. Tires can be buoyant, so if the water is too deep, you might find the ATV suddenly afloat.

1. Physically check the depth and current of the water, especially if you can't see the bottom. You're also checking for boulders, logs, or any other hidden obstacles.

ATV Operation

2. Keep ATV speed slow.
3. Make sure you have a way out on the other side of the water.
4. If you get stuck in the sludge or mud, try rocking the ATV from side to side.
5. Once you've cleared the water, briefly apply the brakes to make sure they work.

Crossing Roads

Crossing roads on your ATV is also a bad idea, so avoid it. If you can't:

1. Stop completely on the shoulder of the road.
2. Check both directions for traffic.
3. Crossing near a blind corner or intersection is dangerous; don't do it.
4. Drive straight across to the opposite shoulder.
5. Take into account that your ATV could stall while crossing; give yourself and your passenger enough time to get off the road.
6. You have to assume that oncoming cars don't see you, and if they do, they won't be able to predict your actions.
7. It's illegal to cross public roads in some places. Know your local laws.

Cold Weather Driving

■ **NOTE:** Check that all control levers move freely. Make sure that the footrest, shift lever, and rear foot brake are free of ice and snow.

WARNING

For your personal safety, it is very important to wear the type and amount of cold-weather clothing according to the coldest anticipated temperatures.

1. With the transmission in neutral, move the ATV forward and backward to check that the wheels roll freely. If the ATV will not roll, the tires may be frozen to the ground or the brake pads may be frozen to the discs.

2. If the tires are frozen to the ground, pour warm water around them to melt the ice.

CAUTION

Before riding, manually move the ATV forward and backward to make certain that all wheels roll freely.

3. If the brakes are frozen, use a suitable heating device to thaw out the brakes.

WARNING

Do not attempt to free frozen brakes by pouring warm water on the brake pads and housings.

■ **NOTE:** After the brakes thaw, dry them by applying them several times while riding slowly.

■ **NOTE:** After riding through water, mud, snow, or slush, it is important to dry both brake systems before parking the ATV.

WARNING

Go slowly and be extra careful when riding on snow-covered or ice-covered terrain. Always be alert to changing terrain conditions when operating the ATV.

4. Practice driving in an open snow-covered or ice-covered area at slow speeds before driving on snow-covered or ice-covered trails.
5. Learn how the ATV responds to steering and braking on the type of terrain to be encountered on the ride.

Stopping The ATV

To stop the ATV, first release the throttle lever. Next, apply the brake.

Stopping The Engine

To stop the engine, turn the ignition switch key to the OFF position or set the engine stop switch to the OFF position.

General Information

TRV Identification Numbers

This ATV has two identification numbers: Vehicle Identification Number (VIN) and Engine Serial Number (ESN).

The VIN is located on the frame support rail.



AF968C

The ESN is located on the back-side of the engine crankcase.



DE001A

These numbers are required by the dealer to complete warranty claims properly. No warranty will be allowed by Arctic Cat if the VIN or ESN is removed or mutilated in any way.

Always provide the ATV name, VIN, and ESN when contacting an authorized Arctic Cat ATV dealer for parts, service, accessories, or warranty. If a complete engine must be replaced, ask the dealer to notify Arctic Cat for correct registration information.

Ignition Switch/key

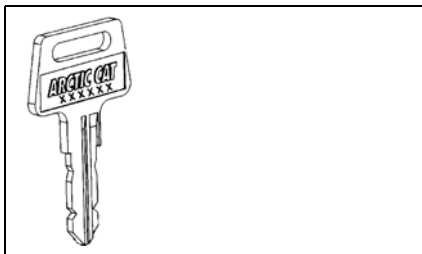

ATV-055

Two keys come with the ATV. Keep the spare key in a safe place. An identifying number is stamped on each key. Use this number when ordering a replacement key.

Control Locations and Functions

Ignition Switch

The ignition switch has three positions.

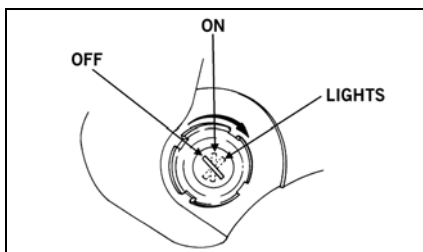

ATV-0056

OFF position — All electrical circuits except the accessory plug are off. The engine will not start. The key can be removed in this position.

■ **NOTE:** The accessory plug is powered by the battery at all times.

ON position — The ignition circuit is complete and the engine can run. The key cannot be removed in this position. The V-belt cooling fan runs continuously.

LIGHTS position — The ignition circuit is complete and the headlights and tail-light are on. The key cannot be removed in this position. The V-belt cooling fan runs continuously.

CAUTION

Leaving the ignition switch in the ON or LIGHTS position for a long period of time when the engine is not running may cause the battery to discharge. Always leave the ignition switch in the OFF position when engine is not running.

Shift Lever

This ATV has a dual-range automatic transmission with reverse.

Drive Select Switch

This switch allows the operator to operate the ATV in either 2-wheel drive (rear wheels) or 4-wheel drive (all wheels). For normal riding on flat, dry, hard surfaces, 2-wheel drive should be sufficient. In situations of aggressive trail conditions, 4-wheel drive would be the desired choice.



FI475A

To either engage or disengage the front wheels, move the switch to the 4WD position or to the 2WD position.

CAUTION

Do not attempt to either engage or disengage the 4WD lock front differential while the ATV is moving.

The 4WD lock allows the operator to mechanically lock the front differential to apply equal power to both front wheels. To engage the lock from 4WD, slide the switch up and move fully to the left; to disengage the lock, move the switch lever to the right.

WARNING

The 4WD lock is intended for use where minimum traction is available. **NEVER EXCEED 10 MPH (16 kph)** with the lock engaged. Maneuverability and handling characteristics will differ with the lock engaged. Failure to follow this procedure may result in loss of control. Control loss can result in severe injury or even death.

Hand Brake

The hand brake is considered to be the normal operating (main) brake. It should be applied whenever a braking situation is needed.

Apply the brake by compressing the brake lever toward the handlebar.

Brake Lever Lock

To engage and release the brake lever lock, use the following procedure.

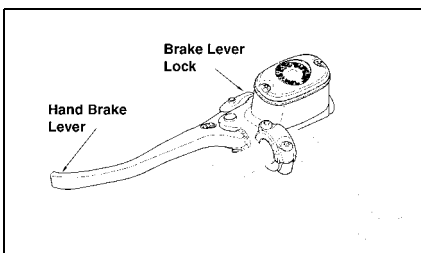

738-420B

1. Squeeze the hand brake two or three times and release it.
2. Depress and hold the brake lever lock.
3. While holding in on the brake lever lock, squeeze the brake lever.

NOTE: It will click as it engages and the brake lever will not return to its released position.

4. Release the brake lever lock by squeezing the brake lever. It will return to its released position.

Check to make sure the brake lever lock engages properly and that the brake (when engaged) locks the wheels.

1. Pump the brake lever 2 or 3 times.

- Engage the brake lever lock.
- Attempt to push the ATV.

■ **NOTE:** The brake lever lock must lock the wheels. If it doesn't, take the ATV to an authorized Arctic Cat ATV dealer for service.

WARNING

Always check to be sure that the brake lever lock has been disengaged before operating the ATV. An accident could result if the brake lever lock is left engaged while the ATV is operated. The brake may relax if left engaged for a long period of time. This could cause an accident; therefore, do not leave the ATV on a hill depending on the brake lever lock. Always block the downhill side of the wheels if leaving the ATV on a hill or park the ATV in a sidehill position.

Rear Foot Brake



CF223

Pressing the rear foot brake downward will apply the brake to the rear wheels.

Headlight HI/LO Switch

Use the headlight HI/LO switch to select the high or low headlight beam when the ignition switch is in the LIGHTS position. When the switch is in the HI position, the high beam will illuminate. When the switch is in the LO position, the low beam will illuminate.

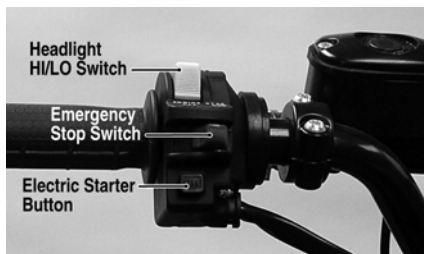

DE033A

Engine Stop Switch

OFF position — The fuel solenoid valve is closed. The engine cannot be started or will not run. If the engine stop switch is used to stop engine without turning off ignition switch, the battery may discharge.

RUN position — The fuel solenoid valve is open and the glow plug timer is activated. The engine can start and run.

Electric Starter Button

Pushing in on this button activates the starter motor. Before starting the engine, make sure the ignition switch is in the ON position, the transmission is in neutral, the reverse shift lever is in the forward position, and the brake lever lock is engaged.

■ **NOTE:** This ATV has safety interlock switches which prevent the starter motor from activating when the transmission is not in neutral.

Throttle Lever



FI475B

Control engine RPM with the position of the throttle lever. Operate this lever with the thumb. Pushing it forward increases engine RPM and allowing it to retract decreases engine RPM.

Throttle Limiter Screw

Throttle lever travel may be limited by adjusting the throttle limiter screw. The throttle limiter should be adjusted according to the operator's skill and experience. To adjust the throttle limiter, use the following procedure.

1. Loosen the jam nut.

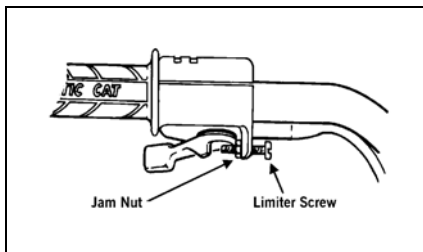

ATV-0063

2. Turn the throttle limiter screw clockwise to decrease engine RPM maximum or counterclockwise to increase engine RPM maximum.
3. Tighten the jam nut securely.

Indicator Lights

There are two indicator lights on the instrument pod. The green (left) light will illuminate whenever the glow plugs are heating. The red (right) light will illuminate whenever the alternator is not charging the battery (key in the ON position).

Speedometer/LCD



CF236A

1. Clock/Engine Hour Meter - The clock function indicates time in the 12-hour mode; the hour meter indicates the total time the ATV has run and cannot be reset to zero. To set the clock, use the following procedure.

A. With the ignition switch ON, press and release the Mode Button (3) until the Clock/Engine Hour Meter (1) is displayed; then (if necessary) press and release the Set/Reset Button (4) to select the clock display.

B. Press and hold the Set/Reset Button (4) until the minutes stop scrolling and the hour display starts to scroll. Momentarily release when the correct hour is displayed; then repeatedly press and release the Set/Reset Button (4) until the correct minutes are displayed.

■ **NOTE:** Clock memory power is supplied through the 15-amp accessory fuse and verified during gauge "power-up" and reset. In the event of clock memory power failure (blown fuse, etc.), the gauge will "power-up," reset, and shut down repeatedly until clock memory power is restored. Always check the 15-amp accessory fuse if this gauge condition is noted.

2. Temperature Indicator - If the engine coolant temperature exceeds the normal operating range, the temperature icon will begin flashing and the LCD will go blank for 30 seconds; then the LCD will return to normal. However, the temperature icon will continue to flash.

CAUTION

Continued operation with high engine temperature may result in engine damage or premature wear.

■ **NOTE:** High engine RPM, low vehicle speed, or heavy load can raise engine temperature. Decreasing engine RPM, reducing load, and selecting an appropriate transmission gear can lower the temperature.

■ **NOTE:** Debris in front of the engine (or packed between the cooling fins of the radiator) can reduce cooling capacity. Using a garden hose, wash the radiator and the engine to remove any debris restricting air flow.

CAUTION

Arctic Cat does not recommend using a pressure washer to clean the radiator core. The pressure may bend or flatten the fins causing restricted air flow, and electrical components on the radiator could be damaged. Use only a garden hose with spray nozzle at normal tap pressure.

3. Mode Button - Shifts the gauge through three set-up modes: speedometer/tachometer, distance, and time.

■ **NOTE:** The Mode Button must be pressed and released to shift modes. Approximately two seconds after the Mode Button is released, the digital gauge will return to full display.

4. Set/Reset Button - In conjunction with the Mode Button, sets and resets various displays on the digital gauge. Also used to shift from speedometer function to tachometer function on the speedometer/tachometer gauge.
5. Fuel Level Indicator - Indicates approximate amount of fuel in the fuel tank.

■ **NOTE:** When the bottom segment flashes, approximately 3.5 L (0.92 U.S. gal.) of fuel remains in the tank.

6. Low Oil Pressure - Will be displayed during self-test at start-up. It will not be displayed during normal operation unless the oil pressure falls below approximately 1.05 kg/cm² (15 psi). The digital gauge will go blank and the oil pressure icon will flash for 30 seconds; then the digital gauge will return to normal with the oil pressure icon continuing to flash.

CAUTION

Continued operation with low oil pressure will result in serious engine damage. Shut the ATV off and determine the cause of low oil pressure.

7. Odometer/Trip Meter - Odometer registers the total distance the vehicle has traveled. The trip meter is resettable and can be used to measure trip or trip legs. The odometer cannot be reset.

■ **NOTE:** To shift between the odometer (ODO) or trip meter (TRIP), press the Mode Button (3) to select the distance mode; then press the Set/Reset Button (4) to select the desired display. Hold the Set/Reset Button down to reset the trip meter.

8. Gear Position Indicator - Indicates which gear is selected.
- R (reverse)/N (neutral)/H (high range)/L (low range).

■ **NOTE:** An E will be displayed if there is an error caused by a no-shift position signal.

9. High Beam Indicator - The High Beam icon will appear only when the headlights are on high beam.
10. 4WD Lock Indicator - Displays LOCK when the front differential lock has been engaged.
11. Drive Select Indicator - Displays 4WD when selected by the drive select switch or when the 4WD lock is engaged. The display is blank when in 2WD.
12. Speedometer - Indicates the approximate vehicle speed in miles per hour (MPH) or kilometers per hour (km/h).

■ **NOTE:** To change mph/km/h display, press and release Mode Button (3) until the icon (MPH/km/h) appears; then press the Set Button (4) to change the display.

Fuel/Vent Hoses

Replace the fuel hoses every two years. Damage from aging may not always be visible. Do not bend or obstruct the routing of the fuel tank vent hose.

Level Stick (Engine Oil)

There is a level stick for checking the engine oil level. To check the oil level, use the following procedure.

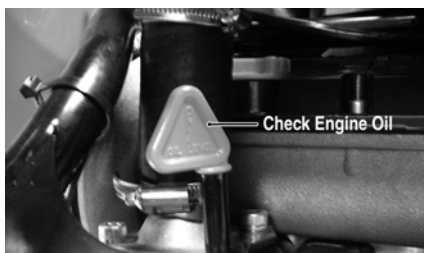

DE003A

■ **NOTE:** The ATV should be on level ground when checking the engine oil level.

1. Open the engine access cover; then pull out the level stick and wipe it with a clean cloth.
2. Install the level stick and push completely into the tube.
3. Remove the level stick; the engine oil level should be above the "L" mark but not higher than the "F" mark.

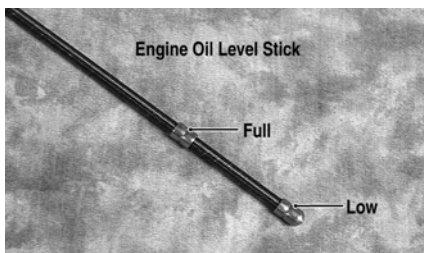

DE024A

CAUTION

Do not overfill the engine with oil. Always make sure the oil level is above the "L" mark but not higher than the "F" mark.

Level Stick (Transmission Lubricant)

There is a level stick located under the operator's seat for checking the transmission lubricant level. To check the transmission lubricant level, use the following procedure.



DE002A

■ **NOTE:** The ATV should be on level ground when checking the transmission lubricant level.

1. Pull the level stick out of the tube and wipe it with a clean cloth.
2. Install the level stick and push it completely into the tube.
3. Remove the level stick; the transmission lubricant level should be above the "L" mark but not higher than the "F" mark.

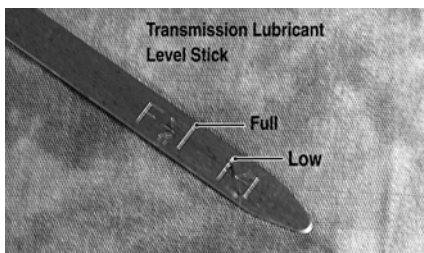

DE023A

CAUTION

Do not overfill the transmission with lubricant. Always make sure the lubricant level is above the "L" mark but not higher than the "F" mark.

Safety Flag Bracket

A bracket is provided for mounting a flag at the rear of the ATV.

Rear Rack

1. To remove the rear rack, remove the front locking pins (A); then pull the two rear latch handles (B) to the rear and rotate to the vertical position. Remove the rack.



DE039A

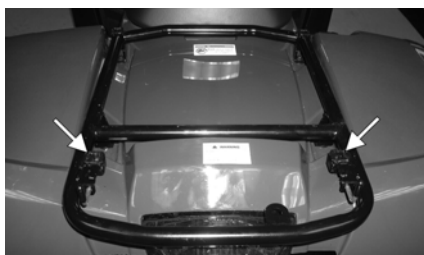

CF229A



DE037A



CF226A

- To install the rear rack, place the rack into the two front receivers; then lower the rear of the rack into the rack latch receivers. Install the two front locking pins; then release the rack latches and lock into position.

Rack Loading (Front and Rear)

The front rack and rear rack are designed to carry specified load capacities. Always refer to the Load Capacity Ratings Chart for proper capacities.

WARNING

Make sure the loads on the front and rear racks will not interfere with the ATV controls or obstruct the view of the operator. Also, make sure the loads are evenly distributed, properly secured, and will not shift while operating the ATV.

Rear Seat (Optional)

- To install the optional rear seat, remove the rear rack; then engage the two front mounting lugs into the mounting rack. While holding down firmly on the front of the seat, push the seat forward until the rear tabs engage the rear mounting latches.

- Lock the seat into position by pulling the two latch handles to the rear and rotating them to the horizontal position.

WARNING

Make sure the seat is secure before mounting the ATV. Severe personal injury may result if the seat is not properly secured.

- To remove the rear seat, pull the two latch handles to the rear and rotate them to the vertical position.
- Lift the rear of the seat up; then pull slightly to the rear and lift the seat off the mountings.

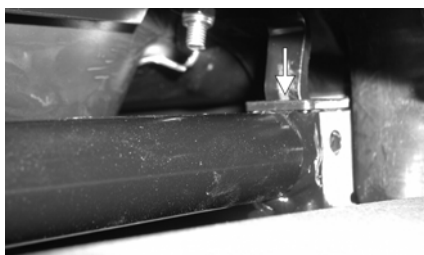

CF227A

Front Seat Lock

■ **NOTE:** The rear seat (if installed) must be removed prior to removing the front seat.

1. To remove the front seat, pull the seat lock lever up (located at the rear of the seat). Raise the rear end of the seat and slide it rearward.
2. To lock the seat into position, slide the front of the seat into the seat retainers and push down firmly on rear of seat. The seat should automatically lock into position.

⚠ **WARNING**

Make sure the seat is secure before mounting the ATV. Severe personal injury may result if the seat is not properly secured.

Trailer and Towing

⚠ **WARNING**

Never use the front rack or rear backrest support as towing or trailering points.

The TRV is equipped with a frame-mounted receiver for a standard 2 in. receiver hitch. The standard receiver hitch must be purchased separately.

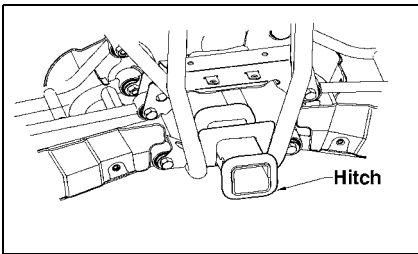

738-424A

⚠ **WARNING**

Make sure that the load in the trailer is properly secured and will not shift while moving. Also, do not overload the trailer.

When loading a trailer properly, two items are critical: Gross Trailer Weight (the weight of the trailer plus cargo) and Trailer Tongue Weight.

⚠ **WARNING**

Never exceed any of the recommended weight restrictions.

Trailer Tongue Weight is the downward force exerted on the hitch by the trailer coupler when the trailer is fully loaded and the coupler is at its normal towing height.

Always maintain a slow speed when trailering and towing and avoid sudden accelerations, quick maneuvers, and sudden stops. Braking distance will be affected when towing a trailer. When towing a trailer, always maintain slow speed and allow more stopping distance than when not towing a trailer.

⚠ **WARNING**

Riding this ATV without extra caution when towing a trailer will be hazardous. Trailer towing can affect the handling and braking of the ATV. Tow only at a low speed never exceeding 10 mph. Avoid sudden accelerations and stopping of the ATV. Do not make quick maneuvers. Avoid uneven surfaces and do not tow on hills. Never carry passengers in a trailer unless the trailer is designed for such use and has a rigid tow bar. Allow more stopping distance than when not towing a trailer.

Transporting TRV

When transporting the TRV, Arctic Cat recommends that the ATV be in its normal operating position (on all four wheels) and the following procedure be used.

1. Engage the brake lever lock and place the transmission in gear.

CAUTION

Failure to engage the brake lever lock and place the transmission in gear could result in the ATV rolling off the trailer in the event of tie-down strap failure.

2. Secure the ATV with load rated hold-down straps.

■ **NOTE:** Suitable hold-down straps are available from your Arctic Cat ATV dealer. Ordinary rope is not recommended because it can stretch under load.

CAUTION

When using hold-down straps, care must be taken not to damage the ATV.

Fuel-Oil-Lubricant**Recommended Fuel**

The recommended fuel to use is biodiesel blend up to 20% (B20), #1 or #2 diesel fuel, or JP 5 or JP 8 turbine fuel. At temperatures above -10°C (14°F), use #2 diesel fuel or a biodiesel blend up to 20%. At temperatures at or below -10°C (14°F), use #1 diesel fuel. Diesel fuel with a minimum cetane number below 42 should not be used.

CAUTION

Never use biodiesel blends at temperatures at or below -10°C (14°F).

Recommended Engine Oil

■ **NOTE:** Arctic Cat recommends the use of genuine Arctic Cat lubricants.

The recommended oil to use is an oil which is rated SJ/CF under API service classification. These oils meet all of the lubrication requirements of the Arctic Cat engine. The recommended engine oil viscosity is SAE 10W-40. Ambient temperature should determine the correct weight of oil. See the viscosity chart or an authorized Arctic Cat ATV dealer for details.

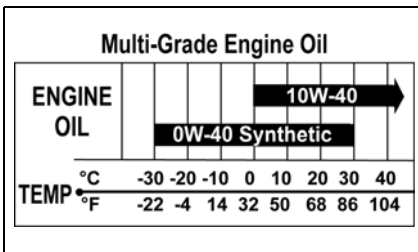

OILCHART

CAUTION

Any oil used in place of the recommended oil could cause serious engine damage.

Recommended Transmission Lubricant

■ **NOTE:** Arctic Cat recommends the use of genuine Arctic Cat lubricants.

The recommended transmission lubricant is SAE approved 80W-90 hypoid. This lubricant meets all of the lubrication requirements of the ATV transmission.

CAUTION

Any lubricant used in place of the recommended lubricant could cause serious transmission damage.

Recommended Front Differential/Rear Drive Lubricant

■ **NOTE:** Arctic Cat recommends the use of genuine Arctic Cat lubricants.

The recommended lubricant (front differential and rear drive) is SAE approved 80W-90 hypoid. This lubricant meets all of the lubrication requirements of the ATV.

CAUTION

Any lubricant used in place of the recommended lubricant could cause serious front differential/rear drive damage.

Filling Fuel Tank**⚠ WARNING**

Always fill the fuel tank in a well-ventilated area. Never add fuel to the fuel tank near any open flames or with the engine running or hot. **DO NOT SMOKE** while filling the fuel tank.

Since diesel fuel expands as its temperature increases, the fuel tank must be filled to its rated capacity only. Expansion room must be maintained in the tank particularly if the tank is filled with cold diesel fuel and then moved to a warm area.

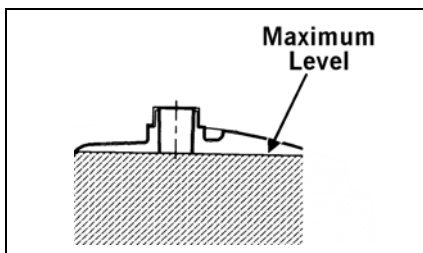

ATV-049D

Allow the engine to cool before filling the fuel tank. Care must be taken not to overflow the tank.

⚠ WARNING

Do not over-flow diesel fuel when filling the fuel tank. A fire hazard could materialize. Always allow the engine to cool before filling the fuel tank.

Tighten the fuel tank cap securely after filling the tank.

⚠ WARNING

Do not overfill the fuel tank.

Engine Break-in

After the completion of the break-in period, the engine oil and oil filter should be changed. Other maintenance after break-in should include checking of all prescribed adjustments and tightening of all fasteners. At the discretion and expense of the owner/operator, the ATV may be taken to an authorized Arctic Cat ATV dealer for this initial service.

New vehicles and renewed engines require a “break-in” period. The first month is most critical to the life of this ATV. Proper operation during this break-in period will help assure maximum life and performance from the ATV.

During the first 10 hours of operation, always use less than ½ throttle. Varying the engine RPM during the break-in period allows the components to “load” (aiding the engine/transmission component mating process) and then “unload” (allowing components to cool). Although it is essential to place some stress on the engine components during break-in, care should be taken not to overload the engine too often. Do not pull a trailer during the break-in period.

When the engine starts, allow it to warm up properly. Idle the engine several minutes until the engine has reached normal operating temperature. Do not idle the engine for excessively long periods of time.

Burnishing Brake Pads

Brake pads must be burnished to achieve full braking effectiveness. Braking distance will be extended until brake pads are properly burnished.

To properly burnish the brakes, use following procedure:

1. Choose an area sufficiently large to safely accelerate to 30 mph and brake to a stop.
2. Accelerate to 30 mph; then compress brake lever to decelerate to 0-5 mph.
3. Repeat procedure twenty times.

⚠ WARNING

Do not attempt sudden stops or put yourself into a situation in which a sudden stop will be required until the brake pads are properly burnished.

General Maintenance

■ **NOTE: Proper maintenance of this ATV is important for optimum performance. Follow the Maintenance Schedule and all ensuing Maintenance Instructions/Information.**

If, at any time, abnormal noises, vibrations, or improper functioning of any component of this ATV is detected, DO NOT OPERATE THE ATV. Take the ATV to an authorized Arctic Cat ATV dealer for inspection and adjustment or repair.

If the owner/operator does not feel qualified to perform any of these maintenance procedures or checks, take the ATV to an authorized Arctic Cat ATV dealer for professional service.

■ **NOTE: The following instructions and information refer to specific items in the maintenance and care of this ATV.**

Maintenance Schedule							
Item	Page	Initial 100 miles	Every 100 miles	Every 300 miles	Every 500 miles	Every 1250 miles	Every 5000 miles
Battery	61	I	I		I		
* Engine nuts and bolts	—	I			I		
* Valve clearance	—						I
Transmission lubricant	58	I		I	I		
	58	Replace every 4 years					
Liquid cooling system	56	I	Inspect every time before riding			Replace coolant every 2 years	
Fuel filter	64	I			I	R	
Oil filter	57	Change after initial 300 miles				R	
Throttle cable	65	I	Inspect every time before riding				
Fuel/vent hoses	48	I	Inspect every time before riding				
	48		Replace every 2 years				
Engine oil	57	Change after initial 300 miles				R	
Air filter	65	I			I	R	
Gear lubricant (Front differential - rear drive)	58	I			I		
	58		Replace every 4 years				
V-Belt	66	I			I		
Muffler/spark arrester	67				C		
Tires/air pressure	67	I	Inspect every time before riding				
	32	I	Inspect every time before riding				
* Brake components	59	I	Inspect every time before riding				
Brake fluid	59	I	*Replace every 2 years				
Brake hoses	60	I	*Replace every 4 years				
* Steering	—	I	Inspect every time before riding				
* Suspension (Ball joint boots, drive axle boots front and rear, tie rods, differential and rear drive bellows)	—	I	Inspect every time before riding				
* Chassis nuts and bolts	—	I	T				
Frame/welds/racks	—	I			I		
Electrical connections	—	I			I		
Headlight/taillight-brakelight	68	I	Inspect every time before riding				
Fuel injection	—						I
Timing belt	—	Replace every 5,000 miles					
Alternator belt	—	I				I	
Engine oil level	48	I	Inspect every time before riding				
Coolant level	56	I	Inspect every time before riding				

I = Inspect and clean, adjust, lubricate, replace as necessary * = Dealer maintenance
T = Tighten R = Replace C = Clean

Liquid Cooling System

The cooling system capacity is approximately 5.6 L (5.9 U.S. qt). The cooling system should be inspected daily for leakage and damage. If leakage or damage is detected, take the ATV to an authorized Arctic Cat ATV dealer for service. Also, the coolant level should be checked periodically.

When filling the cooling system, use a coolant/water mixture which will satisfy the coldest anticipated weather conditions of the area in accordance with the coolant manufacturer's recommendations. While the cooling system is being filled, air may become trapped; therefore, elevate the rear of the ATV 30-40 cm (12-16 in.) to allow air to bleed from the filler neck. Run the engine for several minutes; then shut off the engine and fill with coolant to the top of the filler neck.

■ **NOTE:** Use a good quality, biodegradable glycol-based, automotive-type antifreeze.

WARNING

Never check the coolant level when the engine is hot or the cooling system is under pressure.

CAUTION

After operating the ATV for the initial 5-10 minutes, stop the engine, allow the engine to cool down, and check the coolant level. Add coolant as necessary.

■ **NOTE:** High engine RPM, low vehicle speed, or heavy load can raise engine temperature. Decreasing engine RPM, reducing load, and selecting an appropriate transmission gear can lower the temperature.

To check/add coolant, use the following procedure.

1. Check the level of coolant in the coolant expansion tank located under the right front fender. The coolant level should be between the Full Cold and Full Hot lines.

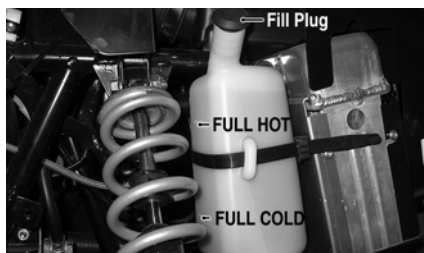

DE019A

2. Remove the rubber plug from the neck of the coolant expansion tank and add coolant as necessary; then install the plug.
3. Remove the filler cap located under the engine access cover and add coolant as necessary to bring to the top of the filler neck. Install and tighten the filler cap securely.

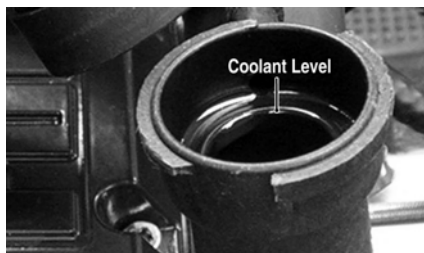

DE582A

Shock Absorbers

Each shock absorber should be visibly checked weekly for excessive fluid leakage (some seal leakage may be observed but it does not indicate the shock is in need of replacement), cracks or breaks in the lower case, or a bent shock rod. If any one of these conditions is detected, replacement is necessary.

■ **NOTE:** When the ATV is operated in extremely cold weather (-23° C/ -10° F or colder), a small amount of leakage may be present. Unless the leakage is excessive, replacement is not necessary.

The shock absorber has a spring force adjustment sleeve with five adjustment positions to allow the spring to be adjusted for different riding and loading conditions. If the spring action is too soft or too stiff, adjust it according to the chart.



CD453

■ **NOTE:** Before attempting to adjust suspension, clean dirt and debris from the sleeve and remove load from the suspension; then use the spanner wrench to adjust the sleeve to the desired position.

Position	Spring Force	Setting	Load
1		Soft	Light
2			
3			
4			
5		Stiff	Heavy

■ **NOTE:** It is recommended that all ATV weight be taken off the suspension prior to adjusting shock absorber sleeves.

General Lubrication

Cables

None of the cables require lubrication; however, it is advisable to lubricate the ends of the cables periodically with a good cable lubricant.

Engine Oil and Filter

Change the engine oil and oil filter at the scheduled intervals. The engine should always be warm when the oil is changed so the oil will drain easily and completely.

1. Park the ATV on level ground.
2. Remove the oil filler cap (located under the engine access cover). Be careful not to allow contaminants to enter the opening.



DE025A

3. Remove the engine drain plug from the bottom of the engine and drain the oil into a drain pan.



DE017A

4. Remove the right-side engine cover.
5. Using the oil filter wrench and a ratchet handle (or a socket or box-end wrench), remove the old oil filter and dispose of properly. Do not re-use oil filter.



DE018

■ **NOTE:** Clean up any excess oil after removing the filter.

- Apply oil to the new filter O-ring and check to make sure it is positioned correctly; then install the new oil filter. Tighten securely.
- Install the drain plug and tighten it securely. Pour the recommended oil in the filler hole. Install the filler cap.
- Start the engine (while the ATV is outside on level ground) and allow it to idle for a few minutes.
- Turn the engine off and wait approximately three minutes. Recheck the oil level.
- Inspect the area around the drain plug and oil filter for leaks.

Transmission Lubricant (Inspecting/Changing)

Check and change the transmission lubricant according to the Maintenance Schedule. When adding or changing the lubricant, use approved SAE 80W-90 hypoid oil and use the following procedure.

- Place the ATV on level ground.
- Remove the transmission fill plug. Make sure not to allow contaminants to enter the opening.

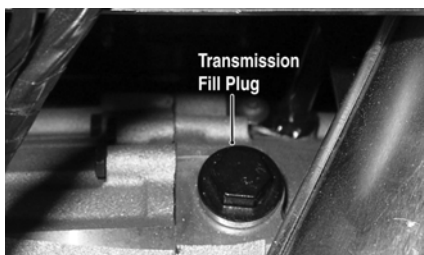

DE026A

- Remove the transmission drain plug from the bottom of the transmission and drain the lubricant into a drain pan.



DE016A

- Install the drain plug and tighten securely. Pour recommended lubricant into the filler hole. Install the filler plug.
- Remove the transmission lubricant level stick and wipe it with a clean cloth; then check the lubricant level with the level stick.



DE002A

Front Differential and Rear Drive Gear Lubricant (Inspecting/Changing)

Check and change the gear lubricant in each according to the Maintenance Schedule. When adding or changing the lubricant, use approved SAE 80W-90 hypoid oil and use the following procedure.

■ **NOTE:** To check each, remove each filler plug. The oil should be 1 in. below the threads of each plug.

- Place the ATV on level ground.
- Remove each oil filler plug.
- Drain the oil into a drain pan by removing in turn the drain plug from each.

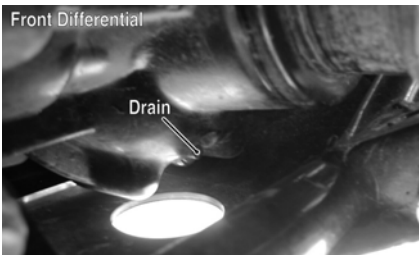
Hydraulic Hand Brake

CF107B

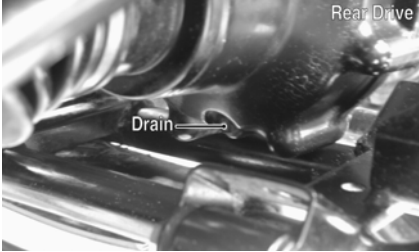

CF106C

4. After all the oil has been drained, install the drain plugs and tighten securely.

CAUTION

Inspect the oil for any signs of metal filings or water. If found, take the ATV to an authorized Arctic Cat ATV dealer for servicing.

5. Pour recommended oil into each filler hole.

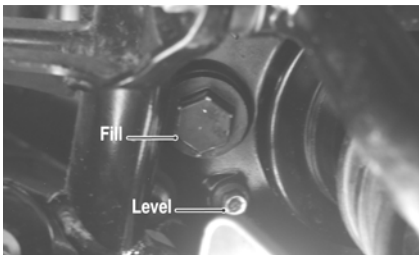

CF113A

6. Install the filler plugs.

WARNING

Be sure to inspect the hydraulic brake system before each use. Always maintain brakes according to the Maintenance Schedule.

Brake Fluid

Check the brake fluid level in the brake fluid reservoir. If the level in the reservoir is not visible in the sight glass, add DOT 4 brake fluid.

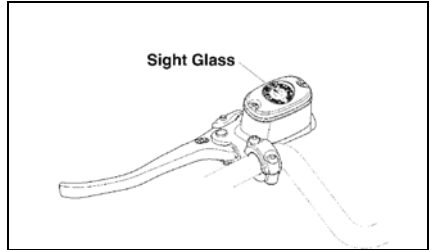

738-420A

■ **NOTE:** If the sight glass appears dark, there is a sufficient amount of fluid in the reservoir.

CAUTION

Be careful not to spill any fluid when filling the brake fluid reservoir. Wipe away spilled fluid immediately.

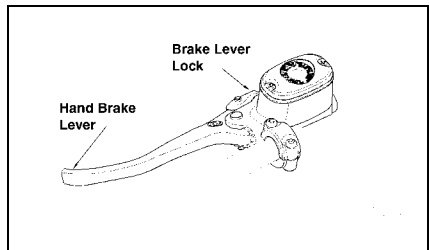
Brake Lever Lock

738-420B

Check to make sure the brake lever lock engages properly and that the brake (when engaged) locks the wheels.

1. Pump the brake lever 2 or 3 times.
2. Engage the brake lever lock.
3. Attempt to push the ATV.

■ **NOTE:** The brake lever lock must lock the wheels. If it doesn't, take the ATV to an authorized Arctic Cat ATV dealer for service.

Brake Hoses

Carefully inspect the hydraulic brake hoses for cracks or other damage. If found, take the ATV to an authorized Arctic Cat ATV dealer to have the brake hoses replaced.

Brake Pads

The clearance between the brake pads and brake discs is adjusted automatically as the brake pads wear. The only maintenance that is required is replacement of the brake pads when they show excessive wear. Check the thickness of each of the brake pads as follows:

1. Remove a front wheel.
2. Measure the thickness of each brake pad.
3. If thickness of either brake pad is less than 1.0 mm (0.039 in.), take the ATV to an authorized Arctic Cat ATV dealer to have brake pads replaced.

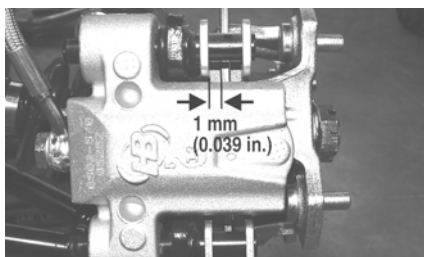

PR376B

4. Install the wheel and tighten to 40 ft-lb.

Rear Foot Brake

The rear foot brake must be properly maintained to be fully functional.

WARNING

Be sure to inspect the rear foot brake system before each use. Always maintain brakes according to the Maintenance Schedule.

1. Check the brake fluid level in the reservoir. The fluid level must be maintained between the MAX and MIN level marks. If the level in the reservoir is low, add DOT 4 brake fluid.

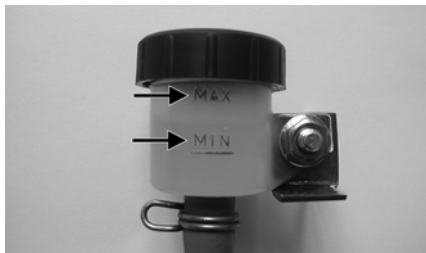

CD474A

■ **NOTE:** The brake fluid reservoir is located on the electrical panel beneath the operator's seat.

2. Press the rear foot brake several times to check for firmness.
3. If the brake is not firm, the system must be bled.

■ **NOTE:** Take the ATV to an authorized Arctic Cat ATV dealer for this service.

Protective Rubber Boots

The protective boots should be inspected periodically according to the Maintenance Schedule.

Ball Joint Boots (Upper and Lower/Right and Left)



CC791

1. Secure the ATV on a support stand to elevate the front wheels.
2. Remove both front wheels.
3. Inspect the four ball joint boots for cracks, tears, or perforations.

4. Check the ball joint for free-play by grasping the steering knuckle and turning it from side to side and up and down.
5. If boot damage is present or ball joint free-play seems excessive, contact an authorized Arctic Cat ATV dealer for service.

Tie Rod Boots (Inner and Outer/Right and Left)

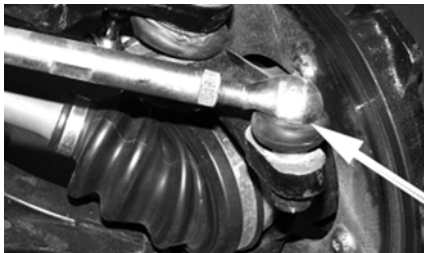

CC792

1. Secure the ATV on a support stand to elevate the front wheels.
2. Remove both front wheels.
3. Inspect the four tie rod boots for cracks, tears, or perforations.
4. Check the tie rod end free-play by grasping the tie rod near the end and attempting to move it up and down.
5. If boot damage is present or tie rod end free-play seems excessive, contact an authorized Arctic Cat ATV dealer for service.

Drive Axle Boots

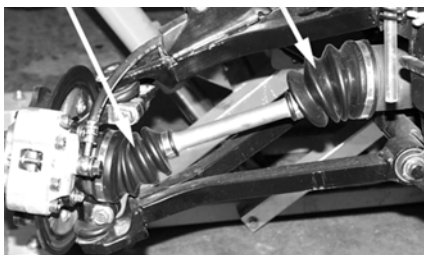

CC793

■ **NOTE:** This ATV has four drive axles and eight boots.

1. Inspect all drive axle boots for cracks, tears, or perforations.

2. If boot damage is present, contact an authorized Arctic Cat ATV dealer for service.

Battery

The battery is located in a battery tray above the rear final drive gear box. It is accessible from the rear of the ATV.

After being in service, batteries require regular cleaning and recharging in order to deliver peak performance and maximum service life. The following procedure is recommended for cleaning and maintaining a sealed battery. Always read and follow instructions provided with battery chargers and battery products.

■ **NOTE:** Refer to all warnings and cautions provided with the battery or battery maintainer/charger.

Loss of battery charge may be caused by ambient temperature, ignition OFF current draw, corroded terminals, self discharge, frequent start/stops, and short engine run times. Frequent winch usage, snowplowing, extended low RPM operation, short trips, and high amperage accessory usage are also reasons for battery discharge.

Maintenance Charging

■ **NOTE:** Arctic Cat recommends the use of the CTEK Multi US 800 or the CTEK Multi US 3300 for battery maintenance charging. Maintenance charging is required on all batteries not used for more than two weeks or as required by battery drain.

1. When charging a battery in the vehicle, be sure the ignition switch is in the OFF position.
2. Clean the battery terminals with a solution of baking soda and water.

■ **NOTE:** The sealing strip should NOT be removed and NO fluid should be added.

3. Be sure the charger and battery are in a well-ventilated area. Be sure the charger is unplugged from the 110-volt electrical outlet.

4. Connect the red terminal lead from the charger to the positive terminal of the battery; then connect the black terminal lead of the charger to the negative terminal of the battery.

■ **NOTE: Optional battery charging adapters are available from your authorized Arctic Cat dealer to connect directly to your vehicle from the recommended chargers to simplify the maintenance charging process. Check with your authorized Arctic Cat dealer for proper installation of these charging adapter connectors.**

5. Plug the battery charger into a 110-volt electrical outlet.
6. If using the CTEK Multi US 800, there are no further buttons to push. If using the CTEK Multi US 3300, press the Mode button (A) at the left of the charger until the Maintenance Charge Icon (B) at the bottom illuminates. The Normal Charge Indicator (C) should illuminate on the upper portion of the battery charger.



800E

■ **NOTE: The maintainer/charger will charge the battery to 95% capacity at which time the Maintenance Charge Indicator (D) will illuminate and the maintainer/charger will change to pulse/float maintenance. If the battery falls below 12.9 DC volts, the charger will automatically start again at the first step of the charge sequence.**

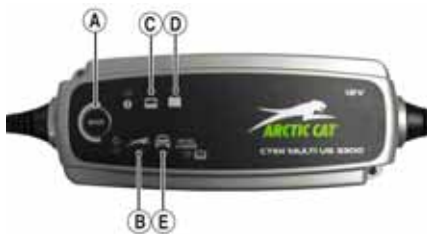

3300A

■ **NOTE: Not using a battery charger with the proper float maintenance will damage the battery if connected over extended periods.**

Charging

■ **NOTE: Arctic Cat recommends the use of the CTEK Multi US 800 or the CTEK Multi US 3300 for battery maintenance charging.**

1. Be sure the battery and terminals have been cleaned with a baking soda and water solution.

■ **NOTE: The sealing strip should NOT be removed and NO fluid should be added.**

2. Be sure the charger and battery are in a well-ventilated area. Be sure the charger is unplugged from the 110-volt electrical outlet.
3. Connect the red terminal lead from the charger to the positive terminal of the battery; then connect the black terminal lead of the charger to the negative terminal of the battery.
4. Plug the charger into a 110-volt electrical outlet.
5. By pushing the Mode button (A) on the left side of the charger, select the Normal Charge Icon (E). The Normal Charge Indicator (C) should illuminate on the upper left portion of the charger.
6. The battery will charge to 95% of its capacity at which time the Maintenance Charge Indicator (D) will illuminate.

■ **NOTE:** For optimal charge and performance, leave the charger connected to the battery for a minimum 1 hour after the Maintenance Charge Indicator (D) illuminates. If the battery becomes hot to the touch, stop charging. Resume after it has cooled.

- Once the battery has reached full charge, unplug the charger from the 110-volt electrical outlet.

■ **NOTE:** If, after charging, the battery does not perform to operator expectations, bring the battery to an authorized Arctic Cat dealer for further troubleshooting.

Jump-Starting

■ **NOTE:** Arctic Cat does not recommend jump-starting a vehicle with a dead battery but rather to remove the battery, service it, and correctly charge it; however, in an emergency, it may be necessary to jump-start a vehicle. If so, use the following procedure to carefully and safely complete this procedure.

WARNING

Improper handling or connecting of a battery may result in severe injury including acid burns, electrical burns, or blindness as a result of an explosion. Always remove rings and watches.

- On the vehicle to be jump-started, remove the battery cover and any terminal boots.

WARNING

Any time service is performed on a battery, the following must be observed: keep sparks, open flame, cigarettes, or any other flame away. Always wear safety glasses. Protect skin and clothing when handling a battery. When servicing battery in enclosed space, keep the area well-ventilated. Make sure battery venting is not obstructed.

- Inspect the battery for any signs of electrolyte leaks, loose terminals, or bulging sides. Leaking or bulging battery cases may indicate a frozen or shorted battery.

WARNING

If any of these conditions exist, **DO NOT attempt a jump-start, boost, or charge the battery. An explosion could occur causing serious injury.**

- Inspect the vehicle to be used for jump-starting to determine if voltage and ground polarity are compatible. The vehicle must have a 12-volt DC, negative ground electrical system.

CAUTION

Always make sure the electrical systems are of the same voltage and ground polarity prior to connecting jumper cables. If not, severe electrical damage may occur.

- Move the vehicle to be used for the jump-start close enough to ensure the jumper cables easily reach; then shift into neutral, set and lock the brakes, shut off all electrical accessories, and turn the ignition switch OFF.

■ **NOTE:** Make sure all switches on the vehicle to be jump-started are turned OFF.

- Disconnect all external accessories such as cell phones, GPS units, and radios on both vehicles.

CAUTION

Failure to disconnect electronic accessories during jump-starting may cause system damage due to power spikes.

- Attach one clamp of the positive (red) jumper cable to the positive (+) terminal (1) of the dead battery (C) being careful not to touch any metal with the other clamp; then attach the other clamp of the positive (red) jumper cable to the positive (+) terminal (2) of the good battery (B).

Fuel Filter

This diesel-powered ATV is equipped with a high efficiency fuel filter. The fuel filter should be changed in accordance with the maintenance schedule or more often if operated under severe conditions or winter operation. To change the fuel filter, use the following procedure.

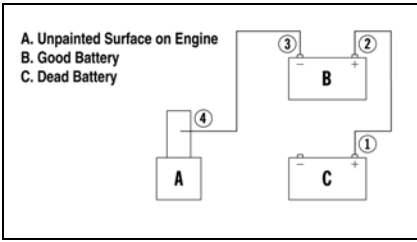

0744-527

■ **NOTE:** Some jumper cables may be the same color but the clamps or ends will be color-coded red and black.

- Attach one clamp of the negative (black) jumper cable to the negative (-) terminal (3) of the good battery (B); then attach the other clamp of the negative (black) jumper cable (4) to an unpainted metal surface (A) on the engine or frame well away from the dead battery and fuel system components.

WARNING

Never make the final connection to a battery as a spark could ignite hydrogen gases causing an explosion of the battery resulting in acid burns or blindness.

- Stand well away from the dead battery and start the vehicle with the good battery. Allow the vehicle to run for several minutes applying some charge to the dead battery.
- Start the vehicle with the dead battery and allow it to run for several minutes before disconnecting the jumper cables.
- Remove the jumper cables in opposite order of hook-up (4, 3, 2, 1). Be careful not to short cables against bare metal.

■ **NOTE:** Have the battery and electrical system checked prior to operating the vehicle again.



DE032D

- Apply a light coat of oil to the seal ring of the new fuel filter; then install the filter. Tighten until the seal ring contacts the filter head; then tighten an additional $\frac{3}{4}$ turn.
- Depress and release the manual primer pump to charge the fuel filter and purge any air from the system.



DE031A

■ **NOTE:** Cycle the manual primer pump until the lever becomes firm and resistance is observed. The system will bleed itself through the tank return circuit.

- Check for any fuel leaks; then start the engine and check for normal engine operation.

Idle RPM

Do not attempt to make engine idle RPM adjustments on the diesel engine. If engine adjustments are necessary, take the ATV to an authorized Arctic Cat ATV dealer. The diesel engine requires special tools and procedures for which your authorized Arctic Cat ATV dealer is equipped and trained.

WARNING

Improper adjustment of a diesel engine governor could cause over-speed or runaway resulting in severe injury or death.

Throttle Cable Adjustment

To adjust the throttle cable free-play:

1. Loosen the jam nut from the throttle cable adjuster.
2. Slide the rubber boot away and turn the adjuster until the throttle lever has proper free-play of 3-6 mm (1/8 - 1/4 in.).

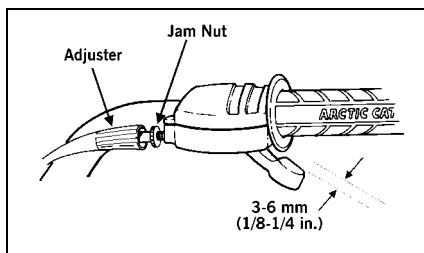

ATV-0047

3. Tighten the knurled nut against the throttle cable adjuster securely; then slide the rubber boot over the adjuster.

Air Filter

The air filter inside the air filter housing must be kept clean to provide good engine power and fuel mileage. If the ATV is used under normal conditions, service the filter at the intervals specified. If operated in dusty, wet, or muddy conditions, inspect and service the filter more frequently. Use the following procedure to remove the filter and inspect and/or clean it.

CAUTION

Failure to inspect the air filter frequently if the ATV is used in dusty, wet, or muddy conditions can damage the engine.

■ **NOTE:** This ATV is equipped with a dry-paper air filter and a cotton-fabric safety element.

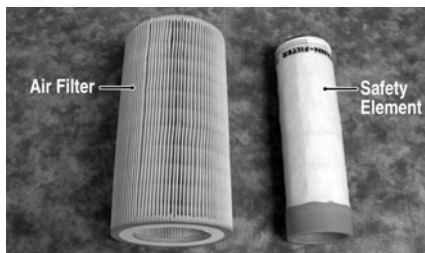

DE014A

1. Open the air filter access cover and remove the operator's seat; then rotate the air filter housing cover counterclockwise and remove from the filter housing.



DE006A

2. Remove the dry-paper air filter. Do not remove the cotton-fabric safety element at this time.

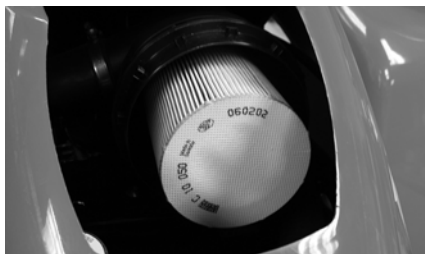

DE007

- Clean dust and debris from the air filter housing; then remove the cotton-fabric safety element using care not to allow dirt and debris to enter the engine.



DE008

- Lightly tap the dry-paper air filter to dislodge the dirt and dust. Do not use compressed air.
- Insert a suitable light into the dry-paper air filter and look for any “pin-points” of light shining out of the filter medium. A bright “pin-point” of light indicates a hole and the filter element must be replaced.

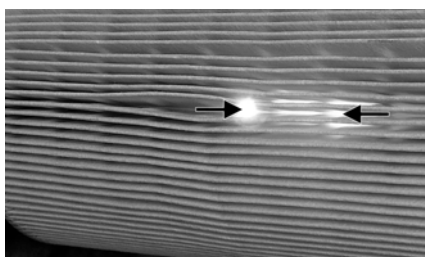

DE028

CAUTION

A torn air filter can cause damage to the engine. Dirt and dust may enter the engine if the element is torn. Carefully examine the element for tears before and after cleaning it. Replace the element with a new one if it is torn.

- Check the safety element for signs of dirt build-up. If dirt is present on the element, it indicates a leak or hole in the dry-paper air filter element and both elements must be replaced.
- Install the safety element; then install the dry-paper air filter.

- Check the drain valve in the air filter housing cover for dirt, deterioration, or poor sealing. Clean or replace as required.



DE015

- Install the air filter housing cover (drain facing downward) and lock it in place by turning clockwise.



DE006A

Draining V-Belt Cover

■ **NOTE:** If the ATV has been driven through water, the V-belt cover must be drained of any water.

To drain the belt cover, use the following procedure.

- Place the ATV on a level surface.
- Remove the drain bolt from the cover and allow the water to drain out.



DE030A

3. Shift the range lever to the neutral position; then start the engine.
4. Increase and decrease engine RPM several times to “blow out” any water; then stop the engine.
5. Install the drain bolt and tighten securely.

■ **NOTE:** The V-belt and clutches should be inspected every 500 miles and the belt replaced (if necessary).

Tires

WARNING

Always use the size and type of tires as specified. Refer to the specifications chart for proper tire inflation pressure, and always maintain proper tire inflation pressure.

Tire Tread Condition

The use of worn-out tires on a ATV is very dangerous. A tire is considered to be worn out when the depth of the tread is less than 3 mm (1/8 in.). Be sure to replace the tires before reaching this minimum specification.

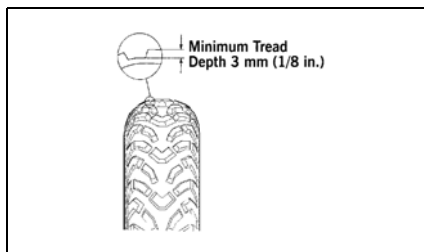

0732-649

WARNING

The use of worn-out tires is dangerous and can increase the risk of an accident.

Tire Replacement

This ATV has low-pressure tubeless tires. Air is sealed by the contact surfaces of the inner wheel rim and the tire bead. If either the inner wheel rim or tire bead is damaged, air may leak. Be extremely careful not to damage these areas when replacing tires.

It is very important to use the proper tools when repairing or replacing tires to prevent damage to the tire bead or wheel rims. If proper tools and related items are not available, have this maintenance performed by an authorized Arctic Cat ATV dealer or a qualified tire repair station.

CAUTION

When breaking the tire bead loose from the wheel, be extremely careful not to damage the inner wheel surface or the tire bead.

WARNING

Use only Arctic Cat approved tires when replacing tires. Failure to do so could result in unstable operation.

Tire Repair (Tubeless)

Should a leak or flat tire occur due to a puncture, the tire may be repaired using a plug-type repair. If the damage is from a cut or if the puncture cannot be repaired using a plug, the tire must be replaced. When operating the ATV in areas where transportation or service facilities are not readily available, it is strongly recommended to carry a plug-type repair kit and a tire pump along.

Wheel Removal

1. Park the ATV on level ground and engage the brake lever lock.
2. Loosen the lug nuts on the wheel to be removed.
3. Elevate the ATV.
4. Remove the lug nuts.
5. Remove the wheel.
6. Install the wheel and install the lug nuts.
7. Tighten the nuts in a crisscross pattern to 40 ft-lb.
8. Remove the jack.

Muffler/Spark Arrester

The muffler has a spark arrester which must be periodically cleaned. At the intervals shown in the Maintenance Schedule, clean the spark arrester using the following procedure.

⚠ WARNING

Wait until the muffler cools to avoid burns.

1. Remove the three cap screws securing the spark arrester assembly to the muffler.

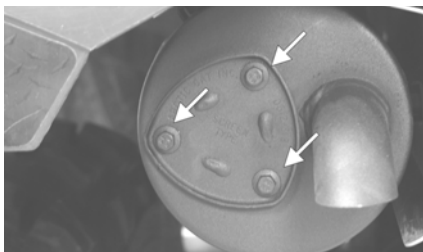

CF105A

2. Using a suitable brush, clean the carbon deposits from the screen taking care not to damage the screen.

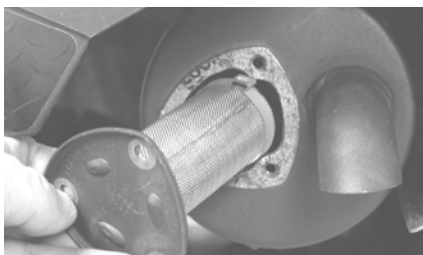

CF104

■ NOTE: If the screen or gasket is damaged in any way, it must be replaced.

3. Install the spark arrester assembly and secure with the three cap screws. Tighten cap screws to 48 in.-lb.

Light Bulb Replacement

The wattage rating of each bulb is shown in the chart. When replacing a burned bulb, always use the same wattage rating.

Headlight	12V/27W (4)
Taillight/Brakelight	12V/8W/27W

CAUTION

Use only specified bulbs indicated in the chart as replacement bulbs.

■ NOTE: The bulb portion of the headlight is fragile. HANDLE WITH CARE. When replacing the headlight bulb, do not touch the glass portion of the bulb. If the glass is touched, it must be cleaned with a dry cloth before installing. Skin oil residue on the bulb will shorten the life of the bulb.

To replace the headlight bulb, use the following procedure.

⚠ WARNING

Do not attempt to remove the bulb when it is hot. Severe burns may result.

1. Rotate the bulb assembly counterclockwise and remove from the headlight housing; then disconnect from the wiring harness.
2. Connect the new bulb assembly to the wiring harness connector; then insert into the headlight housing and rotate fully clockwise.

CAUTION

When replacing the headlight bulb, be careful not to touch the glass portion of the bulb. Grasp the new bulb with a clean cloth.

To replace the taillight/brakelight bulb, use the following procedure.

1. Turn the bulb socket counterclockwise and remove from the light housing.
2. Pull the bulb straight out of the socket.
3. Install the new bulb by pushing it into the socket.
4. Install the socket into the light housing and turn clockwise to lock.

Checking/Adjusting Headlight Aim

The headlights can be adjusted vertically and horizontally. The geometric center of the HIGH beam light zone is to be used for vertical and horizontal aiming.

1. Position the ATV on a level floor so the headlights are approximately 6.1 m (20 ft) from an aiming surface (wall or similar aiming surface).

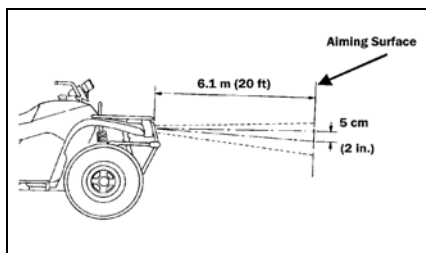

ATV-0070C

■ **NOTE:** There should be an average operating load on the ATV when adjusting the headlight aim.

2. Measure the distance from the floor to the mid-point of each headlight.
3. Using the measurements obtained in step 2, make horizontal marks on the aiming surface.
4. Make vertical marks which intersect the horizontal marks on the aiming surface directly in front of the headlights.
5. Switch on the lights. Make sure the HIGH beam is on. DO NOT USE LOW BEAM.
6. Observe each headlight beam aim. Proper aim is when the most intense beam is centered on the vertical mark 5 cm (2 in.) below the horizontal mark on the aiming surface.
7. Adjust each headlight by turning the adjustment knob clockwise to raise the beam or counterclockwise to lower the beam until correct aim is obtained.

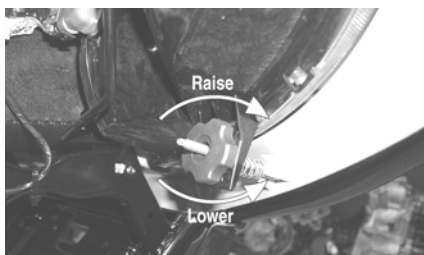

CD714A

Fuses

The fuses are located in a fuse block under the seat. If there is any type of electrical system failure, always check the fuses first.

■ **NOTE:** To remove the fuse, compress the locking tabs on either side of the fuse case and lift out.

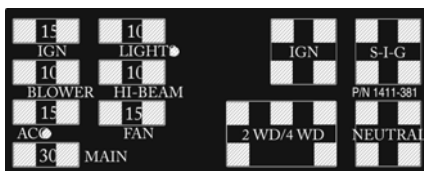

1411-381

CAUTION

Always replace a blown fuse with a fuse of the same type and rating. If the new fuse blows after a short period of use, consult an authorized Arctic Cat ATV dealer immediately.

Electrical Output Terminals

One output terminal for electrical accessories is located on the front wiring harness.

Two output terminals for electrical accessories are located on the front and rear wiring harnesses. The accessory plug is located on the right side of the instrument pod.



DE034

CAUTION

Always use electrical accessories less than 180W.

Tool Storage Tray/ Storage Compartment

A basic tool kit is provided with the ATV.

Maintain the tool kit with the ATV at all times.

The tool storage tray is located beneath the seat.



DE011

The storage compartment is located beneath the tool storage tray. Remove the tool storage tray to access the storage compartment.



DE050

Preparation For Storage

CAUTION

Prior to storing the ATV, it must be properly serviced to prevent rusting and component deterioration.

Arctic Cat recommends the following procedure to prepare this ATV for storage. An authorized Arctic Cat ATV dealer should perform this service; however, the owner/operator may perform this service if desired.

1. Clean the seat cushion (cover and base) with a damp cloth and allow it to dry.
2. Clean the ATV thoroughly by washing dirt, oil, grass, and other foreign matter from the entire ATV. Allow the ATV to dry thoroughly. DO NOT get water into any part of the engine or air intake.
3. Fill the fuel tank with fresh #1 or #2 diesel fuel (according to ambient temperatures); then add a quality antimicrobial additive. Run the engine in a well-ventilated area for several minutes to make sure fresh, treated fuel is circulated throughout the entire injection system.

CAUTION

DO NOT store the ATV with biodiesel (B20) in the fuel system. Severe damage to the fuel system may occur.

4. Plug the hole in the muffler with a clean cloth.
5. Apply light oil to the upper steering post bushing and plungers of the shock absorbers.
6. Tighten all nuts, bolts, cap screws, and screws. Make sure rivets holding components together are tight. Replace all loose rivets. Care must be taken that all calibrated nuts, cap screws, and bolts are tightened to specifications.
7. Fill the cooling system to the bottom of the stand pipe in the filler neck with properly mixed coolant.
8. Disconnect the battery cables (negative cable first); then remove the battery, clean the battery posts and cables, and store in a clean, dry area.

■ **NOTE: For storage, use a battery maintainer or make sure the battery is fully charged (see Battery section in this manual).**

9. Store the ATV indoors in a level position.

CAUTION

Avoid storing outside in direct sunlight and avoid using a plastic cover as moisture will collect on the ATV causing rusting.

Preparation After Storage

Taking the ATV out of storage and correctly preparing it will assure many miles and hours of trouble-free riding. Arctic Cat recommends the following procedure to prepare the ATV.

1. Clean the ATV thoroughly.
2. Clean the engine. Remove the cloth from the muffler.
3. Check all control wires and cables for signs of wear or fraying. Replace if necessary.
4. Change the engine oil and filter.
5. Check the coolant level and add properly mixed coolant as necessary.
6. Charge the battery; then install. Connect the battery cables making sure to connect the positive cable first.
7. Check the entire brake systems (fluid level, pads, etc.), all controls, headlights, taillight, brakelight, and headlight aim; adjust or replace if necessary.
8. Check the tire pressure. Inflate to recommended pressure as necessary.
9. Tighten all nuts, bolts, cap screws, and screws making sure all calibrated nuts, cap screws, and bolts are tightened to specifications.
10. Make sure the steering moves freely and does not bind.
11. Fill the fuel tank with clean diesel fuel of the recommended grade.

Limited Warranty

Arctic Cat Inc. (hereinafter referred to as Arctic Cat) extends a limited warranty on each new Arctic Cat ATV it assembles and on each genuine Arctic Cat part and accessory assembled or sold by an authorized Arctic Cat ATV dealer. Warranty on an Arctic Cat ATV is extended to the original retail purchaser; however, the balance of the unused warranty may be transferred to another party. Warranty coverage is only available in the country in which the original retail purchase occurs to the original retail purchaser resident in that country or to a transferee resident in that country of the balance of the unused warranty.

Arctic Cat warrants only the products it assembles and/or sells and does not warrant that other products will function properly when used with an Arctic Cat ATV or will not damage the ATV. Arctic Cat does not assume any liability for incidental or consequential damages.

Arctic Cat will repair or replace, at its option, free of charge (including any related labor charges), any parts that are found to be warrantable in material or workmanship. This repair work **MUST** be done by an authorized Arctic Cat ATV dealer. No transportation charges will be paid by Arctic Cat. The warranty is validated upon examination of said parts by Arctic Cat or an authorized Arctic Cat ATV dealer. Arctic Cat reserves the right to inspect such parts at its factory for final determination if warranty should apply.

The warranty periods are as follows:

1. Six months from the date of sale — for an Arctic Cat ATV used for recreational purposes.
2. Ninety days from date of invoice — for an Arctic Cat ATV used for commercial purposes, including rental operations (non-transferable).
3. Thirty days from date of sale of ATV on Arctic Cat supplied batteries.
4. Thirty days from date of sale — for all dealer installed genuine Arctic Cat service parts and accessories.
5. Until expiration of the new product warranty (paragraphs 1 and 2 above) — for all eligible replacement parts on new product.

Exclusions to this warranty include normal wear, abuse, or corrosion and the following parts and items:

Tires	CV Boots
Oil Filter	Drive Belt
Air Filter	Torn or Punctured Upholstery
Brake Pads	Cracks or Gouges in Body Panels
Light Bulbs	Fuel Filter
Drive/Driven Clutch Wear Parts	

The following will VOID Arctic Cat's warranty:

1. Failure to perform the proper break-in procedure and all related maintenance, storage procedures (if stored for extended periods), and/or service as recommended in the Operator's Manual.
2. Repairs and/or adjustments by anyone other than an authorized Arctic Cat ATV dealer.
3. Tampering with the speed governor/torque settings.
4. Use of improper fuel or lubricating oils.
5. An accident or subjecting the ATV to misuse, abuse, or negligent operation.
6. Any modification, addition, or removal of parts unless instructed to do so by Arctic Cat.
7. Use of the ATV in any way for racing purposes.
8. Removal of the engine for use in another vehicle.
9. Removal or mutilation of the Vehicle Identification Number or Engine Serial Number.
10. Use of parts not sold or approved by Arctic Cat.
11. Damage due to improper transportation.
12. Use of starting fuel (ether) for cold starts.

In consideration of the foregoing, any implied warranty is limited in duration to the various warranty periods set forth. This warranty gives you specific legal rights, and you may also have other rights which vary from state/province to state/province or country to country. Some jurisdictions do not allow limitations on how long an implied warranty lasts, so the above limitations may not apply to you.

Warranty Procedure/Owner Responsibility

At the time of sale, an ATV Rider Training Certificate and Owner Registration form is to be completed by the selling dealer and consumer. The receipt of the form by Arctic Cat is a condition precedent to warranty coverage. It is the selling dealer's responsibility to retain and/or submit appropriate copies of the form to the appropriate place(s) to initiate warranty coverage.

The dealer will furnish to the consumer a signed copy of the form which must be presented to the dealer when requesting warranty service. The registration form is the consumer's proof of ownership and warranty eligibility. The form is used by the dealer to validate the warranty claim. Retain your copy of the form and keep it in a safe place.

When warranty repair is suspected, the ATV should be taken to the selling dealer, who has the primary responsibility to perform warranty repairs. Subject to the limitations set forth in the Limited Warranty, in the event the selling dealer has ceased to do business, you have moved, or you are in a location away from your selling dealer, warranty may be performed by any authorized Arctic Cat ATV dealer.

The authorized Arctic Cat ATV dealer will examine the ATV or part to determine if, in his opinion, a warrantable condition exists. If a warrantable condition appears to exist, the dealer will repair or replace, at Arctic Cat's option, free of charge, including any related labor costs, all parts that are found to be warrantable and any other parts which the warrantable part caused to be damaged. You, the owner, will then be asked to sign a warranty form to ensure Arctic Cat that the warranty work was actually performed.

It is the owner's responsibility to maintain and service the ATV in accordance with Arctic Cat's recommendations in the Operator's Manual. To protect yourself and your ATV, follow all safety and service tips. Arctic Cat will NOT warrant repairs required as a result of not performing standard operator maintenance, storage procedures, and service as outlined in the Operator's Manual.

Should you have any questions concerning the warranty, contact an authorized Arctic Cat ATV dealer.

Change Of Address, Ownership, Or Warranty Transfer

Arctic Cat Inc. keeps on file the current name and address of the owner of this TRV. This will allow Arctic Cat to reach the current owner with any important safety information which may be necessary to protect customers from personal injury or property damage. Please make sure a copy of this form is completed and returned to Arctic Cat Inc. if you move or if the TRV is sold to another party.

This form may also be used to transfer the unused portion of the original warranty to a second party. In order to transfer warranty, fill out this form completely; then return a copy of this form to Arctic Cat Inc. Arctic Cat will then process the application and issue warranty for the balance of the time remaining of the original warranty.

Address Change

Ownership Change

Warranty Transfer

CHANGE OF ADDRESS/OWNERSHIP/ WARRANTY TRANSFER TO:

Name _____

Address _____

City/State (Province)/Zip Code (Postal Code) _____

Phone # () _____

Year and Model _____

Vehicle Identification Number (VIN) _____

Before operating, you should take an ATV Rider Course to learn ATV riding skills or reinforce your current good riding skills. In U.S.A., call 1-800-887-2887 to enroll in the half-day ATV Rider Course nearest you or ask your dealer for assistance. The course instructor will charge a small fee for each person taking the course. In Canada, call (613) 739-1535.

Fold Back

Place Stamp
Here

CHANGE OF ADDRESS/OWNERSHIP

**ARCTIC CAT INC.
PRODUCT SERVICE AND
WARRANTY DEPT.
P.O. BOX 810
THIEF RIVER FALLS, MN 56701**

[Previous](#)

[Main TOC](#)

[Section TOC](#)

[Next](#)

Arctic Cat ATV Emission Control Warranty Statement (California Only)

Warranty Rights and Obligations

Arctic Cat Inc. (hereinafter referred to as Arctic Cat) and the California Air Resources Board are pleased to explain the emission control system warranty for each new Arctic Cat ATV sold in the state of California. In California, a new ATV must be designed, built, and equipped to meet the state's stringent anti-smog standards.

Arctic Cat warrants the emission control system on the Arctic Cat ATV for the periods listed below provided there has been no abuse, neglect, or improper maintenance of the ATV.

The emission control system may include components such as the pre-combustion chambers, governor, and crankcase vapor recirculation system. Also included may be hoses, belts, connectors, and other emission-related assemblies.

When a warrantable condition exists, Arctic Cat will repair the ATV at no cost to the owner, including diagnosis, parts, and labor.

Emission Control Warranty Coverage

A new Arctic Cat ATV manufactured after January 1, 1997 has a two (2) year warranty on its emissions control components.

If an emission-related component on the ATV is defective, the component will be repaired or replaced by any authorized Arctic Cat ATV dealer.

Owner's Emission Control Warranty Responsibilities

It is the owner's responsibility to perform the required maintenance listed in the Operator's Manual. Arctic Cat recommends the retention of all receipts covering maintenance performed on the ATV, but Arctic Cat cannot deny warranty solely for the lack of receipts or for failure to ensure the performance of all scheduled maintenance on the emission control system.

It is the owner's responsibility to present the ATV to an authorized Arctic Cat ATV dealer as soon as a problem exists. The undisputed warranty repairs should be completed within a reasonable period of time, not to exceed thirty days.

The ATV owner should be aware that Arctic Cat may deny warranty coverage if either the ATV or a component has failed due to abuse, neglect, improper maintenance, or any unapproved modifications.

If you have any questions regarding your warranty rights and responsibilities, contact either Arctic Cat Inc, P.O. Box 810, Thief River Falls, MN 56701, (218) 681-4999 or the California Air Resources Board, 9528 Telstar Avenue, El Monte, CA 91731, (818) 575-6800.

U.S. EPA Diesel Emission Control Statement/ Warranty Coverage (U.S. Only)

STATEMENT/WARRANTY

Arctic Cat warrants to the original retail purchaser, and each subsequent purchaser, that all U.S. EPA-certified Arctic Cat diesel-powered ATV's are designed, built, and equipped to conform to all U.S. EPA Emission Control Regulations. Please read the following information completely.

Your authorized Arctic Cat ATV dealer will repair or replace any defective emission-related component at no cost to you during the warranty period. You may have non-warranty service performed by any repair establishment that uses equivalent components. The regulations provide significant civil penalties for tampering that causes your ATV to no longer meet U.S. EPA emission standards.

Arctic Cat further warrants that the engine and its emission-related components are free from defects in materials or workmanship that could cause the engine to fail to comply with applicable regulations during the warranty period.

If you have any questions about this information, or the emission warranty coverage statement, contact your local authorized Arctic Cat ATV dealer.

WARRANTY PERIOD

The emission warranty period for this ATV begins on the same date as the standard warranty coverage and continues for two (2) years.

COMPONENTS COVERED

The emissions warranty covers major emissions control components and emission-related components listed as follows:

Engine Components

Pre-Combustion Chamber
Engine Valves/Valve Seals
Engine Coolant Temperature Sensor
Intake/Exhaust Manifold

Fuel/Air System

Fuel Injectors
Fuel Control Rack
Governor
Fuel Limiting Device
Crankcase Vapor Recirculation System

Miscellaneous Items Used in Aforementioned Systems

Connectors
Switches
Grommets
Clamps
Hoses
Ties
Gaskets
Wiring

OWNER'S RESPONSIBILITIES

The owner of any ATV warranted under this Arctic Cat Emission Control Statement is responsible for the proper maintenance and use of the ATV as stated in the Operator's Manual. Proper maintenance generally includes replacement and service, at the owner's choosing, such items as air filter, oil and oil filter, or any other part, item, or device related to emissions control as specified in the Operator's Manual. It is the owner's responsibility to ensure that the ATV is used in a manner for which it was designed.

Declaration of Conformity

Application of council directives: EMC Directive 97/24/EC
Date of Issue: June, 1997
EC Machinery Directive 2006/42/EC
Date of Issue: May, 2006

Issued by European Commission.

Type of Equipment: All Terrain Vehicle

Brand Name: Arctic Cat

Model : 700 Diesel

Standards to which conformity is declared: EN 61000-6-2:2005
EN 55012:2007

Manufacturer (if not issuing agent): Arctic Cat Inc. 601 Brooks Ave S.
Thief River Falls, MN
56701 USA

I, the undersigned, hereby declare that the equipment specified above conforms to the directive(s) and standard(s) as specified.

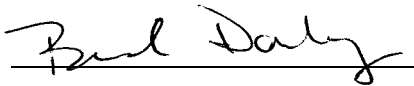

Brad Darling
Vice President/General Manager

Identification Numbers Record

WARNING

Indicates a potential hazard that could result in serious injury or death.



1. KEY IDENTIFICATION NUMBER:

The key identification number is stamped on the key as shown in the illustration. Record this number in the space provided for reference if you ever need a new key.

2. VEHICLE IDENTIFICATION NUMBER:

3. ENGINE SERIAL NUMBER:

Record the Vehicle Identification Number and Engine Serial Number in the spaces provided to assist you in ordering parts from your authorized Arctic Cat ATV dealer or for reference in case the ATV is stolen.

WARNING

Improper use can result in **SEVERE INJURY** or **DEATH**



**ALWAYS USE
AN APPROVED
HELMET AND
PROTECTIVE
GEAR FOR
DRIVER AND
PASSENGER**



**NEVER USE
ON PUBLIC
ROADS**



**NEVER CARRY
MORE THAN
1 PASSENGER**



**NEVER USE
WITH DRUGS
OR ALCOHOL**

NEVER operate:

- without proper 2-UP ATV training or instruction
- at speeds too fast for your skills or the conditions
- on public roads - a collision can occur with another vehicle

THE OPERATOR MUST ALWAYS:

- use proper riding techniques to avoid overturns on hills and rough terrain and in turns
- avoid paved surfaces - pavement may seriously affect handling and control
- reduce speed and use extra caution at all times when carrying a passenger - dismount passenger when conditions require
- make sure passenger reads and understands this label and passenger safety label

**LOCATE AND READ OPERATOR'S MANUAL.
FOLLOW ALL INSTRUCTIONS AND WARNINGS**

YOUR ATV CAN BE HAZARDOUS TO OPERATE.

A collision or rollover can occur quickly, even during routine maneuvers such as turning and driving on hills or over obstacles, if you fail to take proper precautions.

For your safety, understand and follow all the warnings contained in this Operator's Manual and the labels on your ATV.

This Arctic Cat ATV Operator's Manual should be considered a permanent part of the ATV and must remain with the ATV at the time of resale. If the ATV changes ownership more than once, contact Arctic Cat Inc., Service Department, P.O. Box 810, Thief River Falls, MN 56701, for proper registration information.

FAILURE TO FOLLOW THE WARNINGS CONTAINED IN THIS MANUAL CAN RESULT IN SERIOUS INJURY OR DEATH.

Training is available: U.S. owners, call 800-887-2887; Canadian owners, call 613-739-1535.

Un cours d'instruction est disponible: pour les propriétaires canadiens, composez le 613-739-1535.

Particularly important information is distinguished in this manual by the following notations:



The Safety Alert Symbol means ATTENTION! BE ALERT! YOUR SAFETY IS INVOLVED.



WARNING

WARNING indicates a hazardous situation which, if not avoided, could result in death or serious injury.

CAUTION

CAUTION, without the safety alert symbol, is used to address practices not related to personal injury.

■ **NOTE:**

A NOTE provides key information to make procedures easier or more clear.

California Proposition 65



WARNING

This product contains or emits chemicals known to the State of California to cause cancer and birth defects or other reproductive harm.

Foreword

Congratulations and thank you from Arctic Cat Inc. for purchasing an ARCTIC CAT® All-Terrain Vehicle (ATV). Built with American engineering and manufacturing know-how, it is designed to provide superior ride, comfort, utility, and dependable service.

You have chosen a quality Arctic Cat ATV designed and built to give dependable service. Be sure, as the owner/operator of an Arctic Cat ATV, to become thoroughly familiar with its basic operation, maintenance, and storage procedures. Read and understand the entire Operator's Manual before operating the ATV to ensure safe and proper use of your new Arctic Cat ATV. Always operate the ATV within your level of skill and current terrain conditions.

This Operator's Manual is furnished to ensure that the operator is aware of safe operating procedures. It also includes information about the general care and maintenance of your ATV.

Carefully read the following pages. If you have any questions regarding this ATV, contact an authorized Arctic Cat ATV dealer for assistance. Remember, only authorized Arctic Cat ATV dealers have the knowledge and facilities to provide you with the best service possible.

Protect Your Sport

- Know all local, state/provincial riding laws,
- Respect your ATV,
- Respect the environment, and
- You will gain the respect of others.

We also advise you to strictly follow the recommended maintenance program as outlined. This preventive maintenance program is designed to ensure that all critical components on this ATV are thoroughly inspected at various intervals.

All information in this manual is based on the latest product data and specifications available at the time of printing. Arctic Cat Inc. reserves the right to make product changes and improvements which may affect illustrations or explanations without notice.

Some illustrations used in this manual are used for clarity purposes only and are not designed to depict actual conditions. Because Arctic Cat Inc. constantly refines and improves its products, no retroactive obligation is incurred.

Parts and Accessories

When in need of replacement parts, oil, or accessories for your Arctic Cat ATV, be sure to use only GENUINE ARCTIC CAT PARTS, OIL, AND ACCESSORIES. **Only genuine Arctic Cat parts, oil, and accessories are engineered to meet the standards and requirements of your Arctic Cat ATV. For a complete list of accessories, refer to the current Arctic Cat ATV Accessory Catalog.**

To aid in service and maintenance procedures on this ATV, a Service Manual and an Illustrated Parts Manual are available through your local Arctic Cat ATV dealer.

Arctic Cat and the ATV Safety Institute recommend that all ATV operators ride the appropriate-sized ATV according to age.

Category	Age (Years)	Speed Limitations (MPH)	NOTES
Y-12+	12 or Older	15 - Limited 30 - Maximum	Operate Under Adult Supervision
T-14	14 or Older	20 - Limited 30 - Limited 38 - Maximum	Operate Under Adult Supervision
G & S	16 or Older	According to Local Regulations	—

TREAD LIGHTLY! OFFICIAL[®]
ON PUBLIC AND PRIVATE LAND SPONSOR

Table of Contents

Foreword	1
Parts and Accessories	1
Limited Warranty	3
Warranty Procedure/Owner Responsibility	4
Arctic Cat ATV Emission Control Warranty Statement	5
Arctic Cat Emission Control System Limited Warranty	6
U.S. EPA Emission Control Statement/ Warranty Coverage (U.S. Only)	7
Declaration of Conformity	8

DIVISION I - SAFETY

ATV Safety Alert	10
Rider Training Course	11
Hangtags	12
Warning Labels & Information	13
Warnings	14-22
Prevention	23-26
Safe Riding Clothing and Gear	23
ATV Condition	24
TCLOC	24
First Aid and Survival	25
Active Riding	27
Sound Judgment	28-33
Environment	28
Those Around You	29
Equipment	30
Load Capacity Ratings Chart	31
Speedrack	31
Personal Choices	31
SIPDE	33
Supervision	34
Taking Responsibility	34
Inexperienced/Untrained Riders	34
Experienced/Trained Riders	34

DIVISION II - OPERATION/ MAINTENANCE

ATV Specifications	35
Location of Parts and Controls	36
ATV Operation	37-46
Basic Operating Maneuvers	37
Starting a Cold Engine	37
BONE-C	37
Starting the Engine	37
Handling the ATV (Active Riding Techniques)	39
Tips	45
General Information	47-56

ATV Identification Numbers	47
Ignition Switch Key	47
Control Locations and Functions	47
Speedometer/LCD (Digital)	50
Vacuum Fuel Pump	52
Primer - Cold Start	52
Gas/Vent Hoses	52
Carburetor Float Bowl Drain	52
Oil Level Stick	53
Seat Latch	53
Safety Flag Bracket	53
Rack Loading (Front and Rear)	53
Trailing and Towing	54
Transporting ATV	54
Gasoline-Oil-Lubricant	55
Engine Break-In	56
Burnishing Brake Pads	56
General Maintenance	57-73
Maintenance Schedule	58
Liquid Cooling System	59
Shock Absorbers	60
General Lubrication	61
Hydraulic Hand Brake	62
Brake Fluid	62
Brake Lever Lock	63
Brake Hoses	63
Brake Pads	63
Rear Foot Brake	63
Protective Rubber Boots	64
Battery	64
Jump-Starting	66
Spark Plug	67
Engine Idle RPM Adjustment	68
Throttle Cable Adjustment	68
Air Filter	69
Air Filter Housing Drains	70
Draining V-Belt Cover	70
Tires	70
Wheels	71
Muffler/Spark Arrester	71
Light Bulb Replacement	71
Checking/Adjusting Headlight Aim	72
Fuses	73
Electrical Output Terminals	73
Storage Compartment/Tools	73
Preparation for Storage	74
Preparation after Storage	75
Maintenance Record	76
Change of Address, Ownership, or Warranty Transfer	77
Identification Numbers Record	Inside Back Cover

Limited Warranty

Arctic Cat Inc. (hereinafter referred to as Arctic Cat) extends a limited warranty on each new Arctic Cat ATV it assembles and on each genuine Arctic Cat ATV part and accessory assembled or sold by an authorized Arctic Cat ATV dealer. Warranty on an Arctic Cat ATV is extended to the original retail purchaser; however, the balance of the unused warranty may be transferred to another party. Warranty coverage is only available in the country in which the original retail purchase occurs to the original retail purchaser resident in that country or to a transferee resident in that country of the balance of the unused warranty.

Arctic Cat warrants only the products it assembles and/or sells and does not warrant that other products will function properly when used with an Arctic Cat ATV or will not damage the ATV. Arctic Cat does not assume any liability for incidental or consequential damages.

Arctic Cat will repair or replace, at its option, free of charge (including any related labor charges), any parts that are found to be warrantable in material or workmanship. This repair work **MUST** be done by an authorized Arctic Cat ATV dealer. No transportation charges, rental charges, or inconvenience costs will be paid by Arctic Cat. The warranty is validated upon examination of said parts by Arctic Cat or an authorized Arctic Cat ATV dealer. Arctic Cat reserves the right to inspect such parts at its factory for final determination if warranty should apply.

The warranty periods are as follows:

1. Six months from the date of sale — for an Arctic Cat ATV used for recreational purposes.
2. Ninety days from date of invoice — for an Arctic Cat ATV used for commercial purposes, including rental operations (non-transferable).
3. Thirty days from date of sale of ATV on Arctic Cat supplied batteries.
4. Thirty days from date of sale — for all dealer installed genuine Arctic Cat service parts and accessories.
5. Until expiration of the new product warranty (paragraphs 1 and 2 above) — for all eligible replacement parts on new product.

Exclusions to this warranty include normal wear, abuse, or corrosion and the following parts and items:

Tires	CV Boots	Torn or Punctured Upholstery
Oil Filter	Drive Belt	Cracks or Gouges in Body Panels
Air Filter	Brake Pads	Drive/Driven Clutch Wear Parts
Light Bulbs	Spark Plug(s)	

The following will VOID Arctic Cat's warranty:

1. Failure to perform the proper break-in procedure and all related maintenance, storage procedures (if stored for extended periods), and/or service as recommended in the Operator's Manual.
2. Repairs and/or adjustments by anyone other than an authorized Arctic Cat ATV dealer.
3. Use of improper carburetor main jets.
4. Use of improper gasoline, lubricating oils, or spark plug.
5. An accident or subjecting the ATV to misuse, abuse, or negligent operation.
6. Any modification, addition, or removal of parts unless instructed to do so by Arctic Cat.
7. Use of the ATV in any way for racing purposes.
8. Removal of the engine for use in another vehicle.
9. Removal or mutilation of the Vehicle Identification Number or Engine Serial Number.
10. Use of parts not sold or approved by Arctic Cat.
11. Damage due to improper transportation.

In consideration of the foregoing, any implied warranty is limited in duration to the various warranty periods set forth. This warranty gives you specific legal rights, and you may also have other rights which vary from state/province to state/province or country to country. Some jurisdictions do not allow limitations on how long an implied warranty lasts, so the above limitations may not apply to you.

Warranty Procedure/Owner Responsibility

At the time of sale, an ATV Rider Training Certificate and Owner Registration form is to be completed by the selling dealer and consumer. The receipt of the form by Arctic Cat is a condition precedent to warranty coverage. It is the selling dealer's responsibility to retain and/or submit appropriate copies of the form to the appropriate place(s) to initiate warranty coverage.

The dealer will furnish to the consumer a signed copy of the form which must be presented to the dealer when requesting warranty service. The registration form is the consumer's proof of ownership and warranty eligibility. The form is used by the dealer to validate the warranty claim. Retain your copy of the form and keep it in a safe place.

When warranty repair is suspected, the ATV should be taken to the selling dealer, who has the primary responsibility to perform warranty repairs. Subject to the limitations set forth in the Limited Warranty, in the event the selling dealer has ceased to do business, you have moved, or you are in a location away from your selling dealer, warranty may be performed by any authorized Arctic Cat ATV dealer.

The authorized Arctic Cat ATV dealer will examine the ATV or part to determine if, in his opinion, a warrantable condition exists. If a warrantable condition appears to exist, the dealer will repair or replace, at Arctic Cat's option, free of charge, including any related labor costs, all parts that are found to be warrantable and any other parts which the warrantable part caused to be damaged. You, the owner, will then be asked to sign a warranty form to ensure Arctic Cat that the warranty work was actually performed.

It is the owner's responsibility to maintain and service the ATV in accordance with Arctic Cat's recommendations in the Operator's Manual. To protect yourself and your ATV, follow all safety and service tips. Arctic Cat will NOT warrant repairs required as a result of not performing standard operator maintenance, storage procedures, and service as outlined in the Operator's Manual.

Should you have any questions concerning the warranty, contact an authorized Arctic Cat ATV dealer.

Arctic Cat ATV Emission Control Warranty Statement

Warranty Rights and Obligations

Arctic Cat Inc. (hereinafter referred to as Arctic Cat) and the California Air Resources Board are pleased to explain the emission control system warranty for each new Arctic Cat ATV sold in the state of California. In California, a new ATV must be designed, built, and equipped to meet the state's stringent anti-smog standards.

Arctic Cat warrants the emission control system on the Arctic Cat ATV for the periods listed below provided there has been no abuse, neglect, or improper maintenance of the ATV.

The emission control system may include components such as the carburetor, ignition system, and crankcase ventilation system. Also included may be hoses, belts, connectors, and other emission-related assemblies.

When a warrantable condition exists, Arctic Cat will repair the ATV at no cost to the owner, including diagnosis, parts, and labor.

Emission Control Warranty Coverage

A new Arctic Cat ATV manufactured after January 1, 1997 has a two (2) year warranty on its emissions control components.

If an emission-related component on the ATV is defective, the component will be repaired or replaced by any authorized Arctic Cat ATV dealer.

Owner's Emission Control Warranty Responsibilities

It is the owner's responsibility to perform the required maintenance listed in the Operator's Manual. Arctic Cat recommends the retention of all receipts covering maintenance performed on the ATV, but Arctic Cat cannot deny warranty solely for the lack of receipts or for failure to ensure the performance of all scheduled maintenance on the emission control system.

It is the owner's responsibility to present the ATV to an authorized Arctic Cat ATV dealer as soon as a problem exists. The undisputed warranty repairs should be completed within a reasonable period of time, not to exceed thirty days.

The ATV owner should be aware that Arctic Cat may deny warranty coverage if either the ATV or a component has failed due to abuse, neglect, improper maintenance, or any unapproved modifications.

If you have any questions regarding your warranty rights and responsibilities, contact either Arctic Cat Inc, P.O. Box 810, Thief River Falls, MN 56701, (218) 681-4999 or the California Air Resources Board, 9528 Telstar Avenue, El Monte, CA 91731, (818) 575-6800.

Arctic Cat Emission Control System Limited Warranty

Arctic Cat Inc., P.O. Box 810, Thief River Falls, MN 56701 (hereinafter referred to as Arctic Cat) warrants that this new Arctic Cat ATV manufactured on or after January 1st, 1997:

- A. Is designed, built, and equipped so as to conform at the time of initial purchase with all applicable regulations of the California Air Resources Board and
- B. Is free from defects in material and workmanship which could cause such ATV to fail to conform with applicable regulations of the California Air Resources Board for a period of use of two (2) years from the date of initial retail delivery.

Coverage

Warranty defects shall be remedied during customary business hours at any authorized Arctic Cat ATV dealer located within the state of California in compliance with applicable regulations of the California Air Resources Board. Any component or components replaced under this warranty shall become the property of Arctic Cat.

In California, emission related warranted components are specifically defined by the state's Emission Warranty Parts List. These warranted components are carburetor and internal components, intake manifold, fuel injection system, spark advance mechanism, crankcase breather, air cutoff valve, fuel/vapor separator, canister, igniters, breaker governors, ignition coils, ignition wires, ignition points, condensers and spark plugs if failure occurs prior to the first scheduled replacement, and hoses, clamps, and fittings used directly in these parts. Since emission related components may vary from model to model, certain models may not contain all of these components, and certain models may contain functionally equivalent components.

In California, emission control system emergency repairs, as provided for in the California Administrative Code, may also be performed by other than an authorized Arctic Cat ATV dealer. An emergency situation occurs when an authorized Arctic Cat ATV dealer is not reasonably available, a component is not available within thirty (30) days, or a repair is not complete within thirty (30) days. Any replacement component can be used in an emergency repair. Arctic Cat will reimburse the owner for the expenses, including diagnosis, not to exceed suggested retail price as set forth by Arctic Cat for all warranted components replaced and labor charges based on the recommended time allowance set forth by Arctic Cat for the warranty repair and the geographically appropriate hourly labor rate. The owner may be required to keep receipts and failed components in order to receive compensation.

Limitations

This Emission Control System Warranty shall not cover any of the following:

- A. Repair or replacement required as a result of
 - (1) accident,
 - (2) misuse,
 - (3) lack of required maintenance,
 - (4) repairs improperly performed or replacements improperly installed,
 - (5) use of replacement components or accessories not conforming to Arctic Cat specifications which adversely affect performance, and/or
 - (6) use in competitive racing or related events.
- B. Inspections, replacement of components, and other services or adjustments necessary for required maintenance.

Limited Liability

The liability of Arctic Cat under this Emission Control System Warranty is limited solely to the remedying of defects in material and workmanship by an authorized Arctic Cat ATV dealer at its place of business during customary business hours. This warranty does not cover inconvenience or loss of use of the ATV or transportation of the ATV to or from the Arctic Cat ATV dealer.

ARCTIC CAT SHALL NOT BE LIABLE FOR ANY OTHER EXPENSES, LOSS, OR DAMAGE, WHETHER DIRECT, INCIDENTAL, CONSEQUENTIAL, OR EXEMPLARY, ARISING IN CONNECTION WITH THE SALE OR USE OF, OR INABILITY TO USE THE ARCTIC CAT ATV FOR ANY PURPOSE. SOME STATES DO NOT ALLOW THE EXCLUSION OR LIMITATION OF ANY INCIDENTAL OR CONSEQUENTIAL DAMAGES, SO THE ABOVE MAY NOT APPLY TO YOU.

NO EXPRESS EMISSION CONTROL SYSTEM WARRANTY IS GIVEN BY ARCTIC CAT EXCEPT AS SPECIFICALLY SET FORTH HEREIN. ANY EMISSION CONTROL SYSTEM WARRANTY IMPLIED BY LAW, INCLUDING ANY WARRANTY OF MERCHANTABILITY OR FITNESS FOR A PARTICULAR PURPOSE, IS LIMITED TO THE EXPRESS EMISSION CONTROL SYSTEM WARRANTY TERMS STATED IN THIS WARRANTY. THE FOREGOING STATEMENTS OF WARRANTY ARE EXCLUSIVE AND IN LIEU OF ALL OTHER REMEDIES.

No dealer is authorized to modify this Arctic Cat Inc. Limited Emission Control System Warranty.

Legal Rights

THIS WARRANTY GIVES YOU SPECIFIC LEGAL RIGHTS, AND YOU MAY ALSO HAVE OTHER RIGHTS WHICH VARY FROM STATE TO STATE.

THIS WARRANTY IS IN ADDITION TO THE ARCTIC CAT INC. LIMITED ATV WARRANTY.

Additional Information

Any replacement component that is equivalent in performance and durability may be used in the performance of any maintenance or repairs. However, Arctic Cat is not liable for these components. The owner is responsible for the performance of all required maintenance. Such maintenance may be performed at a service establishment or by any individual. The warranty period begins on the date the ATV is delivered to the owner.

U.S. EPA Emission Control Statement/Warranty Coverage (U.S. Only)

STATEMENT/WARRANTY

Arctic Cat warrants to the original retail purchaser, and each subsequent purchaser, that all U.S. EPA-certified Arctic Cat ATV's are designed, built, and equipped to conform to all U.S. EPA Emission Control Regulations. Please read the following information completely.

Your authorized Arctic Cat ATV dealer will repair or replace any defective emission-related component at no cost to you during the warranty period. You may have non-warranty service performed by any repair establishment that uses equivalent components. The regulations provide significant civil penalties for tampering that causes your ATV to no longer meet U.S. EPA emission standards.

Arctic Cat further warrants that the engine and its emission-related components are free from defects in materials or workmanship that could cause the engine to fail to comply with applicable regulations during the warranty period.

If you have any questions about this information, or the emission warranty coverage statement, contact your local authorized Arctic Cat ATV dealer.

WARRANTY PERIOD

The emission warranty period for this ATV begins on the same date as the standard warranty coverage and continues for 30 months or 3100 miles, whichever comes first.

COMPONENTS COVERED

The emissions warranty covers major emissions control components and emission-related components listed as follows:

Engine Management and Sensors

Barometric Pressure Sensor
Camshaft Position Sensor
Engine Control Unit (ECU)
Engine Coolant Temperature Sensor
Intake Air Temperature Sensor
Manifold Absolute Pressure Sensor
Oxygen Sensor
Throttle Position Sensor
Crankshaft Position Sensor
Exhaust Temperature Sensor

Ignition System

Ignition Coil
Knock Sensor System
Spark Plugs
Capacitive Discharge Ignition (CDI) Module
Magneto Pick-Up

Fuel/Air System

Fuel Injectors
Fuel Pressure Regulator
Fuel Pump
Carburetor(s)
Turbocharger Assembly
Air Bypass Valve
Turbo Waste Gate Control Valve
Crankcase Ventilation System
ISC Valve

Miscellaneous Items Used in Aforementioned Systems

Connectors
Switches
Grommets
Clamps
Hoses
Ties
Gaskets
Wiring

OWNER'S RESPONSIBILITIES

The owner of any ATV warranted under this Arctic Cat Emission Control Statement is responsible for the proper maintenance and use of the ATV as stated in the Operator's Manual. Proper maintenance generally includes replacement and service, at the owner's choosing, such items as air filter, oil and oil filter, or any other part, item, or device related to emissions control as specified in the Operator's Manual. It is the owner's responsibility to ensure that the ATV is used in a manner for which it was designed.

Declaration of Conformity

Application of council directives: EMC Directive 97/24/EC
Date of Issue: June, 1997
EC Machinery Directive 2006/42/EC
Date of Issue: May, 2006

Issued by European Commission.

Type of Equipment: All-Terrain Vehicles

Brand Name: Arctic Cat

Model: 650 4x4 Mud Pro 650

Standards to which conformity is declared: EN 61000-6-2:2005
EN 55012:2007

Manufacturer (if not issuing agent): Arctic Cat Inc.
601 Brooks Ave S.
Thief River Falls, MN
56701 USA

I, the undersigned, hereby declare that the equipment specified above conforms to the directive(s) and standard(s) as specified.

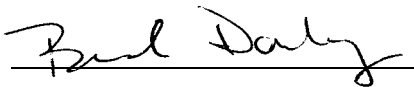

Brad Darling
Vice President/General Manager

DIVISION I - SAFETY

AN ATV IS NOT A TOY AND CAN BE HAZARDOUS TO OPERATE.

- Always go slowly and be extra careful when operating on unfamiliar terrain. Always be alert to changing terrain conditions when operating the ATV.
- Never operate on excessively rough, slippery, or loose terrain.
- Always follow proper procedures for turning as described in this manual. Practice turning at slow speeds before attempting to turn at faster speeds. Do not turn at excessive speed.
- Always have the ATV checked by an authorized Arctic Cat ATV dealer if it has been involved in an accident.
- Never operate the ATV on hills too steep for the ATV or for your abilities. Practice on smaller hills before attempting larger hills.
- Always follow proper procedures for climbing hills as described in this manual. Check the terrain carefully before you start up any hill. Never climb hills with slippery or loose surfaces. Shift your weight forward. Never open the throttle suddenly or make sudden gear changes. Never go over the top of any hill at high speed.
- Always follow proper procedures for going down hills and for braking on hills as described in this manual. Check the terrain carefully before you start down any hill. Shift your weight backward. Never go down a hill at high speed. Avoid going down a hill at an angle which would cause the ATV to lean sharply to one side. Go straight down the hill where possible.
- Always follow proper procedures for crossing the side of a hill as described in this manual. Avoid hills with slippery or loose surfaces. Shift your weight to the uphill side of the ATV. Never attempt to turn the ATV around on any hill until you have mastered the turning techniques described in this manual on level ground. Avoid crossing the side of a steep hill if possible.
- Always be careful of skidding or sliding. On slippery surfaces, such as ice, go slowly and be very cautious in order to reduce the chance of skidding or sliding out of control.
- Always use proper procedures if you stall or roll backward when climbing a hill. To avoid stalling, maintain a steady speed when climbing a hill. If you stall or roll backwards, follow the special procedure for braking described in this manual. Dismount on the uphill side or to either side if pointed straight uphill. Turn the ATV around and mount following the procedure described in this manual.
- Always check for obstacles before operating in a new area. Never attempt to operate over large obstacles, such as large rocks or fallen trees. Always follow proper procedures when operating over obstacles as described in this manual.
- Never operate an ATV in fast flowing water or in water deeper than the footrests. Remember that wet brakes may have reduced stopping capability. Test your brakes after leaving water. If necessary, apply them lightly several times to let friction dry out the pads.
- Always be sure there are no obstacles or people behind you when you operate in reverse. When it is safe to proceed in reverse, go slowly. Avoid turning at sharp angles in reverse.
- Always use the size and type tires specified in this manual. Always maintain proper tire pressure as described in this manual.
- Never improperly install or improperly use accessories on this ATV.
- Never install a twist grip throttle on this ATV.
- Never exceed the stated load capacity for an ATV. Cargo should be properly distributed and securely attached. Reduce speed and follow instructions in this manual for carrying cargo or pulling a trailer and allow greater distance for braking.
- No one under the age of 16 should operate this ATV. Some operators at the age of 16 may not be able to operate an ATV safely. Parents should supervise the use of the ATV at all times. Parents should permit continued use only if they determine that the operator has the ability to operate the ATV safely.

FOR MORE INFORMATION ABOUT ATV SAFETY, call the ATV Safety Institute at 1-800-887-2887 (U.S.) or 1-613-739-1535 (Canada).

ATV Safety Alert

The Consumer Product Safety Commission has concluded that ALL-TERRAIN VEHICLES (ATV's) may present a risk of DEATH or SEVERE INJURY in certain circumstances. Accidents may occur for many reasons:

- *** Over 2591 people, including many children, have died in accidents associated with ATV's since 2005.
- *** Many people have become severely paralyzed or suffered severe internal injuries as a result of accidents associated with ATV's.
- *** Every month thousands of people are treated in hospital emergency rooms for injuries received while riding an ATV.

You should be aware that AN ATV IS NOT A TOY AND CAN BE HAZARDOUS TO OPERATE. An ATV handles differently from other vehicles, including motorcycles and cars. A collision or roll-over can occur quickly, even during routine maneuvers such as turning and driving on hills and over obstacles, if you fail to take proper precautions.

TO AVOID DEATH OR SEVERE PERSONAL INJURY:

- * Always read the Operator's Manual carefully and follow the operating procedures described. Pay special attention to the warnings contained in the manual and on all labels.
- * Never operate an ATV without proper instruction. Take a training course. Beginners should complete a training course.
- * Always follow these age recommendations:
 - A Y-12+ is intended for use by children age 12 or older, and a T-14 is intended for use by an operator age 14 or older.
 - A child under 16 years old should never operate an ATV without adult supervision. Children need to be observed carefully because not all children have the strength, size, skills, or judgment to operate an ATV safely.

- * Never carry a passenger on an ATV. Carrying a passenger may upset the balance of the ATV and may cause it to go out of control.
- * Always avoid paved surfaces. ATV's are not designed to be used on paved surfaces and may seriously affect handling and control.
- * Never operate an ATV on a public road, even a dirt or gravel one, because you may not be able to avoid colliding with other vehicles. Also, operating an ATV on a public road may be against the law.
- * Never operate an ATV without an approved motorcycle helmet, eye protection, boots, gloves, long pants, and a long-sleeved shirt or jacket.
- * Never consume alcohol or drugs before or while operating an ATV.
- * Never operate an ATV at excessive speeds. Go at a speed which is proper for the terrain, visibility conditions, and your experience.
- * Never attempt to do wheelies, jumps, or other stunts.
- * Always be careful when operating an ATV, especially when approaching hills, turns, and obstacles and when operating on unfamiliar or rough terrain.
- * Never lend an ATV to anyone who has not taken a training course or has not been driving an ATV for at least a year.

Rider Training Course

Arctic Cat sponsors a free Rider Training Course to teach ATV riding skills or to reinforce current riding skills. First-time purchasers without any previous ATV riding experience will receive a \$100.00 coupon from Arctic Cat through the SVIA/ASI after completing the training course (U.S. owners only, one incentive, and free rider training courses for appropriate immediate family members per ATV purchase). See an authorized Arctic Cat ATV dealer for details or call (800) 887-2887 for training course information.

In Canada, the Canada Safety Council (CSC) provides an ATV Rider's Course to teach safe ATV operating skills. They also provide a special ATV Rider's Course for children under 14 years of age with parental supervision. Call the CSC at 1-613-739-1535 ext. 227 for more details. Also available is a bilingual computer-based safety training program on a CD-ROM from CATV - call toll-free at 1-877-470-2288.

Au Canada, le conseil canadien de la sécurité (CSC) offre un cours de conduite de VTT pour enseigner les habiletés d'opération sécuritaires de VTT. Un cours spécial de conduite de VTT est également offert aux enfants de moins de 14 ans avec la surveillance d'un parent. Communiquez avec le CSC en composant le: 1-613-739-1535, poste 227 pour de plus amples informations. Un programme de formation bilingue informatisé sur la sécurité est aussi disponible sur disque optique compact par CATV; composez sans frais le: 1-877-470-2288.



FOR MORE INFORMATION ABOUT ATV SAFETY, in the U.S., call the Consumer Product Safety Commission at (800) 638-2772 or the ATV Distributors' Safety Hotline at (800) 852-5344 or in Canada, call the Canada Safety Council at 1-613-739-1535 ext. 227.

Visit the Arctic Cat Inc. website at www.arcticcat.com for additional product information.

Hangtags

An Arctic Cat ATV comes with hangtags containing important safety information. Anyone who rides the ATV should read and understand this information before riding.

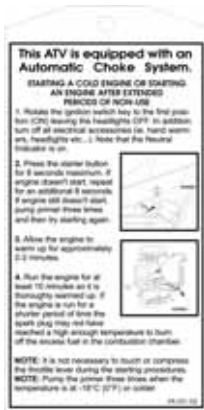

2257-220



2258-133

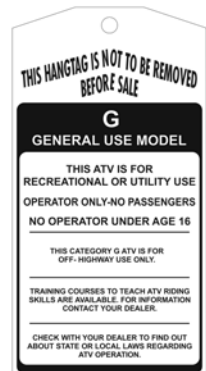

Pour commander des Etiquettes de Mise en Garde gratuites, voyez votre détaillant de autorisé VTT Arctic Cat pour le numéro de pièce 1436-344.

Warning Labels & Information

An Arctic Cat ATV comes with several labels containing important safety information. Anyone who rides the ATV should read and understand this information before riding.

The labels should be considered as permanent parts of the ATV. If a label comes off or becomes hard to read, contact your Arctic Cat ATV dealer for a replacement.

■ **NOTE:** The location and content of labels on the ATV you have purchased may differ from those shown on this page.

A **WARNING**

UNDER 16

Operating this ATV if you are under 16 years of age is illegal in many states and provinces.

NEVER operate this ATV if you are under age 16.

B **WARNING**

Exceeding vehicle's towing limit could cause an accident. Reduce speed when towing a trailer. Read operator's manual for details.

MAXIMUM TOWING WEIGHT
25 lbs (11 kg)

MAXIMUM TOWING CAPACITY
350 lbs (157 kg)

C **WARNING**

Improper ATV use can result in SEVERE INJURY or DEATH.

ALWAYS USE AN APPROVED HELMET AND PROTECTIVE GEAR

NEVER USE ON PUBLIC ROADS

NEVER CARRY PASSENGERS

NEVER USE WITH DRUGS OR ALCOHOL

NEVER operate:

- without proper training or instruction
- at speeds too fast for your skills or the conditions
- on public roads - a collision can occur with another vehicle
- with a passenger-passengers affect balance and steering and increase risk of losing control

ALWAYS:

- use proper riding techniques to avoid vehicle overturns on hills and rough terrain and in turns
- avoid paved surfaces - pavement may seriously affect handling and control

LOCATE AND READ OPERATOR'S MANUAL. FOLLOW ALL INSTRUCTIONS AND WARNINGS.

D **WARNING**

Do not run engine without this shield in place or with drive shaft removed.
Do not attempt any adjustment with engine running.

E **WARNING**

NEVER operate up or down hills greater than 25°.

Riding on hills steeper than 25° can cause the vehicle to overturn and result in severe injury or death.

F

OPERATOR'S MANUAL

PROFIT DEPARTMENT

BEFORE STARTING YOUR PROCEDURE

T	1. Read the manual.
L	2. Read the manual.
O	3. Read the manual.
C	4. Read the manual.
B	5. Read the manual.
O	6. Read the manual.
N	7. Read the manual.
E	8. Read the manual.

G **WARNING/AVERTISSEMENT**

THIS VEHICLE IS AN ALL-TERRAIN VEHICLE AND IS NOT INTENDED FOR USE ON PUBLIC HIGHWAYS. USE VEHICLES ON PUBLIC HIGHWAYS CAN RESULT IN SEVERE INJURY OR DEATH. A FINE MAY BE IMPOSED FOR VIOLATING THIS LAW.

H **WARNING**

Disengage brake lever/kick before operating ATV.

I **WARNING**

NEVER exceed 10 MPH (16KPH) when the differential is in the LOCKED mode.

J **WARNING**

NEVER ride as a passenger.

Passengers can cause a loss of control, resulting in SEVERE INJURY or DEATH.

K **WARNING**

NEVER carry a passenger on this carrier.

L **WARNING**

NEVER carry a passenger on this carrier.

M **WARNING**

Improper tire pressure or overloading can cause loss of control. Loss of control can result in severe injury or death.

Cold tire pressure:
Front: 8.0 psi (54.8 kPa)
Rear: 8.0 psi (54.8 kPa)

Maximum weight capacity: 315 lbs (143 kg)

2012B

Warnings

WARNING

POTENTIAL HAZARD

Operating this ATV without proper instruction.

WHAT CAN HAPPEN

The risk of an accident is greatly increased if the operator does not know how to operate the ATV properly in different situations and on different types of terrain.

HOW TO AVOID THE HAZARD

Beginning and inexperienced operators should complete the certified training course offered. They should then regularly practice the skills learned in the course and the operating techniques described in this Operator's Manual.

For more information about the training course, contact an authorized Arctic Cat ATV dealer or call 1-800-887-2887 (U.S.) or 1-613-739-1535 (Canada).

WARNING

POTENTIAL HAZARD

Allowing anyone under age 16 to operate this ATV.

WHAT CAN HAPPEN

Use of an ATV by children can lead to severe injury or death of the child.

Children under the age of 16 may not have the skills, abilities, or judgment needed to operate the ATV safely and may be involved in a serious accident.

HOW TO AVOID THE HAZARD

A child under 16 should never operate this ATV.

WARNING

POTENTIAL HAZARD

Carrying a passenger on this ATV.

WHAT CAN HAPPEN

Greatly reduces your ability to balance and control this ATV.

Could cause an accident, resulting in injury or death to you and/or your passenger.

HOW TO AVOID THE HAZARD

Never carry a passenger. The long seat is to allow the operator to shift positions as needed during operation. It is not for carrying passengers.

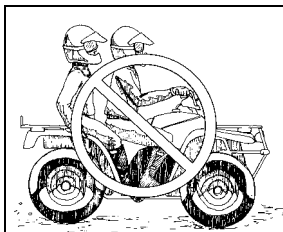

WARNING

POTENTIAL HAZARD

Attempting wheelies, jumps, and other stunts.

WHAT CAN HAPPEN

Increases the chance of an accident including a roll-over.

HOW TO AVOID THE HAZARD

Never attempt stunts, such as wheelies or jumps. Don't try to show off.



Warnings

WARNING

POTENTIAL HAZARD

Operating this ATV on paved surfaces.

WHAT CAN HAPPEN

The ATV's tires are designed for off-road use only, not for use on pavement. Paved surfaces may seriously affect handling and control of the ATV and may cause the ATV to go out of control.

HOW TO AVOID THE HAZARD

Never operate the ATV on any paved surfaces, including sidewalks, driveways, parking lots, and streets.



WARNING

POTENTIAL HAZARD

Operating this ATV without wearing an approved helmet, eye protection, and protective clothing.

WHAT CAN HAPPEN

Operating without an approved helmet increases your chances of a severe head injury or death in the event of an accident.

Operating without eye protection can result in an accident and increases your chances of a severe injury in the event of an accident.

Operating without protective clothing increases your chances of severe injury in the event of an accident.

HOW TO AVOID THE HAZARD

Always wear an approved helmet that fits properly.

You should also wear: Eye protection (goggles or face shield)

Gloves

Boots

Long sleeved shirt or jacket

Long pants

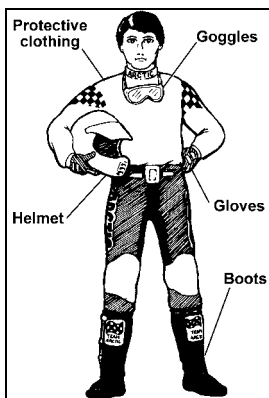

WARNING

POTENTIAL HAZARD

Failure to use extra care when operating on rough, slippery, or loose terrain.

WHAT CAN HAPPEN

Could cause loss of traction or ATV control, which could result in an accident including a rollover.

HOW TO AVOID THE HAZARD

Do not operate on rough, slippery, or loose terrain until you have learned and practiced the skills necessary to control the ATV on such terrain.

Always be especially cautious on these kinds of terrain.

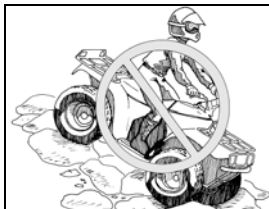

Warnings

WARNING

POTENTIAL HAZARD

Operating this ATV after or while consuming alcohol or drugs.

WHAT CAN HAPPEN

- Could seriously affect your judgment.
- Could cause you to react more slowly.
- Could affect your balance and perception.
- Could result in an accident.

HOW TO AVOID THE HAZARD

Never consume alcohol or drugs before or while driving this ATV.

WARNING

POTENTIAL HAZARD

Operating this ATV at excessive speeds.

WHAT CAN HAPPEN

Increases your chances of losing control of the ATV, which can result in an accident.

HOW TO AVOID THE HAZARD

Always ride at a speed that is proper for the terrain, visibility and operating conditions, and your experience.

WARNING

POTENTIAL HAZARD

- Failure to inspect the ATV before operating.
- Failure to properly maintain the ATV.

WHAT CAN HAPPEN

Increases the possibility of an accident or equipment damage.

HOW TO AVOID THE HAZARD

- Always inspect your ATV each time you use it to make sure the ATV is in safe operating condition.
- Always follow the inspection and maintenance procedures and schedules described in this Operator's Manual.

WARNING

POTENTIAL HAZARD

Removing hands from handlebar or feet from footrests during operation.

WHAT CAN HAPPEN

Removing even one hand or foot can reduce your ability to control the ATV or could cause you to lose your balance and fall off the ATV. If you remove a foot from a footrest, your foot or leg may come into contact with the wheels, which could injure you or cause an accident.

HOW TO AVOID THE HAZARD

Always keep both hands on the handlebar and both feet on the footrests of your ATV during operation.

Warnings

WARNING

POTENTIAL HAZARD

Failure to use extra care when operating the ATV on unfamiliar terrain.

WHAT CAN HAPPEN

You can come upon hidden rocks, bumps, or holes without enough time to react.

Could result in the ATV overturning or going out of control.

HOW TO AVOID THE HAZARD

Go slowly and be extra careful when operating on unfamiliar terrain.

Always be alert to changing terrain conditions when operating the ATV.

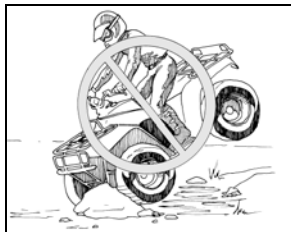

WARNING

POTENTIAL HAZARD

Improperly crossing hills or turning on hills.

WHAT CAN HAPPEN

Could cause loss of control or cause the ATV to overturn.

HOW TO AVOID THE HAZARD

Never attempt to turn the ATV around on any hill until you have mastered the turning technique as described in this Operator's Manual. Practice first on level ground. Be very careful when turning on any hill.

Avoid crossing the side of a steep hill, if possible.

When crossing the side of a hill:

Always follow proper procedures as described in this Operator's Manual.

Avoid hills with slippery or loose surfaces.

Shift your weight to the uphill side of the ATV.

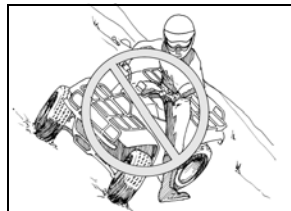

WARNING

POTENTIAL HAZARD

Going down a hill improperly.

WHAT CAN HAPPEN

Could cause loss of control or cause the ATV to overturn.

HOW TO AVOID THE HAZARD

Always follow proper procedures for going down hills as described in this Operator's Manual.

Always check the terrain carefully before you start down any hill.

Shift your weight backward.

Never go down a hill at high speed.

Avoid going down a hill at an angle that would cause the ATV to lean sharply to one side. Go straight down the hill where possible.

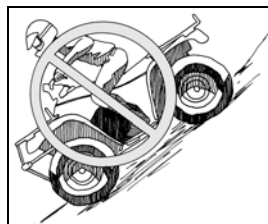

Warnings

WARNING

POTENTIAL HAZARD

Turning improperly.

WHAT CAN HAPPEN

ATV could go out of control, causing a collision or rollover.

HOW TO AVOID THE HAZARD

Always follow proper procedures for turning as described in this Operator's Manual.

Practice turning at slow speeds before attempting to turn at faster speeds.

Do not turn at excessive speed.

WARNING

POTENTIAL HAZARD

Climbing hills improperly.

WHAT CAN HAPPEN

Could cause loss of control or cause the ATV to overturn.



HOW TO AVOID THE HAZARD

Always follow proper procedures for climbing hills as described in this Operator's Manual.

Always check the terrain carefully before you start up any hill.

Never climb hills with slippery or loose surfaces.

Shift your weight forward.

Never open the throttle suddenly or make sudden gear changes. The ATV could flip over backwards.

Never go over the top of any hill at high speed. An obstacle, a sharp drop, or another vehicle or person could be on the other side of the hill.

NEVER OPERATE UP OR DOWN HILLS STEEPER THAN 25°

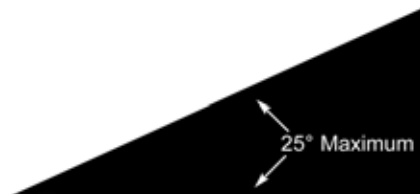

Warnings

WARNING

POTENTIAL HAZARD

Operating on steep hills.

WHAT CAN HAPPEN

The ATV can overturn more easily on steep hills than on level surfaces or small hills.

HOW TO AVOID THE HAZARD

Never operate the ATV on hills too steep for the ATV or for your abilities.

Practice on smaller hills before attempting larger hills.

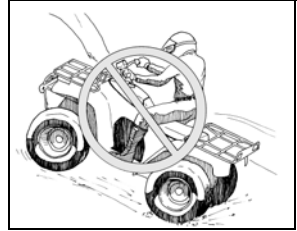

WARNING

POTENTIAL HAZARD

Stalling, rolling backwards, or improperly dismounting while climbing a hill.

WHAT CAN HAPPEN

Could result in the ATV overturning.

HOW TO AVOID THE HAZARD

Use proper gear and maintain steady speed when climbing a hill.

If you lose all forward speed:

Keep weight uphill.

Apply the brakes.

Engage the brake lever lock after you are stopped.

If you begin rolling backwards:

Keep weight uphill.

Apply the brakes while rolling backwards.

When fully stopped, engage the brake lever lock.

Dismount on uphill side or to a side if pointed straight uphill.

Turn the ATV around and mount following the procedure described in this Operator's Manual.

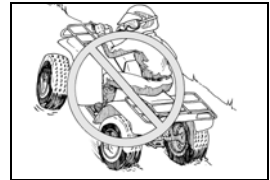

WARNING

POTENTIAL HAZARD

Overloading the ATV or carrying or towing cargo improperly.

WHAT CAN HAPPEN

Could cause changes in ATV handling, which could lead to an accident.

HOW TO AVOID THE HAZARD

Never exceed the stated load capacity for the ATV.

Cargo should be properly distributed and securely attached.

Reduce speed when carrying cargo or pulling a trailer. Allow greater distance for braking.

Always follow the instructions in this Operator's Manual for carrying cargo or pulling a trailer.

Warnings

WARNING

POTENTIAL HAZARD

Improperly operating over obstacles.

WHAT CAN HAPPEN

Could cause loss of control or a collision. Could cause the ATV to overturn.

HOW TO AVOID THE HAZARD

Before operating in a new area, check for obstacles.

Never attempt to ride over large obstacles, such as large rocks or fallen trees.

When you go over obstacles, always follow proper procedures as described in this Operator's Manual.

WARNING

POTENTIAL HAZARD

Skidding or sliding.

WHAT CAN HAPPEN

You may lose control of the ATV.

You may also regain traction unexpectedly, which may cause the ATV to overturn.

HOW TO AVOID THE HAZARD

Learn to safely control skidding or sliding by practicing at slow speeds and on level, smooth terrain.

On extremely slippery surfaces, such as ice, go slowly and be very cautious in order to reduce the chance of skidding or sliding out of control.

WARNING

POTENTIAL HAZARD

Operating the ATV with improper modifications.

WHAT CAN HAPPEN

Improper installation of accessories or modification of the ATV may cause changes in handling which, in some situations, could lead to an accident.

HOW TO AVOID THE HAZARD

Never modify the ATV through improper installation or improper use of accessories. All parts and accessories added to this ATV should be genuine Arctic Cat ATV components designed for use on the ATV and should be installed and used according to instructions. Never install a twist grip throttle. If you have questions, consult an authorized Arctic Cat ATV dealer.

WARNING

POTENTIAL HAZARD

Improperly operating in reverse.

WHAT CAN HAPPEN

You could hit an obstacle or person behind you, resulting in serious injury.

HOW TO AVOID THE HAZARD

Before you engage reverse gear, make sure there are no obstacles or people behind you. When it is safe to proceed, go slowly.

Warnings

WARNING

POTENTIAL HAZARD

Operating this ATV on public streets, roads, or highways.

WHAT CAN HAPPEN

You can collide with another vehicle.

HOW TO AVOID THE HAZARD

Never operate this ATV on any public street, road, or highway, even a dirt or gravel one.

In many states it is illegal to operate an ATV on public streets, roads, or highways.

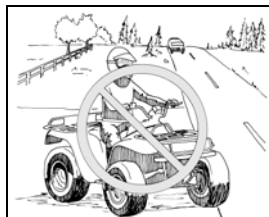

WARNING

POTENTIAL HAZARD

Operating the ATV with improper tires or with improper or uneven tire pressure.

WHAT CAN HAPPEN

Use of improper tires on the ATV or operation of the ATV with improper or uneven tire pressure may cause loss of control increasing your risk of accident.

HOW TO AVOID THE HAZARD

Always use the size and type tires specified in this Operator's Manual for this ATV.

Always maintain proper tire pressure as described in this Operator's Manual.

WARNING

POTENTIAL HAZARD

Operating the ATV through deep or fast flowing water.

WHAT CAN HAPPEN

Tires may float, causing loss of traction and loss of control, which could lead to an accident.

HOW TO AVOID THE HAZARD

Never operate the ATV in fast flowing water or in water deeper than the footrests.

Remember that wet brakes may have reduced stopping capability.

Test your brakes after leaving water. If necessary, apply them several times to dry out the pads.

Warnings

WARNING

POTENTIAL HAZARD

Operating the ATV with differential lock engaged.

WHAT CAN HAPPEN

The increased steering effort and reduced maneuverability caused by the locked differential could result in loss of control and an accident.

HOW TO AVOID THE HAZARD

Never exceed 10 MPH (16 KPH) with the differential lock engaged. Always disengage the differential lock as soon as not needed for additional traction.

WARNING

POTENTIAL HAZARD

Failure to release the brake lever lock before driving the ATV

WHAT CAN HAPPEN

Driving the ATV with the brake lever lock engaged could cause a change in handling or loss of brakes and cause an accident.

HOW TO AVOID THE HAZARD

Always release the brake lever lock before driving the ATV.

Prevention

Overview

When using an ATV, prevention is the name of the game. “Had you only known” something could go wrong, you would have prevented it. If you don’t notice your conditions and surroundings before riding your ATV, you give up control over the situation. Using ATV prevention techniques helps you forecast potential hazards before they injure you or damage your ATV.

Following the safety instructions and warnings in this manual will help you “P.A.S.S.” the safety test. P.A.S.S. stands for “Prevention,” “Active Riding,” “Sound Judgment,” and “Supervision.” Remembering P.A.S.S. and what it stands for will help you have a safe, predictable ride every time you go out on your ATV.

Safe Riding Clothing and Gear

Always wear clothing suited to the type of riding you are doing. ATV riding requires special protective clothing which will make you feel more comfortable and reduce chances of injury.

You’ll find it important to dress correctly for ATV riding in order to prevent scraped skin and serious head injuries. It’s easy and could save you time in the long run not having to contend with an injury. Of course, it also makes sense to remember the seasons. Wear a hat under your helmet and a snowmobile suit in the winter and lighter, protective clothing in the summer. Following is the minimum protection you need to wear during every ride.

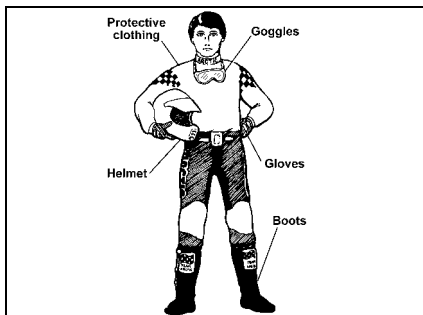

ATV-0004

Gloves

Your hands are targets for flying objects and branches. Along with providing skin protection, gloves will shield your hands from harsh weather. Wear gloves that are weather resistant and have a gripping surface to keep them from sliding off the handlebars. Off-road style gloves with knuckle pads are the best for comfort and protection.

Boots/Ankle Protection

Wear a boot that covers the largest possible area of your leg (preferably up to your knee) and can handle significant impact. Choosing boots with low heels and a good tread will help prevent your feet from slipping off the footrests in wet or rugged conditions or getting hurt if they get hit by rocks, dirt, or branches.

Helmet

Your helmet is the most important piece of protective gear for safe riding. A helmet can prevent a severe head injury. There are several types of helmets on the market, but make sure you wear a helmet that complies with the current standards of the U.S. Department of Transportation (DOT), The Snell Memorial Foundation, or the American National Standards Institute (ANSI). Helmets that comply with one or more of these agency’s standards have a sticker on the inside or outside of the helmet.

TESTIMONIAL

DOCUMENT#: N490117A1
CITY/STATE: N. HUNTINGDON, PA
SEX: M
AGE: 6
BODY PART: HEAD
DATE ACCIDENT: 06-14-94
DISPOSITION: DOA
SYNOPSIS: The 6 year old male victim died from blunt force trauma to the head when the 4-wheel ATV on which he was a passenger struck a rock on a hill connecting two roads and flipped over backwards onto the victim, shattering his bicycle helmet. The victim was life-flighted to the hospital and died that night. The driver of the ATV, the victim’s 29 year old father, sustained minor injuries, but wasn’t treated.

Prevention

Helmets should have one of these:

1. DOT label
2. Snell label
3. ANSI Z90.1 label

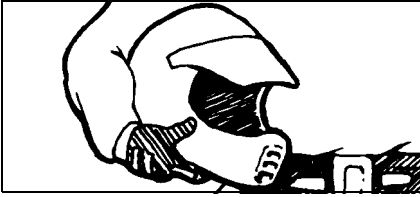

These helmets should provide full-face protection.

If you drop or damage your helmet, get a new one immediately. Your helmet may not protect your head from injury if it has cracks, fissures, or other damage to its outside or core padding.

Remember, your helmet won't do you any good if the chin strap isn't fastened.

Eye Protection

Wear eye protection, such as goggles, to completely surround your eyes to prevent getting dirt or other items in your eyes. Do not depend on sunglasses for proper eye protection. Sunglasses are not recommended; they don't prevent objects from flying in through the sides.

One easy way to remember what parts you need to check is by using the acronym "T-CLOC." It stands for:

T	C	L	O	C
TIRES AND WHEELS	CONTROLS AND CABLES	LIGHTS AND ELECTRIC	OIL AND FUEL	CHASSIS

1. Tires and Wheels

Correct tire pressure is crucial. Consult the ATV Specifications section of this Operator's Manual for tire pressure guidelines. Incorrect tire pressure can cause poor handling, instability, and a loss of ATV control.

Check:

1. Tire pressure
2. Tire surface (tread and sidewalls)

Long Pants and Long Sleeved Shirt

The goal is to protect your body from branches, long grass, airborne objects, or anything else that could scrape your skin. The more thick and durable the material, the better protection it'll provide. Riding pants with kneepads, a jersey, and shoulder pads provide the best protection.

ATV Condition

The second step in Prevention is checking the condition of your ATV. Chances are good that you'll be using your ATV in some rough terrain, and there's no way you want your brakes to go out when riding downhill. You need to check the following parts on your ATV before every ride.

1. Tires and Wheels
2. Controls and Cables
3. Lights and Electric
4. Oil and Fuel
5. Chassis
6. Miscellaneous Items

While checking the tire pressure, inspect the tread and sidewalls of the tires for cracks, cuts, or other damage that could indicate they need to be replaced.

2. Controls and Cables

With the engine running and brake applied, check all transmission positions: forward, neutral, and reverse.

Check:

1. Forward
2. Neutral
3. Reverse

Prevention

A. Brakes

Squeeze the hand brake lever. If it feels soft or “squishy,” it could be low on fluid or have a leak — refer to the General Maintenance section of this Operator’s Manual for instructions. Don’t use the ATV until the brakes are operating normally.

Test the brake lever lock and see if it locks the hand brake lever into position; then disengage it to release the brake. Be sure the rear foot brake near the footrest is working; your brakes could fail during a ride if they’re not maintained.

Check:

1. Hand brake lever
2. Rear foot brake
3. Brake lever lock

B. Throttle

The throttle should have a free, smooth range of motion. If it seems to “stick” at any point, refer to the General Maintenance section of this Operator’s Manual for instructions. Driving your ATV with a sticking throttle can turn your leisurely ride into an unwelcome accident. Don’t drive your ATV if the throttle sticks.

Check:

1. Free, smooth range of motion

3. Lights and Electric

Turn the hi-beam and lo-beam on and off to make sure they work. At the same time, check that the taillight and brake-light work. Also, check the status/warning indicators (reverse, neutral, and hi-lo beam) on the handlebar when you start the ATV. Don’t drive the ATV unless all systems are working. Check the ignition switch and engine stop switch.

Check:

1. Hi-beam
2. Lo-beam
3. Taillight/brakelight
4. Status/warning indicators
5. Ignition switch
6. Engine stop switch

4. Oil and Fuel

Start with a full tank of gas before every ride, and while you’re at it, top off the oil. Don’t forget to check for fluid leaks around the ATV. Watch the overheat indicator to ensure the engine coolant level is adequate.

Check:

1. Gas
2. Oil
3. Fluid leaks

5. Chassis

Grass and leaves can gum-up your suspension and shocks. Clear and clean the suspension arms, shock springs, and fenders. Check smoothness by turning the handlebar full-left and full-right. Check that there is no binding, restrictions, free-play, or looseness in steering components.

Check:

1. Suspension arms
2. Shock springs
3. Fenders
4. Steering

6. Miscellaneous Items

Inspect your air filter. Look for debris or damage that may indicate you need to replace it. A clogged filter can stop an engine. Check your battery terminals for corrosion. Also, be sure to tighten any loose parts, nuts, or bolts.

Check:

1. Air filter
2. Battery
3. Tighten parts, nuts, and bolts

First Aid and Survival

You need to prepare for the unexpected. Emergencies and accidents are traumatic enough, but they’re even worse when you’re not prepared for them. At the minimum during every ATV ride, you should have the following items on board:

- Tools
- Water
- Identification
- First Aid Kit

For rides that are longer in duration and distance, the following additional items are recommended:

Prevention

- Cellular Phone
- Maps/GPS
- Emergency Kit *with Flashlight and First Aid Kit*

Tools

Routine maintenance will generally eliminate the need for emergency repairs. Riding on rough terrain could cause loosening of nuts, bolts, and fasteners. Especially on long rides, carrying the right tools can prevent an inconvenience from becoming a crisis.

Carry these items on your ATV:

- | | |
|--------------|----------------|
| 1. Bulbs | 4. Spark plugs |
| 2. Duct tape | 5. Spare parts |
| 3. Rope | 6. Tool Kit |

Water

Water is so important that you need to carry it regardless of the duration of your ride. Heat exhaustion and heat stroke can creep up suddenly and can take you out of commission. If you become dehydrated, you could find yourself physically unable to safely operate your ATV.

Identification

If something does happen to you, the emergency personnel will want to know who you are and whom to contact. It's possible you may be in no condition to give them that information. Put your I.D. in your pocket before you ride. Without it, you're anonymous.

Cellular Phone

It may be necessary to make an urgent phone call.

Maps/GPS (Global Positioning System)

Maps may be unnecessary when you're familiar with the area. But when you're riding on unfamiliar trails, it's good to know where you are, what's coming up, and how to get back.

Emergency Kit with Flashlight and First Aid Kit

You'll need several items in your Emergency Kit including a flashlight. The matches will come in handy if you need to start a fire to stay warm. Flares are appropriate for signaling help. A first aid kit is very important if an injury of some type should happen. A good First Aid Kit should include bandages, antiseptic spray, gauze, tape, etc.

Carry these items:

1. Flashlight
2. Matches
3. Flares
4. First Aid Kit
5. Money

Active Riding

Overview

“Active Riding” is the second part of “P.A.S.S.” It involves an understanding of how your body weight, balance, gravity, and physical forces affect the handling of the ATV. For example, when you drive a car quickly into a sharp turn, your body is pulled to the outside of the vehicle by centrifugal force. Although a car is relatively stable, enough centrifugal force can cause an ATV to overturn. Constantly shifting your weight is one major difference between driving a car and riding an ATV. Knowing how to shift your weight is necessary to avoid rolling or flipping the ATV.

For complete operating instructions, see ATV Operation sub-section in this manual.

Sound Judgment

Overview

You are not invincible. Knowing that the first “S” in “P.A.S.S.” stands for “Sound Judgment” means you need to use yours.

Do you consider yourself to be pretty conservative, or are you a heavy risk-taker? Before continuing with this section on sound judgment, check your **Risk Factor** by doing this short survey:

1. Do you drive over the speed limit?

1 2 3
Never Sometimes Often

2. Are you more daring around your friends than you are when alone?

1 2 3
Never Sometimes Often

3. Do you drive your car when the gas gauge is on empty?

1 2 3
Never Sometimes Often

4. Do you feel that no matter what you do, you won't get hurt?

1 2 3
Never Sometimes Often

5. Do you drink or use drugs before you drive your car?

1 2 3
Never Sometimes Often

6. Do you drive your car even if it has a major problem with the brakes, tires, or engine?

1 2 3
Never Sometimes Often

7. Do you thrive on the adrenaline rush you get from speeding and dangerous situations?

1 2 3
Never Sometimes Often

8. Do you hurt yourself because you do things that are out of your ability range?

1 2 3
Never Sometimes Often

9. Do you tailgate other drivers when you think they're driving too slow?

1 2 3
Never Sometimes Often

10. Do you ignore weather reports before you do outside activities like swimming, camping, fishing, or boating?

1 2 3
Never Sometimes Often

Add the totals from lines 1-10. **YOUR RISK FACTOR IS:**

10-15: You're pretty conservative. Chances are good that the consistently safe choices you make will help you avoid hurting yourself and the people around you.

16-20: You're straddling the fence. Depending on your mood or whom you're with, the choices you make may help you or hurt you.

21-30: You're taking your chances. Time to reconsider a lot of the judgments you make. You're destined to put yourself in dangerous situations and potentially hurt yourself and the people around you.

Environment

The environment you operate an ATV in is often harsh and sometimes dangerous if you don't take proper precautions.

Weather

You need to consider the weather. It is dangerous to ride your ATV when the weather is bad or potentially bad. Keep abreast with weather forecasts.

Terrain

Always pay close attention to the terrain you're on, even if it is familiar to you. You can't assume that the landscape you're used to doesn't change. Changes to landscape can happen at nearly any time. Fences can be constructed and excavations dug in a short period of time. Weather, climate, and development take their toll.

Sound Judgment

The thing about terrain is that sometimes you don't know it's changed until you get there. Whether it's familiar or not, check out your surroundings before and during your ride.

Night Riding

Riding at night can be very hazardous. Obstacles and other hazards (that are easily identified during daytime) are much more difficult to see and avoid. When night riding, make sure the lights are properly adjusted and in good working order. Reduce speed; do not over-drive the headlights. Never travel in an unfamiliar area or blaze a new trail at night. Always carry a flashlight or flare for signaling an emergency.

Paved Surfaces

Don't do it! The ATV isn't designed for pavement. Its handling becomes more difficult on paved surfaces.

Trail Riding

Use sound judgment when trail riding; that means riding on a trail that fits your ability level. If the trail is pretty rugged, standing up on your footrests will make it easier for you to endure the rough terrain.

Make yourself visible by using headlights and taillights, and pull completely off the trail if you need to stop.

Outsloped trails (trails that slant to allow rain to run off) make trail riding a bit more challenging. Accepting that challenge means keeping your weight shifted into the slope. Denying the challenge means sliding off the trail.

It also helps to know which trails you can ride and who else might be on those same trails. These are signs currently used in some areas to designate trail types and restrictions.

Trail Signs

SYMBOLS



TWO-WHEEL
MOTOR VEHICLE



SEDAN



HIGH
CLEARANCE
VEHICLE 4x4 &
PICKUP



ATV



SNOWMOBILE



OPEN ROUTE
Not always used
(refer to map).

Symbol with RED
SLASH indicates ac-
tivity not allowed.
Symbol with
YELLOW SLASH in-
dicates activity not
recommended.



TRAVEL MANAGEMENT POSTER



NATIONAL FOREST ROUTE MARKERS



Roads maintained
for LOW clearance
vehicles, such as
passenger cars,
motorhomes.



Roads maintained
for HIGH clearance
vehicles.

ATV-0068A

Those Around You

People do all kinds of things that you can't predict or control.

Riding Companions

Leave a lot of space between you and other riders, especially in dusty and dirty conditions, because it'll be difficult to see the riders in front of you stopping.

Riding with companions on several ATV's is not the same as riding one ATV with a passenger. Passengers are prohibited; it's unsafe. The extra weight on the seat makes the ATV difficult to control. About 50% of all ATV accidents involve passengers.

Sound Judgment

Other Vehicles

Depending on where you're riding, you might encounter other ATV's, bikes, or motor vehicles on public lands. Respect the presence of cars if you're crossing roads or riding in public areas and make yourself be seen. If you can't see other vehicles coming, that means you're invisible, too.

Hikers

With the renewed interest in hiking, camping, and other outdoor activities, people can show up in remote areas where you would never expect them. For their sake, keep your eyes open.

Animals and Nature

Respect the outdoors that you love. Don't use your ATV to chase animals or birds. Drive around young trees rather than over them. Keep clear of streams and ditches with standing water.

TESTIMONIAL	
DOCUMENT#:	N380310A1
CITY/STATE:	NEW CUMBERLAND, WV
SEX:	M
AGE:	18
BODY PART:	HEAD
DATE ACCIDENT:	7-30-93
DISPOSITION:	DOA
SYNOPSIS:	An 18 year old male died as the result of injuries which he sustained in an accident while driving a 4-wheel ATV on a gravel public road. The victim lost control of the ATV when he suddenly applied the brakes to avoid a dog crossing the road. During the accident, the ATV's brake lever penetrated the victim's brain through his right eye resulting in death. The victim was not wearing a helmet.

Tread Lightly and leave it as you found it.

Equipment

The last thing you expected was that your ATV would break down in the middle of the field... it's usually so reliable that sometimes you forget the ATV has its limits.

ATV Maintenance

You have to maintain your ATV. The General Maintenance section of this Operator's Manual tells you about taking care of your ATV. If, at any time, abnormal noises, vibrations, or improper functioning of any component of this ATV is detected, **DO NOT OPERATE THE ATV.** Take the ATV to an authorized Arctic Cat ATV dealer for inspection and adjustment or repair.

Cargo Limitations

One reason why passengers are prohibited on ATV's is because their presence throws off the weight and balance of the ATV. Cargo can do the same if it weighs too much. Limit the ATV to the load capacity ratings identified in the following chart for the particular model being operated. So if you're weighing in at over 215 lb (97 kg) when you ride, leave some of that extra cargo at home. The combined weight limit, including you, your rack cargo, and your trailer, is a specified amount, so consult the ATV Load Capacity Ratings Chart and monitor it carefully.

Extra weight on the ATV will also throw you off balance if it's not distributed evenly, side-to-side and front-to-rear. If you have 160 lb (73 kg) on the rear rack only and you're heading up an incline, shifting your own weight forward isn't going to do enough to compensate for that cargo sitting over the back tires.

Cargo has such a huge effect on ATV handling that you need to pay a lot of attention to your speed. Even on really level areas, you should keep it under 10 mph (16 kph) if you've got a trailer attached. Avoid uneven terrain. Also, consider that your braking distance is going to increase with the more weight you carry.

Think about these when dealing with cargo:

1. Rack weight limit
2. Trailer weight limit
3. Weight distribution
4. ATV speed

Sound Judgment

Load Capacity Ratings Chart

Arctic Cat ATV Load Capacity Ratings		
ITEM	Specifications	
	(lb)	(kg)
Max Load Capacity	515	233
Front Rack (Max)	100	45
Rear Rack (Max)	200	91
Tongue Weight	35	16
Rear Rack and Tongue Weight (Max)	200	91
Towing Capacity	1050	477

Max Load Capacity - Total weight of operator, accessories, tongue weight, and cargo on front and rear racks.

Tongue Weight - Weight on trailer tongue.

Rear Rack and Tongue Weight - Total weight on trailer tongue, Speedpoint, and rear rack.

Towing Capacity - Total weight of trailer and all cargo in the trailer.

■ **NOTE: Tongue and accessory weight (winch, snowplow, Speedpoint, gun scabbard brackets, etc.) must be included as part of the front and rear rack weights.**

Speedrack

When installing Speedrack accessories, read and carefully follow the instructions provided in each kit.

■ **NOTE: Use extra caution when operating an ATV with additional loads such as accessories and/or cargo. Handling of the ATV may be adversely affected. Reduce speed when adding additional loads.**

WARNING

POTENTIAL HAZARD

Overloading the ATV or carrying or towing cargo improperly.

WHAT CAN HAPPEN

Could cause changes in ATV handling, which could lead to an accident.

HOW TO AVOID THE HAZARD

Never exceed the stated load capacity for the ATV.

Cargo should be properly distributed and securely attached.

Reduce speed when carrying cargo or pulling a trailer. Allow greater distance for braking.

Always follow the instructions in this Operator's Manual for carrying cargo or pulling a trailer.

Personal Choices

A safe, enjoyable ride is dependent on many personal choices. An ATV, like all motorized vehicles, can be dangerous to operate if you choose to ignore safety precautions, take unnecessary chances, or ride beyond your ability or your vehicle's capability. Don't allow the thrill of freedom or adventure to affect your ability to make good, safe choices.

Alcohol and Drug Consumption

Alcohol is related to a high percentage of all hospital admissions due to ATV accidents in the U.S. This isn't an issue of morality. It's extremely dangerous to drink alcoholic beverages and ride... it's also very foolish. When the alcohol starts kicking in and you're tearing along on your ATV, those odds can catch up to you.

Sound Judgment

TESTIMONIAL

DOCUMENT#: X46481A1
 CITY/STATE: LAUREL, MS
 SEX: M
 AGE: 25
 BODY PART: ALL PARTS BODY
 DATE ACCIDENT: 6-25-93
 DISPOSITION: DOA
 SYNOPSIS: A 25 year old male died from drowning after the 4-wheeled ATV he was driving overturned and landed on the victim, pinning him face down in 6 inches of water in a drainage ditch. The victim had failed to make a right hand turn and drove off the side of the road. The victim was driving at an excessive speed, and under the influence of alcohol. He was pronounced dead at the scene. The victim was not wearing a helmet.

Substances to avoid when riding:

1. Alcohol
2. Over-the-counter or prescription drugs
3. Illegal/mood altering drugs

Alcohol - Effects*

The Number of Drinks that Impair Mental and Physical Abilities

1-2 DRINKS

Mental processes such as restraint, awareness, concentration, and judgment affected; reaction time slowed; inability to perform complicated tasks.

3-4 DRINKS

Depth perception, glare recovery, eye movement, and focus affected; decreased judgment and control.

5+ DRINKS

Coordination deteriorates, loss of critical judgment, and impaired memory and comprehension.

**According to the ATV Safety Institute.*

Be aware of prescription and over-the-counter medications. Drowsiness and impaired judgment can be caused by a wide variety of medications. The same is true of allergy, cold, flu, and headache medications. Your physical size and weight can't protect you... just one anti-histamine tablet can affect your judgment.

If your sense of adventure persuades you to do illegal drugs when you're riding your ATV, this is a reality check. Something to think about—there can be legal consequences that will take away all that freedom you love. Don't use alcohol or drugs before or during your ATV ride.

Your Physical Condition

Being physically exhausted is like being drunk. Try to do something that's detail-oriented when you're really tired, and you'll feel totally uncoordinated.

Don't ride:

1. When you're tired

Reckless Riding

If you are involved in an ATV accident when you're speeding, you have a 25% chance of landing yourself in the hospital. The faster you go, the more likely you are to destroy your head and internal organs, and skip the wheelies, jumps, stunts, and any other showboating.

Laws and Regulations

Any police officer will tell you that ignorance of the law is no defense. Your best defense is to check out your local, state, or provincial ATV laws before riding. It'll also make sure that you can continue to ride in your favorite areas. The quickest way to have a land area closed is by riding over the regulations.

Group Behavior

People occasionally do crazier and riskier things in a group than they would consider doing by themselves. When you're ATV riding with others and things start to get out of hand, decide whether you're willing to be injured or see your friends injured.

Sound Judgment

SIPDE

By themselves, none of these safe behaviors and sound judgments will go very far. But when you put them all together... when you're paying attention to how you feel, when you're monitoring the movements of your ATV, and when you're constantly evaluating your environment, then you're practicing SIPDE. SIPDE is an acronym that stands for:

S	I	P	D	E
SCAN/SEARCH	IDENTIFY HAZARDS	PREDICT WHAT WILL HAPPEN	DECIDE WHAT TO DO	EXECUTE THE DECISION

Supervision

Overview

You're responsible for supervising those who ride your ATV. Your wisdom is valuable... it'll bring them all back safely—your friends, your family, your relatives, and your ATV. It's crucial that you consider yourself a supervisor for all riders of your ATV. Whether you accept responsibility or not, the truth is that you are responsible for others riding your ATV.

Taking Responsibility

You're to the last letter in "P.A.S.S."... "Supervision." You've just gone through the manual, and you've seen what's involved. That puts you in a good position to be confident about what you know. So now it's time to use your knowledge and supervise others who ride your ATV.

Inexperienced/ Untrained Riders

You can't let people ride your ATV who don't know what they're doing. Unless they've had over a year of experience with ATV riding or taken an ATV training course, it's your responsibility to keep them off your ATV. It can be dangerous (especially for underage children)—all the more reason for you to be firm.

TESTIMONIAL

DOCUMENT#: N37023A1
CITY/STATE: MOERSFORKS, NY
SEX: F
AGE: 5
BODY PART: UPPER TRUNK
DATE ACCIDENT: 6-29-93
DISPOSITION: DOA
SYNOPSIS: The victim of this incident, a five year old female, was operating a four wheeled all terrain vehicle (ATV) in the front yard of her parents' house, under the supervision of her father. The victim drove the ATV down an area where the only way to turn around was around a grain silo. The victim was executing a right hand turn when the vehicle tipped over to the right and fell onto her body. The victim was transported to a local hospital where she was pronounced dead on arrival. Photographs of the incident were not taken by law enforcement officials.

Experienced/Trained Riders

If anyone is going to borrow your ATV, you are responsible for their supervision. Before they ride, have them take the training course, have them watch the safety video, and have them read the Operator's Manual. You train them. It doesn't matter how you do it, as long as you do it.

ATV's are all a little different from the handling to the stability to the controls. So regardless of how much experience your family members have with ATV's, they don't have experience with *your* ATV. Let experienced riders get familiar with your ATV—show them the basics before they take off. You don't want it on your conscience that someone got hurt because you didn't tell them how to use your ATV.

Remember that regardless of experience, you should never let anyone under the age of 16 operate your ATV.

Arctic Cat and the ATV Safety Institute recommend that all ATV operators ride the appropriate-sized ATV according to age.

Category	Age (Years)	Speed Limitations (MPH)	NOTES
Y-12+	12 or Older	15 - Limited 30 - Maximum	Operate Under Adult Supervision
T-14	14 or Older	20 - Limited 30 - Limited 38 - Maximum	Operate Under Adult Supervision
G & S	16 or Older	According to Local Regulations	—

DIVISION II - OPERATION/MAINTENANCE

ATV Specifications

ENGINE	
Type	Four-Cycle/Liquid Cooled
Bore x Stroke	98 mm x 85 mm (3.85 x 3.35 in.)
Displacement	641 cc (39 cu in.)
Spark Plug Type	NGK CPR8
Spark Plug Gap	0.5-0.6 mm (0.019-0.024 in.)
Carburetor Type	Keihin CVK36
Brake Type	Hydraulic w/Brake Lever Lock and Rear Foot Brake
CHASSIS	
Length (Overall)	215 cm (84.75 in.) 219.71 cm (86.5 in.) - Mud Pro
Height (Overall)	125 cm (49.3 in.) 131.45 cm (51.75 in.) - Mud Pro
Width (Overall)	120.7 cm (47.5 in.)
Suspension Travel (Front/Rear)	25.4 cm (10 in.)
Tire Size (Front)	25 x 8-12 28 x 9-14 - Mud Pro
Tire Size (Rear)	25 x 10-12 28 x 11-14 - Mud Pro
Tire Inflation Pressure	0.35 kg/cm ² (5.0 psi)
MISCELLANY	
Dry Weight (Approx)	306 kg (674 lb) 360 kg (793 lb) - Mud Pro
Gas Tank Capacity	21.6 L (5.7 U.S. gal.)
Coolant Capacity	2.9 L (3.0 U.S. qt)
Differential Capacity	275 ml (9.3 fl oz)
Rear Drive Capacity	250 ml (8.5 fl oz)
Engine Oil Capacity (Approx.)	1.9 L (2.0 U.S. qt)
Gasoline (Recommended)	87 Octane Regular Unleaded
Engine Oil (Recommended)	Arctic Cat ACX All Weather (Synthetic)
Front Differential/Rear Drive Lubricant	SAE Approved 80W-90 Hypoid
Taillight/Brakelight	12V/8W/27W
Headlight	12V/27W (4)
Starting System	Electric

Specifications subject to change without notice.

Location of Parts and Controls



FI025C



FI016H

- | | |
|--|--|
| <ul style="list-style-type: none"> 1. Battery 2. Headlights 3. Hand Brake Lever 4. Power Distribution Module 5. Radiator Access Panel 6. Seat Latch 7. Storage Compartment 8. Reverse Override Switch 9. Rear Foot Brake 10. Brake Lever Lock 11. Key Switch 12. Shift Lever | <ul style="list-style-type: none"> 13. Throttle Limiter 14. Throttle Lever 15. DC Power Outlet 16. Taillight/Brakelight 17. Operator's Manual Location 18. Headlight HI/LO Switch 19. Starter Button 20. Engine Stop Switch 21. Drive Select Switch |
|--|--|

NOTE: The ATV you have purchased may differ slightly from those shown in the figures of this manual.

ATV Operation

Basic Operating Maneuvers

Active riding and basic maneuvers are the foundation of your ATV ride. Without basic skills, it's impossible to move to this level— active riding. These are your basic maneuvers:

- Mounting the ATV
- Starting the Engine
- Starting a Cold Engine
- Shifting
- Braking/Stopping
- Parking
- Dismounting the ATV

Mounting the ATV

To get seated:

1. From the left side, grab the left-side handlebar, apply the brake, and put your left foot on the footrest.
2. Grab the right-side handlebar.
3. Swing your leg over the seat and set your right foot down on the right-side footrest.
4. Get seated in a comfortable position.
5. Always keep your feet planted on the footrests.

B	O	N	E	C
BRAKES LOCKED	IGNITION SWITCH ON	NEUTRAL TRANSMISSION	ENGINE SWITCH	AUTOMATIC CHOKE

Starting a Cold Engine

■ **NOTE:** It is very important not to touch or compress the throttle lever during the starting procedures.

1. Turn off all electrical accessories (hand warmer, lights, etc.); then rotate the ignition switch key to the first position (ON) leaving the headlights OFF. Note that the N is indicated on the LCD.

■ **NOTE:** Pump the primer three times when the temperature is at 0° C (32° F) or colder. To access the primer, the seat and right-side heat shield must be removed.

Starting the Engine

Always start with the ATV on a flat, level surface. Carbon monoxide poisoning can kill you, so keep your ATV outside while it's running. Follow these steps to start it up:

1. Mount the ATV and sit down.
2. Engage the brake lever lock.
3. Turn on the ignition.
4. Shift into neutral.
5. Move the engine stop switch to RUN.
6. Press the starter button.

CAUTION

Do not run the starter motor for more than eight seconds per starting attempt. The starter motor may over-heat causing severe starter motor damage. Allow 15 seconds between starting attempts to allow the starter motor to cool.

7. Let the engine warm up.

Another way to remember the starting procedure is by using the acronym "BONE-C." It stands for:

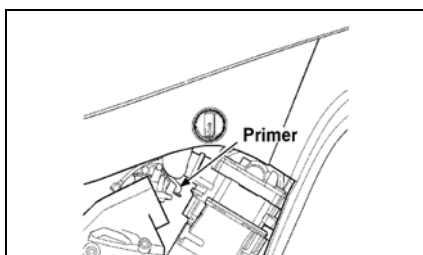

735-887C

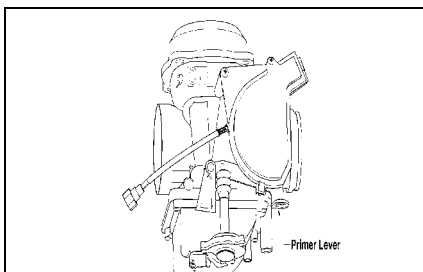

738-436A

2. Press on the starter button.

CAUTION

Do not run the starter motor for more than eight seconds per starting attempt. The starter motor may overheat causing severe starter motor damage. Allow 15 seconds between starting attempts to allow the starter motor to cool.

3. If the engine does not start, press the starter button again for eight seconds.

■ **NOTE:** At this point if the engine does not start, pump the primer three more times; then press the starter button again.

4. Allow the engine to warm up for approximately 2-3 minutes or until the ATV will accelerate without hesitating.

Shifting

The Arctic Cat ATV with an automatic transmission has a dual-range transmission with reverse. To shift the ATV, follow these steps:

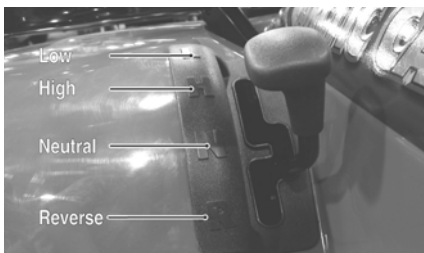

CF130B

1. To engage the high range from neutral, move the shift lever forward.

2. To engage the low range from high range, move the shift lever outward and forward.

■ **NOTE:** The high range is for normal riding with light loads. The low range is for carrying heavy loads or trailer towing. Compared to HIGH range, the LOW range position provides slower speed and greater torque to the wheels.

CAUTION

Always shift into low range when operating on wet or uneven terrain, when towing or pushing heavy loads, and when using a plow. Failure to follow this caution may result in premature V-belt failure or in damage to related drive system components.

3. To engage reverse gear from neutral, move the shift lever outward and rearward into the R position.

CAUTION

Always come to a complete stop before attempting to shift from one range to the other or into reverse. Always shift on level ground, or engage the brake lever lock before shifting into another range or into reverse.

WARNING

Do not start the engine or operate this ATV with the clutch shield removed. Severe injury could result.

Braking/Stopping

Always allow plenty of room and time to stop safely. Sometimes quick stops are inevitable, so always be prepared. Whether you're stopping slowly or stopping quickly, do this:

1. Squeeze the brake lever on the left handlebar to apply both the front and rear brakes.
2. If your wheels lock, release them for a second; then apply them again.

- Never “ride” the brake. Even maintaining minimal pressure on the brake lever will cause the brake pads to drag on the disc and may overheat the brake fluid.

WARNING

Excessive repetitive use of the hydraulic brake for high speed stops will cause overheating of the brake fluid and premature brake pad wear which will result in an unexpected loss of brakes.

WARNING

Use only Arctic Cat approved brake fluid. Never substitute or mix different types or grades of brake fluid. Brake loss can result. Check brake fluid level and pad wear before each use. Brake loss can result in severe injury or even death.

Parking

Parking involves following the previous rules for braking; then:

- After the ATV stops, shift into neutral.
- Stop the engine using the engine stop switch.
- Turn off the ignition.
- If you have to park on a hill, shift the ATV into low gear; otherwise, try to park only on level surfaces.
- Engage the brake lever lock.

Dismounting the ATV

After you’ve followed the procedure for parking, it’s time to dismount:

- Double check that the brake lever lock is engaged.
- Swing your right leg over to the left side of the seat.
- Step to the ground on the left side of the ATV.

Handling the ATV (Active Riding Techniques)

Active riding involves moving your body. You must learn to lean and shift your weight into your turns to maintain control.

Your safety depends on using safe riding techniques. Statistics from the U.S. Consumer Product Safety Commission (CPSC) say that inexperienced riders who don’t use safe riding techniques are **13 times more likely to have an ATV accident** than riders who have over 1 month of experience.

Safe riding techniques include:

- Riding
- Leaning, Weight Shift, and Balance
- Wide Turns
- Sharp Turns
- Quick Turns
- K-Turns
- Riding Uphill
- Riding Downhill
- Sidehilling/Traversing
- Swerving
- Crossing Obstacles

Riding

Once the engine’s warm, the ATV is ready to go.

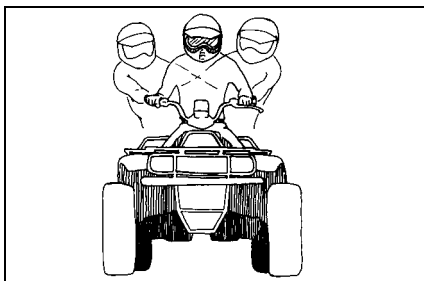

ATV-0012

- Keep your feet on the footrests and both hands on the handlebar.
- Hold the brake lever, and release the brake lever lock.
- Shift into gear.
- Release the brake slowly and apply the throttle.

Leaning, Weight Shift, and Balance

When you turn, the trick is to move forward and slide over to the side of the seat that's on the inside of the turn. Support your body weight on the outside footrest. At the same time, lean your body to the inside of the turn. Pay attention to the handling—if you feel the tires coming off the ground, reduce speed, shift more of your body weight to the side that's lifting, and make the turn wider if possible.

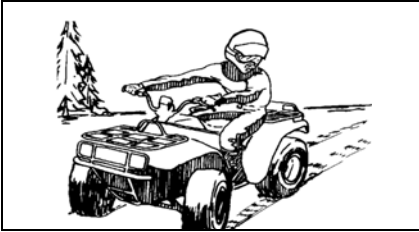

ATV-0013

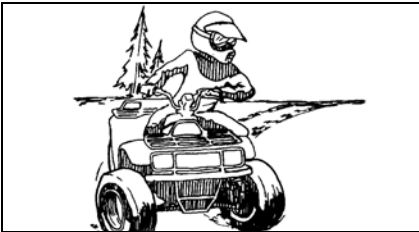

ATV-0024



ATV-0025

Wide Turns

About 20% of ATV accidents happen during turns. If you don't understand turning techniques, it's easy for the ATV to get away from you by losing traction, plowing, or tipping. Use this method for wide turns:

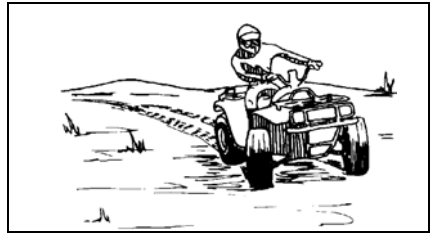

ATV-0046

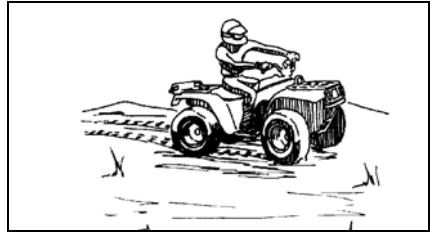

ATV-0045

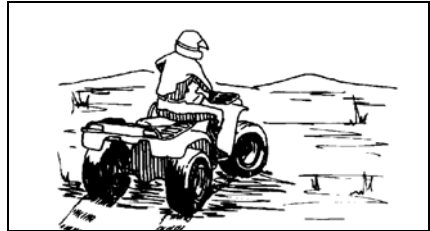

ATV-0044

1. Ease off the throttle as you approach the turn to slow down.
2. Use the principles of leaning, weight shifting, and balancing—shift your body weight to the inside of the turn.
3. Gradually increase your speed as you come out of the turn.

Sharp Turns

After mastering wide turns, practice the advanced skill of sharp turns.

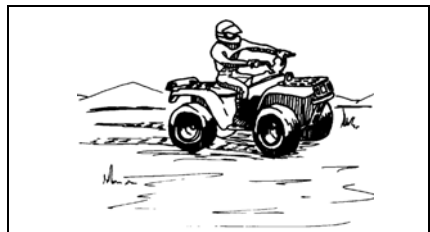

ATV-0038

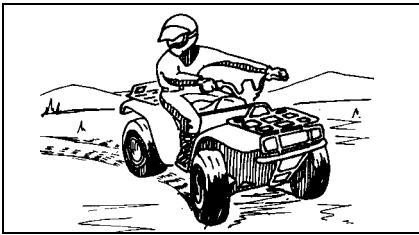

ATV-0039

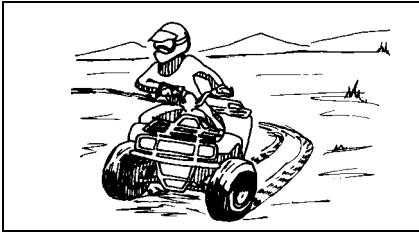

ATV-0040

1. Ease off the throttle as you approach the turn to slow down.
2. Use the principles of leaning, weight shifting, and balancing—shift your body weight to the inside of the turn.
3. You might have to lean into the turn more than you do in a wide turn.
4. If shifting your weight and balance aren't enough to keep the ATV tires on the ground, straighten out the handlebar as much as you can.
5. Gradually increase your speed as you come out of the turn.

Quick Turns

Quick turns are the most difficult turns and should only be done after you are experienced with your ATV.

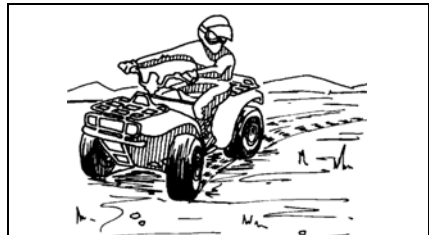

ATV-203

1. Ease off the throttle as you approach the turn to slow down.
2. Turn the handlebar, shift your weight, and balance at the same time as you enter the turn (use the principles of leaning, weight shifting, and balancing—shift your body weight to the inside of the turn).
3. Follow this with slight acceleration.
4. For multiple turns, repeat this movement as needed.
5. To make your turn quicker, try raising yourself off the seat a few inches as you shift your weight.

K-Turns

Use K-turns if you accidentally stall while riding uphill; you need to take action before the ATV rolls backward down the hill.

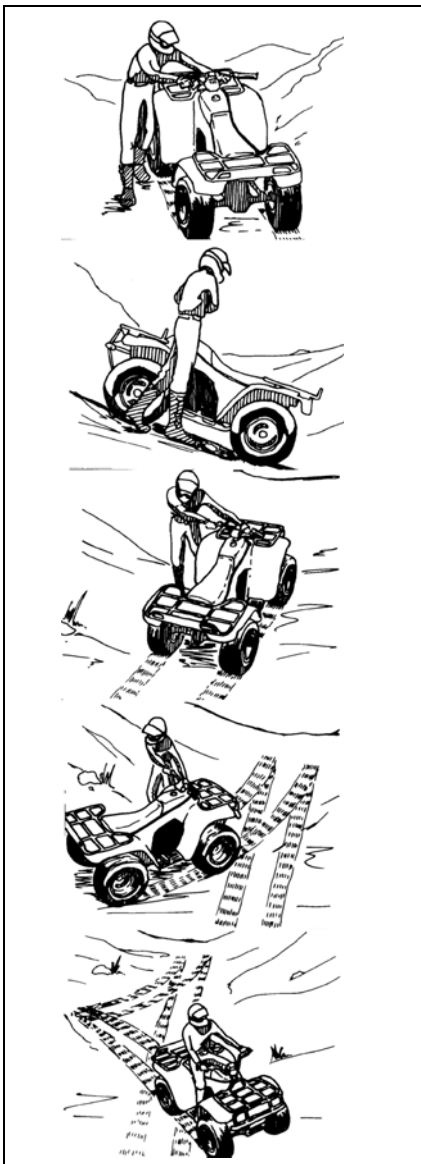

ATV-204

1. Stop where you are, apply the brakes, and shift to neutral.
2. Shut off the engine.
3. Keep your body weight shifted forward.
4. Get off the ATV on the uphill side.

5. If you're to the left of the ATV, turn the handlebar all the way left.
6. Partially release the brake, but lightly hold the brake lever.
7. Let the ATV roll to your right side until it faces slightly downhill.
8. Reapply the brakes.
9. Get back on the ATV from the uphill side, and keep your weight shifted uphill when you sit down.
10. Start the engine and follow the method for riding downhill.

Riding Uphill

Roughly 20% of accidents happen while riding on hills and as a result of the ATV rolling or flipping. So, obviously, use extreme caution and follow this method for riding uphill.

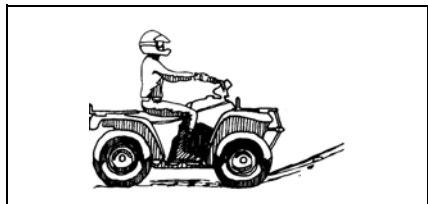

ATV-0019

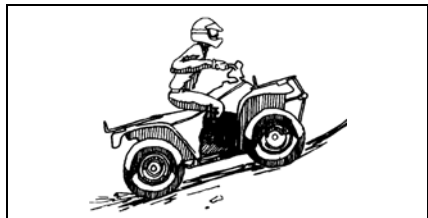

ATV-0032

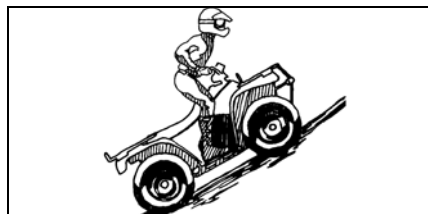

ATV-0033

1. Shift down and accelerate before you start climbing; then maintain a steady pace.

2. Lean as far forward as possible. For steeper hills, come off your seat to stand and lean forward.
3. If you lose speed, quickly shift to a lower gear. At the same time, release the throttle (so your front tires don't lift), **OR**
4. If that doesn't work and you still have forward motion and the terrain permits, do a U-turn, go back down, and try climbing again, **OR**
5. If you have lost all forward motion, follow the K-turn procedure.

NEVER OPERATE UP OR DOWN HILLS STEEPER THAN 25°

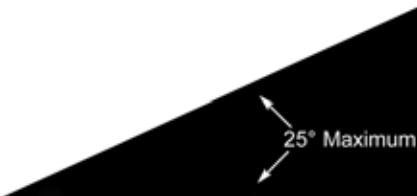

Riding Downhill

Success in riding downhill depends on how well you know your brakes—take it easy on them, or you could flip over.

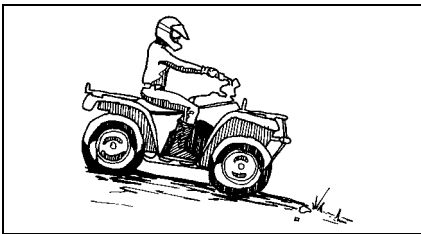

ATV-0018

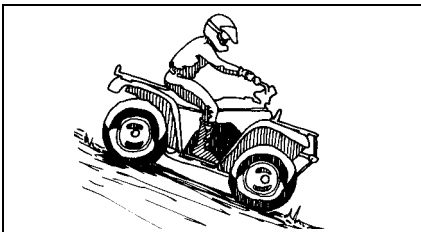

ATV-0030

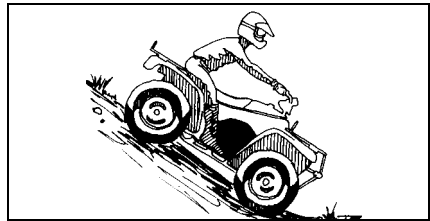

ATV-0031

1. Shift your body weight as far back on the seat as possible.
2. Keep it in a low gear; stay out of neutral.
3. Lightly apply the brake and ease up on the throttle.

Sidehilling/Traversing

Sidehilling is considered an advanced skill; it's really tricky and unpredictable. So, whether your skills are advanced or not, try to avoid this kind of riding. If you're in a situation where you absolutely have to sidehill, follow this method:



ATV-0017

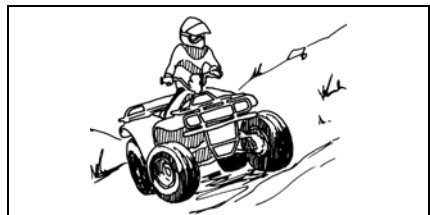

ATV-0028

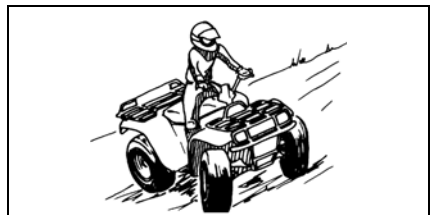

ATV-0029

1. Keep your speed low and consistent.
2. Shift all your body weight to the uphill side of the seat; also, support your weight on the uphill footrest.
3. Steer like you're driving into the hill.
4. If the ATV feels like it's tipping, turn the handlebar downhill. If that's not possible because of the terrain or other conditions or if it just doesn't work, stop and get off. Dismount the ATV on the uphill side.

Swerving

Swerving is usually an emergency reaction to avoid an obstacle but is similar to quick turns. The difference is that quick turns involve slight acceleration in the turn; don't accelerate if you swerve.



ATV-0043

1. Ease off the throttle as you approach the obstacle.
2. Turn the handlebar. At the same time, shift your weight and balance as you swerve. Use the principles of leaning, weight shifting, and balancing—shift your body weight to the inside of the turn.

3. Keep your hand off the brake until the emergency is over and you're back in control.

Crossing Obstacles

Crossing obstacles is risky; avoid it if possible. Riding over logs, rocks, and ruts means combining all the active riding skills into one big motion. Your ATV will respond differently for different obstacles (logs, ruts, etc.), but these are general guidelines for overcoming two-track (both tires contacting the obstacle at the same time) obstacles:

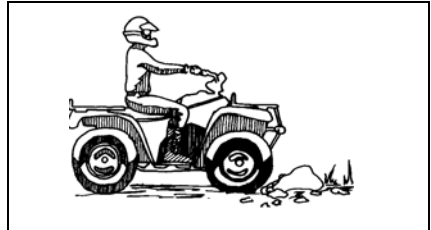

ATV-0016

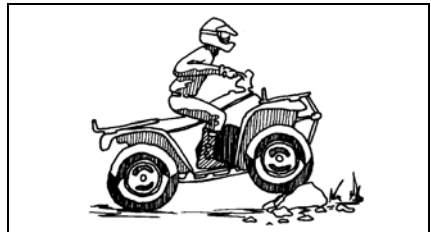

ATV-0026

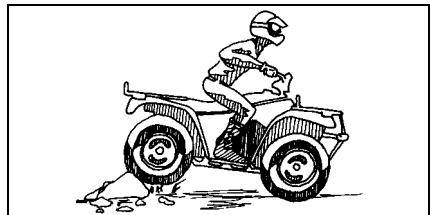

ATV-0027

1. Keep your speed way down; less than 5 mph.
2. Approach the obstacle head-on.
3. Come up off the seat.
4. Keep your weight on the footrests.
5. Apply a little throttle when the front tires make contact with the obstacle.

- Lean forward and release the throttle when the front tires clear the obstacle.
- Keep your body loose to absorb any shock.
- If the ATV starts tipping, shift your weight to keep it in balance.

To clear a single-track (only one tire contacts) obstacle, follow the same rules except:

- Use the ATV's momentum to clear the obstacle.
- Don't pull up on the handlebar.
- Don't apply the throttle.

Tips

Driving an ATV and a car have some similarities; however, there are a few situations that require special attention:

- Reversing
- Skidding or Sliding
- Parking on a Hill
- Stalling on a Hill
- Crossing Water
- Crossing Roads
- Cold Weather Driving
- Stopping the ATV
- Stopping the Engine

Reversing

It's tough to see things behind you.

- Go slowly. It's hard to see behind you.
- Keep your handlebar straight.
- Backing down hills is a bad idea; do a U-turn or K-turn instead to turn around.

Skidding or Sliding

If you lose control after hitting sand, ice, mud, or water:

- Turn your handlebar into the direction of the slide.
- Keep your hand off the brakes until you're out of the skid.
- Shift your weight forward.

Sometimes your ATV may not respond and goes straight ahead instead of letting you turn. Here's how to handle it:

- Slow down.
- Move forward on the seat.
- Lean to inside of turn.
- Turn handlebar.

Parking on a Hill

This shouldn't be necessary, but if it is:

- Keep it in gear.
- Engage the brake lever lock.
- Find something to block the rear tires.

Stalling on a Hill

If you use the right method for riding uphill, this shouldn't happen. But if you have a problem, do this:

- If the ATV hasn't started rolling backwards yet, follow the procedure for the K-Turn, **OR**
- If the ATV is already rolling backward, lean as far forward as possible standing up on the footrests.
- Nice and easy, apply the hand brake lever.
- When you come to a stop, follow the procedure for the K-turn.
- If the ATV continues to roll backward, dismount immediately on the uphill side.

Crossing Water

Your ATV can only handle water up to its footrests. Any more than that and you risk engine damage and/or personal injury. Stay away from fast moving rivers. ATV tires can be buoyant, so if the water is too deep, you might find the ATV suddenly afloat.

- Physically check the depth and current of the water, especially if you can't see the bottom. You're also checking for boulders, logs, or any other hidden obstacles.
- Keep your speed slow.

3. Make sure you have a way out on the other side of the water.
4. If you get stuck in the sludge or mud, try rocking the ATV from side to side.
5. Once you've cleared the water, briefly apply the brakes to make sure they work.
2. If the tires are frozen to the ground, pour warm water around them to melt the ice.

CAUTION

Before riding, manually move the ATV forward and backward to make certain that all wheels roll freely.

Crossing Roads

Crossing roads on your ATV is also a bad idea, so avoid it. If you can't:

1. Stop completely on the shoulder of the road.
2. Check both directions for traffic.
3. Crossing near a blind corner or intersection is dangerous; don't do it.
4. Drive straight across to the opposite shoulder.
5. Take into account that your ATV could stall while crossing; give yourself enough time to get off the road.
6. You have to assume that oncoming cars don't see you, and if they do, they won't be able to predict your actions.
7. It's illegal to cross public roads in some places. Know your local laws.

Cold Weather Driving

■ **NOTE:** Check that all control levers move freely. Make sure the footrest, shift lever, and rear foot brake are free of ice and snow.

WARNING

For your personal safety, it is very important to wear the type and amount of cold-weather clothing according to the coldest anticipated temperatures.

1. With the transmission in neutral, move the ATV forward and backward to check that the wheels roll freely. If the ATV will not roll, the tires may be frozen to the ground or the brake pads may be frozen to the discs.

WARNING

Do not attempt to free frozen brakes by pouring warm water on the brake pads and housings.

■ **NOTE:** After the brakes thaw, dry them by applying them several times while riding slowly.

■ **NOTE:** After riding through water, mud, snow, or slush, it is important to dry both brake systems before parking the ATV.

WARNING

Go slowly and be extra careful when riding on snow-covered or ice-covered terrain. Always be alert to changing terrain conditions when operating the ATV.

4. Practice driving in an open snow-covered or ice-covered area at slow speeds before driving on snow-covered or ice-covered trails.
5. Learn how the ATV responds to steering and braking on the type of terrain to be encountered on the ride.

Stopping The ATV

To stop the ATV, first release the throttle lever. Next, apply the brake.

Stopping The Engine

To stop the engine, turn the ignition switch key to the OFF position or set the engine stop switch to the OFF position.

General Information

ATV Identification Numbers

The Arctic Cat ATV has two identification numbers: Vehicle Identification Number (VIN) and Engine Serial Number (ESN).

The VIN is located on the frame support rail.

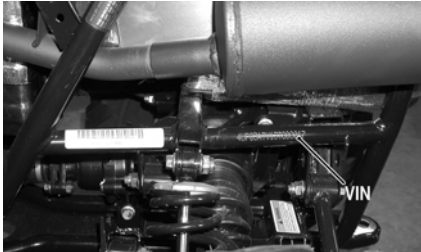

AF968B

The ESN is located on the left-side rear of the engine crankcase.



CF109I

These numbers are required by the dealer to complete warranty claims properly. No warranty will be allowed by Arctic Cat if the VIN or ESN is removed or mutilated in any way.

Always provide the ATV name, Vehicle Identification Number, and Engine Serial Number when contacting an authorized Arctic Cat ATV dealer for parts, service, accessories, or warranty. If a complete engine must be replaced, ask the dealer to notify Arctic Cat for correct registration information.

Ignition Switch Key

Two keys come with the ATV. Keep the spare key in a safe place. An identifying number is stamped on each key. Use this number when ordering a replacement key.



ATV-0055

Control Locations and Functions

Ignition Switch

The ignition switch has three positions.

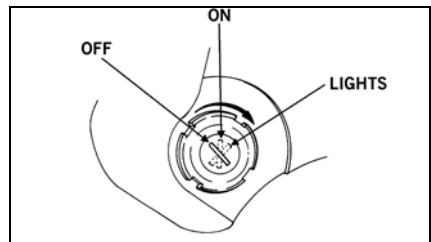

ATV-0056

OFF position — All electrical circuits except the accessory plug are off. The engine will not start. The key can be removed in this position.

■ **NOTE: The accessory plug is powered by the battery at all times.**

ON position — The ignition circuit is complete and the engine can run. The key cannot be removed in this position.

LIGHTS position — The ignition circuit is complete and the headlights and tail-light are on. The key cannot be removed in this position.

CAUTION

Leaving the ignition switch in the ON or LIGHTS position for a long period of time when the engine is not running may cause the battery to discharge. Always leave the ignition switch in the OFF position when engine is not running.

Shift Lever

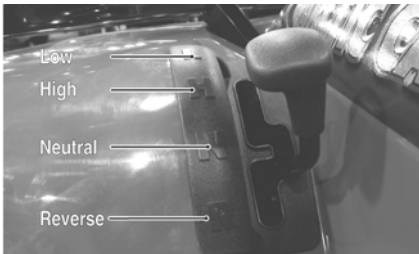

CF130B

These ATV's have a dual-range automatic transmission with reverse. To shift the ATV, follow these steps:

1. To engage the high range from neutral, move the shift lever forward.
2. To engage the low range from high range, move the shift lever outward and forward.

■ **NOTE:** The high range is for normal riding with light loads. The low range is for carrying heavy loads or trailer towing. Compared to HIGH range, the LOW range position provides slower speed and greater torque to the wheels.

CAUTION

Always shift into low range when operating on wet or uneven terrain, when towing or pushing heavy loads, and when using a plow. Failure to follow this caution may result in premature V-belt failure or in damage to related drive system components.

3. To engage reverse gear from neutral, move the shift lever outward and rearward into the R position.

CAUTION

Always come to a complete stop before attempting to shift from one range to the other or into reverse. Always shift on level ground, or engage the brake lever lock before shifting into another range or into reverse.

Drive Select Switch

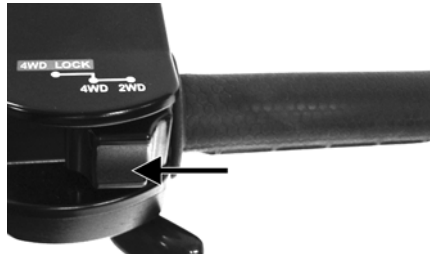

FI475A

This switch allows the operator to operate the ATV in either two-wheel drive (rear wheels) or four-wheel drive (all wheels). For normal riding on flat, dry, hard surfaces, two-wheel drive should be sufficient. In situations of aggressive trail conditions, four-wheel drive would be the desired choice.

To either engage or disengage the front wheels, move the switch to the 4WD position or to the 2WD position.

CAUTION

Do not attempt to either engage or disengage the 4WD lock while the ATV is moving.

The 4WD lock allows the operator to mechanically lock the front differential to apply equal power to both front wheels. To engage the lock from 4WD, slide the switch up and move fully to the left. To disengage the lock, move the switch lever to the right.

WARNING

The 4WD lock is intended for use where minimum traction is available. **NEVER EXCEED 10 MPH (16 kph) with the lock engaged.** Maneuverability and handling characteristics will differ with the lock engaged.

Hand Brake Lever/Brake Lever Lock

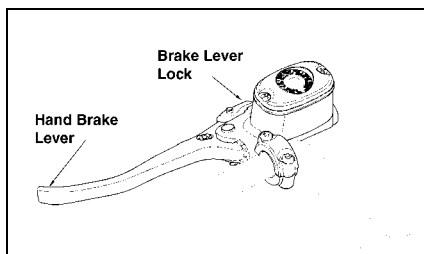

738-420B

The hand brake is considered to be the normal operating (main) brake. It should be applied whenever a braking situation is needed.

Apply the brake by compressing the brake lever toward the handlebar.

To engage and release the brake lever lock, use the following procedure.

1. Squeeze the hand brake two or three times and release it.
2. Depress and hold the brake lever lock.
3. While holding in on the brake lever lock, squeeze the brake lever.

■ **NOTE: It will click as it engages and the brake lever will not return to its released position.**

4. Release the brake lever lock by squeezing the brake lever. It will return to its released position.

Check to make sure the brake lever lock engages properly and that the brake (when engaged) locks the wheels.

1. Pump the brake lever 2 or 3 times.
2. Engage the brake lever lock.
3. Attempt to push the ATV.

■ **NOTE: The brake lever lock must lock the wheels. If it doesn't, take the ATV to an authorized Arctic Cat ATV dealer for service.**

⚠ WARNING

Always check to be sure that the brake lever lock has been disengaged before operating the ATV. An accident could result if the brake lever lock is left engaged while the ATV is operated. The brake may relax if left engaged for a long period of time. This could cause an accident; therefore, do not leave the ATV on a hill depending on the brake lever lock. Always block the downhill side of the wheels if leaving the ATV on a hill or park the ATV in a sidehill position.

Headlight HI/LO Switch

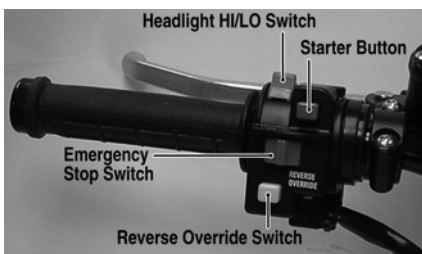

CF245A

Use the headlight HI/LO switch to select the high or low headlight beam when the ignition switch is in the LIGHTS position. When the switch is in the HI position, the high beam will illuminate. When the switch is in the LO position, the low beam will illuminate.

Engine Stop Switch

OFF position — The ignition circuit is off. The engine cannot be started or will not run. If the engine stop switch is used to stop engine without turning off ignition switch, the battery may discharge.

RUN position — The ignition circuit is on. The engine can start and run.

Starter Button

Pushing in on this button activates the starter motor. Before starting the engine, make sure the ignition switch is in the ON position, the transmission is in neutral, and the brake lever lock is engaged.

■ **NOTE:** This ATV has safety interlock switches which prevent the starter motor from activating when the transmission is not in neutral. To start the ATV while in gear, depress the rear foot brake or compress the brake lever; then depress the starter button.

Reverse Override Switch

This ATV is equipped with a reverse speed limiter system. When additional RPM is needed in reverse, depress and hold the override switch.

■ **NOTE:** The reverse override switch is active in 4WD only.

WARNING

Never activate the override switch while the throttle is open as a loss of control may result.

Throttle Lever



FI475B

Control engine RPM with the position of the throttle lever. Operate this lever with the thumb. Pushing it forward increases engine RPM and allowing it to retract decreases engine RPM.

Throttle Limiter Screw

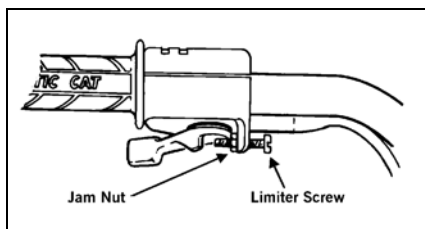

ATV-0053

Throttle lever travel may be limited by adjusting the throttle limiter screw. The throttle limiter should be adjusted according to the operator's skill and experience. To adjust the throttle limiter, use the following procedure.

1. Loosen the jam nut.
2. Turn the throttle limiter screw clockwise to decrease engine RPM maximum or counterclockwise to increase engine RPM maximum.
3. Tighten the jam nut securely.

■ **NOTE:** The ATV is equipped with an RPM limiter that retards ignition timing when maximum RPM is approached. When the RPM limiter is activated, it could be misinterpreted as a high-speed misfire.

Rear Foot Brake



CF117

Pressing the rear foot brake downward will apply the brake to the rear wheels.

Speedometer/LCD (Digital)

■ **NOTE:** All segments of the LCD will activate for approximately two seconds when the ignition switch is rotated to the ON position.

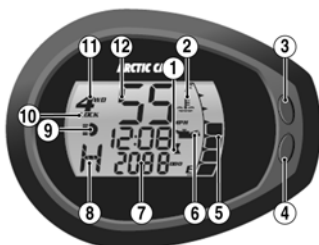

CF236A

1. Clock/Engine Hour Meter - The clock function indicates time in the 12-hour mode; the hour meter indicates the total time the ATV has run and cannot be reset to zero. To set the clock, use the following procedure.

A. With the ignition switch ON, press and release the Mode Button (3) until the Clock/Engine Hour Meter (1) is displayed; then (if necessary) press and release the Set/Reset Button (4) to select the clock display.

B. Press and hold the Set/Reset Button (4) until the minutes stop scrolling and the hour display starts to scroll. Momentarily release when the correct hour is displayed; then repeatedly press and release the Set/Reset Button (4) until the correct minutes are displayed.

■ **NOTE:** Clock memory power is supplied through the 15-amp accessory fuse and verified during gauge “power-up” and reset. In the event of clock memory power failure (blown fuse, etc.), the gauge will “power-up,” reset, and shut down repeatedly until clock memory power is restored. Always check the 15-amp accessory fuse if this gauge condition is noted.

■ **NOTE:** The engine hour meter will not activate until engine speed exceeds 500 RPM.

2. Temperature Indicator - If the engine coolant temperature exceeds the normal operating range, the temperature icon will begin flashing and the LCD will go blank for 30 seconds; then the LCD will return to normal. However, the temperature icon will continue to flash.

CAUTION

Continued operation with high engine temperature may result in engine damage or premature wear.

■ **NOTE:** High engine RPM, low vehicle speed, or heavy load can raise engine temperature. Decreasing engine RPM, reducing load, and selecting an appropriate transmission gear can lower the temperature.

■ **NOTE:** Debris in front of the engine (or packed between the cooling fins of the radiator) can reduce cooling capacity. Using a garden hose, wash the radiator and the engine to remove any debris restricting air flow.

CAUTION

Arctic Cat does not recommend using a pressure washer to clean the radiator core. The pressure may bend or flatten the fins causing restricted air flow, and electrical components on the radiator could be damaged. Use only a garden hose with spray nozzle at normal tap pressure.

3. Mode Button - Shifts the gauge through three set-up modes: speedometer/tachometer, distance, and time.

■ **NOTE:** The Mode Button must be pressed and released to shift modes. Approximately two seconds after the Mode Button is released, the digital gauge will return to full display.

4. Set/Reset Button - In conjunction with the Mode Button, sets and resets various displays on the digital gauge. Also used to shift from speedometer function to tachometer function on the speedometer/tachometer gauge.

5. Fuel Level Indicator - Indicates approximate amount of gasoline in the gas tank.

■ **NOTE:** When the bottom segment flashes, approximately 3.5 L (0.92 U.S. gal.) of gasoline remains in the tank.

6. Low Oil Pressure - Will be displayed during self-test at start-up. It will not be displayed during normal operation as oil pressure is not monitored on these models.

7. Odometer/Trip Meter - Odometer registers the total distance the vehicle has traveled. The trip meter is resetable and can be used to measure trip or trip legs. The odometer cannot be reset.

■ **NOTE: To shift between the odometer (ODO) or trip meter (TRIP), press the Mode Button (3) to select the distance mode; then press the Set/Reset Button (4) to select the desired display. Hold the Set/Reset Button down to reset the trip meter.**

8. Gear Position Indicator - Indicates which gear position is selected.

- R (reverse)/N (neutral)/L (low range)/H (high range)

■ **NOTE: An E will be displayed if there is an error caused by a no-shift position signal.**

9. High Beam Indicator - The High Beam icon will appear only when the headlights are on high beam.
10. 4WD Lock Indicator - Displays LOCK when the front differential lock has been engaged.
11. Drive Select Indicator - Displays 4WD when selected by the drive select switch or when the 4WD lock is engaged. The display is blank when in 2WD.
12. Speedometer - Indicates the approximate vehicle speed in miles per hour (MPH) or kilometers per hour (km/h).

■ **NOTE: To change mph/km/h display, press and release Mode Button (3) until the icon (MPH/km/h) appears; then press the Set Button (4) to change the display.**

Condition Warning Display - Uses odometer/trip meter display of the LCD to warn of a system error condition requiring attention. The LCD will go blank except the word VOLT will flash on the LCD whenever a low voltage (< 9 DC volts) or a high voltage (> 16 DC volts) is detected. When voltage returns to normal, the gauge must be reset by turning the ignition key to the OFF position and then to the ON position.

Vacuum Fuel Pump

A vacuum fuel pump is mounted under the seat to deliver gasoline to the carburetor. The fuel pump operates when the engine is turning.

Primer - Cold Start

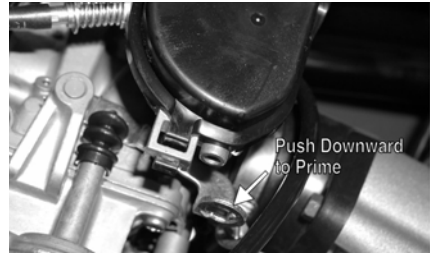

CF123A

The primer is located on the carburetor. Depress and release the lever several times prior to attempting to start a cold engine.

Gas/Vent Hoses

Replace the gas/vent hoses every two years. Damage from aging may not always be visible. Do not bend or obstruct the routing of the carburetor vent hose. Make certain that the vent hose is securely connected to the carburetor and hose holder and the opposite end is always open.

Carburetor Float Bowl Drain

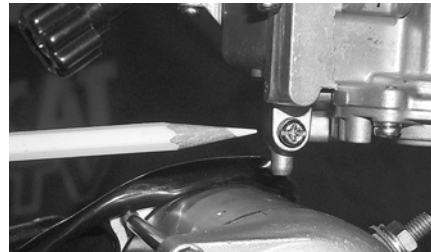

AF925

Periodically, the float bowl should be drained to remove condensation. To drain the float bowl, use the following procedure.

1. Direct the float bowl drain hose into a container.

⚠ WARNING

Do not drain float bowl contents directly onto the engine. Gasoline is highly flammable and could ignite. Use a hose.

2. Loosen the drain screw and allow the gasoline and condensation to flow out.
3. Tighten the drain screw securely.

⚠ WARNING

It is very important that the drain screw be tightened securely. If it is not tightened securely, gasoline could drip onto the engine.

Oil Level Stick

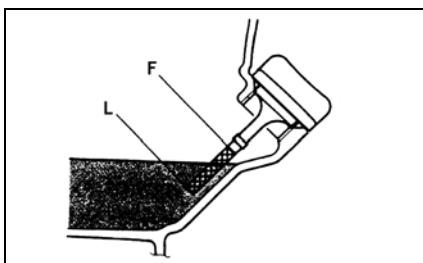

ATV-0100AA

There is an oil level stick for checking the engine oil level. To check the oil level, use the following procedure.

■ **NOTE:** The ATV should be on level ground when checking the engine oil level.

1. Unscrew the oil level stick and wipe it with a clean cloth.
2. Install the oil level stick and thread into the engine case.

■ **NOTE:** The oil level stick should be threaded in for checking purposes.

3. Remove the oil level stick; the engine oil level should be above the “L” mark but not higher than the “F” mark.

CAUTION

Do not overfill the engine with oil. Always make sure the oil level is above the “L” mark but not higher than the “F” mark.

Seat Latch

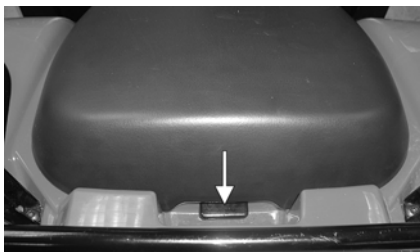

AL676A

1. To remove the seat, lift up on the latch release (located at the rear of the seat); then raise the rear of the seat and slide it rearward.
2. To lock the seat into position, slide the front of the seat into the seat retainers and push down firmly on the rear of seat. The seat should automatically lock into position.

⚠ WARNING

Make sure the seat is secure before mounting the ATV. Severe personal injury may result if the seat is not properly secured.

Safety Flag Bracket

A bracket is provided for mounting a flag at the rear of the ATV.

Rack Loading (Front and Rear)

The front rack and rear rack are designed to carry specified load capacities. Always refer to the ATV Load Capacity Ratings Chart for proper capacities.

⚠ WARNING

Make sure the loads on the front and rear racks will not interfere with the ATV controls or obstruct the view of the operator. Also, make sure the loads are evenly distributed, properly secured, and will not shift while operating the ATV.

Trailer and Towing

⚠ WARNING

Never use the racks as a towing or trailering point.

Arctic Cat ATV's are equipped with a frame-mounted receiver for a standard 5.1 cm (2 in.) receiver hitch. The standard receiver hitch must be purchased separately.

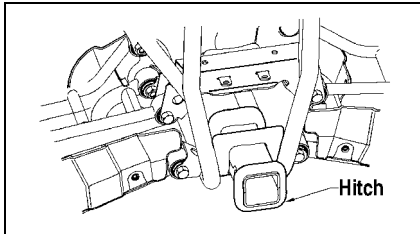

738-424A

When loading a trailer properly, two items are critical: Gross Trailer Weight (the weight of the trailer plus cargo) and Trailer Tongue Weight.

⚠ WARNING

Make sure that the load in the trailer is properly secured and will not shift while moving. Also, do not overload the trailer.

⚠ WARNING

Never exceed any of the ATV weight restrictions.

Trailer Tongue Weight is the downward force exerted on the hitch by the trailer coupler when the trailer is fully loaded and the coupler is at its normal towing height. Refer to the Load Capacity Ratings Chart for tongue weight information.

Always maintain a slow speed when trailering and towing and avoid sudden accelerations, quick maneuvers, and sudden stops. Braking distance will be affected when towing a trailer. When towing a trailer, always maintain slow speed and allow more stopping distance than when not towing a trailer.

⚠ WARNING

Riding an ATV without extra caution when towing a trailer will be hazardous. Trailer towing can affect the handling and braking of the ATV. Never tow a trailer without a rigid tongue and never exceed 10 mph. Avoid sudden accelerations and stopping of the ATV. Do not make quick maneuvers. Avoid uneven surfaces and do not tow on hills. Never carry passengers in a trailer unless the trailer is designed for such use. Allow more stopping distance than when not towing a trailer.

Transporting ATV

When transporting the ATV, Arctic Cat recommends that the ATV be in its normal operating position (on all four wheels) and the following procedure be used.

1. Engage the brake lever lock and place the transmission in gear.

CAUTION

Failure to engage the brake lever lock and place the transmission in gear could result in the ATV rolling off the trailer in the event of tie-down strap failure.

2. Secure the ATV with load rated hold-down straps.

■ NOTE: Suitable hold-down straps are available from your Arctic Cat ATV dealer. Ordinary rope is not recommended because it can stretch under load.

Recommended Engine/ Transmission Oil

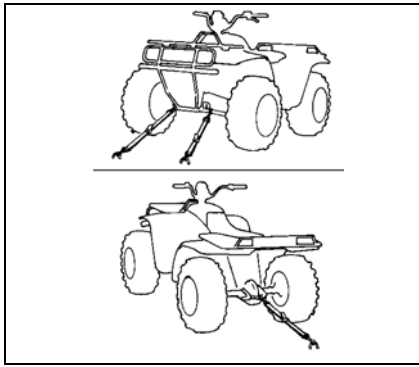

ATV-0067

CAUTION

If using additional hold-down straps in any other areas, care must be taken not to damage the ATV.

Gasoline-Oil-Lubricant Recommended Gasoline

The recommended gasoline to use in this ATV is 87 minimum octane regular unleaded. In many areas, oxygenates (either ethanol or MTBE) are added to the gasoline. Oxygenated gasolines containing up to 10% ethanol, 5% methane, or MTBE are acceptable gasolines.

When using ethanol blended gasoline, it is not necessary to add a gasoline antifreeze since ethanol will prevent the accumulation of moisture in the fuel system.

CAUTION

Do not use white gas. Only Arctic Cat approved gasoline additives should be used.

CAUTION

Any oil used in place of the recommended oil could cause serious engine damage. Do not use oils which contain graphite or molybdenum additives. These oils can adversely affect clutch operation. Also, not recommended are racing, vegetable, non-detergent, and castor-based oils.

The recommended oil to use is Arctic Cat ACX All Weather synthetic engine oil, which has been specifically formulated for use in this Arctic Cat engine. Although Arctic Cat ACX All Weather synthetic engine oil is the only oil recommended for use in this engine, use of any API certified SM 0W-40 oil is acceptable.

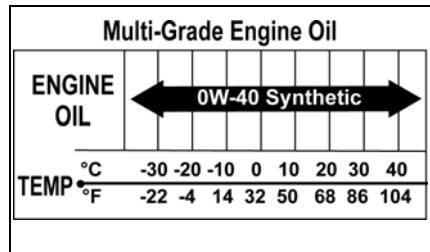

OILCHARTJ

Recommended Front Differential/Rear Drive Lubricant

■ NOTE: Arctic Cat recommends the use of genuine Arctic Cat lubricants.

The recommended lubricant (front differential and rear drive) is SAE approved 80W-90 hypoid. This lubricant meets all of the lubrication requirements of the Arctic Cat ATV.

CAUTION

Any lubricant used in place of the recommended lubricant could cause serious front differential/rear drive damage.

Filling Gas Tank

⚠ WARNING

Always fill the gas tank in a well-ventilated area. Never add gasoline to the ATV gas tank near any open flames or with the engine running or hot. **DO NOT SMOKE** while filling the gas tank.

Since gasoline expands as its temperature increases, the gas tank must be filled to its rated capacity only. Expansion room must be maintained in the tank particularly if the tank is filled with cold gasoline and then moved to a warm area.

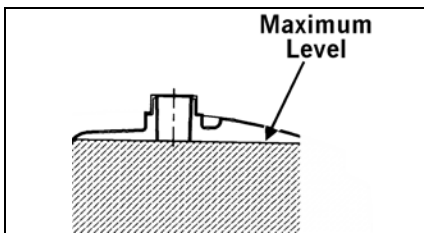

ATV0049D

Allow the engine to cool before filling the gas tank. Care must be taken not to overfill the tank. If overfilled, gas may leak onto the engine creating a fire hazard.

⚠ WARNING

Do not over-flow gasoline when filling the gas tank. A fire hazard could materialize. Always allow the engine to cool before filling the gas tank.

⚠ WARNING

Do not overfill the gas tank.

Tighten the gas tank cap securely after filling the tank.

Engine Break-In

After the completion of the break-in period, the engine oil and oil filter should be changed. Other maintenance after break-in should include checking of all prescribed adjustments and tightening of all fasteners. At the discretion and expense of the owner/operator, the ATV may be taken to an authorized Arctic Cat ATV dealer for this initial service.

New ATV's and renewed ATV engines require a "break-in" period. The first month is most critical to the life of this ATV. Proper operation during this break-in period will help assure maximum life and performance from the ATV.

During the first 10 hours of operation, always use less than ½ throttle. Varying the engine RPM during the break-in period allows the components to "load" (aiding the engine/transmission component mating process) and then "unload" (allowing components to cool). Although it is essential to place some stress on the engine components during break-in, care should be taken not to overload the engine too often. Do not pull a trailer during the break-in period.

When the engine starts, allow it to warm up properly. Idle the engine several minutes until the engine has reached normal operating temperature. Do not idle the engine for excessively long periods of time.

Burnishing Brake Pads

Brake pads must be burnished to achieve full braking effectiveness. Braking distance will be extended until brake pads are properly burnished.

⚠ WARNING

Failure to properly burnish the brake pads could lead to premature brake pad wear or brake loss. Brake loss can result in severe injury.

To properly burnish the brakes, use following procedure:

1. Choose an area sufficiently large to safely accelerate ATV to 30 mph and to brake to a stop.
2. Accelerate to 30 mph; then compress brake lever to decelerate to 0-5 mph.
3. Repeat procedure twenty times.

⚠ WARNING

Do not attempt sudden stops or put yourself into a situation where a sudden stop will be required until the brake pads are properly burnished.

General Maintenance

■ **NOTE: Proper maintenance of the ATV is important for optimum performance. Follow the Maintenance Schedule and all ensuing Maintenance Instructions/Information.**

If, at any time, abnormal noises, vibrations, or improper functioning of any component of this ATV is detected, DO NOT OPERATE THE ATV. Take the ATV to an authorized Arctic Cat ATV dealer for inspection and adjustment or repair.

If the owner/operator does not feel qualified to perform any of these maintenance procedures or checks, take the ATV to an authorized Arctic Cat ATV dealer for professional service.

■ **NOTE: The following instructions and information refer to specific items in the maintenance and care of the ATV.**

Maintenance Schedule

Item	Page	Initial 100 miles after break-in	Every 100 miles or 1 month	Every 300 miles or 3 months	Every 500 miles or 6 months
Battery	64	I	I		
* Engine nuts and bolts	-	I			I
* Valve clearance	-	I			I
Spark plug	67	I		I	I
	67	Replace every 4000 miles or 18 months			
Liquid cooling system	59	I	Inspect every time before riding		
Idle RPM	68	I			I
Throttle cable	61/68	I	Inspect every time before riding		
Gas/vent hoses	52	I	Inspect every time before riding		
	52	Replace every 2 years			
Engine/transmission oil and filter	61	R		R**	
Air filter	69	I		I	
Air filter housing drains	70	I	Inspect every time before riding		
Gear lubricant (Front differential - rear drive)	62	I		I	
	62	Replace every 4 years			
V-Belt	70	I			I
Spark arrester/muffler	71				C
Tires/air pressure	70/ 35	I	Inspect every time before riding		
* Brake components	62	I	Inspect every time before riding		
Brake fluid	62	I	*Replace every 2 years		
Brake hoses	63	I	*Replace every 4 years		
* Steering	-	I	Inspect every time before riding		
* Suspension (Ball joint boots, drive axle boots front and rear, tie rods, differential and rear drive bellows)	-	I	Inspect every time before riding		
* Chassis nuts and bolts	-	I	T		
Frame/welds/racks	-	I			I
Electrical connections	-	I			I
Headlight/taillight-brakelight	72	I	Inspect every time before riding		

I=Inspect and clean, adjust, lubricate, replace as necessary T=Tighten R = Replace C = Clean

* Dealer maintenance

** When using Arctic Cat ACX All Weather synthetic oil, oil change interval can be increased to every 1,000 miles or every year.

Liquid Cooling System

■ **NOTE:** Debris in front of the engine or packed between the cooling fins of the radiator can reduce cooling capability. Using a garden hose, wash the radiator to remove any debris preventing air flow.

CAUTION

Arctic Cat does not recommend using a pressure washer to clean the radiator core. The pressure may bend or flatten the fins causing restricted air flow, and electrical components on the radiator could be damaged. Use only a garden hose with spray nozzle at normal tap pressure.

The cooling system capacity can be found in the specifications chart. The cooling system should be inspected daily for leakage and damage. If leakage or damage is detected, take the ATV to an authorized Arctic Cat ATV dealer for service. Also, the coolant level should be checked periodically.

CAUTION

Continued operation of the ATV with high engine temperature may result in engine damage or premature wear.

■ **NOTE:** High engine RPM, low vehicle speed, or heavy load can raise engine temperature. Decreasing engine RPM, reducing load, and selecting an appropriate transmission gear can lower the temperature.

When filling the cooling system, use a coolant/water mixture which will satisfy the coldest anticipated weather conditions of the area in accordance with the coolant manufacturer's recommendations. While the cooling system is being filled, air pockets may develop; therefore, run the engine for five minutes after the initial fill, shut the engine off, and then fill the cooling system to the bottom of the stand pipe in the radiator neck.

Checking/Filling

1. Remove the four screws securing the radiator access panel.



FI476

2. Move the panel forward until free of the ATV.
3. On Mud Pro models, remove four cap screws securing the snorkel housing to the front inspection panel; then remove two cap screws from the rear of the snorkel housing.

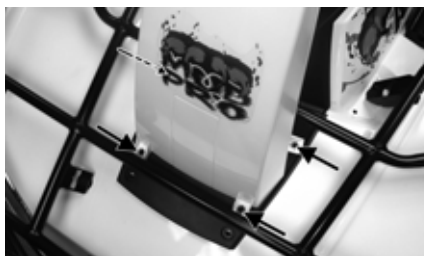

MP006A

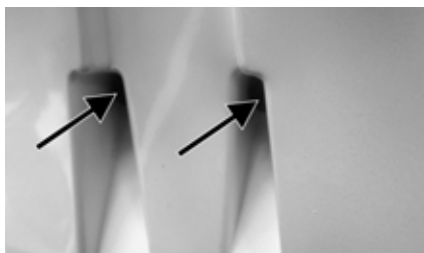

MP007A

4. Separate the front of the snorkel housing from the rear; then remove the snorkel housing.

Maintenance (Mud Pro)

MP003

5. Remove two reinstallable rivets and remove the splash guard. The radiator cap can now be accessed in front of the snorkels.
6. Carefully rotate the radiator cap counterclockwise to release pressure; then remove the cap.

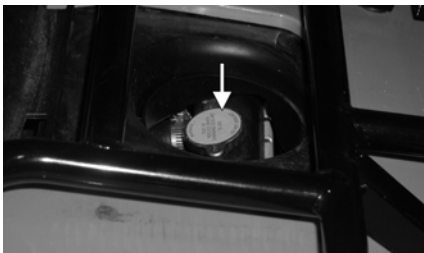

CF142A

7. Add coolant as necessary; then install the radiator cap and access panel or snorkel housing.

■ **NOTE:** Use a good quality, biodegradable glycol-based, automotive-type antifreeze.

⚠ WARNING

Never check the coolant level when the engine is hot or the cooling system is under pressure.

CAUTION

After operating the ATV for the initial 5-10 minutes, stop the engine, allow the engine to cool down, and check the coolant level. Add coolant as necessary.

When operating in muddy conditions, it is extremely important to clean the radiator core frequently. Arctic Cat requires inspecting and/or flushing the radiator core before each use to prevent overheating resulting in severe engine damage. After cleaning, shine a light through the radiator core while observing from the opposite side to determine if all dirt and debris have been removed.

■ **NOTE:** It is necessary to remove four machine screws securing the protective screen to the front of the radiator and move it forward to properly flush the radiator core. Make sure to secure the screen to the radiator after cleaning.

CAUTION

Failure to remove dirt and debris from the radiator prior to operating the ATV may cause overheating resulting in severe engine damage.

CAUTION

Arctic Cat does not recommend using a pressure washer to clean the radiator core. The pressure may bend or flatten the fins causing restricted air flow, and electrical components on the radiator could be damaged. Use only a garden hose with spray nozzle at normal tap pressure.

Shock Absorbers

Each shock absorber should be visibly checked weekly for excessive fluid leakage (some seal leakage may be observed but it does not indicate the shock is in need of replacement), cracks or breaks in the lower case, or a bent shock rod. If any one of these conditions is detected, replacement is necessary.

■ **NOTE:** When the ATV is operated in extremely cold weather (-23°C/-10°F or colder), a small amount of leakage may be present. Unless the leakage is excessive, replacement is not necessary.

The shock absorber has a spring force adjustment sleeve with five adjustment positions to allow the spring to be adjusted for different riding and loading conditions. If the spring action is too soft or too stiff, adjust it according to the chart.



CD453

■ **NOTE:** Before attempting to adjust suspension, clean dirt and debris from the sleeve and remove load from the suspension; then use the spanner wrench to adjust the sleeve to the desired position.

Position	Spring Force	Setting	Load
1	↓ Stronger	Soft	Light
2		↑	↑
3		↕	↕
4		↓	↓
5		Stiff	Heavy

General Lubrication

Cables

None of the cables require lubrication; however, it is advisable to lubricate the ends of the cables periodically with a good cable lubricant.

Engine/Transmission Oil and Filter

■ **NOTE:** Refer to the recommended oil viscosity chart (on page 55) in this manual for the proper engine oil.

Change the engine oil and oil filter at the scheduled intervals. The engine should always be warm when the oil is changed so the oil will drain easily and completely.

1. Park the ATV on level ground.

2. Loosen the oil level stick. Be careful not to allow contaminants to enter the opening.

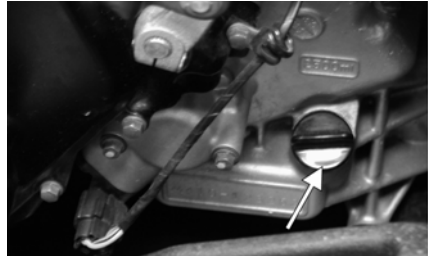

CF109M

3. Remove the drain plug from the bottom of the engine and drain the oil into a drain pan.

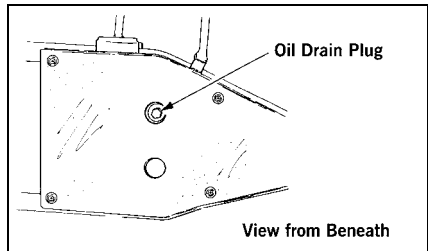

View from Beneath

733-441A

4. Remove the oil filter plug from the filter mounting boss (located on the front-right side of the transmission case) and allow the filter to drain completely.
5. Using the oil filter wrench and a ratchet handle (or a socket or box-end wrench), remove the old oil filter and dispose of properly. Do not re-use oil filter.

■ **NOTE:** Clean up any excess oil after removing the filter.

6. Apply oil to the new filter O-ring and check to make sure it is positioned correctly; then install the new oil filter. Tighten securely.
7. Install the oil filter drain plug and tighten securely.
8. Install the engine drain plug and tighten it securely. Remove the oil filler plug being careful not to let contaminants enter the opening; then pour the recommended oil in the filler hole. Install the level stick.

9. Start the engine (while the ATV is outside on level ground) and allow it to idle for a few minutes.
10. Turn the engine off and wait approximately one minute. Recheck the oil level.
11. Inspect the area around the drain plug and oil filter for leaks.

Front Differential and Rear Drive Gear Lubricant (Inspecting/Changing)

Inspect and change the gear lubricant in each according to the Maintenance Schedule. When changing the lubricant, use approved SAE 80W-90 hypoid oil and use the following procedure.

1. Place the ATV on level ground.
2. Remove each oil filler plug.
3. Drain the oil into a drain pan by removing in turn the drain plug from each.

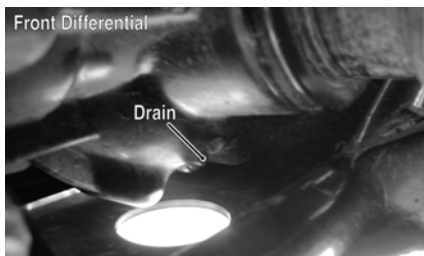

CF107B



CF106C

4. After all the oil has been drained, install the drain plugs and tighten securely.

CAUTION

Inspect the oil for any signs of metal filings or water. If found, take the ATV to an authorized Arctic Cat ATV dealer for servicing.

5. Pour recommended oil into each filler hole.

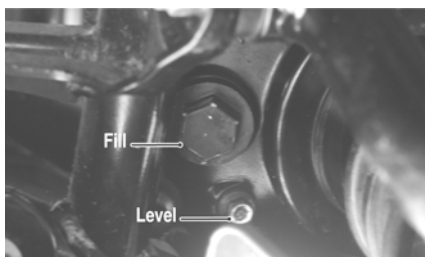

CF113A

■ **NOTE:** Arctic Cat recommends the use of genuine Arctic Cat lubricants.

6. Install the filler plugs.

Hydraulic Hand Brake

⚠ WARNING

Be sure to inspect the hydraulic brake system before each use. Always maintain brakes according to the Maintenance Schedule.

Brake Fluid

Check the brake fluid level in the brake fluid reservoir. If the level in the reservoir is not visible in the sight glass, add DOT 4 brake fluid.

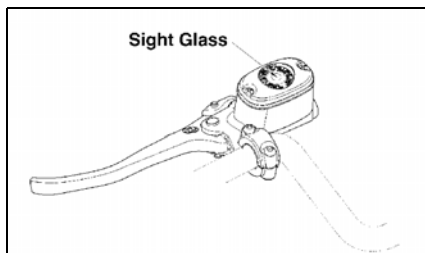

738-420A

■ **NOTE:** If the sight glass appears dark, there is a sufficient amount of fluid in the reservoir.

CAUTION

Be careful not to spill any fluid when filling the brake fluid reservoir. Wipe away spilled fluid immediately.

Brake Lever Lock

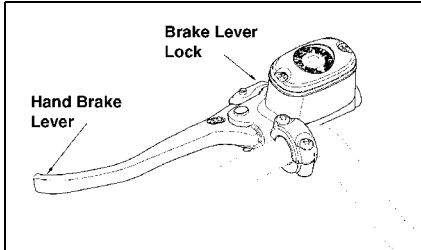

738-420B

Check to make sure the brake lever lock engages properly and that the brake (when engaged) locks the wheels.

1. Pump the brake lever 2 or 3 times.
2. Engage the brake lever lock.
3. Attempt to push the ATV.

■ **NOTE:** The brake lever lock must lock the wheels. If it doesn't, take the ATV to an authorized Arctic Cat ATV dealer for service.

Brake Hoses

Carefully inspect the hydraulic brake hoses for cracks or other damage. If found, take the ATV to an authorized Arctic Cat ATV dealer to have the brake hoses replaced.

Brake Pads

The clearance between the brake pads and brake discs is adjusted automatically as the brake pads wear. The only maintenance that is required is replacement of the brake pads when they show excessive wear. Check the thickness of each of the brake pads as follows:

1. Remove a front wheel.
2. Measure the thickness of each brake pad.

3. If thickness of either brake pad is less than 1.0 mm (0.039 in.), take the ATV to an authorized Arctic Cat ATV dealer to have brake pads replaced.

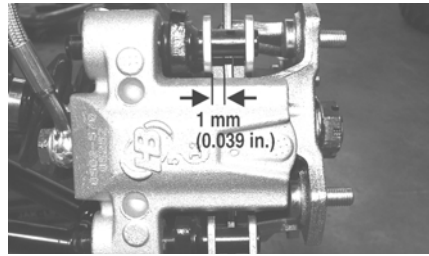

PR376B

4. Install the wheel and tighten using a crisscross pattern to 40 ft-lb (steel wheels) or 80 ft-lb (aluminum wheels).

Rear Foot Brake

The rear foot brake must be maintained to be fully functional.

WARNING

Be sure to inspect the rear foot brake system before each use. Always maintain brakes according to the Maintenance Schedule.

1. Check the brake fluid level in the reservoir. The fluid level must be maintained between the MAX and MIN level marks. If the level in the reservoir is low, add DOT 4 brake fluid.

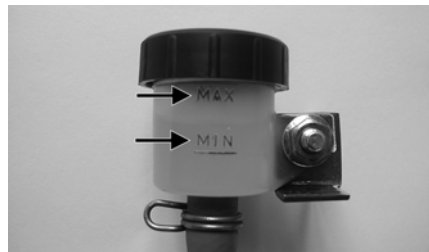

CD474A

■ **NOTE:** The brake fluid reservoir is located under the seat.

2. Press the rear foot brake several times to check for firmness.
3. If the brake is not firm, the system must be bled.

■ **NOTE:** Take the ATV to an authorized Arctic Cat ATV dealer for this service.

Protective Rubber Boots

The protective boots should be inspected periodically according to the Maintenance Schedule.

Ball Joint Boots (Upper and Lower/Right and Left)



CC791

1. Secure the ATV on a support stand to elevate the front wheels.
2. Remove both front wheels.
3. Inspect the four ball joint boots for cracks, tears, or perforations.
4. Check the ball joint for free-play by grasping the steering knuckle and turning it from side to side and up and down.
5. If boot damage is present or ball joint free-play seems excessive, contact an authorized Arctic Cat ATV dealer for service.

Tie Rod Boots (Inner and Outer/Right and Left)

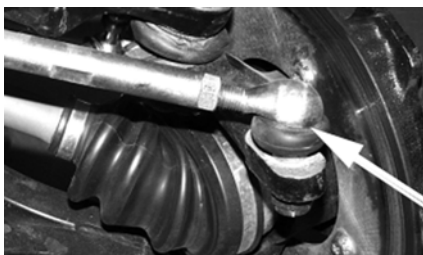

CC792

1. Secure the ATV on a support stand to elevate the front wheels.

2. Remove both front wheels.
3. Inspect the four tie rod boots for cracks, tears, or perforations.
4. Check the tie rod end free-play by grasping the tie rod near the end and attempting to move it up and down.
5. If boot damage is present or tie rod end free-play seems excessive, contact an authorized Arctic Cat ATV dealer for service.

Drive Axle Boots



CC793

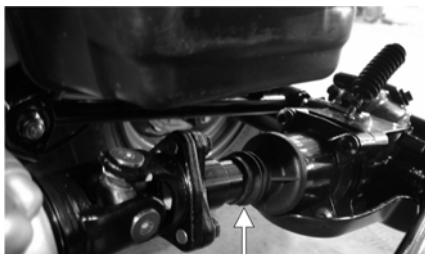

CF125A

1. Inspect all drive axle boots for cracks, tears, or perforations.
2. If boot damage is present, contact an authorized Arctic Cat ATV dealer for service.

Battery

The battery is located under the seat.

After being in service, batteries require regular cleaning and recharging in order to deliver peak performance and maximum service life. The following procedures are recommended for cleaning and maintaining lead-acid batteries. Always read and follow instructions provided with battery chargers and battery products.

■ **NOTE:** Refer to all warnings and cautions provided with the battery or battery maintainer/charger.

Loss of battery charge may be caused by ambient temperature, ignition OFF current draw, corroded terminals, self discharge, frequent start/stops, and short engine run times. Frequent winch usage, snowplowing, extended low RPM operation, short trips, and high amperage accessory usage are also reasons for battery discharge.

Maintenance Charging

■ **NOTE:** Arctic Cat recommends the use of the CTEK Multi US 800 or the CTEK Multi US 3300 for battery maintenance charging. Maintenance charging is required on all batteries not used for more than two weeks or as required by battery drain.

1. When charging a battery in the vehicle, be sure the ignition switch is in the OFF position.

■ **NOTE:** Be sure to maintain the fluid of the battery at the UPPER LEVEL. Use only distilled water when adding fluid to these batteries.

2. Clean the battery terminals with a solution of baking soda and water.
3. Be sure the charger and battery are in a well-ventilated area and ensure the battery charger cables will not contact any battery acid. Be sure the charger is unplugged from the 110-volt electrical outlet.
4. Connect the red terminal lead from the charger to the positive terminal of the battery; then connect the black terminal lead of the charger to the negative terminal of the battery.

■ **NOTE:** Optional battery charging adapters are available from your authorized Arctic Cat dealer to connect directly to your vehicle from the recommended chargers to simplify the maintenance charging process. Check with your authorized Arctic Cat dealer for proper installation of these charging adapter connectors.

5. Plug the battery charger into a 110-volt electrical outlet.

6. If using the CTEK Multi US 800, there are no further buttons to push. If using the CTEK Multi US 3300, press the Mode button (A) at the left of the charger until the Maintenance Charge Icon (B) at the bottom illuminates. The Normal Charge Indicator (C) should illuminate on the upper portion of the battery charger.



800E

■ **NOTE:** The maintainer/charger will charge the battery to 95% capacity at which time the Maintenance Charge Indicator (D) will illuminate and the maintainer/charger will change to pulse/float maintenance. If the battery falls below 12.9 DC volts, the charger will automatically start again at the first step of the charge sequence.



3300A

■ **NOTE:** Not using a battery charger with the proper float maintenance will damage the battery if connected over extended periods.

Charging

■ **NOTE:** Arctic Cat recommends the use of the CTEK Multi US 800 or the CTEK Multi US 3300 for battery maintenance charging.

1. Be sure the battery and terminals have been cleaned with a baking soda and water solution.
2. Be sure the charger and battery are in a well-ventilated area and ensure the battery charger cables will not contact any battery acid. Be sure the charger is unplugged from the 110-volt electrical outlet.
3. Connect the red terminal lead from the charger to the positive terminal of the battery; then connect the black terminal lead of the charger to the negative terminal of the battery.
4. Plug the charger into a 110-volt electrical outlet.
5. By pushing the Mode button (A) on the left side of the charger, select the Normal Charge Icon (E). The Normal Charge Indicator (C) should illuminate on the upper left portion of the charger.
6. The battery will charge to 95% of its capacity at which time the Maintenance Charge Indicator (D) will illuminate.

■ **NOTE:** For optimal charge and performance, leave the charger connected to the battery for a minimum 1 hour after the Maintenance Charge Indicator (D) illuminates. If the battery becomes hot to the touch, stop charging. Resume after it has cooled.

7. Once the battery has reached full charge, unplug the charger from the 110-volt electrical outlet.

■ **NOTE:** If, after charging, the battery does not perform to operator expectations, bring the battery to an authorized Arctic Cat dealer for further troubleshooting.

Jump-Starting

■ **NOTE:** Arctic Cat does not recommend jump-starting a vehicle with a dead battery but rather to remove the battery, service it, and correctly charge it; however, in an emergency, it may be necessary to jump-start a vehicle. If so, use the following procedure to carefully and safely complete this procedure.

WARNING

Improper handling or connecting of a battery may result in severe injury including acid burns, electrical burns, or blindness as a result of an explosion. Always remove rings and watches.

1. On the vehicle to be jump-started, remove the battery cover and any terminal boots.

WARNING

Any time service is performed on a battery, the following must be observed: keep sparks, open flame, cigarettes, or any other flame away. Always wear safety glasses. Protect skin and clothing when handling a battery. When servicing battery in enclosed space, keep the area well-ventilated. Make sure battery venting is not obstructed.

2. Inspect the battery for any signs of electrolyte leaks, loose terminals, or bulging sides. Leaking or bulging battery cases may indicate a frozen or shorted battery.

WARNING

If any of these conditions exist, DO NOT attempt a jump-start, boost, or charge the battery. An explosion could occur causing serious injury.

- Inspect the vehicle to be used for jump-starting to determine if voltage and ground polarity are compatible. The vehicle must have a 12-volt DC, negative ground electrical system.

CAUTION

Always make sure the electrical systems are of the same voltage and ground polarity prior to connecting jumper cables. If not, severe electrical damage may occur.

- Move the vehicle to be used for the jump-start close enough to ensure the jumper cables easily reach; then shift into neutral, set and lock the brakes, shut off all electrical accessories, and turn the ignition switch OFF.

■ **NOTE: Make sure all switches on the vehicle to be jump-started are turned OFF.**

- Disconnect all external accessories such as cell phones, GPS units, and radios on both vehicles.

CAUTION

Failure to disconnect electronic accessories during jump-starting may cause system damage due to power spikes.

- Attach one clamp of the positive (red) jumper cable to the positive (+) terminal (1) of the dead battery (C) being careful not to touch any metal with the other clamp; then attach the other clamp of the positive (red) jumper cable to the positive (+) terminal (2) of the good battery (B).

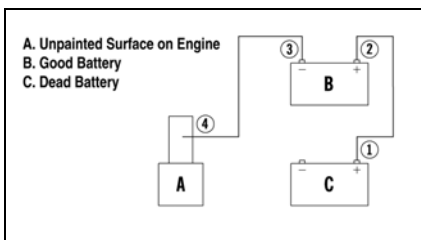

0744-527

■ **NOTE: Some jumper cables may be the same color but the clamps or ends will be color-coded red and black.**

- Attach one clamp of the negative (black) jumper cable to the negative (-) terminal (3) of the good battery (B); then attach the other clamp of the negative (black) jumper cable (4) to an unpainted metal surface (A) on the engine or frame well away from the dead battery and fuel system components.

⚠ WARNING

Never make the final connection to a battery as a spark could ignite hydrogen gases causing an explosion of the battery resulting in acid burns or blindness.

- Stand well away from the dead battery and start the vehicle with the good battery. Allow the vehicle to run for several minutes applying some charge to the dead battery.
- Start the vehicle with the dead battery and allow it to run for several minutes before disconnecting the jumper cables.
- Remove the jumper cables in opposite order of hook-up (4, 3, 2, 1). Be careful not to short cables against bare metal.

■ **NOTE: Have the battery and electrical system checked prior to operating the vehicle again.**

Spark Plug

The ATV comes equipped with a specified spark plug. See the specifications chart for the correct spark plug. A light brown insulator indicates that the plug is correct. A white or dark insulator indicates that the engine may need to be serviced or the carburetor may need to be adjusted. Consult an authorized Arctic Cat ATV dealer if the plug insulator is not a light brown color. To help prevent cold weather fouling, make sure to thoroughly warm up the engine before operating.

To maintain a hot, strong spark, keep the plug free of carbon.

Before removing the spark plug, be sure to clean the area around the spark plug. If you do not, dirt could enter engine when removing or installing the spark plug.

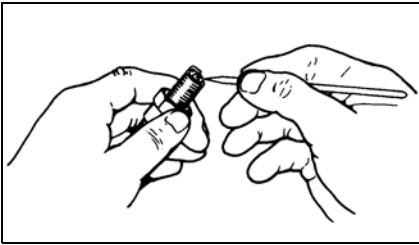

ATV-0051

Adjust the gap to specified amount (see specifications chart) for proper ignition. Use a feeler gauge to check the gap.

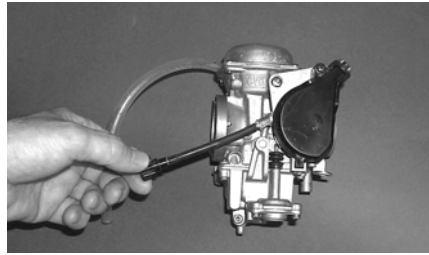

AF920

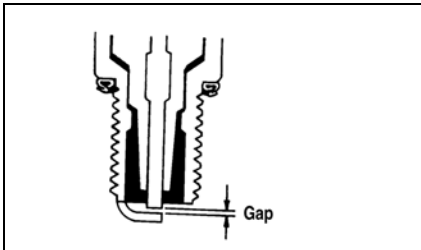

ATV0052B

When installing the spark plug, be sure to tighten it securely. A new spark plug should be tightened 1/2 turn once the washer contacts the cylinder head. A used spark plug should be tightened 1/8 - 1/4 turn once the washer contacts the cylinder head.

Engine Idle RPM Adjustment

■ **NOTE:** The idle adjustment screw is located on the right-hand side of the carburetor.

1. Start the engine and warm it up to normal operating temperature.
2. Turn the idle adjustment screw in or out until the engine idles at 1250-1350 RPM.

⚠ WARNING

Adjust the idle to the correct RPM. Make sure the engine is at normal operating temperature before adjusting the idle RPM.

Throttle Cable Adjustment

To adjust the throttle cable free-play:

1. Loosen the jam nut from the throttle cable adjuster.
2. Slide the rubber boot away and turn the adjuster until the throttle lever has proper free-play of 3-6 mm (1/8-1/4 in.).

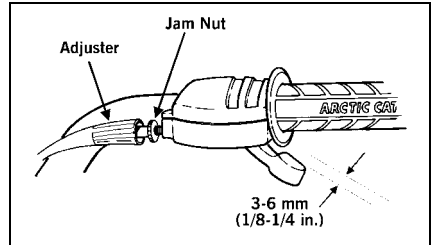

ATV-0047

3. Tighten the jam nut against the throttle cable adjuster securely; then slide the rubber boot over the adjuster.

Air Filter

The air filter inside the air filter housing must be kept clean to provide good engine power and gas mileage. If the ATV is used under normal conditions, service the filter at the intervals specified in the Maintenance Schedule. If operated in dusty, wet, or muddy conditions, inspect and service the filter more frequently. Use the following procedure to remove the filter and inspect and/or clean it.

CAUTION

Failure to inspect the air filter frequently if the ATV is used in dusty, wet, or muddy conditions can damage the engine.

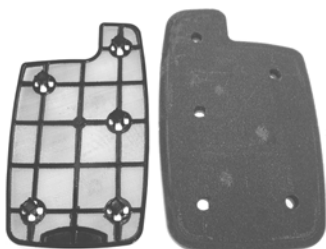

CD747

1. Remove the appropriate reinstallable rivets securing the storage compartment.

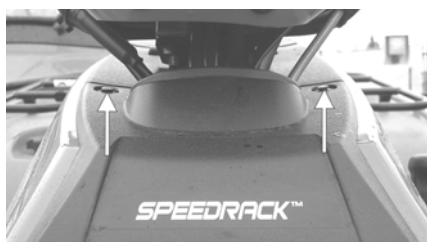

CF260A

2. Raise the storage compartment cover; then slide the cover forward and off the compartment. Remove the storage compartment.



CD669



CD671

3. Unsnap the four spring-clip fasteners and remove the air filter cover.
4. Fill a wash pan larger than the element with a non-flammable solvent; then dip the element in the solvent and wash it.

■ **NOTE: Foam Air Filter Cleaner and Foam Air Filter Oil are available from Arctic Cat.**

5. Squeeze the element by pressing it between the palms of both hands to remove excess solvent. Do not twist or ring the element or it will develop cracks.
6. Dry the element.
7. Put the element in a plastic bag; then pour in air filter oil and work the oil into the element.
8. Squeeze the element to remove excess oil.

CAUTION

A torn air filter can cause damage to the ATV engine. Dirt and dust may get inside the engine if the element is torn. Carefully examine the element for tears before and after cleaning it. Replace the element with a new one if it is torn.

9. Clean any dirt or debris from inside the air cleaner. Be sure no dirt enters the carburetor.
10. Install the air filter and cover.
11. Install the compartment and lid; then install appropriate reinstallable rivets.

Air Filter Housing Drains

Inspect the “duck bill” drains beneath the main housing for debris and for proper sealing.



KX045A

CAUTION

The drain on the right side of the housing is on the “clean air” side of the air filter. Any leak in this drain will allow unfiltered air to enter the engine. Severe engine damage could occur.

Draining V-Belt Cover

■ **NOTE:** If the ATV has been driven through water, the V-belt cover must be drained of any water.

1. Place the ATV on a level surface.
2. Remove the drain bolt from the cover and allow the water to drain out.

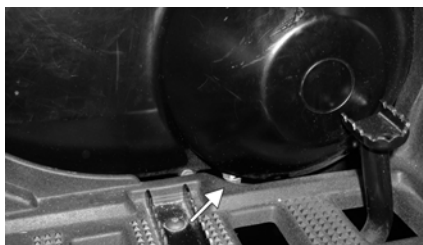

CF110A

3. Shift the range lever to the neutral position; then start the engine.

4. Increase and decrease engine RPM several times to “blow out” any water; then stop the engine.
5. Install the drain bolt and tighten securely.

■ **NOTE:** The V-belt and pulleys should be inspected every 500 miles and the belt replaced (if necessary).

Tires

⚠ WARNING

Always use the size and type of tires as specified. Refer to the Specifications Chart for proper tire inflation pressure, and always maintain proper tire inflation pressure.

Tire Tread Condition

The use of worn-out tires on an ATV is very dangerous. A tire is considered to be worn out when the depth of the tread is less than 3 mm (1/8 in.). Be sure to replace the tires before reaching this minimum specification.

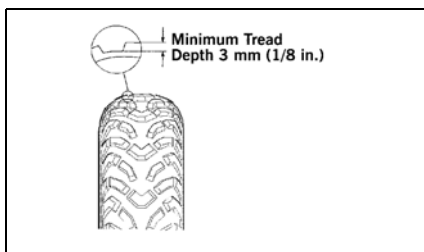

0732-649

⚠ WARNING

The use of worn-out tires can be dangerous and can increase the risk of an accident.

Tire Replacement

The ATV has low-pressure tubeless tires. Air is sealed by the contact surfaces of the inner wheel rim and the tire bead. If either the inner wheel rim or tire bead is damaged, air may leak. Be extremely careful not to damage these areas when replacing tires.

It is very important to use the proper tools when repairing or replacing tires to prevent damage to the tire bead or wheel rims. If proper tools and related items are not available, have this maintenance performed by an authorized Arctic Cat ATV dealer or a qualified tire repair station.

CAUTION

When breaking the tire bead loose from the wheel, be extremely careful not to damage the inner wheel surface or the tire bead.

WARNING

Use only Arctic Cat approved tires when replacing tires. Failure to do so could result in unstable ATV operation.

Tubeless Tire Repair

Should a leak or flat tire occur due to a puncture, the tire may be repaired using a plug-type repair. If the damage is from a cut or if the puncture cannot be repaired using a plug, the tire must be replaced. When operating the ATV in areas where transportation or service facilities are not readily available, it is strongly recommended to carry a plug-type repair kit and a tire pump along.

Wheels

1. Park the ATV on level ground and engage the brake lever lock.
2. Loosen the lug nuts on the wheel to be removed.
3. Elevate the ATV.
4. Remove the lug nuts.
5. Remove the wheel.
6. Install the wheel and install the lug nuts.
7. Tighten the nuts in a crisscross pattern to 40 ft-lb (steel wheels) or 80 ft-lb (aluminum wheels).
8. Remove the jack.

Muffler/Spark Arrester

The muffler has a spark arrester which must be periodically cleaned. At the intervals shown in the Maintenance Schedule, clean the spark arrester using the following procedure.

WARNING

Wait until the muffler cools to avoid burns.

1. Remove the cap screws securing the spark arrester assembly to the muffler.

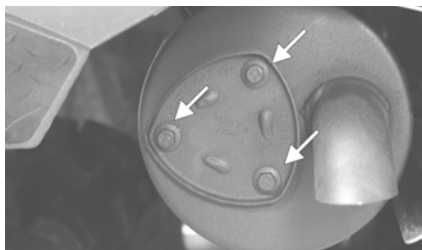

CF105A

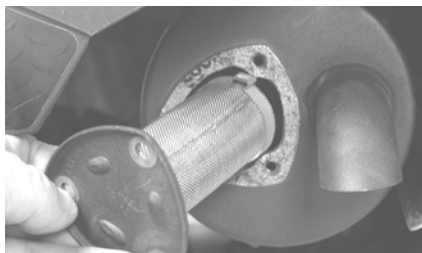

CF104

2. Using a suitable brush, clean the carbon deposits from the screen taking care not to damage the screen.

■ **NOTE:** If the screen or gasket is damaged in any way, it must be replaced.

3. Install the spark arrester assembly and secure with the cap screws. Tighten cap screws to 48 in.-lb.

Light Bulb Replacement

The wattage rating of each bulb is shown in the chart. When replacing a burned bulb, always use the same wattage rating.

Headlight	12V/27W (4)
Taillight/Brakelight	12V/8W/27W

CAUTION

Use only specified bulbs indicated in the chart as replacement bulbs.

Headlight

■ **NOTE:** The bulb portion of the headlight is fragile. **HANDLE WITH CARE.** When replacing the headlight bulb, do not touch the glass portion of the bulb. If the glass is touched, it must be cleaned with a dry cloth before installing. Skin oil residue on the bulb will shorten the life of the bulb.

To replace the headlight bulb, use the following procedure.

1. Rotate the bulb assembly counterclockwise and remove from the headlight housing; then disconnect from the wiring harness.
2. Connect the new bulb assembly to the wiring harness connector; then insert into the headlight housing and rotate fully clockwise.

CAUTION

When replacing the headlight bulb, be careful not to touch the glass portion of the bulb. Grasp the new bulb with a clean cloth.

Taillight/Brakelight

To replace the taillight/brakelight bulb, use the following procedure.

1. Rotate the socket counterclockwise and remove it from the housing.

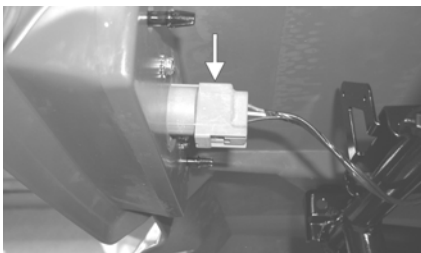

CF135A

2. To remove the bulb from the socket, pull it straight out of the socket.
3. To install the bulb, push it straight into the socket.

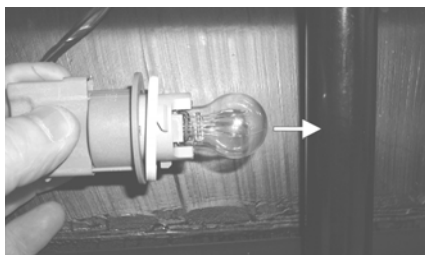

CF132A

4. Insert the socket into the housing and rotate it clockwise.

Checking/Adjusting Headlight Aim

The headlights can be adjusted vertically and horizontally. The geometric center of the HIGH beam light zone is to be used for vertical and horizontal aiming.

1. Position the ATV on a level floor so the headlights are approximately 6.1 m (20 ft) from an aiming surface (wall or similar aiming surface).

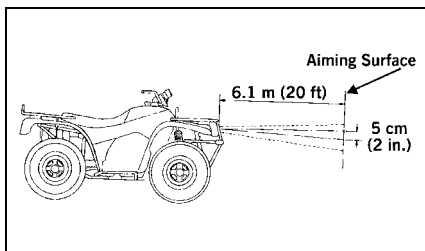

ATV-0070

■ **NOTE:** There should be an average operating load on the ATV when adjusting the headlight aim.

2. Measure the distance from the floor to the mid-point of each headlight.
3. Using the measurements obtained in step 2, make horizontal marks on the aiming surface.
4. Make vertical marks which intersect the horizontal marks on the aiming surface directly in front of the headlights.
5. Switch on the lights. Make sure the HIGH beam is on. **DO NOT USE LOW BEAM.**

6. Observe each headlight beam aim. Proper aim is when the most intense beam is centered on the vertical mark 5 cm (2 in.) below the horizontal mark on the aiming surface.
7. Adjust each headlight until correct aim is obtained by turning the knob clockwise to raise or counterclockwise to lower the beam.

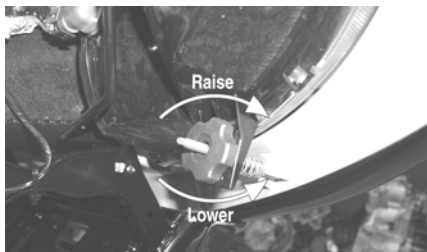

CD714A

Fuses

The fuses are located in a power distribution module under the seat. If there is any type of electrical system failure, always check the fuses first.

CAUTION

Always replace a blown fuse with a fuse of the same type and rating. If the new fuse blows after a short period of use, consult an authorized Arctic Cat ATV dealer immediately.

■ **NOTE:** To remove the fuse, compress the locking tabs on either side of the fuse cover and lift out.

FIS

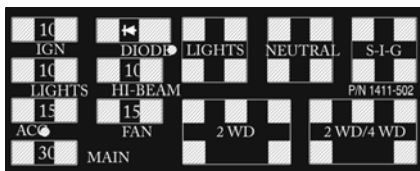

1411-502

Mud Pro

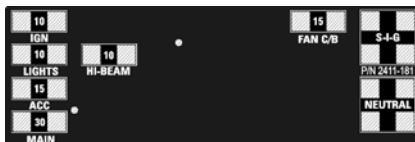

2411-181

Electrical Output Terminals

Two output terminals for electrical accessories are located on the front and rear wiring harnesses. The accessory plug is located on the instrument pod.

CAUTION

Always use electrical accessories less than 180W.

Storage Compartment/Tools

A basic tool kit is provided with the ATV. Maintain the tool kit with the ATV at all times.

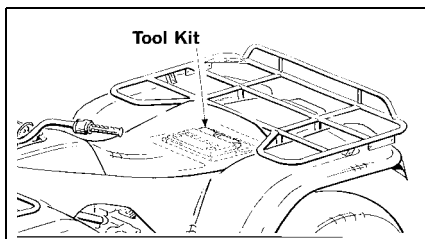

ATV-1097

The storage compartment is above the engine in front of the seat.

Preparation for Storage

CAUTION

Prior to storing the ATV, it must be properly serviced to prevent rusting and component deterioration.

Arctic Cat recommends the following procedure to prepare the ATV for storage. An authorized Arctic Cat ATV dealer should perform this service; however, the owner/operator may perform this service if desired.

1. Clean the seat cushion (cover and base) with a damp cloth and allow to dry.
2. Clean the ATV thoroughly by washing dirt, oil, grass, and other foreign matter from the entire ATV. Allow the ATV to dry thoroughly. DO NOT get water into any part of the engine or air intake.
3. Either drain the gas tank or add a fuel stabilizer to the gas in the gas tank. Remove the air filter housing cover and air filter. Start the engine and allow it to idle; then using Arctic Cat Engine Preserver, rapidly inject the preserver into the air filter opening for a period of 10 to 20 seconds. Install the air filter and housing cover.

CAUTION

If the interior of the air filter housing is dirty, clean the area before starting the engine.

4. Plug the hole in the exhaust system with a clean cloth. Drain the carburetor float bowl.
5. Apply light oil to the upper steering post bushing and plungers of the shock absorbers.
6. Tighten all nuts, bolts, cap screws, and screws. Make sure rivets holding components together are tight. Replace all loose rivets. Care must be taken that all calibrated nuts, cap screws, and bolts are tightened to specifications.
7. Fill the cooling system to the bottom of the stand pipe in the radiator neck with properly mixed coolant.
8. Disconnect the battery cables (negative cable first); then remove the battery, clean the battery posts and cables, and store in a clean, dry area.

■ NOTE: For storage, use a battery maintainer or make sure the battery is fully charged (see Battery section in this manual).

9. Store the ATV indoors in a level position.

CAUTION

Avoid storing outside in direct sunlight and avoid using a plastic cover as moisture will collect on the ATV causing rusting.

Preparation after Storage

Taking the ATV out of storage and correctly preparing it will assure many miles and hours of trouble-free riding. Arctic Cat recommends the following procedure to prepare the ATV.

CAUTION

Before installing the battery, make sure the ignition switch is in the OFF position.

1. Clean the ATV thoroughly.
2. Clean the engine. Remove the cloth from the exhaust system.
3. Check all control wires and cables for signs of wear or fraying. Replace if necessary.
4. Change the engine/transmission oil and filter.
5. Check the coolant level and add properly mixed coolant as necessary.
6. Charge the battery; then install. Connect the battery cables making sure to connect the positive cable first.
7. Check the entire brake systems (fluid level, pads, etc.), all controls, headlights, taillight, brakelight, and headlight aim; adjust or replace if necessary.
8. Check the tire pressure. Inflate to recommended pressure as necessary.
9. Tighten all nuts, bolts, cap screws, and screws making sure all calibrated nuts, cap screws, and bolts are tightened to specifications.
10. Make sure the steering moves freely and does not bind.
11. Check the spark plug. Clean or replace as necessary.
12. Follow the recommendations found in the pre-start inspection.

Change of Address, Ownership, or Warranty Transfer

Arctic Cat Inc. keeps on file the current name and address of the owner of this ATV. This will allow Arctic Cat to reach the current owner with any important safety information which may be necessary to protect customers from personal injury or property damage. Please make sure a copy of this form is completed and returned to Arctic Cat Inc. if you move or if the ATV is sold to another party.

This form may also be used to transfer the unused portion of the original warranty to a second party. In order to transfer warranty, fill out this form completely; then return a copy of this form to Arctic Cat Inc. Arctic Cat will then process the application and issue warranty for the balance of the time remaining of the original warranty.

Address Change

Ownership Change

Warranty Transfer

Change of Address/Ownership/Warranty Transfer to:

Name _____

Address _____

City/State (Province)/Zip Code (Postal Code) _____

Phone # () _____

Year and Model ATV _____

Vehicle Identification Number (VIN) _____

Before operating, you should take an ATV Rider Course to learn ATV riding skills or reinforce your current good riding skills. In U.S.A., call 1-800-887-2887 to enroll in the half-day ATV Rider Course nearest you or ask your dealer for assistance. The course instructor will charge a small fee for each person taking the course. In Canada, call (613) 739-1535.

Fold Back

CHANGE OF ADDRESS/OWNERSHIP

Place
Stamp
Here

**ARCTIC CAT INC.
PRODUCT SERVICE AND
WARRANTY DEPT.
P.O. BOX 810
THIEF RIVER FALLS, MN 56701**

NOTES

NOTES

Identification Numbers Record

WARNING

Indicates a potential hazard that could result in serious injury or death.

The key identification number is stamped on the key as shown in the illustration. Record this number in the space provided for reference if you ever need a new key.



Record the Vehicle Identification Number and Engine Serial Number in the spaces provided to assist you in ordering parts from your authorized Arctic Cat ATV dealer or for reference in case the ATV is stolen.

1. Key Identification Number:

2. Vehicle Identification Number:

3. Engine Serial Number:



WARNING

Improper ATV use can result in SEVERE INJURY or DEATH



**ALWAYS USE
AN APPROVED
HELMET AND
PROTECTIVE
GEAR**



**NEVER USE
ON PUBLIC
ROADS**



**NEVER CARRY
PASSENGERS**



**NEVER USE
WITH DRUGS
OR ALCOHOL**

NEVER operate:

- without proper training or instruction
- at speeds too fast for your skills or the conditions
- on public roads - a collision can occur with another vehicle
- with a passenger - passengers affect balance and steering and increase risk of losing control

ALWAYS:

- use proper riding techniques to avoid vehicle overturns on hills and rough terrain and in turns
- avoid paved surfaces - pavement may seriously affect handling and control

**LOCATE AND READ OPERATOR'S MANUAL
FOLLOW ALL INSTRUCTIONS AND WARNINGS**

YOUR ATV CAN BE HAZARDOUS TO OPERATE.

A collision or rollover can occur quickly, even during routine maneuvers such as turning and driving on hills or over obstacles, if you fail to take proper precautions.

For your safety, understand and follow all the warnings contained in this Operator's Manual and the labels on your ATV.

This Arctic Cat ATV Operator's Manual should be considered a permanent part of the ATV and must remain with the ATV at the time of resale. If the ATV changes ownership more than once, contact Arctic Cat Inc., Service Department, P.O. Box 810, Thief River Falls, MN 56701, for proper registration information.

FAILURE TO FOLLOW THE WARNINGS CONTAINED IN THIS MANUAL CAN RESULT IN SERIOUS INJURY OR DEATH.

Training is available: U.S. owners, call 800-887-2887; Canadian owners, call 613-739-1535.

Un cours d'instruction est disponible: pour les propriétaires canadiens, composez le 613-739-1535.

Particularly important information is distinguished in this manual by the following notations:



The Safety Alert Symbol means ATTENTION! BE ALERT! YOUR SAFETY IS INVOLVED.



WARNING

WARNING indicates a hazardous situation which, if not avoided, could result in death or serious injury.

CAUTION

CAUTION, without the safety alert symbol, is used to address practices not related to personal injury.

■ **NOTE:**

A NOTE provides key information to make procedures easier or more clear.

California Proposition 65



WARNING

This product contains or emits chemicals known to the State of California to cause cancer and birth defects or other reproductive harm.

Foreword

Congratulations and thank you from Arctic Cat Inc. for purchasing an ARCTIC CAT® All-Terrain Vehicle (ATV). Built with American engineering and manufacturing know-how, it is designed to provide superior ride, comfort, utility, and dependable service.

You have chosen a quality Arctic Cat ATV designed and built to give dependable service. Be sure, as the owner/operator of an Arctic Cat ATV, to become thoroughly familiar with its basic operation, maintenance, and storage procedures. Read and understand the entire Operator's Manual before operating the ATV to ensure safe and proper use of your new Arctic Cat ATV. Always operate the ATV within your level of skill and current terrain conditions.

This Operator's Manual is furnished to ensure that the operator is aware of safe operating procedures. It also includes information about the general care and maintenance of your ATV.

Carefully read the following pages. If you have any questions regarding this ATV, contact an authorized Arctic Cat ATV dealer for assistance. Remember, only authorized Arctic Cat ATV dealers have the knowledge and facilities to provide you with the best service possible.

Protect Your Sport

- Know all local, state/provincial riding laws,
- Respect your ATV,
- Respect the environment, and
- You will gain the respect of others.

We also advise you to strictly follow the recommended maintenance program as outlined. This preventive maintenance program is designed to ensure that all critical components on this ATV are thoroughly inspected at various intervals.

All information in this manual is based on the latest product data and specifications available at the time of printing. Arctic Cat Inc. reserves the right to make product changes and improvements which may affect illustrations or explanations without notice.

Some illustrations used in this manual are used for clarity purposes only and are not designed to depict actual conditions. Because Arctic Cat Inc. constantly refines and improves its products, no retroactive obligation is incurred.

Parts and Accessories

When in need of replacement parts, oil, or accessories for your Arctic Cat ATV, be sure to use only GENUINE ARCTIC CAT PARTS, OIL, AND ACCESSORIES. **Only genuine Arctic Cat parts, oil, and accessories are engineered to meet the standards and requirements of your Arctic Cat ATV. For a complete list of accessories, refer to the current Arctic Cat ATV Accessory Catalog.**

To aid in service and maintenance procedures on this ATV, a Service Manual and an Illustrated Parts Manual are available through your local Arctic Cat ATV dealer.

Arctic Cat and the ATV Safety Institute recommend that all ATV operators ride the appropriate-sized ATV according to age.

Category	Age (Years)	Speed Limitations (MPH)	NOTES
Y-12+	12 or Older	15 - Limited 30 - Maximum	Operate Under Adult Supervision
T-14	14 or Older	20 - Limited 30 - Limited 38 - Maximum	Operate Under Adult Supervision
G & S	16 or Older	According to Local Regulations	—

TREAD LIGHTLY! OFFICIAL[®]
ON PUBLIC AND PRIVATE LAND SPONSOR

Table of Contents

Foreword	1	Control Locations and Functions	48
Parts and Accessories	1	Steering.....	51
Limited Warranty	3	Speedometer/LCD (Digital)	52
Warranty Procedure/Owner		Speedometer/LCD (Analog/Digital)	54
Responsibility	4	Electric Fuel Pump	56
Arctic Cat ATV Emission Control		Gas Hoses	57
Warranty Statement	5	Oil Level Stick.....	57
Arctic Cat Emission Control System		Seat Latch	57
Limited Warranty	6	Tailgate Latch (TBX).....	57
U.S. EPA Emission Control Statement/		Cargo Box Latch Handles (TBX)	57
Warranty Coverage (U.S. Only)	7	Side Storage Compartment (TBX)	58
Declaration of Conformity	8	Safety Flag Bracket	58
DIVISION I - SAFETY		Rack Loading (Front and Rear).....	58
ATV Safety Alert	10	Trailer and Towing.....	58
Rider Training Course	11	Transporting ATV	59
Hangtag	12	Gasoline-Oil-Lubricant	59
Warning Labels & Information	13	Engine Break-In	60
Warnings	14-22	Burnishing Brake Pads.....	61
Prevention	23-26	General Maintenance	62-78
Safe Riding Clothing and Gear	23	Maintenance Schedule	63
ATV Condition	24	Liquid Cooling System	64
T-CLOC	24	Oil Cooler (1000).....	66
First Aid and Survival	25	Shock Absorbers	66
Active Riding	27	General Lubrication.....	66
Sound Judgment	28-33	Hydraulic Hand Brake	68
Environment	28	Brake Fluid	68
Those Around You.....	29	Brake Lever Lock	68
Equipment.....	30	Brake Hoses	68
Load Capacity Ratings Chart.....	31	Brake Pads	68
Speedrack	31	Rear Foot Brake	68
Personal Choices	31	Protective Rubber Boots	69
SIPDE	33	Battery.....	70
Supervision	34	Jump-Starting.....	71
Taking Responsibility.....	34	Spark Plug(s)	73
Inexperienced/Untrained Riders	34	Throttle Cable Adjustment.....	73
Experienced/Trained Riders.....	34	Air Filter.....	74
DIVISION II -		Air Filter Housing Drain(s).....	74
OPERATION/		Draining V-Belt Cover.....	75
MAINTENANCE		Tires	75
ATV Specifications	35-36	Wheels	76
Location of Parts and Controls	37	Muffler/Spark Arrester	76
ATV Operation	38-47	Light Bulb Replacement.....	76
Basic Operating Maneuvers	38	Checking/Adjusting Headlight Aim	77
Starting a Cold Engine.....	38	Fuses	78
BONE-C	38	Electrical Output Terminals	78
Starting the Engine	38	Storage Compartment/Tools	78
Handling the ATV (Active Riding		Preparation for Storage	79
Techniques).....	40	Preparation after Storage	80
Tips	45	Maintenance Record	81
General Information	48-61	Change of Address, Ownership, or	
ATV Identification Numbers.....	48	Warranty Transfer	83
Ignition Switch Key	48	Identification Numbers Record	Inside
		Back Cover	

Limited Warranty

Arctic Cat Inc. (hereinafter referred to as Arctic Cat) extends a limited warranty on each new Arctic Cat ATV it assembles and on each genuine Arctic Cat ATV part and accessory assembled or sold by an authorized Arctic Cat ATV dealer. Warranty on an Arctic Cat ATV is extended to the original retail purchaser; however, the balance of the unused warranty may be transferred to another party. Warranty coverage is only available in the country in which the original retail purchase occurs to the original retail purchaser resident in that country or to a transferee resident in that country of the balance of the unused warranty.

Arctic Cat warrants only the products it assembles and/or sells and does not warrant that other products will function properly when used with an Arctic Cat ATV or will not damage the ATV. Arctic Cat does not assume any liability for incidental or consequential damages.

Arctic Cat will repair or replace, at its option, free of charge (including any related labor charges), any parts that are found to be warrantable in material or workmanship. This repair work **MUST** be done by an authorized Arctic Cat ATV dealer. No transportation charges, rental charges, or inconvenience costs will be paid by Arctic Cat. The warranty is validated upon examination of said parts by Arctic Cat or an authorized Arctic Cat ATV dealer. Arctic Cat reserves the right to inspect such parts at its factory for final determination if warranty should apply.

The warranty periods are as follows:

1. Six months from the date of sale — for an Arctic Cat ATV used for recreational purposes.
2. Ninety days from date of invoice — for an Arctic Cat ATV used for commercial purposes, including rental operations (non-transferable).
3. Thirty days from date of sale of ATV on Arctic Cat supplied batteries.
4. Thirty days from date of sale — for all dealer installed genuine Arctic Cat service parts and accessories.
5. Until expiration of the new product warranty (paragraphs 1 and 2 above) — for all eligible replacement parts on new product.

Exclusions to this warranty include normal wear, abuse, or corrosion and the following parts and items:

Tires	CV Boots	Torn or Punctured Upholstery
Oil Filter	Drive Belt	Cracks or Gouges in Body Panels
Air Filter	Brake Pads	Drive/Driven Clutch Wear Parts
Light Bulbs	Spark Plug(s)	

The following will VOID Arctic Cat's warranty:

1. Failure to perform the proper break-in procedure and all related maintenance, storage procedures (if stored for extended periods), and/or service as recommended in the Operator's Manual.
2. Repairs and/or adjustments by anyone other than an authorized Arctic Cat ATV dealer.
3. Use of improper carburetor main jets.
4. Use of improper gasoline, lubricating oils, or spark plug.
5. An accident or subjecting the ATV to misuse, abuse, or negligent operation.
6. Any modification, addition, or removal of parts unless instructed to do so by Arctic Cat.
7. Use of the ATV in any way for racing purposes.
8. Removal of the engine for use in another vehicle.
9. Removal or mutilation of the Vehicle Identification Number or Engine Serial Number.
10. Use of parts not sold or approved by Arctic Cat.
11. Damage due to improper transportation.

In consideration of the foregoing, any implied warranty is limited in duration to the various warranty periods set forth. This warranty gives you specific legal rights, and you may also have other rights which vary from state/province to state/province or country to country. Some jurisdictions do not allow limitations on how long an implied warranty lasts, so the above limitations may not apply to you.

Warranty Procedure/Owner Responsibility

At the time of sale, an ATV Rider Training Certificate and Owner Registration form is to be completed by the selling dealer and consumer. The receipt of the form by Arctic Cat is a condition precedent to warranty coverage. It is the selling dealer's responsibility to retain and/or submit appropriate copies of the form to the appropriate place(s) to initiate warranty coverage.

The dealer will furnish to the consumer a signed copy of the form which must be presented to the dealer when requesting warranty service. The registration form is the consumer's proof of ownership and warranty eligibility. The form is used by the dealer to validate the warranty claim. Retain your copy of the form and keep it in a safe place.

When warranty repair is suspected, the ATV should be taken to the selling dealer, who has the primary responsibility to perform warranty repairs. Subject to the limitations set forth in the Limited Warranty, in the event the selling dealer has ceased to do business, you have moved, or you are in a location away from your selling dealer, warranty may be performed by any authorized Arctic Cat ATV dealer.

The authorized Arctic Cat ATV dealer will examine the ATV or part to determine if, in his opinion, a warrantable condition exists. If a warrantable condition appears to exist, the dealer will repair or replace, at Arctic Cat's option, free of charge, including any related labor costs, all parts that are found to be warrantable and any other parts which the warrantable part caused to be damaged. You, the owner, will then be asked to sign a warranty form to ensure Arctic Cat that the warranty work was actually performed.

It is the owner's responsibility to maintain and service the ATV in accordance with Arctic Cat's recommendations in the Operator's Manual. To protect yourself and your ATV, follow all safety and service tips. Arctic Cat will NOT warrant repairs required as a result of not performing standard operator maintenance, storage procedures, and service as outlined in the Operator's Manual.

Should you have any questions concerning the warranty, contact an authorized Arctic Cat ATV dealer.

Arctic Cat ATV Emission Control Warranty Statement

Warranty Rights and Obligations

Arctic Cat Inc. (hereinafter referred to as Arctic Cat) and the California Air Resources Board are pleased to explain the emission control system warranty for each new Arctic Cat ATV sold in the state of California. In California, a new ATV must be designed, built, and equipped to meet the state's stringent anti-smog standards.

Arctic Cat warrants the emission control system on the Arctic Cat ATV for the periods listed below provided there has been no abuse, neglect, or improper maintenance of the ATV.

The emission control system may include components such as the carburetor, ignition system, and crankcase ventilation system. Also included may be hoses, belts, connectors, and other emission-related assemblies.

When a warrantable condition exists, Arctic Cat will repair the ATV at no cost to the owner, including diagnosis, parts, and labor.

Emission Control Warranty Coverage

A new Arctic Cat ATV manufactured after January 1, 1997 has a two (2) year warranty on its emissions control components.

If an emission-related component on the ATV is defective, the component will be repaired or replaced by any authorized Arctic Cat ATV dealer.

Owner's Emission Control Warranty Responsibilities

It is the owner's responsibility to perform the required maintenance listed in the Operator's Manual. Arctic Cat recommends the retention of all receipts covering maintenance performed on the ATV, but Arctic Cat cannot deny warranty solely for the lack of receipts or for failure to ensure the performance of all scheduled maintenance on the emission control system.

It is the owner's responsibility to present the ATV to an authorized Arctic Cat ATV dealer as soon as a problem exists. The undisputed warranty repairs should be completed within a reasonable period of time, not to exceed thirty days.

The ATV owner should be aware that Arctic Cat may deny warranty coverage if either the ATV or a component has failed due to abuse, neglect, improper maintenance, or any unapproved modifications.

If you have any questions regarding your warranty rights and responsibilities, contact either Arctic Cat Inc, P.O. Box 810, Thief River Falls, MN 56701, (218) 681-4999 or the California Air Resources Board, 9528 Telstar Avenue, El Monte, CA 91731, (818) 575-6800.

Arctic Cat Emission Control System Limited Warranty

Arctic Cat Inc., P.O. Box 810, Thief River Falls, MN 56701 (hereinafter referred to as Arctic Cat) warrants that this new Arctic Cat ATV manufactured on or after January 1st, 1997:

- A. Is designed, built, and equipped so as to conform at the time of initial purchase with all applicable regulations of the California Air Resources Board and
- B. Is free from defects in material and workmanship which could cause such ATV to fail to conform with applicable regulations of the California Air Resources Board for a period of use of two (2) years from the date of initial retail delivery.

Coverage

Warranty defects shall be remedied during customary business hours at any authorized Arctic Cat ATV dealer located within the state of California in compliance with applicable regulations of the California Air Resources Board. Any component or components replaced under this warranty shall become the property of Arctic Cat.

In California, emission related warranted components are specifically defined by the state's Emission Warranty Parts List. These warranted components are carburetor and internal components, intake manifold, fuel injection system, spark advance mechanism, crankcase breather, air cutoff valve, fuel/vapor separator, canister, igniters, breaker governors, ignition coils, ignition wires, ignition points, condensers and spark plugs if failure occurs prior to the first scheduled replacement, and hoses, clamps, and fittings used directly in these parts. Since emission related components may vary from model to model, certain models may not contain all of these components, and certain models may contain functionally equivalent components.

In California, emission control system emergency repairs, as provided for in the California Administrative Code, may also be performed by other than an authorized Arctic Cat ATV dealer. An emergency situation occurs when an authorized Arctic Cat ATV dealer is not reasonably available, a component is not available within thirty (30) days, or a repair is not complete within thirty (30) days. Any replacement component can be used in an emergency repair. Arctic Cat will reimburse the owner for the expenses, including diagnosis, not to exceed suggested retail price as set forth by Arctic Cat for all warranted components replaced and labor charges based on the recommended time allowance set forth by Arctic Cat for the warranty repair and the geographically appropriate hourly labor rate. The owner may be required to keep receipts and failed components in order to receive compensation.

Limitations

This Emission Control System Warranty shall not cover any of the following:

- A. Repair or replacement required as a result of
 - (1) accident,
 - (2) misuse,
 - (3) lack of required maintenance,
 - (4) repairs improperly performed or replacements improperly installed,
 - (5) use of replacement components or accessories not conforming to Arctic Cat specifications which adversely affect performance, and/or
 - (6) use in competitive racing or related events.
- B. Inspections, replacement of components, and other services or adjustments necessary for required maintenance.

Limited Liability

The liability of Arctic Cat under this Emission Control System Warranty is limited solely to the remedying of defects in material and workmanship by an authorized Arctic Cat ATV dealer at its place of business during customary business hours. This warranty does not cover inconvenience or loss of use of the ATV or transportation of the ATV to or from the Arctic Cat ATV dealer.

ARCTIC CAT SHALL NOT BE LIABLE FOR ANY OTHER EXPENSES, LOSS, OR DAMAGE, WHETHER DIRECT, INCIDENTAL, CONSEQUENTIAL, OR EXEMPLARY, ARISING IN CONNECTION WITH THE SALE OR USE OF, OR INABILITY TO USE THE ARCTIC CAT ATV FOR ANY PURPOSE. SOME STATES DO NOT ALLOW THE EXCLUSION OR LIMITATION OF ANY INCIDENTAL OR CONSEQUENTIAL DAMAGES, SO THE ABOVE MAY NOT APPLY TO YOU.

NO EXPRESS EMISSION CONTROL SYSTEM WARRANTY IS GIVEN BY ARCTIC CAT EXCEPT AS SPECIFICALLY SET FORTH HEREIN. ANY EMISSION CONTROL SYSTEM WARRANTY IMPLIED BY LAW, INCLUDING ANY WARRANTY OF MERCHANTABILITY OR FITNESS FOR A PARTICULAR PURPOSE, IS LIMITED TO THE EXPRESS EMISSION CONTROL SYSTEM WARRANTY TERMS STATED IN THIS WARRANTY. THE FOREGOING STATEMENTS OF WARRANTY ARE EXCLUSIVE AND IN LIEU OF ALL OTHER REMEDIES.

No dealer is authorized to modify this Arctic Cat Inc. Limited Emission Control System Warranty.

Legal Rights

THIS WARRANTY GIVES YOU SPECIFIC LEGAL RIGHTS, AND YOU MAY ALSO HAVE OTHER RIGHTS WHICH VARY FROM STATE TO STATE.

THIS WARRANTY IS IN ADDITION TO THE ARCTIC CAT INC. LIMITED ATV WARRANTY.

Additional Information

Any replacement component that is equivalent in performance and durability may be used in the performance of any maintenance or repairs. However, Arctic Cat is not liable for these components. The owner is responsible for the performance of all required maintenance. Such maintenance may be performed at a service establishment or by any individual. The warranty period begins on the date the ATV is delivered to the owner.

U.S. EPA Emission Control Statement/Warranty Coverage (U.S. Only)

STATEMENT/WARRANTY

Arctic Cat warrants to the original retail purchaser, and each subsequent purchaser, that all U.S. EPA-certified Arctic Cat ATV's are designed, built, and equipped to conform to all U.S. EPA Emission Control Regulations. Please read the following information completely.

Your authorized Arctic Cat ATV dealer will repair or replace any defective emission-related component at no cost to you during the warranty period. You may have non-warranty service performed by any repair establishment that uses equivalent components. The regulations provide significant civil penalties for tampering that causes your ATV to no longer meet U.S. EPA emission standards.

Arctic Cat further warrants that the engine and its emission-related components are free from defects in materials or workmanship that could cause the engine to fail to comply with applicable regulations during the warranty period.

If you have any questions about this information, or the emission warranty coverage statement, contact your local authorized Arctic Cat ATV dealer.

WARRANTY PERIOD

The emission warranty period for this ATV begins on the same date as the standard warranty coverage and continues for 30 months or 3100 miles, whichever comes first.

COMPONENTS COVERED

The emissions warranty covers major emissions control components and emission-related components listed as follows:

Engine Management and Sensors

Barometric Pressure Sensor
Camshaft Position Sensor
Engine Control Unit (ECU)
Engine Coolant Temperature Sensor
Intake Air Temperature Sensor
Manifold Absolute Pressure Sensor
Oxygen Sensor
Throttle Position Sensor
Crankshaft Position Sensor
Exhaust Temperature Sensor

Ignition System

Ignition Coil
Knock Sensor System
Spark Plugs
Capacitive Discharge Ignition (CDI) Module
Magneto Pick-Up

Fuel/Air System

Fuel Injectors
Fuel Pressure Regulator
Fuel Pump
Carburetor(s)
Turbocharger Assembly
Air Bypass Valve
Turbo Waste Gate Control Valve
Crankcase Ventilation System
ISC Valve

Miscellaneous Items Used in Aforementioned Systems

Connectors
Switches
Grommets
Clamps
Hoses
Ties
Gaskets
Wiring

OWNER'S RESPONSIBILITIES

The owner of any ATV warranted under this Arctic Cat Emission Control Statement is responsible for the proper maintenance and use of the ATV as stated in the Operator's Manual. Proper maintenance generally includes replacement and service, at the owner's choosing, such items as air filter, oil and oil filter, or any other part, item, or device related to emissions control as specified in the Operator's Manual. It is the owner's responsibility to ensure that the ATV is used in a manner for which it was designed.

Declaration of Conformity

Application of council directives:

EMC Directive 97/24/EC

Date of Issue: June, 1997

EC Machinery Directive 2006/42/EC

Date of Issue: May, 2006

Issued by European Commission.

Type of Equipment: All-Terrain Vehicles

Brand Name: Arctic Cat

Model:450 i 4x4

550 i 4x4

700 i 4x4

700 i Mud Pro

700 i TBX 4x4

1000 i Mud Pro

1000 i 4x4

Standards to which conformity is declared: EN 61000-6-2:2005
EN 55012:2007

Manufacturer (if not issuing agent):

Arctic Cat Inc.

601 Brooks Ave S.

Thief River Falls, MN

56701 USA

I, the undersigned, hereby declare that the equipment specified above conforms to the directive(s) and standard(s) as specified.

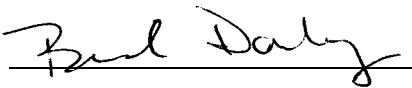

Brad Darling

Vice President/General Manager

DIVISION I - SAFETY

AN ATV IS NOT A TOY AND CAN BE HAZARDOUS TO OPERATE.

- Always go slowly and be extra careful when operating on unfamiliar terrain. Always be alert to changing terrain conditions when operating the ATV.
- Never operate on excessively rough, slippery, or loose terrain.
- Always follow proper procedures for turning as described in this manual. Practice turning at slow speeds before attempting to turn at faster speeds. Do not turn at excessive speed.
- Always have the ATV checked by an authorized Arctic Cat ATV dealer if it has been involved in an accident.
- Never operate the ATV on hills too steep for the ATV or for your abilities. Practice on smaller hills before attempting larger hills.
- Always follow proper procedures for climbing hills as described in this manual. Check the terrain carefully before you start up any hill. Never climb hills with slippery or loose surfaces. Shift your weight forward. Never open the throttle suddenly or make sudden gear changes. Never go over the top of any hill at high speed.
- Always follow proper procedures for going down hills and for braking on hills as described in this manual. Check the terrain carefully before you start down any hill. Shift your weight backward. Never go down a hill at high speed. Avoid going down a hill at an angle which would cause the ATV to lean sharply to one side. Go straight down the hill where possible.
- Always follow proper procedures for crossing the side of a hill as described in this manual. Avoid hills with slippery or loose surfaces. Shift your weight to the uphill side of the ATV. Never attempt to turn the ATV around on any hill until you have mastered the turning techniques described in this manual on level ground. Avoid crossing the side of a steep hill if possible.
- Always be careful of skidding or sliding. On slippery surfaces, such as ice, go slowly and be very cautious in order to reduce the chance of skidding or sliding out of control.
- Always use proper procedures if you stall or roll backward when climbing a hill. To avoid stalling, maintain a steady speed when climbing a hill. If you stall or roll backwards, follow the special procedure for braking described in this manual. Dismount on the uphill side or to either side if pointed straight uphill. Turn the ATV around and mount following the procedure described in this manual.
- Always check for obstacles before operating in a new area. Never attempt to operate over large obstacles, such as large rocks or fallen trees. Always follow proper procedures when operating over obstacles as described in this manual.
- Never operate an ATV in fast flowing water or in water deeper than the footrests. Remember that wet brakes may have reduced stopping capability. Test your brakes after leaving water. If necessary, apply them lightly several times to let friction dry out the pads.
- Always be sure there are no obstacles or people behind you when you operate in reverse. When it is safe to proceed in reverse, go slowly. Avoid turning at sharp angles in reverse.
- Always use the size and type tires specified in this manual. Always maintain proper tire pressure as described in this manual.
- Never improperly install or improperly use accessories on this ATV.
- Never install a twist grip throttle on this ATV.
- Never exceed the stated load capacity for an ATV. Cargo should be properly distributed and securely attached. Reduce speed and follow instructions in this manual for carrying cargo or pulling a trailer and allow greater distance for braking.
- No one under the age of 16 should operate this ATV. Some operators at the age of 16 may not be able to operate an ATV safely. Parents should supervise the use of the ATV at all times. Parents should permit continued use only if they determine that the operator has the ability to operate the ATV safely.

FOR MORE INFORMATION ABOUT ATV SAFETY, call the ATV Safety Institute at 1-800-887-2887 (U.S.) or 1-613-739-1535 (Canada).

ATV Safety Alert

The Consumer Product Safety Commission has concluded that ALL-TERRAIN VEHICLES (ATV's) may present a risk of DEATH or SEVERE INJURY in certain circumstances. Accidents may occur for many reasons:

- *** Over 2591 people, including many children, have died in accidents associated with ATV's since 2005.
- *** Many people have become severely paralyzed or suffered severe internal injuries as a result of accidents associated with ATV's.
- *** Every month thousands of people are treated in hospital emergency rooms for injuries received while riding an ATV.

You should be aware that AN ATV IS NOT A TOY AND CAN BE HAZARDOUS TO OPERATE. An ATV handles differently from other vehicles, including motorcycles and cars. A collision or roll-over can occur quickly, even during routine maneuvers such as turning and driving on hills and over obstacles, if you fail to take proper precautions.

TO AVOID DEATH OR SEVERE PERSONAL INJURY:

- * Always read the Operator's Manual carefully and follow the operating procedures described. Pay special attention to the warnings contained in the manual and on all labels.
- * Never operate an ATV without proper instruction. Take a training course. Beginners should complete a training course.
- * Always follow these age recommendations:
 - A Y-12+ is intended for use by children age 12 or older, and a T-14 is intended for use by an operator age 14 or older.
 - A child under 16 years old should never operate an ATV without adult supervision. Children need to be observed carefully because not all children have the strength, size, skills, or judgment to operate an ATV safely.

- * Never carry a passenger on an ATV. Carrying a passenger may upset the balance of the ATV and may cause it to go out of control.
- * Always avoid paved surfaces. ATV's are not designed to be used on paved surfaces and may seriously affect handling and control.
- * Never operate an ATV on a public road, even a dirt or gravel one, because you may not be able to avoid colliding with other vehicles. Also, operating an ATV on a public road may be against the law.
- * Never operate an ATV without an approved motorcycle helmet, eye protection, boots, gloves, long pants, and a long-sleeved shirt or jacket.
- * Never consume alcohol or drugs before or while operating an ATV.
- * Never operate an ATV at excessive speeds. Go at a speed which is proper for the terrain, visibility conditions, and your experience.
- * Never attempt to do wheelies, jumps, or other stunts.
- * Always be careful when operating an ATV, especially when approaching hills, turns, and obstacles and when operating on unfamiliar or rough terrain.
- * Never lend an ATV to anyone who has not taken a training course or has not been driving an ATV for at least a year.

Rider Training Course

Arctic Cat sponsors a free Rider Training Course to teach ATV riding skills or to reinforce current riding skills. First-time purchasers without any previous ATV riding experience will receive a \$100.00 coupon from Arctic Cat through the SVIA/ASI after completing the training course (U.S. owners only, one incentive, and free rider training courses for appropriate immediate family members per ATV purchase). See an authorized Arctic Cat ATV dealer for details or call (800) 887-2887 for training course information.

In Canada, the Canada Safety Council (CSC) provides an ATV Rider's Course to teach safe ATV operating skills. They also provide a special ATV Rider's Course for children under 14 years of age with parental supervision. Call the CSC at 1-613-739-1535 ext. 227 for more details. Also available is a bilingual computer-based safety training program on a CD-ROM from CATV - call toll-free at 1-877-470-2288.

Au Canada, le conseil canadien de la sécurité (CSC) offre un cours de conduite de VTT pour enseigner les habiletés d'opération sécuritaires de VTT. Un cours spécial de conduite de VTT est également offert aux enfants de moins de 14 ans avec la surveillance d'un parent. Communiquez avec le CSC en composant le: 1-613-739-1535, poste 227 pour de plus amples informations. Un programme de formation bilingue informatisé sur la sécurité est aussi disponible sur disque optique compact par CATV; composez sans frais le: 1-877-470-2288.



FOR MORE INFORMATION ABOUT ATV SAFETY, in the U.S., call the Consumer Product Safety Commission at (800) 638-2772 or the ATV Distributors' Safety Hotline at (800) 852-5344 or in Canada, call the Canada Safety Council at 1-613-739-1535 ext. 227.

Visit the Arctic Cat Inc. website at www.arcticcat.com for additional product information.

Hangtag

An Arctic Cat ATV comes with a hangtag containing important safety information. Anyone who rides the ATV should read and understand this information before riding.

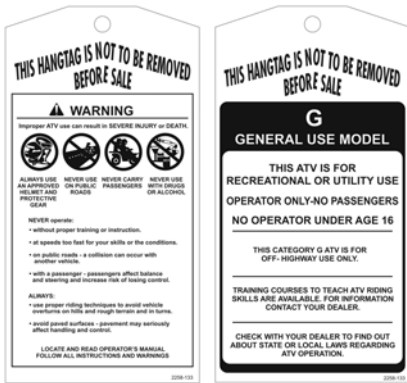

2258-133

Pour commander des Etiquettes de Mise en Garde gratuites, voyez votre détaillant de autorisé VTT Arctic Cat pour le numéro de pièce 1436-344.

Warnings

WARNING

POTENTIAL HAZARD

Operating this ATV without proper instruction.

WHAT CAN HAPPEN

The risk of an accident is greatly increased if the operator does not know how to operate the ATV properly in different situations and on different types of terrain.

HOW TO AVOID THE HAZARD

Beginning and inexperienced operators should complete the certified training course offered. They should then regularly practice the skills learned in the course and the operating techniques described in this Operator's Manual.

For more information about the training course, contact an authorized Arctic Cat ATV dealer or call 1-800-887-2887 (U.S.) or 1-613-739-1535 (Canada).

WARNING

POTENTIAL HAZARD

Allowing anyone under age 16 to operate this ATV.

WHAT CAN HAPPEN

Use of an ATV by children can lead to severe injury or death of the child.

Children under the age of 16 may not have the skills, abilities, or judgment needed to operate the ATV safely and may be involved in a serious accident.

HOW TO AVOID THE HAZARD

A child under 16 should never operate this ATV.

WARNING

POTENTIAL HAZARD

Carrying a passenger on this ATV.

WHAT CAN HAPPEN

Greatly reduces your ability to balance and control this ATV.

Could cause an accident, resulting in injury or death to you and/or your passenger.

HOW TO AVOID THE HAZARD

Never carry a passenger. The long seat is to allow the operator to shift positions as needed during operation. It is not for carrying passengers.

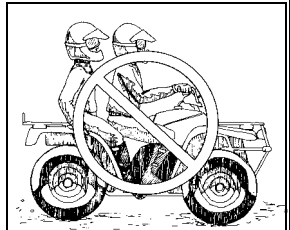

WARNING

POTENTIAL HAZARD

Attempting wheelies, jumps, and other stunts.

WHAT CAN HAPPEN

Increases the chance of an accident including a roll-over.

HOW TO AVOID THE HAZARD

Never attempt stunts, such as wheelies or jumps. Don't try to show off.



Warnings

WARNING

POTENTIAL HAZARD

Operating this ATV on paved surfaces.

WHAT CAN HAPPEN

The ATV's tires are designed for off-road use only, not for use on pavement. Paved surfaces may seriously affect handling and control of the ATV and may cause the ATV to go out of control.

HOW TO AVOID THE HAZARD

Never operate the ATV on any paved surfaces, including sidewalks, driveways, parking lots, and streets.



WARNING

POTENTIAL HAZARD

Operating this ATV without wearing an approved helmet, eye protection, and protective clothing.

WHAT CAN HAPPEN

Operating without an approved helmet increases your chances of a severe head injury or death in the event of an accident.

Operating without eye protection can result in an accident and increases your chances of a severe injury in the event of an accident.

Operating without protective clothing increases your chances of severe injury in the event of an accident.

HOW TO AVOID THE HAZARD

Always wear an approved helmet that fits properly.

You should also wear: Eye protection (goggles or face shield)

Gloves

Boots

Long sleeved shirt or jacket

Long pants

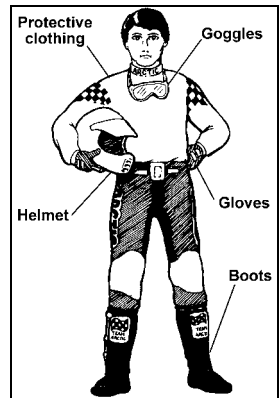

WARNING

POTENTIAL HAZARD

Failure to use extra care when operating on rough, slippery, or loose terrain.

WHAT CAN HAPPEN

Could cause loss of traction or ATV control, which could result in an accident including a rollover.

HOW TO AVOID THE HAZARD

Do not operate on rough, slippery, or loose terrain until you have learned and practiced the skills necessary to control the ATV on such terrain.

Always be especially cautious on these kinds of terrain.

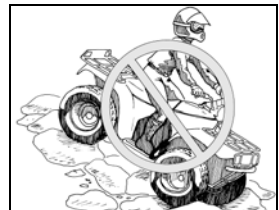

Warnings

WARNING

POTENTIAL HAZARD

Operating this ATV after or while consuming alcohol or drugs.

WHAT CAN HAPPEN

- Could seriously affect your judgment.
- Could cause you to react more slowly.
- Could affect your balance and perception.
- Could result in an accident.

HOW TO AVOID THE HAZARD

Never consume alcohol or drugs before or while driving this ATV.

WARNING

POTENTIAL HAZARD

Operating this ATV at excessive speeds.

WHAT CAN HAPPEN

Increases your chances of losing control of the ATV, which can result in an accident.

HOW TO AVOID THE HAZARD

Always ride at a speed that is proper for the terrain, visibility and operating conditions, and your experience.

WARNING

POTENTIAL HAZARD

- Failure to inspect the ATV before operating.
- Failure to properly maintain the ATV.

WHAT CAN HAPPEN

Increases the possibility of an accident or equipment damage.

HOW TO AVOID THE HAZARD

- Always inspect your ATV each time you use it to make sure the ATV is in safe operating condition.
- Always follow the inspection and maintenance procedures and schedules described in this Operator's Manual.

WARNING

POTENTIAL HAZARD

Removing hands from handlebar or feet from footrests during operation.

WHAT CAN HAPPEN

Removing even one hand or foot can reduce your ability to control the ATV or could cause you to lose your balance and fall off the ATV. If you remove a foot from a footrest, your foot or leg may come into contact with the wheels, which could injure you or cause an accident.

HOW TO AVOID THE HAZARD

Always keep both hands on the handlebar and both feet on the footrests of your ATV during operation.

Warnings

WARNING

POTENTIAL HAZARD

Failure to use extra care when operating the ATV on unfamiliar terrain.

WHAT CAN HAPPEN

You can come upon hidden rocks, bumps, or holes without enough time to react.

Could result in the ATV overturning or going out of control.

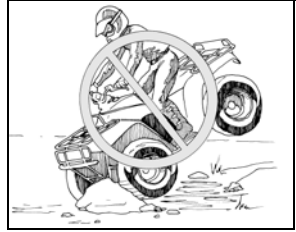

HOW TO AVOID THE HAZARD

Go slowly and be extra careful when operating on unfamiliar terrain.

Always be alert to changing terrain conditions when operating the ATV.

WARNING

POTENTIAL HAZARD

Improperly crossing hills or turning on hills.

WHAT CAN HAPPEN

Could cause loss of control or cause the ATV to overturn.

HOW TO AVOID THE HAZARD

Never attempt to turn the ATV around on any hill until you have mastered the turning technique as described in this Operator's Manual. Practice first on level ground. Be very careful when turning on any hill.

Avoid crossing the side of a steep hill, if possible.

When crossing the side of a hill:

Always follow proper procedures as described in this Operator's Manual.

Avoid hills with slippery or loose surfaces.

Shift your weight to the uphill side of the ATV.

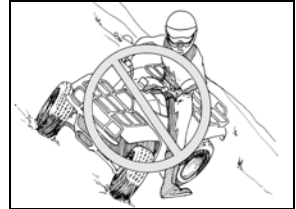

WARNING

POTENTIAL HAZARD

Going down a hill improperly.

WHAT CAN HAPPEN

Could cause loss of control or cause the ATV to overturn.

HOW TO AVOID THE HAZARD

Always follow proper procedures for going down hills as described in this Operator's Manual.

Always check the terrain carefully before you start down any hill.

Shift your weight backward.

Never go down a hill at high speed.

Avoid going down a hill at an angle that would cause the ATV to lean sharply to one side. Go straight down the hill where possible.

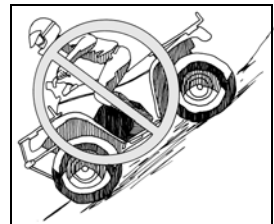

Warnings

WARNING

POTENTIAL HAZARD

Turning improperly.

WHAT CAN HAPPEN

ATV could go out of control, causing a collision or rollover.

HOW TO AVOID THE HAZARD

Always follow proper procedures for turning as described in this Operator's Manual.

Practice turning at slow speeds before attempting to turn at faster speeds.

Do not turn at excessive speed.

WARNING

POTENTIAL HAZARD

Climbing hills improperly.

WHAT CAN HAPPEN

Could cause loss of control or cause the ATV to overturn.



HOW TO AVOID THE HAZARD

Always follow proper procedures for climbing hills as described in this Operator's Manual.

Always check the terrain carefully before you start up any hill.

Never climb hills with slippery or loose surfaces.

Shift your weight forward.

Never open the throttle suddenly or make sudden gear changes. The ATV could flip over backwards.

Never go over the top of any hill at high speed. An obstacle, a sharp drop, or another vehicle or person could be on the other side of the hill.

NEVER OPERATE UP OR DOWN HILLS STEEPER THAN 25°

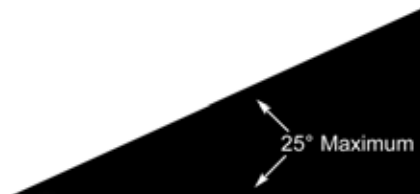

Warnings

WARNING

POTENTIAL HAZARD

Operating on steep hills.

WHAT CAN HAPPEN

The ATV can overturn more easily on steep hills than on level surfaces or small hills.

HOW TO AVOID THE HAZARD

Never operate the ATV on hills too steep for the ATV or for your abilities.

Practice on smaller hills before attempting larger hills.

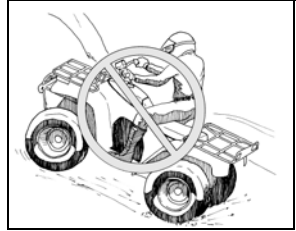

WARNING

POTENTIAL HAZARD

Stalling, rolling backwards, or improperly dismounting while climbing a hill.

WHAT CAN HAPPEN

Could result in the ATV overturning.

HOW TO AVOID THE HAZARD

Use proper gear and maintain steady speed when climbing a hill.

If you lose all forward speed:

Keep weight uphill.

Apply the brakes.

Engage the brake lever lock after you are stopped.

If you begin rolling backwards:

Keep weight uphill.

Apply the brakes while rolling backwards.

When fully stopped, engage the brake lever lock.

Dismount on uphill side or to a side if pointed straight uphill.

Turn the ATV around and mount following the procedure described in this Operator's Manual.

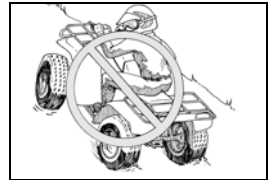

WARNING

POTENTIAL HAZARD

Overloading the ATV or carrying or towing cargo improperly.

WHAT CAN HAPPEN

Could cause changes in ATV handling, which could lead to an accident.

HOW TO AVOID THE HAZARD

Never exceed the stated load capacity for the ATV.

Cargo should be properly distributed and securely attached.

Reduce speed when carrying cargo or pulling a trailer. Allow greater distance for braking.

Always follow the instructions in this Operator's Manual for carrying cargo or pulling a trailer.

Warnings

WARNING

POTENTIAL HAZARD

Improperly operating over obstacles.

WHAT CAN HAPPEN

Could cause loss of control or a collision. Could cause the ATV to overturn.

HOW TO AVOID THE HAZARD

Before operating in a new area, check for obstacles.

Never attempt to ride over large obstacles, such as large rocks or fallen trees.

When you go over obstacles, always follow proper procedures as described in this Operator's Manual.

WARNING

POTENTIAL HAZARD

Skidding or sliding.

WHAT CAN HAPPEN

You may lose control of the ATV.

You may also regain traction unexpectedly, which may cause the ATV to overturn.

HOW TO AVOID THE HAZARD

Learn to safely control skidding or sliding by practicing at slow speeds and on level, smooth terrain.

On extremely slippery surfaces, such as ice, go slowly and be very cautious in order to reduce the chance of skidding or sliding out of control.

WARNING

POTENTIAL HAZARD

Operating the ATV with improper modifications.

WHAT CAN HAPPEN

Improper installation of accessories or modification of the ATV may cause changes in handling which, in some situations, could lead to an accident.

HOW TO AVOID THE HAZARD

Never modify the ATV through improper installation or improper use of accessories. All parts and accessories added to this ATV should be genuine Arctic Cat ATV components designed for use on the ATV and should be installed and used according to instructions. Never install a twist grip throttle. If you have questions, consult an authorized Arctic Cat ATV dealer.

WARNING

POTENTIAL HAZARD

Improperly operating in reverse.

WHAT CAN HAPPEN

You could hit an obstacle or person behind you, resulting in serious injury.

HOW TO AVOID THE HAZARD

Before you engage reverse gear, make sure there are no obstacles or people behind you. When it is safe to proceed, go slowly.

Warnings

WARNING

POTENTIAL HAZARD

Operating this ATV on public streets, roads, or highways.

WHAT CAN HAPPEN

You can collide with another vehicle.

HOW TO AVOID THE HAZARD

Never operate this ATV on any public street, road, or highway, even a dirt or gravel one.

In many states it is illegal to operate an ATV on public streets, roads, or highways.

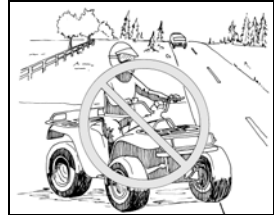

WARNING

POTENTIAL HAZARD

Operating the ATV with improper tires or with improper or uneven tire pressure.

WHAT CAN HAPPEN

Use of improper tires on the ATV or operation of the ATV with improper or uneven tire pressure may cause loss of control increasing your risk of accident.

HOW TO AVOID THE HAZARD

Always use the size and type tires specified in this Operator's Manual for this ATV.

Always maintain proper tire pressure as described in this Operator's Manual.

WARNING

POTENTIAL HAZARD

Operating the ATV through deep or fast flowing water.

WHAT CAN HAPPEN

Tires may float, causing loss of traction and loss of control, which could lead to an accident.

HOW TO AVOID THE HAZARD

Never operate the ATV in fast flowing water or in water deeper than the footrests.

Remember that wet brakes may have reduced stopping capability.

Test your brakes after leaving water. If necessary, apply them several times to dry out the pads.

WARNING

POTENTIAL HAZARD

Application of excessive throttle.

WHAT CAN HAPPEN

May cause wheelies, flip-overs, or loss of control resulting in serious injury or death.

HOW TO AVOID THE HAZARD

Do not accelerate rapidly or in an uncontrolled manner on any terrain. Use extra care when going uphill.

Slowly apply throttle in a controlled manner. Release throttle lever as necessary to maintain control.

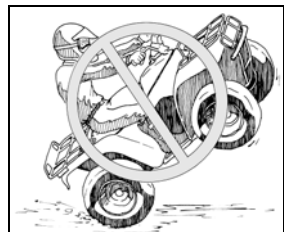

Warnings

WARNING

POTENTIAL HAZARD

Operating the ATV with differential lock engaged.

WHAT CAN HAPPEN

The increased steering effort and reduced maneuverability caused by the locked differential could result in loss of control and an accident.

HOW TO AVOID THE HAZARD

Never exceed 10 MPH (16 KPH) with the differential lock engaged. Always disengage the differential lock as soon as not needed for additional traction.

WARNING

POTENTIAL HAZARD

Failure to release the brake lever lock before driving the ATV.

WHAT CAN HAPPEN

Driving the ATV with the brake lever lock engaged could cause a change in handling or loss of brakes and cause an accident.

HOW TO AVOID THE HAZARD

Always release the brake lever lock before driving the ATV.

Prevention

Overview

When using an ATV, prevention is the name of the game. "Had you only known" something could go wrong, you would have prevented it. If you don't notice your conditions and surroundings before riding your ATV, you give up control over the situation. Using ATV prevention techniques helps you forecast potential hazards before they injure you or damage your ATV.

Following the safety instructions and warnings in this manual will help you "P.A.S.S." the safety test. P.A.S.S. stands for "Prevention," "Active Riding," "Sound Judgment," and "Supervision." Remembering P.A.S.S. and what it stands for will help you have a safe, predictable ride every time you go out on your ATV.

Safe Riding Clothing and Gear

Always wear clothing suited to the type of riding you are doing. ATV riding requires special protective clothing which will make you feel more comfortable and reduce chances of injury.

You'll find it important to dress correctly for ATV riding in order to prevent scraped skin and serious head injuries. It's easy and could save you time in the long run not having to contend with an injury. Of course, it also makes sense to remember the seasons. Wear a hat under your helmet and a snowmobile suit in the winter and lighter, protective clothing in the summer. Following is the minimum protection you need to wear during every ride.

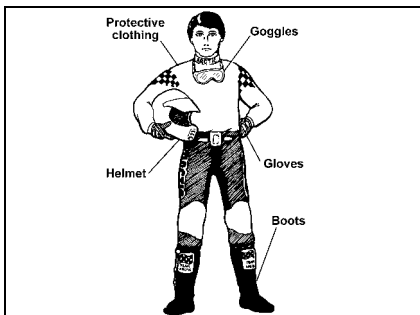

ATV-0004

Gloves

Your hands are targets for flying objects and branches. Along with providing skin protection, gloves will shield your hands from harsh weather. Wear gloves that are weather resistant and have a gripping surface to keep them from sliding off the handlebars. Off-road style gloves with knuckle pads are the best for comfort and protection.

Boots/Ankle Protection

Wear a boot that covers the largest possible area of your leg (preferably up to your knee) and can handle significant impact. Choosing boots with low heels and a good tread will help prevent your feet from slipping off the footrests in wet or rugged conditions or getting hurt if they get hit by rocks, dirt, or branches.

Helmet

Your helmet is the most important piece of protective gear for safe riding. A helmet can prevent a severe head injury. There are several types of helmets on the market, but make sure you wear a helmet that complies with the current standards of the U.S. Department of Transportation (DOT), The Snell Memorial Foundation, or the American National Standards Institute (ANSI). Helmets that comply with one or more of these agency's standards have a sticker on the inside or outside of the helmet.

TESTIMONIAL

DOCUMENT#: N490117A1

CITY/STATE: N. HUNTINGDON, PA

SEX: M

AGE: 6

BODY PART: HEAD

DATE ACCIDENT: 06-14-94

DISPOSITION: DOA

SYNOPSIS: The 6 year old male victim died from blunt force trauma to the head when the 4-wheel ATV on which he was a passenger struck a rock on a hill connecting two roads and flipped over backwards onto the victim, shattering his bicycle helmet. The victim was life-flighted to the hospital and died that night. The driver of the ATV, the victim's 29 year old father, sustained minor injuries, but wasn't treated.

Prevention

Helmets should have one of these:

1. DOT label
2. Snell label
3. ANSI Z90.1 label

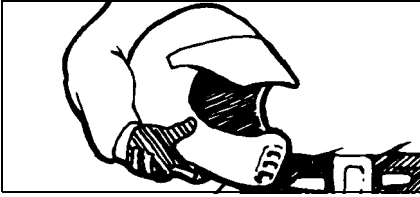

These helmets should provide full-face protection.

If you drop or damage your helmet, get a new one immediately. Your helmet may not protect your head from injury if it has cracks, fissures, or other damage to its outside or core padding.

Remember, your helmet won't do you any good if the chin strap isn't fastened.

Eye Protection

Wear eye protection, such as goggles, to completely surround your eyes to prevent getting dirt or other items in your eyes. Do not depend on sunglasses for proper eye protection. Sunglasses are not recommended; they don't prevent objects from flying in through the sides.

One easy way to remember what parts you need to check is by using the acronym "T-CLOC." It stands for:

T	C	L	O	C
TIRES AND WHEELS	CONTROLS AND CABLES	LIGHTS AND ELECTRIC	OIL AND FUEL	CHASSIS

1. Tires and Wheels

Correct tire pressure is crucial. Consult the ATV Specifications section of this Operator's Manual for tire pressure guidelines. Incorrect tire pressure can cause poor handling, instability, and a loss of ATV control.

Check:

1. Tire pressure
2. Tire surface (tread and sidewalls)

Long Pants and Long Sleeved Shirt

The goal is to protect your body from branches, long grass, airborne objects, or anything else that could scrape your skin. The more thick and durable the material, the better protection it'll provide. Riding pants with kneepads, a jersey, and shoulder pads provide the best protection.

ATV Condition

The second step in Prevention is checking the condition of your ATV. Chances are good that you'll be using your ATV in some rough terrain, and there's no way you want your brakes to go out when riding downhill. You need to check the following parts on your ATV before every ride.

1. Tires and Wheels
2. Controls and Cables
3. Lights and Electric
4. Oil and Fuel
5. Chassis
6. Miscellaneous Items

While checking the tire pressure, inspect the tread and sidewalls of the tires for cracks, cuts, or other damage that could indicate they need to be replaced.

2. Controls and Cables

With the engine running and brake applied, check all transmission positions: forward, neutral, and reverse.

Check:

1. Forward
2. Neutral
3. Reverse

Prevention

A. Brakes

Squeeze the hand brake lever. If it feels soft or “squishy,” it could be low on fluid or have a leak — refer to the General Maintenance section of this Operator’s Manual for instructions. Don’t use the ATV until the brakes are operating normally.

Test the brake lever lock and see if it locks the hand brake lever into position; then disengage it to release the brake. Be sure the rear foot brake near the footrest is working; your brakes could fail during a ride if they’re not maintained.

Check:

1. Hand brake lever
2. Rear foot brake
3. Brake lever lock

B. Throttle

The throttle should have a free, smooth range of motion. If it seems to “stick” at any point, refer to the General Maintenance section of this Operator’s Manual for instructions. Driving your ATV with a sticking throttle can turn your leisurely ride into an unwelcome accident. Don’t drive your ATV if the throttle sticks.

Check:

1. Free, smooth range of motion

3. Lights and Electric

Turn the hi-beam and lo-beam on and off to make sure they work. At the same time, check that the taillight and brake-light work. Also, check the status/warning indicators (reverse, neutral, and hi-lo beam) on the handlebar when you start the ATV. Don’t drive the ATV unless all systems are working. Check the ignition switch and engine stop switch.

Check:

1. Hi-beam
2. Lo-beam
3. Taillight/brakelight
4. Status/warning indicators
5. Ignition switch
6. Engine stop switch

4. Oil and Fuel

Start with a full tank of gas before every ride, and while you’re at it, top off the oil. Don’t forget to check for fluid leaks around the ATV. Watch the overheat indicator to ensure the engine coolant level is adequate.

Check:

1. Gas
2. Oil
3. Fluid leaks

5. Chassis

Grass and leaves can gum-up your suspension and shocks. Clear and clean the suspension arms, shock springs, and fenders. Check smoothness by turning the handlebar full-left and full-right. Check that there is no binding, restrictions, free-play, or looseness in steering components.

Check:

1. Suspension arms
2. Shock springs
3. Fenders
4. Steering

6. Miscellaneous Items

Inspect your air filter. Look for debris or damage that may indicate you need to replace it. A clogged filter can stop an engine. Check your battery terminals for corrosion. Also, be sure to tighten any loose parts, nuts, or bolts.

Check:

1. Air filter
2. Battery
3. Tighten parts, nuts, and bolts

First Aid and Survival

You need to prepare for the unexpected. Emergencies and accidents are traumatic enough, but they’re even worse when you’re not prepared for them. At the minimum during every ATV ride, you should have the following items on board:

- Tools
- Water
- Identification
- First Aid Kit

For rides that are longer in duration and distance, the following additional items are recommended:

Prevention

- Cellular Phone
- Maps/GPS
- Emergency Kit *with Flashlight and First Aid Kit*

Tools

Routine maintenance will generally eliminate the need for emergency repairs. Riding on rough terrain could cause loosening of nuts, bolts, and fasteners. Especially on long rides, carrying the right tools can prevent an inconvenience from becoming a crisis.

Carry these items on your ATV:

- | | |
|--------------|----------------|
| 1. Bulbs | 4. Spark plugs |
| 2. Duct tape | 5. Spare parts |
| 3. Rope | 6. Tool Kit |

Water

Water is so important that you need to carry it regardless of the duration of your ride. Heat exhaustion and heat stroke can creep up suddenly and can take you out of commission. If you become dehydrated, you could find yourself physically unable to safely operate your ATV.

Identification

If something does happen to you, the emergency personnel will want to know who you are and whom to contact. It's possible you may be in no condition to give them that information. Put your I.D. in your pocket before you ride. Without it, you're anonymous.

Cellular Phone

It may be necessary to make an urgent phone call.

Maps/GPS (Global Positioning System)

Maps may be unnecessary when you're familiar with the area. But when you're riding on unfamiliar trails, it's good to know where you are, what's coming up, and how to get back.

Emergency Kit with Flashlight and First Aid Kit

You'll need several items in your Emergency Kit including a flashlight. The matches will come in handy if you need to start a fire to stay warm. Flares are appropriate for signaling help. A first aid kit is very important if an injury of some type should happen. A good First Aid Kit should include bandages, antiseptic spray, gauze, tape, etc.

Carry these items:

1. Flashlight
2. Matches
3. Flares
4. First Aid Kit
5. Money

Active Riding

Overview

“Active Riding” is the second part of “P.A.S.S.” It involves an understanding of how your body weight, balance, gravity, and physical forces affect the handling of the ATV. For example, when you drive a car quickly into a sharp turn, your body is pulled to the outside of the vehicle by centrifugal force. Although a car is relatively stable, enough centrifugal force can cause an ATV to overturn. Constantly shifting your weight is one major difference between driving a car and riding an ATV. Knowing how to shift your weight is necessary to avoid rolling or flipping the ATV.

For complete operating instructions, see ATV Operation sub-section in this manual.

Sound Judgment

Overview

You are not invincible. Knowing that the first “S” in “P.A.S.S.” stands for “Sound Judgment” means you need to use yours.

Do you consider yourself to be pretty conservative, or are you a heavy risk-taker? Before continuing with this section on sound judgment, check your **Risk Factor** by doing this short survey:

1. Do you drive over the speed limit?

1 2 3
Never Sometimes Often

2. Are you more daring around your friends than you are when alone?

1 2 3
Never Sometimes Often

3. Do you drive your car when the gas gauge is on empty?

1 2 3
Never Sometimes Often

4. Do you feel that no matter what you do, you won't get hurt?

1 2 3
Never Sometimes Often

5. Do you drink or use drugs before you drive your car?

1 2 3
Never Sometimes Often

6. Do you drive your car even if it has a major problem with the brakes, tires, or engine?

1 2 3
Never Sometimes Often

7. Do you thrive on the adrenaline rush you get from speeding and dangerous situations?

1 2 3
Never Sometimes Often

8. Do you hurt yourself because you do things that are out of your ability range?

1 2 3
Never Sometimes Often

9. Do you tailgate other drivers when you think they're driving too slow?

1 2 3
Never Sometimes Often

10. Do you ignore weather reports before you do outside activities like swimming, camping, fishing, or boating?

1 2 3
Never Sometimes Often

Add the totals from lines 1-10. **YOUR RISK FACTOR IS:**

10-15: You're pretty conservative. Chances are good that the consistently safe choices you make will help you avoid hurting yourself and the people around you.

16-20: You're straddling the fence. Depending on your mood or whom you're with, the choices you make may help you or hurt you.

21-30: You're taking your chances. Time to reconsider a lot of the judgments you make. You're destined to put yourself in dangerous situations and potentially hurt yourself and the people around you.

Environment

The environment you operate an ATV in is often harsh and sometimes dangerous if you don't take proper precautions.

Weather

You need to consider the weather. It is dangerous to ride your ATV when the weather is bad or potentially bad. Keep abreast with weather forecasts.

Terrain

Always pay close attention to the terrain you're on, even if it is familiar to you. You can't assume that the landscape you're used to doesn't change. Changes to landscape can happen at nearly any time. Fences can be constructed and excavations dug in a short period of time. Weather, climate, and development take their toll.

Sound Judgment

The thing about terrain is that sometimes you don't know it's changed until you get there. Whether it's familiar or not, check out your surroundings before and during your ride.

Night Riding

Riding at night can be very hazardous. Obstacles and other hazards (that are easily identified during daytime) are much more difficult to see and avoid. When night riding, make sure the lights are properly adjusted and in good working order. Reduce speed; do not over-drive the headlights. Never travel in an unfamiliar area or blaze a new trail at night. Always carry a flashlight or flare for signaling an emergency.

Paved Surfaces

Don't do it! The ATV isn't designed for pavement. Its handling becomes more difficult on paved surfaces.

Trail Riding

Use sound judgment when trail riding; that means riding on a trail that fits your ability level. If the trail is pretty rugged, standing up on your footrests will make it easier for you to endure the rough terrain.

Make yourself visible by using headlights and taillights, and pull completely off the trail if you need to stop.

Outsloped trails (trails that slant to allow rain to run off) make trail riding a bit more challenging. Accepting that challenge means keeping your weight shifted into the slope. Denying the challenge means sliding off the trail.

It also helps to know which trails you can ride and who else might be on those same trails. These are signs currently used in some areas to designate trail types and restrictions.

Trail Signs

SYMBOLS



TWO-WHEEL
MOTOR VEHICLE



SEDAN



HIGH
CLEARANCE
VEHICLE 4x4 &
PICKUP



ATV



SNOWMOBILE



OPEN ROUTE
Not always used
(refer to map).

Symbol with RED
SLASH indicates activity not allowed.
Symbol with YELLOW SLASH indicates activity not recommended.



TRAVEL MANAGEMENT POSTER



NATIONAL FOREST ROUTE MARKERS



Roads maintained for LOW clearance vehicles, such as passenger cars, motorhomes.



Roads maintained for HIGH clearance vehicles.

ATV-0068A

Those Around You

People do all kinds of things that you can't predict or control.

Riding Companions

Leave a lot of space between you and other riders, especially in dusty and dirty conditions, because it'll be difficult to see the riders in front of you stopping.

Riding with companions on several ATV's is not the same as riding one ATV with a passenger. Passengers are prohibited; it's unsafe. The extra weight on the seat makes the ATV difficult to control. About 50% of all ATV accidents involve passengers.

Sound Judgment

Other Vehicles

Depending on where you're riding, you might encounter other ATV's, bikes, or motor vehicles on public lands. Respect the presence of cars if you're crossing roads or riding in public areas and make yourself be seen. If you can't see other vehicles coming, that means you're invisible, too.

Hikers

With the renewed interest in hiking, camping, and other outdoor activities, people can show up in remote areas where you would never expect them. For their sake, keep your eyes open.

Animals and Nature

Respect the outdoors that you love. Don't use your ATV to chase animals or birds. Drive around young trees rather than over them. Keep clear of streams and ditches with standing water.

TESTIMONIAL	
DOCUMENT#:	N380310A1
CITY/STATE:	NEW CUMBERLAND, WV
SEX:	M
AGE:	18
BODY PART:	HEAD
DATE ACCIDENT:	7-30-93
DISPOSITION:	DOA
SYNOPSIS:	An 18 year old male died as the result of injuries which he sustained in an accident while driving a 4-wheel ATV on a gravel public road. The victim lost control of the ATV when he suddenly applied the brakes to avoid a dog crossing the road. During the accident, the ATV's brake lever penetrated the victim's brain through his right eye resulting in death. The victim was not wearing a helmet.

Tread Lightly and leave it as you found it.

Equipment

The last thing you expected was that your ATV would break down in the middle of the field... it's usually so reliable that sometimes you forget the ATV has its limits.

ATV Maintenance

You have to maintain your ATV. The General Maintenance section of this Operator's Manual tells you about taking care of your ATV. If, at any time, abnormal noises, vibrations, or improper functioning of any component of this ATV is detected, **DO NOT OPERATE THE ATV**. Take the ATV to an authorized Arctic Cat ATV dealer for inspection and adjustment or repair.

Cargo Limitations

One reason why passengers are prohibited on ATV's is because their presence throws off the weight and balance of the ATV. Cargo can do the same if it weighs too much. Limit the ATV to the load capacity ratings identified in the following chart for the particular model being operated. So if you're weighing in at over 215 lb (97 kg) when you ride, leave some of that extra cargo at home. The combined weight limit, including you, your rack cargo, and your trailer, is a specified amount, so consult the ATV Load Capacity Ratings Chart and monitor it carefully.

Extra weight on the ATV will also throw you off balance if it's not distributed evenly, side-to-side and front-to-rear. If you have 160 lb (73 kg) on the rear rack only and you're heading up an incline, shifting your own weight forward isn't going to do enough to compensate for that cargo sitting over the back tires.

Cargo has such a huge effect on ATV handling that you need to pay a lot of attention to your speed. Even on really level areas, you should keep it under 10 mph (16 kph) if you've got a trailer attached. Avoid uneven terrain. Also, consider that your braking distance is going to increase with the more weight you carry.

Think about these when dealing with cargo:

1. Rack weight limit
2. Trailer weight limit
3. Weight distribution
4. ATV speed

Sound Judgment

Load Capacity Ratings Chart

Arctic Cat ATV Load Capacity Ratings		
ITEM	Specifications	
	(lb)	(kg)
Max Load Capacity	515	233
Max Load Capacity - TBX	600	272
Front Rack (Max)	100	45
Rear Rack (Max)	200	91
Rear Cargo Box - TBX (Max)	300	135
Side Storage Box (each) - TBX (Max)	20	9
Tongue Weight	35	16
Rear Rack and Tongue Weight (Max)	200	91
Rear Cargo Box and Tongue Weight - TBX (Max)	300	135
Towing Capacity	1050	477

Max Load Capacity - Total weight of operator, accessories, tongue weight, and cargo on front and rear racks.

Tongue Weight - Weight on trailer tongue.

Rear Rack and Tongue Weight - Total weight on trailer tongue, Speedpoint, and rear rack.

Rear Rack/Cargo Box and Tongue Weight - Total weight on trailer tongue, Speedpoint, and rear rack/cargo box.

Towing Capacity - Total weight of trailer and all cargo in the trailer.

■ **NOTE: Tongue and accessory weight (winch, snowplow, Speedpoint, gun scabbard brackets, etc.) must be included as part of the front and rear rack/cargo box weights.**

Speedrack

When installing Speedrack accessories, read and carefully follow the instructions provided in each kit.

■ **NOTE: Use extra caution when operating an ATV with additional loads such as accessories and/or cargo. Handling of the ATV may be adversely affected. Reduce speed when adding additional loads.**

WARNING

POTENTIAL HAZARD

Overloading the ATV or carrying or towing cargo improperly.

WHAT CAN HAPPEN

Could cause changes in ATV handling, which could lead to an accident.

HOW TO AVOID THE HAZARD

Never exceed the stated load capacity for the ATV.

Cargo should be properly distributed and securely attached.

Reduce speed when carrying cargo or pulling a trailer. Allow greater distance for braking.

Always follow the instructions in this Operator's Manual for carrying cargo or pulling a trailer.

Personal Choices

A safe, enjoyable ride is dependent on many personal choices. An ATV, like all motorized vehicles, can be dangerous to operate if you choose to ignore safety precautions, take unnecessary chances, or ride beyond your ability or your vehicle's capability. Don't allow the thrill of freedom or adventure to affect your ability to make good, safe choices.

Alcohol and Drug Consumption

Alcohol is related to a high percentage of all hospital admissions due to ATV accidents in the U.S. This isn't an issue of morality. It's extremely dangerous to drink alcoholic beverages and ride... it's also very foolish. When the alcohol starts kicking in and you're tearing along on your ATV, those odds can catch up to you.

Sound Judgment

TESTIMONIAL

DOCUMENT#: X46481A1
 CITY/STATE: LAUREL, MS
 SEX: M
 AGE: 25
 BODY PART: ALL PARTS BODY
 DATE ACCIDENT: 6-25-93
 DISPOSITION: DOA
 SYNOPSIS: A 25 year old male died from drowning after the 4-wheeled ATV he was driving overturned and landed on the victim, pinning him face down in 6 inches of water in a drainage ditch. The victim had failed to make a right hand turn and drove off the side of the road. The victim was driving at an excessive speed, and under the influence of alcohol. He was pronounced dead at the scene. The victim was not wearing a helmet.

Substances to avoid when riding:

1. Alcohol
2. Over-the-counter or prescription drugs
3. Illegal/mood altering drugs

Alcohol - Effects*

The Number of Drinks that Impair Mental and Physical Abilities

1-2 DRINKS

Mental processes such as restraint, awareness, concentration, and judgment affected; reaction time slowed; inability to perform complicated tasks.

3-4 DRINKS

Depth perception, glare recovery, eye movement, and focus affected; decreased judgment and control.

5+ DRINKS

Coordination deteriorates, loss of critical judgment, and impaired memory and comprehension.

*According to the ATV Safety Institute.

Be aware of prescription and over-the-counter medications. Drowsiness and impaired judgment can be caused by a wide variety of medications. The same is true of allergy, cold, flu, and headache medications. Your physical size and weight can't protect you... just one anti-histamine tablet can affect your judgment.

If your sense of adventure persuades you to do illegal drugs when you're riding your ATV, this is a reality check. Something to think about—there can be legal consequences that will take away all that freedom you love. Don't use alcohol or drugs before or during your ATV ride.

Your Physical Condition

Being physically exhausted is like being drunk. Try to do something that's detail-oriented when you're really tired, and you'll feel totally uncoordinated.

Don't ride:

1. When you're tired

Reckless Riding

If you are involved in an ATV accident when you're speeding, you have a 25% chance of landing yourself in the hospital. The faster you go, the more likely you are to destroy your head and internal organs, and skip the wheelies, jumps, stunts, and any other showboating.

Laws and Regulations

Any police officer will tell you that ignorance of the law is no defense. Your best defense is to check out your local, state, or provincial ATV laws before riding. It'll also make sure that you can continue to ride in your favorite areas. The quickest way to have a land area closed is by riding over the regulations.

Group Behavior

People occasionally do crazier and riskier things in a group than they would consider doing by themselves. When you're ATV riding with others and things start to get out of hand, decide whether you're willing to be injured or see your friends injured.

Sound Judgment

SIPDE

By themselves, none of these safe behaviors and sound judgments will go very far. But when you put them all together... when you're paying attention to how you feel, when you're monitoring the movements of your ATV, and when you're constantly evaluating your environment, then you're practicing SIPDE. SIPDE is an acronym that stands for:

S	I	P	D	E
SCAN/SEARCH	IDENTIFY HAZARDS	PREDICT WHAT WILL HAPPEN	DECIDE WHAT TO DO	EXECUTE THE DECISION

Supervision

Overview

You're responsible for supervising those who ride your ATV. Your wisdom is valuable... it'll bring them all back safely—your friends, your family, your relatives, and your ATV. It's crucial that you consider yourself a supervisor for all riders of your ATV. Whether you accept responsibility or not, the truth is that you are responsible for others riding your ATV.

Taking Responsibility

You're to the last letter in "P.A.S.S."... "Supervision." You've just gone through the manual, and you've seen what's involved. That puts you in a good position to be confident about what you know. So now it's time to use your knowledge and supervise others who ride your ATV.

Inexperienced/ Untrained Riders

You can't let people ride your ATV who don't know what they're doing. Unless they've had over a year of experience with ATV riding or taken an ATV training course, it's your responsibility to keep them off your ATV. It can be dangerous (especially for underage children)—all the more reason for you to be firm.

TESTIMONIAL

DOCUMENT#: N37023A1
 CITY/STATE: MOERSFORKS, NY
 SEX: F
 AGE: 5
 BODY PART: UPPER TRUNK
 DATE ACCIDENT: 6-29-93
 DISPOSITION: DOA
 SYNOPSIS: The victim of this incident, a five year old female, was operating a four wheeled all terrain vehicle (ATV) in the front yard of her parents' house, under the supervision of her father. The victim drove the ATV down an area where the only way to turn around was around a grain silo. The victim was executing a right hand turn when the vehicle tipped over to the right and fell onto her body. The victim was transported to a local hospital where she was pronounced dead on arrival. Photographs of the incident were not taken by law enforcement officials.

Experienced/Trained Riders

If anyone is going to borrow your ATV, you are responsible for their supervision. Before they ride, have them take the training course, have them watch the safety video, and have them read the Operator's Manual. You train them. It doesn't matter how you do it, as long as you do it.

ATV's are all a little different from the handling to the stability to the controls. So regardless of how much experience your family members have with ATV's, they don't have experience with *your* ATV. Let experienced riders get familiar with your ATV—show them the basics before they take off. You don't want it on your conscience that someone got hurt because you didn't tell them how to use your ATV.

Remember that regardless of experience, you should never let anyone under the age of 16 operate your ATV.

Arctic Cat and the ATV Safety Institute recommend that all ATV operators ride the appropriate-sized ATV according to age.

Category	Age (Years)	Speed Limitations (MPH)	NOTES
Y-12+	12 or Older	15 - Limited 30 - Maximum	Operate Under Adult Supervision
T-14	14 or Older	20 - Limited 30 - Limited 38 - Maximum	Operate Under Adult Supervision
G & S	16 or Older	According to Local Regulations	—

DIVISION II - OPERATION/MAINTENANCE

ATV Specifications

ENGINE		450/550/700
Type	Four-Cycle/Liquid Cooled OHC	
Bore x Stroke	89 mm x 71.12 mm (3.5 x 2.8 in.) - 450 92 mm x 82 mm (3.62 x 3.22 in.) - 550 102 mm x 85 mm (4.01 x 3.35 in.) - 700	
Displacement	442 cc (27 cu in.) - 450 545 cc (33.6 cu in.) - 550 695 cc (42.4 cu in.) - 700	
Spark Plug Type	NGK CR7E - 450 NGK CPR8E - 550/700	
Spark Plug Gap	0.5-0.6 mm (0.019-0.024 in.) - 550/700 0.7-0.8 mm (0.028-0.031 in.) - 450	
Brake Type	Hydraulic w/Brake Lever Lock and Rear Foot Brake	
CHASSIS		
Length (Overall)	215 cm (84.75 in.) 249 cm (98.00 in.) - TBX 219.71 cm (86.5 in.) - Mud Pro	
Height (Overall)	122.0 cm (48.0 in.) - 700 125 cm (49.3 in.) - 450/550/TBX 131.45 cm (51.75 in.) - Mud Pro	
Width (Overall)	120.7 cm (47.5 in.)	
Suspension Travel (Front/Rear)	25.4 cm (10 in.)	
Tire Size (Front)	25 x 8-12 28 x 9-14 - Mud Pro	
Tire Size (Rear)	25 x 10-12 28 x 11-14 - Mud Pro	
Tire Inflation Pressure	0.35 kg/cm ² (5.0 psi)	
MISCELLANY		
Dry Weight (Approx)	314 kg (692 lb) - 450 316 kg (697 lb) - 550/700 361 kg (796 lb) - TBX 360 kg (793 lb) - Mud Pro	
Gas Tank Capacity	21.6 L (5.7 U.S. gal.) 22.0 L (5.8 U.S. gal.) - TBX	
Coolant Capacity	N/A - 450 2.9 L (3.0 U.S. qt) - 550/700	
Differential Capacity	275 ml (9.3 fl oz)	
Rear Drive Capacity	250 ml (8.5 fl oz)	
Engine Oil Capacity (Approx)	2.8 L (3.0 U.S. qt) - 450 1.9 L (2.0 U.S. qt) - 550/700	
Gasoline (Recommended)	87 Octane Regular Unleaded	
Engine Oil (Recommended)	Arctic Cat ACX All Weather (Synthetic)	
Front Differential/Rear Drive Lubricant	SAE Approved 80W-90 Hypoid	
Taillight/Brakelight	12V/8W/27W	
Headlight	12V/27W (4)	
Starting System	Electric	

Specifications subject to change without notice.

ATV Specifications

ENGINE	1000	1000 Mud Pro
Type	Four-Cycle/Liquid-Cooled V-Twin	
Bore x Stroke	92 mm x 71.6 mm (3.66 x 2.81 in.)	
Displacement	951.9 cc (58 cu in.)	
Spark Plug Type	NGK CPR8E (2)	
Spark Plug Gap	0.5-0.6 mm (0.019 - 0.024 in.)	
Brake Type	Hydraulic w/Brake Lever Lock and Rear Foot Brake	
Fuel System	EFI	
CHASSIS		
Length (Overall)	215 cm (84.75 in.)	240 cm (94.50 in.)
Height (Overall)	121.9 cm (48.0 in.)	131.6 cm (51.8 in.)
Width (Overall)	120.7 cm (47.5 in.)	
Suspension Travel (Front/Rear)	25.4 cm (10 in.)	
Tire Size (Front)	25 x 9-12	28 x 9-14
Tire Size (Rear)	25 x 11-12	28 x 11-14
Tire Inflation Pressure	0.35 kg/cm ² (5.0 psi)	
MISCELLANY		
Dry Weight (Approx)	324.7 kg (716 lb)	361 kg (797 lb)
Gas Tank Capacity	21.6 L (5.7 U.S. gal.)	
Coolant Capacity	3.3 L (3.5 U.S. qt)	
Front Differential Capacity	275 ml (9.3 fl oz)	
Rear Drive Capacity	250 ml (8.5 fl oz)	
Engine Oil Capacity (Approx)	1.9 L (2.0 U.S. qt)	
Gasoline (Recommended)	87 Octane Regular Unleaded	
Engine Oil (Recommended)	Arctic Cat ACX All Weather (Synthetic)	
Differential/Rear Drive Lubricant	SAE Approved 80W-90 Hypoid	
Taillight/Brakelight	12V/8W/27W	
Headlight	12V/27W (4)	
Starting System	Electric	

Specifications subject to change without notice.

Location of Parts and Controls



FI025C



FI016H

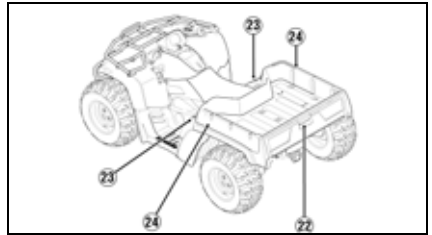

739-569D

- | | |
|--|---|
| <ol style="list-style-type: none"> 1. Battery 2. Headlights 3. Hand Brake Lever 4. Power Distribution Module 5. Radiator Access Panel 6. Seat Latch 7. Storage Compartment 8. Reverse Override Switch 9. Rear Foot Brake 10. Brake Lever Lock 11. Key Switch 12. Shift Lever 13. Throttle Limiter | <ol style="list-style-type: none"> 14. Throttle Lever 15. DC Power Outlet 16. Taillight/Brakelight 17. Operator's Manual Location 18. Headlight HI/LO Switch 19. Starter Button 20. Engine Stop Switch 21. Drive Select Switch 22. Tailgate Latch (TBX) 23. Storage Compartment (TBX) 24. Cargo Box Latch Handle (TBX) |
|--|---|

■ **NOTE:** The ATV you have purchased may differ slightly from those shown in the figures of this manual.

ATV Operation

Basic Operating Maneuvers

Active riding and basic maneuvers are the foundation of your ATV ride. Without basic skills, it's impossible to move to this level— active riding. These are your basic maneuvers:

- Mounting the ATV
- Starting the Engine
- Starting a Cold Engine
- Shifting
- Braking/Stopping
- Parking
- Dismounting the ATV

Mounting the ATV

To get seated:

1. From the left side, grab the left-side handlebar, apply the brake, and put your left foot on the footrest.
2. Grab the right-side handlebar.
3. Swing your leg over the seat and set your right foot down on the right-side footrest.
4. Get seated in a comfortable position.
5. Always keep your feet planted on the footrests.

B	O	N	E	C
BRAKES LOCKED	IGNITION SWITCH ON	NEUTRAL TRANSMISSION	ENGINE SWITCH	AUTOMATIC CHOKE EFI

Starting a Cold Engine

■ **NOTE:** It is very important not to touch or compress the throttle lever during the starting procedures.

1. Turn off all electrical accessories (hand warmer, lights, etc.); then rotate the ignition switch key to the first position (ON) leaving the headlights OFF. Note that the N is indicated on the LCD.
3. Allow the engine to warm up for approximately 2-3 minutes or until the ATV will accelerate without hesi-

Starting the Engine

Always start with the ATV on a flat, level surface. Carbon monoxide poisoning can kill you, so keep your ATV outside while it's running. Follow these steps to start it up:

1. Mount the ATV and sit down.
2. Engage the brake lever lock.
3. Turn on the ignition.
4. Shift into neutral.
5. Move the engine stop switch to RUN.
6. Press the starter button.

CAUTION

Do not run the starter motor for more than eight seconds per starting attempt. The starter motor may over-heat causing severe starter motor damage. Allow 15 seconds between starting attempts to allow the starter motor to cool.

7. Let the engine warm up.

Another way to remember the starting procedure is by using the acronym "BONE-C." It stands for:

2. Press on the starter button.

CAUTION

Do not run the starter motor for more than eight seconds per starting attempt. The starter motor may over-heat causing severe starter motor damage. Allow 15 seconds between starting attempts to allow the starter motor to cool.

■ **NOTE:** Do not touch the throttle lever until the engine has run for at least 3 minutes.

tating.

Shifting

The Arctic Cat ATV with an automatic transmission has a dual-range transmission with reverse. To shift the ATV, follow these steps:

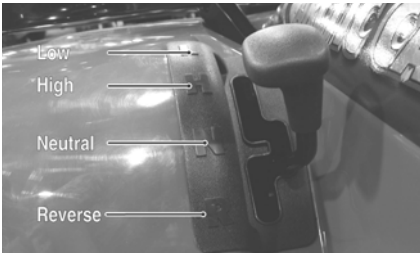

CF130B

1. To engage the high range from neutral, move the shift lever forward.
2. To engage the low range from high range, move the shift lever outward and forward.

■ **NOTE:** The high range is for normal riding with light loads. The low range is for carrying heavy loads or trailer towing. Compared to HIGH range, the LOW range position provides slower speed and greater torque to the wheels.

CAUTION

Always shift into low range when operating on wet or uneven terrain, when towing or pushing heavy loads, and when using a plow. Failure to follow this caution may result in premature V-belt failure or in damage to related drive system components.

3. To engage reverse gear from neutral, move the shift lever outward and rearward into the R position.

CAUTION

Always come to a complete stop before attempting to shift from one range to the other or into reverse. Always shift on level ground, or engage the brake lever lock before shifting into another range or into reverse.

WARNING

Do not start the engine or operate this ATV with the clutch shield removed. Severe injury could result.

Braking/Stopping

Always allow plenty of room and time to stop safely. Sometimes quick stops are inevitable, so always be prepared. Whether you're stopping slowly or stopping quickly, do this:

1. Squeeze the brake lever on the left handlebar to apply both the front and rear brakes.
2. If your wheels lock, release them for a second; then apply them again.
3. Never "ride" the brake. Even maintaining minimal pressure on the brake lever will cause the brake pads to drag on the disc and may overheat the brake fluid.

WARNING

Excessive repetitive use of the hydraulic brake for high speed stops will cause overheating of the brake fluid and premature brake pad wear which will result in an unexpected loss of brakes.

WARNING

Use only Arctic Cat approved brake fluid. Never substitute or mix different types or grades of brake fluid. Brake loss can result. Check brake fluid level and pad wear before each use. Brake loss can result in severe injury or even death.

Parking

Parking involves following the previous rules for braking; then:

1. After the ATV stops, shift into neutral.
2. Stop the engine using the engine stop switch.
3. Turn off the ignition.
4. If you have to park on a hill, shift the ATV into low gear; otherwise, try to park only on level surfaces.
5. Engage the brake lever lock.

Dismounting the ATV

After you've followed the procedure for parking, it's time to dismount:

1. Double check that the brake lever lock is engaged.
2. Swing your right leg over to the left side of the seat.
3. Step to the ground on the left side of the ATV.
2. Hold the brake lever, and release the brake lever lock.
3. Shift into gear.
4. Release the brake slowly and apply the throttle.

Handling the ATV (Active Riding Techniques)

Active riding involves moving your body. You must learn to lean and shift your weight into your turns to maintain control.

Your safety depends on using safe riding techniques. Statistics from the U.S. Consumer Product Safety Commission (CPSC) say that inexperienced riders who don't use safe riding techniques are **13 times more likely to have an ATV accident** than riders who have over 1 month of experience.

Safe riding techniques include:

- Riding
- Leaning, Weight Shift, and Balance
- Wide Turns
- Sharp Turns
- Quick Turns
- K-Turns
- Riding Uphill
- Riding Downhill
- Sidehilling/Traversing
- Swerving
- Crossing Obstacles

Riding

Once the engine's warm, the ATV is ready to go.

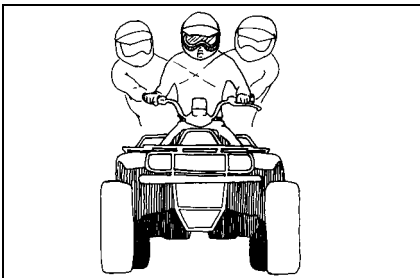

ATV-0012

1. Keep your feet on the footrests and both hands on the handlebar.

Leaning, Weight Shift, and Balance

When you turn, the trick is to move forward and slide over to the side of the seat that's on the inside of the turn. Support your body weight on the outside footrest. At the same time, lean your body to the inside of the turn. Pay attention to the handling—if you feel the tires coming off the ground, reduce speed, shift more of your body weight to the side that's lifting, and make the turn wider if possible.

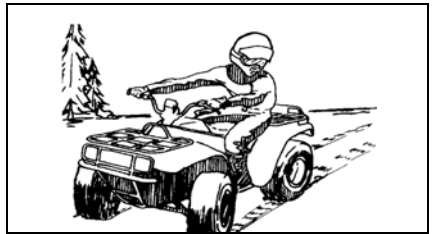

ATV-0013

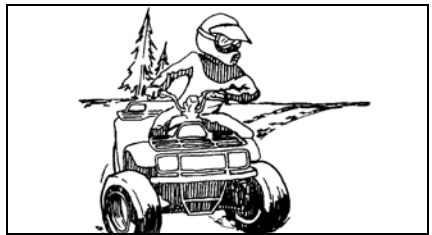

ATV-0024



ATV-0025

Wide Turns

About 20% of ATV accidents happen during turns. If you don't understand turning techniques, it's easy for the ATV to get away from you by losing traction, plowing, or tipping. Use this method for wide turns:

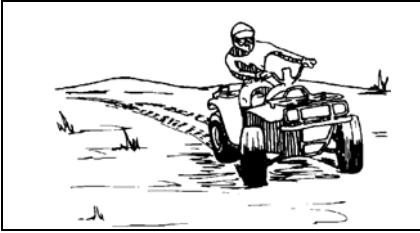

ATV-0046

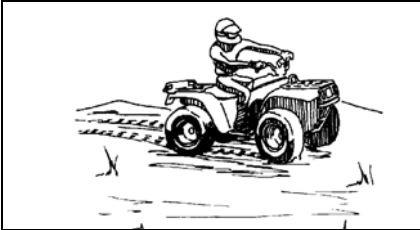

ATV-0045

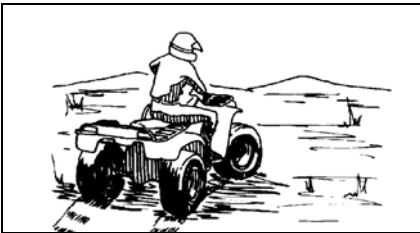

ATV-0044

1. Ease off the throttle as you approach the turn to slow down.
2. Use the principles of leaning, weight shifting, and balancing—shift your body weight to the inside of the turn.
3. Gradually increase your speed as you come out of the turn.

Sharp Turns

After mastering wide turns, practice the advanced skill of sharp turns.

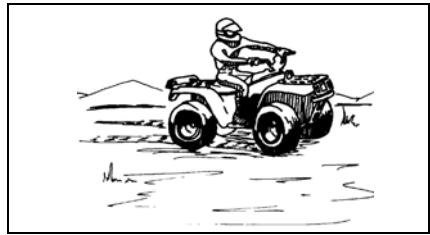

ATV-0038

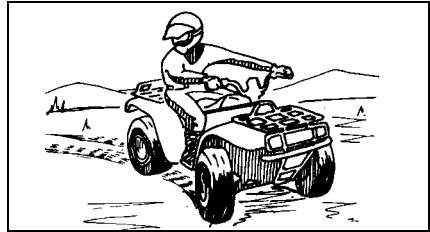

ATV-0039

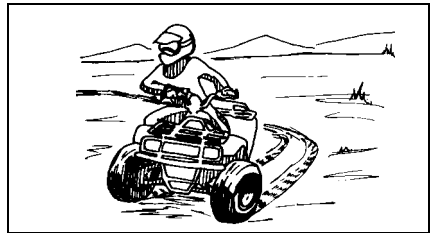

ATV-0040

1. Ease off the throttle as you approach the turn to slow down.
2. Use the principles of leaning, weight shifting, and balancing—shift your body weight to the inside of the turn.
3. You might have to lean into the turn more than you do in a wide turn.
4. If shifting your weight and balance aren't enough to keep the ATV tires on the ground, straighten out the handlebar as much as you can.
5. Gradually increase your speed as you come out of the turn.

Quick Turns

Quick turns are the most difficult turns and should only be done after you are experienced with your ATV.

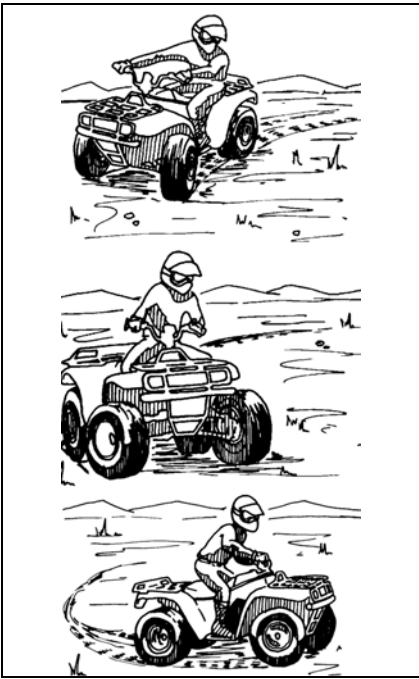

ATV-203

1. Ease off the throttle as you approach the turn to slow down.
2. Turn the handlebar, shift your weight, and balance at the same time as you enter the turn (use the principles of leaning, weight shifting, and balancing—shift your body weight to the inside of the turn).
3. Follow this with slight acceleration.
4. For multiple turns, repeat this movement as needed.
5. To make your turn quicker, try raising yourself off the seat a few inches as you shift your weight.

K-Turns

Use K-turns if you accidentally stall while riding uphill; you need to take action before the ATV rolls backward down the hill.

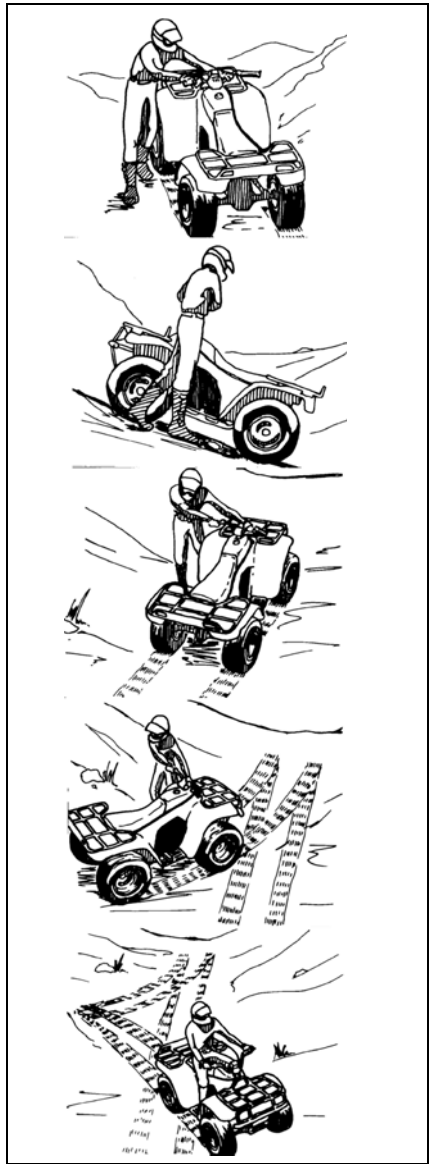

ATV-204

1. Stop where you are, apply the brakes, and shift to neutral.
2. Shut off the engine.
3. Keep your body weight shifted forward.
4. Get off the ATV on the uphill side.

5. If you're to the left of the ATV, turn the handlebar all the way left.
6. Partially release the brake, but lightly hold the brake lever.
7. Let the ATV roll to your right side until it faces slightly downhill.
8. Reapply the brakes.
9. Get back on the ATV from the uphill side, and keep your weight shifted uphill when you sit down.
10. Start the engine and follow the method for riding downhill.

2. Lean as far forward as possible. For steeper hills, come off your seat to stand and lean forward.
3. If you lose speed, quickly shift to a lower gear. At the same time, release the throttle (so your front tires don't lift), **OR**
4. If that doesn't work and you still have forward motion and the terrain permits, do a U-turn, go back down, and try climbing again, **OR**
5. If you have lost all forward motion, follow the K-turn procedure.

Riding Uphill

Roughly 20% of accidents happen while riding on hills and as a result of the ATV rolling or flipping. So, obviously, use extreme caution and follow this method for riding uphill.

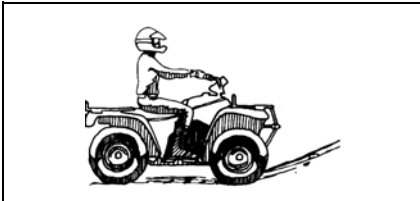

ATV-0019

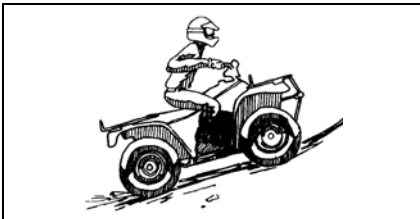

ATV-0032

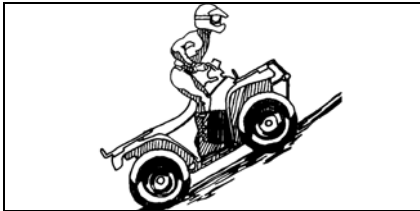

ATV-0033

1. Shift down and accelerate before you start climbing; then maintain a steady pace.

NEVER OPERATE UP OR DOWN HILLS STEEPER THAN 25°

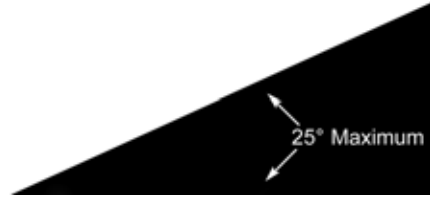

Riding Downhill

Success in riding downhill depends on how well you know your brakes—take it easy on them, or you could flip over.

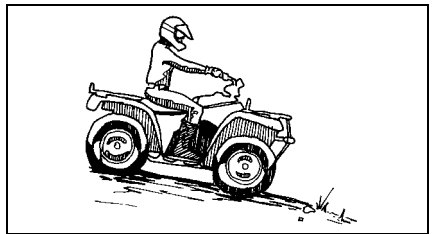

ATV-0018

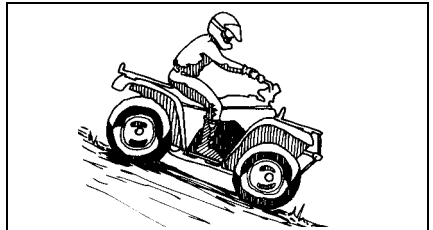

ATV-0030

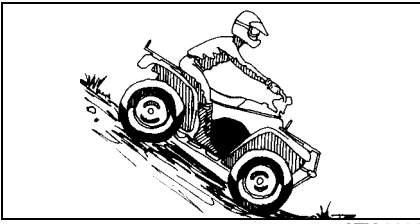

ATV-0031

1. Shift your body weight as far back on the seat as possible.
2. Keep it in a low gear; stay out of neutral.
3. Lightly apply the brake and ease up on the throttle.

Sidehilling/Traversing

Sidehilling is considered an advanced skill; it's really tricky and unpredictable. So, whether your skills are advanced or not, try to avoid this kind of riding. If you're in a situation where you absolutely have to sidehill, follow this method:

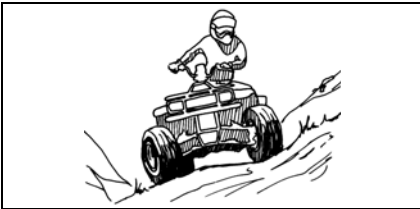

ATV-0017

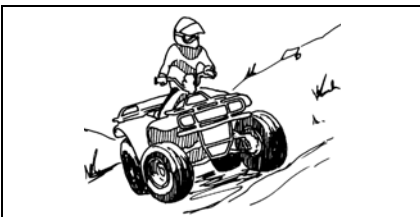

ATV-0028



ATV-0029

1. Keep your speed low and consistent.
2. Shift all your body weight to the uphill side of the seat; also, support your weight on the uphill footrest.
3. Steer like you're driving into the hill.
4. If the ATV feels like it's tipping, turn the handlebar downhill. If that's not possible because of the terrain or other conditions or if it just doesn't work, stop and get off. Dismount the ATV on the uphill side.

Swerving

Swerving is usually an emergency reaction to avoid an obstacle but is similar to quick turns. The difference is that quick turns involve slight acceleration in the turn; don't accelerate if you swerve.



ATV-0043

1. Ease off the throttle as you approach the obstacle.
2. Turn the handlebar. At the same time, shift your weight and balance as you swerve. Use the principles of leaning, weight shifting, and balancing—shift your body weight to the inside of the turn.

- Keep your hand off the brake until the emergency is over and you're back in control.

Crossing Obstacles

Crossing obstacles is risky; avoid it if possible. Riding over logs, rocks, and ruts means combining all the active riding skills into one big motion. Your ATV will respond differently for different obstacles (logs, ruts, etc.), but these are general guidelines for overcoming two-track (both tires contacting the obstacle at the same time) obstacles:

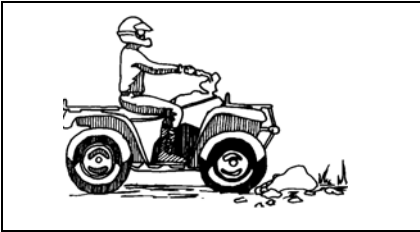

ATV-0016

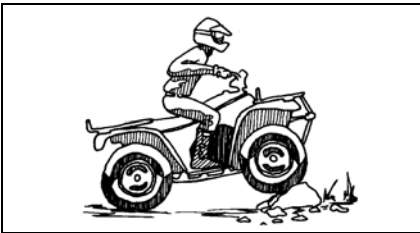

ATV-0026

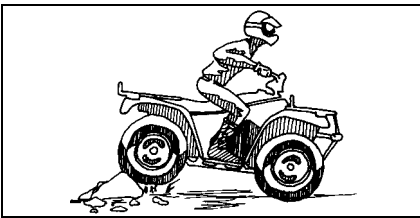

ATV-0027

- Keep your speed way down; less than 5 mph.
- Approach the obstacle head-on.
- Come up off the seat.
- Keep your weight on the footrests.
- Apply a little throttle when the front tires make contact with the obstacle.

- Lean forward and release the throttle when the front tires clear the obstacle.
- Keep your body loose to absorb any shock.
- If the ATV starts tipping, shift your weight to keep it in balance.

To clear a single-track (only one tire contacts) obstacle, follow the same rules except:

- Use the ATV's momentum to clear the obstacle.
- Don't pull up on the handlebar.
- Don't apply the throttle.

Tips

Driving an ATV and a car have some similarities; however, there are a few situations that require special attention:

- Reversing
- Skidding or Sliding
- Parking on a Hill
- Stalling on a Hill
- Crossing Water
- Crossing Roads
- Cold Weather Driving
- Stopping the ATV
- Stopping the Engine

Reversing

It's tough to see things behind you.

- Go slowly. It's hard to see behind you.
- Keep your handlebar straight.
- Backing down hills is a bad idea; do a U-turn or K-turn instead to turn around.

Skidding or Sliding

If you lose control after hitting sand, ice, mud, or water:

- Turn your handlebar into the direction of the slide.
- Keep your hand off the brakes until you're out of the skid.
- Shift your weight forward.

Sometimes your ATV may not respond and goes straight ahead instead of letting you turn. Here's how to handle it:

1. Slow down.
2. Move forward on the seat.
3. Lean to inside of turn.
4. Turn handlebar.

Parking on a Hill

This shouldn't be necessary, but if it is:

1. Keep it in gear.
2. Engage the brake lever lock.
3. Find something to block the rear tires.

Stalling on a Hill

If you use the right method for riding uphill, this shouldn't happen. But if you have a problem, do this:

1. If the ATV hasn't started rolling backwards yet, follow the procedure for the K-Turn, **OR**
2. If the ATV is already rolling backward, lean as far forward as possible standing up on the footrests.
3. Nice and easy, apply the hand brake lever.
4. When you come to a stop, follow the procedure for the K-turn.
5. If the ATV continues to roll backward, dismount immediately on the uphill side.

Crossing Water

Your ATV can only handle water up to its footrests. Any more than that and you risk engine damage and/or personal injury. Stay away from fast moving rivers. ATV tires can be buoyant, so if the water is too deep, you might find the ATV suddenly afloat.

1. Physically check the depth and current of the water, especially if you can't see the bottom. You're also checking for boulders, logs, or any other hidden obstacles.
2. Keep your speed slow.

3. Make sure you have a way out on the other side of the water.
4. If you get stuck in the sludge or mud, try rocking the ATV from side to side.
5. Once you've cleared the water, briefly apply the brakes to make sure they work.

Crossing Roads

Crossing roads on your ATV is also a bad idea, so avoid it. If you can't:

1. Stop completely on the shoulder of the road.
2. Check both directions for traffic.
3. Crossing near a blind corner or intersection is dangerous; don't do it.
4. Drive straight across to the opposite shoulder.
5. Take into account that your ATV could stall while crossing; give yourself enough time to get off the road.
6. You have to assume that oncoming cars don't see you, and if they do, they won't be able to predict your actions.
7. It's illegal to cross public roads in some places. Know your local laws.

Cold Weather Driving

■ **NOTE:** Check that all control levers move freely. Make sure the footrest, shift lever, and rear foot brake are free of ice and snow.



WARNING

For your personal safety, it is very important to wear the type and amount of cold-weather clothing according to the coldest anticipated temperatures.

1. With the transmission in neutral, move the ATV forward and backward to check that the wheels roll freely. If the ATV will not roll, the tires may be frozen to the ground or the brake pads may be frozen to the discs.

- If the tires are frozen to the ground, pour warm water around them to melt the ice.

CAUTION

Before riding, manually move the ATV forward and backward to make certain that all wheels roll freely.

- If the brakes are frozen, take the ATV to a warmer area to thaw out the brakes.

WARNING

Do not attempt to free frozen brakes by pouring warm water on the brake pads and housings.

■ **NOTE:** After the brakes thaw, dry them by applying them several times while riding slowly.

■ **NOTE:** After riding through water, mud, snow, or slush, it is important to dry both brake systems before parking the ATV.

WARNING

Go slowly and be extra careful when riding on snow-covered or ice-covered terrain. Always be alert to changing terrain conditions when operating the ATV.

- Practice driving in an open snow-covered or ice-covered area at slow speeds before driving on snow-covered or ice-covered trails.
- Learn how the ATV responds to steering and braking on the type of terrain to be encountered on the ride.

Stopping The ATV

To stop the ATV, first release the throttle lever. Next, apply the brake.

Stopping The Engine

To stop the engine, turn the ignition switch key to the OFF position or set the engine stop switch to the OFF position.

General Information

ATV Identification Numbers

The Arctic Cat ATV has two identification numbers: Vehicle Identification Number (VIN) and Engine Serial Number (ESN).

The VIN is located on the frame support rail.

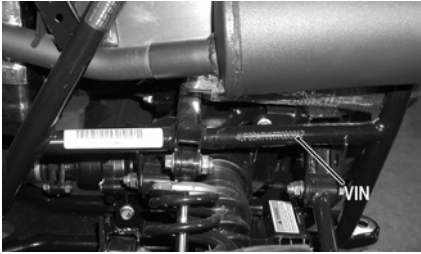

AF968B

The ESN is located on the left-side rear of the engine crankcase.



CF109I

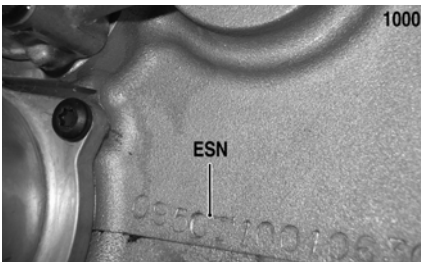

GZ001C

These numbers are required by the dealer to complete warranty claims properly. No warranty will be allowed by Arctic Cat if the VIN or ESN is removed or mutilated in any way.

Always provide the ATV name, Vehicle Identification Number, and Engine Serial Number when contacting an authorized Arctic Cat ATV dealer for parts, service, accessories, or warranty. If a complete engine must be replaced, ask the dealer to notify Arctic Cat for correct registration information.

Ignition Switch Key

Two keys come with the ATV. Keep the spare key in a safe place. An identifying number is stamped on each key. Use this number when ordering a replacement key.



ATV-0055

Control Locations and Functions

Ignition Switch

The ignition switch has three positions.

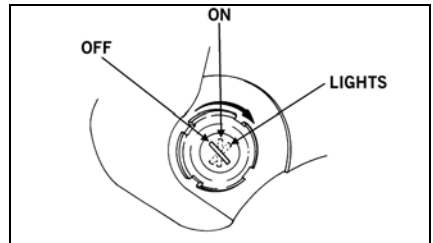

ATV-0056

OFF position — All electrical circuits except the accessory plug are off. The engine will not start. The key can be removed in this position.

■ **NOTE: The accessory plug is powered by the battery at all times.**

ON position — The ignition circuit is complete and the engine can run. The key cannot be removed in this position.

LIGHTS position — The ignition circuit is complete and the headlights and tail-light are on. The key cannot be removed in this position.

CAUTION

Leaving the ignition switch in the ON or LIGHTS position for a long period of time when the engine is not running may cause the battery to discharge. Always leave the ignition switch in the OFF position when engine is not running.

Shift Lever

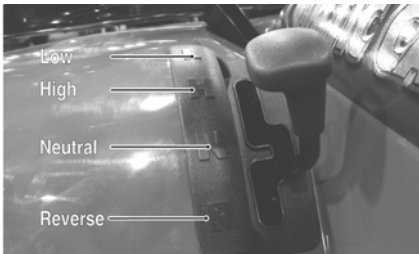

CF130B

These ATV's have a dual-range automatic transmission with reverse. To shift the ATV, follow these steps:

1. To engage the high range from neutral, move the shift lever forward.
2. To engage the low range from high range, move the shift lever outward and forward.

■ **NOTE:** The high range is for normal riding with light loads. The low range is for carrying heavy loads or trailer towing. Compared to HIGH range, the LOW range position provides slower speed and greater torque to the wheels.

CAUTION

Always shift into low range when operating on wet or uneven terrain, when towing or pushing heavy loads, and when using a plow. Failure to follow this caution may result in premature V-belt failure or in damage to related drive system components.

3. To engage reverse gear from neutral, move the shift lever outward and rearward into the R position.

CAUTION

Always come to a complete stop before attempting to shift from one range to the other or into reverse. Always shift on level ground, or engage the brake lever lock before shifting into another range or into reverse.

Drive Select Switch

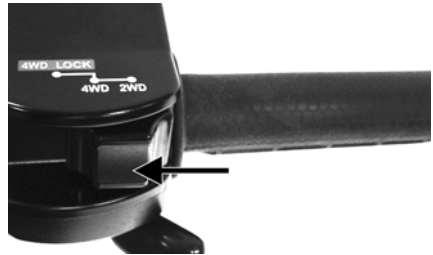

FI475A

This switch allows the operator to operate the ATV in either two-wheel drive (rear wheels) or four-wheel drive (all wheels). For normal riding on flat, dry, hard surfaces, two-wheel drive should be sufficient. In situations of aggressive trail conditions, four-wheel drive would be the desired choice.

To either engage or disengage the front wheels, move the switch to the 4WD position or to the 2WD position.

CAUTION

Do not attempt to either engage or disengage the 4WD lock while the ATV is moving.

The 4WD lock allows the operator to mechanically lock the front differential to apply equal power to both front wheels. To engage the lock from 4WD, slide the switch up and move fully to the left. To disengage the lock, move the switch lever to the right.

WARNING

The 4WD lock is intended for use where minimum traction is available. **NEVER EXCEED 10 MPH (16 kph) with the lock engaged.** Maneuverability and handling characteristics will differ with the lock engaged.

Hand Brake Lever/Brake Lever Lock

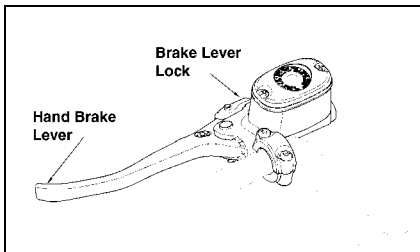

738-420B

The hand brake is considered to be the normal operating (main) brake. It should be applied whenever a braking situation is needed.

Apply the brake by compressing the brake lever toward the handlebar.

To engage and release the brake lever lock, use the following procedure.

1. Squeeze the hand brake two or three times and release it.
2. Depress and hold the brake lever lock.
3. While holding in on the brake lever lock, squeeze the brake lever.

NOTE: It will click as it engages and the brake lever will not return to its released position.

4. Release the brake lever lock by squeezing the brake lever. It will return to its released position.

Check to make sure the brake lever lock engages properly and that the brake (when engaged) locks the wheels.

1. Pump the brake lever 2 or 3 times.
2. Engage the brake lever lock.
3. Attempt to push the ATV.

NOTE: The brake lever lock must lock the wheels. If it doesn't, take the ATV to an authorized Arctic Cat ATV dealer for service.

⚠ WARNING

Always check to be sure that the brake lever lock has been disengaged before operating the ATV. An accident could result if the brake lever lock is left engaged while the ATV is operated. The brake may relax if left engaged for a long period of time. This could cause an accident; therefore, do not leave the ATV on a hill depending on the brake lever lock. Always block the downhill side of the wheels if leaving the ATV on a hill or park the ATV in a sidehill position.

Headlight HI/LO Switch

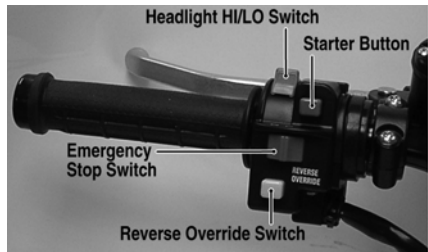

CF245A

Use the headlight HI/LO switch to select the high or low headlight beam when the ignition switch is in the LIGHTS position. When the switch is in the HI position, the high beam will illuminate. When the switch is in the LO position, the low beam will illuminate.

Engine Stop Switch

OFF position — The ignition circuit is off. The engine cannot be started or will not run. If the engine stop switch is used to stop engine without turning off ignition switch, the battery may discharge.

RUN position — The ignition circuit is on. The engine can start and run.

Starter Button

Pushing in on this button activates the starter motor. Before starting the engine, make sure the ignition switch is in the ON position, the transmission is in neutral, and the brake lever lock is engaged.

■ **NOTE:** This ATV has safety interlock switches which prevent the starter motor from activating when the transmission is not in neutral. To start the ATV while in gear, depress the rear foot brake or compress the brake lever; then depress the starter button.

Reverse Override Switch

This ATV is equipped with a reverse speed limiter system. When additional RPM is needed in reverse, depress and hold the override switch.

■ **NOTE:** The reverse override switch is active in 4WD only.

WARNING

Never activate the override switch while the throttle is open as a loss of control may result.

Throttle Lever



FI475B

Control engine RPM with the position of the throttle lever. Operate this lever with the thumb. Pushing it forward increases engine RPM and allowing it to retract decreases engine RPM.

Throttle Limiter Screw

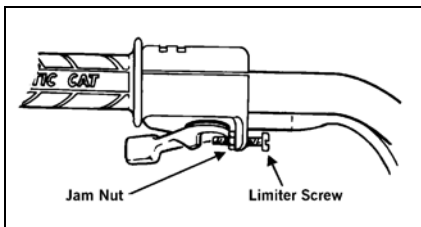

ATV-0053

Throttle lever travel may be limited by adjusting the throttle limiter screw. The throttle limiter should be adjusted according to the operator's skill and experience. To adjust the throttle limiter, use the following procedure.

1. Loosen the jam nut.
2. Turn the throttle limiter screw clockwise to decrease engine RPM maximum or counterclockwise to increase engine RPM maximum.
3. Tighten the jam nut securely.

■ **NOTE:** The ATV is equipped with an RPM limiter that retards ignition timing when maximum RPM is approached. When the RPM limiter is activated, it could be misinterpreted as a high-speed misfire.

Rear Foot Brake

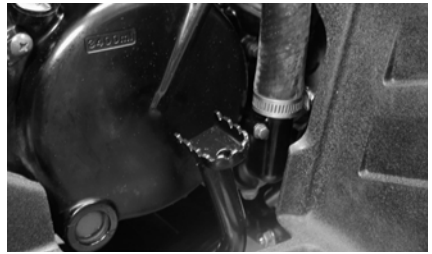

CF117

Pressing the rear foot brake downward will apply the brake to the rear wheels.

Power Steering

Some ATV's were produced with an Electronic Power Steering (EPS) system to reduce steering effort and rider fatigue over a broad range of operating conditions.

The EPS system engages when the ignition switch is turned to the ON position and disengages after approximately five minutes (to conserve battery power) if the engine is not running.

This system is entirely maintenance-free: no adjustment or servicing is required. There are no fluids to check or change, and the EPS system is entirely self-contained and sealed to protect it from the elements.

The EPS system is battery system powered; therefore, the battery must be in good condition and fully charged. Power delivery and overload protection is provided by an EPS relay and 30-amp fuse located under the seat in the Power Distribution Module (PDM).

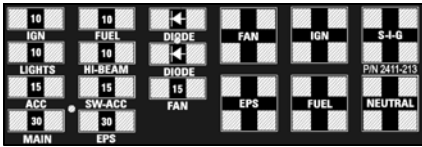

2411-213

The system is self-monitored and will display a “P0635” malfunction code on the LCD gauge/speedometer should an EPS system control circuit problem occur. Do not operate the ATV with a “P0635” malfunction code displayed.

■ **NOTE:** Turn the key switch to the OFF position then back to the ON position to reset the malfunction code. If the code continues to be displayed, take your ATV to an authorized Arctic Cat Dealer for EPS system servicing before resuming operation.

CAUTION

Never operate this ATV with a “P0635” code indicated on the LCD gauge/speedometer. This indicates a malfunction in the EPS system control circuit and could result in a loss of power steering assist.

In the event of electrical power failure, the EPS system becomes disabled (similar to an automobile with the engine shut off). Steering effort increases but steering control can be maintained.

Speedometer/LCD (Digital)

■ **NOTE:** All segments of the LCD will activate for approximately two seconds when the ignition switch is rotated to the ON position.



CF236A

1. Clock/Engine Hour Meter - The clock function indicates time in the 12-hour mode; the hour meter indicates the total time the ATV has run and cannot be reset to zero. To set the clock, use the following procedure.

A. With the ignition switch ON, press and release the Mode Button (3) until the Clock/Engine Hour Meter (1) is displayed; then (if necessary) press and release the Set/Reset Button (4) to select the clock display.

B. Press and hold the Set/Reset Button (4) until the minutes stop scrolling and the hour display starts to scroll. Momentarily release when the correct hour is displayed; then repeatedly press and release the Set/Reset Button (4) until the correct minutes are displayed.

■ **NOTE:** Clock memory power is supplied through the 15-amp accessory fuse and verified during gauge “power-up” and reset. In the event of clock memory power failure (blown fuse, etc.), the gauge will “power-up,” reset, and shut down repeatedly until clock memory power is restored. Always check the 15-amp accessory fuse if this gauge condition is noted.

■ **NOTE:** The engine hour meter will not activate until engine speed exceeds 500 RPM.

2. Temperature Indicator - If the engine coolant temperature exceeds the normal operating range, the temperature icon will begin flashing and the LCD will go blank for 30 seconds; then the LCD will return to normal. However, the temperature icon will continue to flash.

CAUTION

Continued operation with high engine temperature may result in engine damage or premature wear.

■ **NOTE:** High engine RPM, low vehicle speed, or heavy load can raise engine temperature. Decreasing engine RPM, reducing load, and selecting an appropriate transmission gear can lower the temperature.

■ **NOTE:** Debris in front of the engine (or packed between the cooling fins of the radiator) can reduce cooling capacity. Using a garden hose, wash the radiator and the engine to remove any debris restricting air flow.

CAUTION

Arctic Cat does not recommend using a pressure washer to clean the radiator core. The pressure may bend or flatten the fins causing restricted air flow, and electrical components on the radiator could be damaged. Use only a garden hose with spray nozzle at normal tap pressure.

3. Mode Button - Shifts the gauge through three set-up modes: speedometer/tachometer, distance, and time.

■ **NOTE:** The Mode Button must be pressed and released to shift modes. Approximately two seconds after the Mode Button is released, the digital gauge will return to full display.

4. Set/Reset Button - In conjunction with the Mode Button, sets and resets various displays on the digital gauge. Also used to shift from speedometer function to tachometer function on the speedometer/tachometer gauge.

5. Fuel Level Indicator - Indicates approximate amount of gasoline in the gas tank.

■ **NOTE:** When the bottom segment flashes, approximately 3.5 L (0.92 U.S. gal.) of gasoline remains in the tank.

6. Low Oil Pressure - Will be displayed during self-test at start-up. It will not be displayed during normal operation as oil pressure is not monitored on these models.

7. Odometer/Trip Meter - Odometer registers the total distance the vehicle has traveled. The trip meter is resettable and can be used to measure trip or trip legs. The odometer cannot be reset.

■ **NOTE:** To shift between the odometer (ODO) or trip meter (TRIP), press the Mode Button (3) to select the distance mode; then press the Set/Reset Button (4) to select the desired display. Hold the Set/Reset Button down to reset the trip meter.

8. Gear Position Indicator - Indicates which gear position is selected.

- R (reverse)/N (neutral)/L (low range)/H (high range)

■ **NOTE:** An E will be displayed if there is an error caused by a no-shift position signal.

9. High Beam Indicator - The High Beam icon will appear only when the headlights are on high beam.
10. 4WD Lock Indicator - Displays LOCK when the front differential lock has been engaged.
11. Drive Select Indicator - Displays 4WD when selected by the drive select switch or when the 4WD lock is engaged. The display is blank when in 2WD.
12. Speedometer - Indicates the approximate vehicle speed in miles per hour (MPH) or kilometers per hour (km/h).

■ **NOTE:** To change mph/km/h display, press and release Mode Button (3) until the icon (MPH/km/h) appears; then press the Set Button (4) to change the display.

Condition Warning Display - Uses odometer/trip meter display of the LCD to warn of a system error condition requiring attention.

- A. Volt - The LCD will go blank except the word VOLT will flash on the LCD whenever a low voltage (< 9 DC volts) or a high voltage (> 16 DC volts) is detected. When voltage returns to normal, the gauge must be reset by turning the ignition key to the OFF position and then to the ON position.
- B. EFI - On the 550/700 models, the LCD will go blank except the letters EFI will flash on the LCD whenever an electronic fuel injection error is detected. After 30 seconds, the LCD will return to normal; however, the letters EFI will continue to flash until the cause of the error is corrected.
- C. EFI - On the 450/1000 models, the LCD will go blank except a malfunction code will flash on the LCD and a wrench icon will be displayed whenever an electronic fuel injection malfunction is detected. After 30 seconds, the LCD will return to normal; however, the malfunction code and wrench icon will continue to be displayed until the malfunction is corrected.

■ **NOTE:** Take the ATV to an authorized Arctic Cat ATV dealer to have the EFI error corrected and to have the ECU reset as soon as possible.

Speedometer/LCD (Analog/Digital)

■ **NOTE:** All segments of the LCD will activate for approximately two seconds when the ignition switch is rotated to the ON position.

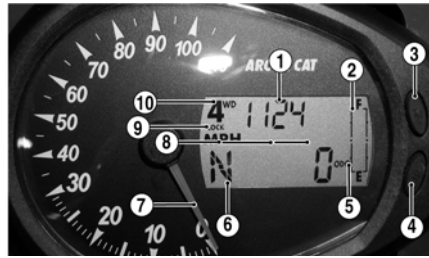

CF094A

1. Clock/Engine Hour Meter - The clock function indicates time in the 12-hour mode; the hour meter indicates the total time the ATV has run and cannot be reset to zero. To set the clock, use the following procedure.

- A. With the ignition switch ON, press and release the Mode Button (3) until the Clock/Engine Hour Meter (1) is displayed; then (if necessary) press and release the Set/Reset Button (4) to select the clock display.

- B. Press and hold the Set/Reset Button (4) until the minutes stop scrolling and the hour display starts to scroll. Momentarily release when the correct hour is displayed; then repeatedly press and release the Set/Reset Button (4) until the correct minutes are displayed.

■ **NOTE:** Clock memory power is supplied through the 15-amp accessory fuse and verified during gauge “power-up” and reset. In the event of clock memory power failure (blown fuse, etc.), the gauge will “power-up,” reset, and shut down repeatedly until clock memory power is restored. Always check the 15-amp accessory fuse if this gauge condition is noted.

■ **NOTE:** The engine hour meter will not activate until engine speed exceeds 500 RPM.

2. Fuel Level Indicator - Indicates approximate amount of gasoline in the gas tank.

■ **NOTE:** When the bottom segment flashes, approximately 3.5 L (0.92 U.S. gal.) of gasoline remains in the tank.

- Mode Button - Shifts the gauge through three set-up modes: speedometer/tachometer, distance, and time.

■ **NOTE:** The Mode Button must be pressed and released to shift modes. Approximately two seconds after the Mode Button is released, the digital gauge will return to full display.

- Set/Reset Button - In conjunction with the Mode Button, sets and resets various displays on the digital gauge. Also used to shift from speedometer function to tachometer function on the speedometer/tachometer gauge.
- Odometer/Trip Meter (T1 and T2) - Odometer registers the total distance the vehicle has traveled. Trip meters can register two distances (for instance, T1 could register trip distance and T2 could register distance between stops). The trip meters can be reset while the odometer only registers accumulated miles/kilometers and the odometer cannot be reset to zero.

All distances correspond to speedometer function selected (MPH or km/h).

■ **NOTE:** To select the odometer (ODO), trip #1 (T1), or trip #2 (T2), press the Mode Button (3) to select the distance mode; then press the Set/Reset Button (4) to select the desired display. Hold the Set/Reset button down to reset trip meters.

- Gear Position Indicator - Indicates which gear position is selected.
 - R (reverse)/N (neutral)/ L (low range)/ H (high range).

■ **NOTE:** An E will be displayed if there is an error caused by a no-shift position signal.

- Speedometer/Tachometer - A needle indicates approximate vehicle speed in mph or km/h when speedometer function is selected or rpm when tachometer function is selected.

- Needle Indicator Display - Displays which speedometer function (MPH or km/h) or tachometer function (RPM) is selected.

■ **NOTE:** The speedometer and tachometer functions may be switched by pressing the Set/Reset Button.

- 4WD Lock Indicator - Displays LOCK when the front differential lock has been engaged.
- Drive Select Indicator - Displays 4WD when selected by the drive select switch or when the 4WD lock is engaged. The display is blank when in 2WD.
- High Beam Indicator - The High Beam icon will appear only when the headlights are on high beam.

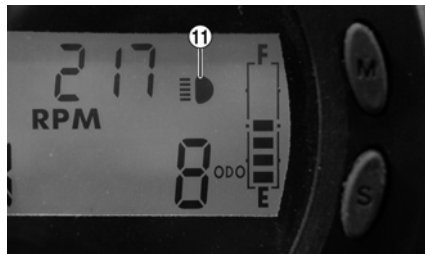

CF101A

- Battery Condition Indicator - The speedometer/tachometer needle will not function and the LCD will go blank except the word VOLT will flash on the LCD whenever a low voltage (< 9 DC volts) or high voltage (>16 DC volts) is detected. When voltage returns to normal, the gauge must be reset by turning the ignition key to OFF; then back to ON.



CF098A

13. Temperature Indicator - The speedometer/tachometer needle will sweep full scale and the LCD will go blank except the high temperature icon will flash. After 30 seconds, the speedometer/tachometer needle and LCD will return to normal, but the temperature icon will continue to flash. The icon should not be visible during normal operation.



CF099A

CAUTION

Continued operation with high engine temperature may result in engine damage or premature wear.

■ **NOTE:** High engine RPM, low vehicle speed, or heavy load can raise engine temperature. Decreasing engine RPM, reducing load, and selecting an appropriate transmission gear can lower the temperature.

■ **NOTE:** Debris in front of the engine (or packed between the cooling fins of the radiator) can reduce cooling capacity. Using a garden hose, wash the radiator and the engine to remove any debris restricting air flow.

CAUTION

Arctic Cat does not recommend using a pressure washer to clean the radiator core. The pressure may bend or flatten the fins causing restricted air flow, and electrical components on the radiator could be damaged. Use only a garden hose with spray nozzle at normal tap pressure.

14. EFI Error Indicator - On the 550/700 models, the speedometer/tachometer needle will sweep full scale and the LCD will go blank except the letters EFI will flash on the LCD whenever an electronic fuel injection error code is detected. After 30 seconds, the LCD and speedometer/tachometer needle will return to normal, but the letters EFI will continue to flash on the LCD until the cause of the error is corrected.

14. EFI Malfunction Indicator - On the 450/1000 models, the speedometer/tachometer needle will sweep full scale and the LCD will go blank except a malfunction code and wrench icon will be displayed on the LCD whenever an electronic fuel injection malfunction code is detected. After 30 seconds, the LCD and speedometer/tachometer will return to normal, but the malfunction code and wrench icon will continue to be displayed on the LCD until the malfunction is corrected.

■ **NOTE:** Take the ATV to an authorized Arctic Cat ATV dealer to have the error corrected and the system error reset as soon as possible.



FI001A

Electric Fuel Pump

An electric fuel pump is incorporated in the gas tank to deliver gasoline to the fuel injector. The fuel pump is activated when the ignition switch is in the ON position.

■ **NOTE:** Both the ignition and fuel pump functions will be interrupted by the Tilt Sensor if the ATV tips over past 60°-70°. Righting the ATV will reactivate the ignition and fuel pump.

Gas Hoses

Replace the gas hoses every two years. Damage from aging may not always be visible.

Oil Level Stick

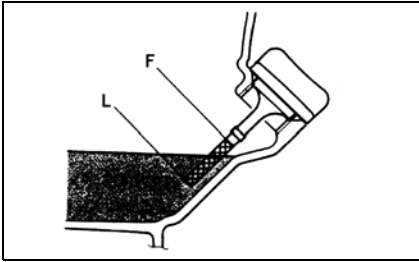

ATV-0100AA

There is an oil level stick for checking the engine oil level. To check the oil level, use the following procedure.

■ **NOTE:** The ATV should be on level ground when checking the engine oil level.

1. Unscrew the oil level stick and wipe it with a clean cloth.
2. Install the oil level stick and thread into the engine case.

■ **NOTE:** The oil level stick should be threaded in for checking purposes.

3. Remove the oil level stick; the engine oil level should be above the "L" mark but not higher than the "F" mark.

CAUTION

Do not overfill the engine with oil. Always make sure the oil level is above the "L" mark but not higher than the "F" mark.

Seat Latch

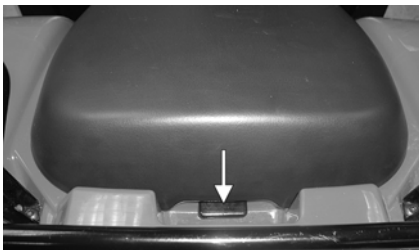

AL676A

1. To remove the seat, lift up on the latch release (located at the rear of the seat); then raise the rear of the seat and slide it rearward.
2. To lock the seat into position, slide the front of the seat into the seat retainers and push down firmly on the rear of seat. The seat should automatically lock into position.

⚠ WARNING

Make sure the seat is secure before mounting the ATV. Severe personal injury may result if the seat is not properly secured.

Tailgate Latch (TBX)

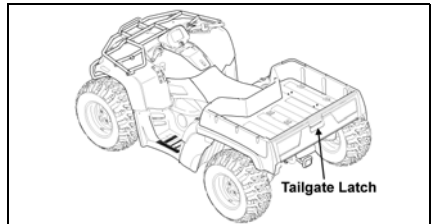

739-569A

1. To open the tailgate, pull the latch (located at the center of the tailgate).
2. To close the tailgate, press forward firmly. The tailgate will latch automatically.

Cargo Box Latch Handles (TBX)

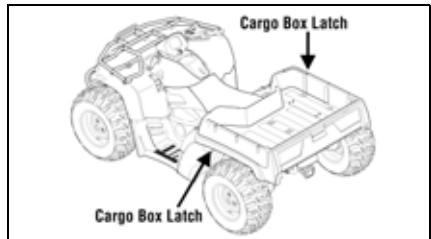

739-569B

1. To raise the cargo box, rotate either handle upward; then raise the cargo box.
2. To lower the cargo box, push down firmly on the front of the box. The box will automatically lock into position.

Side Storage Compartment (TBX)



TB013

1. To open a compartment, lift the straps off the hatch lugs.
2. To close a compartment, pull the straps over the hatch lugs.

Safety Flag Bracket

A bracket is provided for mounting a flag at the rear of the ATV.

Rack Loading (Front and Rear)

The front rack and rear rack are designed to carry specified load capacities. Always refer to the ATV Load Capacity Ratings Chart for proper capacities.

⚠ WARNING

Make sure the loads on the front and rear racks will not interfere with the ATV controls or obstruct the view of the operator. Also, make sure the loads are evenly distributed, properly secured, and will not shift while operating the ATV.

Trailering and Towing

⚠ WARNING

Never use the racks as a towing or trailering point.

Arctic Cat ATV's are equipped with a frame-mounted receiver for a standard 5.1 cm (2 in.) receiver hitch. The standard receiver hitch must be purchased separately.

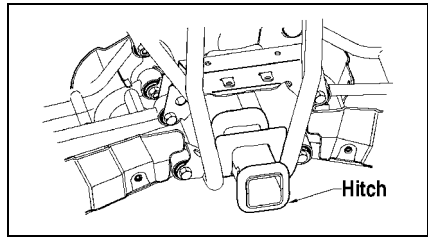

738-424A

When loading a trailer properly, two items are critical: Gross Trailer Weight (the weight of the trailer plus cargo) and Trailer Tongue Weight.

⚠ WARNING

Make sure that the load in the trailer is properly secured and will not shift while moving. Also, do not overload the trailer.

⚠ WARNING

Never exceed any of the ATV weight restrictions.

Trailer Tongue Weight is the downward force exerted on the hitch by the trailer coupler when the trailer is fully loaded and the coupler is at its normal towing height. Refer to the Load Capacity Ratings Chart for tongue weight information.

Always maintain a slow speed when trailering and towing and avoid sudden accelerations, quick maneuvers, and sudden stops. Braking distance will be affected when towing a trailer. When towing a trailer, always maintain slow speed and allow more stopping distance than when not towing a trailer.

⚠ WARNING

Riding an ATV without extra caution when towing a trailer will be hazardous. Trailer towing can affect the handling and braking of the ATV. Never tow a trailer without a rigid tongue and never exceed 10 mph. Avoid sudden accelerations and stopping of the ATV. Do not make quick maneuvers. Avoid uneven surfaces and do not tow on hills. Never carry passengers in a trailer unless the trailer is designed for such use. Allow more stopping distance than when not towing a trailer.

Transporting ATV

When transporting the ATV, Arctic Cat recommends that the ATV be in its normal operating position (on all four wheels) and the following procedure be used.

1. Engage the brake lever lock and place the transmission in gear.

CAUTION

Failure to engage the brake lever lock and place the transmission in gear could result in the ATV rolling off the trailer in the event of tie-down strap failure.

2. Secure the ATV with load rated hold-down straps.

■ **NOTE:** Suitable hold-down straps are available from your Arctic Cat ATV dealer. Ordinary rope is not recommended because it can stretch under load.

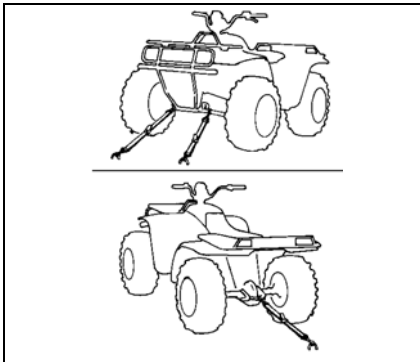

ATV-0067

CAUTION

If using additional hold-down straps in any other areas, care must be taken not to damage the ATV.

Gasoline-Oil-Lubricant

Recommended Gasoline

The recommended gasoline to use in this ATV is 87 minimum octane regular unleaded. In many areas, oxygenates (either ethanol or MTBE) are added to the gasoline. Oxygenated gasolines containing up to 10% ethanol, 5% methane, or MTBE are acceptable gasolines.

When using ethanol blended gasoline, it is not necessary to add a gasoline antifreeze since ethanol will prevent the accumulation of moisture in the fuel system.

CAUTION

Do not use white gas. Only Arctic Cat approved gasoline additives should be used.

Recommended Engine/Transmission Oil

CAUTION

Any oil used in place of the recommended oil could cause serious engine damage. Do not use oils which contain graphite or molybdenum additives. These oils can adversely affect clutch operation. Also, not recommended are racing, vegetable, non-detergent, and castor-based oils.

The recommended oil to use is Arctic Cat ACX All Weather synthetic engine oil, which has been specifically formulated for use in this Arctic Cat engine. Although Arctic Cat ACX All Weather synthetic engine oil is the only oil recommended for use in this engine, use of any API certified SM 0W-40 oil is acceptable.

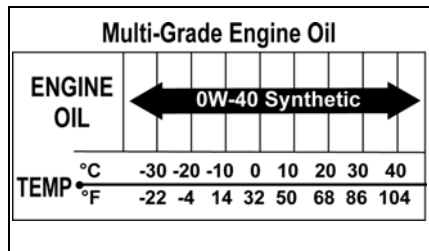

OILCHARTJ

Recommended Front Differential/Rear Drive Lubricant

■ **NOTE:** Arctic Cat recommends the use of genuine Arctic Cat lubricants.

The recommended lubricant (front differential and rear drive) is SAE approved 80W-90 hypoid. This lubricant meets all of the lubrication requirements of the Arctic Cat ATV.

CAUTION

Any lubricant used in place of the recommended lubricant could cause serious front differential/rear drive damage.

Filling Gas Tank**WARNING**

Always fill the gas tank in a well-ventilated area. Never add gasoline to the ATV gas tank near any open flames or with the engine running or hot. DO NOT SMOKE while filling the gas tank.

Since gasoline expands as its temperature increases, the gas tank must be filled to its rated capacity only. Expansion room must be maintained in the tank particularly if the tank is filled with cold gasoline and then moved to a warm area.

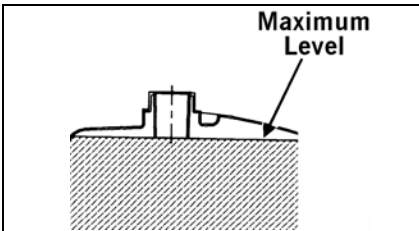

ATV0049D

Allow the engine to cool before filling the gas tank. Care must be taken not to overfill the tank. If overfilled, gas may leak onto the engine creating a fire hazard.

WARNING

Do not over-flow gasoline when filling the gas tank. A fire hazard could materialize. Always allow the engine to cool before filling the gas tank.

WARNING

Do not overfill the gas tank.

Tighten the gas tank cap securely after filling the tank.

Engine Break-In

After the completion of the break-in period, the engine oil and oil filter should be changed. Other maintenance after break-in should include checking of all prescribed adjustments and tightening of all fasteners. At the discretion and expense of the owner/operator, the ATV may be taken to an authorized Arctic Cat ATV dealer for this initial service.

New ATV's and renewed ATV engines require a "break-in" period. The first month is most critical to the life of this ATV. Proper operation during this break-in period will help assure maximum life and performance from the ATV.

During the first 10 hours of operation, always use less than ½ throttle. Varying the engine RPM during the break-in period allows the components to "load" (aiding the engine/transmission component mating process) and then "unload" (allowing components to cool). Although it is essential to place some stress on the engine components during break-in, care should be taken not to overload the engine too often. Do not pull a trailer during the break-in period.

When the engine starts, allow it to warm up properly. Idle the engine several minutes until the engine has reached normal operating temperature. Do not idle the engine for excessively long periods of time.

Burnishing Brake Pads

Brake pads must be burnished to achieve full braking effectiveness. Braking distance will be extended until brake pads are properly burnished.

WARNING

Failure to properly burnish the brake pads could lead to premature brake pad wear or brake loss. Brake loss can result in severe injury.

To properly burnish the brakes, use following procedure:

1. Choose an area sufficiently large to safely accelerate ATV to 30 mph and to brake to a stop.
2. Accelerate to 30 mph; then compress brake lever to decelerate to 0-5 mph.

3. Repeat procedure twenty times.

**WARNING**

Do not attempt sudden stops or put yourself into a situation where a sudden stop will be required until the brake pads are properly burnished.

General Maintenance

■ **NOTE: Proper maintenance of the ATV is important for optimum performance. Follow the Maintenance Schedule and all ensuing Maintenance Instructions/Information.**

If, at any time, abnormal noises, vibrations, or improper functioning of any component of this ATV is detected, DO NOT OPERATE THE ATV. Take the ATV to an authorized Arctic Cat ATV dealer for inspection and adjustment or repair.

If the owner/operator does not feel qualified to perform any of these maintenance procedures or checks, take the ATV to an authorized Arctic Cat ATV dealer for professional service.

■ **NOTE: The following instructions and information refer to specific items in the maintenance and care of the ATV.**

Maintenance Schedule

Item	Page	Initial 100 miles after break-in	Every 100 miles or 1 month	Every 300 miles or 3 months	Every 500 miles or 6 months
Battery	70	I	I		
* Engine nuts and bolts	-	I			I
* Valve clearance	-	I			I
Spark plug(s)	73	I		I	I
	73	Replace every 4000 miles or 18 months			
Liquid cooling system	64	I	Inspect every time before riding		
Oil cooler (1000)	66	I		I	I
Throttle cable	66/73	I	Inspect every time before riding		
Gas hoses	57	I	Inspect every time before riding		
	57	Replace every 2 years			
Engine/transmission oil and filter	66	R		R**	
Air filter	74	I		I	
Air filter housing drain(s)	74	I	Inspect every time before riding		
Gear lubricant (Front differential - rear drive)	67	I		I	
	67	Replace every 4 years			
V-Belt	75	I			I
Spark arrester/muffler	76				C
Tires/air pressure	75/ 35-36	I	Inspect every time before riding		
* Brake components	68	I	Inspect every time before riding		
Brake fluid	68	I	*Replace every 2 years		
Brake hoses	68	I	*Replace every 4 years		
* Steering	-	I	Inspect every time before riding		
* Suspension (Ball joint boots, drive axle boots front and rear, tie rods, differential and rear drive bellows)	-	I	Inspect every time before riding		
* Chassis nuts and bolts	-	I	T		
Frame/welds/racks	-	I			I
Electrical connections	-	I			I
Headlight/taillight-brakelight	76	I	Inspect every time before riding		

I=Inspect and clean, adjust, lubricate, replace as necessary T=Tighten R = Replace C = Clean

* Dealer maintenance

** When using Arctic Cat ACX All Weather synthetic oil, oil change interval can be increased to every 1,000 miles or every year.

Liquid Cooling System

■ **NOTE:** Debris in front of the engine or packed between the cooling fins of the radiator can reduce cooling capability. Using a garden hose, wash the radiator to remove any debris preventing air flow.

CAUTION

Arctic Cat does not recommend using a pressure washer to clean the radiator core. The pressure may bend or flatten the fins causing restricted air flow, and electrical components on the radiator could be damaged. Use only a garden hose with spray nozzle at normal tap pressure.

The cooling system capacity can be found in the specifications chart. The cooling system should be inspected daily for leakage and damage. If leakage or damage is detected, take the ATV to an authorized Arctic Cat ATV dealer for service. Also, the coolant level should be checked periodically.

CAUTION

Continued operation of the ATV with high engine temperature may result in engine damage or premature wear.

■ **NOTE:** High engine RPM, low vehicle speed, or heavy load can raise engine temperature. Decreasing engine RPM, reducing load, and selecting an appropriate transmission gear can lower the temperature.

When filling the cooling system, use a coolant/water mixture which will satisfy the coldest anticipated weather conditions of the area in accordance with the coolant manufacturer's recommendations. While the cooling system is being filled, air pockets may develop; therefore, run the engine for five minutes after the initial fill, shut the engine off, and then fill the cooling system to the bottom of the stand pipe in the radiator neck.

Checking/Filling

1. On the 700/1000, remove the two screws from the front of the radiator access panel. On the 450/550, remove the four screws securing the radiator access panel.

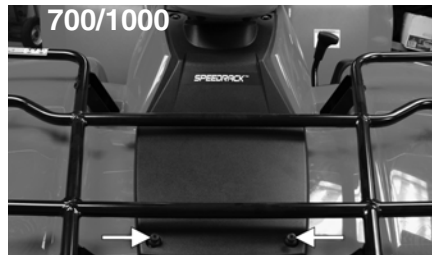

FI465A

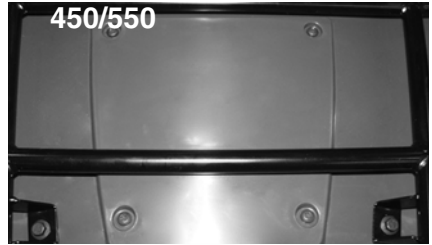

FI476

2. On the 700/1000, lift the front of the access panel; then slide the panel forward to disengage the two rear tabs.
3. On the 700/1000, move the panel rearward until free of the rack. On the 450/550, move the panel forward until free of the ATV.
4. On Mud Pro models, remove four cap screws securing the snorkel housing to the front inspection panel; then remove two cap screws from the rear of the snorkel housing.

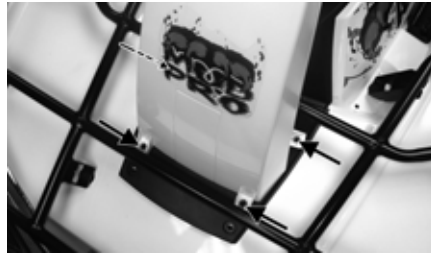

MP006A

■ **NOTE:** Use a good quality, biodegradable glycol-based, automotive-type antifreeze.

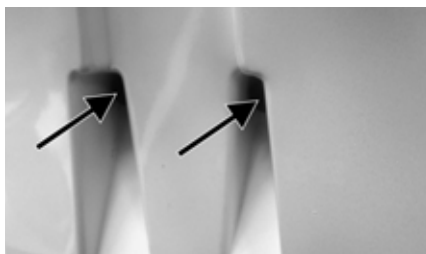

MP007A

5. Separate the front of the snorkel housing from the rear; then remove the snorkel housing.



MP003

6. Remove two reinstallable rivets and remove the splash guard. The radiator cap can now be accessed in front of the snorkels.
7. Carefully rotate the radiator cap counterclockwise to release pressure; then remove the cap.



CF142A

8. Add coolant as necessary; then install the radiator cap and access panel or snorkel housing.

⚠ WARNING

Never check the coolant level when the engine is hot or the cooling system is under pressure.

CAUTION

After operating the ATV for the initial 5-10 minutes, stop the engine, allow the engine to cool down, and check the coolant level. Add coolant as necessary.

Maintenance (Mud Pro)

When operating in muddy conditions, it is extremely important to clean the radiator core frequently. Arctic Cat requires inspecting and/or flushing the radiator core before each use to prevent overheating resulting in severe engine damage. After cleaning, shine a light through the radiator core while observing from the opposite side to determine if all dirt and debris have been removed.

■ **NOTE:** It is necessary to remove four machine screws securing the protective screen to the front of the radiator and move it forward to properly flush the radiator core. Make sure to secure the screen to the radiator after cleaning.

CAUTION

Failure to remove dirt and debris from the radiator prior to operating the ATV may cause overheating resulting in severe engine damage.

CAUTION

Arctic Cat does not recommend using a pressure washer to clean the radiator core. The pressure may bend or flatten the fins causing restricted air flow, and electrical components on the radiator could be damaged. Use only a garden hose with spray nozzle at normal tap pressure.

Oil Cooler (1000)

■ **NOTE:** Dirt and debris must be cleaned from the cooling fins regularly to ensure proper engine oil cooling.

CAUTION

Continued operation of the ATV with high engine temperature may result in engine damage or premature wear.

■ **NOTE:** High engine RPM, low vehicle speed, or heavy load can raise engine temperature. Decreasing engine RPM, reducing load, and selecting an appropriate transmission gear can lower the temperature.

Shock Absorbers

Each shock absorber should be visibly checked weekly for excessive fluid leakage (some seal leakage may be observed but it does not indicate the shock is in need of replacement), cracks or breaks in the lower case, or a bent shock rod. If any one of these conditions is detected, replacement is necessary.

■ **NOTE:** When the ATV is operated in extremely cold weather (-23°C/-10°F or colder), a small amount of leakage may be present. Unless the leakage is excessive, replacement is not necessary.

The shock absorber has a spring force adjustment sleeve with five adjustment positions to allow the spring to be adjusted for different riding and loading conditions. If the spring action is too soft or too stiff, adjust it according to the chart.



CD453

■ **NOTE:** Before attempting to adjust suspension, clean dirt and debris from the sleeve and remove load from the suspension; then use the spanner wrench to adjust the sleeve to the desired position.

Position	Spring Force	Setting	Load
1	↓ Stronger	Soft	Light
2		↑ ↓	↑ ↓
3			
4			
5		Stiff	Heavy

General Lubrication

Cables

None of the cables require lubrication; however, it is advisable to lubricate the ends of the cables periodically with a good cable lubricant.

Engine/Transmission Oil and Filter

■ **NOTE:** Refer to the recommended oil viscosity chart (on page 59) in this manual for the proper engine oil.

Change the engine oil and oil filter at the scheduled intervals. The engine should always be warm when the oil is changed so the oil will drain easily and completely.

1. Park the ATV on level ground.
2. Loosen the oil level stick. Be careful not to allow contaminants to enter the opening.

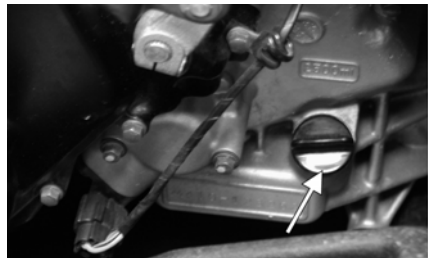

CF109M

3. Remove the drain plug from the bottom of the engine and drain the oil into a drain pan.

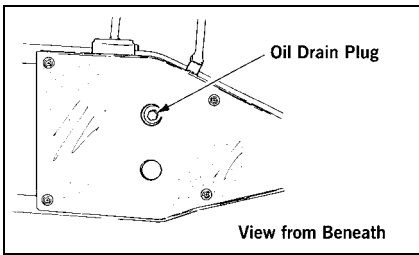

733-441A

- Using the oil filter wrench and a ratchet handle (or a socket or box-end wrench), remove the old oil filter and dispose of properly. Do not re-use oil filter.

■ **NOTE: Clean up any excess oil after removing the filter.**

- Apply oil to the new filter O-ring and check to make sure it is positioned correctly; then install the new oil filter. Tighten securely.
- Install the engine drain plug and tighten it securely. Remove the oil filler plug being careful not to let contaminants enter the opening; then pour the recommended oil in the filler hole. Install the level stick.
- Start the engine (while the ATV is outside on level ground) and allow it to idle for a few minutes.
- Turn the engine off and wait approximately one minute. Recheck the oil level.
- Inspect the area around the drain plug and oil filter for leaks.

Front Differential and Rear Drive Gear Lubricant (Inspecting/Changing)

Inspect and change the gear lubricant in each according to the Maintenance Schedule. When changing the lubricant, use approved SAE 80W-90 hypoid oil and use the following procedure.

- Place the ATV on level ground.
- Remove each oil filler plug.
- Drain the oil into a drain pan by removing in turn the drain plug from each.

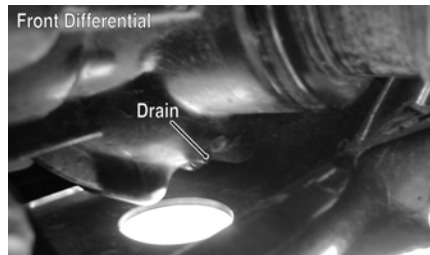

CF107B



CF106C

- After all the oil has been drained, install the drain plugs and tighten securely.

CAUTION

Inspect the oil for any signs of metal filings or water. If found, take the ATV to an authorized Arctic Cat ATV dealer for servicing.

- Pour recommended oil into each filler hole.

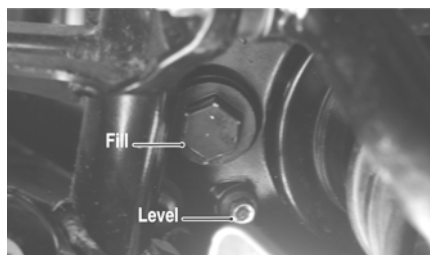

CF113A

■ **NOTE: Arctic Cat recommends the use of genuine Arctic Cat lubricants.**

- Install the filler plugs.

Hydraulic Hand Brake

WARNING

Be sure to inspect the hydraulic brake system before each use. Always maintain brakes according to the Maintenance Schedule.

Brake Fluid

Check the brake fluid level in the brake fluid reservoir. If the level in the reservoir is not visible in the sight glass, add DOT 4 brake fluid.

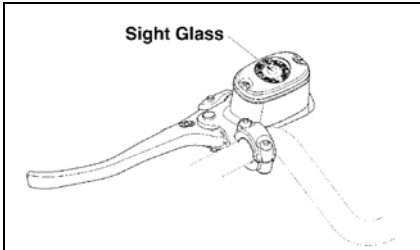

738-420A

■ **NOTE:** If the sight glass appears dark, there is a sufficient amount of fluid in the reservoir.

CAUTION

Be careful not to spill any fluid when filling the brake fluid reservoir. Wipe away spilled fluid immediately.

Brake Lever Lock

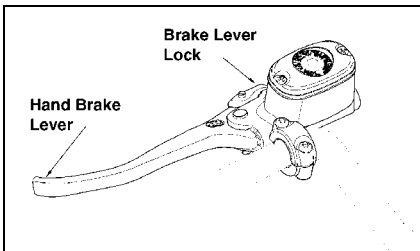

738-420B

Check to make sure the brake lever lock engages properly and that the brake (when engaged) locks the wheels.

1. Pump the brake lever 2 or 3 times.
2. Engage the brake lever lock.
3. Attempt to push the ATV.

■ **NOTE:** The brake lever lock must lock the wheels. If it doesn't, take the ATV to an authorized Arctic Cat ATV dealer for service.

Brake Hoses

Carefully inspect the hydraulic brake hoses for cracks or other damage. If found, take the ATV to an authorized Arctic Cat ATV dealer to have the brake hoses replaced.

Brake Pads

The clearance between the brake pads and brake discs is adjusted automatically as the brake pads wear. The only maintenance that is required is replacement of the brake pads when they show excessive wear. Check the thickness of each of the brake pads as follows:

1. Remove a front wheel.
2. Measure the thickness of each brake pad.
3. If thickness of either brake pad is less than 1.0 mm (0.039 in.), take the ATV to an authorized Arctic Cat ATV dealer to have brake pads replaced.

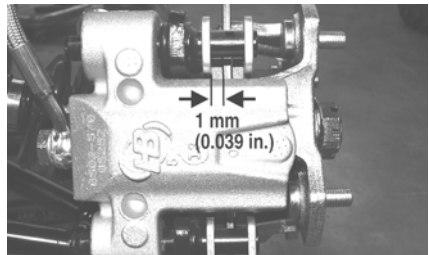

PR376B

4. Install the wheel and tighten using a crisscross pattern to 40 ft-lb (steel wheels) or 80 ft-lb (aluminum wheels).

Rear Foot Brake

The rear foot brake must be maintained to be fully functional.

WARNING

Be sure to inspect the rear foot brake system before each use. Always maintain brakes according to the Maintenance Schedule.

1. Check the brake fluid level in the reservoir. The fluid level must be maintained between the MAX and MIN level marks. If the level in the reservoir is low, add DOT 4 brake fluid.

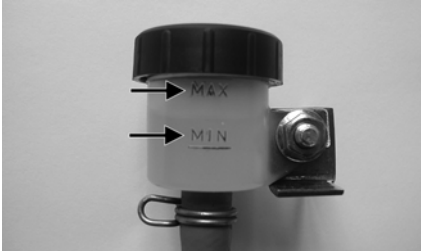

CD474A

■ **NOTE:** The brake fluid reservoir is located under the seat.

2. Press the rear foot brake several times to check for firmness.
3. If the brake is not firm, the system must be bled.

■ **NOTE:** Take the ATV to an authorized Arctic Cat ATV dealer for this service.

Protective Rubber Boots

The protective boots should be inspected periodically according to the Maintenance Schedule.

Ball Joint Boots (Upper and Lower/Right and Left)



CC791

1. Secure the ATV on a support stand to elevate the front wheels.
2. Remove both front wheels.
3. Inspect the four ball joint boots for cracks, tears, or perforations.

4. Check the ball joint for free-play by grasping the steering knuckle and turning it from side to side and up and down.
5. If boot damage is present or ball joint free-play seems excessive, contact an authorized Arctic Cat ATV dealer for service.

Tie Rod Boots (Inner and Outer/Right and Left)

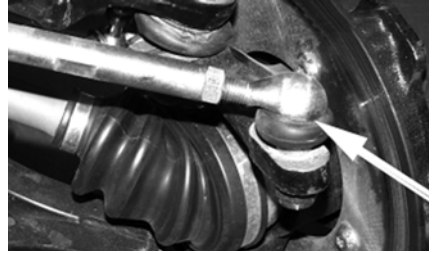

CC792

1. Secure the ATV on a support stand to elevate the front wheels.
2. Remove both front wheels.
3. Inspect the four tie rod boots for cracks, tears, or perforations.
4. Check the tie rod end free-play by grasping the tie rod near the end and attempting to move it up and down.
5. If boot damage is present or tie rod end free-play seems excessive, contact an authorized Arctic Cat ATV dealer for service.

Drive Axle Boots



CC793

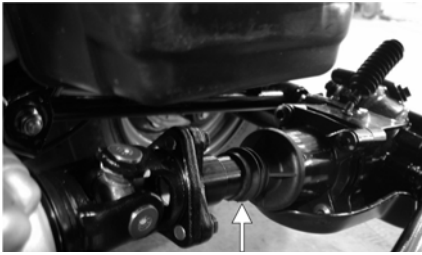

CF125A

1. Inspect all drive axle boots for cracks, tears, or perforations.
2. If boot damage is present, contact an authorized Arctic Cat ATV dealer for service.

Battery

The battery is located under the seat.

After being in service, batteries require regular cleaning and recharging in order to deliver peak performance and maximum service life. The following procedures are recommended for cleaning and maintaining a sealed battery. Always read and follow instructions provided with battery chargers and battery products.

NOTE: Refer to all warnings and cautions provided with the battery or battery maintainer/charger.

Loss of battery charge may be caused by ambient temperature, ignition OFF current draw, corroded terminals, self discharge, frequent start/stops, and short engine run times. Frequent winch usage, snowplowing, extended low RPM operation, short trips, and high amperage accessory usage are also reasons for battery discharge.

Maintenance Charging

NOTE: Arctic Cat recommends the use of the CTEK Multi US 800 or the CTEK Multi US 3300 for battery maintenance charging. Maintenance charging is required on all batteries not used for more than two weeks or as required by battery drain.

1. When charging a battery in the vehicle, be sure the ignition switch is in the OFF position.

2. Clean the battery terminals with a solution of baking soda and water.

NOTE: The sealing strip should NOT be removed and NO fluid should be added.

3. Be sure the charger and battery are in a well-ventilated area. Be sure the charger is unplugged from the 110-volt electrical outlet.
4. Connect the red terminal lead from the charger to the positive terminal of the battery; then connect the black terminal lead of the charger to the negative terminal of the battery.

NOTE: Optional battery charging adapters are available from your authorized Arctic Cat dealer to connect directly to your vehicle from the recommended chargers to simplify the maintenance charging process. Check with your authorized Arctic Cat dealer for proper installation of these charging adapter connectors.

5. Plug the battery charger into a 110-volt electrical outlet.
6. If using the CTEK Multi US 800, there are no further buttons to push. If using the CTEK Multi US 3300, press the Mode button (A) at the left of the charger until the Maintenance Charge Icon (B) at the bottom illuminates. The Normal Charge Indicator (C) should illuminate on the upper portion of the battery charger.



800E

■ **NOTE:** The maintainer/charger will charge the battery to 95% capacity at which time the Maintenance Charge Indicator (D) will illuminate and the maintainer/charger will change to pulse/float maintenance. If the battery falls below 12.9 DC volts, the charger will automatically start again at the first step of the charge sequence.



3300A

■ **NOTE:** Not using a battery charger with the proper float maintenance will damage the battery if connected over extended periods.

Charging

■ **NOTE:** Arctic Cat recommends the use of the CTEK Multi US 800 or the CTEK Multi US 3300 for battery maintenance charging.

1. Be sure the battery and terminals have been cleaned with a baking soda and water solution.

■ **NOTE:** The sealing strip should NOT be removed and NO fluid should be added.

2. Be sure the charger and battery are in a well-ventilated area. Be sure the charger is unplugged from the 110-volt electrical outlet.
3. Connect the red terminal lead from the charger to the positive terminal of the battery; then connect the black terminal lead of the charger to the negative terminal of the battery.
4. Plug the charger into a 110-volt electrical outlet.

5. By pushing the Mode button (A) on the left side of the charger, select the Normal Charge Icon (E). The Normal Charge Indicator (C) should illuminate on the upper left portion of the charger.

6. The battery will charge to 95% of its capacity at which time the Maintenance Charge Indicator (D) will illuminate.

■ **NOTE:** For optimal charge and performance, leave the charger connected to the battery for a minimum 1 hour after the Maintenance Charge Indicator (D) illuminates. If the battery becomes hot to the touch, stop charging. Resume after it has cooled.

7. Once the battery has reached full charge, unplug the charger from the 110-volt electrical outlet.

■ **NOTE:** If, after charging, the battery does not perform to operator expectations, bring the battery to an authorized Arctic Cat dealer for further troubleshooting.

Jump-Starting

■ **NOTE:** Arctic Cat does not recommend jump-starting a vehicle with a dead battery but rather to remove the battery, service it, and correctly charge it; however, in an emergency, it may be necessary to jump-start a vehicle. If so, use the following procedure to carefully and safely complete this procedure.

WARNING

Improper handling or connecting of a battery may result in severe injury including acid burns, electrical burns, or blindness as a result of an explosion. Always remove rings and watches.

1. On the vehicle to be jump-started, remove the battery cover and any terminal boots.

⚠ WARNING

Any time service is performed on a battery, the following must be observed: keep sparks, open flame, cigarettes, or any other flame away. Always wear safety glasses. Protect skin and clothing when handling a battery. When servicing battery in enclosed space, keep the area well-ventilated. Make sure battery venting is not obstructed.

2. Inspect the battery for any signs of electrolyte leaks, loose terminals, or bulging sides. Leaking or bulging battery cases may indicate a frozen or shorted battery.

⚠ WARNING

If any of these conditions exist, DO NOT attempt a jump-start, boost, or charge the battery. An explosion could occur causing serious injury.

3. Inspect the vehicle to be used for jump-starting to determine if voltage and ground polarity are compatible. The vehicle must have a 12-volt DC, negative ground electrical system.

CAUTION

Always make sure the electrical systems are of the same voltage and ground polarity prior to connecting jumper cables. If not, severe electrical damage may occur.

4. Move the vehicle to be used for the jump-start close enough to ensure the jumper cables easily reach; then shift into neutral, set and lock the brakes, shut off all electrical accessories, and turn the ignition switch OFF.

■ **NOTE:** Make sure all switches on the vehicle to be jump-started are turned OFF.

5. Disconnect all external accessories such as cell phones, GPS units, and radios on both vehicles.

CAUTION

Failure to disconnect electronic accessories during jump-starting may cause system damage due to power spikes.

6. Attach one clamp of the positive (red) jumper cable to the positive (+) terminal (1) of the dead battery (C) being careful not to touch any metal with the other clamp; then attach the other clamp of the positive (red) jumper cable to the positive (+) terminal (2) of the good battery (B).

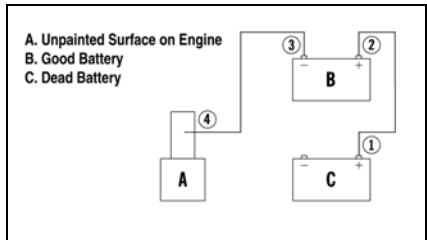

0744-527

■ **NOTE:** Some jumper cables may be the same color but the clamps or ends will be color-coded red and black.

7. Attach one clamp of the negative (black) jumper cable to the negative (-) terminal (3) of the good battery (B); then attach the other clamp of the negative (black) jumper cable (4) to an unpainted metal surface (A) on the engine or frame well away from the dead battery and fuel system components.

⚠ WARNING

Never make the final connection to a battery as a spark could ignite hydrogen gases causing an explosion of the battery resulting in acid burns or blindness.

8. Stand well away from the dead battery and start the vehicle with the good battery. Allow the vehicle to run for several minutes applying some charge to the dead battery.

9. Start the vehicle with the dead battery and allow it to run for several minutes before disconnecting the jumper cables.
10. Remove the jumper cables in opposite order of hook-up (4, 3, 2, 1). Be careful not to short cables against bare metal.

■ **NOTE:** Have the battery and electrical system checked prior to operating the vehicle again.

Spark Plug(s)

The ATV comes equipped with a specified spark plug. See the appropriate specifications chart for the correct spark plug. A light brown insulator indicates that the plug is correct. A white or dark insulator indicates that the engine may need to be serviced or the carburetor may need to be adjusted. Consult an authorized Arctic Cat ATV dealer if the plug insulator is not a light brown color. To help prevent cold weather fouling, make sure to thoroughly warm up the engine before operating.

To maintain a hot, strong spark, keep the plug free of carbon.

Before removing the spark plug, be sure to clean the area around the spark plug. If you do not, dirt could enter engine when removing or installing the spark plug.

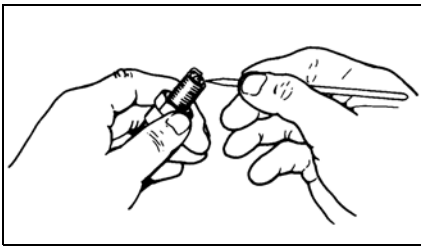

ATV-0051

Adjust the gap to specified amount (see appropriate specifications chart) for proper ignition. Use a feeler gauge to check the gap.

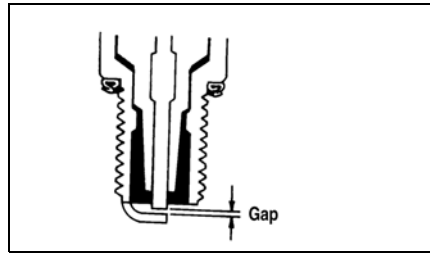

ATV0052B

When installing the spark plug, be sure to tighten it securely. A new spark plug should be tightened 1/2 turn once the washer contacts the cylinder head. A used spark plug should be tightened 1/8 - 1/4 turn once the washer contacts the cylinder head.

Throttle Cable Adjustment

To adjust the throttle cable free-play:

1. Loosen the jam nut from the throttle cable adjuster.
2. Slide the rubber boot away and turn the adjuster until the throttle lever has proper free-play of 3-6 mm (1/8-1/4 in.).

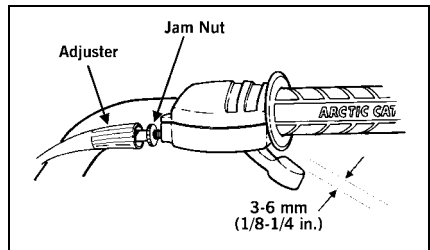

ATV-0047

3. Tighten the jam nut against the throttle cable adjuster securely; then slide the rubber boot over the adjuster.

Air Filter

The air filter inside the air filter housing must be kept clean to provide good engine power and gas mileage. If the ATV is used under normal conditions, service the filter at the intervals specified in the Maintenance Schedule. If operated in dusty, wet, or muddy conditions, inspect and service the filter more frequently. Use the following procedure to remove the filter and inspect and/or clean it.

CAUTION

Failure to inspect the air filter frequently if the ATV is used in dusty, wet, or muddy conditions can damage the engine.

1. Remove the fasteners securing the storage compartment and remove the storage compartment.
2. Remove the air filter housing cover and the air filter/frame assembly.
3. Remove the foam element from the frame making sure not to tear the element.

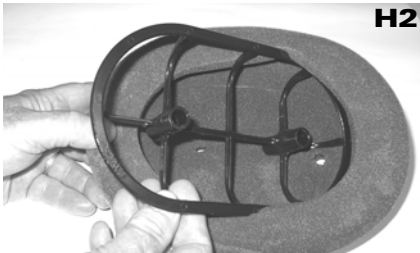

GZ019

450



FI155

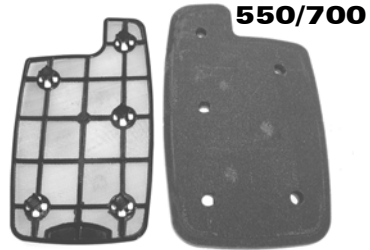

CD747

4. Fill a wash pan larger than the element with a non-flammable solvent; then dip the element in the solvent and wash it.

■ **NOTE: Foam Air Filter Cleaner and Foam Air Filter Oil are available from Arctic Cat.**

5. Squeeze the element by pressing it between the palms of both hands to remove excess solvent. Do not twist or ring the element or it will develop cracks.
6. Dry the element.
7. Put the element in a plastic bag; then pour in air filter oil and work the oil into the element.
8. Squeeze the element to remove excess oil.

CAUTION

A torn air filter can cause damage to the ATV engine. Dirt and dust may get inside the engine if the element is torn. Carefully examine the element for tears before and after cleaning it. Replace the element with a new one if it is torn.

9. Clean any dirt or debris from inside the air cleaner.
10. Install the air filter/frame assembly and cover.
11. Install the storage compartment and cover.

Air Filter Housing Drain(s)

Inspect the “duck bill” drain(s) beneath the main housing for debris and for proper sealing.

Tire Tread Condition

The use of worn-out tires on an ATV is very dangerous. A tire is considered to be worn out when the depth of the tread is less than 3 mm (1/8 in.). Be sure to replace the tires before reaching this minimum specification.

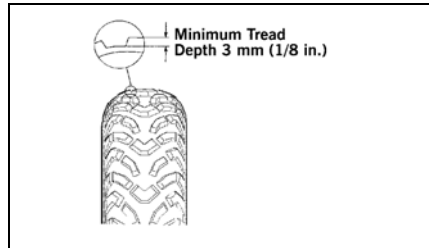

0732-649

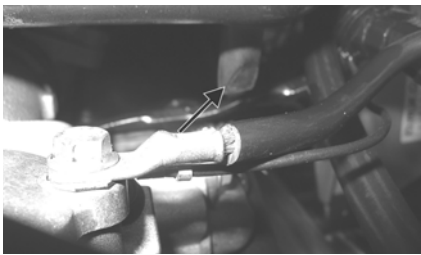

GZ018A

Draining V-Belt Cover

■ **NOTE:** If the ATV has been driven through water, the V-belt cover must be drained of any water.

1. Place the ATV on a level surface.
2. Remove the drain bolt from the cover and allow the water to drain out.

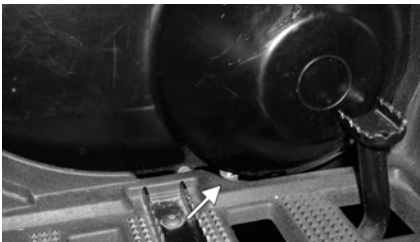

CF110A

3. Shift the range lever to the neutral position; then start the engine.
4. Increase and decrease engine RPM several times to “blow out” any water; then stop the engine.
5. Install the drain bolt and tighten securely.

■ **NOTE:** The V-belt and pulleys should be inspected every 500 miles and the belt replaced (if necessary).

Tires**⚠ WARNING**

Always use the size and type of tires as specified. Refer to the appropriate Specifications Chart for proper tire inflation pressure, and always maintain proper tire inflation pressure.

⚠ WARNING

The use of worn-out tires can be dangerous and can increase the risk of an accident.

Tire Replacement

The ATV has low-pressure tubeless tires. Air is sealed by the contact surfaces of the inner wheel rim and the tire bead. If either the inner wheel rim or tire bead is damaged, air may leak. Be extremely careful not to damage these areas when replacing tires.

It is very important to use the proper tools when repairing or replacing tires to prevent damage to the tire bead or wheel rims. If proper tools and related items are not available, have this maintenance performed by an authorized Arctic Cat ATV dealer or a qualified tire repair station.

CAUTION

When breaking the tire bead loose from the wheel, be extremely careful not to damage the inner wheel surface or the tire bead.

⚠ WARNING

Use only Arctic Cat approved tires when replacing tires. Failure to do so could result in unstable ATV operation.

Tubeless Tire Repair

Should a leak or flat tire occur due to a puncture, the tire may be repaired using a plug-type repair. If the damage is from a cut or if the puncture cannot be repaired using a plug, the tire must be replaced. When operating the ATV in areas where transportation or service facilities are not readily available, it is strongly recommended to carry a plug-type repair kit and a tire pump along.

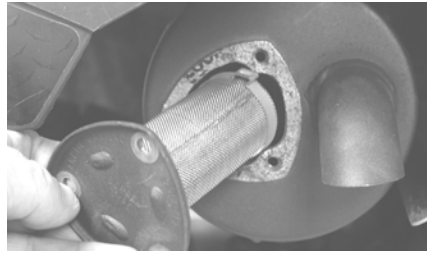

CF104

Wheels

1. Park the ATV on level ground and engage the brake lever lock.
2. Loosen the lug nuts on the wheel to be removed.
3. Elevate the ATV.
4. Remove the lug nuts.
5. Remove the wheel.
6. Install the wheel and install the lug nuts.
7. Tighten the nuts in a crisscross pattern to 40 ft-lb (steel wheels) or 80 ft-lb (aluminum wheels).
8. Remove the jack.

Muffler/Spark Arrester

The muffler has a spark arrester which must be periodically cleaned. At the intervals shown in the Maintenance Schedule, clean the spark arrester using the following procedure.

WARNING

Wait until the muffler cools to avoid burns.

1. Remove the cap screws securing the spark arrester assembly to the muffler.

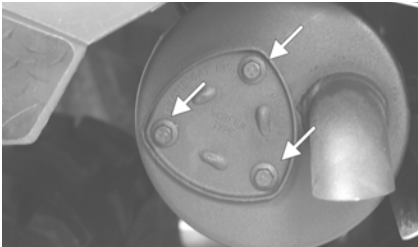

CF105A

2. Using a suitable brush, clean the carbon deposits from the screen taking care not to damage the screen.

■ **NOTE:** If the screen or gasket is damaged in any way, it must be replaced.

3. Install the spark arrester assembly and secure with the cap screws. Tighten cap screws to 48 in.-lb.

Light Bulb Replacement

The wattage rating of each bulb is shown in the chart. When replacing a burned bulb, always use the same wattage rating.

Headlight	12V/27W (4)
Taillight/Brakelight	12V/8W/27W

CAUTION

Use only specified bulbs indicated in the chart as replacement bulbs.

Headlight

■ **NOTE:** The bulb portion of the headlight is fragile. HANDLE WITH CARE. When replacing the headlight bulb, do not touch the glass portion of the bulb. If the glass is touched, it must be cleaned with a dry cloth before installing. Skin oil residue on the bulb will shorten the life of the bulb.

To replace the headlight bulb, use the following procedure.

1. Rotate the bulb assembly counterclockwise and remove from the headlight housing; then disconnect from the wiring harness.

2. Connect the new bulb assembly to the wiring harness connector; then insert into the headlight housing and rotate fully clockwise.

CAUTION

When replacing the headlight bulb, be careful not to touch the glass portion of the bulb. Grasp the new bulb with a clean cloth.

Taillight/Brakelight

To replace the taillight/brakelight bulb, use the following procedure.

1. Rotate the socket counterclockwise and remove it from the housing.

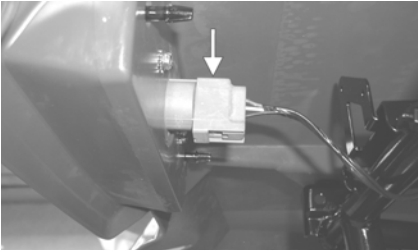

CF135A

2. To remove the bulb from the socket, pull it straight out of the socket.
3. To install the bulb, push it straight into the socket.

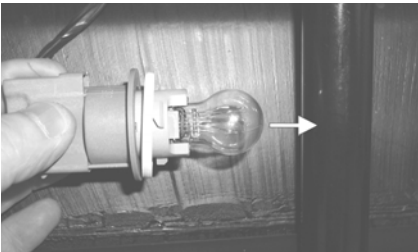

CF132A

4. Insert the socket into the housing and rotate it clockwise.

Checking/Adjusting Headlight Aim

The headlights can be adjusted vertically and horizontally. The geometric center of the HIGH beam light zone is to be used for vertical and horizontal aiming.

1. Position the ATV on a level floor so the headlights are approximately 6.1 m (20 ft) from an aiming surface (wall or similar aiming surface).

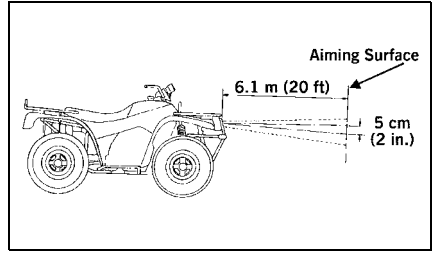

ATV-0070

NOTE: There should be an average operating load on the ATV when adjusting the headlight aim.

2. Measure the distance from the floor to the mid-point of each headlight.
3. Using the measurements obtained in step 2, make horizontal marks on the aiming surface.
4. Make vertical marks which intersect the horizontal marks on the aiming surface directly in front of the headlights.
5. Switch on the lights. Make sure the HIGH beam is on. **DO NOT USE LOW BEAM.**
6. Observe each headlight beam aim. Proper aim is when the most intense beam is centered on the vertical mark 5 cm (2 in.) below the horizontal mark on the aiming surface.
7. Adjust each headlight until correct aim is obtained by turning the knob clockwise to raise or counterclockwise to lower the beam.

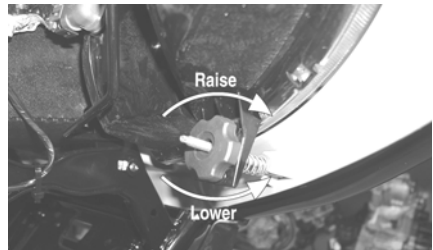

CD714A

Fuses

The fuses are located in a power distribution module under the seat. If there is any type of electrical system failure, always check the fuses first.

CAUTION

Always replace a blown fuse with a fuse of the same type and rating. If the new fuse blows after a short period of use, consult an authorized Arctic Cat ATV dealer immediately.

■ **NOTE:** To remove the fuse, compress the locking tabs on either side of the fuse cover and lift out.

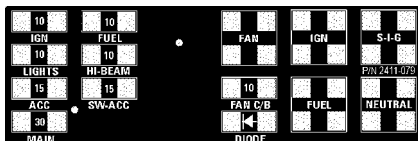

2411-079

1000 H2 Mud Pro

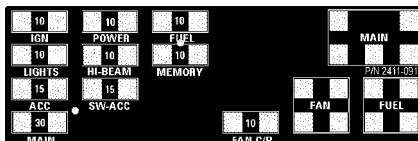

2411-091

Mud Pro

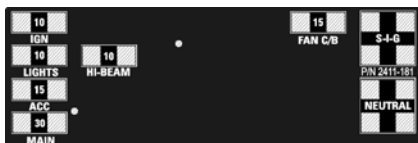

450 H1

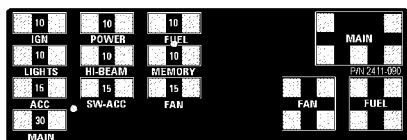

2411-090

550/700/700 TBX/1000

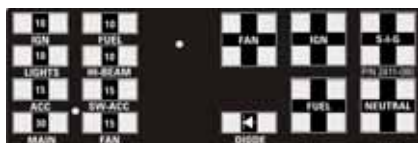

2411-080

Electrical Output Terminals

Two output terminals for electrical accessories are located on the front and rear wiring harnesses. The accessory plug is located on the instrument pod.

CAUTION

Always use electrical accessories less than 180W.

Storage Compartment/Tools

A basic tool kit is provided with the ATV. Maintain the tool kit with the ATV at all times.

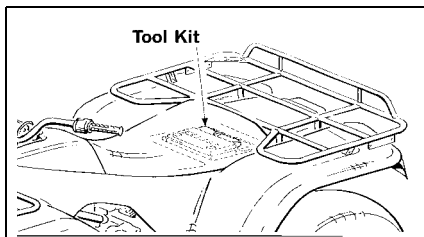

ATV-1097

The storage compartment is above the engine in front of the seat.

Preparation for Storage

CAUTION

Prior to storing the ATV, it must be properly serviced to prevent rusting and component deterioration.

Arctic Cat recommends the following procedure to prepare the ATV for storage. An authorized Arctic Cat ATV dealer should perform this service; however, the owner/operator may perform this service if desired.

1. Clean the seat cushion (cover and base) with a damp cloth and allow to dry.
2. Clean the ATV thoroughly by washing dirt, oil, grass, and other foreign matter from the entire ATV. Allow the ATV to dry thoroughly. DO NOT get water into any part of the engine or air intake.
3. Either drain the gas tank or add a fuel stabilizer to the gas in the gas tank. Remove the air filter housing cover and air filter. Start the engine and allow it to idle; then using Arctic Cat Engine Preserver, rapidly inject the preserver into the air filter opening for a period of 10 to 20 seconds. Install the air filter and housing cover.

CAUTION

If the interior of the air filter housing is dirty, clean the area before starting the engine.

4. Plug the hole in the exhaust system with a clean cloth.
5. Apply light oil to the upper steering post bushing and plungers of the shock absorbers.
6. Tighten all nuts, bolts, cap screws, and screws. Make sure rivets holding components together are tight. Replace all loose rivets. Care must be taken that all calibrated nuts, cap screws, and bolts are tightened to specifications.
7. Fill the cooling system to the bottom of the stand pipe in the radiator neck with properly mixed coolant.
8. Disconnect the battery cables (negative cable first); then remove the battery, clean the battery posts and cables, and store in a clean, dry area.

■ **NOTE: For storage, use a battery maintainer or make sure the battery is fully charged (see Battery section in this manual).**

9. Store the ATV indoors in a level position.

CAUTION

Avoid storing outside in direct sunlight and avoid using a plastic cover as moisture will collect on the ATV causing rusting.

Preparation after Storage

Taking the ATV out of storage and correctly preparing it will assure many miles and hours of trouble-free riding. Arctic Cat recommends the following procedure to prepare the ATV.

CAUTION

Before installing the battery, make sure the ignition switch is in the OFF position.

1. Clean the ATV thoroughly.
2. Clean the engine. Remove the cloth from the exhaust system.
3. Check all control wires and cables for signs of wear or fraying. Replace if necessary.
4. Change the engine/transmission oil and filter.
5. Check the coolant level and add properly mixed coolant as necessary.
6. Charge the battery; then install. Connect the battery cables making sure to connect the positive cable first.
7. Check the entire brake systems (fluid level, pads, etc.), all controls, headlights, taillight, brakelight, and headlight aim; adjust or replace if necessary.
8. Check the tire pressure. Inflate to recommended pressure as necessary.
9. Tighten all nuts, bolts, cap screws, and screws making sure all calibrated nuts, cap screws, and bolts are tightened to specifications.
10. Make sure the steering moves freely and does not bind.
11. Check the spark plug. Clean or replace as necessary.
12. Follow the recommendations found in the pre-start inspection.

NOTES

Change of Address, Ownership, or Warranty Transfer

Arctic Cat Inc. keeps on file the current name and address of the owner of this ATV. This will allow Arctic Cat to reach the current owner with any important safety information which may be necessary to protect customers from personal injury or property damage. Please make sure a copy of this form is completed and returned to Arctic Cat Inc. if you move or if the ATV is sold to another party.

This form may also be used to transfer the unused portion of the original warranty to a second party. In order to transfer warranty, fill out this form completely; then return a copy of this form to Arctic Cat Inc. Arctic Cat will then process the application and issue warranty for the balance of the time remaining of the original warranty.

Address Change

Ownership Change

Warranty Transfer

Change of Address/Ownership/Warranty Transfer to:

Name _____

Address _____

City/State (Province)/Zip Code (Postal Code) _____

Phone # () _____

Year and Model ATV _____

Vehicle Identification Number (VIN) _____

Before operating, you should take an ATV Rider Course to learn ATV riding skills or reinforce your current good riding skills. In U.S.A., call 1-800-887-2887 to enroll in the half-day ATV Rider Course nearest you or ask your dealer for assistance. The course instructor will charge a small fee for each person taking the course. In Canada, call (613) 739-1535.

Fold Back

CHANGE OF ADDRESS/OWNERSHIP

Place
Stamp
Here

**ARCTIC CAT INC.
PRODUCT SERVICE AND
WARRANTY DEPT.
P.O. BOX 810
THIEF RIVER FALLS, MN 56701**

Identification Numbers Record

WARNING

Indicates a potential hazard that could result in serious injury or death.

The key identification number is stamped on the key as shown in the illustration. Record this number in the space provided for reference if you ever need a new key.



Record the Vehicle Identification Number and Engine Serial Number in the spaces provided to assist you in ordering parts from your authorized Arctic Cat ATV dealer or for reference in case the ATV is stolen.

1. Key Identification Number:

2. Vehicle Identification Number:

3. Engine Serial Number:



WARNING

Improper ATV use can result in SEVERE INJURY or DEATH



**ALWAYS USE
AN APPROVED
HELMET AND
PROTECTIVE
GEAR**



**NEVER USE
ON PUBLIC
ROADS**



**NEVER CARRY
PASSENGERS**



**NEVER USE
WITH DRUGS
OR ALCOHOL**

NEVER operate:

- without proper training or instruction
- at speeds too fast for your skills or the conditions
- on public roads - a collision can occur with another vehicle
- with a passenger - passengers affect balance and steering and increase risk of losing control

ALWAYS:

- use proper riding techniques to avoid vehicle overturns on hills and rough terrain and in turns
- avoid paved surfaces - pavement may seriously affect handling and control

**LOCATE AND READ OPERATOR'S MANUAL
FOLLOW ALL INSTRUCTIONS AND WARNINGS**

Your 2-Up ATV Can Be Hazardous To Operate.

A collision or rollover can occur quickly, even during routine maneuvers such as turning and driving on hills or over obstacles, if you fail to take proper precautions.

For your safety and the safety of a passenger, understand and follow all the warnings contained in this Operator's Manual and the labels on your ATV.

Keep this Operator's Manual with your ATV at all times.

FAILURE TO FOLLOW THE WARNINGS CONTAINED IN THIS MANUAL CAN RESULT IN SERIOUS INJURY OR DEATH.

Training is available: U.S. owners, call 800-887-2887; Canadian owners, call 613-739-1535.

Un cours d'instruction est disponible: pour les propriétaires canadiens, composez le 613-739-1535.

Particularly important information is distinguished in this manual by the following notations:



The Safety Alert Symbol means ATTENTION! BE ALERT! YOUR SAFETY IS INVOLVED.



WARNING

WARNING indicates a hazardous situation which, if not avoided, could result in death or serious injury.

CAUTION

CAUTION, without the safety alert symbol, is used to address practices not related to personal injury.

■ **NOTE:**

A NOTE provides key information to make procedures easier or more clear.

California Proposition 65



WARNING

This product contains or emits chemicals known to the State of California to cause cancer and birth defects or other reproductive harm.

Foreword

Congratulations and thank you from Arctic Cat Inc. for purchasing an ARCTIC CAT® TRV. Built with American engineering and manufacturing know-how, it is designed to provide superior ride, comfort, and utility.

This Operator's Manual is furnished to make sure that the operator and passenger are aware of safe operating procedures. It also includes information about the general care and maintenance of your ATV.

Carefully read the following pages. If you have any questions regarding this ATV, contact an authorized Arctic Cat ATV dealer for assistance. Remember, only authorized Arctic Cat ATV dealers have the knowledge and facilities to provide you with the best service possible.

This Arctic Cat TRV Operator's Manual should be considered a permanent part of the ATV and must remain with the ATV at the time of resale. If the ATV changes ownership more than once, contact Arctic Cat Inc., Service Department, P.O. Box 810, Thief River Falls, MN 56701, for proper registration information.

You have chosen a quality Arctic Cat TRV designed and assembled to give dependable service. Be sure, as the owner/operator of an Arctic Cat TRV, to become thoroughly familiar with its basic operation, maintenance, and storage procedures. Read, understand, and follow the entire Operator's Manual before operating the ATV to ensure safe and proper use of your new Arctic Cat ATV. Always operate the ATV within your level of skill and current terrain conditions.

Protect Your Sport

- Know all local, state/provincial riding laws,
- Respect your ATV, and
- Respect the environment

We also advise you to strictly follow the recommended maintenance program as outlined. This preventive maintenance program is designed to ensure that all critical components on this ATV are thoroughly inspected at various intervals.

All information in this manual is based on the latest product data and specifications available at the time of printing. Arctic Cat Inc. reserves the right to make product changes and improvements which may affect illustrations or explanations without notice.

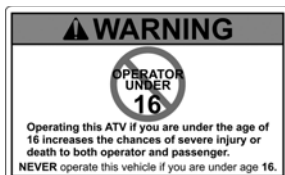

2411-122A

Parts and Accessories

When in need of replacement parts, oil, or accessories for your Arctic Cat TRV, be sure to use only GENUINE ARCTIC CAT PARTS, OIL, AND ACCESSORIES. Only genuine Arctic Cat parts, oil, and accessories are engineered to meet the standards and requirements of your Arctic Cat TRV. For a complete list of accessories, refer to the current Arctic Cat Accessory Catalog.

To aid in service and maintenance procedures on this ATV, a Service Manual and an Illustrated Parts Manual are available through your local Arctic Cat ATV dealer.

Arctic Cat and the ATV Safety Institute recommend that all ATV operators ride the appropriate-sized ATV according to age.

Category	Age (Years)	Speed Limitations (MPH)	Notes
Y-12+	12 or Older	15 - Limited 30 - Maximum	Operate Under Adult Supervision
T-14	14 or Older	20 - Limited 30 - Limited 38 - Maximum	Operate Under Adult Supervision
G & S	16 or Older	According to Local Regulations	—

TREAD LIGHTLY! OFFICIAL SPONSOR®
ON PUBLIC AND PRIVATE LAND

Table of Contents

Foreword	1
Parts and Accessories.....	1
Limited Warranty	3
Warranty Procedure/Owner Responsibility	4
Arctic Cat ATV Emission Control Warranty Statement	5
Arctic Cat Emission Control System Limited Warranty	6
U.S. EPA Emission Control Statement/ Warranty Coverage (U.S. Only)	7
Declaration of Conformity	8

DIVISION I - SAFETY

2-Up ATV Safety Alert	11
Rider Training Course.....	12
Hangtags	13
Warning Labels & Information	14-15
Warnings	16-25
Prevention.....	26-29
Safe Riding Clothing and Gear (Operator and Passenger).....	26
TRV Condition	27
T-CLOC.....	27
First Aid and Survival.....	29
Active Riding	30
Sound Judgment.....	31-35
Environment	31
Those Around You	32
Equipment	33
Load Capacity Ratings Chart	34
Speedrack	34
Personal Choices	34
SIPDE.....	35
Supervision	36
Taking Responsibility	36
Inexperienced Riders	36
Experienced Riders	36

DIVISION II - OPERATION/ MAINTENANCE

TRV Specifications.....	37-38
Location of Parts and Controls.....	39
ATV Operation	40-50
Basic Operating Maneuvers	40
Starting the Engine.....	40
BONE-C	40
Starting a Cold Engine	41
Handling the TRV (Active Riding Techniques)	42
Tips.....	48
General Information	51-65
TRV Identification Numbers.....	51
Ignition Switch Key	51

Control Locations And Functions	51
Power Steering (Cruiser).....	55
Speedometer/LCD (Digital)	56
Speedometer/LCD (Analog/Digital)	58
Electric Fuel Pump.....	60
Gas Hoses	60
Oil Level Stick.....	60
Windshield (Cruiser)	61
Mirrors (Cruiser)	61
Rear Seat Lock	61
Front Seat Lock.....	62
Storage Box (Cruiser)	62
Safety Flag Bracket.....	62
Rack Loading	62
Trailing And Towing	63
Transporting TRV	63
Gasoline-Oil-Lubricant	64
Engine Break-In	65
Burnishing Brake Pads.....	65
General Maintenance	66-82
Maintenance Schedule	67
Liquid Cooling System	68
Oil Cooler (1000).....	69
Shock Absorbers.....	69
General Lubrication.....	69
Hydraulic Hand Brake	71
Brake Fluid.....	71
Brake Lever Lock	71
Brake Hoses	71
Brake Pads.....	71
Rear Foot Brake	72
Protective Rubber Boots	72
Battery.....	73
Spark Plug(s)	76
Throttle Cable Adjustment.....	76
Air Filter.....	77
Air Filter Housing Drains	78
Draining V-Belt Cover.....	78
Tires	78
Wheels	79
Muffler/Spark Arrester.....	79
Light Bulb Replacement.....	80
Checking/Adjusting Headlight Aim	80
Fuses	81
Electrical Output Terminals	81
Tool Storage Tray/Battery Hold- Down	81
Preparation For Storage	83
Preparation After Storage.....	84
Maintenance Record	85
Change Of Address, Ownership, Or Warranty Transfer	87
Identification Numbers Record	Inside Back Cover

Limited Warranty

Arctic Cat Inc. (hereinafter referred to as Arctic Cat) extends a limited warranty on each new Arctic Cat ATV it assembles and on each genuine Arctic Cat ATV part and accessory assembled or sold by an authorized Arctic Cat ATV dealer. Warranty on an Arctic Cat ATV is extended to the original retail purchaser; however, the balance of the unused warranty may be transferred to another party. Warranty coverage is only available in the country in which the original retail purchase occurs to the original retail purchaser resident in that country or to a transferee resident in that country of the balance of the unused warranty.

Arctic Cat warrants only the products it assembles and/or sells and does not warrant that other products will function properly when used with an Arctic Cat ATV or will not damage the ATV. Arctic Cat does not assume any liability for incidental or consequential damages.

Arctic Cat will repair or replace, at its option, free of charge (including any related labor charges), any parts that are found to be warrantable in material or workmanship. This repair work **MUST** be done by an authorized Arctic Cat ATV dealer. No transportation charges, rental charges, or inconvenience costs will be paid by Arctic Cat. The warranty is validated upon examination of said parts by Arctic Cat or an authorized Arctic Cat ATV dealer. Arctic Cat reserves the right to inspect such parts at its factory for final determination if warranty should apply.

The warranty periods are as follows:

1. Six months from the date of sale — for an Arctic Cat ATV used for recreational purposes.
2. Ninety days from date of invoice — for an Arctic Cat ATV used for commercial purposes, including rental operations (non-transferable).
3. Thirty days from date of sale of ATV on Arctic Cat supplied batteries.
4. Thirty days from date of sale — for all dealer installed genuine Arctic Cat service parts and accessories.
5. Until expiration of the new product warranty (paragraphs 1 and 2 above) — for all eligible replacement parts on new product.

Exclusions to this warranty include normal wear, abuse, or corrosion and the following parts and items:

Tires	CV Boots	Torn or Punctured Upholstery
Oil Filter	Drive Belt	Cracks or Gouges in Body Panels
Air Filter	Brake Pads	Drive/Driven Clutch Wear Parts
Light Bulbs	Spark Plug(s)	

The following will VOID Arctic Cat's warranty:

1. Failure to perform the proper break-in procedure and all related maintenance, storage procedures (if stored for extended periods), and/or service as recommended in the Operator's Manual.
2. Repairs and/or adjustments by anyone other than an authorized Arctic Cat ATV dealer.
3. Use of improper carburetor main jets.
4. Use of improper gasoline, lubricating oils, or spark plug.
5. An accident or subjecting the ATV to misuse, abuse, or negligent operation.
6. Any modification, addition, or removal of parts unless instructed to do so by Arctic Cat.
7. Use of the ATV in any way for racing purposes.
8. Removal of the engine for use in another vehicle.
9. Removal or mutilation of the Vehicle Identification Number or Engine Serial Number.
10. Use of parts not sold or approved by Arctic Cat.
11. Damage due to improper transportation.

In consideration of the foregoing, any implied warranty is limited in duration to the various warranty periods set forth. This warranty gives you specific legal rights, and you may also have other rights which vary from state/province to state/province or country to country. Some jurisdictions do not allow limitations on how long an implied warranty lasts, so the above limitations may not apply to you.

Warranty Procedure/Owner Responsibility

At the time of sale, a TRV Owner Registration form is to be completed by the selling dealer and consumer. The receipt of the form by Arctic Cat is a condition precedent to warranty coverage. It is the selling dealer's responsibility to retain and/or submit appropriate copies of the form to the appropriate place(s) to initiate warranty coverage.

The dealer will furnish to the consumer a signed copy of the form which must be presented to the dealer when requesting warranty service. The registration form is the consumer's proof of ownership and warranty eligibility. The form is used by the dealer to validate the warranty claim. Retain your copy of the form and keep it in a safe place.

When warranty repair is suspected, the TRV should be taken to the selling dealer, who has the primary responsibility to perform warranty repairs. Subject to the limitations set forth in the Limited Warranty, in the event the selling dealer has ceased to do business, you have moved, or you are in a location away from your selling dealer, warranty may be performed by any authorized Arctic Cat ATV dealer.

The authorized Arctic Cat ATV dealer will examine the TRV or part to determine if, in his opinion, a warrantable condition exists. If a warrantable condition appears to exist, the dealer will repair or replace, at Arctic Cat's option, free of charge, including any related labor costs, all parts that are found to be warrantable and any other parts which the warrantable part caused to be damaged. You, the owner, will then be asked to sign a warranty form to ensure Arctic Cat that the warranty work was actually performed.

It is the owner's responsibility to maintain and service the TRV in accordance with Arctic Cat's recommendations in the Operator's Manual. To protect yourself and your TRV, follow all safety and service tips. **Arctic Cat will NOT warrant repairs required as a result of not performing standard operator maintenance, storage procedures, and service as outlined in the Operator's Manual.**

Should you have any questions concerning the warranty, contact an authorized Arctic Cat ATV dealer.

Arctic Cat ATV Emission Control Warranty Statement

Warranty Rights and Obligations

Arctic Cat Inc. (hereinafter referred to as Arctic Cat) and the California Air Resources Board are pleased to explain the emission control system warranty for each new Arctic Cat ATV sold in the state of California. In California, a new ATV must be designed, built, and equipped to meet the state's stringent anti-smog standards.

Arctic Cat warrants the emission control system on the Arctic Cat ATV for the periods listed below provided there has been no abuse, neglect, or improper maintenance of the ATV.

The emission control system may include components such as the carburetor, ignition system, and crankcase ventilation system. Also included may be hoses, belts, connectors, and other emission-related assemblies.

When a warrantable condition exists, Arctic Cat will repair the ATV at no cost to the owner, including diagnosis, parts, and labor.

Emission Control Warranty Coverage

A new Arctic Cat ATV manufactured after January 1, 1997 has a two (2) year warranty on its emissions control components.

If an emission-related component on the ATV is defective, the component will be repaired or replaced by any authorized Arctic Cat ATV dealer.

Owner's Emission Control Warranty Responsibilities

It is the owner's responsibility to perform the required maintenance listed in the Operator's Manual. Arctic Cat recommends the retention of all receipts covering maintenance performed on the ATV, but Arctic Cat cannot deny warranty solely for the lack of receipts or for failure to ensure the performance of all scheduled maintenance on the emission control system.

It is the owner's responsibility to present the ATV to an authorized Arctic Cat ATV dealer as soon as a problem exists. The undisputed warranty repairs should be completed within a reasonable period of time, not to exceed thirty days.

The ATV owner should be aware that Arctic Cat may deny warranty coverage if either the ATV or a component has failed due to abuse, neglect, improper maintenance, or any unapproved modifications.

If you have any questions regarding your warranty rights and responsibilities, contact either Arctic Cat Inc, P.O. Box 810, Thief River Falls, MN 56701, (218) 681-4999 or the California Air Resources Board, 9528 Telstar Avenue, El Monte, CA 91731, (818) 575-6800.

Arctic Cat Emission Control System Limited Warranty

Arctic Cat Inc., P.O. Box 810, Thief River Falls, MN 56701 (hereinafter referred to as Arctic Cat) warrants that this new Arctic Cat ATV manufactured on or after January 1st, 1997:

- A. Is designed, built, and equipped so as to conform at the time of initial purchase with all applicable regulations of the California Air Resources Board and
- B. Is free from defects in material and workmanship which could cause such ATV to fail to conform with applicable regulations of the California Air Resources Board for a period of use of two (2) years from the date of initial retail delivery.

Coverage

Warranty defects shall be remedied during customary business hours at any authorized Arctic Cat ATV dealer located within the state of California in compliance with applicable regulations of the California Air Resources Board. Any component or components replaced under this warranty shall become the property of Arctic Cat.

In California, emission related warranted components are specifically defined by the state's Emission Warranty Parts List. These warranted components are carburetor and internal components, intake manifold, fuel injection system, spark advance mechanism, crankcase breather, air cutoff valve, fuel/vapor separator, canister, igniters, breaker governors, ignition coils, ignition wires, ignition points, condensers and spark plugs if failure occurs prior to the first scheduled replacement, and hoses, clamps, and fittings used directly in these parts. Since emission related components may vary from model to model, certain models may not contain all of these components, and certain models may contain functionally equivalent components.

In California, emission control system emergency repairs, as provided for in the California Administrative Code, may also be performed by other than an authorized Arctic Cat ATV dealer. An emergency situation occurs when an authorized Arctic Cat ATV dealer is not reasonably available, a component is not available within thirty (30) days, or a repair is not complete within thirty (30) days. Any replacement component can be used in an emergency repair. Arctic Cat will reimburse the owner for the expenses, including diagnosis, not to exceed suggested retail price as set forth by Arctic Cat for all warranted components replaced and labor charges based on the recommended time allowance set forth by Arctic Cat for the warranty repair and the geographically appropriate hourly labor rate. The owner may be required to keep receipts and failed components in order to receive compensation.

Limitations

This Emission Control System Warranty shall not cover any of the following:

- A. Repair or replacement required as a result of
 - (1) accident,
 - (2) misuse,
 - (3) lack of required maintenance,
 - (4) repairs improperly performed or replacements improperly installed,
 - (5) use of replacement components or accessories not conforming to Arctic Cat specifications which adversely affect performance, and/or
 - (6) use in competitive racing or related events.
- B. Inspections, replacement of components, and other services or adjustments necessary for required maintenance.

Limited Liability

The liability of Arctic Cat under this Emission Control System Warranty is limited solely to the remedying of defects in material and workmanship by an authorized Arctic Cat ATV dealer at its place of business during customary business hours. This warranty does not cover inconvenience or loss of use of the ATV or transportation of the ATV to or from the Arctic Cat ATV dealer.

ARCTIC CAT SHALL NOT BE LIABLE FOR ANY OTHER EXPENSES, LOSS, OR DAMAGE, WHETHER DIRECT, INCIDENTAL, CONSEQUENTIAL, OR EXEMPLARY, ARISING IN CONNECTION WITH THE SALE OR USE OF, OR INABILITY TO USE THE ARCTIC CAT ATV FOR ANY PURPOSE. SOME STATES DO NOT ALLOW THE EXCLUSION OR LIMITATION OF ANY INCIDENTAL OR CONSEQUENTIAL DAMAGES, SO THE ABOVE MAY NOT APPLY TO YOU.

NO EXPRESS EMISSION CONTROL SYSTEM WARRANTY IS GIVEN BY ARCTIC CAT EXCEPT AS SPECIFICALLY SET FORTH HEREIN. ANY EMISSION CONTROL SYSTEM WARRANTY IMPLIED BY LAW, INCLUDING ANY WARRANTY OF MERCHANTABILITY OR FITNESS FOR A PARTICULAR PURPOSE, IS LIMITED TO THE EXPRESS EMISSION CONTROL SYSTEM WARRANTY TERMS STATED IN THIS WARRANTY. THE FOREGOING STATEMENTS OF WARRANTY ARE EXCLUSIVE AND IN LIEU OF ALL OTHER REMEDIES.

No dealer is authorized to modify this Arctic Cat Inc. Limited Emission Control System Warranty.

Legal Rights

THIS WARRANTY GIVES YOU SPECIFIC LEGAL RIGHTS, AND YOU MAY ALSO HAVE OTHER RIGHTS WHICH VARY FROM STATE TO STATE.

THIS WARRANTY IS IN ADDITION TO THE ARCTIC CAT INC. LIMITED ATV WARRANTY.

Additional Information

Any replacement component that is equivalent in performance and durability may be used in the performance of any maintenance or repairs. However, Arctic Cat is not liable for these components. The owner is responsible for the performance of all required maintenance. Such maintenance may be performed at a service establishment or by any individual. The warranty period begins on the date the ATV is delivered to the owner.

U.S. EPA Emission Control Statement/Warranty Coverage (U.S. Only)

STATEMENT/WARRANTY

Arctic Cat warrants to the original retail purchaser, and each subsequent purchaser, that all U.S. EPA-certified Arctic Cat ATV's are designed, built, and equipped to conform to all U.S. EPA Emission Control Regulations. Please read the following information completely.

Your authorized Arctic Cat ATV dealer will repair or replace any defective emission-related component at no cost to you during the warranty period. You may have non-warranty service performed by any repair establishment that uses equivalent components. The regulations provide significant civil penalties for tampering that causes your ATV to no longer meet U.S. EPA emission standards.

Arctic Cat further warrants that the engine and its emission-related components are free from defects in materials or workmanship that could cause the engine to fail to comply with applicable regulations during the warranty period.

If you have any questions about this information, or the emission warranty coverage statement, contact your local authorized Arctic Cat ATV dealer.

WARRANTY PERIOD

The emission warranty period for this ATV begins on the same date as the standard warranty coverage and continues for 30 months or 3100 miles, whichever comes first.

COMPONENTS COVERED

The emissions warranty covers major emissions control components and emission-related components listed as follows:

Engine Management and Sensors

Barometric Pressure Sensor
Camshaft Position Sensor
Engine Control Unit (ECU)
Engine Coolant Temperature Sensor
Intake Air Temperature Sensor
Manifold Absolute Pressure Sensor
Oxygen Sensor
Throttle Position Sensor
Crankshaft Position Sensor
Exhaust Temperature Sensor

Ignition System

Ignition Coil
Knock Sensor System
Spark Plugs
Capacitive Discharge Ignition (CDI) Module
Magneto Pick-Up

Fuel/Air System

Fuel Injectors
Fuel Pressure Regulator
Fuel Pump
Carburetor(s)
Turbocharger Assembly
Air Bypass Valve
Turbo Waste Gate Control Valve
Crankcase Ventilation System
ISC Valve

Miscellaneous Items Used in Aforementioned Systems

Connectors
Switches
Grommets
Clamps
Hoses
Ties
Gaskets
Wiring

OWNER'S RESPONSIBILITIES

The owner of any ATV warranted under this Arctic Cat Emission Control Statement is responsible for the proper maintenance and use of the ATV as stated in the Operator's Manual. Proper maintenance generally includes replacement and service, at the owner's choosing, such items as air filter, oil and oil filter, or any other part, item, or device related to emissions control as specified in the Operator's Manual. It is the owner's responsibility to ensure that the ATV is used in a manner for which it was designed.

Declaration of Conformity

Application of council directives:

EMC Directive 97/24/EC
Date of Issue: June, 1997
EC Machinery Directive 2006/42/EC
Date of Issue: May, 2006

Issued by European Commission.

Type of Equipment: All-Terrain Vehicles

Brand Name: Arctic Cat

Model:

450 i TRV/GT 700 i Cruiser
550 i TRV/GT 1000 i TRV/GT
550 i Cruiser TRV 1000 i Cruiser
700 i TRV/GT

Standards to which conformity is declared:

EN 61000-6-2:2005
EN 55012:2007

Manufacturer (if not issuing agent):

Arctic Cat Inc.
601 Brooks Ave S.
Thief River Falls, MN
56701 USA

I, the undersigned, hereby declare that the equipment specified above conforms to the directive(s) and standard(s) as specified.

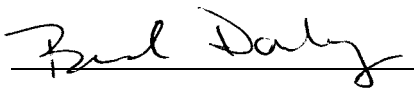

Brad Darling
Vice President/General Manager

DIVISION I - SAFETY

A 2-UP ATV Is Not A Toy And Can Be Hazardous To Operate.

- Always go slowly and be extra careful when operating on unfamiliar terrain. Always be alert to changing terrain conditions when operating the ATV.
- Never operate on excessively rough, slippery, or loose terrain.
- Always follow proper procedures for turning as described in this manual. Practice turning at slow speeds before attempting to turn at faster speeds. Do not turn at excessive speed.
- Always have the ATV checked by an authorized Arctic Cat ATV dealer if it has been involved in an accident.
- Never operate the ATV on hills too steep for the ATV or for your abilities. Practice on smaller hills before attempting larger hills. Never operate up or down hills steeper than 25°.
- Always follow proper procedures for climbing hills as described in this manual. Check the terrain carefully before you start up any hill. Never climb hills with slippery or loose surfaces. Shift your weight forward. Never open the throttle suddenly or make sudden gear changes. Never go over the top of any hill at high speed.
- Always follow proper procedures for going down hills and for braking on hills as described in this manual. Check the terrain carefully before you start down any hill. Shift your weight backward. Never go down a hill at high speed. Avoid going down a hill at an angle which would cause the ATV to lean sharply to one side. Go straight down the hill where possible.
- Always follow proper procedures for crossing the side of a hill as described in this manual. Avoid hills with slippery or loose surfaces. Shift your weight to the uphill side of the ATV. Never attempt to turn the ATV around on any hill until you have mastered the turning techniques described in this manual on level ground. Avoid crossing the side of a steep hill if possible.
- Always use proper procedures if you stall or roll backward when climbing a hill. To avoid stalling, maintain a steady speed when climbing a hill. If you stall or roll backwards, follow the special procedure for braking described in this manual. Dismount on the uphill side or to either side if pointed straight uphill. Turn the ATV around and mount following the procedure described in this manual.
- Always check for obstacles before operating in a new area. Never attempt to operate over large obstacles, such as large rocks or fallen trees. Always follow proper procedures when operating over obstacles as described in this manual.
- Always be careful of skidding or sliding. On slippery surfaces, such as ice, go slowly and be very cautious in order to reduce the chance of skidding or sliding out of control.
- Never operate the ATV in fast flowing water or in water deeper than the footrests. Remember that wet brakes may have reduced stopping capability. Test your brakes after leaving water. If necessary, apply them lightly several times to let friction dry out the pads.
- Always be sure there are no obstacles or people behind you when you operate in reverse. When it is safe to proceed in reverse, go slowly. Avoid turning at sharp angles in reverse.
- Always use the size and type tires specified in this manual. Always maintain proper tire pressure as described in this manual.
- Never improperly install or improperly use accessories on this ATV.
- Never install a twist grip throttle on this ATV.
- Never exceed the stated load capacity for this ATV. Cargo should be properly distributed and securely attached. Reduce speed and follow instructions in this manual for carrying cargo or pulling a trailer and allow greater distance for braking.
- No one under the age of 16 should operate this ATV. Some operators at the age of 16 may not be able to operate the ATV safely. Parents should supervise the use of the ATV at all times. Parents should permit continued use only if they determine that the operator has the ability to operate the ATV safely.

A 2-Up ATV Is Not A Toy And Can Be Hazardous To Operate.

- Never carry a passenger under the age of 12.
- Never carry a passenger who cannot place both feet on the footrests and who cannot securely hold onto the handholds.

FOR MORE INFORMATION ABOUT TRV SAFETY, contact your local Arctic Cat ATV dealer or 1-613-739-1535 (Canada).

TRV PASSENGER INSTRUCTIONS

Operator, tell your passenger to:

- Hold firmly onto the handholds.
- Keep both feet on the footrests even when stopped.
- Stay directly behind you leaning as you lean.

2-Up ATV Safety Alert

You should be aware that A 2-Up ATV IS NOT A TOY AND CAN BE HAZARDOUS TO OPERATE. A TRV handles differently from other vehicles, including motorcycles and cars. A collision or roll-over can occur quickly, even during routine maneuvers such as turning and driving on hills and over obstacles, if you fail to take proper precautions.

TO AVOID DEATH OR SEVERE PERSONAL INJURY:

- * Always read the Operator's Manual carefully and follow the operating procedures described. Pay special attention to the warnings contained in the manual and on all labels.
- * Never operate the ATV or ride as a passenger without proper instruction. Take a training course. Beginners should complete a training course.
- * Never allow anyone under 16 years old to operate an Arctic Cat TRV.
- * Never carry a passenger under the age of 12 on the ATV.
- * Never operate the ATV on pavement. The ATV is not designed to be used on paved surfaces and may be difficult to control.
- * Never operate the ATV on a public road, even a dirt or gravel one, because you may not be able to avoid colliding with another ATV. Also, operating the ATV on a public road may be against the law.
- * Never operate the ATV or ride as a passenger without an approved motorcycle helmet, eye protection, boots, gloves, long pants, and a long-sleeved shirt or jacket.
- * Never consume alcohol or drugs before or while operating the ATV or riding as a passenger.
- * Never operate the ATV at excessive speeds. Go at a speed which is proper for the terrain, visibility conditions, and your experience.
- * Never attempt to do wheelies, jumps, or other stunts.
- * Always be careful when operating the ATV, especially when approaching hills, turns, and obstacles and when operating on unfamiliar or rough terrain.
- * Never lend the ATV to anyone who has not taken a training course.
- * Always inspect the ATV each time you use it to make sure it is in safe operating condition. Always follow the inspection and maintenance procedures and schedules described in this manual.
- * Always keep both hands on the handlebar grips (operator)/handholds (passenger) and both feet firmly planted on the footrests of the ATV during operation.

Rider Training Course

Arctic Cat sponsors a free Rider Training Course to teach ATV riding skills or to reinforce current riding skills. First-time purchasers without any previous ATV riding experience will receive a \$100.00 coupon from Arctic Cat through the SVIA/ASI after completing the training course (U.S. owners only, one incentive, and free rider training courses for appropriate immediate family members per ATV purchase). See an authorized Arctic Cat ATV dealer for details or call (800) 887-2887 for training course information.

In Canada, the Canada Safety Council (CSC) provides an ATV Rider's Course to teach safe ATV operating skills. They also provide a special ATV Rider's Course for children under 14 years of age with parental supervision. Call the CSC at 1-613-739-1535 ext. 227 for more details. Also available is a bilingual computer-based safety training program on a CD-ROM from CATV - call toll-free at 1-877-470-2288.

Au Canada, le conseil canadien de la sécurité (CSC) offre un cours de conduite de VTT pour enseigner les habiletés d'opération sécuritaires de VTT. Un cours spécial de conduite de VTT est également offert aux enfants de moins de 14 ans avec la surveillance d'un parent. Communiquez avec le CSC en composant le: 1-613-739-1535, poste 227 pour de plus amples informations. Un programme de formation bilingue informatisé sur la sécurité est aussi disponible sur disque optique compact par CATV; composez sans frais le: 1-877-470-2288.

FOR MORE INFORMATION ABOUT ATV SAFETY, in the U.S., call the Consumer Product Safety Commission at (800) 638-2772 or the ATV Distributors' Safety Hotline at (800) 852-5344 or in Canada, call the Canada Safety Council at 1-613-739-1535 ext. 227.

Visit the Arctic Cat Inc. website at www.arcticcat.com for additional product information.



Hangtags

This Arctic Cat TRV comes with hangtags containing important safety information. Anyone who rides the ATV should read and understand this information before riding.



DIVISION I - SAFETY



2258-417

Pour commander des Etiquettes de Mise en Garde gratuites, voyez votre détaillant de autorisé VTT Arctic Cat pour le numéro de pièce 1436-344.

Warning Labels & Information (cont)

H **WARNING**

Exceeding vehicle's towing limit could cause an accident. Reduce speed when towing a trailer. Read operator's manual for details.

MAXIMUM TONGUE WEIGHT:
35 lbs (16 kg)

MAXIMUM TOWING CAPACITY:
1850 lbs (847 kg)

I **WARNING**

NEVER operate up or down hills greater than 25°.

Riding on hills steeper than 25° can cause the vehicle to overturn and result in severe injury or death.

J **WARNING**

NEVER carry a passenger on this center MAXIMUM LOAD: 100lb (45kg) evenly distributed.

K **WARNING**

NEVER operate with a passenger unless passenger's seat is installed and mounting pins are properly engaged. Failure to secure pins can result in SEVERE INJURY or DEATH.

M **WARNING**

NEVER carry a passenger on this center MAXIMUM LOAD: 50lb (23kg) evenly distributed.

N **WARNING**

Do not run engine without the cover in place or with cover both removed. Failure to secure any adjustment with engine running.

O **WARNING**

Excessive throttle may cause wheelies, tip-overs, or loss of control resulting in SEVERE INJURY or DEATH. Apply throttle slowly. Release throttle as necessary to maintain control.

L **WARNING**

Failure to stop vehicle completely before engaging reverse could result in your being thrown from the ATV.

TO ENGAGE REVERSE:

1. Stop vehicle completely.
2. Bring engine to idle. Apply brake.
3. Shift transmission to neutral.
4. Shift reverse lever fully toward rear while applying brakes.

Read operator's manual located under the seat for additional information. Write to Arctic Cat for free replacement if missing.

NOTE

● ALWAYS RESPECT THE RIGHTS OF OTHERS, protect the environment, and comply with all applicable laws and regulations.

TRIED LIGHTLY!®
(ON PUBLIC AND PRIVATE LAND)

PRE-RIDE INSPECTION PROCEDURES

T	TIRES AND WHEELS	<ol style="list-style-type: none"> 1. Check for proper air pressure. 2. Check for cuts and gouges. 3. Make sure nuts and bolts are tight.
C	CONTROLS AND CABLE	<ol style="list-style-type: none"> 1. Identify location of all controls. 2. Throttle should operate smoothly and snap closed. 3. Check brake operation, adjustment, and for worn pads. 4. Check shifter operation.
L	LIGHTS AND ELECTRICAL	<ol style="list-style-type: none"> 1. Check ignition switch operation. 2. Check engine stop switch operation. 3. Check all lights.
O	OIL AND FUEL	<ol style="list-style-type: none"> 1. Check fuel level. 2. Check oil level. 3. Check for leaks.
C	CHASSIS AND DRIVE TRAINS	<ol style="list-style-type: none"> 1. Make sure all nuts and bolts are tight. 2. Make sure all debris is removed from around axles and driveshaft. 3. Make sure ATV is loaded properly and not over-loaded.

STARTING PROCEDURES

B	BRAKES	<ol style="list-style-type: none"> 1. Set the PARKING BRAKE.
O	ON	<ol style="list-style-type: none"> 2. Turn the fuel valve on, if present. 3. Turn the ignition key on.
N	NEUTRAL	<ol style="list-style-type: none"> 4. Make sure the transmission is in neutral.
E	ENGINE	<ol style="list-style-type: none"> 5. Turn the "Emergency Stop" switch to "Run" position.
C	CHOKE	<ol style="list-style-type: none"> 6. Automatic Choke, if manual not present. 7. If engine does not start, push primer (3) times, if present.

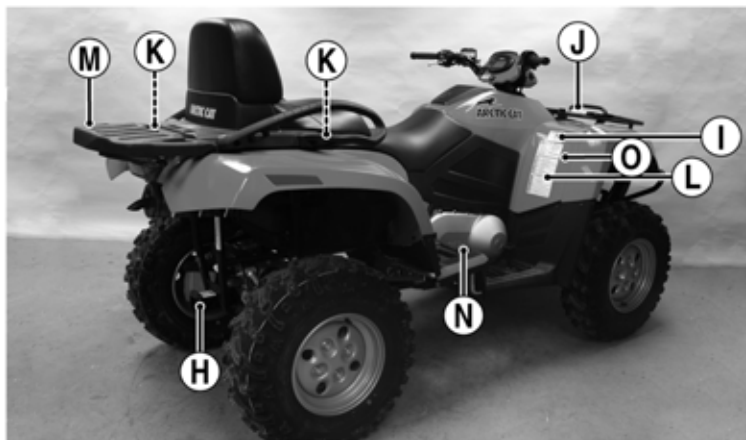

CR040A

Warnings

■ **NOTE:** The illustrations in this Warnings sub-section apply to an operator and a passenger even though some may show only the operator.

WARNING

POTENTIAL HAZARD

Operating this ATV without proper instruction.

WHAT CAN HAPPEN

The risk of an accident is greatly increased if the operator does not know how to operate the ATV properly in different situations and on different types of terrain.

HOW TO AVOID THE HAZARD

Beginning and inexperienced operators should complete the certified training course offered. They should then regularly practice the skills learned in the course and the operating techniques described in this Operator's Manual.

WARNING

POTENTIAL HAZARD

Allowing anyone under age 16 to operate this ATV.

WHAT CAN HAPPEN

Use of the ATV by children can lead to severe injury or death of the child.

Children under the age of 16 may not have the skills, abilities, or judgment needed to operate the ATV safely and may be involved in a serious accident.

HOW TO AVOID THE HAZARD

A child under 16 should never operate this ATV.

WARNING

POTENTIAL HAZARD

Operating this ATV on paved surfaces.

WHAT CAN HAPPEN

The ATV's tires are designed for off-road use only, not for use on pavement. Paved surfaces may seriously affect handling and control of the ATV and may cause the ATV to go out of control.

HOW TO AVOID THE HAZARD

Never operate the ATV on any paved surfaces, including sidewalks, driveways, parking lots, and streets.



Warnings

WARNING

POTENTIAL HAZARD

Carrying a passenger under the age of 12 on this ATV.

WHAT CAN HAPPEN

Could cause an accident, resulting in injury or death to you and/or your passenger.

HOW TO AVOID THE HAZARD

Never carry a passenger under the age of 12. The passenger must allow the operator to shift positions as needed during operation, must always keep feet on the footrests, and must always keep hands on handholds.

 WARNING

PASSENGER SAFETY
To reduce the risk of SEVERE INJURY or DEATH.



NEVER CARRY MORE THAN ONE PASSENGER



NEVER RIDE AFTER USING DRUGS OR ALCOHOL

NEVER carry a passenger too small to firmly plant feet on footrests and securely grasp hand holds.

THE PASSENGER MUST ALWAYS:

- use an approved helmet and protective gear
- securely grasp hand holds and plant feet firmly on footrests while seated in the passenger seat
- tell operator to slow down or stop if uncomfortable-get off and walk if conditions require

2411-257

NEVER CARRY MORE THAN ONE PASSENGER.

WARNING

POTENTIAL HAZARD

Operating this ATV on public streets, roads, or highways.

WHAT CAN HAPPEN

You can collide with another vehicle.

HOW TO AVOID THE HAZARD

Never operate this ATV on any public street, road, or highway, even a dirt or gravel one.

In many states it is illegal to operate the ATV on public streets, roads, or highways.

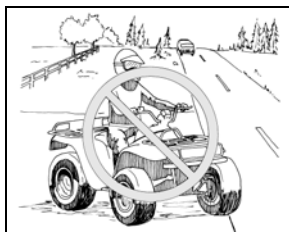

WARNING

POTENTIAL HAZARD

Attempting wheelies, jumps, and other stunts.

WHAT CAN HAPPEN

Increases the chance of an accident including a rollover.

HOW TO AVOID THE HAZARD

Never attempt stunts, such as wheelies or jumps. Don't try to show off.

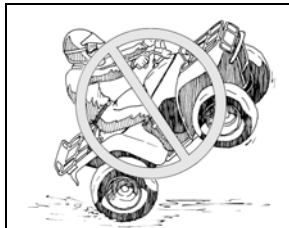

Warnings

WARNING

POTENTIAL HAZARD

Operating this ATV after or while consuming alcohol or drugs.

WHAT CAN HAPPEN

- Could seriously affect your judgment.
- Could cause you to react more slowly.
- Could affect your balance and perception.
- Could result in an accident.

HOW TO AVOID THE HAZARD

Never consume alcohol or drugs before or while driving this ATV.

WARNING

POTENTIAL HAZARD

Operating or riding as a passenger on this ATV without wearing an approved helmet, eye protection, and protective clothing.

WHAT CAN HAPPEN

- Operating or riding as a passenger on this ATV without an approved helmet increases your chances of a severe head injury or death in the event of an accident.
- Operating or riding as a passenger on this ATV without eye protection can result in an accident and increases your chances of a severe injury in the event of an accident.
- Operating or riding as a passenger on this ATV without protective clothing increases your chances of severe injury in the event of an accident.

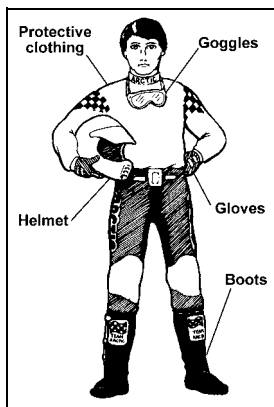

HOW TO AVOID THE HAZARD

Always wear an approved helmet that fits properly.

You should also wear: Eye protection (goggles or face shield)

Gloves

Boots

Long sleeved shirt or jacket

Long pants

WARNING

POTENTIAL HAZARD

Operating this ATV at excessive speeds.

WHAT CAN HAPPEN

Increases your chances of losing control of the ATV, which can result in an accident.

HOW TO AVOID THE HAZARD

Always ride at a speed that is proper for the terrain, visibility and operating conditions, and your experience.

Warnings

WARNING

POTENTIAL HAZARD

Failure to inspect the ATV before operating.

Failure to properly maintain the ATV.

WHAT CAN HAPPEN

Increases the possibility of an accident or equipment damage.

HOW TO AVOID THE HAZARD

Always inspect your ATV each time you use it to make sure the ATV is in safe operating condition.

Always follow the inspection and maintenance procedures and schedules described in this Operator's Manual.

WARNING

POTENTIAL HAZARD

Removing hands from handlebar grips (operator)/handholds (passenger) or feet from the footrests during operation.

WHAT CAN HAPPEN

Removing even one hand or foot can reduce your ability to control the ATV or could cause you to lose your balance and fall off the ATV. If you remove a foot from the footrest, your foot or leg may come into contact with the wheels, which could injure you or cause an accident.

HOW TO AVOID THE HAZARD

Always keep both hands on the handlebar grips (operator)/handholds (passenger) and both feet on the footrests of your ATV during operation.

WARNING

POTENTIAL HAZARD

Going down a hill improperly.

WHAT CAN HAPPEN

Could cause loss of control or cause the ATV to overturn.

HOW TO AVOID THE HAZARD

Always follow proper procedures for going down hills as described in this Operator's Manual.

Always check the terrain carefully before you start down any hill.

Shift your weight backward.

Never go down a hill at high speed.

Avoid going down a hill at an angle that would cause the ATV to lean sharply to one side. Go straight down the hill where possible.

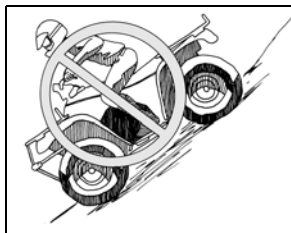

Warnings

WARNING

POTENTIAL HAZARD

Failure to use extra care when operating the ATV on unfamiliar terrain.

WHAT CAN HAPPEN

You can come upon hidden rocks, bumps, or holes without enough time to react.

Could result in the ATV overturning or going out of control.

HOW TO AVOID THE HAZARD

Go slowly and be extra careful when operating on unfamiliar terrain.

Always be alert to changing terrain conditions when operating the ATV.

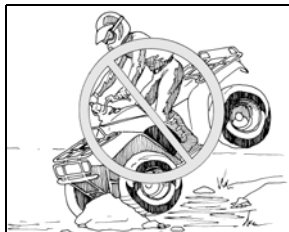

WARNING

POTENTIAL HAZARD

Failure to use extra care when operating on rough, slippery, or loose terrain.

WHAT CAN HAPPEN

Could cause loss of traction or control, which could result in an accident including a rollover.

HOW TO AVOID THE HAZARD

Do not operate on rough, slippery, or loose terrain until you have learned and practiced the skills necessary to control the ATV on such terrain.

Always be especially cautious on these kinds of terrain.

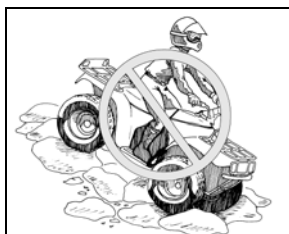

WARNING

POTENTIAL HAZARD

Turning improperly.

WHAT CAN HAPPEN

The ATV could go out of control, causing a collision or rollover.

HOW TO AVOID THE HAZARD

Always follow proper procedures for turning as described in this Operator's Manual.

Practice turning at slow speeds before attempting to turn at faster speeds.

Do not turn at excessive speed.

Warnings

WARNING

POTENTIAL HAZARD

Operating on steep hills.

WHAT CAN HAPPEN

The ATV can overturn more easily on steep hills than on level surfaces or small hills.

HOW TO AVOID THE HAZARD

Never operate the ATV on hills too steep for the ATV or for your abilities.

Practice on smaller hills before attempting larger hills.

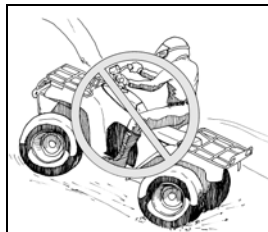

WARNING

POTENTIAL HAZARD

Climbing hills improperly.

WHAT CAN HAPPEN

Could cause loss of control or cause the ATV to overturn.

HOW TO AVOID THE HAZARD

Always follow proper procedures for climbing hills as described in this Operator's Manual.

Always check the terrain carefully before you start up any hill.

Never climb hills with slippery or loose surfaces.

Shift your weight forward.

Never open the throttle suddenly or make sudden gear changes. The ATV could flip over backwards.

Never go over the top of any hill at high speed. An obstacle, a sharp drop, or another ATV or person could be on the other side of the hill.

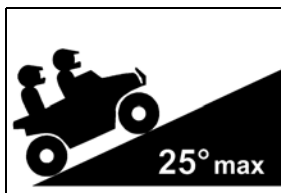

**Never Operate Up Or
Down Hills Steeper
Than 25°.**

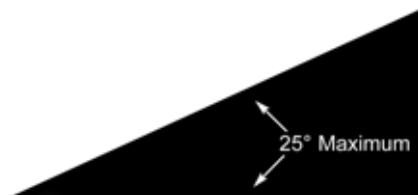

Warnings

WARNING

POTENTIAL HAZARD

Improperly operating in reverse.

WHAT CAN HAPPEN

You could hit an obstacle or person behind you, resulting in serious injury.

HOW TO AVOID THE HAZARD

Before you engage reverse gear, make sure there are no obstacles or people behind you. When it is safe to proceed, go slowly.

WARNING

POTENTIAL HAZARD

Improperly operating over obstacles.

WHAT CAN HAPPEN

Could cause loss of control or a collision. Could cause the ATV to overturn.

HOW TO AVOID THE HAZARD

Before operating in a new area, check for obstacles.

Never attempt to ride over large obstacles, such as large rocks or fallen trees.

When you go over obstacles, always follow proper procedures as described in this Operator's Manual.

WARNING

POTENTIAL HAZARD

Skidding or sliding.

WHAT CAN HAPPEN

You may lose control of the ATV.

You may also regain traction unexpectedly, which may cause the ATV to overturn.

HOW TO AVOID THE HAZARD

Learn to safely control skidding or sliding by practicing at slow speeds and on level, smooth terrain.

On extremely slippery surfaces, such as ice, go slowly and be very cautious in order to reduce the chance of skidding or sliding out of control.

WARNING

POTENTIAL HAZARD

Operating the ATV with improper tires or with improper or uneven tire pressure.

WHAT CAN HAPPEN

Use of improper tires on the ATV, or operation of the ATV with improper or uneven tire pressure, may cause loss of control increasing your risk of accident.

HOW TO AVOID THE HAZARD

Always use the size and type tires specified in this Operator's Manual for this ATV.

Always maintain proper tire pressure as described in this Operator's Manual.

Warnings

WARNING

POTENTIAL HAZARD

Stalling, rolling backwards, or improperly dismounting while climbing a hill.

WHAT CAN HAPPEN

Could result in the ATV overturning.

HOW TO AVOID THE HAZARD

Use proper gear and maintain steady speed when climbing a hill.

If you lose all forward speed:

Keep weight uphill.

Apply the brakes.

Engage the brake lever lock after you are stopped.

If you begin rolling backwards:

Keep weight uphill.

Apply the brakes while rolling backwards.

When fully stopped, engage the brake lever lock.

Have the passenger dismount on uphill side or to a side if pointed straight uphill; then the operator should dismount on uphill side or to a side if pointed straight uphill.

Turn the ATV around and mount following the procedure described in this Operator's Manual.

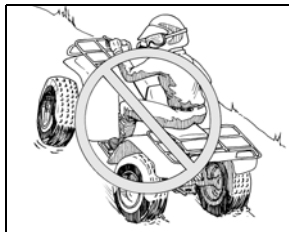

WARNING

POTENTIAL HAZARD

Overloading the ATV or carrying or towing cargo improperly.

WHAT CAN HAPPEN

Could cause changes in handling, which could lead to an accident.

HOW TO AVOID THE HAZARD

Never exceed the stated load capacity for the ATV.

Cargo should be properly distributed and securely attached.

Reduce speed when carrying cargo or pulling a trailer. Allow greater distance for braking.

Always follow the instructions in this Operator's Manual for carrying cargo or pulling a trailer.

Warnings

WARNING

POTENTIAL HAZARD

Operating the ATV through deep or fast flowing water.

WHAT CAN HAPPEN

Tires may float, causing loss of traction and loss of control, which could lead to an accident.

HOW TO AVOID THE HAZARD

Never operate the ATV in fast flowing water or in water deeper than the foot-rests.

Remember that wet brakes may have reduced stopping capability.

Test your brakes after leaving water. If necessary, apply them several times to dry out the pads.

WARNING

POTENTIAL HAZARD

Application of excessive throttle.

WHAT CAN HAPPEN

May cause wheelies, flip-overs, or loss of control resulting in serious injury or death.

HOW TO AVOID THE HAZARD

Do not accelerate rapidly or in an uncontrolled manner on any terrain. Use extra care when going uphill.

Slowly apply throttle in a controlled manner. Release throttle lever as necessary to maintain control.

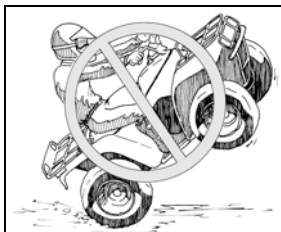

WARNING

POTENTIAL HAZARD

Improperly crossing hills or turning on hills.

WHAT CAN HAPPEN

Could cause loss of control or cause the ATV to overturn.

HOW TO AVOID THE HAZARD

Never attempt to turn the ATV around on any hill until you have mastered the turning technique as described in this Operator's Manual. Practice first on level ground. Be very careful when turning on any hill.

Avoid crossing the side of a steep hill, if possible.

When crossing the side of a hill:

Always follow proper procedures as described in this Operator's Manual.

Avoid hills with slippery or loose surfaces.

Shift your weight to the uphill side of the ATV.

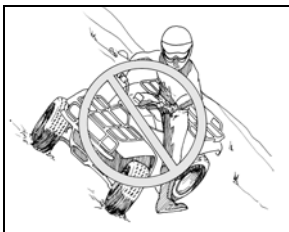

Warnings

WARNING

POTENTIAL HAZARD

Operating the ATV with improper modifications.

WHAT CAN HAPPEN

Improper installation of accessories or modification of the ATV may cause changes in handling which, in some situations, could lead to an accident.

HOW TO AVOID THE HAZARD

Never modify the ATV through improper installation or improper use of accessories. All parts and accessories added to this ATV should be genuine Arctic Cat components designed for use on the ATV and should be installed and used according to instructions. Never install a twist grip throttle. If you have questions, consult an authorized Arctic Cat ATV dealer.

WARNING

POTENTIAL HAZARD

Operating the ATV with improperly installed passenger seat.

WHAT CAN HAPPEN

The passenger seat could shift or separate from the ATV causing the passenger to fall from the vehicle resulting in serious injury or death.

HOW TO AVOID THE HAZARD

Always check the seat latches to make sure they are properly engaged and locked before operating the ATV.

WARNING

POTENTIAL HAZARD

Operating the ATV with differential lock engaged.

WHAT CAN HAPPEN

The increased steering effort and reduced maneuverability caused by the locked differential could result in loss of control and an accident.

HOW TO AVOID THE HAZARD

Never exceed 10 MPH (16 KPH) with the differential lock engaged. Always disengage the differential lock as soon as not needed for additional traction.

WARNING

POTENTIAL HAZARD

Failure to release the brake lever lock before driving the ATV.

WHAT CAN HAPPEN

Driving the ATV with the brake lever lock engaged could cause a change in handling or loss of brakes and cause an accident.

HOW TO AVOID THE HAZARD

Always release the brake lever lock before driving the ATV.

Prevention

Overview

When using this ATV, prevention is the name of the game. “Had you only known” something could go wrong, you would have prevented it. If you don’t notice your conditions and surroundings before riding your ATV, you give up control over the situation. Using ATV prevention techniques helps you forecast potential hazards before they injure you or damage your ATV.

Following the safety instructions and warnings in this manual will help you “P.A.S.S.” the safety test. P.A.S.S. stands for “Prevention,” “Active Riding,” “Sound Judgment,” and “Supervision.” Remembering P.A.S.S. and what it stands for will help you have a safe, predictable ride every time you go out on your ATV.

Safe Riding Clothing and Gear (Operator and Passenger)

Always wear clothing suited to the type of riding you are doing. TRV riding requires special protective clothing which will make you feel more comfortable and reduce chances of injury.

You’ll find it important to dress correctly for riding in order to prevent scraped skin and serious head injuries. It’s easy and could save you time in the long run not having to contend with an injury. Of course, it also makes sense to remember the seasons. Wear a hat under your helmet and a snowmobile suit in the winter and lighter, protective clothing in the summer. Following is the minimum protection you need to wear during every ride:

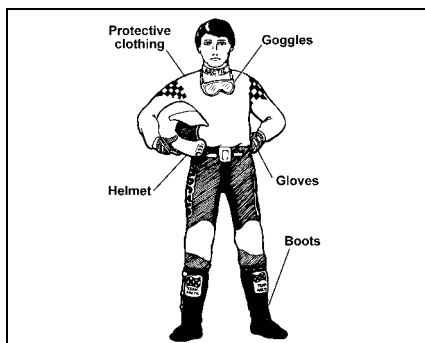

ATV-0004

Gloves

Your hands are targets for flying objects and branches. Along with providing skin protection, gloves will shield your hands from harsh weather. Wear gloves that are weather resistant and have a gripping surface to keep them from sliding off the handlebars. Off-road style gloves with knuckle pads are the best for comfort and protection.

Boots/Ankle Protection

Wear a boot that covers the largest possible area of your leg (preferably up to your knee) and can handle significant impact. Choosing boots with low heels and a good tread will help prevent your feet from slipping off the footrests in wet or rugged conditions or getting hurt if they get hit by rocks, dirt, or branches.

Helmet

Your helmet is the most important piece of protective gear for safe riding. A helmet can prevent a severe head injury. There are several types of helmets on the market, but make sure you wear a helmet that complies with the current standards of the U.S. Department of Transportation (DOT), The Snell Memorial Foundation, or the American National Standards Institute (ANSI). Helmets that comply with one or more of these agency’s standards have a sticker on the inside or outside of the helmet.

Prevention

Helmets should have one of these:

1. DOT label
2. Snell label
3. ANSI Z90.1 label

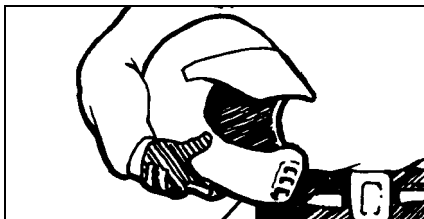

These helmets should provide full-face protection.

If you drop or damage your helmet, get a new one immediately. Your helmet may not protect your head from injury if it has cracks, fissures, or other damage to its outside or core padding.

Remember, your helmet won't do you any good if the chin strap isn't fastened.

Eye Protection

Wear eye protection, such as goggles, to completely surround your eyes to prevent getting dirt or other items in your eyes. Do not depend on sunglasses for proper eye protection. Sunglasses are not recommended; they don't prevent objects from flying in through the sides.

Long Pants and Long Sleeved Shirt

The goal is to protect your body from branches, long grass, airborne objects, or anything else that could scrape your skin. The more thick and durable the material, the better protection it'll provide. Riding pants with kneepads, a jersey, and shoulder pads provide the best protection.

TRV Condition

The second step in Prevention is checking the condition of your ATV. Chances are good that you'll be using your ATV in some rough terrain, and there's no way you want your brakes to go out when riding downhill. You need to check the following parts on your ATV before every ride.

- | | |
|--------------------------|----------------------------|
| 1. Tires and Wheels | 4. Oil and Fuel |
| 2. Controls and Cable | 5. Chassis and Drive Train |
| 3. Lights and Electrical | 6. Miscellaneous Items |

One easy way to remember what parts you need to check is by using the acronym "T-CLOC." It stands for:

T	C	L	O	C
TIRES AND WHEELS	CONTROLS AND CABLE	LIGHTS AND ELECTRICAL	OIL AND FUEL	CHASSIS AND DRIVE TRAIN

1. TIRES AND WHEELS

Correct tire pressure is crucial. Consult the General Maintenance section of this Operator's Manual for tire pressure guidelines. Incorrect tire pressure can cause poor handling, instability, and a loss of ATV control.

Check:

1. Tire pressure
2. Tire surface (tread and sidewalls)

While checking the tire pressure, inspect the tread and sidewalls of the tires for cracks, cuts, or other damage that could indicate they need to be replaced.

Prevention

2. CONTROLS AND CABLE

With the engine running and brake applied, check all transmission positions: forward, neutral, and reverse.

Check:

1. Forward
2. Neutral
3. Reverse

A. Brakes

Squeeze your hand brake lever. If it feels soft or “squishy,” it could be low on fluid or have a leak — refer to the General Maintenance section of this Operator’s Manual for instructions. Don’t use the ATV until the brakes are operating normally.

Check:

1. Hand brake lever
2. Rear foot brake
3. Brake lever lock

Test the brake lever lock and see if it locks the hand brake lever into position; then disengage it to release the brake. Be sure the rear foot brake near the footrest is working; your brakes could fail during a ride if they’re not maintained.

B. Throttle

The throttle should have a free, smooth range of motion. If it seems to “stick” at any point, refer to the General Maintenance section of this Operator’s Manual for instructions. Driving your ATV with a sticking throttle can turn your leisurely ride into an unwelcome accident. Don’t drive your ATV if the throttle sticks.

Check:

1. Free, smooth range of motion

3. LIGHTS AND ELECTRICAL

Turn the hi-beam and lo-beam on and off to make sure they work. At the same time, verify the taillight and brakelight work. Also, check the status/warning indicators (reverse, neutral, and HI-LO beam) on the LCD when you start the ATV. Don’t drive the ATV unless all systems are working. Check the ignition switch and engine stop switch.

Check:

1. Hi-beam
2. Lo-beam
3. Taillight/brakelight
4. Status/warning indicators
5. Ignition switch
6. Engine stop switch

4. OIL AND FUEL

Start with a full tank of gas before every ride, and while you’re at it, top off the oil. Don’t forget to check for fluid leaks around the ATV. Watch the overheat lamp to ensure the engine coolant level is adequate.

Check:

1. Gas
2. Oil
3. Fluid leaks

5. CHASSIS AND DRIVE TRAIN

Grass and leaves can gum-up your suspension and shocks. Clear and clean the suspension arms, shock springs, and fenders. Check smoothness by turning the handlebar full-left and full-right. Verify there is no binding, restrictions, free-play, or looseness in steering components.

Check:

1. Suspension arms
2. Shock springs
3. Fenders
4. Steering

Prevention

6. MISCELLANEOUS ITEMS

Inspect your air filter. Look for debris or damage that may indicate you need to replace it. A clogged filter can stop an engine. Check your battery terminals for corrosion. Also, be sure to tighten any loose parts, nuts, or bolts.

Check:

1. Air filter
2. Battery
3. Tighten parts, nuts, and bolts

First Aid and Survival

You need to prepare for the unexpected. Emergencies and accidents are traumatic enough, but they're even worse when you're not prepared for them. At the minimum during every ATV ride, you should have the following items on board:

- Tools
- Water
- Identification
- First Aid Kit

For rides that are longer in duration and distance, the following additional items are recommended:

- Cellular Phone
- Maps/GPS
- Emergency Kit *with Flashlight and First Aid Kit*

Tools

Routine maintenance will generally eliminate the need for emergency repairs. Riding on rough terrain could cause loosening of nuts, bolts, and fasteners. Especially on long rides, carrying the right tools can prevent an inconvenience from becoming a crisis.

Carry these items on your ATV:

1. Bulbs
2. Duct tape
3. Rope
4. Spark plugs
5. Spare parts
6. Tool Kit

Water

Water is so important that you need to carry it regardless of the duration of your ride. Heat exhaustion and heat stroke can creep up suddenly and can take you out of commission. If you become dehydrated, you could find yourself physically unable to safely operate your ATV.

Identification

If something does happen to you, the emergency personnel will want to know who you are and whom to contact. It's possible you may be in no condition to give them that information. Put your I.D. in your pocket before you ride. Without it, you're anonymous.

Cellular Phone

It may be necessary to make an urgent phone call.

Maps/GPS (Global Positioning System)

Maps may be unnecessary when you're familiar with the area. But when you're riding on unfamiliar trails, it's good to know where you are, what's coming up, and how to get back.

Emergency Kit with Flashlight and First Aid Kit

You'll need several items in your Emergency Kit including a flashlight. The matches will come in handy if you need to start a fire to stay warm. Flares are appropriate for signaling help. A first aid kit is very important if an injury of some type should happen. A good First Aid Kit should include bandages, antiseptic spray, gauze, tape, etc.

Carry these items:

1. Flashlight
2. Matches
3. Flares
4. First Aid Kit
5. Money

Active Riding

Overview

“Active Riding” is the second part of “P.A.S.S.” It involves an understanding of how your body weight, balance, gravity, and physical forces affect the handling of the ATV. For example, when you drive a car quickly into a sharp turn, your body is pulled to the outside of the turn by centrifugal force. Although a car is relatively stable, enough centrifugal force can cause the ATV to overturn. Constantly shifting operator and passenger weight is one major difference between driving a car and riding the ATV. Knowing how to shift your weight is necessary to avoid rolling or flipping the ATV.

For complete operating instructions, see ATV OPERATION section in this manual.

Sound Judgment

Overview

You are not invincible. Knowing the first “S” in “P.A.S.S.” stands for “Sound Judgment” means you need to use yours.

Do you consider yourself to be pretty conservative, or are you a heavy risk-taker? Before continuing with this section on sound judgment, check your **Risk Factor** by doing this short survey:

1. Do you drive over the speed limit?

1 2 3
Never Sometimes Often

2. Are you more daring around your friends than you are when alone?

1 2 3
Never Sometimes Often

3. Do you drive your car when the gas gauge is on empty?

1 2 3
Never Sometimes Often

4. Do you feel no matter what you do, you won't get hurt?

1 2 3
Never Sometimes Often

5. Do you drink or use drugs before you drive your car?

1 2 3
Never Sometimes Often

6. Do you drive your car even if it has a major problem with the brakes, tires, or engine?

1 2 3
Never Sometimes Often

7. Do you thrive on the adrenaline rush you get from speeding and dangerous situations?

1 2 3
Never Sometimes Often

8. Do you hurt yourself because you do things out of your ability range?

1 2 3
Never Sometimes Often

9. Do you tailgate other drivers when you think they're driving too slow?

1 2 3
Never Sometimes Often

10. Do you ignore weather reports before you do outside activities like swimming, camping, fishing, or boating?

1 2 3
Never Sometimes Often

Add the totals from lines 1-10. **YOUR RISK FACTOR IS:**

10-15: You're pretty conservative. Chances are good that the consistently safe choices you make will help you avoid hurting yourself and the people around you.

16-20: You're straddling the fence. Depending on your mood or whom you're with, the choices you make may help you or hurt you.

21-30: You're taking your chances. Time to reconsider a lot of the judgments you make. You're destined to put yourself in dangerous situations and potentially hurt yourself and the people around you.

Environment

The environment you operate an ATV in is often harsh and sometimes dangerous if you don't take proper precautions.

Weather

You need to consider the weather. It is dangerous to ride your ATV when the weather is bad or potentially bad. Keep abreast with weather forecasts.

Sound Judgment

Terrain

Always pay close attention to the terrain you're on, even if it is familiar to you. You can't assume the landscape you're used to doesn't change. Changes to landscape can happen at nearly any time. Fences can be constructed and excavations dug in a short period of time. Weather, climate, and development take their toll.

Night Riding

Riding at night can be very hazardous. Obstacles and other hazards (that are easily identified during daytime) are much more difficult to see and avoid. When night riding, make sure the lights are properly adjusted and in good working order. Reduce speed; do not over-drive the headlights. Never travel in an unfamiliar area or blaze a new trail at night. Always carry a flashlight or flare for signaling an emergency.

Paved Surfaces

Don't do it! The ATV isn't designed for pavement. Its handling becomes more difficult on paved surfaces.

Trail Riding

Use sound judgment when trail riding; that means riding on a trail that fits your ability level. If the trail is pretty rugged, standing up on your footrests will make it easier for you to endure the rough terrain.

Make yourself visible by using headlights and taillights, and pull completely off the trail if you need to stop.

Outsloped trails (trails that slant to allow rain to run off) make trail riding a bit more challenging.

It also helps to know which trails you can ride and who else might be on those same trails. These are signs currently used in some areas to designate trail types and restrictions.

Trail Signs

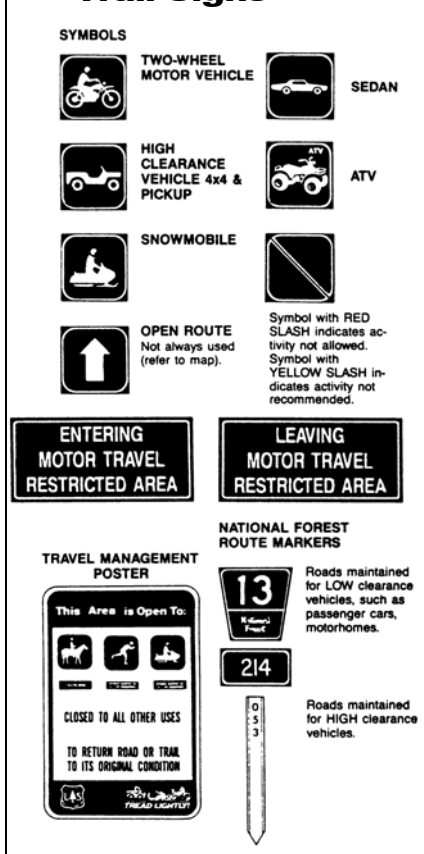

Those Around You

People do all kinds of things you can't predict or control.

Passenger

Never carry a passenger under the age of 12. Never carry a passenger who cannot place both feet on the footrests and who cannot securely hold onto the handholds.

You are responsible for the passenger and you must instruct the passenger on the correct procedures for riding.

Sound Judgment

Riding Companions

Leave a lot of space between you and other riders, especially in dusty and dirty conditions, because it'll be difficult to see the riders in front of you stopping.

Riding with companions on several vehicles is not the same as riding one ATV with a passenger.

Other Vehicles

Depending on where you're riding, you might encounter ATV's, bikes, or motor vehicles on public lands. Respect the presence of cars if you're crossing roads or riding in public areas and make yourself be seen. If you can't see other vehicles coming, that means you're invisible, too.

Hikers

With the renewed interest in hiking, camping, and other outdoor activities, people can show up in remote areas where you would never expect them. For their sake, keep your eyes open.

Animals and Nature

Respect the outdoors that you love. Don't use your ATV to chase animals or birds. Drive around young trees rather than over them. Keep clear of streams and ditches with standing water.

Tread Lightly and leave it as you found it.

Equipment

The last thing you expected was that your ATV would break down in the middle of the field... it's usually so reliable that sometimes you forget the ATV has its limits.

Maintenance

You have to maintain your ATV. The General Maintenance section of this Operator's Manual tells you about taking care of your ATV. If, at any time, abnormal noises, vibrations, or improper functioning of any component of this ATV is detected, **DO NOT OPERATE THE ATV**. Take the ATV to an authorized Arctic Cat ATV dealer for inspection and adjustment or repair.

Cargo Limitations

Limit the ATV to the load capacity ratings identified in the Load Capacity Ratings chart. So if you and your passenger combined weigh in at over 500 lb (226 kg), leave some of that extra cargo at home. The combined weight limit, including you, your passenger, your rack cargo, and your trailer, is a specified amount, so consult the chart and monitor it carefully.

Extra weight on the ATV will also throw you off balance if it's not distributed evenly, side-to-side and front-to-rear.

Cargo has such a huge affect on handling that you need to pay a lot of attention to your speed. Even on really level areas, you should keep it under 10 mph (16 kph) if you've got a trailer attached. Avoid uneven terrain. Also, consider that your braking distance is going to increase with the more weight you carry.

Think about these when dealing with cargo:

1. Rack weight limit
2. Trailer weight limit
3. Weight distribution
4. Speed

Sound Judgment

Load Capacity Ratings Chart

ARCTIC CAT LOAD CAPACITY RATINGS		
Item	Specifications	
	(lb)	(kg)
Max Load Capacity	600	272
Front Rack (Max)	100	45
Rear Rack (Max)	50	23
Storage Box (Max)	35	16
Tongue Weight	35	16
Rear Rack, Storage Box, and Tongue Weight (Max)	50	23
Towing Capacity	1050	477

Max Load Capacity - Total weight of operator and passenger, accessory weight, tongue weight, and cargo on the front and rear rack.

Tongue Weight - Weight on trailer tongue.

Towing Capacity - Total weight of trailer and all cargo in the trailer.

Speedrack

When installing Speedrack accessories, make sure to read and carefully follow the instructions provided in each kit including all weight restrictions as noted on placards and decals.

■ **NOTE:** Use extra caution when operating this ATV with additional loads such as passenger, accessories, and/or cargo. Handling of the ATV may be adversely affected. Reduce speed when adding additional loads.

WARNING

POTENTIAL HAZARD

Overloading the ATV or carrying or towing cargo improperly.

WHAT CAN HAPPEN

Could cause changes in handling, which could lead to an accident.

HOW TO AVOID THE HAZARD

Never exceed the stated load capacity.

Cargo should be properly distributed and securely attached.

Reduce speed when carrying cargo or pulling a trailer. Allow greater distance for braking.

Always follow the instructions in this Operator's Manual for carrying cargo or pulling a trailer.

Personal Choices

A safe, enjoyable ride is dependent on many personal choices. An ATV, like all motorized vehicles, can be dangerous to operate if you choose to ignore safety precautions, take unnecessary chances, or ride beyond your ability or your vehicle's capability. Don't allow the thrill of freedom or adventure to affect your ability to make good, safe choices.

Alcohol and Drug Consumption (Operator and/or Passenger)

Alcohol is related to a high percentage of all hospital admissions due to accidents in the U.S. It's extremely dangerous to drink alcoholic beverages and ride... it's also very foolish.

Substances to avoid when riding:

1. Alcohol
2. Over-the-counter or prescription drugs
3. Illegal/mood altering drugs

Sound Judgment

Be aware of prescription and over-the-counter medications. Drowsiness and impaired judgment can be caused by a wide variety of medications. The same is true of allergy, cold, flu, and headache medications. Your physical size and weight can't protect you... just one anti-histamine tablet can affect your judgment.

If your sense of adventure persuades you to do illegal drugs when you're riding your ATV, this is a reality check. Something to think about—there can be legal consequences that will take away all that freedom you love. Don't use alcohol or drugs before or during your ride.

THE EFFECTS OF ALCOHOL*

The Number of Drinks that Impair Mental and Physical Abilities

1-2 DRINKS

Mental processes such as restraint, awareness, concentration, and judgment affected; reaction time slowed; inability to perform complicated tasks.

3-4 DRINKS

Depth perception, glare recovery, eye movement, and focus affected; decreased judgment and control.

5+ DRINKS

Coordination deteriorates, loss of critical judgment, and impaired memory and comprehension.

*According to the ATV Safety Institute.

Your Physical Condition

Being physically exhausted is like being drunk. Try to do something that's detail-oriented when you're really tired, and you'll feel totally uncoordinated.

Don't ride:

1. When you're tired

Reckless Riding

If you are involved in an accident when you're speeding, you have a 25% chance of landing yourself in the hospital. The faster you go, the more likely you are to destroy your head and internal organs, and skip the wheelies, jumps, stunts, and any other showboating.

Laws and Regulations

Any police officer will tell you ignorance of the law is no defense. Your best defense is to check out your local, state, or provincial laws before riding. It'll also make sure you can continue to ride in your favorite areas. The quickest way to have a land area closed is by riding over the regulations.

Group Behavior

People occasionally do crazier and riskier things in a group than they would consider doing by themselves. When you're riding with others and things start to get out of hand, decide whether you're willing to be injured or see your friends injured.

SIPDE

By themselves, none of these safe behaviors and sound judgments will go very far. But when you put them all together... when you're paying attention to how you feel, when you're monitoring the movements of your ATV, and when you're constantly evaluating your environment, then you're practicing SIPDE. SIPDE is an acronym that stands for:

S	I	P	D	E
SCAN/ SEARCH	IDENTIFY HAZARDS	PREDICT WHAT WILL HAPPEN	DECIDE WHAT TO DO	EXECUTE THE DECISION

Supervision

Overview

You're responsible for supervising those who ride your ATV. Your wisdom is valuable... it'll bring them all back safely—your friends, your family, your relatives, and your ATV. It's crucial you consider yourself a supervisor for all riders of your ATV. Whether you accept responsibility or not, the truth is you are responsible for others riding your ATV.

Taking Responsibility

You're to the last letter in "PASS"... "Supervision." You've just gone through the manual, and you've seen what's involved. That puts you in a good position to be confident about what you know. So now it's time to use your knowledge and supervise others who ride your ATV.

Inexperienced/Untrained Riders

You can't let people ride your ATV who don't know what they're doing. Unless they've had over a year of experience with riding an all-terrain ATV or taken a training course, it's your responsibility to keep them off your ATV. It can be dangerous (especially for under-aged children)—all the more reason for you to be firm.

Experienced/Trained Riders

If anyone is going to borrow your ATV, you are responsible for their supervision. Before they ride, have them take the training course, have them watch the safety video, and have them read the Operator's Manual. You train them. It doesn't matter how you do it, as long as you do it.

TRV's are a little different from the handling to the stability to the controls. So regardless of how much experience your family members have, they don't have experience with *your* ATV. Let experienced riders get familiar with your ATV—show them the basics before they take off. You don't want it on your conscience that someone got hurt because you didn't tell them how to use your ATV.

Remember that regardless of experience, you should never let anyone under the age of 16 operate your ATV.



2411-257

2411-257

DIVISION II - OPERATION/MAINTENANCE

TRV Specifications

ENGINE AND DRIVE	450 H1	550 H1	700 H1
Type	Four-Cycle/Liquid Cooled		
Bore x Stroke	89.0 mm x 71.2 mm (3.50 x 2.80 in.)	92 mm x 82 mm (3.62 x 3.22 in.)	102 mm x 85 mm (4.01 x 3.35 in.)
Displacement	442 cc (27 cu in.)	545 cc (33.3 cu in.)	695 cc (42.4 cu in.)
Spark Plug Type	NGK CR7E	NGK CPR8E	
Spark Plug Gap	0.7-0.8 mm (0.028-0.031 in.)	0.5-0.6 mm (0.019-0.024 in.)	
Brake Types	Hydraulic w/Brake Lever Lock and Rear Foot Brake		
CHASSIS			
Length (Overall)	250.4 cm (98.6 in.) 256.5 cm (101.0 in.) - Cruiser		
Height (Overall)	127.8 cm (50.3 in.) 139.7 cm (55.0 in.) - Cruiser		
Width (Overall)	120.6 cm (47.5 in.)		
Suspension Travel	25.4 cm (10.0 in.)		
Tire Size (Front)	AT25 x 8-12		
Tire Size (Rear)	AT25 x 10-12		
Tire Inflation Pressure	0.35 kg/cm ² (5.0 psi)		
MISCELLANY			
Dry Weight (Approx)	326.1 kg (719 lb)	346.5 kg (764 lb) 353.3 kg (779 lb) - Cruiser	346.5 kg (764 lb) 354.7 kg (782 lb) - Cruiser
Gas Tank Capacity	20.1 L (5.3 U.S. gal.)		
Coolant Capacity	2.9 L (3.0 U.S. qt)		
Differential Capacity	275 ml (9.3 fl oz)		
Rear Drive Capacity	250 ml (8.5 fl oz)		
Engine Oil Capacity (Approx)	2.8 L (3.0 U.S. qt)	1.9 L (2.0 U.S. qt)	
Gasoline (Recommended)	87 Octane Regular Unleaded		
Engine Oil (Recommended)	Arctic Cat ACX All Weather (Synthetic)		
Differential/Rear Drive Lubricant	SAE Approved 80W-90 Hypoid		
Taillight/Brakelight	12V/8W/27W		
Headlight	12V/27W (4)		
Starting System	Electric		

Specifications subject to change without notice.

TRV Specifications

ENGINE AND DRIVE		1000 H2
Type	Four-Cycle/Liquid-Cooled V-Twin	
Bore x Stroke	92 mm x 71.6 mm (3.66 x 2.81 in.)	
Displacement	952 cc (58 cu in.)	
Spark Plug Type	NGK CPR8E (2)	
Spark Plug Gap	0.5-0.6 mm (0.019-0.024 in.)	
Brake Types	Hydraulic w/Brake Lever Lock and Rear Foot Brake	
CHASSIS		
Length (Overall)	250.4 cm (98.6 in.) 256.5 cm (101.0 in.) - Cruiser	
Height (Overall)	127.8 cm (50.3 in.) 139.7 cm (55.0 in.) - Cruiser	
Width (Overall)	120.6 cm (47.5 in.)	
Suspension Travel	25.4 cm (10.0 in.)	
Tire Size (Front)	AT25 x 8-12	
Tire Size (Rear)	AT25 x 10-12	
Tire Inflation Pressure	0.5 kg/cm ² (7.0 psi)	
MISCELLANY		
Dry Weight (Approx)	354.3 kg (781 lb) 362 kg (798 lb) - Cruiser	
Gas Tank Capacity	20.1 L (5.3 U.S. gal.)	
Coolant Capacity	3.3 L (3.5 U.S. qt)	
Differential Capacity	275 ml (9.3 fl oz)	
Rear Drive Capacity	250 ml (8.5 fl oz)	
Engine Oil Capacity (Approx)	1.9 L (2.0 U.S. qt)	
Gasoline (Recommended)	87 Octane Regular Unleaded	
Engine Oil (Recommended)	Arctic Cat ACX All Weather (Synthetic)	
Differential/Rear Drive Lubricant	SAE Approved 80W-90 Hypoid	
Taillight/Brakelight	12V/8W/27W	
Headlight	12V/27W (4)	
Starting System	Electric	

Specifications subject to change without notice.

Location of Parts and Controls



CR037A



CR036A

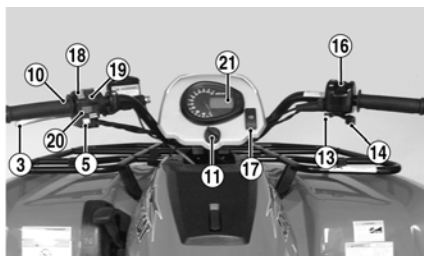

CR028C

1. Battery
2. Headlights
3. Hand Brake Lever
4. Passenger Seat Latch Handles
5. Reverse Override Switch
6. Seat Lock Lever
7. Storage Compartment
8. Rear Foot Brake
9. Taillight/Brakelight
10. Brake Lever Lock
11. Key Switch
12. Shift Lever
13. Throttle Limiter
14. Throttle Lever
15. Operator's Manual Location
16. Drive Select Switch
17. Handwarmer/Thumbwarmer Switch (Cruiser)
18. Headlight HI/LO Switch
19. Starter Button
20. Engine Stop Switch
21. Speedometer/LCD

■ **NOTE:** The ATV you have purchased may differ slightly from those shown in the figures of this manual.

ATV Operation

Basic Operating Maneuvers

Active riding and basic maneuvers are the foundation of your ride. Without basic skills, it's impossible to move to this level — active riding. These are your basic maneuvers:

- Mounting the TRV (Operator)
- Mounting the TRV (Passenger)
- Starting the Engine
- Starting a Cold Engine
- Varying Temperature Adjustments
- Shifting
- Braking/Stopping
- Parking
- Dismounting the TRV

Mounting the TRV (Operator)

1. From the left side, grab the left-side handlebar, apply the brake, and put your left foot on the footrest.
2. Grab the right-side handlebar.
3. Swing your leg over the seat and set your right foot down on the right-side footrest.
4. Get seated in a comfortable position.
5. Always keep your feet planted on the footrests.

Mounting the TRV (Passenger)

1. After the operator is seated and has the brake firmly applied, with your left hand, grasp the left shoulder of the operator, and with your right hand grasp the backrest; then swing your leg over the seat and set your right foot down on the right-side footrest.

B	O	N	E	C
BRAKES LOCKED	ON KEY SWITCH	NEUTRAL TRANSMISSION	ENGINE STOP SWITCH ON	CHOKE AUTOMATIC

2. Get seated in a comfortable position and keep hands firmly on the handholds.
3. Always keep your feet planted on the footrests.

Starting the Engine

Always start with the ATV on a flat, level surface. Carbon monoxide poisoning can kill you, so keep your ATV outside while it's running. Follow these steps to start it up:

1. Mount the ATV and sit down.
2. Engage the brake lever lock.
3. Turn on the ignition.
4. Shift into neutral.
5. Move the engine stop switch to RUN.
6. Press the starter button.

CAUTION

Do not run the starter motor for more than eight seconds per starting attempt. The starter motor may overheat causing severe starter motor damage. Allow 15 seconds between starting attempts to allow the starter motor to cool.

7. Let the engine warm up.

Another way to remember the starting procedure is by using the acronym "BONE-C." It stands for:

ATV Operation

Starting a Cold Engine

■ **NOTE:** It is very important not to touch or compress the throttle lever during the starting procedures.

1. Turn off all electrical accessories (hand warmer, lights, etc.); then rotate the ignition switch key to the first position (ON) leaving the headlights OFF. Note that the N is indicated on the LCD.
2. Press the starter button.

CAUTION

Do not run the starter motor for more than eight seconds per starting attempt. The starter motor may overheat causing severe starter motor damage. Allow 15 seconds between starting attempts to allow the starter motor to cool.

■ **NOTE:** Do not touch the throttle lever until the engine has run for at least 3 minutes.

3. Allow the engine to warm up for approximately 2-3 minutes or until the ATV will accelerate without hesitating.

Shifting

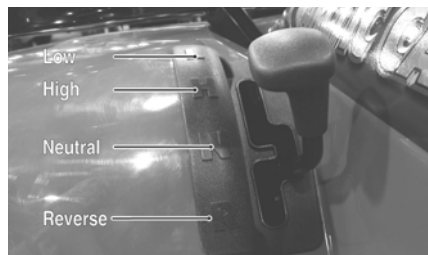

CF130B

The automatic transmission has a dual-range transmission with reverse. To shift the transmission, follow these steps:

1. To engage the high range from neutral, move the shift lever forward.

2. To engage the low range from high range, move the shift lever outward and forward.

■ **NOTE:** The high range is for normal riding with light loads. The low range is for carrying heavy loads or trailer towing. Compared to HIGH range, the LOW range position provides slower speed and greater torque to the wheels.

CAUTION

Always shift into low range when operating on wet or uneven terrain, when towing or pushing heavy loads, and when using a plow. Failure to follow this caution may result in premature V-belt failure or in damage to related drive system components.

3. To engage reverse gear from neutral, move the shift lever outward and rearward into the R position.

CAUTION

Always come to a complete stop before attempting to shift from one range to the other or into reverse. Always shift on level ground, or engage the brake lever lock before shifting into another range or into reverse.

WARNING

Do not start the engine or operate this ATV with the clutch shield removed. Severe injury could result.

Braking/Stopping

Always allow plenty of room and time to stop safely. Sometimes quick stops are inevitable, so always be prepared. Whether you're stopping slowly or stopping quickly, do this:

1. Squeeze the brake lever on the left handlebar to apply both the front and rear brakes.
2. If your wheels lock, release them for a second; then apply them again.

ATV Operation

- Never “ride” the brake. Even maintaining minimal pressure on the brake lever will cause the brake pads to drag on the disc and may overheat the brake fluid.

⚠ WARNING

Excessive repetitive use of the hydraulic brake for high speed stops will cause overheating of the brake fluid and premature brake pad wear which will result in an unexpected loss of brakes.

⚠ WARNING

Use only Arctic Cat approved brake fluid. Never substitute or mix different types or grades of brake fluid. Brake loss can result. Check brake fluid level and pad wear before each use. Brake loss can result in severe injury or even death.

Parking

Parking involves following the previous rules for braking; then:

- After the ATV stops, shift into neutral.
- Stop the engine using the engine stop switch.
- Turn off the ignition.
- If you have to park on a hill, shift the ATV into low gear; otherwise, try to park only on level surfaces.
- Engage the brake lever lock.

Dismounting the TRV

After you’ve followed the procedure for parking, it’s time to dismount:

- The operator should double check that the brake lever lock is engaged.
- The passenger should grasp the left shoulder of the operator with the right hand and with the left hand grasp the left-side handhold; then swing the right leg over the seat and step to the ground on the left side of the ATV.

- The operator should swing the right leg over to the left side of the seat.
- The operator should step to the ground on the left side of the ATV.

Handling the TRV (Active Riding Techniques)

Active riding involves moving your body. You and your passenger must learn to lean and shift body weight into turns to maintain control.

Safe riding techniques include:

- Riding
- Leaning, Weight Shift, and Balance
- Wide Turns
- Sharp Turns
- Quick Turns
- K-Turns
- Riding Uphill
- Riding Downhill
- Sidehilling/Traversing
- Swerving
- Crossing Obstacles

Riding

Once the engine’s warm, the ATV is ready to go.

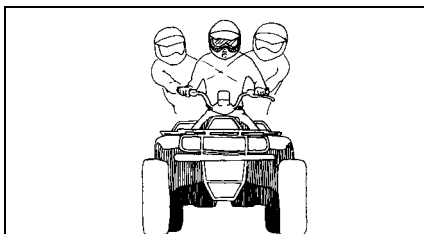

ATV-0012

- Keep your feet on the footrests and both hands on the handlebar.
- Hold the brake lever, and release the brake lever lock.
- Shift into gear.
- Release the brake slowly and apply the throttle.

ATV Operation

Leaning, Weight Shift, and Balance

When you turn, the trick is to move forward and slide over to the side of the seat that's on the inside of the turn. Support your body weight on the outside footrest. At the same time, lean your body and the passenger body to the inside of the turn. Pay attention to the handling—if you feel the tires coming off the ground, reduce speed, shift more of your body weight and passenger's body weight to the side that's lifting, and make the turn wider if possible.

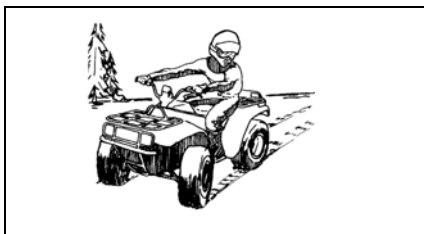

ATV-0013



ATV-0024



ATV-0025

Wide Turns

Many accidents happen during turns. If you don't understand turning techniques, it's easy for the ATV to get away from you by losing traction, plowing, or tipping. Use this method for wide turns:

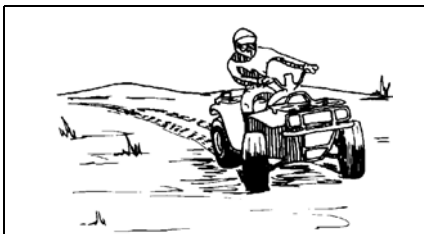

ATV-0046

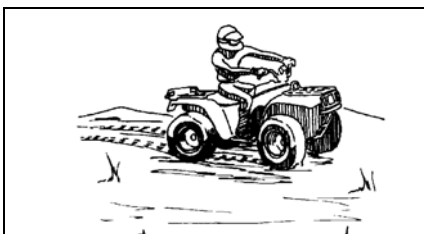

ATV-0045

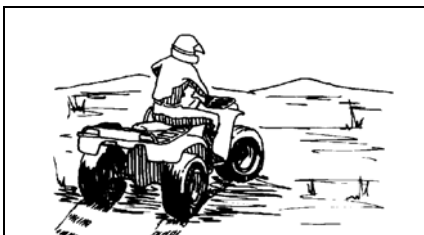

ATV-0044

1. Ease off the throttle as you approach the turn to slow down.
2. Use the principles of leaning, weight shifting, and balancing—shift your body weight and passenger's body weight to the inside of the turn.
3. Gradually increase your speed as you come out of the turn.

ATV Operation

Sharp Turns

After mastering wide turns, practice the advanced skill of sharp turns.

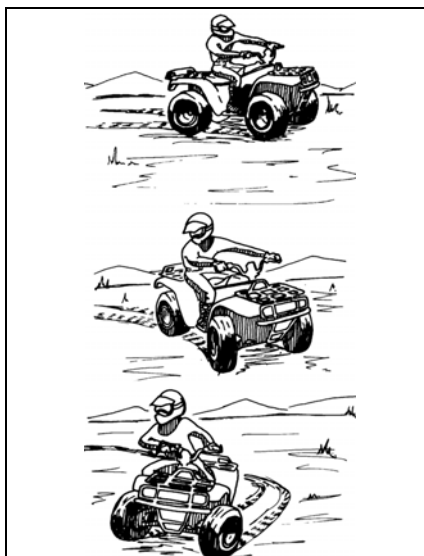

ATV-202

1. Ease off the throttle as you approach the turn to slow down.
2. Use the principles of leaning, weight shifting, and balancing—shift your body weight to the inside of the turn.
3. You might have to lean into the turn more than you do in a wide turn.
4. If shifting your weight and balance aren't enough to keep the ATV tires on the ground, straighten out the handlebar as much as you can.
5. Gradually increase your speed as you come out of the turn.

Quick Turns

Quick turns are the most difficult turns and should only be done after you are experienced with your ATV.

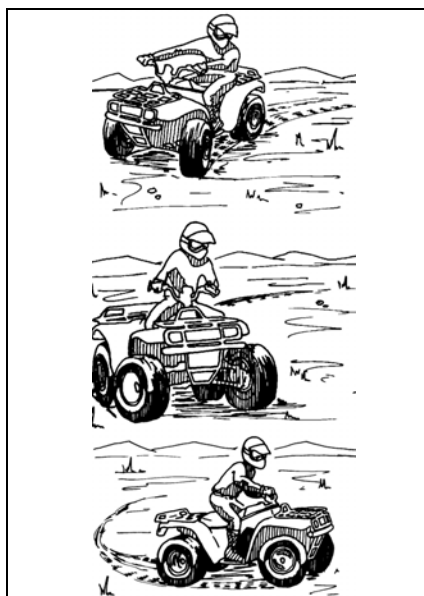

ATV-203

1. Ease off the throttle as you approach the turn to slow down.
2. Turn the handlebar and shift weight and balance at the same time as you enter the turn (use the principles of leaning, weight shifting, and balancing—shift your body weight and passenger's body weight to the inside of the turn).
3. Follow this with slight acceleration.
4. For multiple turns, repeat this movement as needed.
5. To make your turn quicker, try raising yourself off the seat a few inches as you shift your weight.

K-Turns

Use K-turns if you accidentally stall while riding uphill; you need to take action before the ATV rolls backward down the hill.

ATV Operation

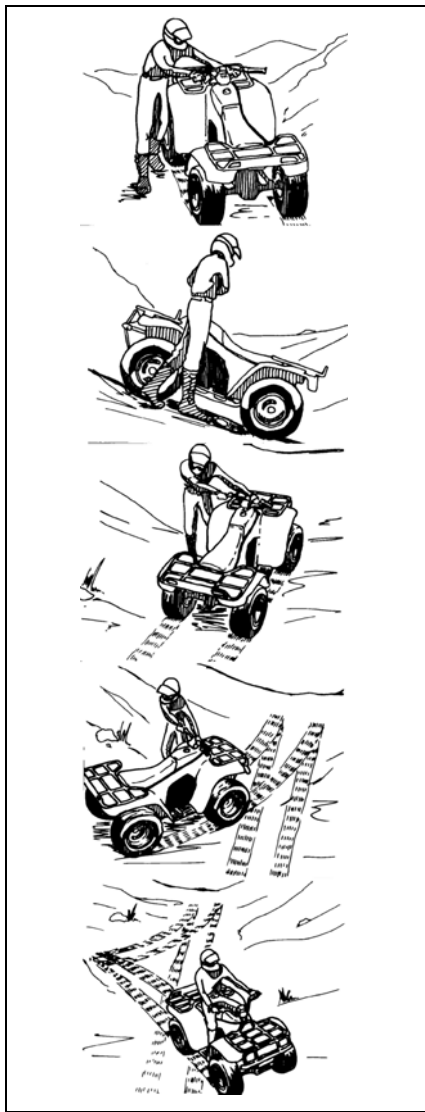

ATV-204

1. Stop where you are, apply the brakes, and shift to neutral.
2. Shut off the engine.
3. Keep your body weight shifted forward.
4. Ask the passenger to dismount.
5. Get off the ATV on the uphill side.

6. If you're to the left of the ATV, turn the handlebar all the way left.
7. Partially release the brake, but lightly hold the brake lever.
8. Let the ATV roll to your right side until it faces slightly downhill.
9. Reapply the brakes.
10. Get back on the ATV from the uphill side, have your passenger mount the ATV from the uphill side, and keep your body weight and the passenger's body weight shifted uphill when you sit down.
11. Start the engine and follow the method for riding downhill.

Riding Uphill

Many accidents happen while riding on hills and as a result of the ATV rolling or flipping. So, obviously, use extreme caution and follow this method for riding uphill.

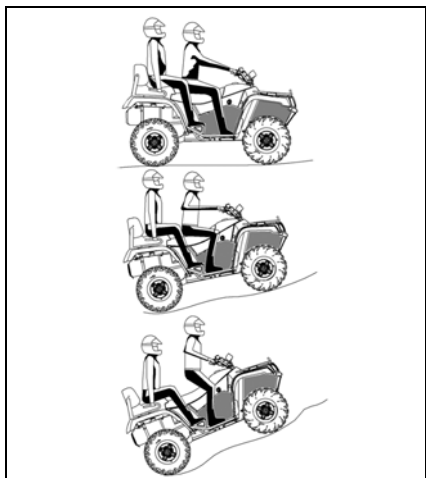

ATV-207

1. Accelerate before you start climbing; then maintain a steady pace.
2. Both the operator and the passenger should lean as far forward as possible. For steeper hills, the operator should come off the seat to stand and lean forward.

ATV Operation

3. If you lose speed, release the throttle (so your front tires don't lift), **OR**
4. If that doesn't work and you still have forward motion and the terrain permits, do a U-turn, go back down, and try climbing again, **OR**
5. If you have lost all forward motion, follow the K-turn procedure.

Never Operate Up Or Down Hills Steeper Than 25°

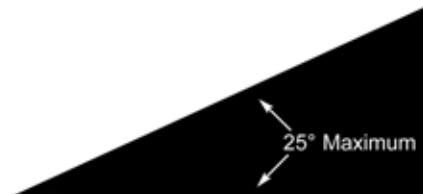

Riding Downhill

Success in riding downhill depends on how well you know your brakes—take it easy on them, or you could flip over.

1. Shift your body weight and passenger's body weight as far back on the seat as possible.
2. Keep it in a gear; stay out of neutral.
3. Lightly apply the brake and ease up on the throttle.

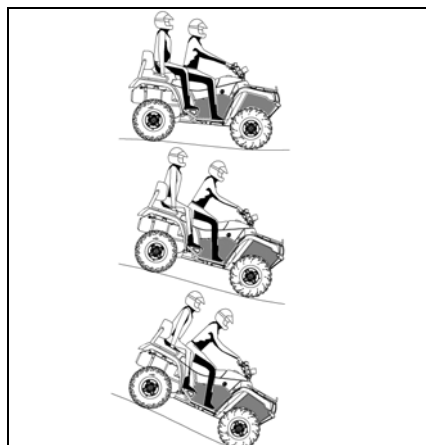

ATV-208

Sidehilling/Traversing

Sidehilling is considered an advanced skill; it's really tricky and unpredictable. So, whether your skills are advanced or not, try to avoid this kind of riding. If you're in a situation where you absolutely have to sidehill, follow this method:



ATV-0017



ATV-0028

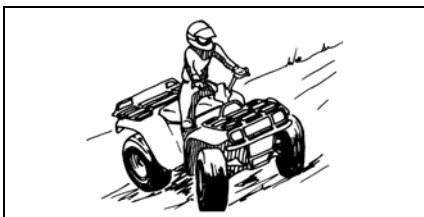

ATV-0029

1. Keep your speed low and consistent.
2. Shift all your body weight and passenger's body weight to the uphill side of the seat; also, support weight on the uphill footrest.
3. Steer like you're driving into the hill.

ATV Operation

- If the ATV feels like it's tipping, turn the handlebar downhill. If that's not possible because of the terrain or other conditions or if it just doesn't work, stop and get off. Have the passenger dismount on the uphill side first; then you should dismount on the uphill side.

Swerving

Swerving is usually an emergency reaction to avoid an obstacle but is similar to quick turns. The difference is that quick turns involve slight acceleration in the turn; don't accelerate if you swerve.

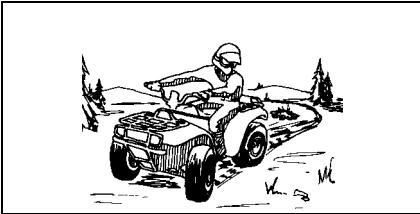

ATV-0043

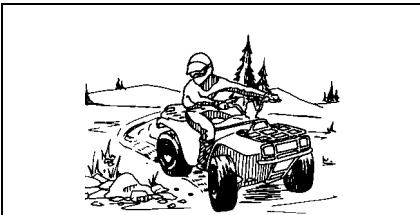

ATV-0042



ATV-0041

- Ease off the throttle as you approach the obstacle.

- Turn the handlebar. At the same time, shift weight and balance as you swerve. Use the principles of leaning, weight shifting, and balancing—shift your body weight and the passenger's body weight to the inside of the turn.
- Keep your hand off the brake until the emergency is over and you're back in control.

Crossing Obstacles

Crossing obstacles is risky; avoid it if possible. Riding over logs, rocks, and ruts means combining all the active riding skills into one big motion. Your ATV will respond differently for different obstacles (logs, ruts, etc.), but these are general guidelines for overcoming two-track (both tires contacting the obstacle at the same time) obstacles:

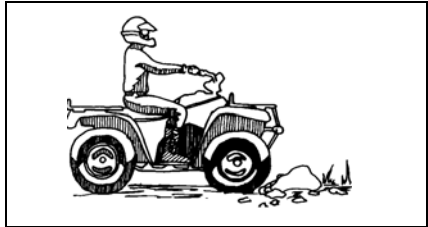

ATV-0016

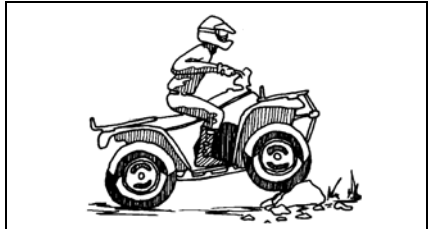

ATV-0026

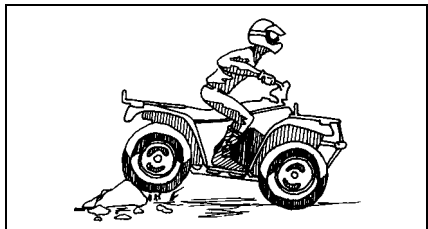

ATV-0027

ATV Operation

1. Stop the ATV.
2. Have the passenger dismount.
3. Keep your speed way down; less than 5 mph.
4. Approach the obstacle head-on.
5. Come up off the seat.
6. Keep your weight on the footrests.
7. Apply a little throttle when the front tires make contact with the obstacle.
8. Lean forward and release the throttle when the front tires clear the obstacle.
9. Keep your body loose to absorb any shock.
10. If the ATV starts tipping, shift your body weight to keep it in balance.

To clear a single-track (only one tire contacts) obstacle, follow the same rules except:

1. Use the ATV's momentum to clear the obstacle.
2. Don't pull up on the handlebar.
3. Don't apply the throttle.

Tips

Driving an ATV and a car have some similarities; however, there are always exceptions to the rules. Here are a few situations that require special attention:

- Reversing
- Skidding or Sliding
- Parking on a Hill
- Stalling on a Hill
- Crossing Water
- Crossing Roads
- Cold Weather Driving
- Stopping the TRV
- Stopping the Engine

Reversing

It's tough to see things behind you.

1. Go slowly. It's hard to see behind you.

2. Keep your handlebar straight.
3. Backing down hills is a bad idea; do a U-turn or K-turn instead to turn around.

Skidding or Sliding

If you lose control after hitting sand, ice, mud, or water:

1. Turn your handlebar into the direction of the slide.
2. Keep your hand off the brakes until you're out of the skid.
3. Shift your weight forward.

Sometimes your ATV may not respond and goes straight ahead instead of letting you turn. Here's how to handle it:

1. Slow down.
2. Move forward on the seat.
3. Lean to inside of turn and have your passenger lean to the inside of the turn.
4. Turn handlebar.

Parking on a Hill

This shouldn't be necessary, but if it is:

1. Keep it in gear.
2. Engage the brake lever lock.
3. Find something to block the rear tires.

Stalling on a Hill

If you use the right method for riding uphill, this shouldn't happen. But if you have a problem, do this:

1. If the ATV hasn't started rolling backwards yet, follow the procedure for the K-turn, **OR**
2. If the ATV is already rolling backward, both the operator and the passenger should lean as far forward as possible and the operator can be standing up on the footrests.
3. Nice and easy, apply the hand brake lever.

ATV Operation

- When you come to a stop, follow the procedure for the K-turn.

Crossing Water

This ATV can only handle water up to its footrests. Any more than that and you risk engine damage and/or personal injury. Stay away from fast moving rivers. Tires can be buoyant, so if the water is too deep, you might find the ATV suddenly afloat.

- Physically check the depth and current of the water, especially if you can't see the bottom. You're also checking for boulders, logs, or any other hidden obstacles.
- Keep ATV speed slow.
- Make sure you have a way out on the other side of the water.
- If you get stuck in the sludge or mud, try rocking the ATV from side to side.
- Once you've cleared the water, briefly apply the brakes to make sure they work.

Crossing Roads

Crossing roads on your ATV is also a bad idea, so avoid it. If you can't:

- Stop completely on the shoulder of the road.
- Check both directions for traffic.
- Crossing near a blind corner or intersection is dangerous; don't do it.
- Drive straight across to the opposite shoulder.
- Take into account that your ATV could stall while crossing; give yourself and your passenger enough time to get off the road.
- You have to assume that oncoming cars don't see you, and if they do, they won't be able to predict your actions.
- It's illegal to cross public roads in some places. Know your local laws.

Cold Weather Driving

■ **NOTE:** Check that all control levers move freely. Make sure that the footrest, shift lever, and rear foot brake are free of ice and snow.

WARNING

For your personal safety, it is very important to wear the type and amount of cold-weather clothing according to the coldest anticipated temperatures.

- With the transmission in neutral, move the ATV forward and backward to check that the wheels roll freely. If the ATV will not roll, the tires may be frozen to the ground or the brake pads may be frozen to the discs.
- If the tires are frozen to the ground, pour warm water around them to melt the ice.

CAUTION

Before riding, manually move the ATV forward and backward to make certain that all wheels roll freely.

- If the brakes are frozen, use a suitable heating device to thaw out the brakes.

WARNING

Do not attempt to free frozen brakes by pouring warm water on the brake pads and housings.

■ **NOTE:** After the brakes thaw, dry them by applying them several times while riding slowly.

■ **NOTE:** After riding through water, mud, snow, or slush, it is important to dry both brake systems before parking the ATV.

ATV Operation

WARNING

Go slowly and be extra careful when riding on snow-covered or ice-covered terrain. Always be alert to changing terrain conditions when operating the ATV.

4. Practice driving in an open snow-covered or ice-covered area at slow speeds before driving on snow-covered or ice-covered trails.

5. Learn how the ATV responds to steering and braking on the type of terrain to be encountered on the ride.

Stopping The ATV

To stop the ATV, first release the throttle lever. Next, apply the brake.

Stopping The Engine

To stop the engine, turn the ignition switch key to the OFF position or set the engine stop switch to the OFF position.

General Information

TRV Identification Numbers

This ATV has two identification numbers: Vehicle Identification Number (VIN) and Engine Serial Number (ESN).

The VIN is located on the frame support rail.



AF968B

The ESN is located on the left-side of the engine crankcase.



CF109N



GZ001D

These numbers are required by the dealer to complete warranty claims properly. No warranty will be allowed by Arctic Cat if the VIN or ESN is removed or mutilated in any way.

Always provide the ATV name, VIN, and ESN when contacting an authorized Arctic Cat ATV dealer for parts, service, accessories, or warranty. If a complete engine must be replaced, ask the dealer to notify Arctic Cat for correct registration information.

Ignition Switch Key

Two keys come with the ATV. Keep the spare key in a safe place. An identifying number is stamped on each key. Use this number when ordering a replacement key.

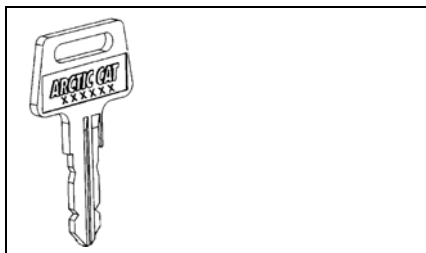

Control Locations And Functions

Ignition Switch

The ignition switch has three positions.

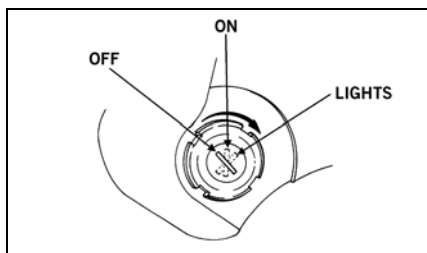

ATV-0056

OFF position — All electrical circuits except the accessory plug are off. The engine will not start. The key can be removed in this position.

■ **NOTE:** The accessory plug is powered by the battery at all times.

ON position — The ignition circuit is complete and the engine can run. The key cannot be removed in this position.

LIGHTS position — The ignition circuit is complete and the headlights and tail-light are on. The key cannot be removed in this position.

CAUTION

Leaving the ignition switch in the ON or LIGHTS position for a long period of time when the engine is not running may cause the battery to discharge. Always leave the ignition switch in the OFF position when engine is not running.

Shift Lever

This ATV has a dual-range automatic transmission with reverse. To shift the ATV, follow these steps:

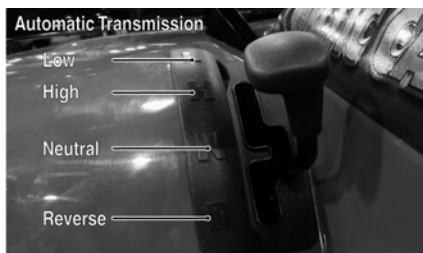

CF130A

1. To engage the high range from neutral, move the shift lever forward.
2. To engage the low range from high range, move the shift lever outward and forward.

■ **NOTE:** The high range is for normal riding with light loads. The low range is for carrying heavy loads or trailer towing. Compared to HIGH range, the LOW range position provides slower speed and greater torque to the wheels.

CAUTION

Always shift into low range when operating on wet or uneven terrain, when towing or pushing heavy loads, and when using a plow. Failure to follow this caution may result in premature V-belt failure or in damage to related drive system components.

3. To engage reverse gear from neutral, move the shift lever outward and rearward into the R position.

CAUTION

Always come to a complete stop before attempting to shift from one range to the other or into reverse. Always shift on level ground, or engage the brake lever lock before shifting into another range or into reverse.

Drive Select Switch



FI475A

This switch allows the operator to operate the ATV in either 2-wheel drive (rear wheels) or 4-wheel drive (all wheels). For normal riding on flat, dry, hard surfaces, 2-wheel drive should be sufficient. In situations of aggressive trail conditions, 4-wheel drive would be the desired choice.

To either engage or disengage the front wheels, move the switch to the 4WD position or to the 2WD position.

CAUTION

Do not attempt to either engage or disengage the 4WD lock while the ATV is moving.

The 4WD lock allows the operator to mechanically lock the front differential to apply equal power to both front wheels.

To engage the lock from 4WD, slide the switch up and move it fully to the left. To disengage the lock, move the switch lever to the right.

⚠ WARNING

The 4WD lock is intended for use where minimum traction is available. **NEVER EXCEED 10 MPH (16 kph)** with the lock engaged. Maneuverability and handling characteristics will differ with the lock engaged. **ALWAYS** shift into four-wheel drive prior to engaging the front differential lock. Failure to follow this procedure may result in loss of control. Control loss can result in severe injury or even death.

**Handwarmers/
Thumbwarmer (Cruiser)**

The operator's handwarmers/thumbwarmer are controlled by a rocker-type switch on the instrument pod. There are three positions on the switch (Low/Off/High).



CR027C

The passenger's handwarmers are controlled by a rocker-type switch located beneath the right-side handgrip. There are three positions on the switch (Low/Off/High).

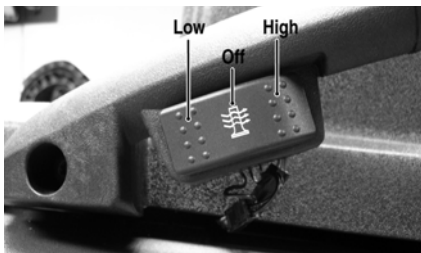

CR009A

■ **NOTE:** Operating handwarmers, lights, and/or other accessories at low engine RPM for extended time may cause excessive battery discharge resulting in erratic engine operation.

CAUTION

Always charge a discharged battery prior to storage or severe battery damage may occur (See **GENERAL MAINTENANCE - BATTERY** in this manual).

Hand Brake

The hand brake is considered to be the normal operating (main) brake. It should be applied whenever a braking situation is needed.

Apply the brake by compressing the brake lever toward the handlebar.

Brake Lever Lock

To engage and release the brake lever lock, use the following procedure.

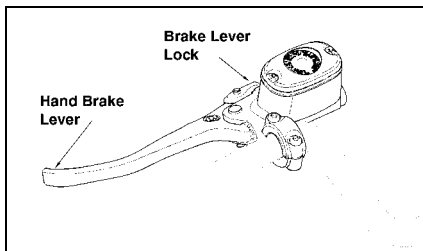

738-420B

1. Squeeze the hand brake two or three times and release it.
2. Depress and hold the brake lever lock.
3. While holding in on the brake lever lock, squeeze the brake lever.

■ **NOTE:** It will click as it engages and the brake lever will not return to its released position.

4. Release the brake lever lock by squeezing the brake lever. It will return to its released position.

Check to make sure the brake lever lock engages properly and that the brake (when engaged) locks the wheels.

1. Pump the brake lever 2 or 3 times.
2. Engage the brake lever lock.
3. Attempt to push the ATV.

■ **NOTE:** The brake lever lock must lock the wheels. If it doesn't, take the ATV to an authorized Arctic Cat ATV dealer for service.

⚠ WARNING

Always check to be sure that the brake lever lock has been disengaged before operating the ATV. An accident could result if the brake lever lock is left engaged while the ATV is operated. The brake may relax if left engaged for a long period of time. This could cause an accident; therefore, do not leave the ATV on a hill depending on the brake lever lock. Always block the downhill side of the wheels if leaving the ATV on a hill or park the ATV in a sidehill position.

Rear Foot Brake



CF223

Pressing the rear foot brake downward will apply the brake to the rear wheels.

Headlight HI/LO Switch

Use the headlight HI/LO switch to select the high or low headlight beam when the ignition switch is in the LIGHTS position. When the switch is in the HI position, the high beam will illuminate. When the switch is in the LO position, the low beam will illuminate.

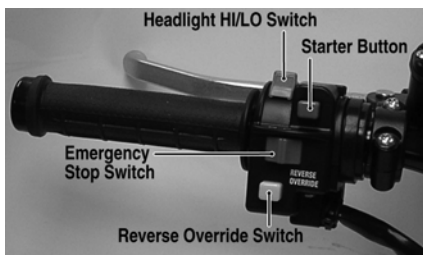

CF245A

Engine Stop Switch

OFF position — The ignition circuit is off. The engine cannot be started or will not run. If the engine stop switch is used to stop engine without turning off ignition switch, the battery may discharge.

RUN position — The ignition circuit is on. The engine can start and run.

Electric Starter Button

Pushing in on this button activates the starter motor. Before starting the engine, make sure the ignition switch is in the ON position, the transmission is in neutral, the reverse shift lever is in the forward position, and the brake lever lock is engaged.

■ **NOTE:** This ATV has safety interlock switches which prevent the starter motor from activating when the transmission is not in neutral. To start the ATV while in gear, depress the rear foot brake or compress the brake lever; then depress the starter button.

Reverse Override Switch

This ATV is equipped with a reverse speed limiter system. When additional RPM is needed in reverse, depress and hold the override switch.

■ **NOTE:** On the EFI models, the override is active only when 4WD is selected.

⚠ WARNING

Never activate the override switch while the throttle is open as a loss of control may result.

Throttle Lever



FI475B

Control engine RPM with the position of the throttle lever. Operate this lever with the thumb. Pushing it forward increases engine RPM and allowing it to retract decreases engine RPM.

Throttle Limiter Screw

Throttle lever travel may be limited by adjusting the throttle limiter screw. The throttle limiter should be adjusted according to the operator's skill and experience. To adjust the throttle limiter, use the following procedure.

1. Loosen the jam nut.

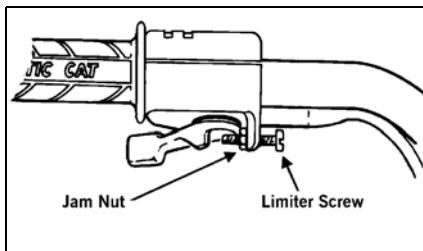

ATV-0053

2. Turn the throttle limiter screw clockwise to decrease engine RPM maximum or counterclockwise to increase engine RPM maximum.
3. Tighten the jam nut securely.

■ **NOTE:** This ATV is equipped with an RPM limiter that retards ignition timing when maximum RPM is approached. When the RPM limiter is activated, it could be misinterpreted as a high-speed misfire.

Power Steering (Cruiser)

Some ATV's were produced with an Electronic Power Steering (EPS) system to reduce steering effort and rider fatigue over a broad range of operating conditions.

The EPS system engages when the ignition switch is turned to the ON position and disengages after approximately five minutes (to conserve battery power) if the engine is not running.

This system is entirely maintenance-free: no adjustment or servicing is required. There are no fluids to check or change, and the EPS system is entirely self-contained and sealed to protect it from the elements.

The EPS system is battery system powered; therefore, the battery must be in good condition and fully charged. Power delivery and overload protection is provided by an EPS relay and 30-amp fuse located under the seat in the Power Distribution Module (PDM).

The system is self-monitored and will display a "P0635" malfunction code on the LCD gauge/speedometer should an EPS system control circuit problem occur. Do not operate the ATV with a "P0635" malfunction code displayed.

■ **NOTE:** Turn the key switch to the OFF position then back to the ON position to reset the malfunction code. If the code continues to be displayed, take your ATV to an authorized Arctic Cat Dealer for EPS system servicing before resuming operation.

CAUTION

Never operate this ATV with a "P0635" code indicated on the LCD gauge/speedometer. This indicates a malfunction in the EPS system control circuit and could result in a loss of power steering assist.

In the event of electrical power failure, the EPS system becomes disabled (similar to an automobile with the engine shut off). Steering effort increases but steering control can be maintained.

Speedometer/LCD (Digital)

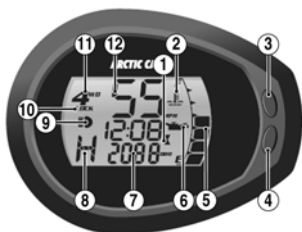

CF236A

1. Clock/Engine Hour Meter - The clock function indicates time in the 12-hour mode; the hour meter indicates the total time the ATV has run and cannot be reset to zero. To set the clock, use the following procedure.

- A. With the ignition switch ON, press and release the Mode Button (3) until the Clock/Engine Hour Meter (1) is displayed; then (if necessary) press and release the Set/Reset Button (4) to select the clock display.
- B. Press and hold the Set/Reset Button (4) until the minutes stop scrolling and the hour display starts to scroll. Momentarily release when the correct hour is displayed; then repeatedly press and release the Set/Reset Button (4) until the correct minutes are displayed.

■ **NOTE:** Clock memory power is supplied through the 15-amp accessory fuse and verified during gauge “power-up” and reset. In the event of clock memory power failure (blown fuse, etc.), the gauge will “power-up,” reset, and shut down repeatedly until clock memory power is restored. Always check the 15-amp accessory fuse if this gauge condition is noted.

■ **NOTE:** The engine hour meter will not activate until engine speed exceeds 500 RPM.

2. Temperature Indicator - If the engine coolant temperature exceeds the normal operating range, the temperature icon will begin flashing and the LCD will go blank for 30 seconds; then the LCD will return to normal. However, the temperature icon will continue to flash.

CAUTION

Continued operation with high engine temperature may result in engine damage or premature wear.

■ **NOTE:** High engine RPM, low vehicle speed, or heavy load can raise engine temperature. Decreasing engine RPM, reducing load, and selecting an appropriate transmission gear can lower the temperature.

■ **NOTE:** Debris in front of the engine (or packed between the cooling fins of the radiator) can reduce cooling capacity. Using a garden hose, wash the radiator and the engine to remove any debris restricting air flow.

CAUTION

Arctic Cat does not recommend using a pressure washer to clean the radiator core. The pressure may bend or flatten the fins causing restricted air flow, and electrical components on the radiator could be damaged. Use only a garden hose with spray nozzle at normal tap pressure.

3. Mode Button - Shifts the gauge through three set-up modes: speedometer/tachometer, distance, and time.

■ **NOTE:** The Mode Button must be pressed and released to shift modes. Approximately two seconds after the Mode Button is released, the digital gauge will return to full display.

4. Set/Reset Button - In conjunction with the Mode Button, sets and resets various displays on the digital gauge. Also used to shift from speedometer function to tachometer function on the speedometer/tachometer gauge.
5. Fuel Level Indicator - Indicates approximate amount of gasoline in the gas tank.
11. Drive Select Indicator - Displays 4WD when selected by the drive select switch or when the 4WD lock is engaged. The display is blank when in 2WD.
12. Speedometer - Indicates the approximate vehicle speed in miles per hour (MPH) or kilometers per hour (km/h).

■ **NOTE: When the bottom segment flashes, approximately 3.5 L (0.92 U.S. gal.) of gasoline remains in the tank.**

6. Low Oil Pressure - Will be displayed during self-test at start-up. It will not be displayed during normal operation as oil pressure is not monitored on these models.
7. Odometer/Trip Meter - Odometer registers the total distance the vehicle has traveled. The trip meter is resettable and can be used to measure trip or trip legs. The odometer cannot be reset.

■ **NOTE: To shift between the odometer (ODO) or trip meter (TRIP), press the Mode Button (3) to select the distance mode; then press the Set/Reset Button (4) to select the desired display. Hold the Set/Reset Button down to reset the trip meter.**

8. Gear Position Indicator - Indicates which gear is selected.
 - R (reverse)/N (neutral)/L (low range)/H (high range).

■ **NOTE: An E will be displayed if there is an error caused by a no-shift position signal.**

9. High Beam Indicator - The High Beam icon will appear only when the headlights are on high beam.
10. 4WD Lock Indicator - Displays LOCK when the front differential lock has been engaged.

■ **NOTE: To change mph/km/h display, press and release Mode Button (3) until the icon (MPH/km/h) appears; then press the Set Button (4) to change the display.**

Condition Warning Display - Uses odometer/trip meter display of the LCD to warn of a system error condition requiring attention.

- A. Volt - The LCD will go blank except the word VOLT will flash on the LCD whenever a low voltage (< 9 DC volts) or a high voltage (> 16 DC volts) is detected. When voltage returns to normal, the gauge must be reset by turning the ignition key to the OFF position and then to the ON position.
- B. EFI - On the 550/700 models, the LCD will go blank except the letters EFI will flash on the LCD whenever an electronic fuel injection error is detected. After 30 seconds, the LCD will return to normal; however, the letters EFI will continue to flash until the cause of the error is corrected.
- C. EFI - On the 450/1000 models, the LCD will go blank except a malfunction code will flash on the LCD and a wrench icon will be displayed whenever an electronic fuel injection malfunction is detected. After 30 seconds, the LCD will return to normal; however, the malfunction code and wrench icon will continue to be displayed until the malfunction is corrected.

■ **NOTE: Take the ATV to an authorized Arctic Cat ATV dealer to have the EFI error corrected and to have the ECU reset as soon as possible.**

Speedometer/LCD (Analog/Digital)



CF094A

1. Clock/Engine Hour Meter - The clock function indicates time in the 12 hour mode; the hour meter indicates the total time the ATV has run and cannot be reset to zero. To set the clock, use the following procedure.

- A. With the ignition switch ON, press and release the Mode Button (3) until the Clock/Engine Hour Meter (1) is displayed; then (if necessary) press and release the Set/Reset Button (4) to the clock display.
- B. Press and hold the Set/Reset Button (4) until the minutes stop scrolling and the hour display starts to scroll. Momentarily release when the correct hour is displayed; then repeatedly press and release the Set/Reset Button (4) until the correct minutes are displayed.

■ **NOTE:** Approximately two seconds after releasing either Button, the LCD will return to normal operation.

■ **NOTE:** Clock memory power is supplied through the 15-amp accessory fuse and verified during gauge “power-up” and reset. In the event of clock memory power failure (blown fuse, etc.), the gauge will “power-up,” reset, and shut down repeatedly until clock memory power is restored. Always check the 15-amp accessory fuse if this gauge condition is noted.

■ **NOTE:** The engine hour meter will not activate until engine speed exceeds 500 RPM.

2. Fuel Level Indicator - Indicates approximate amount of gasoline in the gas tank.

■ **NOTE:** When the bottom segment flashes, approximately 3.5 L (0.92 U.S. gal.) of gasoline remains in the tank.

3. Mode Button - Shifts the gauge through three set-up modes: speedometer/tachometer, distance, and time.

■ **NOTE:** The Mode Button must be pressed and released to shift modes. Approximately two seconds after the Mode Button is released, the digital gauge will return to full display.

4. Set/Reset Button - In conjunction with the Mode Button, sets and resets various displays on the digital gauge. Also used to shift from speedometer function to tachometer function on the speedometer/tachometer gauge.
5. Odometer/Trip Meter (T1 and T2) - Odometer registers the total distance the vehicle has traveled. Trip meters can register two distances (for instance, T1 could register trip distance and T2 could register distance between stops). The trip meters can be reset while the odometer only registers accumulated miles/kilometers and the odometer cannot be reset to zero.

All distances correspond to speedometer function selected (MPH or km/h).

■ **NOTE:** To select the odometer (ODO), trip #1 (T1), or trip #2 (T2), press the Mode Button (3) to select the distance mode; then press the Set/Reset Button (4) to select the desired display. Hold the Set/Reset button down to reset trip meters.

6. Gear Position Indicator - Indicates which gear is selected.

- R (reverse)/N (neutral)/H (high range)/L (low range).

■ **NOTE: An E will be displayed if there is an error caused by a no-shift position signal.**

7. Speedometer/Tachometer - A needle indicates approximate vehicle speed in mph or km/h when speedometer function is selected or rpm when tachometer function is selected.
8. Needle Indicator Display - Displays which speedometer function (MPH or km/h) or tachometer function (RPM) is selected.

■ **NOTE: The speedometer and tachometer functions may be switched by pressing the Set/Reset Button.**

9. 4WD Lock Indicator - Displays LOCK when the front differential lock has been engaged.
10. Drive Select Indicator - Displays 4WD when selected by the drive select switch or when the 4WD lock is engaged. The display is blank when in 2WD.
11. High Beam Indicator - The High Beam icon will appear only when the headlights are on high beam.

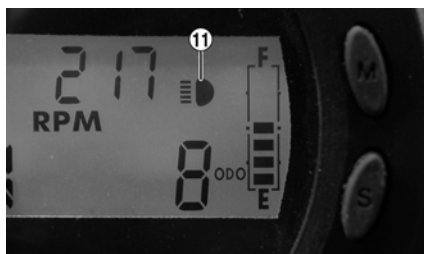

CF101A

12. Battery Condition Indicator - The speedometer/tachometer needle will not function and the LCD will go blank except the word VOLT will flash on the LCD whenever a low voltage (< 9 DC volts) or high voltage (>16 DC volts) is detected. When voltage returns to normal, the gauge must be reset by turning the ignition key to OFF; then back to ON.



CF098A

13. Temperature Indicator - The speedometer/tachometer needle will sweep full scale and the LCD will go blank except the high temperature icon will flash. After 30 seconds, the speedometer/tachometer needle and LCD will return to normal, but the temperature icon will continue to flash. The icon should not be visible during normal operation.



CF099A

CAUTION

Continued operation with high engine temperature may result in engine damage or premature wear.

■ **NOTE:** High engine RPM, low vehicle speed, or heavy load can raise engine temperature. Decreasing engine RPM, reducing load, and selecting an appropriate transmission gear can lower the temperature.

■ **NOTE:** Debris in front of the engine (or packed between the cooling fins of the radiator) can reduce cooling capacity. Using a garden hose, wash the radiator and the engine to remove any debris restricting air flow.

■ **NOTE:** Take the ATV to an authorized Arctic Cat ATV dealer to have the error corrected and the system error reset as soon as possible.



FI01B

CAUTION

Arctic Cat does not recommend using a pressure washer to clean the radiator core. The pressure may bend or flatten the fins causing restricted air flow, and electrical components on the radiator could be damaged. Use only a garden hose with spray nozzle at normal tap pressure.

14. EFI Error Indicator - On the 550/700 models, The speedometer/tachometer needle will sweep full scale and the LCD will go blank except the letters EFI will flash on the LCD whenever an electronic fuel injection error code is detected. After 30 seconds, the LCD and speedometer/tachometer needle will return to normal, but the letters EFI will continue to flash on the LCD until the cause of the error is corrected.

EFI Malfunction Indicator - On the 450/1000 models, the speedometer/tachometer needle will sweep full scale and the LCD will go blank except a malfunction code and wrench icon will be displayed on the LCD whenever an electronic fuel injection malfunction code is detected. After 30 seconds, the LCD and speedometer/tachometer will return to normal, but the malfunction code and wrench icon will continue to be displayed on the LCD until the malfunction is corrected.

Electric Fuel Pump

An electric fuel pump is incorporated in the gas tank to deliver gasoline to the fuel injector. The fuel pump is activated when the ignition switch is in the ON position.

■ **NOTE:** Both the ignition and fuel pump functions will be interrupted by the Tilt Sensor if the ATV tips over past 60°-70°. Righting the ATV will reactivate the ignition and fuel pump.

Gas Hoses

Replace the gas hose every two years. Damage from aging may not always be visible.

Oil Level Stick

There is an oil level stick for checking the engine oil level. To check the oil level, use the following procedure.

■ **NOTE:** The ATV should be on level ground when checking the engine oil level.

1. Unscrew the oil level stick and wipe it with a clean cloth.
2. Install the oil level stick and thread it completely into the engine case.
3. Remove the oil level stick; the engine oil level should be within the operating range but not above the FULL mark.



GZ461A

CAUTION

Do not overfill the engine with oil. Always make sure the oil level is within the operating range.

Windshield (Cruiser)

CAUTION

Remove the windshield before trailering the ATV or damage to the windshield may occur.

To remove the windshield, loosen the left and right plastic knobs and remove the windshield assembly. Tighten the knobs securely or remove them completely to prevent loss.



CR003

To install the windshield, loosen the left and right plastic knobs; then install the tapered windshield pins into the mounts and tighten knobs securely.

Mirrors (Cruiser)

The mirrors can be adjusted to the desired viewing angle or moved to a stowed position when operating in trees or brush.

WARNING

Always adjust the mirrors to a position that will not catch tree branches or under-brush which could cause a loss of control and severe injury or death.

Rear Seat Lock

1. To remove the rear seat, pull the two latch handles to the rear and rotate them to the vertical position.



CR017D

2. Lift the rear of the seat up; then pull slightly to the rear and lift the seat off the mountings.
3. To lock the seat into position, engage the two front mounting lugs into the mounting rack; then, holding down firmly on the front of the seat, push the seat forward until the rear tabs engage the rear mounting latches.
4. Lock the seat into position by rotating the latch handles to the horizontal position; then push the handles forward to lock.



CR017E

⚠ WARNING

Make sure the seat is secure before mounting the ATV. Severe personal injury may result if the seat is not properly secured.

Front Seat Lock

■ **NOTE:** On the TRV models, the rear seat must be removed prior to removing the front seat. On the Cruiser models, it is necessary only to elevate the front of the rear seat.

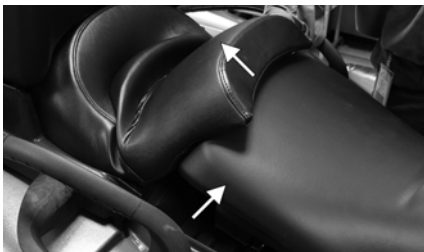

CR010A

1. To remove the front seat, pull the seat lock lever up (located at the rear of the seat). Raise the rear end of the seat and slide it rearward.
2. To lock the seat into position, slide the front of the seat into the seat retainers and push down firmly on rear of seat. The seat should automatically lock into position.

⚠ WARNING

Make sure the seat is secure before mounting the ATV. Severe personal injury may result if the seat is not properly secured.

Storage Box (Cruiser)

To open the storage box, unlock the storage box latch and turn the knob clockwise; then open the lid by lifting up on the rear.



CR011A

To close the storage box, close the lid completely; then rotate the knob counter-clockwise and lock with the key.

CAUTION

Do not operate or trailer the ATV with lock unlocked or damage to the box will occur.

⚠ WARNING

MAXIMUM LOAD:
35lb (16kg)
evenly distributed

1411-877

Safety Flag Bracket

A bracket is provided for mounting a flag at the rear of the ATV.

Rack Loading

The racks are designed to carry specified load capacity. Always refer to the Load Capacity Ratings Chart for proper capacity.

⚠ WARNING

Make sure the load on the rack will not interfere with the controls or obstruct the view of the operator. Also, make sure the load is evenly distributed, properly secured, and will not shift while operating the ATV.

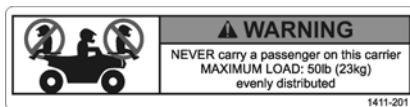
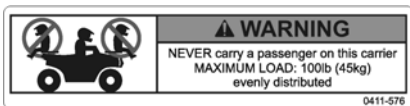

Trailer And Towing

⚠ WARNING

Never use the front rack or rear backrest support as towing or trailering points.

The TRV is equipped with a frame-mounted receiver for a standard 5.1 cm (2 in.) receiver hitch. The standard receiver hitch must be purchased separately.

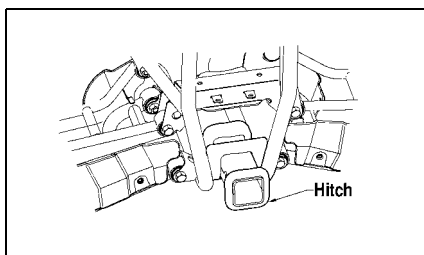

738-424A

⚠ WARNING

Make sure that the load in the trailer is properly secured and will not shift while moving. Also, do not overload the trailer.

When loading a trailer properly, two items are critical: Gross Trailer Weight (the weight of the trailer plus cargo) and Trailer Tongue Weight.

⚠ WARNING

Never exceed any of the recommended weight restrictions.

Trailer Tongue Weight is the downward force exerted on the hitch by the trailer coupler when the trailer is fully loaded and the coupler is at its normal towing height.

Always maintain a slow speed when trailering and towing and avoid sudden accelerations, quick maneuvers, and sudden stops. Braking distance will be affected when towing a trailer. When towing a trailer, always maintain slow speed and allow more stopping distance than when not towing a trailer.

⚠ WARNING

Riding an ATV without extra caution when towing a trailer will be hazardous. Trailer towing can affect the handling and braking of the ATV. Never tow a trailer without a rigid tongue and never exceed 10 mph. Avoid sudden accelerations and stopping of the ATV. Do not make quick maneuvers. Avoid uneven surfaces and do not tow on hills. Never carry passengers in a trailer unless the trailer is designed for such use. Allow more stopping distance than when not towing a trailer.

Transporting TRV

When transporting the ATV, Arctic Cat recommends that the ATV be in its normal operating position (on all four wheels) and the following procedure be used.

1. Engage the brake lever lock and place the transmission in gear.

CAUTION

Failure to engage the brake lever lock and place the transmission in gear could result in the ATV rolling off the trailer in the event of tie-down strap failure.

2. Secure the ATV with load rated hold-down straps.

■ **NOTE:** Suitable hold-down straps are available from your Arctic Cat ATV dealer. Ordinary rope is not recommended because it can stretch under load.

CAUTION

When using hold-down straps, care must be taken not to damage the ATV.

Gasoline-Oil-Lubricant

Recommended Gasoline

The recommended gasoline to use is 87 minimum octane regular unleaded. In many areas, oxygenates (either ethanol or MTBE) are added to the gasoline. Oxygenated gasolines containing up to 10% ethanol, 5% methane, or MTBE are acceptable gasolines.

When using ethanol blended gasoline, it is not necessary to add a gasoline antifreeze since ethanol will prevent the accumulation of moisture in the fuel system.

CAUTION

Do not use white gas. Only Arctic Cat approved gasoline additives should be used.

Recommended Engine/Transmission Oil

CAUTION

Any oil used in place of the recommended oil could cause serious engine damage. Do not use oils which contain graphite or molybdenum additives. These oils can adversely affect clutch operation. Also, not recommended are racing, vegetable, non-detergent, and castor-based oils.

The recommended oil to use is Arctic Cat ACX All Weather synthetic engine oil, which has been specifically formulated for use in this Arctic Cat engine. Although Arctic Cat ACX All Weather synthetic engine oil is the only oil recommended for use in this engine, use of any API certified SM 0W-40 oil is acceptable.

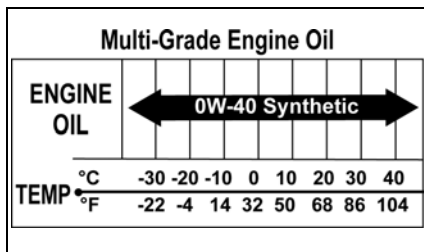

OILCHARTJ

Recommended Front Differential/Rear Drive Lubricant

■ **NOTE:** Arctic Cat recommends the use of genuine Arctic Cat lubricants.

The recommended lubricant (front differential and rear drive) is SAE approved 80W-90 hypoid. This lubricant meets all of the lubrication requirements of the ATV.

CAUTION

Any lubricant used in place of the recommended lubricant could cause serious front differential/rear drive damage.

Filling Gas Tank

⚠ WARNING

Always fill the gas tank in a well-ventilated area. Never add gasoline to the gas tank near any open flames or with the engine running or hot. **DO NOT SMOKE** while filling the gas tank.

Since gasoline expands as its temperature increases, the gas tank must be filled to its rated capacity only. Expansion room must be maintained in the tank particularly if the tank is filled with cold gasoline and then moved to a warm area.

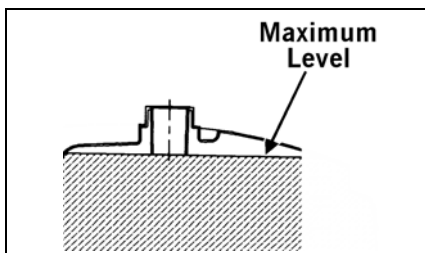

ATV-049D

Allow the engine to cool before filling the gas tank. Care must be taken not to overfill the tank. If overfilled, gas may leak onto the engine creating a fire hazard.

WARNING

Do not overfill the gas tank.

Tighten the gas tank cap securely after filling the tank.

Engine Break-In

After the completion of the break-in period, the engine oil and oil filter should be changed. Other maintenance after break-in should include checking of all prescribed adjustments and tightening of all fasteners. At the discretion and expense of the owner/operator, the ATV may be taken to an authorized Arctic Cat ATV dealer for this initial service.

New vehicles and renewed engines require a “break-in” period. The first month is most critical to the life of this ATV. Proper operation during this break-in period will help assure maximum life and performance from the ATV.

During the first 10 hours of operation, always use less than ½ throttle. Varying the engine RPM during the break-in period allows the components to “load” (aiding the engine/transmission component mating process) and then “unload” (allowing components to cool). Although it is essential to place some stress on the engine components during break-in, care should be taken not to overload the engine too often. Do not pull a trailer during the break-in period.

When the engine starts, allow it to warm up properly. Idle the engine several minutes until the engine has reached normal operating temperature. Do not idle the engine for excessively long periods of time.

Burnishing Brake Pads

Brake pads must be burnished to achieve full braking effectiveness. Braking distance will be extended until brake pads are properly burnished.

To properly burnish the brakes, use following procedure:

1. Choose an area sufficiently large to safely accelerate to 30 mph and brake to a stop.
2. Accelerate to 30 mph; then compress brake lever to decelerate to 0-5 mph.
3. Repeat procedure twenty times until brakes are burnished.

WARNING

Do not attempt sudden stops or put yourself into a situation in which a sudden stop will be required until the brake pads are properly burnished.

General Maintenance

■ **NOTE:** Proper maintenance of this ATV is important for optimum performance. Follow the Maintenance Schedule and all ensuing maintenance instructions/information.

If, at any time, abnormal noises, vibrations, or improper functioning of any component of this ATV is detected, DO NOT OPERATE THE ATV. Take the ATV to an authorized Arctic Cat ATV dealer for inspection and adjustment or repair.

If the owner/operator does not feel qualified to perform any of these maintenance procedures or checks, take the ATV to an authorized Arctic Cat ATV dealer for professional service.

■ **NOTE:** The following instructions and information refer to specific items in the maintenance and care of this ATV.

Maintenance Schedule

Item	Page	After break-in	1 month	3 months	6 months
Battery	73	I	I		
* Engine nuts and bolts	—	I			I
* Valve clearance	—	I			I
Spark plug(s)	76	I		I	I
	76	Replace every 18 months			
Liquid cooling system	68	I	Inspect every time before riding		
Throttle cable	76	I	Inspect every time before riding		
Gas hoses	60	I	Inspect every time before riding		
	60	Replace every 2 years			
Engine/transmission oil and filter	69	R		R**	
Air filter	77	I		I	C
Gear lubricant (Front differential - rear drive)	70	I		I	
	70	Replace every 4 years			
V-Belt Cover	78	I			I
Muffler/spark arrester	79				C
Tires/air pressure	78	I	Inspect every time before riding		
	37-38	I	Inspect every time before riding		
* Brake components	71/72	I	Inspect every time before riding		
Brake fluid	71	I	*Replace every 2 years		
Brake hoses	71	I	*Replace every 4 years		
* Steering	—	I	Inspect every time before riding		
* Suspension (Ball joint boots, drive axle boots front and rear, tie rods, differential and rear drive bellows)	—	I	Inspect every time before riding		
* Chassis nuts and bolts	—	I	T		
Frame/welds/racks	—	I			I
Electrical connections	—	I			I
Headlights/taillight-brakelight	80	I	Inspect every time before riding		

I=Inspect and clean, adjust, lubricate, replace as necessary T=Tighten R = Replace C = Clean
 * = Dealer maintenance ** = When using Arctic Cat ACX All Weather synthetic oil, oil change interval can be increased to every 1,000 miles or every year.

Liquid Cooling System

The cooling system should be inspected daily for leakage and damage. If leakage or damage is detected, take the ATV to an authorized Arctic Cat ATV dealer for service. Also, the coolant level should be checked periodically.

When filling the cooling system, use a coolant/water mixture which will satisfy the coldest anticipated weather conditions of the area in accordance with the coolant manufacturer's recommendations. While the cooling system is being filled, air pockets may develop; therefore, run the engine for five minutes after the initial fill, shut the engine off, and then fill the cooling system to the bottom of the stand pipe in the radiator neck.

■ **NOTE:** Use a good quality, biodegradable glycol-based, automotive-type antifreeze.

CAUTION

After operating the ATV for the initial 5-10 minutes, stop the engine, allow the engine to cool down, and check the coolant level. Add coolant as necessary.

⚠ WARNING

Never check the coolant level when the engine is hot or the cooling system is under pressure.

■ **NOTE:** High engine RPM, low vehicle speed, or heavy load can raise engine temperature. Decreasing engine RPM, reducing load, and selecting an appropriate transmission gear can lower the temperature.

To check/add coolant, use the following procedure.

1. Remove the two reinstallable rivets from the front of the radiator access panel.

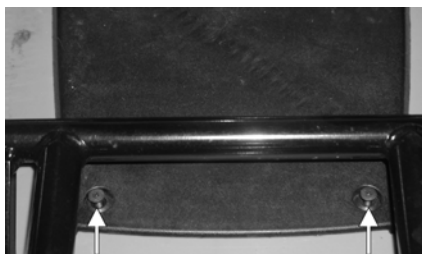

CF134A

2. Lift the front of the access panel; then slide the panel forward to disengage the two rear tabs.

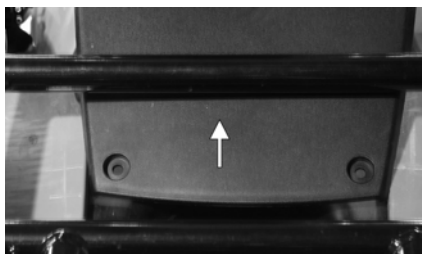

CF133A

3. Move the panel rearward until free of the rack.
4. Carefully rotate the radiator cap counterclockwise to release pressure; then remove the cap.



CF142A

5. Add coolant as necessary; then install the radiator cap and access panel.

Oil Cooler (1000)

■ **NOTE:** Dirt and debris must be cleaned from the cooling fins regularly to ensure proper engine oil cooling.

CAUTION

Continued operation of the ATV with high engine temperature may result in engine damage or premature wear.

■ **NOTE:** High engine RPM, low vehicle speed, or heavy load can raise engine temperature. Decreasing engine RPM, reducing load, and selecting an appropriate transmission gear can lower the temperature.

Shock Absorbers

Each shock absorber should be visibly checked weekly for excessive fluid leakage (some seal leakage may be observed but it does not indicate the shock is in need of replacement), cracks or breaks in the lower case, or a bent shock rod. If any one of these conditions is detected, replacement is necessary.

■ **NOTE:** When the ATV is operated in extremely cold weather ($-23^{\circ}\text{C}/-10^{\circ}\text{F}$ or colder), a small amount of leakage may be present. Unless the leakage is excessive, replacement is not necessary.

The shock absorber has a spring force adjustment sleeve with five adjustment positions to allow the spring to be adjusted for different riding and loading conditions. If the spring action is too soft or too stiff, adjust it according to the chart.



CD453

Position	Spring Force	Setting	Load
1	↓ Stronger	Soft	Light
2		↑	↑
3		↕	↕
4		↓	↓
5		Stiff	Heavy

■ **NOTE:** Before attempting to adjust suspension, clean dirt and debris from the sleeve and remove load from the suspension; then use the spanner wrench to adjust the sleeve to the desired position.

■ **NOTE:** It is recommended that all ATV weight be taken off the suspension prior to adjusting shock absorber sleeves.

General Lubrication

Cables

None of the cables require lubrication; however, it is advisable to lubricate the ends of the cables periodically with a good cable lubricant.

Engine/Transmission Oil and Filter

Change the engine oil and oil filter at the scheduled intervals. The engine should always be warm when the oil is changed so the oil will drain easily and completely.

1. Park the ATV on level ground.
2. Remove the oil level stick/filler plug. Be careful not to allow contaminants to enter the opening.

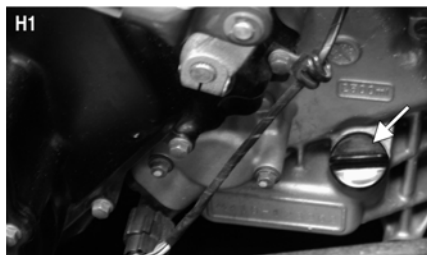

CF109P

Front Differential And Rear Drive Gear Lubricant (Inspecting/Changing)

Check and change the gear lubricant in each according to the Maintenance Schedule. When changing the lubricant, use approved SAE 80W-90 hypoid oil and use the following procedure.

■ **NOTE:** To check each, remove each filler plug. The oil level should be at the threads of each plug.

1. Place the ATV on level ground.
2. Remove each oil filler plug.
3. Drain the oil into a drain pan by removing in turn the drain plug from each.

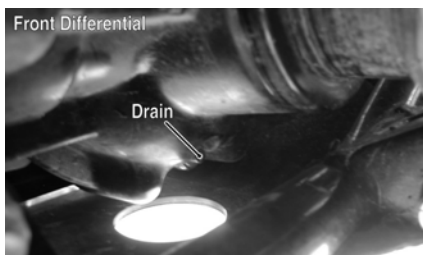

CF107B

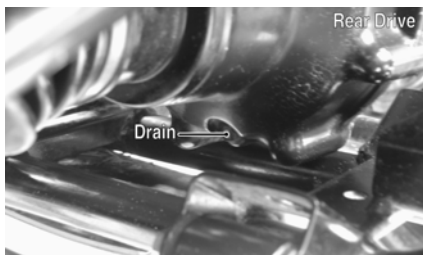

CF106C

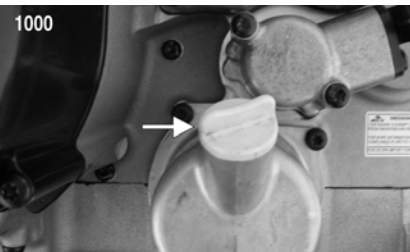

GZ007C

3. Remove the drain plug from the bottom of the engine and drain the oil into a drain pan.

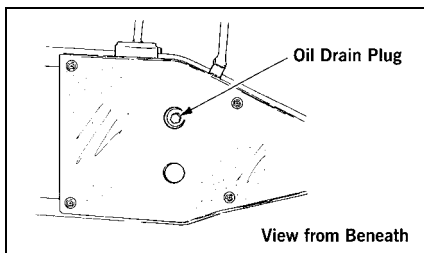

733-441A

4. Using the oil filter wrench and a ratchet handle (or a socket or box-end wrench), remove the old oil filter and dispose of properly. Do not re-use oil filter.

■ **NOTE:** Clean up any excess oil after removing the filter.

5. Apply oil to the new filter seal and check to make sure it is positioned correctly; then install the new oil filter. Tighten securely.
6. Install the engine drain plug and tighten it securely. Pour the recommended oil in the filler hole. Install the level stick/filler plug.
7. Start the engine (while the ATV is outside on level ground) and allow it to idle for a few minutes.
8. Turn the engine off and wait approximately three minutes. Recheck the oil level.
9. Inspect the area around the drain plug and oil filter for leaks.

4. After all the oil has been drained, install the drain plugs and tighten securely.

CAUTION

Inspect the oil for any signs of metal filings or water. If found, take the ATV to an authorized Arctic Cat ATV dealer for servicing.

5. Pour recommended oil into each filler hole.

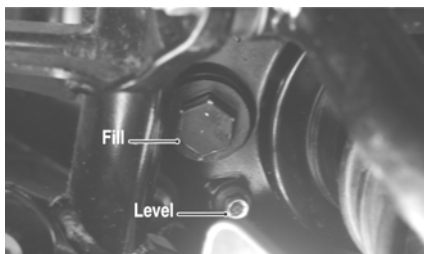

CF113A

6. Install the filler plugs.

Hydraulic Hand Brake

WARNING

Be sure to inspect the hydraulic brake system before each use. Always maintain brakes according to the Maintenance Schedule.

Brake Fluid

Check the brake fluid level in the brake fluid reservoir. If the level in the reservoir is not visible in the sight glass, add DOT 4 brake fluid.

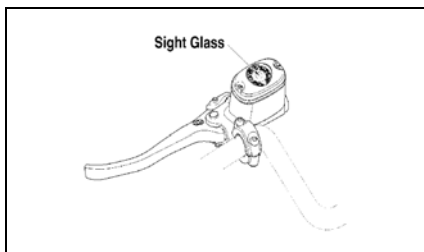

738-420A

■ **NOTE:** If the sight glass appears dark, there is a sufficient amount of fluid in the reservoir.

CAUTION

Be careful not to spill any fluid when filling the brake fluid reservoir. Wipe away spilled fluid immediately.

Brake Lever Lock

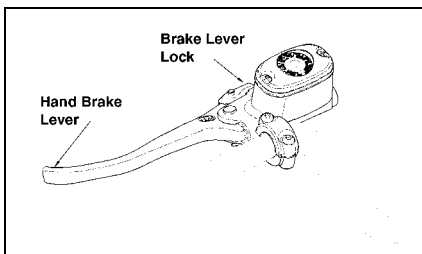

738-420B

Check to make sure the brake lever lock engages properly and that the brake (when engaged) locks the wheels.

1. Pump the brake lever 2 or 3 times.
2. Engage the brake lever lock.
3. Attempt to push the ATV.

■ **NOTE:** The brake lever lock must lock the wheels. If it doesn't, take the ATV to an authorized Arctic Cat ATV dealer for service.

Brake Hoses

Carefully inspect the hydraulic brake hoses for cracks or other damage. If found, take the ATV to an authorized Arctic Cat ATV dealer to have the brake hoses replaced.

Brake Pads

The clearance between the brake pads and brake discs is adjusted automatically as the brake pads wear. The only maintenance that is required is replacement of the brake pads when they show excessive wear. Check the thickness of each of the brake pads as follows:

1. Remove a front wheel.
2. Measure the thickness of each brake pad.
3. If thickness of either brake pad is less than 1.0 mm (0.039 in.), take the ATV to an authorized Arctic Cat ATV dealer to have brake pads replaced.

■ **NOTE:** Take the ATV to an authorized Arctic Cat ATV dealer for this service.

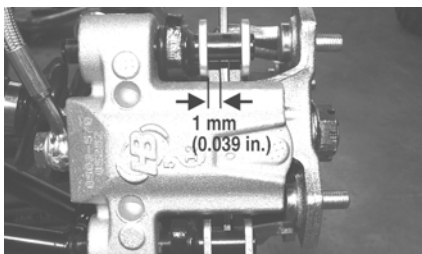

PR376B

4. Install the wheel and tighten using a crisscross pattern to 40 ft-lb (steel wheels) or 80 ft-lb (aluminum wheels).

Rear Foot Brake

The rear foot brake must be properly maintained to be fully functional.

WARNING

Be sure to inspect the rear foot brake system before each use. Always maintain brakes according to the Maintenance Schedule.

1. Check the brake fluid level in the reservoir. The fluid level must be maintained between the MAX and MIN level marks. If the level in the reservoir is low, add DOT 4 brake fluid.

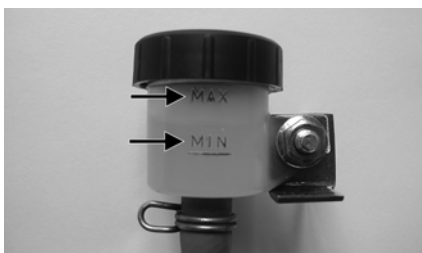

CD474A

■ **NOTE:** The brake fluid reservoir is located on the electrical panel beneath the operator's seat.

2. Press the rear foot brake several times to check for firmness.
3. If the brake is not firm, the system must be bled.

Protective Rubber Boots

The protective boots should be inspected periodically according to the Maintenance Schedule.

Ball Joint Boots (Upper and Lower/Right and Left)



CC791

1. Secure the ATV on a support stand to elevate the front wheels.
2. Remove both front wheels.
3. Inspect the four ball joint boots for cracks, tears, or perforations.
4. Check the ball joint for free-play by grasping the steering knuckle and turning it from side to side and up and down.
5. If boot damage is present or ball joint free-play seems excessive, contact an authorized Arctic Cat ATV dealer for service.

Tie Rod Boots (Inner and Outer/Right and Left)



CC792

1. Secure the ATV on a support stand to elevate the front wheels.
2. Remove both front wheels.
3. Inspect the four tie rod boots for cracks, tears, or perforations.
4. Check the tie rod end free-play by grasping the tie rod near the end and attempting to move it up and down.
5. If boot damage is present or tie rod end free-play seems excessive, contact an authorized Arctic Cat ATV dealer for service.

Drive Axle Boots

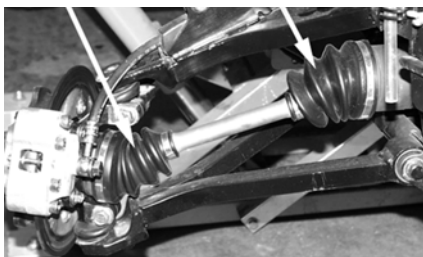

CC793

■ **NOTE:** This ATV has four drive axles and eight boots.

1. Inspect all drive axle boots for cracks, tears, or perforations.
2. If boot damage is present, contact an authorized Arctic Cat ATV dealer for service.

Battery

The battery is located under the seat.

After being in service, batteries require regular cleaning and recharging in order to deliver peak performance and maximum service life. The following procedures are recommended for cleaning and maintaining sealed batteries. Always read and follow instructions provided with battery chargers and battery products.

■ **NOTE:** Refer to all warnings and cautions provided with the battery or battery maintainer/charger.

Loss of battery charge may be caused by ambient temperature, ignition OFF current draw, corroded terminals, self discharge, frequent start/stops, and short engine run times. Frequent winch usage, snow plowing, extended low RPM operation, short trips, and high amperage accessory usage are also reasons for battery discharge.

Maintenance Charging

■ **NOTE:** Arctic Cat recommends the use of the CTEK Multi US 800 or the CTEK Multi US 3300 for battery maintenance charging. Maintenance charging is required on all batteries not used for more than two weeks or as required by battery drain.

1. When charging a battery in the vehicle, be sure the ignition switch is in the OFF position.
2. Clean the battery terminals with a solution of baking soda and water.

■ **NOTE:** The sealing strip should NOT be removed and NO fluid should be added.

3. Be sure the charger and battery are in a well-ventilated area. Be sure the charger is unplugged from the 110-volt electrical outlet.
4. Connect the red terminal lead from the charger to the positive terminal of the battery; then connect the black terminal lead of the charger to the negative terminal of the battery.

■ **NOTE:** Optional battery charging adapters are available from your authorized Arctic Cat dealer to connect directly to your vehicle from the recommended chargers to simplify the maintenance charging process. Check with your authorized Arctic Cat dealer for proper installation of these charging adapter connectors.

5. Plug the battery charger into a 110-volt electrical outlet.

- If using the CTEK Multi US 800, there are no further buttons to push. If using the CTEK Multi US 3300, press the Mode button (A) at the left of the charger until the Maintenance Charge Icon (B) at the bottom illuminates. The Normal Charge Indicator (C) should illuminate on the upper portion of the battery charger.



800E

■ **NOTE:** The maintainer/charger will charge the battery to 95% capacity at which time the Maintenance Charge Indicator (D) will illuminate and the maintainer/charger will change to pulse/float maintenance. If the battery falls below 12.9 DC volts, the charger will automatically start again at the first step of the charge sequence.



3300A

■ **NOTE:** Not using a battery charger with the proper float maintenance will damage the battery if connected over extended periods.

Charging

■ **NOTE:** Arctic Cat recommends the use of the CTEK Multi US 800 or the CTEK Multi US 3300 for battery maintenance charging.

- Be sure the battery and terminals have been cleaned with a baking soda and water solution.

■ **NOTE:** The sealing strip should **NOT** be removed and **NO** fluid should be added.

- Be sure the charger and battery are in a well-ventilated area. Be sure the charger is unplugged from the 110-volt electrical outlet.
- Connect the red terminal lead from the charger to the positive terminal of the battery; then connect the black terminal lead of the charger to the negative terminal of the battery.
- Plug the charger into a 110-volt electrical outlet.
- By pushing the Mode button (A) on the left side of the charger, select the Normal Charge Icon (E). The Normal Charge Indicator (C) should illuminate on the upper left portion of the charger.
- The battery will charge to 95% of its capacity at which time the Maintenance Charge Indicator (D) will illuminate.

■ **NOTE:** For optimal charge and performance, leave the charger connected to the battery for a minimum 1 hour after the Maintenance Charge Indicator (D) illuminates. If the battery becomes hot to the touch, stop charging. Resume after it has cooled.

- Once the battery has reached full charge, unplug the charger from the 110-volt electrical outlet.

■ **NOTE:** If, after charging, the battery does not perform to operator expectations, bring the battery to an authorized Arctic Cat dealer for further troubleshooting.

Jump-Starting

■ **NOTE:** Arctic Cat does not recommend jump-starting a vehicle with a dead battery but rather to remove the battery, service it, and correctly charge it; however, in an emergency, it may be necessary to jump-start a vehicle. If so, use the following procedure to carefully and safely complete this procedure.

⚠ WARNING

Improper handling or connecting of a battery may result in severe injury including acid burns, electrical burns, or blindness as a result of an explosion. Always remove rings and watches.

1. On the vehicle to be jump-started, remove the battery cover and any terminal boots.

⚠ WARNING

Any time service is performed on a battery, the following must be observed: keep sparks, open flame, cigarettes, or any other flame away. Always wear safety glasses. Protect skin and clothing when handling a battery. When servicing a battery in an enclosed space, keep the area well-ventilated. Make sure battery venting is not obstructed.

2. Inspect the battery for any signs of electrolyte leaks, loose terminals, or bulging sides. Leaking or bulging battery cases may indicate a frozen or shorted battery.

⚠ WARNING

If any of these conditions exist, **DO NOT** attempt a jump-start, boost, or charge the battery. An explosion could occur causing serious injury.

3. Inspect the vehicle to be used for jump-starting to determine if voltage and ground polarity are compatible. The vehicle must have a 12-volt DC, negative ground electrical system.

CAUTION

Always make sure the electrical systems are of the same voltage and ground polarity prior to connecting jumper cables. If not, severe electrical damage may occur.

4. Move the vehicle to be used for the jump-start close enough to ensure the jumper cables easily reach; then shift into neutral, set and lock the brakes, shut off all electrical accessories, and turn the ignition switch OFF.

■ **NOTE:** Make sure all switches on the vehicle to be jump-started are turned OFF.

5. Disconnect all external accessories such as cell phones, GPS units, and radios on both vehicles.

CAUTION

Failure to disconnect electronic accessories during jump-starting may cause system damage due to power spikes.

6. Attach one clamp of the positive (red) jumper cable to the positive (+) terminal (1) of the dead battery (C) being careful not to touch any metal with the other clamp; then attach the other clamp of the positive (red) jumper cable to the positive (+) terminal (2) of the good battery (B).

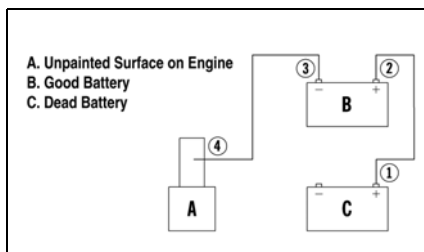

0744-527

■ **NOTE:** Some jumper cables may be the same color but the clamps or ends will be color-coded red and black.

- Attach one clamp of the negative (black) jumper cable to the negative (-) terminal (3) of the good battery (B); then attach the other clamp of the negative (black) jumper cable (4) to an unpainted metal surface (A) on the engine or frame well away from the dead battery and fuel system components.

WARNING

Never make the final connection to a battery as a spark could ignite hydrogen gases causing an explosion of the battery resulting in acid burns or blindness.

- Stand well away from the dead battery and start the vehicle with the good battery. Allow the vehicle to run for several minutes applying some charge to the dead battery.
- Start the vehicle with the dead battery and allow it to run for several minutes before disconnecting the jumper cables.
- Remove the jumper cables in opposite order of hook-up (4, 3, 2, 1). Be careful not to short cables against bare metal.

■ **NOTE:** Have the battery and electrical system checked prior to operating the vehicle again.

Spark Plug(s)

This ATV comes equipped with a specified spark plug. See the appropriate specifications chart for the correct spark plug. A light brown insulator indicates that the plug is correct. A white or dark insulator indicates that the engine may need to be serviced. Consult an authorized Arctic Cat ATV dealer if the plug insulator is not a light brown color. To help prevent cold weather fouling, make sure to thoroughly warm up the engine before operating.

To maintain a hot, strong spark, keep the plug free of carbon.

Before removing the spark plug, be sure to clean the area around the spark plug. If you do not, dirt could enter engine when removing or installing the spark plug.

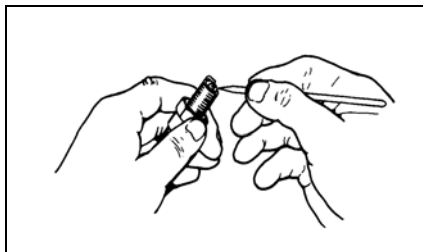

ATV-0051

Adjust the gap to specification for proper ignition (see appropriate specification chart). Use a feeler gauge to check the gap.

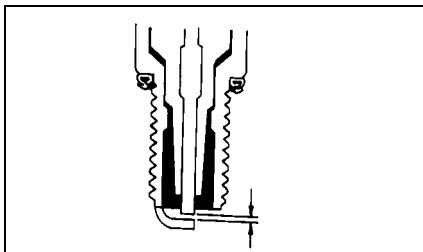

ATV-0052

When installing the spark plug, be sure to tighten it securely. A new spark plug should be tightened 1/2 turn once the washer contacts the cylinder head. A used spark plug should be tightened 1/8 - 1/4 turn once the washer contacts the cylinder head.

Throttle Cable Adjustment

To adjust the throttle cable free-play:

- Loosen the jam nut from the throttle cable adjuster.
- Slide the rubber boot away and turn the adjuster until the throttle lever has proper free-play of 3-6 mm (1/8-1/4 in.).

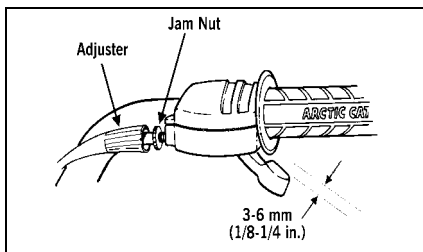

ATV-0047

3. Tighten the knurled nut against the throttle cable adjuster securely; then slide the rubber boot over the adjuster.

3. Lift out the storage box; then unsnap the four spring-clips and remove the air filter cover.

Air Filter

The air filter inside the air filter housing must be kept clean to provide good engine power and gas mileage. If the ATV is used under normal conditions, service the filter at the intervals specified. If operated in dusty, wet, or muddy conditions, inspect and service the filter more frequently. Use the following procedure to remove the filter and inspect and/or clean it.



FI468

CAUTION

Failure to inspect the air filter frequently if the ATV is used in dusty, wet, or muddy conditions can damage the engine.

1. Remove the reinstallable rivets at the rear of the steering post cover; then unlatch the storage compartment lid.



CF260A

2. Lift up on the rear of the steering post cover and slide the storage compartment cover assembly forward to disengage the mounting lugs; then lift and remove the cover assembly from the storage compartment.



FI467

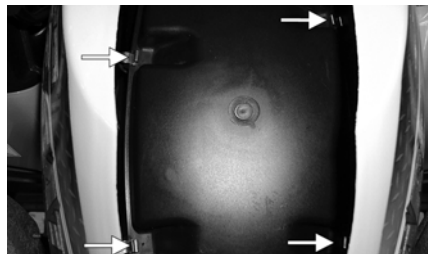

CD675A

4. Remove the air filter assembly and separate the foam filter from the frame.

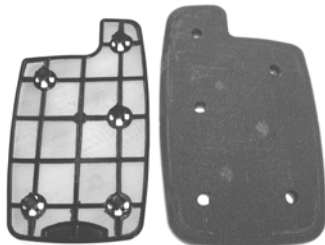

CD747

5. Fill a wash pan larger than the element with a non-flammable cleaning solvent; then dip the element in the solvent and wash it.

■ **NOTE:** Foam Air Filter Cleaner and Foam Air Filter Oil are available from Arctic Cat.

6. Squeeze the element by pressing it between the palms of both hands to remove excess solvent. Do not twist or wring the element or it will develop cracks.

7. Dry the element.
8. Put the element in a plastic bag; then pour in air filter oil and work the oil into the element.
9. Squeeze the element to remove excess oil; then install in the frame.

CAUTION

A torn air filter can cause damage to the engine. Dirt and dust may get inside the engine if the element is torn. Carefully examine the element for tears before and after cleaning it. Replace the element with a new one if it is torn.

10. Clean any dirt or debris from inside the air filter housing.
11. Place the filter in the air filter housing making sure it is properly in position and seated; then install the cover and secure with the fasteners.

Air Filter Housing Drains

Inspect the “duck bill” drain beneath the main housing for debris and for proper sealing.

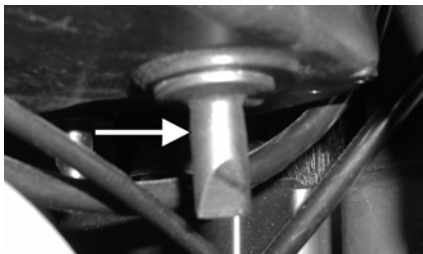

PR141A

Draining V-Belt Cover

■ **NOTE:** If the ATV has been driven through water, the V-belt cover must be drained of any water.

1. Place the ATV on a level surface.
2. Remove the drain bolt from the cover and allow the water to drain out.

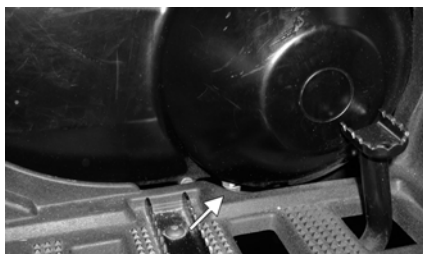

CF110A

3. Shift the range lever to the neutral position; then start the engine.
4. Increase and decrease engine RPM several times to “blow out” any water; then stop the engine.
5. Install the drain bolt and tighten securely.

■ **NOTE:** The V-belt and clutches should be inspected every 500 miles and the belt replaced (if necessary).

Tires

⚠ WARNING

Always use the size and type of tires as specified. Refer to the specifications chart for proper tire inflation pressure, and always maintain proper tire inflation pressure.

Tire Tread Condition

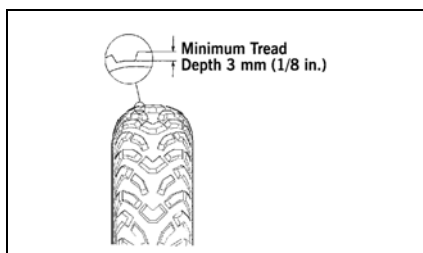

0732-649

The use of worn-out tires on a ATV is very dangerous. A tire is considered to be worn out when the depth of the tread is less than 3 mm (1/8 in.). Be sure to replace the tires before reaching this minimum specification.

⚠ WARNING

The use of worn-out tires can be dangerous and can increase the risk of an accident.

Tire Replacement

This ATV has low-pressure tubeless tires. Air is sealed by the contact surfaces of the inner wheel rim and the tire bead. If either the inner wheel rim or tire bead is damaged, air may leak. Be extremely careful not to damage these areas when replacing tires.

It is very important to use the proper tools when repairing or replacing tires to prevent damage to the tire bead or wheel rims. If proper tools and related items are not available, have this maintenance performed by an authorized Arctic Cat ATV dealer or a qualified tire repair station.

CAUTION

When breaking the tire bead loose from the wheel, be extremely careful not to damage the inner wheel surface or the tire bead.

⚠ WARNING

Use only Arctic Cat approved tires when replacing tires. Failure to do so could result in unstable operation.

Tire Repair (Tubeless)

Should a leak or flat tire occur due to a puncture, the tire may be repaired using a plug-type repair. If the damage is from a cut or if the puncture cannot be repaired using a plug, the tire must be replaced. When operating the ATV in areas where transportation or service facilities are not readily available, it is strongly recommended to carry a plug-type repair kit and a tire pump along.

Wheels

1. Park the ATV on level ground and engage the brake lever lock.
2. Loosen the lug nuts on the wheel to be removed.
3. Elevate the ATV.

4. Remove the lug nuts.
5. Remove the wheel.
6. Install the wheel and install the lug nuts.
7. Tighten the nuts in a crisscross pattern to 40 ft-lb (steel wheels) or 80 ft-lb (aluminum wheels).
8. Remove the jack.

Muffler/Spark Arrestor

The muffler has a spark arrester which must be periodically cleaned. At the intervals shown in the Maintenance Schedule, clean the spark arrester using the following procedure.

⚠ WARNING

Wait until the muffler cools to avoid burns.

1. Remove the three cap screws securing the spark arrester assembly to the muffler.

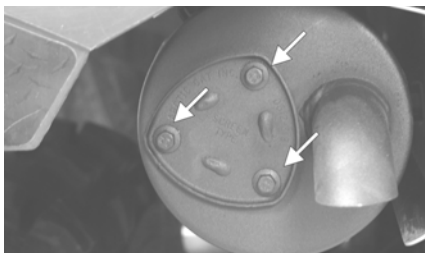

CF105A

2. Using a suitable brush, clean the carbon deposits from the screen taking care not to damage the screen.

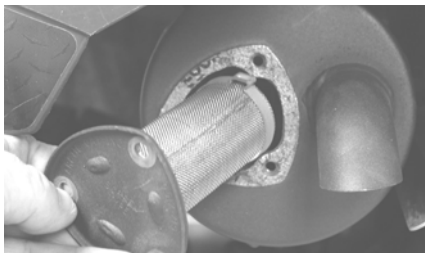

CF104

■ **NOTE:** If the screen or gasket is damaged in any way, it must be replaced.

3. Install the spark arrester assembly and secure with the three cap screws. Tighten cap screws to 48 in.-lb.

Light Bulb Replacement

The wattage rating of each bulb is shown in the chart. When replacing a burned bulb, always use the same wattage rating.

Headlight	12V/27W (4)
Taillight/Brakelight	12V/8W/27W

CAUTION

Use only specified bulbs indicated in the chart as replacement bulbs.

■ **NOTE:** The bulb portion of the headlight is fragile. **HANDLE WITH CARE.** When replacing the headlight bulb, do not touch the glass portion of the bulb. If the glass is touched, it must be cleaned with a dry cloth before installing. Skin oil residue on the bulb will shorten the life of the bulb.

WARNING

Do not attempt to remove the bulb when it is hot. Severe burns may result.

To replace the headlight bulb, use the following procedure.

1. Rotate the bulb assembly counter-clockwise and remove from the headlight housing; then disconnect from the wiring harness.
2. Connect the new bulb assembly to the wiring harness connector; then insert into the headlight housing and rotate fully clockwise.

CAUTION

When replacing the headlight bulb, be careful not to touch the glass portion of the bulb. Grasp the new bulb with a clean cloth.

To replace the taillight/brakelight bulb, use the following procedure.

1. Remove the two screws and remove the lens cover.
2. Push the bulb in and turn it counter-clockwise.
3. Install the new bulb by turning it clockwise while pushing in.
4. Install the lens cover.

CAUTION

Tighten the lens cover screws only until they are snug.

Checking/Adjusting Headlight Aim

The headlights can be adjusted vertically and horizontally. The geometric center of the HIGH beam light zone is to be used for vertical and horizontal aiming.

1. Position the ATV on a level floor so the headlights are approximately 6.1 m (20 ft) from an aiming surface (wall or similar aiming surface).

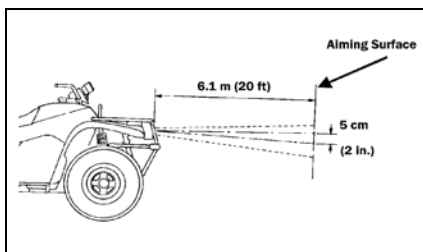

ATV-0070C

■ **NOTE:** There should be an average operating load on the ATV when adjusting the headlight aim.

2. Measure the distance from the floor to the mid-point of each headlight.
3. Using the measurements obtained in step 2, make horizontal marks on the aiming surface.
4. Make vertical marks which intersect the horizontal marks on the aiming surface directly in front of the headlights.

- Switch on the lights. Make sure the HIGH beam is on. DO NOT USE LOW BEAM.
- Observe each headlight beam aim. Proper aim is when the most intense beam is centered on the vertical mark 5 cm (2 in.) below the horizontal mark on the aiming surface.
- Adjust each headlight by turning the adjustment knob clockwise to raise the beam or counterclockwise to lower the beam until correct aim is obtained.

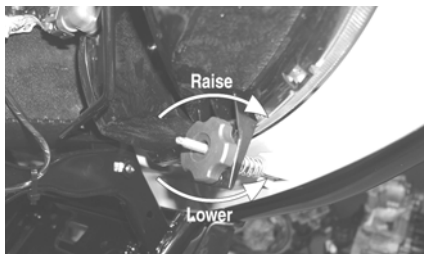

CD714A

Fuses

The fuses are located in a fuse block under the seat. If there is any type of electrical system failure, always check the fuses first.

■ **NOTE:** To remove the fuse, compress the locking tabs on either side of the fuse case and lift out.

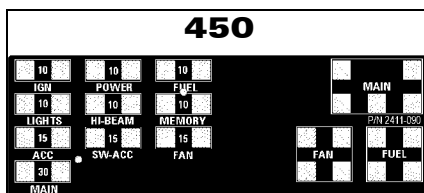

2411-090

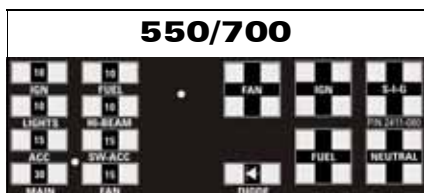

2411-080

700 Cruiser



2411-081

700s

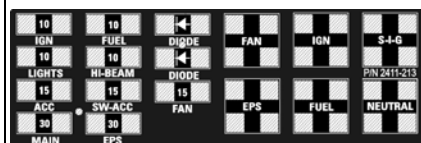

2411-213

1000s Cruiser



2411-214

CAUTION

Always replace a blown fuse with a fuse of the same type and rating. If the new fuse blows after a short period of use, consult an authorized Arctic Cat ATV dealer immediately.

Electrical Output Terminals

Two output terminals for electrical accessories are located on the front wiring harness and one output terminal for electrical accessories is located on the rear wiring harness. The accessory plug is located on the right side of the instrument pod.

CAUTION

Always use electrical accessories less than 180W.

Tool Storage Tray/ Battery Hold-Down

A basic tool kit is provided with the ATV.

The tool storage tray is located beneath the seat. It also serves as the battery hold-down.



CF157

Maintain the tool kit with the ATV at all times.

Preparation For Storage

CAUTION

Prior to storing the ATV, it must be properly serviced to prevent rusting and component deterioration.

Arctic Cat recommends the following procedure to prepare this ATV for storage. An authorized Arctic Cat ATV dealer should perform this service; however, the owner/operator may perform this service if desired.

1. Clean the seat cushion (cover and base) with a damp cloth and allow to dry.
2. Clean the ATV thoroughly by washing dirt, oil, grass, and other foreign matter from the entire ATV. Allow the ATV to dry thoroughly. **DO NOT** get water into any part of the engine or air intake.
3. Either drain the gas tank or add a fuel stabilizer to the gas in the gas tank. Remove the air filter housing cover and air filter. Start the engine and allow it to idle; then using Arctic Cat Engine Preserver, rapidly inject the preserver into the air filter opening for a period of 10 to 20 seconds. Install the air filter and housing cover.

CAUTION

If the interior of the air filter housing is dirty, clean the area before starting the engine.

4. Plug the hole in the exhaust system with a clean cloth.
5. Apply light oil to the upper steering post bushing and plungers of the shock absorbers.
6. Tighten all nuts, bolts, cap screws, and screws. Make sure rivets holding components together are tight. Replace all loose rivets. Care must be taken that all calibrated nuts, cap screws, and bolts are tightened to specifications.
7. Fill the cooling system to the bottom of the stand pipe in the radiator neck with properly mixed coolant.
8. Disconnect the battery cables (negative cable first); then remove the battery, clean the battery posts and cables, and store in a clean, dry area.

■ NOTE: For storage, use a battery maintainer or make sure the battery is fully charged (see Battery section in this manual).

9. Store the ATV indoors in a level position.

CAUTION

Avoid storing outside in direct sunlight and avoid using a plastic cover as moisture will collect on the ATV causing rusting.

Preparation After Storage

Taking the ATV out of storage and correctly preparing it will assure many miles and hours of trouble-free riding. Arctic Cat recommends the following procedure to prepare the ATV.

1. Clean the ATV thoroughly.
2. Clean the engine. Remove the cloth from the exhaust system.
3. Check all control wires and cables for signs of wear or fraying. Replace if necessary.
4. Change the engine/transmission oil and filter.
5. Check the coolant level and add properly mixed coolant as necessary.
6. Charge the battery; then install. Connect the battery cables making sure to connect the positive cable first.
7. Check the entire brake systems (fluid level, pads, etc.), all controls, headlights, taillight, brakelight, and headlight aim; adjust or replace if necessary.
8. Check the tire pressure. Inflate to recommended pressure as necessary.
9. Tighten all nuts, bolts, cap screws, and screws making sure all calibrated nuts, cap screws, and bolts are tightened to specifications.
10. Make sure the steering moves freely and does not bind.
11. Check the spark plug. Clean or replace as necessary.
12. Follow the recommendations found in the pre-start inspection.

NOTES

Change Of Address, Ownership, Or Warranty Transfer

Arctic Cat Inc. keeps on file the current name and address of the owner of this TRV. This will allow Arctic Cat to reach the current owner with any important safety information which may be necessary to protect customers from personal injury or property damage. Please make sure a copy of this form is completed and returned to Arctic Cat Inc. if you move or if the TRV is sold to another party.

This form may also be used to transfer the unused portion of the original warranty to a second party. In order to transfer warranty, fill out this form completely; then return a copy of this form to Arctic Cat Inc. Arctic Cat will then process the application and issue warranty for the balance of the time remaining of the original warranty.

Address Change

Ownership Change

Warranty Transfer

CHANGE OF ADDRESS/OWNERSHIP/ WARRANTY TRANSFER TO:

Name _____

Address _____

City/State (Province)/Zip Code (Postal Code) _____

Phone # () _____

Year and Model _____

Vehicle Identification Number (VIN) _____

Before operating, you should take an ATV Rider Course to learn ATV riding skills or reinforce your current good riding skills. In U.S.A., call 1-800-887-2887 to enroll in the half-day ATV Rider Course nearest you or ask your dealer for assistance. The course instructor will charge a small fee for each person taking the course. In Canada, call (613) 739-1535.

Fold Back

Place
Stamp
Here

CHANGE OF ADDRESS/OWNERSHIP

ARCTIC CAT INC.
PRODUCT SERVICE AND
WARRANTY DEPT.
P.O. BOX 810
THIEF RIVER FALLS, MN 56701

Identification Numbers Record

WARNING

Indicates a potential hazard that could result in serious injury or death.



1. KEY IDENTIFICATION NUMBER:

The key identification number is stamped on the key as shown in the illustration. Record this number in the space provided for reference if you ever need a new key.

2. VEHICLE IDENTIFICATION NUMBER:

3. ENGINE SERIAL NUMBER:

Record the Vehicle Identification Number and Engine Serial Number in the spaces provided to assist you in ordering parts from your authorized Arctic Cat ATV dealer or for reference in case the ATV is stolen.

WARNING

Improper use can result in SEVERE INJURY or DEATH



**ALWAYS USE
AN APPROVED
HELMET AND
PROTECTIVE
GEAR FOR
DRIVER AND
PASSENGER**



**NEVER USE
ON PUBLIC
ROADS**



**NEVER CARRY
MORE THAN
1 PASSENGER**



**NEVER USE
WITH DRUGS
OR ALCOHOL**

NEVER operate:

- without proper ATV training or instruction
- at speeds too fast for your skills or the conditions
- on public roads - a collision can occur with another vehicle
- with a passenger unless passenger seat is securely in place

THE OPERATOR MUST ALWAYS:

- use proper riding techniques to avoid overturns on hills and rough terrain and in turns
- avoid paved surfaces - pavement may seriously affect handling and control
- reduce speed and use extra caution at all times when carrying a passenger - dismount passenger when conditions require
- make sure passenger reads and understands this label and passenger safety label

**LOCATE AND READ OPERATOR'S MANUAL.
FOLLOW ALL INSTRUCTIONS AND WARNINGS.**