

Operation & Maintenance Manual

FORKLIFTS

D20S-5, D25S-5, D30S-5, D33S-5, D35C-5

G20E-5, G25E-5, G30E-5

GC20E-5, GC25E-5, GC30E-5, GC33E-5

G20P-5, G25P-5, G30P-5, G33P-5, G35C-5

G20P-5 Plus, G25P-5 Plus,

G30P-5 Plus, G33P-5 Plus, G35C-5 Plus

GC20P-5, GC25P-5, GC30P-5, GC33P-5

Original Instruction

 **WARNING**

Do not start, operate or service this machine unless you have read and understood these instructions and received proper training.

Unsafe or improper use of the machine may cause serious injury or death.

Operators and maintenance personnel must read this manual and receive training before operating or maintaining the machine.

This manual should be kept with the machine for reference and periodically reviewed by the machine operator and by all personnel who will come into contact with it.

The following warning is provided pursuant to California Health & Safety Code Sections 25247.5 et, seq,

 **WARNING**

California Proposition 65

Engine Exhaust, some of its constituents, and certain vehicle components contain or emit chemicals known to the State of California to cause cancer and birth defects or other reproductive harm.

Battery posts, terminals and related accessories contain lead and lead compounds, chemicals known to the State of California to cause cancer and birth defects or other reproductive harm.

WASH HANDS AFTER HANDLING.

Table of Contents

Information Section

Foreword	2
----------------	---

Safety Section

Important Safety Information	4
Safety	5
Warning Signs and Labels	5
Parking brake	9
General Hazard Information	10
Operation Information	11
Maintenance Information	14
Operator Restraint System (If Equipped)	17
Avoiding Lift Truck Tipover	21
Safety Rules	23
How to Survive in a Tipover	29

General Section

Declaration of Conformity	30
Specifications	31
Noise and Vibration	47
Capacity Chart (Without Sideshifter Pneumatic) ..	48
Capacity Chart (With Sideshifter Pneumatic)	52
Capacity Chart (Without Sideshifter cushion)	56
Capacity Chart (With Sideshifter cushion)	60
Serial Number	64
Operator's Warning and Identification Plate	67

Operation Section

Operator's Station and Monitoring Systems	68
Seat Switch System (If Equipped)	72
Lift Truck Controls	74
Refueling	76
Before Starting the Engine	79
Starting the Engine	81
Dual Fuel System	84
Lift Truck Operation	87
Mono-Ped Control System (Option)	150
Auto Shift Controller ASC-100 (If Equipped)	151
Finger Tip (Option)	154
Operating Techniques	158
Parking the Lift Truck	162
Lift Fork Adjustment	163
Storage Information	164
Transportation Hints	165
Towing Information	166

Maintenance Section

Inspection, Maintenance and Repair of Lift Truck	
Forks	167
Tire Inflation Information	171
Torque Specifications	172
Cooling System Specifications	174
Fuel Specifications	176
Lubricant Information	178
Lubricant Viscosities and Refill Capacities	180
Maintenance Intervals	181
When Required	185
Every 10 Service Hours or Daily	192
First 50 - 100 Service Hours or a Week	198
First 250 Service Hours or a Month	203
Every 250 Service Hours or Monthly	204
Every 500 Service Hours or 3 Months	214
Every 1000 Service Hours or 6 Months	224
Every 1500 Service Hours or 9 Months	230
Every 2000 Service Hours or Yearly	234
Every 2500 Service Hours or 15 Months	241
Every 3000 Service Hours or 18 Months	246

Index Section

Index	247
-------------	-----

Foreword

Literature Information

This manual should be stored in the operator's compartment in the literature holder or seat back literature storage area.

This manual contains safety, operation, transportation, lubrication and maintenance information.

Some photographs or illustrations in this publication show details or attachments that can be different from your lift truck. Guards and covers might have been removed for illustrative purposes.

Continuing improvement and advancement of product design might have caused changes to your lift truck which are not included in this publication. Read, study and keep this manual with the lift truck.

Whenever a question arises regarding your lift truck, or this publication, please consult your DOOSAN dealer for the latest available information.

Safety

The Safety Section lists basic safety precautions. In addition, this section identifies the text and locations of warning signs and labels used on the lift truck.

Read and understand the basic precautions listed in the Safety Section before operating or performing lubrication, maintenance and repair on this lift truck.

Operator Restraint System (If Equipped)

This manual contains safety, operation and maintenance information for the DOOSAN operator restraint system. Read, study and keep it handy.

WARNING

Your DOOSAN truck comes equipped with an operator restraint system. Should it become necessary to replace the seat for any reason, it should only be replaced with another DOOSAN operator restraint system.

Photographs or illustrations guide the operator through correct procedures of checking, operation and maintenance of the DOOSAN operator restraint system.

SAFE and EFFICIENT OPERATION of a lift truck depends to a great extent on the skill and alertness on the part of the operator. To develop this skill the operator should read and understand the Safe Driving Practices contained in this manual.

Forklift trucks seldom tipover, but in the rare event they do, the operator may be pinned to the ground by the lift truck or the overhead guard. This could result in serious injury or death.

Operator training and safety awareness is an effective way to prevent accidents, but accidents can still happen. The DOOSAN operator restraint system can minimize injuries. The DOOSAN operator restraint system keeps the operator substantially within the confines of the operator's compartment and the overhead guard.

This manual contains information necessary for Safe Operation. Before operating a lift truck, make sure that the necessary instructions are available and understood.

Operation

The Operation Section is a reference for the new operator and a refresher for the experienced one. This section includes a discussion of gauges, switches, lift truck controls, attachment controls, transportation and towing information. Photographs and illustrations guide the operator through correct procedures of checking, starting, operating and stopping the lift truck. Operating techniques outlined in this publication are basic. Skill and techniques develop as the operator gains knowledge of the lift truck and its capabilities.

Maintenance

The Maintenance Section is a guide to equipment care. The illustrated, step-by-step instructions are grouped by servicing intervals. Items without specific intervals are listed under “When Required” topics. Items in the “Maintenance Intervals” chart are referenced to detailed instructions that follow.

Maintenance Intervals

Use the service hour meter to determine servicing intervals. Calendar intervals shown (daily, weekly, monthly, etc.) can be used instead of service hour meter intervals if they provide more convenient servicing schedules and approximate the indicated service hour meter reading. Recommended service should always be performed at the interval that occurs first.

Under extremely severe, dusty or wet operating conditions, more frequent lubrication than is specified in the “Maintenance Intervals” chart might be necessary.

Perform service on items at multiples of the original requirement. For example, at “Every 500 Service Hours or 3 Months”, also service those items listed under “Every 250 Service Hours or Monthly” and “Every 10 Service Hours or Daily”.

Environment Management

Note that DOOSAN INFRACORE is ISO 14001 certified which is harmonized with ISO 9001. Periodic ENVIRONMENTAL AUDITS & ENVIRONMENTAL PERFORMANCE EVALUATIONS have been made by internal and external inspection entities. LIFE-CYCLE ANALYSIS has also been made through out the total product life. ENVIRONMENT MANAGEMENT SYSTEM includes DESIGN FOR ENVIRONMENT from the initial stage of the design. ENVIRONMENT MANAGEMENT SYSTEM considers environmental laws & regulations, reduction or elimination of resource consumption as well as environmental emission or pollution from industrial activities, energy saving, environment-friendly product design(lower noise, vibration, emission, smoke, heavy metal free, ozone depleting substance free, etc.), recycling, material cost reduction, and even environmentally oriented education for the employee.

Important Safety Information

Most accidents involving product operation, maintenance and repair are caused by failure to observe basic safety rules or precautions. An accident can often be avoided by recognizing potentially hazardous situations before an accident occurs. A person must be alert to potential hazards, and use common sense. Persons must also have the necessary training, skills and tools before attempting to perform these functions.

Improper operation, lubrication, maintenance or repair of this product can be dangerous and could result in injury or death.

Do not operate or perform any lubrication, maintenance or repair on this product, until you have read and understood the operation, lubrication, maintenance and repair information.

Safety precautions and warnings are provided in this manual and on the product. If these hazard warnings are not heeded, bodily injury or death could occur to you or other persons.

The hazards are identified by the "Safety Alert Symbol" and followed by a "Signal Word" such as "WARNING" as shown below.



The meaning of this safety alert symbol is as follows:

Attention! Become Alert! Your Safety is involved.

The message that appears under the warning, explaining the hazard, can be either written or pictorially presented.

Operations that may cause product damage are identified by NOTICE labels on the product and in this publication.

DOOSAN cannot anticipate every possible circumstance that might involve a potential hazard, and common sense is always required. The warnings in this publication and on the product are therefore not all inclusive. Before any tool, procedure, work method or operating technique not specifically recommended by DOOSAN is used, you must be sure that it is safe for you and others. You should also ensure that the product will not be damaged or made unsafe by the operation, lubrication, maintenance or repair procedures you choose.

The information, specifications, and illustration in this publication are on the basis of information available at the time it was written. The specifications, torques, pressures, measurements, adjustments, illustrations, and other items can change at any time. These changes can affect the service given to the product. Obtain the complete and most current information before starting any job. DOOSAN dealers have the most current information available.

Safety

The safety rules and regulations in this section are representative of some, but not all rules and regulations noted under the Occupational Safety and Health Act (OSHA) and are paraphrased without representation that the OSHA rules and regulations have been reproduced verbatim.

Please refer to 1910. 178 in Federal Register Vol. 37, No. 202, the National Fire Protection Association No. 505 (NFPA), American National Standard, ANSI B56. 1 Safety Standard for Low lift and High Lift Trucks and subsequent revisions for a complete list of OSHA rules and regulations as to the safe operation of powered industrial lift trucks. Since regulations vary from country to country outside in U.S.A., operate this lift truck in accordance with local regulations.

DOOSAN lift trucks are manufactured according to the regulations and standards laid down in EU Machinery Directive 98/37/EC and EMC directive 2004/108/EC. Please refer to the Directives 89/655/EC and 89/391/EC and its amendments for the safe use of DOOSAN lift trucks.

The most effective method of preventing serious injury or death to the lift truck operator or others is for the lift truck operator to be familiar with the proper operation of the lift truck, to be alert and to avoid actions or conditions which can result in an accident.

Do not operate a lift truck if in need of repair, defective or in any way unsafe. Report all defects and unsafe conditions immediately. Do not attempt any adjustments or repairs unless trained and authorized to do so.

Warning Signs and Labels

There are several specific safety signs on your lift truck. Their exact location and description of the hazard are reviewed in this section. Please take the time to familiarize yourself with these safety signs. Make sure that you can read all warning and instruction labels. Clean or replace these labels if you cannot read the words or see the pictures. When cleaning the labels use a cloth, water and soap. Do not use solvent, gasoline, etc. You must replace a label if it is damaged, missing or cannot be read. If a label is on a part that is replaced, make sure a new label is installed on the replaced part. See your dealer for new labels.

Training Required To Operate or Service Warning

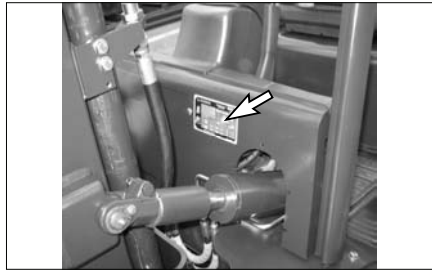

Located on the right side of the steering wheel.

WARNING

Improper operation or maintenance could result in injury or death. Do not operate or work on the lift truck unless you are properly trained. Read and understand the Operation and Maintenance Manual. Additional manuals are available from DOOSAN Lift Truck dealers.

This label also provides allowable lift truck capacity information

General Warning to Operator



Located on the right side of the operator's seat (STD).

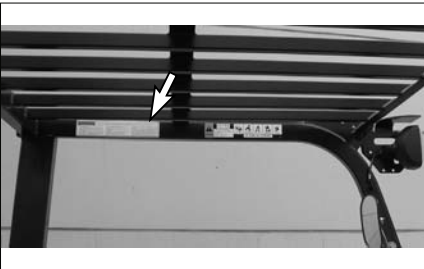

Located on the overhead guard (If Convenience Package Equipped).

⚠ WARNING

Only trained and authorized personnel may operate this machine. For safe operation, read and follow the operation and maintenance Manual furnished with this lift truck and observe the following warnings:

1. Before starting machine. Check all controls and warning devices for proper operation.
2. Refer to machine identification plate for allowable machine capacity. Do not overload. Operate machines equipped with attachments as partially loaded machines when not handling a load.
3. Put directional control or shift lever in neutral before "ON - OFF" switch is turned on.
4. Start, turn and brake smoothly. Slow down for turns, slippery or uneven surfaces. Extremely poor surfaces should be repaired. Avoid running over loose objects or holes in the roadway surfaces. Use extreme caution when turning on inclines.
5. Travel with load as low as possible and tilted back. If load interferes with visibility, travel with load trailing.
6. On grade operations travel with load up grade.
7. Watch out for pedestrians and obstructions. Check overhead clearances.
8. Do not permit riders on forks or machine at any time.
9. Do not allow anyone to stand or pass under the elevated portion of any machine.
10. Be sure operating surface can safely support machine.
11. Operate machine and attachments only from operator's position.
12. Do not handle unstable or loosely stacked loads.
13. Use minimum tilt when picking up or depositing a load.
14. Use extreme care when handling long, high, or wide loads.
15. Forks should be completely under load and spread apart as far as load permits.
16. Machine should be equipped with overhead guard or equivalent protection. Where load requires it, use a load backrest extension. Use extreme caution if operating without these devices.
17. Parking - Lower lifting mechanism to floor. Put directional control or shift lever in neutral. Set parking/secondary brake. Turn "ON - OFF" switch off. Chock wheels if machine is on incline. Disconnect battery when storing electric machines.
18. Observe safety rules when handling fuel for engine powered machine and when changing batteries for electric machines.
19. Avoid overuse of the inching pedal as this may cause the automatic transmission oil to overheat or the clutch to slip. Do not use as a footrest or for long periods of time.
20. If user operates continuously pushing work or both brake pedal and accelerator pedal were depressed at the same time, it may cause the automatic transmission oil to overheat or the clutch to slip.

Pressure Warning

⚠ WARNING

Contents under pressure may be hot. Allow to cool before opening.



Located on the radiator top tank by the radiator cap.

Hand Placement Warning

⚠ WARNING



No hands. Do not place hands in this area. Do not touch, lean on, or reach through the mast or permit others to do so.



Located on the mast.

No Standing On Fork Warning

No Standing Under Fork Warning

⚠ WARNING

Do not stand or ride on the forks. Do not stand or ride on a load or pallet on the forks. Do not stand or walk under the forks.

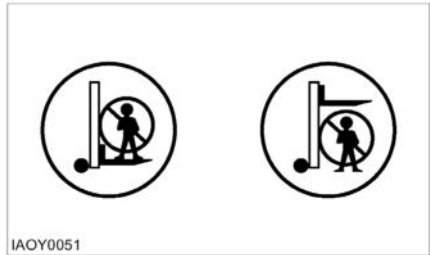

Located on the lift cylinder.

Load Backrest Must Be In Place Warning

⚠ WARNING

Operation without this device in place may be hazardous.



Located on the load backrest.

Overhead Guard Must Be In Place Warning

⚠ WARNING

Operation without this device in place may be hazardous. This guard conforms to A.N.S.I.B56.1 and F.E.M.Section IV. This design has been tested with an impact of appropriate valve.

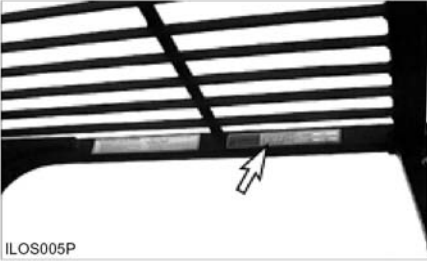

Located on the Overhead Guard.

No Riders Warning

⚠ WARNING

To avoid personal injury, allow no riders. A lift truck is designed for only one operator and no riders.



Located beside the operator's station (STD) or on front of the hood (Convenience Package).

Moving Fan Warning

⚠ WARNING

To avoid personal injury, stay clear of moving fan.



Located inside the engine compartment cover.

Parking brake

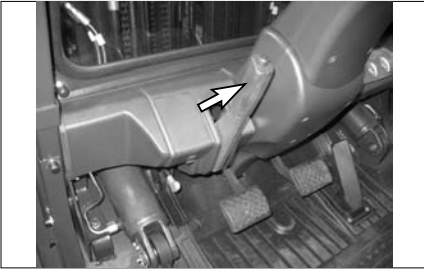

Pull the lever **BACK** to engage the parking brake.



Push the lever **FORWARD** to release the parking brake.

Applying the parking brake puts the transmission in **NEUTRAL**. The parking brake must be applied when leaving the lift truck and when starting the lift engine. If the operator leaves the seat without applying the parking brake, an audible alarm will sound.

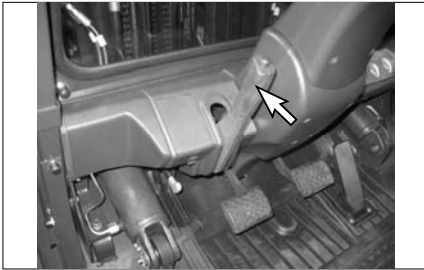

WARNING

When leaving machine apply parking brake!
Parking brake is not automatically applied.
Alarm will sound if parking brake is not applied.

WARNING

Correct adjustment is necessary to provide adequate braking. See the MAINTENANCE section for adjustment procedures. The lift truck may creep at engine idle and can cause damage, injury or death. Always apply the parking brake when leaving the lift truck. The parking brake is NOT automatically applied.

General Hazard Information



Attach a “Do Not Operate” or similar warning tag to start switch or controls before servicing or repairing the lift truck.

Do not start or service the lift truck when a “DO NOT OPERATE” or similar warning tag is attached to the start switch or controls.

Wear a hard hat, protective glasses and other protective equipment as required by job conditions.

Know the width of your attachments so proper clearance can be maintained when operating near fences, boundary obstacles, etc.

Do not wear loose clothing or jewelry that can catch on controls or other parts of the lift truck.

Keep the lift truck, especially the deck and steps, free of foreign material such as debris, oil tools and other items which are not part of the lift truck.

Secure all loose items such as lunch boxes, tools and other items which are not part of the lift truck.

Know the appropriate work-site hand signals and who gives them. Accept signals from one person only.

Always use the overhead guard. The overhead guard is intended to protect the lift truck operator from overhead obstructions and from falling objects.

A truck that is used for handing small objects or uneven loads must be fitted with a load backrest.

If the lift truck must be operated without the overhead guard in place due to low overhead clearance, use extreme care. Make sure there is no possibility of falling objects from any adjacent storage or work area. Make sure the load is stable and fully supported by the carriage and the load backrest extension (if equipped).

Do not raise loads any higher than necessary and never raise a load higher than 1830 mm (72 in) with the overhead guard removed.

Always use load backrest extension when the carriage or attachment does not fully support the load. The load backrest extension is intended to prevent the load or any part of the load from falling backwards into the operator’s station.

When operating the lift truck, do not depend only on flashing lights or back-up alarm (if equipped) to warn pedestrians.

Always be aware of pedestrians and do not proceed until the pedestrians are aware of your presence and intended actions and have moved clear of the lift truck and/or load.

Do not drive lift truck up to anyone standing in front of an object.

Obey all traffic rules and warning signs.

Keep hands, feet and head inside the operator station. Do not hold onto the overhead guard while operating the lift truck. Do not climb on any part of the mast or overhead guard or permit others to do so.

Do not allow unauthorized personnel to ride on the forks or any other part of the lift truck, at any time.

When working in a building or dock, observe floor load limits and overhead clearances.

Inhaling Freon gas through a lit cigarette or other smoking method or inhaling fumes released from a flame contacting Freon can cause bodily harm or death. Do not smoke when servicing air conditioners or wherever Freon gas may be present.

Never put maintenance fluids into glass containers. Use all cleaning solutions with care.

Do not use steam, solvent, or high pressure to clean electrical components.

Report all needed repairs.



Inspect the part of the chain that is normally operated over the crosshead roller. When the chain bends over the roller, the movement of the parts against each other causes wears.

Inspect to be sure that chain link pins do not extend outside of the bore hole.

If any single link pin is extended beyond its connecting corresponding link, it should be suspected of being broken inside of its bore hole.

Inspect the chain anchor and the anchor links for wear.

Do not change any factory set adjustment values (including engine rpm setting) unless you have both authorization and training. Especially Safety equipment and switches may not be removed or adjusted incorrectly. Repairs, adjustments and maintenances that are not correct can make a dangerous operating condition.

For any checkup, repair, adjustments, maintenance and all other work concerning your forklift truck, please contact your DOOSAN dealer. We would like to draw your attention to the fact that any secondary damages due to improper handling, insufficient maintenance, wrong repairs or the use of other than original DOOSAN spare parts waive any liability by DOOSAN.

Operation Information

Mounting and Dismounting

Mount and dismount the lift truck carefully.

Clean your shoes and wipe your hands before mounting.

Use both hands and face the lift truck when mounting and dismounting.

Use the handgrips for mounting and dismounting.

Do not try to climb on or off the lift truck when carrying tools or supplies.

Do not use any controls as handholds when entering or leaving the operator's station.

Never get on or off a moving lift truck. Never jump off the lift truck.

Keep hands and steering wheel free of slippery material.

Before Starting the Lift Truck

Perform a walk-around inspection daily and at the start of each shift. Refer to the topic "Walk-around Inspection" in "Every 10 Service Hours or Daily" section of this manual.

Adjust the seat so that full brake pedal travel can be obtained with the operator's back against the seat back.

Make sure the lift truck is equipped with a lighting system as required by conditions.

Make sure all hydraulic controls are in the HOLD position.

Make sure the direction control lever is in the NEUTRAL position.

Make sure the parking brake is engaged.

Make sure no one is standing and/or working on, underneath or close to the lift truck before operating the lift truck.

Operate the lift truck and controls only from the operator's station.

Safety Section

Make sure the lift truck horn, lights, backup alarm (if equipped) and all other devices are working properly.

Check for proper operation of mast and attachments. Pay particular attention to unusual noises or erratic movement which might indicate a problem.

Make sure service and parking brakes, steering, and directional controls are operational.

Make sure all personnel are clear of lift truck and travel path.

Refer to the topic "Lift Truck Operation" in the "Operation Section" of this manual for specific starting instructions.

Starting the Lift truck



Do not start the engine or move any of the controls if there is a "DO NOT OPERATE" or similar warning tag attached to the start switch or controls.

Before Operating the Lift Truck

Test brakes, steering controls, horn and other devices for proper operation. Report any faulty performance. Do not operate lift truck until repaired.

Learn how your lift truck operates. Know its safety devices. Know how the attachments work. Before moving the lift truck, look around. Start, turn and brake smoothly.

An operator must constantly observe his lift truck for proper operation.

Operating the Lift Truck

Always keep the lift truck under control.

ObeY all traffic rules and warning signs.

Never leave the lift truck with the engine operating, or with the parking brake disengaged.

Operate the engine only in a well ventilated area.

Lower a mast, with or without load, before turning or traveling. Tip over could result. Watch out for overhead obstructions.

Always observe floor load limits and overhead clearance.

Start, turn, and brake smoothly. Slow down for turns, grades, slippery or uneven surfaces.

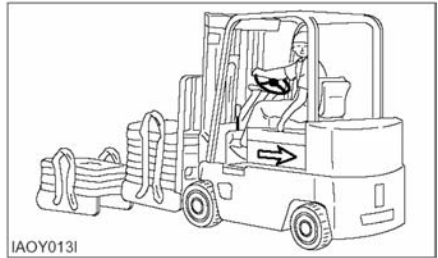

Use special care when operating on grades. Do not angle across or turn on grades. Do not use lift truck on slippery grades. Travel with forks downgrade when unloaded. Travel with load upgrade.

Do not overload, or handle offset, unstable, or loosely stacked loads. Refer to load capacity plate on the lift truck. Use extreme caution when handling suspended, long, high or wide load.



Tilt the elevated load forward only when directly over unloading area and with load as low as possible.

Do not stunt ride or indulge in horseplay.

Always look and keep a clear view of the path of travel.

Travel in reverse if load or attachment obstructs visibility. Use extreme caution if visibility is obstructed.

Stay in designated travel path, clear of dock edges, ditches, other drop-offs and surfaces which cannot safely support the lift truck.

Slow down and use extra care through doorways, intersections and other location where visibility is reduced.

Slow down for cross aisles, turns, ramps, dips, uneven or slippery surfaces and in congested areas, avoid pedestrians, other vehicles, obstruction, pot holes and other hazards or objects in the path of travel.

Always use overhead guards except where operation conditions do not permit. Do not operate lift truck in high stacking areas without overhead guards.

When stacking, watch for falling objects. Use load backrest extension and overhead guard.

Refer to the topic "Operation Techniques" in the "Operation Section" of this manual.

Loading or Unloading Trucks/Trailers

Do not operate lift trucks on trucks or trailers which are not designed or intended for that purpose. Be certain truck or trailer brakes are applied and wheel chocks in place (or be certain unit is locked to the loading dock) before entering onto trucks or trailers.

If trailer is not coupled to tractor, make sure the trailer landing gear is properly secured in place. On some trailers, extra supports may be needed to prevent upending or corner dipping.

Be certain dock plates are in good condition and properly placed and secured. Do not exceed the rated capacity of dock boards or bridge plates.

Lift Truck Parking

When leaving the operator station, park the lift truck in authorized areas only. Do not block traffic.



- Park the lift truck level, with the forks lowered and the mast tilted forward until the fork tips touch the floor.
- Move the direction control lever to NEUTRAL.
- Engage the parking brake.
- Turn the key switch off and remove the key.
- Turn the disconnect switch to OFF (if equipped).
- Block the drive wheels when parking on an incline.

Maintenance Information

Perform all maintenance unless otherwise specified as follows:

- Park the lift truck in authorized areas only.
- Park the lift truck level, with the forks lowered and the mast tilted forward until the fork tips touch the floor.
- Place the transmission controls in neutral.
- Engage the parking brake.
- Stop the engine.
- Remove the start switch key and turn the disconnect switch OFF (if equipped).
- Block the drive wheels when parking on an incline.

Pressure Air

Pressure air can cause personal injury. When using pressure air for cleaning, wear a protective face shield, protective clothing and protective shoes.

The maximum air pressure must be below 205 kPa (30 psi) for cleaning purposes.

Fluid Penetration

Always use a board or cardboard when checking for a leak. Escaping fluid under pressure, even a pinhole size leak, can penetrate body tissue, causing serious injury, and possible death. If fluid is injected into your skin, it must be treated by a doctor familiar with this type of injury immediately.

Crushing or Cutting Prevention

Support equipment and attachments properly when working beneath them. Do not depend on hydraulic cylinders to hold it up. Any attachment can fall if a control is moved, or if a hydraulic line breaks.

Never attempt adjustments while the lift truck is moving or the engine is running unless otherwise specified.

Where there are attachment linkages, the clearance in the linkage area will increase or decrease with movement of the attachment.

Stay clear of all rotating and moving parts.

Keep objects away from moving fan blades.

They will throw or cut any object or tool that falls or is pushed into them.

Do not use a kinked or frayed wire rope cable. Wear gloves when handling the wire rope cable.

Retainer pins, when struck with force, can fly out and injure nearby persons. Make sure the area is clear of people when driving retainer pins.

Wear protective glasses when striking a retainer pin to avoid injury to your eyes.

Chips or other debris can fly off objects when struck. Make sure no one can be injured by flying debris before striking any object.

Falling Objects Protective Structure (FOPS)

This is an attached guard located above the operator's compartment and secured to the lift truck.

To avoid possible weakening of the Falling Objects Protective Structure (FOPS), consult a DOOSAN dealer before altering, by adding weight to, welding on, or cutting or drilling holes into the structure.

The overhead guard is not intended to protect against every possible impact. The overhead guard may not protect against some objects penetrating into the operator's station from the sides or ends of the lift truck.

The lift truck is equipped with an overhead guard and FOPS as standard. If there is a possibility of overhead objects falling through the guard, the guard must be equipped with smaller holes or a Plexiglas cover.

Any altering done that is not specifically authorized by DOOSAN invalidates DOOSAN's FOPS certification. The protection offered by this FOPS will be impaired if it has been subjected to structural damage. Structural damage can be caused by an overturn accident, by falling objects, etc.

Do not mount any item such as fire extinguishers, first aid kits and lights by welding brackets to or drilling holes in any FOPS structure. See your DOOSAN dealer for mounting guidelines.

Burn Prevention

Coolant

At operating temperature, the engine coolant is hot and under pressure. The radiator and all lines to heaters or the engine contain hot water or steam. Any contact can cause severe burns.

Steam can cause personal injury.

Check the coolant level only after engine has been stopped and the filter cap is cool enough to remove with your bare hand.

Remove the cooling system filter cap slowly to relieve pressure.

Cooling system additive contains alkali that can cause personal injury. Avoid contact with the skin and eyes and do not drink.

Allow cooling system components to cool before draining.

Oils

Hot oil and components can cause personal injury. Do not allow hot oil or components to contact the skin.

At operation temperature, the hydraulic tank is hot and can be under pressure.

Remove the hydraulic tank filter cap only after the engine has been stopped and the filter cap is cool enough to remove with your bare hand.

Remove the hydraulic tank filter cap slowly to relieve pressure.

Relieve all pressure in air, oil fuel or cooling systems before any lines, fittings or related items are disconnected or removed.

Batteries

Batteries give off flammable fumes which can explode.

Do not smoke when observing the battery electrolyte levels.

Electrolyte is an acid and can cause personal injury if it contacts skin or eyes.

Always wear protective glasses when working with batteries.

Fire or Explosion Prevention

All fuels, most lubricants and some coolant mixtures are flammable.

Fuel leaked or spilled onto hot surfaces or electrical components can cause a fire.

Do not smoke while refueling or in a refueling area.

Do not smoke in areas where batteries are charged, or where flammable materials are stored.

Batteries in series can be located in separate compartments. When using jumper cables always connect positive(+) cable to positive(+) terminal of battery connected to starter solenoid and negative(-) cable from external source to starter negative(-) terminal. (If not equipped with starter negative(-) terminal, connect to engine block.)

See the Operation Section of this manual for specific starting instructions.

Clean and tighten all electrical connections. Check daily for loose or frayed electrical wires. Have all loose or frayed electrical wires tightened, repaired or replaced before operating the lift truck.

Keep all fuels and lubricants stored in properly marked containers and away from all unauthorized persons.

Store all oily rags or other flammable material in a protective container, in a safe place.

Do not weld or flame cut on pipes or tubes that contain flammable fluids. Clean them thoroughly with nonflammable solvent before welding or flame cutting on them.

Remove all flammable materials such as fuel, oil and other debris before they accumulate on the lift truck.

Do not expose the lift truck to flames, burning brush, etc., if at all possible.

Shields, which protect hot exhaust components from oil or fuel spray in the event of a line, tube or seal failure, must be installed correctly.

Do not operate in areas where explosive gases exist or are suspected.

Fire Extinguisher

Have a fire extinguisher-type BC and 1.5KG minimum capacity-on rear overhead guard leg with latch and know how to use it. Inspect and have it serviced as recommended on its instruction plate.

Ether

Ether is poisonous and flammable.

Breathing ether vapors or repeated contact of ether with skin can cause personal injury.

Use ether only in well-ventilated areas. Do not smoke while changing ether cylinders.

Use ether with care to avoid fires.

Do not store replacement ether cylinders in living areas or in the operator's compartment.

Do not store ether cylinders in direct sunlight or at temperatures above 39°C (102°F).

Discard cylinders in a safe place. Do not puncture or burn cylinders.

Keep ether cylinders out of the reach of unauthorized personnel.

Lines, Tubes and Hoses

Do not bend or strike high pressure lines. Do not install bent or damaged lines, tubes or hoses.

Repair any loose or damaged fuel and oil lines, tubes and hoses. Leaks can cause fires. Contact your DOOSAN dealer for repair or replacement.

Check lines, tubes and hoses carefully. Do not use your bare hand to check for leaks. Use a board or cardboard to check for leaks. See Fluid Penetration in the Safety Section for more details. Tighten all connections to the recommended torque. Replace if any of the following conditions are found.

- End fittings damaged or leaking.
- Outer covering chafed or cut and wire reinforcing exposed.
- Outer covering ballooning locally.
- Evidence of kinking or crushing of the flexible part of hose.
- Armoring embedded in the outer cover.
- End fittings displaced.

Make sure that all clamps, guards and heat shields are installed correctly to prevent vibration, rubbing against other parts, and excessive heat during operation.

Tire Information

Explosions of air-inflated tires have resulted from heat-induced gas combustion inside the tires. The heat, generated by welding or heating rim components, external fire, or excessive use of brakes can cause gaseous combustion.

A tire explosion is much more violent than a blowout. The explosion can propel the tire, rim and axle components as far as 500 m (1500 ft) or more from the lift truck. Both the force of the explosion and the flying debris can cause personal injury or death, and property damage.

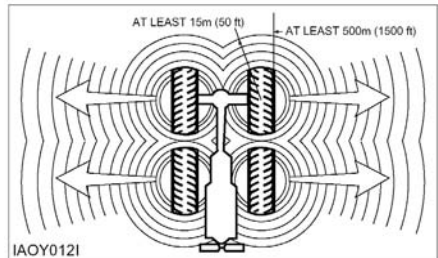

Do not approach a warm tire closer than the outside of the area represented by the shaded area in the above drawing.

Dry nitrogen (N₂) gas is recommended for inflation of tires. If the tires were originally inflated with air, nitrogen is still preferred for adjusting the pressure. Nitrogen mixes properly with air.

Nitrogen inflated tires reduce the potential of a tire explosion, because nitrogen does not support combustion. Also, nitrogen helps prevent oxidation and the resulting deterioration of rubber and corrosion of rim components.

Proper nitrogen inflation equipment and training in its use are necessary to avoid over-inflation. A tire blowout or rim failure can result from improper or misused equipment.

Stand behind the tread and use a self-attaching chuck when inflation a tire.

Servicing, changing tires and rims can be dangerous and should be done only by trained personnel using proper tools and procedures. If correct procedures are not followed while servicing tires and rims, the assemblies could burst with explosive force and cause serious personal injury or death. Follow carefully the specific information provided by your tire or rim servicing personnel or dealer.

Operator Restraint System(If Equipped)

Warning Signs and Labels

Your DOOSAN lift truck has the following tipover warning decals.

Make sure that you can read all safety signs. Clean or replace these if you cannot read the words or see the pictures. When cleaning the labels use a cloth, water and soap. Do not use solvent, gasoline, etc. You must replace a label if it is damaged, missing or cannot be read. If a label is on a part that is replaced, make sure a new label is installed on the replaced part. See you DOOSAN Lift Truck dealer for new labels.

The most effective method of preventing serious injury or death to yourself or others is to familiarize yourself with the proper operation of the lift truck, to be alert, and to avoid actions or conditions which can result in an accident.

⚠ WARNING

Tipover can occur if the truck is improperly operated. In the event of tipover, injury or death could result.

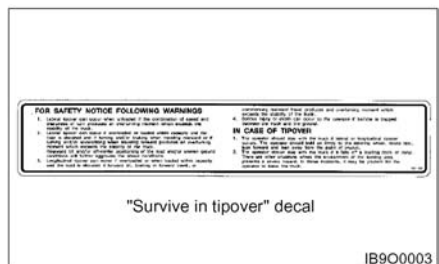
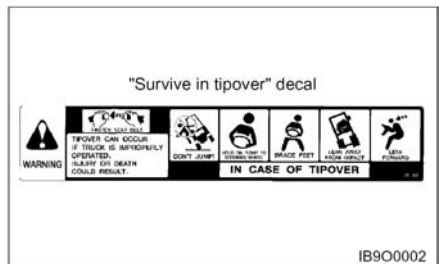

Weight adjustment

Pull the weight adjustment lever upwards and move right or left side.
Adjust to driver's weight in 7 steps (50 ~ 110 kg)

NOTICE

Do not place your hand or fingers under the seat.
Injury may occur as the seat moves up and down.



Backrest Inclination

The backrest angle can be adjusted by using the lever on the left side of seat.

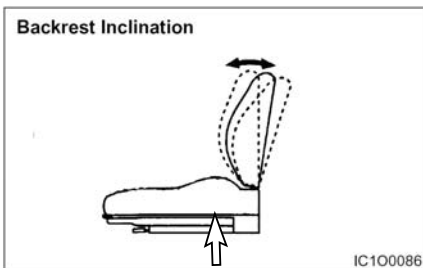

Seat Belt

The Operator Restraint System, Prevents the operator from jumping from the operator's compartment in the event of a forward or side tipover. The system is designed to keep the operator on the seat and in the operator's compartment in the event of a tipover.

Inspection

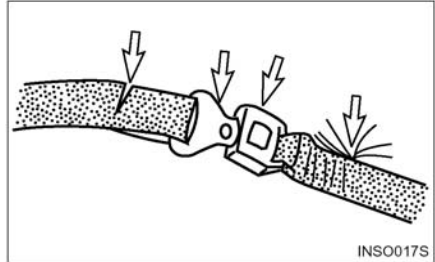

1. If the seat belt is torn, if pulling motion is interrupted during extension of the belt, or if the belt cannot be inserted into the buckle properly, replace the seat belt assembly.

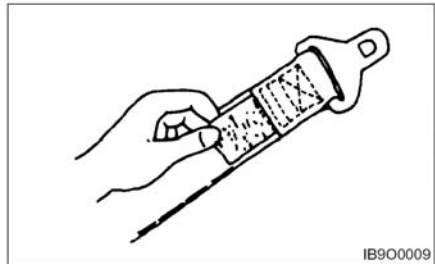

2. Belt Maintenance - Every 500 service hours. Check that the belt fastening works properly and that winding device is free from run lock when jerked. Check that the belt is suitably fastened to the seat. Check that the seat is correctly secured to the hood and the chassis. On visual inspection, fastenings must be intact, otherwise, contact the safety manager.

⚠ WARNING

Your DOOSAN truck comes equipped with a DOOSAN operator restraint system. Should it become necessary to replace the seat for any reason, it should only be replaced with another DOOSAN operator restraint system.

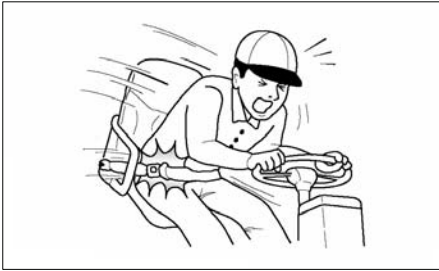

3. In the event of a tipover, the seat and restraint system should be inspected for damage and replaced, if necessary.

NOTE: Operator restraints shall be examined at the regular truck service intervals. It is recommended that they be replaced if any of the following conditions are found:

- Cut or frayed strap
- Worn or damaged hardware including anchor points
- Buckle or retractor malfunction
- Loose stitching

⚠ WARNING

The seat belt may cause the operator to bend at the waist. If you are pregnant or have suffered from some abdominal disease, consult a doctor before you use the seat belt.

Fasten the Seat Belt

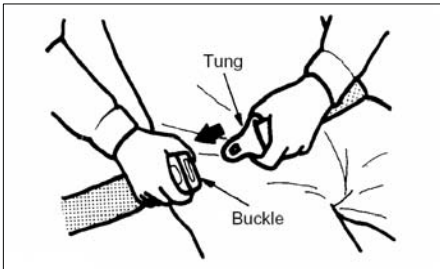

1. Grip the plate (connector) of the belt and pull the belt from the retractor. Then insert the plate into the slot of the buckle until a snap is heard. Pull on the belt to confirm it is latched.
2. Make sure the belt is not twisted.

⚠ WARNING

If you fasten the belt across your abdomen, the belt may injure your abdomen in an accident.

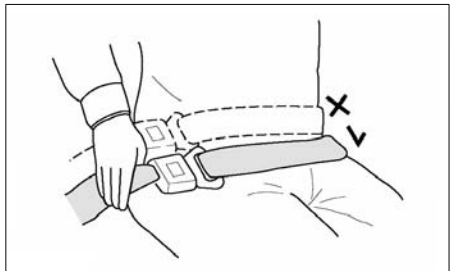

3. Be sure to fasten the belt across your hips, not across your abdomen.

NOTE: The belt is designed to automatically adjust to your size and movement. A quick pull on the belt will confirm that the automatic adjuster will hold the belt position in the event of an accident.

Release the Seat Belt

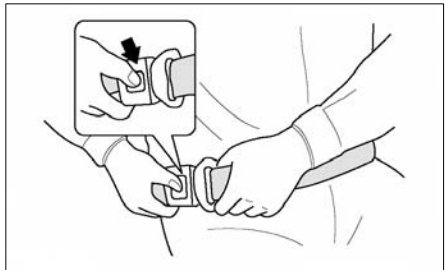

Push the button of the buckle to release the belt. The belt will automatically retract when released. Hold the plate of the belt and allow the belt to slowly retract.

Avoiding Lift Truck Tipover

Lift Truck Stability

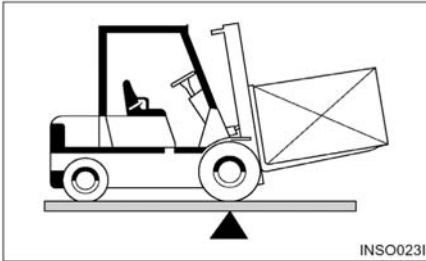

Counterbalanced lift truck design is based on the balance of two weights on opposite sides of a fulcrum (the front axle). The load on the forks must be balanced by the weight of the lift truck. The location of the center of gravity of both the truck and the load is also a factor. This basic principle is used for picking up a load. The ability of the lift truck to handle a load is discussed in terms of center of gravity and both forward and sideways stability.

Center of Gravity (CG)

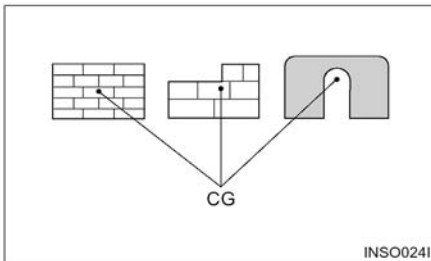

The point within an object, at which the whole weight of the object may be regarded as being concentrated, is called the center of gravity or CG. If the object is uniform, its geometric center will coincide with its CG. If it is not uniform, the CG could be at a point outside of the object. When the lift truck picks up a load, the truck and load have a new combined CG.

Stability and Center of Gravity

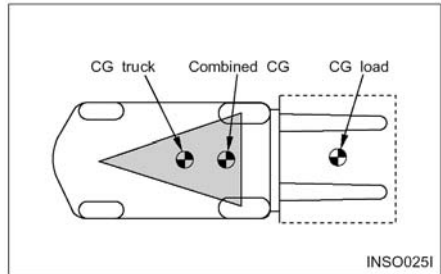

The stability of the lift truck is determined by the location of its CG; or, if the truck is loaded, the combined CG of the truck and load. The lift truck has moving parts and, therefore, has a CG that moves. The CG moves forward or backward as the mast is tilted forward or backward. The CG moves up or down as the mast moves up or down. The CG and, therefore, the stability of the loaded lift truck, are affected by a number of factors such as:

- the size, weight, shape and position of the load
- the height to which the load is lifted
- the amount of forward or backward tilt
- tire pressure
- dynamic forces created when the lift truck is accelerated, braked or turned
- condition and grade of surfaces on which the lift truck is operated

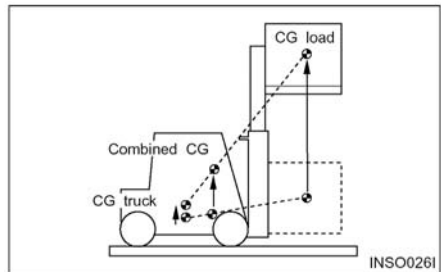

These same factors are also important for unloaded lift trucks. They tip over sideways easier than a loaded lift truck carrying its load in the lowered position.

Lift Truck Stability Base

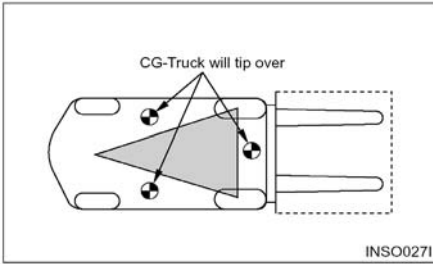

For the lift truck to be stable (not tip over forward or to the side), the CG must stay within the area of the lift truck stability base – a triangular area between the front wheels and the pivot of the steer wheels. If the CG moves forward of the front axle, the lift truck will tip forward. If the CG moves outside of the line on either side of the stability base, the lift truck will tip to the side.

WARNING

Dynamic forces (braking, acceleration, turning) also affect stability and can produce tipover even when the CG is within the stability triangle.

Capacity Load (Weight and Load Center)

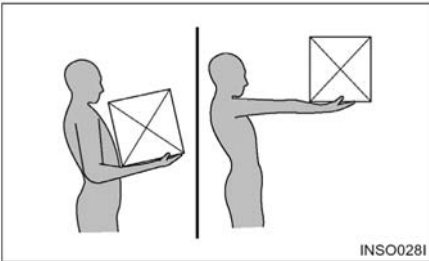

The capacity load of the lift truck is shown on the capacity/nameplate riveted to the truck. It is determined by the weight and load center. The load center is determined by the location of the CG of the load.

The load center shown on the nameplate is the horizontal distance from the front face of the forks, or the load face of an attachment, to the CG of the load. The location of the CG in the vertical direction is the same as the horizontal dimension.

Remember that, unless otherwise indicated, the capacity load shown on the nameplate is for a standard lift truck with standard backrest, forks and mast, and having no special-purpose attachment. In addition, the capacity load assumes that the load center is no further from the top of the forks than it is from the face of the backrest. If these conditions do not exist, the operator may have to reduce the safe operating load because the truck stability may be reduced. The lift truck should not be operated if its capacity/nameplate does not indicate capacity load.

NOTE: If the load is not uniform, the heaviest portion should be placed closer to the backrest and centered on the forks.

NOTICE

1. Capacity/Nameplates originally attached to forklifts sold by DOOSAN shall not be removed, altered or replaced without DOOSAN's approval.
 2. DOOSAN assumes no responsibility for lift trucks placed in service without a valid DOOSAN Nameplate.
 3. If necessary to change your specification, contact your DOOSAN lift truck dealer.
-

Safety Rules



Only properly trained and authorized personnel should operate forklift trucks. Wear a hard hat and safety shoes when operating a lift truck. Do not wear loose clothing.



Inspect and check the condition of your forklift truck using the operator's check list before starting work. Immediately report to your supervisor any obvious defects or required repairs.



Do not operate your truck in unauthorized areas. Know your forklift truck and think safety. Do not compromise safety. Follow all safety rules and read all warning signs.

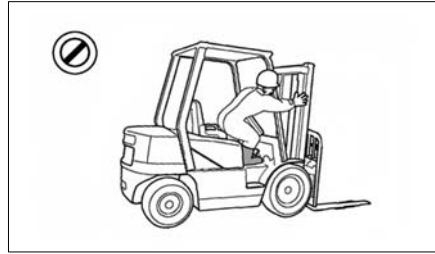

Do not operate a lift truck unless you are in the operator's seat. Keep hands and feet inside the operator's compartment. Do not put any part of the body outside of the operator's compartment. Never put any part of body into the mast structure or between the mast and the truck.



Do not start, stop, turn or change direction suddenly or at high speed. Sudden movement can cause the lift truck to tip over. Slow the speed of your truck and use the horn near corners, exits, entrances, and near people.

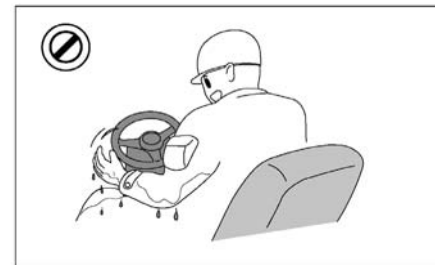

Never operate a lift truck with wet hands or shoes. Never hold any controls with grease on your hands. Your hands or feet will slide off of the controls and cause an accident.

Safety Section

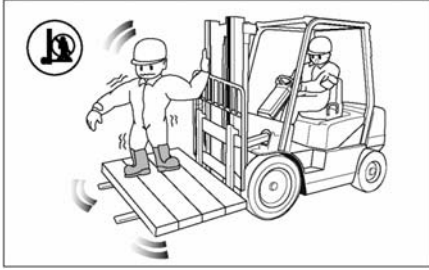

Do not raise anyone on the forks of your lift truck. Do not let other people ride on the truck. Lift trucks are designed to carry loads, not people.

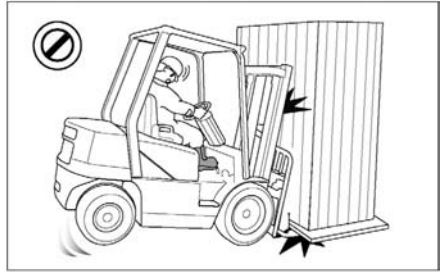

Do not overload. Always handle loads within the rated capacity shown on the capacity plate. Do not add extra counterweight to the truck. An overload can cause the truck to roll over and cause injury to personnel and damage to the lift truck.



Do not operate your truck without the load backrest extension and overhead guard. Keep the load against the backrest with the mast tilted backward



Do not drive on soft ground. Observe all signs, especially those on maximum permitted floor loadings, elevator capacities and clearance heights. Handle loads carefully and check them closely for stability and balance.



Do not lift or move loads that are not safe. Do not pick up an off center load. Such a load increases the possibility of a tipover to the side. Make sure loads are correctly stacked and positioned across both forks. Always use the proper size pallet. Position the forks as wide as possible under the load. Position loads evenly on the forks for proper balance. Do not lift a load with one fork.



Do not drive on slippery surfaces. Sand, gravel, ice or mud can cause a tipover. If unavoidable, slow down.

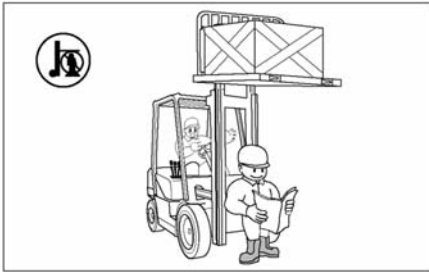

Do not permit anyone to stand or walk under the load or lifting mechanism. The load can fall and cause injury or death to anyone standing below.

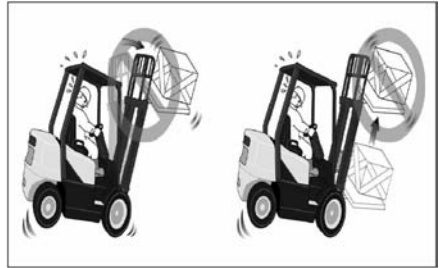

Do not elevate the load with the mast tilted forward. Do not tilt the elevated loads forwards. This will cause the lift truck to tip over forward.

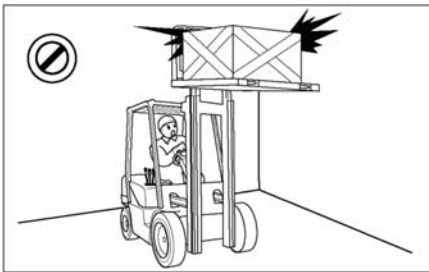

Look out for overhead obstructions when raising or stacking loads. Do not travel with a raised load. Do not travel with the mast raised. The lift truck can roll over and cause injury or death to you or other personnel.

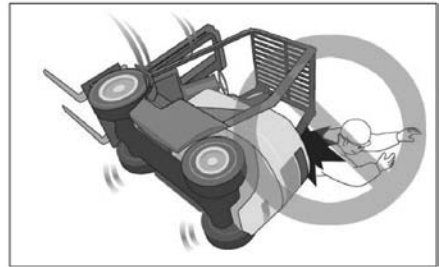

Do not jump off if your truck starts to tip over. Stay in your seat to survive.

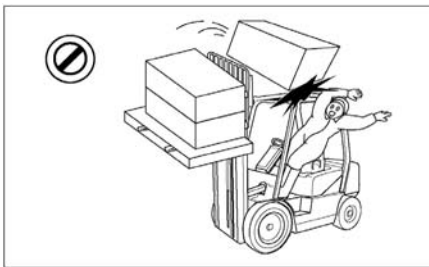

Do not move loose loads that are higher than the load backrest. Be alert for falling loads when stacking. Travel with the load tilted back and the forks as low as possible. This will increase stability to the truck and load and permit better visibility for you.

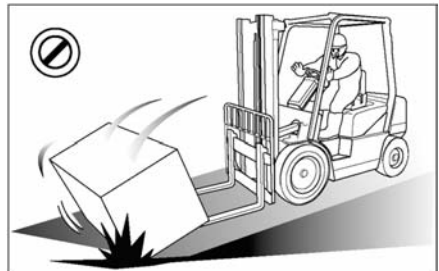

Go up ramps in forward direction and down ramps in reverse direction when moving loads. Never elevate a load with the forklift truck on an incline. Go straight off and straight down. Use an assistant when going up or down a ramp with a bulky load.

Safety Section

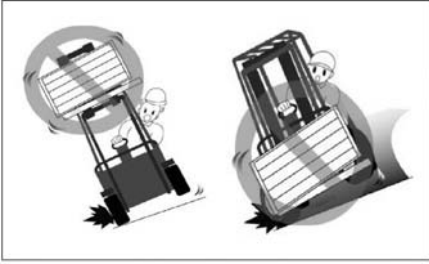

Do not stack or turn on ramps. Do not attempt to pick-up or deposit a load unless the lift truck is level. Do not turn on or drive across an incline.



Do not drive in forward direction when loads restrict your visibility. Operate your lift truck in reverse to improve visibility except when moving up a ramp.

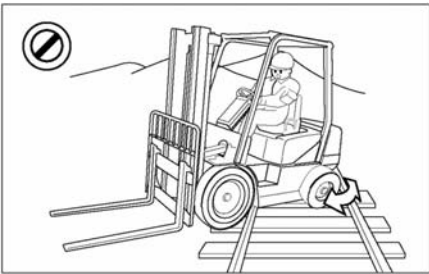

Do not go over rough terrain. If unavoidable, slow down. Cross railroad tracks slowly and diagonally whenever possible. A railroad crossing can give a loaded forklift truck a real jolt. For smoother crossing, cross the railroad diagonally so one wheel crosses at a time.

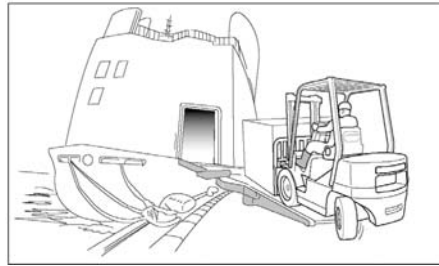

Be careful when operating a lift truck near the edge of a loading dock or ramp. Maintain a safe distance from the edge of docks, ramps and platforms. Always watch tail swing. The truck can fall over the edge and cause injury or death.

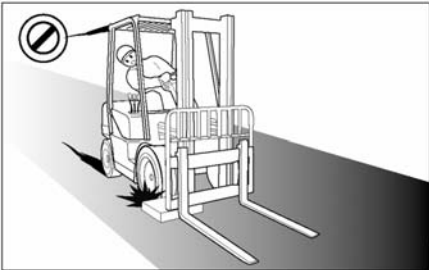

Avoid running over loose objects. Look in the direction of travel. Look out for other persons or obstructions in your path of travel. An operator must be in full control of his lift truck at all times.

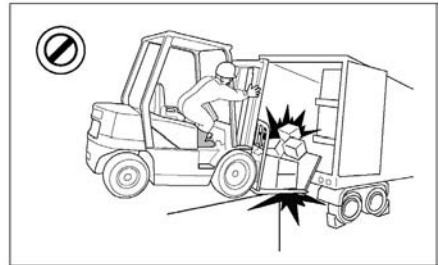

Do not operate on bridge plates unless they can support the weight of the truck and load. Make sure that they are correctly positioned. Put blocks on the vehicle you enter to keep it from moving.

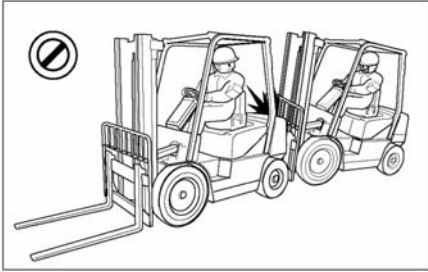

Do not operate your truck close to another truck. Always keep a safe distance from other trucks and make sure there is enough distance to stop safely. Never overtake other vehicles.

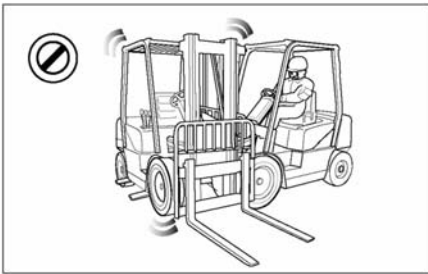

Do not use your lift truck to push or tow another truck. Do not let another push or tow your truck. If a truck will not move, call a service technician.

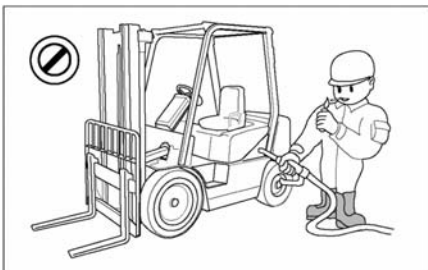

Forklift trucks may only be refueled at specially reserved locations. Switch off the engine when refueling. Smoking and handling of naked flames during refueling are strictly prohibited. This prohibition also applies during the changing of the LPG (liquefied propane gas) tank. Mop up spilt fuel and do not forget to close the fuel tank before restarting the engine.

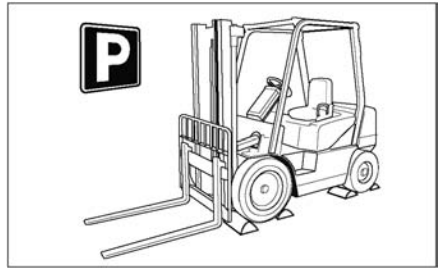

Park your lift truck in authorized areas only. Fully lower the forks to the floor, put direction lever in NEUTRAL position, engage the parking brake, and turn the key to the OFF position. Remove the key and put blocks behind the wheels to prevent the truck from rolling. Shut off your forklift truck when leaving it unattended. Check the condition of your forklift truck after the day's work.

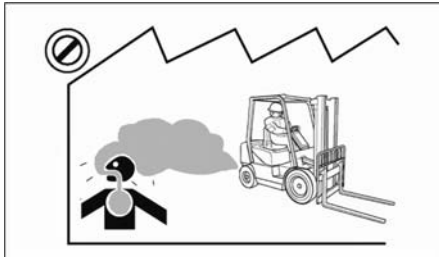

Exhaust from all internal combustion engines contains carbon monoxide, a colorless, odorless, tasteless, poisonous gas. Exposure to carbon monoxide can cause serious injury or health problems, including death and avoid unnecessary idling of the engine. If nausea, dizziness or headaches are experienced stop the truck and seek fresh air.

Safety Section

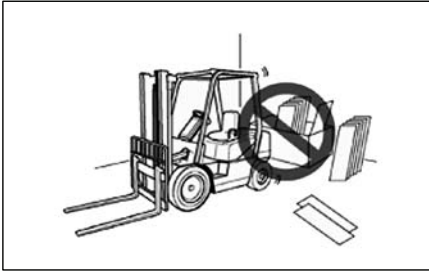

Do not operate forklifts near flammable or combustible materials.
To avoid the discoloration, deformation or combustion of materials (such as lumber, veneer board, paper products and other similar items), always park at least 30 cm (12 inches) away from them.

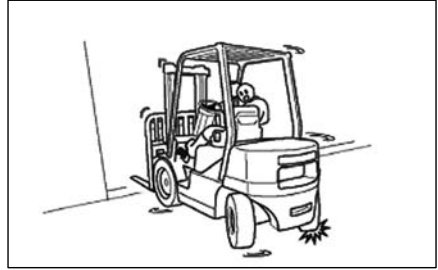

An unloaded forklift may be easier to tip over than a loaded truck.
When traveling without a load, the risk of lateral overturn is greater.

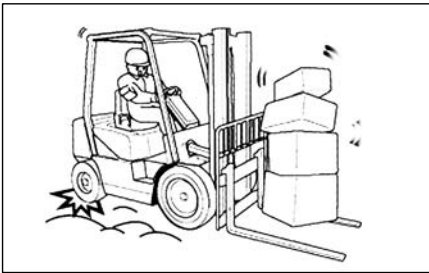

Forklift trucks are not cars. They often have small tires, no suspension, and are very heavy.
The forklift's center of gravity will also change when carrying loads.
Avoid uneven bumps, pot holes and other hazards whenever possible.

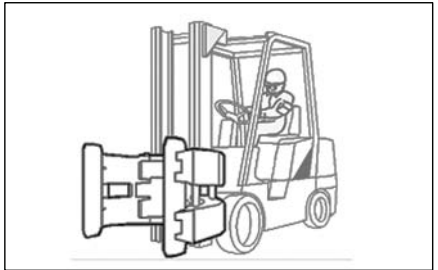

There are many special attachments available to replace the forks on a lift truck.
All carry safety implications and special training in their operation is highly recommended.



Carrying a load suspended on a chain or a cable may unbalance a truck.
Take extra care around pedestrians with a suspended load as it may sway or even strike them.

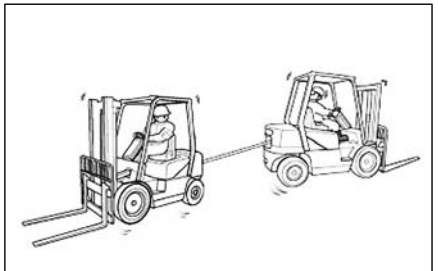

The counterweight draw bar should not be used for towing the forklift or for towing another forklift.
Towing is only advised in emergencies, by trained operators and at low speed, no faster than 2 km/h, to a convenient location for repair.

How to Survive in a Tipover

⚠️ WARNING

In the event of a tipover, the risk of serious injury or death will be reduced if the operator is using the operator restraint system and follows the instructions provided.

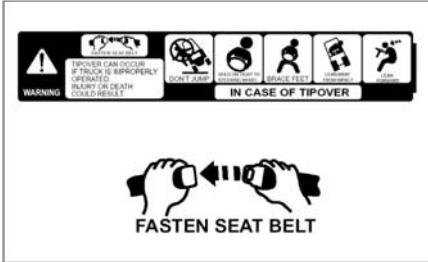

Always use operator restraint system.



Don't jump.



Hold on tight.



Brace your feet and keep them within the operator's compartment.



Lean away from the direction of fall.



Lean forward.

Declaration of Conformity

We,

Manufacturer

Doosan Infracore Co., Ltd.
7-11, Hwasu-dong, Dong-gu, Incheon, Korea 401-010

Authorized Representative, Compiler of Technical File According to 2006/42/EC and Keeper of
Technical File According to 2000/14/EC

Doosan Infracore Europe S.A., Mr. K. S. Yoon
1A Rue Achille Degrace 7080 Frameries, Belgium

herewith declare

that the following equipment conforms with the appropriate requirements of the Directives 2006/42/EC(Machinery Directive), 2000/14/EC as amended by 2005/88/EC(Noise Emission in the environment by equipment for use outdoors), and 2004/108/EC (EMC Directive) based on its design and type, as brought into circulation by us.

Description of the equipment :

Type : *Lift Truck, Combustion-engine driven, Counterbalanced*

Function : *Lifting and Moving materials*

Family : *D25S-5 Series*

G25E-5 Series

GC25E-5 Series

G25P-5 Series

G25P-5 Plus Series

GC25P-5 Series

Model Name : *D20S-5, D25S-5, D30S-5, D33S-5, D35C-5*

G20E-5, G25E-5, G30E-5, GC20E-5, GC25E-5, GC30E-5, GC33E-5

G20P-5, G25P-5, G30P-5, G33P-5, GC35C-5

G20P-5 PLUS, G25P-5 PLUS, G30P-5 PLUS,

G33P-5 PLUS, GC35C-5 PLUS

GC20P-5, GC25P-5, GC30P-5, G330P-5

Specifications

CHARACTERISTICS					
1	MANUFACTURER			DOOSAN	DOOSAN
2	MODEL			D20S-5 (YANMAR, TIER2)	D25S-5 (YANMAR, TIER2)
3	CAPACITY	at rated load center	kg	2000	2500
4	LOAD CENTER	distance	mm	500	500
5	POWER TYPE	electric, diesel, gas, LPG-gas		diesel	diesel
6	OPERATOR TYPE	stand-on, ride-seated		rider-seated	rider-seated
7	TIRES	C=cushion, P=pneumatic		p	p
8	WHEELS(x=driven)	number of front/rear		2/2	2/2
DIMENSIONS					
9	LIFT WITH STD	maximum fork height with rated load	mm	3230	3230
10	TWO-STAGE MAST	free lift	mm	152	152
11	FORK CARRIAGE	ISO class		II	II
12	FORKS	thickness x width x length	mm	40x100x1050	40x100x1050
13		fork spacing (maximum x minimum)	mm	275x1035	275x1035
14	TILT OF MAST	forward/backward	deg	6/10	6/10
15	OVERALL DIMENSIONS	length to fork face	mm	2530	2595
16		width	mm	1170	1170
17		mast lowered height	mm	2175	2175
18		mast extended height	mm	4490	4490
19		overhead guard height	mm	2183	2183
20		seat height	mm	1026	1026
21	OUTSIDE TURNING RADIUS		mm	2220	2265
22	LOAD MOMENT CONSTANT		mm	480	480
23	90.° STACKING AISLE		mm	2700	2745
23 a	90.° INTERSECTING AISLE		mm	1970	2000
PERFORMANCE					
24	SPEED	travel, loaded/unloaded	km/hr	21/21.5	21/21.5
25		lift, loaded/unloaded	mm/s	530/550	520/550
26		lowering, loaded/unloaded	mm/s	510/460	510/460
27	DRAWBAR PULL	at 1.6km/hr, loaded/unloaded	kg	1765	1740
28	GRADEABILITY	at 1.6km/hr, loaded/unloaded	%	33	28
29	ACCELERATION	time reached at max speed, loaded/unloaded	sec		
WEIGHT					
30	TOTAL WEIGHT at unloaded		kg	3580	3950
31	AXLE LOAD	at loaded, front/rear	kg	4930/650	5660/790
32		at unloaded, front/rear	kg	1720/1860	1650/2300
CHASSIS					
33	TIRES	number of front/rear		2/2	2/2
34		front size		7.00x15-12	7.00x15-12
35		rear size		6.50x10-10	6.50x10-10
36	WHEEL BASE		mm	1625	1625
37	TREAD	front/rear	mm	975/1000	975/1000
38	GROUND CLEARANCE	at loaded, the lowest point	mm	115	115
39		at loaded, center of wheelbase	mm	143	143
40	SEVICE BRAKE			foot/hyd	foot/hyd
41	PARKING BRAKE			hand/mech	hand/mech
DRIVE					
42	BATTERY	voltage/capacity	V/AH	12/85	12/85
43	ENGINE	manufacturer/model		YANMAR/4TNV98	YANMAR/4TNV98
44		rated output / rpm	kw(hp)	46.3(62.1)/2200	46.3(62.1)/2200
45		max. torque / rpm	N-m(lb•ft)	240(177)/1320	240(177)/1320
46		cycle/cylinders/displacement	cc	4/4/3319	4/4/3319
47	TRANSMISSION	type		powershift	powershift
48		number of speeds forward/reverse		1/1	1/1
49	OPERATING PRESSURE	system/attachment	bar	181/156	195/156
50	NOISE LEVEL	equivalent continuous sound pressure level (Leq) at operator's ear (DI : BITA/CE pREN 12053)	dB(A)		

General Section

DOOSAN	DOOSAN	DOOSAN	1
D30S-5	D33S-5	D35C-5	2
(YANMAR,TIER2)	(YANMAR,TIER2)	(YANMAR,TIER2)	3
3000	3250	3500	4
500	500	500	5
diesel	diesel	diesel	6
rider-seated	rider-seated	rider-seated	7
p	p	p	8
2/2	2/2	2/2	9
3230	3230	3000	10
152	152	152	11
III	III	III	12
45x125x1050	45x125x1050	45x125x1050	13
286x1044	286x1044	286x1044	14
6/10	6/10	6/10	15
2700	2730	2765	16
1197	1197	1255	17
2165	2165	2165	18
4490	4490	4260	19
2183	2183	2183	20
1026	1026	1026	21
2365	2395	2420	22
485	485	495	23
2850	2880	2915	24
2050	2100	2170	23a
20/20.5	20/20.5	20.5/21	25
500/550	490/550	480/550	26
510/460	510/460	510/460	27
1830	1820	1750	28
25	23.5	21.5	29
			30
4450	4630	4810	31
6580/870	6940/940	7340/970	32
1840/2610	1800/2830	1780/3030	33
2/2	2/2	2/2	34
28x9x15-12	28x9x15-12	250x15-18	35
6.50x10-10	6.50x10-12	6.50x10-12	36
1700	1700	1700	37
982/1000	982/1000	1026/1000	38
105	105	105	39
143	143	143	40
foot/hyd	foot/hyd	foot/hyd	41
hand/mech	hand/mech	hand/mech	42
12/85	12/85	12/85	43
YANMAR/4TNV98	YANMAR/4TNV98	YANMAR/4TNV98	44
46.3(62.1)/2200	46.3(62.1)/2200	46.3(62.1)/2200	45
240(177)/1320	240(177)/1320	240(177)/1320	46
4/4/3319	4/4/3319	4/4/3319	47
powershift	powershift	powershift	48
1/1	1/1	1/1	49
216/156	216/156	216/156	50
			51

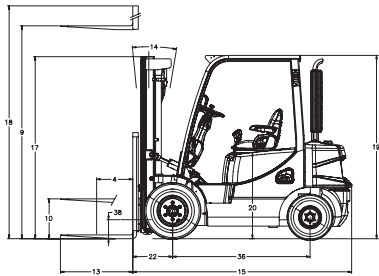
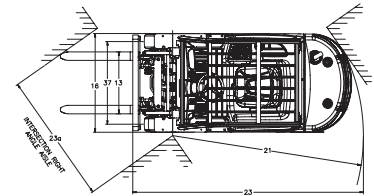

Specifications

CHARACTERISTICS					
1	MANUFACTURER			DOOSAN	DOOSAN
2	MODEL			D20S-5 (YANMAR, TIER3)	D25S-5 (YANMAR, TIER3)
3	CAPACITY	at rated load center	kg	2000	2500
4	LOAD CENTER	distance	mm	500	500
5	POWER TYPE	electric, diesel, gas, LPG-gas		diesel	diesel
6	OPERATOR TYPE	stand-on, ride-seated		rider-seated	rider-seated
7	TIRES	C=cushion, P=pneumatic		p	p
8	WHEELS(x=driven)	number of front/rear		2/2	2/2
DIMENSIONS					
9	LIFT WITH STD	maximum fork height with rated load	mm	3230	3230
10	TWO-STAGE MAST	free lift	mm	152	152
11	FORK CARRIAGE	ISO class		II	II
12	FORKS	thickness x width x length	mm	40x100x1050	40x100x1050
13		fork spacing (maximum x minimum)	mm	275x1035	275x1035
14	TILT OF MAST	forward/backward	deg	6/10	6/10
15		length to fork face	mm	2530	2595
16	OVERALL DIMENSIONS	width	mm	1170	1170
17		mast lowered height	mm	2175	2175
18		mast extended height	mm	4490	4490
19		overhead guard height	mm	2183	2183
20		seat height	mm	1026	1026
21	OUTSIDE TURNING RADIUS		mm	2220	2265
22	LOAD MOMENT CONSTANT		mm	480	480
23	90.° STACKING AISLE		mm	2700	2745
23 a	90.° INTERSECTING AISLE		mm	1970	2000
PERFORMANCE					
24	SPEED	travel, loaded/unloaded	km/hr	19/19.5	19/19.5
25		lift, loaded/unloaded	mm/s	530/550	520/550
26		lowering, loaded/unloaded	mm/s	510/460	510/460
27	DRAWBAR PULL	at 1.6km/hr, loaded/unloaded	kg	1765	1740
28	GRADEABILITY	at 1.6km/hr, loaded/unloaded	%	33	28
29	ACCELERATION	time reached at max speed, loaded/unloaded	sec		
WEIGHT					
30	TOTAL WEIGHT at unloaded		kg	3580	3950
31	AXLE LOAD	at loaded, front/rear	kg	4930/650	5660/790
32		at unloaded, front/rear	kg	1720/1860	1650/2300
CHASSIS					
33	TIRES	number of front/rear		2/2	2/2
34		front size		7.00x15-12	7.00x15-12
35		rear size		6.50x10-10	6.50x10-10
36	WHEEL BASE		mm	1625	1625
37	TREAD	front/rear	mm	975/1000	975/1000
38	GROUND CLEARANCE	at loaded, the lowest point	mm	115	115
39		at loaded, center of wheelbase	mm	143	143
40	SEVICE BRAKE			foot/hyd	foot/hyd
41	PARKING BRAKE			hand/mech	hand/mech
DRIVE					
42	BATTERY	voltage/capacity	V/AH	12/85	12/85
43	ENGINE	manufacturer/model		YANMAR/4TNE98	YANMAR/4TNE98
44		rated output / rpm	kw(hp)	43.7(58.6)/2300	43.7(58.6)/2300
45		max. torque / rpm	N-m(lb•ft)	181(133)/1600	181(133)/1600
46		cycle/cylinders/displacement	cc	4/4/3319	4/4/3319
47	TRANSMISSION	type		powershift	powershift
48		number of speeds forward/reverse		1/1	1/1
49	OPERATING PRESSURE	system/attachment	bar	181/156	195/156
50	NOISE LEVEL	equivalent continuous sound pressure level (Leq) at operator's ear (DI : BITA/CE pREN 12053)	dB(A)		

General Section

DOOSAN	DOOSAN	DOOSAN	
D30S-5 (YANMAR,TIER3)	D33S-5 (YANMAR,TIER3)	D35C-5 (YANMAR,TIER3)	
3000	3250	3500	2
500	500	500	3
diesel	diesel	diesel	4
rider-seated	rider-seated	rider-seated	5
p	p	p	6
2/2	2/2	2/2	7
			8
			9
3230	3230	3000	10
152	152	152	11
III	III	III	12
45x125x1050	45x125x1050	45x125x1050	13
286x1044	286x1044	286x1044	14
6/10	6/10	6/10	15
2700	2730	2765	16
1197	1197	1255	17
2165	2165	2165	18
4490	4490	4260	19
2183	2183	2183	20
1026	1026	1026	21
2365	2395	2420	22
485	485	495	23
2850	2880	2915	24
2050	2100	2170	25a
			26
18/18.5	18/18.5	18.5/19	27
500/550	490/550	420/550	28
510/460	510/460	510/460	29
1830	1820	1750	30
25	23.5	21.5	31
			32
			33
4450	4630	4810	34
6580/870	6940/940	7340/970	35
1840/2610	1800/2830	1780/3030	36
			37
2/2	2/2	2/2	38
28x9x15-12	28x9x15-12	250x15-18	39
6.50x10-10	6.50x10-12	6.50x10-12	40
1700	1700	1700	41
982/1000	982/1000	1026/1000	42
105	105	105	43
143	143	143	44
foot/hyd	foot/hyd	foot/hyd	45
hand/mech	hand/mech	hand/mech	46
			47
12/85	12/85	12/85	48
YANMAR/4TNE98	YANMAR/4TNE98	YANMAR/4TNE98	49
43.7(58.6)/2300	43.7(58.6)/2300	43.7(58.6)/2300	50
181(133)/1600	181(133)/1600	181(133)/1600	51
4/4/3319	4/4/3319	4/4/3319	52
powershift	powershift	powershift	53
1/1	1/1	1/1	54
216/156	216/156	216/156	55
			56

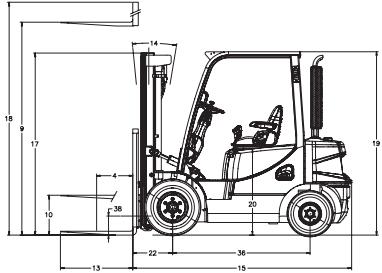
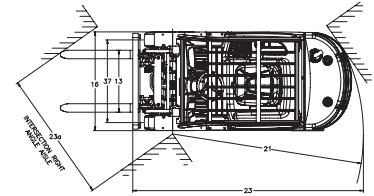

Specifications

CHARACTERISTICS			
1	MANUFACTURER		
2	MODEL		
3	CAPACITY	at rated load center	kg
4	LOAD CENTER	distance	mm
5	POWER TYPE	electric, diesel, gas, LPG-gas	
6	OPERATOR TYPE	stand-on, ride-seated	
7	TIRES	C=cushion, P=pneumatic	
8	WHEELS(x=driven)	number of front/rear	
DIMENSIONS			
9	LIFT WITH STD TWO-STAGE MAST	maximum fork height with rated load	mm
10		free lift	mm
11	FORK CARRIAGE	ISO class	
12	FORKS	thickness x width x length	mm
13		fork spacing (maximum x minimum)	mm
14	TILT OF MAST	forward/backward	deg
15	OVERALL DIMENSIONS	length without forks	mm
16		width	mm
17		mast lowered height	mm
18		mast extended height	mm
19		overhead guard height	mm
20		seat height	mm
21	OUTSIDE TURNING RADIUS		mm
22	LOAD MOMENT CONSTANT		mm
23	90. STACKING AISLE		mm
23a	90. INTERSECTING AISLE		mm
PERFORMANCE			
24	SPEED	travel, loaded/unloaded	km/hr
25		lift, loaded/unloaded	mm/s
26		lowering, loaded/unloaded	mm/s
27	DRAWBAR PULL	at 1.6km/hr, loaded/unloaded	kg
28	GRADEABILITY	at 1.6km/hr, loaded/unloaded	%
29	ACCELERATION	time reached at max speed, loaded/unloaded	sec
WEIGHT			
30	TOTAL WEIGHT at unloaded		kg
31	AXLE LOAD	at loaded, front/rear	kg
32		at unloaded, front/rear	kg
CHASSIS			
33	TIRES	number of front/rear	
34		front size	
35		rear size	
36	WHEEL BASE		mm
37	TREAD	front/rear	mm
38	GROUND CLEARANCE	at loaded, the lowest point	mm
39		at loaded, center of wheelbase	mm
40	SEVICE BRAKE		
41	PARKING BRAKE		
DRIVE			
42	BATTERY	voltage/capacity	V/AH
43	ENGINE	manufacturer/model	
44		rated output / rpm	kw(hp)
45		max. torque / rpm	N•m(lb•ft)
46		cycle/cylinders/displacement	cc
47	TRANSMISSION	type	
48		number of speeds forward/reverse	
49	OPERATING PRESSURE	system/attachment	bar
50	NOISE LEVEL	equivalent continuous sound pressure level (Leq) at operator's ear (DI : BITA/CE prEN 12053)	dB(A)

General Section

DOOSAN	DOOSAN	DOOSAN	1
G20E-5	G25E-5	G30E-5	2
2000	2500	3000	3
500	500	500	4
LP	LP	LP	5
rider-seated	rider-seated	rider-seated	6
p	p	p	7
2/2	2/2	2/2	8
3230	3230	3230	9
152	152	152	10
II	II	III	11
40x100x1050	40x100x1050	45x125x1050	12
275x1035	275x1035	286x1044	13
6/10	6/10	6/10	14
2530	2595	2700	15
1170	1170	1197	16
2175	2175	2165	17
4490	4490	4490	18
2183	2183	2183	19
1026	1026	1026	20
2220	2265	2365	21
480	480	485	22
2700	2745	2850	23
1970	2000	2050	23a
19/20	19/20	18/19	24
530/600	510/600	500/600	25
510/460	510/460	510/460	26
1440	1415	1485	27
27	22.5	20.5	28
			29
3570	3940	4380	30
4940/630	5670/770	6310/1050	31
1730/1840	1660/2280	1800/2580	32
2/2	2/2	2/2	33
7.00x15-12	7.00x15-12	28x9x15-12	34
6.50x10-10	6.50x10-10	6.50x10-10	35
1625	1625	1700	36
975/1000	975/1000	982/1000	37
115	115	105	38
143	143	143	39
foot/hyd	foot/hyd	foot/hyd	40
hand/mech	hand/mech	hand/mech	41
12/45	12/45	12/45	42
G420F(E)	G420F(E)	G420F(E)	43
39.9(53.5)/2500	39.9(53.5)/2500	39.9(53.5)/2500	44
157(116)/1600	157(116)/1600	157(116)/1600	45
4/4/1975	4/4/1975	4/4/1975	46
powershift	powershift	powershift	47
1/1	1/1	1/1	48
181/156	195/156	216/156	49
			50

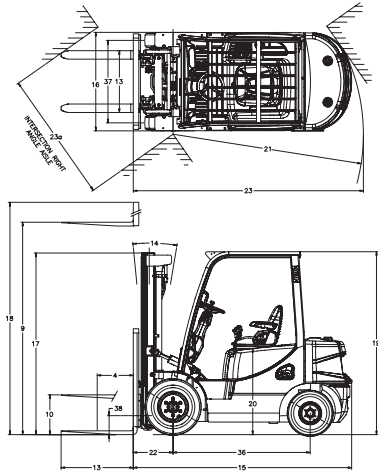

Specifications

CHARACTERISTICS			
1	MANUFACTURER		
2	MODEL		
3	CAPACITY	at rated load center	kg
4	LOAD CENTER	distance	mm
5	POWER TYPE	electric, diesel, gas, LPG-gas	
6	OPERATOR TYPE	stand-on, ride-seated	
7	TIRES	C=cushion, P=pneumatic	
8	WHEELS(x=driven)	number of front/rear	
DIMENSIONS			
9	LIFT WITH STD TWO-STAGE MAST	maximum fork height with rated load	mm
10		free lift	mm
11	FORK CARRIAGE	ISO class	
12	FORKS	thickness x width x length	mm
13		fork spacing (maximum x minimum)	mm
14	TILT OF MAST	forward/backward	deg
15	OVERALL DIMENSIONS	length without forks	mm
16		width	mm
17		mast lowered height	mm
18		mast extended height	mm
19		overhead guard height	mm
20		seat height	mm
21	OUTSIDE TURNING RADIUS		mm
22	LOAD MOMENT CONSTANT		mm
23	90. STACKING AISLE		mm
23a	90. INTERSECTING AISLE		mm
PERFORMANCE			
24	SPEED	travel, loaded/unloaded	km/hr
25		lift, loaded/unloaded	mm/s
26		lowering, loaded/unloaded	mm/s
27	DRAWBAR PULL	at 1.6km/hr, loaded/unloaded	kg
28	GRADEABILITY	at 1.6km/hr, loaded/unloaded	%
29	ACCELERATION	time reached at max speed, loaded/unloaded	sec
WEIGHT			
30	TOTAL WEIGHT at unloaded		kg
31	AXLE LOAD	at loaded, front/rear	kg
32		at unloaded, front/rear	kg
CHASSIS			
33	TIRES	number of front/rear	
34		front size	
35		rear size	
36	WHEEL BASE		mm
37	TREAD	front/rear	mm
38	GROUND CLEARANCE	at loaded, the lowest point	mm
39		at loaded, center of wheelbase	mm
40	SEVICE BRAKE		
41	PARKING BRAKE		
DRIVE			
42	BATTERY	voltage/capacity	V/AH
43	ENGINE	manufacturer/model	
44		rated output / rpm	kw(hp)
45		max. torque / rpm	N•m(lb•ft)
46		cycle/cylinders/displacement	cc
47	TRANSMISSION	type	
48		number of speeds forward/reverse	
49	OPERATING PRESSURE	system/attachment	bar
50	NOISE LEVEL	equivalent continuous sound pressure level (Leq) at operator's ear (DI : BITA/CE prEN 12053)	dB(A)

General Section

DOOSAN	DOOSAN	DOOSAN	1
G20E-5	G25E-5	G30E-5	2
2000	2500	3000	3
500	500	500	4
LP/Gas	LP/Gas	LP/Gas	5
rider-seated	rider-seated	rider-seated	6
p	p	p	7
2/2	2/2	2/2	8
3230	3230	3230	9
152	152	152	10
II	II	III	11
40x100x1050	40x100x1050	45x125x1050	12
275x1035	275x1035	286x1044	13
6/10	6/10	6/10	14
2530	2595	2700	15
1170	1170	1197	16
2175	2175	2165	17
4490	4490	4490	18
2183	2183	2183	19
1026	1026	1026	20
2220	2265	2365	21
480	480	485	22
2700	2745	2850	23
1970	2000	2050	23a
19/20	19/20	18/19	24
530/600	510/600	500/600	25
510/460	510/460	510/460	26
1800	1780	1860	27
34	28.5	26	28
			29
3570	3940	4380	30
4940/630	5670/770	6540/840	31
1730/1840	1660/2280	1800/2580	32
2/2	2/2	2/2	33
7.00x15-12	7.00x15-12	28x9x15-12	34
6.50x10-10	6.50x10-10	6.50x10-10	35
1625	1625	1700	36
975/1000	975/1000	982/1000	37
115	115	105	38
143	143	143	39
foot/hyd	foot/hyd	foot/hyd	40
hand/mech	hand/mech	hand/mech	41
12/45	12/45	12/45	42
G424IE	G424IE	G424IE	43
48.7(65.3)/2600	48.7(65.3)/2600	48.7(65.3)/2600	44
186/1900	186/1900	186/1900	45
4/4/2359	4/4/2359	4/4/2359	46
powershift	powershift	powershift	47
1/1	1/1	1/1	48
181/156	195/156	216/156	49
			50

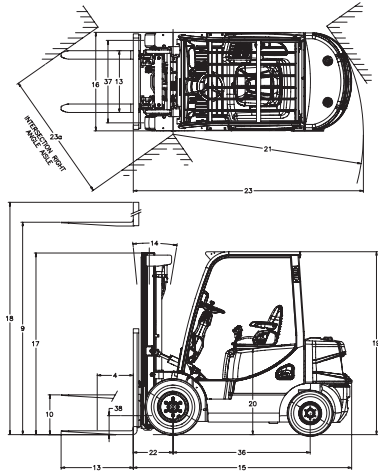

Specifications

CHARACTERISTICS						
1	MANUFACTURER			DOOSAN	DOOSAN	
2	MODEL			G20P-5	G25P-5	
3	CAPACITY	at rated load center	kg	2000	2500	
4	LOAD CENTER	distance	mm	500	500	
5	POWER TYPE	electric, diesel, gas, LPG-gas		lp	lp	
6	OPERATOR TYPE	stand-on, ride-seated		rider-seated	rider-seated	
7	TIRES	C=cushion, P=pneumatic		p	p	
8	WHEELS(x=driven)	number of front/rear		2/2	2/2	
DIMENSIONS						
9	LIFT WITH STD	maximum fork height with rated load	mm	3230	3230	
10	TWO-STAGE MAST	free lift	mm	152	152	
11	FORK CARRIAGE	ISO class		II	II	
12	FORKS	thickness x width x length	mm	40x100x1050	40x100x1050	
13		fork spacing (maximum x minimum)	mm	275x1035	275x1035	
14	TILT OF MAST	forward/backward	deg	6/10	6/10	
15	OVERALL DIMENSIONS	length without forks	mm	2530	2595	
16		width	mm	1170	1170	
17		mast lowered height	mm	2175	2175	
18		mast extended height	mm	4490	4490	
19		overhead guard height	mm	2183	2183	
20		seat height	mm	1026	1026	
21	OUTSIDE TURNING RADIUS		mm	2220	2265	
22	LOAD MOMENT CONSTANT		mm	480	480	
23	90° STACKING AISLE		mm	2700	2745	
23a	90° INTERSECTING AISLE		mm	1970	2000	
PERFORMANCE						
24	SPEED	travel, loaded/unloaded	km/hr	19/20	19/20	
25		lift, loaded/unloaded	mm/s	530/600	510/600	
26		lowering, loaded/unloaded	mm/s	510/460	510/460	
27	DRAWBAR PULL	at 1.6km/hr, loaded/unloaded	kg	1750	1725	
28	GRADEABILITY	at 1.6km/hr, loaded/unloaded	%	33	28	
29	ACCELERATION	time reached at max speed, loaded/unloaded	sec			
WEIGHT						
30	TOTAL WEIGHT at unloaded			kg	3570	3940
31	AXLE LOAD	at loaded, front/rear	kg	4940/630	5670/770	
32		at unloaded, front/rear	kg	1730/1840	1660/2280	
CHASSIS						
33		number of front/rear		2/2	2/2	
34	TIRES	front size		7.00x15-12	7.00x15-12	
35		rear size		6.50x10-10	6.50x10-10	
36	WHEEL BASE		mm	1625	1625	
37	TREAD	front/rear	mm	975/1000	975/1000	
38	GROUND	at loaded, the lowest point	mm	115	115	
39	CLEARANCE	at loaded, center of wheelbase	mm	143	143	
40	SEVICE BRAKE			foot/hyd	foot/hyd	
41	PARKING BRAKE			hand/mech	hand/mech	
DRIVE						
42	BATTERY	voltage/capacity	V/AH	12/65	12/65	
43		manufacturer/model		G424F(E)	G424F(E)	
44	ENGINE	rated output / rpm	kw(hp)	47.7(64)/2550	47.7(64)/2550	
45		max. torque / rpm	N•m(lb•ft)	182(135)/2200	182(135)/2200	
46		cycle/cylinders/displacement	cc	4/4/2405	4/4/2405	
47	TRANSMISSION	type		powershift	powershift	
48		number of speeds forward/reverse		1/1	1/1	
49	OPERATING PRESSURE	system/attachment	bar	181/156	195/156	
50	NOISE LEVEL	equivalent continuous sound pressure level (Leq) at operator's ear (DI : BITA/CE prEN 12053)	dB(A)			

General Section

DOOSAN	DOOSAN	DOOSAN	
G30P-5	G33P-5	G35C-5	1
3000	3250	3500	2
500	500	500	3
lp	lp	lp	4
rider-seated	rider-seated	rider-seated	5
p	p	p	6
2/2	2/2	2/2	7
			8
3230	3230	3000	9
152	152	152	10
III	III	III	11
45x125x1050	45x125x1050	45x125x1050	12
286x1044	286x1044	286x1044	13
6/10	6/10	6/10	14
2700	2730	2765	15
1197	1197	1255	16
2165	2165	2165	17
4490	4490	4260	18
2183	2183	2183	19
1026	1026	1026	20
2365	2395	2420	21
485	485	495	22
2850	2880	2915	23
2050	2100	2170	23a
18/19	18/19	18.5/19.5	24
500/600	500/600	420/600	25
510/460	510/460	510/460	26
1815	1805	1735	27
25.5	24	21.5	28
			29
4380	4560	4750	30
6310/1050	6890/920	7300/950	31
1800/2780	1760/2800	1750/3000	32
2/2	2/2	2/2	33
28x9x15-12	28x9x15-12	250x15-18	34
6.50x10-10	6.50x10-12	6.50x10-12	35
1700	1700	1700	36
982/1000	982/1000	1026/1000	37
105	105	105	38
143	143	143	39
foot/hyd	foot/hyd	foot/hyd	40
hand/mech	hand/mech	hand/mech	41
12/65	12/65	12/65	42
G424F(E)	G424F(E)	G424F(E)	43
47.7(64)/2550	47.7(64)/2550	47.7(64)/2550	44
182(135)/2200	182(135)/2200	182(135)/2200	45
4/4/2405	4/4/2405	4/4/2405	46
powershift	powershift	powershift	47
1/1	1/1	1/1	48
216/156	216/156	216/156	49
			50

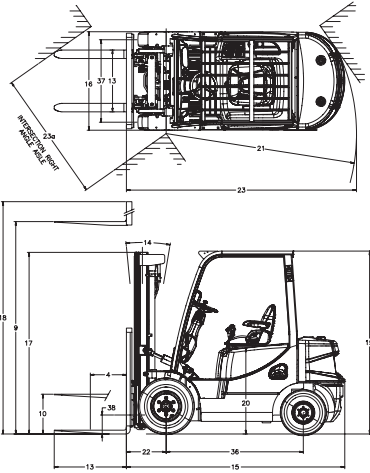

Specifications

CHARACTERISTICS						
1	MANUFACTURER			DOOSAN	DOOSAN	
2	MODEL			G20P-5 Plus	G25P-5 Plus	
3	CAPACITY	at rated load center	kg	2000	2500	
4	LOAD CENTER	distance	mm	500	500	
5	POWER TYPE	electric, diesel, gas, LPG-gas		lp	Lp	
6	OPERATOR TYPE	stand-on, ride-seated		rider-seated	rider-seated	
7	TIRES	C=cushion, P=pneumatic		p	P	
8	WHEELS(x=driven)	number of front/rear		2/2	2/2	
DIMENSIONS						
9	LIFT WITH STD	maximum fork height with rated load	mm	3230	3230	
10	TWO-STAGE MAST	free lift	mm	152	152	
11	FORK CARRIAGE	ISO class		II	II	
12	FORKS	thickness x width x length	mm	40x100x1050	40x100x1050	
13		fork spacing (maximum x minimum)	mm	275x1035	275x1035	
14	TILT OF MAST	forward/backward	deg	6/10	6/10	
15	OVERALL DIMENSIONS	length without forks	mm	2530	2595	
16		width	mm	1170	1170	
17		mast lowered height	mm	2175	2175	
18		mast extended height	mm	4490	4490	
19		overhead guard height	mm	2183	2183	
20		seat height	mm	1026	1026	
21	OUTSIDE TURNING RADIUS		mm	2220	2265	
22	LOAD MOMENT CONSTANT		mm	480	480	
23	90° STACKING AISLE		mm	2700	2745	
23a	90° INTERSECTING AISLE		mm	1970	2000	
PERFORMANCE						
24	SPEED	travel, loaded/unloaded	km/hr	19/20	19/20	
25		lift, loaded/unloaded	mm/s	530/600	520/600	
26		lowering, loaded/unloaded	mm/s	510/460	510/460	
27	DRAWBAR PULL	at 1.6km/hr, loaded/unloaded	kg	1820	1800	
28	GRADEABILITY	at 1.6km/hr, loaded/unloaded	%	34.5	29	
29	ACCELERATION	time reached at max speed, loaded/unloaded	sec			
WEIGHT						
30	TOTAL WEIGHT at unloaded			kg	3570	3940
31	AXLE LOAD	at loaded, front/rear	kg	4940/630	5670/770	
32		at unloaded, front/rear	kg	1730/1840	1660/2280	
CHASSIS						
33	TIRES	number of front/rear		2/2	2/2	
34		front size		7.00x15-12	7.00x15-12	
35		rear size		6.50x10-10	6.50x10-10	
36	WHEEL BASE		mm	1625	1625	
37	TREAD	front/rear	mm	975/1000	975/1000	
38	GROUND	at loaded, the lowest point	mm	115	115	
39	CLEARANCE	at loaded, center of wheelbase	mm	143	143	
40	SEVICE BRAKE			foot/hyd	foot/hyd	
41	PARKING BRAKE			hand/mech	hand/mech	
DRIVE						
42	BATTERY	voltage/capacity	V/AH	12/65	12/65	
43	ENGINE	manufacturer/model		G430FE	G430FE	
44		rated output / rpm	kw(hp)	49.5(66.3)/2600	49.5(66.3)/2600	
45		max. torque / rpm	N•m(lb•ft)	203(150)/1600	203(150)/1600	
46		cycle/cylinders/displacement	cc	4/4/2967	4/4/2967	
47	TRANSMISSION	type		powershift	powershift	
48		number of speeds forward/reverse		1/1	1/1	
49	OPERATING PRESSURE	system/attachment	bar	181/156	195/156	
50	NOISE LEVEL	equivalent continuous sound pressure level (Leq) at operator's ear (DI : BITA/CE prEN 12053)	dB(A)			

General Section

DOOSAN	DOOSAN	DOOSAN	1
G30P-5 Plus	G33P-5 Plus	G35C-5 Plus	2
3000	3250	3500	3
500	500	500	4
lp	lp	lp	5
rider-seated	rider-seated	rider-seated	6
p	p	p	7
2/2	2/2	2/2	8
3230	3230	3000	9
152	152	152	10
III	III	III	11
45x125x1050	45x125x1050	45x125x1050	12
286x1044	286x1044	286x1044	13
6/10	6/10	6/10	14
2700	2730	2765	15
1197	1197	1255	16
2165	2165	2165	17
4490	4490	4260	18
2183	2183	2183	19
1026	1026	1026	20
2365	2395	2420	21
485	485	495	22
2850	2880	2915	23
2050	2100	2170	23a
18/19	18/19	18.5/19.5	24
510/600	530/600	520/600	25
510/460	510/460	510/460	26
1890	1880	1810	27
26.5	25	22.5	28
			29
4380	4560	4750	30
6540/1050	6890/920	7300/950	31
1800/2580	1760/2800	1750/3000	32
2/2	2/2	2/2	33
28x9x15-12	28x9x15-12	250x15-18	34
6.50x10-10	6.50x10-12	6.50x10-12	35
1700	1700	1700	36
982/1000	982/1000	1026/1000	37
105	105	105	38
143	143	143	39
foot/hyd	foot/hyd	foot/hyd	40
hand/mech	hand/mech	hand/mech	41
12/65	12/65	12/65	42
G430FE	G430FE	G430FE	43
49.5(66.3)/2600	49.5(66.3)/2600	49.5(66.3)/2600	44
203(150)/1600	203(150)/1600	203(150)/1600	45
4/4/2967	4/4/2967	4/4/2967	46
powershift	powershift	powershift	47
1/1	1/1	1/1	48
216/156	216/156	216/156	49
			50

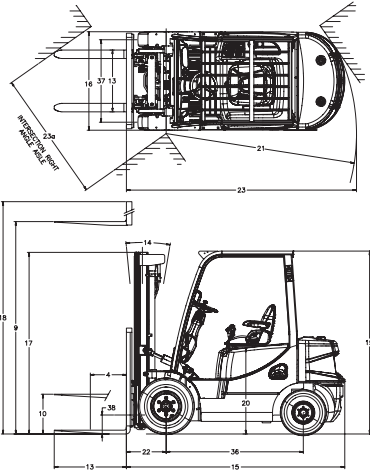

Specifications

CHARACTERISTICS			
1	MANUFACTURER		DOOSAN
2	MODEL		GC20E-5
3	CAPACITY	at rated load center	kg 2000
4	LOAD CENTER	distance	mm 500
5	POWER TYPE	electric, diesel, gas, LPG-gas	LP
6	OPERATOR TYPE	stand-on, ride-seated	ride-seated
7	TIRES	C=cushion, P=pneumatic	C
8	WHEELS(x=driven)	number of front/rear	2/2
DIMENSIONS			
9	LIFT WITH STD TWO-STAGE MAST	maximum fork height with rated load	mm 3230
10		free lift	mm 152
11	FORK CARRIAGE	ISO class	II
12	FORKS	thickness x width x length	mm 40x100x1050
13		fork spacing (maximum x minimum)	mm 297x905
14	TILT OF MAST	forward/backward	deg 6/8
15	OVERALL DIMENSIONS	length without forks	mm 2218
16		width	mm 1110
17		mast lowered height	mm 2130
18		mast extended height	mm 4480
19		overhead guard height	mm 2150
20		seat height	mm 1038
21	OUTSIDE TURNING RADIUS		mm 2000
22	LOAD MOMENT CONSTANT		mm 367
23	90. STACKING AISLE		mm 2367
23a	90. INTERSECTING AISLE		mm 1798
PERFORMANCE			
24	SPEED	travel, loaded/unloaded	km/hr 16/16
25		lift, loaded/unloaded	mm/s 530/600
26		lowering, loaded/unloaded	mm/s 510/460
27	DRAWBAR PULL	at 1.6km/hr, loaded/unloaded	kg 1795
28	GRADEABILITY	at 1.6km/hr, loaded/unloaded	% 35.5
29	ACCELERATION	time reached at max speed, loaded/unloaded	sec
WEIGHT			
30	TOTAL WEIGHT at unloaded		kg 3410
31	AXLE LOAD	at loaded, front/rear	kg 4770/640
32		at unloaded, front/rear	kg 1540/1870
CHASSIS			
33	TIRES	number of front/rear	2/2
34		front size	21x7-15
35		rear size	16x5-10.5
36	WHEEL BASE		mm 1410
37	TREAD	front/rear	mm 932/983
38	GROUND CLEARANCE	at loaded, the lowest point	mm 90
39		at loaded, center of wheelbase	mm 135
40	SEVICE BRAKE		foot/hyd
41	PARKING BRAKE		hand/mech
DRIVE			
42	BATTERY	voltage/capacity	V/AH 12/45
43	ENGINE	manufacturer/model	G420F(E)
44		rated output / rpm	kw(hp) 39.9(53.5)/2500
45		max. torque / rpm	N*m(lb*ft) 157(116)/1600
46		cycle/cylinders/displacement	cc 4/4/1975
47	TRANSMISSION	type	powershift
48		number of speeds forward/reverse	1/1
49	OPERATING PRESSURE	system/attachment	bar 181/156
50	NOISE LEVEL	equivalent continuous sound pressure level (Leq) at operator's ear (DI : BITA/CE prEN 12053)	dB(A)

General Section

DOOSAN	DOOSAN	DOOSAN	1
GC25E-5	GC30E-5	GC33E-5	2
2500	3000	3000(6500LBS)	3
500	500	600	4
LP	LP	LP	5
rider-seated	rider-seated	rider-seated	6
C	C	C	7
2/2	2/2	2/2	8
3230	3230	3230	9
152	152	152	10
II	III	III	11
40x100x1050	45x125x1050	45x125x1050	12
297x905	282x954	282x954	13
6/8	6/8	6/8	14
2268	2333	2368	15
1110	1110	1110	16
2130	2130	2130	17
4480	4480	4480	18
2150	2150	2150	19
1038	1038	1038	20
2045	2105	2135	21
367	373	373	22
2412	2478	2508	23
1822	1872	1907	23a
16/16	16/16	16/16	24
510/600	500/600	500/600	25
510/460	510/460	510/460	26
1775	1750	1740	27
30	25.5	23.5	28
			29
3710	4180	4350	30
5500/710	6330/850	6490/860	31
1460/2250	1470/2710	1420/2930	32
2/2	2/2	2/2	33
21x7-15	21x8-15	21x8-15	34
16x5-10.5	16x6-10.5	16x6-10.5	35
1410	1410	1410	36
932/983	907/956	907/956	37
90	90	90	38
135	135	135	39
foot/hyd	foot/hyd	foot/hyd	40
hand/mech	hand/mech	hand/mech	41
12/45	12/45	12/45	42
G420F(E)	G420F(E)	G420F(E)	43
39.9(53.5)/2500	39.9(53.5)/2500	39.9(53.5)/2500	44
157(116)/1600	157(116)/1600	157(116)/1600	45
4/4/1975	4/4/1975	4/4/1975	46
powershift	powershift	powershift	47
1/1	1/1	1/1	48
195/156	216/156	216/156	49
			50

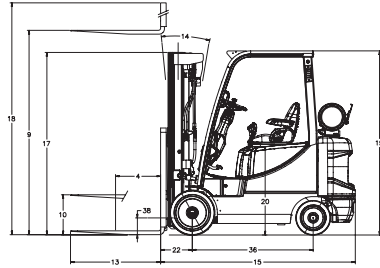
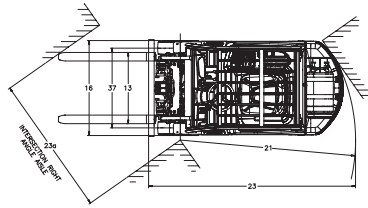

Specifications

CHARACTERISTICS			
1	MANUFACTURER		DOOSAN
2	MODEL		GC20P-5
3	CAPACITY	at rated load center	kg
4	LOAD CENTER	distance	mm
5	POWER TYPE	electric, diesel, gas, LPG-gas	LP
6	OPERATOR TYPE	stand-on, ride-seated	ride-seated
7	TIRES	C=cushion, P=pneumatic	C
8	WHEELS(x=driven)	number of front/rear	2/2
DIMENSIONS			
9	LIFT WITH STD TWO-STAGE MAST	maximum fork height with rated load	mm
10		free lift	mm
11	FORK CARRIAGE	ISO class	II
12	FORKS	thickness x width x length	mm
13		fork spacing (maximum x minimum)	mm
14	TILT OF MAST	forward/backward	deg
15	OVERALL DIMENSIONS	length without forks	mm
16		width	mm
17		mast lowered height	mm
18		mast extended height	mm
19		overhead guard height	mm
20		seat height	mm
21	OUTSIDE TURNING RADIUS		mm
22	LOAD MOMENT CONSTANT		mm
23	90. STACKING AISLE		mm
23a	90. INTERSECTING AISLE		mm
PERFORMANCE			
24	SPEED	travel, loaded/unloaded	km/hr
25		lift, loaded/unloaded	mm/s
26		lowering, loaded/unloaded	mm/s
27	DRAWBAR PULL	at 1.6km/hr, loaded/unloaded	kg
28	GRADEABILITY	at 1.6km/hr, loaded/unloaded	%
29	ACCELERATION	time reached at max speed, loaded/unloaded	sec
WEIGHT			
30	TOTAL WEIGHT at unloaded		kg
31	AXLE LOAD	at loaded, front/rear	kg
32		at unloaded, front/rear	kg
CHASSIS			
33	TIRES	number of front/rear	2/2
34		front size	21x7-15
35		rear size	16x5-10.5
36	WHEEL BASE		mm
37	TREAD	front/rear	mm
38	GROUND CLEARANCE	at loaded, the lowest point	mm
39		at loaded, center of wheelbase	mm
40	SEVICE BRAKE		foot/hydr
41	PARKING BRAKE		hand/mech
DRIVE			
42	BATTERY	voltage/capacity	V/AH
43	ENGINE	manufacturer/model	G424F(E)
44		rated output / rpm	kw(hp)
45		max. torque / rpm	N•m(lb•ft)
46		cycle/cylinders/displacement	cc
47	TRANSMISSION	type	powershift
48		number of speeds forward/reverse	1/1
49	OPERATING PRESSURE	system/attachment	bar
50	NOISE LEVEL	equivalent continuous sound pressure level (Leq) at operator's ear (DI : BITA/CE prEN 12053)	dB(A)

General Section

DOOSAN	DOOSAN	DOOSAN	1
GC25P-5	GC30P-5	GC33P-5	2
2500	3000	3000(6500LBS)	3
500	500	600	4
LP	LP	LP	5
rider-seated	rider-seated	rider-seated	6
C	C	C	7
2/2	2/2	2/2	8
3230	3230	3230	9
152	152	152	10
II	III	III	11
40x100x1050	45x125x1050	45x125x1050	12
297x905	282x954	282x954	13
6/8	6/8	6/8	14
2268	2333	2368	15
1110	1110	1110	16
2130	2130	2130	17
4480	4480	4480	18
2150	2150	2150	19
1038	1038	1038	20
2045	2105	2135	21
367	373	373	22
2419	2479	2509	23
1822	1872	1907	23a
16/16	16/16	16/16	24
510/600	500/600	500/600	25
510/460	510/460	510/460	26
2050	2125	2115	27
37	31	29	28
			29
3730	4200	4370	30
5510/720	6340/860	6500/870	31
1470/2260	1490/2710	1430/2940	32
2/2	2/2	2/2	33
21x7-15	21x8-15	21x8-15	34
16x5-10.5	16x6-10.5	16x6-10.5	35
1410	1410	1410	36
932/983	907/956	907/956	37
90	90	90	38
135	135	135	39
foot/hyd	foot/hyd	foot/hyd	40
hand/mech	hand/mech	hand/mech	41
12/65	12/65	12/65	42
G424F(E)	G424F(E)	G424F(E)	43
47.7(64)/2550	47.7(64)/2550	47.7(64)/2550	44
182(135)/2200	182(135)/2200	182(135)/2200	45
4/4/2405	4/4/2405	4/4/2405	46
powershift	powershift	powershift	47
1/1	1/1	1/1	48
195/156	216/156	216/156	49
			50

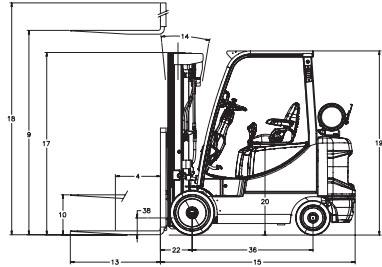
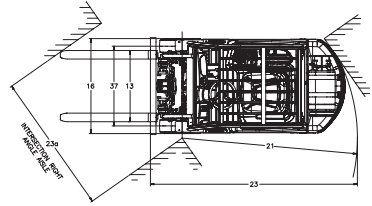

Noise and Vibration

Model	Sound Pressure Level at Operator's ear (Leq.) according to EN12053 Guaranteed Sound	Power level(L _{WA}) By Noise Directive 2000/14/EC	Whole-body Vibration Level according to EN13059 (m/s ²)	
	dB(A)	dB(A)	Mean	Uncertainty
TIER - II (B3.3 E/G) D20S-5,D25S-5,D30S-5, D33S-5, D35C-5 (W/O Cabin)	82	104	0.7	0.2
TIER - III (4TNE98 E/G) D20S-5,D25S-5,D30S-5, (W/O Cabin)	83	105		
TIER - III (4TNE98 E/G) D33S-5, D35C-5 (W/O Cabin)	85	106		
TIER - III (G420F(E) E/G) G20E-5,G25E-5,G30E-5 (W/O Cabin)	82	104		
TIER - III (G424I(E) E/G) G20E-5,G25E-5,G30E-5 (W/O Cabin)	82	105		
TIER - III (G424F(E) E/G) G20P-5,G25P-5,G30P-5, G33P-5,G35C-5 (W/O Cabin)	84	106		
TIER - III (G430FE E/G) G20P-5 Plus,G25P-5 Plus, G30P-5 Plus,G33P-5 Plus, G35C-5 Plus (W/O Cabin)	83	106		
TIER - III (G420F(E) E/G) GC20E-5,GC25E-5,GC30E-5, GC33E-5 (W/O Cabin)	80	*NA	1.1	0.3
TIER - III (G424F(E) E/G) GC20P-5,GC25P-5,GC30P-5, GC33P-5 (W/O Cabin)	82	*NA		

* NA : Not Applicable

Capacity Chart (Without Sideshifter Pneumatic)

MODEL	SINGLE TIRE	
	STD, FFL	FFT
D20S-5, G20E-5, G20P-5, G20P-5 Plus	<p>A. 2030–4350mm MFH MAST B. 4960mm MFH MAST</p>	<p>A. 3900–4290mm MFH MAST B. 4730mm MFH MAST C. 5560mm MFH MAST D. 6010mm MFH MAST</p>
	<p>A. 2030–4350mm MFH MAST B. 4960mm MFH MAST</p>	<p>A. 3900–4290mm MFH MAST B. 4730mm MFH MAST C. 5560mm MFH MAST D. 6010mm MFH MAST</p>
D30S-5, G30E-5, G30P-5, G30P-5 Plus	<p>A. 2030–4350mm MFH MAST B. 4960mm MFH MAST</p>	<p>A. 3900–4730mm MFH MAST B. 5560mm MFH MAST C. 6010mm MFH MAST</p>

Capacity Chart (Without Sideshifter Pneumatic)

MODEL	SINGLE TIRE	
	STD, FFL	FFT
D33S-5, G33P-5, G33P-5 Plus	<p>A. 2030–3800mm MFH MAST B. 3950–4350mm MFH MAST C. 4960mm MFH MAST</p>	<p>A. 3900–4290mm MFH MAST B. 4730mm MFH MAST C. 5560mm MFH MAST D. 6010mm MFH MAST</p>
	<p>A. 1800–3805mm MFH MAST B. 4205mm MFH MAST C. 4805mm MFH MAST</p>	<p>A. 3555–3960mm MFH MAST B. 4380mm MFH MAST C. 4820mm MFH MAST D. 5205mm MFH MAST E. 5655mm MFH MAST</p>

Capacity Chart (Without Sideshifter Pneumatic)

MODEL	DOUBLE TIRE	
	STD, FFL	FFT
D20S-5, G20E-5, G20P-5, G20P-5 Plus	<p>A. 2030–4350mm MFH MAST B. 4960mm MFH MAST</p>	<p>A. 3900–4290mm MFH MAST B. 4730mm MFH MAST C. 5560mm MFH MAST D. 6010mm MFH MAST</p>
	<p>A. 2030–4350mm MFH MAST B. 4960mm MFH MAST</p>	<p>A. 3900–4730mm MFH MAST B. 5560mm MFH MAST C. 6010mm MFH MAST</p>
D30S-5, G30E-5, G30P-5, G30P-5 Plus	<p>A. 2030–4350mm MFH MAST B. 4960mm MFH MAST</p>	<p>A. 3900–4730mm MFH MAST B. 5560mm MFH MAST C. 6010mm MFH MAST</p>

Capacity Chart (Without Sideshifter Pneumatic)

MODEL	DOUBLE TIRE	
	STD, FFL	FFT
D33S-5, G33P-5, G33P-5 Plus	<p>A. 2030–4350mm MFH MAST B. 4960mm MFH MAST</p>	<p>A. 3900–4290mm MFH MAST B. 4730mm MFH MAST C. 5560mm MFH MAST D. 6010mm MFH MAST</p>
	<p>A. 1800–3805mm MFH MAST B. 4205mm MFH MAST C. 4805mm MFH MAST</p>	<p>A. 3555–3960mm MFH MAST B. 4380mm MFH MAST C. 4820mm MFH MAST D. 5205mm MFH MAST E. 5655mm MFH MAST</p>

Capacity Chart (With Sideshifter Pneumatic)

MODEL	SINGLE TIRE	
	STD, FFL	FFT
D20S-5, G20E-5, G20P-5, G20P-5 Plus	<p>A. 2300–3950mm MFH MAST B. 4350mm MFH MAST C. 4960mm MFH MAST</p>	<p>A. 3900mm MFH MAST B. 4290mm MFH MAST C. 4730mm MFH MAST D. 5560mm MFH MAST E. 6010mm MFH MAST</p>
	<p>A. 2030–3950mm MFH MAST B. 4350mm MFH MAST C. 4960mm MFH MAST</p>	<p>A. 3900mm MFH MAST B. 4290mm MFH MAST C. 4730mm MFH MAST D. 5560mm MFH MAST E. 6010mm MFH MAST</p>
D30S-5, G30E-5, G30P-5, G30P-5 Plus	<p>A. 2030–3950mm MFH MAST B. 4350mm MFH MAST C. 4960mm MFH MAST</p>	<p>A. 3900mm MFH MAST B. 4290mm MFH MAST C. 4730mm MFH MAST D. 5560mm MFH MAST E. 6010mm MFH MAST</p>

Capacity Chart (With Sideshifter Pneumatic)

MODEL	SINGLE TIRE	
	STD, FFL	FFT
D33S-5, G33P-5, G33P-5 Plus	<p>A. 2030–3800mm MFH MAST B. 3950mm MFH MAST C. 4350mm MFH MAST D. 4960mm MFH MAST</p>	<p>A. 3900mm MFH MAST B. 4290mm MFH MAST C. 4730mm MFH MAST D. 5560mm MFH MAST E. 6010mm MFH MAST</p>
	D35C-5, G35C-5, G35C-5 Plus	<p>A. 1800–3805mm MFH MAST B. 4205mm MFH MAST C. 4805mm MFH MAST</p>

Capacity Chart (With Sideshifter Pneumatic)

MODEL	DOUBLE TIRE	
	STD, FFL	FFT
D20S-5, G20E-5, G20P-5, G20P-5 Plus	<p>A. 2030–3950mm MFH MAST B. 4350mm MFH MAST C. 4960mm MFH MAST</p>	<p>A. 3900mm MFH MAST B. 4290mm MFH MAST C. 4730mm MFH MAST D. 5560mm MFH MAST E. 6010mm MFH MAST</p>
	<p>A. 2030–3950mm MFH MAST B. 4350mm MFH MAST C. 4960mm MFH MAST</p>	<p>A. 3900mm MFH MAST B. 4290mm MFH MAST C. 4730mm MFH MAST D. 5560mm MFH MAST E. 6010mm MFH MAST</p>
D30S-5, G30E-5, G30P-5, G30P-5 Plus	<p>A. 2030–3950mm MFH MAST B. 4350mm MFH MAST C. 4960mm MFH MAST</p>	<p>A. 3900mm MFH MAST B. 4290mm MFH MAST C. 4730mm MFH MAST D. 5560mm MFH MAST E. 6010mm MFH MAST</p>

Capacity Chart (With Sideshifter Pneumatic)

MODEL	DOUBLE TIRE	
	STD, FFL	FFT
D33S-5, G33P-5, G33P-5 Plus	<p>A. 2030–3950mm MFH MAST B. 4350mm MFH MAST C. 4960mm MFH MAST</p>	<p>A. 3900mm MFH MAST B. 4290mm MFH MAST C. 4730mm MFH MAST D. 5560mm MFH MAST E. 6010mm MFH MAST</p>
	<p>A. 1800–3805mm MFH MAST B. 4205mm MFH MAST C. 4805mm MFH MAST</p>	<p>A. 3555–3960mm MFH MAST B. 4380mm MFH MAST C. 4820mm MFH MAST D. 5205mm MFH MAST E. 5655mm MFH MAST</p>

Capacity Chart (Without Sideshifter cushion)

MODEL	NARROW TIRE	
	STD, FFL	FFT
GC20E-5, GC20P-5	<p>A. 2030-4350mm MFH MAST B. 4960mm MFH MAST</p>	<p>A. 3900-4290mm MFH MAST B. 4730mm MFH MAST C. 5560mm MFH MAST D. 6010mm MFH MAST</p>
	<p>A. 2030-4350mm MFH MAST B. 4960mm MFH MAST</p>	<p>A. 3900mm MFH MAST B. 4290mm MFH MAST C. 4730mm MFH MAST D. 5560mm MFH MAST E. 6010mm MFH MAST</p>
GC30E-5, GC30P-5	<p>A. 2030-3950mm MFH MAST B. 4350mm MFH MAST C. 4960mm MFH MAST</p>	<p>A. 3900-4290mm MFH MAST B. 4730mm MFH MAST C. 5560mm MFH MAST D. 6010mm MFH MAST</p>

Capacity Chart (Without Sideshifter cushion)

MODEL	NARROW TIRE	
	STD, FFL	FFT
GC33E-5, GC33P-5	<p>A. 2030–3950mm MFH MAST B. 4350mm MFH MAST C. 4960mm MFH MAST</p>	<p>A. 3900mm MFH MAST B. 4290mm MFH MAST C. 4730mm MFH MAST D. 5560mm MFH MAST E. 6010mm MFH MAST</p>

Capacity Chart (Without Sideshifter cushion)

MODEL	WIDE TIRE	
	STD, FFL	FFT
GC20E-5, GC20P-5	<p>A. 2030-4350mm MFH MAST B. 4960mm MFH MAST</p>	<p>A. 3900-4290mm MFH MAST B. 4730mm MFH MAST C. 5560mm MFH MAST D. 6010mm MFH MAST</p>
	<p>A. 2030-3950mm MFH MAST B. 4350mm MFH MAST C. 4960mm MFH MAST</p>	<p>A. 3900mm MFH MAST B. 4290mm MFH MAST C. 4730mm MFH MAST D. 5560mm MFH MAST E. 6010mm MFH MAST</p>
GC30E-5, GC30P-5	<p>A. 2030-3950mm MFH MAST B. 4350mm MFH MAST C. 4960mm MFH MAST</p>	<p>A. 3900-4290mm MFH MAST B. 4730mm MFH MAST C. 5560mm MFH MAST D. 6010mm MFH MAST</p>

Capacity Chart (Without Sideshifter cushion)

MODEL	WIDE TIRE	
	STD, FFL	FFT
GC33E-5, GC33P-5		
	<p>A. 2030-3950mm MFH MAST B. 4350mm MFH MAST C. 4960mm MFH MAST</p>	<p>A. 3900mm MFH MAST B. 4290mm MFH MAST C. 4730mm MFH MAST D. 5560mm MFH MAST E. 6010mm MFH MAST</p>

Capacity Chart (With Sideshifter cushion)

MODEL	NARROW TIRE	
	STD, FFL	FFT
GC20E-5, GC20P-5	<p>A. 2030–3950mm MFH MAST B. 4350mm MFH MAST C. 4960mm MFH MAST</p>	<p>A. 3900mm MFH MAST B. 4290mm MFH MAST C. 4730mm MFH MAST D. 5560mm MFH MAST E. 6010mm MFH MAST</p>
	<p>A. 2030–3950mm MFH MAST B. 4350mm MFH MAST C. 4960mm MFH MAST</p>	<p>A. 3900mm MFH MAST B. 4290mm MFH MAST C. 4730mm MFH MAST D. 5560mm MFH MAST E. 6010mm MFH MAST</p>
GC30E-5, GC30P-5	<p>A. 2030–3950mm MFH MAST B. 4350mm MFH MAST C. 4960mm MFH MAST</p>	<p>A. 3900mm MFH MAST B. 4290mm MFH MAST C. 4730mm MFH MAST D. 5560mm MFH MAST E. 6010mm MFH MAST</p>

Capacity Chart (With Sideshifter cushion)

MODEL	NARROW TIRE	
	STD, FFL	FFT
GC33E-5, GC33P-5		
	<p>A. 2030–3950mm MFH MAST B. 4350mm MFH MAST C. 4960mm MFH MAST</p>	<p>A. 3900mm MFH MAST B. 4290mm MFH MAST C. 4730mm MFH MAST D. 5560mm MFH MAST E. 6010mm MFH MAST</p>

Capacity Chart (With Sideshifter cushion)

MODEL	WIDE TIRE	
	STD, FFL	FFT
GC20E-5, GC20P-5	<p>A. 2030–3950mm MFH MAST B. 4350mm MFH MAST C. 4960mm MFH MAST</p>	<p>A. 3900mm MFH MAST B. 4290mm MFH MAST C. 4730mm MFH MAST D. 5560mm MFH MAST E. 6010mm MFH MAST</p>
	<p>A. 2030–3950mm MFH MAST B. 4350mm MFH MAST C. 4960mm MFH MAST</p>	<p>A. 3900mm MFH MAST B. 4290mm MFH MAST C. 4730mm MFH MAST D. 5560mm MFH MAST E. 6010mm MFH MAST</p>
GC30E-5, GC30P-5	<p>A. 2030–3950mm MFH MAST B. 4350mm MFH MAST C. 4960mm MFH MAST</p>	<p>A. 3900mm MFH MAST B. 4290mm MFH MAST C. 4730mm MFH MAST D. 5560mm MFH MAST E. 6010mm MFH MAST</p>

Capacity Chart (With Sideshifter cushion)

MODEL	WIDE TIRE	
	STD, FFL	FFT
GC33E-5, GC33P-5	<p>A. 2030–3950mm MFH MAST B. 4350mm MFH MAST C. 4960mm MFH MAST</p>	<p>A. 3900mm MFH MAST B. 4290mm MFH MAST C. 4730mm MFH MAST D. 5560mm MFH MAST E. 6010mm MFH MAST</p>

Serial Number

Serial Number Locations

For quick reference, record your lift truck's serial numbers in the spaces provided below the photographs.



Lift Truck Serial Number

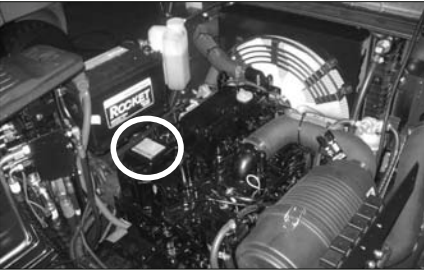

3.3 liter Diesel Engine (4TNV98) Serial Number

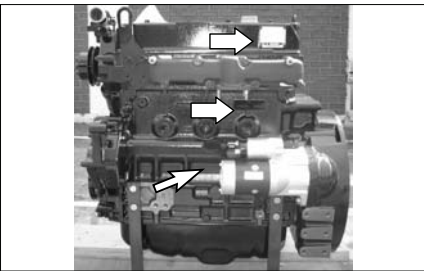

3.3 liter Diesel Engine (4TNE98) Serial Number

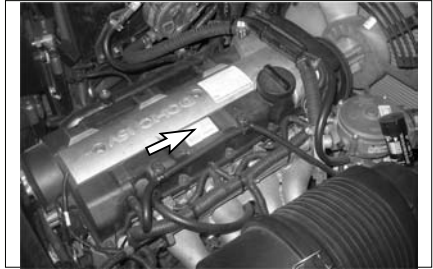

2.0 liter Spark-Ignition Engine Serial Number (G420F(E))

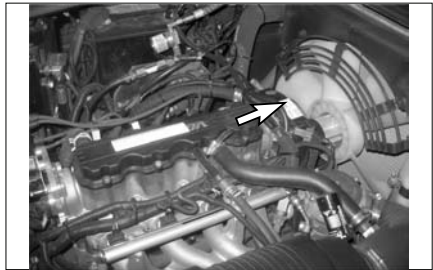

2.4 liter Spark-Ignition Engine Serial Number (G424F(E))

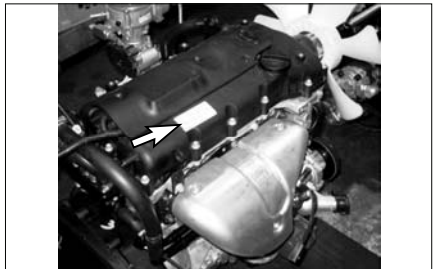

2.4 liter Spark-Ignition Engine Serial Number (G424I(E))

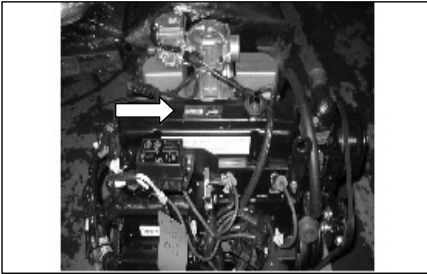

3.0 liter Spark-Ignition Engine Serial Number (G430FE)

• _____



ILOG005P
Typical Example

Side Shifter Serial Number (If Equipped)

• _____

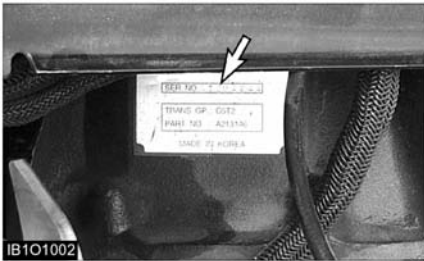

Power Shift Transmission Serial Number

• _____

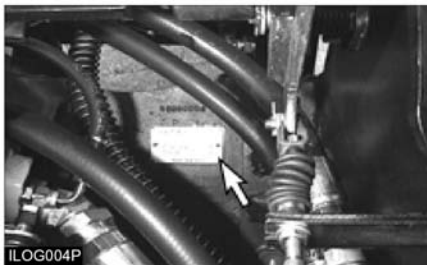

Drive Axle Serial Number

• _____

Attachment Abbreviations (Includes Special Forks)

SC	-Special Carriage-increased width, height or outreach
SSS	-Shaft-type Sideshift Carriage
HSS	-Hook-type Sideshift Carriage (ITA)
CW	-Counterweight
SF	-Special Forks
SWS	-Swing Shift, Sideshift
RAM	-Ram or Boom
DBC BH	-Double Cube Block Handler
HFP	-Hydraulic Fork Positioner
CR	-Crane Arm or Crane Boom
TH	-Tire Handler
CTH	-Container Handler
LPP	-Load Push-Pull Device
CC	-Carton Clamp
RC	-Roll Clamp
LS	-Load Stabilizer
PWH	-Pulp Wood Handler
SS-ST	Sideshift-Side Tilt Carriage

Operator's Warning and Identification Plate

Familiarize yourself with the OPERATOR'S WARNING PLATE and IDENTIFICATION, LIFT CAPACITY and ATTACHMENT PLATES. DO NOT exceed capacity as equipped load ratings.

Operator's Warning Plate



Located on the right side of the operator's seat.

Identification, Lift Capacity and Attachment Plate

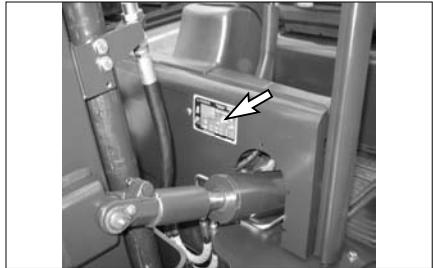

Located on the cowl to the right side of the steering column.

If Convenience Package Equipped



Located on the overhead guard.

Below are abbreviations that may appear on the IDENTIFICATION, LIFT CAPACITY and ATTACHMENT PLATES and their meanings.

Mast Abbreviations

- STD - Standard Mast (single inner member, low free lift)
- FF - Full Free Lift Mast (single inner member with high free lift duplex cylinder)
- FFT - Triple Lift Mast (two inner members) with either low or full free lift characteristics.
- QUAD - Quadruple (Quad) Mast (with three inner members)

NOTE: When only a mast-type is listed on the identification plate, a standard carriage and forks are used.

Operator's Station and Monitoring Systems

Instrument Panel

Your lift truck may not have the same indicator or warning lights as shown in the illustrations. Due to the various options available, typical instrument panels are shown.

However, the symbols on the indicators and lights on your panel identify what those particular items are. Also, the symbol for each of the items is identified and an explanation of their function and location is described on the following pages.

Diesel (12V)

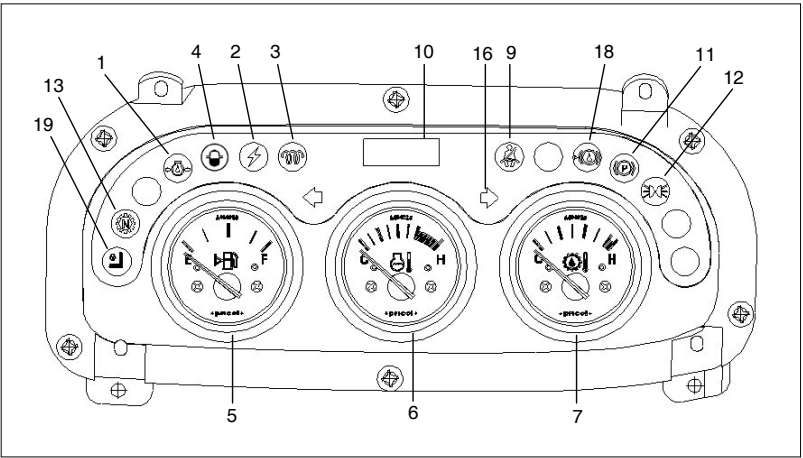

LPG/GAS (12V)

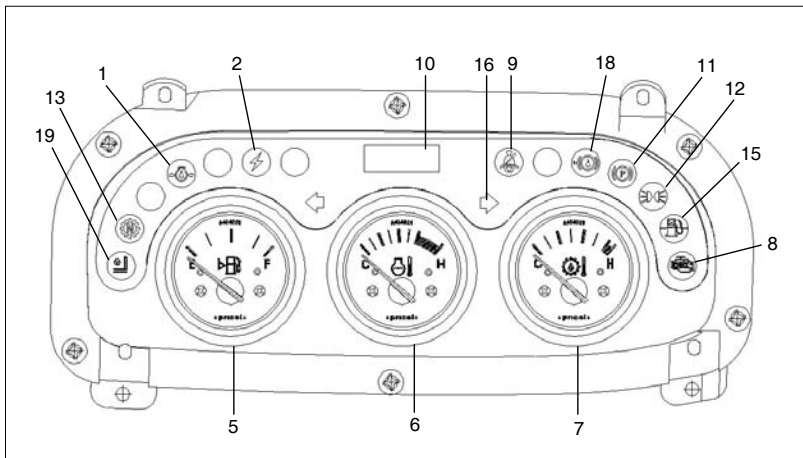



1. Engine Oil Pressure Indicator Light - (Except for G430FE) Indicates insufficient engine oil pressure. The light will come on when the ignition switch is turned to the ON position. The light should go off after the engine is started. If the light turns on while operating the lift truck, insufficient engine oil pressure is indicated. Park the lift truck and stop the engine.



2. Alternator Indicator Light - Indicates if the battery charging system is operational. The light will come on when the ignition switch is turned to the ON position.

The light should go off after the engine is started, indicating the alternator is producing sufficient voltage to charge the battery. If the light turns on with the engine running, check the alternator charging system for a malfunction.



3. Diesel Engine Start Preheat Indicator Light - The light will come ON when the key is turned to the ON position from the OFF position. This indicates that the glow plugs are preheating the pre-combustion chambers for easier starting.

The amount of time needed to preheat the pre-combustion chambers is approximately seven seconds, depending on the surrounding air temperature. When the light goes OFF the maximum pre-combustion chamber temperature has been reached and the key can be turned to the START position to start the engine.



4. Diesel Engine Water in Fuel Filter Indicator Light - Indicates when the engine is running, there is water in the fuel filter exceeds 100cc.

The light will come ON when the ignition switch is turned to the ON position. The light should go off after the engine is started. If the light turns on with the engine running, park the lift truck and stop the engine.

Drain some fuel (and any water) until clean fuel flows from the filter which approximately takes 5 to 6 seconds



5. Fuel Level Gauge - Indicates fuel level (Gas, Diesel, or Dual Fuel Trucks Only)



6. Engine Coolant Temperature Gauge - Indicates coolant temperature. If both tenth & ninth flash out of phase while operating the lift truck, overheating is indicated. Park the lift truck and stop the engine.

Check the cooling system for a malfunction. Both tenth & ninth will flash out of phase when the coolant temperature reaches approximately 106°C (223°F) on all engines.



7. Transmission Oil Temperature Gauge - Indicates transmission oil temperature. If both tenth & ninth flash out of phase while operating the lift truck, excessive transmission oil temperature is indicated. Park the lift truck and stop the engine.



8. G420F(E)/G424F(E)/G424I(E)/G430FE Engine Malfunction Indicator Lamp (MIL)

G420F(E) and G424F(E) and G424I(E) and G430FE engine control systems are equipped with built-in fault diagnostics. Detected system faults can be displayed by the Malfunction Indicator Lamp (MIL) as Diagnostic Fault Codes (DFC) or flash codes, and viewed in detail with the use of service tool software. When the ignition key is turned ON the MIL will perform a self-test, illuminate once and then go OFF. If a detected fault condition exists, the fault or faults will be stored in the memory of the engine control module (ECM). Once a fault occurs the MIL will illuminate and remain ON. This signals the operator that a fault has been detected by the SECM.



9. Seat Belt Warning Light (If Equipment)

Indicates when the seat belt dose not fastened by operator.

The light will come on when the ignition switch is turned to the on position.

The light should go off after engine is started.



10. Service hour Meter - Indicates the total number of hours the engine and the lift truck have operated. The hour meter will operate when the ignition switch is in the ON position, whether the engine is running or not. The hour meter is used to determine lubrication and maintenance intervals.



11. Parking indicator light- The light will come ON when the parking lever is applied.





12. Front Floodlights- Push down on the switch(14), to the first step, to turn the front floodlights on.

Front and Rear Floodlights – Push down on the switch(14), to the second step, to turn both the front and rear floodlights on. The floodlights are optional.

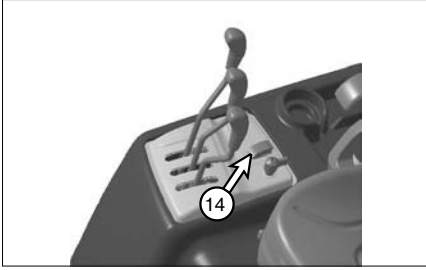

13. Transmission Neutral Position Light - Indicates the neutral position of transmission.





-  **14. Front and Rear Floodlights Switch** – The front floodlight is ON when push down switch to the first step.

The front and rear floodlights are ON when push down switch to the second step.

-  **15. Low Level Light of LP GAS** – Indicates the low Level of LP GAS (LP or DUAL only)

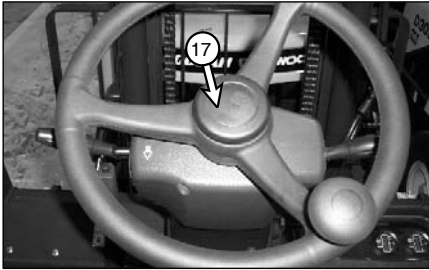
-  **16. Directional Turning Indicator Light**



-  **17. Horn Switch** - Push on the horn button to sound the horn.

-  **18. Brake oil level** – Brake oil level Lamp indicates when the brake oil level is low.

-  **19. Mast interlock** – Alarm warning lights when operator leaves the seat without applying parking brake and then, operation of mast is automatically interrupted.

Electrical Disconnect Switch (If Equipped)

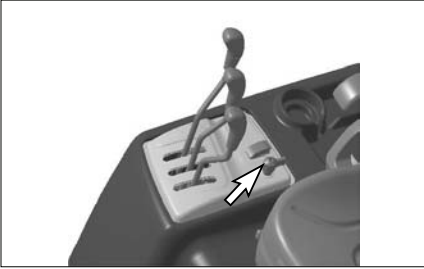

1. ON - Connects the battery for electrical power to all electrical circuits.



2. OFF - Disconnects the battery from all electrical circuits.

Engine Compartment

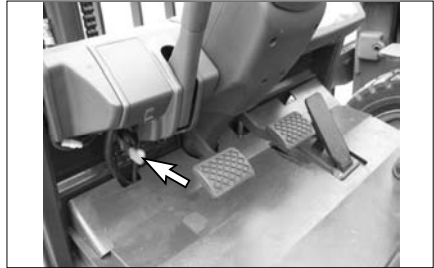

1. The engine compartment is accessible by pulling the latch (GC Series), or pushing down the lever located at cowl (G.D Series) and raising the hood and seat assembly (Note: Unlock latch before pulling-if key equipped)

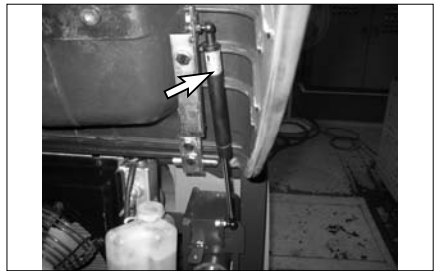

2. The hood and seat assembly is held up by a support cylinder. Make certain the air cylinder is operating properly and securely hold the hood up before doing anything in the engine compartment.

Seat Switch System (If Equipped)



The lift truck is equipped with a SEAT SWITCH SYSTEM. In normal operation if the direction lever is placed in either forward or reverse, the lift truck will move at a speed proportional to the accelerator pedal's position. If the operator leaves the seat without setting the parking brake, within three seconds after leaving the seat, the SEAT SWITCH SYSTEM will automatically disengage the transmission. The directional lever, however, will remain in that forward or reverse location although internally the transmission will have shifted into neutral.

Before exiting the lift truck, the parking brake should always be applied.

WARNING

WHEN LEAVING MACHINE APPLY PARKING BRAKE!

PARKING BRAKE IS NOT AUTOMATICALLY APPLIED.

NOTE: Some trucks may be equipped (ask your dealer if this applies to your truck) with an alarm that will sound if the parking brake is not applied when leaving the machine.

NOTICE

Prior to operating the lift truck, be sure to understand and check the SEAT SWITCH SYSTEM.

While in normal operation and on level ground, select a direction with the directional lever and with the park brake released. You will note that the truck will move slowly in the selected direction. If you lift your hips off of the seat, within three seconds, the SEAT SWITCH SYSTEM will disengage the transmission allowing the truck to coast but not automatically stop.

To restore the lift truck to normal operation, while sitting in the operator's seat depress the brake pedal to hold the lift truck, return the directional lever to the neutral position, and then reselect a direction of travel (either forward or reverse). The transmission will then re-engage.

If seat or seat switch replacement becomes necessary, be sure to use genuine DOOSAN Infracore lift truck parts. Lift trucks should never be operated without an operational SEAT SWITCH SYSTEM.

⚠ WARNING

When closing the engine hood, be careful not to pinch your hand.

Circuit Breaker



Circuit Breaker -Protects the main electrical circuits. To reset the circuit breaker, push the button in. Located in the engine compartment.

Seat

NOTE: Seat arrangements may vary. Basic operation will be similar.

Seat adjustment should be checked at the beginning of each shift and when operators change.

Lock the seat into position before operating, to prevent an unexpected seat change.

Adjust seat to allow full brake pedal travel with operator's back against seat back.



NOTE: The seat can only be correctly adjusted with the operator fully seated.

Tilt Steering Column

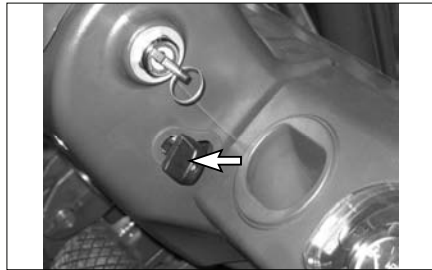

To adjust the steering column, push down the knob(1), and move the steering column to the desired position, then release the knob(1).

Fuel Selector Switch (G420F(E)/G424F(E)/G424I(E) Dual Fuel Only)

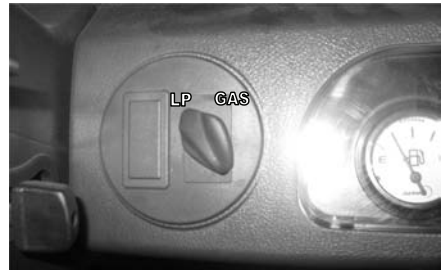

1. LPG - This position supplies electrical power to the LP fuellock solenoid, when the ignition switch is in the ON or the START position.

With the LP fuel tank valve open, LP can then flow the tank through the converter to the carburetor.



2. OFF – This position shuts off all fuel supply to the carburetor/injector.





3. GAS - This position supplies electrical power to gasoline fuel pump and injector. This will allow gasoline fuel to flow from the tank through the fuel filter and fuel pump to the injector.

Lift Truck Controls

Direction Control Lever



-  1. Forward - Push the lever forward for FORWARD direction travel.
-  2. Neutral - Move the lever to center position for NEUTRAL.
-  3. Reverse - Pull the lever back for REVERSE direction travel.

Transmission Inching Control Pedal

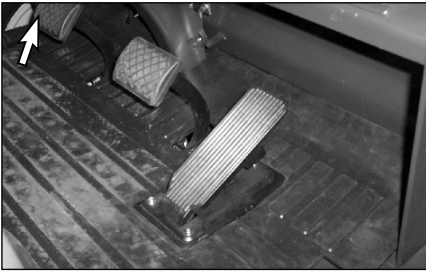



-  Inching Control Pedal - Pushing down on the inching pedal, modulates the hydraulic pressure to the clutch packs, permitting disc slippage.

Further pushing on the pedal completely relieves clutch pack pressure and applies the service brakes to stop and hold the lift truck.

NOTE: The purpose of the inching control pedal is to provide precise inching control at slow travel speed, with high engine rpm. This is used for fast hydraulic lift during load approach, pickup or positioning.

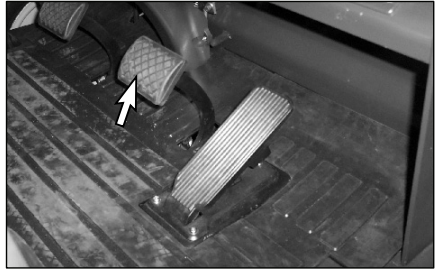

Service Brake Pedal

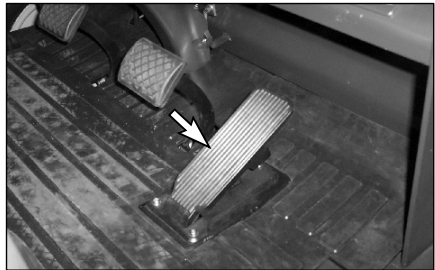

-  Push DOWN on the brake pedal to slow or stop the lift truck.
-  RELEASE the brake pedal to allow the lift truck to move.

Accelerator Pedal



-  Push DOWN on the pedal to increase engine rpm (speed).
-  RELEASE the pedal to decrease engine rpm (speed).

Parking Brake Lever

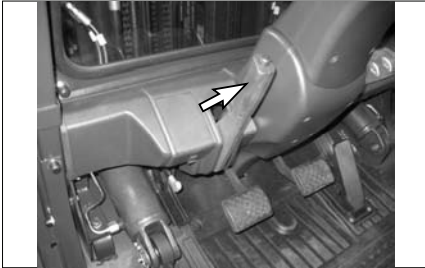

Pull the lever **BACK** to engage the parking brake.



Push the lever **FORWARD** to release the parking brake.

Lift Control

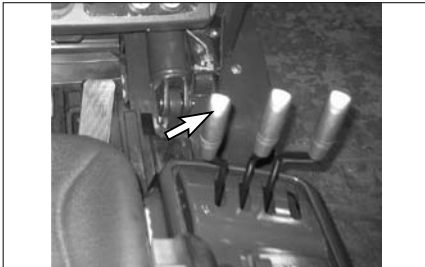

NOTE: To prevent a sudden change of position of the load, operate all lift, tilt and attachment controls smoothly.



1. Lower Position - Push the lever **FORWARD** smoothly to lower the load.



2. Hold Position - When the lever is released it will return to the **HOLD** or center position. Lifting or lowering action will stop.



3. Lift Position - Pull the lever **BACK** smoothly to lift the load.

Tilt Control

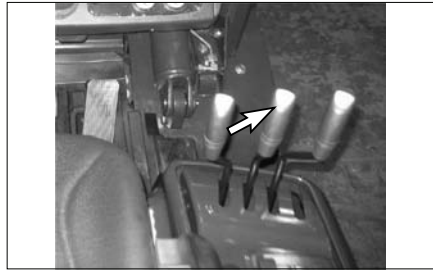

1. Mast Tilt Forward - Push the lever **FORWARD** smoothly to tilt the mast forward.



2. Mast Hold - When the lever is released it will return to the **HOLD** or center position. Tilting action will stop.



3. Mast Tilt Back - Pull the lever **BACK** smoothly to tilt the mast backward.

Sideshift Attachment (If Equipped)



1. Sideshift Left - Push the lever **FORWARD** to shift the carriage to the left.



2. Sideshift Hold - When the lever is released it will return to the **HOLD** or center position. Sideshifting action will stop.



3. Sideshift Right - Pull the lever **BACK** to shift the carriage to the right.

Refueling

Gasoline or Diesel Engine Equipped

⚠ WARNING

Explosive fumes may be present during refueling.

Do not smoke in refueling areas.

Lift truck should be refueled only at designated safe locations. Safe outdoor locations are preferable to those indoors.

Stop the engine and get off the lift truck during refueling.

NOTICE

Do not allow the lift truck to become low on fuel or completely run out of fuel. Sediment or other impurities in the fuel tank could be drawn into the fuel system. This could result in difficult starting or damage to components.

Fill the fuel tank at the end of each day of operation to drive out moisture laden air and to prevent condensation.

In the cold weather, the moisture condensation can cause rust in the fuel system and hard starting due to its freezing

Do not fill the tank to the top. Fuel expands when it gets warm and may overflow.



1. Park the lift truck only at a designated safe location. Place the transmission in NEUTRAL. Lower the forks to the ground. Engage the parking brake. Stop the engine.



2. Open the filter cap.
3. Fill the fuel tank slowly. Close the filter cap. If spillage occurs, wipe off excess fuel and wash down area with water.

NOTE: Drain water and sediment from fuel tank as required by prevailing conditions. Also, drain water and sediment from the main fuel storage tank weekly and before the tank is refilled. This will help prevent water or sediment being pumped from the storage tank into the lift truck fuel tank.

Changing LP Tanks

WARNING

Only trained, authorized personnel should fill or exchange LP tanks.

Personnel engaged in filling of LP containers should wear protective clothing such as face shield, long sleeves and gauntlet gloves.

Do not refuel or store LP powered lift trucks near any underground entrance, elevator shafts or any other place where LP could collect in a pocket causing a potentially dangerous condition.

Examine all LP containers before filling and again before reuse, for damage to various valves, liquid gauge, fittings and hand valve wheels.

All defective or damaged LP containers must be removed from service.

Explosive fumes may be present during refueling.

Do not smoke in refueling areas.

Lift truck should be refueled only at designated safe locations. Safe outdoor locations are preferable to indoor locations.

Stop the engine and get off the lift truck during refueling.

The careless handling of LP containers can result in a serious accident.

Use extreme care when transporting containers to prevent damage to them.

1. Park the lift truck on level ground, with the parking brake applied, the transmission in NEUTRAL, the forks lowered and the engine running at low idle.

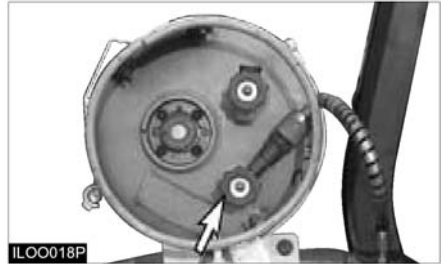

2. Close the fuel shut off valve at the LP tank. Run the engine until it stops, then turn off the ignition switch and the disconnect switch (if equipped).
3. Disconnect the fuel supply line.

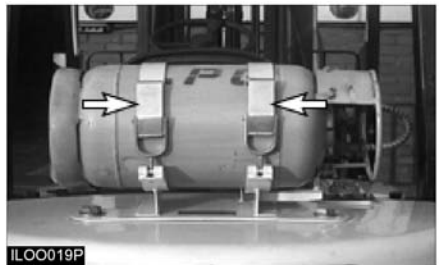

If Swing out type LP-Cradle Equipped



4. Loosen the retaining clamps and remove the tank.
5. Check the mounting to be sure the locating pin (dowel) is not missing or broken.

NOTICE

If the location pin (dowel) is missing or broken, be sure the pin is replaced.

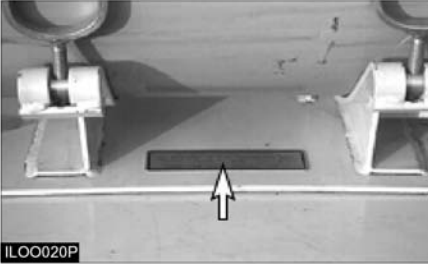

6. Check to be sure that the LP warning plate is in position on the lift truck, and is legible.
7. Check to be sure the replacement tank is of the correct type.
8. Inspect the replacement tank for damage such as dents, scrapes or gouges and for indication of leakage at valves or threaded connections.

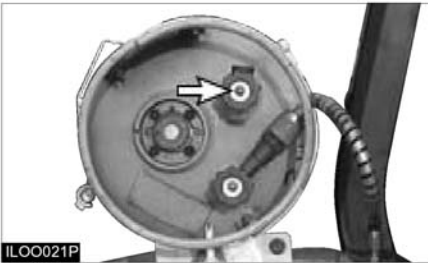

9. Check for debris in the relief valve, for damage to various valves and liquid level gauge.
10. Inspect the quick - disconnect couplings for deterioration, damage or missing flexible seals.

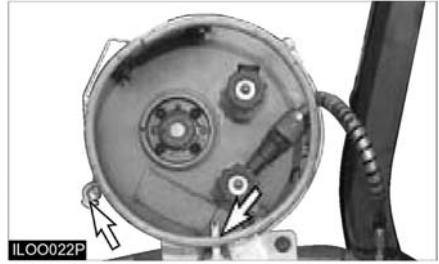

11. Position the replacement tank so that the locating pin (dowel) is in place.

⚠ WARNING

The LP tank must not extend past the counterweight

12. Clamp the tank securely.
13. Connect the fuel supply line.
14. Open the fuel valve by slowly turning it counterclockwise. If the fuel valve is opened too quickly, a back pressure check valve will shut off the fuel supply. If this happens, close the fuel valve completely. Wait five seconds and then open the fuel valve very slowly.
15. Inspect the LP fuel lines and fittings with a soap solution after filling the tank or when looking for leaks.

Before Starting the Engine

Walk - Around Inspection

Make a thorough walk - around inspection before mounting the lift truck or starting the engine. Look for such items as loose bolts, debris buildup, oil or coolant leaks. Check condition of tires, mast, carriage, forks or attachments. Have repairs made as needed and all debris removed.



1. Inspect the operator's compartment for loose items and cleanliness.
2. Inspect the instrument panel for broken or damaged indicator lights or gauges.
3. Test the horn and other safety devices for proper operation.
4. Inspect the mast and lift chains for wear, broken links, pins and loose rollers.



5. Inspect the carriage, forks or attachments for wear, damage and loose or missing bolts.
6. Inspect the tires and wheels for cuts, gouges, foreign objects, inflation pressure and loose or missing bolts.



7. Inspect the overhead guard for damage and loose or missing mounting bolts.
8. Inspect the hydraulic system for leaks, worn hoses or damaged lines.
9. Look for transmission and drive axle leaks on the truck and on the ground.

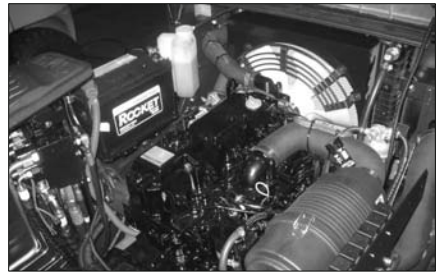

10. Inspect the engine compartment for oil, coolant and fuel leaks.

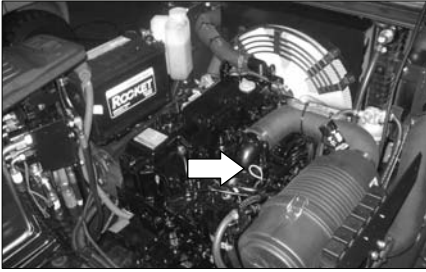

11. Measure the engine crankcase oil level with the dip stick. Maintain the oil level between the MAX. and MIN., (or FULL and ADD) notches on the dip stick.

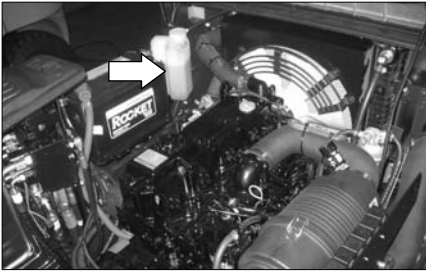

12. Observe the engine coolant level in the coolant recovery bottle. With the engine cold, maintain the level to the COLD mark. If the recovery bottle is empty, also fill the radiator at the top tank.



13. Observe the fuel level gauge after starting the truck. Add fuel if necessary.

⚠ WARNING

Personal injury may occur from accidents caused by improper seat adjustment. Always adjust the operator's seat before starting the lift truck engine.

Seat adjustment must be done at the beginning of each shift and when operators change.



14. To position the seat, PUSH the lever away from the seat track and move the seat forward or backward to a comfortable position.

Starting the Engine

Prestart Conditions

NOTE: The engine will not start unless the transmission directional control lever is in the NEUTRAL position.

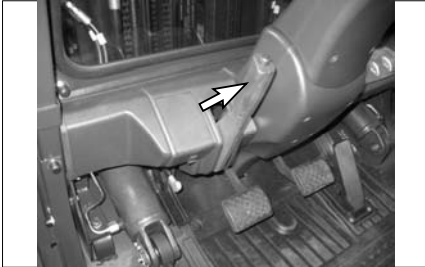

1. Engage the parking brake, if not already engaged. Place the transmission directional control lever in the NEUTRAL position.

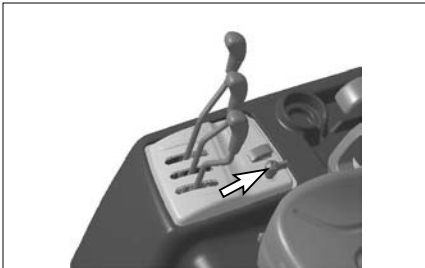

2. Lift trucks equipped with electrical disconnect switches; the engine will not start unless the disconnect switch is in the ON (closed) position.

NOTICE

When you restart the engine after turning off it, wait 4 to 5 seconds and restart it to protect the starter.

Gasoline Engine

NOTICE

Do not leave the key in ON position when engine is not running.
Do not engage the starter more than 10 seconds at any one time.

1. Don't press accelerator pedal, and turn the ignition switch to the START position.
2. Once the engine starts, release the ignition switch.
3. If the engine does not start, repeat step 1.
4. If engine coolant is cold, engine speed could be higher than low idle speed. Don't drive forklift until engine speed becomes normal low idle speed.

NOTICE

If the inside of engine cylinder is wet by gasoline, the engine could not start. In this case, press accelerator pedal fully and turn the ignition switch to ON position for 10 seconds. The inside of cylinder would be dry because ECM does not allow gasoline fuel injection. Repeat it three times. Don't press accelerator pedal and turn the Ignition switch to the START position to start engine.

LP Engine

⚠ WARNING

LP fuel is flammable and can cause personal injury.

Inspect LP fuel lines and fitting for leaks.

Inspect tank for secure mounting.

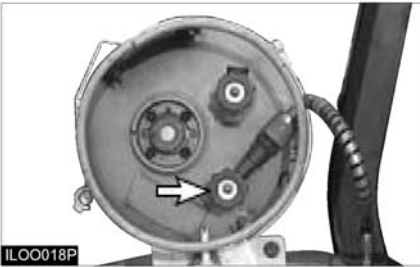

1. Turn the tank fuel valve ON by slowly turning the valve counterclockwise. Observe the LP gauge (if equipped).
2. Don't press accelerator pedal, and turn the ignition switch to the START position.
3. Once the engine starts, release the ignition switch.
4. If the engine does not start, repeat step 2.
5. If engine coolant is cold, engine speed could be higher than normal low idle speed. Don't drive forklift until engine speed becomes normal low idle speed.

Diesel Engine

Starting a Cold Diesel Engine

1. Turn the key to the ON position. The start pre heat light will come ON. The preheat light will stay ON approximately seven seconds, depending on the surrounding air temperature.

NOTICE

Do not engage the starter for more than 10 seconds.

2. When the preheat light goes OFF, turn the key to the START position, with the accelerator pedal pressed.
3. Release the key when the engine starts and release the accelerator pedal to a low idle position.
4. If the engine stalls or does not start, turn the key to the OFF position, then repeat steps 1 thru 3.

Starting a Warm Diesel Engine

1. Turn the key to the ON position and then to START position, without waiting for the preheat light to go OFF. At the same time press the accelerator.
2. Release the key when the engine starts and release the accelerator pedal to a low idle position.

Starting From a 12 Volt External Source

WARNING

Sparks occurring near the battery could cause vapors to explode.

Always connect the external power source ground cable to a point away from and below the battery, and well clear of fuel system components.



NOTICE

Do not reverse battery cables. It can cause damage to the alternator.

Always connect the external power source cables in parallel with the lift truck battery cables : POSITIVE(+) to POSITIVE(+) and NEGATIVE(-) to NEGATIVE(-).

Attach ground cable last, remove first. All lift trucks equipped with DOOSAN built internal combustion engines are NEGATIVE(-) ground.

Dual Fuel System

Changing From Gasoline to LP – Gas



NOTE: The Underwriter's Laboratory (U.L.) requires that the gasoline tank must be at least one - quarter full when operating on LP. This will allow the lift truck to be restarted on gasoline and moved to an approved refueling area, when operating in a hazardous area.

1. Park the lift truck level in an authorized refueling area with the forks lowered, the parking brake applied, the transmission in NEUTRAL and the engine running.

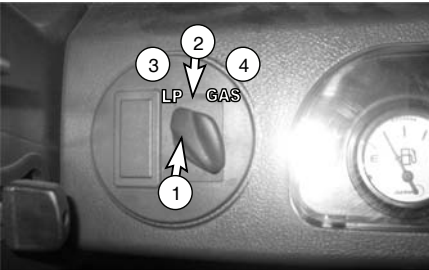

2. Move lever (1), on the fuel selector switch to the OFF (2) position. Leave lever (1) in this position until the engine stops.
3. Move lever (1) to the LPG (3) position.

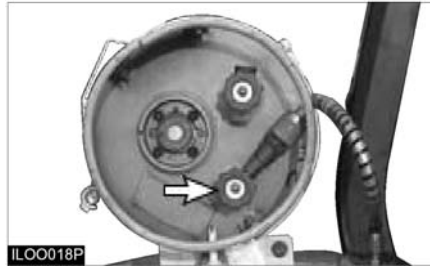

4. Open the fuel valve, on the LP tank, by slowly turning the valve counterclockwise.
5. Turn the ignition switch key to the OFF position and then to the START position to start the engine. Release it when the engine starts.

Changing From LP to Gasoline

1. Park the lift truck level in an authorized refueling area with the forks lowered, the parking brake applied, the transmission in NEUTRAL and the engine running.

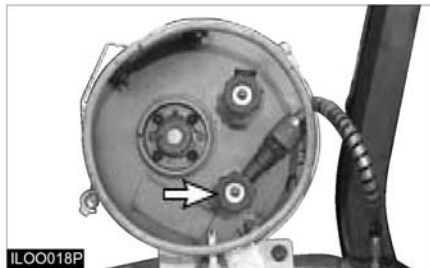

2. Close the fuel valve on the LP tank. hood open.

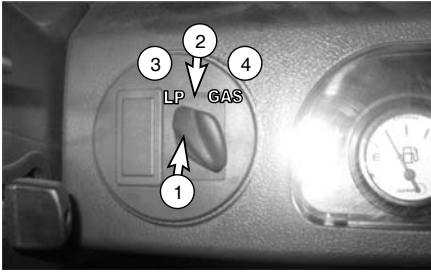

3. Move lever (1) from the LPG (3) POSITION to the OFF (2) position. Allow the engine to run until the fuel in the line runs out and engine stops.
4. Move lever (1) from the LPG (3) position to the GAS (4) position.
5. Turn the ignition switch key to the OFF position.
6. Turn the ignition switch key to the START position and start the engine. Release it when the engine starts.

After Starting the Engine

Observe all indicator lights and gauges frequently during operation, to make sure all systems are working properly. The entire indicator lights will come ON with the ignition switch in the ON position before the engine is started.

Diesel (12V)

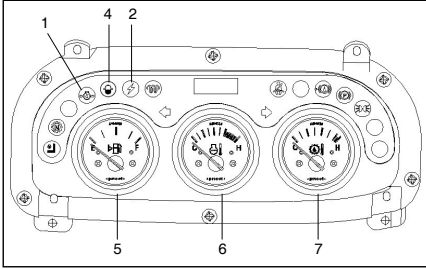

LPG/GAS (12V)

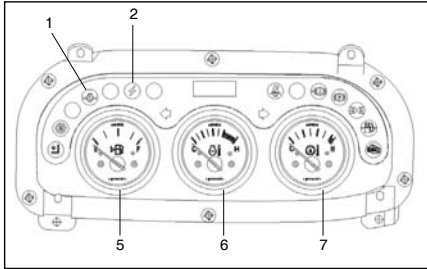

1. The engine oil pressure indicator light (1), will not come ON with the engine running, unless there is low or no oil pressure. Stop the engine immediately, if the light comes ON.
2. The alternator indicator light (2), should not come ON during normal operation. The alternator is not charging if the light comes ON with the engine running.
3. The spark-ignition G420/424F(E)/G424I(E)/G430FE engine MIL(Malfunction Indicator Light)(3) will not come ON with the engine running, unless the fault or faults are stored in the memory of the engine control module(ECM). Stop the engine and check the electric engine control system if the light comes ON. Refer G420F(E)/G424F(E)/G424I(E)/G430FE Engines of this section.

4. The diesel engine water in fuel filter indicator light(4), will not come ON with the engine running, unless water in fuel filter exceeds 100cc. Stop the engine immediately and drain the water if the light comes ON.
5. Observe the fuel level gauge (5) for fuel level in the tank.
6. The engine coolant temperature gauge pointer (6) will be in the green band with the engine running, unless the coolant temperature is excessive.
7. The transmission oil temperature gauge pointer (7) will be in the green band with the engine running, unless the oil temperature is excessive.

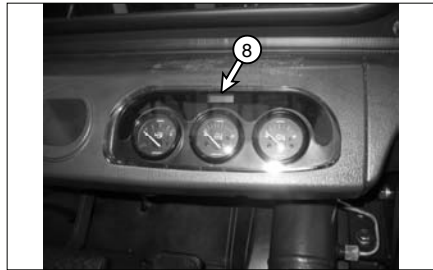

8. Observe the hour meter (8) to make sure it is operating properly.

Lift Truck Operation

Power Shift Transmission/ Drive axle

1. Start the engine. See topic “Starting the Engine”.

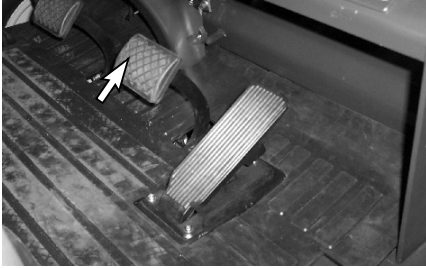

2. Push down on the service brake pedal to hold the lift truck until ready to move it.
3. Release the parking brake.

NOTE: The parking brake must be released before the directional control can be used.



4. Select the direction of travel by pushing the directional lever FORWARD for forward direction or by pulling the lever BACK for reverse direction.

⚠ WARNING

A lift truck with the engine running but without an operator can move slowly (creep) if the transmission is engaged.

This could result in personal injury.

Always place the transmission control lever in the NEUTRAL (center) position and apply the parking brake before dismantling the lift truck.

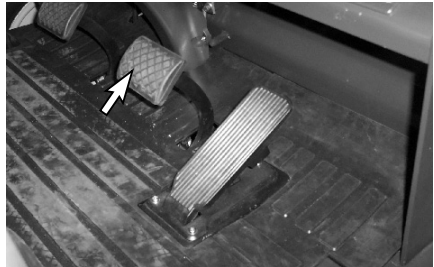

5. Release the service brake.
6. Push down on the accelerator pedal to obtain the desired travel speed. Release the pedal to decrease travel speed.

⚠ WARNING

Sudden reversal of a loaded lift truck traveling forward can cause the load to fall or the lift truck to tip over.

Stop the loaded lift truck completely, before shifting to reverse.

Failure to comply could result in personal injury.

NOTE: Where conditions permit, directional changes can be made under full power at speeds up to 6 km/h (3.73 mph). A speed of 6 km/h (3.73 mph) is a fast walk. Directional shift changes at speeds above 6 km/h (3.73 mph) are considered abusive. Bring the lift truck to a complete stop where load stability or other factors prevent safe operation under full power shifts.

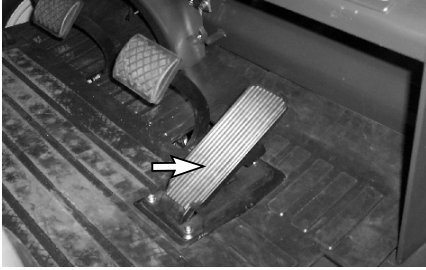

7. To change the lift truck direction of travel, release the accelerator pedal.
8. Push down on the service brake pedal to reduce the lift truck speed as necessary.



9. Move the directional lever to the desired direction of travel. Slowly push down on the accelerator pedal as the lift truck changes direction.
10. When the direction change is completed, continue to push down on the accelerator pedal to obtain the desired travel speed.

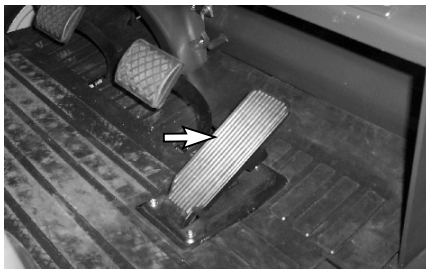

11. To stop the lift truck when traveling in either direction, release the accelerator pedal.
12. Push down on the service brake pedal and bring the lift truck to a smooth stop.

Inching

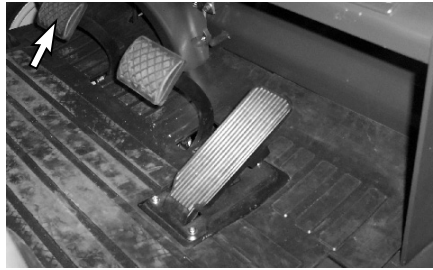

NOTE: The purpose of the inching pedal is to provide precise lift truck inching control at very slow travel speed and high engine rpm. This is used for fast hydraulic lift, during load approach, pick up or load positioning.

1. To inch (creep) in either direction, slowly push down on the inching pedal. This will start to apply the service brakes and allow the transmission clutch discs to slip.
2. Vary the position of the inching pedal and the accelerator pedal to control the inching speed and distance.
3. Pushing down further on the inching pedal will disengage the transmission completely and apply the service brakes fully to stop and hold the lift truck. This will provide full engine power for fast hydraulic lift.
4. Avoid overuse of the inching pedal as this may cause the automatic transmission oil to overheat or the clutch to slip. Do not use as a footrest or for long periods of time.
5. If user operates continuously pushing work or both brake pedal and accelerator pedal were depressed at the same time, it may cause the automatic transmission oil to overheat or the clutch to slip.

WARNING

Do not use inching pedal instead of brake pedal.

It will give wearing to transmission clutch disc.

Electronic Controlled Spark-Ignition Engines

G420FE Engine and G424FE Engine and G424IE Engine

EMS (Engine management system) of G420FE engine and G424FE engine and G424IE engine is a closed loop system utilizing a 3-way catalytic muffler to reduce the emission level in the exhaust gas. In order to obtain maximum effect from the catalyst, an accurate control of the air fuel ratio is

required. A small engine control module (SECM) uses two heated exhaust gas oxygen sensors (HEGO) in the exhaust system to monitor exhaust gas content. One HEGO is installed in front of the catalytic muffler and one is installed after the catalytic muffler.

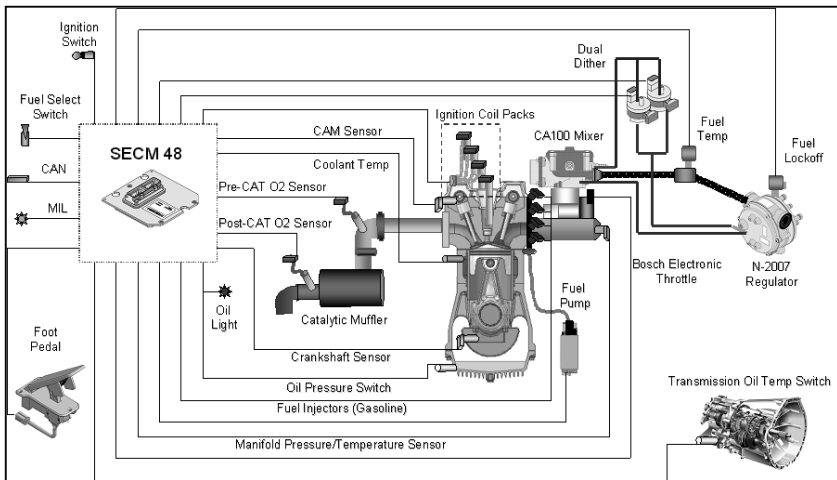

EMS schematic of G420FE / G424FE / G424IE Dual fuel engine

The SECM makes any necessary corrections to the air fuel ratio by controlling the inlet fuel pressure to the air/fuel mixer by modulating the dual fuel trim valves (FTV) connected to the regulator. Reducing the fuel pressure leans the air/fuel mixture and increasing the fuel pressure enriches the air/fuel mixture. To calculate any necessary corrections to the air fuel ratio, the SECM uses a number of different sensors to gain information about the engine's performance. Engine speed is monitored by the SECM through a variable reluctance (VR) or Hall Effect sensor. Intake manifold air temperature and absolute pressure are monitored with a TMAP sensor. MI-07 is a drive-by-wire (DBW) system connecting the accelerator pedal to the electronic throttle through the electrical harness; mechanical cables are not used. A throttle position sensor (TPS) monitors throttle position in relation to the accelerator pedal position sensor (APP) command.

Even engine coolant temperature and adequate oil pressure are monitored by the SECM. The SECM controller has full adaptive learning capabilities, allowing it to adapt control function as operating conditions change. Factors such as ambient temperature, fuel variations, ignition component wear, clogged air filter, and other operating variables are compensated.

MPI (multi-point injection) is used for this system. Fuel injection pressure and flow rate depend on engine-specific fuel injection requirements. A variety of regulators and injectors can be used to fit individual needs. The gasoline fuel pressure regulator is a one-way, non-return configuration. All gasoline specific components are automotive production parts and validated to strict automotive standards. Four (4) sequential injection channels are supported.

G420F Engine and G424F Engine and G424I Engine

EMS (Engine management system) of G420F engine and G424F engine and G424I engine is an open loop LP system and/or closed loop gasoline system. 3-way catalytic muffler is not used for this system.

LPG regulator and the mixer are operated in open loop as no mixture adjustments are made by the SECM. Manifold pressure from the TMAP, rpm from the crank position sensor and throttle position is used by the SECM to calculate load. Feedback from the electronic throttle is still provided to the SECM by the throttle position sensors (TPS).

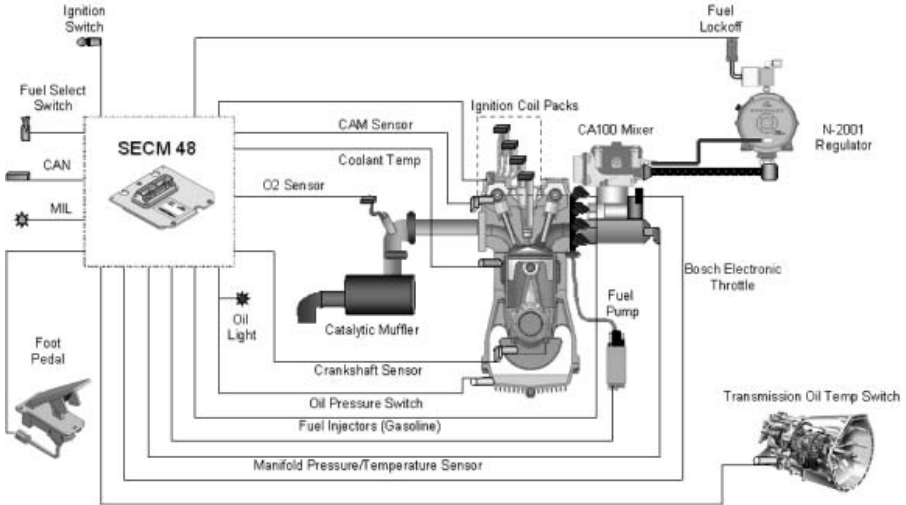

EMS schematic of G420F / G424F / G424I Dual Fuel engine

Basic Troubleshooting(LP)

The MI-07 systems are equipped with built-in fault diagnostics. Detected system faults can be displayed by the Malfunction Indicator Lamp (MIL) and are covered in the Advanced Diagnostics section. Items such as fuel level, plugged fuel lines, clogged fuel filters and malfunctioning pressure regulators may not set a fault code by the Small Engine Control Module (SECM). Below are

basic checks that should be made before referring to the Advanced Diagnostics section, if engine or drivability problems are encountered.

Locating a problem in a propane engine is done exactly the same way as with a gasoline engine. Consider all parts of the ignition and mechanical systems as well as the fuel system.

Problem	Probable Cause	Corrective Action
Engine Cranking but Will Not Start	Fuel container empty	Fill fuel container <ul style="list-style-type: none"> Do not exceed 80% of liquid capacity
	Liquid valve closed	Slowly open liquid valve
	Excess flow valve closed	Reset excess flow valve <ul style="list-style-type: none"> Close liquid valve Wait for a "click" sound Slowly open liquid valve
	Plugged fuel line	Remove obstruction from the fuel line <ul style="list-style-type: none"> Close liquid fuel valve Using caution, disconnect the fuel line (some propane may escape) Clear obstruction with compressed air Re-connect fuel line Slowly open liquid fuel valve Leak test
	Broken Fuse - SECM	Replace Fuse for SECM <ul style="list-style-type: none"> See Maintenance Section, Fuses replacement
	Clogged fuel filter	Repair/replace as required <ul style="list-style-type: none"> See Maintenance Section, LP Fuel Filter replacement
	Faulty vapor connection between the pressure regulator/converter and the mixer	Check connection <ul style="list-style-type: none"> Verify no holes in hose Clamps must be tight Look for kinked, pinched and/or collapsed hose
	Fuel Lock-off malfunction	Repair/replace Fuel Lock-off <ul style="list-style-type: none"> See Engine Service Manual
	Pressure regulator/converter malfunction	Test pressure regulator/converter operation <ul style="list-style-type: none"> See Engine Service Manual
	Incorrect air/fuel or ignition/spark control	See Advanced Diagnostics
No VR Sensor Signal	Verify the VR signal is present <ul style="list-style-type: none"> See Advanced Diagnostics 	

Problem	Probable Cause	Corrective Action
Difficult to Start	Fuel container almost empty	LPG Vapor from liquid outlet <ul style="list-style-type: none"> ● Fill fuel container ● Do not exceed 80% of liquid capacity
	Excess flow valve closed	Reset excess flow valve <ul style="list-style-type: none"> ● Close liquid valve ● Wait for a “click” sound ● Slowly open liquid valve
	Clogged fuel filter	Repair/replace as required <ul style="list-style-type: none"> ● <i>See Maintenance Section, LP Fuel Filter replacement</i>
	Plugged fuel line	Remove obstruction from the fuel line <ul style="list-style-type: none"> ● Close liquid fuel valve ● Using caution, disconnect the fuel line (some propane may escape) ● Clear obstruction with compressed air ● Re-connect fuel line ● Slowly open liquid fuel valve ● Leak test
	Faulty vapor connection between the pressure regulator/convertor and the mixer	Check connection <ul style="list-style-type: none"> ● Verify no holes in hose ● Clamps must be tight ● Look for kinked, pinched and/or collapsed hose
	Pressure regulator/convertor malfunction	Test pressure regulator/convertor operation <ul style="list-style-type: none"> ● <i>See Engine Service Manual</i>
	Fuel container almost empty	LPG Vapor from liquid outlet <ul style="list-style-type: none"> ● Fill fuel container ● Do not exceed 80% of liquid capacity
	Air filter clogged	Check air filter <ul style="list-style-type: none"> ● Clean/replace as required
	Incorrect air/fuel or ignition control	See Advanced Diagnostics
	Engine Mechanical	See Engine Service Manual

Problem	Probable Cause	Corrective Action
Will Not Run Continuously	Fuel container almost empty	LPG Vapor from liquid outlet <ul style="list-style-type: none"> • Fill fuel container • Do not exceed 80% of liquid capacity
	Excess flow valve closed	Reset excess flow valve <ul style="list-style-type: none"> • Close liquid valve • Wait for a "click" sound • Slowly open liquid valve
	Clogged fuel filter	Repair/replace as required <ul style="list-style-type: none"> • <i>See Maintenance Section, LP Fuel Filter replacement</i>
	Plugged fuel line	Remove obstruction from the fuel line <ul style="list-style-type: none"> • Close liquid fuel valve • Using caution, disconnect the fuel line (some propane may escape) • Clear obstruction with compressed air • Re-connect fuel line • Slowly open liquid fuel valve & Leak test
	Pressure regulator freezes	Check level in cooling system <ul style="list-style-type: none"> • Must be full, check coolant strength • -35F minimum Check coolant hoses <ul style="list-style-type: none"> • Watch for kinks and/or pinched hoses • Verify one pressure hose and one return hose
	Fuel Lock-off malfunction	Repair/replace Fuel Lock-off <ul style="list-style-type: none"> • <i>See Engine Service Manual</i>
	Incorrect idle speed or ignition problem	See Advanced Diagnostics
	Engine Mechanical	See Engine Service Manual
Will Not Accelerate/Hesitation During Acceleration	Fuel container almost empty	LPG Vapor from liquid outlet <ul style="list-style-type: none"> • Fill fuel container • Do not exceed 80% of liquid capacity
	Excess flow valve closed	Reset excess flow valve <ul style="list-style-type: none"> • Close liquid valve • Wait for a "click" sound • Slowly open liquid valve

Problem	Probable Cause	Corrective Action
Will Not Accelerate/Hesitation During Acceleration	Clogged fuel filter	Repair/replace as required <ul style="list-style-type: none"> • See <i>Maintenance Section, LP Fuel Filter replacement</i>
	Faulty vapor connection between the pressure regulator/converter and the mixer	Check connection <ul style="list-style-type: none"> • Verify no holes in hose • Clamps must be tight • Look for kinked, pinched and/or collapsed hose
	Throttle butterfly valve not opening or sticking	See Advanced Diagnostics
	Foot Pedal signal incorrect or intermittent	
	Incorrect air/fuel or ignition control	
Engine Mechanical	See Engine Service Manual	
Engine Stalls	Fuel container almost empty	LPG Vapor from liquid outlet <ul style="list-style-type: none"> • Fill fuel container • Do not exceed 80% of liquid capacity
	Excess flow valve closed	Reset excess flow valve <ul style="list-style-type: none"> • Close liquid valve • Wait for a “click” sound • Slowly open liquid valve
	Clogged fuel filter	Repair/replace as required <ul style="list-style-type: none"> • See <i>Maintenance Section, LP Fuel Filter replacement</i>
	Plugged fuel line	Remove obstruction from the fuel line <ul style="list-style-type: none"> • Close liquid fuel valve • Using caution, disconnect the fuel line (some propane may escape) • Clear obstruction with compressed air • Re-connect fuel line • Slowly open liquid fuel valve & Leak test

Problem	Probable Cause	Corrective Action
Engine Stalls	Fuel Lock-off malfunction	Repair/replace Fuel Lock-off <ul style="list-style-type: none"> ● <i>See Engine Service Manual</i>
	Faulty vapor connection between the pressure regulator/converter and the mixer	Check connection <ul style="list-style-type: none"> ● Verify no holes in hose ● Clamps must be tight ● Look for kinked, pinched and/or collapsed hose
	Pressure regulator freezes	Check level in cooling system <ul style="list-style-type: none"> ● Must be full, check coolant strength ● -35F minimum ● Check coolant hoses ● Watch for kinks and/or pinched hoses ● Verify one pressure hose and one return hose
	Pressure regulator malfunction	Test pressure regulator operation <ul style="list-style-type: none"> ● <i>See Engine Service Manual</i>
	Vacuum leak	Check for vacuum leaks <ul style="list-style-type: none"> ● Between mixer and throttle body ● Between throttle body and intake manifold ● Between intake manifold and cylinder head
	Air/Fuel Mixer malfunction	Check mixer <ul style="list-style-type: none"> ● <i>See Engine Service Manual</i>
	Engine Mechanical	See Engine Manufacturers Service Manual
Rough Idle	Faulty vapor connection between the pressure regulator/converter and the mixer	Check connection <ul style="list-style-type: none"> ● Verify no holes in hose ● Clamps must be tight ● Look for kinked, pinched and/or collapsed hose
	Pressure regulator malfunction	Test pressure regulator operation <ul style="list-style-type: none"> ● <i>See Engine Service Manual</i>
	Vacuum leak	Check for vacuum leaks <ul style="list-style-type: none"> ● Between mixer and throttle body ● Between throttle body and intake manifold ● Between intake manifold and cylinder head
	Air/Fuel Mixer malfunction	Check mixer <ul style="list-style-type: none"> ● <i>See Engine Service Manual</i>

Problem	Probable Cause	Corrective Action
Rough Idle	Incorrect Idle speed control	See Advanced Diagnostics & See Engine Service Manual
	Incorrect timing or spark control	See Engine Service Manual
	Engine Mechanical	See Engine Service Manual
High Idle Speed	Incorrect Idle speed control	See Advanced Diagnostics & See Engine Service Manual
	Throttle sticking	See Engine Service Manual
	Foot pedal sticking or incorrect pedal signal	Check pedal return spring travel for binding <ul style="list-style-type: none"> • See <i>Advanced Diagnostics</i>
Poor High Speed Performance	Clogged fuel filter	Repair/replace as required <ul style="list-style-type: none"> • See <i>Maintenance section, Fuel Filter replacement</i>
	Plugged fuel line	Remove obstruction from the fuel line <ul style="list-style-type: none"> • Close liquid fuel valve • Using caution, disconnect the fuel line (some propane may escape) • Clear obstruction with compressed air • Re-connect fuel line • Slowly open liquid fuel valve & Leak test
	Air filter clogged	Check air filter <ul style="list-style-type: none"> • Clean/replace as required
	Faulty vapor connection between the pressure regulator/converter and the mixer	Check connection <ul style="list-style-type: none"> • Verify no holes in hose • Clamps must be tight • Look for kinked, pinched and/or collapsed hose
	Pressure regulator malfunction	Test pressure regulator operation <ul style="list-style-type: none"> • See <i>Engine Service Manual</i>
	Air/Fuel Mixer malfunction	Check mixer <ul style="list-style-type: none"> • See <i>Engine Service Manual</i>
	Restricted exhaust system	Check exhaust system <ul style="list-style-type: none"> • Measure exhaust back pressure
	Incorrect ignition control	See Advanced Diagnostics & See Engine Service Manual
	Incorrect air/fuel control	
	Incorrect throttle position	

Problem	Probable Cause	Corrective Action
Excessive Fuel Consumption/LPG Exhaust Smell	Air/Fuel Mixer malfunction	Check mixer • <i>See Engine Service Manual</i>
	Air filter clogged	Check air filter • Clean/replace as required
	Vacuum leak	Check system vacuum hoses from regulator to FTV and mixer • Repair/replace as necessary
	Pressure regulator malfunction/fuel pressure too high	Test pressure regulator operation • <i>See Engine Service Manual</i>
	Faulty FTV	Check FTV for housing cracks or obstructions • <i>See Advanced Diagnostics FTV operation</i> • Repair and/or replace as necessary
	Weak ignition and/or spark control	See Advanced Diagnostics
	Incorrect air/fuel control	See Advanced Diagnostics
	Exhaust system leaks	Repair exhaust system
	Oxygen sensor failure	Replace as necessary • <i>See Advanced Diagnostics</i>

Basic Troubleshooting (Gasoline)

Problem	Probable Cause	Corrective Action
Engine Cranking but Will Not Start (Gas)	Fuel tank empty	Fill fuel container <ul style="list-style-type: none"> • The tank should be at least ¼ full to properly prime the fuel pump. • Fuel select switch is not on GAS
	Clogged fuel filter	Repair/replace as required <ul style="list-style-type: none"> • <i>See Maintenance section Primary and Secondary Fuel Filter replacement</i>
	Faulty vapor connection between the pressure regulator/ converter and the mixer (LPG)	Check connection <ul style="list-style-type: none"> • Verify no holes in hose • Clamps must be tight • Look for kinked, pinched and/or collapsed hose
	Electric Fuel Pump malfunction (GAS)	Check electrical connection <ul style="list-style-type: none"> • Check Relay and fuse Turn key ON and verify pump is operating
	Fuel Pressure regulator malfunction	Test pressure regulator operation <ul style="list-style-type: none"> • <i>See Engine Service Manual</i>
	Fuel Injector malfunction	Test Injector operation <ul style="list-style-type: none"> • <i>See Engine Service Manual</i>
	Incorrect air/fuel or ignition/ spark control	See Advanced Diagnostics
	No VR Sensor Signal	Verify the VR signal is present <ul style="list-style-type: none"> • <i>See Advanced Diagnostics</i>

Problem	Probable Cause	Corrective Action
Difficult to Start (Gas)	Fuel tank almost empty	Fuel Pump Cavitations <ul style="list-style-type: none"> • The tank should be at least ¼ full to properly prime the fuel pump • Fuel select switch is not on GAS
	Clogged fuel filter	Repair/replace as required <ul style="list-style-type: none"> • See <i>Maintenance section, Primary and Secondary Fuel Filter replacement</i>
	Electric Fuel Pump malfunction (GAS)	Check electrical connection <ul style="list-style-type: none"> • Check Relay and fuse Turn key ON and verify pump is operating • See <i>Engine Service Manual</i>
	Pressure regulator malfunction	Test pressure regulator operation <ul style="list-style-type: none"> • See <i>Engine Service Manual</i>
	Fuel Injector malfunction	Test Injector operation <ul style="list-style-type: none"> • See <i>Engine Service Manual</i>
	Air filter clogged	Check air filter <ul style="list-style-type: none"> • Clean/replace as required
	Incorrect air/fuel or ignition control	See <i>Advanced Diagnostics</i>
	Engine Mechanical	See <i>Engine Service Manual</i>
Will Not Run Continuously (Gas)	Isolate the gasoline system by running the lift truck on LPG	Verify LPG cylinder is full and valve is open. If the problem does not exist in LPG mode proceed with the corrective action steps below. If the problem also exists in LPG mode then the root cause is most likely to be something other than the fuel system <ul style="list-style-type: none"> • See <i>Advanced Diagnostics</i>
	Fuel tank almost empty	Fuel Pump Cavitations <ul style="list-style-type: none"> • The tank should be at least ¼ full to properly prime the fuel pump
	Clogged fuel filter	Repair/replace as required <ul style="list-style-type: none"> • See <i>Maintenance section, Primary and Secondary Fuel Filter replacement</i>

Problem	Probable Cause	Corrective Action
<p>Will Not Run Continuously (Gas)</p>	<p>Electric Fuel Pump malfunction (GAS)</p>	<p>Check electrical connection</p> <ul style="list-style-type: none"> • Check Relay and fuse Turn key ON and verify pump is operating • <i>See Engine Service Manual</i>
	<p>Pressure regulator malfunction</p>	<p>Test pressure regulator operation</p> <ul style="list-style-type: none"> • <i>See Engine Service Manual</i>
	<p>Fuel Injector malfunction</p>	<p>Test Injector operation</p> <ul style="list-style-type: none"> • <i>See Engine Service Manual</i>
	<p>Incorrect idle speed or ignition problem</p>	<p>See Advanced Diagnostics</p>
	<p>Engine Mechanical</p>	<p>See Engine Service Manual</p>
<p>Will Not Accelerate/Hesitation During Acceleration or Engine Stalls (Gas)</p>	<p>Isolate the gasoline system by running the lift truck on LPG</p>	<p>Verify LPG cylinder is full and valve is open. If the problem does not exist in LPG mode proceed with the corrective action steps below.</p> <p>If the problem also exists in LPG mode then the root cause is most likely to be something other than the fuel system</p> <ul style="list-style-type: none"> • <i>See Advanced Diagnostics</i>
	<p>Fuel tank almost empty</p>	<p>Fuel Pump Cavitations</p> <ul style="list-style-type: none"> • The tank should be at least ¼ full to properly prime the fuel pump
	<p>Clogged fuel filter</p>	<p>Repair/replace as required</p> <ul style="list-style-type: none"> • <i>See Maintenance section, Primary and Secondary Fuel Filter replacement</i>
	<p>Pressure regulator malfunction</p>	<p>Test pressure regulator operation</p> <ul style="list-style-type: none"> • <i>See Engine Service Manual</i>
	<p>Fuel Injector malfunction</p>	<p>Test Injector operation</p>

Problem	Probable Cause	Corrective Action
Will Not Accelerate/Hesitation During Acceleration or Engine Stalls (Gas)	Throttle butterfly valve not opening or sticking	See Advanced Diagnostics
	Foot Pedal signal incorrect or intermittent	
	Incorrect air/fuel or ignition control	
	Engine Mechanical	See Engine Service Manual
Rough Idle (Gas)	Isolate the gasoline system by running the lift truck on LPG	<p>Verify LPG cylinder is full and valve is open. If the problem does not exist in LPG mode proceed with the corrective action steps below.</p> <p>If the problem also exists in LPG mode then the root cause is most likely to be something other than the fuel system</p> <ul style="list-style-type: none"> • <i>See Advanced Diagnostics & Service Manual</i>
	Pressure regulator malfunction	Test pressure regulator operation <ul style="list-style-type: none"> • <i>See Engine Service Manual</i>
	Clogged fuel filter	Repair/replace as required <ul style="list-style-type: none"> • <i>See Maintenance section, Primary and Secondary Fuel Filter replacement</i>
	Pressure regulator malfunction	Test pressure regulator operation <ul style="list-style-type: none"> • <i>See Engine Service Manual</i>
	Fuel Injector malfunction	Test Injector operation <ul style="list-style-type: none"> • <i>See Engine Service Manual</i>
	Vacuum leak	Check for vacuum leaks <ul style="list-style-type: none"> • Between mixer and throttle body • Between throttle body and intake manifold • Between intake manifold and cylinder head

Problem	Probable Cause	Corrective Action
Rough Idle (Gas)	Incorrect Idle speed control	See Advanced Diagnostics & Engine Service Manual
	Incorrect timing or spark control	
	Engine Mechanical	See Engine Service Manual
High Idle Speed (Gas)	Incorrect Idle speed control	See Advanced Diagnostics & Engine Service Manual
	Throttle sticking	
	Foot pedal sticking or incorrect pedal signal	Check pedal return spring travel for binding See Advanced Diagnostics

Problem	Probable Cause	Corrective Action
Poor High Speed Performance (Gas)	Isolate the gasoline system by running the lift truck on LPG	Verify LPG cylinder is full and valve is open. If the problem does not exist in LPG mode proceed with the corrective action steps below. If the problem also exists in LPG mode then the root cause is most likely to be something other than the fuel system See Advanced Diagnostics & Dual Fuel Engine Service Manual
	Clogged fuel filter	Repair/replace as required • See <i>Maintenance section, Fuel Filter replacement</i>
	Plugged fuel line	Remove obstruction from the fuel line • Close liquid fuel valve • Using caution, disconnect the fuel line (some propane may escape) • Clear obstruction with compressed air • Re-connect fuel line • Slowly open liquid fuel valve & Leak test
	Air filter clogged	Check air filter • Clean/replace as required
	Faulty vapor connection between the pressure regulator/convertor and the mixer	Check connection • Verify no holes in hose • Clamps must be tight • Look for kinked, pinched and/or collapsed hose
	Pressure regulator malfunction	Test pressure regulator operation • See Dual Fuel Engine Service Manual

Problem	Probable Cause	Corrective Action
Poor High Speed Performance (Gas)	Air/Fuel Mixer malfunction	Check mixer • See <i>Engine Service Manual</i>
	Restricted exhaust system	Check exhaust system • <i>Measure exhaust back pressure</i>
	Incorrect ignition control	See Advanced Diagnostics & Engine Service Manual
	Incorrect air/fuel control	
	Incorrect throttle position	

Advanced Diagnostics

MI-07 systems are equipped with built-in fault diagnostics. Detected system faults can be displayed by the Malfunction Indicator Lamp (MIL) as Diagnostic Fault Codes (DFC) or flash codes, and viewed in detail with the use of the Service Tool software. When the ignition key is turned on, the MIL will illuminate and remain on until the engine is started. Once the engine is started, the MIL lamp will go out unless one or more fault conditions are present. If a detected fault condition exists, the fault or faults will be stored in the memory of the small engine control module (SECM). Once an active fault occurs the MIL will illuminate and remain ON. This signals the operator that a fault has been detected by the SECM.

Reading Diagnostic Fault Codes

All MI-07 fault codes are three-digit codes. When the fault codes are retrieved (displayed) the MIL will flash for each digit with a short pause (0.5 seconds) between digits and a long pause (1.2 seconds) between fault codes. A code 12 is displayed at the end of the code list.

EXAMPLE: A code 461 (ETCSticking) has been detected and the engine has shut down and the MIL has remained ON. When the codes are displayed the MIL will flash four times (4), pause, then flash six times (6), pause, then flash one time (1) This identifies a four sixty one (461), which is the ETCSticking fault. If any additional faults were stored, the SECM would again have a long pause, then display the next fault by flashing each digit. Since no other faults were stored there will be a long pause then one flash (1), pause, then two flashes (2). This identifies a twelve, signifying the end of the fault list. This list will then repeat.

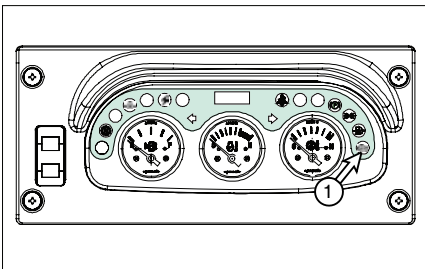

(1) Malfunction Indicator Lamp(MIL) for Engine control system.

Displaying Fault Codes (DFC) from SECM Memory

To enter code display mode you must turn OFF the ignition key. Now turn ON the key but do not start the engine. As soon as you turn the key to the ON position you must cycle the foot pedal by depressing it to the floor and then fully releasing the pedal (pedal maneuver). You must fully cycle the foot pedal three (3) times within five (5) seconds to enable the display codes feature of the SECM. Simply turn the key OFF to exit display mode. The code list will continue to repeat until the key is turned OFF.

Table 2. MI-07 Diagnostic Fault Codes (Flash Codes)

DFC	PROBABLE FAULT	FAULT ACTION *	CORRECTIVE ACTION FIRST CHECK
12	NONE Signifies the end of one pass through the fault list	NONE	None, used as end of the fault list identification
131	Inj1Open Gasoline Injector 1 open circuit, broken injector 1 wire or defective injector	(1) TurnOnMil (2) Disable LiquidO2Ctrl (3) Delayed EngineShutdown	Check INJ1 wiring for an open circuit SECM (Signal) A5 to Injector 1 Pin A Switched 12V to Injector 1 Pin B Check Injector 1 Resistance, 12 to14 ohms (cold)
132	Inj2Open Gasoline Injector 2 open circuit, broken injector 2 wire or defective injector	(1) TurnOnMil (2) Disable LiquidO2Ctrl (3) Delayed EngineShutdown	Check INJ2 wiring for an open circuit SECM (Signal) A8 to Injector 2 Pin A Switched 12V to Injector 2 Pin B Check Injector 2 Resistance, 12 to14 ohms (cold)
133	Inj3Open Gasoline Injector 3 open circuit, broken injector 3 wire or defective injector	(1) TurnOnMil (2) Disable LiquidO2Ctrl (3) Delayed EngineShutdown	Check INJ3 wiring for an open circuit SECM (Signal) A4 to Injector 3 Pin A Switched 12V to Injector 3 Pin B Check Injector 3 Resistance, 12 to14 ohms (cold)
134	Inj4Open Gasoline Injector 4 open circuit, broken injector 4 wire or defective injector	(1) TurnOnMil (2) Disable LiquidO2Ctrl (3) Delayed EngineShutdown	Check INJ4 wiring for an open circuit SECM (Signal) A7 to Injector 4 Pin A Switched 12V to Injector 4 Pin B Check Injector 4 Resistance, 12 to 14 ohms (cold)
141 (14)	ECTRangeLow Coolant Sensor failure or shorted to GND	(1) TurnOnMil (2) DelayedEngine Shutdown	Check ECT sensor connector and wiring for a short to GND SECM (Signal) Pin B15 To ECT Pin 3 SECM (Sensor GND) Pin B1 to ECT Pin 1 SECM (System GND) Pin A16, B17
151 (15)	ECTRangeHigh Coolant sensor disconnected or open circuit	(1) TurnOnMil (2) DelayedEngine Shutdown	Check if ECT sensor connector is disconnected or for an open ECT circuit SECM (Signal) Pin B15 to ECT Pin 3 SECM (Sensor GND) Pin B1 to ECT Pin 1

(*) Fault actions shown are default values specified by the OEM.

Table 2. MI-07 Diagnostic Fault Codes (Flash Codes) cont'd.

DFC	PROBABLE FAULT	FAULT ACTION *	CORRECTIVE ACTION FIRST CHECK
161 (16)	ECTOverTempFault Engine coolant temperature is high. The sensor has measured an excessive coolant temperature typically due to the engine overheating.	(1) TurnOnMil (2) DelayedEngine Shutdown	Check coolant system for radiator blockage, proper coolant level and for leaks in the system. Possible ECT short to GND, check ECT signal wiring SECM (Signal) Pin B15 to ECT Pin 3 SECM (Sensor GND) Pin B1 to ECT Pin 1 SECM (System GND) Pin A16, B17 Check regulator for coolant leaks
171	ECT_IR_Fault Engine coolant temperature not changing as expected	TurnOnMil (Disabled in all software MI07SEQ062V05 and higher)	Check for coolant system problems, e.g. defective or stuck thermostat
181	FuelSelectConflict Conflict in fuel select signals, normally set if both of the fuel select signals are shorted to ground	(1) TurnOnMil (2) Delayed EngineShutdown	Check fuel select switch connection for a short to GND SECM (SIGNAL) Pin A12 SECM (SIGNAL) Pin A15 SECM (Sensor GND) Pin B1
191	CamEdgesFault No CAM signal when engine is known to be rotating, broken crankshaft sensor leads or defective CAM sensor	None	Check CAM sensor connections SECM (SIGNAL) Pin B10 to CAM sensor Pin 2 SECM (Sensor GND) Pin B1 to CAM sensor Pin 3 Switched 12V to CAM sensor Pin 1 Check for defective CAM sensor
192	CamSyncFault Loss of synchronization on the CAM sensor, normally due to noise on the signal or an intermittent connection on the CAM sensor	None	Check CAM sensor connections SECM (SIGNAL) Pin B10 to CAM sensor Pin 2 SECM (Sensor GND) Pin B1 to CAM sensor Pin 3 Switched 12V to CAM sensor Pin 1 Check for defective CAM sensor
193	CrankEdgesFault No crankshaft signal when engine is known to be rotating, broken crankshaft sensor leads or defective crank sensor	None	Check Crankshaft sensor connections SECM (SIGNAL) Pin B5 to Crank sensor Pin 3 SECM (Sensor GND) PIN B1 to Crank sensor Pin 2 Switched 12V to Crank sensor Pin 1 Check for defective Crank sensor
194	CrankSyncFault Loss of synchronization on the crankshaft sensor, normally due to noise on the signal or an intermittent connection on the crankshaft sensor	None	Check Crankshaft sensor connections SECM (SIGNAL) Pin B5 to Crank sensor Pin 3 SECM (Sensor GND) Pin B1 to Crank sensor Pin 2 Switched 12V to Crank sensor Pin 1 Check for defective Crank sensor

(*) Fault actions shown are default values specified by the OEM.

Table 2. MI-07 Diagnostic Fault Codes (Flash Codes) cont'd.

DFC	PROBABLE FAULT	FAULT ACTION *	CORRECTIVE ACTION FIRST CHECK
221 (22)	TPS1RangeLow TPS1 sensor voltage out of range low, normally set if the TPS1 signal has shorted to ground, circuit has opened or sensor has failed	(1) TurnOnMil (2) CutThrottle	Check throttle connector connection and TPS1 sensor for an open circuit or short to GND SECM Pin B23 (signal) to ETC Pin 6 SECM Pin B1 (sensor GND) to ETC Pin 2 SECM (system GND) Pin A16, B17
222	TPS2RangeLow TPS2 sensor voltage out of range low, normally set if the TPS2 signal has shorted to ground, circuit has opened or sensor has failed	(1) TurnOnMil (2) CutThrottle	Check throttle connector connection and TPS2 sensor for an open circuit or short to GND SECM Pin B4 (signal) to ETC Pin 5 SECM Pin B1 (sensor GND) to ETC Pin 2 SECM (system GND) Pin A16, B17
231 (23)	TPS1RangeHigh TPS1 sensor voltage out of range high, normally set if the TPS1 signal has shorted to power or the ground for the sensor has opened	(1) TurnOnMil (2) CutThrottle	Check throttle connector and TPS1 sensor wiring for a shorted circuit SECM Pin B23 (signal) to ETC Pin 6 SECM Pin B1 (sensor GND) to ETC Pin 2
232	TPS2RangeHigh TPS2 sensor voltage out of range high, normally set if the TPS2 signal has shorted to power or the ground for the sensor has opened	(1) TurnOnMil (2) CutThrottle	Check throttle connector and TPS1 sensor wiring for a shorted circuit SECM Pin B4 (signal) to ETC Pin 5 SECM pin B1 (sensor GND) to ETC Pin 2
241 (24)	TPS1AdaptLoMin Learned closed throttle end of TPS1 sensor range lower than expected	None	N/A
242	TPS2AdaptLoMin Learned closed throttle end of TPS2 sensor range lower than expected	None	N/A
251 (25)	TPS1AdaptHiMax Learned WOT end of TPS1 sensor range higher than expected	None	N/A
252	TPS2AdaptHiMax Learned WOT end of TPS2 sensor range higher than expected	None	N/A
271	TPS1AdaptHiMin Learned WOT end of TPS1 sensor range lower than expected	None	N/A

(*) Fault actions shown are default values specified by the OEM.

Table 2. Diagnostic Fault Codes (Flash Codes) cont'd.

DFC	PROBABLE FAULT	FAULT ACTION *	CORRECTIVE ACTION FIRST CHECK
272	TPS2AdaptHiMin Learned WOT end of TPS2 sensor range lower than expected	None	N/A
281	TPS1AdaptLoMax Learned closed throttle end of TPS1 sensor range higher than expected	None	N/A
282	TPS2AdaptLoMax Learned closed throttle end of TPS2 sensor range higher than expected	None	N/A
291	TPS_Sensors_Conflict TPS sensors differ by more than expected amount NOTE: The TPS is not a serviceable item and can only be repaired by replacing the DV-EV throttle assembly.	(1) TurnOnMil (2) CutThrottle	Check the throttle connector and pins for corrosion. To check the TPS disconnect the throttle connector and measure the resistance from: TPS Pin 2 (GND) to Pin 6 (TPS1 SIGNAL) (0.7 Ω ± 30%) TPS Pin 3 (PWR) to Pin 6 (TPS1 SIGNAL) (1.4 Ω ± 30%)
292	TPS_Intermittent Signal from the SECM to the throttle position sensor power or ground is not continuous	TurnOnMil	Check the throttle connector and pins for corrosion. Check continuity between throttle body Pin 3 and SECM Pin B24 (XDPR +5Vdc) Check continuity between throttle body Pin 2 and SECM Pin B1 (sensor ground) Check continuity on TPS1: between throttle body Pin 6 and SECM Pin B23 Check continuity on TPS2: between throttle body Pin 5 and SECM Pin B4 *Note: move wires around when checking for continuity to duplicate intermittent signal
331 (33)	MAPTimeRangeLow Manifold Absolute Pressure sensor input is low, normally set if the TMAP pressure signal wire has been disconnected or shorted to ground or the circuit has opened to the SECM	TurnOnMil	Check TMAP connector and MAP signal wiring for an open circuit TMAP Pin 4 to SECM Pin B18 (signal) TMAP Pin 1 to SECM Pin B1 (sensor GND) TMAP Pin 3 to SECM Pin B24 (XDRP +5 Vdc) Check the MAP sensor by disconnecting the TMAP connector and measuring at the sensor: TMAP Pin 1(GND) to Pin 4 (pressure signal KPA) (2.4kΩ - 8.2kΩ) TMAP Pin 3 (power) to Pin 4 (pressure signal KPA) (3.4kΩ - 8.2kΩ)

<p>332</p>	<p>MAPRangeLow Manifold Absolute Pressure sensor input is low, normally set if the TMAP pressure signal wire has been disconnected or shorted to ground or the circuit has opened to the SECM</p>	<p>(1) TurnOnMil (2) EngineShutdown</p>	<p>Check TMAP connector and MAP signal wiring for an open circuit TMAP Pin 4 to SECM Pin B18 (signal) TMAP Pin 1 to SECM Pin B1 (sensor GND) TMAP Pin 3 to SECM Pin B24 (XDRP +5 Vdc) Check the MAP sensor by disconnecting the TMAP connector and measuring at the sensor: TMAP Pin 1(GND) to Pin 4 (pressure signal KPA) (2.4kΩ - 8.2kΩ) TMAP Pin 3 (power) to Pin 4 (pressure signal KPA) (3.4kΩ - 8.2kΩ)</p>
-------------------	---	--	--

(*) Fault actions shown are default values specified by the OEM.

Table 2. Diagnostic Fault Codes (Flash Codes) cont'd.

DFC	PROBABLE FAULT	FAULT ACTION *	CORRECTIVE ACTION FIRST CHECK
341 (34)	MAPTimeRangeHigh Manifold Absolute Pressure Sensor Input is High, normally set if the TMAP pressure signal wire has become shorted to power, shorted to the IAT signal, the TMAP has failed or the SECM has failed.	TurnOnMil	Check TMAP connector and MAP signal wiring for a shorted circuit TMAP Pin 4 to SECM Pin B18 (signal) TMAP Pin 1 to SECM Pin B1 (sensor GND) TMAP Pin 3 to SECM Pin B24 (XDRP +5 Vdc) Check the MAP sensor by disconnecting the TMAP connector and measuring at the sensor: TMAP Pin 1(GND) to Pin 4 (pressure signal KPA) (2.4kΩ - 8.2kΩ) TMAP Pin 3 (power) to Pin 4 (pressure signal KPA) (3.4kΩ - 8.2kΩ)
342	MAPRangeHigh Manifold Absolute Pressure Sensor Input is High, normally set if the TMAP pressure signal wire has become shorted to power, shorted to the IAT signal, the TMAP has failed or the SECM has failed	(1) TurnOnMil (2) Engine Shutdown	Check TMAP connector and MAP signal wiring for a shorted circuit TMAP Pin 4 to SECM Pin B18 (signal) TMAP Pin 1 to SECM Pin B1 (sensor GND) TMAP Pin 3 to SECM Pin B24 (XDRP +5 Vdc) Check the MAP sensor by disconnecting the TMAP connector and measuring at the sensor: TMAP Pin 1(GND) to Pin 4 (pressure signal KPA) (2.4kΩ - 8.2kΩ) TMAP Pin 3 (power) to Pin 4 (pressure signal KPA) (3.4kΩ - 8.2kΩ)
351	MAP_IR_HI MAP sensor indicates higher pressure than expected	TurnOnMil	Check for vacuum leaks. Check that TMAP sensor is mounted properly. Possible defective TMAP sensor.
352	MAP_IR_LO MAP sensor indicates lower pressure than expected	TurnOnMil	Possible defective TMAP sensor.
353	MAP_STICKING MAP sensor not changing as expected	TurnOnMil	Check that TMAP sensor is mounted properly. Possible defective TMAP sensor.
371 (37)	IATRangeLow Intake Air Temperature Sensor Input is Low normally set if the IAT temperature sensor wire has shorted to chassis ground or the sensor has failed.	TurnOnMil	Check TMAP connector and IAT signal wiring for a shorted circuit TMAP Pin 2 to SECM Pin B12 (signal) TMAP Pin 1 to SECM Pin B1 (sensor GND) To check the IAT sensor of the TMAP disconnect the TMAP connector and measure the IAT resistance Resistance is approx 2400 ohms at room temperature.

(*) Fault actions shown are default values specified by the OEM.

Table 2. Diagnostic Fault Codes (Flash Codes) cont'd.

DFC	PROBABLE FAULT	FAULT ACTION *	CORRECTIVE ACTION FIRST CHECK
381 (38)	IATRangeHigh Intake Air Temperature Sensor Input is High normally set if the IAT temperature sensor wire has been disconnected or the circuit has opened to the SECM.	TurnOnMil	Check TMAP connector and IAT signal wiring for a shorted circuit TMAP Pin 2 to SECM Pin B12 (signal) TMAP Pin 1 to SECM Pin B1 (sensor GND) To check the IAT sensor of the TMAP disconnect the TMAP connector and measure the IAT resistance Resistance is approx 2400 ohms at room temperature.
391	IAT_IR_Fault Intake Air Temperature not changing as expected	None	Check connections to TMAP sensor. Check that TMAP sensor is properly mounted to manifold.
421	EST1_Open EST1 output open, possibly open EST1 signal or defective spark module	TurnOnMil	Check coil driver wiring and connector for open circuit SECM Pin A9 (EST1) to OEM ignition system. See application note. Verify GND on ignition module Pin A (of both connectors) Verify +12 Vdc on ignition module Pin B (of both connectors) Refer to application manual for specific engine details.
422	EST2_Open EST2 output open, possibly open EST2 signal or defective spark module	TurnOnMil	Check coil driver wiring and connector for open circuit SECM Pin A10 (EST2) to OEM ignition system. See application note. Verify GND on ignition module Pin A (of both connectors) Verify +12 Vdc on ignition module Pin B (of both connectors) Refer to application manual for specific engine details.
423	EST3_Open EST3 output open, possibly open EST3 signal or defective spark module	TurnOnMil	Check coil driver wiring and connector for open circuit SECM Pin A3 (EST3) to OEM ignition system. See application note. Verify GND on ignition module Pin A (of both connectors) Verify +12 Vdc on ignition module Pin B (of both connectors) Refer to application manual for specific engine details.

(*) Fault actions shown are default values specified by the OEM.

Table 2. Diagnostic Fault Codes (Flash Codes) cont'd.

DFC	PROBABLE FAULT	FAULT ACTION *	CORRECTIVE ACTION FIRST CHECK
424	EST4_Open EST4 output open, possibly open EST4 signal or defective spark module	TurnOnMil	Check coil driver wiring and connector for open circuit SECM Pin A6 (EST4) to OEM ignition system. See application manual. Verify GND on ignition module Pin A (of both connectors) Verify +12 Vdc on ignition module Pin B (of both connectors) Refer to application manual for specific engine details.
425	EST5_Open EST5 output open, possibly open EST5 signal or defective spark module	None	N/A
426	EST6_Open EST6 output open, possibly open EST6 signal or defective spark module	None	N/A
427	EST7_Open EST7 output open, possibly open EST7 signal or defective spark module	None	N/A
428	EST8_Open EST8 output open, possibly open EST8 signal or defective spark module	None	N/A
431	EST1_Short EST1 output shorted high or low, EST1 signal shorted to ground or power or defective spark module	None	N/A

(*) Fault actions shown are default values specified by the OEM.

Table 2. Diagnostic Fault Codes (Flash Codes) cont'd.

DFC	PROBABLE FAULT	FAULT ACTION *	CORRECTIVE ACTION FIRST CHECK
432	EST2_Short EST2 output shorted high or low, EST2 signal shorted to ground or power or defective spark module	None	N/A
433	EST3_Short EST3 output shorted high or low, EST3 signal shorted to ground or power or defective spark module	None	N/A
434	EST4_Short EST4 output shorted high or low, EST4 signal shorted to ground or power or defective spark module	None	N/A
435	EST5_Short EST5 output shorted high or low, EST5 signal shorted to ground or power or defective spark module	None	N/A
436	EST6_Short EST6 output shorted high or low, EST6 signal shorted to ground or power or defective spark module	None	N/A

(*) Fault actions shown are default values specified by the OEM.

Table 2. Diagnostic Fault Codes (Flash Codes) cont'd.

DFC	PROBABLE FAULT	FAULT ACTION *	CORRECTIVE ACTION FIRST CHECK
437	EST7_Short EST7 output shorted high or low, EST7 signal shorted to ground or power or defective spark module	None	N/A
438	EST8_Short EST8 output shorted high or low, EST8 signal shorted to ground or power or defective spark module	None	N/A
461 (26)	ETC_Sticking Electronic Throttle Control is sticking. This can occur if the throttle plate (butterfly valve) inside the throttle bore is sticking. The plate sticking can be due to some type of obstruction, a loose throttle plate, or worn components shaft bearings. NOTE: The throttle assembly is not a serviceable item and can only be repaired by replacing the DV-EV throttle assembly.	(1) TurnOnMil (2) EngineShutdown (3) CutThrottle	Check for debris or obstructions inside the throttle body Perform the throttle test using the Service Tool and re-check for fault <ul style="list-style-type: none"> • Check throttle-plate shaft for bearing wear • Check the ETC driver wiring for an open circuit SECM Pin A17 to ETC + Pin 1 SECM Pin A18 to ETC - Pin 4 Check the ETC internal motor drive by disconnecting the throttle connector and measuring the motor drive resistance at the throttle TPS Pin 1 (+DRIVER) to Pin 4 (-DRIVER) ~3.0-4.0Ω
471	ETC_Open_Fault Electronic Throttle Control Driver has failed, normally set if driver signals have failed open or become disconnected, electronic throttle or SECM is defective.	(1) TurnOnMil (2) CutThrottle	Check the ETC driver wiring for an open circuit SECM Pin A17 to ETC + Pin 1 SECM Pin A18 to ETC - Pin 4 Check the ETC internal motor drive by disconnecting the throttle connector and measuring the motor drive resistance at the throttle TPS Pin 1 (+DRIVER) to Pin 4 (-DRIVER) ~3.0-4.0Ω
481 (28)	ETCSpringTest Electronic Throttle Control Spring Return Test has failed. The SECM will perform a safety test of the throttle return spring following engine shutdown. If the drive mechanism is damaged, or the return spring has lost tension the throttle will fail the test and set the fault. NOTE: The throttle assembly is not a serviceable item and can only be repaired by replacing the DV-EV throttle assembly.	(1) TurnOnMil (2) EngineShutdown (3) CutThrottle	Perform throttle spring test by cycling the ignition key and re-check for fault

(*) Fault actions shown are default values specified by the OEM.

Table 2. Diagnostic Fault Codes (Flash Codes) cont'd.

DFC	PROBABLE FAULT	FAULT ACTION *	CORRECTIVE ACTION FIRST CHECK
491 (29)	HbridgeFault_ETC Electronic Throttle Control Driver has failed. Indeterminate fault on Hbridge driver for electronic throttle control. Possibly either ETC+ or ETC- driver signals have been shorted to ground	(1) TurnOnMil (2) CutThrottle	Check ETC driver wiring for a shorted circuit SECM Pin A17 to ETC + Pin 1 SECM Pin A18 to ETC - Pin 4 <ul style="list-style-type: none"> Perform the throttle test using the Service Tool and re-check for fault Check the ETC internal motor drive by disconnecting the throttle connector and measuring the motor drive resistance at the throttle TPS Pin 1 (+DRIVER) to Pin 4 (-DRIVER) ~3.0-4.0Ω
521 (52)	LowOilPressureFault Low engine oil pressure	(1) TurnOnMil (2) DelayedEngine Shutdown	Check engine oil level Check electrical connection to the oil pressure switch SECM Pin B9 to Oil Pressure Switch
531 (53)	SysVoltRangeLow System voltage too low	TurnOnMil	Check battery voltage <ul style="list-style-type: none"> Perform maintenance check on electrical connections to the battery and chassis ground Check battery voltage during starting and with the engine running to verify charging system and alternator function Measure battery power at SECM with a multimeter (with key on) SECM Pin A23 (DRVP) to SECM Pin A16 (DRVG) SECM Pin A23 (DRVP) to SECM Pin B17 (DRVG)
541 (54)	SysVoltRangeHigh System voltage too high	(1) TurnOnMil (2) DelayedEngine Shutdown	Check battery and charging system voltage <ul style="list-style-type: none"> Check battery voltage during starting and with the engine running Check voltage regulator, alternator, and charging system Check battery and wiring for overheating and damage Measure battery power at SECM with a multimeter (with key on) SECM Pin A23 (DRVP) to SECM Pin A16 (DRVG) SECM Pin A23 (DRVP) to SECM Pin B17 (DRVG)

(*) Fault actions shown are default values specified by the OEM.

Table 2. Diagnostic Fault Codes (Flash Codes) cont'd.

DFC	PROBABLE FAULT	FAULT ACTION *	CORRECTIVE ACTION FIRST CHECK
551 (55)	SensVoltRangeLow Sensor reference voltage XDRP too low	(1) TurnOnMil (2) DelayedEngine Shutdown	Measure transducer power at the TMAP connector with a multimeter TMAP Pin 3 XDRP +5 Vdc to TMAP Pin 1 XDRG GND Verify transducer power at the SECM with a multimeter SECM Pin B24 +5 Vdc to SECM Pin B1 XDRG GND Verify transducer power at ETC with a multimeter ETC Pin 3 XDRP PWR to ETC Pin 2 XDRG GND Verify transducer power to the foot pedal with a multimeter.
561 (56)	SensVoltRangeHigh Sensor reference voltage XDRP too high	(1) TurnOnMil (2) DelayedEngine Shutdown	Measure transducer power at the TMAP connector with a multimeter TMAP Pin 3 XDRP +5 Vdc to TMAP Pin 1 XDRG GND Verify transducer power at the SECM with a multimeter SECM Pin B24 +5 Vdc to SECM Pin B1 XDRG GND Verify transducer power at ETC with a multimeter ETC Pin 3 XDRP PWR to ETC Pin 2 XDRG GND Verify transducer power to the foot pedal with a multimeter.
571 (57)	HardOverspeed Engine speed has exceeded the third level (3 of 3) of overspeed protection	(1) TurnOnMil (2) HardRevLimit (3) EngineShutdown	Usually associated with additional ETC faults • Check for ETC Sticking or other ETC faults Verify if the lift truck was motored down a steep grade
572	MediumOverspeed Engine speed has exceeded the second level (2 of 3) of overspeed protection	(1) TurnOnMil (2) MediumRevLimit (3) DelayedEngine Shutdown	Usually associated with additional ETC faults • Check for ETC Sticking or other ETC faults Verify if the lift truck was motored down a steep grade
573	SoftOverspeed Engine speed has exceeded the first level (1 of 3) of overspeed protection	(1) TurnOnMil (2) SoftRevLimit	Usually associated with additional ETC faults • Check for ETC Sticking or other ETC faults Verify if the lift truck was motored down a steep grade
611 (61)	APP1RangeLow APP1 sensor voltage out of range low, normally set if the APP1 signal has shorted to ground, circuit has opened or sensor has failed	TurnOnMil	Check foot pedal connector • Check APP1 signal at SECM PIN B7

(*) Fault actions shown are default values specified by the OEM.

Table 2. Diagnostic Fault Codes (Flash Codes) cont'd.

DFC	PROBABLE FAULT	FAULT ACTION *	CORRECTIVE ACTION FIRST CHECK
612 (65)	APP2RangeLow APP2 sensor voltage out of range low, normally set if the APP2 signal has shorted to ground, circuit has opened or sensor has failed	TurnOnMil	Check foot pedal connector • Check APP2 signal at SECM PIN B16
621 (62)	APP1RangeHigh APP1 sensor voltage out of range high, normally set if the APP1 signal has shorted to power or the ground for the sensor has opened	TurnOnMil	Check foot pedal connector • Check APP1 signal at SECM PIN B7
622 (66)	APP2RangeHigh APP2 sensor voltage out of range high, normally set if the APP2 signal has shorted to power or the ground for the sensor has opened	TurnOnMil	Check foot pedal connector • Check APP2 signal at SECM PIN B16
631 (63)	APP1AdaptLoMin Learned idle end of APP1 sensor range lower than expected	TurnOnMil	Check APP connector and pins for corrosion • Cycle the pedal several times and check APP1 signal at SECM Pin B7
632 (67)	APP2AdaptLoMin Learned idle end of APP2 sensor range lower than expected	TurnOnMil	Check APP connector and pins for corrosion • Cycle the pedal several times and check APP2 signal at SECM Pin B16
641 (64)	APP1AdaptHiMax Learned full pedal end of APP1 sensor range higher than expected	TurnOnMil	Check APP connector and pins for corrosion Cycle the pedal several times and check APP1 signal at SECM Pin B7
642 (68)	APP2AdaptHiMax Learned full pedal end of APP2 sensor range higher than expected	TurnOnMil	Check APP connector and pins for corrosion Cycle the pedal several times and check APP2 signal at SECM Pin B16
651	APP1AdaptHiMin Learned full pedal end of APP1 sensor range lower than expected	TurnOnMil	Check APP connector and pins for corrosion Cycle the pedal several times and check APP1 signal at SECM Pin B7
652	APP2AdaptHiMin Learned full pedal end of APP2 sensor range lower than expected	TurnOnMil	Check APP connector and pins for corrosion Cycle the pedal several times and check APP2 signal at SECM Pin B16
661	APP1AdaptLoMax Learned idle end of APP1 sensor range higher than expected	TurnOnMil	Check APP connector and pins for corrosion Cycle the pedal several times and check APP1 signal at SECM Pin B7
662	APP2AdaptLoMax Learned idle end of APP2 sensor range higher than expected	TurnOnMil	Check APP connector and pins for corrosion Cycle the pedal several times and check APP2 signal at SECM Pin B16
691 (69)	APP_Sensors_Conflict APP position sensors do no track well, intermittent connections to APP or defective pedal assembly	(1) TurnOnMil (2) Cut Throttle	Check APP connector and pins for corrosion • Cycle the pedal several times and check APP1 signal at SECM Pin B7 • Cycle the pedal several times and check APP2 signal at SECM Pin B16

(*) Fault actions shown are default values specified by the OEM.

Table 2. Diagnostic Fault Codes (Flash Codes) cont'd.

DFC	PROBABLE FAULT	FAULT ACTION *	CORRECTIVE ACTION FIRST CHECK
711 (71)	LSDFault_Dither1 Dither Valve 1 Fault, signal has opened or shorted to ground or power or defective dither 1 valve	(1) TurnOnMil (2) Disable GasO2 Ctrl (3) Disable GasPost O2Ctrl (Certified Units Only)	Check FTV1 for an open wire or FTV connector being disconnected FTV1 Pin 1 (signal) to SECM Pin A1 FTV1 Pin 2 (power) to SECM (DRVP) Pin A23 Check FTV1 for an open coil by disconnecting the FTV connector and measuring the resistance ($\sim 26\Omega \pm 2\Omega$)
712	LSDFault_Dither2 Dither Valve 2 Fault, signal has opened or shorted to ground or power or defective dither 2 valve	(1) TurnOnMil (2) Disable GasO2 Ctrl (3) Disable GasPost O2Ctrl (Certified Units Only)	Check FTV1 for an open wire or FTV connector being disconnected or signal shorted to GND FTV2 Pin 1 (signal) to SECM Pin A2 FTV2 Pin 2 (power) to SECM (DRVP) Pin A23 Check FTV1 for an open coil by disconnecting the FTV connector and measuring the resistance ($\sim 26\Omega \pm 2\Omega$)
713	LSDFault_CSValve	None	N/A
714	LSDFault_CheckEngine Check Engine Lamp Fault, signal has opened or shorted to ground or power or defective check engine lamp	None	Check 'Check Engine Lamp' for an open wire or shorted to GND
715	LSDFault_CrankDisable Crank Disable Fault, signal has opened or shorted to ground or power or defective crank disable relay	None	N/A
716	LSDFault_FuelPump Fuel pump fault, signal has opened, shorted to ground or power, or defective fuel pump	TurnOnMil	Check fuel pump for an open wire or connector being disconnected or signal shorted to GND Fuel Pump Pin B (signal) from SECM Pin A13 Fuel Pump Pin A (power) from main relay 1 Pin A23 Check Fuel Pump for an open coil by disconnecting the Fuel Pump connector and measuring the resistance ($\sim 26\Omega \pm 3\Omega$) Check for 12V to fuel pump
717	LSDFault_LockOff Fuel lock off Valve Fault, signal has opened or shorted to ground or power or defective Fuel lock off valve	TurnOnMil	Check fuel lock off valve for an open wire or connector being disconnected or signal shorted to GND Lock off Pin B (signal) from SECM Pin A11 Lock off Pin A (power) from main relay 1 Pin A23 Check lock off valve for an open coil by disconnecting the lock off valve connector and measuring the resistance ($\sim 26\Omega \pm 3\Omega$) Check for 12V to lock off valve

<p>718</p>	<p>LSDFault_MIL Malfunction Indicator Lamp Fault, signal has opened or shorted to ground or power or defective MIL lamp</p>	<p>None</p>	<p>None</p>
<p>721 (72)</p>	<p>GasFuelAdaptRangeLo In LPG mode, system had to adapt rich more than expected</p>	<p>(1) TurnOnMil (2) Disable GasO2 Ctrl (3) Disable GasPost O2Ctrl (Certified Units Only)</p>	<p>Check for vacuum leaks. Check fuel trim valves, e.g. leaking valve or hose Check for missing orifice(s).</p>
<p>722</p>	<p>GasDesEquivLo In LPG mode, system had to adapt rich more than expected</p>	<p>None</p>	<p>N/A</p>

(*) Fault actions shown are default values specified by the OEM.

Table 2. Diagnostic Fault Codes (Flash Codes) cont'd.

DFC	PROBABLE FAULT	FAULT ACTION *	CORRECTIVE ACTION FIRST CHECK
731 (73)	GasFuelAdaptRangeHi In LPG mode, system had to adapt lean more than expected	(1) TurnOnMil (2) Disable GasO2 Ctrl (3) Disable GasPost O2Ctrl (Certified Units Only)	Check dual dither valves, e.g. plugged valve or hose. Check for plugged orifice(s).
732	GasDesEquivHi In LPG mode, system had to adapt rich more than expected	None	N/A
741 (74)	GasO2NotActive Pre-catalyst O2 sensor inactive on LPG, open O2 sensor signal or heater leads, defective O2 sensor	(1) TurnOnMil (2) DisableGas O2Ctrl (3) Disable GasPost O2Ctrl (Certified Units Only)	Check that Pre-catalyst O2 sensor connections are OK. O2 (signal) Pin 3 to SECM Pin B13 O2 Pin 2 (HEATER GND) to SECM (DRVG GNG) Pins A16, B17 O2 Pin 1 (HEATER PWR) to SECM (DRVP + 12V) Pin A23 Verify O2 sensor heater circuit is operating by measuring heater resistance ($2.1\Omega \pm 0.4\Omega$) O2 Pin 2 (HEATER GND) to Pin 1 (HEATER PWR)
742	GasPostO2NotActive Post-catalyst O2 sensor inactive on LPG, open O2 sensor signal or heater leads, defective O2 sensor.	(1) TurnOnMil (2) DisableGasPost O2Ctrl (Certified Units Only)	Check that Post-catalyst O2 sensor connections are OK. O2 (signal) Pin 3 to SECM Pin B19 O2 Pin 2 (HEATER GND) to SECM (DRVG GNG) Pins A16, B17 O2 Pin 1 (HEATER PWR) to Post O2 Heater Relay. Relay pin 87. This relay only turns on after engine has been running for some time and SECM has calculated that water condensation in exhaust has been removed by exhaust heat. Post O2 Heater Relay has SECM (DRVP + 12V) applied to the relay coil power. The relay coil ground is controlled by SECM Pin A20 to activate the relay to flow current through the post O2 heater. Verify O2 sensor heater circuit is operating by measuring heater resistance ($2.1\Omega \pm 0.4\Omega$) O2 Pin 2 (HEATER GND) to Pin 1 (HEATER PWR)
743	GasCatInactive	None	N/A
751	GasO2FailedLean Pre-catalyst O2 sensor indicates extended lean operation on LPG	(1) TurnOnMil (2) DisableGas O2Ctrl (3) Disable GasPost O2Ctrl (Certified Units Only)	Check for vacuum leaks. Check dual dither valves, e.g. leaking valve or hose. Check for missing orifice(s).

752	GasPostO2FailedLean Pre-catalyst O2 sensor indicates extended lean operation on LPG	(1) TurnOnMil (2) DisableGasPostO2Ctrl (Certified Units Only)	Correct other faults that may contribute to 752 (e.g. faults pertaining to dither valves, Pre-Cat O2, Post Cat O2 sensor) Check for vacuum leaks Check for leaks in exhaust, catalytic converter, HEGO sensors; repair leaks. Check all sensor connections (see fault 742 corrective actions).
771 (77)	GasO2FailedRich Pre-catalyst O2 sensor indicates extended rich operation on LPG	(1) TurnOnMil (2) DisableGasO2Ctrl (3) DisableGasPostO2Ctrl (Certified Units Only)	Check dual dither valves, e.g. plugged valve or hose. Check for plugged orifice(s).

(*) Fault actions shown are default values specified by the OEM.

Table 2. Diagnostic Fault Codes (Flash Codes) cont'd.

DFC	PROBABLE FAULT	FAULT ACTION *	CORRECTIVE ACTION FIRST CHECK
772	GasPostO2FailedRich Pre-catalyst O2 sensor indicates extended rich operation on LPG	(1) TurnOnMil (2) DisableGasPostO2Ctrl (Certified Units Only)	Correct other faults that may contribute to 772 (e.g. faults pertaining to FTVs, Pre-Cat O2, Post Cat O2 sensor) Look for leaks in exhaust, catalytic converter, HEGO sensors; repair leaks. Check all sensor connections (see fault 742 corrective actions).
821	LiqFuelAdaptRangeHi In Gasoline mode, system had to adapt lean more than expected	(1) TurnOnMil (2) Disable LiquidO2 Ctrl (3) Disable LiqPostO2Ctrl	Check for vacuum leaks. Low gasoline fuel pressure, perform gasoline pressure test. Injector problems, e.g. plugged, defective injector.
822	LiqDesEquivHi	None	N/A
831	LiqFuelAdaptRangeLow In Gasoline mode, system had to adapt rich more than expected	(1) TurnOnMil (2) Disable LiquidO2 Ctrl (3) Disable LiqPostO2Ctrl	Low gasoline fuel pressure, perform gasoline pressure test Injector problems, e.g. leaking, defective injector.
832	LiqDesEquivLo	None	N/A
841	LiqO2NotActive Pre-catalyst O2 sensor inactive on gasoline, open O2 sensor signal or heater leads, defective O2 sensor	(1) TurnOnMil (2) DisableLiquidO2Ctrl (3)DisableLiquidPostO2Ctrl	Check that Pre-catalyst O2 sensor connections are OK. O2 (signal) Pin 3 to SECM Pin B13 O2 Pin 2 (HEATER GND) to SECM (DRVG GNG) Pins A16, B17 O2 Pin 1 (HEATER PWR) to SECM (DRVP + 12V) PIN A23 Verify O2 sensor heater circuit is operating by measuring heater resistance ($2.1\Omega \pm 0.4\Omega$) O2 Pin 2 (HEATER GND) to Pin 1 (HEATER PWR)
842	LiqPostO2NotActive Post-catalyst O2 sensor inactive on gasoline, open O2 sensor signal or heater leads, defective O2 sensor.	(1) TurnOnMil (2) DisableLiqPostO2Ctrl (Certified Units Only)	Check that Post-catalyst O2 sensor connections are OK. O2 (signal) Pin 3 to SECM Pin B19 O2 Pin 2 (HEATER GND) to SECM (DRVG GNG) Pins A16, B17 O2 Pin 1 (HEATER PWR) to Post O2 Heater Relay. Relay pin 87. This relay only turns on after engine has been running for some time and SECM has calculated that water condensation in exhaust has been removed by exhaust heat. Post O2 Heater Relay has SECM (DRVP + 12V) applied to the relay coil power. The relay coil ground is controlled by SECM Pin A20 to activate the relay to flow current through the post O2 heater. Verify O2 sensor heater circuit is operating by measuring heater resistance ($2.1\Omega \pm 0.4\Omega$) O2 Pin 2 (HEATER GND) to Pin 1 (HEATER PWR)
843	LiqCatInactive	None	N/A
851	LiqO2FailedLean Pre-catalyst O2 sensor indicates extended lean operation on gasoline	(1) TurnOnMil (2) DisableLiquidO2Ctrl (3)DisableLiquidPostO2Ctrl	Check for vacuum leaks. Low gasoline fuel pressure, perform gasoline pressure test. Injector problems, e.g. plugged, defective injector

(*) Fault actions shown are default values specified by the OEM.

Table 2. Diagnostic Fault Codes (Flash Codes) cont'd.

DFC	PROBABLE FAULT	FAULT ACTION *	CORRECTIVE ACTION FIRST CHECK
852	LiqPostO2FailedLean Pre-catalyst O2 sensor indicates extended lean operation on gasoline	(1) TurnOnMil (2) DisableLiqPost O2Ctrl (Certified Units Only)	Correct other faults that may contribute to 852 (e.g. faults pertaining to Injectors, MAP, IAT, Pre-Cat O2, Post Cat O2 sensor) Look for leaks in exhaust, catalytic converter, HEGO sensors; repair leaks. Check all sensor connections (see fault 842 corrective actions).
871	LiqO2FailedRich Pre-catalyst O2 sensor indicates extended rich operation on gasoline	(1) TurnOnMil (2) DisableLiquid O2Ctrl (3)DisableLiquid PostO2Ctrl	High gasoline fuel pressure, perform gasoline pressure test Injector problems, e.g. leaking, defective injector
872	LiqPostO2FailedRich Pre-catalyst O2 sensor indicates extended rich operation on gasoline	(1) TurnOnMil (2) DisableLiq PostO2Ctrl (Certified Units Only)	Correct other faults that may contribute to 872 (e.g. faults pertaining to Injectors, MAP, IAT, Pre-Cat O2, Post Cat O2 sensor) Look for leaks in exhaust, catalytic converter, HEGO sensors; repair leaks. Check all sensor connections (see fault 842 corrective actions).
911	O2RangeLow Pre-catalyst O2 sensor voltage out of range low, sensor signal shorted to ground	None	N/A
912	O2_PostCatRangeLow Post-catalyst O2 sensor voltage out of range low, sensor signal shorted to ground	None	N/A
921	O2RangeHigh Pre-catalyst O2 sensor voltage out of range high, sensor signal shorted to power	(1) TurnOnMil (2) DisableLiquid O2Ctrl (3) DisableGas O2Ctrl (Certified Units Only)	Check if O2 sensor installed before catalyst is shorted to +5Vdc or battery. O2 (signal) Pin 3 to SECM Pin B13 SECM (XDRP + 5V) Pin B24 SECM (DRVP + 12V) Pin A23
922	O2_PostCatRangeHigh Post-catalyst O2 sensor voltage out of range low, sensor signal shorted to ground	(1) TurnOnMil (2) Disable asoline Post-catalyst O2Ctrl (3) Disable LPG Post-catalyst O2Ctrl (Certified Units Only)	Check if O2 sensor installed after catalyst is shorted to +5Vdc or battery. O2 (signal) Pin 3 to SECM Pin B19 Possible voltage sources: SECM (XDRP + 5V) Pin B24 and SECM (DRVP + 12V) Pin A23
931	FuelTempRangeLow Fuel Temperature Sensor Input is Low normally set if the fuel temperature sensor wire has shorted to chassis ground or the sensor has failed.	TurnOnMil (Certified Units Only)	Check fuel temp sensor connector and wiring for a short to GND SECM (signal) Pin B14 to FTS Pin 1 SECM (sensor GND) Pin B1 to FTS Pin 2 SECM (system GND) Pin A16, B17
932	FuelTempRangeHigh Fuel Temperature Sensor Input is High normally set if the fuel temperature sensor wire has been disconnected or the circuit has opened to the SECM.	TurnOnMil (Certified Units Only)	Check if fuel temp sensor connector is disconnected or for an open FTS circuit SECM (signal) Pin B14 to FTS Pin 1 SECM (sensor GND) Pin B1 to FTS Pin 2

(*) Fault actions shown are default values specified by the OEM.

Table 2. Diagnostic Fault Codes (Flash Codes) cont'd.

DFC	PROBABLE FAULT	FAULT ACTION *	CORRECTIVE ACTION FIRST CHECK
933	TransOilTemp Excessive transmission oil temperature	(1) TurnOnMil (2) DelayedEngine Shutdown	Refer to drivetrain manufacturer's transmission service procedures.
991	ServiceFault1 Service Interval 1 has been reached	None	Perform service procedure related to Service Interval 1 (determined by OEM)
992	ServiceFault2 Service Interval 2 has been reached	None	Perform service procedure related to Service Interval 2 (determined by OEM)
993	ServiceFault3 Service Interval 3 has been reached	None	Perform service procedure related to Service Interval 3 (determined by OEM)
994	ServiceFault4 Service Interval 4 has been reached-replace HEGO sensors	TurnOnMil (Certified Units Only)	Replace Pre-catalyst HEGO sensor Replace Post-catalyst HEGO sensor
995	ServiceFault5 Service Interval 5 has been reached-replace timing belt	TurnOnMil	Replace engine timing belt

(*) Fault actions shown are default values specified by the OEM.

Electronic Controlled Spark-Ignition Engines

G430FE Engine

The primary components of the fuel system are the fuel supply, direct electronic pressure regulator (DEPR), fuel mixer, electronic throttle control (ETC) device, 2-Stage convertor, engine control module (ECM), and a catalytic converter. The system operates on a slightly positive fuel pressure. Primary fuel pressure can be measured at the LD 2-Stage convertor. Secondary fuel pressure command and actual fuel pressure is monitored by the ECM.

To obtain maximum effect from the catalyst and accurate control of the air fuel ratio, the emission certified engine is equipped with an onboard computer or Engine Control Module (ECM). The ECM is a 32 bit controller which receives input data from sensors mounted to the engine and fuel system and then outputs various signals to control engine operation.

One specific function of the controller is to maintain a closed loop fuel control which is accomplished by use of the Heated Exhaust Gas Oxygen sensor (HEGO) mounted in the exhaust system. The HEGO sensor sends a voltage signal to the controller which then outputs signals to the EPR to change the amount of fuel being delivered from the regulator or mixer to the engine.

The controller also performs diagnostic functions on the fuel system and notifies the operator of engine malfunctions by turning on a Malfunction Indicator Light (MIL) mounted in the dash. Malfunctions in the system are identified by a Diagnostic Trouble Code (DTC) number. In addition to notifying the operator of the malfunction in the system, the controller also stores the information about the malfunction in its memory. A technician can then utilize a computerized diagnostic scan tool to retrieve the stored diagnostic code and by using the diagnostic charts in this manual to determine the cause of the malfunction. In the event a technician does not have the computerized diagnostic tool, the MIL light can be used to identify the diagnostic code to activate the "blink" feature and count the number of blinks to determine the diagnostic code number to locate the fault in the system.

EMS schematic of G430FE LP engine

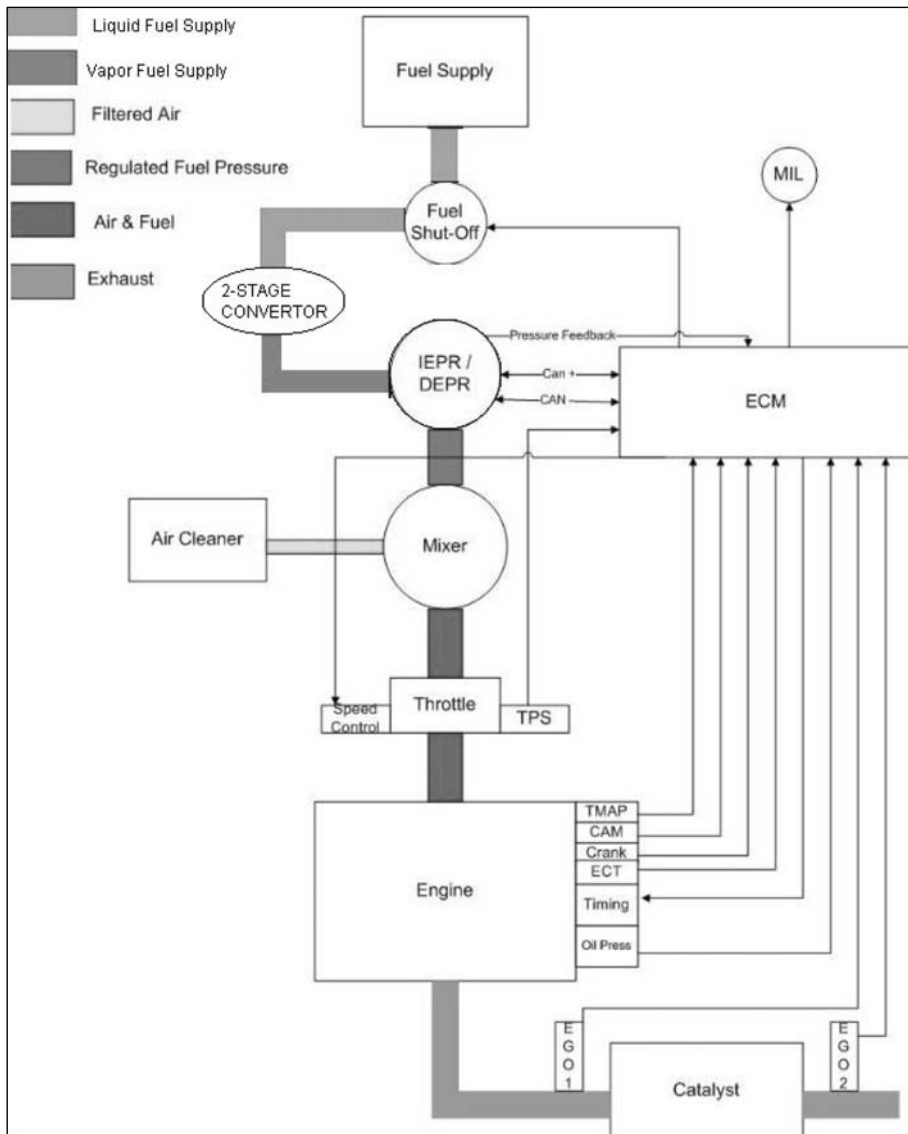

Basic Troubleshooting(LP)

The G430FE fuel systems are equipped with built-in fault diagnostics. Detected system faults can be displayed by the Malfunction Indicator Lamp (MIL) and are covered in the Advanced Diagnostics section. Items such as fuel level, plugged fuel lines, clogged fuel filters and malfunctioning pressure regulators may not set a fault code by the Engine Control Module (ECM).

Below are basic checks that should be made before referring to the Advanced Diagnostics section, if engine or drivability problems are encountered.

Locating a problem in a propane engine is done exactly the same way as with a gasoline engine.

Consider all parts of the ignition and mechanical systems as well as the fuel system.

FUEL SYSTEM SYMPTOM DIAGNOSTICS

Checks	Action
<p>Before Using This Section</p>	<p>Before using this section, you should have performed On Board Diagnostic (OBD) Check and determined that:</p> <ol style="list-style-type: none"> 1. The ECM and MIL are operating correctly. 2. There are no Diagnostic Trouble Codes (DTCs) stored, or a DTC exists but without a MIL. <p>Several of the following symptom procedures call for a careful visual and physical check. These checks are very important as they can lead to prompt diagnosis and correction of a problem.</p>
<p>Fuel System Check</p>	<ol style="list-style-type: none"> 1. Verify the customer complaint. 2. Locate the correct symptom table. 3. Check the items indicated under that symptom. 4. Operate the equipment under the conditions the symptom occurs. Verify HEGO switching between lean and rich. IMPORTANT! Normal HEGO switching indicates the fuel system is in closed loop and operating correctly at that time. 5. Take a data snapshot using the DST under the condition that the symptom occurs to review at a later time.
<p>Visual and Physical Checks</p>	<ul style="list-style-type: none"> • Check all ECM system fuses and circuit breakers. • Check the ECM ground for being clean, tight and in its proper location. • Check the vacuum hoses for splits, kinks and proper connections. • Check thoroughly for any type of leak or restriction. • Check for air leaks at all the mounting areas of the intake manifold sealing surfaces. • Check for proper installation of the mixer assembly. • Check for air leaks at the mixer assembly. <p>Check the ignition wires for the following conditions:</p> <ul style="list-style-type: none"> • Cracking • Hardening • Proper routing • Carbon tracking. <p>Check the wiring for the following items: proper connections, pinches or cuts.</p> <p>The following symptom tables contain groups of possible causes for each symptom. The order of these procedures is not important. If the DST readings do not indicate a problem, then proceed in a logical order, easiest to check or most likely to cause the problem.</p>

INTERMITTENT

Checks	Action
DEFINITION: <i>The problem may or may not turn ON the (MIL) or store a Diagnostic Trouble Code (DTC).</i>	
Preliminary Checks	Do not use the DTC tables. If a fault is an intermittent, the use of the DTC tables with this condition may result in the replacement of good parts.
Faulty Electrical Connections or Wiring	<p>Faulty electrical connections or wiring can cause most intermittent problems. Check the suspected circuit for the following conditions:</p> <ul style="list-style-type: none"> • Faulty fuse or circuit breaker, connectors poorly mated, terminals not fully seated in the connector (backed out). Terminals not properly formed or damaged. • Wire terminals poorly connected. • Terminal tension is insufficient. • Carefully remove all the connector terminals in the problem circuit in order to ensure the proper contact tension. • If necessary, replace all the connector terminals in the problem circuit in order to ensure the proper contact tension (except those noted as “Not Serviceable”). See section <i>Wiring Schematics</i>. • Checking for poor terminal to wire connections requires removing the terminal from the connector body.
Operational Test	If a visual and physical check does not locate the cause of the problem, operate the vehicle with the DST connected. When the problem occurs, an abnormal voltage or scan reading indicates a problem circuit.
Intermittent MIL Illumination	<p>The following components can cause intermittent MIL and no DTC(s):</p> <ul style="list-style-type: none"> • A defective relay. • Switch that can cause electrical system interference. Normally, the problem will occur when the faulty component is operating. • The improper installation of add on electrical devices, such as lights, 2-way radios, electric motors, etc. • The ignition secondary voltage shorted to a ground. • The MIL circuit or the Diagnostic Test Terminal intermittently shorted to ground. • The MIL wire grounds.
Loss of DTC Memory	<p>To check for the loss of the DTC Memory:</p> <ol style="list-style-type: none"> 1. Disconnect the TMAP sensor. 2. Idle the engine until the MIL illuminates. 3. The ECM should store a TMAP DTC which should remain in the memory when the ignition is turned OFF. If the TMAP DTC does not store and remain, the ECM is faulty.

NO START

Checks	Action
DEFINITION: <i>The engine cranks OK but does not start.</i>	
Preliminary Checks	None
ECM Checks	Use the DST to : <ul style="list-style-type: none"> • Check for proper communication with both the ECM • Check all system fuses engine fuse holder. Refer to <i>Engine Controls Schematics</i>. • Check battery power, ignition power and ground circuits to the ECM. Refer to <i>Engine Control Schematics</i>. Verify voltage and/or continuity foreach.
Sensor Checks	<ul style="list-style-type: none"> • Check the TMAP sensor. • Check the cam angle sensor for output (RPM).
Fuel System Checks	<p>Important: A closed LPG manual fuel shut off valve will create a no start condition.</p> <ul style="list-style-type: none"> • Check for air intake system leakage between the mixer and the throttle body. Verify proper operation of the low pressure lock-off solenoids. • Verify proper operation of the fuel control solenoids. • Check the fuel system pressures. • Refer to the <i>LPG Fuel System Diagnosis</i>. • Check for proper mixer air valve operation.
Ignition System Checks	<p>Note: LPG being a gaseous fuel requires higher secondary ignition system voltages for the equivalent gasoline operating conditions.</p> <ol style="list-style-type: none"> 1. Check for the proper ignition voltage output with <i>J 26792</i> or the equivalent. 2. Verify that the spark plugs are correct for use with LPG. <p>Check the spark plugs for the following conditions:</p> <ul style="list-style-type: none"> • Wet plugs. • Cracks. • Wear. • Improper gap. • Burned electrodes. • Heavy deposits. • Check for bare or shorted ignition wires. • Check for loose ignition coil connections at the coil.

NO START

Checks	Action
Engine Mechanical Checks	<p>Important: The LPG Fuel system is more sensitive to intake manifold leakage than the gasoline fuel system.</p> <p>Check for the following:</p> <ul style="list-style-type: none">• Vacuum leaks.• Improper valve timing.• Low compression.• Improper valve clearance.• Worn rocker arms.• Broken or weak valve springs. <p>Worn camshaft lobes.</p>
Exhaust System Checks	<p>Check the exhaust system for a possible restriction:</p> <ul style="list-style-type: none">• Inspect the exhaust system for damaged or collapsed pipes:• Inspect the muffler for signs of heat distress or for possible internal failure.• Check for possible plugged catalytic converter. Refer to <i>Restricted Exhaust System Diagnosis</i>.

HARD START

Checks	Action
<p>DEFINITION: The engine cranks OK, but does not start for a long time. The engine does eventually run, or may start but immediately dies.</p>	
<p>Preliminary Checks</p>	<p>Make sure the vehicle's operator is using the correct starting procedure.</p>
<p>Sensor Checks</p>	<ul style="list-style-type: none"> • Check the Engine Coolant Temperature sensor with the DST. Compare the engine coolant temperature with the ambient air temperature on a cold engine. If the coolant temperature reading is more than 10 degrees greater or less than the ambient air temperature on a cold engine, check for high resistance in the coolant sensor circuit. Check the cam angle sensor. • Check the Throttle Position (TPS) and Foot Pedal Position (FPP) sensor connections.
<p>Fuel System Checks</p>	<p>Important: A closed LPG manual fuel shut off valve will create an extended crank OR no start condition.</p> <ul style="list-style-type: none"> • Verify the excess flow valve is not tripped or that the manual shut-off valve is not closed. <p>Check mixer assembly for proper installation and leakage.</p> <ul style="list-style-type: none"> • Verify proper operation of the low pressure lock-off solenoid. • Verify proper operation of the EPR. • Check for air intake system leakage between the mixer and the throttle body. Check the fuel system pressures. Refer to the <i>Fuel System Diagnosis</i>.
<p>Ignition System Checks</p>	<p>Note: LPG being a gaseous fuel requires higher secondary ignition system voltages for the equivalent gasoline operating conditions.</p> <ul style="list-style-type: none"> • Check for the proper ignition voltage output with J 26792 or the equivalent. • Verify that the spark plugs are the correct type and properly gapped. <p>Check the spark plugs for the following conditions:</p> <ul style="list-style-type: none"> • Wet plugs. • Cracks. • Wear. • Burned electrodes. • Heavy deposits • Check for bare or shorted ignition wires. • Check for moisture in the distributor cap. • Check for loose ignition coil connections. <p>Important:</p> <ol style="list-style-type: none"> 1. If the engine starts but then immediately stalls, check the cam angle sensor. 2. Check for improper gap, debris or faulty connections.

HARD START

Checks	Action
Engine Mechanical Checks	<p>Important: The LPG Fuel system is more sensitive to intake manifold leakage than the gasoline fuel supply system.</p> <p>Check for the following:</p> <ul style="list-style-type: none">• Vacuum leaks• Improper valve timing• Low compression• Improper valve clearance.• Worn rocker arms• Broken or weak valve springs• Worn camshaft lobes. <p>Check the intake and exhaust manifolds for casting ash.</p>
Exhaust System Checks	<p>Check the exhaust system for a possible restriction:</p> <ul style="list-style-type: none">• Inspect the exhaust system for damaged or collapsed pipes.• Inspect the muffler for signs of heat distress or for possible internal failure. <p>Check for possible plugged catalytic converter. Refer to <i>Restricted Exhaust System Diagnosis</i>.</p>

CUTS OUT, MISSES

Checks	Action
<p>DEFINITION: A surging or jerking that follows engine speed, usually more pronounced as the engine load increases, but normally felt below 1500 RPM. The exhaust has a steady spitting sound at idle, low speed, or hard acceleration for the fuel starvation that can cause the engine to cut-out.</p>	
Preliminary Checks	None
Ignition System Checks	<ol style="list-style-type: none"> 1. Start the engine. 2. Check for proper ignition output voltage with spark tester J 26792. 3. Check for a cylinder misfire. 4. Verify that the spark plugs are the correct type and properly gapped. <p>Remove the spark plugs and check for the following conditions:</p> <ul style="list-style-type: none"> • Insulation cracks. • Wear. • Improper gap. • Burned electrodes. • Heavy deposits. <p>Visually/Physically inspect the secondary ignition for the following:</p> <ul style="list-style-type: none"> • Ignition wires for arcing and proper routing. • Cross- ring. • Ignition coils for cracks or carbon tracking
Engine Mechanical Checks	<p>Perform a cylinder compression check. Check the engine for the following:</p> <ul style="list-style-type: none"> • Improper valve timing. • Improper valve clearance. • Worn rocker arms. • Worn camshaft lobes. • Broken or weak valve springs. • Check the intake and exhaust manifold passages for casting ash.
Fuel System Checks	<p>Check the fuel system:</p> <ul style="list-style-type: none"> • Plugged fuel filter. • Low fuel pressure, etc. Refer to <i>LPG Fuel System Diagnosis</i>. • Check the condition of the wiring to the low pressure lock-off solenoid.
Additional Check	<p>Check for Electromagnetic Interference (EMI), which may cause a misfire condition. Using the DST, monitor the engine RPM and note sudden increases in rpms displayed on the scan tool but with little change in the actual engine rpm. If this condition exists, EMI may be present. Check the routing of the secondary wires and the ground circuit.</p>

HESITATION, SAG, STUMBLE

Checks	Action
<p>DEFINITION: <i>The engine has a momentary lack of response when putting it under load. The condition can occur at any engine speed. The condition may cause the engine to stall if it's severe enough.</i></p>	
Preliminary Checks	None
Fuel System Checks	<ul style="list-style-type: none"> • Check the fuel pressure. Refer to <i>LPG Fuel System Diagnosis</i>. • Check for low fuel pressure during a moderate or full throttle acceleration. If the fuel pressure drops below specification, there is possibly a faulty low pressure regulator or a restriction in the fuel system. • Check the TMAP sensor response and accuracy. • Check Shut-Off electrical connection. • Check the mixer air valve for sticking or binding. • Check the mixer assembly for proper installation and leakage. Check the EPR.
Ignition System Checks	<p>Note: LPG being a gaseous fuel requires higher secondary ignition system voltages for the equivalent gasoline operating conditions. If a problem is reported on LPG and not gasoline, do not discount the possibility of a LPG only ignition system failure and test the system accordingly.</p> <ul style="list-style-type: none"> • Check for the proper ignition voltage output with J 26792 or the equivalent. Verify that the spark plugs are the correct type and properly gapped. • Check for faulty spark plug wires. • Check for fouled spark plugs.
Additional Check	<ul style="list-style-type: none"> • Check for manifold vacuum or air induction system leaks. • Check the alternator output voltage.

BACKFIRE

Checks	Action
<p>DEFINITION: The fuel ignites in the intake manifold, or in the exhaust system, making a loud popping noise.</p>	
Preliminary Checks	None
Ignition System Checks	<p>Important! LPG, being a gaseous fuel, requires higher secondary ignition system voltages for the equivalent gasoline operating conditions. The ignition system must be maintained in peak condition to prevent backfire.</p> <ul style="list-style-type: none"> • Check for the proper ignition coil output voltage using the spark tester J26792 or the equivalent. • Check the spark plug wires by connecting an ohmmeter to the ends of each wire in question. If the meter reads over 30,000 ohms, replace the wires. • Check the connection at ignition coil. • Check for deteriorated spark plug wire insulation. <p>Remove the plugs and inspect them for the following conditions:</p> <ul style="list-style-type: none"> • Wet plugs. • Cracks. • Wear. • Improper gap. • Burned electrodes. • Heavy deposits.
Engine Mechanical Check	<p>Important! The LPG Fuel system is more sensitive to intake manifold leakage than a gasoline fuel supply system.</p> <p>Check the engine for the following:</p> <ul style="list-style-type: none"> • Improper valve timing. • Engine compression. • Manifold vacuum leaks. • Intake manifold gaskets. • Sticking or leaking valves. • Exhaust system leakage. • Check the intake and exhaust system for casting ash or other restrictions.
Fuel System Checks	Perform a fuel system diagnosis. Refer to <i>LPG Fuel System Diagnosis</i> .

LACK OF POWER, SLUGGISHNESS, OR SPONGINESS

Checks	Action
DEFINITION: <i>The engine delivers less than expected power.</i>	
Preliminary Checks	<ul style="list-style-type: none"> • Refer to the <i>LPG Fuel system OBD System Check</i>. • Compare the customer's vehicle with a similar unit to verify customer has an actual problem. <i>Do not compare the power output of the vehicle operating on LPG to a vehicle operating on gasoline as the fuels do have different drive feel characteristics.</i> • Remove the air filter and check for dirt or restriction. • Check the vehicle transmission. • Refer to the OEM transmission diagnostics.
Fuel System Checks	<ul style="list-style-type: none"> • Check for a restricted fuel filter, contaminated fuel, or improper fuel pressure. Refer to <i>LPG Fuel System Diagnosis</i>. • Check for the proper ignition output voltage with the spark tester <i>J 26792</i> or the equivalent. • Check for proper installation of the mixer assembly. Check all air inlet ducts for condition and proper installation. • Check for fuel leaks between the EPR and the mixer. • Verify that the LPG tank manual shut-off valve is fully open. • Verify that liquid fuel (not vapor) is being delivered to the EPR.
Sensor Checks	<ul style="list-style-type: none"> • Check the Heated Exhaust Gas Oxygen Sensors (HEGO) for contamination and performance. Check for proper operation of the TMAP sensor. • Check for proper operation of the TPS and FPP sensors.
Exhaust System Checks	<p>Check the exhaust system for a possible restriction:</p> <ul style="list-style-type: none"> • Inspect the exhaust system for damaged or collapsed pipes. • Inspect the muffler for signs of heat distress or for possible internal failure. • Check for possible plugged catalytic converter.
Engine Mechanical Check	<p>Check the engine for the following:</p> <ul style="list-style-type: none"> • Engine compression. • Valve timing. • Improper or worn camshaft. • Refer to <i>Engine Mechanical</i> in the Service Manual.
Additional Check	<ul style="list-style-type: none"> • Check the ECM grounds for being clean, tight, and in their proper locations. • Check the alternator output voltage. <p>If all procedures have been completed and no malfunction has been found, review and inspect the following items:</p> <ul style="list-style-type: none"> • Visually and physically, inspect all electrical connections within the suspected circuit and/or systems. • Check the DST data.

ROUGH, UNSTABLE, OR INCORRECT IDLE, STALLING

Checks	Action
<p>DEFINITION: <i>The engine runs unevenly at idle. If severe enough, the engine may shake.</i></p>	
Preliminary Checks	None.
Sensor Checks	<p>Check the Heated Exhaust Gas Oxygen Sensors (HEGO) performance:</p> <ul style="list-style-type: none"> • Check for silicone contamination from fuel or improperly used sealant. If contaminated, the sensor may have a white powdery coating result in a high but false signal voltage (rich exhaust indication). The ECM will reduce the amount of fuel delivered to the engine causing a severe driveability problem. <p>Check the Temperature Manifold Absolute Pressure (TMAP) sensor response and accuracy.</p>
Fuel System Checks	<ul style="list-style-type: none"> • Check for rich or lean symptom that causes the condition. • Drive the vehicle at the speed of the complaint. • Monitoring the oxygen sensors will help identify the problem. • Check for a sticking mixer air valve. • Verify proper operation of the EPR. • Perform a cylinder compression test. Refer to <i>Engine Mechanical</i> in the Service Manual. • Check the EPR fuel pressure. Refer to the <i>LPG Fuel System Diagnosis</i>. • Check mixer assembly for proper installation and connection.
Ignition System Checks	<ul style="list-style-type: none"> • Check for the proper ignition output voltage using the spark tester <i>J26792</i> or the equivalent. • Verify that the spark plugs are the correct type and properly gapped. <p>Remove the plugs and inspect them for the following conditions:</p> <ul style="list-style-type: none"> • Wet plugs. • Cracks. • Wear. • Improper gap. • Burned electrodes. • Blistered insulators. • Heavy deposits. <p>Check the spark plug wires by connecting an ohmmeter to the ends of each wire in question. If the meter reads over 30,000 ohms, replace the wires.</p>
Additional Checks	<p>Important: The LPG Fuel system is more sensitive to intake manifold leakage than the gasoline fuel supply system.</p> <ul style="list-style-type: none"> • Check for vacuum leaks. Vacuum leaks can cause a higher than normal idle and low throttle angle control command. • Check the ECM grounds for being clean, tight, and in their proper locations. Check the battery cables and ground straps. They should be clean and secure. Erratic voltage may cause all sensor readings to be skewed resulting in poor idle quality.

ROUGH, UNSTABLE, OR INCORRECT IDLE, STALLING

Checks	Action
Engine Mechanical Check	Check the engine for: <ul style="list-style-type: none">• Broken motor mounts.• Improper valve timing.• Low compression.• Improper valve clearance.• Worn rocker arms.• Broken or weak valve springs.• Worn camshaft lobes.

Advanced Diagnostics

The Fuel system has built-in diagnostics for system trouble shooting. The system has a dash mounted malfunction indicator lamp (MIL) that provides indications of engine or fuel system related problem. Most engine control system related problems that affect emissions or driveability of the vehicle will set a (DTC) diagnostic trouble code and illuminate the MIL.

The MIL serves as notification to the operator of a problem related to the emission control system so the driver can arrange for service as soon as possible. It will also display DTCs that have been stored due to a system malfunction.

The MIL should illuminate when the key is in the ON position and the engine is not running. This feature verifies that the lamp is in proper working order. If the MIL does not illuminate with the vehicle key ON/engine OFF, repair it as soon as possible. Once the engine is in start or run mode, the MIL should turn off. If the lamp remains on while the engine is in the start or run mode a diagnostic trouble code may be set.

The MIL will be turned OFF after three (3) consecutive run cycles or by clearing the active code with the Diagnostic Scan Tool (DST).

Diagnostic Trouble Codes are set when the GCP (Electronic Control Module) runs a diagnostic self test and the test fails. When a DTC is set, the ECM will illuminate the MIL on the instrument panel and also save the DTC in memory. The ECM will continue to run the self test. If the system continues to fail the test, the lamp will stay illuminated and the DTC is stored as an active DTC. If the self test runs and passes, the DTC will be stored as historic DTC. All DTCs are stored as historic faults until they are cleared. Most DTCs will automatically clear from memory if the DTC does not reset within 50 to 100 consecutive engine run cycles.

While a Diagnostic Trouble Code is current for a sensor, the ECM may assign a default "limp home" value and use that value in its control algorithms. All of the system diagnostic self-tests run continuously during normal vehicle operation.

The Diagnostic Trouble Codes can be read by using either the MIL lamp or a laptop computer. Diagnostic Trouble Codes can be cleared from memory with a laptop computer, or by turning the ignition key to the OFF position and removing the ECM power fuse or battery cable for at least 15 seconds.

If more than one DTC is detected, start the diagnostic repair with the lowest DTC number set. Diagnose each problem to correction unless directed to do otherwise by the diagnostic chart. The DTCs are numbered in order of importance. Both DTC 112 and DTC122 pertain to the oxygen sensor, so it is possible that a repair that corrects DTC 112 may also correct the problem causing the DTC 122.

Diagnostic test charts contained in this manual refer to the DST to be connected and in the "System Data Mode." This simply means that the DST is connected and communicating with the PC. In some instances the chart will call out a special test mode. An example of this would be instructions for the DST to be connected and in the DBW (drive by wire) mode. Always be sure to follow the special instructions to avoid a false diagnosis of fuel system components.

BLINK CODE FUNCTION

Although the DST is considered a required tool to access the DTC codes, codes may be retrieved without a laptop computer using the blink code function. To enable this function follow the steps below:

- Jump pins 1 and 4 at the DLC connector (see illustration below)
- Turn the ignition key to the on position
- The system will now enter the self diagnostic blink code mode. Be ready with pen and paper to write down any codes that may be stored.
- The ECM will flash the MIL indicator with a pause between represented numbers that represent DTC codes. The sequence starts with code 1654. Code 1654 confirms the system has entered the blink code mode. The ECM will flash code 1654 (3) times before displaying the actual DTC code that may be set.

Example:

One short blink (pause) six short blinks (pause) five short blinks (pause) four short blinks.

- If no DTC codes are found, the ECM will continue to flash 1654 only. This means no stored DTC codes were found.
- If one of the numbers in the DTC code is zero (0), no flash will occur to represent the zero value—it will be represented as a short pause.

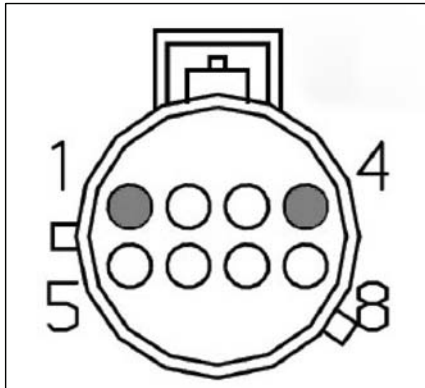

Diagnostic Connector Terminal Identification

Malfunction Indicator Lamp (MIL) Operation

How does my MIL work?

The emissions control system utilizes a MIL to warn the operator or technician of a possible issue with the engine or emissions control system. The system will keep the MIL illuminated for the entire key cycle in which the trouble code was set. It will keep the MIL illuminated for three additional engine run cycles under the following two circumstances: (1) The fault caused the engine to shut down or (2) the fault is related to the exhaust gas oxygen (EGO) sensors. This function is called MIL persistence.

How does MIL persistence work?

In the event the DTC is related to either an engine shutdown fault OR an oxygen sensor fault the following statement applies: If the vehicle is not serviced by a technician and the condition causing the MIL illumination (DTC) no longer exists, the MIL will remain illuminated for the 3 additional start cycles. The MIL will go out on the 4th start cycle if the condition does not reoccur.

In the event the DTC is not related to an engine shut down or an oxygen sensor fault and the condition causing the MIL illumination (DTC) no longer exists, the MIL will go out at the next run cycle.

If the condition is serviced by a technician and the DTC is cleared using a Diagnostic Service Tool (DST), the MIL will go out immediately.

Diagnostic Trouble Codes (DTC) are permanently retained in the historic DTC section until cleared with a DST or the auto clear requirements are met. The auto clear feature will clear out historic faults after 40 run cycles.

What are the requirements for a run cycle?

A run cycle is when the engine speed is above the "run speed" set point for 1.5 seconds or longer. The "run speed" is the transition point when the ECM recognizes the engine is going from the cranking parameters to the engine running parameters. The run speed is typically set at 450 rpm.

DIAGNOSTIC TROUBLE CODE (DTC) CHART – SORTED BY DTC # (1 of 4)

Description	DTC Set 2		Description	DTC Set 2	
	SPN-2	FMI-2		SPN-2	FMI-2
DTC 11: Intake cam / distributor position error	520800	7	DTC 268: Injector 3 coil shorted	653	6
DTC 16: Crank and/or cam could not synchronize during start	636	8	DTC 270: Injector 4 open or short to ground	654	5
DTC 24: Exhaust cam position error	520801	7	DTC 271: Injector 4 coil shorted	654	6
DTC 87 Fuel pressure lower than expected	94	1	DTC 273: Injector 5 open or short to ground	655	5
DTC 88 Fuel pressure higher than expected	94	0	DTC 274: Injector 5 coil shorted	655	6
DTC 91: FP low voltage	94	4	DTC 276: Injector 6 open or short to ground	656	5
DTC 92: FP high voltage	94	3	DTC 277: Injector 6 coil shorted	656	6
DTC 107: MAP voltage low	106	4	DTC 279: Injector 7 open or short to ground	657	5
DTC 108: MAP pressure high	106	16	DTC 280: Injector 7 coil shorted	657	6
DTC 111: IAT higher than expected stage 1	105	15	DTC 282: Injector 8 open or short to ground	658	5
DTC 112: IAT voltage low	105	4	DTC 283: Injector 8 coil shorted	658	6
DTC 113: IAT voltage high	105	3	DTC 285: Injector 9 open or short to ground	659	5
DTC 116: ECT higher than expected stage 1	110	15	DTC 286: Injector 9 coil shorted	659	6
DTC 117: ECT voltage low	110	4	DTC 288: Injector 10 open or short to ground	660	5
DTC 118: ECT voltage high	110	3	DTC 289: Injector 10 coil shorted	660	6
DTC 121: TPS1-2 lower than expected	51	1	DTC 1631: PWM1-Gauge1 open / ground short	697	5
DTC 122: TPS1 voltage low	51	4	DTC 299: Boost control underboost failure 1	692	1
DTC 123: TPS1 voltage high	51	3	DTC 301: Cylinder 1 emissions/catalyst damaging misfire	1323	31
DTC 127: IAT higher than expected stage 2	105	0	DTC 302: Cylinder 2 emissions/catalyst damaging misfire	1324	31
DTC 129: BP pressure low	108	1	DTC 303: Cylinder 3 emissions/catalyst damaging misfire	1325	31
DTC 134: EGO1 open / lazy	724	10	DTC 304: Cylinder 4 emissions/catalyst damaging misfire	1326	31
DTC 140: EGO3 open / lazy	520209	10	DTC 305: Cylinder 5 emissions/catalyst damaging misfire	1327	31
DTC 154: EGO2 open / lazy	520208	10	DTC 306: Cylinder 6 emissions/catalyst damaging misfire	1328	31
DTC 160: EGO4 open / lazy	520210	10	DTC 307: Cylinder 7 emissions/catalyst damaging misfire	1329	31
DTC 171: Adaptive-learn gasoline bank1 high	520200	0	DTC 308: Cylinder 8 emissions/catalyst damaging misfire	1330	31
DTC 172: Adaptive-learn gasoline bank1 low	520200	1	DTC 326: Knock1 excessive or erratic signal	731	2
DTC 174: Adaptive-learn gasoline bank2 high	520201	0	DTC 327: Knock1 sensor open or not present	731	4
DTC 175: Adaptive-learn gasoline bank2 low	520201	1	DTC 331: Knock2 excessive or erratic signal	520241	2
DTC 182: FT low voltage	174	4	DTC 332: Knock2 sensor open or not present	520241	4
DTC 183: FT high voltage	174	3	DTC 336: CRANK input signal noise	636	2
DTC 187: Gaseous fuel temperature sender low voltage	520240	4	DTC 337: Crank signal loss	636	4
DTC 188: Gaseous fuel temperature sender high voltage	520240	3	DTC 341: CAM input signal noise	723	2
DTC 217: ECT higher than expected stage 2	110	0	DTC 342: Loss of CAM input signal	723	4
DTC 219: RPM higher than max allowed govern speed	515	15	DTC 359: Fuel run-out longer than expected	1239	7
DTC 221: TPS1-2 higher than expected	51	0	DTC 420: Catalyst inactive on gasoline (Bank 1)	520211	10
DTC 222: TPS2 voltage low	520251	4	DTC 430: Catalyst inactive on gasoline (Bank 2)	520212	10
DTC 223: TPS2 voltage high	520251	3	DTC 502: Roadspeed input loss of signal	84	1
DTC 234: Boost control overboost failure	1692	0	DTC 508: IAC ground short	520252	6
DTC 236: TIP active	1692	2	DTC 509: IAC coil open/short	520252	5
DTC 237: TIP low voltage	1127	4	DTC 520: Oil pressure sender low pressure stage 1	100	18
DTC 238: TIP high voltage	1127	3	DTC 521: Oil pressure sender high pressure	100	0
DTC 261: Injector 1 open or short to ground	651	5	DTC 522: Oil pressure sender low voltage	100	4
DTC 262: Injector 1 coil shorted	651	6	DTC 523: Oil pressure sender high voltage	100	3
DTC 264: Injector 2 open or short to ground	652	5	DTC 524: Oil pressure low	100	1
DTC 265: Injector 2 coil shorted	652	6	DTC 562: Vbat voltage low	168	17
DTC 267: Injector 3 open or short to ground	653	5	DTC 563: Vbat voltage high	168	15

DIAGNOSTIC TROUBLE CODE (DTC) CHART – SORTED BY DTC # (2 of 4)

Description	DTC Set 2		Description	DTC Set 2	
	SPN-2	FMI-2		SPN-2	FMI-2
DTC 601: Microprocessor failure - FLASH	628	13	DTC 1175: MegaJector voltage supply low	520260	4
DTC 604: Microprocessor failure - RAM	630	12	DTC 1176: MegaJector internal actuator fault detection	520260	12
DTC 606: Microprocessor failure - COP	629	31	DTC 1177: MegaJector internal circuitry fault detection	520260	12
DTC 615: Start relay coil open	1321	5	DTC 1178: MegaJector internal comm fault detection	520260	12
DTC 616: Start relay ground short	1321	4	DTC 1182: Fuel impurity level high	520401	0
DTC 617: Start relay coil short to power	1321	3	DTC 1183: MegaJector autozero / lockoff failure	520803	31
DTC 627: Fuel pump relay coil open	1348	5	DTC 1311: Cylinder 1 misfire detected	1323	11
DTC 628: Fuel-pump high-side open or short to ground	1347	5	DTC 1312: Cylinder 2 misfire detected	1324	11
DTC 628: Fuel pump relay control ground short	1348	4	DTC 1313: Cylinder 3 misfire detected	1325	11
DTC 629: Fuel-pump high-side short to power	1347	6	DTC 1314: Cylinder 4 misfire detected	1326	11
DTC 629: Fuel pump relay coil short to power	1348	3	DTC 1315: Cylinder 5 misfire detected	1327	11
DTC 642: Sensor supply voltage 1 low	1079	4	DTC 1316: Cylinder 6 misfire detected	1328	11
DTC 643: Sensor supply voltage 1 high	1079	3	DTC 1317: Cylinder 7 misfire detected	1329	11
DTC 650: MIL open	1213	5	DTC 1318: Cylinder 8 misfire detected	1330	11
DTC 652: Sensor supply voltage 2 low	1080	4	DTC 1411: EMWT1 voltage high	441	3
DTC 653: Sensor supply voltage 2 high	1080	3	DTC 1412: EMWT2 voltage high	442	3
DTC 685: Power relay coil open	1485	5	DTC 1413: EMWT1 voltage low	441	4
DTC 686: Power relay ground short	1485	4	DTC 1414: EMWT2 voltage low	442	4
DTC 687: Power relay coil short to power	1485	3	DTC 1415: EMWT1 higher than expected stage 1	441	15
DTC 916: Shift actuator feedback out-of-range	520226	3	DTC 1416: EMWT2 higher than expected stage 1	442	15
DTC 919: Shift unable to reach desired gear	520226	7	DTC 1413: Cylinder 3 misfire detected	441	0
DTC 920: Shift actuator or drive circuit failed	520226	31	DTC 1418: EMWT2 higher than expected stage 2	442	0
DTC 1111: RPM above fuel rev limit level	515	16	DTC 1419: ERWT1 voltage high	443	3
DTC 1112: RPM above spark rev limit level	515	0	DTC 1420: ERWT2 voltage high	444	3
DTC 1121: FPP1/2 simultaneous voltages out-of-range (redundanc	91	31	DTC 1421: ERWT1 voltage low	443	4
DTC 1122: FPP1/2 do not match each other or IVS (redundancy lo	520250	31	DTC 1422: ERWT2 voltage low	444	4
DTC 1131: WGP voltage high	1192	3	DTC 1423: ERWT1 higher than expected stage 1	443	15
DTC 1132: WGP voltage low	1192	4	DTC 1424: ERWT2 higher than expected stage 1	444	15
DTC 1151: Closed-loop LPG high	520206	0	DTC 1425: ERWT1 higher than expected stage 2	443	0
DTC 1152: Closed-loop LPG low	520206	1	DTC 1426: ERWT2 higher than expected stage 2	444	0
DTC 1153: Closed-loop NG high	520207	0	DTC 1511: AUX analog Pull-Up 1 high voltage	520216	3
DTC 1154: Closed-loop NG low	520207	1	DTC 1512: AUX analog Pull-Up 1 low voltage	520216	4
DTC 1155: Closed-loop gasoline bank1 high	520204	0	DTC 1513: AUX analog Pull-Up 2 high voltage	520217	3
DTC 1156: Closed-loop gasoline bank1 low	520204	1	DTC 1514: AUX analog Pull-Up 2 low voltage	520217	4
DTC 1157: Closed-loop gasoline bank2 high	520205	0	DTC 1515: AUX analog Pull-Down 1 high voltage	520215	3
DTC 1158: Closed-loop gasoline bank2 low	520205	1	DTC 1516: AUX analog Pull-Down 1 low voltage	520215	4
DTC 1161: Adaptive-learn LPG high	520202	0	DTC 1517: AUX analog Pull-Up 3 high voltage	520218	3
DTC 1162: Adaptive-learn LPG low	520202	1	DTC 1518: AUX analog Pull-Up 3 low voltage	520218	4
DTC 1163: Adaptive-learn NG high	520203	0	DTC 1521: CHT higher than expected stage 1	110	16
DTC 1164: Adaptive-learn NG low	520203	1	DTC 1522: CHT higher than expected stage 2	110	0
DTC 1165: Catalyst inactive on LPG	520213	10	DTC 1531: Gov1/2/3 interlock failure	520270	31
DTC 1166: Catalyst inactive on NG	520214	10	DTC 1541: AUX analog Pull-Up/Down 1 high voltage	520219	3
DTC 1171: MegaJector delivery pressure higher than expected	520260	0	DTC 1542: AUX analog Pull-Up/Down 1 low voltage	520219	4
DTC 1172: MegaJector delivery pressure lower than expected	520260	1	DTC 1543: AUX analog Pull-Up/Down 2 high voltage	520220	3
DTC 1173: MegaJector comm lost	520260	31	DTC 1544: AUX analog Pull-Up/Down 2 low voltage	520220	4
DTC 1174: MegaJector voltage supply high	520260	3	DTC 1545: AUX analog Pull-Up/Down 3 high voltage	520221	3

DIAGNOSTIC TROUBLE CODE (DTC) CHART – SORTED BY DTC # (3 of 4)

Description	DTC Set 2		Description	DTC Set 2	
	SPN-2	FMI-2		SPN-2	FMI-2
DTC 1546: AUX analog Pull-Up/Down 3 low voltage	520221	4	DTC 1662: PWM6 short to power	925	3
DTC 1547: AUX analog Pull-Up/Down 4 high voltage	713	3	DTC 1663: PWM7 open / ground short	926	5
DTC 1548: AUX analog Pull-Up/Down 4 low voltage	713	4	DTC 1664: PWM7 short to power	926	3
DTC 1551: AUX digital 1 high voltage	520222	3	DTC 1665: PWM8 open / ground short	2646	5
DTC 1552: AUX digital 1 low voltage	520222	4	DTC 1666: PWM8 short to power	2646	3
DTC 1553: AUX digital 2 high voltage	520223	3	DTC 1669: PWM9 open / ground short	2647	5
DTC 1554: AUX digital 2 low voltage	520223	4	DTC 1670: PWM9 short to power	2647	3
DTC 1555: AUX digital 3 high voltage	520224	3	DTC 2111: Unable to reach lower TPS	51	7
DTC 1555: Water Intrusion Detection	520224	3	DTC 2112: Unable to reach higher TPS	51	7
DTC 1556: AUX digital 3 low voltage	520224	4	DTC 2115: FPP1 higher than IVS	91	0
DTC 1561: AUX analog Pull-Down 2 high voltage	0	3	DTC 2116: FPP2 higher than IVS	29	0
DTC 1561: AUX analog Pull-Down 3 high voltage	0	3	DTC 2120: FPP1 invalid voltage and FPP2 disagrees with IVS	520250	31
DTC 1561: AUX analog Pull-Down 2 low voltage	0	4	DTC 2121: FPP1-2 lower than expected	91	18
DTC 1561: AUX analog Pull-Down 3 low voltage	0	4	DTC 2122: FPP1 voltage high	91	3
DTC 1611: Sensor supply voltage 1 and 2 out-of-range	1079	31	DTC 2123: FPP1 voltage low	91	4
DTC 1612: Microprocessor failure - RTI 1	629	31	DTC 2125: FPP2 invalid voltage and FPP1 disagrees with IVS	520250	31
DTC 1613: Microprocessor failure - RTI 2	629	31	DTC 2126: FPP1-2 higher than expected	91	16
DTC 1614: Microprocessor failure - RTI 3	629	31	DTC 2127: FPP2 voltage low	29	4
DTC 1615: Microprocessor failure - A/D	629	31	DTC 2128: FPP2 voltage high	29	3
DTC 1616: Microprocessor failure - Interrupt	629	31	DTC 2130: IVS stuck at-idle, FPP1/2 match	558	5
DTC 1621: RS-485 Rx inactive	0	31	DTC 2131: IVS stuck off-idle, FPP1/2 match	558	6
DTC 1622: RS-485 Rx noise	0	31	DTC 2135: TPS1/2 simultaneous voltages out-of-range 51	31	
DTC 1623: RS-485 Rx bad packet format	0	31	DTC 2139: FPP1 lower than IVS	91	1
DTC 1624: RS-485 remote shutdown request	0	31	DTC 2140: FPP2 lower than IVS	29	1
DTC 1625: J1939 shutdown request	1384	31	DTC 2229: BP pressure high	108	0
DTC 1626: CAN-J1939 Tx fault	639	12	DTC 2300: Spark coil 1 primary open or short to ground	1268	5
DTC 1627: CAN-J1939 Rx fault	639	12	DTC 2301: Spark coil 1 primary shorted	1268	6
DTC 1628: J1939 CAN address / engine-number conflict	639	13	DTC 2303: Spark coil 2 primary open or short to ground	1269	5
DTC 1629: J1939 TSC1 message receipt loss	639	9	DTC 2304: Spark coil 2 primary shorted	1269	6
DTC 1630: J1939 ETC message receipt loss	91	2	DTC 2306: Spark coil 3 primary open or short to ground	1270	5
DTC 1632: PWM1-Gauge1 short to power	697	6	DTC 2307: Spark coil 3 primary shorted	1270	6
DTC 1633: PWM2-Gauge2 open / ground short	698	5	DTC 2309: Spark coil 4 primary open or short to ground	1271	5
DTC 1634: PWM2-Gauge2 short to power	698	6	DTC 2310: Spark coil 4 primary shorted	1271	6
DTC 1635: PWM3-Gauge3 open / ground short	699	5	DTC 2312: Spark coil 5 primary open or short to ground	1272	5
DTC 1636: PWM3-Gauge3 short to power	699	6	DTC 2313: Spark coil 5 primary shorted	1272	6
DTC 1637: PWM4 open / ground short	700	5	DTC 2315: Spark coil 6 primary open or short to ground	1273	5
DTC 1638: PWM4 short to power	700	6	DTC 2316: Spark coil 6 primary shorted	1273	6
DTC 1639: PWM5 open / ground short	520230	5	DTC 2318: Spark coil 7 primary open or short to ground	1274	5
DTC 1640: PWM5 short to power	520230	6	DTC 2319: Spark coil 7 primary shorted	1274	6
DTC 1641: Buzzer control ground short	920	4	DTC 2321: Spark coil 8 primary open or short to ground	1275	5
DTC 1642: Buzzer open	920	5	DTC 2322: Spark coil 8 primary shorted	1275	6
DTC 1643: Buzzer control short to power	920	3	DTC 2324: Spark coil 9 primary open or short to ground	1276	5
DTC 1644: MIL control ground short	1213	4	DTC 2325: Spark coil 9 primary shorted	1276	6
DTC 1645: MIL control short to power	1213	3	DTC 2327: Spark coil 10 primary open or short to ground	1277	5
DTC 1651: J1939 ETC message receipt loss while in-gear	91	9	DTC 2328: Spark coil 10 primary shorted	1277	6
DTC 1661: PWM6 open / ground short	925	5	DTC 2428: EGT temperature high	173	0

DIAGNOSTIC TROUBLE CODE (DTC) CHART – SORTED BY DTC # (4 of 4)

Description	DTC Set 2	
	SPN-2	FMI-2
DTC 2618: Tach output ground short	645	4
DTC 2619: Tach output short to power	645	3
DTC 8901: UEGO microprocessor internal fault	3221	31
DTC 8902: UEGO heater supply high voltage	3222	3
DTC 8903: UEGO heater supply low voltage	3222	4
DTC 8904: UEGO cal resistor voltage high	3221	3
DTC 8905: UEGO cal resistor voltage low	3221	4
DTC 8906: UEGO return voltage shorted high	3056	3
DTC 8907: UEGO return voltage shorted low	3056	4
DTC 8908: UEGO pump voltage shorted high	3218	3
DTC 8909: UEGO pump voltage shorted low	3218	4
DTC 8910: UEGO sense cell voltage high	3217	3
DTC 8911: UEGO sense cell voltage low	3217	4
DTC 8912: UEGO pump voltage at high drive limit	3225	3
DTC 8913: UEGO pump voltage at low drive limit	3225	4
DTC 8914: UEGO sense cell slow to warm up	3222	10
DTC 8915: UEGO pump cell slow to warm up	3225	10
DTC 8916: UEGO sense cell impedance high	3222	0
DTC 8917: UEGO pump cell impedance high	3225	0
DTC 8918: UEGO pump cell impedance low	3225	1

DIAGNOSTIC TROUBLE CODE (DTC) CHART – SORTED BY SPN:FMI (1 of 4)

Description	DTC Set 2		Description	DTC Set 2	
	SPN-2	FMI-2		SPN-2	FMI-2
DTC 1561: AUX analog Pull-Down 2 high voltage	0	3	DTC 107: MAP voltage low	106	4
DTC 1561: AUX analog Pull-Down 3 high voltage	0	3	DTC 108: MAP pressure high	106	16
DTC 1561: AUX analog Pull-Down 2 low voltage	0	4	DTC 2229: BP pressure high	108	0
DTC 1561: AUX analog Pull-Down 3 low voltage	0	4	DTC 129: BP pressure low	108	1
DTC 1621: RS-485 Rx inactive	0	31	DTC 1522: CHT higher than expected stage 2	110	0
DTC 1622: RS-485 Rx noise	0	31	DTC 217: ECT higher than expected stage 2	110	0
DTC 1623: RS-485 Rx bad packet format	0	31	DTC 118: ECT voltage high	110	3
DTC 1624: RS-485 remote shutdown request	0	31	DTC 117: ECT voltage low	110	4
Undefined DTC - Index 10297	0	31	DTC 116: ECT higher than expected stage 1	110	15
Undefined DTC - Index 10298	0	31	DTC 1521: CHT higher than expected stage 1	110	16
Undefined DTC - Index 10299	0	31	DTC 563: Vbat voltage high	168	15
DTC 2116: FPP2 higher than IVS	29	0	DTC 562: Vbat voltage low	168	17
DTC 2140: FPP2 lower than IVS	29	1	DTC 2428: EGT temperature high	173	0
DTC 2128: FPP2 voltage high	29	3	DTC 183: FT high voltage	174	3
DTC 2127: FPP2 voltage low	29	4	DTC 182: FT low voltage	174	4
DTC 221: TPS1-2 higher than expected	51	0	DTC 1417: EMWT1 higher than expected stage 2	441	0
DTC 121: TPS1-2 lower than expected	51	1	DTC 1411: EMWT1 voltage high	441	3
DTC 123: TPS1 voltage high	51	3	DTC 1413: EMWT1 voltage low	441	4
DTC 122: TPS1 voltage low	51	4	DTC 1415: EMWT1 higher than expected stage 1	441	15
DTC 2112: Unable to reach higher TPS	51	7	DTC 1418: EMWT2 higher than expected stage 2	442	0
DTC 2111: Unable to reach lower TPS	51	7	DTC 1412: EMWT2 voltage high	442	3
DTC 2135: TPS1/2 simultaneous voltages out-of-ran	51	31	DTC 1414: EMWT2 voltage low	442	4
DTC 502: Roadspeed input loss of signal	84	1	DTC 1416: EMWT2 higher than expected stage 1	442	15
DTC 2115: FPP1 higher than IVS	91	0	DTC 1425: ERWT1 higher than expected stage 2	443	0
DTC 2139: FPP1 lower than IVS	91	1	DTC 1419: ERWT1 voltage high	443	3
DTC 1630: J1939 ETC message receipt loss	91	2	DTC 1421: ERWT1 voltage low	443	4
DTC 2122: FPP1 voltage high	91	3	DTC 1423: ERWT1 higher than expected stage 1	443	15
DTC 2123: FPP1 voltage low	91	4	DTC 1426: ERWT2 higher than expected stage 2	444	0
DTC 1651: J1939 ETC message receipt loss while in	91	9	DTC 1420: ERWT2 voltage high	444	3
DTC 2126: FPP1-2 higher than expected	91	16	DTC 1422: ERWT2 voltage low	444	4
DTC 2121: FPP1-2 lower than expected	91	18	DTC 1424: ERWT2 higher than expected stage 1	444	15
DTC 1121: FPP1/2 simultaneous voltages out-of-ran	91	31	DTC 1112: RPM above spark rev limit level	515	0
DTC 88 Fuel pressure higher than expected	94	0	DTC 219: RPM higher than max allowed govern speed	515	15
DTC 87 Fuel pressure lower than expected	94	1	DTC 1111: RPM above fuel rev limit level	515	16
DTC 92: FP high voltage	94	3	DTC 2130: IVS stuck at-idle, FPP1/2 match	558	5
DTC 91: FP low voltage	94	4	DTC 2131: IVS stuck off-idle, FPP1/2 match	558	6
DTC 521: Oil pressure sender high pressure	100	0	DTC 601: Microprocessor failure - FLASH	628	13
DTC 524: Oil pressure low	100	1	DTC 606: Microprocessor failure - COP	629	31
DTC 524: Oil pressure sender low pressure	100	1	DTC 1612: Microprocessor failure - RT1 1	629	31
DTC 523: Oil pressure sender high voltage	100	3	DTC 1613: Microprocessor failure - RT1 2	629	31
DTC 522: Oil pressure sender low voltage	100	4	DTC 1614: Microprocessor failure - RT1 3	629	31
DTC 520: Oil pressure sender low pressure stage 1	100	18	DTC 1615: Microprocessor failure - A/D	629	31
DTC 127: IAT higher than expected stage 2	105	0	DTC 1616: Microprocessor failure - Interrupt	629	31
DTC 113: IAT voltage high	105	3	DTC 604: Microprocessor failure - RAM	630	12
DTC 112: IAT voltage low	105	4	DTC 336: CRANK input signal noise	636	2
DTC 111: IAT higher than expected stage 1	105	15	DTC 337: Crank signal loss	636	4

DIAGNOSTIC TROUBLE CODE (DTC) CHART – SORTED BY SPN:FMI (2 of 4)

Description	DTC Set 2		Description	DTC Set 2	
	SPN-2	FMI-2		SPN-2	FMI-2
DTC 16: Crank and/or cam could not synchronize du	636	8	DTC 1661: PWM6 open / ground short	925	5
DTC 1629: J1939 TSC1 message receipt loss	639	9	DTC 1664: PWM7 short to power	926	3
DTC 1626: CAN-J1939 Tx fault	639	12	DTC 1663: PWM7 open / ground short	926	5
DTC 1627: CAN-J1939 Rx fault	639	12	DTC 643: Sensor supply voltage 1 high	1079	3
DTC 1628: J1939 CAN address / engine-number con	639	13	DTC 642: Sensor supply voltage 1 low	1079	4
DTC 2619: Tach output short to power	645	3	DTC 1611: Sensor supply voltage 1 and 2 out-of-range	1079	31
DTC 2618: Tach output ground short	645	4	DTC 653: Sensor supply voltage 2 high	1080	3
DTC 261: Injector 1 open or short to ground	651	5	DTC 652: Sensor supply voltage 2 low	1080	4
DTC 262: Injector 1 coil shorted	651	6	DTC 238: TIP high voltage	1127	3
DTC 264: Injector 2 open or short to ground	652	5	DTC 237: TIP low voltage	1127	4
DTC 265: Injector 2 coil shorted	652	6	DTC 1131: WGP voltage high	1192	3
DTC 267: Injector 3 open or short to ground	653	5	DTC 1132: WGP voltage low	1192	4
DTC 268: Injector 3 coil shorted	653	6	DTC 1645: MIL control short to power	1213	3
DTC 270: Injector 4 open or short to ground	654	5	DTC 1644: MIL control ground short	1213	4
DTC 271: Injector 4 coil shorted	654	6	DTC 650: MIL open	1213	5
DTC 273: Injector 5 open or short to ground	655	5	DTC 359: Fuel run-out longer than expected	1239	7
DTC 274: Injector 5 coil shorted	655	6	DTC 2300: Spark coil 1 primary open or short to ground	1268	5
DTC 276: Injector 6 open or short to ground	656	5	DTC 2301: Spark coil 1 primary shorted	1268	6
DTC 277: Injector 6 coil shorted	656	6	DTC 2303: Spark coil 2 primary open or short to ground	1269	5
DTC 279: Injector 7 open or short to ground	657	5	DTC 2304: Spark coil 2 primary shorted	1269	6
DTC 280: Injector 7 coil shorted	657	6	DTC 2306: Spark coil 3 primary open or short to ground	1270	5
DTC 282: Injector 8 open or short to ground	658	5	DTC 2307: Spark coil 3 primary shorted	1270	6
DTC 283: Injector 8 coil shorted	658	6	DTC 2309: Spark coil 4 primary open or short to ground	1271	5
DTC 285: Injector 9 open or short to ground	659	5	DTC 2310: Spark coil 4 primary shorted	1271	6
DTC 286: Injector 9 coil shorted	659	6	DTC 2312: Spark coil 5 primary open or short to ground	1272	5
DTC 288: Injector 10 open or short to ground	660	5	DTC 2313: Spark coil 5 primary shorted	1272	6
DTC 289: Injector 10 coil shorted	660	6	DTC 2315: Spark coil 6 primary open or short to ground 1273	5	
DTC 1631: PWM1-Gauge1 open / ground short	697	5	DTC 2316: Spark coil 6 primary shorted	1273	6
DTC 1632: PWM1-Gauge1 short to power	697	6	DTC 2318: Spark coil 7 primary open or short to ground	1274	5
DTC 1633: PWM2-Gauge2 open / ground short	698	5	DTC 2319: Spark coil 7 primary shorted	1274	6
DTC 1634: PWM2-Gauge2 short to power	698	6	DTC 2321: Spark coil 8 primary open or short to ground	1275	5
DTC 1635: PWM3-Gauge3 open / ground short	699	5	DTC 2322: Spark coil 8 primary shorted	1275	6
DTC 1636: PWM3-Gauge3 short to power	699	6	DTC 2324: Spark coil 9 primary open or short to ground	1276	5
DTC 1637: PWM4 open / ground short	700	5	DTC 2325: Spark coil 9 primary shorted	1276	6
DTC 1638: PWM4 short to power	700	6	DTC 2327: Spark coil 10 primary open or short to ground	1277	5
DTC 1547: AUX analog Pull-Up/Down 4 high voltage	713	3	DTC 2328: Spark coil 10 primary shorted	1277	6
DTC 1548: AUX analog Pull-Up/Down 4 low voltage	713	4	DTC 617: Start relay coil short to power	1321	3
DTC 341: CAM input signal noise	723	2	DTC 616: Start relay ground short	1321	4
DTC 342: Loss of CAM input signal	723	4	DTC 615: Start relay coil open	1321	5
DTC 134: EGO1 open / lazy	724	10	DTC 1311: Cylinder 1 misfire detected	1323	11
DTC 326: Knock1 excessive or erratic signal	731	2	DTC 301: Cylinder 1 emissions/catalyst damaging misfire	1323	31
DTC 327: Knock1 sensor open or not present	731	4	DTC 1312: Cylinder 2 misfire detected	1324	11
DTC 1643: Buzzer control short to power	920	3	DTC 302: Cylinder 2 emissions/catalyst damaging misfire	1324	31
DTC 1641: Buzzer control ground short	920	4	DTC 1313: Cylinder 3 misfire detected	1325	11
DTC 1642: Buzzer open	920	5	DTC 303: Cylinder 3 emissions/catalyst damaging misfire	1325	31
DTC 1662: PWM6 short to power	925	3	DTC 1314: Cylinder 4 misfire detected	1326	11

DIAGNOSTIC TROUBLE CODE (DTC) CHART – SORTED BY SPN:FMI (3 of 4)

Description	DTC Set 2		Description	DTC Set 2	
	SPN-2	FMI-2		SPN-2	FMI-2
DTC 304: Cylinder 4 emissions/catalyst damaging m	1326	31	DTC 175: Adaptive-learn gasoline bank2 low	520201	1
DTC 1315: Cylinder 5 misfire detected	1327	11	DTC 1161: Adaptive-learn LPG high	520202	0
DTC 305: Cylinder 5 emissions/catalyst damaging m	1327	31	DTC 1162: Adaptive-learn LPG low	520202	1
DTC 1316: Cylinder 6 misfire detected	1328	11	DTC 1163: Adaptive-learn NG high	520203	0
DTC 306: Cylinder 6 emissions/catalyst damaging m	1328	31	DTC 1164: Adaptive-learn NG low	520203	1
DTC 1317: Cylinder 7 misfire detected	1329	11	DTC 1155: Closed-loop gasoline bank1 high	520204	0
DTC 307: Cylinder 7 emissions/catalyst damaging m	1329	31	DTC 1156: Closed-loop gasoline bank1 low	520204	1
DTC 1318: Cylinder 8 misfire detected	1330	11	DTC 1157: Closed-loop gasoline bank2 high	520205	0
DTC 308: Cylinder 8 emissions/catalyst damaging m	1330	31	DTC 1158: Closed-loop gasoline bank2 low	520205	1
DTC 628: Fuel-pump high-side open or short to grou	1347	5	DTC 1151: Closed-loop LPG high	520206	0
DTC 629: Fuel-pump high-side short to power	1347	6	DTC 1152: Closed-loop LPG low	520206	1
DTC 629: Fuel pump relay coil short to power	1348	3	DTC 1153: Closed-loop NG high	520207	0
DTC 628: Fuel pump relay control ground short	1348	4	DTC 1154: Closed-loop NG low	520207	1
DTC 627: Fuel pump relay coil open	1348	5	DTC 154: EGO2 open / lazy	520208	10
DTC 1625: J1939 shutdown request	1384	31	DTC 140: EGO3 open / lazy	520209	10
DTC 687: Power relay coil short to power	1485	3	DTC 160: EGO4 open / lazy	520210	10
DTC 686: Power relay ground short	1485	4	DTC 420: Catalyst inactive on gasoline (Bank 1)	520211	10
DTC 685: Power relay coil open	1485	5	DTC 430: Catalyst inactive on gasoline (Bank 2)	520212	10
DTC 234: Boost control overboost failure	1692	0	DTC 1165: Catalyst inactive on LPG	520213	10
DTC 299: Boost control underboost failure	1692	1	DTC 1166: Catalyst inactive on NG	520214	10
DTC 236: TIP active	1692	2	DTC 1515: AUX analog Pull-Down 1 high voltage	520215	3
DTC 1666: PWM8 short to power	2646	3	DTC 1516: AUX analog Pull-Down 1 low voltage	520215	4
DTC 1665: PWM8 open / ground short	2646	5	DTC 1511: AUX analog Pull-Up 1 high voltage	520216	3
DTC 1670: PWM9 short to power	2647	3	DTC 1512: AUX analog Pull-Up 1 low voltage	520216	4
DTC 1669: PWM9 open / ground short	2647	5	DTC 1513: AUX analog Pull-Up 2 high voltage	520217	3
DTC 8906: UEGO return voltage shorted high	3056	3	DTC 1514: AUX analog Pull-Up 2 low voltage	520217	4
DTC 8907: UEGO return voltage shorted low	3056	4	DTC 1517: AUX analog Pull-Up 3 high voltage	520218	3
DTC 8910: UEGO sense cell voltage high	3217	3	DTC 1518: AUX analog Pull-Up 3 low voltage	520218	4
DTC 8911: UEGO sense cell voltage low	3217	4	DTC 1541: AUX analog Pull-Up/Down 1 high voltage	520219	3
DTC 8908: UEGO pump voltage shorted high	3218	3	DTC 1542: AUX analog Pull-Up/Down 1 low voltage	520219	4
DTC 8909: UEGO pump voltage shorted low	3218	4	DTC 1543: AUX analog Pull-Up/Down 2 high voltage	520220	3
DTC 8904: UEGO cal resistor voltage high	3221	3	DTC 1544: AUX analog Pull-Up/Down 2 low voltage	520220	4
DTC 8905: UEGO cal resistor voltage low	3221	4	DTC 1545: AUX analog Pull-Up/Down 3 high voltage	520221	3
DTC 8901: UEGO microprocessor internal fault	3221	31	DTC 1546: AUX analog Pull-Up/Down 3 low voltage	520221	4
DTC 8916: UEGO sense cell impedance high	3222	0	DTC 1551: AUX digital 1 high voltage	520222	3
DTC 8902: UEGO heater supply high voltage	3222	3	DTC 1552: AUX digital 1 low voltage	520222	4
DTC 8903: UEGO heater supply low voltage	3222	4	DTC 1553: AUX digital 2 high voltage	520223	3
DTC 8914: UEGO sense cell slow to warm up	3222	10	DTC 1554: AUX digital 2 low voltage	520223	4
DTC 8917: UEGO pump cell impedance high	3225	0	DTC 1555: AUX digital 3 high voltage	520224	3
DTC 8918: UEGO pump cell impedance low	3225	1	DTC 1555: Water Intrusion Detection	520224	3
DTC 8912: UEGO pump voltage at high drive limit	3225	3	DTC 1556: AUX digital 3 low voltage	520224	4
DTC 8913: UEGO pump voltage at low drive limit	3225	4	DTC 916: Shift actuator feedback out-of-range	520226	3
DTC 8915: UEGO pump cell slow to warm up	3225	10	DTC 919: Shift unable to reach desired gear	520226	7
DTC 171: Adaptive-learn gasoline bank1 high	520200	0	DTC 920: Shift actuator or drive circuit failed	520226	31
DTC 172: Adaptive-learn gasoline bank1 low	520200	1	DTC 1639: PWM5 open / ground short	520230	5
DTC 174: Adaptive-learn gasoline bank2 high	520201	0	DTC 1640: PWM5 short to power	520230	6

DIAGNOSTIC TROUBLE CODE (DTC) CHART – SORTED BY SPN:FMI (4 of 4)

Description	DTC Set 2	
	SPN-2	FMI-2
DTC 188: Gaseous fuel temperature sender high vol	520240	3
DTC 187: Gaseous fuel temperature sender low volta	520240	4
DTC 331: Knock2 excessive or erratic signal	520241	2
DTC 332: Knock2 sensor open or not present	520241	4
DTC 2120: FPP1 invalid voltage and FPP2 disagrees	520250	31
DTC 2125: FPP2 invalid voltage and FPP1 disagrees	520250	31
DTC 1122: FPP1/2 do not match each other or IVS (520250	31
DTC 223: TPS2 voltage high	520251	3
DTC 222: TPS2 voltage low	520251	4
DTC 509: IAC coil open/short	520252	5
DTC 508: IAC ground short	520252	6
DTC 1171: MegaJector delivery pressure higher than	520260	0
DTC 1172: MegaJector delivery pressure lower than	520260	1
DTC 1174: MegaJector voltage supply high	520260	3
DTC 1175: MegaJector voltage supply low	520260	4
DTC 1176: MegaJector internal actuator fault detecti	520260	12
DTC 1177: MegaJector internal circuitry fault detectio	520260	12
DTC 1178: MegaJector internal comm fault detection	520260	12
DTC 1173: MegaJector comm lost	520260	31
DTC 1531: Gov1/2/3 interlock failure	520270	31
DTC 1182: Fuel impurity level high	520401	0
DTC 11: Intake cam / distributor position error	520800	7
DTC 24: Exhaust cam position error	520801	7
DTC 1183: MegaJector autozero / lockoff failure	520803	31

Mono-Ped Control System (Option)

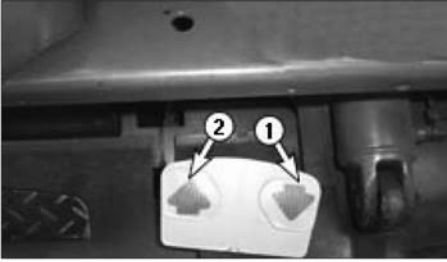

Forward-Push the left side (2) of the pedal for FORWARD direction travel.



Neutral-The lift truck should not move when the Mono-Ped pedal is released..



Reverse-Push the right side (1) of the pedal for REVERSE direction travel.

The MONO-PED pedal controls the speed and direction of the lift truck. Pushing on the right side of the pedal (1) causes the lift truck to move in REVERSE. The optional reverse lights and optional back-up alarm will be ON in the REVERSE position. Pushing on the left side of the pedal (2) causes the lift truck to move in FORWARD.

The speed of the truck increases as the pedal is depressed

Auto Shift Controller ASC-100 (If Equipped)

Product Description

The Autoshift controller is an electrical control system, specially designed for use on forklift trucks with internal combustion engines.

Its primary purpose is to prevent the operator from driving the truck outside of the design parameters, e.g. selecting the reverse gear when traveling in excess of 5.1 km/h (3.17 mph) in a forward direction, and vice versa.

The Autoshift controller is mounted on a convenient position away from excessive heat sources and the truck's electrical system is retrofitted. An inductive speed sensor is mounted on the differential housing where it will pick up a pulse from a yoke tooth pattern. This pulse is used to monitor the truck in motion and its travel speed. To enable the system to change gears smoothly, the shift points for offset speed are adjustable.

The Autoshift controller prevents strain and abuse to the transmission. It also prevents damage to the half shaft, excessive tire wear and heat to the transmission.

⚠ WARNING

Improper operation or maintenance could result in injury or death. Do not operate or work on the lift truck unless you are properly trained. For safe operation, carefully read and follow this Operation and Maintenance Manual.

Adjustments

SW2 (Direction Inhibit Point)	
NOTCH	Vehicle Speed
0	3.3 km/h (2.05 mph)
1	3.6 km/h (2.24 mph)
2	3.9 km/h (2.42 mph)
3	4.2 km/h (2.61 mph)
4	4.5 km/h (2.80 mph)
5	4.8 km/h (2.98 mph)
6	5.1 km/h (3.17 mph)
7	5.4 km/h (3.36 mph)
8	5.7 km/h (3.54 mph)
9	6.0 km/h (3.73 mph)

Direction Inhibit Point

- This is accomplished on each machine with a factory - adjusted controller.
- The SW2 is for adjustment of optimal direction inhibit speed.
- Factory - setting value is 5.1 km/h (3.17 mph)
- SW1 is not used.

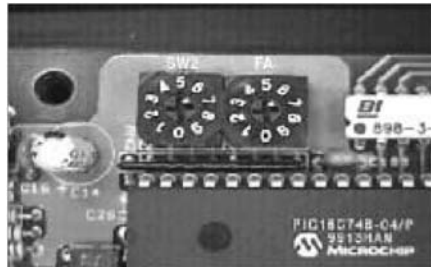

Adjustment Switch

Diagnostics Features

ASC-100 has an internal indicator on the right side of the controller for displaying the selected gear and the abnormal condition.

Below is a description applicable for many ASC-100 implementations.

Display for Operator

This information is given during normal operating when something special happens. For example, on ASC-100's with the speed sensor, one of the indicators is used to indicate a sensor problem.

Display	Description	Remark
A	Automatic operation	
P	Speed sensor open	Flashing
F	Controller fault	Flashing
6	Forward Sol. Short	Flashing
7	Reverse Sol. Short	Flashing

Display for Troubleshooting

This information is input signal for diagnostics. This test is used to verify an operation of direction control lever.

Display	Description	Remark
A	Automatic operation	
3	Forward s/w input	Lever input test
4	Reverse s/w input	Lever input test

Operation

This system can basically operate in 2 pre-selected modes.

- Automatic mode (Direction Inhibit mode): Selected as factory-setting.
- Manual mode (Fail-Safe mode): manual operation in emergency.

Automatic mode (Direction Inhibit mode)

- Start the engine. See topic "Starting the engine".
- Push down on the service brake pedal to hold the lift truck until ready to move it.
- Release the parking brake.
- Check diagnostics display on controller. See "Diagnostics Features".

NOTICE

The parking brake must be released before the direction control lever can be used.

- The gear direction is selected with the direction control lever.
- In automatic mode, if the turbine speed in a forward direction is higher than direction inhibit speed, though the reverse gear is selected by operator, the direction of travel will not be changed until the speed is reduced sufficiently by pushing down on the service brake pedal.

 **WARNING**

When you want to change the direction of travel, you must push down on the service brake pedal to reduce the travel speed.

In automatic mode, the lift truck's stopping distance may be longer than in manual mode. BE CAUTIOUS!

- When the directional change is completed, continue to push down on the accelerator pedal to obtain the desired travel speed.

Manual Mode (Fail-Safe mode)

The system still allows movement of the vehicle in case of controller breakdown by selecting the manual mode with the Fail-Safe mode Switch in the controller.

WARNING

In the manual mode, direction inhibition function can not be operated normally. The sudden reversal of a loaded lift truck traveling forward can cause the load to fall or the lift truck to tip.

If the controller fails

An operator can operate the truck manually by selecting the Manual mode with the Fail-Safe mode switch on the PCB (Printed Circuit Board).

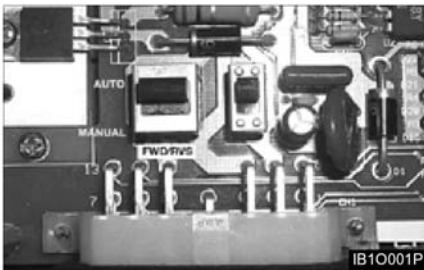

Fail-Safe mode switch

NOTICE

Direction Inhibit Function is usable in factory-setting controller. If you don't want to use this function, make sure to select the manual mode with the Fail-Safe mode switch on PCB.

Finger Tip (Option)

Function of Knobs

If finger tip control option is equipped, the hall-effect type electric knobs replace conventional control valve levers.

Lift Control knob

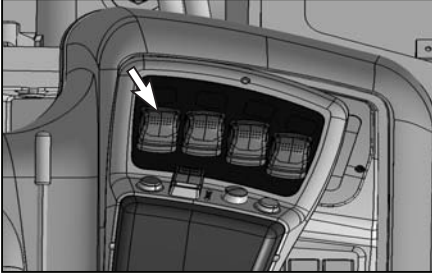

Lower - Push the knob forward smoothly to lower the lift forks.



Hold - Release the lift knob. The knob will return to the center(hold) position and the forks will remain in the position they are in.



Raise - Pull the knob back smoothly to raise the lift forks.

NOTE: To prevent a sudden change of position of the load, operate all lift, tilt and attachment knobs smoothly.

Tilt Control knob

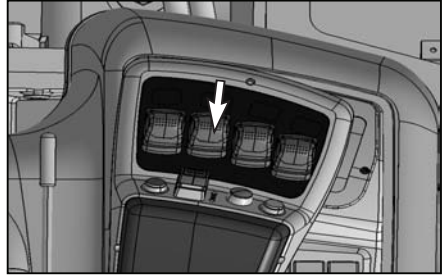

Tilt Forward - Push the knob forward smoothly to tilt the lift forks forward.



Hold - Release the tilt knob. The knob will return to the center(hold) position and the forks will remain in the position they are in.



Tilt Back - Pull the knob back smoothly to tilt the lift forks back..

NOTE: To prevent a sudden change of position of the load, operate all lift, tilt and attachment knobs smoothly.

Sideshift Attachment Control

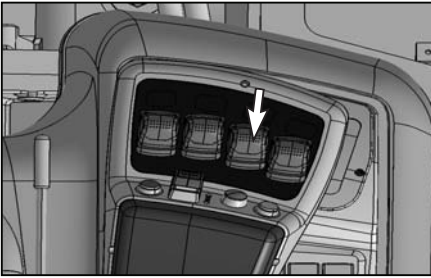

Sideshift Left - Push the knob forward smoothly to shift the carriage to the left.



Sideshift Hold - Release the sideshift attachment knob. The knob will return to the center(hold) position and sideshifting action will stop.



Sideshift Right - Pull the knob back smoothly to shift the carriage to the right.

NOTE: To prevent a sudden change of position of the load, operate all lift, tilt and attachment knobs smoothly.

Warning Lamp

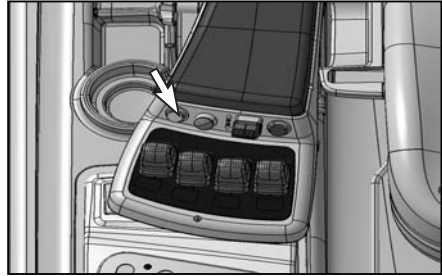

The state of the finger tip system can be checked by the external warning lamp blinking..

Blinking Lamp	State
No Lighting	Normal
Lighting	E-Stop Condition
Lamp Blinking	System Failure

If the warning lamp is blinking, refer to "Diagnosis LED on finger tip ECU".

Emergency Switch

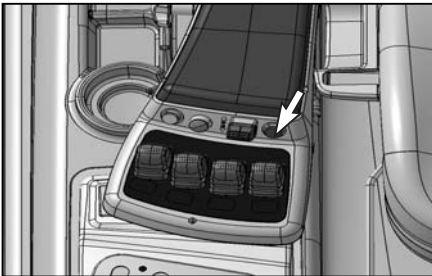

In case of emergency, push this button. Pushing button makes the finger tip system on and off alternately. So if the finger tip control dose not work, then press this button once.

Auto Tilt Leveling Switch

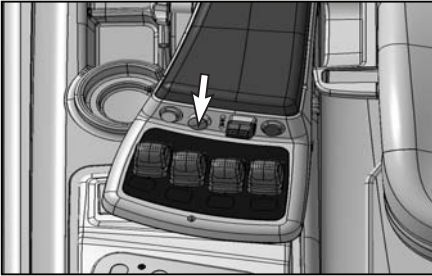

In case of auto tilt leveling, push this button. Pushing button makes auto tilt leveling function on and off alternately. When the function is on, the mast stops at a vertical position while tilting forward and backward.

Forward and Reverse Lever

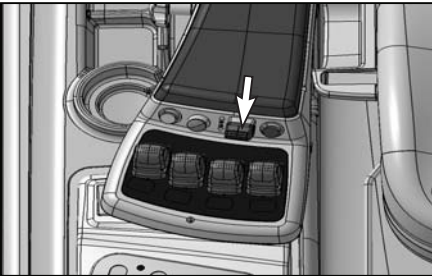

Forward - Push the lever forward. The lift truck will move forward.



Neutral - Move the lever to center position. The lift truck should not move when lever is in neutral.



Reverse - Pull the lever toward the operator. The lift truck will move in reverse..

NOTE: On leaving the seat or turning the key switch off, make sure that all knobs and Forward & Reverse lever are in the neutral position. Otherwise, the whole finger tip system won't work on returning to the seat or turning a key on.

[Aux2] Optional Selector Switch for SAFETY Operating a Rotating Cramp Attachment

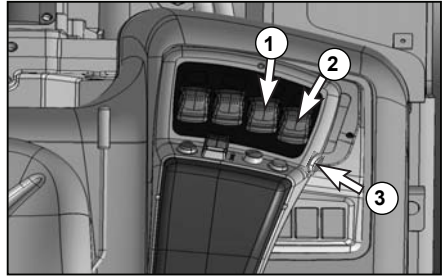

NOTICE

In case that the rotating cramp attachment is installed on the finger tip truck, the optional selector switch(3) (momentary type) is installed on the right side of edge face in the arm rest to prevent the operator from unintentionally removing and dropping a load in the cramping position.

AUX1(1) knob is assigned to a rotation of attachment and AUX2(2) knob is assigned to a cramping motion (removing and cramping a load) of attachment.

When working a cramping motion is necessary, please push or pull AUX2(2) knob within 3 seconds after pushing a selector switch(3). Otherwise, the cramping doesn't work any longer.

In case that the AUX2(2) knob is not again used within 10 seconds after pushing or pulling AUX2(2) knob, the cramping motion is disable. In order to make it possible to do it, push a selector switch(3) again to activate a cramping motion.

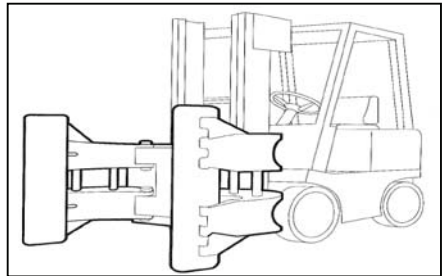

Adjustment of Armrest

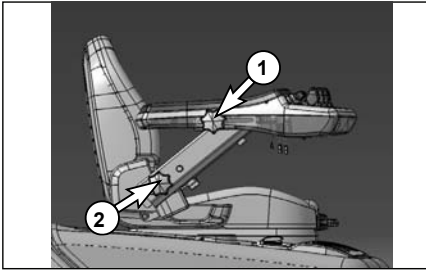

By using 2 knobs, adjust the position of the armrest to give the operator the best comfortable position of arm.

knob #1 - Forward and backward adjustment

knob #2 - Up and down adjustment.

Forward and Backward Adjustment

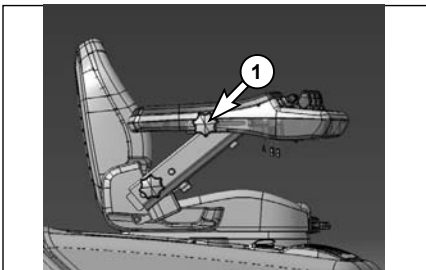

1. Loosen the knob bolt(1)..
2. Adjust the position of armrest forward or backward.
3. Tighten the knob bolt(1) to be locked tightly.

Up and Down Adjustment

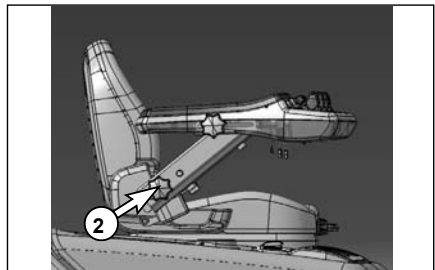

To move the armrest down, turn the knob(2) counterclockwise

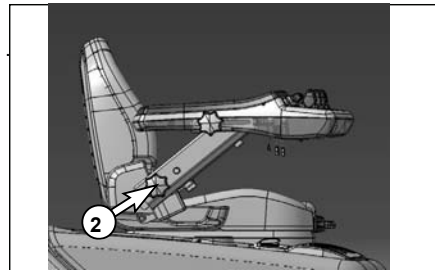

To move the armrest up, turn the knob(2) clockwise.

Operating Techniques

Inching into Loads

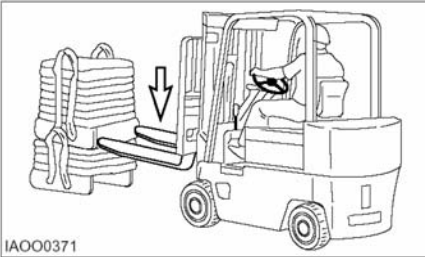

Typical Example

1. Move the lift truck slowly **FORWARD** into position and engage the load. The lift truck should be square with load, forks spaced evenly between pallet stringers and as far apart as load permits.

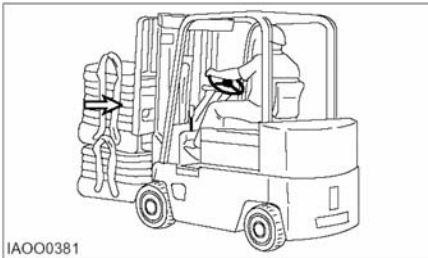

Typical Example

2. Move the lift truck **FORWARD** until the load touches the carriage.

Lifting the Load

1. Lift the load carefully and tilt the mast back a short distance.

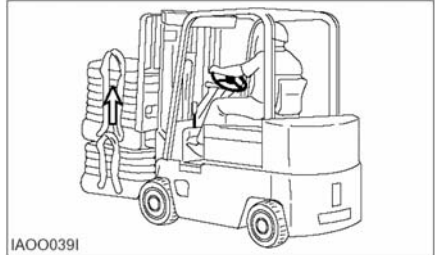

Typical Example

2. Tilt the mast further back to cradle the load.

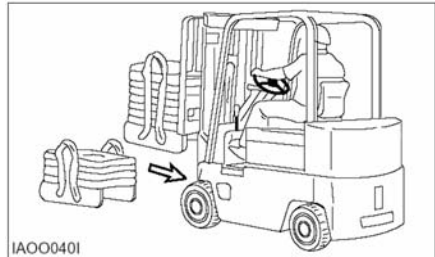

Typical Example

3. Operate the lift truck in reverse until the load is clear of the other material.
4. Lower the cradled load to the travel position.

NOTE: Lift and tilt speeds are controlled by engine rpm.

Traveling With the Load

NOTICE

Travel with the load as low as possible, while still maintaining ground clearance.

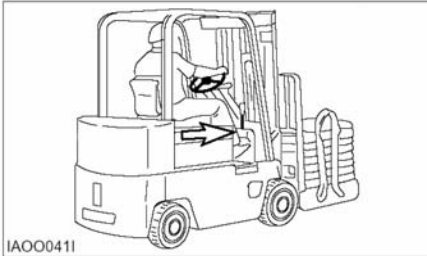

Typical Example

1. Travel with the load uphill on upgrades and downgrades.

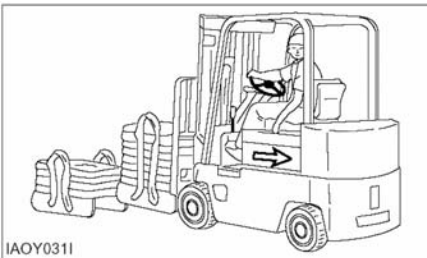

Typical Example

2. For better vision, travel in reverse with bulky loads.

Unloading

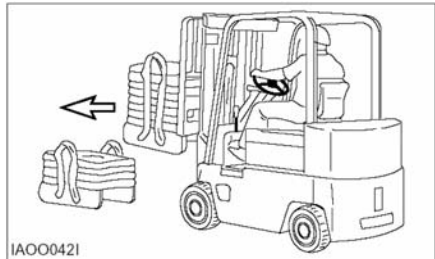

Typical Example

1. Move the lift truck into the unloading position.

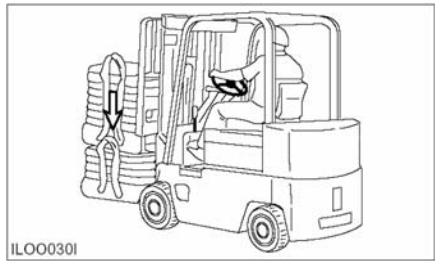

Typical Example

2. Tilt the mast FORWARD only when directly over the unloading area.

WARNING

Do not tilt the mast forward with the load unless directly over the unloading area, even if the power is off.

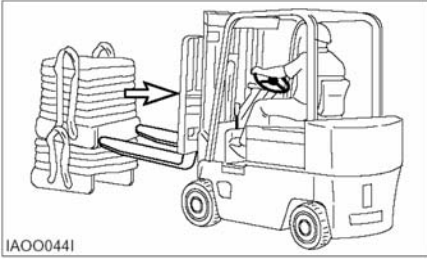

Typical Example

3. Deposit the load and BACK away carefully to disengage the forks.

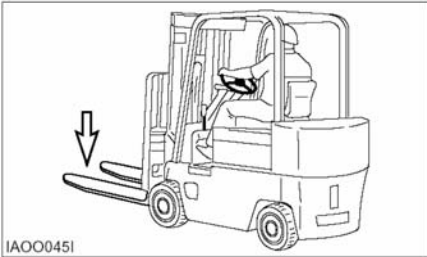

Typical Example

4. Lower the carriage and forks to the travel position or to the park position.

Turning

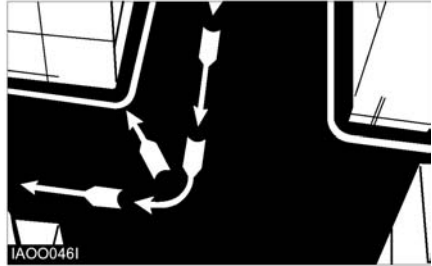

1. When turning sharp corners, keep close to the inside corner. Begin the turn when the inside drive wheel meets the corner.

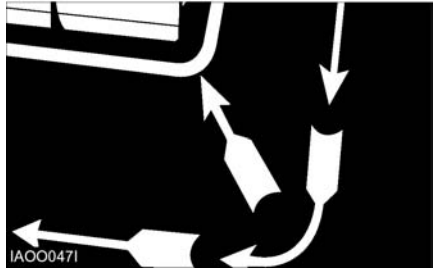

2. In narrow aisles, keep away from the stockpile when turning into the aisle. Allow for counter weight swing.

Lifting Drums or Round Objects

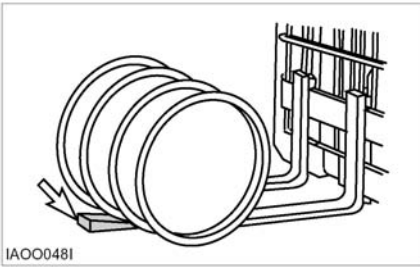

1. Block drums or round objects. Tilt the mast FORWARD and slide the fork tips along the floor to get under the load.

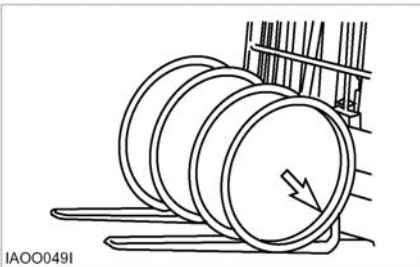

2. Before lifting, tilt the mast BACK slightly until the load is cradled on the forks.

Operating in hot weather

Keep the following points in mind when you operate the lift truck in hot weather.

1. Check the radiator. Clogging can cause overheating. Clean them out regularly with a blast of compressed air, also, check for leakage of water.
2. Check the fan belt tension and adjust to proper tension.
3. Even if the engine overheats and the coolant boils over, let the engine idle for a while with opening engine hood until temperature falls before shutting off the engine.

Parking the Lift Truck



NOTE: Park the lift truck level with the fork lowered and the mast tilted forward until the fork touches the floor. Block the drive wheels when parking on an incline.

1. Park in an authorized area only. Do not block traffic. If LP equipped, do not park near elevator shafts or any other area where LP could collect in a pocket (low area), causing a potentially dangerous condition.



2. Place the transmission controls in NEUTRAL.
3. Engage the parking brake.
4. Tilt the mast forward and lower the fork to the ground.

▲ WARNING

Blocking the wheels will prevent unexpected lift truck movement, which could cause personal injury.

5. Turn the key in the ignition switch to the OFF position and remove the key.

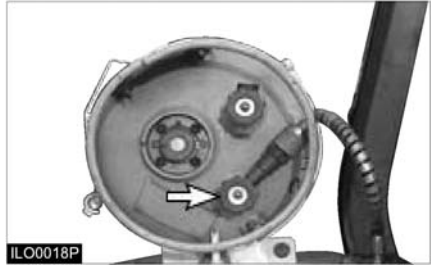

NOTE: If a LP equipped lift truck is stopped or parked for an indefinite or prolonged period of time, shut off the LP fuel tank valve.

6. Actuate each loading lever several times to remove the residual pressure in the respective cylinders and hoses.

If Parking Brake Alarm Equipped

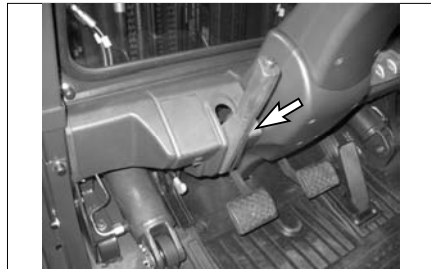

▲ WARNING

When leaving machine apply parking brake! Parking brake is not automatically applied. Alarm will sound if parking brake is not applied.

Lift Fork Adjustment

WARNING

When adjusting the fork spread, be careful not to pinch your hand between forks and the carriage slot.

Hook-on type Fork



1. Move up the hook pin to the free position.
2. Raise the hook pin in each fork to side the fork on the carriage bar.
3. Adjust the forks in the position most appropriate for the load and as wide as possible for load stability.
4. When adjusting the forks, make sure that the weight of the load is centered on the truck.
5. After adjustment, set the fork locks to keep the forks in place.

WARNING

Make sure the forks are locked before carrying a load.

Storage Information

Before Storage

Before storing your lift truck, clean and inspect as the following procedures.

- Wipe away grease, oil, etc. adhering to the body of the truck with waste cloth, and use water, if needed.
- While cleaning the truck, check general condition of the truck. Especially check the truck body for dents or damage and tires for wear or nails or stones in the tread.
- Fill the fuel tank with fuel specified.
- Check for leakage of hydraulic oil, engine oil, fuel, or coolant, etc.
- Apply grease, where needed.
- Check for looseness of nuts and bolts, especially hub nuts.
- Check mast rollers to see that they rotate smoothly.
- Prime the oil into the lift cylinders by actuating the lift lever all the way several times.
- Drain off coolant completely in cold weather, if antifreeze is not used.

Long Time Storage

Perform the following service and checks in addition to the "Parking the lift truck" services.

- Taking the rainy season into consideration, park the machine at a higher and hard ground.
- Avoid parking on soft grounds such as an asphalt ground in summer.
- Dismount the battery from the machine. Even though the machine is parked indoors, if the place is hot or humid, the battery should be kept in a dry, cool place. Charge the battery once a month.
- Apply antirust to the exposed parts which tend to rust.
- Cover components such as the breather and air cleaner which may be caught with humidity.
- The machine should be operated at least once a week. Fill the cooling system, if cooling water is discharged, and mount the battery. Start the engine and warm up thoroughly. Move the machine a little forwards and backwards. Operate the hydraulic controls several times.

To Operate the Lift Truck after a Long Time Storage

- Remove covers and antirust from each of the components and exposed parts.
- Drain the engine crankcase, transmission (clutch type machine), differential and final reduction gear, clean the inside of them and add new oil.
- Drain off foreign matter and water from the hydraulic oil tank and fuel tank.
- Remove the head cover from the engine cylinder. Oil valves and rocker shaft and check each valve for proper operation.
- Add cooling water to the specified level.
- Charge the battery and mount it on the machine. Connect the cables.
- Perform pre - operational checks carefully. (refer to "Before Starting the Engine")
- Warm up the machine.

Transportation Hints

Lift Truck Shipping

Check travel route for overpass clearances. Make sure there is adequate clearance if the lift truck being transported is equipped with a high mast, overhead guard or cab.

To prevent the lift truck from slipping while loading, or shifting in transit, remove ice, snow or other slippery material from the loading dock and the truck bed before loading.

NOTICE

Obey all state and local laws governing the height, weight, width and length of a load.
Observe all regulations governing wide loads.

NOTICE

Remove ice, snow or other slippery material from the shipping vehicle and the loading dock.

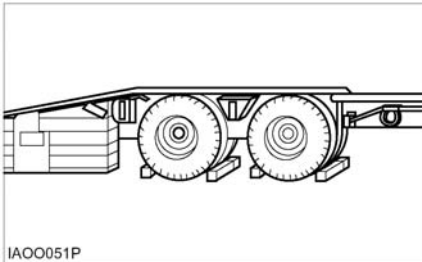

Always block the trailer or the rail car wheels before loading the lift truck.

Position the lift truck on the truck bed or the rail car.

Apply the parking brake and place the transmission control in NEUTRAL.

Tilt the mast forward and lower forks to the floor.

Turn the ignition switch to the OFF position and remove the key. If LP equipped, shut off the LP fuel tank.

Block the wheels and secure the lift truck with tiedowns.

Machine Lifting and Tiedown Information

NOTICE

Improper lifting or tiedowns can allow load to shift and cause injury and/or damage.

1. Weight and instructions given herein apply to lift trucks as manufactured by DOOSAN.
2. Use proper rated cables and slings for lifting. Position the crane for level lift truck lift.
3. Spreader bar widths should be sufficient to prevent contact with the lift truck.
4. Use the tiedown locations provided for lift truck tiedown.

Check the state and local laws governing weight, width and length of a load.

Contact your DOOSAN Lift Truck dealer for shipping instructions for your lift truck.

Towing Information

WARNING

Personal injury or death could result when towing a disabled lift truck incorrectly.

Block the lift truck wheels to prevent movement before releasing the brakes. The lift truck can roll free if it is not blocked.

Follow the recommendations below, to properly perform the towing procedure.

These towing instructions are for moving a disabled lift truck a short distance, at low speed, no faster than 2 km/h (1.2 mph), to a convenient location for repair. These instructions are for emergencies only. Always haul the lift truck if long distance moving is required.

Shield must be provided on the towing lift truck to protect the operator if the tow line or bar should break.

Do not allow riders on the lift truck being towed unless the operator can control the steering and/or braking.

Before towing, make sure the tow line or bar is in good condition and has enough strength for the towing situation involved. Use a towing line or bar with a strength of at least 1.5 times the gross weight of the towing lift truck for a disabled lift truck stuck in the mud or when towing on a grade.

Keep the tow line angle to a minimum. Do not exceed a 30° angle from the straight ahead position. Connect the tow line as low as possible on the lift truck that is being towed.

Quick lift truck movement could overload the tow line or bar and cause it to break. Gradual and smooth lift truck movement will work better.

Normally, the towing lift truck should be as large as the disabled lift truck. Satisfy yourself that the towing lift truck has enough brake capacity, weight and power, to control both lift trucks for the grade and the distance involved.

To provide sufficient control and braking when moving a disabled lift truck downhill, a larger towing lift truck or additional lift trucks connected to the rear could be required. This will prevent uncontrolled rolling.

The different situation requirements cannot be given, as minimal towing lift truck capacity is required on smooth level surfaces to maximum on inclines or poor surface conditions.

Consult your DOOSAN Lift Truck dealer for towing a disabled lift truck.

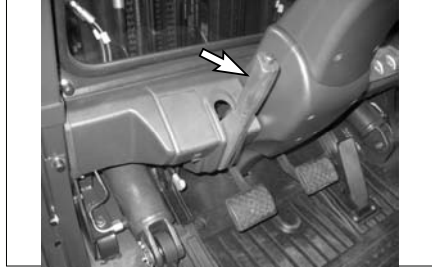

1. Release the parking brake.

NOTICE

Release the parking brake to prevent excessive wear and damage to the parking brake system.

2. Check that the service brake pedal is released.
3. Key switch is in the OFF position.
4. Direction control lever is in neutral.
5. Fasten the tow bar to the lift truck.
6. Remove the wheel blocks. Tow the lift truck slowly. Do not tow any faster than 2 km/h (1.2 mph).

WARNING

Be sure all necessary repairs and adjustments have been made before a lift truck that has been towed to a service area is put back into operation.

Inspection, Maintenance and Repair of Lift Truck Forks

The following section gives practical guidelines for inspection, maintenance and repair of lift truck forks. It also provides general information on the design and application of forks and the common cause of fork failures.

Lift truck forks can be dangerously weakened by improper repair or modification. They can also be damaged by the cumulative effects of age, abrasion, corrosion, overloading and misuse.

A fork failure during use can cause damage to the equipment and the load. A fork failure can also cause serious injury.

A good fork inspection and maintenance program along with the proper application can be very effective in preventing sudden failures on the job. Repairs and modifications should be done only by the fork manufacturer or a qualified technician who knows the material used and the required welding and heat treatment process.

Users should evaluate the economics of returning the forks to the manufacturer for repairs or purchasing new forks. This will vary depending on many factors including the size and type of fork.

Forks should be properly sized to the weight and length of the loads, and to the size of the machine on which they are used. The general practice is to use a fork size such that the combined rated capacity of the number of forks used is equal to or greater than the "Standard (or rated) Capacity" of the lift truck.

The individual load rating, in most cases, will be stamped on the fork in a readily visible area. This is generally on the top or side of the fork shank.

- A fork rated at 1500 pounds at 24 inch load center will be stamped 1500x24.
- A fork rated at 2000 kg at 600 mm load center will be stamped 2000x600.

The manufacturer identification and year and date of manufacture are also usually shown.

Some countries have standards or regulations which apply specifically to the inspection and repair of forks.

Users may also refer to the International Organization For Standardization-ISO Technical Report 5057- Inspection and Repair of Fork Arms and ISO Standard 2330 - Fork Arms - Technical Characteristics and Testing.

While there are no specific standards or regulations in the United States, users should be familiar with the requirements for inspection and maintenance of lift trucks as provided by the 29 Code Federal Register 1910.178 Powered Industrial Truck, and ANSI/ASME Safety Standard(s) B56.1, B56.5 or B56.6 as applicable to the type of machine(s) in use.

Environment Protection

When servicing this lift truck, use an authorized servicing area and an approved container to collect coolant, oil, fuel, grease, electrolyte and any other potential environmental pollutant before any lines, fittings or related items are disconnected or removed. After servicing, dispose of those materials in an authorized place and container. When cleaning the lift truck, be sure to use an authorized area.

Causes of Fork Failure

Improper Modification or Repair

Fork failure can occur as a result of a field modification involving welding, flame cutting or other similar processes which affect the heat treatment and reduces the strength of the fork.

In most cases, specific processes and techniques are also required to achieve proper welding of the particular alloy steels involved. Critical areas most likely to be affected by improper processing are the heel section, the mounting components and the fork tip.

Bent or Twisted Forks

Forks can be bent out of shape by extreme overloading, glancing blows against walls or other solid objects or using the fork tip as a pry bar.

Bent or twisted forks are much more likely to break and cause damage or injury. They should be removed from service immediately.

Fatigue

Parts which are subjected to repeated or fluctuating loads can fail after a large number of loading cycles even though the maximum stress was below the static strength of the part.

The first sign of a fatigue failure is usually a crack which starts in an area of high stress concentration. This is usually in the heel section or on the fork mounting.

As the crack progresses under repetitive load cycling, the load bearing cross section of the remaining metal is decreased in size until it becomes insufficient to support the load and complete failure occurs.

Fatigue failure is the most common mode of fork failure. It is also one which can be anticipated and prevented by recognizing the conditions which lead up to the failure and by removing the fork service prior to failing.

- Repetitive Overloading

Repetitive cycling of loads which exceeds the fatigue strength of the material can lead to fatigue failure. The overload could be caused by loads in excess of the rated fork capacity and by use of the forks tips as pry bars. Also, by handling loads in a manner which causes the fork tips to spread and the forks to twist laterally about their mountings.

- Wear

Forks are constantly subjected to abrasion as they slide on floors and loads. The thickness of the fork blade is gradually reduced to the point where it may not be capable of handling the load for which it was designed.

- Stress Risers

Scratches, nicks and corrosion are points of high stress concentration where cracks can develop. These cracks can progress under repetitive loading in a typical mode of fatigue failure.

Overloading

Extreme overloading can cause permanent bending or immediate failure of the forks. Using forks of less capacity than the load or lift truck when lifting loads and using forks in a manner for which they were not designed are some common causes of overloading.

Fork Inspection



Establish a daily and 12 month inspection routine by keeping a record for the forks on each lift truck. Initial information should include the machine serial number on each the forks are used, the fork manufacturer, type, original section size, original length and capacity. Also list any special characteristics specified in the fork design.

Record the date and results of each inspection, making sure the following information is included.

- Actual wear conditions, such as percent of original blade thickness remaining.
- Any damage, failure or deformation which might impair the use of the truck.
- Note any repairs or maintenance.

An ongoing record of this information will help in identifying proper inspection intervals for each operation, in identifying and solving problem areas and in anticipating time for replacement of the forks.

First Installation

1. Inspect forks to ensure they are the correct size for the truck on which they will be used. Make sure they are the correct length and type for the loads to be handled.

If the forks have been previously used, perform the "12 Month Inspection".

If the forks are rusted, see "Maintenance and Repair".

2. Make sure fork blades are level to each other within acceptable tolerances. See "Forks, Step 4," in the "2000 Service Hours or Yearly" in "Maintenance Intervals"
3. Make sure positioning lock is in place and working. Lock forks in position before using truck. See "Forks, Step 7", in the "2000 Service Hours or Yearly" in "Maintenance Intervals".

Daily Inspection

1. Visually inspect forks for cracks, especially in the heel section, around the mounting brackets, and all weld areas. Inspect for broken or jagged fork tips, bent or twisted blades and shanks.
2. Make sure positioning lock is in place and working. Lock the forks in position before using the truck. See "2000 Service Hours or Yearly" in "Maintenance Intervals".
3. Remove all defective forks from service.

12 Months Inspection

Forks should be inspected, at a minimum, every 12 months. If the truck is being used in a multi-shift or heavy duty operation, they should be checked every six months. See "Forks" in the "2000 Service Hours or Yearly" in "Maintenance Intervals."

Maintenance and Repair

1. Repair forks only in accordance with the manufacturer's recommendations.

Most repairs or modifications should be done only by the original manufacturer of the forks or an expert knowledgeable of the materials, design, welding and heat treatment process.

2. The following repairs or modifications SHOULD NOT be attempted.

- Flame cutting holes or cutouts in fork blades.
- Welding on brackets or new mounting hangers.
- Repairing cracks or other damage by welding.
- Bending or resetting.

3. The following repairs MAY be performed.

- Forks may be sanded or lightly ground, to remove rust, corrosion or minor defects from the surfaces.
- Heel sections may be ground with a carbon stone to remove minor surface cracks or defects. Polish the inside radius of the heel section to increase the fatigue life of the fork. Always grind or polish in the direction of the blade and shank length.
- Repair or replace the positioning locks on hook type forks.
- Repair or replace most fork retention devices used with other fork types.

4. A fork should be load tested before being returned to service on completion of repairs authorized and done in accordance with the manufacturer's recommendations.

Most manufacturers and standards require the repaired fork to be tested with a load 2.5 times the specified capacity and at the load center marked on the fork arm.

With the fork restrained in the same manner as its mounting on the lift truck, apply the test load twice, gradually and without shock. Maintain the test for 30 seconds each time.

Check the fork arm before and after the second application of the test load. It shall not show any permanent deformation.

Consult the fork manufacturer for further information as may be applicable to the specific fork involved.

Testing is not required for repairs to the positioning lock or the markings.

Tire Inflation Information

Tire Inflation

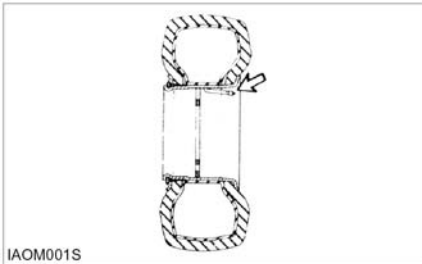

WARNING

Personal injury or death could result when tires are inflated incorrectly.

Use a self - attaching inflation chuck and stand behind the tread when inflating a tire.

Proper inflation equipment and training in using the equipment are necessary to avoid over-inflation. A tire blowout or rim failure can result from improper or misused equipment.

NOTICE

Set the tire inflation equipment regulator at no more than 140 kPa (20 psi) over the recommended tire pressure.

Tire Shipping Pressure

The tire inflation pressures shown in the following chart are cold inflation shipping pressures.

Size	Ply Rating or Strength Index	Shipping Pressure	
		kPa	psi
6.5X10	10	790	115
7.0X15	12	825	120
28X9-15	12	825	120

¹ Standard tire, ply rating and inflation pressures.

The operating inflation pressure is based on the weight of a ready - to - work machine without attachments, at rated payload, and in average operating conditions. Pressures for each application may vary and should always be obtained from your tire supplier.

NOTE: Fill tires to the recommended pressures listed \pm 35 kPa (5 psi). Tires can be filled with nitrogen.

Tire Inflation Pressures Adjustment

Tire inflation in a warm shop area, 18° to 21°C (65° to 70°F), will be underinflated if the machine works in freezing temperatures. Low pressure shortens the life of a tire.

Torque Specifications

Metric Hardware

Most of the nuts, bolts, studs, and threaded holes in your lift truck are metric. In this manual we provide specifications in both metric and U.S. customary measurement. Always replace metric hardware with metric hardware. See the parts books for proper replacement.

NOTE: For proper fit, use only metric tools on metric hardware. Non-metric tools might slip and cause injury.

Torque for Standard Hose Clamps - Worm Drive

NOTICE

The chart below gives the torques for initial installation of hose clamps on new hose and for reassembly or retightening of hose clamps on existing hose.

Clamp Width	Initial Installation Torque On New Hose	
	N•m ¹	lb•in
16 mm (.625 in)	7.5 ± 0.5	65 ± 5
13.5 mm (.531 in)	4.5 ± 0.5	40 ± 5
8 mm (.312 in)	0.9 ± 0.2	8 ± 2
Clamp Width	Reassembly or Retightening Torque On Existing Hose	
	N•m ¹	lb•in
16 mm (.625 in)	4.5 ± 0.5	40 ± 5
13.5 mm (.531 in)	3.0 ± 0.5	25 ± 5
8 mm (.312 in)	0.7 ± 0.2	6 ± 2

¹ Newton meter (N•m) is approximately the same as 0.1 kg•m.

Torque for Standard Bolts, Nuts, and Taperlock Studs

NOTICE

The two charts below give general torques for bolts, nuts, and taperlock studs of SAE Grade 5 or better quality.

Torques for Bolts and Nuts with Standard Threads

Thread Size Inch	Standard Nut and Bolt Torque	
	N•m	lb•ft
1/4	12 ± 4	9 ± 3
5/16	25 ± 7	18 ± 5
3/8	45 ± 7	33 ± 5
7/16	70 ± 15	50 ± 11
1/2	100 ± 15	75 ± 11
9/16	150 ± 20	110 ± 15
5/8	200 ± 25	150 ± 18
3/4	360 ± 50	270 ± 37
7/8	570 ± 80	420 ± 60
1	875 ± 100	640 ± 75
1 1/8	1100 ± 150	820 ± 110
1 1/4	1350 ± 175	1000 ± 130
1 3/8	1600 ± 200	1180 ± 150
1 1/2	2000 ± 275	1480 ± 200

¹ Newton meter (N•m) is approximately the same as 0.1 kg •m.

Torques for Taperlock Studs

Thread Size Inch	Standard Taperlock Stud Torque	
	N•m ¹	lb•ft
1/4	8 ± 3	6 ± 2
5/16	17 ± 5	13 ± 4
3/8	35 ± 5	26 ± 4
7/16	45 ± 10	33 ± 7
1/2	65 ± 10	48 ± 7
5/8	110 ± 20	80 ± 15
3/4	170 ± 30	125 ± 22
7/8	260 ± 40	190 ± 30
1	400 ± 60	300 ± 45
1/8	500 ± 700	370 ± 50
1/4	650 ± 80	480 ± 60
3/8	750 ± 90	550 ± 65
1/2	870 ± 100	640 ± 75

¹ Newton meter (N•m) is approximately the same as 0.1 kg•m.

Torque for Metric Fasteners

NOTICE

Be very careful never to mix metric with U.S. customary (standard) fasteners. Mismatched or incorrect fasteners will cause lift truck damage or malfunction and may even result in personal injury.

Original fasteners removed from the lift truck should be saved for reassembly whenever possible. If new fasteners are needed, they must be of the same size and grade as the ones that are being replaced.

The material strength identification is usually shown on the bolt head by numbers (8.8, 10.9, etc.). This chart gives standard torques for bolts and nuts with Grade 8.8.

NOTE: Metric hardware must be replaced with metric hardware. Check parts book.

Thread Size Metric	Standard Torque	
	N•m ¹	lb•ft
M6	12 ± 4	9 ± 3
M8	25 ± 7	18 ± 5
M10	55 ± 10	41 ± 7
M12	95 ± 15	70 ± 11
M14	150 ± 20	110 ± 15
M16	220 ± 30	160 ± 22
M20	450 ± 70	330 ± 50
M24	775 ± 100	570 ± 75
M30	1600 ± 200	1180 ± 150
M36	2700 ± 400	2000 ± 300

¹ Newton meter (1 N•m) is approximately the same as 0.1 kg•m.

²ISO - International Standards organization.

Cooling System Specifications

Coolant Information

NOTE: The following information is generic and valid for lift trucks.

Engine operating temperatures have increased to improve engine efficiency. This means proper cooling system maintenance is especially important. Overheating, overcooling, pitting, cavitation erosion, cracked heads, piston seizures, and plugged radiators are classic cooling system failures. In fact, coolant is as important as the quality of fuel and lubricating oil.

Filling at over 20 liters (5 U.S. gallons) per minute can cause air pockets in the cooling system.

After draining and refilling the cooling system, operate the engine with the radiator cap removed until the coolant reaches normal operating temperature and the coolant level stabilizes. Add coolant as necessary to fill the system to the proper level.

Never operate without a thermostat in the cooling system. Cooling system problems can arise without a thermostat.

NOTICE

DOOSAN recommends that the coolant mixture contain 50% commercially available automotive antifreeze, and 50% water.

The coolant mix with concentration of antifreeze smaller than 30% does not provide sufficient corrosion protection. Concentrations over 60% adversely affect freeze protection and heat transfer rates.

Never add coolant to an overheated engine, engine damage can result. Allow the engine to cool first. If the machine is to be stored in, or shipped to, an area with freezing temperatures, the cooling system must be protected to the lowest expected outside (ambient) temperature.

The engine cooling system is normally protected to -28°C (-20°F) with antifreeze, when shipped from the factory unless special requirements are defined.

Check the specific gravity of the coolant solution frequently in cold weather to ensure adequate protection.

Clean the cooling system if it is contaminated, the engine overheats or foaming is observed in the radiator.

Old coolant should be drained, the system cleaned and new coolant added every 2000 service hours or yearly.

Refer to topic, "Cooling System - Clean, Change" in Every 2000 Service Hours or Yearly section.

Coolant Water

Hard water, or water with high levels of calcium and magnesium ions, encourages the formation of insoluble chemical compounds by combining with cooling system additives such as silicates and phosphates.

The tendency of silicates and phosphates to precipitate out-of-solution increases with increasing water hardness. Hard water or water with high levels of calcium and magnesium ions encourages the formation of insoluble chemicals, especially after a number of heating and cooling cycles.

DOOSAN prefers the use of distilled water or deionized water to reduce the potential and severity of chemical insolubility.

Acceptable Water	
Water Content	Limits (PPM)
Chlorides (Cl)	50 maximum
Sulfates (SO ₄)	50 maximum
Total hardness	80mg/l
Total solids	250 maximum
PH	6.0 to 8.0

ppm = parts per million

Using water that meets the minimum acceptable water requirement may not prevent drop-out of these chemical compounds totally, but should minimize the rate to acceptable levels.

Antifreeze

NOTICE

DOOSAN recommends using automotive antifreeze suitable for gasoline engines having aluminum alloy parts. Antifreeze of poor quality will cause corrosion of the cooling system, and thus always use automotive antifreeze prepared by a reliable maker, and never use it mixed with antifreeze of different brand.

DOOSAN recommends that the coolant mix contain 50% commercially available automotive antifreeze, or equivalent and acceptable water to maintain and adequate water pump cavitation temperature for efficient water pump performance.

Premix coolant solution to provide protection to the lowest expected outside (ambient) temperature. Pure undiluted antifreeze will freeze at -23°C (-10°F).

Use a greater concentration (above 50%) of commercially available automotive antifreeze only as needed for anticipated outside (ambient) temperatures. Do not exceed the recommendations, provided with the commercially available automotive antifreezes, regarding the coolant mixture of antifreeze to water.

Make proper antifreeze additions.

Adding pure antifreeze as a makeup solution for cooling system top-up is an unacceptable practice. It increases the concentration of antifreeze in the cooling system which increases the concentration of dissolved solids and undissolved chemical inhibitors in the cooling system. Add antifreeze mixed with water to the same freeze protection as your cooling system.

Use the chart below to assist in determining the concentration of antifreeze to use.

Antifreeze Concentrations	
Protection Temperature	Concentrations
Protection to -15°C (5°F)	30% antifreeze and 70% water
Protection to -23°C (-10°F)	40% antifreeze and 60% water
Protection to -37°C (-34°F)	50% antifreeze and 50% water
Protection to -51°C (-60°F)	60% antifreeze and 40% water

Fuel Specifications

General Fuel Information

Use only fuel as recommended in this section.

NOTICE

Fill the fuel tank at the end of each day of operation to drive out moisture laden air and to prevent condensation. Maintain a constant level near the top of the day tank to avoid drawing moisture into the tank as the level decreases.

Do not fill the tank to the top. Fuel expands as it gets warm and can overflow.

Do not fill the fuel filters with fuel before installing them. Contaminated fuel will cause accelerated wear to the fuel system parts.

Drain the water and sediment from main fuel storage tank before it is refilled. This will help prevent water and/or sediment from being pumped from the fuel storage tank into the engine fuel tank.

Diesel Fuel Specifications

Diesel fuel should comply with the following specifications. The table lists several worldwide specifications for diesel fuels.

Diesel Fuel Specification	Location
ASTM D975 No.1D/2D	USA
EN590:96	EU
ISO 8217 DMX	International
BS 2869-A1 or A2	United Kingdom
JIS K2204 Grade No. 2	Japan
KSM-2610	Korea
GB252	China

Additional Technical Fuel Requirements

- The fuel cetane number should be equal to 45 or higher.
- The sulfur content must not exceed 0.5% by volume. Less than 0.05% is preferred.
- For electronically controlled engines, for example 4TNV98-ZSDF, it is mandatory to use fuel that does not contain 0.1 % or more sulfur content.
- In general, using a high sulfur fuel may possible result in corrosion inside the cylinder.
- Especially in U.S.A. and Canada, Low Sulfur (300-500mg/kg sulfur content) or Ultra Low Sulfur

fuel should be used.

- Bio-Diesel fuels. See Bio-Diesel Fuels on next page.
- NEVER mix kerosene, used engine oil, or residual fuels with the diesel fuel.
- The water and sediment in the fuel should not exceed 0.05% by volume.
- Keep the fuel tank and fuel-handling equipment clean at all times.
- Poor quality fuel can reduce engine performance and / or cause engine damage.
- Fuel additives are not recommended. Some fuel additives may cause poor engine performance.
- Consult your Doosan representative for more information.
- The ash content must not exceed 0.01% by volume.
- The carbon residue content must not exceed 0.35% by volume. Less than 0.1 % is preferred.
- The total aromatics content should not exceed 35% by volume. Less than 30% is preferred.
- The PAH (polycyclic aromatic hydrocarbons) content should be below 10% by volume.
- The metal content of Na, Mg, Si, and Al should be equal to or lower than 1 mass ppm.
- Lubricity: The wear mark of WS1.4 should be Max. 0.01 8 in (460 pm) at HFRR test.

Bio-Diesel Fuels

In Europe and in the United States, as well as some other countries, non-mineral oil based fuel resources such as RME (Rapeseed Methyl Ester) and SOME (Soybean Methyl Ester), collectively known as FAME (Fatty Acid Methyl Esters), are being used as extenders for mineral oil derived diesel fuels.

Doosan approves the use of bio-diesel fuels that do not exceed a blend of 5% (by volume) of FAME with 95% (by volume) of approved mineral oil derived diesel fuel. Such bio-diesel fuels are known in the marketplace as B5 diesel fuels.

These 95 diesel fuels must meet certain requirements.

- The bio-fuels must meet the minimum specifications for the country in which they are used.
 - In Europe, bio-diesel fuels must comply with the European Standard EN14214.
 - In the United States, bio-diesel fuels must comply with the American Standard ASTM D-6751.
- Bio-fuels should be purchased only from recognized and authorized diesel fuel suppliers.

Precautions and concerns regarding the use of bio-fuels:

- Free methanol in FAME may result in corrosion of aluminum and zinc FIE components.
- Free water in FAME may result in plugging of fuel filters and increased bacterial growth.
- High viscosity at low temperatures may result in fuel delivery problems, injection pump seizures, and poor injection nozzle spray atomization.
- FAME may have adverse effects on some elastomers (seal materials) and may result in fuel leakage and dilution of the engine lubricating oil.
- Even bio-diesel fuels that comply with a suitable standard as delivered, will require additional care and attention to maintain the quality of the fuel in the equipment or other fuel tanks. It is important to maintain a supply of clean, fresh fuel. Regular flushing of the fuel system, and / or fuel storage containers, may be necessary.
- The use of bio-diesel fuels that do not comply with the standards as agreed to by the diesel engine manufacturers and the diesel fuel injection equipment manufacturers, or biodiesel fuels that have degraded as per the precautions and concerns above, may affect the warranty coverage of your engine.

Gasoline Specifications

Only unleaded gasoline should be used for DOOSAN forklift trucks.

The gasoline in which methanol is contained is not recommended. The gasoline in which ethanol is contained is not recommended, either.

It is recommended to use gasoline fuel that has octane number 87, to prevent knocking trouble.

LP Specifications

LP is "liquefied petroleum gas". The exact composition of LP varies slightly between different parts of the country and different refineries. HD5 or HD10 is recommended for DOOSAN forklift trucks.

Composition of HD5	
Propane (C ₃ H ₈)	90.0 %
Propylene	up to 5 %
Butane (C ₄ H ₁₀)	2.0 %
iso - Butane	1.5 %
Methane (CH ₄)	1.5 %
Total	100 %

WARNING

Remember LP is heavier than air and will sink to the lowest spot possible. Avoid areas near floor drains or lubrication pits where escaped fuel may collect.

Lubricant Information

Lubricant Information

Certain abbreviations follow Society of Automotive Engineers (SAE) J754 nomenclature and some classifications follow SAE J183 abbreviations.

The MIL specifications are U.S.A. Military Specifications.

The recommended oil viscosities can be found in the Lubricant Viscosities chart in this publication.

Grease is classified by the National Lubricating Grease Institute (NLGI) based on ASTM D217-68 Worked Penetration characteristics which are given a defined consistency number.

Engine Oil (DEO and EO)

The following oil specifications provide guidelines for the selection of commercial products:

- Gasoline/LP Engine : API SJ or higher
- Diesel Engine : API CH4, ACEA E5

NOTICE

Failure to follow the oil recommendations can cause shortened engine life due to carbon deposits or excessive wear.

Consult the EMA Lubricating Oils Data Book for a listing of oil brands.

NOTE: The percentage of sulfur in the fuel will affect the engine oil recommendations. For fuel sulfur effects, the Infrared Analysis or the ASTM D2896 procedure can be used to evaluate the residual neutralization properties of engine oil. The sulfur products formation depends on the fuel sulfur content, oil formulation, crankcase blow-by, engine operating conditions and ambient temperature.

Hydraulic Oil (HYDO)

The following commercial classifications can be used in the hydraulic system.

- | | |
|---------------------|-----------|
| • ISO 6743/4 | HM |
| • AFNOR NFE 48-603 | HM |
| • DIN 51524 TEIL 2 | H-LP |
| • HAGGLUNDS DENISON | HFO-HF2 |
| • CINCINNATI | P68,69,70 |

Viscosity: ISO VG32

Industrial premium hydraulic oils that have passed the Vickers vane pump test (35VQ25). These oils should have antiwear, antifoam, antirust and antioxidant additives for heavy duty use as stated by the oil supplier. ISO viscosity grade of 32 would normally be selected.

NOTICE

Make-up oil added to the hydraulic tanks must mix with the oil already in the systems. Use only petroleum products unless the systems are equipped for use with special products. If the hydraulic oil becomes cloudy, water or air is entering the system. Water or air in the system will cause pump failure. Drain the fluid, retighten all hydraulic suction line clamps, purge and refill the system. Consult your DOOSAN Lift Truck dealer for purging instructions.

Drive Axle Oil

NOTE: Do not use Gear Oil in the final drives or differentials. Gear Oil can cause seal material to fail and possibly leak oil.

NOTE: Failure to follow the recommendation will cause shortened life due to excessive gear wear.

The API CD/TO-2 specification or MIL-L-2104D, E or F oils could be used.

NOTE: Multi-grade oils are not blended by DOOSAN for use in transmissions. Multi-grade oils which use high molecular weight polymers as viscosity index improvers lose their viscosity effectiveness by permanent and temporary shear of the viscosity index improver and therefore, are not recommended for transmission and drive train compartments.

Lubricating Grease (MPGM)

Use Multipurpose Molybdenum Grease (MPGM) for all lubrication points. If MPGM grease can not be used, multipurpose type grease which contains 3% to 5% molybdenum disulfide can be used.

NLGI No.2 grade is suitable for most temperatures. Use NLGI No.1 or No.0 grade for extremely low temperature.

Transmission Oil

NOTICE

This oil is formulated for transmissions and drive trains only, and should not be used in engines. Shortened engine life will result.

NOTE: Multi-grade oils are not blended by DOOSAN for use in transmissions. Multi-grade oils which use high molecular weight polymers as viscosity index improvers lose their viscosity effectiveness by permanent and temporary shear of the viscosity index improver and therefore, are not recommended for transmission and drive train compartments.

NOTE: Failure to follow this recommendation can cause shortened transmission life due to material incompatibility, inadequate frictional requirements for disk materials and/or excessive gear wear.

The API CD/TO - 2 specification or MIL - L 2104D, E or F oil could be used.

Brake Fluid

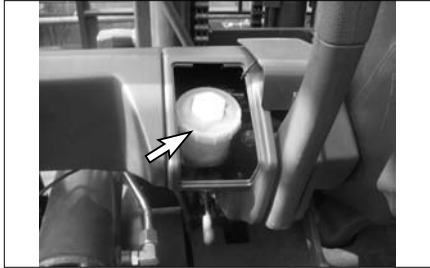

Oil Cooled Disc Brake Only

Use heavy duty hydraulic brake fluid certified by oil supplier to meet the latest version of following classifications.

- ISO 6743/4
 - AFNOR NFE 48-603
 - DIN 51524 TEIL 2
 - HAGGLUNDS DENISON
 - CINCINNATI
- HM
HM
H-LP
HFO-HF2
P68,69,70

Viscosity : ISO VG32

Brake reservoir oils that have passed the Vickers vane pump test (35VQ25). These oils should have antiwear, antifoam, antirust and antioxidation additives for heavy duty use as stated by the oil supplier. ISO viscosity grade of 32 would normally be selected.

The following products are authorized for use.

Supplier	Product Name
TOTAL	AZOLLAZS
SHELL	TELLUS
MOBIL	DTE20S'
CALTEX	RANDO HD
ESS	NOTO H
CASTROL	HYSPIN AWS

Lubricant Viscosities and Refill Capacities

Lubricant Viscosities

LUBRICANT VISCOSITIES FOR AMBIENT (OUTSIDE) TEMPERATURES					
Compartment or System	Oil Viscosities	°C		°F	
		Min	Max	Min	Max
G420F(E) G424F(E) Engine Crankcase (Gasoline and LP) API SJ	SAE 10W30	-20	+40	-4	+104
	SAE 5W30	-30	+30	-22	+86
G424(E) G430FE Engine Crankcase (Gasoline and LP) API SL	SAE 10W30	-20	+40	-4	+104
	SAE 5W30	-30	+30	-22	+86
Engine Crankcase (Diesel) API CH4, ACEA E5	SAE 15W40	-15	+50	-5	+122
Power Shift Transmission & Drive Axle Housing API CD/TO-2	SAE 10W	-20	+22	-4	+72
	SAE 30	+10	+50	+50	+122
Hydraulic and Power Steering System ISO 6743/4 HM	ISO VG 22	-30	+20	-22	+68
	ISO VG 32	-20	+30	-4	+86
	ISO VG 46	-10	+40	+14	+104
	ISO VG 68	0	+50	+32	+122
Brake Reservoir (Only for OCDB) ISO 6743/4HM	ISO VG32	-20	+30	-4	+86

The SAE grade number indicates the viscosity of oil. A proper SAE grade number should be selected according to ambient temperature.

Refill Capacities

REFILL CAPACITIES - (APPROXIMATE)			
Compartment or System		Liters	U.S Gal.
Engine Crankcase w/Filter G420F & G420FE 2.0 liter Gasoline & LP		4.2	1.11
Engine Crankcase w/Filter G424F & G424FE 2.4 liter Gasoline & LP		4.5	1.19
Engine Crankcase w/Filter G424I & G424IE 2.4 liter Gasoline & LP		5.7	1.56
Engine Crankcase w/Filter G430FE 3.0 liter LP		4.3	1.14
Engine Crankcase w/Filter 4TNN98 Diesel		7.6	2.00
Engine Crankcase w/Filter 4TNE98 Diesel		9.2	2.43
Cooling System w/Coolant Recovery Bottle G420F & G420FE 2.0 liter G424I & G424(E) 2.4 liter Gasoline & LP		8.5	2.25
Cooling System w/Coolant Recovery Bottle G424F & 424FE 2.4 liter G430FE 3.0 liter Gasoline & LP		9.0	2.38
Cooling System w/Coolant Recovery Bottle 4TNN98 & 4TNE98 Diesel		10.7	2.83
Fuel Tank - G, D Series Gasoline or Diesel		51	13.74
Fuel Tank - GC Series Gasoline		40	10.56
LP	G Series	15.2kg	33.5lb
	GC Series	15.2kg	33.5lb
Powershift Transmission	G, D Series	13.0	3.43
	GC Series	11.2	3.0
Drive Axle	G, D Series	9.2	2.43
	GC Series	10.0	2.64
Hydraulic & Power Steering System		34	8.98
Brake Reservoir (Only for OCDB)		0.6	0.3

Maintenance Intervals

NOTICE

Never exceed the Maintenance Intervals specified in the manual. Defects and/or damage to the important functional components may be resulted in.

NOTICE

All maintenance and repair, except Every 10 Service Hours or Daily, on the lift truck must be performed by qualified and authorized personnel only.

NOTICE

Careless disposal of waste oil can harm the environment and can be dangerous to persons. Always dispose of waste oil to authorized personnel only.

When Required

Fuel Tank Filter Cap and Screen (If Equipped) - Clean	185
Seat, Hood Latch & Support Cylinder - Check, Lubricate	185
Fuses, Bulbs, Circuit Breaker & Relay - Change, Reset	186
Priming the Fuel System(Diesel Engine Only) ...	187
Water Separator (Diesel Engine Only) - Check, Drain	189
Tires and Wheels (D, G-Series) - Inspect, Check	191
Carriage Roller Extrusion – Adjust	191

Every 10 Service Hours or Daily

Inspect Engine for Fluid Leaks	192
Engine Oil Level - Check	192
Coolant Level – Check	193
Air Cleaner Indicator-Check	194
Inspect Foot Pedal Operation (G420F(E) /G424F(E) /G424I(E) /G430FE Only)	194
Inspect Engine for Exhaust Leaks	194
Walk-Around Inspection - Inspect	194
Mast Channels – Lubricate	195
Transmission Oil Level – Check	196
Parking Brake - Inspect	196

First 50 - 100 Service Hours or a Week

Engine Oil & Filter (Diesel Engine Only) - Change	198
Transmission Oil, Oil Filter & Strainer - Check, Clean, Change	199
Drive Axle Oil - Change	201
Parking Brake - Test, Adjust	201

First 250 Service Hours or a Month

Hydraulic Return Filter – Change	203
--	-----

Every 250 Service Hours or Monthly

Air Intake System - Check, Clean	204
Brake Oil Level - Check	206
Hydraulic Oil Level – Check	206
Drive Axle Oil Level - Check	207
Mast, Carriage, Lift Chains & Attachments - Inspect, Lubricate	207
Steering Mechanism - Check, Lubricate	207
Battery Terminal - Clean, Inspect	208
Engine Oil & Filter (LP & Gasoline Engine Only) - Change	208
PCV Valve System - Inspect, Clean	209
Wheel Bolts & Nuts - Inspect	211
Inspect Tightness (GC - Series)	211
Governor Lever and Engine Speed Control (Diesel Engine Only) - Check ,Adjust	212

Every 500 Service Hours or 3 Months

Belts - Check, Adjust	214
Mast Hinge Pin – Lubricate	214
Tilt Cylinders - Check, Adjust, Lubricate	214
Crosshead Rollers - Inspect	215
Transmission Oil Filter – Change	216
Overhead Guard – Inspect	216
Drive Axle Oil & Strainer - Change, Clean	217
Steer Suspension – Inspect	218
Parking Brake - Test, Adjust	218
Inching & Braking Control Shaft - Lubricate	218
Horn and Lights (If Equipped) - Check	218
Inspect Vacuum Lines and Fittings (G420F(E) /G424F(E) /G424I(E) Engine Only)	219
Fuel Trim Valve(FTV) Inspection (G420F(E) /G424F(E) /G424I(E) Engine Only)	219
Inspect Electrical System (G420F(E) /G424F(E) /G424I(E) /G430FE Engine Only)	220
Fuel Filter (Diesel Engine Only) - Change	221

Engine Oil & Filter (Diesel Engine Only) - Change 222
 Water Separator (4TNV98 Diesel Engine Only) -
 Clean 223

Every 1000 Service Hours or 6 Months

Hydraulic Return Filter, Breather & Strainer - Check,
 Change 224
 Transmission Oil, Oil Filter & Strainer - Check,
 Clean, Change 225
 Lift Chains - Test, Check, Adjust 225
 Universal Joint – Inspect 227
 Air Intake System - Change 227
 Inspect Coolant Hoses (LP, Dual Fuel Engine Only)
 228
 LP Regulator/Converter Inspection (LP, Dual Fuel
 Engine Only) 228
 Fuel Lines & Fittings - Check 228
 Inspect Mixer Assembly (G420F(E) /G424F(E)
 /G424I(E) /G430FE Engine Only) 229
 Inspect Throttle Assembly (G420F(E) /G424F(E)
 /G424I(E) /G430FE Engine Only) 229
 Engine Valve Lash (Diesel Engine Only) - Check,
 Adjust 229

Every 1500 Service Hours or 9 Months

Inspect Ignition System (LP, Gasoline & Dual Fuel
 Engines Only) 230
 Replace Spark Plugs (G424F(E) LP, Dual Fuel
 Engine / G430FE Engine Only) 231
 Replace LP Fuel Filter Element (LP, Dual Fuel
 Engine Only) 232
 Fuel Filter (LP Engine Only) 232
 Testing Fuel Lock-off Operation (LP Engine Only)
 232
 Fuel Injectors (Diesel Engine Only) – Inspect,
 Clean, Test 233
 Crankcase Breather System (4TNV98 Diesel
 Engine Only) - Inspect 233

Every 2000 Service Hours or Yearly

Engine Valve Lash (Diesel Engine Only) – Check,
 Adjust 234
 Steer Wheel Bearings - Reassemble 234
 Drive Wheel Bearing (Power Shaft and Drive
 Wheel) – Reassemble 236
 Cooling System – Clean, Change 237
 Forks – Inspect 239

Every 2500 Service Hours or 15 Months

Hydraulic Oil - Check, Clean, Change 241
 Inspect Battery System 241
 Replace Oxygen Sensor (G420F(E) /G424F(E)
 /G424I(E) /G430FE Engine Only) 242
 Replace Spark Plugs (G420F(E)/G424I(E) Engine
 Only) 243
 Checking the TMAP Sensor (G420F(E) /G424F(E)
 /G424I(E) /G430FE Engine Only) 244
 Inspect for Intake Leaks (G420F(E) /G424F(E)
 /G424I(E) /G430FE Engine Only) 244

Every 3000 Service Hours or 18 Months

Timing Belt [G420F(E)/G424F(E) LP, Gasoline,
 Dual Fuel Engine Only] - Change 246

Quick Reference to Maintenance Schedule																				
ITEMS	SERVICES	PAGE	Frequency																	
			When Required	50-100 Service Hours or a Week	250 Service Hours or a Month	10 Service Hours or a Daily	250 Service Hours or a Monthly	500 Service Hours or 3 Months	1000 Service Hours or 6 Months	1500 Service Hours or 9 Months	2000 Service Hours or a Yearly	2500 Service Hours or 15 Months	3000 Service Hours or 18 Months							
Air Cleaner Indicator	Check	194				O														
Air Intake System	Change	227																		
Air Intake System	Check, Clean	204							O											
Battery Terminal	Clean, Inspect	208								O										
Belts	Check, Adjust	214									O									
Brake Oil Level	Check	206							O											
Carriage Roller Extrusion	Adjust	191	O																	
Checking the TMAP Sensor (G420F(E)/G424F(E)/G424I(E)/G430FE Engine Only)		244																		O
Coolant Level	Check	193							O											
Cooling System	Clean, Change	237																		O
Crankcase Breather System (4TNV98 Diesel Engine Only)	Inspect	233																		O
Crosshead Rollers	Inspect	215									O									
Drive Axle Oil	Change	201		O																
Drive Axle Oil & Strainer	Change, Clean	217									O									
Drive Axle Oil Level	Check	207								O										
Drive Wheel Bearing (Power Shaft and Drive Wheel)	Reassemble	236																		O
Engine Oil & Filter (Diesel Engine Only)	Change	198, 222		O							O									
Engine Oil & Filter (LP & Gasoline Engine Only)	Change	208								O										
Engine Oil Level	Check	192							O											
Engine Valve Lash (Diesel Engine Only)	Check, Adjust	229, 234										O								O
Forks	Inspect	239																		O
Fuel Filter (Diesel Engine Only)	Change	221									O									
Fuel Filter (LP Engine Only)		232																		O
Fuel Injectors (Diesel Engine Only)	Inspect, Clean, Test	233																		O
Fuel Lines & Fittings	Check	228																		O
Fuel Tank Filter Cap and Screen (If Equipped)	Clean	185	O																	
Fuel Trim Valve(FTV) Inspection (G420F(E)/G424F(E)/G424I(E) Engine Only)		219										O								
Fuses, Bulbs, Circuit Breaker & Relay	Change, Reset	186	O																	
Governor Lever and Engine Speed Control (Diesel Engine Only)	Check ,Adjust	212									O									
Horn and Lights (If Equipped)	Check	218										O								
Hydraulic Oil	Check, Clean, Change	241																		O
Hydraulic Oil Level	Check	206									O									
Hydraulic Return Filter	Change	203							O											
Hydraulic Return Filter, Breather & Strainer	Check, Change	224																		O
Inching & Braking Control Shaft	Lubricate	218										O								
Inspect Battery System		241																		O
Inspect Coolant Hoses (LP, Dual Fuel Engine Only)		228																		O
Inspect Electrical System (G420F(E)/G424F(E)/G424I(E)/G430FE Engine Only)		220																		O
Inspect Engine for Exhaust Leaks		194									O									
Inspect Engine for Fluid Leaks		192									O									
Inspect Foot Pedal Operation (G420F(E)/G424F(E)/G424I(E)/G430FE Only)		194									O									

When Required

You must read and understand the warnings and instructions contained in the Safety section of this manual, before performing any operation or maintenance procedures.

Fuel Tank Filter Cap and Screen (If Equipped) - Clean

Park the lift truck with the forks lowered, parking brake applied, transmission in neutral and the engine stopped.



1. Remove the filter cap assembly. Clean in clean, nonflammable solvent.
2. Dry cap assembly.
3. Install filter cap assembly.

WARNING

Fuel leaked or spilled onto hot surfaces or electrical components can cause a fire.

4. Drain moisture and sediment from fuel tank as required by prevailing conditions.

Seat, Hood Latch & Support Cylinder - Check, Lubricate



1. Check the operation of the seat adjuster rod. Make sure that the seat slides freely on its track. Lightly oil the seat slider tracks if necessary.

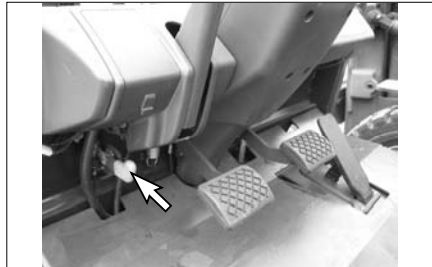

2. Push the lever down to raise the hood and seat assembly. Make certain the support cylinder will hold the hood open. (Note: Unlock latch before pulling it - if key equipped)



Typical Example

3. Lightly oil the hood latch mechanism and the rod for the hood support cylinder.

Fuses, Bulbs, Circuit Breaker & Relay - Change, Reset

Fuses

NOTE: If a fuse filament separates, use only the same type and size fuses for replacement. If the filament in a new fuse separates, have the circuits and instruments checked.

NOTICE

Always replace fuses with ones of the correct ampere rating.



Typical Example

Check the fuses. Use a flashlight, if necessary.

Fuses are identified as follows:

1. Horn - 10 amps.
2. Head/Rear Lamp - 15 amps.
3. Fwd./Rev. Solenoid, lamp Relay & Back-up Lamp/alarm - 10 amps.
4. Instrument Panel & Fuel Shutoff - 15 amps.
5. Turn Signal Lamp, Stop/Strobe Lamp & C.S.D.
6. Start Relay - 5 amp.

10A	HORN					
15A	OPTION (BAT +)					
15A	HEAD LAMP CLEARANCE LAMP + PARKING ALARM					
15A	ACC					
15	TURN SIG LAMP STOP LAMP, STROBE					
10A	START RELAY					
15A	INST. PANEL CONT. GP - FUEL LOCK					
15A	FIR CONTROL LAMP RELAY					
15A	OPTION (IGNITION)					

Check the fuses. Use a flashlight, if necessary.



Remove the front cover from the fuse box located under the cowl.

Fuse - Protects an electrical circuit from an overload. Opens (filament separates) if an overload occurs.

Bulbs

Bulbs are identified as follows:

1. Bulb-head lamp halogen (12V-35W)
- *2. Bulb-back up (12V-10W)
- *3. Bulb-turn signal (12V-23W)
- *4. Bulb-stop & tail (12V-23/8W)

*Optional lamp or light

Circuit Breaker

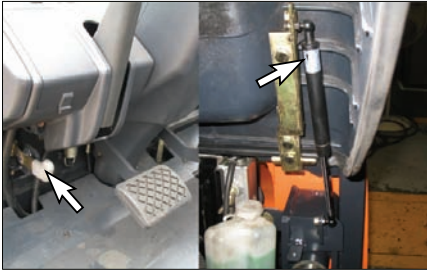

1. Raise the hood and seat assembly. Make sure the support cylinder securely holds the hood open.

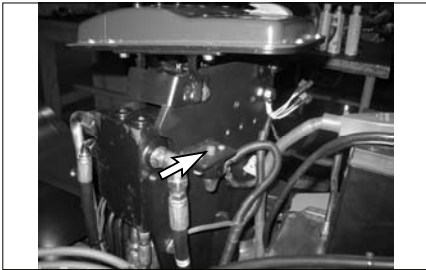

2. The main circuit breaker is located on the rear of the support for the hydraulic controls.

NOTE: To reset circuit breakers push in on the button. The button should stay in if the breaker is reset. If the button will not stay in, or comes out shortly after reset, have the circuits checked.

Priming the Fuel System(Diesel Engine Only)

4TNV98 Diesel Engine Only

The fuel system needs to be primed under certain conditions.

- Before starting the engine for the first time
- After running out of fuel and fuel has been added to the fuel tank
- After fuel system maintenance such as changing the fuel filter and draining the water separator, or replacing a fuel system component.

To prime the fuel system

1. Turn the key to the **ON** position for 10 to 15 seconds. This will allow the electric fuel pump to prime the fuel system.
2. **NEVER** use the starter motor to crank the engine in order to prime the fuel system. This may cause the starter motor to overheat and damage the coils, pinion and ring gear

4TNE98 Diesel Engine Only

The fuel system needs to be primed under certain conditions.

- Before starting the engine for the first time.
- After running out of fuel and fuel has been added to the fuel tank.
- After fuel system maintenance such as changing the fuel filter and draining the fuel filter / water separator, or replacing a fuel system component.

To prime the fuel system on engines equipped with an electric fuel pump:

1. Place an approved container under the air bleed port.
2. Loosen the air bleed port 2 or 3 turns.
3. Turn the key to the ON position for 10 to 15 seconds or until the fuel coming out of the air bleed port is free of bubbles.
4. Tighten the air bleed port.

Maintenance Section

5. Wipe up any spills and properly dispose of fuel.
6. NEVER use the starter motor to crank the engine in order to prime the fuel system. This may cause the starter motor to overheat and damage the coils, pinion and / or ring gear.

To prime the fuel system on engines not equipped with an electric fuel system:

1. Place an approved container under the air bleed port.
2. Loosen the air bleed port (**Figure 2, (1)**) 2 or 3 turns.
3. Operate the fuel priming pump (**Figure 2, (2)**) until the fuel coming out of the air bleed port is free of bubbles.
4. Tighten the air bleed port.
5. Wipe up any spills and properly dispose of fuel.
6. NEVER use the starter motor to crank the engine in order to prime the fuel system. This may cause the starter motor to overheat and damage the coils, pinion and / or ring gear.

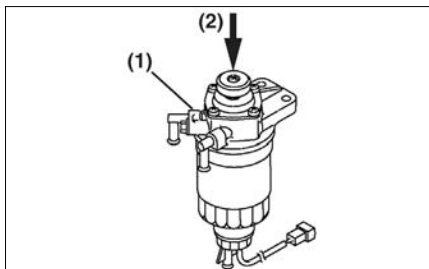

Figure 2

Water Separator (Diesel Engine Only) - Check, Drain

4TNV98 Diesel Engine Only

Drain the fuel filter / water separator whenever there are contaminants, such as water, collected in the bottom of the cup. NEVER wait until the scheduled periodic maintenance if contaminants are discovered.

The cup of the separator is made from semi-transparent material. In the cup is a red colored float ring. The float ring will rise to the surface of the water to show how much needs to be drained. Also, some optional fuel filter / water separators are equipped with a sensor to detect the amount of contaminants. This sensor sends a signal to an indicator to alert the operator.

Drain the fuel filter / water separator as follows:

1. Position an approved container under the fuel filter / water separator (**Figure 5-7, (1)**) to collect the contaminants.

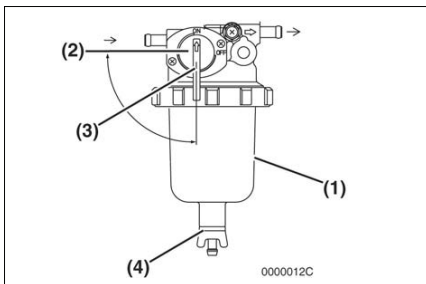

Figure 5-7

2. Close (**Figure 5-7, (2)**) the fuel cock (**Figure 5-7, (3)**).
3. Loosen the drain cock (**Figure 5-7, (4)**) at the bottom of the fuel filter / water separator. Drain any water collected inside.
4. Hand-tighten the drain cock.

⚠ WARNING

If the fuel filter/water separator is positioned higher than the fuel level in the fuel tank, water may not drip out when the fuel filter/water separator drain cock is opened. If this happens, turn the air vent screw on the top of the fuel filter/water separator 2-3 turns counterclockwise.

Be sure to tighten the air vent screw after the water has drained out.

5. Open the fuel cock (**Figure 5-7, (3)**).
6. Be sure to prime the diesel fuel system when you are finished. See topic "Priming the Fuel System – When required"
7. Check for leaks.

4TNE98 Diesel Engine Only

NEVER wait until the scheduled periodic maintenance if the fuel filter indicator comes on.

The fuel filter / water separator contains a sensor to detect the amount of water and contaminants. This sensor sends a signal to an indicator to alert the operator.

Drain the fuel filter / water separator as follows:

1. Position an approved container under the fuel filter / water separator (**Figure 5-1, (1)**) to collect the contaminants.
2. Loosen the drain cock (**Figure 5-1, (2)**) at the bottom of the fuel filter / water separator. Drain any water collected inside.
3. Hand tighten the drain cock.
4. Be sure to prime the diesel fuel system when you are done. See Priming the Fuel System.

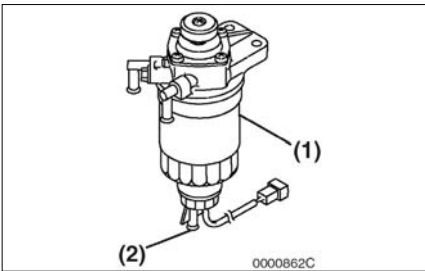
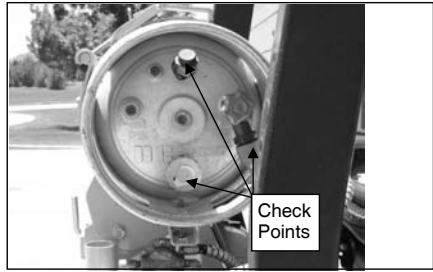

Figure 5-1

Test Fuel System for Leaks(LP and Dual Fuel Engines Only)



1. Obtain a leak check squirt bottle or pump spray bottle.
2. Fill the bottle with an approved leak check solution.
3. Spray a generous amount of the solution on the fuel system fuel lines and connections, starting at the storage container.
4. Wait approximately 15-60 seconds then perform a visual inspection of the fuel system. Leaks will cause the solution to bubble.
5. Repair any leaks before continuing.
6. Crank the engine through several revolutions. This will energize the fuel lock-off and allow fuel to flow to the pressure regulator/convertor. Apply additional leak check solution to the regulator/convertor fuel connections and housing. Repeat leak inspection as listed above.
7. Repair any fuel leaks before continuing.

WARNING

Prior to any service or maintenance activity, Test Fuel System for Leaks.

Tires and Wheels (D, G-Series) - Inspect, Check

WARNING

Service and changing tires and rims can be dangerous and should be done only by trained personnel using proper tools and procedures. If correct procedures are not followed while servicing tires and rims, the assemblies could burst with explosive force and cause serious physical injury or death. Follow carefully the specific information provided by your tire servicing man or dealer.

Check Inflation and Damage

Inspect tires for wear, cuts, gouges and foreign objects. Look for bent rims and correct seating of locking ring.

Check tires for proper inflation. See "Tire Inflation Pressures".

To inflate tires always use a clip-on chuck with a minimum 60 cm (24 inches) length of hose to an in-line valve and gauge.

Always stand behind the tread of the tire. NOT in front of the rim.



Do not re-inflate a tire that has been run while flat or underinflated, without first checking to make sure the locking ring on the rim is not damaged and is in the correct position.

When tires are changed, be sure to clean all rim parts and, if necessary, repaint to stop detrimental effects of corrosion. Sand blasting is recommended for removal of rust.

Check all components carefully and replace any cracked, badly worn, damaged and severely rusted or corroded parts with new parts of the same size and type. If there is any doubt, replace with new parts.

Do not, under any circumstances, attempt to rework, weld, heat or braze any rim components.

Carriage Roller Extrusion – Adjust

1. Set the mast vertical.
2. Lower the carriage completely.
3. On full free lift and full free triple lift models, the bottom of the inner mast must be flush with the bottom of the stationary mast.

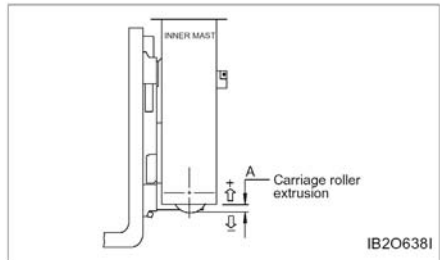

4. Measure the distance from the bottom of the inner upright to the bottom of carriage bearing.
5. The measurement (A) must be as follows in Chart below.

Height of carriage roller extrusion (A)		
STD mast	FF mast	FFT mast
0	41	41

Every 10 Service Hours or Daily

You must read and understand the warnings and instructions contained in the Safety section of this manual, before performing any operation or maintenance procedures.

Inspect Engine for Fluid Leaks

1. Start the engine and allow it to reach operating temperatures.
2. Turn the engine off.
3. Inspect the entire for oil and/or coolant leaks.
4. Repair as necessary before continuing.

Engine Oil Level - Check

1. Raise the hood and seat assembly.

 **WARNING**

Hot oil and components can cause personal injury. Do not allow hot oil or components to contact skin.

Gasoline and LP Engines

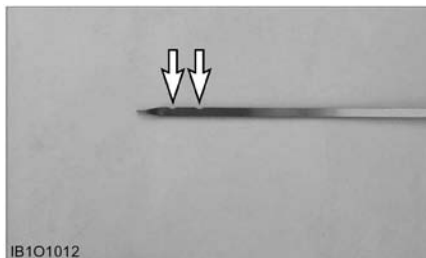

1. Maintain oil level between the MAX. and MIN. marks on the dipstick.

Diesel Engines



1. Maintain oil level between the MAX. and MIN. marks on the dipstick.

Coolant Level – Check

WARNING

At operating temperature, the engine coolant is hot and under pressure.

Steam can cause personal injury.

Check the coolant level only after the engine has been stopped and the filter cap is cool enough to touch with your bare hand.

Remove the filter cap slowly to relieve pressure.

Cooling system conditioner contains alkali. Avoid contact with the skin and eyes to prevent personal



4TNV98 Diesel Engine

1. Observe the coolant level with engine cold. Maintain coolant level to the proper line on expansion bottle. If the expansion bottle has no coolant, it will be necessary to check coolant at the radiator filter neck.
2. Remove the radiator cap. Fill radiator to the top of the filter neck. Inspect radiator cap. Replace if damaged. Install the radiator cap.



3. Start and run the engine to stabilize the coolant level in the filter neck. If low, add coolant until it reaches the top of the filter neck. Install the radiator cap. Observe coolant level in the expansion bottle. If necessary, add coolant to bring the coolant to the appropriate line on the expansion bottle.
4. Stop the engine.
5. Inspect the cooling system for leaks, hose cracks or loose connections.

WARNING

Pressure air can cause personal injury.

When using pressure air for cleaning, wear a protective face shield, protective clothing and protective shoes.

Maximum air pressure must be less than 205 kPa (30 psi) for cleaning purposes.

6. Blow any dust and lint from the radiator fins.

Air Cleaner Indicator-Check

Checking Service Indicator



1. Observe the air cleaner service indicator.
2. Service the air cleaner when the RED band in the service indicator, locks in the visible position. See topic, "Air Intake System - Check, Clean" in "Every 250 Service Hours or Monthly".

NOTE: Service the element more frequently, as required, in severe dust or lint conditions. Also, service it more frequently where the operator is required to wear a respirator.

3. Close hood and seat assembly.

Inspect Foot Pedal Operation (G420F(E)/G424F(E)/G424I(E) /G430FE Only)

1. Verify foot pedal travel is smooth without sticking.

 **WARNING**

When the acceleration pedal harness is connected or disconnected, should be worked key OFF condition.

If not, occurred malfunction, can cause the personal injury.

Inspect Engine for Exhaust Leaks

1. Start the engine and allow it to reach operating temperatures.
2. Perform visual inspection of exhaust system. Repair any/all leaks found.

Walk-Around Inspection - Inspect

For maximum service life of the lift truck, make a thorough walk-around inspection. Look around and under the truck for such items as loose or missing bolts, debris or dirt buildup, fuel, oil or coolant leaks and cut or gouged tires.

Have any repairs made and debris removed, as needed.



1. Inspect the tires and wheels for cuts, gouges, foreign objects, inflation pressure and loose or missing bolts.
2. Inspect the mast and lift chains for wear, broken links, pins and loose rollers.
3. Inspect the hydraulic system for leaks, worn hoses or damaged lines.
4. Look for transmission and drive axle leaks on the lift truck and on the ground.



5. Inspect the operator's compartment for loose items and cleanliness.
6. Inspect the instrument panel for broken gauges and indicator lights.
7. Test the horn and other safety devices for proper operation.



8. Inspect the cooling system for leaks, worn hoses and debris buildup.
9. Inspect engine compartment for oil, coolant and fuel leaks.
10. Inspect the forks.
 - Visually inspect forks for cracks, especially in the heel section, around the mounting brackets, and all weld areas.
 - Inspect for broken or jagged fork tips, bent or twisted blades and shanks.
 - Make sure positioning lock is in place and working.
Lock the forks in position before using the truck. See Step 7 of "Forks" in "Every 2000 Service Hours or Yearly".
 - Remove all defective forks from service.

Mast Channels – Lubricate

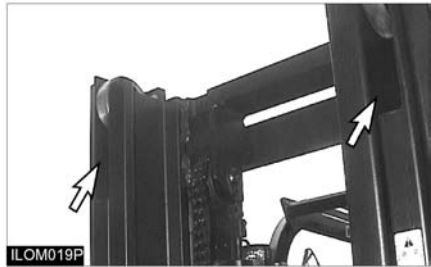

The channels on the roller-type mast require a break-in period. Apply a light film of lubricant on the channels where the rollers ride. This will prevent metal peel until the rollers set a pattern.

Transmission Oil Level – Check

⚠ WARNING

Hot oil and components can cause personal injury. Do not allow hot oil or components to contact skin.

1. Start and operate the lift truck until the engine reaches normal operating temperature.
2. Park the lift truck level with the forks lowered, parking brake applied and the transmission controls in NEUTRAL.
3. With the service brake applied and the engine at low idle, shift the directional control lever to forward and then to reverse, to fill the clutches.
4. Shift the direction control lever to the NEUTRAL position.
5. Remove the dip stick/filter cap. Observe the oil level.
6. Maintain the oil level between the Min and Max marks on the dip stick/filter cap.
When the oil temperature is 40°C approximately, the cold side mark on the dipstick is applicable.
When the oil temperature is 80°C approximately, the hot side mark on the dipstick is applicable.

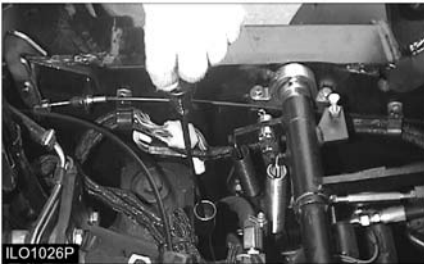

Parking Brake - Inspect

Inspection from Operator's Seat, Engine OFF

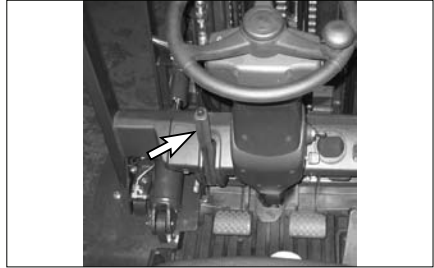

1. Grasp the parking brake lever with your hand and press down the release button with your thumb. The lever should move freely forward and backward.
2. Remove your thumb from the release button. The lever should resist movement when pulled fully back and a clicking sound should be heard. The lever should remain fully back until you press the release button with your thumb.
3. Report a missing, damaged or loose parking brake lever, any inability or difficulty engaging and releasing the parking brake lever, or any restricted movement of the parking brake lever.

Inspection from Operator's Seat, Engine ON

PARKING BRAKE SWITCH

1. With the parking brake engaged, the direction control lever in NEUTRAL and the engine running, shift the direction control lever to FORWARD.
2. The lift truck should not move forward or feel like it wants to move forward, even when the engine is accelerated briefly.
3. Repeat this procedure in REVERSE. Report truck movement or tendency to move under power with the parking brake engaged.

Parking Brake

NOTE: The parking brake is required to be adjusted to hold the lift truck with capacity load on a 15% grade.

If there is a 15% grade in your workplace, engage a capacity load and drive over to the grade. If the maximum grade in your workplace is less than 15% or if the maximum load carried by the lift truck is less than the lift truck's load capacity, pick up the maximum load and drive to the steepest grade in your workplace.

1. Raise the forks or load engaging attachment about 30 cm (12 in) from the floor.
2. Drive forward up the grade, or in reverse down the grade, and stop the lift truck with the service brakes.
3. Engage the parking brake and release the service brakes.
4. If the lift truck moves down the grade, control its speed with the service brakes, release the parking brake and return directly to the inspection area.
5. Park the lift truck, engage the parking brake, shift the direction control lever to NEUTRAL, lower the forks or load engaging attachment to the floor, shut OFF the engine, remove the key, chock the tires, terminate the inspection, tag the lift truck "Do Not Operate" and immediately report the failure of the parking brake to hold the lift truck.

First 50 - 100 Service Hours or a Week

You must read and understand the warnings and instructions contained in the Safety section of this manual, before performing any operation or maintenance procedures.

Engine Oil & Filter (Diesel Engine Only) - Change

The engine oil in a new engine becomes contaminated from the initial break-in of internal parts. It is very important that the initial oil and filter change is performed as scheduled

NOTE: The oil drain plug may be in another location if an optional oil pan is used..

Drain the engine oil as follows:

1. Make sure the engine is level.
2. Start the engine and bring it up to operating temperature.
3. Stop the engine.
4. Remove one of the oil filler caps (**Figure 5-1, (1)**) to vent the engine crankcase and allow the engine oil to drain more easily.
5. Position a container under the engine to collect waste oil.

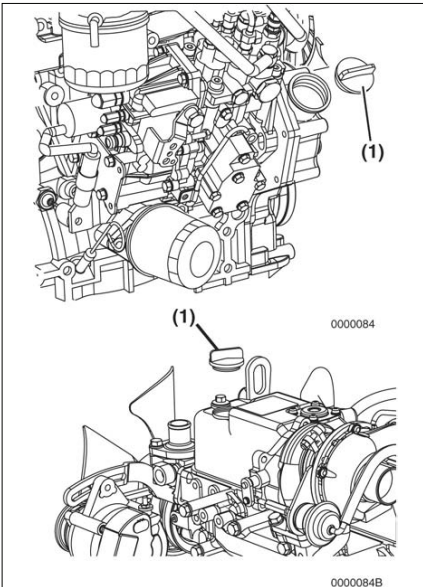

Figure 5-1

6. Remove the oil drain plug (**Figure 5-2, (1)**) from the engine oil pan. Allow oil to drain.
7. After all oil has been drained from the engine, reinstall the oil drain plug (**Figure 5-2, (1)**) and tighten to 139.8 - 47.0 ft•lb (53.9 - 63.7 N•m; 5.5 - 6.5 kgf•m).
8. Dispose of used oil properly

Remove the engine oil filter as follows:

1. Turn the engine oil filter (**Figure 5-2, (2)**) counterclockwise (**Figure 5-2, (3)**) using a filter wrench.

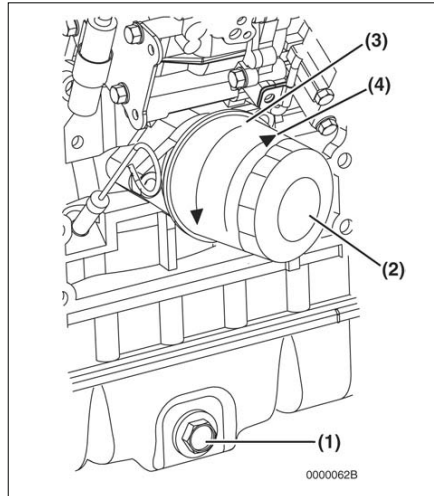

Figure 5-2

2. Clean the engine oil filter mounting face.
3. Lightly coat the gasket on the new oil filter with engine oil. Install the new engine oil filter manually by turning it clockwise (**Figure 5-2, (4)**) until it contacts the mounting surface. Tighten to 14 - 17 ft•lb (19.6 - 23.5 N•m; 2.0 - 2.4 kgf•m) or one additional turn using the filter wrench.
4. Add new engine oil to the engine as specified in Adding Engine Oil on page 4-14.

⚠ WARNING

NEVER overfill the engine with engine oil.

ALWAYS keep the oil level between the upper and lower lines on the oil cap/dipstick.

- Warm up the engine by running it for five minutes and check for any engine oil leaks.
- After engine is warm, shut it off and let it sit for 10 minutes.
- Recheck the engine oil level.
- Add engine oil (**Figure 5-3, (5)**) as needed until the level is between the upper (**Figure 5-3, (2)**) and lower lines (**Figure 5-3, (3)**) shown on the dipstick (**Figure 5-3, (1)**).

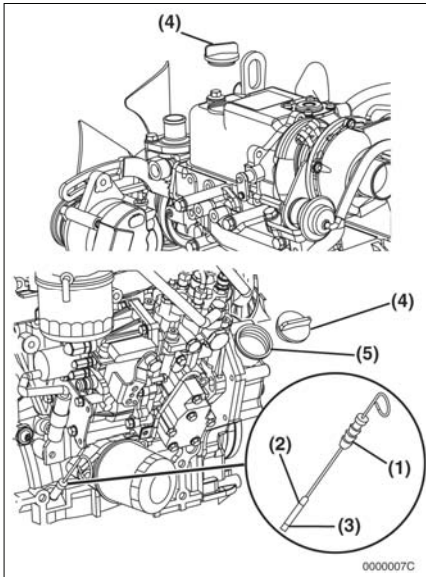

Figure 5-3

- Reinstall the oil filler cap (**Figure 5-3, (4)**). If any engine oil is spilled, wipe it away with a clean cloth.

NOTICE

Servicing of the engine oil and oil filter element will largely affect the engine performance as well as the engine life.

Engine oil and filter element must be changed after the first 50 hours.

Transmission Oil, Oil Filter & Strainer - Check, Clean, Change**⚠ WARNING**

Hot oil and components can cause personal injury. Do not allow hot oil or components to contact skin.

Park the lift truck level, with the forks lowered, parking brake engaged, direction control lever in NEUTRAL and the engine stopped.

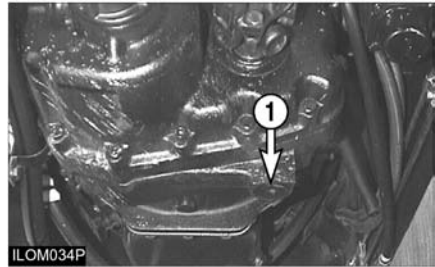

- Remove drain plug (1). Allow the oil to drain into a suitable container. Clean the magnetic drain plug. Check O-ring seal and replace if necessary. Remove the spring and the strainer.

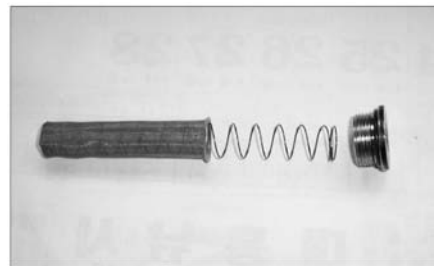

- Wash the strainer assembly in clean, nonflammable solvent and dry it. Install the strainer assembly.

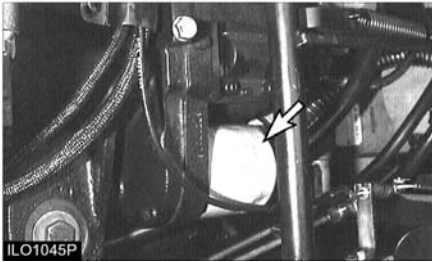

3. Remove the floor mat and the floor plate. Remove and discard the oil filter.
4. Wipe off the filter base. Make certain that all of the old seal is removed.
5. Apply a small amount of clean oil on the seal of the new filter.
6. Install the filter by hand. When the filter contacts the base, tighten an additional 3/4 turn.



7. Remove the dip stick/filter cap. Fill the compartment with oil. See "Refill Capacities". Install the dip stick/filter cap.
8. Start the engine.
9. With the service brake applied and engine at low idle, shift the direction control lever to forward and reverse to fill the clutches.
10. Shift the direction control lever into NEUTRAL. Engage the parking brake.
11. Remove the dip stick/filter cap. Observe the oil level.

12. Maintain the oil level between the Min and Max marks on the dip stick/filter cap. When the oil temperature is 40°C approximately, the cold side mark on the dipstick is applicable. When the oil temperature is 80°C approximately, the hot side mark on the dipstick is applicable.
13. Check for oil leaks at the filters and drain plug.
14. Stop the engine. Install the floor mat and floor plate.

Drive Axle Oil - Change

Park the lift truck on a level surface. Apply the parking brake. Place the directional control lever in NEUTRAL and stop the engine.

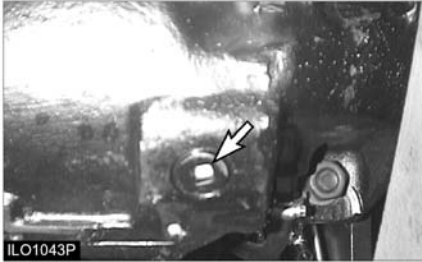

1. Remove drain plug. Allow the oil to drain into a suitable container. Clean the magnetic drain plug. Check O - ring seal and replace if necessary.
2. Install the drain plug.
3. Remove the dip stick/filter cap. Fill the drive axle housing with oil. See "Refill Capacities".
4. Start the lift truck. With the engine at low idle, place the directional control lever to the NEUTRAL.
5. Maintain the oil level between lower mark and upper mark on the dip stick/filter cap.



6. Install the dip stick/filter cap.

NOTE: Tighten the dipstick plug fully not to allow foreign parts(rain, water etc) to enter into drive axle.

Parking Brake - Test, Adjust

Parking Brake Testing

NOTICE

OSHA requires the parking brake to hold the lift truck, with capacity load, on a 15% grade. Testing requires a test load equal to the capacity of the truck and a 15% grade. If the maximum grade in the workplace is less than its capacity, use the Parking Brake inspection procedure covered in 'Inspection from Operator's Seat, Engine On' in "Every 10 Service Hours or Daily" section.

1. Pick up capacity load and drive over to a 15% grade.
2. Drive forward up the 15% grade. Halfway up the grade, stop the lift truck with its service brakes.
3. Engage the parking brake and slowly release the service brake.

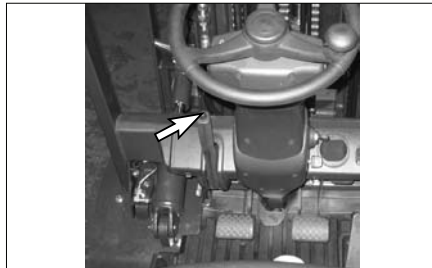

4. Engage the parking brake and shift the transmission to NEUTRAL. Slowly release the service brakes.
5. The parking brake adjustment is proper if it holds the lift truck on the grade. The parking brake needs adjusting if it does not hold the lift truck on the grade.
6. If the lift truck starts to move in reverse down the grade with the parking brake engaged, stop it with the service brakes, disengage the parking brake and reverse slowly down the grade controlling your speed with the service brakes.

⚠ WARNING

To prevent personal injury, the operator **MUST** be ready to use the service brake if the parking brake is not adjusted correctly and the lift truck starts to move.

Parking Brake Adjusting

1. Park the lift truck on a level surface, lowered the forks, shift the transmission to NEUTRAL and shut OFF the engine and block the wheels securely.
2. Chock the lift truck's tires to prevent unintentional movement.



7. Loosen lock nut (5). Tighten screw (6) to 6 to 7 N•m (50 to 60 lb•in). Loosen the screw (6) 1 1/6 turns and tighten the lock nut (5).

NOTICE

Turn the adjustment screw (6) clockwise to tighten. Turning the screw (6) too far counterclockwise could allow parts to fall into the bottom of the transmission. The transmission would then require disassembly to remove the parts.

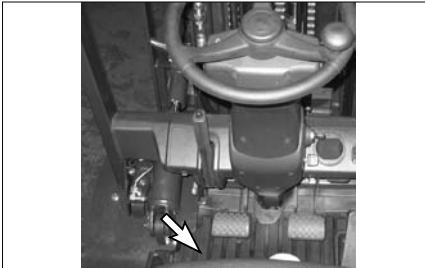

3. Remove the floor mat and floor plate.
4. Make sure the parking brake lever is released.

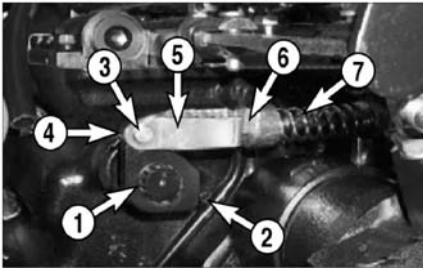

5. Make sure the brake lever (1) is held against stop pin (2). If the brake lever (1) is held against the stop pin (2), go to step 7. If the brake lever (1) is NOT held against the stop pin (2), go to step 6.
6. Remove the pin (3) and the cotter pin (4). Tighten the nut (6) to compress the spring (7) further and pull downward and turn the clevis (5) until the pin (3) fits into the brake lever when the lever (1) is held against the stop pin (2). Then install the pin (3) and the cotter pin (4) and return the nut (6) to the clevis (5).

8. Reinstall the floor plate and floor mat.
9. Engage the parking brake, remove the tire chocks and test the parking brake. Refer to 'Parking Brake Testing' in the preceding section.

First 250 Service Hours or a Month

You must read and understand the warnings and instructions contained in the Safety section of this manual, before performing any operation or maintenance procedures.

Hydraulic Return Filter – Change

⚠ WARNING

Hot oil and components can cause personal injury. Do not allow hot oil or components to contact skin.

Park the lift truck level with the forks lowered, parking brake engaged, transmission in NEUTRAL and the engine stopped.

1. Loosen the bolts of the hydraulic tank top plate assembly.



2. Remove the return filter from tank top plate assembly.
3. Change the return filter.
4. Install the tank top plate assembly and fasten the bolts.
5. Start the engine and operate the hydraulic controls, and the steering system, through a few cycles to fill the lines. Look for oil leaks.
6. Stop the engine and check the oil level. With all cylinders retracted, maintain the oil level to the FULL mark on the dip stick/filter cap assembly.

Every 250 Service Hours or Monthly

You must read and understand the warnings and instructions contained in the Safety section of this manual, before performing any operation or maintenance procedures.

Air Intake System - Check, Clean Precleaner (If Equipped)

NOTICE

Never service precleaner with the engine running.

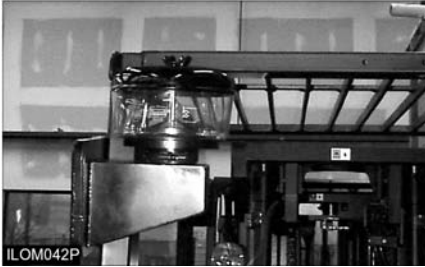

1. Check the precleaner bowl for dirt build-up. If the dirt is up to the line, remove the precleaner bowl and empty it. Periodically wash the cover and bowl in water.

Servicing Filter Element

NOTICE

Never service filter with the engine running.



Service the air cleaner when the red target in the service indicator stays locked in the visible position with the engine stopped.

1. To service the air cleaner, raise the hood and seat assembly. Make certain the support cylinder securely holds the hood open. Loosen the cover latches and remove the cover.

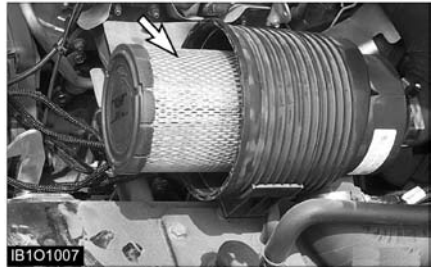

2. Rotate the element slightly to separate it from its base and remove it from the air cleaner housing.
3. Clean and inspect the element or replace with a new element. See topic, "Cleaning Primary Filter Element".
4. Clean the inside of air cleaner housing and the cover. Inspect all connections between the air cleaner and carburetor. Check intake hose for cracks, damage necessary to prevent leakage.

NOTICE

Do not allow dirty air to enter the intake hose when cleaning the inside of the air cleaner housing.

5. Check the air cleaner housing for loose latches.
6. Reset the air cleaner service indicator.
7. Install the air filter element.
8. Install the cover and tighten the cover latches.
9. Start the engine and observe the position of the indicator. If the indicator shows RED after the installation of the primary element, install another clean or a new element or, replace the secondary element. See topic, "Air Intake System-Change" in "Every 1000 Service Hours or 6 months section
10. Stop the engine and close the hood and seat assembly.

Cleaning Primary Filter Elements

WARNING

Pressure air can cause personal injury.

When using pressure air for cleaning, wear a protective face shield, protective clothing and protective shoes.

The maximum air pressure must be below 205 kPa (30 psi) for cleaning purposes.

NOTICE

Do not clean the elements by bumping or tapping them.

Inspect filter elements after cleaning. Do not use a filter with damaged pleats, gaskets or seals.

When cleaning with pressure air, use 205 kPa (30 psi) maximum pressure to prevent filter element damage.

When cleaning with pressure water, use 280 kPa (40 psi) maximum pressure to prevent filter element damage.

Have spare elements on hand to use while cleaning used elements.

The primary element should be replaced after 6 months service or after cleaning no more than 3 times.

Air-205 kPa (30 psi) Maximum Pressure



Direct air on the inside and outside of the element along the length of the pleats. Check the element for any tears, rips or damage

Water-280kPa (40 psi) Maximum Pressure



Direct water on the inside and outside of the element along the length of the pleats. Air dry it thoroughly and then examine it.

Detergent

1. Wash the element in warm water and mild household detergent.
2. Rinse the element with clean water. See instructions in preceding topic for cleaning with water.
3. Air dry it thoroughly, and then examine it.

Checking Element



1. Insert a light inside the clean dry element and examine it. Discard the element if tears, rips or damage are found.
2. Wrap and store good elements in a clean, dry place.

Brake Oil Level - Check

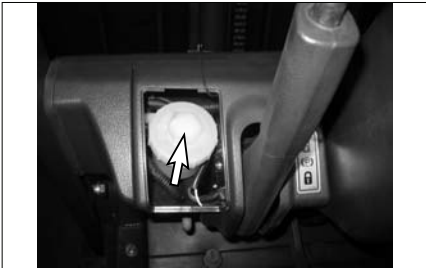

The brake reservoir is located on the left side of the steering column.

1. Remove the filler cap.
2. Maintain the brake fluid level to the fluid level mark on the brake system reservoir.
3. Clean and install the filler cap

Hydraulic Oil Level – Check

⚠ WARNING

At operating temperature, the hydraulic tank is hot and under pressure.

Hot oil can cause burns.

Remove the filter cap only when the engine is stopped, and the cap is cool enough to touch with your bare hand. Remove the filter cap slowly to relieve pressure.

1. Operate the lift truck for a few minutes to warm the oil. Park the lift truck on a level surface, with the forks lowered, mast tilted back, parking brake engaged, transmission in NEUTRAL and the engine stopped.
2. Raise the hood and seat assembly. Make sure the air lift cylinder securely holds the hood open.



3. Remove the dip stick/filter cap. Maintain the oil level to the FULL mark on the dip stick/filter cap.

Drive Axle Oil Level - Check

Park the lift truck on a level surface. Apply the parking brake. The engine at low idle. Place the directional control lever in NEUTRAL.

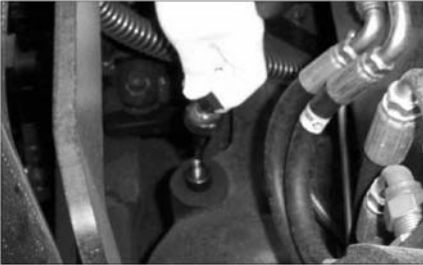

1. Remove the dip stick/filter cap. Observe the oil level.
2. Maintain the oil level between the lower mark and upper marks on the dip stick/filter cap.

Mast, Carriage, Lift Chains & Attachments - Inspect, Lubricate

1. Operate the lift, tilt and attachment controls. Listen for unusual noises. These may indicate a need for repair.
2. Inspect for loose bolts and nuts on the carriage. Remove any debris from the carriage and mast.
3. Inspect the forks and attachments for free operation and damage. Have repairs made if necessary.



4. Brush a film of oil on all links of the chain.

5. Raise and lower the carriage a few times to allow lubricant to enter into the chain links.

NOTICE

Lubricate chains more frequently than normal in applications where the lift truck is operating in an atmosphere which could cause corrosion of components or when lift truck must work in rapid lift cycles.

6. Inspect the chain anchors and individual links for wear, loose pins or cracked leaves.

Steering Mechanism - Check, Lubricate

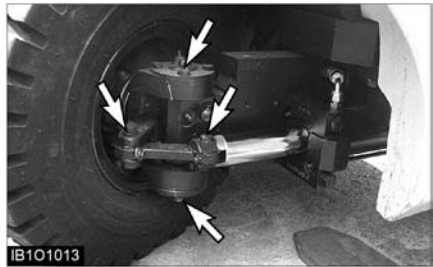

1. Lubricate the steer axle king pins, total of four fittings. Two on the right side and two on the left side.
2. Lubricate the steering link bearings, total of four fittings. Two on the right side and two on the left side.
3. Check for any worn or loose components of the steering mechanism. Remove any debris or trash as

Battery Terminal - Clean, Inspect

⚠ WARNING

Batteries give off flammable fumes that can explode.

Do not smoke when observing the battery electrolyte levels.

Electrolyte is an acid and can cause personal injury if it contacts skin or eyes.

Always wear protective glasses when working with batteries.



1. Clean the top of the battery and terminals.
2. Check terminals for corrosion. Coat terminals with heavy grease.

Engine Oil & Filter (LP & Gasoline Engine Only) - Change

Gasoline, LP Engine Crankcase

1. Operate lift truck a few minutes to warm oil. Park the lift truck with the forks lowered, parking brake applied, transmission in neutral and the engine stopped.
2. Raise rear of lift truck off ground and block securely.

⚠ WARNING

Hot oil and components can cause personal injury. Do not allow hot oil or components to contact skin.

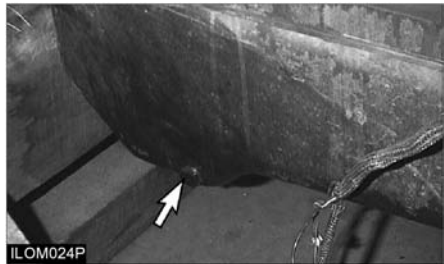

3. Remove the crankcase drain plug and allow oil to drain into a suitable container. Clean and install drain plug.
4. Raise the hood and seat assembly.

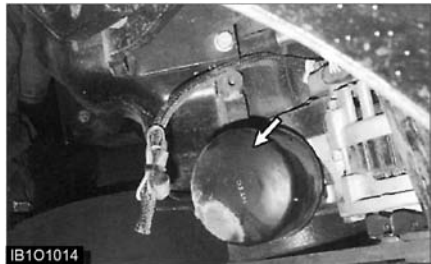

5. Remove and discard oil filter element.
6. Wipe sealing surface of oil filter element mounting base. Make sure the entire old gasket is removed.

7. Before installing a new filter element, apply a small amount of clean engine oil to the filter element gasket.
8. Install the new filter element. When the gasket contacts the base, tighten it 3/4 of a turn more. Do not over-tighten.
9. Raise the lift truck, remove the blocking and lower the lift truck.
10. Fill the crankcase. See "Refill Capacities".
11. Start the engine and allow the oil to fill the filter and passages.
12. Check for oil leaks.



13. Stop the engine and measure the oil level. Maintain the oil level to the FULL mark on the dip stick.
14. Close hood and seat assembly

PCV Valve System - Inspect, Clean

G420F(E) Gasoline, LP and Dual Fuel Engines

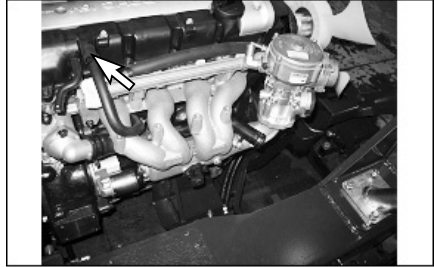

G424F(E) LP and Dual Fuel Engines

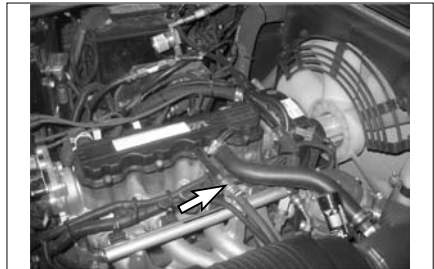

G424I(E) LP and Dual Fuel Engines



G430FE LP Engine



1. Loosen the hose clamps and remove the PCV valve.
2. Shake the PCV valve. If it rattles, reinstall it. If it does not rattle, replace it.
3. Tighten the hose clamps

Wheel Bolts & Nuts - Inspect Inspect Tightness (D, G - Series)

Steer Wheels

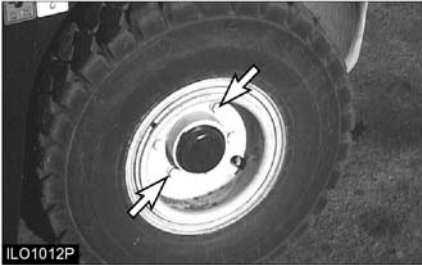

Typical Example

1. Inspect tightness of wheel bolts in a sequence opposite each other 110 N•m (75 lb•ft).

Drive Wheels

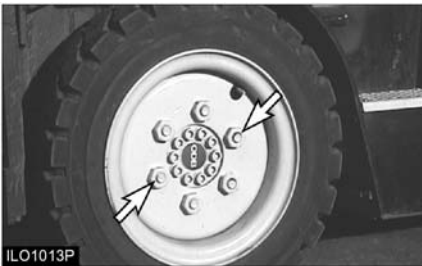

Typical Example

2. Inspect tightness of wheel nuts in a sequence opposite each other to 610 N•m (450 lb•ft).

Inspect Tightness (GC - Series)

Drive Wheels

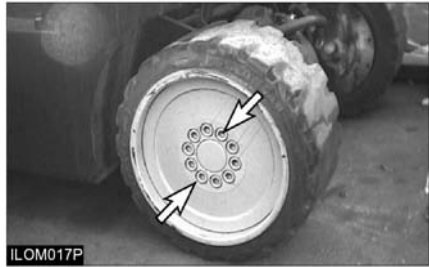

Typical Example

1. Inspect tightness of wheel bolts in a sequence opposite each other to 245 N•m (180 lb•ft).

Governor Lever and Engine Speed Control (Diesel Engine Only) - Check ,Adjust

4TNV98 Diesel Engine Only

The governor lever and engine speed control (throttle lever, pedal, etc.) of the machine are connected together by a throttle cable or rod. If the cable becomes stretched, or the connections loosen, the governor lever may not respond to change of engine speed control position. This may make operation of the machine unsafe. Check the cable periodically and adjust if necessary.

NEVER force the throttle cable or pedal to move. This may deform the governor lever or stretch the cable and cause irregular operation of the engine speed control

Checking and adjusting the governor lever:

1. Check that the governor lever (**Figure 5-11, (1)**) makes uniform contact with the high idle (**Figure 5-11, (2)**) and low idle (**Figure 5-11, (3)**) speed limit screws when the engine speed control is in the high idle speed or low idle speed position.

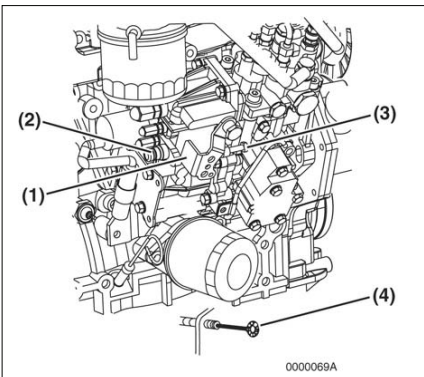

Figure 5-11

2. If the governor lever does not make contact with the high idle or low idle speed limit screw, adjust the throttle cable.
3. In some engine speed control applications, loosen the throttle cable lock nut (**Figure 5-11, (4)**) and adjust the cable so the governor lever makes proper contact with the high / low idle speed limit screw

WARNING

NEVER attempt to adjust the low or high idle speed limit screw. This may impair the safety and performance of the machine and shorten its life. If the idle speed limit screws require adjustment, see your authorized Yanmar industrial engine dealer or distributor..

4TNE98 Diesel Engine Only

The governor lever and engine speed control (accelerator lever, pedal, etc.) of the machine are connected together by an accelerator cable or rod. If the cable becomes stretched, or the connections loosen, the governor lever may not respond to change of engine speed control position. This may make operation of the machine unsafe. Check the cable periodically and adjust if necessary. Consult your authorized Yanmar industrial engine dealer or distributor for the adjustment procedure.

NEVER force the accelerator cable or pedal to move. This may deform the governor lever or stretch the cable and cause irregular operation of the engine speed control.

Checking and adjusting the governor lever:

1. Check that the governor lever (**Figure 5-12, (1)**) makes uniform contact with the low idle (**Figure 5-12, (2)**) and high idle (**Figure 5-12, (3)**) speed limit screws when the engine speed control is in the high idle speed or low idle speed position.
2. If the governor lever does not make contact with the high idle or low idle speed limit screw, adjust the accelerator cable.
3. In some engine speed control applications, loosen the accelerator cable locknut and adjust the cable so the governor lever makes proper contact with the high / low idle speed limit screw.

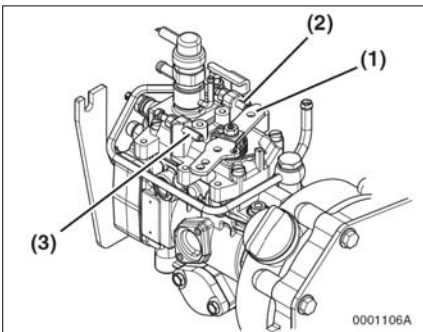
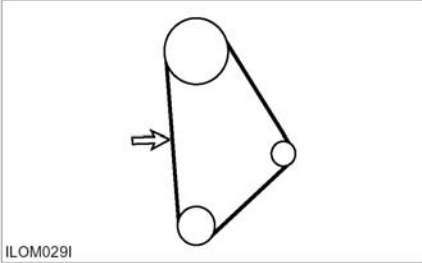

Figure 5-12

Every 500 Service Hours or 3 Months

You must read and understand the warnings and instructions contained in the Safety section of this manual, before performing any operation or maintenance procedures.

Belts - Check, Adjust



Typical Example

1. Check the condition and adjustment of the belt. Correct adjustment allows 10 mm (3/8 inch) deflection under 110 N (25 lb) of force.

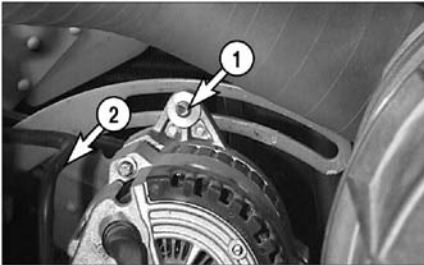

NOTICE

Failure to loosen the alternator mounting bolt (2) will cause excessive stress and break the alternator mounting ear.

2. To adjust the alternator drive belt, loosen adjusting bracket bolt (1) and mounting bolt (2). Move the alternator in or out as required. Tighten bolts (1) and (2).

Mast Hinge Pin – Lubricate



Typical Example

1. Lower the forks and tilt the mast forward.
2. Lubricate the two fittings for the mast hinge pins, one on each side of the mast.

Tilt Cylinders - Check, Adjust, Lubricate

Chassis Pivot Eyebolts-Lubricate



Typical Example

1. Remove floor plates. (GC-series only)
2. Lubricate two fittings for the pivot eyebolts, one on each tilt cylinder.
3. Check the pivot eye pins for loose retainer bolts and wear.

Mast Pivot Eyes-Lubricate

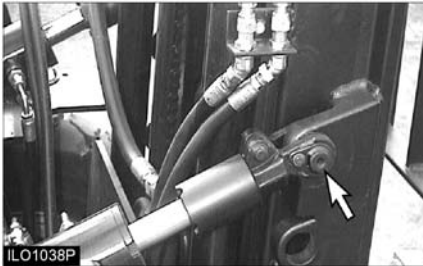

Typical Example

1. Lubricate two fittings for the mast pivot eyes, one on each side of the pin.
2. Check the pivot eye pins for loose retainer bolts and wear.

Cylinder Rod Extension-Adjust

NOTE: The following description is for forward tilt. For cylinder rod back tilt, the collar should be stationary by the tilt eye. If it is not, the O-ring inside the collar may need to be replaced. To adjust back tilt, spacers must be added or removed.



Typical Example

1. Check to make sure the tilt cylinders extend and retract evenly.
2. If one cylinder continues to move after the other cylinder has stopped in full forward or backward tilt, an adjustment must be made to one cylinder.



Typical Example

3. To adjust the cylinder rod extension, move the spacer to the rear and loosen the pinch bolt on the clevis.
4. Turn the cylinder rod in or out of the clevis to obtain the proper adjustment. Turning the rod into the clevis shortens the stroke. Turning the rod out of the clevis lengthens the stroke.
5. Tighten the pinch bolts to a torque of 95 ± 15 Name (70 ± 10 abaf). Check the cylinder rods again for even travel.

Crosshead Rollers - Inspect

Check Operation

1. Operate the mast through a lift cycle. Watch the chains move over the crosshead rollers. Make sure the chain is tracking over the rollers properly.

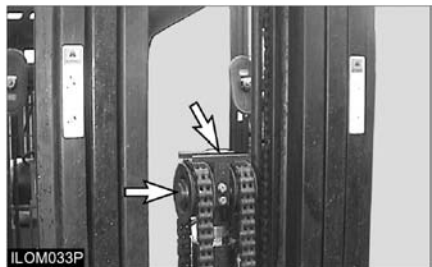

Typical Example

2. Check for damaged crosshead rollers, guards and retainer rings.

Transmission Oil Filter – Change

WARNING

Hot oil and components can cause personal injury. Do not allow hot oil or components to contact skin.

Park the lift truck level, with the forks lowered, parking brake engaged, direction control lever in NEUTRAL and the engine stopped.

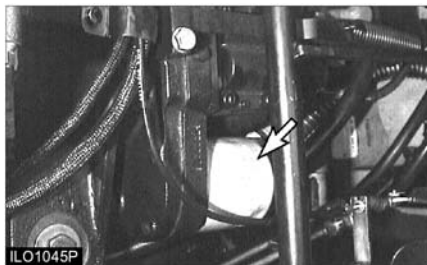

1. Remove the floor mat and the floor plate. Remove and discard the oil filter.
2. Wipe off the filter base. Make certain that all of the old seal is removed.
3. Apply a small amount of clean oil on the seal of the new filter.
4. Install the filter by hand. When the filter contacts the base, tighten an additional 3/4 turn.
5. Start the engine.
6. With the service brake applied and engine at low idle, shift the direction control lever to forward and reverse to fill the clutches.
7. Shift the direction control lever into NEUTRAL. Engage the parking brake.
8. Remove the dip stick/filter cap. Observe the oil level.
9. Maintain the oil level between the Min and Max marks on the dip stick/filter cap. When the oil temperature is 40°C approximately, the cold side mark on the dipstick is applicable. When the oil temperature is 80°C approximately, the hot side mark on the dipstick is applicable.
10. Check for oil leaks at the filters.
11. Stop the engine. Install the floor mat and floor plate.

Overhead Guard – Inspect



1. Check tightness of overhead guard mounting bolts at 95 N•m (70 lb•ft).
2. Check overhead guard for bent or cracked sections. Have repairs made if needed.

Drive Axle Oil & Strainer - Change, Clean

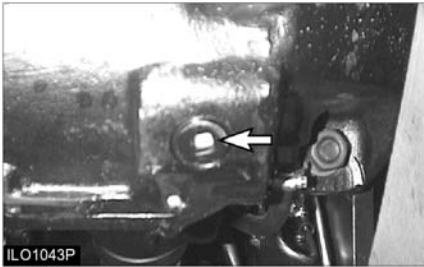

Park the lift truck level, with the forks lowered, parking brake engaged, transmission in NEUTRAL and engine stopped.

1. Remove drain plug. Allow the oil to drain into a suitable container. Clean the magnetic drain plug. Check O - ring seal and replace if necessary.
2. Install the drain plug.



3. Wash the strainer assembly in clean, non flammable solvent and dry it. Install the strainer assembly and reconnect the hose.
4. Remove the dip stick/filter cap. Fill the drive axle housing with oil. See "Refill Capacities."
5. Start the lift truck with engine at low idle, place the directional control lever to the NEUTRAL.
6. Maintain the oil level between lower mark and upper mark on the dip stick/filter cap.

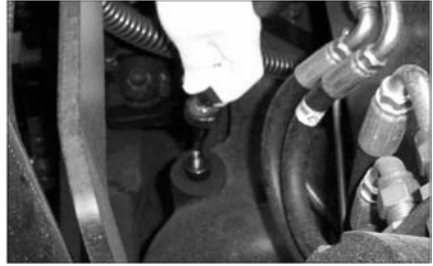

7. Install the dip stick/filter cap.

Steer Suspension – Inspect



1. Inspect the suspension mounting bolts. Tighten suspension mounting bolts, if necessary, to $240 \pm 30 \text{ N}\cdot\text{m}$ ($180 \pm 20 \text{ lb}\cdot\text{ft}$).



2. Look for leaks at the power steering hose connections.
3. Remove any trash buildup on the suspension or the steer axle.

Parking Brake - Test, Adjust

See topic, "Parking Brake - Test, Adjust" in "First 50-100 Service Hours or a Week".

Inching & Braking Control Shaft - Lubricate



1. Lubricate three fittings for the inching and brake pedal control shaft.

Horn and Lights (If Equipped) - Check



1. Press horn button, to determine if horn is operational.
2. Check and replace all defective gauges.
3. Check all lights such as warning, directional, backup, driving and flood lights for correct operation. Replace all burned out bulbs. Have repairs made if needed.

Inspect Vacuum Lines and Fittings (G420F(E)/G424F(E)/G424I(E) Engine Only)

1. Visually inspect vacuum lines and fittings for physical damage such as brittleness, cracks and kinks. Repair/replace as required.
2. Solvent or oil damage may cause vacuum lines to become soft resulting in a collapsed line while the engine is running.
3. If abnormally soft lines are detected, replace as necessary.

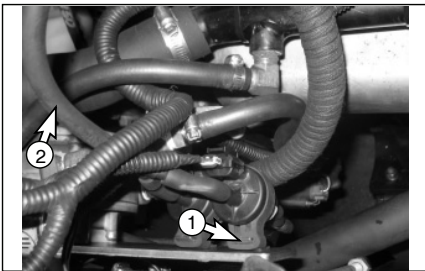

- (1) Fuel Trim Valve(FTV)
(2) Vacuum lines

Fuel Trim Valve(FTV) Inspection (G420F(E)/G424F(E)/G424I(E) Engine Only)

1. Visually inspect the Fuel trim valve for abrasions or cracking. Replace as necessary.
2. To ensure the valve is not leaking a blow-by test can be performed.
3. With the engine off, disconnect the electrical connector to the FTV.
4. Disconnect the vacuum lines from the FTV to the pressure regulator/converter, at the converter's tee connection.
5. Lightly blow through the vacuum line connected to the FTV. Air should not pass through the FTV when de-energized. If air leaks past the FTV when de-energized replace the FTV.

**Inspect Electrical System
(G420F(E)/G424F(E)/G424I(E)
/G430FE Engine Only)**

1. Check for loose, dirty or damaged connectors and wires on the harness including: Fuel lock-off, TMAP sensor, O2 sensor, Electronic throttle, Control Relays, Fuel Trim Valve, Foot Pedal, and crank sensor.
2. Repair and/or replace as necessary.

Fuel Filter (Diesel Engine Only) - Change

4TNV98 Diesel Engine Only

Replace the fuel filter at specified intervals to prevent contaminants from adversely affecting the diesel fuel flow.

1. Stop the engine and allow it to cool.
2. Close the fuel cock of the fuel filter / water separator.
3. Remove the fuel filter with a filter wrench, turning it to the left (**Figure 5-13, (1)**). When removing the fuel filter, carefully hold it to prevent the fuel from spilling. Wipe up all spilled fuel.

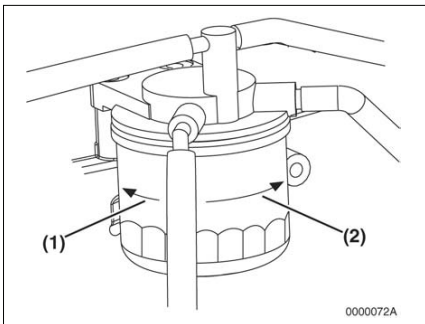

Figure 5-13

4. Clean the filter mounting surface and apply a small amount of diesel fuel to the gasket of the new fuel filter.
5. Install the new fuel filter. Turn to the right (**Figure 5-13, (2)**) and hand-tighten it only until it comes in contact with the mounting surface. Tighten to 14-17 ft•lb (19.6-23.5 N•m; 2.0-2.4kg•m) or one additional turn using the filter wrench.
6. Open the fuel cock of the fuel filter / water separator.
7. Prime the fuel system. See topic "Priming the Fuel System" in "When Required".
8. Check for leaks.

4TNE98 Diesel Engine Only

Replace the fuel filter at specified intervals to prevent contaminants from adversely affecting the diesel fuel flow.

1. Stop the engine and allow it to cool.
2. Close all fuel cocks in fuel line.
3. Disconnect the fuel filter sensor connector (**Figure 5-14, (1)**).

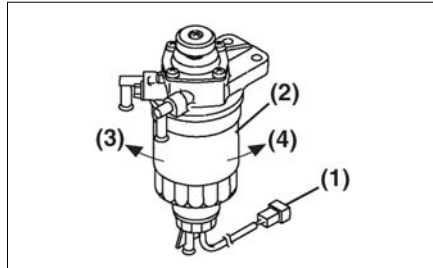

Figure 5-14

4. Place an approved container under fuel filter.
5. Carefully open the drain plug (**Figure 5-15, (1)**) to drain fuel from the fuel filter.
6. Remove the fuel filter (**Figure 5-14, (2)**) by turning it to the left (Figure 5-14, (3)). Wipe up all spilled fuel.
7. Remove the drain plug (**Figure 5-15, (2)**) by turning it to the left (**Figure 5-15, (3)**).
8. Check the condition of the drain plug O-ring (**Figure 5-15, (4)**). Replace the O-ring if damaged.

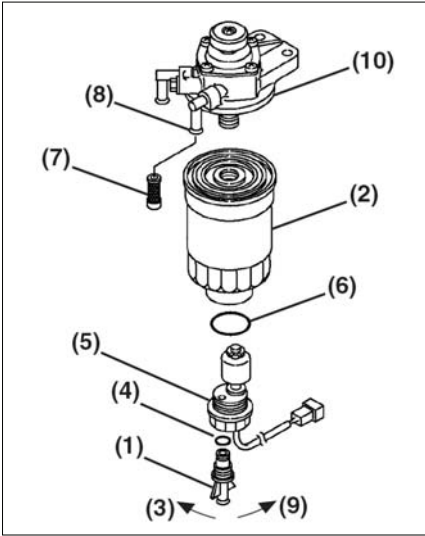

Figure 5-15

9. Set the drain plug aside for reinstallation.
10. Remove the fuel filter sensor assembly (Figure 5-15, (5)) by turning it to the left (Figure 5-15, (3)).
11. Carefully remove the in-line fuel filter (Figure 5-15, (7)) from the output nipple (Figure 5-15, (8)) that goes to the fuel injection pump.
12. Dispose of the fuel, fuel filters and O-ring (if replaced) properly. Follow the guidelines of the EPA or other government agency.
13. Carefully install the new in-line fuel filter (Figure 5-15, (7)) into the output nipple (Figure 5-15, (8)).
14. Carefully install the fuel filter sensor assembly (Figure 5-15, (5)) in the new fuel filter using the new O-ring supplied with the fuel filter (Figure 5-15, (2)) by turning the fuel filter sensor assembly to the right (Figure 5-15, (9)).
15. Install the drain plug (Figure 5-15, (1)) on the new fuel filter (Figure 5-15, (3)) by turning the drain plug to the right (Figure 5-15, (8)). Hand tighten only.
16. Clean the fuel filter mounting surface (Figure 5-15, (10)) and apply a small amount of diesel fuel to the gasket of the new filter.
17. Install the new fuel filter (Figure 5-14, (2)) by turning it to the right (Figure 5-14, (4)) until it contacts the mounting surface. Tighten one additional turn.
18. Open all fuel cocks in the fuel line.
19. Reconnect the fuel filter sensor connector (Figure 5-14, (1)).
20. Prime the fuel system. See Priming the Fuel System.
21. Check for fuel leaks.

Engine Oil & Filter (Diesel Engine Only) - Change

See topic, "Engine Oil & Filter (Diesel Engine Only) - Change" in " First 50-100 Service Hours or a Week".

Water Separator (4TNV98 Diesel Engine Only) - Clean

Periodically clean the fuel filter / water separator element and inside cup.

1. Position an approved container under the cup (**Figure5-16, (1)**) of the fuel filter/water separator to collect the contaminants.

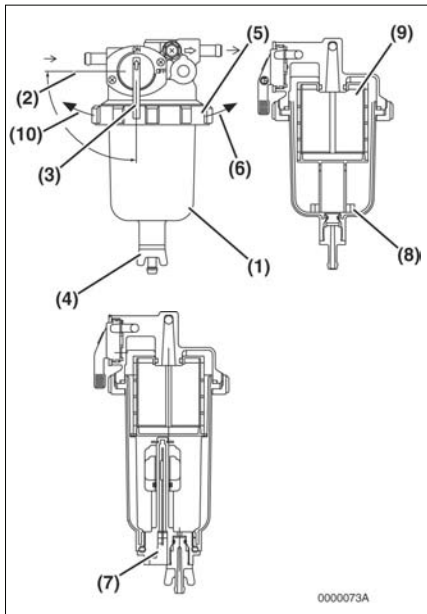

Figure5-16

2. Close (**Figure5-16, (2)**) the fuel cock (**Figure5-16, (3)**).
3. Loosen the drain cock (**Figure5-16, (4)**) and drain the contaminants. See Drain Fuel Filter/Water Separator.
4. Turn the retaining ring (**Figure5-16, (5)**) to the left (**Figure5-16, (10)**) and remove the cup (**Figure5-16, (6)**). If equipped, disconnect the sensor wire (**Figure5-16, (7)**) from the cup before removing the cup.
5. Carefully hold the cup to prevent fuel from spilling. If you spill any fuel, clean up the spill completely.
6. Remove the float ring (**Figure5-16, (8)**) from the cup. Pour the contaminants into the container and dispose of it properly.
7. Clean the element (**Figure5-16, (9)**) and inside cup. Replace the element if it is damaged.
8. Install the element and O-ring in the bracket.
9. Position the float ring in the cup.
10. Check the condition of the cup O-ring. Replace if necessary.
11. Install the cup to the bracket by tightening the retaining ring to the right (**Figure5-16, (6)**) to a torque of 11-15 ft•lb (15-20 N•m; 1.5-2.0kg•m).
12. Close the drain cock. Reconnect the sensor wire if equipped.
13. Open the fuel cock (**Figure5-16, (3)**).
14. Prime the fuel system. See topic, "Priming the Fuel System" in "When required".
15. Check for leaks

Every 1000 Service Hours or 6 Months

You must read and understand the warnings and instructions contained in the Safety section of this manual, before performing any operation or maintenance procedures.

Hydraulic Return Filter, Breather & Strainer - Check, Change

⚠ WARNING

Hot oil and components can cause personal injury. Do not allow hot oil or components to contact skin.

Park the lift truck level with the forks lowered, parking brake engaged, transmission in NEUTRAL and the engine stopped.

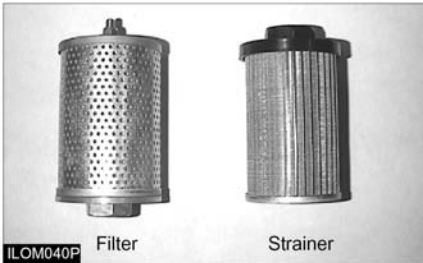

1. Loosen the bolts of the hydraulic tank top plate assembly.
2. Remove the return filter from tank top plate assembly.
3. Install new return filter by hand.
4. Remove the suction strainer from the tank.
5. Install the new strainer by hand.
6. Install the tank top plate assembly and fasten the bolts.



Typical Example

7. Remove and discard the air breather.
8. Install a new air breather.
9. Start the engine and operate the hydraulic controls, and the steering system, through a few cycles to fill the lines. Look for oil leaks.
10. Stop the engine and check the oil level. With all cylinders retracted, maintain the oil level to the FULL mark on the dipstick/filter cap assembly.

Transmission Oil, Oil Filter & Strainer - Check, Clean, Change

See topic, "Transmission Oil, Oil Filter & Strainer-Check, Clean, Change" in "First 50 - 100 Service Hours"

Lift Chains - Test, Check, Adjust

Lift Chain Wear Test

Inspect the part of the chain that is normally operated over the cross head roller. When the chain bends over the roller, the movement of the parts against each other causes wears.

Inspect to be sure that chain link pins do not extend outside of the link hole. If any single link pin is extended beyond its connecting corresponding link, it should be suspected of being broken inside of its link hole. Lift chains are required to check for wear about every 1,000 service hours or 6 months.

Chain wear test is a measurement of wear of the chain links and pins. Take the following steps to check chain wear.

1. Lift the mast and carriage enough for getting tension on lift chains.



Typical example

2. Measure precisely ten links of chain distance at the center of pins in millimeter.
3. Calculate chain wear rate*.
4. If the chain wears rate is 2% or more, replace the lift chain.

*Chain wear rate (%)

$$= \left(\frac{\text{Actual measurement} - \text{Pitch}^{**} \times 10}{\text{Pitch}^{**} \times 10} \right) \times 100$$

**Chain Pitch = 19.05mm (0.75in)

Check for Equal Tension



Typical example

Lift the carriage and the mast high enough for getting tension on lift chains. Check the chains, and make sure the tension is the same. Lift chains are required to check for equal tension about every 1,000 service hours or 6 months.

⚠ WARNING

Personal injury can be caused by sudden movement of the mast and carriage. Keep hands and feet clear of any parts that can move.

Lift Chain Adjustment



Typical example for carriage equal tension

If the tension is not the same on both chains, take the procedure as follows.

NOTE: If carriage height is not correct, make adjustments by following procedures.

Carriage Chain Adjustment

Make sure that carriage height is correct. If correct, adjust the chain for equal tension. If not, adjust the chain for correct carriage height by adjusting anchor nuts (1), (2).

NOTE: See the previous section, "Carriage Roller Extrusion" in "When Required" for proper height of carriage.

1. Fully lower the carriage and tilt mast forward or lift the carriage and put blocks under the carriage to release the tension from the lift chains.
2. Loosen nut(1) and adjust nut(2) to get proper distance from bottom of inner upright to the bottom of carriage bearing.

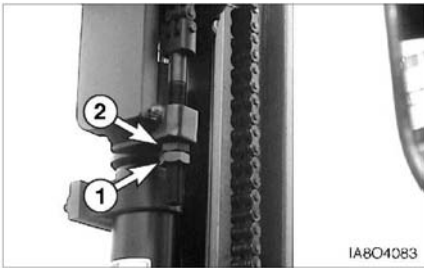

Typical example for carriage chain of STD mast

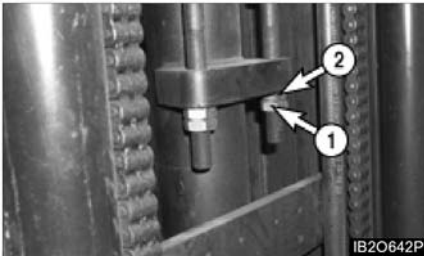

Typical example for carriage chain of FF, FFT mast

3. Make adjustment anchor nut (1), (2) for equal chain tension.
4. Set the mast vertical and raise the carriage and check equal chain tension. If not equal, repeat the same procedure as step 1 through step 3.
5. Put LOCTITE No. 242 Tread lock on the threads of the anchor nuts (1), (2) after the adjustment is completed.

Mast Chain Adjustment - FF, FFT Mast

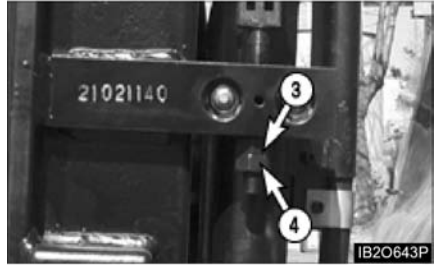

Typical example for FF mast

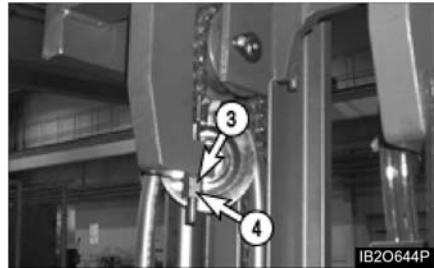

Typical example for FFT mast

Make sure that mast height is correct. If correct, adjust chain for equal tension. If not, adjust mast chain for correct mast height by adjusting anchor nuts (3), (4).

NOTE: See the previous section, "Carriage Roller Extrusion" in "When Required" for proper inner mast height.

1. Lift the inner mast and put blocks under the inner mast to release the tension from the lift chains.
2. Loosen nut (3) and adjust nut (4) to make inner mast rail flush with outer mast rail bottom.
3. Make adjustment anchor nuts (3), (4) for equal chain tension.
4. Raise the inner mast and check equal chain tension. If not equal, repeat the same procedure as step 1 through step 3.
5. Put LOCTITE No. 242 tread lock on the threads of the anchor nuts (3), (4) after the adjustment is completed.

Universal Joint – Inspect

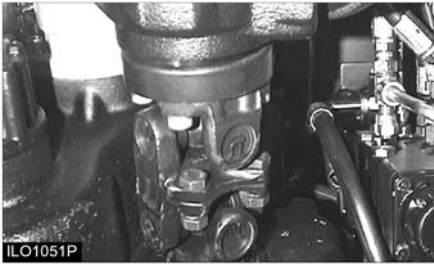

Check for worn or damaged bearings. Have worn or damaged bearings replaced. Check for loose retaining bolts and nuts. Tighten the bolts and nuts, if necessary.

Air Intake System - Change

Changing Primary Element

See topic, “Air Intake System - Check, Clean” in “Every 250 Service Hours or Monthly”

Changing Secondary Element

1. Remove the primary air cleaner element. See topic “Servicing Filter Element.” Clean the inside of the air cleaner housing and cover.

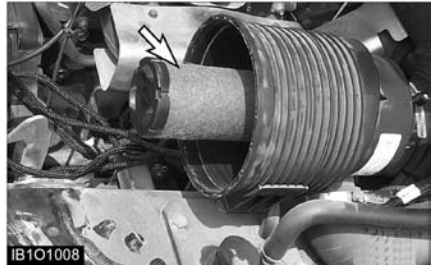

2. Remove the secondary element. Inspect the gasket between the air cleaner housing and the engine inlet. Replace the gasket if it is damaged.

NOTICE

Always replace the secondary element. Do not attempt to reuse it by cleaning.

3. Install a new secondary element. Install a new or cleaned primary element. Install the cover. Tighten the latches.
4. Start the engine and observe the air cleaner service indicator. If the indicator shows RED after installing a new secondary element and a cleaned primary (outer) element, replace the cleaned primary filter with a new element.
5. Stop the engine. Close the hood and seat assembly.

Inspect Coolant Hoses (LP, Dual Fuel Engine Only)

1. Visually inspect coolant hoses and clamps. Remember to check the two coolant lines that connect to the pressure regulator/convertor.
2. Replace any hoses that shows signs of swelling, cracking, abrasion or deterioration.

G420F(E)/G424F(E)/G424I(E) Engine Only

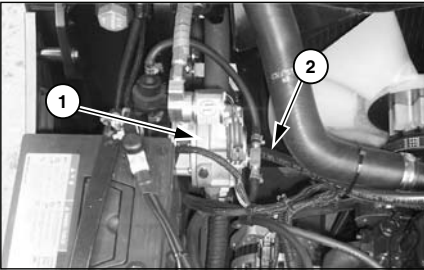

G430FE Engine Only

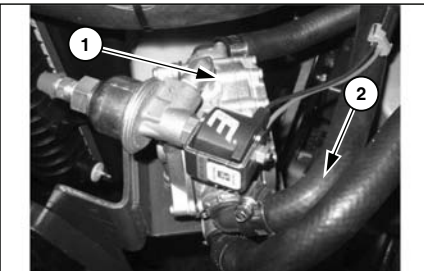

- (1) LP Regulator/Converter
(2) Coolant hoses

LP Regulator/Converter Inspection (LP, Dual Fuel Engine Only)

1. Visually inspect the pressure regulator / converter housing for coolant leaks. Refer to the pressure regulator/convertor section of the service manual if maintenance is required.

NOTE: For pressure testing and internal inspection of the pressure regulator/convertor, refer to the pressure regulator/convertor section of the service manual.

Fuel Lines & Fittings - Check

Visually inspect fuel lines and fittings for physical damage. Replace as required.

G420F(E)/G424F(E)/G424I(E) Engine Only

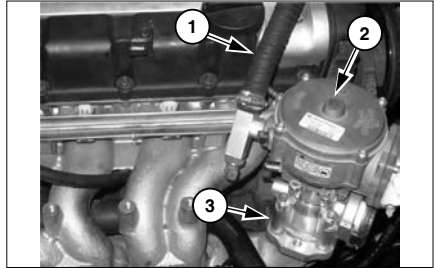

G430FE Engine Only

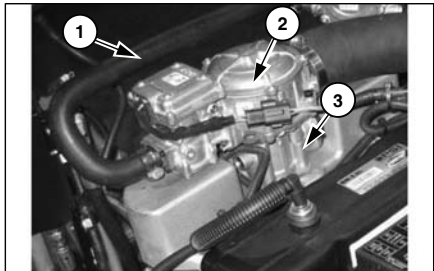

- (1) Fuel lines
(2) LP mixer
(3) Throttle Assembly

Inspect Mixer Assembly (G420F(E)/G424F(E)/G424I(E) /G430FE Engine Only)

Refer to the LP mixer section of the engine service manual for procedures.

Inspect Throttle Assembly (G420F(E)/G424F(E)/G424I(E) /G430FE Engine Only)

1. Visually inspect the throttle assembly motor housing for coking, cracks and missing cover-retaining clips. Repair and/or replace as necessary.

NOTE: Refer to the LP mixer and throttle section of the service manual for procedures on removing the mixer and inspecting the throttle plate.

Engine Valve Lash (Diesel Engine Only) - Check, Adjust

NOTICE

The valve clearances are to be adjusted at the times of the following situations.

- When the engine is overhauled and the cylinder heads are disassembled.
 - When severe noise comes from valve train.
 - When the engine is not normally operated even though there is no trouble in the fuel system.
-

WARNING

To prevent possible injury when adjusting diesel engines, do not use the starter motor to turn the flywheel.

Hot engine components can cause burns. Allow additional time for the engine to cool before measuring valve clearance.

NOTICE

Measure the valve lash with the engine stopped. To obtain an accurate measurement, allow at least 20 minutes to cool the engine cylinder head and block temperature.

Set the clearance to the nominal appropriate clearance given in the "Valve Clearance Setting" shown below.

Valve Clearances		
Engine	Valve	Clearance
3.3 liter (4TNV98 & 4TNE98) Diesel	Exhaust Valves	0.2 mm (.008 in)
	Intake Valves	0.2 mm (.008 in)

Refer to the "Service Manual" for the complete valve adjustment procedure.

In regards to G420F(E) and G424F(E) Engines, valve adjustment is not necessary because of automatic adjusting system

Every 1500 Service Hours or 9 Months

Inspect Ignition System (LP, Gasoline & Dual Fuel Engines Only)

1. Disconnect Battery Cables.
2. Remove and inspect the spark plugs. Replace as required.
3. Test secondary cables with an Ohmmeter. If the maximum resistance is higher than 25 kOhms, repair and/or replace(G424F(E) engine only).
4. Inspect the ignition coil for cracks and heat deterioration. Visually inspect the coil heat sink fins. If any fins are broken replace as required.

G420F(E) Engine



G424I(E) Engine

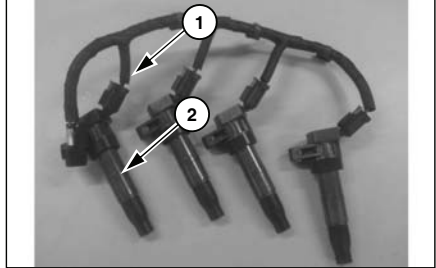

G430FE Engine

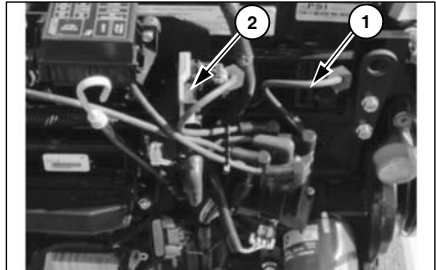

G424F(E) Engine

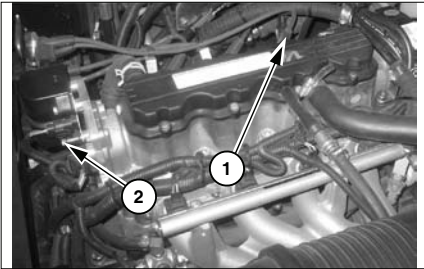

- (1) Spark Plug Cables
(2) Ignition Coil

Replace Spark Plugs (G424F(E) LP, Dual Fuel Engine / G430FE Engine Only)

1. Disconnect Battery Cables.
2. Using a gentle twisting motion remove the high voltage cables from the spark plugs. Replace any damaged cables.
3. Remove the spark plugs.
4. Gap the new spark plugs to the proper specifications.
G424F(E)/G430FE Engine : 0.9 mm
5. Apply anti-seize compound to the spark plug threads and install.
G424F(E) Engine : 25 N•m (18 lb•ft)
G430FE Engine : 30 N•m (22 lb•ft)

 **WARNING**

DO NOT OVERTIGHTEN THE SPARK PLUGS.

6. Re-install the high voltage cables.

Replace LP Fuel Filter Element (LP, Dual Fuel Engine Only)

Park the lift truck in an authorized refueling area with the forks lowered, parking brake applied and the transmission in Neutral.

1. Close the fuel shutoff valve on the LP-Fuel tank. Run the engine until the fuel in the system runs out and the engine stops.
2. Turn off the ignition switch.
3. Scribe a line across the filter housing covers, which will be used for alignment purposes when re-installing the filter cover.

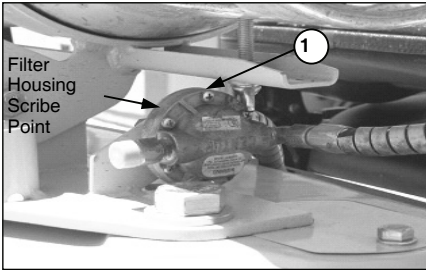

(1) screws

4. Remove the cover retaining screws (1).

Fuel Filter (LP Engine Only)

Disassembly

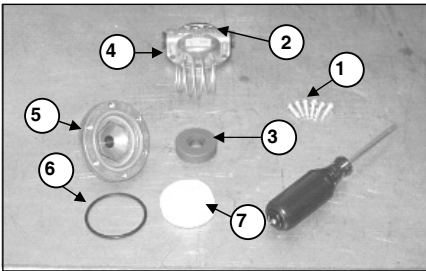

1. Remove top cover (2), magnet (3), spring (4), and filter element (7) from bottom cover (5).
2. Replace the filter element (7).

3. Check bottom cover O-ring seal (6) for damage. Replace if necessary.
4. Re-assemble the filter assembly aligning the scribe lines on the top and bottom covers.
5. Install the cover retaining screws, tightening the screws in an opposite sequence across the cover.
6. Open the fuel valve by slowly turning the valve counterclockwise.
7. Crank the engine several revolutions to open the fuel lock-off. **DO NOT START THE ENGINE.** Turn the ignition key switch to the off position.
8. Check the filter housing, fuel lines and fittings for leaks. Repair as necessary.

Testing Fuel Lock-off Operation (LP Engine Only)

1. Start engine.
2. Locate the electrical connector for the fuel lock
3. Disconnect the electrical connector.
4. The engine should run out of fuel and stop within a short period of time.
5. Turn the ignition key switch off and re-connect the fuel lock-off connector.

NOTE: The length of time the engine runs on trapped fuel vapor increases with any increase in distance between the fuel lock-off and the pressure regulator/converter.

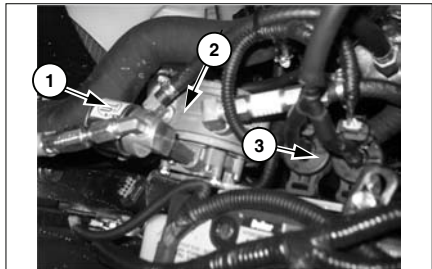

(1) LP fuel lock-off
(2) Regulator/Converter
(3) Fuel Trim valve (FTV)

Fuel Injectors (Diesel Engine Only)

– Inspect, Clean, Test

WARNING



HIGH-PRESSURE HAZARD!

Avoid skin contact with the high-pressure diesel fuel spray caused by a fuel system leak such as a broken fuel injection line. High-pressure fuel can penetrate your skin and result in serious injury. If you are exposed to high-pressure fuel spray, obtain prompt medical treatment.

NEVER check for a fuel leak with your hands. ALWAYS use a piece of wood or cardboard. Have your authorized Yanmar industrial engine dealer or distributor repair the damage.

Failure to comply could result in death or serious injury.

Proper operation of the fuel injectors is required to obtain the optimum injection pattern for full engine performance. The EPA / ARB requires that the fuel injectors are inspected, cleaned and tested every 1500 hours. See *Testing of Fuel Injectors on Service Manual*

Crankcase Breather System (4TNV98 Diesel Engine Only) - Inspect

Proper operation of the crankcase breather system is required to maintain the emission requirements of the engine. The EPA / ARB requires that the crankcase breather system is inspected every 1500 hours.

4TNV98 engines use a crankcase breather system that has a spring-backed diaphragm (**Figure5-19, (1)**) in the valve cover (**Figure5-19, (2)**). When the crankcase pressure reaches a predetermined value, the diaphragm opens a passage that allows crankcase fumes to be routed to the intake manifold.

To inspect the diaphragm and spring (**Figure5-19, (3)**):

1. Remove the bolts retaining the diaphragm cover (**Figure5-19, (4)**).

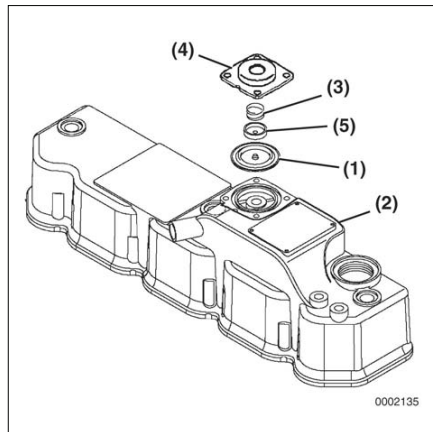

Figure5-19

2. Remove the diaphragm cover, spring, diaphragm plate (**Figure5-19, (5)**) and diaphragm.
3. Inspect the diaphragm for tears. Inspect the spring for distortion. Replace components if necessary.
4. Reinstall the diaphragm, diaphragm plate, spring and diaphragm cover. Tighten the diaphragm bolts to specified torque.

Failure of the diaphragm and / or spring will cause the loss of pressure control and allow an excessive amount of crankcase fumes to be routed to the intake manifold. This could result in excessive deposits in the intake system, high engine exhaust smoke levels, excessive engine oil consumption, and / or engine run-on due to the burning of the engine oil

Every 2000 Service Hours or Yearly

You must read and understand the warnings and instructions contained in the Safety section of this manual, before performing any operation or maintenance procedures

Engine Valve Lash (Diesel Engine Only) – Check, Adjust

See topic “Engine valve Lash (Diesel Engine Only) – Check, Adjust”. In First 250 Service hours.

Steer Wheel Bearings - Reassemble

Park the lift truck level with the forks lowered, parking brake engaged, transmission in NEUTRAL and the engine stopped.

NOTE: The procedure is shown on a GC-Series lift truck. It is the same for D, G-Series lift trucks.

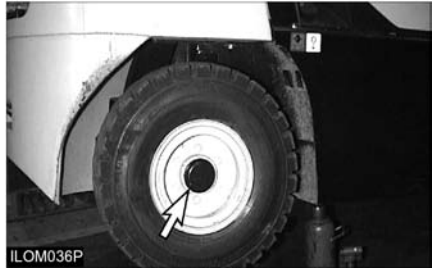

Typical Example

1. Lift the steer wheels off the ground. Place stands or blocking under the frame and steer axle to support the lift truck.



Typical Example

2. Remove the hub cap which is pressed into the wheel hub.

3. Straighten the lock washer tangs.

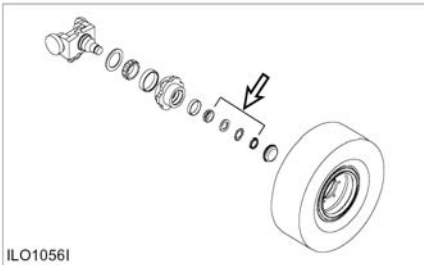

4. Remove the locknut, lock washer and flat washer.
Remove the outer wheel bearing.

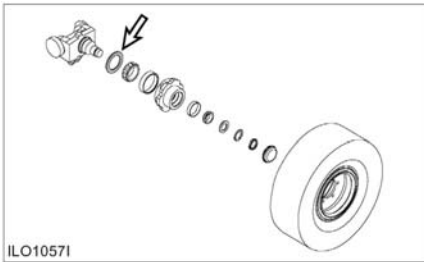

5. Remove the wheel assembly. Examine the seal for damage and wear. Replace the seal if necessary.
6. Remove the inner bearing. Clean and lubricate the steering knuckle. Reassemble both the inner and outer bearing cones.
7. Install the inner bearing. Lubricate the seal and install the wheel assembly on the knuckle.

8. Install the outer wheel bearing and the out washer. Install a new lock washer and fit the locknut.

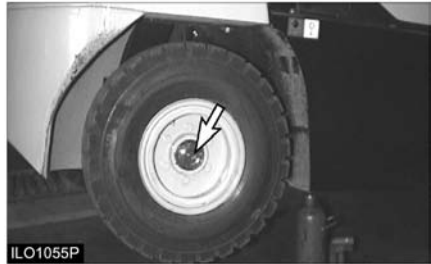

Typical Example

9. Tighten the locknut to 135 N•m (100 lb•ft), while turning wheel hub to seat the bearing.
10. Loosen the locknut. Retorque it to 50 ± 5 N•m (37 ± 4 lb•ft). Bend the lock washer tang to secure locknut.
11. Install the hub cap.
12. Raise the lift truck and remove the blocking.
Lower the lift truck to the ground.

Drive Wheel Bearing (Power Shaft and Drive Wheel) – Reassemble

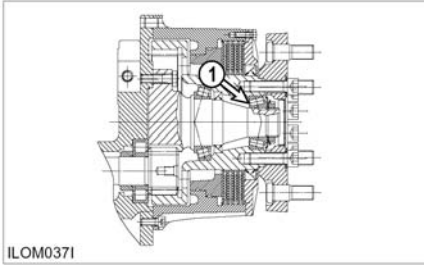

Consult your DOOSAN lift truck dealer for the proper wheel bearing reassembling procedure. Packing of bearings and adjustment procedure must be made by a trained mechanic or dealer personnel.

Pack power shaft bearings (1) and spindle bearings (2). Pack ring gear (3) to the depth of the teeth.

D, G-Series Lift Trucks

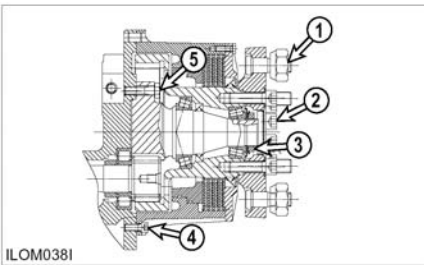

Torque for single or dual wheel mounting nuts (1) is $644 \pm 34 \text{ N}\cdot\text{m}$ ($470 \pm 25 \text{ lb}\cdot\text{ft}$).

Torque for adapter assembly bolts (2) is $285 \pm 13 \text{ N}\cdot\text{m}$ ($210 \pm 10 \text{ lb}\cdot\text{ft}$).

Tighten wheel bearing nut (3) to $135 \text{ N}\cdot\text{m}$ ($100 \text{ lb}\cdot\text{ft}$) while the wheel is turned in both directions. Loosen the nut completely and tighten nut again to $50 \pm 5 \text{ N}\cdot\text{m}$ ($37 \pm 4 \text{ lb}\cdot\text{ft}$). Bend the lock washer tab into a groove of the nut.

Torque for bolts (4) that hold cover to drive axle housing is $55 \pm 10 \text{ N}\cdot\text{m}$ ($40 \pm 7 \text{ lb}\cdot\text{ft}$).

Apply Loctite No.242 to threads of spindle bolts (5).Torque for spindle bolts is $115 \pm 14 \text{ N}\cdot\text{m}$ ($85 \pm 10 \text{ lb}\cdot\text{ft}$).

GC-Series Lift Trucks.

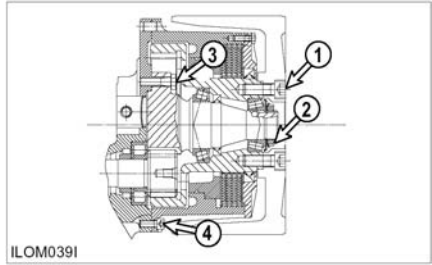

Torque for wheel bolts (1) is $270 \pm 25 \text{ N}\cdot\text{m}$ ($200 \pm 20 \text{ lb}\cdot\text{ft}$).

Tighten wheel bearing nut (2) $135 \text{ N}\cdot\text{m}$ ($100 \text{ lb}\cdot\text{ft}$) while the wheel is turned in both directions. Loosen the nut completely and tighten nut again to $50 \pm 5 \text{ N}\cdot\text{m}$ ($37 \pm 4 \text{ lb}\cdot\text{ft}$). Bend the lock washer tab into a groove of the nut.

Torque for bolts (3) that hold cover to drive axle housing is $55 \pm 10 \text{ N}\cdot\text{m}$ ($40 \pm 7 \text{ lb}\cdot\text{ft}$).

Apply Loctite No. 242 to threads of spindle bolts (4). Torque for spindle bolts is $115 \pm 14 \text{ N}\cdot\text{m}$ ($85 \pm 10 \text{ lb}\cdot\text{ft}$).

Cooling System – Clean, Change

▲ WARNING

At operating temperature, the engine coolant is hot and under pressure.

Steam can cause personal injury.

Check the coolant level only after the engine has been stopped and the filler cap is cool enough to touch with your bare hand.

Remove the filler cap slowly to relieve pressure.

Coolant is included antifreeze for forbidding corrosion. Avoid contact with the skin and eyes to prevent personal injury.

Use all cleaning solution with care.

The Lift truck must be level, the forks lowered, the parking brake engaged, the transmission in NEUTRAL and the engine stopped and cool.

1. Turn the radiator cap slowly to relieve the pressure, and then remove the cap.



2. Remove the drain plug or water hose on engine block.



4TNE98 3.3L Diesel Engine

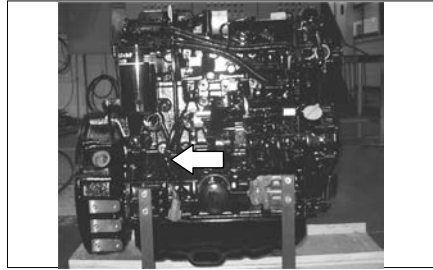

4TNV98 3.3L Diesel Engine

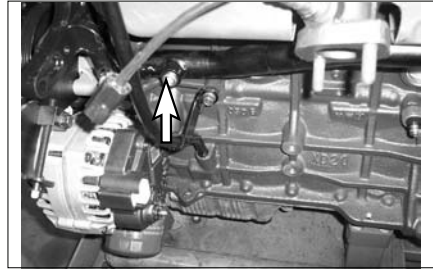

G420F(E) 2.0L LPG/Gasoline Engine

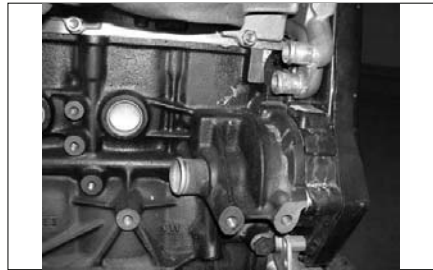

G424F(E) 2.4L LPG/Gasoline Engine



G424(E) 2.4L LPG/Gasoline Engine

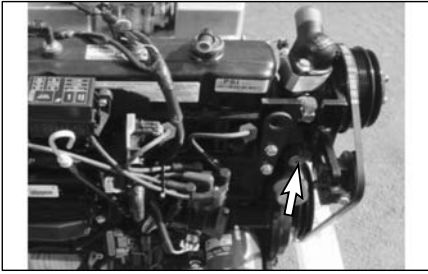

G430FE 3.0L LPG Engine

3. Open the radiator drain valve. Allow the coolant to drain into a suitable container. Drain the recovery bottle.



NOTICE

Hold the drain port when the radiator drain valve is turned because the tank and the drain port are separated.



4. After draining the coolant completely, close the radiator drain valve and the block drain plug, fill the engine and the radiator full with a radiator cleaner, and clean the engine and the radiator.
5. Start and run the engine for 30 minutes.

6. Stop the engine and drain the cleaning solution into a suitable container.
7. Flush the system with clean water, until draining water is clear.
8. Close the drain valve and install the block drain plug. Fill coolant to top of the filler neck.
9. Start and run the engine to stabilize the coolant level. See topic, "Coolant Level – Check" in "Every 10 Service hours or Daily".

NOTICE

Inject the coolant additionally into below specific port of G424(E) engine besides the radiator if needs more coolant while clean & change the cooling system.

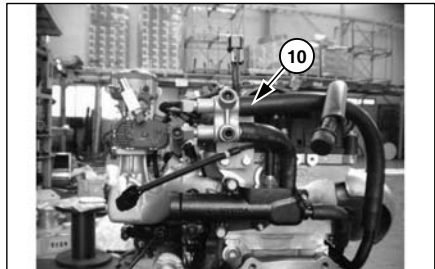

10. Remove the indicated coolant hose above picture and then, add the coolant to hose as much as needed.

Forks – Inspect

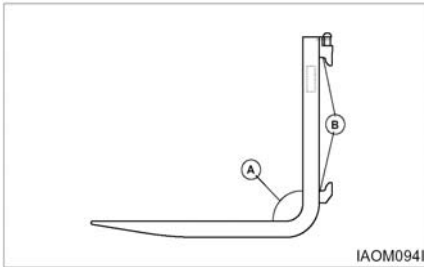

Forks should be inspected, at a minimum, every 12 months. If the truck is being used in a multi-shift or heavy duty operation, they should be checked every six months.

1. Inspect the forks carefully for cracks. Special attention should be given to the heel section (A), all weld areas and mounting brackets (B). Inspect the top and bottom hooks on forks used on hook type carriages and tubes on shaft mounted forks.

Forks with cracks should be removed from service.

"Wet Test" magnetic particle inspection is generally preferred due to its sensitivity and the ease of interpreting the results. Portable equipment is usually recommended so it can be moved to the lift truck.

Inspectors should be trained and qualified in accordance with The American Society for Non Destructive Testing, Level II Qualifications.

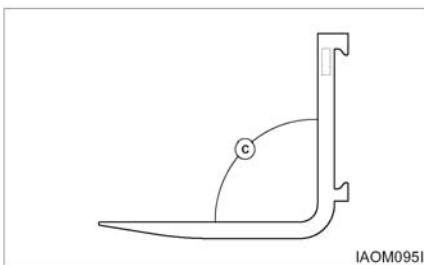

2. Check the angle between the upper face of the blade and the front face of the shank. The fork should be withdrawn from service if angle (C) exceeds 93 degrees or deviates by more than 3 degrees from an original angle other than 90 degrees, as may be found in some special application forks.

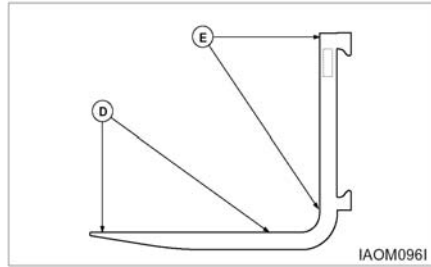

3. Check the straightness of the upper face of blade (D) and the front face of shank (E) with a straight edge.

The fork should be withdrawn from service if the deviation from straightness exceeds 0.5 percent of the length of the blade and/or the height of the shank respectively 5 mm/1000 mm (0.18"/36").

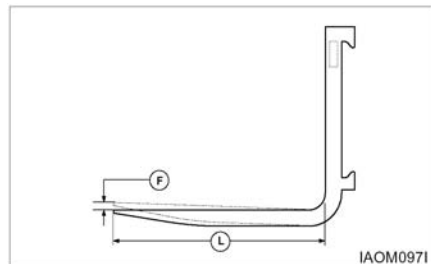

4. Check the difference in height of one fork tip to the other when mounted on the fork carrier. A difference in fork tip height can result in uneven support of the load and cause problems with entering loads.

The maximum recommended difference in fork tip elevation (F) is 6.5 mm (0.25") for pallet forks and 3 mm (0.125") for fully tapered forks. The maximum allowable difference in fork tip elevation between the two or more forks is 3 percent of blade length (L).

Replace one or both forks when the difference in fork tip height exceeds the maximum allowable difference. Contact your local DOOSAN Lift Truck Dealer for further information.

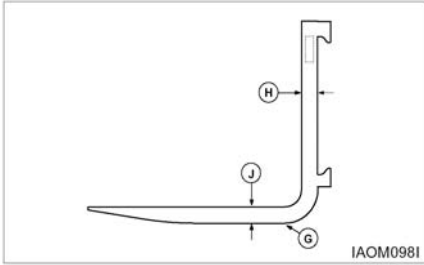

5. Check the fork blade (J) and shank (H) for wear with special attention to the heel (G). The fork should be withdrawn from service if the thickness is reduced to 90 percent or less of the original thickness.

Fork blade length may also be reduced by wear, especially on tapered forks and platens. Remove the forks from service when the blade length is no longer adequate for the intended loads.

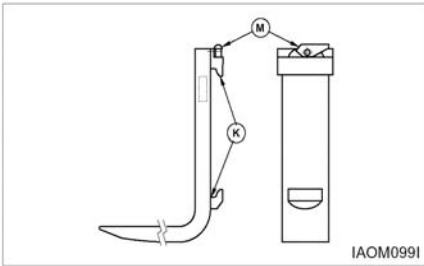

6. Check the fork mountings (K) for wear, crushing and other local deformation, which can cause excessive side to side wobble of the forks. Excessive clearance on hook type forks may allow them to fall from the carrier. Forks which show visible signs of such damage should be removed from service.
7. Check the positioning lock and other fork retention devices to make sure they are in place and working.

Hook type forks use a spring loaded pin (M), located in the top hook, to engage notches in the top carriage bar to hold the fork in place.

When adjusting the fork spacing, the forks are prevented from sliding off the end of the carriage by stop blocks. These stop blocks are at both ends of the carriage and in the path of the bottom fork hook. The load backrest extension may be used in place of the stop blocks in some cases.

Shaft mounted forks may use set collars or spacers on the shaft to either side of the fork. They may also use U bolts, pins, or similar devices which engage the fork through the top structure of the carriage.

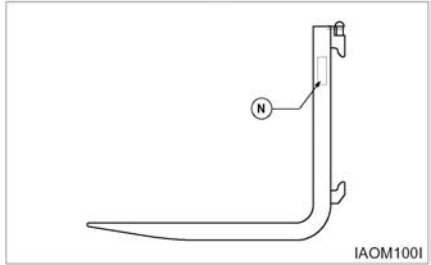

8. Check fork markings (N) for legibility. Renew markings as required to retain legibility.
9.
 - a. Lift the mast and operate the tilt control lever, until the top surface of the forks is parallel with the floor. Place two straight bars that are the same width as the carriage, across the forks as shown.
 - b. Measure the distance from the bottom of each end of the two bars to the floor. The forks must be parallel within 3 mm (.12 in) for Full Tapered and Polished (FTP) forks, all other forks 6.4 mm (.25 in), for their complete length.
 - c. Put one fork, one third from the tip, under a fixture that will not move. Then operate the tilt control with caution until the rear of the truck lifts just off the floor. Follow the same procedure with the second fork. Repeat Step a.

Every 2500 Service Hours or 15 Months

You must read and understand the warnings and instructions contained in the Safety section of this manual, before performing any operation or maintenance procedures.

Hydraulic Oil - Check, Clean, Change

WARNING

Hot oil and components can cause personal injury. Do not allow hot oil or components to contact skin.

Park the lift truck level with the forks lowered, parking brake engaged, transmission in NEUTRAL and the engine stopped.

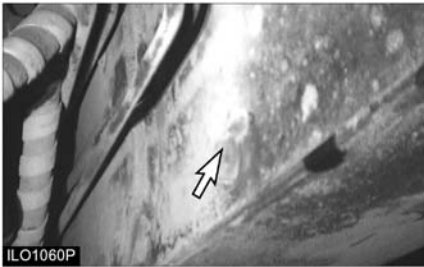

1. Remove the hydraulic tank drain plug. Allow the oil to drain into a suitable container. Clean and install the plug.
2. Remove the dipstick/filter cap assembly.
3. Fill the hydraulic tank. See topic "Refill Capacities". Install the dipstick/filter cap assembly.
4. Start the engine and operate the hydraulic controls, and the steering system, through a few cycles to fill the lines. Look for oil leaks.
5. Stop the engine and check the oil level. With all cylinders retracted, maintain the oil level to the FULL mark on the dipstick/filter cap assembly.

Inspect Battery System

1. Clean battery outer surfaces with a mixture of baking soda and water.
2. Inspect battery outer surfaces for damage and replace as necessary.
3. Remove battery cable and clean, repair and/or replace as necessary.



Replace Oxygen Sensor (G420F(E)/G424F(E)/G424I(E) /G430FE Engine Only)

G420F(E) Engine

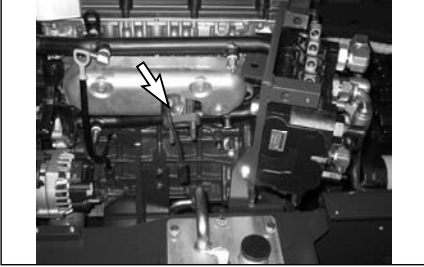

G424F(E) Engine

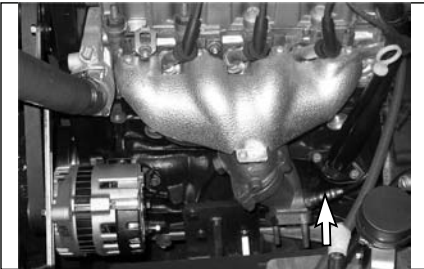

G424I(E) Engine



G430FE Engine

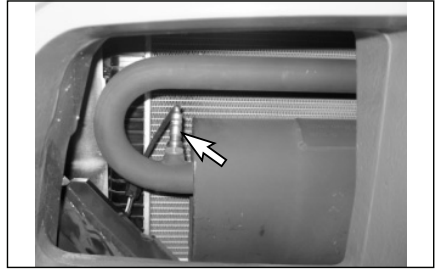
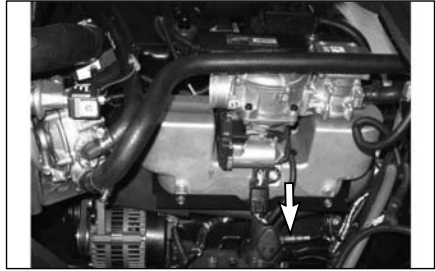

When indicated by MIL, replace oxygen sensor on the exhaust manifold and oxygen sensor on muffler assembly.

1. Stop engine and wait until the exhaust pipe and exhaust pipe is cooled.
2. Disconnect the electrical connector of oxygen sensor
3. Remove oxygen sensor
4. Assemble new oxygen sensor
Tightening torque : 45 N•m (32.5 lb•ft)
5. Connect the electrical connector of oxygen sensor

WARNING

When assembling the filters, check the arrow mark on the filter surface.

The arrow mark position is same as fuel flow direction.

Replace Spark Plugs (G420F(E)/G424I(E) Engine Only)

1. Disconnect Battery Cables.
2. Remove the ignition wiring harness.
3. Remove the ignition coil assy.
4. Remove spark plugs.
5. Gap the new spark plugs to the proper specifications.
G420F(E) Engine : 0.7 ~ 0.8 mm
G424I(E) Engine : 0.8 ~ 0.9 mm
6. Apply anti-seize compound to the spark plug threads and install.
G420F(E)/G424I(E) Engine : 25 N•m (18 lb•ft)

⚠ WARNING

DO NOT OVERTIGHTEN THE SPARK PLUGS.

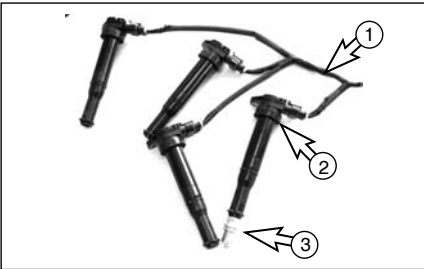

(1) Ignition wiring harness (2) Ignition Coil Assy (3) Spark plug

Checking the TMAP Sensor (G420F(E)/G424F(E)/G424I(E) /G430FE Engine Only)

1. Verify that the TMAP sensor (F) is mounted tightly into the manifold adapter (E), with no leakage.
2. If the TMAP is found to be loose, remove the TMAP retaining screw and the TMAP sensor from the manifold adapter.
3. Visually inspect the TMAP O-ring seal for damage. Replace as necessary.
4. Apply a thin coat of an approved silicon lubricant to the TMAP o-ring seal.
5. Re-install the TMAP sensor into the manifold adapter and securely tighten the retaining screw.

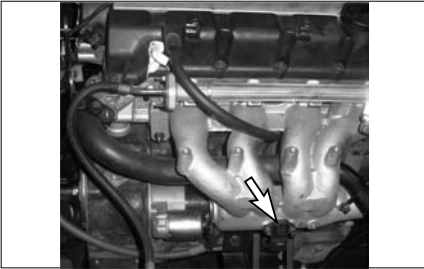

Inspect for Intake Leaks (G420F(E)/G424F(E)/G424I(E) /G430FE Engine Only)

1. Visually inspect the intake manifold, throttle assembly (2), and manifold adapters (3), for looseness and leaks. Repair as necessary.

Replace PCV Valve and breather element - Change (LP, Gasoline and Dual Fuel Engines)

G420F(E) Engine

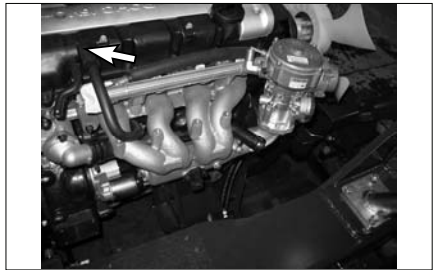

G424F(E) Engine

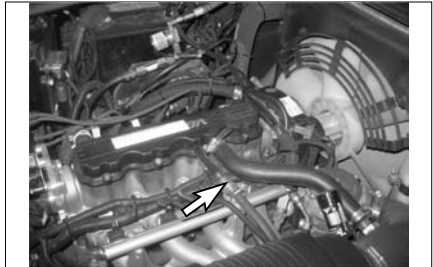

G424I(E) Engine



G430FE Engine



1. Loosen the hose clamps and remove the PCV valve.
2. Assemble new PCV valve and hose.
3. Tighten the hose clamps

Every 3000 Service Hours or 18 Months

You must read and understand the warnings and instructions contained in the Safety section of this manual, before performing any operation or maintenance procedures.

Timing Belt [G420F(E)/G424F(E) LP, Gasoline, Dual Fuel Engine Only] - Change

See the "Service manual" for the procedure and specification.



WARNING

G420F(E) is dual over-head CAM engine. If timing belt is not replaced on time, engine could be damaged.

Index

#

12 Months Inspection.....	170
4TNE98 Diesel Engine Only	187,190,213,221
4TNV98 Diesel Engine Only	187,189,212,221

A

[Aux2] Optional Selector Switch for SAFETY Operating a Rotating Cramp Attachment	156
Accelerator Pedal	74
Additional Technical Fuel Requirements.....	176
Adjustment of Armrest	157
Adjustments.....	151
Advanced Diagnostics	104,139
After Starting the Engine.....	86
Air Cleaner Indicator-Check.....	194
Air Intake System - Change	227
Air Intake System - Check, Clean	204
Antifreeze	175
Attachment Abbreviations (Includes Special Forks)	66
Auto Shift Controller ASC-100 (If Equipped).....	151
Auto Tilt Leveling Switch.....	156
Automatic mode (Direction Inhibit mode)	152
Avoiding Lift Truck Tipover	21

B

Basic Troubleshooting (Gasoline).....	98
Basic Troubleshooting(LP).....	91,127
Battery Terminal - Clean, Inspect.....	208
Before Operating the Lift Truck.....	12
Before Starting the Engine.....	79
Before Starting the Lift Truck	11
Before Storage.....	164
Belts - Check, Adjust	214
Bent or Twisted Forks	168
Bio-Diesel Fuels.....	176
BLINK CODE FUNCTION.....	140
Brake Fluid	179
Brake Oil Level - Check	206
Bulbs	186
Burn Prevention.....	15

C

Capacity Chart (With Sideshifter cushion)	60,61,62,63
Capacity Chart (With Sideshifter Pneumatic)	52,53,54,55

Capacity Chart (Without Sideshifter cushion)	56,57,58,59
Capacity Chart (Without Sideshifter Pneumatic)	48,49,50,51
Carriage Roller Extrusion – Adjust.....	191
Causes of Fork Failure	168
Center of Gravity (CG).....	21
Changing From Gasoline to LP – Gas	84
Changing From LP to Gasoline	84
Changing LP Tanks.....	77
Changing Primary Element.....	227
Changing Secondary Element	227
Chassis Pivot Eyebolts-Lubricate	214
Check for Equal Tension	225
Check Inflation and Damage	191
Check Operation.....	215
Checking Service Indicator	194
Checking the TMAP Sensor (G420F(E) /G424F(E) /G424I(E) /G430FE Engine Only)	244
Circuit Breaker.....	73,187
Cleaning Primary Filter Elements	205
Coolant Information	174
Coolant Level – Check	193
Coolant Water.....	175
Cooling System – Clean, Change.....	237
Cooling System Specifications	174
Crankcase Breather System (4TNV98 Diesel Engine Only) - Inspect	233
Crosshead Rollers - Inspect	215
Crushing or Cutting Prevention.....	14
Cylinder Rod Extension-Adjust	215

D

D, G-Series Lift Trucks	236
Daily Inspection	169
Declaration of Conformity.....	30
Diagnostics Features	152
Diesel Engine	82
Diesel Engines.....	192
Diesel Fuel Specifications.....	176
Direction Control Lever	74
Direction Inhibit Point.....	151
Disassembly	232
Display for Operator	152
Display for Troubleshooting.....	152
Displaying Fault Codes (DFC) from SECM Memory	104
Drive Axle Oil - Change	201
Drive Axle Oil & Strainer - Change, Clean	217
Drive Axle Oil Level - Check	207
Drive Axle Oil.....	178
Drive Wheel Bearing (Power Shaft and Drive Wheel) – Reassemble.....	236
Dual Fuel System	84

E

Electrical Disconnect Switch (If Equipped)..... 71
 Electronic Controlled Spark-Ignition Engines 125
 Emergency Switch 155
 EMS schematic of G430FE LP engine..... 126
 Engine Compartment..... 71
 Engine Oil & Filter (Diesel Engine Only) - Change 198,222
 Engine Oil & Filter (LP & Gasoline Engine Only) - Change..... 208
 Engine Oil (DEO and EO) 178
 Engine Oil Level - Check 192
 Engine Valve Lash (Diesel Engine Only) – Check, Adjust..... 229,234
 Environment Management..... 3
 Environment Protection..... 167
 Every 10 Service Hours or Daily 192
 Every 1000 Service Hours or 6 Months 224
 Every 1500 Service Hours or 9 Months 230
 Every 2000 Service Hours or Yearly 234
 Every 250 Service Hours or Monthly..... 204
 Every 2500 Service Hours or 15 Months 241
 Every 3000 Service Hours or 18 Months 246
 Every 500 Service Hours or 3 Months 214

F

Fatigue..... 168
 Finger Tip (Option)..... 154
 Fire or Explosion Prevention 15
 First 250 Service Hours or a Month 203
 First 50 - 100 Service Hours or a Week 198
 First Installation..... 169
 Fluid Penetration..... 14
 Foreword 2
 Fork Inspection 169
 Forks – Inspect 239
 Forward and Backward Adjustment 157
 Forward and Reverse Lever 156
 Fuel Filter (Diesel Engine Only) - Change..... 221
 Fuel Filter (LP Engine Only)..... 232
 Fuel Injectors (Diesel Engine Only) – Inspect, Clean, Test 233
 Fuel Lines & Fittings - Check..... 228
 Fuel Selector Switch (G420F(E)/G424F(E)/G424I(E) Dual Fuel Only)..... 73
 Fuel Specifications..... 176
 Fuel Tank Filter Cap and Screen (If Equipped) - Clean 185
 Fuel Trim Valve(FTV) Inspection (G420F(E) /G424F(E) /G424I(E) Engine Only) 219
 Function of Knobs 154
 Fuses..... 186
 Fuses, Bulbs, Circuit Breaker & Relay - Change, Reset..... 186

G

G420F Engine and G424F Engine and G424I Engine 90
 G420F(E) Engine..... 230,242
 G420F(E) Gasoline, LP and Dual Fuel Engines 209
 G420F(E)/G424F(E)/G424I(E) Engine Only 228
 G420FE Engine and G424FE Engine and G424IE Engine 89
 G424F(E) Engine..... 230,242
 G424F(E) LP and Dual Fuel Engines 209
 G424I(E) Engine 230,242
 G424I(E) LP and Dual Fuel Engines 210
 G430FE Engine Only 228
 G430FE Engine 125,230,242
 G430FE LP Engine..... 210
 Gasoline and LP Engines 192
 Gasoline Engine 81
 Gasoline or Diesel Engine Equipped 76
 Gasoline Specifications 177
 Gasoline, LP Engine Crankcase 208
 GC-Series Lift Trucks 236
 General Fuel Information 176
 General Hazard Information 10
 General Warning to Operator 6
 Governor Lever and Engine Speed Control (Diesel Engine Only) - Check ,Adjust..... 212

H

Hand Placement Warning..... 7
 Hook-on type Fork 163
 Horn and Lights (If Equipped) - Check..... 218
 How to Survive in a Tipover..... 29
 Hydraulic Oil - Check, Clean, Change 241
 Hydraulic Oil (HYDO) 178
 Hydraulic Oil Level – Check..... 206
 Hydraulic Return Filter – Change..... 203
 Hydraulic Return Filter, Breather & Strainer - Check, Change..... 224

I

Identification, Lift Capacity and Attachment Plate 67
 If Convenience Package Equipped 67
 If Optional Suspension Seat (weight adjusting type) Equipped 18
 If Parking Brake Alarm Equipped..... 162
 Important Safety Information 4
 Improper Modification or Repair..... 168
 Index 247
 Inching & Braking Control Shaft - Lubricate 218
 Inching into Loads 158
 Inching..... 88
 Inspect Battery System 241
 Inspect Coolant Hoses (LP, Dual Fuel Engine Only)..... 228

Inspect Electrical System (G420F(E) /G424F(E) /G424I(E) /G430FE Engine Only)	220
Inspect Engine for Exhaust Leaks.....	194
Inspect Engine for Fluid Leaks.....	192
Inspect Foot Pedal Operation (G420F(E) /G424F(E) /G424I(E) /G430FE Only)	194
Inspect for Intake Leaks (G420F(E) /G424F(E) /G424I(E) /G430FE Engine Only)	244
Inspect Ignition System (LP, Gasoline & Dual Fuel Engines Only)	230
Inspect Mixer Assembly (G420F(E) /G424F(E) /G424I(E) /G430FE Engine Only)	229
Inspect Throttle Assembly (G420F(E) /G424F(E) /G424I(E) /G430FE Engine Only)	229
Inspect Tightness (D, G - Series).....	211
Inspect Tightness (GC - Series).....	211
Inspect Vacuum Lines and Fittings (G420F(E) /G424F(E) /G424I(E) Engine Only)	219
Inspection from Operator's Seat, Engine OFF ...	196
Inspection from Operator's Seat, Engine ON	196
Inspection, Maintenance and Repair of Lift Truck Forks	167
Instrument Panel.....	68

L

Lift Chain Adjustment.....	225
Lift Chain Wear Test	225
Lift Chains - Test, Check, Adjust	225
Lift Control knob.....	154
Lift Control	75
Lift Fork Adjustment.....	163
Lift Truck Controls	74
Lift Truck Operation	87
Lift Truck Parking.....	13
Lift Truck Shipping	165
Lift Truck Stability Base	22
Lift Truck Stability	21
Lifting Drums or Round Objects	161
Lifting the Load	158
Literature Information.....	2
Load Backrest Must Be In Place Warning.....	7
Long Time Storage	164
LP Engine	82
LP Regulator/Converter Inspection (LP, Dual Fuel Engine Only).....	228
LP Specifications	177
Lubricant Information	178
Lubricant Viscosities and Refill Capacities.....	180
Lubricant Viscosities	180
Lubricating Grease (MPGM)	179

M

Machine Lifting and Tiedown Information.....	165
Maintenance and Repair.....	170

Maintenance Information	14
Maintenance Intervals	3,181
Maintenance	3
Make proper antifreeze additions.....	175
Malfunction Indicator Lamp (MIL) Operation.....	141
Manual Mode (Fail-Safe mode)	153
Mast Abbreviations	67
Mast Channels – Lubricate	195
Mast Hinge Pin – Lubricate.....	214
Mast Pivot Eyes-Lubricate	215
Mast, Carriage, Lift Chains & Attachments - Inspect, Lubricate.....	207
Metric Hardware	172
Mono-Ped Control System (Option).....	150
Mounting and Dismounting	11
Moving Fan Warning	8

N

No Riders Warning	8
No Standing On Fork Warning.....	7
No Standing Under Fork Warning.....	7
Noise and Vibration	47

O

Oil Cooled Disc Brake Only	179
Operating in hot weather	161
Operating Techniques	158
Operating the Lift Truck	12
Operation Information.....	11
Operation.....	2,152
Operator's Warning and Identification Plate.....	67
Operator's Warning Plate	67
Operator Restraint System(If Equipped).....	2,17
Operator's Station and Monitoring Systems.....	68
Overhead Guard – Inspect	216
Overhead Guard Must Be In Place Warning.....	8
Overloading.....	168

P

Parking Brake - Inspect	196
Parking Brake - Test, Adjust	201,218
Parking Brake Adjusting	202
Parking Brake Lever	75
Parking Brake Testing	201
Parking Brake	9,197
Parking the Lift Truck.....	162
PCV Valve System - Inspect, Clean	209
Power Shift Transmission/ Drive axle	87
Precleaner (If Equipped).....	204
Pressure Air.....	14
Pressure Warning.....	7
Prestart Conditions	81
Priming the Fuel System(Diesel Engine Only) ...	187

Product Description 151

R

Reading Diagnostic Fault Codes..... 104
 Refill Capacities 180
 Refueling 76
 Replace LP Fuel Filter Element (LP, Dual Fuel Engine Only) 232
 Replace Oxygen Sensor (G420F(E) /G424F(E) /G424I(E) /G430FE Engine Only) 242
 Replace PCV Valve and breather element - Change (LP, Gasoline and Dual Fuel Engines)..... 244
 Replace Spark Plugs (G420F(E)/G424I(E) Engine Only) 243
 Replace Spark Plugs (G424F(E) LP, Dual Fuel Engine / G430FE Engine Only)..... 231

S

Safety Rules 23
 Safety 2,5
 Seat Adjustment 18
 Seat Switch System (If Equipped)..... 72
 Seat 73
 Seat, Hood Latch & Support Cylinder - Check, Lubricate 185
 Serial Number Locations..... 64
 Serial Number 64
 Service Brake Pedal 74
 Servicing Filter Element 204
 Sideshift Attachment (If Equipped)..... 75
 Sideshift Attachment Control 155
 Specifications 31,33,35,37,39,41,43,45
 Stability and Center of Gravity 21
 Starting a Cold Diesel Engine 82
 Starting a Warm Diesel Engine 82
 Starting From a 12 Volt External Source 83
 Starting the Engine 81
 Starting the Lift truck 12
 Steer Suspension – Inspect 218
 Steer Wheel Bearings - Reassemble 234
 Steering Mechanism - Check, Lubricate 207
 Storage Information 164

T

Table of Contents 1
 Testing Fuel Lock-off Operation (LP Engine Only) 232
 Tilt Control knob..... 154
 Tilt Control 75
 Tilt Cylinders - Check, Adjust, Lubricate 214
 Tilt Steering Column 73
 Timing Belt [G420F(E)/G424F(E) LP, Gasoline, Dual

Fuel Engine Only] - Change..... 246
 Tire Inflation Information 171
 Tire Inflation Pressures Adjustment 171
 Tire Inflation..... 171
 Tire Shipping Pressure 171
 Tires and Wheels (D, G-Series) - Inspect, Check
 To Operate the Lift Truck after a Long Time Storage 164
 Torque for Metric Fasteners 173
 Torque for Standard Bolts, Nuts, and Taperlock Studs 172
 Torque for Standard Hose Clamps - Worm Drive 172
 Torque Specifications 172
 Torques for Bolts and Nuts with Standard Threads 172
 Torques for Taperlock Studs 173
 Towing Information 166
 Training Required To Operate or Service Warning 5
 Transmission Inching Control Pedal 74
 Transmission Oil Filter – Change..... 216
 Transmission Oil Level – Check 196
 Transmission Oil..... 179
 Transmission Oil, Oil Filter & Strainer - Check, Clean, Change..... 199,225
 Transportation Hints 165
 Traveling With the Load..... 159
 Turning 160

U

Universal Joint – Inspect..... 227
 Unloading 159
 Up and Down Adjustment 157

W

Walk-Around Inspection - Inspect..... 194
 Walk - Around Inspection..... 79
 Warning Lamp 155
 Warning Signs and Labels 5, 17
 Water Separator (4TNV98 Diesel Engine Only) - Clean 223
 Water Separator (Diesel Engine Only) - Check, Drain 189
 Wheel Bolts & Nuts - Inspect 211
 When Required..... 185