

Operation & Maintenance Manual

LIFT TRUCKS

D50S-5, D60S-5, D70S-5

D80S-5, D90S-5

G50S-5, G60S-5, G70S-5

 **WARNING**

Do not start, operate or service this machine unless you have read and understood these instructions and received proper training.

Unsafe or improper use of the machine may cause serious injury or death.

Operators and maintenance personnel must read this manual and receive training before operating or maintaining the machine.

This manual should be kept with the machine for reference and periodically reviewed by the machine operator and by all personnel who will come into contact with it.

The following warning is provided pursuant to California Health & Safety Code Sections 25247.5 et, seq,

 **WARNING**

California Proposition 65

Engine Exhaust, some of its constituents, and certain vehicle components contain or emit chemicals known to the State of California to cause cancer and birth defects or other reproductive harm.

Battery posts, terminals and related accessories contain lead and lead compounds, chemicals known to the State of California to cause cancer and birth defects or other reproductive harm.

WASH HANDS AFTER HANDLING.

Table of Contents

Information Section

Foreword	2
----------------	---

Safety Section

Safety	5
Warning Signs and Labels	5
General Hazard Information	10
Operation Information	11
Maintenance Information	14
Operator Restraint System (If Equipped)	17
Avoiding Lift Truck Tipover	21
Safety Rules	23
How to Survive in a Tipover (If Operator Restraint System Equipped)	28

General Section

Specifications	30
Noise & Vibration	38
Capacity Chart - Without Side Shifter	39
Capacity Chart - With Side Shifter	41
Serial Number	43
Operator's Warning and Identification Plate	45

Operation Section

Operator's Station and Monitoring Systems	47
Seat Switch System	52
Lift Truck Controls	56
Refueling	60
Before Starting the Engine	63
Starting the Engine	66
After Starting the Engine	69
Lift Truck Operation	105
Auto Shift Controller ASC-200/201 (If Equipped) ..	107
Operating Techniques	112
Parking the Lift Truck	116
Lift Fork Adjustment	117
Storage Information	118
Transportation Hints	119
Towing Information	120

Maintenance Section

Inspection, Maintenance and Repair of Lift Truck Forks	121
Tire Inflation Information	125
Torque Specifications	126
Cooling System Specifications	128
Fuel Specifications	130
Lubricant Specifications	132
Maintenance Intervals	136
When Required	140
Every 10 Service Hours or Daily	147
First 50-100 Service Hours or a Week	152
First 250 Service Hours or a Month	159
Every 250 Service Hours or Monthly	160
Every 500 Service Hours or 3 Months	168
Every 1000 Service Hours or 6 Months	172
Every 1500 Service Hours or 9 Months	178
Every 2000 Service Hours or Yearly	181
Every 2500 Service Hours or 15 Months	185

Index Section

Index	187
-------------	-----

Foreword

Literature Information

This manual should be stored in the operator's compartment in the literature holder or seat back literature storage area.

This manual contains safety, operation, transportation, lubrication and maintenance information.

Some photographs or illustrations in this publication show details or attachments that can be different from your lift truck. Guards and covers might have been removed for illustrative purposes.

Continuing improvement and advancement of product design might have caused changes to your lift truck which are not included in this publication. Read, study and keep this manual with the lift truck.

Whenever a question arises regarding your lift truck, or this publication, please consult your DOOSAN dealer for the latest available information.

Safety

The Safety Section lists basic safety precautions. In addition, this section identifies the text and locations of warning signs and labels used on the lift truck. Read and understand the basic precautions listed in the Safety Section before operating or performing lubrication, maintenance and repair on this lift truck.

Operator Restraint System (If Equipped)

This manual contains safety, operation and maintenance information for the DOOSAN operator restraint system. Read, study and keep it handy.

WARNING

Your DOOSAN truck comes equipped with an operator restraint system. Should it become necessary to replace the seat for any reason, it should only be replaced with another DOOSAN operator restraint system.

Photographs or illustrations guide the operator through correct procedures of checking, operation and maintenance of the DOOSAN operator restraint system.

SAFE and EFFICIENT OPERATION of a lift truck depends to a great extent on the skill and alertness on the part of the operator. To develop this skill the operator should read and understand the Safe Driving Practices contained in this manual.

Forklift trucks seldom tipover, but in the rare event they do, the operator may be pinned to the ground by the lift truck or the overhead guard. This could result in serious injury or death.

Operator training and safety awareness is an effective way to prevent accidents, but accidents can still happen. The DOOSAN operator restraint system can minimize injuries. The DOOSAN operator restraint system keeps the operator substantially within the confines of the operator's compartment and the overhead guard.

This manual contains information necessary for Safe Operation. Before operating a lift truck make sure that the necessary instructions are available and understood.

Operation

The Operation Section is a reference for the new operator and a refresher for the experienced one. This section includes a discussion of gauges, switches, lift truck controls, attachment controls, transportation and towing information. Photographs and illustrations guide the operator through correct procedures of checking, starting, operating and stopping the lift truck. Operating techniques outlined in this publication are basic. Skill and techniques develop as the operator gains knowledge of the lift truck and its capabilities.

Maintenance

The Maintenance Section is a guide to equipment care. The illustrated, step-by-step instructions are grouped by servicing intervals. Items without specific intervals are listed under "When Required" topics. Items in the "Maintenance Intervals" chart are referenced to detailed instructions that follow.

Maintenance Intervals

Use the service hour meter to determine servicing intervals. Calendar intervals shown (daily, weekly, monthly, etc.) can be used instead of service hour meter intervals if they provide more convenient servicing schedules and approximate the indicated service hour meter reading. Recommended service should always be performed at the interval that occurs first.

Under extremely severe, dusty or wet operating conditions, more frequent lubrication than is specified in the "Maintenance Intervals" chart might be necessary.

Perform service on items at multiples of the original requirement. For example, at "Every 500 Service Hours or 3 Months", also service those items listed under "Every 250 Service Hours or Monthly" and "Every 10 Service Hours or Daily".

Environment Management

Note that DOOSAN INDUSTRIAL VEHICLE DIVISION is ISO 14001 certified which is harmonized with ISO 9001. Periodic ENVIRONMENTAL AUDITS & ENVIRONMENTAL PERFORMANCE EVALUATIONS have been made by internal and external inspection entities. LIFECYCLE ANALYSIS has also been made through out the total product life. ENVIRONMENT MANAGEMENT SYSTEM includes DESIGN FOR ENVIRONMENT from the initial stage of the design. ENVIRONMENT MANAGEMENT SYSTEM considers environmental laws & regulations, reduction or elimination of resource consumption as well as environmental emission or pollution from industrial activities, energy saving, environment friendly product design (lower noise, vibration, emission, smoke, heavy metal free, ozone depleting substance free, etc.), recycling, material cost reduction, and even environmentally oriented education for the employee.

Important Safety Information

Most accidents involving product operation, maintenance and repair are caused by failure to observe basic safety rules or precautions. An accident can often be avoided by recognizing potentially hazardous situations before an accident occurs. A person must be alert to potential hazards, and use common sense. Persons must also have the necessary training, skills and tools before attempting to perform these functions.

Improper operation, lubrication, maintenance or repair of this product can be dangerous and could result in injury or death.

Do not operate or perform any lubrication, maintenance or repair on this product, until you have read and understood the operation, lubrication, maintenance and repair information.

Safety precautions and warnings are provided in this manual and on the product. If these hazard warnings are not heeded, bodily injury or death could occur to you or other persons.

The hazards are identified by the "Safety Alert Symbol" and followed by a "Signal Word" such as "WARNING" as shown below.



The meaning of this safety alert symbol is as follows:

Attention! Become Alert! Your Safety is Involved.

The message that appears under the warning, explaining the hazard, can be either written or pictorially presented.

Operations that may cause product damage are identified by NOTICE labels on the product and in this publication.

DOOSAN cannot anticipate every possible circumstance that might involve a potential hazard, and common sense is always required. The warnings in this publication and on the product are therefore not all inclusive. Before any tool, procedure, work method or operating technique not specifically recommended by DOOSAN is used, you must be sure that it is safe for you and others. You should also ensure that the product will not be damaged or made unsafe by the operation, lubrication, maintenance or repair procedures you choose.

The information, specifications, and illustration in this publication are on the basis of information available at the time it was written. The specifications, torques, pressures, measurements, adjustments, illustrations, and other items can change at any time. These changes can affect the service given to the product. Obtain the complete and most current information before starting any job. DOOSAN dealers have the most current information available.

Safety

The safety rules and regulations in this section are representative of some, but not all rules and regulations noted under the Occupational Safety and Health Act (OSHA) and are paraphrased without representation that the OSHA rules and regulations have been reproduced verbatim.

Please refer to 1910. 178 in Federal Register Vol. 37, No. 202, the National Fire Protection Association No. 505 (NFPA), American National Standard, ANSI B56. 1 Safety Standard for Low lift and High Lift Trucks and subsequent revisions for a complete list of OSHA rules and regulations as to the safe operation of powered industrial lift trucks. Since regulations vary from country to country outside in U.S.A., operate this lift truck in accordance with local regulations.

DOOSAN lift trucks are manufactured according to the regulations and standards laid down in EU Machinery Directive 98/37/EC and EMC directive 89/336/EC. Please refer to the Directives 89/655/EC and 89/391/EC and its amendments for the safe use of DOOSAN lift trucks.

The most effective method of preventing serious injury or death to the lift truck operator or others is for the lift truck operator to be familiar with the proper operation of the lift truck, to be alert and to avoid actions or conditions which can result in an accident.

Do not operate a lift truck if in need of repair, defective or in any way unsafe. Report all defects and unsafe conditions immediately. Do not attempt any adjustments or repairs unless trained and authorized to do so.

Warning Signs and Labels

There are several specific safety signs on your lift truck. Their exact location and description of the hazard are reviewed in this section. Please take the time to familiarize yourself with these safety signs.

Make sure that you can read all warning and instruction labels. Clean or replace these labels if you cannot read the words or see the pictures. When cleaning the labels use a cloth, water and soap. Do not use solvent, gasoline, etc.

You must replace a label if it is damaged, missing or cannot be read. If a label is on a part that is replaced, make sure a new label is installed on the replaced part. See your dealer for new labels.

Training Required To Operate or Service Warning

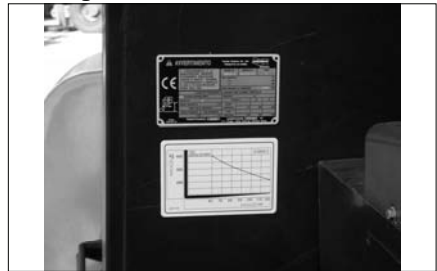

Located on the right side of the fire wall.

WARNING

Improper operation or maintenance could result in injury or death. Do not operate or work on the lift truck unless you are properly trained. Read and understand the Operation and Maintenance Manual. Additional manuals are available from DOOSAN Lift Truck dealers.

This label also provides allowable lift truck capacity information.

General Warnings to Operator



Located on the right side of the operator's seat.

WARNING

Only trained and authorized personnel may operate this machine. For safe operation, read and follow the operation and maintenance Manual furnished with this lift truck and observe the following warnings :

1. Before starting machine. Check all controls and warning devices for proper operation.
2. Refer to machine identification plate for allowable machine capacity. Do not overload. Operate machines equipped with attachments as partially loaded machines when not handling a load.
3. Put directional control or shift lever in neutral before "ON-OFF" switch is turned on.
4. Start, turn and brake smoothly. Slow down for turns, slippery or uneven surfaces. Extremely poor surfaces should be repaired. Avoid running over loose objects or holes in the roadway surfaces. Use extreme caution when turning on inclines.
5. Travel with load as low as possible and tilted back. If load interferes with visibility, travel with load trailing.
6. On grade operations travel with load up grade.
7. Watch out for pedestrians and obstructions. Check overhead clearances.
8. Do not permit riders on forks or machine at any time.
9. Do not allow anyone to stand or pass under the elevated portion of any machine.
10. Be sure operating surface can safely support machine.
11. Operate machine and attachments only from operator's position.
12. Do not handle unstable or loosely stacked loads.
13. Use minimum tilt when picking up or depositing a load.
14. Use extreme care when handling long, high, or wide loads.
15. Forks should be completely under load and spread apart as far as load permits.
16. Machine should be equipped with overhead guard or equivalent protection. Where load requires it, use load backrest extension. Use extreme caution if operating without these devices.
17. Parking-Lower lifting mechanism to floor. Put directional control or shift lever in neutral. Set parking/secondary brake. Turn "ON - OFF" switch off. Chock wheels if machine is on incline. Disconnect battery when storing electric machines.
18. Observe safety rules when handling fuel for engine powered machine and when changing batteries for electric machines.

Pressure Warning

⚠ WARNING

Contents under pressure may be hot. Allow to cool before opening.



Located on the radiator top tank by the radiator cap.

Hand Placement Warning

⚠ WARNING



No hands. Do not place hands in this area. Do not touch, lean on, or reach through the mast or permit others to do so.



Located on the mast.

No Standing On Forks Warning, No Standing Under Forks Warning

⚠ WARNING

Do not stand or ride on the forks. Do not stand or ride on a load or pallet on the forks. Do not stand or walk under the forks.

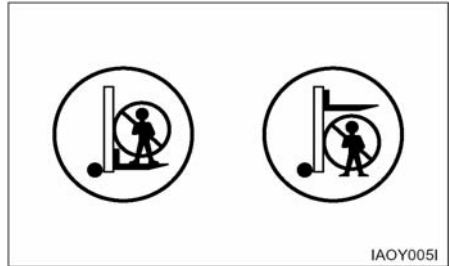

Located on the lift cylinder.

Load Backrest Must Be In Place Warning

⚠ WARNING

Operation without this device in place may be hazardous.

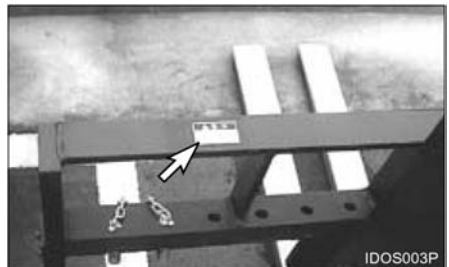

Located on the load backrest.

Overhead Guard Must Be In Place Warning

⚠ WARNING

Operation without this device in place may be hazardous. This guard conforms to A.N.S.I.B56.1 and F.E.M. Section IV. This design has been tested with an impact of appropriate value.



Located on the Overhead Guard.

No Riders Warning

⚠ WARNING

To avoid personal injury, allow no riders. A lift truck is designed for only one operator and no riders.



Located beside the operator's station.

Moving Fan Warning

⚠ WARNING

To avoid personal injury, stay clear of moving fan.



Located inside the engine compartment cover.

Parking brake



Pull the lever **BACK** to engage the parking brake.



Push the lever **FORWARD** to release the parking brake.

Applying the parking brake puts the transmission in **NEUTRAL**. The parking brake must be applied when leaving the lift truck and when starting the engine. If the operator leaves the seat without applying the parking brake, an audible alarm will sound.



⚠ WARNING

**When leaving machine apply parking brake!
Parking brake is not automatically applied.
Alarm will sound if parking brake is not applied.**

⚠ WARNING

Correct adjustment is necessary to provide adequate braking. See the MAINTENANCE section for adjustment procedures. The lift truck may creep at engine idle and can cause damage, injury or death. Always apply the parking brake when leaving the lift truck. The parking brake is NOT automatically applied.

General Hazard Information

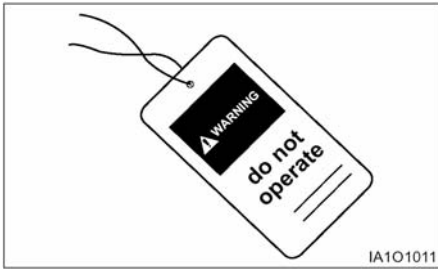

Attach a "Do not Operate" or similar warning tag to start switch or controls before servicing or repairing the lift truck.

Do not start or service the lift truck when a "DO NOT OPERATE" or similar warning tag is attached to the start switch or controls.

Wear a hard hat, protective glasses and other protective equipment as required by job conditions.

Know the width of your attachments so proper clearance can be maintained when operating near fences, boundary obstacles, etc.

Do not wear loose clothing or jewelry that can catch on controls or other parts of the lift truck.

Keep the lift truck, especially the deck and steps, free of foreign material such as debris, oil tools and other items which are not part of the lift truck.

Secure all loose items such as lunch boxes, tools and other items which are not part of the lift truck.

Know the appropriate work-site hand signals and who gives them. Accept signals from one person only.

Always use the overhead guard. The overhead guard is intended to protect the lift truck operator from overhead obstructions and from falling objects.

A truck that is used for handing small objects or uneven loads must be fitted with a load backrest.

If the lift truck must be operated without the overhead guard in place due to low overhead clearance, use extreme care. Make sure there is no possibility of falling objects from any adjacent storage or work area. Make sure the load is stable and fully supported by the carriage and the load backrest extension (if equipped).

Do not raise loads any higher than necessary and never raise a load higher than 1830 mm (72 in) with the overhead guard removed.

Always use load backrest extension when the carriage or attachment does not fully support the load. The load backrest extension is intended to prevent the load or any part of the load from falling backwards into the operator's station.

When operating the lift truck, Do not depend only on flashing lights or back-up alarm (if equipped) to warn pedestrians.

Always be aware of pedestrians and Do not proceed until the pedestrians are aware of your presence and intended actions and have moved clear of the lift truck and/or load.

Do not drive lift truck up to anyone standing in front of an object.

Obey all traffic rules and warning signs.

Keep hands, feet and head inside the operator station. Do not hold onto the overhead guard while operating the lift truck. Do not climb on any part of the mast or overhead guard or permit others to do so.

Do not allow unauthorized personnel to ride on the forks or any other part of the lift truck, at any time.

When working in a building or dock, observe floor load limits and overhead clearances.

Inhaling Freon gas through a lit cigarette or other smoking method or inhaling fumes released from a flame contacting Freon can cause bodily harm or death. Do not smoke when servicing air conditioners or wherever Freon gas may be present.

Never put maintenance fluids into glass containers.

Use all cleaning solutions with care.

Do not use steam, solvent, or high pressure to clean electrical components.

Report all needed repairs.



Inspect the part of the chain that is normally operated over the crosshead roller. When the chain bends over the roller, the movement of the parts against each other causes wear.

Inspect to be sure that chain link pins Do not extend outside of the bore hole.

If any single link pin is extended beyond its connecting corresponding link, it should be suspected of being broken inside of its bore hole.

Inspect the chain anchor and the anchor links for wear.

Do not change any factory set adjustment values (including engine rpm setting) unless you have both authorization and training. Especially Safety equipment and switches may not be removed or adjusted incorrectly. Repairs, adjustments and maintenances that are not correct can make a dangerous operating condition.

For any checkup, repair, adjustments, maintenance and all other work concerning your forklift truck, please contact your DOOSAN dealer. We would like to draw your attention to the fact that any secondary damages due to improper handling, insufficient maintenance, wrong repairs or the use of other than original DOOSAN spare parts waive any liability by DOOSAN.

Operation Information

Mounting and Dismounting

Mount and dismount the lift truck carefully.

Clean your shoes and wipe your hands before mounting.

Face the lift truck when mounting and dismounting.

Use both hands face the lift truck when mounting and dismounting.

Use the handgrips for mounting and dismounting.

Do not try to climb on or off the lift truck when carrying tools or supplies.

Never get on or off a moving lift truck.

Do not use any controls as handholds when entering or leaving the operator's station.

Never get on or off a moving lift truck. Never jump off the lift truck.

Keep hands and steering wheel free of slippery material.

Before Starting the Lift Truck

Perform a walk-around inspection daily and at the start of each shift. Refer to the topic "Walk-around Inspection" in "Every 10 Service Hours or Daily" section of this manual.

Adjust the seat so that full brake pedal travel can be obtained with the operator's back against the seatback.

Make sure the lift truck is equipped with a lighting system as required by conditions.

Make sure all hydraulic controls are in the HOLD position.

Make sure the direction control lever is in the NEUTRAL position.

Make sure the parking brake is engaged.

Make sure no one is standing and/or working on, underneath or close to the lift truck before operating the lift truck.

Operate the lift truck and controls only from the operator's station.

Make sure the lift truck horn, lights, backup alarm (if equipped) and all other devices are working properly.

Check for proper operation of mast and attachments. Pay particular attention to unusual noises or erratic movement which might indicate a problem.

Make sure service and parking brakes, steering, and directional controls are operational. Make sure all personnel are clear of lift truck and travel path.

Refer to the topic "Lift Truck Operation" in the "Operation Section" of this manual for specific starting instructions.

Starting the Lift Truck

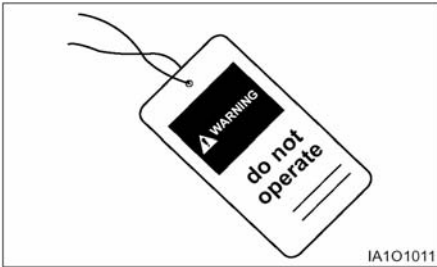

Do not start the engine or move any of the controls if there is a "DO NOT OPERATE" or similar warning tag attached to the start switch or controls.

Before Operating the Lift Truck

Test brakes, steering controls, horn and other devices for proper operation. Report any faulty performance. Do not operate lift truck until repaired.

Learn how your lift truck operates. Know its safety devices. Know how the attachments work. Before moving the lift truck, look around. Start, turn and brake smoothly.

An operator must constantly observe his lift truck for proper operation.

Operating the Lift Truck

Always keep the lift truck under control.

Obeys all traffic rules and warning signs.

Never leave the lift truck with the engine operating, or with the parking brake disengaged.

Operate the engine only in a well ventilated area.

Lower the mast, with or without load, before turning or traveling. Tip over could result. Watch out for overhead obstructions.

Always observe floor load limits and overhead clearance.

Start, turn, and brake smoothly. Slow down for turns, grades, slippery or uneven surfaces.

Watch the road carefully for any obstacle when driving the truck. Do not go fast over bumps, pot holes or other rough grounds, otherwise the engine might go OFF by a severe impact.

In case of engine going OFF, press the brake pedal at one time as hard as possible in order to stop the truck. Pressing the brake pedal several times has a risk that the brake would not work.

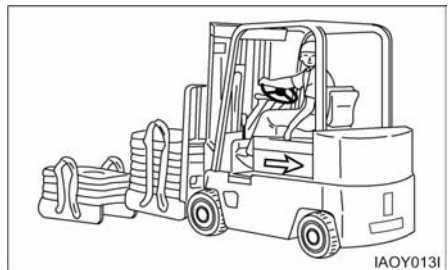

Use special care when operating on grades. Do not angle across or turn on grades. Do not use a lift truck on slippery grades. Travel with forks downgrade when unloaded. Travel with load upgrade.

Do not overload, or handle offset, unstable, or loosely stacked loads. Refer to load capacity plate on the lift truck. Use extreme caution when handling suspended, long, high or wide load.



Tilt an elevated load forward only when directly over unloading area and with load as low as possible.

Do not stunt ride or indulge in horseplay. Always look and keep a clear view of the path of travel.

Travel in reverse if load or attachment obstructs visibility. Use extreme caution if visibility is obstructed.

Stay in designated travel path, clear of dock edges, ditches, other drop-offs and surfaces which cannot safely support the lift truck.

Slow down and use extra care through doorways, intersections and other location where visibility is reduced.

Slow down for cross aisles, turns, ramps, dips, uneven or slippery surfaces and in congested areas and avoid pedestrians, other vehicles, obstruction, pot holes and other hazards or objects in the path of travel.

Always use overhead guards except where operation conditions Do not permit. Do not operate lift truck in high stacking areas without overhead guards.

When stacking, watch for falling objects. Use load backrest extension and overhead guard.

Refer to the topic "Operation Techniques" in the "Operation Section" of this manual.

Loading or Unloading Trucks/Trailers

Do not operate lift trucks on trucks or trailers which are not designed or intended for that purpose. Be certain truck or trailer brakes are applied and wheel chocks in place (or be certain unit is locked to the loading dock) before entering onto trucks or trailers.

If trailer is not coupled to tractor, make sure the trailer landing gear is properly secured in place. On

some trailers, extra supports may be needed to prevent upending or corner dipping.

Be certain dock plates are in good condition and properly placed and secured. Do not exceed the rated capacity of dock boards or bridge plates.

Lift Truck Parking

When leaving the operator station, park the lift truck in authorized areas only. Do not block traffic.



- Park the lift truck level, with the forks lowered and the mast tilted forward until the fork tips touch the floor.
- Move the direction control lever to NEUTRAL.
- Engage the parking brake.
- Turn the key switch off and remove the key.
- Turn the disconnect switch to OFF.
- Block the drive wheels when parking on an incline.

Maintenance Information

Perform all maintenance unless otherwise specified as follows :

- Park the lift truck in authorized areas only.
- Park the lift truck level, with the forks lowered and the mast tilted forward until the fork tips touch the floor.
- Place the transmission controls in neutral.
- Engage the parking brake.
- Stop the engine.
- Remove the start switch key and turn the disconnect switch OFF (if equipped).
- Block the drive wheels when parking on an incline.

Pressure Air

Pressure air can cause personal injury. When using pressure air for cleaning, wear a protective face shield, protective clothing and protective shoes.

The maximum air pressure must be below 205 kPa (30 psi) for cleaning purposes.

Fluid Penetration

Always use a board or cardboard when checking for a leak. Escaping fluid under pressure, even a pinhole size leak, can penetrate body tissue, causing serious injury, and possible death. If fluid is injected into your skin, it must be treated by a doctor familiar with this type of injury immediately.

Crushing or Cutting Prevention

Support equipment and attachments properly when working beneath them. Do not depend on hydraulic cylinders to hold it up. Any attachment can fall if a control is moved, or if a hydraulic line breaks.

Never attempt adjustments while the lift truck is moving or the engine is running unless otherwise specified.

Where there are attachment linkages, the clearance in the linkage area will increase or decrease with movement of the attachment.

Stay clear of all rotating and moving parts.

Keep objects away from moving fan blades. They will throw or cut any object or tool that falls or is pushed into them.

Do not use a kinked or frayed wire rope cable. Wear gloves when handling the wire rope cable.

Retainer pins, when struck with force, can fly out and injure nearby persons. Make sure the area is clear of people when driving retainer pins.

Wear protective glasses when striking a retainer pin to avoid injury to your eyes.

Chips or other debris can fly off objects when struck. Make sure no one can be injured by flying debris before striking any object.

Falling Objects Protective Structure (FOPS)

This is an attached guard located above the operator's compartment and secured to the lift truck.

To avoid possible weakening of the Falling Objects Protective Structure (FOPS), consult a DOOSAN dealer before altering, by adding weight to, welding on, or cutting or drilling holes into the structure.

The overhead guard is not intended to protect against every possible impact. The overhead guard may not protect against some objects penetrating into the operator's station from the sides or ends of the lift truck.

The lift truck is equipped with an overhead guard and FOPS as standard. If there is a possibility of overhead objects falling through the guard, the guard must be equipped with smaller holes or a Plexiglas cover.

Any altering done that is not specifically authorized by DOOSAN invalidates DOOSAN's FOPS certification. The protection offered by this FOPS will be impaired if it has been subjected to structural damage. Structural damage can be caused by an overturn accident, by falling objects, etc.

Do not mount any item such as fire extinguishers, first aid kits and lights by welding brackets to or drilling holes in any FOPS structure. See your DOOSAN dealer for mounting guidelines.

Burn Prevention

Coolant

At operating temperature, the engine coolant is hot and under pressure. The radiator and all lines to heaters or the engine contain hot water or steam.

Any contact can cause severe burns. Steam can cause personal injury.

Check the coolant level only after engine has been stopped and the filter cap is cool enough to remove with your bare hand.

Remove the cooling system filter cap slowly to relieve pressure.

Cooling system additive contains alkali that can cause personal injury. Avoid contact with the skin and eyes and Do not drink.

Allow cooling system components to cool before draining.

Oils

Hot oil and components can cause personal injury. Do not allow hot oil or components to contact the skin.

At operation temperature, the hydraulic tank is hot and can be under pressure.

Remove the hydraulic tank filter cap only after the engine has been stopped and the filter cap is cool enough to remove with your bare hand.

Remove the hydraulic tank filter cap slowly to relieve pressure.

Relieve all pressure in air, oil fuel or cooling systems before any lines, fittings or related items are disconnected or removed.

Batteries

Batteries give off flammable fumes which can explode.

Do not smoke when observing the battery electrolyte levels.

Electrolyte is an acid and can cause personal injury if it contacts skin or eyes.

Always wear protective glasses when working with batteries.

Fire or Explosion Prevention

All fuels, most lubricants and some coolant mixtures are flammable.

Fuel leaked or spilled onto hot surfaces or electrical components can cause a fire.

Do not smoke while refueling or in a refueling area.

Do not smoke in areas where batteries are charged, or where flammable materials are stored.

Batteries in series can be located in separate compartments. When using jumper cables always connect positive(+) cable to positive(+) terminal of battery connected to starter solenoid and negative(-) cable from external source to starter negative(-) terminal.

(If not equipped with starter negative (-) terminal, connect to engine block.)

See the Operation Section of this manual for specific starting instructions.

Clean and tighten all electrical connections. Check daily for loose or frayed electrical wires. Have all loose or frayed electrical wires tightened, repaired or replaced before operating the lift truck.

Keep all fuels and lubricants stored in properly marked containers and away from all unauthorized persons.

Store all oily rags or other flammable material in a protective container, in a safe place.

Do not weld or flame cut on pipes or tubes that contain flammable fluids. Clean them thoroughly with nonflammable solvent before welding or flame cutting on them.

Remove all flammable materials such as fuel, oil and other debris before they accumulate on the lift truck.

Do not expose the lift truck to flames, burning brush, etc., if at all possible.

Shields, which protect hot exhaust components from oil or fuel spray in the event of a line, tube or seal failure, must be installed correctly.

Do not operate in areas where explosive gases exist or are suspected.

Fire Extinguisher

Have a fire extinguisher-type BC and 1.5KG minimum capacity-on rear overhead guard leg with latch and know how to use it. Inspect and have it serviced as recommended on its instruction plate.

Ether

Ether is poisonous and flammable. Breathing ether vapors or repeated contact of ether with skin can cause personal injury.

Use ether only in well-ventilated areas.
Do not smoke while changing ether cylinders.

Use ether with care to avoid fires.
Do not store replacement ether cylinders in living areas or in the operator's compartment.

Do not store ether cylinders in direct sunlight or at temperatures above 39°C (102°F).

Discard cylinders in a safe place. Do not puncture or burn cylinders.

Keep ether cylinders out of the reach of unauthorized personnel.

Lines, Tubes and Hoses

Do not bend or strike high pressure lines. Do not install bent or damaged lines, tubes or hoses.

Repair any loose or damaged fuel and oil lines, tubes and hoses. Leaks can cause fires. Contact your DOOSAN dealer for repair or replacement.

Check lines, tubes and hoses carefully. Do not use your bare hand to check for leaks. Use a board or cardboard to check for leaks. See Fluid Penetration in the Safety Section for more details. Tighten all connections to the recommended torque. Replace if any of the following conditions are found.

- End fittings damaged or leaking.
- Outer covering chafed or cut and wire reinforcing exposed.
- Outer covering ballooning locally.
- Evidence of kinking or crushing of the flexible part of hose.
- Armoring embedded in the outer cover.
- End fittings displaced.

Make sure that all clamps, guards and heat shields are installed correctly to prevent vibration, rubbing against other parts, and excessive heat during operation.

Tire Information

Explosions of air-inflated tires have resulted from heat-induced gas combustion inside the tires. The heat, generated by welding or heating rim components, external fire, or excessive use of brakes can cause gaseous combustion.

A tire explosion is much more violent than a blowout. The explosion can propel the tire, rim and axle components as far as 500 m (1500 ft) or more from the lift truck. Both the force of the explosion and the flying debris can cause personal injury or death, and property damage.

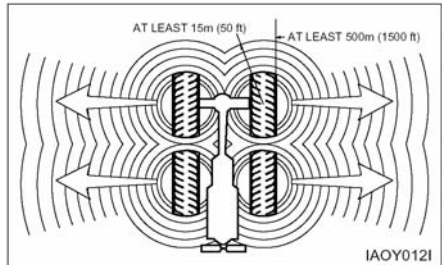

Do not approach a warm tire closer than the outside of the area represented by the shaded area in the above drawing.

Dry nitrogen (N₂) gas is recommended for inflation of tires. If the tires were originally inflated with air, nitrogen is still preferred for adjusting the pressure. Nitrogen mixes properly with air.

Nitrogen inflated tires reduce the potential of a tire explosion, because nitrogen does not support combustion. Also, nitrogen helps prevent oxidation and the resulting deterioration of rubber and corrosion of rim components.

Proper nitrogen inflation equipment and training in its use are necessary to avoid over inflation. A tire blowout or rim failure can result from improper or misused equipment.

Stand behind the tread and use a self-attaching chuck when inflating a tire.

Servicing, changing tires and rims can be dangerous and should be done only by trained personnel using proper tools and procedures. If correct procedures are not followed while servicing tires and rims, the assemblies could burst with explosive force and cause serious personal injury or death. Follow carefully the specific information provided by your tire or rim servicing personnel or dealer.

Operator Restraint System (If Equipped)

Warning Signs and Labels

Your DOOSAN lift truck has the following tipover warning decals.

Make sure that you can read all safety signs. Clean or replace these if you cannot read the words or see the pictures. When cleaning the labels use a cloth, water and soap. Do not use solvent, gasoline, etc. You must replace a label if it is damaged, missing or cannot be read. If a label is on a part that is replaced, make sure a new label is installed on the replaced part. See your DOOSAN Lift Truck dealer for new labels.

The most effective method of preventing serious injury or death to yourself or others is to familiarize yourself with the proper operation of the lift truck, to be alert, and to avoid actions or conditions which can result in an accident.

WARNING

Tipover can occur if the truck is improperly operated. In the event of tipover, injury or death could result.



IB900002



IB900003

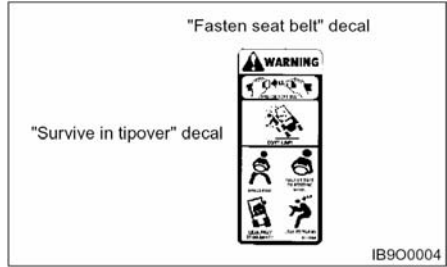

IB900004

The "Survive in tipover" warning is located on the overhead guard. It shows the proper use of the operator restraint system.

Seat Adjustment

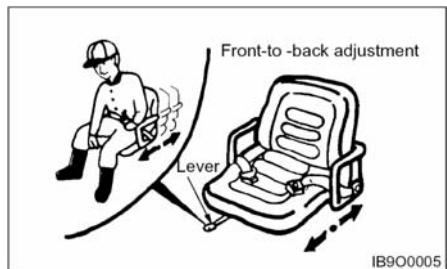

IB900005

Move the lever, slide the seat to the desired position, and release the lever.

Adjust the seat before operating the lift truck. After adjusting, set the seat to make sure it is properly locked. Do not adjust the seat while the truck is in motion.

WARNING

Do not place your hand or fingers under the seat. Injury may occur as the seat moves up and down.

If Optional Suspension Seat Equipped

Forward and Backward Adjustment

The seat can be adjusted by pushing the lever on the right side of seat.



Adjust the seat before operating the lift truck. After adjusting, set the seat to make sure it is properly locked. DO NOT adjust the seat while the truck is in motion.

Weight adjustment

Pull the weight adjustment lever upwards and move right or left side.
Adjust to driver's weight in 7 steps (50 ~ 110 kg)

NOTICE

Do not place your hand or fingers under the seat. Injury may occur as the seat moves up and down.

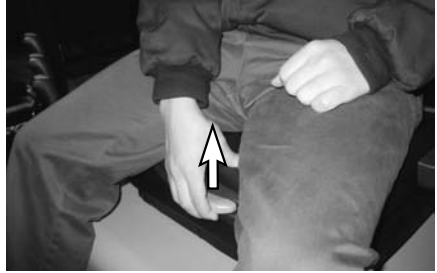

Backrest Inclination

The backrest angle can be adjusted by using the lever on the left side of seat.

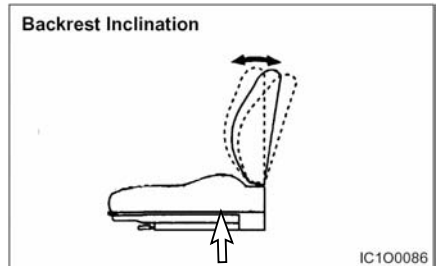

Seat Belt

The Operator Restraint System, Prevents the operator from the operator's compartment in the event of forward or side tipover. The system is designed to keep the operator on the seat and in the operator's compartment in the event of tipover.

Inspection

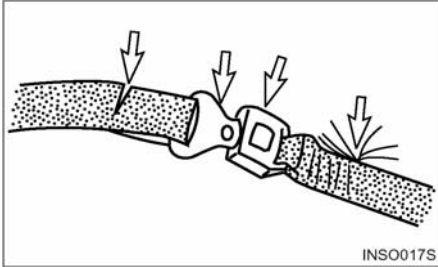

1. If the seat belt is torn, if pulling motion is interrupted during extension of the belt, or if the belt cannot be inserted into the buckle properly, replace the seat belt assembly.

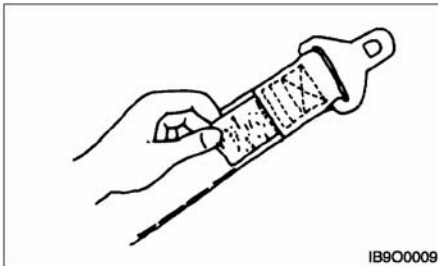

2. Belt Maintenance – Every 500 service hours. Check that the belt fastening works properly and that winding device is free from run lock when jerked. Check that the belt is suitably fastened to the seat. Check that the seat is correctly secured to the hood and the chassis. On visual inspection, fastenings must be intact, otherwise, contact the safety manager.

⚠ WARNING

Your DOOSAN truck comes equipped with a DOOSAN operator restraint system. Should it become necessary to replace the seat for any reason, it should only be replaced with another DOOSAN operator restraint system.



3. In the event of tipover, the seat and restraint system should be inspected for damage and replaced, if necessary.

NOTE: Operator restraints shall be examined at the regular truck service intervals. It is recommended that they be replaced if any of the following conditions are found:

- Cut or frayed strap
- Worn or damaged hardware including anchor points
- Buckle or retractor malfunction
- Loosen stitching

⚠ WARNING

The seat belt may cause the operator to bend at the waist. If you are pregnant or have suffered from some abdominal disease, consult a doctor before you use the seat belt.

Fasten the Seat Belt

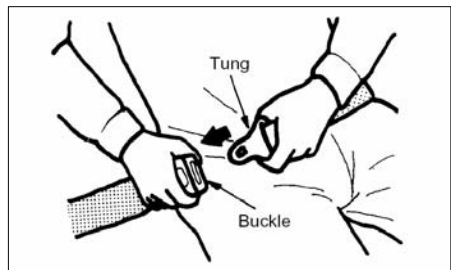

1. Grip the plate (connector) of the belt and pull the belt from the retractor. Then insert the plate into the slot of the buckle until a snap is heard. Pull on the belt to confirm it is latched.
2. Make sure the belt is not twisted.

⚠ WARNING

If you fasten the belt across your abdomen, the belt may injure your abdomen in an accident.

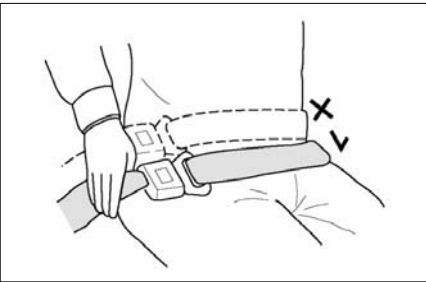

3. Be sure to fasten the belt across your hips, not across your abdomen.

NOTE: The belt is designed to automatically adjust to your size and movement. A quick pull on the belt will confirm that the automatic adjuster will hold the belt position in the event of an accident.

Release the Seat Belt

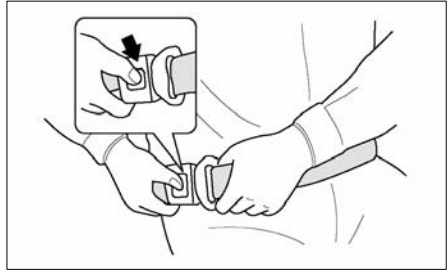

Push the button of the buckle to release the belt. The belt will automatically retract when released. Hold the plate of the belt and allow the belt to slowly retract.

Avoiding Lift Truck Tipover

Lift Truck Stability

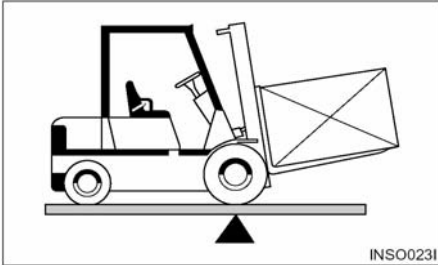

Counterbalanced lift truck design is based on the balance of two weights on opposite sides of a fulcrum (the front axle). The load on the forks must be balanced by the weight of the lift truck.

The location of the center of gravity of both the truck and the load is also a factor. This basic principle is used for picking up a load. The ability of the lift truck to handle a load is discussed in terms of center of gravity and both forward and sideways stability.

Center of Gravity (CG)

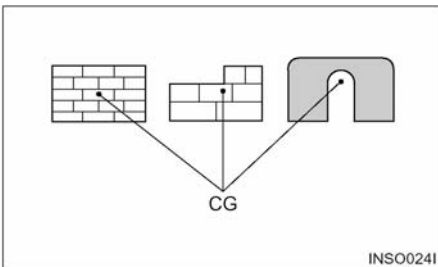

The point within an object, at which the whole weight of the object may be regarded as being concentrated, is called the center of gravity or CG. If the object is uniform, its geometric center will coincide with its CG. If it is not uniform, the CG could be at a point outside of the object. When the lift truck picks up a load, the truck and load have a new combined CG.

Stability and Center of Gravity

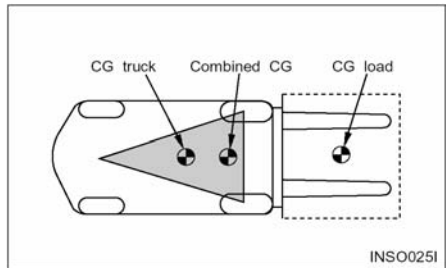

The stability of the lift truck is determined by the location of its CG; or, if the truck is loaded, the combined CG of the truck and load. The lift truck has moving parts and, therefore, has a CG that moves. The CG moves forward or backward as the mast is tilted forward or backward. The CG moves up or down as the mast moves up or down. The CG and, therefore, the stability of the loaded lift truck, are affected by a number of factors such as:

- the size, weight, shape and position of the load
- the height to which the load is lifted
- the amount of forward or backward tilt
- tire pressure
- dynamic forces created when the lift truck is accelerated, braked or turned
- condition and grade of surfaces on which the lift truck is operated

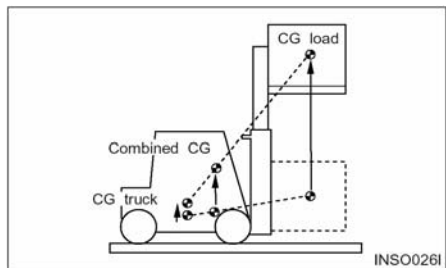

These same factors are also important for unloaded lift trucks. They tip over sideways easier than a loaded lift truck carrying its load in the lowered position.

Lift Truck Stability Base

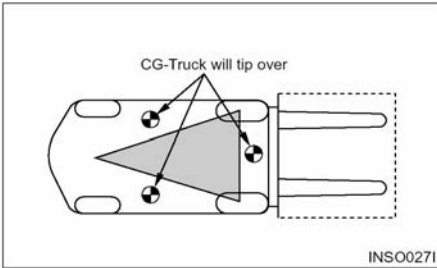

For the lift truck to be stable (not tip over forward or to the side), the CG must stay within the area of the lift truck stability base – a triangular area between the front wheels and the pivot of the steer wheels. If the CG moves forward of the front axle, the lift truck will tip forward. If the CG moves outside of the line on either side of the stability base, the lift truck will tip to the side.



Dynamic forces (braking, acceleration, turning) also affect stability and can produce tipover even when the CG is within the stability triangle.

Capacity Load (Weight and Load Center)

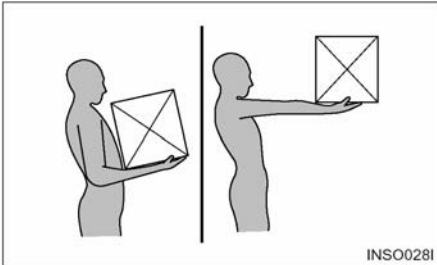

The capacity load of the lift truck is shown on the capacity/nameplate riveted to the truck. It is determined by the weight and load center. The load center is determined by the location of the CG of the load.

The load center shown on the nameplate is the horizontal distance from the front face of the forks, or the load face of an attachment, to the CG of the load. The location of the CG in the vertical direction is the same as the horizontal dimension.

Remember that, unless otherwise indicated, the

capacity load shown on the nameplate is for a standard lift truck with standard backrest, forks and mast, and having no special-purpose attachment. In addition, the capacity load assumes that the load center is no further from the top of the forks than it is from the face of the backrest. If these conditions do not exist, the operator may have to reduce the safe operating load because the truck stability may be reduced. The lift truck should not be operated if its capacity/nameplate does not indicate capacity load.

NOTE: If the load is not uniform, the heaviest portion should be placed closer to the backrest and centered on the forks.

NOTICE

1. Capacity/Nameplates originally attached to forklifts sold by DOOSAN shall not be removed, altered or replaced without DOOSAN's approval.
 2. DOOSAN assumes no responsibility for lift trucks placed in service without a valid DOOSAN Nameplate.
 3. If necessary to change your specification, contact your DOOSAN lift truck dealer.
-

Safety Rules



Only properly trained and authorized personnel should operate forklift trucks. Wear a hard hat and safety shoes when operating a lift truck. Do not wear loose clothing.



Inspect and check the condition of your forklift truck using the operator's check list before starting work. Immediately report to your supervisor any obvious defects or required repairs.

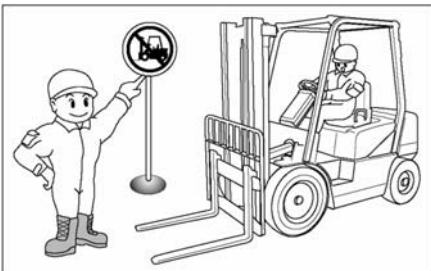

Do not operate your truck in unauthorized areas. Know your forklift truck and think safety. Do not compromise safety. Follow all safety rules and read all warning signs.

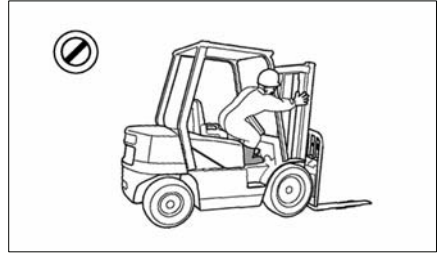

Do not operate a lift truck unless you are in the operator's seat. Keep hands and feet inside the operator's compartment. Do not put any part of the body outside of the operator's compartment. Never put any part of body into the mast structure or between the mast and the truck.

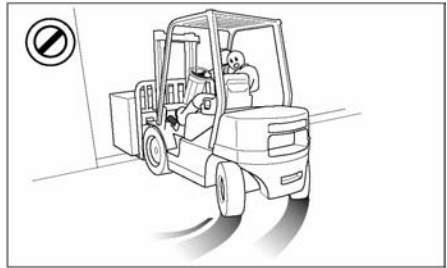

Do not start, stop, turn or change direction suddenly or at high speed. Sudden movement can cause the lift truck to tip over. Slow the speed of your truck and use the horn near corners, exits, entrances, and near people.

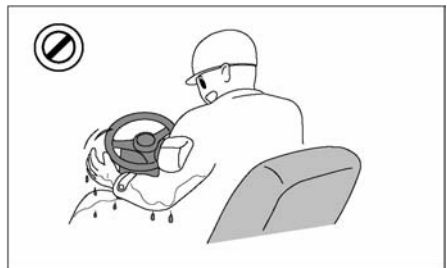

Never operate a lift truck with wet hands or shoes. Never hold any controls with grease on your hands. Your hands or feet will slide off of the controls and cause an accident.

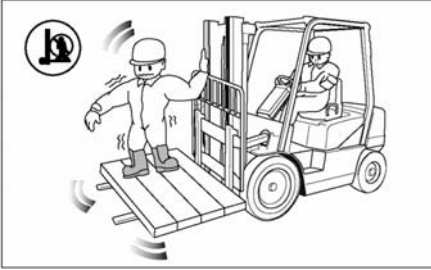

Do not raise anyone on the forks of your lift truck. Do not let other people ride on the truck. Lift trucks are designed to carry loads, not people.

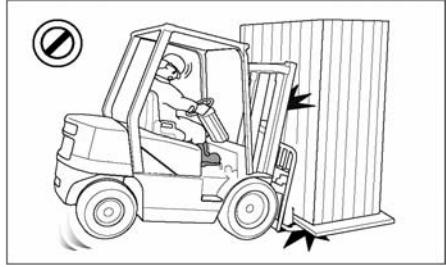

Do not overload. Always handle loads within the rated capacity shown on the capacity plate. Do not add extra counterweight to the truck. An overload can cause the truck to roll over and cause injury to personnel and damage to the lift truck.



Do not operate your truck without the load backrest extension and overhead guard. Keep the load against the backrest with the mast tilted backward.



Do not drive on soft ground. Observe all signs, especially those on maximum permitted floor loadings, elevator capacities and clearance heights. Handle loads carefully and check them closely for stability and balance.



Do not lift or move loads that are not safe. Do not pick up an off center load. Such a load increases the possibility of a tipover to the side. Make sure loads are correctly stacked and positioned across both forks. Always use the proper size pallet. Position the forks as wide as possible under the load. Position loads evenly on the forks for proper balance. Do not lift a load with one fork.



Do not drive on slippery surfaces. Sand, gravel, ice or mud can cause a tipover. If unavoidable, slow down.

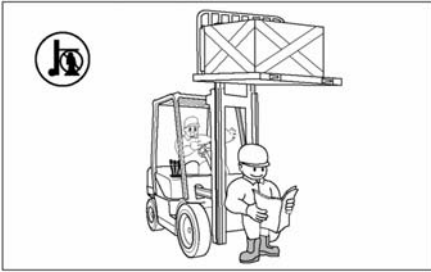

Do not permit anyone to stand or walk under the load or lifting mechanism. The load can fall and cause injury or death to anyone standing below.

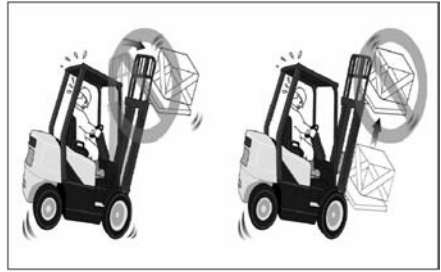

Do not elevate the load with the mast tilted forward. Do not tilt the elevated loads forwards. This will cause the lift truck to tip over forward.

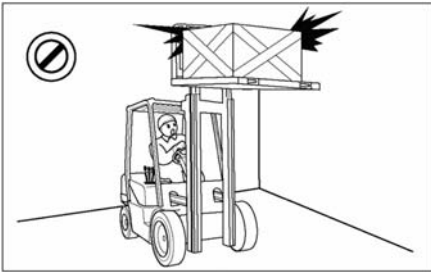

Look out for overhead obstructions when raising or stacking loads. Do not travel with a raised load. Do not travel with the mast raised. The lift truck can roll over and cause injury or death to you or other personnel.

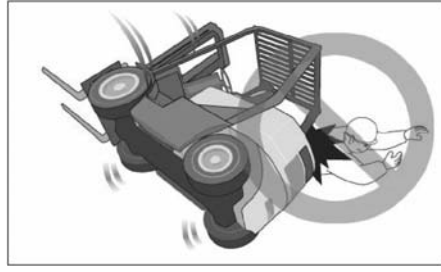

Do not jump off if your truck starts to tip over. Stay in your seat to survive.

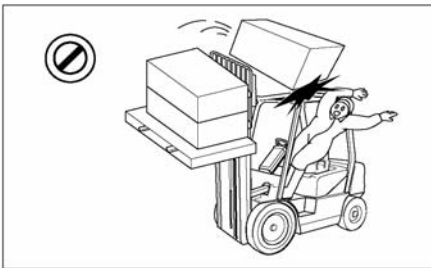

Do not move loose loads that are higher than the load backrest. Be alert for falling loads when stacking. Travel with the load tilted back and the forks as low as possible. This will increase stability to the truck and load and permit better visibility for you.

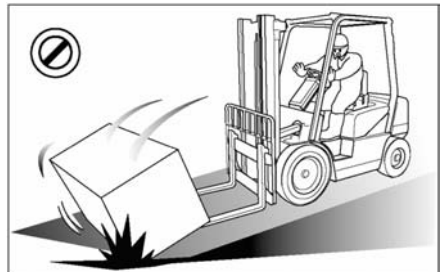

Go up ramps in forward direction and down ramps in reverse direction when moving loads. Never elevate a load with the forklift truck on an incline. Go straight off and straight down. Use an assistant when going up or down a ramp with a bulky load.

Safety Section

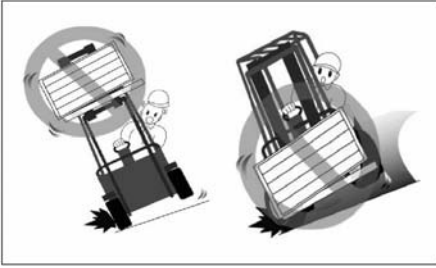

Do not stack or turn on ramps.
Do not attempt to pick-up or deposit a load unless the lift truck is level. Do not turn on or drive across an incline.



Do not drive in forward direction when loads restrict your visibility. Operate your lift truck in reverse to improve visibility except when moving up a ramp.

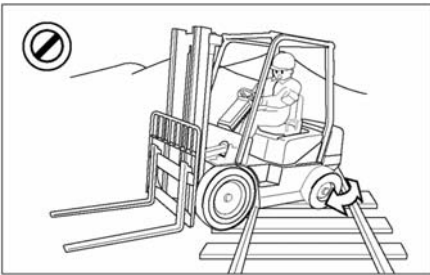

Do not go over rough terrain. If unavoidable, slow down.
Cross railroad tracks slowly and diagonally whenever possible. A railroad crossing can give a loaded forklift truck a real jolt. For smoother crossing, cross the railroad diagonally so one wheel crosses at a time.

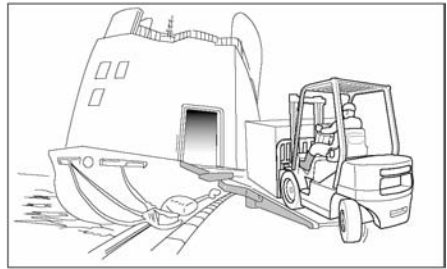

Be careful when operating a lift truck near the edge of a loading dock or ramp. Maintain a safe distance from the edge of docks, ramps and platforms. Always watch tail swing. The truck can fall over the edge and cause injury or death.

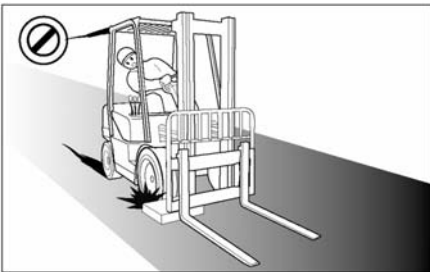

Avoid running over loose objects. Look in the direction of travel. Look out for other persons or obstructions in your path of travel. An operator must be in full control of his lift truck at all times.

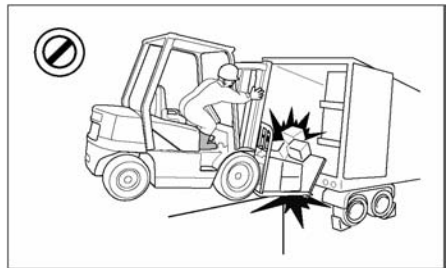

Do not operate on bridge plates unless they can support the weight of the truck and load. Make sure that they are correctly positioned. Put blocks on the vehicle you enter to keep it from moving.

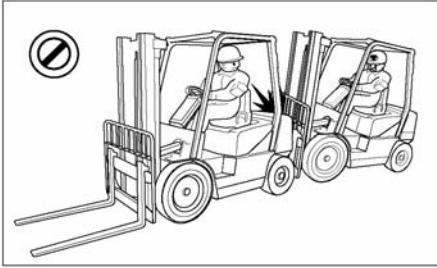

Do not operate your truck close to another truck. Always keep a safe distance from other trucks and make sure there is enough distance to stop safely. Never overtake other vehicles.

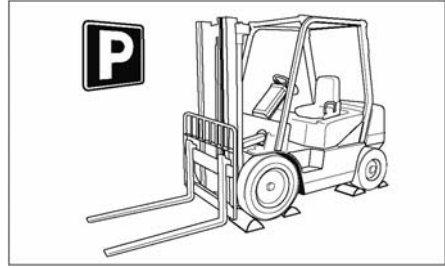

Park your lift truck in authorized areas only. Fully lower the forks to the floor, put direction lever in NEUTRAL position, engage the parking brake, and turn the key to the OFF position. Remove the key and put blocks behind the wheels to prevent the truck from rolling. Shut off your forklift truck when leaving it unattended.

Check the condition of your forklift truck after the day's work.



Do not use your lift truck to push or tow another truck.

Do not let another push or tow your truck.

If a truck will not move, call a service technician.

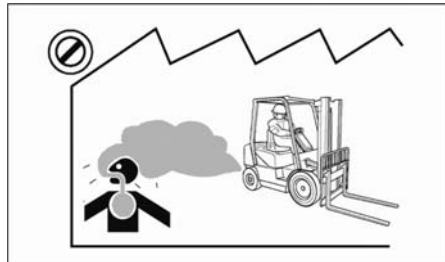

Exhaust from all internal combustion engines contains carbon monoxide, a colorless, odorless, tasteless, poisonous gas. Exposure to carbon monoxide can cause serious injury or health problems, including death, and avoid unnecessary idling of the engine. If nausea, dizziness or headaches are experienced stop the truck and seek fresh air.

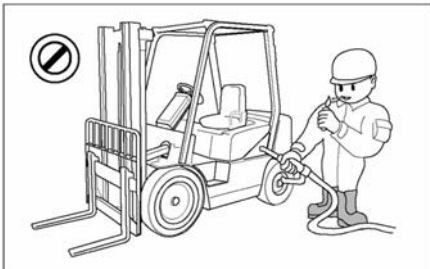

Forklift trucks may only be refueled at specially reserved locations. Switch off the engine when refueling.

Smoking and handling of naked flames during refueling are strictly prohibited. This prohibition also applies during the changing of the LPG (liquefied propane gas) tank.

Mop up spilt fuel and Do not forget to close the fuel tank before restarting the engine.

How to Survive in a Tipover (If Operator Restraint System Equipped)

WARNING

In the event of a tipover, the risk of serious injury or death will be reduced if the operator is using the operator restraint system and follows the instructions provided.

WARNING TIPOVER CAN OCCUR IF TRUCK IS IMPROPERLY OPERATED. INJURY OR DEATH COULD RESULT.

IN CASE OF TIPOVER

HOLD ON TIGHT

INSO0481

Hold on tight.

WARNING TIPOVER CAN OCCUR IF TRUCK IS IMPROPERLY OPERATED. INJURY OR DEATH COULD RESULT.

IN CASE OF TIPOVER

FASTEN SEAT BELT

INSO0461

Always use operator restraint system.

WARNING TIPOVER CAN OCCUR IF TRUCK IS IMPROPERLY OPERATED. INJURY OR DEATH COULD RESULT.

IN CASE OF TIPOVER

BRACE FEET

INSO0491

Brace your feet and keep them within the operator's compartment.

WARNING TIPOVER CAN OCCUR IF TRUCK IS IMPROPERLY OPERATED. INJURY OR DEATH COULD RESULT.

IN CASE OF TIPOVER

DON'T JUMP

INSO0471

Don't jump.



Lean away from the direction of fall.



Lean forward.

Specifications

CHARACTERISTICS				3 Speed	
1	Manufacturer			DOOSAN	DOOSAN
2	MODEL			D50S-5	D60S-5
3	Capacity	at rated load center	kg	5000	6000
4	Load center	distance	mm	600	600
5	Power type	electric, diesel, gasoline, LPG		diesel	diesel
6	Operator type	stand-on, rider-seated		rider-seated	rider-seated
7	Tire type	c=cushion, p=pneumatic		p	p
8	Wheels(x=driven)	number, front/rear		4/2	4/2
DIMENSIONS					
9	Lift with STD	maximum fork height with rated load	mm	3000	3000
10	two stage mast	free lift	mm	205	205
13	Forks	thickness x width x length	mm	60x150x1200	60x180x1200
		fork spacing (minimum x maximum)	mm	350x2032	410x2032
14	Tilt of mast	forward / backward	deg	15/10	15/10
15	Overall dimensions	length to face of forks	mm	3507	3568
16		width	mm	2108	2108
17		mast lowered height	mm	2500	2500
18		mast extended height	mm	4340	4340
19		overhead guard height	mm	2455	2455
20		seat height	mm	1333	1333
21	Turning radius (minimum outside)		mm	3301	3331
22	Load moment constant		mm	632	632
23	90 stacking aisle	add load length and clearance	mm	3924	3958
23a	90 intersecting aisle		mm	2990	3020
PERFORMANCE					
24	Speed	travel, loaded/unloaded	km/h	29.6/32.4	29.1/32.2
25		lift, loaded/unloaded	mm/s	500/530	490/530
26		lowering, loaded/unloaded	mm/s	501/450	501/450
28	Drawbar pull	at 1.6 km/h, loaded	kg	5990	5945
30	Gradeability	at 1.6 km/h, loaded	%	49.2	42.4
WEIGHT					
32	Total weight	unloaded	kg	8570	9240
33	Axle load	with loaded, front/rear	kg	12175/1395	13585/1655
34		without loaded, front/rear	kg	4435/4135	4300/4940
CHASSIS					
35	Tires	number of front/rear		4/2	4/2
36		size, front		8.25x15-14PR	8.25x15-14PR
37		size, rear		8.25x15-14PR	8.25x15-14PR
38	Wheel base		mm	2250	2250
39	Tread width	front/rear	mm	1584/1550	1584/1550
40	Ground clearance	loaded, at the lowest point	mm	176	176
41		loaded, at center of wheelbase	mm	205	205
42	Brakes	service brake		foot/hydraulic	foot/hydraulic
43		parking brake		hand/mechanical	hand/mechanical
DRIVE					
45	Battery	voltage/capacity	v/ah	24/75	24/75
49	Engine	manufacturer/model		DOOSAN/DB58S	DOOSAN/DB58S
50		rated output (at rpm)	KW(hp)/rpm	73.6(99.2)/2200	73.6(99.2)/2200
51		max. torque	N-m(lb-ft)/rpm	363(268)/1600	363(268)/1600
52		cycle/cylinders/displacement	cc	4/6/5785	4/6/5785
55	Transmission	type			
56		no. speeds forward/reverse		Full Auto	Full Auto

3 Speed			
DOOSAN	DOOSAN	DOOSAN	1
D70S-5	D80S-5	D90S-5	2
7000	8000	9000	3
600	600	600	4
diesel	diesel	diesel	5
rider-seated	rider-seated	rider-seated	6
p	p	p	7
4/2	4/2	4/2	8
3000	3100	3100	9
205	215	215	10
60x180x1200	70x180x1200	70x180x1200	13
410x2032	410x2092	410x2092	
15/10	15/10	15/10	14
3647	3970	4040	15
2108	2230	2230	16
2500	2835	2835	17
4340	4375	4375	18
2455	2648	2648	19
1333	1526	1526	20
3380	3610	3680	21
632	725	725	22
4000	4330	4355	23
3058	3308	3327	23a
28.5/32.0	29.8/33.8	27.7/33.4	24
445/470	430/470	430/470	25
499/450	500/450	500/450	26
5915	5498	5449	28
37.2	30.6	28.6	30
9970	11545	12195	32
14980/1990	14920/4360	16920/4705	33
4150/5820	4600/6500	4680/7315	34
4/2	4/2	4/2	35
8.25x15-14PR	9.00x20-14PR	9.00x20-14PR	36
8.25x15-14PR	9.00x20-14PR	9.00x20-14PR	37
2250	2500	2500	38
1584/1550	1640/1750	1646/1750	39
176	258	258	40
205	205	205	41
foot/hydraulic	foot/hydraulic	foot/hydraulic	42
hand/mechanical	hand/mechanical	hand/mechanical	43
24/75	24/75	24/75	45
DOOSAN/DB58S	DOOSAN/DB58S	DOOSAN/DB58S	49
73.6(99.2)/2200	73.6(99.2)/2200	73.6(99.2)/2200	50
363(268)/1600	363(268)/1600	363(268)/1600	51
4/6/5785	4/6/5785	4/6/5785	52
Full Auto	Full Auto	Full Auto	55
3/3	3/3	3/3	56

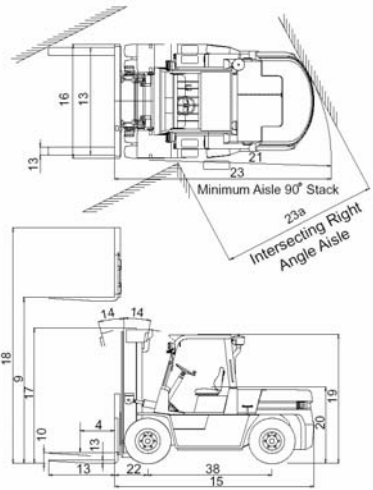

IA201004

Specifications

CHARACTERISTICS			
1	Manufacturer		
2	MODEL		
3	Capacity	at rated load center	kg
4	Load center	distance	mm
5	Power type	electric,diesel,gasoline,LPG	
6	Operator type	stand-on, rider-seated	
7	Tire type	c=cushion, p=pneumatic	
8	Wheels(x=driven)	number, front/rear	
DIMENSIONS			
9	Lift with STD	maximum fork height with rated load	mm
10	two stage mast	free lift	mm
13	Forks	thickness x width x length	mm
		fork spacing(minimum x maximum)	mm
14	Tilt of mast	forward / backward	deg
15	Overall dimensions	length to face of forks	mm
16		width	mm
17		mast lowered height	mm
18		mast extended height	mm
19		overhead guard height	mm
20		seat height	mm
21	Turning radius (minimum outside)		mm
22	Load moment constant		mm
23	90 stacking aisle	add load length and clearance	mm
23a	90 intersecting aisle		mm
PERFORMANCE			
24	Speed	travel, loaded/unloaded	km/h
25		lift, loaded/unloaded	mm/s
26		lowering, loaded/unloaded	mm/s
28	Drawbar pull	at 1.6 km/h, loaded	kg
30	Gradeability	at 1.6 km/h, loaded	%
WEIGHT			
32	Total weight	unloaded	kg
33	Axle load	with loaded, front/rear	kg
34		without loaded, front/rear	kg
CHASSIS			
35	Tires	number of front/rear	
36		size, front	
37		size, rear	
38	Wheel base		mm
39	Tread width	front/rear	mm
40	Ground clearance	loaded, at the lowest point	mm
41		loaded, at center of wheelbase	mm
42	Brakes	service brake	
43		parking brake	
DRIVE			
45	Battery	voltage/capacity	v/ah
49	Engine	manufacturer/model	
50		rated output (at rpm)	KW(hp)/rpm
51		max. torque	N-m(lb-ft)/rpm
52		cycle/cylinders/displacement	cc
55	Transmission	type	
56		no. speeds forward/reverse	

2 Speed			
DOOSAN	DOOSAN	DOOSAN	
D50S-5	D60S-5	D70S-5	1
5000	6000	7000	2
600	600	600	3
diesel	diesel	diesel	4
600	600	600	5
diesel	diesel	diesel	6
600	600	600	7
diesel	diesel	diesel	8
3000	3000	3000	9
205	205	205	10
60x150x1200	60x180x1200	60x180x1200	13
350x2032	410x2032	410x2032	13
15/10	15/10	15/10	14
3507	3568	3647	15
2108	2108	2108	16
2500	2500	2500	17
4340	4340	4340	18
2455	2455	2455	19
1333	1333	1333	20
3301	3331	3380	21
632	632	632	22
3924	3958	4000	23
2990	3020	3058	23a
25/26.5	24.5/26.5	24.0/26.5	24
415/445	415/445	415/445	25
490/460	490/460	490/460	26
4908	4875	4875	28
39.4	34.1	30.3	30
8395	9085	9810	32
12010/1385	13430/1655	14820/1990	33
4270/4125	4145/4940	3985/5830	34
4/2	4/2	4/2	35
8.25x15-14PR	8.25x15-14PR	8.25x15-14PR	36
8.25x15-14PR	8.25x15-14PR	8.25x15-14PR	37
2250	2250	2250	38
1584/1550	1584/1550	1584/1550	39
176	176	176	40
205	205	205	41
foot/hydraulic	foot/hydraulic	foot/hydraulic	42
hand/mechanical	hand/mechanical	hand/mechanical	43
24/75	24/75	24/75	45
DOOSAN/DB58S	DOOSAN/DB58S	DOOSAN/DB58S	49
69.1(93.1)/2400	69.1(93.1)/2400	69.1(93.1)/2400	50
323(238)/1600	323(238)/1600	323(238)/1600	51
4/6/5785	4/6/5785	4/6/5785	52
Power Shift	Power Shift	Power Shift	55
2/2	2/2	2/2	56

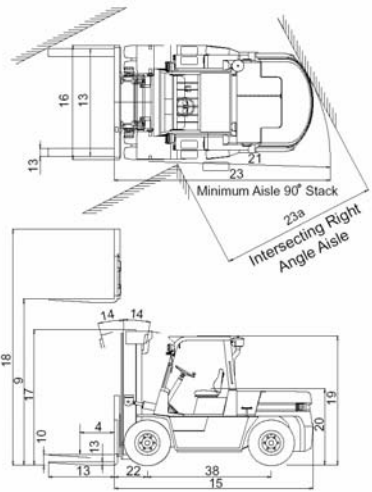

IA201004

Specifications

CHARACTERISTICS				TIER-2	
1	Manufacturer			DOOSAN	DOOSAN
2	MODEL			G50S-5	G60S-5
3	Capacity	at rated load center	kg	5000	6000
4	Load center	distance	mm	600	600
5	Power type	electric,diesel,gasoline,LPG		LPG	LPG
6	Operator type	stand-on, rider-seated		rider-seated	rider-seated
7	Tire type	c=cushion, p=pneumatic		p	p
8	Wheels(x=driven)	number, front/rear		4/2	4/2
DIMENSIONS					
9	Lift with STD	maximum fork height with rated load	mm	3000	3000
10	two stage mast	free lift	mm	205	205
13	Forks	thickness x width x length	mm	60x150x1200	60x180x1200
		fork spacing(minimum x maximum)	mm	350x2032	410x2032
14	Tilt of mast	forward / backward	deg	15/10	15/10
15	Overall dimensions	length to face of forks	mm	3507	3568
16		width	mm	2108	2108
17		mast lowered height	mm	2500	2500
18		mast extended height	mm	4340	4340
19		overhead guard height	mm	2455	2455
20		seat height	mm	1333	1333
21	Turning radius (minimum outside)		mm	3301	3331
22	Load moment constant		mm	632	632
23	90 stacking aisle	add load length and clearance	mm	3924	3958
23a	90 intersecting aisle		mm	2990	3020
PERFORMANCE					
24	Speed	travel, loaded/unloaded	km/h	24.0/25.4	23.8/25.4
25		lift, loaded/unloaded	mm/s	380/410	380/410
26		lowering, loaded/unloaded	mm/s	490/460	490/460
28	Drawbar pull	at 1.6 km/h, loaded	kg	5010	4990
30	Gradeability	at 1.6 km/h, loaded	%	40.9	35.5
WEIGHT					
32	Total weight	unloaded	kg	8235	8905
33	Axle load	with loaded, front/rear	kg	11840/1395	13260/1645
34		without loaded, front/rear	kg	4100/4135	3975/4930
CHASSIS					
35	Tires	number of front/rear		4/2	4/2
36		size, front		8.25x15-14PR	8.25x15-14PR
37		size, rear		8.25x15-14PR	8.25x15-14PR
38	Wheel base		mm	2250	2250
39	Tread width	front/rear	mm	1584/1550	1584/1550
40	Ground clearance	loaded, at the lowest point	mm	176	176
41		loaded, at center of wheelbase	mm	205	205
42	Brakes	service brake		foot/hydraulic	foot/hydraulic
43		parking brake		hand/mechanical	hand/mechanical
DRIVE					
45	Battery	voltage/capacity	v/ah	12/75	12/75
49	Engine	manufacturer/model		G643E(TIER-2)	G643E(TIER-2)
50		rated output (at rpm)	KW(hp)/rpm	69.0/2450	69.0/2450
51		max. torque	N-m(lb-ft)/rpm	301/1400	301/1400
52		cycle/cylinders/displacement	cc	4/6/4294	4/6/4294
55	Transmission	type			
56		no. speeds forward/reverse		Power Shift	Power Shift

TIER-2		TIER-3			
DOOSAN	DOOSAN	DOOSAN	DOOSAN	DOOSAN	1
G70S-5	G50S-5	G60S-5	G70S-5		2
7000	5000	6000	7000		3
600	600	600	600		4
LPG	LPG	LPG	LPG		5
rider-seated	rider-seated	rider-seated	rider-seated		6
p	p	p	p		7
4/2	4/2	4/2	4/2		8
3000	3000	3000	3000		9
205	205	205	205		10
60x180x1200	60x150x1200	60x180x1200	60x180x1200		13
410x2032	350x2032	410x2032	410x2032		
15/10	15/10	15/10	15/10		14
3647	3507	3568	3647		15
2108	2108	2108	2108		16
2500	2500	2500	2500		17
4340	4340	4340	4340		18
2455	2455	2455	2455		19
1333	1333	1333	1333		20
3380	3301	3331	3380		21
632	632	632	632		22
4000	3924	3958	4000		23
3058	2990	3020	3058		23a
23.6/25.4	24.0/25.4	23.8/25.4	23.6/25.4		24
380/410	380/410	380/410	380/410		25
490/460	490/460	490/460	490/460		26
4965	5010	4990	4965		28
31.3	40.9	35.5	31.3		30
9635	8235	8905	9635		32
14650/1985	11840/1395	13260/1645	14650/1985		33
3815/5820	4100/4135	3975/4930	3815/5820		34
4/2	4/2	4/2	4/2		35
8.25x15-14PR	8.25x15-14PR	8.25x15-14PR	8.25x15-14PR		36
8.25x15-14PR	8.25x15-14PR	8.25x15-14PR	8.25x15-14PR		37
2250	2250	2250	2250		38
1584/1550	1584/1550	1584/1550	1584/1550		39
176	176	176	176		40
205	205	205	205		41
foot/hydraulic	foot/hydraulic	foot/hydraulic	foot/hydraulic		42
hand/mechanical	hand/mechanical	hand/mechanical	hand/mechanical		43
12/75	12/75	12/75	12/75		45
G643E(TIER-2)	G643E(TIER-3)	G643E(TIER-3)	G643E(TIER-3)		49
69.0/2450	69.0(93)/2450	69.0(93)/2450	69.0(93)/2450		50
301/1400	294(217)/1600	294(217)/1600	294(217)/1600		51
4/6/4294	4/6/4294	4/6/4294	4/6/4294		52
Power Shift	Power Shift	Power Shift	Power Shift		55
2/2	2/2	2/2	2/2		56

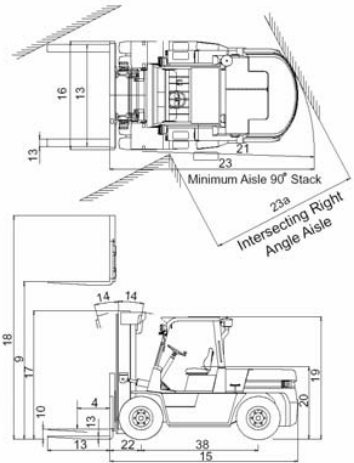

IA201004

Specifications

CHRACTERISTICS			
1	Manufacturer		
2	MODEL		
3	Capacity	at rated load center	kg
4	Load center	distance	mm
5	Power type	electric,diesel,gasoline,LPG	
6	Operator type	stand-on, rider-seated	
7	Tire type	c=cushion, p=pneumatic	
8	Wheels(x=driven)	number, front/rear	
DIMENSIONS			
9	Lift with STD	maximum fork height with rated load	mm
10	two stage mast	free lift	mm
13	Forks	thickness x width x length	mm
		fork spacing(minimum x maximum)	mm
14	Tilt of mast	forward / backward	deg
15	Overall dimensions	length to face of forks	mm
16		width	mm
17		mast lowered height	mm
18		mast extended height	mm
19		overhead guard height	mm
20		seat height	mm
21	Turning radius (minimum outside)		mm
22	Load moment constant		mm
23	90 stacking aisle	add load length and clearance	mm
23a	90 intersecting aisle		mm
PERFORMANCE			
24	Speed	travel, loaded/unloaded	km/h
25		lift, loaded/unloaded	mm/s
26		lowering, loaded/unloaded	mm/s
28	Drawbar pull	at 1.6 km/h, loaded	kg
30	Gradeability	at 1.6 km/h, loaded	%
WEIGHT			
32	Total weight	unloaded	kg
33	Axle load	with loaded, front/rear	kg
34		without loaded, front/rear	kg
CHASSIS			
35	Tires	number of front/rear	
36		size, front	
37		size, rear	
38	Wheel base		mm
39	Tread width	front/rear	mm
40	Ground clearance	loaded, at the lowest point	mm
41		loaded, at center of wheelbase	mm
42	Brakes	service brake	
43		parking brake	
DRIVE			
45	Battery	voltage/capacity	v/ah
49	Engine	manufacturer/model	
50		rated output (at rpm)	KW(hp)/rpm
51		max. torque	N-m(lb-ft)/rpm
52		cycle/cylinders/displacement	cc
55	Transmission	type	
56		no. speeds forward/reverse	

NON_CERTI			
DOOSAN	DOOSAN	DOOSAN	1
G50S-5	G60S-5	G70S-5	2
5000	6000	7000	3
600	600	600	4
LPG	LPG	LPG	5
rider-seated	rider-seated	rider-seated	6
p	p	p	7
4/2	4/2	4/2	8
3000	3000	3000	9
205	205	205	10
60x150x1200	60x180x1200	60x180x1200	13
350x2032	410x2032	410x2032	
15/10	15/10	15/10	14
3507	3568	3647	15
2108	2108	2108	16
2500	2500	2500	17
4340	4340	4340	18
2455	2455	2455	19
1333	1333	1333	20
3301	3331	3380	21
632	632	632	22
3924	3958	4000	23
2990	3020	3058	23a
24.0/25.4	23.8/25.4	23.6/25.4	24
380/410	380/410	380/410	25
490/460	490/460	490/460	26
5010	4990	4965	28
40.9	35.5	31.3	30
8235	8905	9635	32
11840/1395	13260/1645	14650/1985	33
4100/4135	3975/4930	3815/5820	34
4/2	4/2	4/2	35
8.25x15-14PR	8.25x15-14PR	8.25x15-14PR	36
8.25x15-14PR	8.25x15-14PR	8.25x15-14PR	37
2250	2250	2250	38
1584/1550	1584/1550	1584/1550	39
176	176	176	40
205	205	205	41
foot/hydraulic	foot/hydraulic	foot/hydraulic	42
hand/mechanical	hand/mechanical	hand/mechanical	43
12/75	12/75	12/75	45
G643	G643	G643	49
69(93) /2450	69(93) /2450	69(93) /2450	50
301(222)/1400	301(222)/1400	301(222)/1400	51
4/6/4294	4/6/4294	4/6/4294	52
Power Shift	Power Shift	Power Shift	55
2/2	2/2	2/2	56

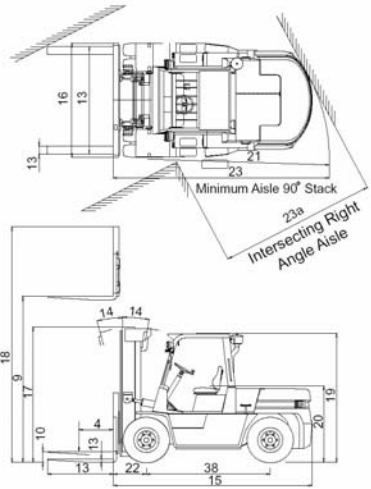

IA2O1004

Noise &Vibration

Noise

Model		Noise Level [Unit : dB(A)]				
		Sound Pressure Level at Operator's ear (Leq.)		Sound Pressure Level at By-stander position (AS 3713)		Guaranteed Sound Power Level (L _{WA})
		AS 3713	prEN 12053	Drive-By	Lifting Mode	
D50S-5 D60S-5 D70S-5 D80S-5 D90S-5 (3 speed)	W/O Cabin	83.7	85.8	81.3	78.3	109
	With Cabin	87.5	89.6	85	86	110
D50S-5 D60S-5 D70S-5 (2 speed)	W/O Cabin	82.8	85.1	81.7	78.3	109
G50/60/70S-5	W/O Cabin	82.7	84.5	83.4	84.7	107

* Test Model: D70S-5(3 Speed), D70S-5(2 Speed), G70S-5

Vibration (weighted overall value)

Unit: m/sec²

Model	Measuring Place		
	Seat	Steering Wheel	Floor Plate
D50/60/70/80/90S-5 (3 speed)	0.1	0.2	0.1
D50/60/70S-5 (2 speed)	0.3	1.8	0.5
G50/60/70S-5	0.3	1.4	0.4

* Test course: Concrete road

Capacity Chart - Without Side Shifter

MODEL	STD	FFT
D50S-5, G50S-5		<p data-bbox="703 411 871 491"> A. FFT 4550mm MAST B. FFT 5000mm MAST C. FFT 5600mm MAST D. FFT 6050mm MAST </p>
	D60S-5, G60S-5	
D70S-5, G70S-5		

Capacity Chart - Without Side Shifter

MODEL	STD	FFT
D80S-5		<p style="text-align: center;">A-FFT 4350-5400mm MAST B-FFT 5850mm MAST</p>
D90S-5		<p style="text-align: center;">A-FFT 4350-5400mm MAST B-FFT 5850mm MAST</p>

Capacity Chart - With Side Shifter

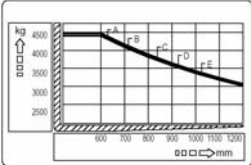
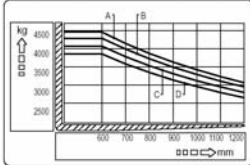
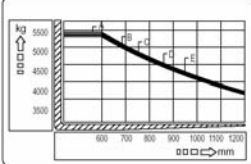
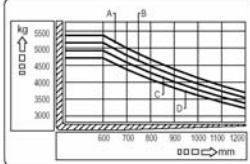
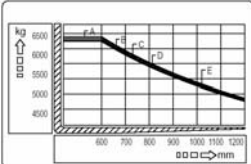
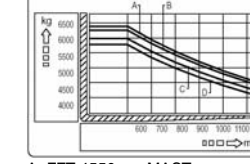
MODEL	STD	FFT
<p>D50S-5, G50S-5</p>	 <p>A. 3000 ~ 4000 mm (118 in - 158 in) MFH MAST B. 4500 mm (177 in) MFH MAST C. 5000 mm (197 in) MFH MAST D. 5500 mm (217 in) MFH MAST E. 6000 mm (236 in) MFH MAST</p>	 <p>A. FFT 4550mm MAST B. FFT 5000mm MAST C. FFT 5600mm MAST D. FFT 6050mm MAST</p>
	 <p>A. 3000 ~ 4000 mm (118 in - 158 in) MFH MAST B. 4500 mm (177 in) MFH MAST C. 5000 mm (197 in) MFH MAST D. 5500 mm (217 in) MFH MAST E. 6000 mm (236 in) MFH MAST</p>	 <p>A. FFT 4550mm MAST B. FFT 5000mm MAST C. FFT 5600mm MAST D. FFT 6050mm MAST</p>
<p>D70S-5, G70S-5</p>	 <p>A. 3000 ~ 4000 mm (118 in - 158 in) MFH MAST B. 4500 mm (177 in) MFH MAST C. 5000 mm (197 in) MFH MAST D. 5500 mm (217 in) MFH MAST E. 6000 mm (236 in) MFH MAST</p>	 <p>A. FFT 4550mm MAST B. FFT 5000mm MAST C. FFT 5600mm MAST D. FFT 6050mm MAST</p>

Capacity Chart - With Side Shifter

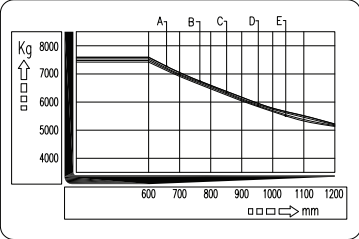
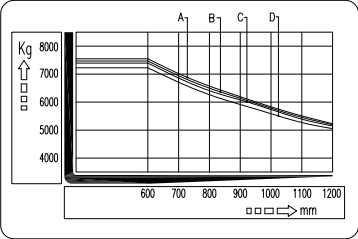
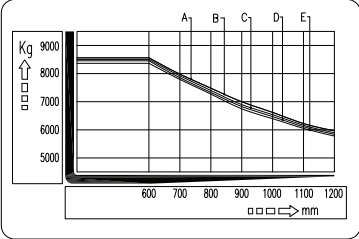
MODEL	STD	FFT
<p style="text-align: center;">D80S-5</p>	 <p style="text-align: center;"> A-STD 3100-3600mm MAST B-STD 4100mm MAST C-STD 4600mm MAST D-STD 5100mm MAST E-STD 5600mm MAST </p>	 <p style="text-align: center;"> A-FFT 4350mm MAST B-FFT 4800mm MAST C-FFT 5400mm MAST D-FFT 5850mm MAST </p>
	<p style="text-align: center;">D90S-5</p>	 <p style="text-align: center;"> A-STD 3100-3600mm MAST B-STD 4100mm MAST C-STD 4600mm MAST D-STD 5100mm MAST E-STD 5600mm MAST </p>

Serial Number

Serial Number Locations

For quick reference, record your lift truck's serial numbers in the spaces provided below the photographs.



Typical Example

Lift Truck Serial Number

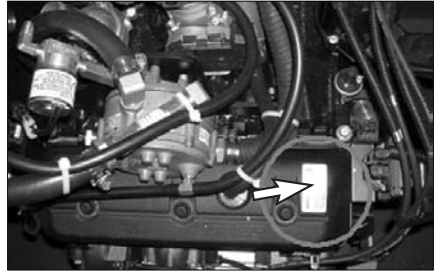

4.3 liter GM Vortec Engine Serial Number (G643E)

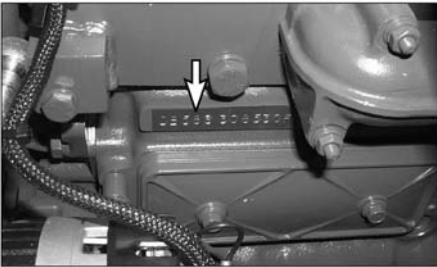

Typical Example

Diesel Engine

5.8 liter (DB58S) Diesel Engine Serial Number

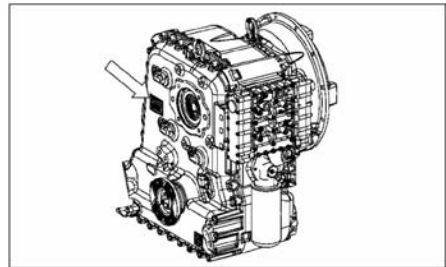

D50/60/70/80/90S-5(3 speed)

Transmission Serial Number



Typical Example

G50/60/70S-5

4.3 liter GM Vortec Engine Serial Number (G643)



D50/60/70S-5(2 speed), G50/60/70S-5

Transmission Serial Number

General Section



D50/60/70/80/90S-5(3 speed), G50/60/70S-5

Transmission Serial Number



Side shifter Serial Number (If equipped)



DRIVE AXLE Serial Number (OCDB type)

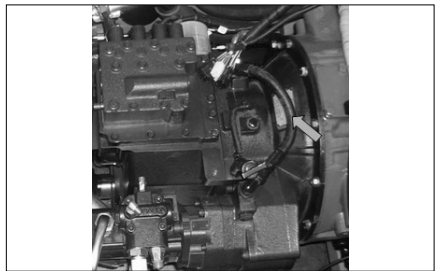

D50/60/70S-5(2 speed), G50/60/70S-5



DRIVE AXLE Serial Number (Shoe type)

Operator's Warning and Identification Plate

Familiarize yourself with the Operator's WARNING Plate and IDENTIFICATION, LIFT CAPACITY and ATTACHMENT PLATES. DO NOT exceed Capacity as equipped load ratings.

WARNING

The load capacity of lift truck should never be exceeded. Overloading of the lift truck could be a hazard to the safety of others, material, or damage the truck.

Operator's Warning Plate



Typical Example

Located by the right side of the operator's seat.

Identification, Lift Capacity and Attachment Plate



Typical Example

Located on the cowl to the right side of the steering column.

Lift Truck Capacity Rating

DO NOT exceed allowable lift truck working capacity load ratings.

The capacity of the lift truck is given by weight and distance to the load center. For example: a capacity of 1200kg(2640 lb) at 600mm(24in) means that the lift truck can lift 1200kg(2640lb) if the load center is 600 mm (24in) from both the vertical and horizontal faces of the forks.

Before attempting to lift any load, ensure that the weight and load center combination is within the capacity of the lift truck as shown on the capacity rating plate. To determine the load center, measure the distance from the face of the carriage to the gravitational center of the load.

The rated capacity on the plate refers to the capacity of the lift truck as it left the factory. Subsequent changes of any form to the equipment or battery can alter the lift truck's rating.

The rated capacity of the lift truck applies to operating conditions where the lift truck is on level ground. The capacity of the lift truck is reduced on inclines.

Below are abbreviations that may appear on the Identification, Lift Capacity and Attachment Plate and their meanings.

Mast Abbreviations

- STD -** Standard Mast
(single inner member, low free lift)
 - FF -** Full Free Lift Mast
(single inner member with high free lift duplex cylinder)
 - FFT -** Triple Lift Mast (two inner members) with either low or full free lift characteristics.
 - QUAD** Quadruple (Quad) Mast(with three inner members)
- NOTE:** When only a mast-type is listed on the identification plate, a standard carriage and forks are used.

Attachment Abbreviations (includes Special Forks)

- SC-** Special Carriage-increased width, height or outreach
- SSS -** Shaft-type Sideshift Carriage
- HSS -** Hook-type Sideshift Carriage (ITA)
- CW -** Counterweight
- SF -** Special Forks
- SWS -** Swing Shift, Sideshift
- RAM -** Ram or Boom
- DBCBH -** Double Cube Block Handler
- HFP -** Hydraulic Fork Positioner
- CR -** Crane Arm or Crane Boom
- TH -** Tire Handler
- CTH -** Container Handler
- LPP -** Load Push-Pull Device
- CC -** Carton Clamp
- RC -** Roll Clamp
- LS -** Load Stabilizer
- PWH -** Pulp Wood Handler
- SS-ST -** Sideshift-Side Tilt Carriage

Operator's Station and Monitoring Systems

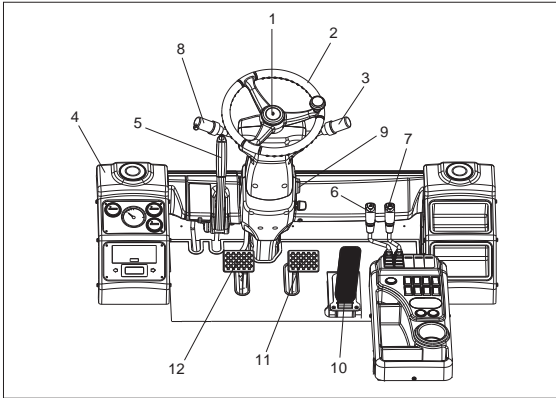

1. Horn Switch
2. Steering Handwheel
3. Turn Signal Lever
4. Instrument Panel
5. Parking Brake Lever
6. Lift Lever
7. Tilt Lever
8. Direction Control Lever
9. Engine Ignition Start Switch
10. Accelerator Pedal
11. Service Foot Brake Pedal
12. Inching Control Pedal
14. Transmission oil temperature gauge
15. Speed Meter
16. Fuel Level Gauge
17. Engine coolant gauge
18. Transmission Display
19. Hour Counter
20. Warning Light

Typical Example

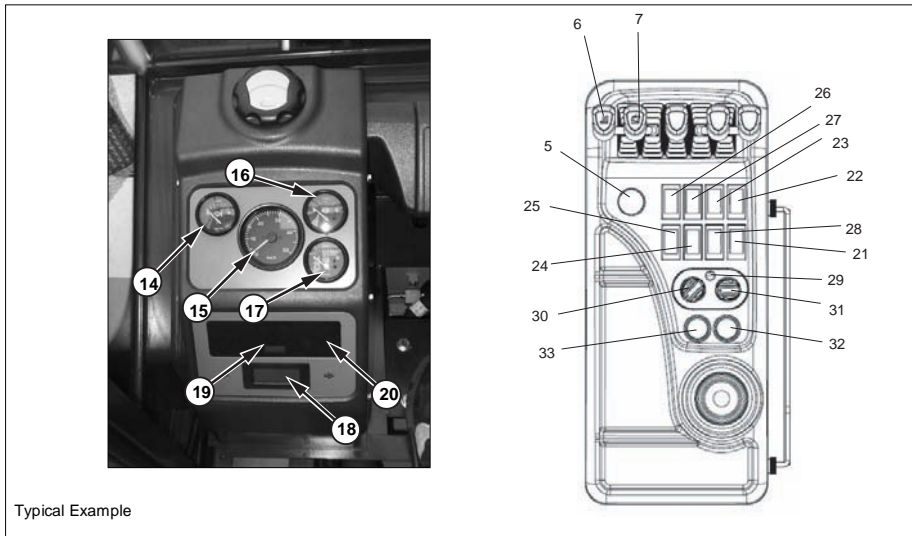

Typical Example

21. Hazard Lamp Switch
22. Automatic Transmission
23. Eco & Power Switch(Inching Switch)
24. Light Switch
25. Wiper Switch
26. Engine Emergency stop Switch
27. Engine Diagnostic Switch

28. Empty plug
29. Air Conditioner
30. Fan
31. Heater
32. Cigar Jack Connector
33. Power Jack Connector

Instrument Panel

1. Engine Ignition Start Switch

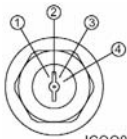

IC000031

The key switch is a four position switch. Position (1) is ACCESSORY ON. Position (2) is OFF. Position (3) is ON or RUN and accessory ON.

Position (4) is START, which engages the starter.

After the key has been turned to the START position, the key must be returned to the OFF position before it can be turned to the START position again.

2. Engine Coolant Gauge



IC000061

Indicates coolant temperature. If the pointer moves beyond the green band while operating the lift truck, overheating is indicated. Park the lift truck and stop the engine.

Check the cooling system for a malfunction. The point will be at the end of the green band when the coolant temperature reaches approximately 103°C(217°F) on all engines.

3. Transmission Oil Temperature Gauge



IC000071

Indicates transmission oil temperature. If the pointer moves beyond the green band while operating the lift truck, excessive transmission oil temperature is indicated. Park the lift truck and stop the engine.

Check the system for a malfunction. The pointer will be at the end of the green band when the transmission oil temperature reaches approximately 120°C (248°F).

4. Fuel Level Gauge



IC000081

Indicates fuel level in the fuel tank.

5. Hour Counter



Indicates the total number of hours the engine and the lift truck have operated. The hour meter will operate when the ignition switch is in the ON position, whether the engine is

running or not.

The hour meter is used to determine lubrication and maintenance intervals.

6. Speed meter



Indicates the truck travelling speed(km/h).

7. Turn Signal Lever



IDO40041

This is the lever to indicate the turning direction of the lift truck. As this lever is maneuvered, the signal lamp blinks.

R	Turn to the right
N	Neutral
L	Turn to the left

8. Horn Switch



IDO40031

To give alarm to fellow worker(s) around and in the path of your truck, press the rubber at the center of the handwheel.

WARNING

Don't run the truck while the alarm is sounding. It is dangerous to do so, since poor effect is expected.

9. Light Switch

Switch \ Light	1 st Ste p	2 nd Ste p
Clearance Lamp	O	X
Tail Lamp	O	X
License plate Lamp	O	X
Instrument Lamp	O	X
Head Lamp	O	X

O : means "lights on"

X : means "lights off"

These lamps light up regardless of position of the ignition switch.

10. Hazard Lamp Switch

Push the button to active the hazard lamp. Hazard lamp put the same with turn signal lamp.

Warning Light

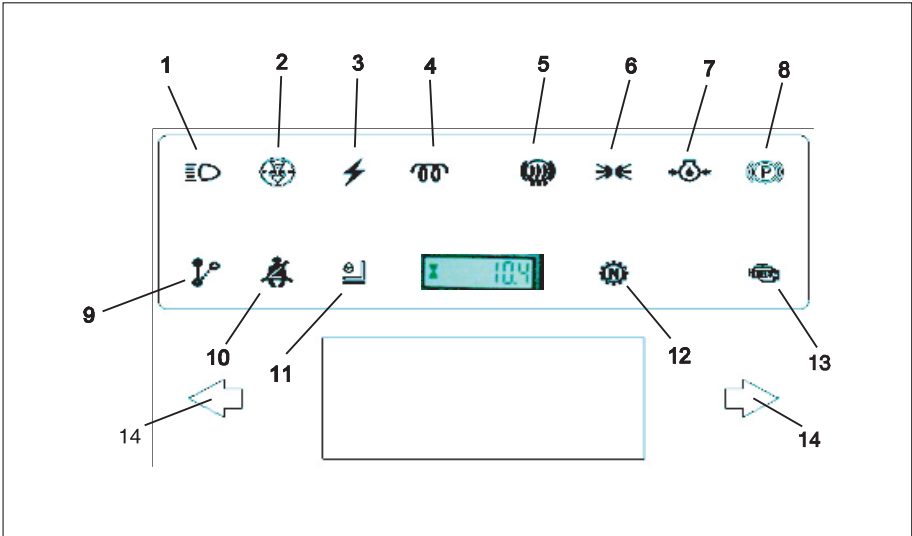

- 1. Upper Indicator Light
- 2. Air Cleaner Indicator Light
- 3. Alternator Indicator Light
- 4. Diesel Engine Start Preheat Indicator Light
- 5. Air Dryer Heater Light
- 6. Front Flood Light
- 7. Engine Oil Pressure Indicator Light

- 8. Parking Indicator Light
- 9. Levering Light
- 10. Seat Belt Warning wight
- 11. Seat Leaving Warning Light
- 12. Transmission Neutral Position Light
- 13. Engine Malfunction Indicator Light
- 14. Directional Turning Indicator Lights

(1) Upper Indicator Light



Indicates the upper indicator light is on.

(2) Air Cleaner Indicator Light



Indicates that the air filter is blocked. If the light stays on after starting the engine, stop the engine, remove the air filter element and clean it thoroughly using compressed air. Refit the filter, and check that the light goes out when the engine is started.

(3) Alternator Indicator Light



Indicates if the battery charging system is operational. The light will come on when the ignition switch is turned to the ON position.

The light should go off after the engine is started, indicating the alternator is producing sufficient voltage to charge the battery. If the light turns on with the engine running, check the alternator charging system for a malfunction.

(4) Diesel Engine Start Preheat Indicator Light



The light will come ON when the key is turned to the ON position from the OFF position. This indicates that the glow plugs are preheating the pre-combustion chambers for easier starting.

The amount of time needed to preheat the pre-combustion chambers is approximately seven seconds, depending on the surrounding air temperature. When the light goes OFF the maximum pre-combustion chamber temperature has been reached and the key can be turned to the START position to start the engine.

(5) Air-Dryer heater Light



This indicates that an air-dryer heater begins to work to steam up water vapor from the air chamber.

After water vapor is eliminated, the lamp should go off. If the lamp doesn't go off for a long time check the air brake system for a malfunction.

(6) Front Floodlights



Push down on the switch(14), to the first step, to turn the front floodlights on.

(14) Directional Turning Indicator Light



Pull the lever to activate the right turn signal.
Push the lever to activate the left turn signal.

(7) Engine Oil Pressure Indicator Light



Indicates insufficient engine oil pressure. The light will come on when the ignition switch is turned to the ON position. The light should go off after the engine is started. If the light turns on while operating the lift truck, insufficient engine oil pressure is indicated. Park the lift truck and stop the engine.

(8) Parking indicator light



The light will come ON when the parking lever is applied.

(9) Levering light(If Equipment)



Indicates tilt and lift control lever. The light comes on when lift and tilt lever move forward/backward with installed solenoid valve.

(10) Seat Belt Warning Light



Indicates when the seat belt dose not fastened by operator. The light will come on when the ignition switch is turned to the on position. The light should go off after engine is started.

(11) Seat Leaving warning Light



When operator leaves seat without engine stop, hydraulic control lever cannot operate.

(12) Transmission Neutral Position Light



Indicates the neutral position of transmission.

(13) Engine Malfunction Indicator Lamp



Engine control systems are equipped with built-in fault diagnostics. Detected system faults can be displayed by the Malfunction Indicator Lamp (MIL) as Diagnostic Fault Codes (DFC) or flash codes, and viewed in detail with the use of service tool software. When the ignition key is turned ON the MIL will perform a self-test, illuminate once and then go OFF. If a detected falut condition exists, the fault or faults will be stored in the memory of the engine control unit(ECM). Once a fault occurs the MIL will illuminate and remain ON. This signals the operator that a faults has been detected by the ECU.

Seat Switch System



The lift truck is equipped with a SEAT SWITCH SYSTEM. In normal operation if the direction lever is placed in either forward or reverse, the lift truck will move at a speed proportional to the accelerator pedal's position. If the operator leaves the seat without setting the parking brake, within three seconds after leaving the seat, the SEAT SWITCH SYSTEM will automatically disengage the transmission. The directional lever, however, will remain in that forward or reverse location although internally the transmission will have shifted into neutral.

Before exiting the lift truck, the parking brake should always be applied.

WARNING

WHEN LEAVING MACHINE APPLY PARKING BRAKE!

PARKING BRAKE IS NOT AUTOMATICALLY APPLIED.

NOTE: Some trucks may be equipped (ask your dealer if this applies to your truck) with an alarm that will sound if the parking brake is not applied when leaving the machine.

NOTICE

1. Prior to operating the lift truck, be sure to understand and check the SEAT SWITCH SYSTEM.
2. While in normal operation and on level ground, select a direction with the directional lever and with the park brake released. You will note that the truck will move slowly in the selected direction. If you lift your hips off of the seat, within three seconds, the SEAT SWITCH SYSTEM will disengage the transmission allowing the truck to coast but not automatically stop.
3. To restore the lift truck to normal operation, while sitting in the operator's seat depress the brake pedal to hold the lift truck, return the directional lever to the neutral position, and then reselect a direction of travel (either forward or reverse). The transmission will then re-engage.
4. If seat or seat switch replacement becomes necessary, be sure to use genuine DOOSAN Infracore lift truck parts. Lift trucks should never be operated without an operational SEAT SWITCH SYSTEM.

Steering Column Tilting Angle Adjustment



Typical Example

The tilting angle of the steering wheel is adjustable within a range of 15 degrees to suit individual operators. The steering column is unlocked by turning the lever counter clockwise and locked by turning it clockwise.

Tow Eye



Typical Example

It is for emergency use in towing a disabled vehicle or being towed by another truck when your truck is disabled. Use wire rope strong enough according to the weight and size of the vehicle to be towed.

Fuse Box



Typical Example

Fuse Locations

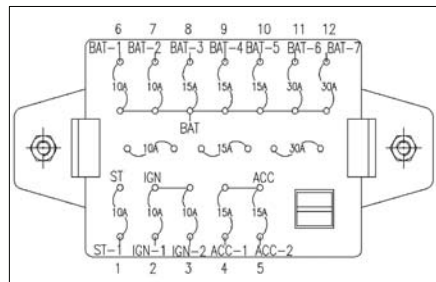

Fuses protect the electrical system from damage caused by overloaded circuits. Change a fuse if the element separates. If the element of a new fuse separates, have the circuit checked and repaired.

Operation Section

1. D50/60/70S-5 (2 Speed)

No.	Description	Rated Capacity
1	Engine Start	10A
2	Engine Stop Motor Relay Coil, Preheat System, Iso3691 Valve	10A
3	T/M Solenoid Valve Control Sys.	10A
4	Cabin Relay Coil, Aircon Relay Coil	15A
5	Gague Panel, Stop Lamp, Strobe Light	15A
6	Horn	10A
7	Spare	10A
8	Head Lamp Relay Coil, Rear Lamp, Turn Signal Lamp Clearance Lamp	15A
9	Head Lamp(Hi Beam), Head Lamp(Low Beam)	15A
10	Cigar Lighter, Power Socket, CD Player, Wiper Motor (CABIN)	15A
11	Ignition Switch (St, Ign, Acc)	30A
12	Aircon, Heater	30A

2. D50/60/70/80/90S-5 (3 Speed)

No.	Description	Rated Capacity
1	Engine Start	10A
2	Engine Stop Motor Relay Coil, Preheat System, Iso3691 Valve	10A
3	TCU(T/M Control Unit) Ignition, T/M Display	10A
4	Cabin Relay Coil, Aircon Relay Coil	15A
5	Gague Panel, Stop Lamp, Strobe Light	15A
6	Horn	10A
7	TCU(T/M Control Unit) Power	10A
8	Head Lamp Relay Coil, Rear Lamp, Turn Signal Lamp Clearance Lamp	15A
9	Head Lamp(Hi Beam), Head Lamp(Low Beam)	15A
10	Cigar Lighter, Power Socket, CD Player, Wiper Motor (CABIN)	15A
11	Ignition Switch (St, Ign, Acc)	30A
12	Aircon, Heater	30A

3. G50/60/70S-5 (2 Speed)

E	Description	Rated Capacity
1	Engine Start	10A
2	ECU(Engine Control Unit) Main Relay Coil, Iso3691 Valve	10A
3	T/M Solenoid Valve Control Sys.	10A
4	Cabin Relay Coil, Aircon Relay Coil	15A
5	Gague Panel, Stop Lamp, Strobe Light	15A
6	Horn	10A
7	Spare	10A
8	Head Lamp Relay Coil, Rear Lamp, Turn Signal Lamp Clearance Lamp	15A
9	Head Lamp(Hi Beam), Head Lamp(Low Beam)	15A
10	Cigar Lighter, Power Socket, CD Player, Wiper Motor (CABIN)	15A
11	Ignition Switch (St, Ign, Acc)	30A
12	Aircon, Heater	30A

Circuit Breaker



Typical Example Diesel Engine Truck

Circuit Breaker protects the main electrical circuit. It is located in the engine compartment on the left side.

To reset the circuit breaker, push the button in. If the button comes back out, have the electrical circuits checked.

Seat

Seat Adjustment

NOTE: Seat arrangements may vary. Basic operation will be similar.

Seat adjustment should be checked at the beginning of each shift and when operators change. Lock the seat into position before operating, to prevent an unexpected seat change.



Typical Example

Adjust seat to allow full brake pedal travel with operator's back against seat back.

NOTE: The seat can only be correctly adjusted with the operator fully seated.

Lift Truck Controls

Direction Control Lever



Typical Example

Forward – Reverse

F	Forward
N	Neutral
R	Reverse

Speed Select

1	1st
2	2nd
3	3rd (3 speed ONLY)

Rotating the direction control lever changes the speed of travel. With handle rotated counter clockwise (towards the operator), the lift truck is in FIRST speed.

Rotate the lever clockwise (away from the operator) for the SECOND and THIRD speeds. Always brake to a full stop before reversing the direction of travel.

Do not fail to place the forward-reverse lever in the neutral position before starting the engine.

Neutral Lever Lock (3 Speed Only)

A transmission neutral lever lock is in base of the direction control lever. This neutral lever lock prevents the direction control lever from being moved out of "NEUTRL".

N "NEUTRAL LOCK" position. Prevents the direction control lever to be moved out of "NEUTRAL".

D "DRIVE" position. Allows the direction control lever to be moved from "NEUTRAL" to "FORWARD and REVERSE".

⚠ WARNING

"LOCK" the direction control lever. Whenever machine is parked, "LOCK" the direction control lever in "NEUTRAL" to prevent accidental machine movement.

Transmission Display (3 Speed Only)

A transmission display is to the right of the steering wheel on the dash. The LCD indicates gears, direction of travel and error codes.

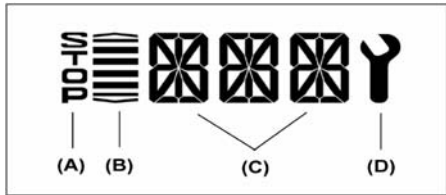

(A) Indicates travel direction and gear selection. See the figure below for more detailed information.

(B) Indicates normal operation and error codes. For a list of error codes, see "Transmission Error Codes" in "When Required" maintenance section.

NOTE : Most codes are only two digits.

(C) Indicates that error codes have occurred and are stored.

(D) Indicates that operation must be stopped immediately to prevent damage to transmission and hazardous operation condition.

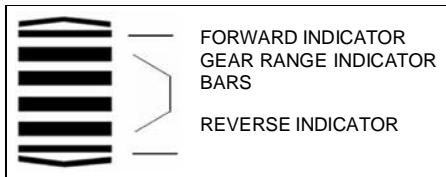

The gear range indicator bars will indicate which gear is selected by displaying the corresponding number of bars.

The forward and reverse indicator bars will be "OFF" when the transmission is in "MANUAL MODE". When transmission is in "AUTOMATIC MODE", all the gear range indicator bars and both travel direction indicators will be "ON".

Automatic Transmission Switch (3 Speed Only)

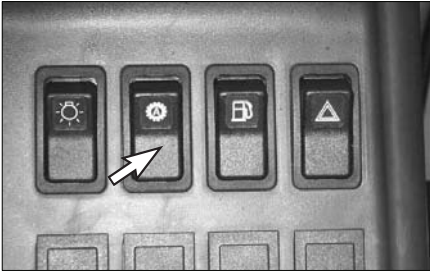

Automatic speed range:
 . FORWARD: 3 speeds.

. REVERSE: 3 speeds.

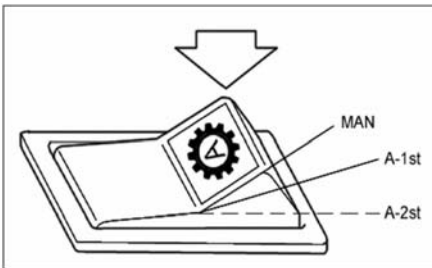

MAN When this switch is in "MAN"(manual) position, travel mode is switched to "MANUAL" and allows operator to choose speeds manually.

A-1st When this switch is in "A-1st"(automatic 1st) position, gears are started from 1st speed and changed "AUTOMATICALLY" to the appropriate speed up to the limit set by the gear ratio according to travel load and engine rpm.

A-2nd When this switch is in "A-2nd"(automatic 2nd) position, gears are started from 2nd speed and changed "AUTOMATICALLY" to the appropriate speed up to the limit set by the gear ratio according to travel load and engine rpm.

Inching Switch (3 Speed Only)

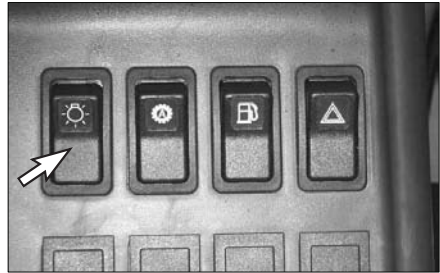

This switch changes over the modes of the inching control pedal, inching and no-inching.

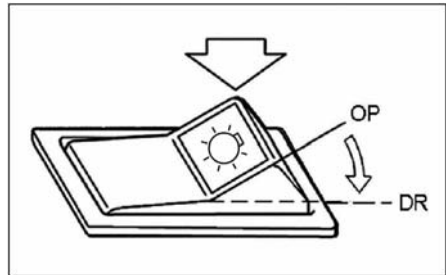

DR In this position, the "NO INCHING" mode is selected. In the "NO INCHING" mode, the inching pedal control is disabled but braking function by pushing on the inching pedal is still active.

OP In this position, the "INCHING" mode is selected. In the "INCHING" mode, normal inching function is enabled by pushing on the inching pedal.

NOTE: When driving a middle or long distance without using the inching function, set this switch to "DR" position to prevent the transmission clutch pedals from unnecessary wear or overheat.

Transmission Inching Control Pedal



Typical Example



Inching Control Pedal - Pushing down on the inching pedal, modulates the hydraulic pressure to the clutch packs, permitting disc slippage.

Further pushing on the pedal completely relieves clutch pack pressure and applies the service brakes to stop and hold the lift truck.

NOTE: The purpose of the inching control pedal is to provide precise inching control at slow travel speed, with high engine rpm. This is used for fast hydraulic lift during load approach, pickup or positioning.

Service Foot Brake Pedal



Typical Example



Push **DOWN** on the brake pedal to slow or stop the lift truck.



RELEASE the brake pedal to allow the lift truck to move.

Accelerator Pedal



Typical Example



Push **DOWN** on the pedal to increase engine rpm (speed).



RELEASE the pedal to decrease engine rpm (speed).

Parking Brake Lever

NOTICE

Do not engage the parking brake while the lift truck is moving unless an emergency exists. The use of the parking brake as a service foot brake in regular operation will cause severe damage to the parking brake system.



The parking brake lever is located at the left side of the steering wheel.

Lift Control



The forks can be raised or lowered by pulling backwards or pushing forwards on this lever. The lift speed is controlled by tilt angle of the lever and accelerator pedal effort. The lowering speed can be controlled by tilt angle of the lever. The engine speed or accelerator pedal has nothing to do with the lowering speed of the forks.

Tilt Control



The mast can be tilted by operation of this tilt lever. Pulling on this lever backwards will tilt the mast backwards, and pushing it forwards will tilt the mast forwards. The tilt speed can be controlled by tilt angle of the lever and accelerator pedal effort.

Refueling

Diesel Engine Equipped

⚠ WARNING

Explosive fumes may be present during refueling.

Do not smoke in refueling areas. Lift truck should be refueled only at designated safe locations. Safe outdoor locations are preferable to those indoors.

Stop the engine and get off the lift truck during refueling.

NOTICE

Do not allow the lift truck to become low on fuel or completely run out of fuel. Sediment or other impurities in the fuel tank could be drawn into the fuel system. This could result in difficult starting or damage to components.

Fill the fuel tank at the end of each day of operation to drive out moisture laden air and to prevent condensation. In the cold weather, the moisture condensation can cause rust in the fuel system and hard starting due to its freezing. Do not fill the tank to the top. Fuel expands when it gets warm and may overflow.



Typical Example

1. Park the lift truck only at a designated safe location. Place the transmission in NEUTRAL. Lower the forks to the ground. Engage the parking brake. Stop the engine.



Typical Example

2. Remove the filter cap.
3. Fill the fuel tank slowly. See topic, "Refill Capacities." in maintenance section. Install the filter cap. If spillage occurs, wipe off excess fuel and absorb any excess fuel with absorbent material.

NOTE: Drain water and sediment from fuel tank as required by prevailing conditions. Also, drain water and sediment from the main fuel storage tank weekly and before the tank is refilled. This will help prevent water or sediment being pumped from the storage tank into the lift truck fuel tank.

Changing LP Tanks

WARNING

Only trained, authorized personnel should fill or exchange LP tanks.

Personnel engaged in filling of LP containers should wear protective clothing such as face shield, long sleeves and gauntlet gloves. Do not refuel or store LP powered lift trucks near any underground entrance, elevator shafts or any other place where LP could collect in a pocket causing a potentially dangerous condition.

Examine all LP containers before filling and again before reuse, for damage to various valves, liquid gauge, fittings and hand valve wheels.

All defective or damaged LP containers must be removed from service.

Explosive fumes may be present during refueling.

Do not smoke in refueling areas.

Lift truck should be refueled only at designated safe locations. Safe outdoor locations are preferable to indoor locations.

Stop the engine and get off the lift truck during refueling.

The careless handling of LP containers can result in a serious accident.

Use extreme care when transporting containers to prevent damage to them.

1. Park the lift truck on level ground, with the parking brake applied, the transmission in NEUTRAL, the forks lowered and the engine running at low idle.

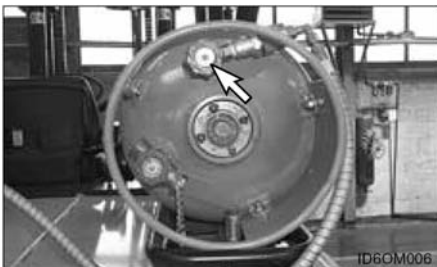

2. Close the fuel inlet valve at the LP - Gas tank. Run the engine until it stops, then turn off the ignition switch and the electrical disconnect switch (if equipped).
3. Disconnect the fuel supply line.

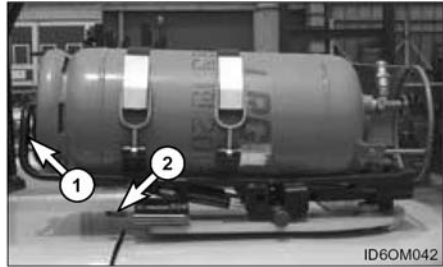

4. Grasp the tank support bar (1). Pull and release the latch switch (2).
5. Grasp the tank support bar (1) and rotate cradle slowly to the rear of a tank.

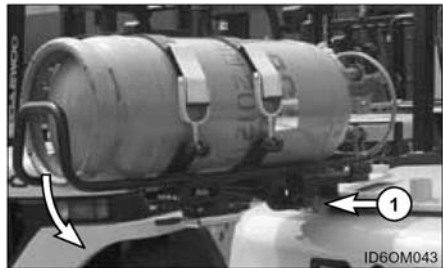

6. Pull the release knob (1) and then push down the tank.

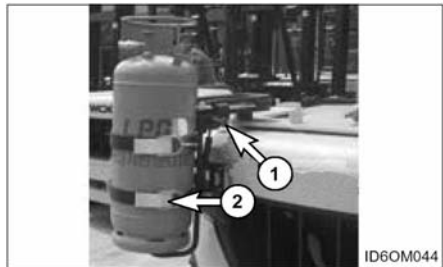

7. Lock the tank cradle by knob (1). Loosen the retaining clamps (2) and remove the tank.
8. Check the mounting to be sure the locating pin (dowel) is not missing or broken.

NOTICE

If the location pin (dowel) is missing or broken, be sure the pin is replaced.

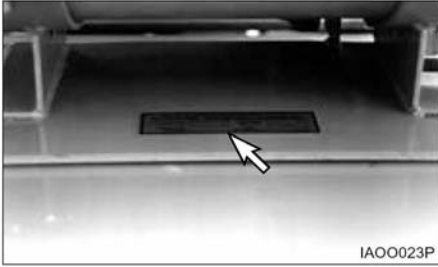

9. Check to be sure that the LP warning plate is in position on the lift truck, and is legible.
10. Check to be sure the replacement tank is of the correct type.
11. Inspect the replacement tank for damage such as dents, scrapes or gouges and for indication of leakage at valves or threaded connections.

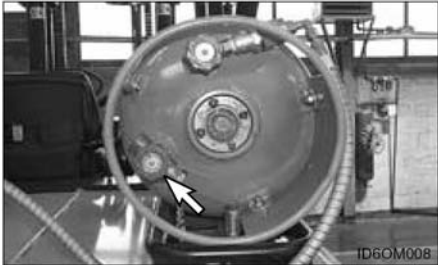

12. Check for debris in the relief valve, for damage to various valves and liquid level gauge.
13. Inspect the quick-disconnect couplings for deterioration, damage or missing flexible seals.

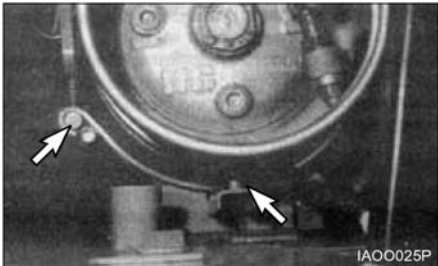

14. Position the replacement tank so that the locating pin (dowel) is in place.

⚠ CAUTION

The LP tank must not extend past the counterweight.

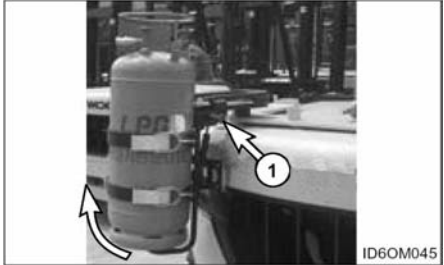

15. Grasp a new tank and clamp securely. Pull the release knob (1) and push the tank cradle upward when locked.
16. Rotate the tank cradle forward of the truck and lock it with latch. Connect the fuel supply line.
17. Open the fuel valve by slowly turning the valve counterclockwise. If the fuel valve is opened too quickly, a back pressure check valve will shut off the fuel supply. If this happens, close the fuel valve completely. Wait five seconds and then open the fuel valve very slowly.
18. Inspect the LP fuel lines and fittings with a soap solution after filling the tank or when looking for leaks.

Before Starting the Engine

Walk-Around Inspection

Make a thorough walk-around inspection before mounting the lift truck or starting the engine. Look for such items as loose bolts, debris buildup, oil or coolant leaks. Check condition of tires, mast, carriage, forks or attachments. Have repairs made as needed and all debris removed.



Typical Example

1. Inspect the operator's compartment for loose items and cleanliness.
2. Inspect the instrument panel for broken or damaged indicator lights or gauges.
3. Test the horn and other safety devices for proper operation.



Typical Example

4. Inspect the mast and lift chains for wear, broken links, pins and loose rollers.
5. Inspect the carriage, forks or attachments for wear, damage and loose or missing bolts.
6. Inspect the tires and wheels for cuts, gouges, foreign objects, inflation pressure and loose or missing bolts.

7. Inspect the overhead guard for damage and loose or missing mounting bolts.
8. Inspect the hydraulic system for leaks, worn hoses or damaged lines.
9. Look for transmission and drive axle leaks on the lift truck and on the ground.



Typical Example

Diesel Engine(3 speed)

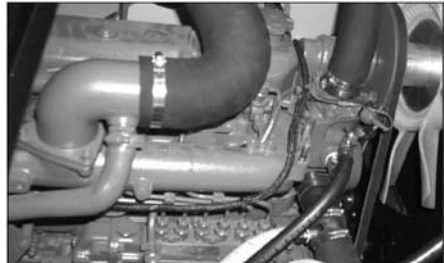

Typical Example

Diesel Engine(2 speed)



Typical Example LP Engine



Typical Example Diesel Engine

10. Inspect the engine compartment for oil, coolant and fuel leaks.

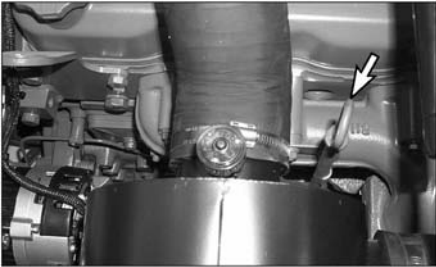

Typical Example Diesel Engine



Typical Example LP Engine

12. Observe the engine coolant level in the coolant recovery bottle. With the engine cold, maintain the level to the COLD mark. If the recovery bottle is empty, also fill the radiator at the top tank.

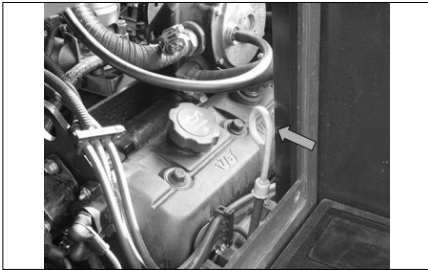

Typical Example LP Engine

11. Measure the engine crankcase oil level with the dip stick. Maintain the oil level between the MAX. and MIN., (or FULL and ADD) notches on the dip stick.



Typical Example

13. Observe the fuel level gauge after starting the truck. Add fuel if necessary.

⚠ WARNING

Personal injury may occur from accidents caused by improper seat adjustment. Always adjust the operator's seat before starting the lift truck engine. Seat adjustment must be done at the beginning of each shift and when operators change.



Typical Example

14. To position the seat, PUSH the lever away from the seat track and move the seat forward or backward to a comfortable position.
15. Inspect seat belt for wear and correct operation.

Starting the Engine

Prestart Conditions

NOTE: The engine will not start unless the transmission directional control lever is in the NEUTRAL position.



Typical Example

1. Engage the parking brake, if not already engaged.
2. Place the transmission directional control lever in NEUTRAL position.

Diesel Engine

Starting a Cold Diesel Engine

1. Turn the ignition key to the ON position. The start preheat light will come ON. The preheat light will stay ON approximately seven seconds, depending on the ambient air temperature.

NOTICE

Do not engage the starter for more than 10 seconds.

2. When the preheat light goes OFF, turn the ignition key to the START position, with the accelerator pedal fully depressed.
3. Release the ignition key when the engine starts and release the accelerator pedal to a low idle position.
4. If the engine stalls or does not start, turn the ignition key to the OFF position, then repeat steps 1 thru 3.

Starting a Warm Diesel Engine

1. Turn the ignition key to the ON position and then to START position, without waiting for the preheat light to go OFF. At the same time fully depress the accelerator.
2. Release the ignition key when the engine starts and release the accelerator pedal to a low idle position.

LP Engine

WARNING

LP fuel is flammable and can cause personal injury.
Inspect LP fuel lines and fitting for leaks.
Inspect tank for secure mounting.

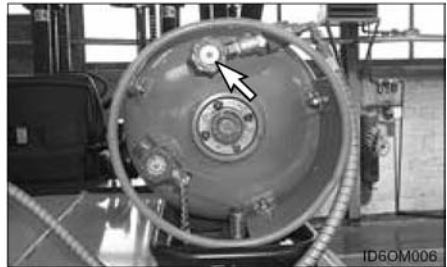

1. Open the tank fuel valve by slowly turning the valve counterclockwise. Observe the LP gauge (if equipped).
2. Turn the ignition switch to the START position. Release it when the engine starts.
3. If the engine does not start, Do not press on the accelerator pedal. Turn the starter switch to OFF position, the repeat step 2 and depress the accelerator pedal slightly during cranking.
4. Allow the engine to warm up slowly.

Starting From a 24/12 Volt External Source

WARNING

Sparks occurring near the battery could cause vapors to explode.

Always connect the external power source ground cable to a point away from and below the battery, and well clear of fuel system components.



Typical Example Diesel Engine Truck



Typical Example LP Engine Truck

NOTICE

Do not reverse battery cables. It can cause damage to the alternator.

Always connect the external power source cables in parallel with the lift truck battery cables :
 POSITIVE(+) to POSITIVE(+) and NEGATIVE(-) to NEGATIVE(-).

Attach ground cable last, remove first.

All lift trucks equipped with DOOSAN built internal combustion engines are NEGATIVE(-) ground.

Starting with Jumper Cables

WARNING

Batteries give off flammable fumes that can explode.

Prevent sparks near the batteries. They could cause vapors to explode. Do not allow jump cable ends to contact each other or the lift truck. Do not smoke when checking battery electrolyte levels.

Electrolyte is an acid and can cause personal injury if it contacts skin or eyes.

Always wear eye protection when starting a lift truck with jump cables.

Improper jump procedures can cause an explosion resulting in personal injury.

Always connect battery positive (+) to battery positive (+) and battery negative (-) to battery negative (-).

Jump only with a battery source and with the same voltage as the stalled lift truck.

Turn off all lights and accessories on the stalled lift truck. Otherwise, they will operate when the jump source is connected.

NOTICE

When starting from another machine, make sure the machines Do not touch. This could prevent damage to engine bearings and electrical circuits.

Turn on (close) the disconnect switch prior to the boost connection to prevent damage to electrical components on the stalled machine.

Severely discharged maintenance free batteries might not fully recharge by the alternator alone after jump starting.

The batteries must be charged to the proper voltage by the battery charger.

Many batteries thought to be unusable, are still rechargeable.

This machine has a 24 volt starting system. Use only equal voltage for jump starting. Use of a welder or higher voltage equipment will damage the electrical system.

Use of Jumper Cables

When auxiliary start receptacles are not available, use the following procedure.

1. Make initial determination as to failure of lift truck to crank. Procedure applies even if lift truck does not have diagnostic connector.
2. Place the directional control in NEUTRAL on the stalled lift truck. Engage the parking/secondary brake. Lower all attachments to the ground. Move all controls to HOLD (CENTER).
3. On stalled lift truck, turn the start switch to OFF. Turn off all accessories.
4. On stalled lift truck, turn on (close) the disconnect switch (if equipped).
5. Move boost start lift truck near enough to stalled lift truck for cables to reach, but DO NOT ALLOW LIFT TRUCKS TO TOUCH.
6. Stop the engine on the boost lift truck. Or, if using an auxiliary power source, turn off the charging system.
7. Make sure battery caps are all in place and tight on both lift trucks.

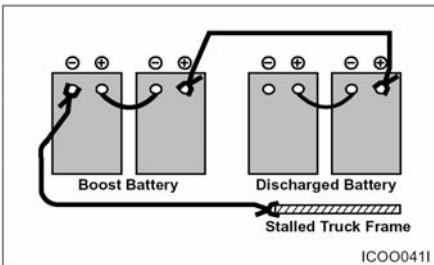

Typical Example of 24 Voltage

8. Connect positive (+) jumper cable (red) to positive (+) cable terminal of discharged battery, or battery set on the stalled lift truck. Do not allow positive cable clamps to touch any metal other than battery terminals.
9. Connect the other end of this positive jumper cable (red) to positive (+) terminal of boost battery. Use procedure of Step 8 to determine correct terminal.

10. Connect one end of the negative (-) jumper cable to the other terminal (negative) of the boost battery.
11. Make final connection of negative (-) cable to the stalled truck frame (not battery negative post) away from battery, fuel or hydraulic lines, or moving parts.
12. Start the engine on the boost lift truck, or energize the charging system on the auxiliary power source.
13. Wait a minimum of two minutes for the batteries in the stalled lift truck to partially charge.
14. Attempt to start the stalled engine. Refer to section on ' Engine Starting' .
15. Immediately after starting the stalled engine, disconnect the jumper cables in reverse order.
16. Conclude failure analysis on starting/charging system of the stalled lift truck as required with the engine running and charging system in operation.

After Starting the Engine

Observe all indicator lights and gauges frequently during operation, to make sure all systems are working properly.

WARNING

If any light comes on, have corrections made before operating truck.

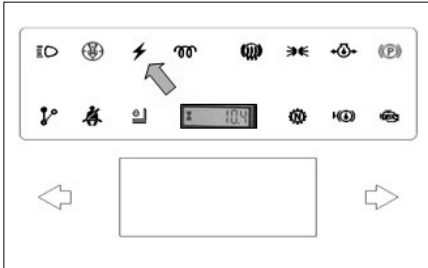

Typical Example

1. Alternator indicator light will be OUT in normal operation. If the light comes ON with the engine running, the alternator is not charging.



Typical Example

2. Observe fuel gauge and service hour meter frequently to assure they are operating properly.
3. Observe the brake air pressure gauge and indicator light frequently (if equipped) while engine is running. Air pressure indicator must be in the green range. If light comes on, it indicates loss of air pressure.

NOTE: Do not idle engines for prolonged periods of time. These engines can be started easily, even when hot.

NOTE: At an oil temperature in the shifting circuit lower than -12°C , the transmission must be warmed-up for some minutes. This must be carried out in Neutral with an increased engine speed (about 1500 rpm). Until this oil temperature is reached, the Electronics remains in Neutral, and the symbol of the cold start phase will be indicated on the Transmission Display.

Indication on the Transmission Display



After the indication on the Transmission Display is extinguished, the full driving program can be utilized out of "NEUTRAL".

4. The engine oil pressure indicator light (1), will not come ON with the engine running, unless there is low or no oil pressure. Stop the engine immediately, if the light comes ON.
5. The G643E engine MIL (Malfunction indicator Light) will not come ON with engine running, unless the fault or faults are stored in the memory of the engine control module (ECM). Stop the engine and check the electric engine control system if the light comes ON. Refer G643E Engine of this section.

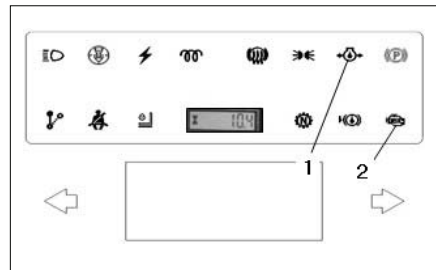

- (1) Engine oil pressure indicator light
- (2) Engine malfunction indicator light

Electronic Controlled Spark-Ignition Engines

G643E Engine

EMS (Engine management system) of G643E engine is a closed loop system utilizing a catalytic muffler to reduce the emission level in the exhaust gas. In order to obtain maximum effect from the catalyst, an accurate control of the air fuel ratio is required. A small engine control module (SECM)

uses two heated exhaust gas oxygen sensors (HEGO) in the exhaust system to monitor exhaust gas content. One HEGO is installed in front of the catalytic muffler and one is installed after the catalytic muffler.

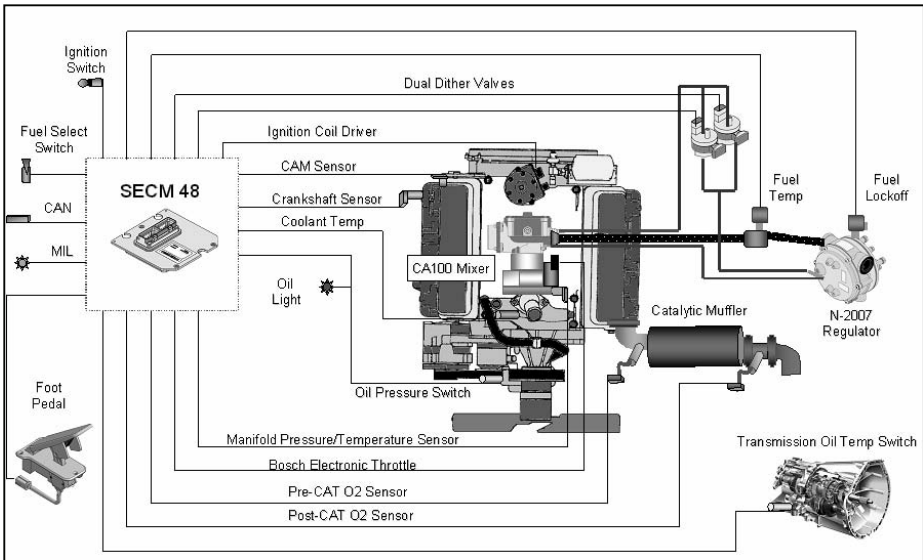

EMS schematic of G643E LP engine

The SECM makes any necessary corrections to the air fuel ratio by controlling the inlet fuel pressure to the air/fuel mixer by modulating the dual fuel trim valves (FTV) connected to the regulator. Reducing the fuel pressure leans the air/fuel mixture and increasing the fuel pressure enriches the air/fuel mixture. To calculate any necessary corrections to the air fuel ratio, the SECM uses a number of different sensors to gain information about the engine's performance. Engine speed is monitored by the SECM through a variable reluctance (VR) or Hall Effect sensor. Intake manifold air temperature and absolute pressure are monitored with a TMAP sensor. MI-07 is a drive-by-wire (DBW) system connecting the accelerator pedal to the electronic throttle through the electrical harness; mechanical

cables are not used. A throttle position sensor (TPS) monitors throttle position in relation to the accelerator pedal position sensor (APP) command. Even engine coolant temperature and adequate oil pressure are monitored by the SECM. The SECM controller has full adaptive learning capabilities, allowing it to adapt control function as operating conditions change. Factors such as ambient temperature, fuel variations, ignition component wear, clogged air filter, and other operating variables are compensated.

G643 Electronic Controlled LP Engines (If Equipped) General Description

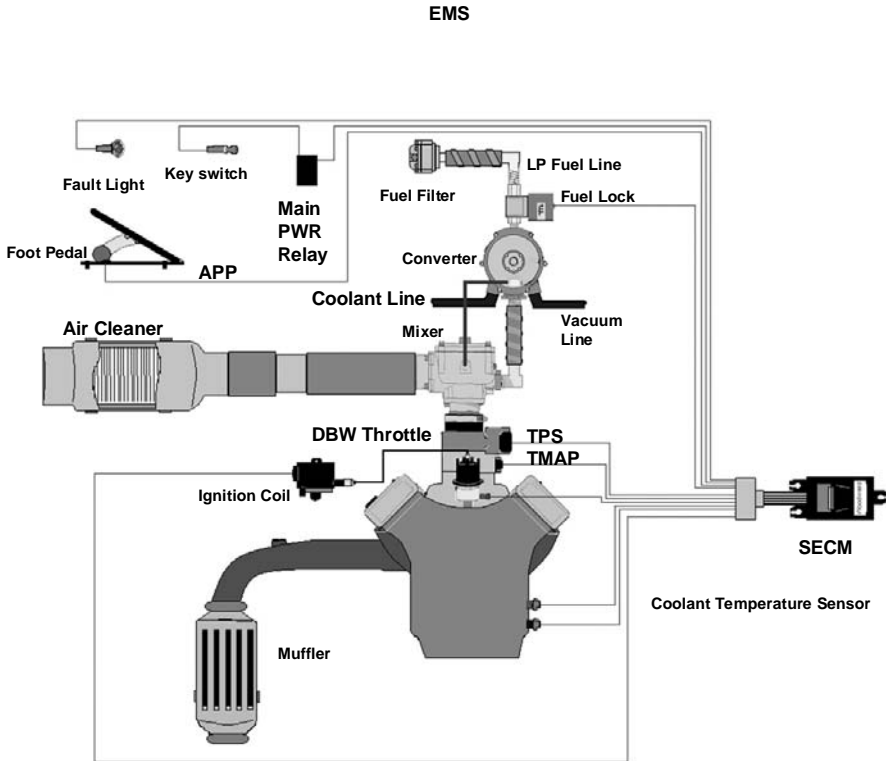

Engine speed is monitored by the SECM through a variable reluctance (VR) sensor. Intake manifold air temperature and absolute pressure is monitored with a (TMAP) sensor. The MI-04 is a drive by wire (DBW) system connecting the accelerator pedal to the electronic throttle through the electrical harness, mechanical cables are not used. A throttle position sensor (TPS) monitors throttle position in relation to the accelerator pedal position sensor (APP) feedback. Even engine coolant temperature and adequate oil pressure is monitored by the SECM. The SECM controller has full adaptive learning capabilities, allowing it to adapt control function as

operating conditions change. Factors such as ambient temperature, fuel variations, ignition component wear, clogged air filter, and other operating variables are compensated.

Basic Troubleshooting

The EMS systems are equipped with built-in fault diagnostics. Detected system faults can be displayed by the Malfunction Indicator Lamp (MIL) and are covered in the Advanced Diagnostics section. Items such as fuel level, plugged fuel lines, clogged fuel filters and malfunctioning pressure regulators may not set a fault code by the Small Engine Control Module (SECM). Below are basic

checks that should be made before referring to the Advanced Diagnostics section, if engine or drivability problems are encountered.

Locating a problem in a propane engine is done exactly the same way as with a gasoline engine. Consider all parts of the ignition and mechanical systems as well as the fuel system.

Problem	Probable Cause	Corrective Action
Engine Cranking but Will Not Start	Fuel container empty	Fill fuel container <ul style="list-style-type: none"> • Do not exceed 80% of liquid capacity
	Liquid valve closed	Slowly open liquid valve
	Excess flow valve closed	Reset excess flow valve <ul style="list-style-type: none"> • Close liquid valve • Wait for a "click" sound • Slowly open liquid valve
	Plugged fuel line	Remove obstruction from the fuel line <ul style="list-style-type: none"> • Close liquid fuel valve • Using caution, disconnect the fuel line (some propane may escape) • Clear obstruction with compressed air • Re-connect fuel line • Slowly open liquid fuel valve • Leak test
	Broken Fuse - SECM	Replace Fuse for SECM <ul style="list-style-type: none"> • See <i>Maintenance Section, Fuses replacement</i>
	Clogged fuel filter	Repair/replace as required <ul style="list-style-type: none"> • See <i>Maintenance Section, LP Fuel Filter replacement</i>
	Faulty vapor connection between the pressure regulator/converter and the mixer	Check connection <ul style="list-style-type: none"> • Verify no holes in hose • Clamps must be tight • Look for kinked, pinched and/or collapsed hose
	Fuel Lock-off malfunction	Repair/replace Fuel Lock-off <ul style="list-style-type: none"> • See <i>Engine Service Manual</i>
	Pressure regulator/converter malfunction	Test pressure regulator/converter operation <ul style="list-style-type: none"> • See <i>Engine Service Manual</i>
Incorrect air/fuel or ignition/spark control	See <i>Advanced Diagnostics</i>	

Problem	Probable Cause	Corrective Action
Engine Cranking but Will Not Start	No VR Sensor Signal	Verify the VR signal is present <ul style="list-style-type: none"> • See Advanced Diagnostics
Difficult to Start	Fuel container almost empty	LPG Vapor from liquid outlet <ul style="list-style-type: none"> • Fill fuel container • Do not exceed 80% of liquid capacity
	Excess flow valve closed	Reset excess flow valve <ul style="list-style-type: none"> • Close liquid valve • Wait for a “click” sound • Slowly open liquid valve
	Clogged fuel filter	Repair/replace as required <ul style="list-style-type: none"> • See <i>Maintenance Section, LP Fuel Filter replacement</i>
	Plugged fuel line	Remove obstruction from the fuel line <ul style="list-style-type: none"> • Close liquid fuel valve • Using caution, disconnect the fuel line (some propane may escape) • Clear obstruction with compressed air • Re-connect fuel line • Slowly open liquid fuel valve • Leak test
	Faulty vapor connection between the pressure regulator/converter and the mixer	Check connection <ul style="list-style-type: none"> • Verify no holes in hose • Clamps must be tight • Look for kinked, pinched and/or collapsed hose
	Pressure regulator/converter malfunction	Test pressure regulator/converter operation <ul style="list-style-type: none"> • See <i>Engine Service Manual</i>
	Fuel container almost empty	LPG Vapor from liquid outlet <ul style="list-style-type: none"> • Fill fuel container • Do not exceed 80% of liquid capacity
	Air filter clogged	Check air filter <ul style="list-style-type: none"> • Clean/replace as required
	Incorrect air/fuel or ignition control	See <i>Advanced Diagnostics</i>
	Engine Mechanical	See <i>Engine Service Manual</i>

Problem	Probable Cause	Corrective Action
Will Not Run Continuously	Fuel container almost empty	LPG Vapor from liquid outlet <ul style="list-style-type: none"> • Fill fuel container • Do not exceed 80% of liquid capacity
	Excess flow valve closed	Reset excess flow valve <ul style="list-style-type: none"> • Close liquid valve • Wait for a “click” sound Slowly open liquid valve
	Clogged fuel filter	Repair/replace as required <ul style="list-style-type: none"> • See <i>Maintenance Section, LP Fuel Filter replacement</i>
	Plugged fuel line	Remove obstruction from the fuel line <ul style="list-style-type: none"> • Close liquid fuel valve • Using caution, disconnect the fuel line (some propane may escape) • Clear obstruction with compressed air • Re-connect fuel line • Slowly open liquid fuel valve & Leak test
	Pressure regulator freezes	Check level in cooling system <ul style="list-style-type: none"> • Must be full, check coolant strength • -35F minimum Check coolant hoses <ul style="list-style-type: none"> • Watch for kinks and/or pinched hoses • Verify one pressure hose and one return hose
	Fuel Lock-off malfunction	Repair/replace Fuel Lock-off <ul style="list-style-type: none"> • See <i>Engine Service Manual</i>
	Incorrect idle speed or ignition problem	<i>See Advanced Diagnostics</i>
	Engine Mechanical	<i>See Engine Service Manual</i>
Will Not Accelerate/Hesitation During Acceleration	Fuel container almost empty	LPG Vapor from liquid outlet <ul style="list-style-type: none"> • Fill fuel container • Do not exceed 80% of liquid capacity
	Excess flow valve closed	Reset excess flow valve <ul style="list-style-type: none"> • Close liquid valve • Wait for a “click” sound Slowly open liquid valve

Problem	Probable Cause	Corrective Action
Will Not Accelerate/Hesitation During Acceleration	Clogged fuel filter	Repair/replace as required <ul style="list-style-type: none"> • See <i>Maintenance Section, LP Fuel Filter replacement</i>
	Faulty vapor connection between the pressure regulator/converter and the mixer	Check connection <ul style="list-style-type: none"> • Verify no holes in hose • Clamps must be tight • Look for kinked, pinched and/or collapsed hose
	Throttle butterfly valve not opening or sticking	<i>See Advanced Diagnostics</i>
	Foot Pedal signal incorrect or intermittent	
	Incorrect air/fuel or ignition control	
Engine Mechanical	<i>See Engine Service Manual</i>	
Engine Stalls	Fuel container almost empty	LPG Vapor from liquid outlet <ul style="list-style-type: none"> • Fill fuel container • Do not exceed 80% of liquid capacity
	Excess flow valve closed	Reset excess flow valve <ul style="list-style-type: none"> • Close liquid valve • Wait for a "click" sound • Slowly open liquid valve
	Clogged fuel filter	Repair/replace as required <ul style="list-style-type: none"> • See <i>Maintenance Section, LP Fuel Filter replacement</i>
	Plugged fuel line	Remove obstruction from the fuel line <ul style="list-style-type: none"> • Close liquid fuel valve • Using caution, disconnect the fuel line (some propane may escape) • Clear obstruction with compressed air • Re-connect fuel line • Slowly open liquid fuel valve & Leak test

Problem	Probable Cause	Corrective Action
Engine Stalls	Fuel Lock-off malfunction	Repair/replace Fuel Lock-off <ul style="list-style-type: none"> • See <i>Engine Service Manual</i>
	Faulty vapor connection between the pressure regulator/converter and the mixer	Check connection <ul style="list-style-type: none"> • Verify no holes in hose • Clamps must be tight • Look for kinked, pinched and/or collapsed hose
	Pressure regulator freezes	Check level in cooling system <ul style="list-style-type: none"> • Must be full, check coolant strength • -35F minimum Check coolant hoses <ul style="list-style-type: none"> • Watch for kinks and/or pinched hoses • Verify one pressure hose and one return hose
	Pressure regulator malfunction	Test pressure regulator operation <ul style="list-style-type: none"> • See <i>Engine Service Manual</i>
	Vacuum leak	Check for vacuum leaks <ul style="list-style-type: none"> • Between mixer and throttle body • Between throttle body and intake manifold • Between intake manifold and cylinder head
	Air/Fuel Mixer malfunction	Check mixer <ul style="list-style-type: none"> • See <i>Engine Service Manual</i>
	Engine Mechanical	<i>See Engine Manufacturers Service Manual</i>
Rough Idle	Faulty vapor connection between the pressure regulator/converter and the mixer	Check connection <ul style="list-style-type: none"> • Verify no holes in hose • Clamps must be tight • Look for kinked, pinched and/or collapsed hose
	Pressure regulator malfunction	Test pressure regulator operation <ul style="list-style-type: none"> • See <i>Engine Service Manual</i>
	Vacuum leak	Check for vacuum leaks <ul style="list-style-type: none"> • Between mixer and throttle body • Between throttle body and intake manifold • Between intake manifold and cylinder head
	Air/Fuel Mixer malfunction	Check mixer <ul style="list-style-type: none"> • See <i>Engine Service Manual</i>

Problem	Probable Cause	Corrective Action
Rough Idle	Incorrect Idle speed control	<i>See Advanced Diagnostics & See Engine Service Manual</i>
	Incorrect timing or spark control	
	Engine Mechanical	<i>See Engine Service Manual</i>
High Idle Speed	Incorrect Idle speed control	<i>See Advanced Diagnostics & See Engine Service Manual</i>
	Throttle sticking	
	Foot pedal sticking or incorrect pedal signal	Check pedal return spring travel for binding <ul style="list-style-type: none"> • <i>See Advanced Diagnostics</i>
Poor High Speed Performance	Clogged fuel filter	Repair/replace as required <ul style="list-style-type: none"> • <i>See Maintenance section, Fuel Filter replacement</i>
	Plugged fuel line	Remove obstruction from the fuel line <ul style="list-style-type: none"> • Close liquid fuel valve • Using caution, disconnect the fuel line (some propane may escape) • Clear obstruction with compressed air • Re-connect fuel line • Slowly open liquid fuel valve & Leak test
	Air filter clogged	Check air filter <ul style="list-style-type: none"> • <i>Clean/replace as required</i>
	Faulty vapor connection between the pressure regulator/converter and the mixer	Check connection <ul style="list-style-type: none"> • Verify no holes in hose • Clamps must be tight • Look for kinked, pinched and/or collapsed hose
	Pressure regulator malfunction	Test pressure regulator operation <ul style="list-style-type: none"> • <i>See Engine Service Manual</i>
	Air/Fuel Mixer malfunction	Check mixer <ul style="list-style-type: none"> • <i>See Engine Service Manual</i>
	Restricted exhaust system	Check exhaust system <ul style="list-style-type: none"> • Measure exhaust back pressure
	Incorrect ignition control	<i>See Advanced Diagnostics & See Engine Service Manual</i>
	Incorrect air/fuel control	
	Incorrect throttle position	

Problem	Probable Cause	Corrective Action
Excessive Fuel Consumption/LPG Exhaust Smell	Air/Fuel Mixer malfunction	Check mixer <ul style="list-style-type: none"> • See <i>Engine Service Manual</i>
	Air filter clogged	Check air filter <ul style="list-style-type: none"> • Clean/replace as required
	Vacuum leak	Check system vacuum hoses from regulator to FTV and mixer <ul style="list-style-type: none"> • Repair/replace as necessary
	Pressure regulator malfunction/fuel pressure too high	Test pressure regulator operation <ul style="list-style-type: none"> • See <i>Engine Service Manual</i>
	Faulty FTV (G643E only)	Check FTV for housing cracks or obstructions <ul style="list-style-type: none"> • See <i>Advanced Diagnostics FTV operation</i> • Repair and/or replace as necessary
	Weak ignition and/or spark control	<i>See Advanced Diagnostics</i>
	Incorrect air/fuel control	<i>See Advanced Diagnostics</i>
	Exhaust system leaks	Repair exhaust system
	Oxygen sensor failure	Replace as necessary <ul style="list-style-type: none"> • See <i>Advanced Diagnostics</i>

Mixer Idle Screw / Power Valve Adjust

(G643 Engine Only)

- Forklift have Unstable Idle RPM, You can adjust idle screw. Idle Screw turn to rich side (turn in screw)

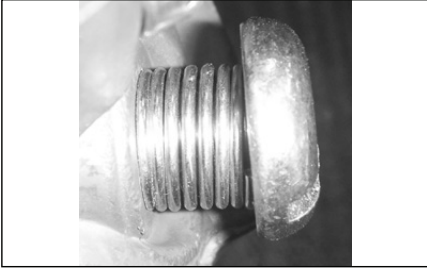

- Forklift have Poor High Speed Performance, you can adjust power valve, power valve turn to rich side. Power valve marked "R" and "L". "R" is rich side and "L" is lean side.

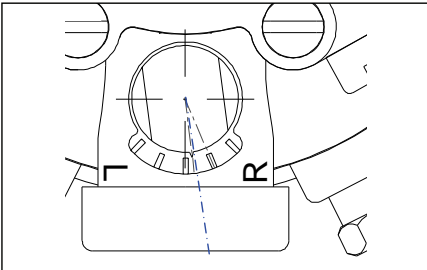

Advanced Diagnostics (G643 Engine Only)

Advanced Diagnostics

The MI-04 systems are equipped with built-in fault diagnostics. Detected system faults can be displayed by the Malfunction Indicator Lamp (MIL) as Diagnostic Fault Codes (DFC) or flash codes, and viewed in detail with the use of service tool software. When the ignition key is turned ON the MIL will perform a self-test, illuminate once and then go OFF. If a detected fault condition exists, the fault or faults will be stored in the memory of the small engine control module (SECM). Once a fault occurs the MIL will illuminate and remain ON. This signals the operator that a fault has been detected by the SECM.

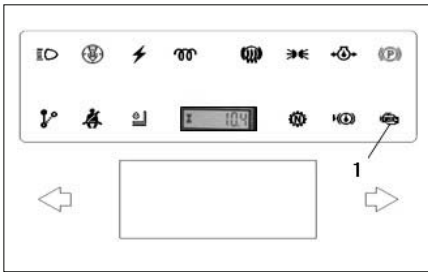

(1) Malfunction Indicator Lamp(MIL) for Engine control system

Reading Diagnostic Fault Codes

All MI-04 fault codes are two digit codes. When the fault codes are retrieved (displayed) the MIL will flash for each digit with a short pause (0.5 seconds) between digits and a long pause (1.2 seconds) between fault codes. A code 12 is displayed at the beginning of the code list.

EXAMPLE: A code 26 has been detected (ETCSticking) and the engine has shutdown and the MIL has remained **ON**. When the codes are displayed the MIL will flash one time (1), pause, then flash two times (2). This identifies a twelve (12), which is the beginning of the fault list. It will then pause for 1.2 seconds (long pause) and flash two times (2), pause, then flash six times (6). This identifies a twenty-six (26), which is the ETCSticking fault. If any additional faults were stored the SECM would again have a long pause, then display the next fault by flashing each digit. Since no other faults were stored there will be a long pause then one flash (1), pause, then two flashes (2). This identifies a twelve meaning the fault list will begin again.

Displaying Fault Codes (DFC) From SECM Memory

To enter code display mode you must turn **OFF** the ignition key. Now turn **ON** the key but Do not start the engine. As soon as you turn the key to the **ON** position you must cycle the foot pedal by depressing it to the floor and then fully releasing the pedal (pedal maneuver). You must fully cycle the foot pedal three (3) times within five (5) seconds to enable the display codes feature of the SECM. Simply turn the key **OFF** to exit display mode. The code list will continue to repeat until the key is turned **OFF**. An automatic code display feature is activated if a foot pedal fault condition exists. This feature enables the service technician to view the fault codes by turning the key to the **ON** position, if a foot pedal malfunction is preventing the retrieval of the stored fault codes from the SECM.

Malfunction Indicator Light (MIL)

 **ON**  **OFF**  **ON**  **ON**  **OFF** = CODE 12

Table a. MI-04 Diagnostic Fault Codes (Flash Codes)

DFC	Probable Fault	Action	Corrective Action, First Check
12	NONE Signifies the end of one pass through the fault list	NONE	None, used as a beginning and end of the fault list identification
14	ECTSensorInputLow Coolant sensor failure or shorted to GND	Stored Fault Code (MIL Only)	Check ECT sensor connector and wiring for a short to GND
15	ECTSensorInputHigh Coolant sensor disconnected or open circuit	Stored Fault Code (MIL Only)	Check if ECT sensor connector is disconnected or for an open ECT circuit
16	ECTRangeHigh Engine Overheating	Delayed Engine Shutdown	Check coolant system for radiator blockage, proper coolant level and for leaks in the system. Possible ECT short to GND, check ECT signal wiring Check regulator for coolant leaks
22	ThrottleSensorInputLo TPS1 signal disconnected or open circuit <i>(Expected faults when ETC connector is unplugged CODES: 22 & 24)</i>	Disable Throttle	Check throttle connector connection and TPS1 sensor for an open circuit
23	ThrottleSensorInputHi TPS1 sensor failure or shorted circuit	Disable Throttle	Check throttle connector and TPS1 sensor wiring for a shorted circuit
24	ThrottleSensorRangeLo TPS1 potentiometer malfunction. Improper TPS reading may be due to dirt or oxidation on the sensor traces.	Stored Fault Code (MIL Only)	Check the throttle connector and pins for corrosion.
25	ThrottleSensorRangeHi TPS1 potentiometer malfunction. Improper TPS reading may be due to dirt or oxidation on the sensor traces.	Stored Fault Code (MIL Only)	Check the throttle connector and pins for corrosion.

Table a. MI-04 Diagnostic Fault Codes (Flash Codes)

DFC	Probable Fault	Action	Corrective Action, First Check
26	ETCSticking Throttle plate sticking inside the throttle body or the ETC driver signal is open	Engine Shutdown	Check for debris or obstructions inside the throttle body Check throttle-plate shaft for bearing wear <ul style="list-style-type: none"> Check the ETC driver wiring for an open circuit
27	PredictedTPSDifference Measured TPS1 is different than SECM Calculated throttle position	Engine Shutdown	Check for manifold leaks between the throttle and the engine <i>Note: Fault Code 27 is predicted TPS. This fault means that the throttle and our calculated prediction for throttle Do not agree. This code often comes up as suspected during transient maneuvers. It is not system trouble. If the fault really sets, then the engine will shut down.</i>
28	ETCSpringTestFailed Upon initial key-up the internal throttle return spring has become weak	Power Limit	Perform throttle spring test by cycling the ignition key and re-check for fault
29	ETCDriverFault Throttle driver over-current or driver signals shorted	Disable Throttle	Check ETC driver wiring for a shorted circuit ETC+ PIN1 to SECM PIN 22 ETC- PIN 4 to SECM PIN 24 Perform Throttle test and with the Service Tool and re-check for fault Check the ETC internal motor drive by disconnecting the throttle connector and measuring the motor drive resistance at the throttle TPS PIN 1 (+DRIVER) to PIN 4 (-DRIVER) -3.0Ω +/-30%
33	MapSensorInputLow MAP signal disconnected, open circuit or sensor malfunction <i>(Expected faults when TMAP connector is unplugged CODES: 33 & 38)</i>	Disable Throttle	Check TMAP connector and MAP signal wiring for an open circuit

Table a. MI-04 Diagnostic Fault Codes (Flash Codes)

DFC	Probable Fault	Action	Corrective Action, First Check
34	MapSensorInputHigh TMAP sensor failure or shorted circuit	Disable Throttle	Check TMAP connector and MAP signal wiring for a shorted circuit
37	IATSensorInputLow TMAP sensor failure or shorted circuit	Stored Fault Code (MIL Only)	Check TMAP connector and IAT signal wiring for a shorted circuit
38	IATSensorInputHigh IAT signal disconnected, open circuit or sensor malfunction	Stored Fault Code (MIL Only)	Check TMAP connector and IAT signal wiring for an open circuit TMAP PIN 2 to SECM PIN 4 (SIGNAL) TMAP PIN 1 to SECM PIN 1 (GND) TMAP PIN 3 to SECM PIN 18 (XDCR +5VDC) To check the IAT sensor of the TMAP disconnect the TMAP connector and measure the IAT resistance *See the IAT table in Chapter 6.0
42	EST1Low Coil driver signal low or under-current	Stored Fault Code (MIL Only)	Check coil driver wiring and connector for shorts SECM PIN 7(EST1) to COIL PIN A Verify GND on COIL PIN B Verify GND on COIL PIN C Verify GND on COIL PIN D Verify +12vdc on COIL PIN E To check the Smart Coil internal circuit disconnect the coil connector and measure the resistance from pin to pin *See Smart Coil resistance check in Chapter 6.0
43	EST1High Coil driver signal high or over-current	Stored Fault Code (MIL Only)	Check coil driver wiring for an open circuit or disconnected connector

Table a. MI-04 Diagnostic Fault Codes (Flash Codes)

DFC	Probable Fault	Action	Corrective Action, First Check
53	BatterySensorInputLow Battery voltage measured below +8.0 VDC	Stored Fault Code (MIL Only)	Check battery voltage Perform maintenance check on electrical connections to the battery and chassis ground <ul style="list-style-type: none"> • Check battery voltage during starting and with the engine running to verify charging system and alternator function • Measure battery power at the SECM with a multimeter
54	BatterySensorInputHigh Battery voltage measured above +15.9 VDC	Stored Fault Code (MIL Only)	Check battery and charging system voltage Check battery voltage during starting and with the engine running Check voltage regulator, alternator and charging system Check battery and wiring for overheating and damage Measure battery power at the SECM with a multimeter
55	XDRPSensorInputLow +5VDC Transducer power supplied by the SECM to the sensors is below +4.60VDC <i>(Expected faults when Transducer power is lost</i> CODES: 22, 24, 33, 62, 64, 66, 68 & 69)	Engine Shutdown	Measure transducer power at the TMAP connector with a multimeter Verify transducer power at the SECM with a multimeter Verify transducer power at ETC with a multimeter Verify transducer power to the foot pedal with a multimeter

Table a. MI-04 Diagnostic Fault Codes (Flash Codes)

DFC	Probable Fault	Action	Corrective Action, First Check
56	XDRPSensorInputHigh +5VDC Transducer power supplied by the SECM to the sensors is above +5.20VDC	Engine Shutdown	Measure transducer power at the TMAP connector with a multimeter Verify transducer power at the SECM with a multimeter Verify transducer power at ETC with a multimeter Verify transducer power to the foot pedal with a multimeter
57	Engine OverSpeed Engine RPM increased beyond maximum RPM set point	Engine Shutdown	Usually associated with additional ETC faults <ul style="list-style-type: none"> • Check for ETC Sticking or other ETC faults • Verify if the lift truck was motored down a steep grade
61	Pedal1 SensorInputLo APP1 signal disconnected, open circuit or sensor malfunction <i>(Expected faults when APP connector is unplugged)</i> CODES: 61 & 66	MIN Power Limit	Check foot pedal connector
62	Pedal1 SensorInputHi APP1 sensor failure or shorted circuit	MIN Power limit	Check foot pedal connector
63	Pedal1 SensorRangeLo APP1 potentiometer malfunction. Improper APP1 reading may be due to dirt or oxidation on the sensor traces.	Stored Fault Code (MIL Only)	Check foot pedal connector
64	Pedal1 SensorRangeHi APP1 potentiometer malfunction. Improper APP1 reading may be due to dirt or oxidation on the sensor traces	Stored Fault Code (MIL Only)	Check foot pedal connector

Table a. MI-04 Diagnostic Fault Codes (Flash Codes)

DFC	Probable Fault	Action	Corrective Action, First Check
65	Pedal2SensorInputLo APP2 sensor failure or shorted circuit	MIN power Limit	Check foot pedal connector
66	Pedal2SensorInputHi APP2 signal disconnected, open circuit or sensor malfunction <i>(Expected faults when APP connector is unplugged CODES: 61 & 66)</i>	MIN power Limit	Check foot pedal connector
67	Pedal2SensorRangeLo APP2 potentiometer malfunction. Improper APP2 reading may be due to dirt or oxidation on the sensor traces.	Stored Fault Code (MIL Only)	Check foot pedal connector
68	Pedal2SensorRangeHi APP2 potentiometer malfunction. Improper APP2 reading may be due to dirt or oxidation on the sensor traces.	Stored Fault Code (MIL Only)	Check foot pedal connector
69	Pedal1ToPedal2Difference Measured APP2 pedal position signal is different than APP1 signal	MIN power Limit	Check foot pedal connector
71	AFRTTrimValveOutput FTV modulation driver signal fault (G643E only)	Stored Fault Code (MIL, Disable Adaptive learns)	Check FTV for an open wire or FTV connector being disconnected

Table a. MI-04 Diagnostic Fault Codes (Flash Codes)

DFC	Probable Fault	Action	Corrective Action, First Check
72	<p>AFRTrimValveLowerDC FTV duty cycle at lower (lean) limit (G643E only)</p>	<p>Stored Fault Code (MIL, Disable Adaptive learns)</p>	<p>Engine measured Air/Fuel ratio at the O2 sensor is excessively lean. <i>If LP fuel in LP tank is not enough, this fault code can be set. If LP tank is frozen, this fault code can be set, too. It is not system trouble.</i></p> <ul style="list-style-type: none"> • Check for intake manifold leaks • Check balance line (vacuum hose) connection at the regulator • Check N-CA55-500-TR mixer for heavy end build-up and operation (see mixer section) • Check N2001 secondary for operation or low primary pressure (see N2001 Regulator section)
73	<p>AFRTrimValveUpperDC FTV duty cycle at high (rich) limit <i>(Expected fault when FTV connector is unplugged)</i> (G643E only)</p>	<p>Stored Fault Code (MIL, Disable Adaptive learns)</p>	<p>Engine measured Air/Fuel ratio at the O2 sensor is excessively rich</p> <p>Check FTV connector wiring for an open circuit</p> <ul style="list-style-type: none"> • Check N-CA55-500-TR mixer for heavy end build-up and operation (see mixer section) • Check N2001 secondary for operation (see N2001 Regulator section)

Table a. MI-04 Diagnostic Fault Codes (Flash Codes)

DFC	Probable Fault	Action	Corrective Action, First Check
74	O2SensorSwitching O2 sensor is not switching across the reference AFR voltage (G643E only)	Stored Fault Code (MIL, Disable Adaptive learns)	<i>Note : If LP fuel in LP tank is not enough, this fault code can be set. If LP tank is frozen, this fault code can be set, too. It is not system trouble.</i> Check the FTV for proper operation <ul style="list-style-type: none"> • Check FTV Hose Connections
77	OxygenSensorInputHigh O2 sensor SECM driver signal is shorted to power (G643E only)	Stored Fault Code (MIL, Disable Adapts)	Check if O2 sensor is shorted to +5VDC or Battery. <i>(AFRTTrimValveLowerDC fault should also occur)</i>

Advanced Diagnostics (G643E Engine Only)

MI-07 systems are equipped with built-in fault diagnostics. Detected system faults can be displayed by the Malfunction Indicator Lamp (MIL) as Diagnostic Fault Codes (DFC) or flash codes, and viewed in detail with the use of the Service Tool software. When the ignition key is turned on, the MIL will illuminate and remain on until the engine is started. Once the engine is started, the MIL lamp will go out unless one or more fault conditions are present. If a detected fault condition exists, the fault or faults will be stored in the memory of the small engine control module (SECM). Once an active fault occurs the MIL will illuminate and remain ON. This signals the operator that a fault has been detected by the SECM.

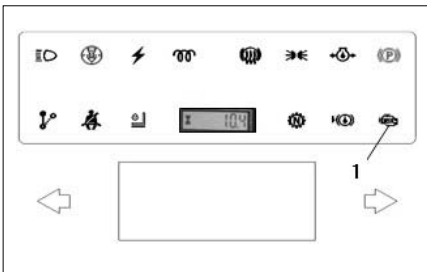

(1) Malfunction Indicator Lamp(MIL) for Engine control system

Reading Diagnostic Fault Codes

All MI-07 fault codes are three-digit codes. When the fault codes are retrieved (displayed) the MIL will flash for each digit with a short pause (0.5 seconds) between digits and a long pause (1.2 seconds) between fault codes. A code 12 is displayed at the end of the code list.

EXAMPLE: A code 461 (ETCSticking) has been detected and the engine has shut down and the MIL has remained **ON**. When the codes are displayed the MIL will flash four times (4), pause, then flash six times (6), pause, then flash one time (1) This identifies a four sixty one (461), which is the ETCSticking fault. If any additional faults were stored, the SECM would again have a long pause, then display the next fault by flashing each digit. Since no other faults were stored there will be a long pause then one flash (1), pause, then two flashes (2). This identifies a twelve, signifying the end of the fault list. This list will then repeat.

Displaying Fault Codes (DFC) from SECM Memory

To enter code display mode you must turn **OFF** the ignition key. Now turn **ON** the key but do not start the engine. As soon as you turn the key to the ON position you must cycle the foot pedal by depressing it to the floor and then fully releasing the pedal (pedal maneuver). You must fully cycle the foot pedal three (3) times within five (5) seconds to enable the display codes feature of the SECM. Simply turn the key **OFF** to exit display mode. The code list will continue to repeat until the key is turned **OFF**.

Table 2. MI-07 Diagnostic Fault Codes (Flash Codes)

DFC	PROBABLE FAULT	FAULT ACTION *	CORRECTIVE ACTION FIRST CHECK
12	NONE Signifies the end of one pass through the fault list	NONE	None, used as end of the fault list identification
141 (14)	ECTRangeLow Coolant Sensor failure or shorted to GND	TurnOnMil	Check ECT sensor connector and wiring for a short to GND SECM (Signal) Pin B15 To ECT Pin 3 SECM (Sensor GND) Pin B1 to ECT Pin 1 SECM (System GND) Pin A16, B17
151 (15)	ECTRangeHigh Coolant sensor disconnected or open circuit	(1) TurnOnMil (2) DelayedEngine Shutdown (3) CheckEngineLight	Check if ECT sensor connector is disconnected or for an open ECT circuit SECM (Signal) Pin B15 to ECT Pin 3 SECM (Sensor GND) Pin B1 to ECT Pin 1
161 (16)	ECTOverTempFault Engine coolant temperature is high. The sensor has measured an excessive coolant temperature typically due to the engine overheating.	(1) TurnOnMil (2) DelayedEngine Shutdown (3) CheckEngineLight	Check coolant system for radiator blockage, proper coolant level and for leaks in the system. Possible ECT short to GND, check ECT signal wiring SECM (Signal) Pin B15 to ECT Pin 3 SECM (Sensor GND) Pin B1 to ECT Pin 1 SECM (System GND) Pin A16, B17 Check regulator for coolant leaks
171	ECT_IR_Fault Engine coolant temperature not changing as expected	None	Check for coolant system problems, e.g. defective or stuck thermostat
181	FuelSelectConflict Conflict in fuel select signals, normally set if both of the fuel select signals are shorted to ground	TurnOnMil	Check fuel select switch connection for a short to GND SECM (SIGNAL) Pin A12 SECM (SIGNAL) Pin A15 SECM (Sensor GND) Pin B1
193	CrankEdgesFault No crankshaft signal when engine is known to be rotating, broken crankshaft sensor leads or defective crank sensor	None	Check Crankshaft sensor connections SECM (SIGNAL) Pin B5 to Crank sensor Pin 3 SECM (Sensor GND) PIN B1 to Crank sensor Pin 2 Switched 12V to Crank sensor Pin 1 Check for defective Crank sensor

(*) Fault actions shown are default values specified by the OEM.

Table 2. MI-07 Diagnostic Fault Codes (Flash Codes) cont'd.

DFC	PROBABLE FAULT	FAULT ACTION*	CORRECTIVE ACTION FIRST CHECK
194	CrankSyncFault Loss of synchronization on the crankshaft sensor, normally due to noise on the signal or an intermittent connection on the crankshaft sensor	None	Check Crankshaft sensor connections SECM (SIGNAL) Pin B5 to Crank sensor Pin 3 SECM (Sensor GND) Pin B1 to Crank sensor Pin 2 Switched 12V to Crank sensor Pin 1 Check for defective Crank sensor
221 (22)	TPS1RangeLow TPS1 sensor voltage out of range low, normally set if the TPS1 signal has shorted to ground, circuit has opened or sensor has failed	TurnOnMil	Check throttle connector connection and TPS1 sensor for an open circuit or short to GND SECM Pin B23 (signal) to ETC Pin 6 SECM Pin B1 (sensor GND) to ETC Pin 2 SECM (system GND) Pin A16, B17
222	TPS2RangeLow TPS2 sensor voltage out of range low, normally set if the TPS2 signal has shorted to ground, circuit has opened or sensor has failed	TurnOnMil	Check throttle connector connection and TPS2 sensor for an open circuit or short to GND SECM Pin B4 (signal) to ETC Pin 5 SECM Pin B1 (sensor GND) to ETC Pin 2 SECM (system GND) Pin A16, B17
231 (23)	TPS1RangeHigh TPS1 sensor voltage out of range high, normally set if the TPS1 signal has shorted to power or the ground for the sensor has opened	TurnOnMil	Check throttle connector and TPS1 sensor wiring for a shorted circuit SECM Pin B23 (signal) to ETC Pin 6 SECM Pin B1 (sensor GND) to ETC Pin 2
232	TPS2RangeHigh TPS2 sensor voltage out of range high, normally set if the TPS2 signal has shorted to power or the ground for the sensor has opened	TurnOnMil	Check throttle connector and TPS1 sensor wiring for a shorted circuit SECM Pin B4 (signal) to ETC Pin 5 SECM pin B1 (sensor GND) to ETC Pin 2
241 (24)	TPS1AdaptLoMin Learned closed throttle end of TPS1 sensor range lower than expected	None	Check the throttle connector and pins for corrosion. To check the TPS disconnect the throttle connector and measure the resistance from: TPS Pin 2 (GND) to Pin 6 (TPS1 SIGNAL) (0.7 Ω ± 30%) TPS Pin 3 (PWR) to Pin 6 (TPS1 SIGNAL) (1.4 Ω ± 30%)

(*) Fault actions shown are default values specified by the OEM.

Table 2. MI-07 Diagnostic Fault Codes (Flash Codes) cont'd.

DFC	PROBABLE FAULT	FAULT ACTION *	CORRECTIVE ACTION FIRST CHECK
242	TPS2AdaptLoMin Learned closed throttle end of TPS2 sensor range lower than expected	None	Check the throttle connector and pins for corrosion. To check the TPS disconnect the throttle connector and measure the resistance from: TPS Pin 2 (GND) to Pin 5 (TPS2 SIGNAL) ($1.3K \Omega \pm 30\%$) TPS PIN 3 (PWR) to PIN 5 (TPS2 SIGNAL) ($0.6K \Omega \pm 30\%$)
251 (25)	TPS1AdaptHiMax Learned WOT end of TPS1 sensor range higher than expected	None	N/A
252	TPS2AdaptHiMax Learned WOT end of TPS2 sensor range higher than expected	None	N/A
271	TPS1AdaptHiMin Learned WOT end of TPS1 sensor range lower than expected	None	N/A
272	TPS2AdaptHiMin Learned WOT end of TPS2 sensor range lower than expected	None	N/A
281	TPS1AdaptLoMax Learned closed throttle end of TPS1 sensor range higher than expected	None	N/A
282	TPS2AdaptLoMax Learned closed throttle end of TPS2 sensor range higher than expected	None	N/A
291	TPS_Sensors_Conflict TPS sensors differ by more than expected amount NOTE: The TPS is not a serviceable item and can only be repaired by replacing the DV-EV throttle assembly.	(1) TurnOnMil (2) Engine Shutdown	Perform checks for DFCs 241 & 242

(*) Fault actions shown are default values specified by the OEM.

Table 2. MI-07 Diagnostic Fault Codes (Flash Codes) cont'd.

DFC	PROBABLE FAULT	FAULT ACTION *	CORRECTIVE ACTION FIRST CHECK
<p>331 (33)</p>	<p>MAPTimeRangeLow Manifold Absolute Pressure sensor input is low, normally set if the TMAP pressure signal wire has been disconnected or shorted to ground or the circuit has opened to the SECM</p>	<p>None</p>	<p>Check TMAP connector and MAP signal wiring for an open circuit TMAP Pin 4 to SECM Pin B18 (signal) TMAP Pin 1 to SECM Pin B1 (sensor GND) TMAP Pin 3 to SECM Pin B24 (XDRP +5 Vdc) Check the MAP sensor by disconnecting the TMAP connector and measuring at the sensor TMAP Pin 1(GND) to Pin 4 (pressure signal KPA) (2.4kΩ - 8.2kΩ) TMAP Pin 3 (power) to Pin 4 (pressure signal KPA) (3.4kΩ - 8.2kΩ)</p>
<p>332</p>	<p>MAPRangeLow Manifold Absolute Pressure sensor input is low, normally set if the TMAP pressure signal wire has been disconnected or shorted to ground or the circuit has opened to the SECM</p>	<p>(1) TurnOnMil (2) CutThrottle</p>	<p>Check TMAP connector and MAP signal wiring for an open circuit TMAP Pin 4 to SECM Pin B18 (signal) TMAP Pin 1 to SECM Pin B1 (sensor GND) TMAP Pin 3 to SECM Pin B24 (XDRP +5 Vdc) Check the MAP sensor by disconnecting the TMAP connector and measuring at the sensor: TMAP Pin 1(GND) to Pin 4 (pressure signal KPA) (2.4kΩ - 8.2kΩ) TMAP Pin 3 (power) to Pin 4 (pressure signal KPA) (3.4kΩ - 8.2kΩ)</p>
<p>341 (34)</p>	<p>MAPTimeRangeHigh Manifold Absolute Pressure Sensor Input is High, normally set if the TMAP pressure signal wire has become shorted to power, shorted to the IAT signal, the TMAP has failed or the SECM has failed.</p>	<p>None</p>	<p>Check TMAP connector and MAP signal wiring for a shorted circuit TMAP Pin 4 to SECM Pin B18 (signal) TMAP Pin 1 to SECM Pin B1 (sensor GND) TMAP Pin 3 to SECM Pin B24 (XDRP +5 Vdc) Check the MAP sensor by disconnecting the TMAP connector and measuring at the sensor TMAP Pin 1(GND) to Pin 4 (pressure signal KPA) (2.4kΩ - 8.2kΩ) TMAP Pin 3 (power) to Pin 4 (pressure signal KPA) (3.4kΩ - 8.2kΩ)</p>

Table 2. MI-07 Diagnostic Fault Codes (Flash Codes) cont'd.

DFC	PROBABLE FAULT	FAULT ACTION *	CORRECTIVE ACTION FIRST CHECK
342	MAPRangeHigh Manifold Absolute Pressure Sensor Input is High, normally set if the TMAP pressure signal wire has become shorted to power, shorted to the IAT signal, the TMAP has failed or the SECM has failed	(1) TurnOnMil (2) CutThrottle	Check TMAP connector and MAP signal wiring for a shorted circuit TMAP Pin 4 to SECM Pin B18 (signal) TMAP Pin 1 to SECM Pin B1 (sensor GND) TMAP Pin 3 to SECM Pin B24 (XDRP +5 Vdc) Check the MAP sensor by disconnecting the TMAP connector and measuring at the sensor: TMAP Pin 1(GND) to Pin 4 (pressure signal KPA) (2.4k Ω - 8.2k Ω) TMAP Pin 3 (power) to Pin 4 (pressure signal KPA) (3.4k Ω - 8.2k Ω)
351	MAP_IR_HI MAP sensor indicates higher pressure than expected	None	Check for vacuum leaks. Check that TMAP sensor is mounted properly. Possible defective TMAP sensor.
352	MAP_IR_LO MAP sensor indicates lower pressure than expected	None	Possible defective TMAP sensor.
353	MAP_STICKING MAP sensor not changing as expected	None	Check that TMAP sensor is mounted properly. Possible defective TMAP sensor.
371 (37)	IATRangeLow Intake Air Temperature Sensor Input is Low normally set if the IAT temperature sensor wire has shorted to chassis ground or the sensor has failed.	TurnOnMil	Check TMAP connector and IAT signal wiring for a shorted circuit TMAP Pin 2 to SECM Pin B12 (signal) TMAP Pin 1 to SECM Pin B1 (sensor GND) To check the IAT sensor of the TMAP disconnect the TMAP connector and measure the IAT resistance Resistance is approx 2400 ohms at room temperature.
381 (38)	IATRangeHigh Intake Air Temperature Sensor Input is High normally set if the IAT temperature sensor wire has been disconnected or the circuit has opened to the SECM.	TurnOnMil	Check TMAP connector and IAT signal wiring for a shorted circuit TMAP Pin 2 to SECM Pin B12 (signal) TMAP Pin 1 to SECM Pin B1 (sensor GND) To check the IAT sensor of the TMAP disconnect the TMAP connector and measure the IAT resistance Resistance is approx 2400 ohms at room temperature.
391	IAT_IR_Fault Intake Air Temperature not changing as expected	None	Check connections to TMAP sensor. Check that TMAP sensor is properly mounted to manifold.

(*) Fault actions shown are default values specified by the OEM.

Table 2. MI-07 Diagnostic Fault Codes (Flash Codes) cont'd.

DFC	PROBABLE FAULT	FAULT ACTION *	CORRECTIVE ACTION FIRST CHECK
421	EST1_Open EST1 output open, possibly open EST1 signal or defective spark module	TurnOnMil	Check coil driver wiring and connector for open circuit SECM Pin A9 (EST1) to OEM ignition system. See application note. Verify GND on ignition module Pin A (of both connectors) Verify +12 Vdc on ignition module Pin B (of both connectors) Refer to application manual for specific engine details.
431	EST1_Short EST1 output shorted high or low, EST1 signal shorted to ground or power or defective spark module	TurnOnMil	Check coil driver wiring and connector for shorts SECM Pin A9 (EST1) to ignition module Pin D (4-pin connector) Verify GND on ignition module Pin A (of both connectors) Verify +12 Vdc on ignition module Pin B (of both connectors) Refer to application manual for specific engine details.
461 (26)	ETC_Sticking Electronic Throttle Control is sticking. This can occur if the throttle plate (butterfly valve) inside the throttle bore is sticking. The plate sticking can be due to some type of obstruction, a loose throttle plate, or worn components shaft bearings. NOTE: The throttle assembly is not a serviceable item and can only be repaired by replacing the DV-EV throttle assembly.	(1) TurnOnMil (2) EngineShutdown (3) CutThrottle	Check for debris or obstructions inside the throttle body Perform the throttle test using the Service Tool and re-check for fault Check throttle-plate shaft for bearing wear Check the ETC driver wiring for an open circuit SECM Pin A17 to ETC + Pin 1 SECM Pin A18 to ETC - Pin 4 Check the ETC internal motor drive by disconnecting the throttle connector and measuring the motor drive resistance at the throttle TPS Pin 1 (+DRIVER) to Pin 4 (-DRIVER) ~3.0-4.0Ω
471	ETC_Open_Fault Electronic Throttle Control Driver has failed, normally set if either of the ETC driver signals have opened or become disconnected, electronic throttle or SECM is defective.	None	Check the ETC driver wiring for an open circuit SECM Pin A17 to ETC + Pin 1 SECM Pin A18 to ETC - Pin 4 Check the ETC internal motor drive by disconnecting the throttle connector and measuring the motor drive resistance at the throttle TPS Pin 1 (+DRIVER) to Pin 4 (-DRIVER) ~3.0-4.0Ω

(*) Fault actions shown are default values specified by the OEM.

Table 2. MI-07 Diagnostic Fault Codes (Flash Codes) cont'd.

DFC	PROBABLE FAULT	FAULT ACTION *	CORRECTIVE ACTION FIRST CHECK
481 (28)	<p>ETCSpringTest Electronic Throttle Control Spring Return Test has failed. The SECM will perform a safety test of the throttle return spring following engine shutdown. If this spring has become weak the throttle will fail the test and set the fault.</p> <p>NOTE: The throttle assembly is not a serviceable item and can only be repaired by replacing the DV-EV throttle assembly.</p>	<p>(1) TurnOnMil (2) EngineShutdown</p>	Perform throttle spring test by cycling the ignition key and re-check for fault
491 (29)	<p>HbridgeFault_ETC Electronic Throttle Control Driver has failed. Indeterminate fault on Hbridge driver for electronic throttle control. Possibly either ETC+ or ETC- driver signals have been shorted to ground</p>	TurnOnMil	<p>Check ETC driver wiring for a shorted circuit SECM Pin A17 to ETC + Pin 1 SECM Pin A18 to ETC - Pin 4 Perform the throttle test using the Service Tool and re-check for fault Check the ETC internal motor drive by disconnecting the throttle connector and measuring the motor drive resistance at the throttle TPS Pin 1 (+DRIVER) to Pin 4 (-DRIVER) ~3.0-4.0Ω</p>
521 (52)	<p>LowOilPressureFault Low engine oil pressure</p>	<p>(1) TurnOnMil (2) DelayedEngine Shutdown (3) CheckEngine Light</p>	<p>Check engine oil level Check electrical connection to the oil pressure switch SECM Pin B9 to Oil Pressure Switch</p>
531 (53)	<p>SysVoltRangeLow System voltage too low</p>	TurnOnMil	<p>Check battery voltage Perform maintenance check on electrical connections to the battery and chassis ground Check battery voltage during starting and with the engine running to verify charging system and alternator function Measure battery power at SECM with a multimeter (with key on) SECM Pin A23 (DRVP) to SECM Pin A16 (DRVG) SECM Pin A23 (DRVP) to SECM Pin B17 (DRVG)</p>

(*) Fault actions shown are default values specified by the OEM.

Table 2. MI-07 Diagnostic Fault Codes (Flash Codes) cont'd.

DFC	PROBABLE FAULT	FAULT ACTION *	CORRECTIVE ACTION FIRST CHECK
541 (54)	SysVoltRangeHigh System voltage too high	TurnOnMil	Check battery and charging system voltage Check battery voltage during starting and with the engine running Check voltage regulator, alternator, and charging system Check battery and wiring for overheating and damage Measure battery power at SECM with a multimeter (with key on) SECM Pin A23 (DRVP) to SECM Pin A16 (DRVG) SECM Pin A23 (DRVP) to SECM Pin B17 (DRVG)
551 (55)	SensVoltRangeLow Sensor reference voltage XDRP too low	(1) TurnOnMil (2) EngineShutdown	Measure transducer power at the TMAP connector with a multimeter TMAP Pin 3 XDRP +5 Vdc to TMAP Pin 1 XDRG GND Verify transducer power at the SECM with a multimeter SECM Pin B24 +5 Vdc to SECM Pin B1 XDRG GND Verify transducer power at ETC with a multimeter ETC Pin 3 XDRP PWR to ETC Pin 2 XDRG GND Verify transducer power to the foot pedal with a multimeter.
561 (56)	SensVoltRangeHigh Sensor reference voltage XDRP too high	(1) TurnOnMil (2) EngineShutdown	Measure transducer power at the TMAP connector with a multimeter TMAP Pin 3 XDRP +5 Vdc to TMAP Pin 1 XDRG GND Verify transducer power at the SECM with a multimeter SECM Pin B24 +5 Vdc to SECM Pin B1 XDRG GND Verify transducer power at ETC with a multimeter ETC Pin 3 XDRP PWR to ETC Pin 2 XDRG GND Verify transducer power to the foot pedal with a multimeter.
571 (57)	HardOverspeed Engine speed has exceeded the third level (3 of 3) of overspeed protection	(1) TurnOnMil (2) HardRevLimit	Usually associated with additional ETC faults Check for ETC Sticking or other ETC faults Verify if the lift truck was motored down a steep grade

(*) Fault actions shown are default values specified by the OEM.

Table 2. MI-07 Diagnostic Fault Codes (Flash Codes) cont'd.

DFC	PROBABLE FAULT	FAULT ACTION *	CORRECTIVE ACTION FIRST CHECK
572	MediumOverspeed Engine speed has exceeded the second level (2 of 3) of overspeed protection	(1) TurnOnMil (2) MediumRevLimit	Usually associated with additional ETC faults Check for ETC Sticking or other ETC faults Verify if the lift truck was motored down a steep grade
573	SoftOverspeed Engine speed has exceeded the first level (1 of 3) of overspeed protection	(1) TurnOnMil (2) SoftRevLimit	Usually associated with additional ETC faults Check for ETC Sticking or other ETC faults Verify if the lift truck was motored down a steep grade
611 (61)	APP1RangeLow APP1 sensor voltage out of range low, normally set if the APP1 signal has shorted to ground, circuit has opened or sensor has failed	(1) TurnOnMil (2) CheckEngine Light	Check foot pedal connector Check APP1 signal at SECM PIN B7
612 (65)	APP2RangeLow APP2 sensor voltage out of range low, normally set if the APP2 signal has shorted to ground, circuit has opened or sensor has failed	TurnOnMil	Check foot pedal connector Check APP2 signal at SECM PIN B16
621 (62)	APP1RangeHigh APP1 sensor voltage out of range high, normally set if the APP1 signal has shorted to power or the ground for the sensor has opened	1) TurnOnMil (2) CheckEngine Light	Check foot pedal connector Check APP1 signal at SECM PIN B7
622 (66)	APP2RangeHigh APP2 sensor voltage out of range high, normally set if the APP2 signal has shorted to power or the ground for the sensor has opened	TurnOnMil	Check foot pedal connector Check APP2 signal at SECM PIN B16
631 (63)	APP1AdaptLoMin Learned idle end of APP1 sensor range lower than expected	None	Check APP connector and pins for corrosion Cycle the pedal several times and check APP1 signal at SECM Pin B7
632 (67)	APP2AdaptLoMin Learned idle end of APP2 sensor range lower than expected	None	Check APP connector and pins for corrosion Cycle the pedal several times and check APP2 signal at SECM Pin B16
641 (64)	APP1AdaptHiMax Learned full pedal end of APP1 sensor range higher than expected	None	N/A
642 (68)	APP2AdaptHiMax Learned full pedal end of APP2 sensor range higher than expected	None	N/A

(*) Fault actions shown are default values specified by the OEM.

Table 2. MI-07 Diagnostic Fault Codes (Flash Codes) cont'd.

DFC	PROBABLE FAULT	FAULT ACTION *	CORRECTIVE ACTION FIRST CHECK
651	APP1AdaptHiMin Learned full pedal end of APP1 sensor range lower than expected	None	N/A
652	APP2AdaptHiMin Learned full pedal end of APP2 sensor range lower than expected	None	N/A
661	APP1AdaptLoMax Learned idle end of APP1 sensor range higher than expected	None	N/A
662	APP2AdaptLoMax Learned idle end of APP2 sensor range higher than expected	None	N/A
691 (69)	APP_Sensors_Conflict APP position sensors do not track well, intermittent connections to APP or defective pedal assembly	1) TurnOnMil 2) Level1PowerLimit	Check APP connector and pins for corrosion Cycle the pedal several times and check APP1 signal at SECM Pin B7 Cycle the pedal several times and check APP2 signal at SECM Pin B16
711 (71)	LSDFault_Dither1 Dither Valve 1 Fault, signal has opened or shorted to ground or power or defective dither 1 valve	TurnOnMil	Check FTV1 for an open wire or FTV connector being disconnected FTV1 Pin 1 (signal) to SECM Pin A1 FTV1 Pin 2 (power) to SECM (DRVP) Pin A23 Check FTV1 for an open coil by disconnecting the FTV connector and measuring the resistance ($-26\Omega \pm 2\Omega$)
712	LSDFault_Dither2 Dither Valve 2 Fault, signal has opened or shorted to ground or power or defective dither 2 valve	TurnOnMil	Check FTV1 for an open wire or FTV connector being disconnected or signal shorted to GND FTV2 Pin 1 (signal) to SECM Pin A2 FTV2 Pin 2 (power) to SECM (DRVP) Pin A23 Check FTV1 for an open coil by disconnecting the FTV connector and measuring the resistance ($-26\Omega \pm 2\Omega$)
714	LSDFault_CheckEngine Check Engine Lamp Fault, signal has opened or shorted to ground or power or defective check engine lamp	None	Check 'Check Engine Lamp' for an open wire or shorted to GND

(*) Fault actions shown are default values specified by the OEM.

Table 2. MI-07 Diagnostic Fault Codes (Flash Codes) cont'd.

DFC	PROBABLE FAULT	FAULT ACTION *	CORRECTIVE ACTION FIRST CHECK
715	LSDFault_CrankDisable Crank Disable Fault, signal has opened or shorted to ground or power or defective crank disable relay	None	N/A
717	LSDFault_LockOff Fuel lock off Valve Fault, signal has opened or shorted to ground or power or defective Fuel lock off valve	TurnOnMil	Check fuel lock off valve for an open wire or connector being disconnected or signal shorted to GND Lockoff Pin B (signal) to SECM Pin A11 Lockoff Pin A (power) to SECM (DRVP) Pin A23 Check CSV for an open coil by disconnecting the CSV connector and measuring the resistance ($-26\Omega \pm 3\Omega$)
718	LSDFault_MIL Malfunction Indicator Lamp Fault, signal has opened or shorted to ground or power or defective MIL lamp	None	Check MIL lamp for an open wire or short to GND.
721 (72)	GasFuelAdaptRangeLo In LPG mode, system had to adapt rich more than expected	TurnOnMil	Check for vacuum leaks. Check fuel trim valves, e.g. leaking valve or hose Check for missing orifice(s).
731 (73)	GasFuelAdaptRangeHi In LPG mode, system had to adapt lean more than expected	TurnOnMil	Check fuel trim valves, e.g. plugged valve or hose. Check for plugged orifice(s).
741 (74)	GasO2NotActive Pre-catalyst O2 sensor inactive on LPG, open O2 sensor signal or heater leads, defective O2 sensor	(1) TurnOnMil (2) DisableGas O2Ctrl	Check that Pre-catalyst O2 sensor connections are OK. O2 (signal) Pin 3 to SECM Pin B13 O2 Pin 2 (HEATER GND) to SECM (DRVG GNG) Pins A16, B17 O2 Pin 1 (HEATER PWR) to SECM (DRVP + 12V) Pin A23 Verify O2 sensor heater circuit is operating by measuring heater resistance ($2.1\Omega \pm 0.4\Omega$) O2 Pin 2 (HEATER GND) to Pin 1 (HEATER PWR)

(*) Fault actions shown are default values specified by the OEM.

Table 2. MI-07 Diagnostic Fault Codes (Flash Codes) cont'd.

DFC	PROBABLE FAULT	FAULT ACTION *	CORRECTIVE ACTION FIRST CHECK
742	GasPostO2NotActive Post-catalyst O2 sensor inactive on LPG, open O2 sensor signal or heater leads, defective O2 sensor.	(1) TurnOnMil (2) DisableGas Post O2Ctrl	Check that Post-catalyst O2 sensor connections are OK. O2 (signal) Pin 3 to SECM Pin B19 O2 Pin 2 (HEATER GND) to SECM (DRVG GNG) Pins A16, B17 O2 Pin 1 (HEATER PWR) to Post O2 Heater Relay. Relay pin 87. This relay turns on only after engine has been running for some time and SECM has calculated that water condensation in exhaust has been removed by exhaust heat. Post O2 Heater Relay has SECM (DRVP + 12V) applied to the relay coil power. The relay coil ground is controlled by SECM Pin A20 to activate the relay to flow current through the post O2 heater. Verify O2 sensor heater circuit is operating by measuring heater resistance ($2.1\Omega \pm 0.4\Omega$) O2 Pin 2 (HEATER GND) to Pin 1 (HEATER PWR)
743	Reserved		
751	GasO2FailedLean Pre-catalyst O2 sensor indicates extended lean operation on LPG	(1) TurnOnMil (2) DisableGas O2Ctrl	Check for vacuum leaks. Check fuel trim valves, e.g. leaking valve or hose. Check for missing orifice(s).
752	GasPostO2FailedLean Pre-catalyst O2 sensor indicates extended lean operation on LPG	(1) TurnOnMil (2) DisableGas Post O2Ctrl	Correct other faults that may contribute to 752 (e.g. faults pertaining to fuel trim valves, Pre-Cat O2, Post Cat O2 sensor) Check for vacuum leaks Check for leaks in exhaust, catalytic converter, HEGO sensors; repair leaks. Check all sensor connections (see fault 742 corrective actions).
771 (77)	GasO2FailedRich Pre-catalyst O2 sensor indicates extended rich operation on LPG	(1) TurnOnMil (2) DisableGas O2Ctrl	Check fuel trim valves, e.g. plugged valve or hose. Check for plugged orifice(s).

(*) Fault actions shown are default values specified by the OEM.

Table 2. MI-07 Diagnostic Fault Codes (Flash Codes) cont'd.

DFC	PROBABLE FAULT	FAULT ACTION *	CORRECTIVE ACTION FIRST CHECK
772	GasPostO2FailedRich Pre-catalyst O2 sensor indicates extended rich operation on LPG	(1) TurnOnMil (2) DisableGas PostO2Ctrl	Correct other faults that may contribute to 772 (e.g. faults pertaining to FTVs, Pre-Cat O2, Post Cat O2 sensor) Look for leaks in exhaust, catalytic converter, HEGO sensors; repair leaks. Check all sensor connections (see fault 742 corrective actions).
843	Reserved		
911	O2RangeLow Pre-catalyst O2 sensor voltage out of range low, sensor signal shorted to ground	(1) TurnOnMil (2) DisableGas O2Ctrl	Check if O2 sensor installed before the catalyst is shorted to GND or sensor GND. O2 (signal) Pin 3 to SECM Pin B13 SECM (DRVG GND) Pins A16, B17 SECM (XDRG sensor GND) Pin B1
912	O2_PostCatRangeLow Post-catalyst O2 sensor voltage out of range low, sensor signal shorted to ground	(1) TurnOnMil (2) Disable LPG Post-catalyst O2Ctrl	Check if O2 installed after the catalyst sensor is shorted to GND or sensor GND. O2 (signal) Pin 3 to SECM Pin B19 Possible sources: SECM (DRVG GND) Pins A16, B17 and SECM (XDRG sensor GND) Pin B1
921	O2RangeHigh Pre-catalyst O2 sensor voltage out of range high, sensor signal shorted to power	(1) TurnOnMil (2) DisableGas O2Ctrl	Check if O2 sensor installed before catalyst is shorted to +5Vdc or battery. O2 (signal) Pin 3 to SECM Pin B13 SECM (XDRP + 5V) Pin B24 SECM (DRVP + 12V) Pin A23
922	O2_PostCatRangeHigh Post-catalyst O2 sensor voltage out of range low, sensor signal shorted to ground	(1) TurnOnMil (2) Disable LPG Post-catalyst O2Ctrl	Check if O2 sensor installed after catalyst is shorted to +5Vdc or battery. O2 (signal) Pin 3 to SECM Pin B19 Possible voltage sources: SECM (XDRP + 5V) Pin B24 and SECM (DRVP + 12V) Pin A23

(*) Fault actions shown are default values specified by the OEM.

Table 2. MI-07 Diagnostic Fault Codes (Flash Codes) cont'd.

DFC	PROBABLE FAULT	FAULT ACTION *	CORRECTIVE ACTION FIRST CHECK
931	FuelTempRangeLow Fuel Temperature Sensor Input is Low normally set if the fuel temperature sensor wire has shorted to chassis ground or the sensor has failed.	TurnOnMil	Check fuel temp sensor connector and wiring for a short to GND SECM (signal) Pin B14 to FTS Pin 1 SECM (sensor GND) Pin B1 to FTS Pin 2 SECM (system GND) Pin A16, B17
932	FuelTempRangeHigh Fuel Temperature Sensor Input is High normally set if the fuel temperature sensor wire has been disconnected or the circuit has opened to the SECM.	TurnOnMil	Check if fuel temp sensor connector is disconnected or for an open FTS circuit SECM (signal) Pin B14 to FTS Pin 1 SECM (sensor GND) Pin B1 to FTS Pin 2
933	TransOilTemp Excessive transmission oil temperature	(1) TurnOnMil (2) Delayed EngineShutdown	Refer to drivetrain manufacturer's transmission service procedures.
991	ServiceFault1 Service Interval 1 has been reached	None	Perform service procedure related to Service Interval 1 (determined by OEM)
992	ServiceFault2 Service Interval 2 has been reached	None	Perform service procedure related to Service Interval 2 (determined by OEM)
993	ServiceFault3 Service Interval 3 has been reached	None	Perform service procedure related to Service Interval 3 (determined by OEM)
994	ServiceFault4 Service Interval 4 has been reached—replace HEGO sensors	TurnOnMil	Replace Pre-catalyst HEGO sensor Replace Post-catalyst HEGO sensor
995	ServiceFault5 Service Interval 5 has been reached—replace timing belt	TurnOnMil	Replace engine timing belt

(*) Fault actions shown are default values specified by the OEM.

Lift Truck Operation

Power Shift Transmission / Drive Axle

1. Start the engine. See item "Starting the Engine"



Typical Example

2. PUSH DOWN on the service foot brake pedal to hold the lift truck until ready to move it.
3. RELEASE the parking brake.



Typical Example

4. Select the direction of travel by PUSHING the directional lever FORWARD for forward direction or PULLING the lever BACK for reverse direction.
5. Rotate the speed range control to first (low) speed range.

NOTE: From a stopped position, move the lift truck in first (low) range ONLY.

WARNING

A lift truck with the engine running but without an operator can move slowly (creep) if the transmission is left engaged. This could result in personal injury. Always place the transmission control levers in the NEUTRAL (center) position and apply the parking brake before dismounting from the lift truck.

6. RELEASE the service foot brake.
7. PUSH DOWN on the accelerator pedal to obtain the desired travel speed. RELEASE the pedal to decrease travel speed.
8. Transmission speed changes to second and third speed range can be made on the go, without deceleration or braking. When faster travel speed is needed.

NOTICE

Come to a complete stop before changing direction of travel.

WARNING

Sudden reversal of a loaded lift truck traveling forward can cause the load to fail or the lift truck to tip over. Stop the loaded lift truck completely, before shifting to reverse. Failure to comply could result in personal injury.

9. To change the lift truck direction of travel, RELEASE the accelerator pedal.
10. PUSH DOWN on the service foot brake pedal to bring the lift truck to a complete stop.
11. SHIFT the directional lever to the desired direction of travel. Rotate the speed selector lever to first (low) speed range, if it is not already in this position.
12. RELEASE the service foot brake. PUSH DOWN on the accelerator pedal to obtain the desired travel speed.

⚠ WARNING

Watch the road carefully for any obstacle when driving the truck. Do not go fast over bumps, pot holes or other rough grounds, otherwise the engine might go OFF by a severe impact.

In case of engine going OFF, press the brake pedal at one time as hard as possible in order to stop the truck. Pressing the brake pedal several times has a risk that the brake would not work.



Typical Example

13. To stop the lift truck when travelling in either direction, RELEASE accelerator pedal (1).
14. PUSH DOWN on service foot brake pedal (2) and bring the lift truck to a smooth stop.

Inching

NOTE: The purpose of the inching pedal is to provide precise lift truck inching control at very slow travel speed and high engine rpm. This is used for fast hydraulic lift during load approach, pick up or load positioning.



Typical Example

1. To inch (creep) in either direction, slowly push down on the inching pedal. This will start to apply the service foot brakes and allow the transmission clutch discs to slip.
2. Vary the position of inching pedal and the accelerator pedal to control the inching speed and distance.
3. Pushing down further on the inching pedal will disengage the transmission completely and apply the service brakes fully to stop and hold the lift truck. This will provide full engine power for fast hydraulic lift.

Auto Shift Controller ASC-200/201 (If Equipped)

Product Description

The Autoshift controller is an electrical control system, specially designed for use on forklift trucks with internal combustion engines.

Its primary purpose is to prevent the operator from operating the truck outside of the design parameters, e.g. selecting the reverse gear when travelling in excess of 5 km/h (3.11 mph) in a forward direction, and vice versa.

The Autoshift controller is mounted on a convenient position away from excessive heat sources and retrofits into the truck's electrical system. An inductive speed sensor is mounted on the transmission case where it will pick up a pulse from a gear tooth pattern. This pulse is used to monitor the truck in motion and its travel speed. To enable the system to change gears smoothly, the shift points for offset speed are adjustable.

An operator no longer has to change gears with his hands, therefore he can be more productive.

The Autoshift controller prevents strain and abuse to the transmission by changing gears up and down automatically. It also prevents damage to the half shaft, excessive tire wear and heat to the transmission.

Features

Product	Adaptable To
ASC-200	D50/60/70S-5 (2 Speed)
ASC-201	G50/60/70S-5

- 1) 2 - speed auto shift control
- 2) Prevent downshifting at high speed
- 3) Inhibit selecting direction at high speed outside of the design parameters.



Adjustments

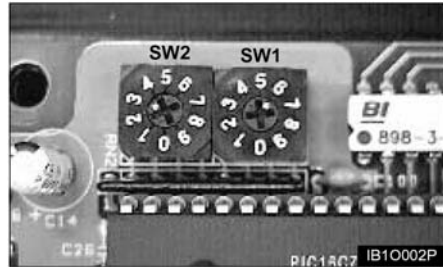

Adjustment Switch

• Low-High Shift Point (SW1)

ASC-200/201 allows you to set the 2 speed Auto Gear Shift Point, the maximum travel speed at which the Auto Shift Controller up-shift or down-shift the transmission automatically according to the vehicle speed. For adjustment of 2 speed Auto Gear Shift speed, the SW1 switch is used on the printed circuit board.

SW1(Low-High SHIFT) Tow Speed Auto Gear Shift Point		
Notch	Vehicle Speed	
	ASC-200	ASC-201
0	2.5km/h(1.55mph)	5.57km/h(3.46mph)
1	3.0km/h(1.86mph)	
2	3.5km/h(2.17mph)	
3	4.0km/h(2.49mph)	
4	4.5km/h(2.80mph)	6.17km/h(3.84mph)
5	5.0km/h(3.11mph)	
6	5.5km/h(3.42mph)	
7	6.0km/h(3.73mph)	
8	6.5km/h(4.04mph)	
9	7.0km/h(4.35mph)	8.40km/h(5.22mph)

For example if SW1 is put 5th notch, the 2 speed auto gear shift speed will be 5.0km/h(3.11mph) in ASC-200 or 6.17km/h(3.84mph) in ASC-201. The factory setting value as a default for SW1 of each model is as follows.

Product	Notch	Vehicle Speed
ASC-200	5	5.0km/h (3.11mph)
ASC-201	6	6.78km/h (4.21mph)

• **Direction Inhibit Point (SW2)**

Auto Shift allows you to set the Direction Inhibit Speed, the maximum travel speed at which the transmission can be reversed. For adjustment of direction inhibit speed, the SW2 switch is used on the printed circuit board.

Using a philips screwdriver, turn the SW1 adjustment until the white dot is next to the notch corresponding to the selected vehicle speed. You may reset Inhibit Speed to one of ten settings between a minimum of 3.3km/h(2.05mph) and a maximum of 6.0km/h(3.75mph) travel speed.

SW2(FWD RVS SHIFT) Direction Inhibit Point	
Notch	Vehicle Speed
0	3.3km/h (2.05mph)
1	3.6km/h (2.24mph)
2	3.9km/h (2.42mph)
3	4.2km/h (2.61mph)
4	4.5km/h (2.80mph)
5	4.8km/h (2.98mph)
6	5.1km/h (3.17mph)
7	5.4km/h (3.36mph)
8	5.7km/h (3.54mph)
9	6.0km/h (3.73mph)

For example if SW2 is put 7th notch, the Direction Inhibit Speed will be 5.4km/h(3.36mph) which is factory setting value as a default.

Product	Notch	Adaptable
ASC-200	7	5.4km/h(3.36mph)
ASC-201	3	4.2km/h(2.61mph)

NOTICE

The transmission of your lift truck may be reversed under full power up to a travel of 6.0 km/h (3.73 mph). But the Inhibit Speed of Auto Shift is set by the factory at 4-5 km/h (2.5-3.2 mph) because reversing the transmission at lower travel speeds prolongs the lift of the transmission, axle shafts and tires.

Diagnostics Features



ASC-200/201 has internal indicator on the right side of the controller for displaying the selected gear and the abnormal condition.

⚠ WARNING

Do not diagnose or repair Auto Shift Controller Faults unless trained and authorized to do so. Improper performance of maintenance procedures is dangerous and could result in personal injury or death.

Below is a description applicable for many ASC-200/201 implementations.

• **Display for Operator**

Display	Description	Remark
A	Automatic operation	
H	High speed	At 2nd shift gear
L	Low speed	At 1st shift gear
PT/M	Speed sensor open	Flashing
E	E/G Speed sensor open	Flashing
F	Controller fault	Flashing
5	H/L Sol. Short	Flashing
6	Forward Sol. Short	Flashing
7	Reverse Sol. Short	Flashing

This information is given during normal operating when something special happens. For example, on ASC-200/201's with the speed sensor, one of the indicators is used to indicate a sensor problem.

• Display for Troubleshooting

Display	Description	Remark
A	Automatic operation	
2	High speed s/w input	Lever input test
3	Forward s/w input	Lever input test
4	Reverse s/w input	Lever input test

This information is input for signal diagnostics.
This test is used to verify operation of direction control lever.

Operation

This system can be basically operated in two preselected modes, automatic mode and manual mode.

NOTE: In ASC-200 factory-setting controller, automatic mode is selected for both direction inhibit and two-speed auto shift control as a default on the PCB(Printed Circuit Board).In ASC-201 factory-setting controller, manual mode(Fail-Safe Mode) is selected as a default for direction inhibit while automatic mode is selected as a default for two-speed auto shift control.

Automatic mode

Direction Inhibit

1. Start the engine with the direction control lever in NEUTRAL and the parking brake engaged.
2. Press down on the service brake pedal, disengage the parking brake and move the direction control lever to FORWARD.

NOTE: Release the parking brake before using the directional control lever.

3. Observe the LED on the Auto Shift Controller. The LED should indicate "A" while the direction control lever is in FORWARD, NEUTRAL and REVERSE. Report Auto Shift as faulty if the LED indicates anything other than "A".
4. Keep the service brake pushed down until ready to move the truck.
5. To change directions of a traveling lift truck when the Auto Shift Controller LED displays "A", shift the direction control lever to the opposite direction and wait for the lift truck to change direction.
6. If however, your travel speed is higher than the pre-selected direction change speed as direction inhibit point in the controller, Auto Shift will shift the transmission to NEUTRAL until the lift truck's travel speed slows to the pre-selected direction change speed, and then shift the transmission to the direction selected.
7. You should be prepared to help slow the lift truck to the pre-selected direction change speed by pressing down on the service brake pedal.

 **WARNING**

When you want to change the travel direction, you must press down on the service brake pedal to reduce the travel speed. Be cautious that the lift truck's stopping distance may be longer than in manual mode because the lift truck continues to travel forward regardless of the selection of reverse with the direction control lever until the vehicle speed is sufficiently reduced.

8. The direction of travel will change automatically when the vehicle speed is reduced as much as the pre-selected speed in the controller.

 **WARNING**

Bring the loaded lift truck to a complete stop before changing travel direction. Changing travel direction while traveling may cause the lift truck to lose the load or tip over.

9. When the direction change is completed, continue to push down on the accelerator pedal to obtain the desired travel speed.

NOTICE

The transmission of your lift truck may be reversed under full power up to a travel of 6.0 km/h (3.73 mph). But the Inhibit Speed of Auto Shift is set by the factory at 4-5 km/h (2.5-3.2 mph) because reversing the transmission at lower travel speeds prolongs the lift of the transmission, axle shafts and tires.

Two-Speed Auto Shift Control

While traveling forward with the high speed gear, that is, 2nd gear selected, the ASC-200 /201 can upshift or down-shift the transmission automatically according to the vehicle speed by its own speed ratio control so that the appropriate gear may be engaged in every situation.

NOTICE

Two-Speed Auto Shift Control function can be accomplished only when the direction control lever is placed in the high speed (2nd gear) position.

Manual Mode (Fail-Safe mode)

In case that the controller is broken down or you don't want to use the functions of the Auto Shift Controller, you can select Manual Mode. In Manual Mode, you can operate your lift truck in the same manner as any lift truck without Auto Shift Controller. You can select the Manual mode or the Automatic mode by doing following procedures.

 **WARNING**

In the manual mode, direction inhibition function can not be operated normally. The sudden reversal of a loaded lift truck traveling forward can cause the load to fall or the lift truck to tip over.

1. Park the lift truck in a designed service area.
2. Lower the lift truck's forks or lode engaging attachment to the travel surface, shift the direction control lever to NEUTRAL, engage the parking brake, shut OFF the engine and remove the key.
3. Turn OFF the electrical disconnect switch, if equipped. Chock the front and rear tires to prevent unintentional movement of the lift truck.
4. Remove the Controller cover plate screws and cover plates.
5. Locate the FWD/RVS selection switch (1) and the High/Low(H/L) selection switch (2) on the printed circuit board.
6. Move the switches as indicated, up for Automatic(AUTO) operation or down for Manual(MANUAL) operation.

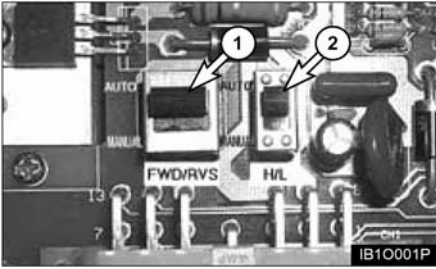

Typical Example of ASC-200

NOTE: In ASC-200 factory-setting controller, automatic mode is selected for both direction inhibit and two-speed auto shift control as a default on the PCB(Printed Circuit Board).In ASC-201 factory-setting controller, manual mode(Fail-Safe Mode) is selected as a default for direction inhibit while automatic mode is selected as a default for two-speed auto shift control.

7. Replace the Controller cover plate and screws.
8. Turn ON the electrical disconnect switch, if equipped.
9. Start engine. check the Controller LED indication for "A". For indications other than "A", see following section on Fault Diagnosis.

NOTE: After operating the truck manually by selecting the Manual Mode switch on PCB(Printed Circuit Board), the position of mode must be checked before operating the truck automatically.

Operating Techniques

Inching into Loads

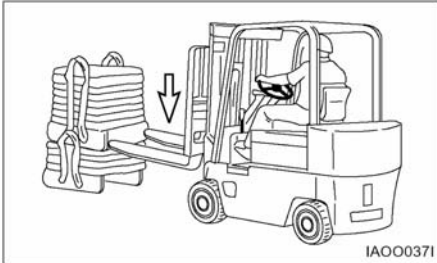

Typical Example

1. Move the lift truck slowly FORWARD into position and engage the load. The truck should be square with load, forks spaced evenly between pallet stringers and as far apart as load permits.



Typical Example

2. Move the lift truck FORWARD until the load touches the carriage.

Lifting the Load

1. Lift the load carefully and tilt the mast back a short distance.

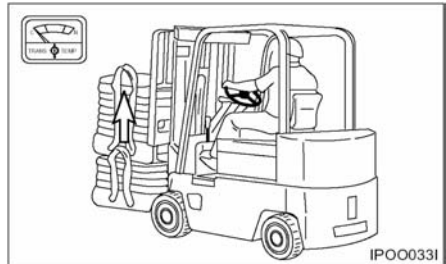

Typical Example

2. Tilt the mast further back to cradle the load



Typical Example

3. Operate the lift truck in reverse until the load is clear of the other material.
4. Lower the cradled load to the travel position.

NOTE: Lift and tilt speeds are controlled by engine rpm.

Traveling with the Load

NOTICE

Travel with the load as low as possible, while still maintaining ground clearance.



Typical Example

1. Carry the load as low as possible but maintain clearance.
2. On grades, always travel with the load on the UPHILL side, as shown above.

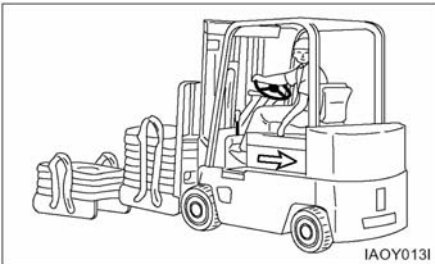

Typical Example

3. For better vision, travel in reverse with bulky loads.

Unloading

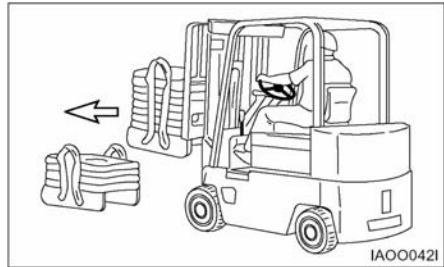

Typical Example

1. Move the lift truck into the unloading position.



Typical Example

2. Tilt the mast FORWARD only when directly over the unloading area.

WARNING

Do not tilt the mast forward with the load unless directly over the unloading area, even if the power is off.

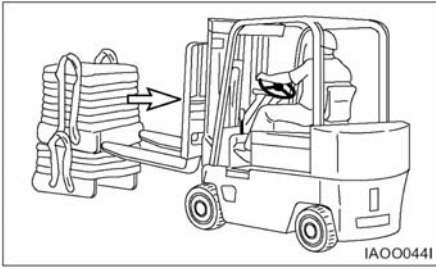

Typical Example

3. Deposit the load and BACK away carefully to disengage the forks.

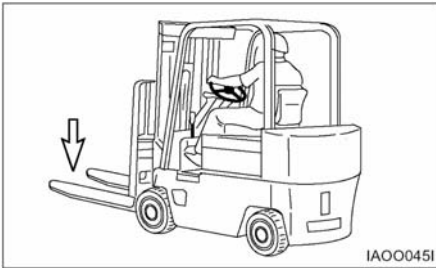

Typical Example

4. Lower the carriage and forks to the travel position or to the park position.

Turning

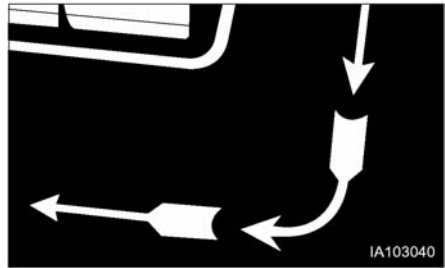

1. When turning sharp corners, keep close to the inside corner. Begin the turn when the inside drive wheel meets the corner.

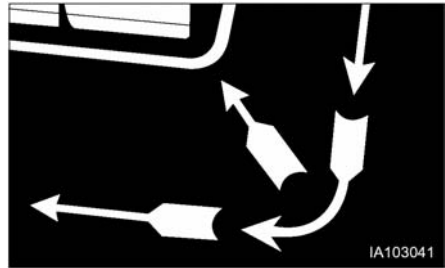

2. In narrow aisles, keep away from the stockpile when turning into the aisle. Allow for counterweight swing.

Lifting Drums or Round Objects

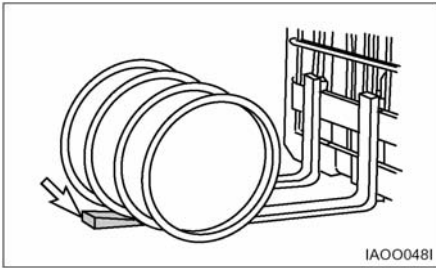

1. Block drums or round objects. Tilt the mast FORWARD and slide the fork tips along the floor to get under the load.

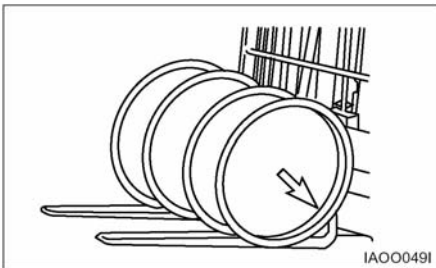

2. Before lifting, tilt the mast BACK slightly until the load is cradled on the forks.

Operating in Hot Weather

Keep the following points in mind when you operate the lift truck in hot weather.

1. Check the radiator. Clogging can cause the overheating. Clean them out regularly with a blast of compressed air. Also, check the leakage of water.
2. Check the fan belt tension and adjust to proper tension.
3. Even if the engine overheats and the coolant boils over, let the engine idle for a while with opening engine hood until temperature falls before shut off the engine.

Parking the Lift Truck



Typical Example

Park the lift truck level, with the forks lowered and the mast tilted forward until the fork tips touch the floor.

Block the drive wheels when parking on an incline.

1. Park in authorized area only. Do not block traffic.



Typical Example

2. Place the transmission controls in NEUTRAL.
3. Engage the parking brake.



Typical Example

4. Lower the forks to the ground.

WARNING

Blocking the wheels will prevent unexpected lift truck movement, which could cause personal injury.

5. Turn the ignition key switch to the OFF position and remove the key.

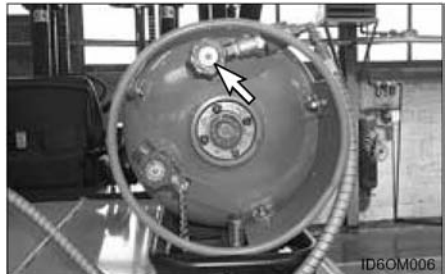

NOTE: If a LP equipped lift truck is stopped or parked for an indefinite or prolonged period of time, close the fuel shutoff valve on the LP tank. Run the engine until fuel in the line runs out and the engine stops. Turn off the ignition switch and disconnect switch (if equipped).

6. Actuate each loading lever several times to remove the residual pressure in the respective cylinders and hoses.
7. Block the drive wheels if parking on an incline.

Lift Fork Adjustment

WARNING

When adjusting the fork spread, be careful not to pinch your hand between forks and the carriage slot.

WARNING

Make sure the forks are locked before carrying a load.

For load stability, always adjust the forks as wide as possible. Position the load evenly on both forks.

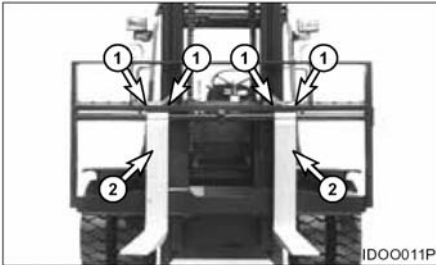

Typical Example of Shaft type Fork

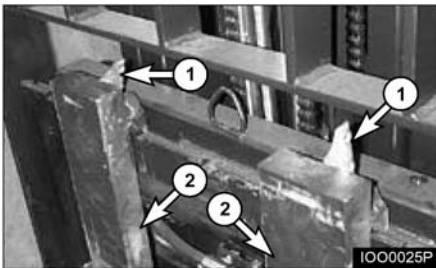

Typical Example of Hook-on type Fork

1. Move up the hook pin(1) in each fork to slide the fork(2) on the carriage bar.
2. Adjust the forks in the position most appropriate for the load and as wide as possible for load stability.
3. When adjusting the forks, make sure that the weight of the load is centered on the truck.
4. After adjustment, set the hook pins to keep the forks in place.

Storage Information

Before Storage

Before storing your lift truck, clean and inspect as per the following procedures.

1. Wipe away grease, oil, etc. adhering to the body of the truck with waste cloth, and use water, if needed.
2. While cleaning the truck, check general condition of the truck. Especially check the truck body for dents or damage and tires for wear or nails or stones in the tread.
3. Fill the fuel tank with fuel specified.
4. Check for leakage of hydraulic oil, engine oil, fuel, or coolant, etc.
5. Apply grease, where needed.
6. Check for looseness of nuts and bolts, especially hub nuts.
7. Check mast rollers to see that they rotate smoothly.
8. Prime the oil into the lift cylinders by actuating the lift lever all the way several times.
9. Drain off coolant completely in cold weather, if antifreeze is not used.

Long Time Storage

Perform the following service and checks in addition to the "Parking the lift truck" services.

1. Taking the rainy season into consideration, park the machine on higher and hard ground.
2. Avoid parking on soft grounds such as an asphalt ground in summer.
3. Dismount the battery from the machine. Even though the machine is parked indoors, if the place is hot or humid, the battery should be kept in a dry, cool place. Charge the battery once a month.
4. Apply antirust to the exposed parts which tend to rust.

5. Cover components such as the breather and air cleaner which may be caught with humidity.
6. The machine should be operated at least once a week. Fill the cooling system, if cooling water is discharged, and mount the battery. Start the engine and warm up thoroughly. Move the machine a little forwards and backwards. Operate the hydraulic controls several times.

To Operate the Lift Truck After a Long Time Storage

1. Remove covers and antirust from each of the components and exposed parts.
2. Drain the engine crankcase, transmission (clutch type machine), differential and final reduction gear, clean the inside of them and add new oil.
3. Drain off foreign matter and water from the hydraulic oil tank and fuel tank.
4. Remove the head cover from the engine cylinder. Oil valves and rocker shaft and check each valve for proper operation.
5. Add cooling water to the specified level.
6. Charge the battery and mount it on the machine. Connect the cables.
7. Perform pre - operational checks carefully. (refer to "Before Starting the Engine")
8. Warm up the machine.

Transportation Hints

Lift Truck Shipping

Check travel route for overpass clearances. Make sure there is adequate clearance if the lift truck being transported is equipped with a high mast, overhead guard or cab.

To prevent the lift truck from slipping while loading, or shifting in transit, remove ice, snow or other slippery material from the loading dock and the truck bed before loading.

NOTICE

Obey all state and local laws governing the height, weight, width and length of a load.
Observe all regulations governing wide loads.

NOTICE

Remove ice, snow or other slippery material from the shipping vehicle and the loading dock.

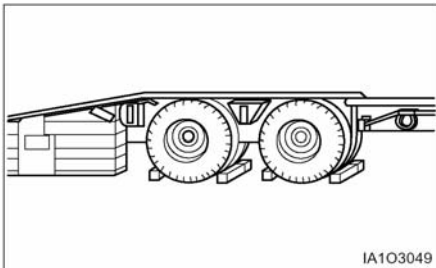

Typical Example

Always block the trailer or the rail car wheels before loading the lift truck.

Position the lift truck on the truck bed or the rail car. Apply the parking brake and place the transmission control in NEUTRAL.

Turn ignition switch to the OFF position and remove the key.
If LP equipped, remove the LP fuel tank.

Block the wheels and secure lift truck with tiedowns.

Machine Lifting and Tiedown Information

NOTICE

Improper lifting or tiedowns can allow load to shift and cause injury and/or damage.

1. Weight is given on the serial plate.
2. Use proper rated cables and slings for lifting. Position the crane for level lift truck lift.
3. Spreader bar widths should be sufficient to prevent contact with the lift truck
4. Use the tiedown locations provided for lift truck tiedown.

Check the state and local laws governing weight, width, and length of a load.
Contact your DOOSAN Lift Truck dealer for shipping instructions for your lift truck.

Towing Information

WARNING

Personal injury or death could result when towing a disabled lift truck incorrectly. Block the lift truck wheels to prevent movement before releasing the brakes. The lift truck can roll free if it is not blocked. Follow the recommendations below, to properly perform the towing procedure.

These towing instructions are for moving a disabled lift truck a short distance, at low speed, no faster than 2 km/h (1.2 mph), to a convenient location for repair. These instructions are for emergencies only. Always transport the lift truck if long distance moving is required.

Shield must be provided on the towing lift truck to protect the operator if the tow line or bar should break.

Do not allow riders on the lift truck being towed unless the operator can control the steering and/or braking.

Before towing, make sure the tow line or bar is in good condition and has enough strength for the towing situation involved. Use a towing line or bar with a strength of at least 1.5 times the gross weight of the towing lift truck for a disabled lift truck stuck in the mud or when towing on a grade.

Keep the tow line angle to a minimum. Do not exceed a 30° angle from the straight ahead position. Connect the tow line as low as possible on the lift truck that is being towed.

Quick lift truck movement could overload the tow line or bar and cause it to break. Gradual and smooth lift truck movement will work better.

Normally, the towing lift truck should be as large as the disabled lift truck. Satisfy yourself that the towing lift truck has enough brake capacity, weight and power, to control both lift trucks for the grade and the distance involved.

To provide sufficient control and braking when moving a disabled lift truck downhill, a larger towing lift truck or additional lift trucks connected to the rear could be required. This will prevent uncontrolled rolling. The different situation requirements cannot be given, as minimal towing lift truck capacity is required on smooth level surfaces to maximum on inclines or poor surface conditions.

Consult your DOOSAN Lift Truck dealer for towing a disabled lift truck.



Typical Example

1. Release the parking brake.
-

NOTICE

Release the parking brake to prevent excessive wear and damage to the parking foot brake system.

2. Check that the service foot brake pedal is released.
3. Key switch is in the OFF position.
4. Direction control lever is in neutral.
5. Fasten the tow bar to the lift truck.
6. Remove the wheel blocks. Tow the lift truck slowly. Do not tow any faster than 2 km/h (1.2 mph).

WARNING

Be sure all necessary repairs and adjustments have been made before a lift truck that has been towed to a service area is put back into operation.

Inspection, Maintenance and Repair of Lift Truck Forks

The following section gives practical guidelines for inspection, maintenance and repair of lift truck forks. It also provides general information on the design and application of forks and the common cause of fork failures.

Lift truck forks can be dangerously weakened by improper repair or modification. They can also be damaged by the cumulative effects of age, abrasion, corrosion, overloading and misuse.

A fork failure during use can cause damage to the equipment and the load. A fork failure can also cause serious injury.

A good fork inspection and maintenance program along with the proper application can be very effective in preventing sudden failures on the job.

Repairs and modifications should be done only by the fork manufacturer or a qualified technician who knows the material used and the required welding and heat treatment process.

Users should evaluate the economics of returning the forks to the manufacturer for repairs or purchasing new forks. This will vary depending on many factors including the size and type of fork.

Forks should be properly sized to the weight and length of the loads, and to the size of the machine on which they are used. The general practice is to use a fork size such that the combined rated capacity of the number of forks used is equal to or greater than the "Standard(or rated) Capacity" of the lift truck.

The individual load rating, in most cases, will be stamped on the fork in a readily visible area. This is generally on the top or side of the fork shank.

- A fork rated at 1500 pounds at 24 inch load center will be stamped 1500X24.
- A fork rated at 2000 kg at 600 mm load center will be stamped 2000X600.

The manufacturer identification and year and date of manufacture is also usually shown. Some countries have standards or regulations which apply specifically to the inspection and repair of forks.

Users may also refer to the International Organization For Standardization-ISO Technical Report 5057-Inspection and Repair of Fork Arms and ISO Standard 2330-Fork Arms-Technical Characteristics and Testing.

While there are no specific standards or regulations in the United States, users should be familiar with the requirements for inspection and maintenance of lift trucks as provided by the 29 Code Federal Register 1910.178 Powered Industrial Truck, and ANSI/ASME Safety Standard(s) B56.1, B56.5 or B56.6 as applicable to the type of machine(s) in use.

Environment Protection

When servicing this lift truck, use an authorized servicing area and an approved container to collect coolant, oil, fuel, grease, electrolyte and any other potential environmental pollutant before any lines, fittings or related items are disconnected or removed. After servicing, dispose of those materials in an authorized place and container. When cleaning the lift truck, be sure to use an authorized area.

Causes of Fork Failure

Improper Modification or Repair

Fork failure can occur as a result of a field modification involving welding, flame cutting or other similar processes which affect the heat treatment and reduces the strength of the fork.

In most cases, specific processes and techniques are also required to achieve proper welding of the particular alloy steels involved. Critical areas most likely to be affected by improper processing are the heel section, the mounting components and the fork tip.

Bent or Twisted Forks

Forks can be bent out of shape by extreme overloading, glancing blows against walls or other solid objects or using the fork tip as a pry bar.

Bent or twisted forks are much more likely to break and cause damage or injury. They should be removed from service immediately.

Fatigue

Parts which are subjected to repeated or fluctuating loads can fail after a large number of loading cycles even though the maximum stress was below the static strength of the part.

The first sign of a fatigue failure is usually a crack which starts in an area of high stress concentration. This is usually in the heel section or on the fork mounting.

As the crack progresses under repetitive load cycling, the load bearing cross section of the remaining metal is decreased in size until it becomes insufficient to support the load and complete failure occurs.

Fatigue failure is the most common mode of fork failure. It is also one which can be anticipated and prevented by recognizing the conditions which lead up to the failure and by removing the fork service prior to failing.

- Repetitive Overloading

Repetitive cycling of loads which exceeds the fatigue strength of the material can lead to fatigue failure. The overload could be caused by loads in excess of the rated fork capacity and by use of the forks tips as pry bars. Also, by handling loads in a manner which causes the fork tips to spread and the forks to twist laterally about their mountings.

- Wear

Forks are constantly subjected to abrasion as they slide on floors and loads. The thickness of the fork blade is gradually reduced to the point where it may not be capable of handling the load for which it was designed.

- Stress Risers

Scratches, nicks and corrosion are points of high stress concentration where cracks can develop. These cracks can progress under repetitive loading in a typical mode of fatigue failure.

Overloading

Extreme overloading can cause permanent bending or immediate failure of the forks. Using forks of less capacity than the load or lift truck when lifting loads and using forks in a manner for which they were not designed are some common causes of overloading.

Fork Inspection



Establish a daily and 12 month inspection routine by keeping a record for the forks on each lift truck.

Initial information should include the machine serial number on each the forks are used, the fork manufacturer, type, original section size, original length and capacity. Also list any special characteristics specified in the fork design.

Record the date and results of each inspection, making sure the following information is included.

- Actual wear conditions, such as percent of original blade thickness remaining.
- Any damage, failure or deformation which might impair the use of the truck.
- Note any repairs or maintenance.

An ongoing record of this information will help in identifying proper inspection intervals for each operation, in identifying and solving problem areas and in anticipating time for replacement of the forks.

First Installation

1. Inspect forks to ensure they are the correct size for the truck on which they will be used. Make sure they are the correct length and type for the loads to be handled.
If the forks have been previously used, perform the "12 Month Inspection".
If the forks are rusted, see "Maintenance and Repair".
2. Make sure fork blades are level to each other within acceptable tolerances. See "Forks, Step 4," in the "2000 Service Hours or Yearly" in "Maintenance Intervals"
3. Make sure positioning lock is in place and working. Lock forks in position before using truck. See "Forks, Step 7", in the "2000 Service Hours or Yearly" in "Maintenance Intervals".

Daily Inspection

1. Visually inspect forks for cracks, especially in the heel section, around the mounting brackets, and all weld areas. Inspect for broken or jagged fork tips, bent or twisted blades and shanks.
2. Make sure positioning lock is in place and working. Lock the forks in position before using the truck. See "2000 Service Hours or Yearly" in "Maintenance Intervals".
3. Remove all defective forks from service.

12 Months Inspection

Forks should be inspected, at a minimum, every 12 months. If the truck is being used in a multi-shift or heavy duty operation, they should be checked every six months. See "Forks" in the "2000 Service Hours or Yearly" in "Maintenance Intervals."

Maintenance and Repair

1. Repair forks only in accordance with the manufacturer's recommendations.

Most repairs or modifications should be done only by the original manufacturer of the forks or an expert knowledgeable of the materials, design, welding and heat treatment process.

2. The following repairs or modifications SHOULD NOT be attempted.

- Flame cutting holes or cutouts in fork blades.
 - Welding on brackets or new mounting hangers.
 - Repairing cracks or other damage by welding.
 - Bending or resetting.
3. The following repairs MAY be performed.
 - Forks may be sanded or lightly ground, to remove rust, corrosion or minor defects from the surfaces.
 - Heel sections may be ground with a carbon stone to remove minor surface cracks or defects. Polish the inside radius of the heel section to increase the fatigue life of the fork. Always grind or polish in the direction of the blade and shank length.
 - Repair or replace the positioning locks on hook type forks.
 - Repair or replace most fork retention devices used with other fork types.
 4. A fork should be load tested before being returned to service on completion of repairs authorized and done in accordance with the manufacturer's recommendations.

Most manufacturers and standards require the repaired fork to be tested with a load 2.5 times the specified capacity and at the load center marked on the fork arm.

With the fork restrained in the same manner as its mounting on the lift truck, apply the test load twice, gradually and without shock. Maintain the test for 30 seconds each time.

Check the fork arm before and after the second application of the test load. It shall not show any

permanent deformation.

Consult the fork manufacturer for further information as may be applicable to the specific fork involved.

Testing is not required for repairs to the positioning lock or the markings.

Tire Inflation Information

Tires Inflation

WARNING

Personal injury or death could result when tires are inflated incorrectly.

Use a self-attaching inflation chuck and stand behind the tread when inflating a tire.

Proper inflation equipment, and training in using the equipment, are necessary to avoid overinflation. A tire blowout or rim failure can result from improper or misused equipment.

Always remove (deflate) all air from a single tire and from both tires on a dual assembly before changing them.

NOTICE

When changing tires, change them in sets, even if only one of the tires is damaged. If new and used tires are used on the same axle, tilting of the mast and rapid tire wear will result.

The mounting faces of the hub, wheel nuts and wheels must be free of any foreign material and lubricants of any kind. Tighten wheel nuts again after 24 hours of operation.

Do not reinflate a tire that has been driven on while flat or underinflated, without first checking to be sure the locking ring on the wheel is not damaged and in position.

Always deflate tires before changing them.

Tire Shipping Pressure

The tire inflation pressures shown in the following chart are cold inflation shipping pressures.

Size	Ply Rating Or Strength Index	Shipping Pressure	
		kPa	psi
8.25 x 15	14PR	790	115
8.25 x 15	16PR	880	128
9.00 x 20	14PR	790	115

Standard tire, ply rating and inflation pressures.

The operating inflation pressure is based on the weight of a ready-to-work machine without attachments, at rated payload, and in average operating conditions. Pressures for each application may vary and should always be obtained from your tire supplier.

NOTE: Fill tires to the recommended pressures listed \pm 35 kPa (5 psi). Tires can be filled with nitrogen.

Tire Inflation Pressures Adjustment

A tire inflation in a warm shop area, 18° to 21°C (65° to 70°F), will be underinflated if the machine works in freezing temperatures. Low pressure shortens the life of a tire.

Torque Specifications



Metric Hardware - This lift truck is almost totally metric design. Specifications are given in metric and U.S. Customary measurement.

Metric hardware must be replaced with metric hardware. Check parts books for proper replacement.

NOTE : Use only metric tools on most hardware for proper fit. Other tools could slip and possibly cause injury.

Torques for Standard Hose Clamps - Worm Drive Band Type

NOTICE

The following chart gives the torques for initial installation of hose clamps on new hose and for reassembly or retightening of hose clamps on existing hose.

Clamp Width	Initial Installation Torque On New Hose	
	N•m ¹	lb•in
16 mm (.625 in)	7.5 ± 0.5	65 ± 5
13.5 mm (.531 in)	4.5 ± 0.5	40 ± 5
8 mm (.312 in)	0.9 ± 0.2	8 ± 2
Clamp Width	Reassembly or Retightening Torque On Existing Hose	
	N•m ¹	lb•in
16 mm (.625 in)	4.5 ± 0.5	40 ± 5
13.5 mm (.531 in)	3.0 ± 0.5	25 ± 5
8 mm (.312 in)	0.7 ± 0.2	6 ± 2

¹1 Newton meter (N•m) is approximately the same as 0.1 kg•m.

Torques for Standard Bolts, Nuts and Taperlock Studs

NOTICE

The following charts give general torques for bolts, nuts and taperlock studs or SAE Grade 5 or better quality.

Torques for Bolts and Nuts With Standard Threads

Thread Size Inch	Standard Nut and Bolt Torque	
	N•m	lb•ft
1/4	12 ± 4	9 ± 3
5/16	25 ± 7	18 ± 5
3/8	45 ± 7	33 ± 5
7/16	70 ± 15	50 ± 11
1/2	100 ± 15	75 ± 11
9/16	150 ± 20	110 ± 15
5/8	200 ± 25	150 ± 18
3/4	360 ± 50	270 ± 37
7/8	570 ± 80	420 ± 60
1	875 ± 100	640 ± 75
1 1/8	1100 ± 150	820 ± 110
1 1/4	1350 ± 175	1000 ± 130
1 3/8	1600 ± 200	1180 ± 150
1 1/2	2000 ± 275	1480 ± 200

¹1 Newton meter (N•m) is approximately the same as 0.1 kg •m.

Torques for Taperlock Studs

Thread Size Inch	Standard Taperlock Stud Torque	
	N•m ¹	lb•ft
1/4	8 ± 3	6 ± 2
5/16	17 ± 5	13 ± 4
3/8	35 ± 5	26 ± 4
7/16	45 ± 10	33 ± 7
1/2	65 ± 10	48 ± 7
5/8	110 ± 20	80 ± 15
3/4	170 ± 30	125 ± 22
7/8	260 ± 40	190 ± 30
1	400 ± 60	300 ± 45
1/8	500 ± 700	370 ± 50
1/4	650 ± 80	480 ± 60
3/8	750 ± 90	550 ± 65
1/2	870 ± 100	640 ± 75

¹1 Newton meter (N•m) is approximately the same as 0.1 kg•m.

Torques for Metric Fasteners

NOTICE

Be very careful never to mix metric with U.S. customary (standard) fasteners. Mismatched or incorrect fasteners will cause lift truck damage or malfunction and may even result in personal injury.

Original fasteners removed from the lift truck should be saved for reassembly whenever possible. If new fasteners are needed, they must be of the same size and grade as the ones that are being replaced.

The material strength identification is usually shown on the bolt head by numbers (8.8, 10.9, etc). The following chart gives standard torques for bolts and nuts with Grade 8.8.

NOTE: Metric hardware must be replaced with metric hardware. Check parts book for proper replacement.

Thread Size Metric	Standard Torque	
	N•m ¹	lb•ft
M6	12 ± 4	9 ± 3
M8	25 ± 7	18 ± 5
M10	55 ± 10	41 ± 7
M12	95 ± 15	70 ± 11
M14	150 ± 20	110 ± 15
M16	220 ± 30	160 ± 22
M20	450 ± 70	330 ± 50
M24	775 ± 100	570 ± 75
M30	1600 ± 200	1180 ± 150
M36	2700 ± 400	2000 ± 300

¹1 Newton meter (1 N•m) is approximately the same as 0.1 kg•m.

²ISO - International Standards organization.

Cooling System Specifications

Coolant Information

NOTE: The following information is generic and valid for lift trucks.

Engine operating temperatures have increased to improve engine efficiency. This means proper cooling system maintenance is especially important. Overheating, overcooling, pitting, cavitation erosion, cracked heads, piston seizures, and plugged radiators are classic cooling system failures. In fact, coolant is as important as the quality of fuel and lubricating oil.

Refer to topic, "Cooling System - Clean, Change" in Every 2000 Service Hours or Yearly section. Filling at over 20 liters (5 U.S. gallons) per minute can cause air pockets in the cooling system.

After draining and refilling the cooling system, operate the engine with the radiator cap removed until the coolant reaches normal operating temperature and the coolant level stabilizes. Add coolant as necessary to fill the system to the proper level.

Never operate without a thermostat in the cooling system. Cooling system problems can arise without a thermostat.

NOTICE

DOOSAN recommends that the coolant mixture contain a minimum of 30% antifreeze or equivalent.

Never add coolant to an overheated engine, engine damage can result. Allow the engine to cool first.

All water is corrosive at engine operating temperature. The cooling system should be protected with a 3 to 6% concentration of liquid supplemental coolant additive at all times, regardless of the concentration of antifreeze.

Excessive supplemental coolant additive greater than the recommended 6%, together with concentrations of antifreeze greater than 65% can cause deposits to form and can result in radiator tube blockage, overheating, and/or water pump seal damage.

If the machine is to be stored in, or shipped to, an area with freezing temperatures, the cooling system must be protected to the lowest expected outside (ambient) temperature.

The engine cooling system is normally protected to -28°C(-20°F) with antifreeze, when shipped from the factory unless special requirements are defined.

Check the specific gravity of the coolant solution frequently in cold weather to ensure adequate protection.

Clean the cooling system if it is contaminated, the engine overheats or foaming is observed in the radiator.

Old coolant should be drained, the system cleaned and new coolant added every 2000 service hours or yearly.

Coolant Water

Hard water, or water with high levels of calcium and magnesium ions, encourages the formation of insoluble chemical compounds by combining with cooling system additives such as silicates and phosphates.

The tendency of silicates and phosphates to precipitate out-of-solution increases with increasing water hardness. Hard water, or water with high levels of calcium and magnesium ions encourages the formation of insoluble chemicals, especially after a number of heating and cooling cycles.

DOOSAN prefers the use of distilled water or deionized water to reduce the potential and severity of chemical insolubility.

Acceptable Water	
Water Content	Limits (PPM)
Chlorides (Cl)	50 maximum
Sulfates (SO ₄)	50 maximum
Total hardness	80 mg/l
Total solids	250 maximum
PH	6.0 to 8.0

ppm = parts per million

Using water that meets the minimum acceptable water requirement may not prevent drop-out of these chemical compounds totally, but should minimize the rate to acceptable levels.

Antifreeze

NOTICE

DOOSAN recommends using automotive antifreeze suitable for gasoline engines having aluminum alloy parts. Antifreeze of poor quality will cause corrosion of the cooling system, and thus always use automotive antifreeze prepared by a reliable maker, and never use it mixed with antifreeze of different brand.

DOOSAN recommends that the coolant mix contain 50% commercially available automotive antifreeze, or equivalent and acceptable water to maintain and adequate water pump cavitation temperature for efficient water pump performance.

Premix coolant solution to provide protection to the lowest expected outside (ambient) temperature. Pure undiluted antifreeze will freeze at -23°C (-10°F).

Use a greater concentration (above 50%) of commercially available automotive antifreeze only as needed for anticipated outside (ambient) temperatures. Do not exceed the recommendations, provided with the commercially available automotive antifreezes, regarding the coolant mixture of antifreeze to water.

Make proper antifreeze additions.

Adding pure antifreeze as a makeup solution for cooling system top-up is an unacceptable practice. It increases the concentration of antifreeze in the cooling system which increase the concentration of dissolved solids and undissolved chemical inhibitors in the cooling system. Add antifreeze mixed with water to the same freeze protection as your cooling system.

Use the chart below to assist in determining the concentration of antifreeze to use.

Antifreeze Concentrations	
Protection Temperature	Concentrations
Protection to -15 °C (5 °F)	30% antifreeze and 70% water
Protection to -23 °C (-10 °F)	40% antifreeze and 60% water
Protection to -37 °C (-34 °F)	50% antifreeze and 50% water
Protection to -51 °C (-60 °F)	60% antifreeze and 40% water

Fuel Specifications

General Fuel Information

Use only fuel as recommended in this section.

NOTICE

Fill the fuel tank at the end of each day of operation to drive out moisture laden air and to prevent condensation. Maintain a constant level near the top of the day tank to avoid drawing moisture into the tank as the level decreases.

Do not fill the tank to the top. Fuel expands as it gets warm and can overflow.

Do not fill the fuel filters with fuel before installing them. Contaminated fuel will cause accelerated wear to the fuel system parts.

Drain the water and sediment from main fuel storage tank before it is refilled. This will help prevent water and/or sediment from being pumped from the fuel storage tank into the engine fuel tank.

Diesel Specifications

Fuel Types

DOOSAN Diesel Engines have the ability to burn a wide variety of fuels. These fuels are divided into two general groups, preferred and permissible.

The Preferred Fuels provide maximum engine service life and performance. They are distillate fuels. They are commonly called diesel fuel, MDO diesel, furnace oil, gas oil or kerosene (for cold weather operation).

Experience has proven that distillate fuels meeting the following basic specifications will result in optimum engine performance and durability.

DOOSAN strongly encourages the use of fuels that meet the Preferred Fuels specification.

The permissible fuels are crude oils or blended fuels. Use of these fuels can result in higher maintenance costs and reduced engine service life.

Crude oil is used to describe oils/fuels that are not refined and are in the original state as when pumped from the ground. Certain types of crude oils can be burned in DOOSAN Engines.

PREFERRED DISTILLATE FUEL FOR DIESEL ENGINES	
Specifications	Requirements*
Aromatics (AST D1319)	35% Max.
Ash (ASTM D482)	0.02% Weight Max.
Cetane Number (ASTM D613)	35 Min. for 45 Max. 40 Min. for DI Engines
Cloud Point (ASTM D97)	Not Above Lowest Expected Ambient Temperature
Gravity API (ASTM D287)	30 Min. and 45 Max.
Pour Point (ASTM D97)	6 C (10 F) Below Ambient Min.
Sulfur (ASTM D2788, D3605 or D1552)	0.5 Max. (See Sulfur Topic)
Viscosity, Kinematic @ 38°C (100°F)(ASTM D445)	20.0 cSt Max. 1.4 cSt Min.
Water & Sediment (ASTM D1796)	0.01% Max.

*As delivered to fuel system

Fuel Sulfur Content

The percentage of sulfur in the fuel will affect the engine oil recommendations. Fuel sulfur is chemically changed during combustion to form both sulfurous and sulfuric acid. These acids chemically attack metal surfaces and cause corrosive wear.

Certain additives used in lubricating oils contain alkaline compounds that are formulated to neutralize these acids. The measure of this reserve alkalinity in lubricating oil is known as its Total Base Number (TBN). TBN is essential to neutralize the acids from combustion gases and to minimize corrosive wear.

Any API classification performance of oil should have sufficient TBN for fuels with less than 0.5% sulfur. For fuels with 0.5% to 1.5% sulfur by weight, engine oil must have a TBN of 20 times the percentage of fuel sulfur as measured by the ASTM (American Society of Testing Materials) D-2896 method. (ASTM D-2896 can normally be found at your local technological society, library or college).

DOOSAN recommends infrared analysis (in conjunction with wear metal analysis) of used oil in determining the effectiveness of oil TBN and acid neutralization.

For fuel with sulfur exceeding 1.5% by weight, use an oil with a TBN of 30 and reduce the oil change interval by one half. Also, infrared analysis and wear metal analysis should be used to establish oil change intervals.

Periodically request fuel sulfur content information from your fuel supplier. Fuel sulfur content can change with each bulk delivery.

LP Specifications

LP is "liquefied petroleum gas". The exact composition of LP varies slightly between different parts of the country and different refineries. HD5 is recommended for DOOSAN forklift trucks. Remember LP is heavier than air and will sink to the lowest spot possible. Avoid areas near floor drains or lubrication pits where escaped fuel may collect.

Composition of HD5	
Propane (C ₃ H ₈)	90.0 %
Propylene	up to 5 %
Butane (C ₄ H ₁₀)	2.0 %
iso-Butane	1.5 %
Methane (CH ₄)	1.5 %
Total	100 %

Lubricant Specifications

Lubricant Information

Some classifications and abbreviations we use in this section follow S.A.E. (Society of Automotive Engineers) J754 nomenclature and others follow S.A.E. J183.

All MIL specifications are U.S.A. Military.

Recommended oil viscosities are given in the "Lubricant Viscosities" chart later in this section of the manual.

Greases are classified according to the National Lubricating Grease Institute (NLGI) based on ASTM D217-68 worked Penetration characteristics which give a defined consistency number.

Engine Oil (DEO and EO)

The following oil specifications provide guidelines for the selection of commercial products :

- .Gasoline/LP Engine : API SJ
- .Diesel Engine : API CH4 or ACEA E5

NOTICE

Failure to follow the oil recommendations can cause shortened engine life due to carbon deposits or excessive wear.

Consult the EMA Lubricating Oils Data Book for a listing of oil brands.

NOTE: The percentage of sulfur in the fuel will affect the engine oil recommendations. For fuel sulfur effects, the Infrared Analysis or the ASTM D2896 procedure can be used to evaluate the residual neutralization properties of engine oil. The sulfur products formation depends on the fuel sulfur content, oil formulation, crankcase blowby, engine operating conditions and ambient temperature.

Hydraulic Oil (HYDO)

The following commercial classifications can be used in the hydraulic system.

- ISO 6743/4 HM
- AFNOR NFE 48-603 HM
- DIN 51524 TEIL 2 H-LP
- HAGGLUNDS DENISON HFO-HF2
- CINCINNATI P68, 69, 70

Viscosity : ISO VG32

Industrial premium hydraulic oils that have passed the Vickers vane pump test (35VQ25). These oils should have antiwear, antifoam, antirust and antioxidation additives for heavy duty use as stated by the oil supplier. ISO viscosity grade of 32 would normally be selected.

Transmission Oil (TDTO)

NOTICE

These oils are formulated for transmissions and drive trains only, and should not be used in engines. Shortened engine life will result.

NOTE: Multi-grade oils are not blended by DOOSAN for use in transmissions. Multi-grade oils which use high molecular weight polymers as viscosity index improvers lose their viscosity effectiveness by permanent and temporary shear of the viscosity index improver and therefore, are not recommended for transmission and drive train compartments.

NOTE: Failure to follow this recommendation can cause shortened transmission life due to material incompatibility, inadequate frictional requirements for disk materials and/or excessive gear wear.

Select Oil that meets below specifications.

- D50/60/70/80/90S-5(3 Speed)
: API CD/TO-2 or MIL-L-2104D,E
- D50/60/70S-5 (2 Speed), G50/60/70S-5
: GM DEXRON

Drive Axle Oil

NOTE : Failure to follow the recommendation will cause shortened life due to excessive gear wear.

• Shoe Brake

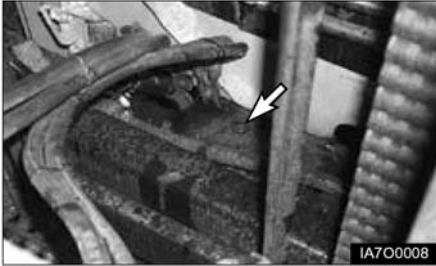

Select oil that meets below specifications.

- API GL-5
- MIL-L-2105 C, D

Gear Oil offers maximum protection against the scoring and pitting of gear teeth and rolling element bearings.

Gear Oil can also provide excellent stability under high temperature conditions and has superior low temperature performance. It will also give protection against rust and corrosion.

• Oil Cooled Disc Brake (OCDB)

Select oil that meets below specifications.
: Universal Transmission Tractor Oil (UTTO)
The following UTTO products are authorized for use.

Supplier	Product Name
TOTAL	TRANSMISSION MP
MOBIL	MOBIL FLUID 424

Brake Oil (Only for OCDB)

As brake oil for oil cooled disc brake system (OCDB), use the oil that has the same specifications with hydraulic oil.

The following commercial classifications can be used in the brake system.

- ISO 6743/4 HM
- AFNOR NFE 48-603 HM
- DIN 51524 TEIL 2 H-LP
- HAGGLUNDS DENISON HFO-HF2
- CINCINNATI P68, 69, 70

Viscosity : ISO VG32

These oils should have antiwear, antifoam, antitrust and antioxidation additives for heavy duty use as stated by the oil supplier. ISO viscosity grade of 32 would normally be selected.

The following products are authorized for use.

Supplier	Product Name
TOTAL	AZOLLA ZS
SHELL	TELLUS
MOBIL	DTE20S'
CALTEX	RANDO HD
ESS	NOTO H
CASTROL	HYPIN AWS

Lubricating Grease

NOTICE

Use MPGM for heavily loaded bearings and joints where an extreme pressure grease will maximize the life of DOOSAN equipment. This NLGI No. 2 grade is suitable for most temperatures.

If MPGM is not available, use a multipurpose type grease which contains 3 to 5% molybdenum.

This NLGI no. 2 grade is recommended for light duty automotive type applications where a high temperature [up to 175°C (350°F)] is required.

This grease offers excellent mechanical stability, high resistance to oxidation, good rust protection and excellent breakaway torque.

If this grease is not available, use a similar multipurpose grease.

Lubricant Viscosities and Refill Capacities

Lubricant Viscosities

LUBRICANT VISCOSITIES FOR AMBIENT (OUTSIDE) TEMPERATURES						
Compartment or System	Oil Viscosities	°C		°F		
		Min	Max	Min	Max	
Engine Crankcase (LP) and Lift Chains API SJ	SAE 10W30	-20	+40	-4	+104	
	SAE 5W30	-30	+30	-22	+86	
Engine Crankcase (Diesel) API CH4 or ACEA E5	SAE 15W40	-15	+50	+5	+122	
Power Shift Transmission API CD/TO-2	SAE 10W	-20	-22	-4	+72	
	SAE 30	+10	+50	+50	+122	
Hydraulic and Power Steering System ISO 6743/4 HM	ISO VG32	-20	+30	-4	+86	
	ISO VG46	-10	+40	+14	+104	
	ISO VG68	0	+50	+32	+122	
Drive Axle Housing	Shoe Brake API GL-5	SAE 80W90	-20	+50	-4	+122
	Disc Brake (OCDB) UTTO	ISO VG68	-20	+80	-4	+176
Brake Reservoir (Only for OCDB) ISO 6743/4 HM	ISO VG32	-20	+30	-4	+86	

The SAE grade number indicates the viscosity of oil. A proper SAE grade number should be selected according to ambient temperature.

Refill Capacities

Refill Capacities (Approximate)		D50/60/70/ 80/90S-5 (3 speed)	D50/60/70S-5 (2 speed)	G50/60/70S-5
Compartment or System		Liters	Liters	Liters
Engine Crankcase w/Filter		20.5	20.5	4.3
Cooling System w/Coolant Recovery Bottle		23	18.5	19.0
Fuel Tank - Diesel		140	140	-
Power Shift Transmission		23	11	11
Hydraulic Power Steering System		117 Proper quantity	117 Proper quantity	117 Proper quantity
Drive Axle	Shoe Brake	11.8	11.8	11.8
	Disc Brake (OCDB)	14.0	14.0	14.0
Brake Reservoir (Only for OCDB)		1.0	1.0	1.0

Maintenance Intervals

NOTICE

All maintenance and repair, except every 10 service hours or daily, on the lift truck must be performed by qualified and authorized personnel only.

NOTICE

Careless disposal of waste oil can harm the environment and can be dangerous to persons. Always dispose of waste oil to an authorized personnel only.

When Required

Engine Valve Lash (Diesel E/G Only) - Check, Adjust.....	140
Priming the Fuel System (Diesel Engine Only)	140
Test Fuel System for Leaks (LP Engine Only)	141
Fuel Tank Filter Cap & Screen - Clean.....	142
Seat - Check, Lubricate.....	142
Fuses, Bulbs & Circuit Breaker - Change, Reset..	143
Tires and Wheels - Inspect, Check.....	144
Radiator Cap - Clean, Change	145
Carriage Roller Extrusion - Adjust.....	145
Brake Oil (OCDB) – Check.....	146

Every 10 Service Hours or Daily

Inspection Engine for Fluid Leaks.....	147
Engine Oil Level - Check	147
Coolant Level – Check	147
Air Cleaner Indicator – Check.....	148
Inspect Foot Pedal Operation (LP Engine Only) ..	149
Inspect Engine for Exhaust Leaks.....	149
Walk-Around Inspection - Inspect	149
Mast Channels – Lubricate.....	150
Transmission Oil Level – Check.....	151

First 50-100 Service Hours or a Week

Engine Oil & Oil Filter (Diesel E/G Only) - Change	152
Transmission Oil & Oil Filter – Change.....	153
Drive Axle Oil - Change.....	155
Parking Brake - Test, Adjust.....	157

First 250 Service Hours or a Month

Hydraulic Return Filter – Change.....	159
---------------------------------------	-----

Every 250 Service Hours or Monthly

Air Intake System - Check, Clean.....	160
Engine Oil & Filter(LP Engine Only) - Change.....	163
Hydraulic Oil Level – Check.....	164
Drive Axle Oil Level – Check.....	164
Mast, Carriage, Lift Chains & Attachments - Inspect, Lubricate	165
Steering Mechanism - Check, Lubricate	166
Battery Terminal - Clean, Inspect	167
Wheel Bolts & Nuts - Inspect.....	167

Every 500 Service Hours or 3 Months

Belts (Diesel E/G Only) - Check, Adjust	168
Mast Hinge Pins – Lubricate	168
Tilt Cylinders - Check, Adjust, Lubricate	169
Crosshead Rollers - Inspect.....	169
Transmission Oil Filter (2 Speed Only) – Change ...	169
Parking Brake - Test, Adjust.....	169
Drive Axle Oil (OCDB) - Change.....	169
Horn and Lights(If Equipped) – Check	170
Overhead Guard – Inspect	170
Steer Suspension – Inspect.....	170
Universal Joint - Inspect, Lubricate.....	170
Engine Oil & Filter(Diesel Engine Only) – Change	171
Inspect Vacuum Lines and Fittings (G643(E) Engine only).....	171
Fuel Trim Valve(FTV) Inspection (G643E Engine only).....	171
Inspect Electrical System (G643E Engine only) ..	171

Every 1000 Service Hours or 6 Months

Carburetor (LP - Gas Engine Only) - Adjust, Clean	172
Fuel Filter - Check, Clean, Change	172
Air Intake System - Change	172
Inspect Coolant Hoses (LP Engines Only).....	173
LP Regulator/Converter Inspection (LP Engine Only)	173
Fuel Lines & Fittings – Check	173
Inspect Mixer Assembly (LP Engine Only).....	173
Inspect Throttle Assembly (LP Engine Only)	173
Hydraulic Oil, Return Filter, Strainer & Breather - Check, Clean, Change.....	174
Transmission Oil & Filter (3 Speed Only) – Change	175
Transmission Oil (2 Speed Only) – Change.....	175
Lift Chains - Test, Check, Adjust.....	175

Every 1500 Service Hours or 9 Months

Drive Axle Oil (Shoe Brake Only) - Change	178
Inspect Ignition System (LP Engine Only)	178
Replace Spark Plugs (LP Engine Only).....	178
Replace LP Fuel Filter Element (LP Engine Only)	179
Testing Fuel Lock-off Operation (LP Engine Only)	180

Every 2000 Service Hours or Yearly

Steer Wheel Bearings - Reassemble.....	181
Cooling System - Clean, Change.....	182
Fork – Inspect.....	183

Every 2500 Service Hours or 15 Months

Inspect Battery System	185
Checking the TMAP Sensor (LP Engine Only)	185
Inspect for Intake Leaks (LP Engine Only).....	186
Replace PCV Valve and breather element - Change (LP Engine Only)	186
Replace Oxygen Sensor (G643E Engine Only)...	186

Quick Reference to Maintenance Schedule			FIRST		EVERY							
ITEMS	SERVICES	PAGE	When Required	50-100 Service Hours or a Week	250 Service Hours or a Month	10 Service Hours or Daily	250 Service Hours or a Monthly	500 Service Hours or 3 Months	1000 Service Hours or 6 Months	1500 Service Hours or 9 Months	2000 Service Hours or Yearly	2500 Service Hours or 15 Months
				Air Cleaner Indicator	Check	148				o		
Air Intake System	Change	172							o			
Air Intake System	Check, Clean	160					o					
Battery Terminal	Clean, Inspect	167					o					
Belts (Diesel E/G Only)	Check, Adjust	168						o				
Brake Oil (OCDB)	Check	146	o									
Carburetor (LP - Gas Engine Only)	Adjust, Clean	172							o			
Carriage Roller Extrusion	Adjust	145	o									
Checking the TMAP Sensor (LP Engine Only)		185										o
Coolant Level	Check	147				o						
Cooling System	Clean, Change	182										o
Crosshead Rollers	Inspect	169						o				
Drive Axle Oil	Change	155		o								
Drive Axle Oil (OCDB)	Change	169						o				
Drive Axle Oil (Shoe Brake Only)	Change	178								o		
Drive Axle Oil Level	Check	164					o					
Engine Oil & Filter (Diesel Engine Only)	Change	171						o				
Engine Oil & Filter (LP Engine Only)	Change	163					o					
Engine Oil & Oil Filter (Diesel E/G Only)	Change	152		o								
Engine Oil Level	Check	147				o						
Engine Valve Lash (Diesel E/G Only)	Check, Adjust	140	o									
Fork	Inspect	183									o	
Fuel Filter	Check, Clean, Change	172							o			
Fuel Lines & Fittings	Check	173							o			
Fuel Tank Filter Cap & Screen	Clean	141	o									
Fuel Tank Filter Cap & Screen	Clean	142	o									
Fuel Trim Valve (FTV) Inspection (G643E Engine only)		171						o				
Fuses, Bulbs & Circuit Breaker	Change, Reset	143	o									
Horn and Lights (If Equipped)	Check	170						o				
Hydraulic Oil Level	Check	164					o					
Hydraulic Oil, Return Filter, Strainer & Breather	Check, Clean, Change	174							o			
Hydraulic Return Filter	Change	159			o							
Inspect Mixer Assembly (LP Engine Only)		173							o			
Inspect Battery System		185										o
Inspect Coolant Hoses (LP Engines Only)		173							o			
Inspect Electrical System (G643E Engine only)		171						o				
Inspect Engine for Exhaust Leaks		149				o						
Inspect Foot Pedal Operation (LP Engine Only)		149				o						

Quick Reference to Maintenance Schedule			FIRST								EVERY											
ITEMS	SERVICES	PAGE	When Required	50-100 Service Hours or a Week		250 Service Hours or a Month		10 Service Hours or Daily		250 Service Hours or a Monthly		500 Service Hours or 3 Months		1000 Service Hours or 6 Months		1500 Service Hours or 9 Months		2000 Service Hours or Yearly		2500 Service Hours or 15 Months		
Inspect for Intake Leaks (LP Engine Only)		186																				O
Inspect Ignition System (LP Engine Only)		178																				O
Inspect Throttle Assembly (LP Engine Only)		173																				O
Inspect Vacuum Lines and Fittings (G643(E) Engine only)		171																				O
Inspection Engine for Fluid Leaks		147																				O
Lift Chains - Test, Check, Adjust		175																				O
LP Regulator/Converter Inspection (LP Engine Only)		173																				O
Mast Channels	Lubricate	150																				O
Mast Hinge Pins	Lubricate	168																				O
Mast, Carriage, Lift Chains & Attachments	Inspect, Lubricate	165																				O
Overhead Guard	Inspect	170																				O
Parking Brake	Test, Adjust	157																				O
Parking Brake	Test, Adjust	169																				O
Priming the Fuel System (Diesel Engine Only)		140																				O
Radiator Cap	Clean, Change	145																				O
Replace LP Fuel Filter Element (LP Engine Only)		179																				O
Replace Oxygen Sensor (G643E Engine Only)		186																				O
Replace PCV Valve and breather element	Change (LP Engine Only)	186																				O
Replace Spark Plugs (LP Engine Only)		178																				O
Seat	Check, Lubricate	142																				O
Steer Suspension	Inspect	170																				O
Steer Wheel Bearings	Reassemble	181																				O
Steering Mechanism	Check, Lubricate	166																				O
Test Fuel System for Leaks (LP Engine Only)		141																				O
Testing Fuel Lock-off Operation (LP Engine Only)		180																				O
Tilt Cylinders	Check, Adjust, Lubricate	169																				O
Tires and Wheels	Inspect, Check	144																				O
Transmission Oil & Filter (3 Speed Only)	Change	175																				O
Transmission Oil & Oil Filter	Change	153																				O
Transmission Oil (2 Speed Only)	Change	175																				O
Transmission Oil Filter (2 Speed Only)	Change	169																				O
Transmission Oil Level	Check	151																				O
Universal Joint	Inspect, Lubricate	170																				O
Walk-Around Inspection	Inspect	149																				O
Wheel Bolts & Nuts	Inspect	167																				O

When Required

You must read and understand the warnings and instructions contained in the Safety section of this manual, before performing any operation or maintenance procedures.

Engine Valve Lash (Diesel E/G Only) - Check, Adjust

NOTICE

The valve clearances are to be adjusted at the times of the following situations.

- When the engine is overhauled and the cylinder heads are disassembled.
- When severe noise comes from valve train.
- When the engine is not normally operated even though there is no trouble in the fuel system.

WARNING

To prevent possible injury when adjusting diesel engines, Do not use the starter motor to turn the flywheel.

Hot engine components can cause burns. Allow additional time for the engine to cool before measuring valve clearance.

NOTICE

Measure the valve lash with the engine stopped. To obtain an accurate measurement, allow at least 20 minutes for the engine cylinder head and block to cool.

Set the clearance to the nominal appropriate clearance given in the "Valve Clearance Setting" chart shown below.

Valve Clearances		
Engine	Valve	Clearance
5.8 Liter (DB58S) Diesel	Exhaust Valves	.40 mm (.16 in)
	Intake Valves	.40 mm (.16 in)

Refer to the "Service Manual" for the complete valve adjustment procedure.

NOTE: In case of LP Engine, no valve adjustment is necessary.

Priming the Fuel System (Diesel Engine Only)

Bleeding the Fuel System

After changing the fuel filter, or after having serviced any part of the fuel system, make sure that the air is bled from the system.

1. Release the feed pump cap (1) on the injection pump.
2. Release an air bleed nut (2) on the injection pump.
3. Operate feed pump vertical until completely remove an air.
4. Tighten air bleed nut (2).
5. Make sure to check leakage of injection pump & filter after operating feed pump many times.

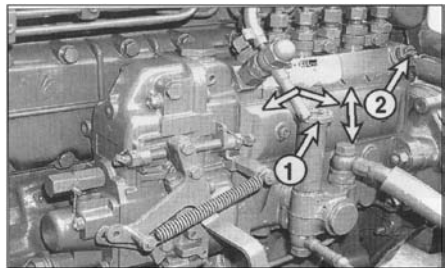

Draining the Water From the Fuel Filter

Diesel Engine Only

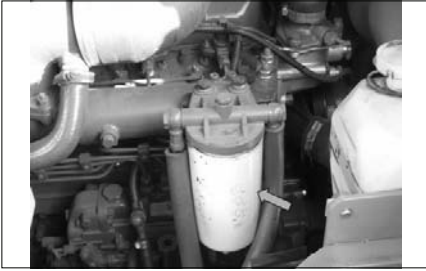

Typical Example

1. Turn the wing nut counter clockwise to open the drain valve on the bottom of the fuel filter.
2. Drain some fuel (and any water) until clean fuel flows from the filter.

Test Fuel System for Leaks (LP Engine Only)

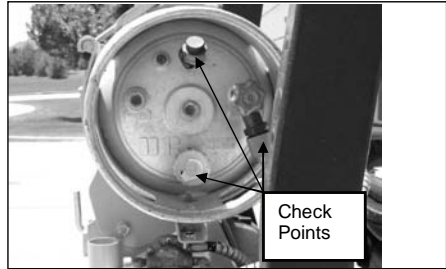

- Obtain a leak check squirt bottle or pump spray bottle.
- Fill the bottle with an approved leak check solution.
- Spray a generous amount of the solution on the fuel system fuel lines and connections, starting at the storage container.
- Wait approximately 15-60 seconds then perform a visual inspection of the fuel system. Leaks will cause the solution to bubble.
- Repair any leaks before continuing.
- Crank the engine through several revolutions. This will energize the fuel lock-off and allow fuel to flow to the pressure regulator/convertor. Apply additional leak check solution to the regulator/convertor fuel connections and housing. Repeat leak inspection as listed above.
- Repair any fuel leaks before continuing.

WARNING

Prior to any service or maintenance activity, Test Fuel System for Leaks

Fuel Tank Filter Cap & Screen - Clean

Park the lift truck with the forks lowered, parking brake applied, transmission in neutral and the engine stopped.



Typical Example

1. Raise the left side cover.
2. Remove the filter cap assembly. Separate the cap from the screen. Clean both in clean, nonflammable solvent.
3. Dry and assemble cap and screen.
4. Install cap assembly.

WARNING

Fuel leaked or spilled onto hot surfaces or electrical components can cause a fire.

5. Drain moisture and sediment from fuel tank as required by prevailing conditions.

Seat - Check, Lubricate



Typical Example

Check the operation of the seat adjuster rod. Make sure that the seat slides freely on its track. Lightly oil the seat slider tracks if necessary.

Fuses, Bulbs & Circuit Breaker - Change, Reset

Fuses

NOTE: If a fuse filament separates, use only the same type and size fuses for replacement. If the filament in a new fuse separates, have the circuits and instruments checked.

NOTICE

Always replace fuses with ones of the correct ampere rating.

Remove the front cover of fuse box. The fuses are located under the cover.



Fuse - Protects an electrical circuit from an overload. Opens (filament separates) if an overload occurs.



Typical Example

Check the fuses. Use a flashlight, if necessary. Fuses are identified as follows :

1. Horn - 10 amp.
2. Head Lamp - 15 amp
3. Fwd./Rev. Solenoid, lamp Relay & Back-up Lamp/alarm - 10 amp.
4. Instrument Panel & Fuel Shutoff - 15 amp.
5. Turn Signal Lamp, Stop/Strobe Lamp - 15 amp
6. Start Relay - 10 amp

Fuse & Relay (LP Engine Only)

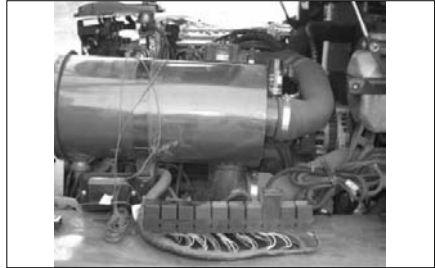

- (1)Relay
(2)Fuse

Located on top of engine

Circuit Breaker

1. Raise the floor mat.



Typical Example LP Engine Truck

2. The main circuit breaker is located on the rear of the support for the controls.

NOTE: To reset circuit breakers push on the button. The button should stay in if the breaker is reset. If the button will not stay in, or comes out shortly after reset, have the circuits checked.

Bulbs

Bulbs are identified as follows

[Diesel Engine]

1. Bulb-head lamp halogen(24V-70/75W)
2. Bulb-rear(24V-55W)
3. Bulb-turn signal(Front, 24V-25/10W)
4. Bulb-turn signal(Rear, 24V-25W)
5. Bulb-stop & tail(24V-25/10W)
6. Bulb-back up(24V-10W)

[LP Engine]

1. Bulb-head lamp halogen(12V-60/55W)
2. Bulb-rear(12V-55W)
3. Bulb-turn signal(Front, 12V-23/8W)
4. Bulb-turn signal(Rear, 12V-23W)
5. Bulb-stop & tail(12V, 23/8W)
6. Bulb-back up(12V-10W)

Tires and Wheels - Inspect, Check

WARNING

Servicing and changing tires and rims can be dangerous and should be done only by trained personnel using proper tools and procedures. Deflate tire before removing wheel nuts from the truck.

If correct procedures are not followed while servicing tires and rims, the assemblies could burst with explosive force and cause serious physical injury or death.

Follow carefully the specific information provided by your tire servicing man or dealer.

Check Inflation and Damage

Inspect tires for wear, cuts, gouges and foreign objects. Look for bent rims and correct seating of locking ring.

Check tires for proper inflation. See "Tire Inflation Pressures".

To inflate tires always use a clip-on chuck with a minimum 60 cm (24 inches) length of hose to an inline valve and gauge.

Always stand behind the tread of the tire. NOT in front of the rim.



Typical Example

Do not reinflate a tire that has been run while flat or underinflated, without first checking to make sure the rim is not damaged and is in the correct position.

When tires are changed, be sure to clean all rim parts and, if necessary, repaint to stop detrimental effects of corrosion. Sand blasting is recommended for removal of rust.

Check all components carefully and replace any cracked, badly worn, damaged and severely rusted or corroded parts with new parts of the same size and type. If there is any doubt, replace with new parts.

Do not, under any circumstances, attempt to rework, weld, heat or braze any rim components.

Radiator Cap - Clean, Change

Clean Pressure Cap



The radiator cap is located on the left side of the lift truck. (Diesel Engine Truck)
The radiator cap is located on the right side of the lift truck. (LP Engine Truck)

WARNING

Hot oil and components can cause personal injury. Do not allow hot oil or components to contact skin.



1. Remove the radiator cap slowly to relieve pressure.
2. Inspect the cap for damage, deposits or foreign material. Clean the cap with a clean cloth or change the cap as necessary.
3. Install the cap.

Clean Outside of Radiator Core

WARNING

Pressure air can cause personal injury.

When using pressure air for cleaning, wear a protective face shield, protective clothing and protective shoes.

The maximum air pressure must be below 205 kPa (30 psi) for cleaning purposes.

Compressed air, high pressure water or steam can be used to remove dust, leaves and general debris from a radiator. Clean as required by condition of radiator.

The use of compressed air is preferred.

Carriage Roller Extrusion - Adjust

1. Set the mast vertical.
2. Lower the carriage completely.
3. On full free lift and full free triple lift models, the bottom of the inner mast must be flush with the bottom of the stationary mast.

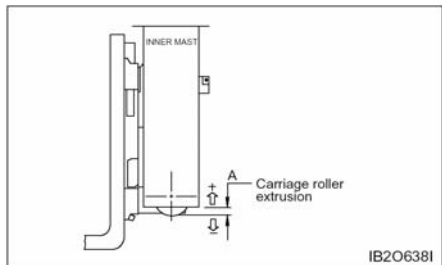

4. Measure the distance from the bottom of the inner upright to the bottom of carriage bearing.
5. The measurement (A) must be as follows in Chart below.

Height of carriage roller extrusion (A)		
STD mast	FF mast	FFT mast
D50/60/70S-5 (3 Speed, 2 Speed), G50/60/70S-5		
23	-	26
D80/90S-5(3 Speed)		
42	-	42

Brake Oil (OCDB) – Check Only for Oil Cooled Disc Brake

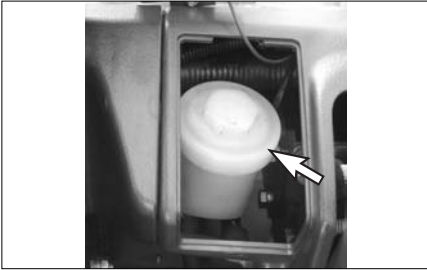

The brake reservoir is located on the left side of the steering column.

1. Remove the filter cap.
2. Maintain the brake fluid level to the fluid level mark on the brake system reservoir.
3. Clean and install the filter cap.

Every 10 Service Hours or Daily

You must read and understand the warnings and instructions contained in the Safety section of this manual, before performing any operation or maintenance procedures.

Inspection Engine for Fluid Leaks

1. Start the engine and allow it to reach operating temperatures.
2. Turn the engine off.
3. Inspect the entire engine for oil and/or coolant leaks.
4. Repair as necessary before continuing.

Engine Oil Level - Check

1. Raise the hood and seat assembly.

WARNING

Hot oil and components can cause personal injury. Do not allow hot oil or components to contact skin.

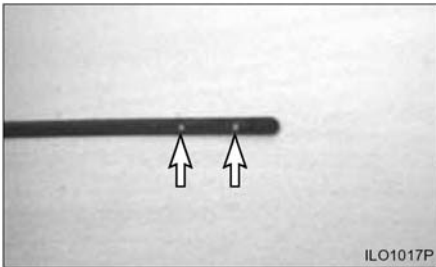

Typical Example

2. Maintain oil level between the MAX. and MIN. marks on the dipstick.

Coolant Level – Check

WARNING

At operating temperature, the engine coolant is hot and under pressure.

Steam can cause personal injury.

Check the coolant level only after the engine has been stopped and the filter cap is cool enough to touch with your bare hand.

Remove the filter cap slowly to relieve pressure.

Cooling system conditioner contains alkali. Avoid contact with the skin and eyes to prevent personal injury.



Typical Example Diesel Engine Truck



Typical Example LP Engine Truck

1. Observe the coolant level with engine cold. Maintain coolant level to the proper line on expansion bottle. If the expansion bottle has no coolant, it will be necessary to check coolant at the radiator filter neck.

2. Remove the radiator cap. Fill radiator to the top of the filter neck. Inspect radiator cap. Replace if damaged. Install the radiator cap.



Typical Example

3. Start and run the engine to stabilize the coolant level in the filter neck. If low, add coolant until it reaches the top of the filter neck. Install the radiator cap. Observe coolant level in the expansion bottle. If necessary, add coolant to bring the coolant to the appropriate line on the expansion bottle.
4. Stop the engine.
5. Inspect the cooling system for leaks, hose cracks or loose connections.

 **WARNING**

Pressure air can cause personal injury.

When using pressure air for cleaning, wear a protective face shield, protective clothing and protective shoes.

Maximum air pressure must be less than 205 kPa (30 psi) for cleaning purposes.

6. Blow any dust and lint from the radiator fins.

Air Cleaner Indicator – Check

Service Indicator

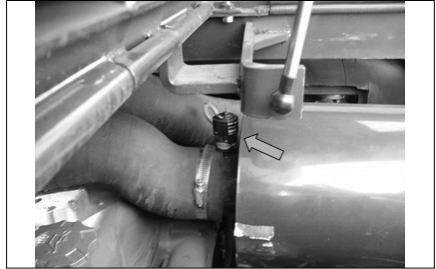

Typical Example

Diesel Engine Truck

1. Observe the air cleaner service indicator.
2. Service the air cleaner when the RED band in the service indicator, locks in the visible position. See topic, "Air Intake System - Check, Clean" in "Every 250 Service Hours or Monthly".

NOTE: Service the element more frequently, as required, in severe dust or lint conditions. Also, service it more frequently where the operator is required to wear a respirator.

3. Close hood and seat assembly.

Inspect Foot Pedal Operation (LP Engine Only)

1. Verify foot pedal travel is smooth without sticking.

WARNING

When the acceleration pedal harness is connected or disconnected, should be worked key OFF condition.

If not, occurred malfunction, can cause the personal injury.

Inspect Engine for Exhaust Leaks

1. Start the engine and allow it to reach operating temperatures.
2. Perform visual inspection of exhaust system. Repair any/all leaks found.

Walk-Around Inspection - Inspect

For maximum service life of the lift truck, make a thorough walk-around inspection. Look around and under the truck for such items as loose or missing bolts, debris or dirt buildup, fuel, oil or coolant leaks and cut or gouged tires.

Have any repairs made and debris removed, as needed.



Typical Example

1. Inspect the tires and wheels for cuts, gouges, foreign objects, inflation pressure and loose or missing bolts.
2. Inspect the mast and lift chains for wear, broken links, pins and loose rollers.

3. Inspect the hydraulic system for leaks, worn hoses or damaged lines.
4. Look for transmission and driveaxle leaks on the lift truck and on the ground.



Typical Example

5. Inspect the operator's compartment for loose items and cleanliness.
6. Inspect the instrument panel for broken gauges and indicator lights.
7. Test the horn and other safety devices for proper operation.



Typical Example

Diesel Engine(3 Speed)

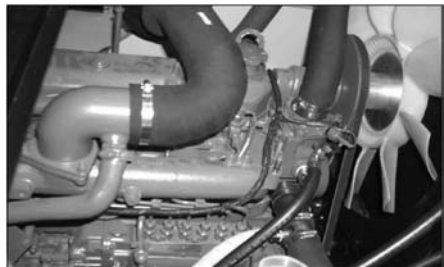

Typical Example

Diesel Engine(2 Speed)



LP Engine

8. Inspect engine compartment for oil, coolant and fuel leaks.
 9. Inspect the cooling system for leaks, worn hoses and debris buildup.
 10. Inspect the carriages, forks or attachments for wear, damage, and loose or missing bolts.
- Visually inspect forks for cracks, especially in the heel section, around the mounting brackets, and all weld areas.
 - Inspect for broken or jagged fork tips, bent or twisted blades and shanks.
 - Make sure positioning lock is in place and working. Lock the forks in position before using the truck. See Step 7 of "Forks" in "Every 2000 Service Hours or Yearly".
 - Remove all defective forks from service.

Mast Channels – Lubricate



Typical Example

The channels on the roller-type mast require a break-in period. Apply a light film of lubricant on the channels where the rollers ride. This will prevent metal peel until the rollers set a pattern.

Transmission Oil Level – Check

WARNING

Hot oil and components can cause personal injury. Do not allow hot oil or components to contact skin.

1. Start and operate the lift truck until the transmission reaches normal operating temperature (about 80°C).
2. Park the lift truck level with the forks lowered, parking brake applied and the transmission controls in NEUTRAL.
3. With the service brake applied and the engine at low idle, shift the directional control lever to forward and then to reverse, to fill the clutches.

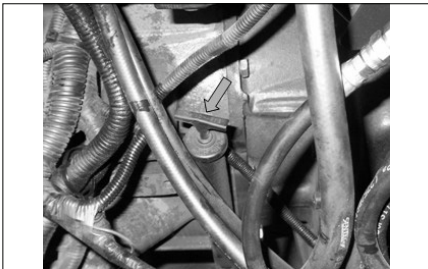

Typical Example D50/60/70/80/90S-5 (3 Speed)

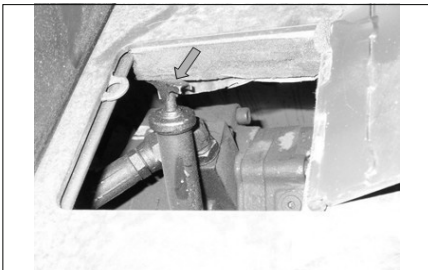

Typical Example D50/60/70S-5 (2 Speed), G50/60/70S-5

4. Shift the transmission into NEUTRAL. Engage the parking brake.



5. Loosen the oil dipstick counter-clockwise, remove and clear it. Insert the oil dipstick slowly into the oil level tube until contact is obtained, and pull the dipstick out again.
6. When the oil temperature is around 40°C, the marking on the oil dipstick must be lying above the cold start mark, "COLD". When the oil temperature is around 80°C, the oil level must be lying in the zone "HOT".
7. Install the oil dipstick again and tighten it clockwise.
8. Check for oil leaks at the filter and drain plug.
9. Stop the engine.

First 50-100 Service Hours or a Week

You must read and understand the warnings and instructions contained in the Safety section of this manual, before performing any operation or maintenance procedures.

Engine Oil & Oil Filter (Diesel E/G Only) - Change

The percentage of sulfur in the fuel will affect the engine oil recommendations. If the fuel has over 0.5% sulfur content, the engine oil must have a TBN of 20 times the percentage of fuel sulfur (TBN as measured by the ASTM D-2896 method). Your oil supplier should be able to furnish the correct oils.

1. Operate lift truck a few minutes to warm oil. Park the lift truck with the forks lowered, parking brake applied, transmission in neutral and the engine stopped.
2. Raise rear of lift truck off the ground and block securely.

WARNING

Hot oil and components can cause personal injury. Do not allow hot oil or components to contact skin.

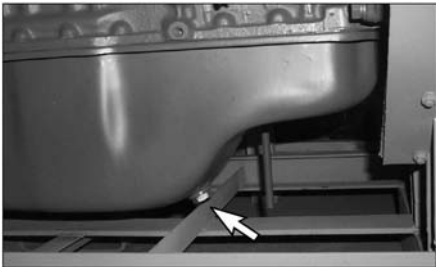

Typical Example

Diesel Engine Truck

NOTICE

Careless disposal of waste oil can harm the environment and can be dangerous to persons. Always dispose of waste oil to authorized and licensed personnel only.

3. Remove the crankcase drain plug and allow oil to drain. Clean and install drain plug.
4. Raise the left side cover.
5. Remove and discard oil filter element.
6. Wipe sealing surface of oil filter element mounting base. Make sure all of the old gasket is removed.
7. Before installing a new filter element, apply a small amount of clean engine oil to the filter element gasket.
8. Install the new filter element. When the gasket contacts the base, tighten it 3/4 of a turn more. Do not overtighten.
9. Raise the lift truck, remove the blocking and lower the lift truck.

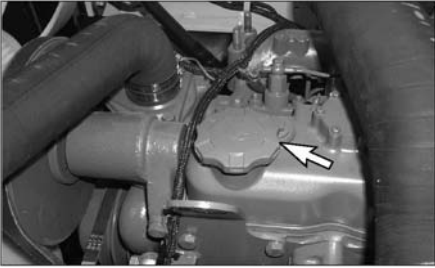

Typical Example

Diesel Engine Truck

10. Fill the crankcase. See "Refill Capacities".
11. Start the engine and allow the oil to fill the filter and passages.
12. Check for oil leaks.
13. Stop the engine and measure the oil level. Maintain the oil level between the MAX. and MIN marks on dip stick.
14. Close side cover.

NOTICE

Servicing of the engine oil and oil filter element will largely affect the engine performance as well as the engine life.

Engine oil and filter element must be changed after the first 50-100 Service hours or a week.

Transmission Oil & Oil Filter – Change

WARNING

Hot oil and components can cause personal injury. Do not allow hot oil or components to contact skin.

Park the lift truck level, with the forks lowered, parking brake engaged, transmission in NEUTRAL and the engine stopped.

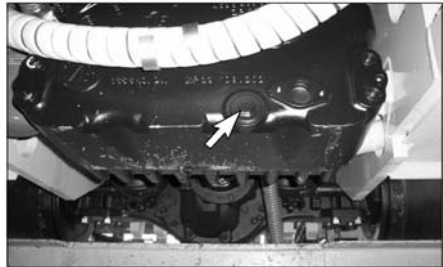

Typical Example

D50/60/70/80/90S-5 (3 Speed)

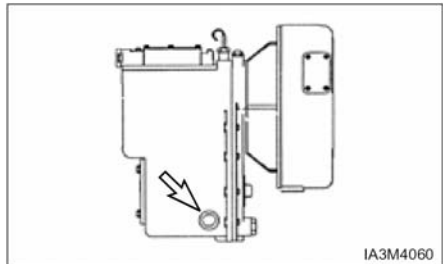

Typical Example

D50/60/70S-5 (2 Speed), G50/60/70S-5

1. Remove drain plug. Allow the oil to drain.

NOTICE

Careless disposal of waste oil can harm the environment and can be dangerous to persons. Always dispose of waste oil to authorized and licensed personnel only.

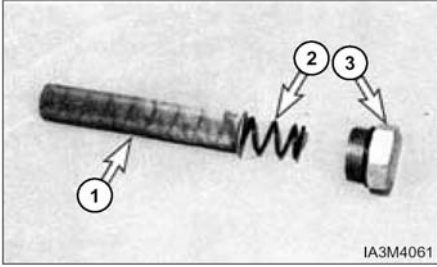

Typical Example D50/60/70S-5 (2 Speed), G50/60/70S-5

2. Wash the strainer (screen) , spring and drain plug in clean, nonflammable solvent. Dry the strainer, spring and drain plug. [D50/60/ 70S-5 (2 Speed), G50/60/70S-5 Only]

3. Install the drain plug.

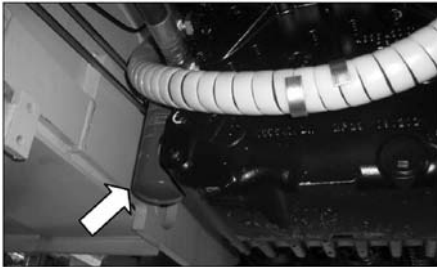

Typical Example D50/60/70/80/90S-5 (3 Speed)

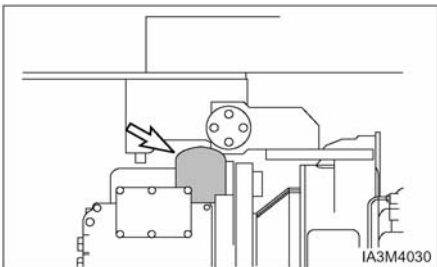

Typical Example D50/60/70S-5 (2 Speed), G50/60/70S-5

4. Rotate the oil filter counter clockwise to remove it.

• Replacement Interval of Transmission Oil Filter

D50/60/70S-5 (3 Speed)
: Every 1,000 Service Hours or 6 Months.

D50/60/70S-5 (2 Speed), G50/60/70S-5
: Every 500 Service Hours or 3 Months.

5. Put a small amount of clean oil on the seal gasket on the new filter. Install the filter by hand. When the filter contacts the base, tighten it an additional 3/4 turn.

6. Close the hood and seat assembly.

7. Open the access door in the floor plate.

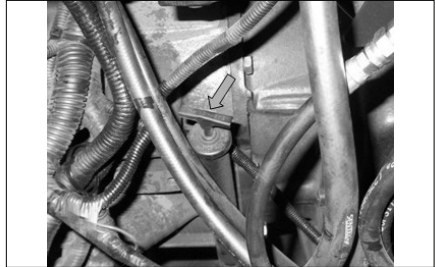

Typical Example D50/60/70/80/90S-5 (3 Speed)

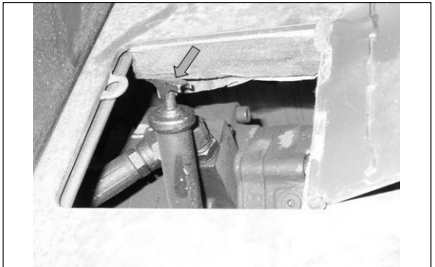

Typical Example D50/60/70S-5 (2 Speed), G50/60/70S-5

8. Remove the dip stick/filter cap. Fill the compartment with oil. See "Refill Capacities". Install the dip stick/filter cap.

9. Start the engine.

10. With the service brake applied and engine at low idle, shift the transmission to forward and reverse to fill the clutches.

11. Shift the transmission into NEUTRAL. Engage the parking brake.

12. Loosen the oil dipstick counter-clockwise, remove and clear it. Insert the oil dipstick slowly into the oil level tube until contact is obtained, and pull the dipstick out again.



13. When the oil temperature is around 40°C, the marking on the oil dipstick must be lying above the cold start mark, "COLD". When the oil temperature is around 80°C, the oil level must be lying in the zone "HOT".
14. Install the oil dipstick again and tighten it clockwise.
15. Check for oil leaks at the filter and drain plug.
16. Stop the engine.

Drive Axle Oil - Change

Park the lift truck on a level surface, parking brake applied, transmission in neutral.

WARNING

Hot oil and components can cause personal injury. Do not allow hot oil or components to contact skin.

Shoe Brake Type

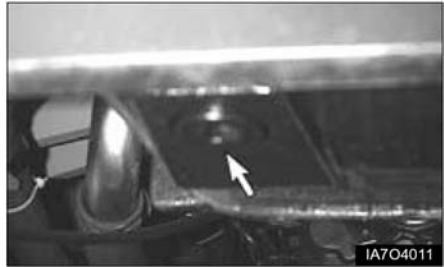

Typical Example

1. Raise the carriage high enough to access the drive axle housing level/fill plug with breather.
2. Block the bottom of the carriage with a block of wood to hold the carriage in the raised position.
3. Turn the ignition switch OFF.
4. Remove the drive axle housing level/fill plug with breather.
Wash them in clean, nonflammable solvent.
5. Place an appropriate container under the axle to catch the oil as it drains.
Remove the drive axle housing drain plug.
6. Allow the oil to drain completely out.
Discard the old oil according to local regulations.
7. Clean and reinstall the drive axle housing drain plug.



Typical Example

8. Remove planetary hub level/drain/fill plugs. Allow the oil to drain completely out. Reinstall the planetary hub plugs.
9. Fill the drive axle housing with sufficient fresh oil through the drive axle housing level/fill plug opening until it reaches the bottom of the hole. See the section, "Lubricant the Viscosities," and "Refill Capacities" for the type and amount of oil to use.
10. Remove the wood blocking and Lower the carriage.
11. Operate the lift truck for a few minutes. And align the planetary hub drain/fill/level plugs to the horizontal position. Remove the plugs.
12. Fill the planetary hubs, through the drain/fill/level hole, until the oil reaches the hole. See the section, "Refill Capacities".
13. Clean and reinstall the planetary hub drain/fill/level plugs.

Oil Cooled Disc Brake (OCDB) Type

Park the lift truck on a level surface. Apply the parking brake. Place the directional control level in NEUTRAL and stop the engine.

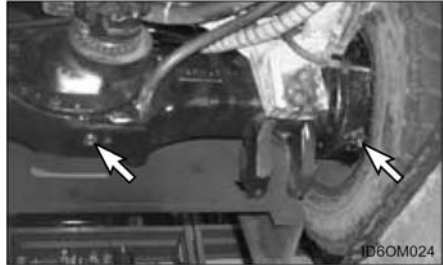

1. Remove three drain plugs of the drive axle housing and both wheel ends. Allow the oil to drain into a suitable container. Clean the magnetic drain plugs. Check O-ring seal and replace if necessary.
2. Install the drain plug.
3. Remove strainer assembly.

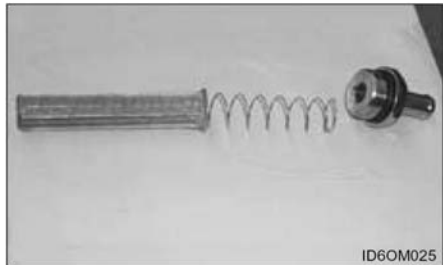

4. Wash the strainer assembly in clean, nonflammable solvent and dry it.
5. Install the strainer assembly and reconnect the hose and harness.

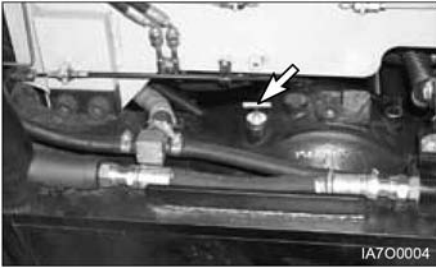

6. Remove the dip stick/filter cap. Fill the drive axle housing with oil. See "Lubricant Specification - Drive Axle Oil" and "Refill Capacity".
7. Start the lift truck. With the engine at low idle, place the directional control lever to the NEUTRAL.
8. Maintain the oil level between lower mark and upper mark on the dip stick/filter cap.
9. Install the dip stick/filter cap.

Parking Brake - Test, Adjust

WARNING

To prevent personal injury, the operator must be ready to use the service brake if the parking brake is not adjusted correctly and the lift truck starts to move.

NOTE: Be sure area around the lift truck is clear of personnel and obstructions.

1. Drive the lift truck with a rated load up a 15% incline.
2. Halfway up the incline, stop the lift truck by applying the service brakes.



Typical Example

3. Engage the parking brake and slowly release the service brake.
4. If the parking brake has the correct adjustment the lift truck will be hold in place. If the parking brake does not hold, adjust the parking brake.

To Adjust

Park the lift truck level, with the forks lowered, transmission in NEUTRAL, the engine stopped and the wheels securely blocked.



Typical Example

1. Release the parking brake
2. Turn the adjustment knob, clockwise to tighten the brake.
3. Test the parking brake adjustment. Repeat the adjustment procedure, if necessary.

First 250 Service Hours or a Month

You must read and understand the warnings and instructions contained in the Safety section of this manual, before performing any operation or maintenance procedures.

Hydraulic Return Filter – Change

WARNING

Hot oil and components can cause personal injury. Do not allow hot oil or components to contact skin.

Park the lift truck level with the forks lowered, parking brake engaged, transmission in NEUTRAL and the engine stopped.

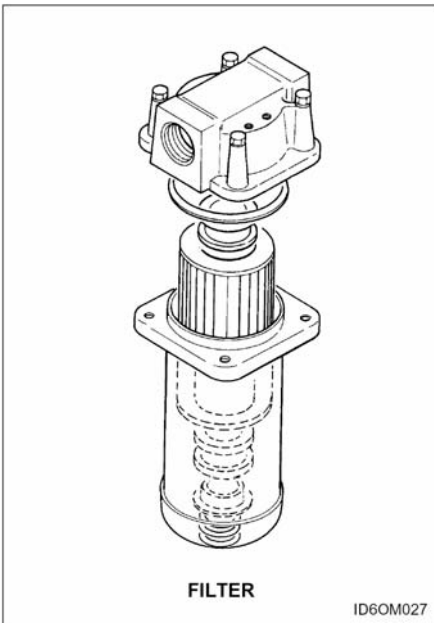

1. Remove the floor plate.
2. Remove bolts and filter housing.
3. Remove and discard filter element from filter housing.

4. Clean the filter housing with a clean, nonflammable solvent.
5. Clean the housing base.
6. Insert a new filter element into the filter housing.
7. Inspect the filter housing seal. Replace if necessary.
8. Apply a small amount of clean oil to the filter element seal and housing seal.
9. Install the filter housing with filter to the housing base. Install bolts and tighten 20 to 30 N•m (15 to 20 lb•ft).
10. Start the engine and operate the hydraulic controls, and the steering system, through a few cycles to fill the lines. Look for oil leaks.
11. Stop the engine and check the oil level. With all cylinders retracted, maintain the oil level to the FULL mark on the dip stick/filter cap assembly.

Every 250 Service Hours or Monthly

You must read and understand the warnings and instructions contained in the Safety section of this manual, before performing any operation or maintenance procedures.

Air Intake System - Check, Clean

Precleaner (If Equipped)

NOTICE

Never service precleaner with the engine running.



Typical Example

1. Check the precleaner bowl for dirt build-up. If the dirt is up to the line, remove the precleaner bowl and empty it. Periodically wash the cover and bowl in water.

Servicing Filter Element

NOTICE

Never service filter with the engine running.

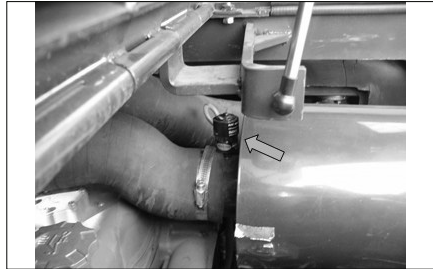

Typical Example

Diesel Engine Truck

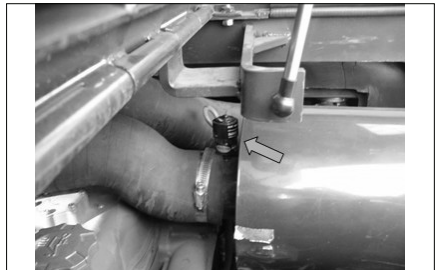

Typical Example

LP Engine Truck

Service the air cleaner when the red target in the service indicator stays locked in the visible position with the engine stopped.

1. To service the air cleaner, raise the side cover. Loosen the cover latches and remove the cover.

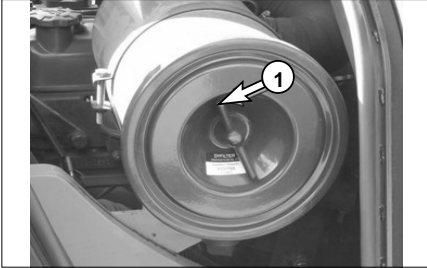
Diesel Engine Truck (Dual Element)

Typical Example

10. Start the engine and observe the position of the indicator. If the indicator shows RED after the installation of the primary element, install another clean or a new element or, replace the secondary element. See topic, "Air Intake System - Change" in Every 1000 Service Hours or 6 months section.

11. Stop the engine and close the right side cover.

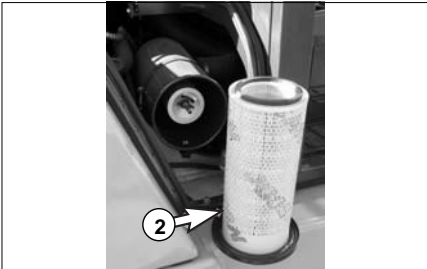
LP Engine Truck

Typical Example

2. Replace the nut or clamp(1).
3. Remove the element to separate it from its base and remove it from the air cleaner housing.
4. Clean and inspect the element (2).
5. Clean the inside of air cleaner housing and the cover. Inspect all connections between the air cleaner and carburetor. Check intake hose for cracks, damage and loose clamps. Tighten or replace parts as necessary to prevent leakage.

NOTICE

Do not allow dirty air to enter the intake hose when cleaning the inside of the cleaner housing.

6. Check the air cleaner housing for loose latches.
7. Reset the air cleaner service indicator.
8. Install the air filter element.
9. Install the cover and tighten the cover latches.

Cleaning Primary Filter Elements

WARNING

Pressure air can cause personal injury.

When using pressure air for cleaning, wear a protective face shield, protective clothing and protective shoes.

The maximum air pressure must be below 205 kPa (30 psi) for cleaning purposes.

NOTICE

Do not clean the elements by bumping or tapping them.

Inspect filter elements after cleaning. Do not use a filter with damaged pleats, gaskets or seals.

When cleaning with pressure air, use 205 kPa (30 psi) maximum pressure to prevent filter element damage.

When cleaning with pressure water, use 280 kPa (40 psi) maximum pressure to prevent filter element damage.

Have spare elements on hand to use while cleaning used elements.

The primary element should be replaced after a year's service or after cleaning no more than 6 times.

Air-205 kPa (30 psi) Maximum Pressure

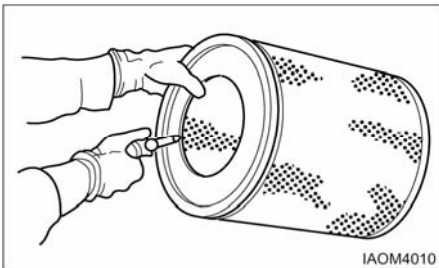

Direct air on the inside and outside of the element along the length of the pleats. Check the element for any tears, rips or damage.

Water-280 kPa (40 psi) Maximum Pressure

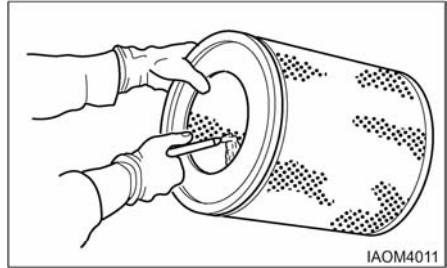

Direct water on the inside and outside of the element along the length of the pleats. Air dry it thoroughly and then examine it.

Detergent

1. Wash the element in warm water and mild household detergent.
2. Rinse the element with clean water. See instructions in preceding topic for cleaning with water.
3. Air dry it thoroughly, and then examine it.

Checking Element

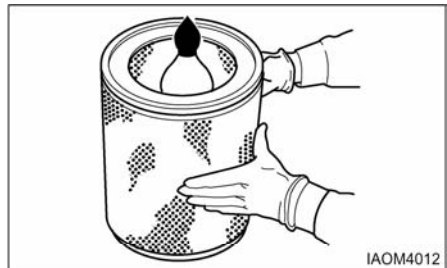

1. Insert a light inside the clean dry element and examine it. Discard the element if tears, rips or damage are found.
2. Wrap and store good elements in a clean, dry place..

Engine Oil & Filter(LP Engine Only) - Change

LP Engine Crankcase

1. Operate lift truck a few minutes to warm oil. Park the lift truck with the forks lowered, parking brake applied, transmission in neutral and the engine stopped.
2. Raise rear of lift truck off ground and block securely.

WARNING

Hot oil and components can cause personal injury. Do not allow hot oil or components to contact skin.

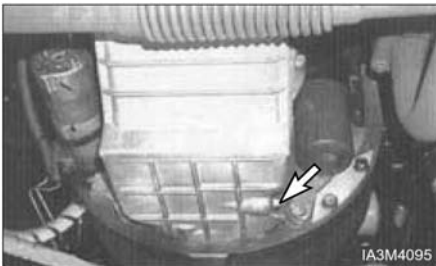

3. Remove the crankcase drain plug and allow oil to drain. Clean and install drain plug.
4. Raise the hood and seat assembly.
5. Remove and discard oil filter element.
6. Wipe sealing surface of oil filter element mounting base. Make sure all of the old gasket is removed.
7. Before installing a new filter element, apply a small amount of clean engine oil to the filter element gasket.
8. Install the new filter element. When the gasket contacts the base, tighten it 3/4 of a turn more. Do not overtighten.
9. Raise the lift truck, remove the blocking and lower the lift truck.

10. Fill the crankcase. See " Refill Capacities ".
11. Start the engine and allow the oil to fill the filter and passages.
12. Check for oil leaks.

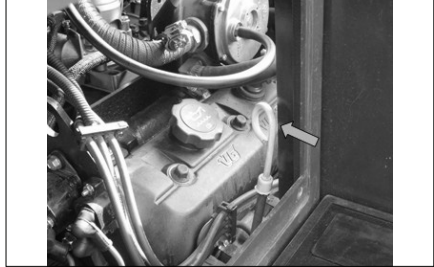

13. Stop the engine and measure the oil level. Maintain the oil level to the FULL mark on the dip stick.
14. Close hood and seat assembly.

Hydraulic Oil Level – Check

WARNING

At operating temperature, the hydraulic tank is hot and under pressure.

Hot oil can cause burns.

Remove the filter cap only when the engine is stopped, and the cap is cool enough to touch with your bare hand. Remove the filter cap slowly to relieve pressure.

1. Operate the lift truck for a few minutes to warm the oil. Park the lift truck on a level surface, with the forks lowered, mast tilted back, parking brake engaged, transmission in NEUTRAL and the engine stopped.
2. Raise the hood and seat assembly. Make sure the air lift cylinder securely holds the hood open.



Typical Example

3. Check the oil level.
4. Maintain the oil level to the FULL mark on the dip stick/filter cap assembly.
5. Install the dip stick/filter cap assembly.

Drive Axle Oil Level – Check

WARNING

Hot oil and components can cause personal injury. Do not allow hot oil or components to contact skin.

Shoe Brake Type

Park the lift truck on a level surface, parking brake applied, transmission in neutral.

1. Raise the carriage high enough to access the drive axle housing level/fill plug.
2. Block the bottom of the carriage with a block of wood to hold the carriage in the raised position.
3. Turn the ignition switch OFF.



4. Remove the drive axle housing level/fill plug.
5. Check if oil reaches the bottom of level/fill hole.
6. Maintain oil level to the bottom of level/fill hole.
7. Install the drive axle housing level/fill plug.
8. Remove the wood blocking and lower the carriage.
9. Align planetary hub level/drain/fill plugs to the horizontal position.
10. Remove the plugs and check if oil reaches the level/drain/fill hole.
11. Maintain the oil level to the hole.
12. Install the planetary hub level/drain/fill plugs.

Oil Cooled Disc Brake (OCDB) Type

Park the lift truck on a level surface. Apply the parking brake. The engine is at the low idle. Place the directional control level in NEUTRAL.



1. Remove the dip stick/filter cap. Observe the oil level.
2. Maintain the oil level between lower mark and upper mark on the dip stick/filter cap.
3. Install the dip stick/filter cap.

Mast, Carriage, Lift Chains & Attachments - Inspect, Lubricate

1. Operate the lift, tilt and attachment controls. Listen for unusual noises. These may indicate a need for repair.
2. Check for loose bolts and nuts on the carriage. Remove any debris from the carriage and mast.
3. Check the forks and attachments for free operation and damage. Have repairs made if necessary.

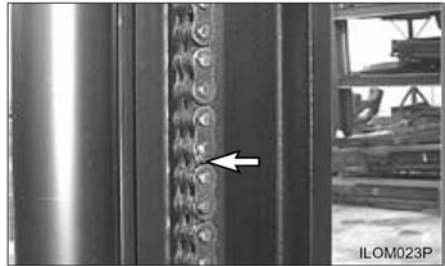

Typical Example

4. Brush a film of oil on all links of the chain.
5. Raise and lower the carriage a few times to allow lubricant to enter into the chain links.

NOTICE

Lubricate chains more frequently than normal in applications where the lift truck is operating in a atmosphere which could cause corrosion of components or when lift truck must work in rapid lift cycles.

6. Check the air cleaner housing for loose latches.

Lubricate Mast Side Rollers

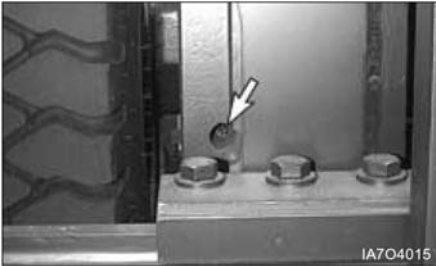

Typical Example

1. Lubricate the 2 fittings on the inner mast.

Lubricate Carriage Side Rollers

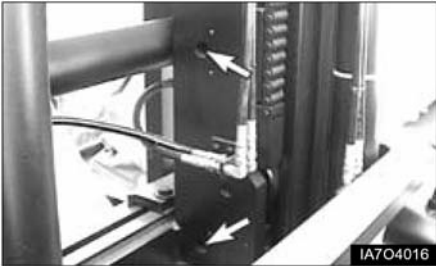

Typical Example

1. Lubricate the 4 fittings for the carriage side rollers, two on each side of the carriage side rollers.



Typical Example

2. Lubricate the 2 fittings for the carriage middle rollers, one on each side of the carriage middle rollers.

Steering Mechanism - Check, Lubricate

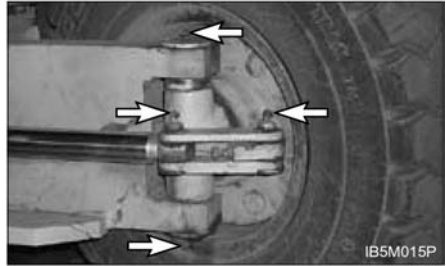

Typical Example

1. Lubricate the steer axle king pins, total of four fittings. Two on the right side and two on the left side.
2. Lubricate the steering link bearings, total of four fittings. Two on the right side and two on the left side
3. Check for any worn or loose components of the steering mechanism. Remove any debris or trash as required.

Battery Terminal - Clean, Inspect

WARNING

Batteries give off flammable fumes that can explode.

Do not smoke when observing the battery electrolyte levels.

Electrolyte is an acid and can cause personal injury if it contacts skin or eyes.

Always wear protective glasses when working with batteries.



Typical Example

Diesel Engine Truck



Typical Example

LP Engine Truck

1. Clean the top of the battery and terminals.
2. Check terminals for corrosion. Coat terminals with heavy grease.

Wheel Bolts & Nuts - Inspect

Inspect Tightness

Steer Wheels



Typical Example

1. Install steer wheel. Put two nuts opposite each other (180°). Tighten bolt.
2. Inspect tightness of wheel nuts in a sequence opposite each other 610 ~ 680 N.m (370~450 lb.ft).

Drive Wheels



Typical Example

1. Install drive wheel. Put two nuts opposite each other (180°).
2. Inspect tightness of wheel nuts in a sequence opposite each other to 500~600 N.m (370~450 lb.ft).

Every 500 Service Hours or 3 Months

You must read and understand the warnings and instructions contained in the Safety section of this manual, before performing any operation or maintenance procedures.

Belts (Diesel E/G Only) - Check, Adjust

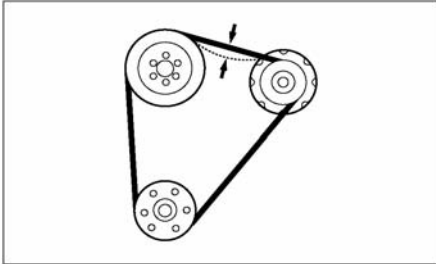

Typical Example

D50/60/70/80S-5(3 Speed)

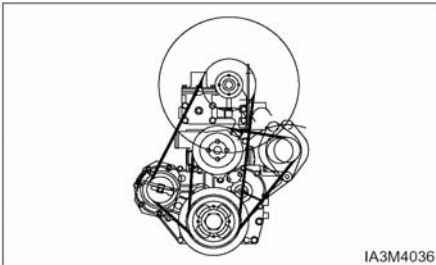

Typical Example

D50/60/70S-5(2 Speed)

1. Check the condition and adjustment of the belt. Correct adjustment allows 10 mm (3/8 inch) deflection under 110 N (25 lb) of force.

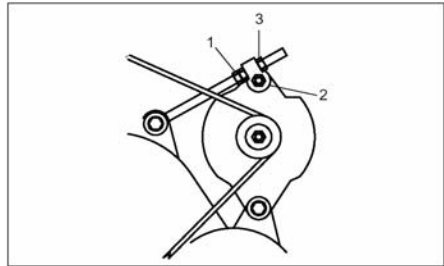

Typical Example

NOTICE

Failure to loosen the alternator mounting bolt(2) will cause excessive stress and break the alternator mounting ear.

2. To adjust the alternator drive belt, loosen adjusting bracket nut (1), mounting bolt and nut (2) and nut (3). Move the nut (1) in or out as required. Tighten the mounting bolt and nut (1, 2, 3).

Mast Hinge Pins – Lubricate



Typical Example

1. Lower the forks and tilt the mast forward.
2. Lubricate the two fittings for the mast hinge pins, one on each side of the mast.

Tilt Cylinders - Check, Adjust, Lubricate

Chassis Pivot Eyebolts

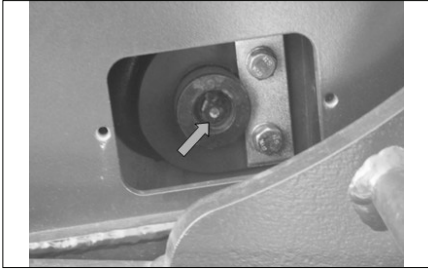

Typical Example

1. Lubricate two fittings for the pivot eyebolts, one on each tilt cylinder.
2. Check the pivot eye pins for loose retainer bolts and wear.

Mast Pivot Eyes



Typical Example

1. Lubricate two fittings for the mast pivot eyes, one on each side of the mast.
2. Check the pivot eye pins for loose retainer bolts and wear.

Crosshead Rollers - Inspect

1. Operate the mast through a lift cycle. Watch the chains move over the crosshead rollers. Make sure the chain is tracking over the rollers properly.



Typical Example

2. Check for damaged crosshead rollers, guards and retainer rings.

Transmission Oil Filter (2 Speed Only) – Change

Only for D50/60/70S-5(2 Speed), G50/60/70S-5

See topic, "Transmission Oil & Oil Filter - Change" in "First 50-100 Service Hours or a Week".

Parking Brake - Test, Adjust

See topic, "Parking Brake - Test, Adjust " in " First 50-100 Service Hours or a Week."

Drive Axle Oil (OCDB) - Change

See topic, "Drive Axle Oil - Change" in "First 50-100 Service Hours or a Week".

Horn and Lights(If Equipped) – Check

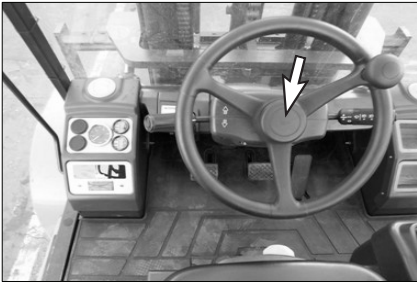

Typical Example

1. Press horn button, to determine if horn is operational.
2. Check and replace all defective gauges.
3. Check all lights such as warning, directional, backup, driving and flood lights for correct operation. Replace all burned out bulbs. Have repairs made if needed.

Overhead Guard – Inspect

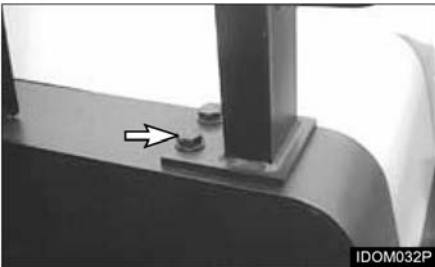

Typical Example

1. Check tightness of overhead guard mounting bolts at 240 N•m (175 lb•ft).
2. Check overhead guard for bent or cracked sections. Have repairs made if needed.

Steer Suspension – Inspect

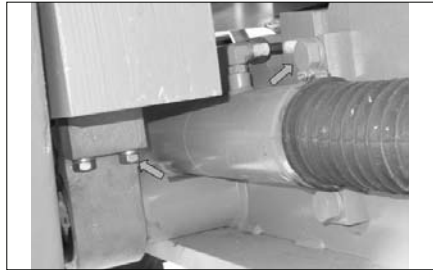

1. Inspect the suspension mounting bolts. Tighten suspension each four mounting bolts(total eight bolts), if necessary, to $240\pm 40\text{N}\cdot\text{m}$ ($177\pm 29\text{lb}\cdot\text{ft}$) .
2. Look for leaks at the power steering hose and tube connections .
3. Remove any trash buildup on the suspension or steer axle.

Universal Joint - Inspect, Lubricate



Typical Example

Check for worn or damaged bearings. Check for loose retaining bolts and nuts. Tighten the bolts and nuts, if necessary.($55\text{N}\cdot\text{m}$, 41 lb•ft) Lubricate one fitting on the universal joint.

Engine Oil & Filter(Diesel Engine Only) – Change

Diesel Engine Crankcase

See topic, "Engine Oil & Filter (Diesel E/G Only) - Change" in "First 50-100 Service Hours or a Week".

Inspect Vacuum Lines and Fittings (G643(E) Engine only)

- Visually inspect vacuum lines and fittings for physical damage such as brittleness, cracks and kinks. Repair/replace as required.
- Solvent or oil damage may cause vacuum lines to become soft resulting in a collapsed line while the engine is running.
- If abnormally soft lines are detected, replace as necessary.

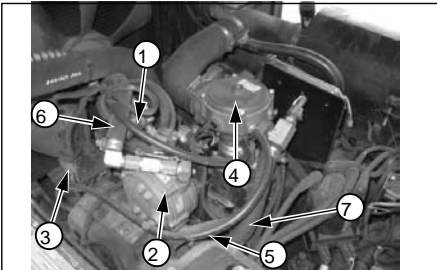

- (1) LP fuel lock-off,
 (2) LP regulator/converter
 (3) Fuel Trim Valve(FTV) : G643E only)
 (4) LP mixer
 (5) Vacuum lines,
 (6) Coolant lines,
 (7) LP fuel line

Fuel Trim Valve(FTV) Inspection (G643E Engine only)

- Visually inspect the Fuel trim valve(3) for abrasions or cracking. Replace as necessary.
- To ensure the valve is not leaking a blow-by test can be performed.
 1. With the engine off, disconnect the electrical connector to the FTV.
 2. Disconnect the vacuum line from the FTV to the pressure regulator/converter, at the converter's tee connection.
 3. ightly blow through the vacuum line connected to the FTV. Air should not pass through the FTV when de-energized. If air leaks past the FTV when de-energized replace the FTV.

Inspect Electrical System (G643E Engine only)

- Check for loose, dirty or damaged connectors and wires on the harness including: Fuel lock-off, TMAP sensor, O2 sensor, Electronic throttle, Control Relays, Fuel Trim Valve, Foot Pedal, and Distributor sensor.
- Repair and/or replace as necessary

Every 1000 Service Hours or 6 Months

You must read and understand the warnings and instructions contained in the Safety section of this manual, before performing any operation or maintenance procedures.

Carburetor (LP - Gas Engine Only) - Adjust, Clean

If the engine is hard to start or the exhaust is smoking, the carburetor may need cleaning and adjusting.

Before adjusting the carburetor make sure the engine is at normal operating temperature. Park the lift truck with the forks lowered, parking brake applied, transmission in neutral and the engine stopped.

For the complete procedure and specifications for your specific engine, see the " Service Manual ".

Fuel Filter - Check, Clean, Change

Diesel Engine

Park lift truck with the forks lowered, parking brake applied, transmission in neutral, engine stopped and cool.

1. Raise the right side cover.

WARNING

Fuel leaked or spilled onto hot surfaces or electrical components can cause a fire. Turn the disconnect switch OFF or disconnect the battery when changing fuel filters.



Typical Example

Diesel Engine Truck

2. Remove fuel filter cartridge assembly.
3. Before installing a new cartridge assembly, apply a small amount of clean fuel to the filter cartridge gasket.

NOTICE

Do not fill fuel filters with fuel before installing them. Contaminated fuel will cause accelerated wear to fuel system parts.

4. Install the new fuel filter cartridge assembly.
5. Turn the new fuel filter cartridge assembly until the filter gasket is fitted against the sealing face.
6. Turn the fuel filter cartridge assembly an additional 2/3 of turn.

Air Intake System - Change Changing Primary Element

See topic, "Air Intake System - Check, Clean" in "Every 250 Service Hours or Monthly".

Changing Secondary Element

Replace the secondary element after the primary element has been cleaned three times or yearly.

1. Remove the primary air cleaner element. See topic "Servicing Filter Element". Clean the inside of the air cleaner housing and cover.



2. Remove the secondary element. Inspect the gasket between the air cleaner housing and the engine inlet. Replace the gasket if it is damaged.

NOTICE

Always replace the secondary element. Do not attempt to reuse it by cleaning.

3. Install a new secondary element. Install a new or cleaned primary element. Install the cover. Tighten the latches.
4. Start the engine and observe the air cleaner service indicator. If the indicator shows RED after installing a new secondary element and a cleaned primary (outer) element, replace the cleaned primary filter with a new element.
5. Stop the engine. Close the hood and seat assembly.

Inspect Coolant Hoses (LP Engines Only)

- Visually inspect coolant hoses and clamps. Remember to check the two coolant lines that connect to the pressure regulator/converter.
- Replace any hose that shows signs of swelling, cracking, abrasion or deterioration.

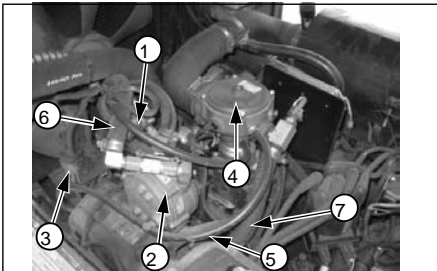

- (1) LP fuel lock-off,
- (2) LP regulator/converter
- (3) Fuel Trim Valve (FTV),
- (4) LP mixer
- (5) Vacuum lines,
- (6) Coolant lines,
- (7) LP fuel line

LP Regulator/Converter Inspection (LP Engine Only)

- Visually inspect the pressure regulator/converter housing(2) for coolant leaks. Refer to the pressure regulator/converter section of the service manual if maintenance is required.

NOTE: For pressure testing and internal inspection of the pressure regulator/converter, refer to the pressure regulator/converter section of the service manual.

Fuel Lines & Fittings – Check

Visually inspect fuel lines and fittings for physical damage. Replace as required.

Inspect Mixer Assembly (LP Engine Only)

Refer to the LP mixer section of the engine service manual for procedures.

Inspect Throttle Assembly (LP Engine Only)

- Visually inspect the throttle assembly motor housing for coking, cracks and missing cover-retaining clips. Repair and/or replace as necessary.

NOTE: Refer to the LP mixer and throttle section of the service manual for procedures on removing the mixer and inspecting the throttle plate.

Hydraulic Oil, Return Filter, Strainer & Breather - Check, Clean, Change

⚠ WARNING

Hot oil and components can cause personal injury. Do not allow hot oil or components to contact skin.

Park the lift truck level with the forks lowered, parking brake engaged, transmission in NEUTRAL and the engine stopped.

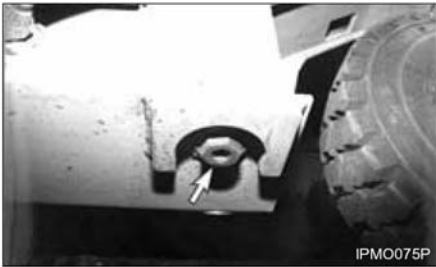

1. Remove the hydraulic tank drain plug located on the bottom of the frame. Allow the oil to drain in a suitable container. Clean and install the plug.

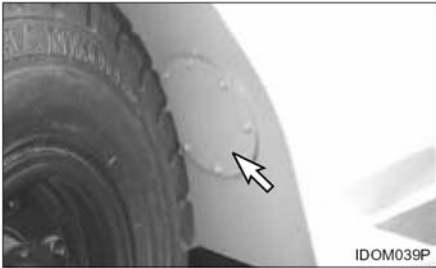

2. Loosen the bolts of the hydraulic tank cover.
3. Remove the strainer from the tank.
4. Install the new strainer by hand.
5. Install the hydraulic tank cover and fasten the bolts.



6. Remove the breather.
7. Wash the breather in clean, nonflammable solvent and dry it.
8. Fill the hydraulic tank. See topic, "Refill Capacities."
9. Install the breather.

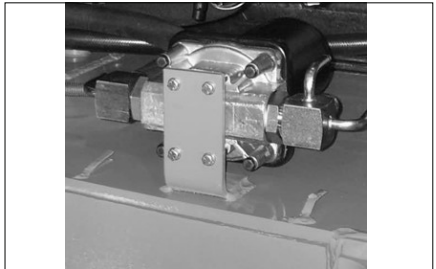

10. Remove the floor plate.
11. Remove bolts and filter housing.
12. Remove and discard filter element from filter housing.
13. Clean the filter housing with a clean, nonflammable solvent.
14. Clean the housing base.
15. Insert a new filter element into the filter housing.
16. Inspect the filter housing seal. Replace if necessary.
17. Apply a small amount of clean oil to the filter element seal and housing seal.
18. Install the filter housing with filter to the housing base. Install bolts and tighten 20 to 30 N•m (15 to 20 lb•ft).

19. Start the engine and operate the hydraulic controls, and the steering system, through a few cycles to fill the lines. Look for oil leaks.
20. Stop the engine and check the oil level. With all cylinders retracted, maintain the oil level to the FULL mark on the dip stick/filter cap assembly.

Transmission Oil & Filter (3 Speed Only) – Change

Only for D50/60/70/80/90S-5 (3 Speed)

See topic, "Transmission Oil & Oil Filter - Change" in "First 50-100 Service Hours or a Week".

Transmission Oil (2 Speed Only) – Change

Only for D50/60/70S-5 (2 Speed), G50/60/70S-5

See topic, "Transmission Oil & Oil Filter - Change" in "First 50-100 Service Hours or a Week".

Lift Chains - Test, Check, Adjust

Lift Chain Wear Test

Inspect to be sure that chain link pins Do not extend outside of the link hole. If any single link pin is extended beyond its connecting corresponding link, it should be suspected of being broken inside of its link hole. Lift chains are required to check for wear about every 1,000 service hours or 6 months.

Chain wear test is a measurement of wear of the chain links and pins. Take the following steps to check chain wear.

Chain wear test is a measurement of wear of the chain links and pins. Take the following steps to check chain wear.

1. Lift the mast and carriage enough for getting tension on lift chains.



Typical example

2. Measure precisely ten links of chain distance at the center of pins in millimeter.
3. Calculate chain wear rate*.
4. If the chain wear rate is 2% or more, replace the lift chain.

Check for Equal Tension



Typical example

Lift the carriage and the mast high enough for getting tension on lift chains. Check the chains, and make sure the tension is the same. Lift chains are required to check for equal tension about every 1,000 service hours or 6 months.

WARNING

Personal injury can be caused by sudden movement of the mast and carriage. Keep hands and feet clear of any parts that can move.

Lift Chain Adjustment



Typical example for carriage equal tension

If the tension is not the same on both chains, take the procedure as follows.

NOTE: If carriage height is not correct, make adjustments by following procedures.

Carriage Chain Adjustment - STD Mast

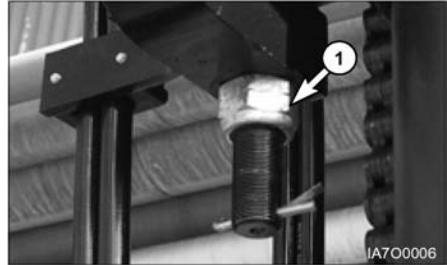

Typical example for carriage chain of STD mast

Make sure that carriage height is correct. If correct, adjust chain for equal tension. If not, adjust chain for correct carriage height by adjusting anchor nuts(1).

NOTE: See the previous section, "Carriage Roller Extrusion" in "When Required" for proper carriage height.

1. Fully lower the carriage and tilt mast forward or lift the carriage and put blocks under the carriage to release the tension from the lift chains.
2. Adjust nut(1) to get proper distance from the bottom of inner upright to the bottom of carriage bearing.
3. Make adjustment anchor nut(1) for equal chain tension.
4. Set the mast vertical and raise the carriage and check equal chain tension. If not equal, repeat the same procedure as step 1 through step 3.
5. Put LOCTITE No. 242 tread lock on the threads of the anchor nuts(1) after the adjustment is completed.

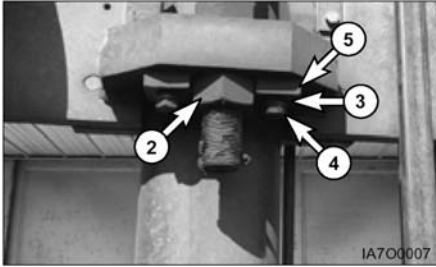
Carriage Chain Adjustment - FFT

Typical example for carriage chain of FFT mast

Make sure that carriage height is correct. If correct, adjust chain for equal tension. If not, adjust chain for correct carriage height by adjusting anchor nuts(2).

NOTE: See the previous section, "Carriage Roller Extrusion" in "When Required" for proper carriage height.

1. Fully lower the carriage and tilt mast forward or lift the carriage and put blocks under the carriage to release the tension from the lift chains.
2. Remove bolt(3), washer(4) and stopper(5) and adjust nut(2) to get proper distance from bottom of inner upright to the bottom of carriage bearing.
3. Make adjustment anchor nut(2) for equal chain tension.
4. Set the mast vertical and raise the carriage and check equal chain tension. If not equal, repeat the same procedure as step 1 through step 3.
5. Put LOCTITE No. 242 tread lock on the threads of the anchor nuts(2) after the adjustment is completed.

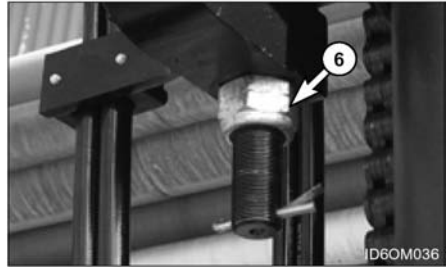
Mast Chain Adjustment - FFT

Typical example for FFT mast

Make sure that mast height is correct. If correct, adjust chain for equal tension. If not, adjust mast chain for correct mast height by adjusting anchor nuts(6).

NOTE: See the previous section, "Carriage Roller Extrusion" in "When Required" for proper inner mast height.

1. Lift the inner mast and put blocks under the inner mast to release the tension from the lift chains.
2. Adjust nut(6) to make inner mast bottom flush with outer mast bottom.
3. Make adjustment anchor nut(6) for equal chain tension.
4. Raise the inner mast and check equal chain tension. If not equal, repeat the same procedure above step 1 through step 3.
5. Put LOCTITE No. 242 tread lock on the threads of the anchor nuts(6) after the adjustment is completed.

Every 1500 Service Hours or 9 Months

You must read and understand the warnings and instructions contained in the Safety section of this manual, before performing any operation or maintenance procedures.

Drive Axle Oil (Shoe Brake Only) - Change

See topic, "Drive Axle Oil - Change" in "First 50-100 Service Hours or a Week."

Inspect Ignition System (LP Engine Only)

1. Disconnect Battery Cables.
2. Remove and inspect the spark plugs. Replace as required.
3. Test secondary cables with an Ohmmeter. If maximum resistance is higher than 25 kOhms, repair and/or replace.
4. Remove distributor cap and perform visual inspection. Replace cap and rotor if corrosion is found on the contacts.
5. Inspect the ignition coil for cracks and heat deterioration. Visually inspect the coil heat sink fins. If any fins are broken replace as required.



Replace Spark Plugs (LP Engine Only)

1. Disconnect Battery Cables.
2. Using a gentle twisting motion remove the high voltage cables from the spark plugs. Replace any damaged cables.
3. Remove the spark plugs.
4. Gap the new spark plugs to the proper specifications.
G643(E) Engine : 0.9mm (0.035 inch)
5. Apply anti-seize compound to the spark plug threads and install.
G643(E) Engine : 30 N•m (22 lb•ft)

CAUTION

DO NOT OVERTIGHTEN THE SPARK PLUGS.

6. Re-install the high voltage cables.

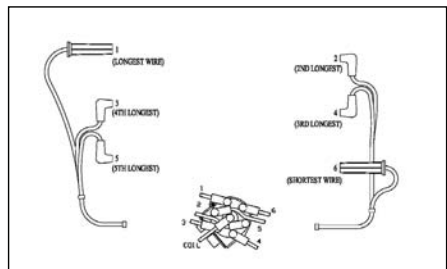

Replace LP Fuel Filter Element (LP Engine Only)

Park the lift truck in an authorized refueling area with the forks lowered, parking brake applied and the transmission in Neutral.

1. Close the fuel shutoff valve on the LP-Fuel tank. Run the engine until the fuel in the system runs out and the engine stops.
2. Turn off the ignition switch.
3. Scribe a line across the filter housing covers, which will be used for alignment purposes when re-installing the filter cover.

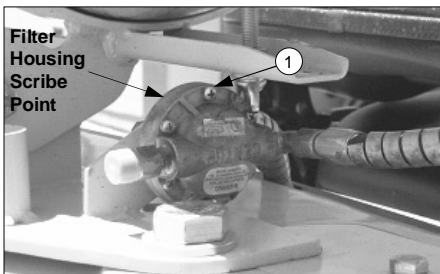

(1) SCREW

4. Remove the cover retaining screws (1)

Fuel Filter - Disassembly

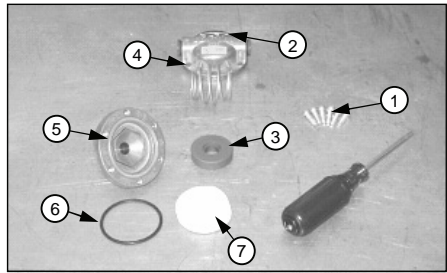

5. Remove top cover (2), magnet (3), spring (4), and filter element (7) from bottom cover (5).
6. Replace the filter element (7).
7. Check bottom cover O-ring seal (6) for damage. Replace if necessary.
8. Re-assemble the filter assembly aligning the scribe lines on the top and bottom covers.
9. Install the cover retaining screws, tightening the screws in an opposite sequence across the cover.
10. Open the fuel valve by slowly turning the valve counterclockwise.
11. Crank the engine several revolutions to open the fuel lock-off. **DO NOT START THE ENGINE.** Turn the ignition key switch to the off position.
12. Check the filter housing, fuel lines and fittings for leaks. Repair as necessary.

Testing Fuel Lock-off Operation (LP Engine Only)

- Start engine.
- Locate the electrical connector for the fuel lock
- Disconnect the electrical connector.
- The engine should run out of fuel and stop within a short period of time.
- Turn the ignition key switch off and re-connect the fuel lock-off connector.

NOTE: The length of time the engine runs on trapped fuel vapor increases with any increase in distance between the fuel lock-off and the pressure regulator/convertor.

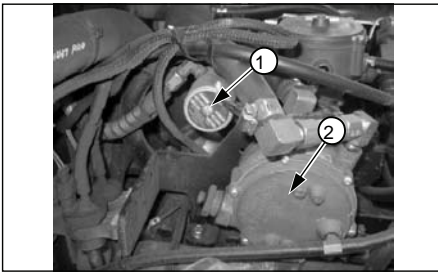

- (1) LP fuel lock-off,
(2) LP regulator/convertor

Every 2000 Service Hours or Yearly

You must read and understand the warnings and instructions contained in the Safety section of this manual, before performing any operation or maintenance procedures.

Steer Wheel Bearings - Reassemble

Park the lift truck level with the forks lowered, parking brake engaged, transmission in NEUTRAL and the engine stopped.



Typical Example

1. Lift the steer wheels off the ground. Place stands or blocking under the frame and steer axle to support the lift truck.
2. Remove the hub cap and gasket.

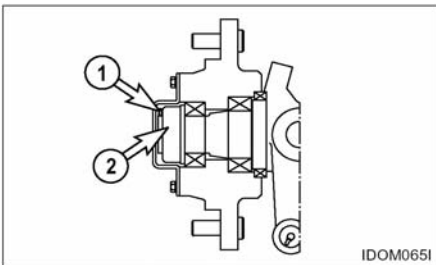

Typical Example

3. Remove the pin (1) and nut (2). Remove the outer wheel bearing.



Typical Example

4. Remove the wheel assembly. Examine the wheel for damage and wear. Replace the wheel if necessary.
5. Remove the inner bearing. Clean and lubricate the steering knuckle. Reassemble both the inner and outer bearing cones.
6. Install the inner bearing. Lubricate the seal and install the wheel assembly on the knuckle.
7. Install the outer wheel bearing and the outer nut.
8. Tighten the nut to 200 N•m (148 lb•ft), while turning wheel hub to seat the bearing.
9. Install the pin.
10. Install the hub cap.
11. Raise the lift truck and remove the blocking. Lower the lift truck to the ground.

Cooling System - Clean, Change

WARNING

At operating temperature, the engine coolant is hot and under pressure.

Steam can cause personal injury.

Check the coolant level only after the engine has been stopped and the filter cap is cool enough to touch with your bare hand.

Remove the filter cap slowly to relieve pressure.

Cooling system conditioner contains alkali.

Avoid contact with the skin and eyes to prevent personal injury.

Use all cleaning solutions with care.

The lift truck must be level, the forks lowered, the parking brake engaged, the transmission in NEUTRAL and the engine stopped and cool.



Typical Example

1. Turn the radiator cap slowly to relieve the pressure, then remove the cap.
2. Remove the block drain plug.

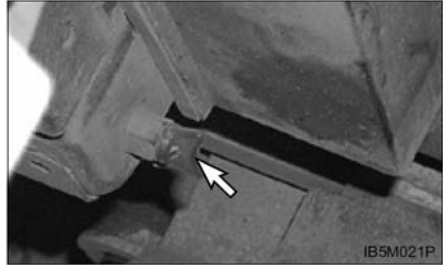

Typical Example

3. Open radiator drain valve. Allow the coolant to drain. Drain the recovery bottle.
4. Close radiator drain valve and install block drain plug. Fill the cooling system with 1 kg (2 lb) sodium bisulphate per 40 liters (10 gallons) of water. Most commercial cooling system cleaners can be used.
5. Start and run the engine for 30 minutes.
6. Stop the engine and drain the cleaning solution.
7. Flush the system with clean water, until draining water is clear.
8. Close the drain valve and install the block drain plug. Fill the system with neutralizing solution, 250 g (1/2 lb) sodium carbonate per 40 liters (10 gallons) of water.
9. Start and run the engine for 10 minutes.
10. Stop the engine and drain the neutralizing solution.
11. Flush the system with clean water until draining water is clear.
12. Close the drain valve and install the block drain plug. Add coolant to the top of the filter neck.
13. Start and run the engine to stabilize the coolant level. See topic, "Coolant level - Check" in "Every 10 Service Hours or Daily".

Fork – Inspect

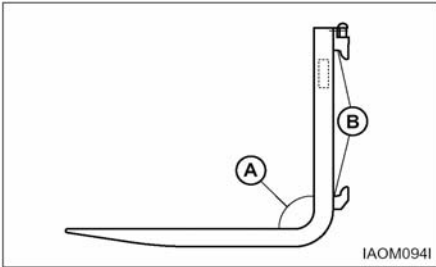

Forks should be inspected, at a minimum, every 12 months. If the truck is being used in a multi-shift or heavy duty operation, they should be checked every six months.

1. Inspect the forks carefully for cracks. Special attention should be given to the heel section (A), all weld areas and mounting brackets (B). Inspect the top and bottom hooks on forks used on hook type carriages and tubes on shaft mounted forks.

Forks with cracks should be removed from service.

"Wet Test" magnetic particle inspection is generally preferred due to its sensitivity and the ease of interpreting the results. Portable equipment is usually recommended so it can be moved to the lift truck.

Inspectors should be trained and qualified in accordance with The American Society for Non Destructive Testing, Level II Qualifications.

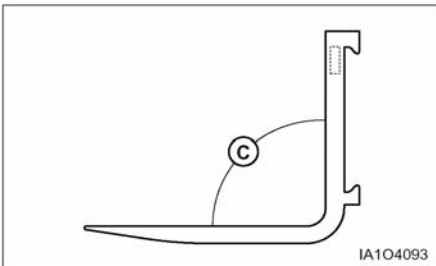

2. Check the angle between the upper face of the blade and the front face of the shank. The fork should be withdrawn from service if angle (C) exceeds 93 degrees or deviates by more than 3 degrees from an original angle other than 90 degrees, as may be found in some special application forks.

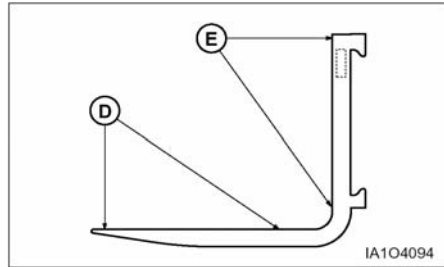

3. Check the straightness of the upper face of blade (D) and the front face of shank (E) with a straight edge.

The fork should be withdrawn from service if the deviation from straightness exceeds 0.5 percent of the length of the blade and/or the height of the shank respectively 5 mm/1000 mm (0.18"/36").

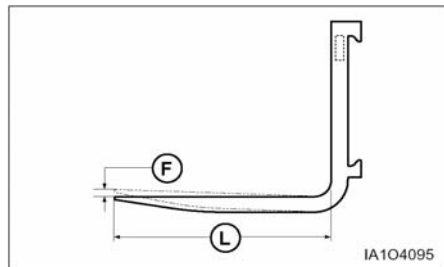

4. Check the difference in height of one fork tip to the other when mounted on the fork carrier. A difference in fork tip height can result in uneven support of the load and cause problems with entering loads.

The maximum recommended difference in fork tip elevation (F) is 6.5 mm (0.25") for pallet forks and 3 mm (0.125") for fully tapered forks. The maximum allowable difference in fork tip elevation between the two or more forks is 3 percent of blade length (L).

Replace one or both forks when the difference in fork tip height exceeds the maximum allowable difference. Contact your local DOOSAN Lift Truck Dealer for further information.

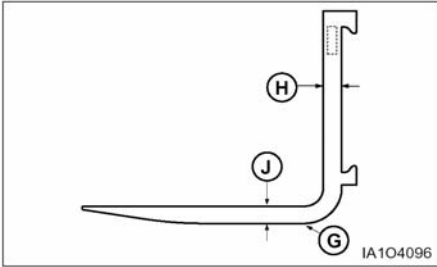

5. Check the fork blade (J) and shank (H) for wear with special attention to the heel (G). The fork should be withdrawn from service if the thickness is reduced to 90 percent or less of the original thickness.

Fork blade length may also be reduced by wear, especially on tapered forks and platens. Remove the forks from service when the blade length is no longer adequate for the intended loads.

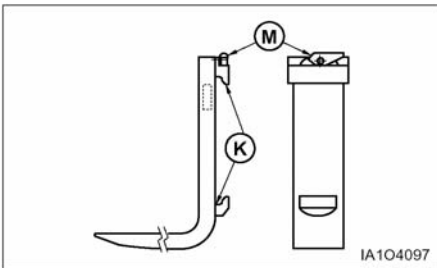

6. Check the fork mountings (K) for wear, crushing and other local deformation, which can cause excessive side to side wobble of the forks. Excessive clearance on hook type forks may allow them to fall from the carrier. Forks which show visible signs of such damage should be removed from service.

7. Check the positioning lock and other fork retention devices to make sure they are in place and working.

Hook type forks use a spring loaded pin (M), located in the top hook, to engage notches in the top carriage bar to hold the fork in place.

When adjusting the fork spacing, the forks are prevented from sliding off the end of the carriage by stop blocks. These stop blocks are at both ends of the carriage and in the path of the bottom fork hook. The load backrest extension may be used in place of the stop blocks in some cases.

Shaft mounted forks may use set collars or spacers on the shaft to either side of the fork. They may also use U bolts, pins, or similar devices which engage the fork through the top structure of the carriage.

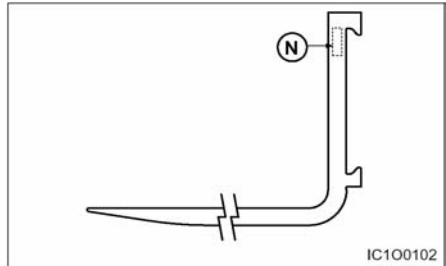

8. Check fork markings (N) for legibility. Renew markings as required to retain legibility.

9.
 - a. Lift the mast and operate the tilt control lever, until the top surface of the forks is parallel with the floor. Place two straight bars that are the same width as the carriage, across the forks as shown.
 - b. Measure the distance from the bottom of each end of the two bars to the floor. The forks must be parallel within 3 mm (.12 in) for Full Tapered and Polished (FTP) forks, all other forks 6.4 mm (.25 in), for their complete length.
 - c. Put one fork, one third from the tip, under a fixture that will not move. Then operate the tilt control with caution until the rear of the truck lifts just off the floor. Follow the same procedure with the second fork. Repeat Step a.

Every 2500 Service Hours or 15 Months

You must read and understand the warnings and instructions contained in the Safety section of this manual, before performing any operation or maintenance procedures.

Inspect Battery System

- Clean battery outer surfaces with a mixture of baking soda and water.
- Inspect battery outer surfaces for damage and replace as necessary.
- Remove battery cable and clean, repair and/or replace as necessary.



Checking the TMAP Sensor (LP Engine Only)

1. Verify that the TMAP sensor (2) is mounted tightly into the manifold adapter (3), with no leakage.
2. If the TMAP is found to be loose, remove the TMAP retaining screw and the TMAP sensor from the manifold adapter.
3. Visually inspect the TMAP O-ring seal for damage. Replace as necessary.
4. Apply a thin coat of an approved silicon lubricant to the TMAP o-ring seal.
5. Re-install the TMAP sensor into the manifold adapter and securely tighten the retaining screw.

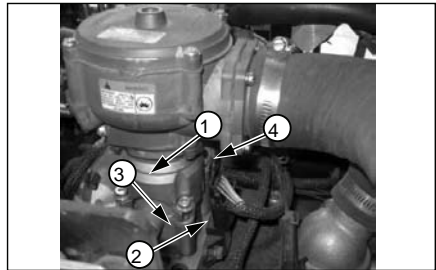

- (1) Adapter-Throttle body
- (2) TMAP sensor,
- (3) Adapter-Manifold,
- (4) Throttle body

Inspect for Intake Leaks (LP Engine Only)

1. Visually inspect the intake manifold, throttle assembly (4), and manifold adapters (3), for looseness and leaks. Repair as necessary.

Replace PCV Valve and breather element - Change (LP Engine Only)

1. Loosen the hose clamps and remove the PCV valve.
2. Assemble new PCV valve and hose.
3. Tighten the hose clamps

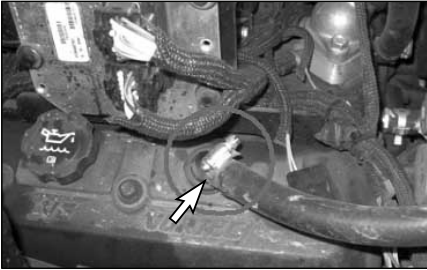

Replace Oxygen Sensor (G643E Engine Only)

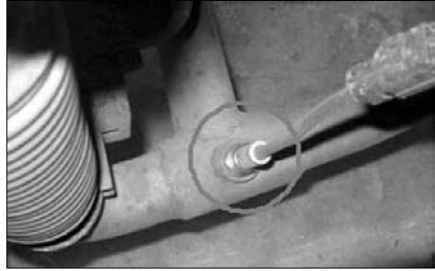

Exhaust Tube

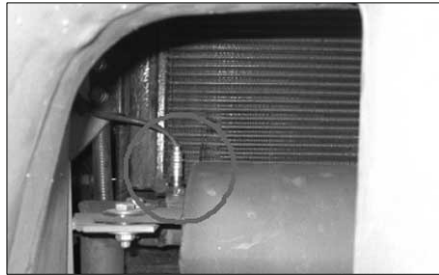

Muffler Ass'y

When indicated by MIL, replace oxygen sensors on the exhaust tube and muffler assembly.

1. Stop engine and wait until the exhaust pipe and exhaust pipe is cooled.
2. Disconnect the electrical connector of oxygen sensor.
3. Remove oxygen sensor.
4. Assemble new oxygen sensor Tightening torque : 45 N•m (32.5 lb•ft)
5. Connect the electrical connector of oxygen sensor.

Index

#		Brake Oil (Only for OCDB)	133
		Bulbs	144
		Burn Prevention.....	15
	12 Months Inspection		124
A		C	
Accelerator Pedal	58	Capacity Chart - With Side Shifter	41, 42
Adjustments	107	Capacity Chart - Without Side Shifter.....	39, 40
Advanced Diagnostics.....	80	Capacity Chart - Without Side Shifter	40
Advanced Diagnostics (G643 Engine Only)	80	Carburetor (LP - Gas Engine Only) - Adjust, Clean	172
Advanced Diagnostics (G643E Engine Only).....	90	Carriage Roller Extrusion - Adjust.....	145
After Starting the Engine	69	Causes of Fork Failure.....	122
Air-205 kPa (30 psi) Maximum Pressure	162	Center of Gravity (CG).....	21
Air Cleaner Indicator – Check.....	148	Changing LP Tanks.....	61
Air Intake System - Change.....	172	Changing Primary Element.....	172
Air Intake System - Check, Clean	160	Changing Secondary Element.....	172
Antifreeze	129	Chassis Pivot Eyebolts	169
Attachment Abbreviations (includes Special Forks)	46	Check for Equal Tension	176
Auto Shift Controller ASC-200/201 (If Equipped).....	107	Check Inflation and Damage	144
Automatic mode.....	109	Checking Element	162
Automatic Transmission Switch (3 Speed Only).....	57	Checking the TMAP Sensor (LP Engine Only)	185
Avoiding Lift Truck Tipover	21	Circuit Breaker.....	55, 143
B		Clean Outside of Radiator Core.....	145
Basic Troubleshooting.....	72	Clean Pressure Cap.....	145
Battery Terminal - Clean, Inspect.....	167	Cleaning Primary Filter Elements	162
Before Operating the Lift Truck	12	Coolant Information.....	128
Before Starting the Engine.....	63	Coolant Level – Check.....	147
Before Starting the Lift Truck.....	11	Coolant Water.....	129
Before Storage.....	118	Cooling System - Clean, Change.....	182
Belts (Diesel E/G Only) - Check, Adjust.....	168	Cooling System Specifications.....	128
Bent or Twisted Forks	122	Crosshead Rollers - Inspect.....	169
Bleeding the Fuel System.....	140	Crushing or Cutting Prevention	14
Brake Oil (OCDB) – Check.....	146		

D

Daily Inspection 123
 Detergent..... 162
 Diagnostics Features..... 108
 Diesel Engine Crankcase..... 171
 Diesel Engine Equipped..... 60
 Diesel Engine..... 66, 172
 Diesel Specifications 130
 Displaying Fault Codes (DFC) From SECM Memory
 81, 90
 Draining the Water From the Fuel Filter..... 141
 Drive Axle Oil - Change..... 155
 Drive Axle Oil (OCDB) - Change 169
 Drive Axle Oil (Shoe Brake Only) - Change 178
 Drive Axle Oil Level – Check 164
 Drive Axle Oil 133

E

Electronic Controlled Spark-Ignition Engines 70
 Engine Oil & Filter(Diesel Engine Only) – Change
 171
 Engine Oil & Filter(LP Engine Only) - Change 163
 Engine Oil & Oil Filter (Diesel E/G Only) - Change
 152
 Engine Oil (DEO and EO)..... 132
 Engine Oil Level - Check..... 147
 Engine Valve Lash (Diesel E/G Only) - Check,
 Adjust..... 140
 Environment Management..... 3
 Environment Protection..... 121
 Every 10 Service Hours or Daily..... 147
 Every 1000 Service Hours or 6 Months 172
 Every 1500 Service Hours or 9 Months 178
 Every 2000 Service Hours or Yearly 181
 Every 250 Service Hours or Monthly..... 160
 Every 2500 Service Hours or 15 Months 185

Every 500 Service Hours or 3 Months..... 168

F

Fatigue 122
 Features 107
 Fire or Explosion Prevention 15
 First 250 Service Hours or a Month 159
 First 50-100 Service Hours or a Week 152
 First Installation 123
 Fluid Penetration 14
 Foreword..... 2
 Fork – Inspect..... 183
 Fork Inspection 123
 Fuel Filter - Check, Clean, Change..... 172
 Fuel Filter - Disassembly 179
 Fuel Lines & Fittings – Check..... 173
 Fuel Specifications 130
 Fuel Sulfur Content 130
 Fuel Tank Filter Cap & Screen - Clean..... 141, 142
 Fuel Trim Valve(FTV) Inspection (G643E Engine
 only)..... 171
 Fuel Types 130
 Fuse & Relay (LP Engine Only) 143
 Fuse Box..... 53
 Fuse Locations 53
 Fuses..... 143
 Fuses, Bulbs & Circuit Breaker - Change, Reset 143

G

G643 Electronic Controlled LP Engines (If
 Equipped)..... 71
 G643E Engine 70
 General Description 71
 General Fuel Information 130
 General Hazard Information..... 10
 General Warnings to Operator..... 6

H

Hand Placement Warning.....	7
Horn and Lights(If Equipped) – Check.....	170
How to Survive in a Tipover (If Operator Restraint System Equipped)	28
Hydraulic Oil (HYDO)	132
Hydraulic Oil Level – Check.....	164
Hydraulic Oil, Return Filter, Strainer & Breather - Check, Clean, Change	174
Hydraulic Return Filter – Change	159

I

Identification, Lift Capacity and Attachment Plate..	45
If Optional Suspension Seat Equipped	18
Improper Modification or Repair	122
Inching into Loads	112
Inching Switch (3 Speed Only)	57
Inching.....	106
Inspect Battery System	185
Inspect Coolant Hoses (LP Engines Only)	173
Inspect Electrical System (G643E Engine only)..	171
Inspect Engine for Exhaust Leaks.....	149
Inspect Foot Pedal Operation (LP Engine Only)..	149
Inspect for Intake Leaks (LP Engine Only)	186
Inspect Ignition System (LP Engine Only)	178
Inspect Mixer Assembly (LP Engine Only)	173
Inspect Throttle Assembly (LP Engine Only).....	173
Inspect Tightness.....	167
Inspect Vacuum Lines and Fittings (G643(E) Engine only).....	171
Inspection Engine for Fluid Leaks	147
Inspection, Maintenance and Repair of Lift Truck Forks.....	121
Instrument Panel.....	48
Index.....	187

L

Lift Chain Adjustment.....	176
Lift Chain Wear Test	175
Lift Chains - Test, Check, Adjust.....	175
Lift Control.....	59
Lift Fork Adjustment.....	117
Lift Truck Capacity Rating	45
Lift Truck Controls	56
Lift Truck Operation.....	105
Lift Truck Parking	13
Lift Truck Shipping	119
Lift Truck Stability Base	22
Lift Truck Stability	21
Lifting Drums or Round Objects.....	115
Lifting the Load.....	112
Literature Information.....	2
Load Backrest Must Be In Place Warning.....	7
Long Time Storage.....	118
LP Engine Crankcase	163
LP Engine	66
LP Regulator/Converter Inspection (LP Engine Only)..	173
LP Specifications.....	131
Lubricant Information	132
Lubricant Specifications.....	132
Lubricant Viscosities and Refill Capacities.....	135
Lubricant Viscosities	135
Lubricate Carriage Side Rollers	166
Lubricate Mast Side Rollers.....	166
Lubricating Grease.....	134

M

Machine Lifting and Tiedown Information.....	119
Maintenance and Repair.....	124
Maintenance Information	14
Maintenance Intervals.....	3, 136

Index Section

Maintenance.....	3	Overhead Guard – Inspect.....	170
Make proper antifreeze additions.....	129	Overhead Guard Must Be In Place Warning.....	8
Manual Mode (Fail-Safe mode).....	110	Overloading.....	122
Mast Abbreviations.....	46	P	
Mast Channels – Lubricate.....	150	Parking Brake - Test, Adjust.....	157, 169
Mast Hinge Pins – Lubricate.....	168	Parking Brake Lever.....	59
Mast Pivot Eyes.....	169	Parking brake.....	8
Mast, Carriage, Lift Chains & Attachments - Inspect, Lubricate.....	165	Parking the Lift Truck.....	116
Mixer Idle Screw / Power Valve Adjust (<u>G643 Engine Only</u>).....	79	Power Shift Transmission / Drive Axle.....	105
Mounting and Dismounting.....	11	Precleaner (If Equipped).....	160
Moving Fan Warning.....	8	Pressure Air.....	14
No Riders Warning.....	8	Pressure Warning.....	7
No Standing On Forks Warning, No Standing Under Forks Warning.....	7	Prestart Conditions.....	66
N		Priming the Fuel System (Diesel Engine Only)....	140
Noise &Vibration.....	38	Product Description.....	107
Noise.....	38	R	
O		Radiator Cap - Clean, Change.....	145
Oil Cooled Disc Brake (OCDB) Type.....	156, 165	Reading Diagnostic Fault Codes.....	80, 90
Only for D50/60/70/80/90S-5 (3 Speed).....	175	Refill Capacities.....	135
Only for D50/60/70S-5 (2 Speed), G50/60/70S-5	169, 175	Refueling.....	60
Only for Oil Cooled Disc Brake.....	146	Replace LP Fuel Filter Element (LP Engine Only)	179
Operating in Hot Weather.....	115	Replace Oxygen Sensor (G643E Engine Only)....	186
Operating Techniques.....	112	Replace PCV Valve and breather element - Change (LP Engine Only).....	186
Operating the Lift Truck.....	12	Replace Spark Plugs (LP Engine Only).....	178
Operation Information.....	11	S	
Operation.....	3, 109	Safety Rules.....	23
Operator's Warning and Identification Plate.....	45	Safety.....	2, 5
Operator's Warning Plate.....	45	Seat - Check, Lubricate.....	142
Operator Restraint System (If Equipped).....	2, 17	Seat Adjustment.....	17, 55
Operator's Station and Monitoring Systems.....	47	Seat Switch System.....	52

Seat	55
Serial Number Locations.....	43
Serial Number	43
Service Foot Brake Pedal	58
Service Indicator	148
Servicing Filter Element	160
Shoe Brake Type.....	155, 164
Specifications.....	30, 32, 34, 36
Stability and Center of Gravity	21
Starting From a 24/12 Volt External Source	67
Starting the Engine	66
Starting the Lift Truck	12
Starting with Jumper Cables.....	67
Steer Suspension – Inspect.....	170
Steer Wheel Bearings - Reassemble.....	181
Steering Column Tilting Angle Adjustment	53
Steering Mechanism - Check, Lubricate	166
Storage Information	118

T

Test Fuel System for Leaks (LP Engine Only)	141
Testing Fuel Lock-off Operation (LP Engine Only).....	180
Table of Contents	1
Tilt Control	59
Tilt Cylinders - Check, Adjust, Lubricate	169
Tire Inflation Information	125
Tire Inflation Pressures Adjustment	125
Tire Shipping Pressure.....	125
Tires and Wheels - Inspect, Check	144
Tires Inflation	125
To Adjust	158
To Operate the Lift Truck After a Long Time Storage ..	118
Torque Specifications.....	126
Torques for Bolts and Nuts With Standard Threads.....	126
Torques for Metric Fasteners.....	127
Torques for Standard Bolts, Nuts and Taperlock Studs	126

Torques for Standard Hose Clamps - Worm Drive Band Type.....	126
Torques for Taperlock Studs.....	127
Tow Eye	53
Towing Information.....	120
Training Required To Operate or Service Warning .	5
Transmission Display (3 Speed Only)	56
Transmission Inching Control Pedal.....	58
Transmission Oil & Filter (3 Speed Only) – Change	175
Transmission Oil & Oil Filter – Change	153
Transmission Oil (2 Speed Only) – Change.....	175
Transmission Oil (TDTO).....	132
Transmission Oil Filter (2 Speed Only) – Change ...	169
Transmission Oil Level – Check.....	151
Transportation Hints.....	119
Traveling with the Load.....	113
Turning	114

U

Universal Joint - Inspect, Lubricate.....	170
Unloading.....	113

V

Vibration (weighted overall value).....	38
---	----

W

Walk-Around Inspection - Inspect	149
Walk-Around Inspection.....	63
Warning Light	50
Warning Signs and Labels.....	5, 17
Water-280 kPa (40 psi) Maximum Pressure	162
Wheel Bolts & Nuts - Inspect.....	167
When Required.....	140

