

Operation & Maintenance Manual

SEAM022500

D155AX-5

BULLDOZER

SERIAL NUMBERS D155AX-70001 and up

WARNING

Unsafe use of this machine may cause serious injury or death. Operators and maintenance personnel must read this manual before operating or maintaining this machine. This manual should be kept near the machine for reference and periodically reviewed by all personnel who will come into contact with it.

NOTICE

Komatsu has Operation & Maintenance Manuals written in some other languages. If a foreign language manual is necessary, contact your local distributor for availability.

KOMATSU

1. FOREWORD

This manual provides rules and guidelines which will help you use this machine safely and effectively. Keep this manual handy and have all personnel read it periodically. If this manual has been lost or has become dirty and can not be read, request a replacement manual from Komatsu or your Komatsu distributor.

If you sell the machine, be sure to give this manual to the new owners.

Continuing improvements in the design of this machine can lead to changes in detail which may not be reflected in this manual. Consult Komatsu or your Komatsu distributor for the latest available information of your machine or for questions regarding information in this manual.

This manual may contain attachments and optional equipment that are not available in your area. Consult Komatsu or your Komatsu distributor for those items you may require.

WARNING

- **Improper operation and maintenance of this machine can be hazardous and could result in serious injury or death.**
- **Operators and maintenance personnel should read this manual thoroughly before beginning operation or maintenance.**
Keep this manual in a readily available place near the machine, and have all personnel involved in working on the machine read the manual periodically.
- **Some actions involved in operation and maintenance of the machine can cause a serious accident, if they are not done in a manner described in this manual.**
- **The procedures and precautions given in this manual apply only to intended uses of the machine. If you use your machine for any unintended uses that are not specifically prohibited, you must be sure that it is safe for you and others. In no event should you or others engage in prohibited uses or actions as described in this manual.**
- **Komatsu delivers machines that comply with all applicable regulations and standards of the country to which it has been shipped. If this machine has been purchased in another country or purchased from someone in another country, it may lack certain safety devices and specifications that are necessary for use in your country. If there is any question about whether your product complies with the applicable standards and regulations of your country, consult Komatsu or your Komatsu distributor before operating the machine.**
- **The description of safety is given in SAFETY INFORMATION on page 0-2 and in SAFETY from page 1-1.**

CALIFORNIA

Proposition 65 Warning

Diesel engine exhaust and some of its constituents are known to the State of California to cause cancer, birth defects, and other reproductive harm.

2. SAFETY INFORMATION

Most accidents are caused by the failure to follow fundamental safety rules for the operation and maintenance of machines. To avoid accidents, read, understand and follow all precautions and warnings in this manual and on the machine before performing operation and maintenance.

To identify safety messages in this manual and on machine labels, the following signal words are used.

-  **DANGER** – This word is used on safety messages and safety labels where there is a high probability of serious injury or death if the hazard is not avoided. These safety messages or labels usually describe precautions that must be taken to avoid the hazard. Failure to avoid this hazard may also result in serious damage to the machine.

-  **WARNING** – This word is used on safety messages and safety labels where there is a potentially dangerous situation which could result in serious injury or death if the hazard is not avoided. These safety messages or labels usually describe precautions that must be taken to avoid the hazard. Failure to avoid this hazard may also result in serious damage to the machine.

-  **CAUTION** – This word is used on safety messages and safety labels for hazards which could result in minor or moderate injury if the hazard is not avoided. This word might also be word for hazards where the only result could be damage to the machine.

- NOTICE** – This word is used for precautions that must be taken to avoid actions which could shorten the life of the machine.

Safety precautions are described in SAFETY from page 1-1.

Komatsu cannot predict every circumstance that might involve a potential hazard in operation and maintenance. Therefore the safety messages in this manual and on the machine may not include all possible safety precautions. If any procedures or actions not specifically recommended or allowed in this manual are used, you must be sure that you and others can do such procedures and actions safely and without damaging the machine. If you are unsure about the safety of some procedures, contact your Komatsu distributor.

3. INTRODUCTION

3.1 INTENDED USE

This Komatsu BULLDOZER is designed to be used mainly for the following work.

- Dozing
- Cutting into hard or frozen ground or ditching
- Felling trees, removing stumps
- Pushing
- Ripping

See the section "12.16 WORK POSSIBLE USING BULLDOZER" and "12.15 RIPPER OPERATION" for further details.

3.2 BREAKING IN THE MACHINE

NOTICE

Before operating the machine for the first time, check that there is coolant in the radiator. If the machine is delivered with no coolant in the radiator, flush the inside of the radiator thoroughly with tap water, then fill the radiator with coolant.

Your Komatsu machine has been thoroughly adjusted and tested before shipment.

However, operating the machine under severe conditions at the beginning can adversely affect the performance and shorten the machine life.

Be sure to break in the machine for the initial 100 hours (as indicated by the service meter.)

During breaking in:

- Idle the engine for 5 minutes after starting it up.
- Avoid operation with heavy loads or at high speeds.
- Avoid sudden starts, sudden acceleration, sudden steering and sudden stops except in cases of emergency.

The precautions given in this manual for operating, maintenance, and safety procedures are only those that apply when this product is used for the specified purpose. If the machine is used for a purpose that is not listed in this manual, Komatsu cannot bear any responsibility for safety. All consideration of safety in such operations is the responsibility of the user.

Operations that are prohibited in this manual must never be carried out under any circumstances.

4. LOCATION OF PLATES, TABLE TO ENTER SERIAL NO. AND DISTRIBUTOR

4.1 MACHINE SERIAL NO. PLATE POSITION

Under the front of the console box on the right side of the operator's seat.

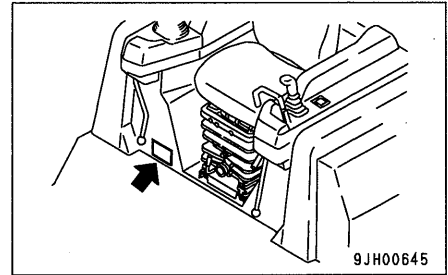

4.2 ENGINE SERIAL NO. PLATE POSITION

On the upper of the engine cell motor on the right side of the machine.

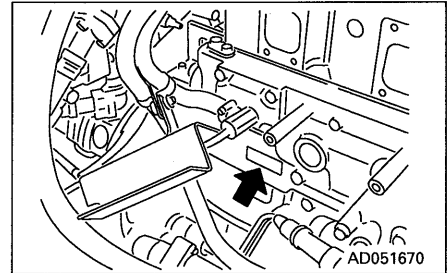

4.3 BLADE SERIAL NO. PLATE POSITION

This is located at the right side of blade back surface.

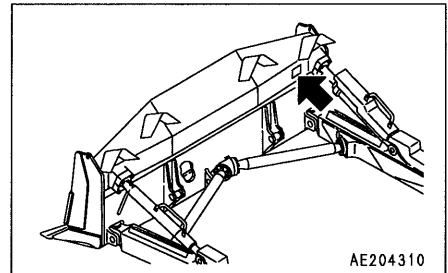

4.4 RIPPER SERIAL NO. PLATE POSITION

This is located at the left side surface of ripper beam.

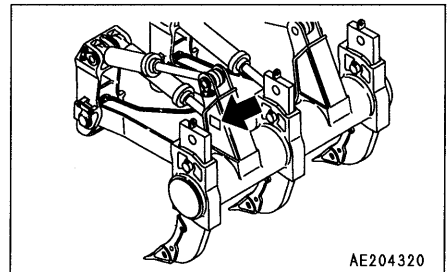

4.5 TABLE TO ENTER SERIAL NO. AND DISTRIBUTOR

Machine serial No.:	
Engine serial No.:	
Distributor name:	
Address:	Phone:
Service personnel for your machine:	

5. CONTENTS

1. Foreword	0- 1
2. Safety information	0- 2
3. Introduction	0- 3
4. Location of plates, table to enter serial No. and distributor	0- 4

SAFETY

6. General precautions	1- 2
7. Precautions during operation	1- 8
7.1 Before starting engine	1- 8
7.2 After starting engine	1-10
7.3 Transportation	1-16
7.4 Battery	1-17
7.5 Towing	1-19
8. Precautions for maintenance	1-20
8.1 Before carrying out maintenance	1-20
8.2 During maintenance	1-24
9. Position for attaching safety labels	1-29
9.1 Position for attaching safety labels	1-29
9.2 Content and use of warning plates	1-33

OPERATION

10. General view	2- 2
10.1 General view of machine	2- 2
10.2 General view of controls and gauges	2- 3
11. Explanation of components	2- 6
11.1 Front panel (meters, lamps, switches)	2- 7
11.2 Switches	2-19
11.3 Control levers, pedals, dial	2-22
11.4 Dust indicator	2-28
11.5 Power source	2-28
11.6 Fuse box	2-28
11.7 Door-open lock (machines equipped with cab)	2-30
11.8 Sash glass intermediate lock (machines equipped with cab)	2-30
11.9 Hot and cool box (machines equipped with cab)	2-30
11.10 Door pocket (machines equipped with cab)	2-31
11.11 Ashtray (machines equipped with cab)	2-31
11.12 Tool box	2-31
11.13 Using car radio (machines equipped with cab, car radio)	2-32
11.14 Handling air conditioner (machines equipped with cab)	2-36
11.15 Handling heater (machines equipped with cab)	2-40
11.16 Handling accumulator	2-41
11.17 Location of fire extinguisher	2-42

12. Operation	2-43
12.1 Check before starting engine	2-43
12.2 Starting engine	2-57
12.3 Operations and checks after starting engine	2-60
12.4 Moving machine	2-62
12.5 Shifting gear	2-64
12.6 Shifting between forward and reverse	2-65
12.7 Steering machine	2-66
12.8 Stopping machine	2-68
12.9 Precautions for operation	2-69
12.10 Parking machine	2-71
12.11 Check after finishing work	2-72
12.12 Stopping engine	2-73
12.13 Check after stopping engine	2-74
12.14 Locking	2-74
12.15 Ripper operation	2-75
12.16 Work possible using bulldozer	2-77
12.17 Adjusting posture of work equipment	2-79
12.18 Tips for longer undercarriage life	2-85
13. Transportation	2-88
13.1 Loading, unloading work	2-88
13.2 Precautions for loading	2-88
13.3 Method of lifting machine	2-89
13.4 Precautions for transportation	2-90
13.5 Removal of cab (machines equipped with cab)	2-90
14. Cold weather operation	2-91
14.1 Precautions for low temperature	2-91
14.2 After completion of work	2-93
14.3 After cold weather	2-93
15. Long-term storage	2-94
15.1 Before storage	2-94
15.2 During storage	2-94
15.3 After storage	2-94
16. Troubleshooting	2-95
16.1 After running out of fuel	2-95
16.2 Method of towing machine	2-95
16.3 If battery is discharged	2-96
16.4 Other trouble	2-99

MAINTENANCE

17. Guides to maintenance	3- 2
18. Outlines of service	3- 5
18.1 Outline of oil, fuel, coolant	3- 5
18.2 Relating to electric system	3- 7
19. Wear parts list	3- 8
20. Use of fuel, coolant and lubricants according to ambient temperature	3-10
21. Standard tightening torques for bolts and nuts	3-14
21.1 Introduction of necessary tools	3-14
21.2 Torque list.....	3-15
22. Periodic replacement of safety critical parts	3-16
23. Maintenance schedule chart	3-19
24. Service Procedure	3-22
24.1 Initial 250 hours service	3-22
24.2 When required	3-23
24.3 Check before starting	3-42
24.4 Every 250 hours service	3-52
24.5 Every 500 hours service	3-61
24.6 Every 1000 hours service	3-63
24.7 Every 2000 hours service	3-69
24.8 Every 4000 hours service	3-73

SPECIFICATIONS

25. Specifications	4- 2
---------------------------------	------

OPTIONS, ATTACHMENTS

26. General precautions	5- 2
26.1 Precautions related to safety	5- 2
27. Introduction of optional parts and attachments	5- 3
27.1 Introduction of optional parts attachments	5- 3
28. Using seat belt	5- 4
28.1 Fasten the belt and remove it in the following manner	5- 4
29. Handling headrest	5- 6
29.1 Adjusting height of headrest	5- 6
30. Handling reversible fan	5- 7
30.1 Reversing reversible fan	5- 7
31. Handling cap with lock	5- 8
31.1 Opening and closing lockable cap	5- 8
32. Procedure for selecting ripper point	5- 9
32.1 Procedure for selecting ripper point	5- 9

SAFETY

 **WARNING**

Read and follow all safety precautions. Failure to do so may result in serious injury or death.

This safety section also contains precautions for optional equipment and attachments.

6. GENERAL PRECAUTIONS

⚠ WARNING: For reasons of safety, always follow these safety precautions.

SAFETY RULES

- Only trained and authorized personnel can operate and maintain the machine.
- Follow all safety rules, precautions and instructions when operating or performing maintenance on the machine.
- Do not operate the machine if you are not feeling well, or if you are taking medicine which will make you sleepy, or if you have been drinking. Operating in such a condition will adversely affect your judgement and may lead to an accident.
- When working with another operator or with a person on worksite traffic duty, be sure that all personnel understand all hand signals that are to be used.
- Always follow all rules related to safety.

SAFETY FEATURES

- Be sure that all guards and covers are in their proper position. Have guards and covers repaired if damaged.
- Use safety features such as safety lock levers and the seat belt properly.
- Never remove any safety features. Always keep them in good operating condition.
 - **Safety lock lever → See "12.10 PARKING MACHINE".**
 - **Seat belt → See "28. USING SEAT BELT".**
- Improper use of safety features could result in serious bodily injury or death.

CLOTHING AND PERSONAL PROTECTIVE ITEMS

- Avoid loose clothing, jewelry, and loose long hair. They can catch on controls or in moving parts and cause serious injury or death.
- Also, do not wear oily clothes, because they are flammable.
- Wear a hard hat, safety glasses, safety shoes, mask or gloves when operating or maintaining the machine. Always wear safety goggles, hard hat and heavy gloves if your job involves scattering metal chips or minute materials particularly when driving pins with a hammer and when cleaning the air cleaner element with compressed air. Check also that there is no one near the machine.
- Check that all protective equipment functions properly before using.

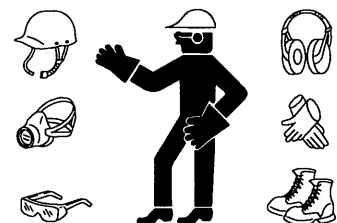

AE305770

UNAUTHORIZED MODIFICATION

Any modification made without authorization from Komatsu can create hazards. Before making a modification, consult your Komatsu distributor. Komatsu will not be responsible for any injury or damage caused by any unauthorized modification.

ALWAYS APPLY LOCK WHEN LEAVING OPERATOR'S SEAT

- When standing up from the operator's seat, always place the safety lock levers securely in the LOCK position. If you accidentally touch the levers when they are not locked, the work equipment may suddenly move and cause serious injury or damage.
- When leaving the machine, lower the blade and ripper completely to the ground, set the safety lock levers to the LOCK position, then stop the engine. Use the key to lock all the equipment. Always remove the key and take it with you.

Work equipment posture → See "12.10 PARKING MACHINE".

Locking → See "12.14 LOCKING"

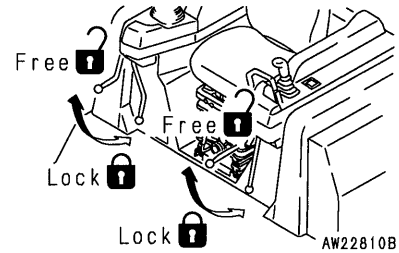

MOUNTING AND DISMOUNTING

- Never jump on or off the machine. Never get on or off a moving machine.
- When getting on or off the machine, always face the machine and use the handrails and steps.
- Never hold any control levers or lock levers when getting on or off the machine.
- To ensure safety, always maintain three-point contact (both feet and one hand, or both hands and one foot) with the handrails and steps to ensure that you support yourself.
- If there is any oil, grease, or mud on the handrails or steps, wipe it off immediately. Always keep these parts clean. Repair any damage and tighten any loose bolts.
- Use the parts marked by arrow A in the diagram below when getting on or off machine. Never use the parts marked by arrow B when getting on or off the machine. Use them only when moving along the top of the track or when checking or carrying out maintenance inside the side cover, or when filling the tank with oil.

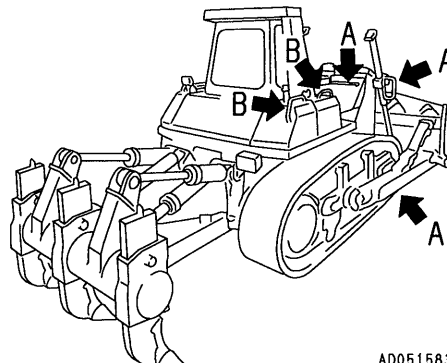
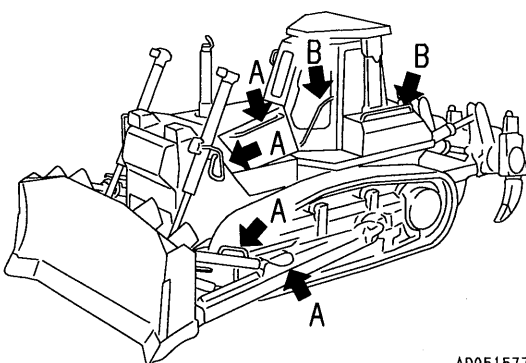

AL187320

FIRE PREVENTION FOR FUEL AND OIL

Fuel, oil, and antifreeze can be ignited by a flame. Fuel is particularly flammable and can be hazardous.

Always observe the following:

- Keep any flame or lighted cigarette away from flammable fluids.
- Stop the engine and do not smoke when refueling.
- Tighten all fuel and oil caps securely.
- Use well-ventilated areas for adding or storing oil and fuel.
- Keep oil and fuel in the determined place and do not allow unauthorized persons to enter.



A0055020



A0055040

PRECAUTIONS WHEN HANDLING AT HIGH TEMPERATURE

- Immediately after operations are stopped, the engine oil and hydraulic oil are at high temperature and are still under pressure. Attempting to remove the cap, drain the oil or water, or replace the filters may lead to serious burns. Always wait for the temperature to go down, and follow the specified procedures when carrying out these operations.
- To prevent hot water from spurting out, stop the engine, wait for the water to cool, then loosen the cap slowly to relieve the pressure before removing the cap.
(When checking if the water temperature has gone down, put your hand near the front face of the radiator and check the air temperature. Be careful not to touch the radiator.)
- To prevent hot oil from spurting out, stop the engine, wait for the oil to cool, then loosen the cap slowly to relieve the pressure before removing the cap.
(When checking if the oil temperature has gone down, put your hand near the front face of the hydraulic tank and check the air temperature. Be careful not to touch the hydraulic tank.)

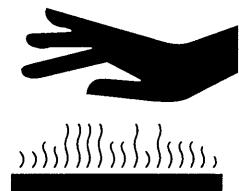

A0055050

ASBESTOS DUST HAZARD PREVENTION

Asbestos dust can be hazardous to your health if it is inhaled.

Komatsu does not use asbestos in its products, but if you handle materials containing asbestos fibers, follow the guidelines given below:

- Never use compressed air for cleaning.
- Use water to keep down the dust when cleaning.
- If there is danger that there may be asbestos dust in the air, operate the machine from an upwind position whenever possible.
- Use an approved respirator if necessary.



A0055060

CRUSHING OR CUTTING PREVENTION

Do not enter, or put your hand or arm or any other part of your body between movable parts such as the work equipment and cylinders, or between the machine and work equipment.

If the work equipment is operated, the clearance will change and this may lead to serious damage or personal injury.

If it is necessary to go between movable parts, always lock the levers and be sure that the work equipment cannot move. For details, see "8. PRECAUTIONS FOR MAINTENANCE".



A0055230

FIRE EXTINGUISHER AND FIRST AID KIT

Always follow the precautions below to prepare for action if any injury or fire should occur.

- Be sure that fire extinguishers have been provided and read the labels to ensure that you know how to use them.
- Provide a first aid kit at the storage point. Carry out periodic checks and add to the contents if necessary.
- Know what to do in the event of a fire or injury.
- Decide the phone numbers of persons (doctor, ambulance, fire station, etc.) to contact in case of an emergency. Post these contact numbers in specified places and make sure that all personnel know the numbers and correct contact procedures.

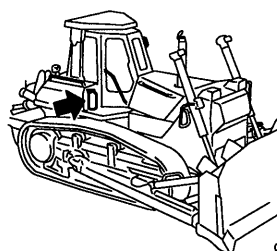

9JH00651

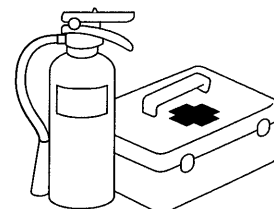

A0055070

PRECAUTIONS FOR ROPS

- Do not operate machine with ROPS removed if equipped.
- The ROPS is installed to protect the operator if the machine should overturn. It is designed not only to take the load when the machine overturns, but also to absorb the impact energy.
- The Komatsu ROPS fulfills all worldwide regulations and standards, but if any unauthorized modification is carried out on it, or if it is damaged when the machine overturns, its strength will be reduced and it will not be able to provide its original capacity. It will be able to provide this capacity only if modifications and repairs are carried out in the specified way.
- When carrying out modification or repairs, always consult your Komatsu distributor first.
- Even when the ROPS is installed, if you do not fasten your seat belt securely, it cannot protect you properly. Always fasten your seat belt when operating the machine.
Seat belts → See "28. USING SEAT BELT."

PRECAUTIONS FOR ATTACHMENTS

- When installing and using an optional attachment, read the instruction manual for the attachment and the information related to attachments in this manual.
- Do not use attachments that are not authorized by Komatsu or your Komatsu distributor. Use of unauthorized attachments could create a safety problem and adversely affect the proper operation and useful life of the machine.
- Any injuries, accidents, product failures resulting from the use of unauthorized attachments will not be the responsibility of Komatsu.

MACHINES WITH ACCUMULATOR

On machines equipped with an accumulator, for a short time after the engine is stopped, if the work equipment control lever is moved to the LOWER position, the work equipment will move down under its own weight.

After stopping the engine, always place the safety lock in the LOCK position.

When releasing the pressure inside the work equipment circuit on machines equipped with an accumulator, follow the procedure given in the inspection and maintenance section.

Method of releasing pressure → See "11.16 HANDLING ACCUMULATOR".

The accumulator is filled with high-pressure nitrogen gas, and it is extremely dangerous if it is handled in the wrong way. Always observe the following precautions.

- Never make any hole in the accumulator or expose it to flame or fire.
- Do not weld any boss to the accumulator.
- When carrying out disassembly or maintenance of the accumulator, or when disposing of the accumulator, it is necessary to release the gas from the accumulator. A special air bleed valve is necessary for this operation, so please contact your Komatsu distributor.

Gas in accumulator → See "11.16 HANDLING ACCUMULATOR".



9JM01087

VENTILATION FOR ENCLOSED AREAS

Exhaust fumes from the engine can kill.

- If it is necessary to start the engine within an enclosed area, or you handle fuel, flushing oil, or paint, open the doors and windows to ensure that you provide adequate ventilation to prevent gas poisoning.
- If opening the doors and windows still does not provide adequate ventilation, set up fans.



A0055060

7. PRECAUTIONS DURING OPERATION

⚠ WARNING: For reasons of safety, always follow these safety precautions.

7.1 BEFORE STARTING ENGINE

SAFETY AT WORKSITE

- Before starting operations, thoroughly check the area for any unusual conditions that could be dangerous.
- Check the terrain and condition of the ground at the worksite, and determine the best and safest method of operation.
- Make the ground surface as hard and horizontal as possible before carrying out operations. If the jobsite is dusty, spray water before starting operations.
- If you need to operate on a road, protect pedestrians and cars by designating a person for worksite traffic duty or by installing fences and putting up No Entry signs around the worksite.
- If water lines, gas lines, or high-voltage electrical lines may be buried under the worksite, contact each utility and identify their locations. Be careful not to sever or damage any of these lines.
- Check the ground condition and the depth and flow of water before operating in water or crossing a river. NEVER be in water which is in excess of the permissible water depth.
Permissible water depth → See "12.9 PRECAUTIONS FOR OPERATION".

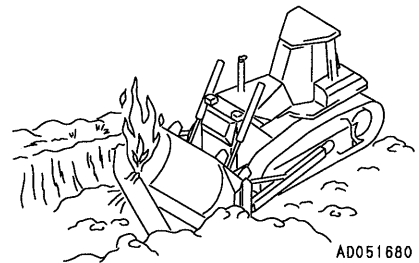

A0051680

CHECKS BEFORE STARTING ENGINE

Carry out the following checks before starting the engine at the beginning of the days work. Failure to carry out these checks may lead to serious injury or damage.

- Completely remove all flammable materials accumulated around the engine and battery, return all fuel containers to their proper place, remove all parts and tools from the operator's compartment, and remove any dirt from the mirrors, handrails, and steps.
Walk-around checks → See "12.1.1 WALK-AROUND CHECK".
 - Check the coolant level, fuel level, and oil level in the hydraulic tank, check for clogging of the air cleaner, and check the electric wiring.
Checks before starting → See "12.1.2 CHECK BEFORE STARTING".
 - Adjust the operator's seat to a position where it is easy to carry out operations, and check for wear or damage to the seat belt and seat belt mounting equipment.
Adjusting operator's seat → See "12.1.3 ADJUSTMENT BEFORE STARTING OPERATION".
Seat belt → See "28. USING SEAT BELT".
 - Check that the gauges work properly, and check that the control levers are all at the NEUTRAL position.
Method of checking operation of gauges →
See "12.1.4 OPERATIONS AND CHECKS BEFORE STARTING ENGINE".
 - Check that the mirrors and window glass provide a clear view.
- If the above inspections show any abnormality, carry out repairs immediately.



A0055020

PRECAUTIONS FOR SLIDING GLASS INTERMEDIATE LOCK

The sliding glass intermediate lock is to prevent rattling of the glass. Even when the lock is used, the glass may move because of the shock when starting or stopping suddenly.
Do not put your head or hands out of the window during operations.

WHEN STARTING ENGINE

- Walk around your machine again just before mounting it, and check for people and objects that might be in the way.
- Never start the engine if a warning tag has been attached to the blade control lever.
- When starting the engine, sound the horn as an alert.
- Start and operate the machine only while seated.
- An additional worker may ride in the machine only when sitting in the passenger seat. Do not allow anyone to ride on the machine body.
- Do not short circuit the starting motor circuit to start the engine. It is not only dangerous, but will also cause damage to the equipment.

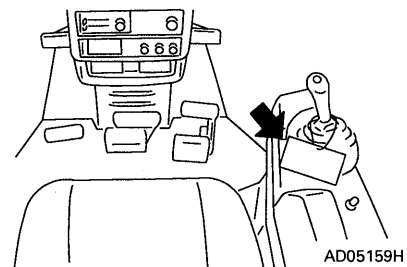

7.2 AFTER STARTING ENGINE**CHECKS AFTER STARTING ENGINE**

Failure to carry out the checks properly after starting the engine will lead to delays in discovery of abnormalities, and this may lead to serious injury or damage to the machine.

When carrying out the checks, use a wide area where there are no obstructions. Do not allow anyone near the machine.

- Check the operation of the gauges and equipment, and check the operation of the blade, brakes, travel system, and steering system.
- Checks for any abnormality in the sound of the machine, vibration, heat, smell, or gauges; check also that there is no leakage of air, oil, or fuel.
- If any abnormality is found, carry out repairs immediately.
If the machine is used when it is not in proper condition, it may lead to serious injury or damage to the machine.

PRECAUTIONS WHEN STARTING OFF

- Before moving the machine off, check again that there are no persons or obstacles in the surrounding area.
- When moving the machine off, sound the horn to warn people in the surrounding area.
- Always sit in the operator's seat when driving the machine.
- Fasten your seat belt securely.
- The operator must not let any other person sit anywhere except in the assistant's seat.
- Check that the travel alarm (option) works properly.
- Always close the door of the operator's cab and check that the door is locked in position securely.

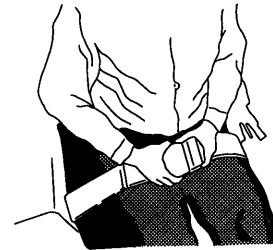

AE305800

PRECAUTIONS WHEN MOVING FORWARD OR BACKWARD

To prevent serious injury or death, always do the following before moving the machine or doing the leveling work.

- Before changing between forward and reverse, reduce speed and stop the machine.
 - Before operating the machine, sound the horn to warn people in the area.
 - Check that there is no one near the machine. Be particularly careful to check behind the machine.
 - When operating in areas that may be hazardous or have poor visibility, designate a person to direct worksite traffic.
 - Ensure that no unauthorized person can come within the direction of turning or direction of travel.
- Always be sure to carry out the above precautions even when the machine is equipped with a backup alarm and mirrors.

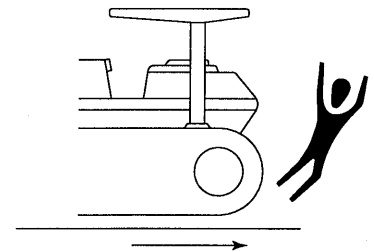

A0055080

PRECAUTIONS WHEN TRAVELING

- Never turn the key in the starting switch to the OFF position when traveling.
It is dangerous if the engine stops when the machine is traveling, because it becomes impossible to operate the steering.
- It is dangerous to look around you when operating. Always concentrate on your work.
- It is dangerous to drive too fast, or to start suddenly, stop suddenly, turn sharply, or zigzag.
- If you find any abnormality in the machine during operation (noise, vibration, smell, incorrect gauges, air leakage, oil leakage, etc.), move the machine immediately to a safe place and look for the cause.
- Set the work equipment to a height of 40 – 50 cm (16 – 20 in) from the ground level and travel on level ground.
- When traveling, do not operate the work equipment control levers. If the work equipment control levers have to be operated, never operate them suddenly.
- Do not operate the steering suddenly. The work equipment may hit the ground surface and cause the machine to lose its balance, or may damage the machine or structures in the area.
- When traveling on rough ground, travel at low speed, and avoid sudden changes in direction.
- Avoid traveling over obstacles as far as possible. If the machine has to travel over an obstacle, keep the work equipment as close to the ground as possible and travel at low speed. Never travel over obstacles which make the machine tilt strongly (10° or more).
- When traveling or carrying out operations, always keep your distance from other machines or structures to avoid coming into contact with them.
- NEVER be in water which is in excess of the permissible water depth.
Permissible water depth → See “12.9 PRECAUTIONS FOR OPERATION”.
- When passing over bridges or structures on private land, check first that the structure is strong enough to support the mass of the machine. When traveling on public roads, check first with the relevant authorities and follow their instructions.

TRAVELING ON SLOPES

- Traveling on slopes could result in the machine tipping over or slipping to the side.
- When traveling on slopes, keep the work equipment approximately 20 – 30 cm (8 – 12 in) above the ground. In case of emergency, quickly lower the bucket to the ground to help the machine to stop.
- Do not turn on slopes or travel across slopes. Always go down to a flat place to perform these operations.
- Do not travel on grass, fallen leaves, or wet steel plates. Even slight slopes may cause the machine to slip to the side, so travel at low speed and make sure that the machine is always traveling directly up or down the slope.
- If the engine stops on a slope, place the travel lever at the neutral position and lower the work equipment to the ground. Do not operate the steering. There is danger that the machine will turn under its own weight.
- When traveling downhill with the machine being pushed by its own weight, the machine may steer in the opposite direction, so be careful when steering.

Reverse steering when traveling downhill → See "12.7.2 TURNING WHILE DESCENDING A SLOPE".

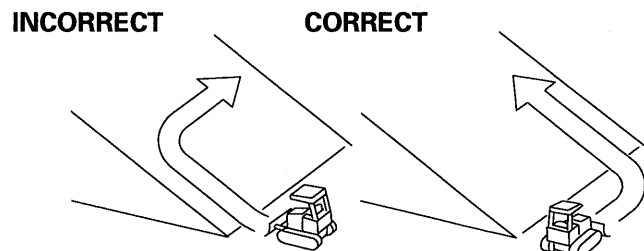

AD051690

PRECAUTIONS WHEN OPERATING

- Be careful not to approach too close to the edge of cliffs.
- Carry out only work that is specified as the purpose of the machine. Carrying out other operations will cause breakdowns.
- Do the following to ensure good visibility.
 - When operating in dark places, turn on the working lamps and front lamps, and install lighting at the jobsite if necessary.
 - Do not carry out operations in fog, mist, snow, or heavy rain, or other conditions where the visibility is poor. Wait for the weather to clear so that visibility is sufficient to carry out work.
- Always do as follows to prevent the work equipment from hitting other objects.
 - To prevent accidents caused by hitting other objects, always operate the machine at a speed which is safe for operation, particularly in confined spaces, indoors, and in places where there are other machines.

DO NOT GO CLOSE TO HIGH-VOLTAGE CABLES

- Do not let the machine touch overhead electric cables. Even going close to high-voltage cables can cause electric shock. Always maintain the safe distance given below between the machine and the electric cable.
- To prevent accidents, always do as follows.
 - On jobsites where there is danger that the machine may touch the electric cables, consult the electricity company before starting operations to check that the actions determined by the relevant laws and regulations have been taken.
 - Wear rubber shoes and gloves. Lay a rubber sheet on top of the operator’s seat, and be careful not to touch the chassis with any exposed part of your body.
 - Use a signalman to give warning if the machine approaches too close to the electric cables.
 - If the work equipment should touch the electric cable, the operator should not leave the operator’s compartment.
 - When carrying out operations near high voltage cables, do not let anyone come close to the machine.
 - Check with the electricity company about the voltage of the cables before starting operations.

	Voltage	Min. safety distance
Low voltage	100 - 200 V	2 m
	6,600 V	2 m
Very high voltage	22,000 V	3 m
	66,000 V	4 m
	154,000 V	5 m
	187,000 V	6 m
	275,000 V	7 m
	500,000 V	11 m

OPERATE CAREFULLY ON SNOW

- When working on snow or icy roads, even a slight slope may cause the machine to slip to the side, so always travel at low speed and avoid sudden starting, stopping, or turning. There is danger of slipping particularly on uphill or downhill slopes.
- With frozen road surfaces, the ground becomes soft when the temperature rises, so the travel conditions become unstable. In such cases be extremely careful when traveling.
- When there has been heavy snow, the road shoulder and objects placed beside the road are buried in the snow and cannot be seen, so always carry out operations carefully.
When traveling on snow-covered slopes, never apply the brakes suddenly. Reduce the speed and use the engine as a brake while applying the foot brake intermittently (depress the brake intermittently several times). If necessary, lower the bucket to the ground to stop the machine.
- The load varies greatly according to the characteristics of the snow, so adjust the load accordingly and be careful not to let the machine slip.

WORKING ON LOOSE GROUND

- Do not operate the machine on soft ground. It is difficult to get the machine out again.
- Avoid operating your machine too close to the edge of cliffs, overhangs, and deep ditches. If these areas collapse under the mass or vibration of your machine, it could fall or tip over and this could result in serious injury or death. Remember that the soil after heavy rain, blasting, or earthquakes is weakened in these areas.
- Earth laid on the ground and the soil near ditches is loose. It can collapse under the mass or vibration of your machine and cause your machine to tip over.
- Install the head guard (FOPS) when working in areas where there is danger of falling stones.
- Install the ROPS and wear the seat belt when working in areas where there is danger of falling rocks or of the machine turning over.

PARKING MACHINE

- Park the machine on level ground where there is no danger of falling rocks or landslides, or of flooding if the land is low, and lower the work equipment to the ground.
- If it is necessary to park the machine on a slope, set blocks under the tracks to prevent the machine from moving, then dig the work equipment into the ground.
- After stopping the engine, operate the blade control lever several times to the RAISE and LOWER positions to release the remaining pressure in the hydraulic circuit.
- When parking on public roads, provide fences, signs, flags, or lights, and put up any other necessary signs to ensure that passing traffic can see the machine clearly, and park the machine so that the machine, flags, and fences do not obstruct traffic.

Parking procedure → See "12.10 PARKING MACHINE".

- When leaving the machine, set the safety lock lever to the LOCK position, stop the engine, and use the key to lock all the equipment. Always remove the key and take it with you.

Work equipment posture → See "12.10 PARKING MACHINE".

Locks → See "12.14 LOCKING".

- Always close the door of the operator's compartment.

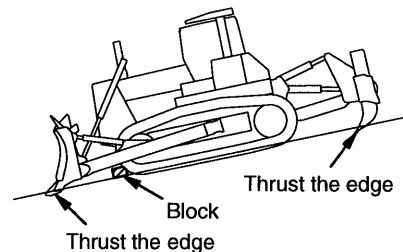

PRECAUTIONS IN COLD AREAS

- After completing operations, remove all water, snow, or mud stuck to the wiring harness, connector ①, switches, or sensors, and cover these parts.
If the water freezes, it will cause malfunctions of the machine when it is next used, which may lead to unexpected accidents.
- Carry out the warming-up operation thoroughly. If the machine is not thoroughly warmed up before the control levers are operated, the reaction of the machine will be slow, and this may lead to unexpected accidents.
- Operate the control levers to relieve the hydraulic pressure (raise to above the set pressure for the hydraulic circuit and release the oil to the hydraulic tank) to warm up the oil in the hydraulic circuit. This ensures good response from the machine and prevents malfunctions.
- If the battery electrolyte is frozen, do not charge the battery or start the engine with a different power source. There is danger that this will ignite the battery.
When charging or starting the engine with a different power source, melt the battery electrolyte and check for leakage of battery electrolyte before starting.
Battery charge rate → See "14. COLD WEATHER OPERATION".

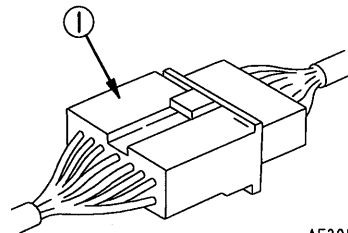

AE305820

7.3 TRANSPORTATION

LOADING AND UNLOADING

- Loading and unloading the machine always involves potential hazards. **EXTREME CAUTION SHOULD BE USED.**
- Perform loading and unloading on firm, level ground only. Maintain a safe distance from the edge of a road.
- **ALWAYS** block the wheels of the hauling vehicle and place blocks under both ramps before loading and unloading.
- **ALWAYS** use ramps of adequate strength. Be sure the ramps are wide and long enough to provide a safe loading slope.
- Be sure that the ramps are securely positioned and fastened, and that the two sides are at the same level as one another.
- Be sure the ramp surface is clean and free of grease, oil, ice and loose materials. Remove dirt from the machine tracks.
- **NEVER** correct your steering on the ramps. If necessary, drive away from the ramps and climb again.
- After loading, block the machine tracks and secure the machine with tie-downs.

Loading and unloading → See "13. TRANSPORTATION".

Tie-downs → See "13. TRANSPORTATION".

CORRECT

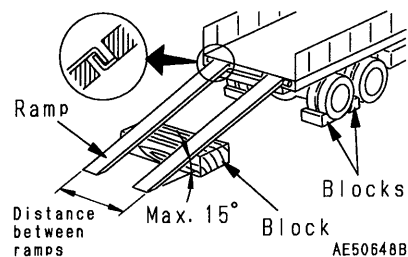

SHIPPING

- When shipping the machine on a hauling vehicle, obey all state and local laws governing the weight, width, and length of a load. Also obey all applicable traffic regulations.
- Determine the shipping route while taking into account the width, height and weight of the load.

7.4 BATTERY

BATTERY HAZARD PREVENTION

Battery electrolyte contains sulphuric acid, and batteries generate hydrogen gas, so mistaken handling can lead to serious injury or fire. For this reason, always observe the following precautions.

- Never bring any lighted cigarette or flame near the battery.
- When working with batteries, ALWAYS wear safety glasses and rubber gloves.
- If you spill acid on your clothes or skin, immediately flush the area with large amounts of water.
- Battery acid could cause blindness if splashed into the eyes. If acid gets into your eyes, flush them immediately with large quantities of water and see a doctor at once.
- If you accidentally drink electrolyte, drink a large quantity of water or milk, beaten egg or vegetable oil. Call a doctor or poison prevention center immediately.
- Before working with batteries, stop the engine and turn the starting switch to the OFF position.
- Avoid short-circuiting the battery terminals (between the positive ⊕ terminal and negative ⊖ terminal) through accidental contact with metal objects, such as tools.
- When installing the battery, connect the positive ⊕ terminal first, and when removing the battery, disconnect the negative ⊖ terminal (ground side) first.
- When removing or installing, check which is the positive ⊕ terminal and negative ⊖ terminal, and tighten the nuts securely.
If the battery electrolyte is near the LOWER LEVEL, add distilled water. Do not add distilled water above the UPPER LEVEL.
- When cleaning the top surface of the battery, wipe it with a damp cloth. Never use gasoline, thinner, or any other organic solvent or cleaning agent.
- Tighten the battery caps securely.
- If the battery electrolyte is frozen, do not charge the battery or start the engine with a different power source. There is danger that this will ignite the battery.
When charging or starting the engine with a different power source, melt the battery electrolyte and check for leakage of battery electrolyte before starting.
- Always remove the battery from the chassis before charging it.

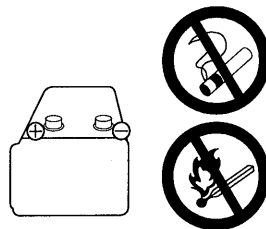
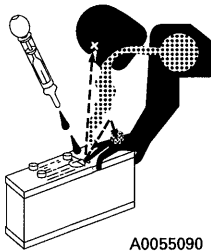

STARTING WITH BOOSTER CABLES

If any mistake is made in the method of connecting the booster cables, it may cause a fire, so always do as follows.

- Carry out the starting operation with two workers (with one worker sitting in the operator's seat).
- When starting from another machine, do not allow the two machines to touch.
- When connecting the booster cables, turn the starting switch OFF for both the normal machine and problem machine.
- Be sure to connect the positive \oplus cable first when installing the booster cables. Disconnect the ground or negative \ominus cable first when removing them.
- The final ground connection is the connection of the ground to the engine block of the problem machine. However, this will cause sparks, so be sure to connect it as far as possible from the battery.

Starting procedure when using booster cables → See "16.3 IF BATTERY IS DISCHARGED".

- When removing the booster cables, be careful not to let the booster cable clips touch each other or to let the clips touch the machine.

INCORRECT

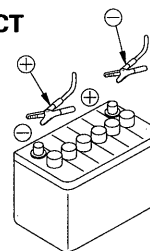

A0067320

CHARGING BATTERY

If the battery is handled incorrectly when it is being charged, there is danger that the battery may explode, so follow the instructions in HANDLING BATTERY and in the instruction manual for the charger, and always observe the following precautions.

- Carry out the charging in a well-ventilated place, and remove the battery caps. This disperses the hydrogen gas and prevents explosion.
- Set the voltage on the charger to match the voltage on the battery to be charged. If the voltage setting is wrong, it will cause the charger to overheat and catch fire, and this may lead to an explosion.

Connect the positive \oplus charging clip of the charger to the positive \oplus terminal of the battery, then connect the negative \ominus charging clip to the negative \ominus terminal of the battery. Be sure to tighten both terminals securely.

- If the battery charge is less than 1/10 of the rated charge, and high speed charging is carried out, set to a value below the rated capacity of the battery.

If there is an excessive flow of charging current, it may cause leakage or evaporation of the electrolyte, which may catch fire and explode.

INCORRECT

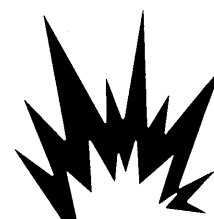

A0055110

7.5 TOWING

FIT WIRE TO HOOK WHEN TOWING

- Injury or death could result if a disabled machine is towed incorrectly.
- If your machine is towed by another machine, **ALWAYS** use a wire rope with a sufficient towing capacity.
- If your machine is towed by another machine, stop the engine and release the brake. Please contact your Komatsu distributor to have the brake released.
- **NEVER** allow a disabled machine to be towed on a slope.
- Do not use a kinked or frayed wire rope.
- Do not straddle the towing cable or wire rope.
- When connecting up a towing machine, do not let anyone enter the area between the towing machine and the equipment being towed.
- Set the towing machine and the towing connection of the equipment being towed in a straight line when connecting it.
- Take up the slack in the wire rope and tow the machine.
- When lifting the machine up, use the towing hook.
- If the machine is stuck in sandy soil, dig out the soil around the towing hook, then use the towing hook to pull the machine out.
Permissible load for towing hook: 29300 kg (288371 N)

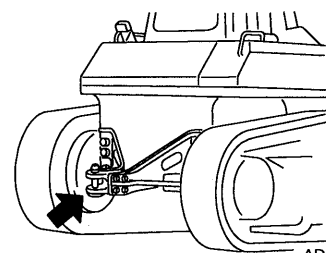
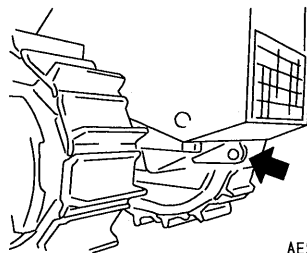

8. PRECAUTIONS FOR MAINTENANCE

⚠ WARNING: For reasons of safety, always follow these safety precautions.

8.1 BEFORE CARRYING OUT MAINTENANCE

NOTIFICATION OF FAILURE

Carrying out maintenance not described in the Komatsu operation and maintenance manual may lead to unexpected failures.
Please contact your Komatsu distributor for repairs.

WARNING TAG

- ALWAYS attach the "DO NOT OPERATE" warning tag to the blade control lever in the operator's cab to alert others that you are working on the machine. Attach additional warning tags around the machine if necessary.
- If others start the engine, or touch or operate the blade control lever while you are performing service or maintenance, you could suffer serious injury or death.

Warning tag Part No. 09963-A1640

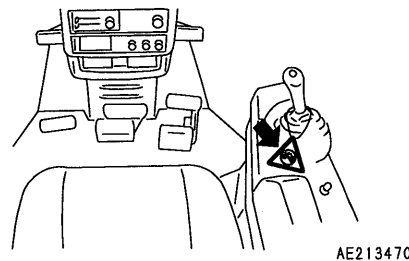

CLEAN BEFORE INSPECTION AND MAINTENANCE

- Clean the machine before carrying out inspection and maintenance. This will ensure that dirt does not get into the machine and will also ensure that maintenance can be carried out safely.
- If inspection and maintenance are carried out with the machine still dirty, it will be difficult to find the location of problems, and there is also the danger that you will get dirty or mud in your eyes, and that you will slip and injure yourself.
- When washing the machine, always do as follows.
 - Wear non-slip shoes to prevent yourself from slipping on the wet surface.
 - When using high-pressure steam to wash the machine, always wear protective clothing. This will protect you from being hit by high-pressure water, and cutting your skin or getting mud or dust into your eyes.
 - Do not spray water directly on to the electrical system (sensors, connectors) ①. If water gets into the electrical system, there is danger that it will cause defective operation and malfunction.

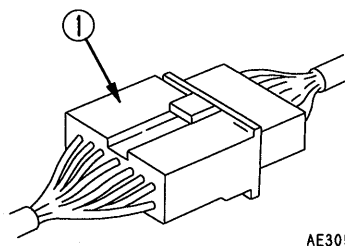
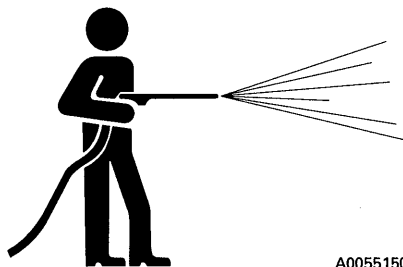

⚠ WARNING: Failure to follow these safety precautions may lead to a serious accident.

8. PRECAUTIONS FOR MAINTENANCE

KEEP WORK PLACE CLEAN AND TIDY

Do not leave hammers or other tools lying around in the work place. Wipe up all grease, oil, or other substances that will cause you to slip. Always keep the work place clean and tidy to enable you to carry out operations safely.

If the work place is not kept clean and tidy, there is danger that you will trip, slip, or fall over and injure yourself.

APPOINT LEADER WHEN WORKING WITH OTHERS

When repairing the machine or when removing and installing the work equipment, appoint a leader and follow his instructions during the operation.

When working with others, misunderstandings between workers can lead to serious accidents.

RADIATOR WATER LEVEL

- When inspecting the radiator water level, stop the engine, and wait for the engine and radiator to cool down. Check the water level in the sub-tank. Under normal conditions, do not open the radiator cap.
- If there is no sub-tank, or the radiator cap must be removed, always do as follows.
- Wait for the radiator water temperature to go down before checking the water level. (When checking if the water temperature has gone down, put your hand near the engine or radiator and check the air temperature. Be careful not to touch the radiator or engine.)
- Release the internal pressure before removing the radiator cap, and remove the radiator cap slowly.

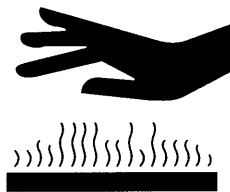

A0055050

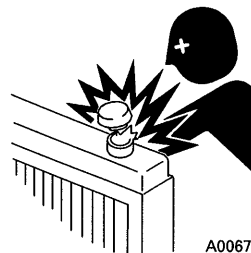

A0067380

STOP ENGINE BEFORE CARRYING OUT INSPECTION AND MAINTENANCE

- When carrying out inspection and maintenance, park the machine on level ground where there is no danger of falling rocks or land slides, or of flooding if the land is low, then lower the work equipment to the ground and stop the engine.
- Operate the blade control lever several times to the RAISE and LOWER positions to release the remaining pressure in the hydraulic circuit, then set safety lock lever to the LOCK position.
- Put blocks under the track to prevent the machine from moving.
- The worker carrying out the maintenance should be extremely careful not to touch or get caught in the moving parts.

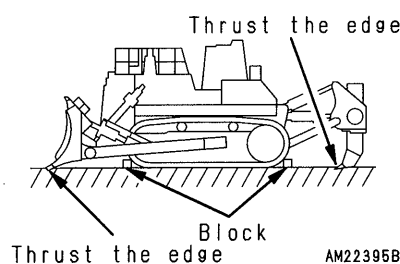

AM22395B

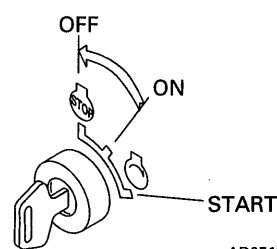

AD051781

SAFETY DEVICES FOR WORK EQUIPMENT

When carrying out inspection and maintenance with the work equipment raised, fit stand securely to the boom to prevent the work equipment from coming down.

Place the work equipment control levers at hold, and set safety lock lever to the lock position.



A0055140

PROPER TOOLS

Use only tools suited to the task. Using damaged, low quality, faulty, or makeshift tools could cause personal injury.

Broken pieces of chisels or hammers could fly into your eyes and blind you.

Tools → See "21.1 INTRODUCTION OF NECESSARY TOOLS".



A0055120

PERIODIC REPLACEMENT OF SAFETY CRITICAL PARTS

Hoses and other parts of the fuel, hydraulic, and brake system are critical parts for ensuring safety, so they must be replaced periodically.

Replacement of safety critical parts requires skill, so please ask your Komatsu distributor to carry out replacement.

- Replace these components periodically with new ones, regardless of whether or not they appear to be defective.

These components deteriorate over time, and can cause fire because of oil leakage or failure in the work equipment system.

- Replace or repair any such components if any defect is found, even though they have not reached the time specified.

Replacement of safety critical parts →

See "22. PERIODIC REPLACEMENT OF SAFETY CRITICAL PARTS".

USE OF LIGHTING

- When checking fuel, oil, or battery electrolyte, always use lighting with anti-explosion specifications. If such lighting equipment is not used, there is danger of explosion.
- If work is carried out in dark places without installing lighting, there is danger of injury, so always install proper lighting.
- Even if it is dark, do not use a lighter or flame instead of lighting. There is danger of starting a fire, and if the battery gas ignites, it may cause an explosion.
- When using the machine as the power supply for the lighting, follow the instructions in this Operation and Maintenance Manual.

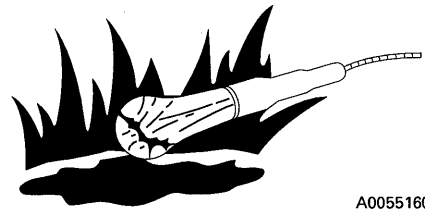

A0055160

PREVENTION OF FIRE

There is danger of the fuel and battery gas catching fire during maintenance, so always follow the precautions below when carrying out maintenance.

- Store fuel, oil, grease, and other flammable materials away from flame.
- Use non-flammable materials as the flushing oil for cleaning parts. Do not use diesel oil or gasoline. There is danger that they will catch fire.
- Never smoke when carrying out inspection or maintenance. Always smoke in the prescribed place.
- When checking fuel, oil, or battery electrolyte, always use lighting with anti-explosion specifications. Never use lighters or matches as lighting.
- When carrying out grinding or welding operations on the chassis, remove any flammable materials to a safe place.
- Be sure that a fire extinguisher is present at the inspection and maintenance point.



A0055020

8.2 DURING MAINTENANCE

PERSONNEL

Only authorized personnel can service and repair the machine. Do not allow unauthorized personnel into the area. If necessary, employ an observer. Extra precaution should be used when grinding, welding, and using a sledge-hammer.



ATTACHMENTS

- Appoint a leader before starting removal or installation operations for attachments.
- Do not allow anyone other than the workers close to the machine or attachment.
- Place attachments that have been removed from the machine in a safe place so that they do not fall. Put a fence around the attachments, and set up No Entry signs to prevent unauthorized persons from coming close.



A0055130

WORK UNDER THE MACHINE

- Stop the machine on firm, level ground, and always lower all work equipment to the ground before performing service or repairs under the machine.
- Always block the track shoes securely.
- It is extremely dangerous to work under the machine if the track shoes are off the ground and the machine is supported only by the work equipment. Never work under the machine if the machine is poorly supported.



A0055140

WORK ON TOP OF MACHINE

- When carrying out maintenance on top of the machine, make sure that the footholds are clean and free of obstructions, and follow the precautions below to prevent yourself from falling.
 - Do not spill oil or grease.
 - Do not leave tools lying around.
 - Mind your step when you are walking.
- Never jump down from the machine. When getting on or off the machine, always use the steps and handrails, and maintain three-point contact (both feet and one hand or both hands and one foot) at all times.
- Use protective equipment if necessary.



AD305870

LOCKING INSPECTION COVERS

When carrying out maintenance with the inspection cover open, lock it securely with a lock bar. If maintenance is carried out with the inspection cover open and not locked in position, it may close suddenly if knocked or blown by the wind, and may cause injury to the operator.

MAINTENANCE WITH ENGINE RUNNING

To prevent injury, do not carry out maintenance with the engine running. If maintenance must be carried out with the engine running, carry out the operation with at least two workers and do as follows.

- One worker must always sit in the operator's seat and be ready to stop the engine at any time. All workers must maintain contact with the other workers.
- When carrying out operations near rotating parts, there is danger of being caught in the parts, so be extremely careful.
- When cleaning inside the radiator, set safety lock lever to the LOCK position to prevent the work equipment from moving.
- Do not touch any control levers. If any control lever must be operated, always give a signal to the other workers to warn them to move to a safe place.
- Never touch the fan blade or fan belt with any tool or any part of your body. There is danger of serious injury.

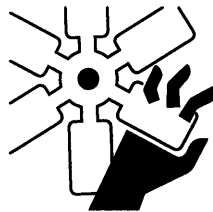

A0055210

DO NOT DROP TOOLS OR PARTS INSIDE MACHINE

- When opening the inspection window or tank oil filler to carry out inspection, be careful not to drop any nuts, bolts, or tools inside the machine. If such parts are dropped into the machine, it will cause breakage of the machine, mistaken operation, and other failures. If you drop any part into the machine, always be sure to remove it from the machine.
- When carrying out inspection, do not carry any unnecessary tools or parts in your pocket.

PRECAUTIONS WHEN USING HAMMER

When using a hammer, always wear safety glasses, safety helmet, and other protective clothing, and put a brass bar between the hammer and the part being hammered. If hard metal parts such as pins, edges, teeth, or bearings are hit with a hammer, there is danger that broken pieces might fly into your eyes and cause injury.

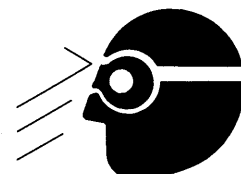

AE305880

REPAIR WELDING

Welding operations must always be carried out by a qualified welder and in a place equipped with a proper equipment. Gas is generated, and there is danger of fire or electrocution when carrying out welding, so never allow any unqualified personnel to carry out welding.

The qualified welder must follow the precautions given below.

- Disconnect the battery terminals to prevent explosion of the battery.
- Remove the paint from the place being welded to prevent gas from being generated.
- If hydraulic equipment or piping, or places close to these are heated, flammable vapor or spray will be generated, and there is danger of this catching fire, so avoid applying heat to such places.
- If heat is applied directly to rubber hoses or piping under pressure, they may suddenly burst, so cover them with fireproof sheeting.
- Always wear protective clothing.
- Ensure that there is good ventilation.
- Clear up any flammable materials, and make sure that there is a fire extinguisher at the workplace.

PRECAUTIONS WITH BATTERY

When repairing the electrical system or when carrying out electrical welding, remove the negative ⊖ terminal of the battery to stop the flow of current.

Handling battery → See "16.3 IF BATTERY IS DISCHARGED".

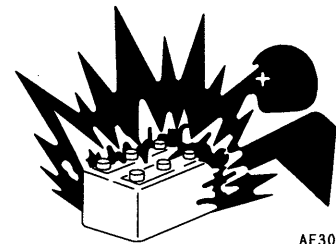

AE305890

WHEN ABNORMALITY IS LOCATED

- If any abnormality is found during inspection, always carry out repairs. In particular, if the machine is used when there is any abnormality in the brakes or work equipment systems, it may lead to serious accident.
- Depending on the type of failure, please contact your Komatsu distributor for repairs.

RULES TO FOLLOW WHEN ADDING FUEL OR OIL

If any flame is brought close to fuel or oil, there is danger that it will catch fire, so always follow the precautions below.

- Stop the engine when adding fuel or oil.
- Do not smoke.
- Spilled fuel and oil may cause you to slip, so always wipe it up immediately.
- Always tighten the cap of the fuel and oil fillers securely.
- Always add fuel and oil in a well-ventilated place.



A0055020



A0055040

PRECAUTIONS WHEN USING HIGH-PRESSURE GREASE TO ADJUST TRACK TENSION

- Grease is pumped into the track tension adjustment system under high pressure. If the specified procedure for maintenance is not followed when making adjustment, plug ① may fly out and cause damage or personal injury.
- When loosening grease drain plug ①, never loosen it more than one turn.
- Never put your face, hands, feet, or any other part of your body directly in front of any grease drain valve.

Adjusting track tension → See "24.2 WHEN REQUIRED".



A0055200

HANDLING HIGH-PRESSURE HOSES

- If oil or fuel leaks from high-pressure hoses, it may cause fire or defective operation, which may lead to personal injury or damage. If any damaged hoses or loose bolts are found, stop work and contact your Komatsu distributor for repairs.
- Replacing high-pressure hoses requires a high level of skill, and the torque is determined according to the type of hose and size, so please do not carry out replacement yourself. Ask your Komatsu distributor to carry out replacement.

PRECAUTIONS WITH HIGH-PRESSURE OIL

When inspecting or replacing high-pressure piping or hoses, always check that the pressure in the hydraulic circuit has been released. If the circuit is still under pressure, it will lead to serious injury or damage, so always do as follows.

- For details of the method of releasing the pressure, see **"8.1 BEFORE CARRYING OUT MAINTENANCE, STOP ENGINE BEFORE CARRYING OUT INSPECTION AND MAINTENANCE"**. Never carry out inspection or replacement before releasing the pressure completely.
- Wear safety glasses and leather gloves.
- If there is any leakage from the piping or hoses, the piping, hoses, and the surrounding area will be wet, so check for cracks in the piping and hoses and for swelling in the hoses. If it is difficult to locate the leakage, always please contact your Komatsu distributor for repairs.
- If you are hit by a jet of high-pressure oil, consult a doctor immediately for medical attention.

INCORRECT



A0055180

CORRECT

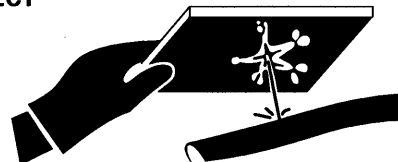

A0055190

PRECAUTIONS WHEN CARRYING OUT MAINTENANCE AT HIGH TEMPERATURE

Immediately after stopping operations, the engine coolant, oil at all parts, the exhaust manifold, and the muffler are at high temperature.

In this condition, if the cap is removed, or the oil is drained, or the filters are replaced, this may result in burns or other injury. Wait for the temperature to go down, then carry out the inspection and maintenance in accordance with the procedures given in this manual.

Cleaning inside of cooling system → See "24.2 WHEN REQUIRED".

Checking coolant level, oil level in hydraulic tank → see "24.3 CHECK BEFORE STARTING".

Checking lubricating oil level, adding oil → see "24.3-4 PERIODIC MAINTENANCE".

Changing oil, replacing filters → see "24.4-7 PERIODIC MAINTENANCE".

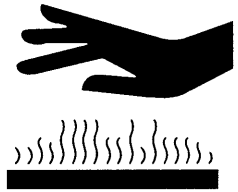

A0055050

CHECKS AFTER INSPECTION AND MAINTENANCE

Failure to carry out inspection and maintenance fully, or failure to check the function of various maintenance locations may cause unexpected problems and may even lead to personal injury or damage, so always do as follows.

- Checks when engine is stopped
 - Have all the inspection and maintenance locations been checked?
 - Have all the inspection and maintenance items been carried out correctly?
 - Have any tools or parts dropped inside the machine? It is particularly dangerous if they get caught in the lever linkage.
 - Has water and oil leakage been repaired? Have bolts been tightened?
- Checks when engine is running

For details of checks when the engine is running, see **"8.2 DURING MAINTENANCE, MAINTENANCE WITH ENGINE RUNNING"**, and be extremely careful to ensure safety.
- Do the inspection and maintenance locations work normally?
- Is there any oil leakage when the engine speed is raised and load is applied to the hydraulic system?

WASTE MATERIALS

To prevent pollution, particularly in places where people or animals are living, always follow the procedures given below.

- Never dump waste oil in a sewer system, rivers, etc.
- Always put oil drained from your machine in containers. Never drain oil directly onto the ground.
- Obey appropriate laws and regulations when disposing of harmful objects such as oil, fuel, coolant, solvent, filters, and batteries.

INCORRECT

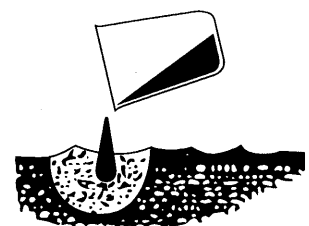

A0055220

9. POSITION FOR ATTACHING SAFETY LABELS

Always keep these labels clean. If they are lost or damaged, attaching them again or replacing them with a new label.

There are other labels in addition to the safety labels listed as follows, so handle them in the same way.

Safety labels may be available in languages other than English.

To find out what labels are available, contact your Komatsu distributor.

9.1 POSITION FOR ATTACHING SAFETY LABELS

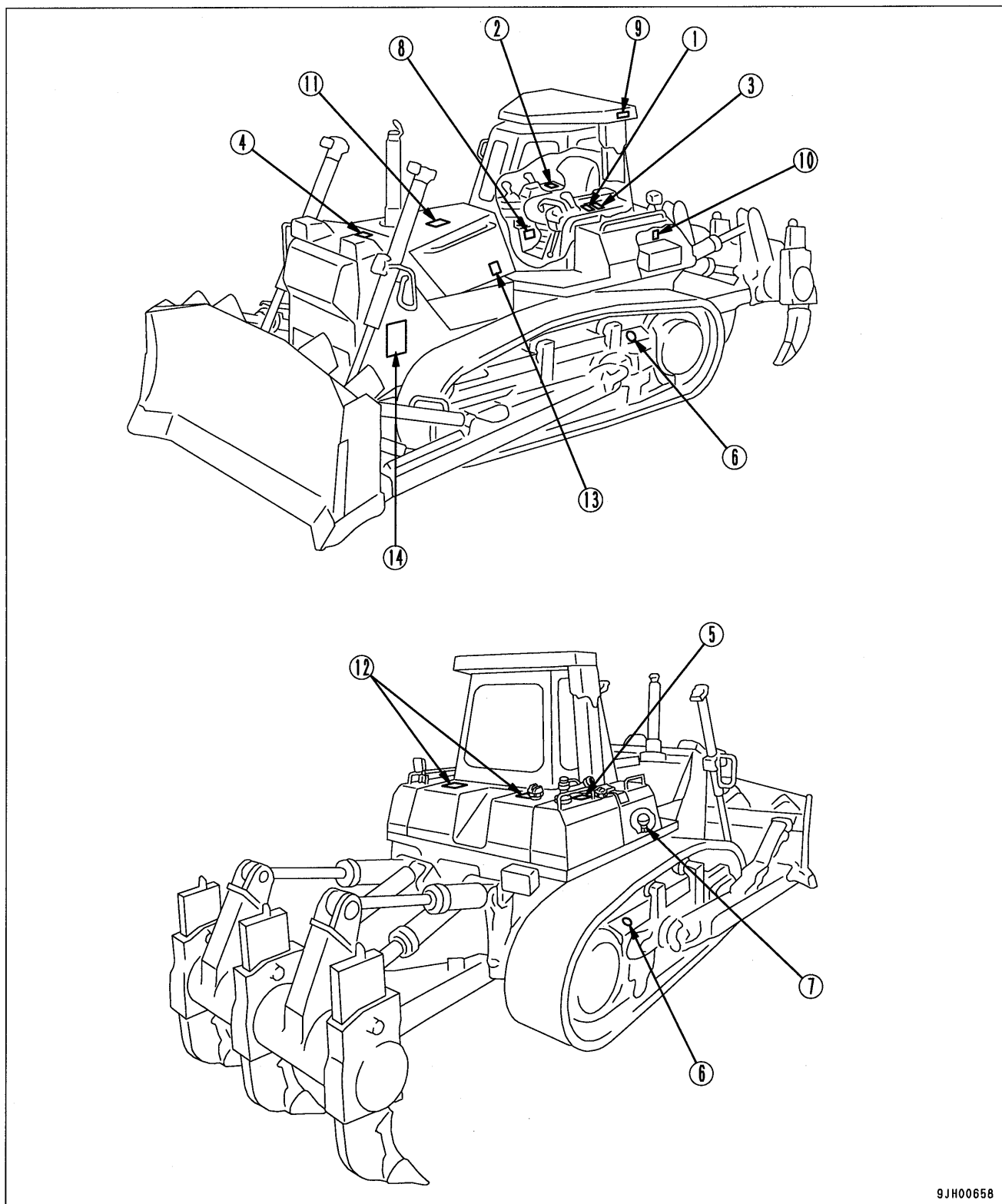

9JH00658

9. POSITION FOR ATTACHING SAFETY LABELS

1. Warning before operating machine
(09651-A0641)

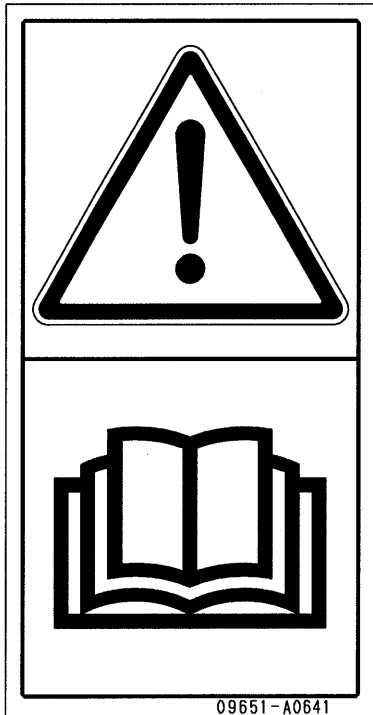

3. Warning for leaving operator's seat
(09654-B0641)

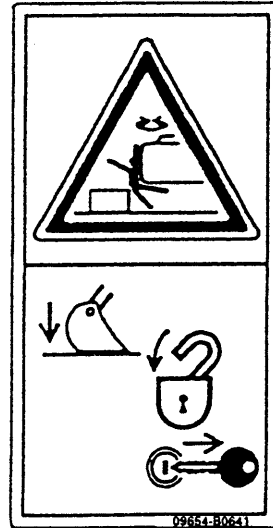

2. Warning before moving in reverse
(09802-B0750)

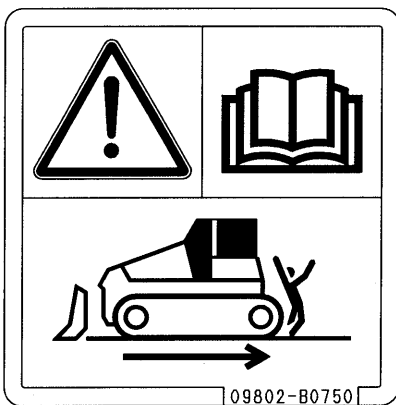

4. Warning for hot water hazard
(09653-A0481)



5. Warning for hot oil hazard
(09653-A0481)

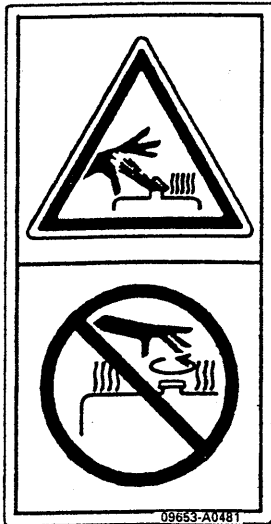

7. Warning for handling accumulator
(09659-A057B)

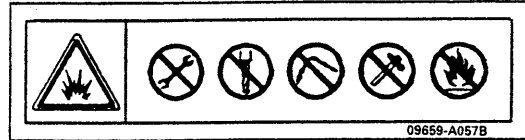

6. Warning for adjusting track tension
(09657-A0881)

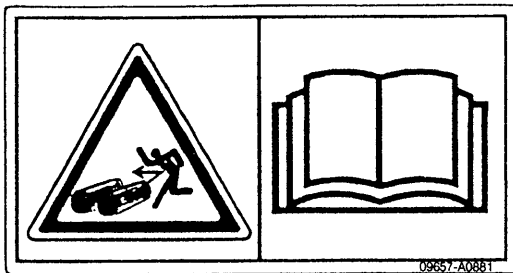

8. Warning for use of seat belt
(195-98-12940)

CAUTION

- ALWAYS USE SEAT BELT WHEN OPERATING MACHINE.
- ALWAYS CHECK CONDITION OF THE SEAT BELT, THE CONNECTING BRACKETS AND THE TIGHTENING BOLTS.
- ADJUST SEAT TO ALLOW FULL BRAKE PEDAL TRAVEL WITH OPERATOR'S BACK AGAINST SEAT BACK.
- AFTER ADJUSTING THE HEIGHT, FORE AND AFT POSITIONS OF THE SEAT, TIGHTEN THE TETHER BELT BEFORE SITTING IN THE SEAT.

195-98-12940

9. POSITION FOR ATTACHING SAFETY LABELS

9. Warning for ROPS
(09620-30200)

KOMATSU

ROLL-OVER PROTECTIVE STRUCTURE (ROPS)
THE ROLL-OVER PROTECTIVE STRUCTURE OF THIS MACHINE COMPLIES WITH
THE FOLLOWING STANDARDS OR (RECOMMENDED PRACTICES)
INTERNATIONAL STANDARD: ISO 3471 (ROPS) & ISO 3449 (FOPS)
AMERICAN STANDARD: SAE J & SAE J

MODEL MACHINE MODEL SERIAL NO. MAX MASS

WARNING

- Altering ROPS may weaken it. Consult Komatsu Distributor before altering.
- ROPS may provide less protection if it has been structurally damaged or involved in roll-over.
- Always wear seat belt when moving.

Komatsu Ltd. Japan 2-3-6 Akasaka, Minato-ku, Tokyo, Japan 09620-30200

10. Warning for battery cable
(09808-A0881)

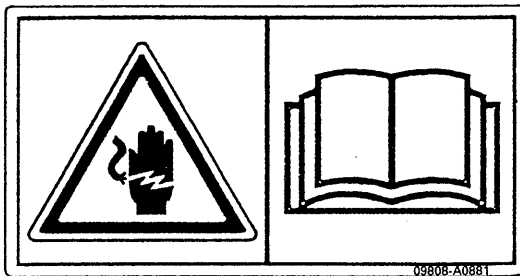

12. Caution for fuel tank
(09805-C0881)

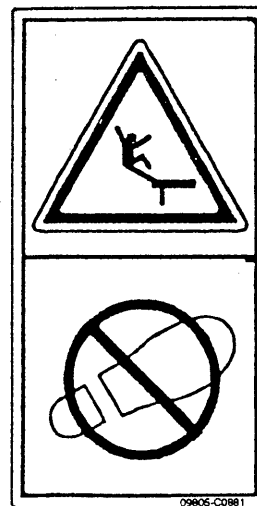

11. Caution for hood
(09805-C0881)

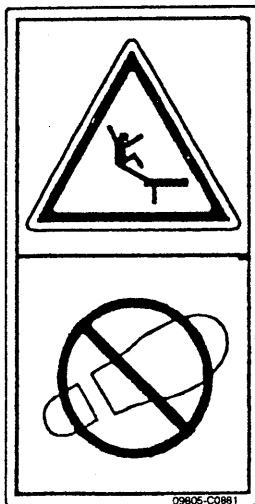

13. Caution for engine running
(09667-A0481)

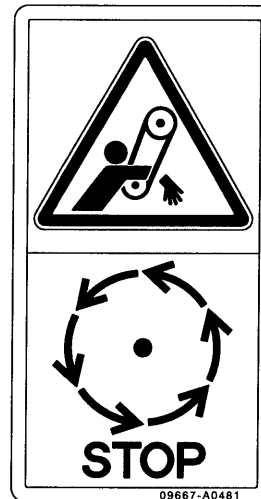

14. Caution for approach when machine moving
(09806-B1683)

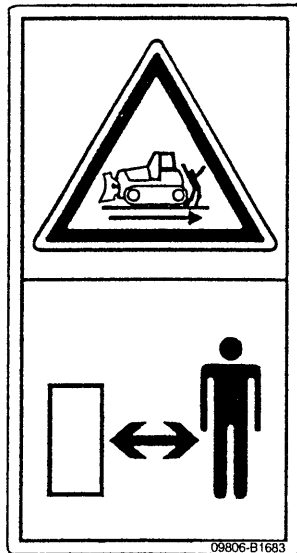

9.2 CONTENT AND USE OF WARNING PLATES

1. Warning to prevent operation during maintenance
(09963-A1640)

Hang this warning plate on the controls in the operator's compartment.

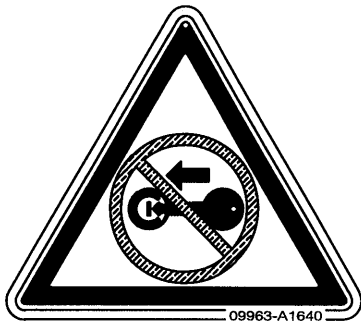

OPERATION

10. GENERAL VIEW

10.1 GENERAL VIEW OF MACHINE

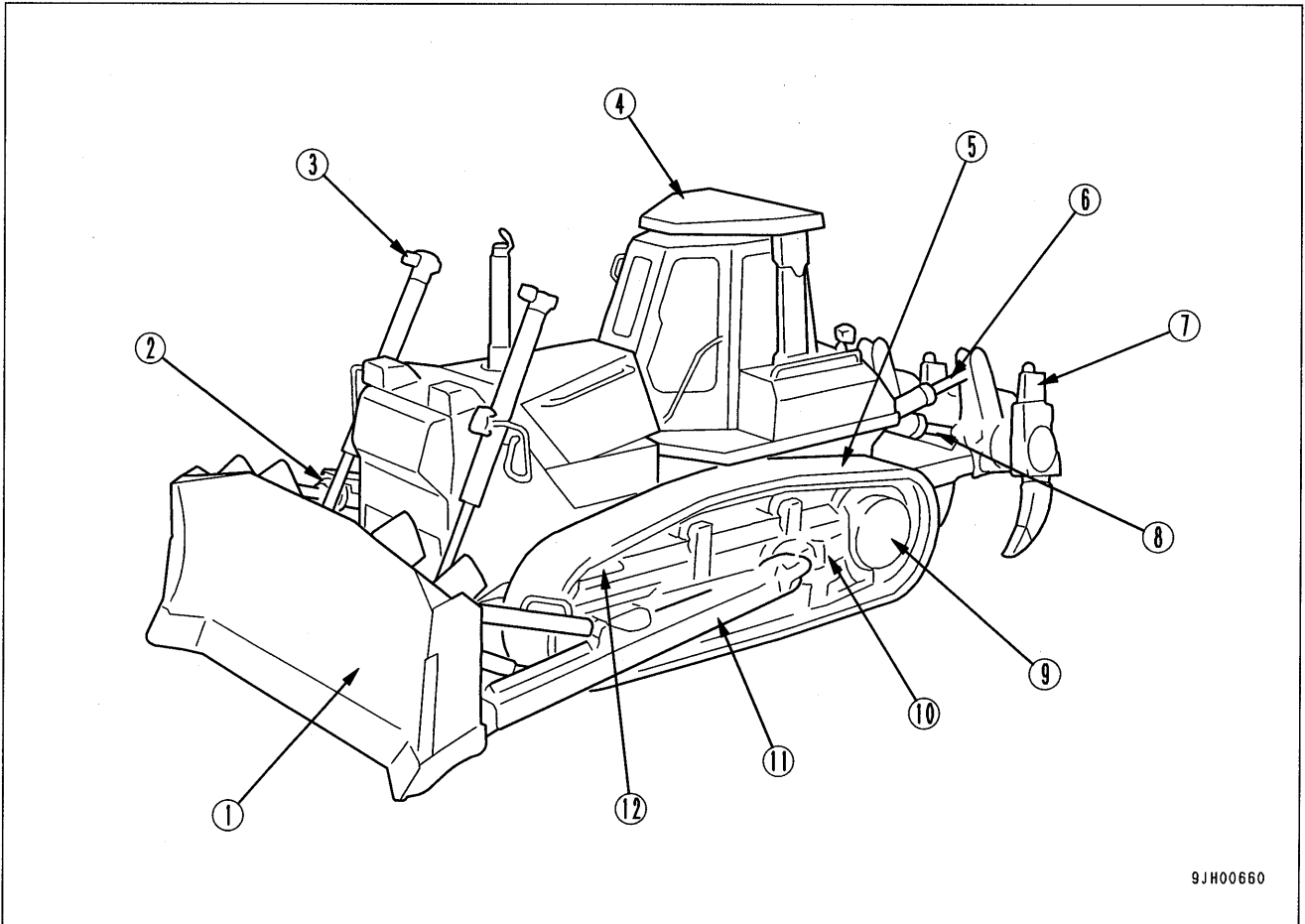

- 1. Blade
- 2. Blade tilt cylinder
- 3. Blade lift cylinder
- 4. Cab
- 5. Track shoe
- 6. Ripper tilt cylinder

- 7. Multi ripper
- 8. Ripper lift cylinder
- 9. Sprocket
- 10. Track frame
- 11. Frame
- 12. Idler

10.2 GENERAL VIEW OF CONTROLS AND GAUGES

Machines equipped with cab
Monitor panel specification

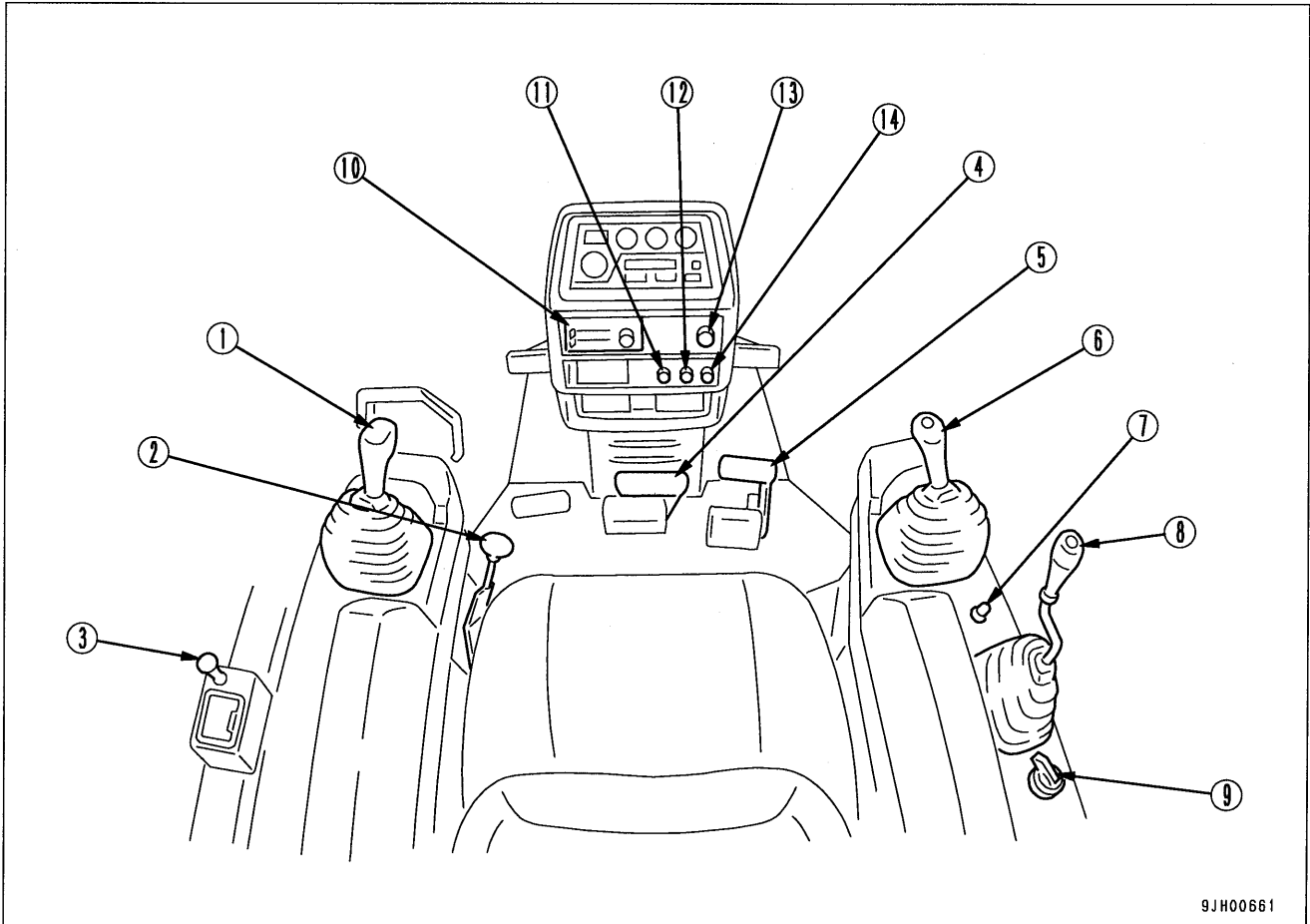

9JH00661

- | | |
|--|---|
| 1. Joystick (Steering, directional and gear shift lever) | 9. Pin-puller control switch |
| 2. Fuel control lever | 10. Air conditioner panel or heater panel |
| 3. Cigarette lighter | 11. Head lamp switch |
| 4. Brake pedal | 12. Rear lamp switch |
| 5. Deceleration pedal | 13. Starting switch |
| 6. Blade control lever | 14. Glow switch |
| 7. Horn switch | 15. Safety lever |
| 8. Ripper control lever | 16. Parking lever |

10. GENERAL VIEW

Machines equipped with canopy Monitor panel specification

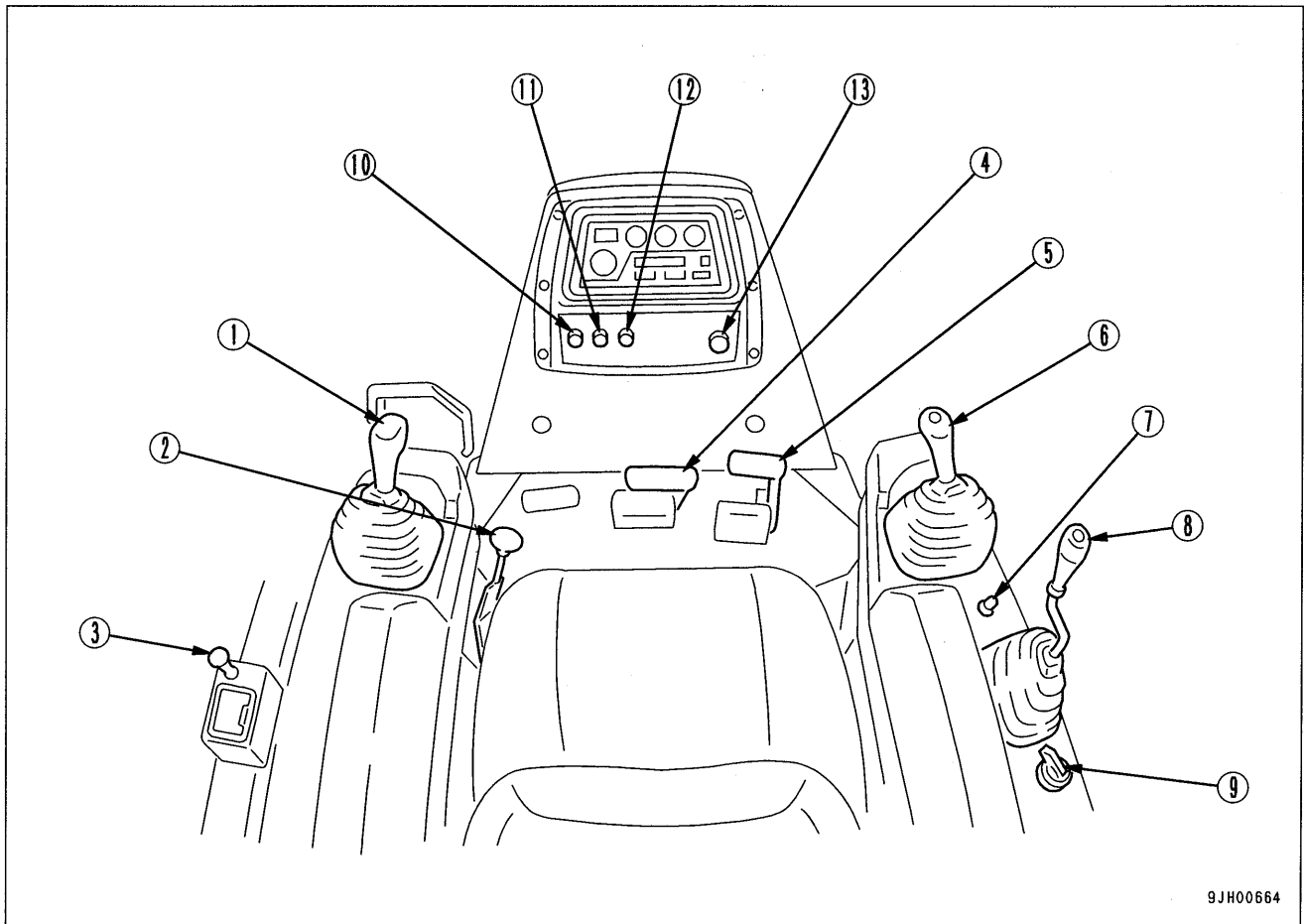

9JH00664

- | | |
|--|------------------------------|
| 1. Joystick (Steering, directional and gear shift lever) | 9. Pin-puller control switch |
| 2. Fuel control lever | 10. Head lamp switch |
| 3. Cigarette lighter | 11. Rear lamp switch |
| 4. Brake pedal | 12. Glow switch |
| 5. Deceleration pedal | 13. Starting switch |
| 6. Blade control lever | 14. Safety lever |
| 7. Horn switch | 15. Parking lever |
| 8. Ripper control lever | |

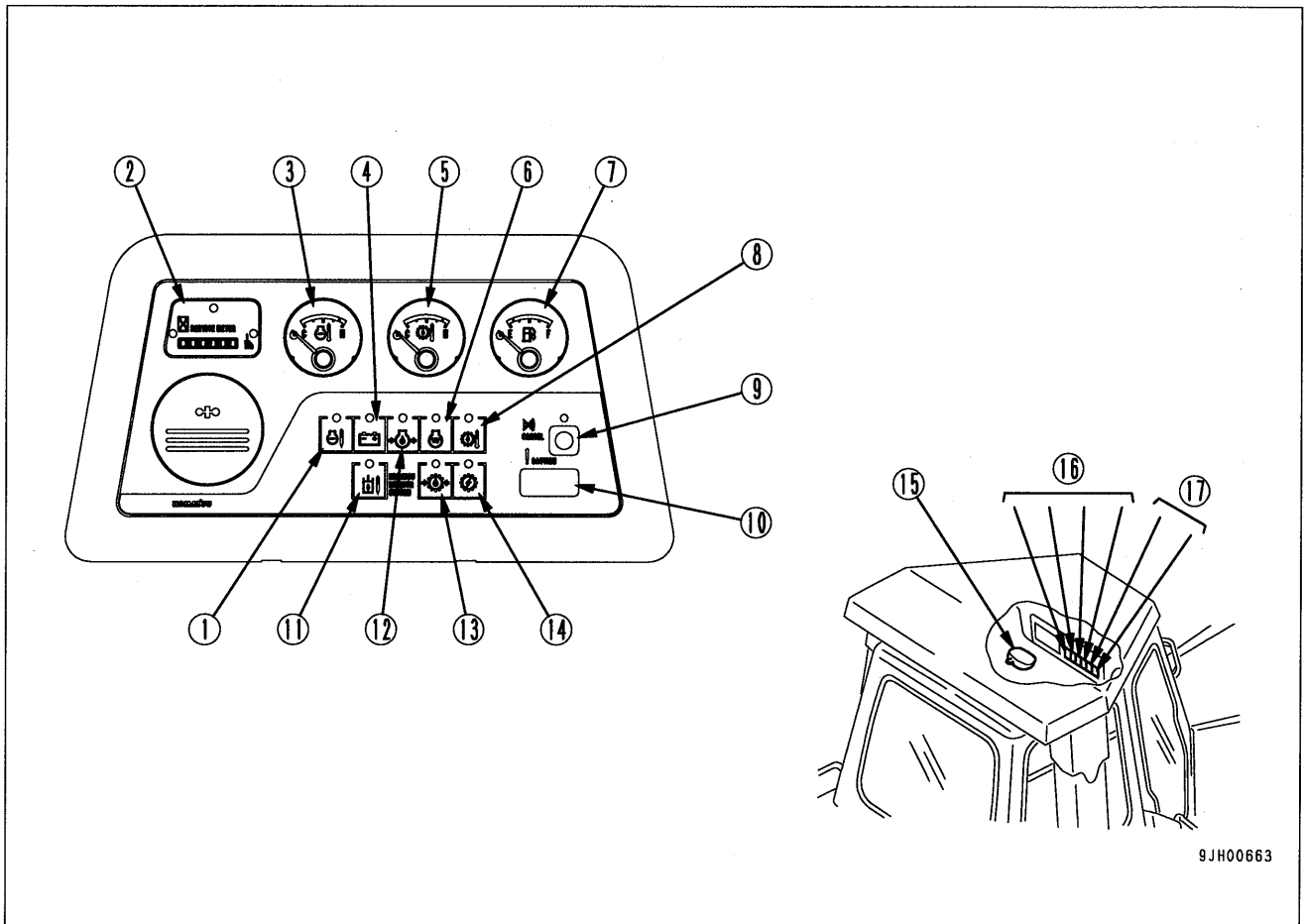

9JH00663

1. Engine water temperature caution lamp
2. Service meter
3. Engine water temperature gauge
4. Charge lamp
5. Transmission oil temperature gauge
6. Glow signal lamp
7. Fuel gauge
8. Transmission oil temperature caution lamp
9. Monitor caution cancel switch
10. Monitor caution lamp
11. HSS oil temperature caution lamp
12. Engine oil pressure caution lamp
13. HSS charge pressure caution lamp
14. Electronic system caution lamp
15. Room lamp (only machines equipped with cab)
16. Wiper switch (only machines equipped with cab)
17. Additional working lamp switch (only machines equipped with cab)

HSS: Hydro Static Steering System

11. EXPLANATION OF COMPONENTS

The following is an explanation of the devices needed for operating the machine.

To carry out suitable operations correctly and safely, it is important to understand fully the methods of operating the equipment and the meanings of the displays.

Before reading the explanation of components, please read the table below to check what equipment is installed to your machine.

Equipment		Section No.	D155AX-5	
			Canopy	Cab
Front panel				
Monitor panel	11.1.1	○	○	
Gauge panel		-	-	
Air conditioner panel	11.1.2	-	○	
Heater panel	11.1.3	-	○	
Switch panel (cab)	11.1.4	-	○	
Switch panel (canopy)	11.1.5	○	-	
Switches				
Horn switch	11.2 1	○	○	
Room lamp switch	11.2 2	-	○	
Cigarette lighter	11.2 3	-	○	
Wiper switch	11.2 4	-	○	
Additional working lamp switch	11.2 5	-	○	
Control levers, pedals, switches				
Fuel control lever	11.3 1	○	○	
Joystick (counterrotation turning possible)	11.3 2	○	○	
Brake pedal	11.3 3	○	○	
Decelerator pedal	11.3 4	○	○	
Parking lever	11.3 5	○	○	
Safety lever (for blade control lever, ripper control lever)	11.3 6	○	○	
Blade control lever	11.3 7			
Power tiltdozer specification		○	○	
Power tilt, power pitch dozer specification		○	○	
Angle dozer specification		○	○	
Engine				
Dust indicator	11.4	○	○	

11.1 FRONT PANEL (METERS, LAMPS, SWITCHES)

11.1.1 MONITOR PANEL (MONITOR PANEL SPECIFICATION)

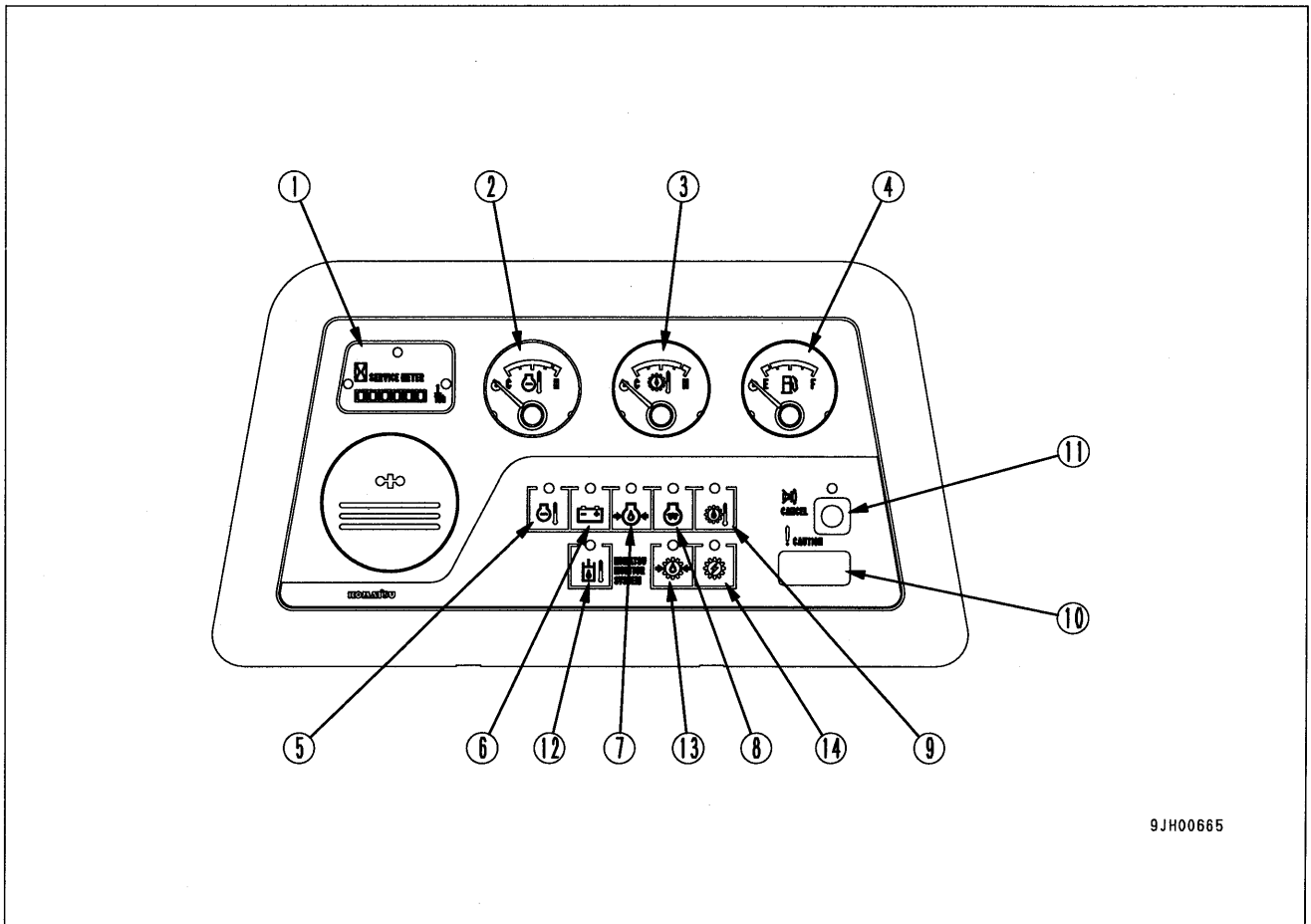

9JH00665

- ① Service meter
- ② Engine water temperature gauge
- ③ Transmission oil temperature gauge
- ④ Fuel gauge
- ⑤ Engine water temperature caution lamp
- ⑥ Charge lamp
- ⑦ Engine oil pressure caution lamp
- ⑧ Glow signal lamp
- ⑨ Transmission oil temperature caution lamp
- ⑩ Monitor caution lamp
- ⑪ Monitor caution cancel switch
- ⑫ HSS oil temperature caution lamp
- ⑬ HSS charge pressure caution lamp
- ⑭ Electronic system caution lamp (HSS controller)

HSS: Hydro Static Steering System

11. EXPLANATION OF COMPONENTS

1. SERVICE METER

This meter shows the total operation hours of the machine. The service meter advances while the engine is running – even if the machine is not traveling.

Set the periodic maintenance intervals using this display.

When the engine is running, the green pilot lamp ① at the top of the meters flashes to indicate that the meter is advancing.

Meter ② will advance by 1 for each hour of operation regardless of the engine speed.

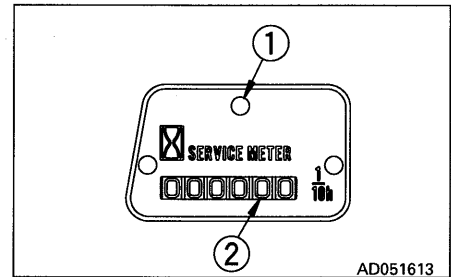

2. ENGINE WATER TEMPERATURE GAUGE

This gauge indicates the cooling water temperature.

When the indicator is in the white range during operation, the water temperature is normal.

If the indicator moves from the white range into the red range during operation, stop the machine immediately, run the engine under no load at a midrange speed, and wait for the indicator to go down to the white range.

After starting the engine, warm up it until the indicator moves into the white range.

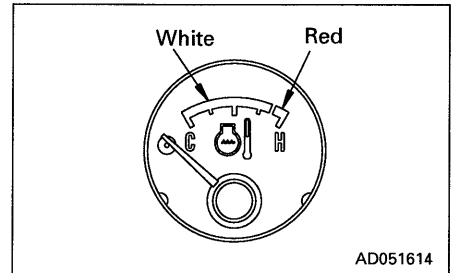

3. TRANSMISSION OIL TEMPERATURE GAUGE

This indicates the temperature of the transmission lubricating oil.

When the indicator is in the white range during operation, the oil temperature is normal.

If the indicator moves from the white range into the red range during operation, stop the machine, run the engine under no load at a midrange speed, and wait for the indicator to go down to the white range.

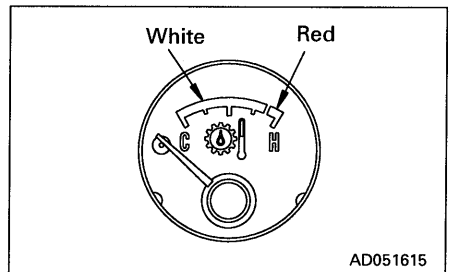

4. FUEL GAUGE

When the starting switch is turned ON, this displays the amount of fuel remaining in the fuel tank.

F indicates a full tank.

When the indicator points to E, it indicates that there is less than 60 ℓ (15.84 US gal, 13.20 UK gal) remaining, so add fuel.

Always fill the tank after finishing operations.

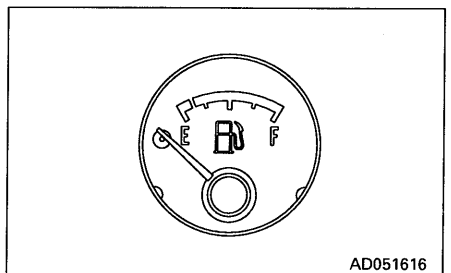

5. ENGINE WATER TEMPERATURE CAUTION LAMP

This warns of a rise in the temperature of the engine cooling water.

If the lamp lights up, stop the machine, run the engine under no load at a midrange speed, and wait for the indicator of the engine water temperature gauge to go down to the white range.

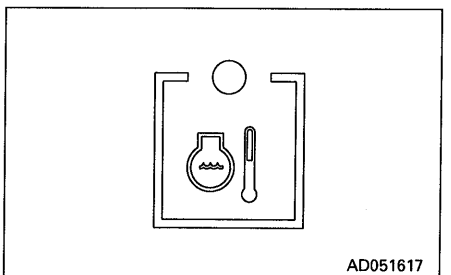

6. CHARGE LAMP

This lamp indicates malfunction of the alternator.

When the starting switch is turned ON, it will light up, but it should go out when the engine speed rises.

If the lamp lights up during operation, stop the engine and check the V-belt tension. If any abnormality is found, see "16. TROUBLESHOOTING".

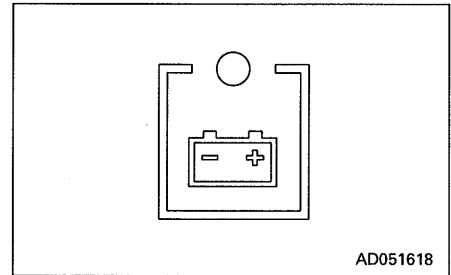
**7. ENGINE OIL PRESSURE CAUTION LAMP**

This lamp warns that the engine lubricating oil pressure has dropped. When the starting switch is turned ON, it will light up.

When the lamp goes off after the engine is started, the oil pressure is normal.

When the lamp lights up during operation, the oil pressure is lower.

Immediately stop the engine and look for the cause. For details, see "16. TROUBLESHOOTING".

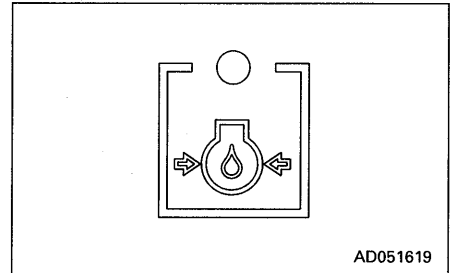
**8. GLOW SIGNAL LAMP**

This indicates the electrical intake air heater is red-heated.

While preheating is being carried out with the glow switch, the lamp lights up.

In the case of automatic preheating, the lamp goes out when the preheating is completed.

In the case of manual preheating, the lamp goes out when the glow switch is released.

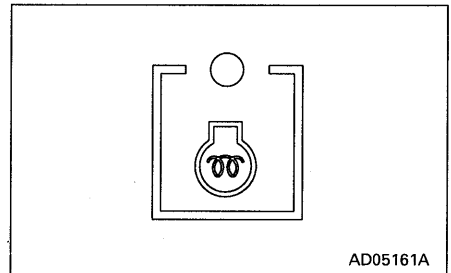
**9. TRANSMISSION OIL TEMPERATURE CAUTION LAMP**

This warns the operator that the oil temperature at the transmission outlet port has risen.

If the lamp lights up, stop the machine, run the engine under no load at a midrange speed, and wait for the transmission oil temperature gauge to go down to the white range.

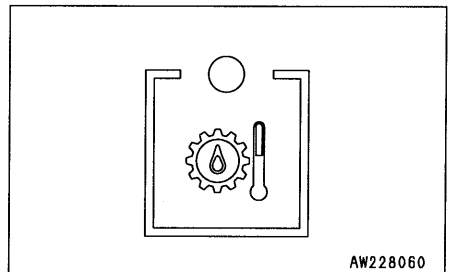
**10. MONITOR CAUTION LAMP**

If any of caution lamps 5, 6, 7, 9, 12, 13 or 14 light up or flash, the monitor caution lamp lights up. In addition, the alarm buzzer sounds at the same time.

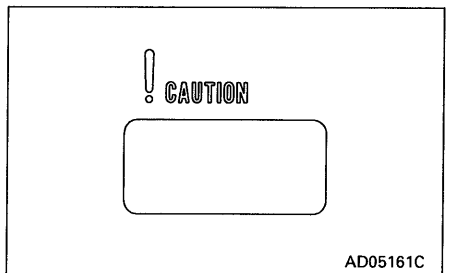
**11. MONITOR CAUTION CANCEL SWITCH**

This switch is used to cancel monitor caution lamp ⑩. Press the switch to turn the monitor caution lamp out and to stop the alarm buzzer.

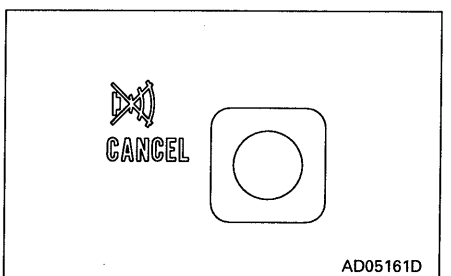

11. EXPLANATION OF COMPONENTS

12. HSS OIL TEMPERATURE CAUTION LAMP

This lamp warns of any rise in the oil temperature at the HSS monitor outlet port. If this lamp lights up, run the engine at low idling or stop the engine and wait for the hydraulic oil temperature to go down.

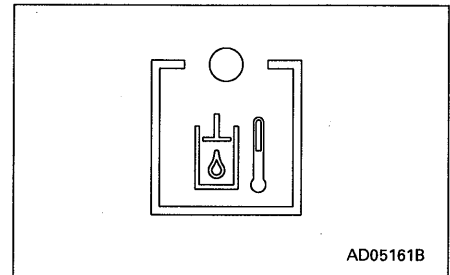

13. HSS CHARGE PRESSURE CAUTION LAMP

If any drop in the HSS charge pressure is detected by the pressure detector, the lamp flashes and the alarm buzzer sounds at the same time to warn the operator. If there is any abnormality, stop the engine immediately and contact your Komatsu distributor.

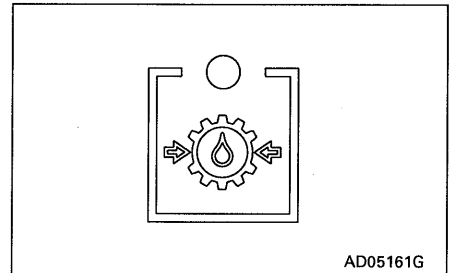

14. ELECTRONIC SYSTEM CAUTION LAMP (HSS CONTROLLER)

 **WARNING**

If this caution lamp flashes, the machine may move in a different way from that intended by the operator. If such a problem occurs, use the foot brake to stop the machine.

If HSS controller detects any abnormality in the machine or HSS controller itself, this lamp flashes to warn the operator. In such case, stop the engine and contact your Komatsu distributor.

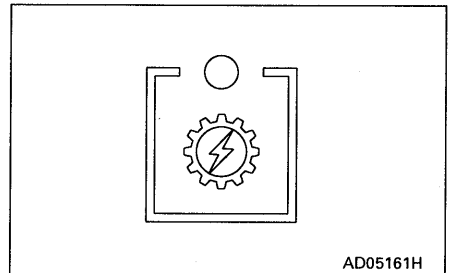

REMARK

The alarm buzzer sounds in the following cases.

1. When the engine water temperature is abnormally high
2. When the engine oil pressure is abnormally low
3. When the HSS hydraulic oil temperature is abnormally high
4. When the transmission oil temperature is abnormally high
5. When the HSS charge pressure is abnormally low
6. When there is any abnormality in the HSS controller itself

When the starting switch is turned to the ON position, the buzzer sounds for approx. 1 second, but this is to check the function of the buzzer. It does not indicate any abnormality.

**11.1.2 AIR CONDITIONER PANEL
(MACHINES EQUIPPED WITH CAB, AIR
CONDITIONER)**

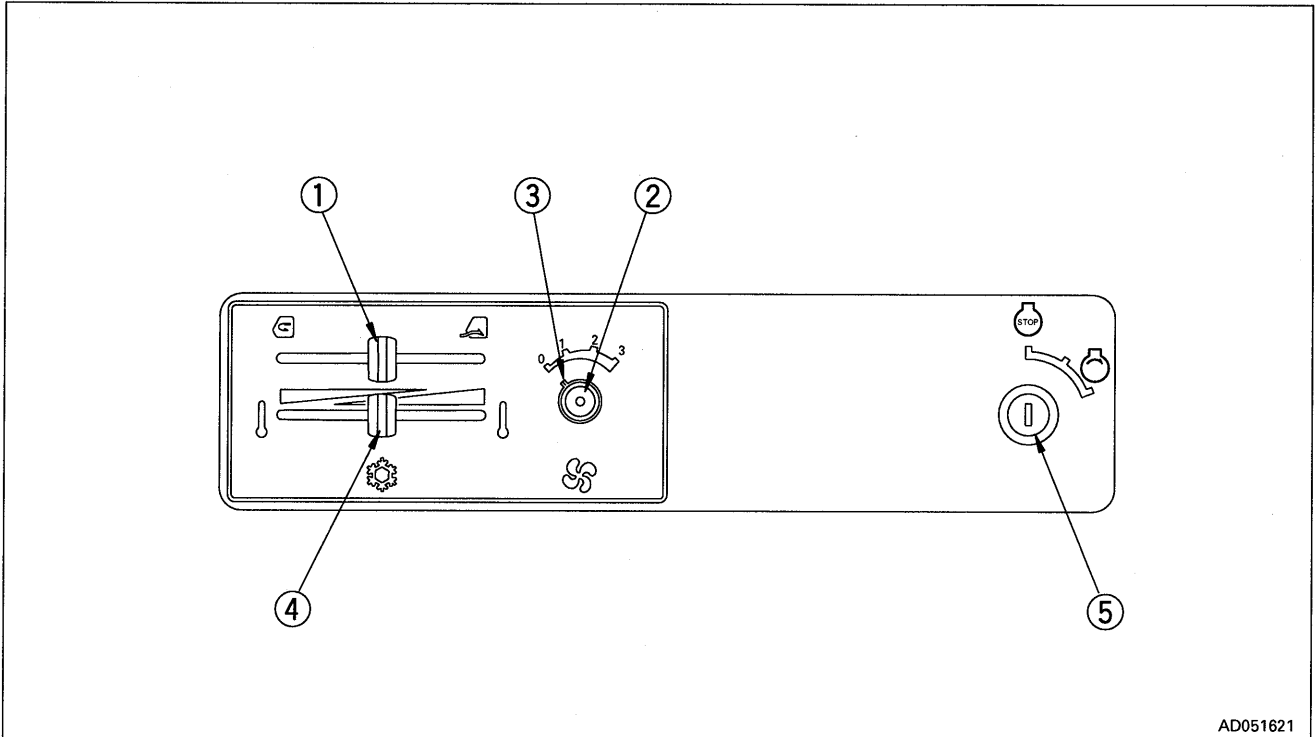



AD051621

For details of handling levers and switches ① to ④ below, see "11.14 HANDLING AIR CONDITIONER".

1. FRESH/RECIRC SELECTOR LEVER

This changes the air intake port used when cooling or heating.

- RECIRC (): Move lever to left to suck in air inside cab
Turn the switch normally to this position when strong cooling is needed. In this position, no ventilation or pressurizing is carried out.
- FRESH (): Move lever to right to suck in air from outside
This is the standard position for cooling and heating.

In this position, fresh air is brought in from outside to carry out ventilation. In addition, the inside of the cab is pressurized to prevent the entry of dust.

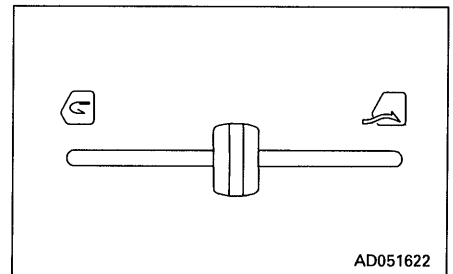

AD051622

2. AIR CONDITION SWITCH

When the switch is pressed and the blue lamp lights up, the cooling function is actuated. Use this switch for cooling or dehumidifying.

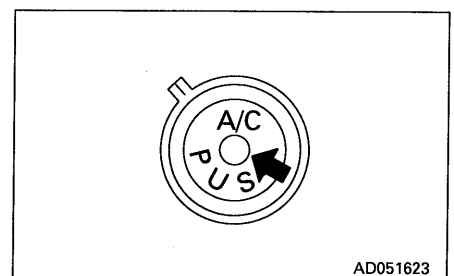

AD051623

11. EXPLANATION OF COMPONENTS

3. BLOWER SWITCH

This acts as the wind flow control switch and main switch when cooling or heating.

- The air flow can be set to three stages: 1 (LOW) → 2 (MEDIUM) → 3 (HIGH).
- If the switch is set to 0, the power is switched off and the air conditioner stops.

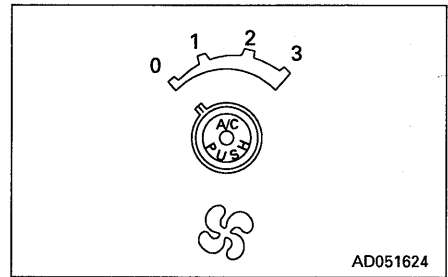

4. TEMPERATURE CONTROL LEVER

This is used to control the temperature for cooling or heating.

- When the temperature control lever is moved to the right, the temperature of the air coming from the vents becomes lower. (The water valve is closed and the heating function is stopped.)
- When the temperature control lever is moved to the left, the temperature of the air coming from the vents becomes higher. (The water valve is opened and the heating function is started.)

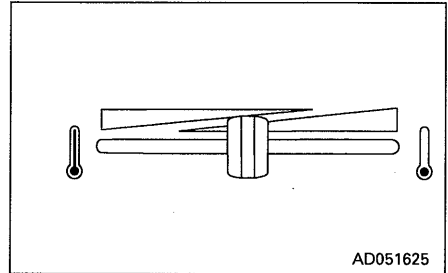

5. STARTING SWITCH

This switch is used to start the engine.

OFF () position: OFF

At this position, the starting switch key can be inserted or removed. When the switch is turned to this position, the electrical circuits are switched off.

Do not the starting switch key at the OFF position while the engine is running.

ON position: ON

In this position, electric current flows in the charging and lamp circuits.

Keep the starting switch key at the ON position while the engine is running.

START () position: START

This is the position to start the engine. Hold the key at this position while cranking. Release the key immediately after the engine has been started. The key will return to ON position when released.

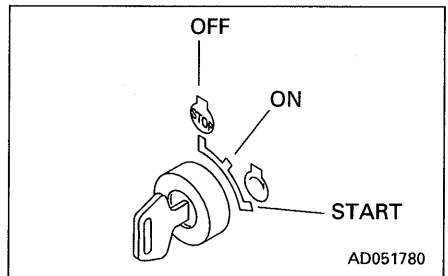

**11.1.3 HEATER PANEL
(MACHINES EQUIPPED WITH CAB, HEATER)**

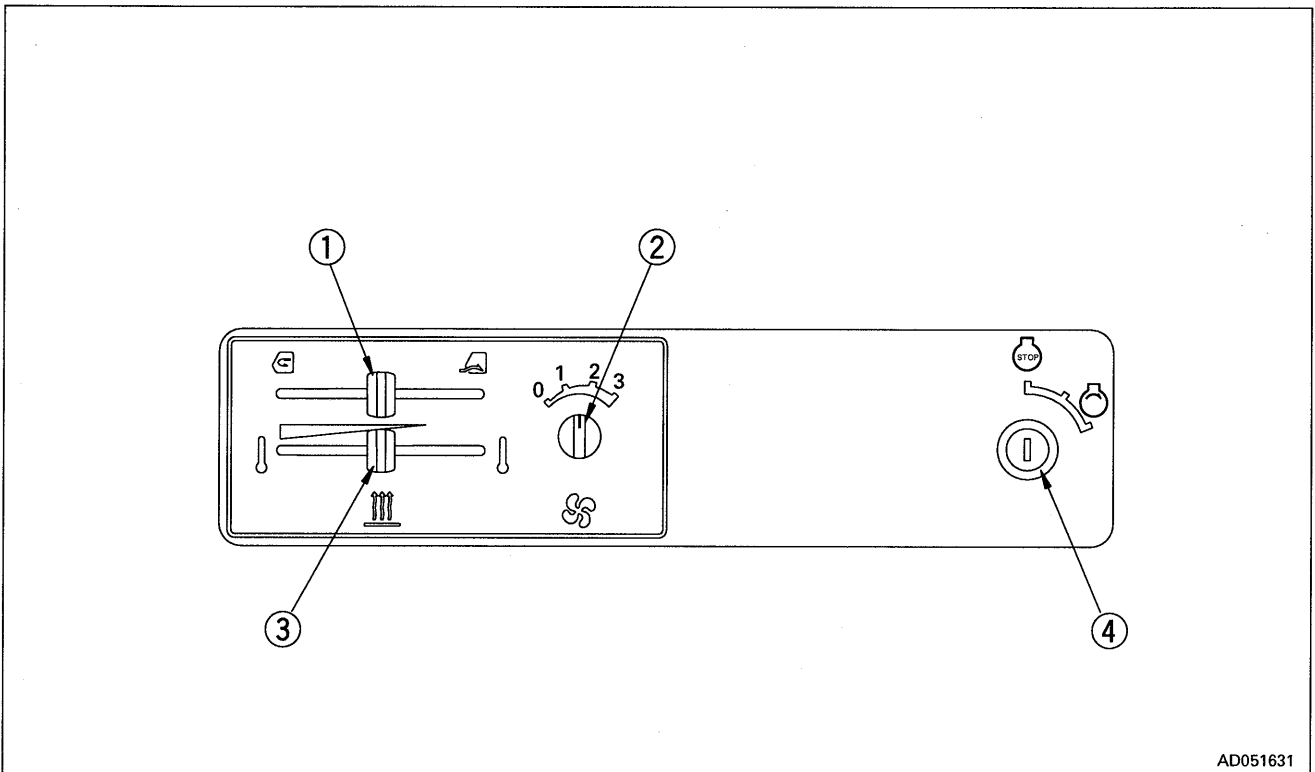



AD051631

For details of handling switches ① to ③ below, see "11.15 HANDLING HEATER".

1. FRESH/RECIRC SELECTOR LEVER

This changes the air intake port used when cooling or heating.

- RECIRC (): Move lever to left to suck in air inside cab
Turn the switch normally to this position when strong cooling is needed. In this position, no ventilation or pressurizing is carried out.
- FRESH (): Move lever to right to suck in air from outside
This is the standard position for cooling and heating.
In this position, fresh air is brought in from outside to carry out ventilation. In addition, the inside of the cab is pressurized to prevent the entry of dust.

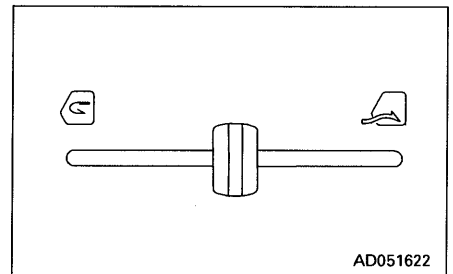

AD051622

2. BLOWER SWITCH

This acts as the wind flow control switch and main switch when cooling or heating.

- The air flow can be set to three stages: 1 (LOW) → 2 (MEDIUM) → 3 (HIGH).
- If the switch is set to 0, the power is switched off and the heater stops.

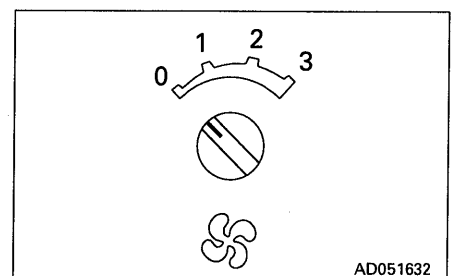

AD051632

3. TEMPERATURE CONTROL LEVER

This is used to control the temperature for heating.

- When the temperature control lever is moved to the right, the temperature of the air coming from the vents becomes lower.
- When the temperature control lever is moved to the left, the temperature of the air coming from the vents becomes higher.

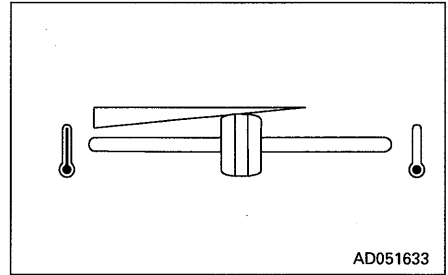

4. STARTING SWITCH

This switch is used to start the engine.

OFF () position: OFF

At this position, the starting switch key can be inserted or removed. When the switch is turned to this position, the electrical circuits are switched off.

Do not the starting switch key at the OFF position while the engine is running.

ON position: ON

In this position, electric current flows in the charging and lamp circuits.

Keep the starting switch key at the ON position while the engine is running.

START () position: START

This is the position to start the engine. Hold the key at this position while cranking. Release the key immediately after the engine has been started. The key will return to ON position when released.

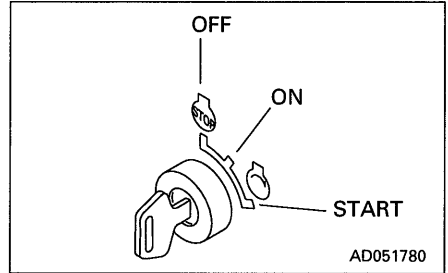

**11.1.4 SWITCH PANEL
(MACHINES EQUIPPED WITH CAB)**

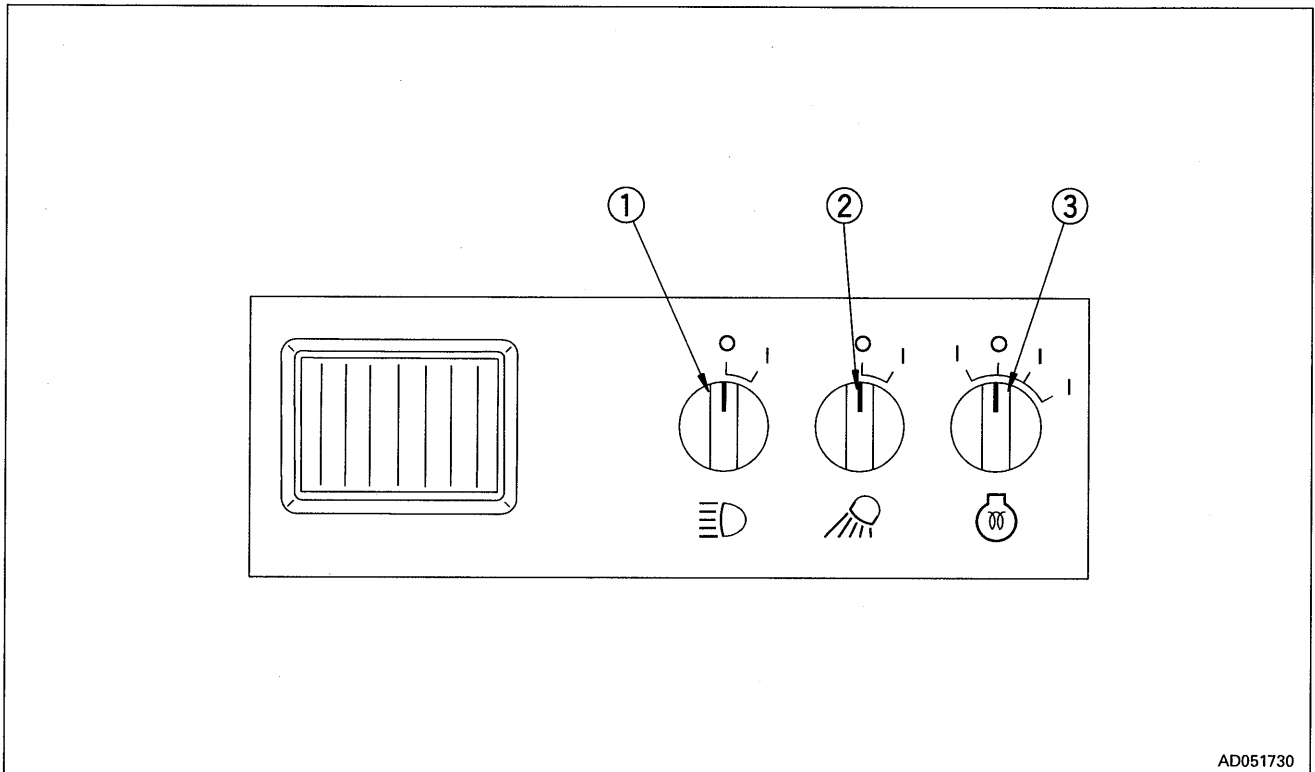

AD051730

1. HEAD LAMP SWITCH

This lights up the head lamps.

OFF position: Lamps are out

ON position: Lamps light up

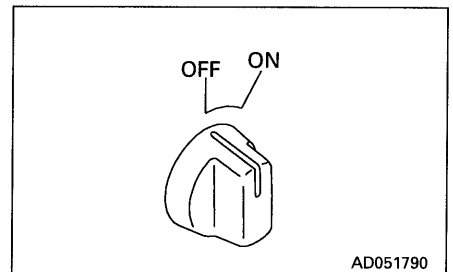

AD051790

2. REAR LAMP SWITCH

This lights up the rear lamps.

OFF position: Lamps are out

ON position: Lamps light up

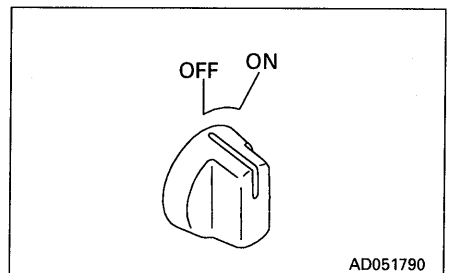

AD051790

3. GLOW SWITCH

This actuates the electrical heater to warm up the engine intake air.

OFF position: The preheating is not actuated.

AUTO position: AUTO preheating is actuated. The length of the preheating time varies according to the ambient temperature when the ambient temperature is below approx. -5°C .

I position: This is used when AUTO preheating is not enough to start the engine in cold weather simply with the glows witch at the AUTO position.

When the switch is released, it will return to the AUTO position.

II position: This is used when carrying out preheating manually without using AUTO preheating.

When the switch is released, it will return to the OFF position.

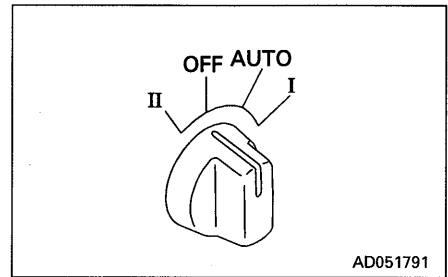

**11.1.5 SWITCH PANEL
(MACHINES EQUIPPED WITH CANOPY)**

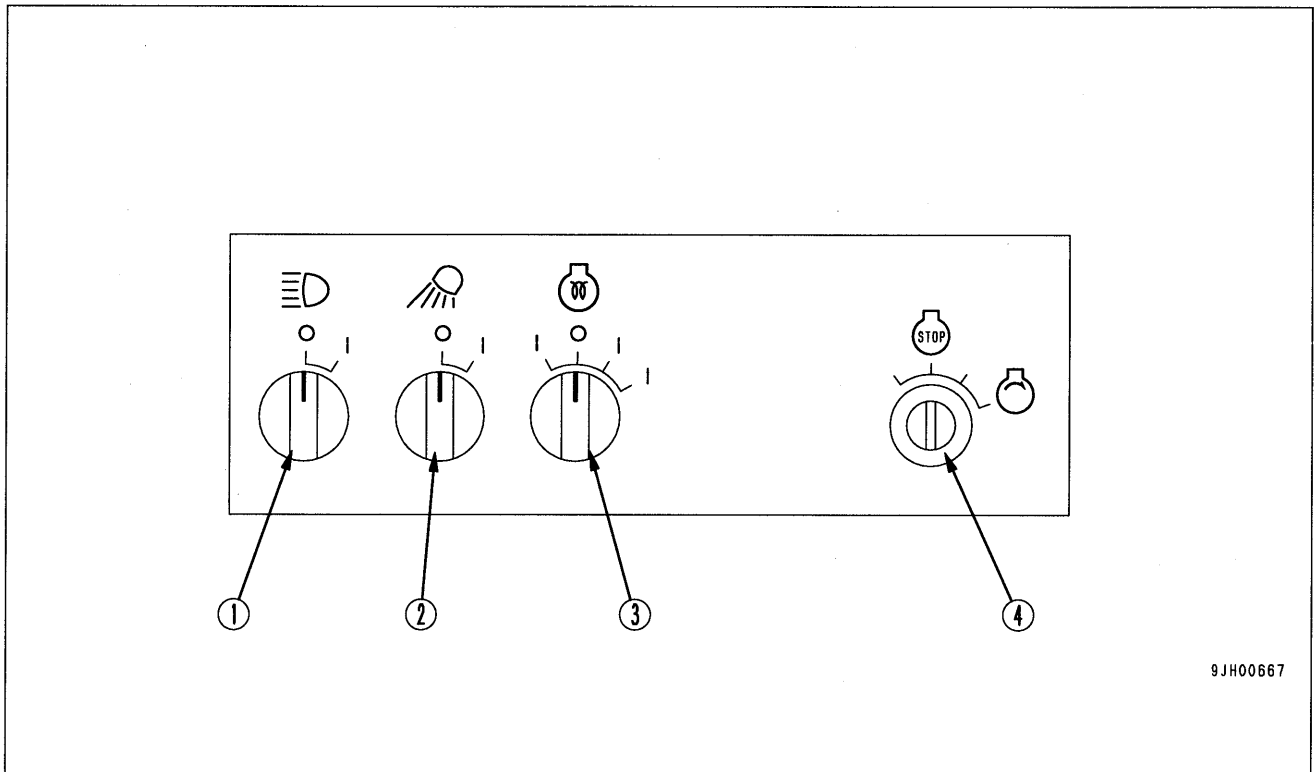

9JH00667

1. HEAD LAMP SWITCH

This lights up the head lamps.

OFF position: Lamps are out
ON position: Lamps light up

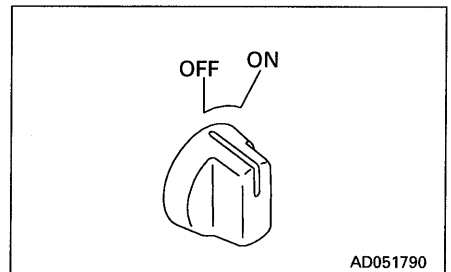

AD051790

2. REAR LAMP SWITCH

This lights up the rear lamps.

OFF position: Lamps are out
ON position: Lamps light up

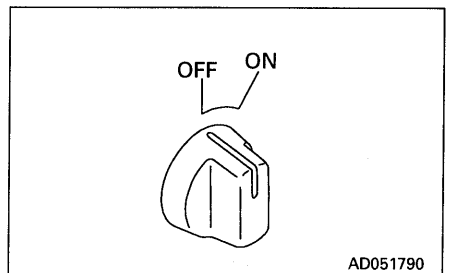

AD051790

3. GLOW SWITCH (MONITOR PANEL SPECIFICATION)

This actuates the electrical heater to warm up the engine intake air.

OFF position: The preheating is not actuated.

AUTO position: AUTO preheating is actuated. The length of the preheating time varies according to the ambient temperature when the ambient temperature is below approx. -5°C .

I position: This is used when AUTO preheating is not enough to start the engine in cold weather simply with the glow switch at the AUTO position.

When the switch is released, it will return to the AUTO position.

II position: This is used when carrying out preheating manually without using AUTO preheating.

When the switch is released, it will return to the OFF position.

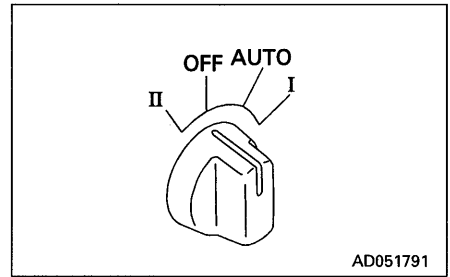

4. STARTING SWITCH

This switch is used to start the engine.

OFF (STOP) position: OFF

At this position, the starting switch key can be inserted or removed. When the switch is turned to this position, the electrical circuits are switched off.

Do not the starting switch key at the OFF position while the engine is running.

ON position: ON

In this position, electric current flows in the charging and lamp circuits.

Keep the starting switch key at the ON position while the engine is running.

START () position: START

This is the position to start the engine. Hold the key at this position while cranking. Release the key immediately after the engine has been started. The key will return to ON position when released.

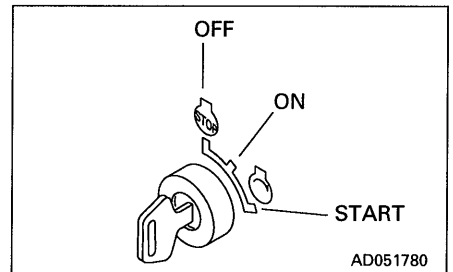

11.2 SWITCHES

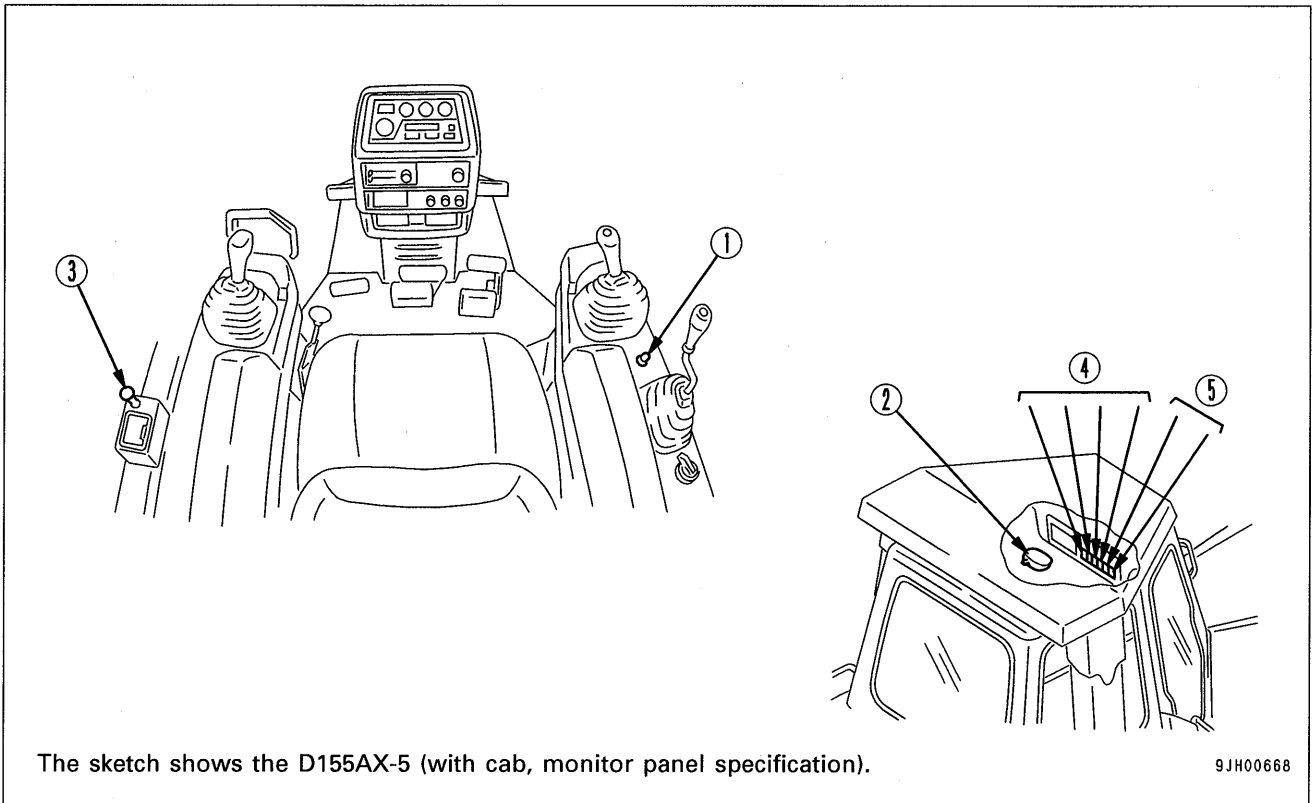

The sketch shows the D155AX-5 (with cab, monitor panel specification).

9JH00668

1. HORN SWITCH

The horn sounds when the button at the rear of the blade control lever at the right side of the operator's seat is pressed.

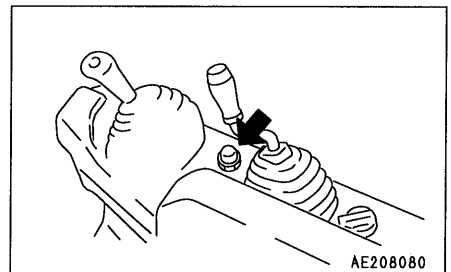

AE208080

2. ROOM LAMP SWITCH (MACHINES EQUIPPED WITH CAB)

This lights up the room lamp.

ON position: Lamp lights up

OFF position: Lamp is out

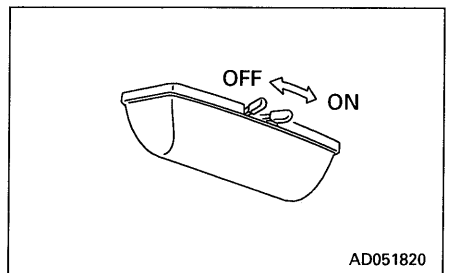

AD051820

3. CIGARETTE LIGHTER (MACHINES EQUIPPED WITH CAB)

This is used to light cigarettes.

When the cigarette lighter is pushed in, it will return to its original position after a few seconds, so take it out to light your cigarette.

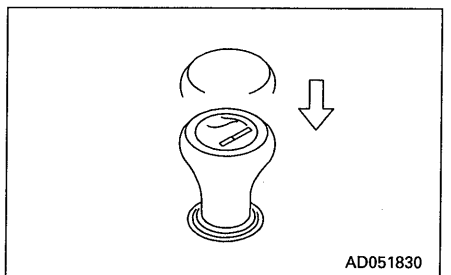

AD051830

NOTICE

This cigarette lighter is 24V. Do not use it as the power source for 12 V equipment.

The capacity of the cigarette lighter is 120 W.

4. WIPER SWITCH (MACHINES EQUIPPED WITH CAB)

This activates the wipers.

The wiper switches are as follows.

- Ⓐ Left door
- Ⓑ Front window
- Ⓒ Right door
- Ⓓ Rear window

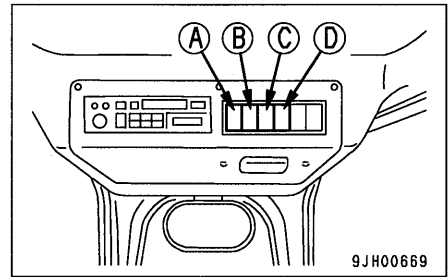

This is also used as the window washer switch.
The switch is operated as follows.

- Window washer only
Keep the switch pressed to the OFF position to spray out water.
- Wiper only
If this is switched on, the wiper will start.
- Wiper and window washer
If this is kept pressed to the ON position while the wiper is working, water will be sprayed out.

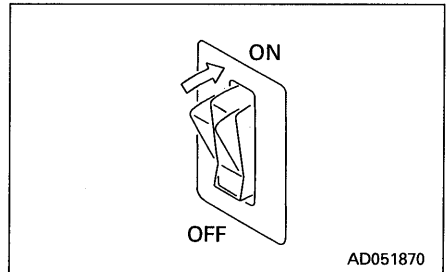
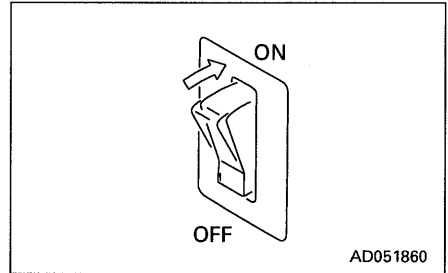
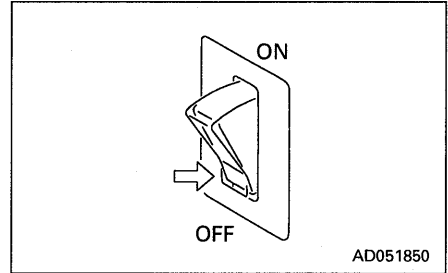

5. ADDITIONAL WORKING LAMP SWITCH (MACHINES EQUIPPED WITH CAB)

This is used to turn on the additional working lamp.

- Ⓐ Head lamp switch
- Ⓑ Rear lamp switch

Push in the direction of the arrow to turn on the lamps.

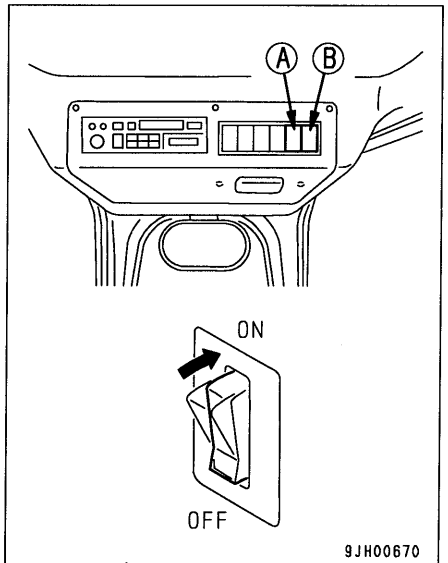

REMARK

When installing the cab, check the colors of the washer tank and window washer hoses, and be sure to connect correctly.

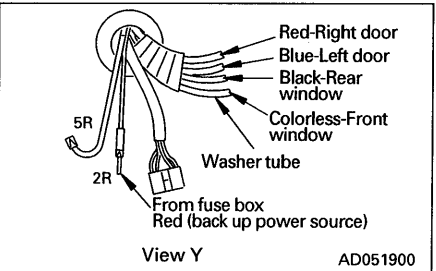
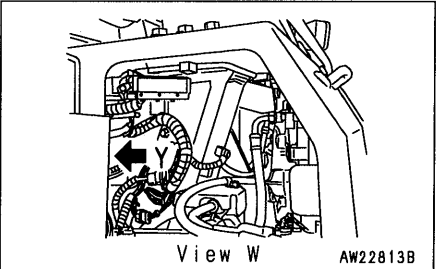
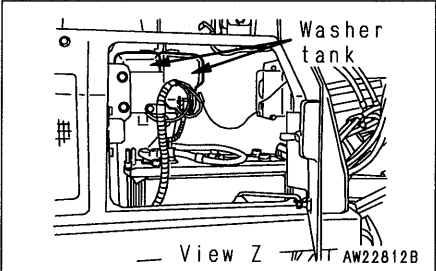
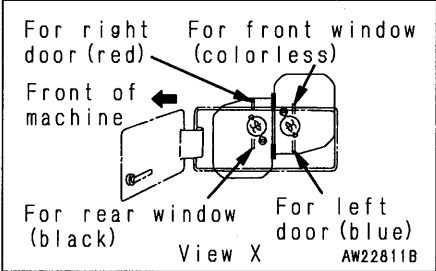
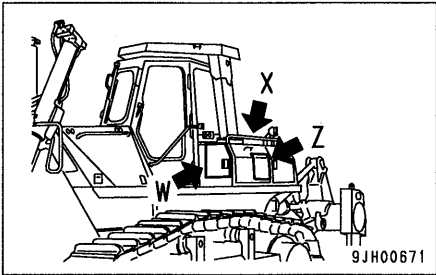

11.3 CONTROL LEVERS, PEDALS, DIAL

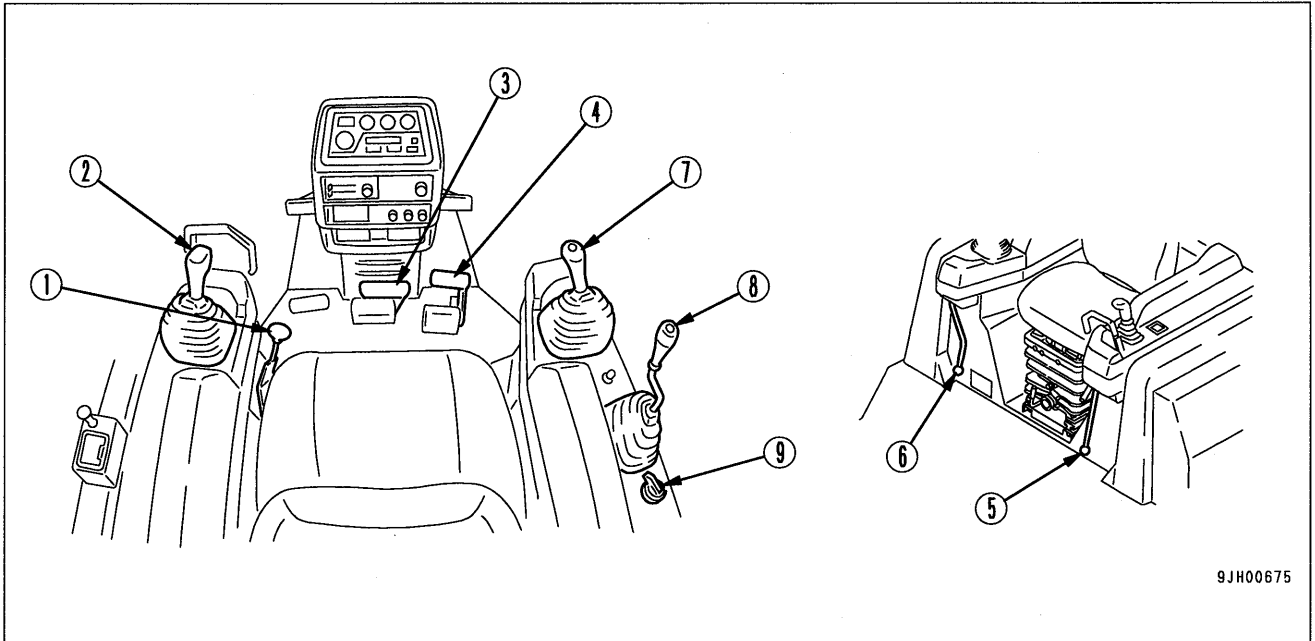

9JH00675

1. FUEL CONTROL LEVER

This is used to adjust the engine speed and output.

- a Engine stop: Push lever fully to front
- b Low idling: Pull lever back from position a to position where operating effort changes (becomes lighter)
- c Full throttle: Pull lever back fully from position b

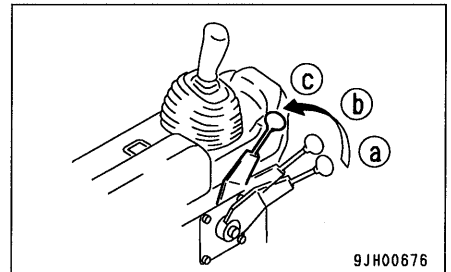

9JH00676

2. JOYSTICK (STEERING, DIRECTIONAL AND GEAR SHIFT LEVER)

WARNING

- When turning while traveling at the maximum speed, it will take 5 to 10 seconds before the machine turns in a pivot turn. The slower the travel speed, the shorter this time becomes. Be careful not to hit any obstacle when operating.
- When switching between forward and reverse, change of actual machine travel direction will take slightly longer than on the conventional TORQFLOW machine. When operating in dangerous places, such as the edge of a cliff, carry out direction change between forward and reverse earlier.

This lever is used to switch between forward and reverse to steer and gear shift the machine or carry out counterrotation turns.

- Switching between forward and reverse
 - Position ① : FORWARD
 - Position ② : REVERSE
 - Position N : Neutral
- Steering operations
 - Position ③ : Left turn
 - Position ④ : Right turn

When the lever is pushed forward, the machine will travel forward, and when it is moved back, the machine will travel in reverse.

When the lever is being set to the FORWARD or REVERSE position, if it is moved to the left or right to steer the machine, the machine will turn smoothly in the direction of the lever with a turning angle that matches the amount the lever is moved.

If this lever is operated fully to the left or right, the turning radius will become smaller.

REMARK

- When carrying out turning operations, if the lever is released, it will return to position ① or ② and the machine will travel in a straight line.
- During steering operations, if you use the lever guide to support your hand, the turning performance will be improved.

● **Gear shifting**

Rotate the joystick 30° to carry out gear shifting operation.

- Position ① : 1st
- Position ② : 2nd
- Position ③ : 3rd

For details of the maximum speed at each speed range, see "25. SPECIFICATIONS".

When gear shifting operation is carried out, the display panel at the rear of the joystick will display the speed range.

- 1st: ① is displayed on the display panel
- 2nd: ② is displayed on the display panel
- 3rd: ③ is displayed on the display panel

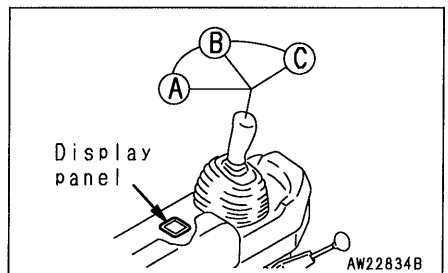
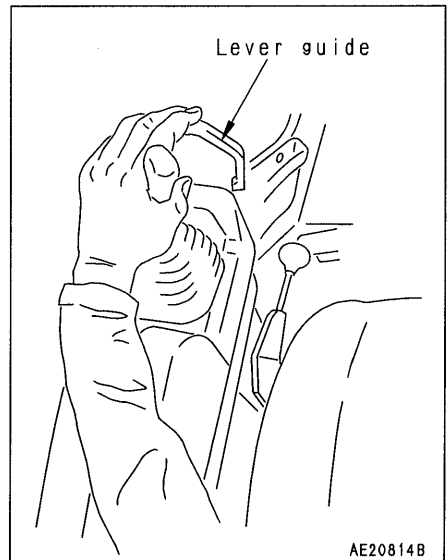
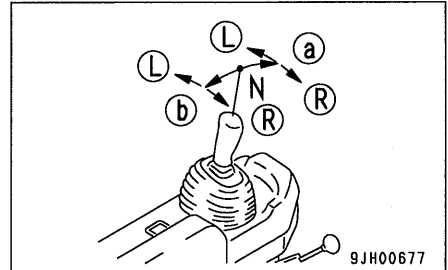

11. EXPLANATION OF COMPONENTS

● Counterrotation turn

WARNING

When carrying out a counterrotation turn, if the load is not equal on the left and right sides, the machine may carry out a pivot turn, so check the ground conditions and be careful not to hit any obstacles.

If the steering and directional lever is operated partially in the direction of turn with the lever at the **N** position, the left and right tracks will rotate in opposite directions and the machine will turn smoothly on the spot. If the steering lever is operated fully, the speed of the counterrotation turn will increase.

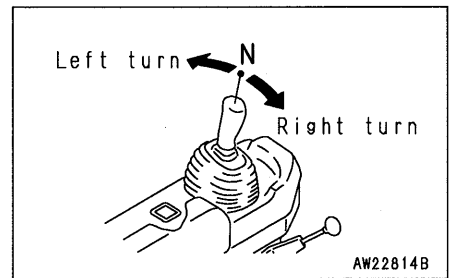

3. BRAKE PEDAL

WARNING

Do not place your foot on this pedal unnecessarily.

Depress the pedal to apply the right and left brakes.

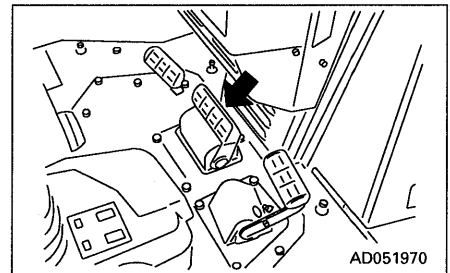

4. DECELERATION PEDAL

WARNING

- Do not place your foot on this pedal unnecessarily.
- When passing over the top of a hill or when a load is dumped over a cliff, the load is suddenly reduced, so there is danger that the travel speed will also increase suddenly. To prevent this, depress the decelerator pedal to reduce the travel speed.

This pedal is used for reducing the engine speed or stopping the machine.

Depress this pedal to reduce the speed when shifting between forward and reverse or when stopping the machine.

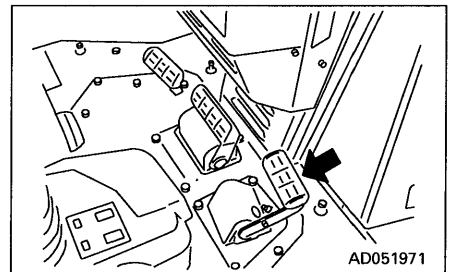

5. PARKING LEVER

WARNING

When the machine is parked, always set the parking lever to the **LOCK** position.

This lever is used to apply the parking brake.

REMARK

- If the steering, directional, and gearshift lever is at the FORWARD or REVERSE position and the parking brake lever is operated to the LOCK position, the steering, directional, and gearshift lever is automatically returned to the N position.
- When starting the engine, if the parking lever is not at the lock position, the limit switch is actuated and the engine does not start.

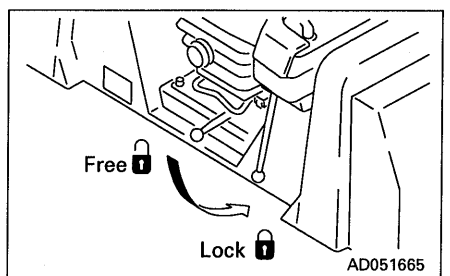

6. SAFETY LEVER (FOR BLADE CONTROL LEVER, RIPPER CONTROL LEVER)

WARNING

- When standing up from the operator's seat, always set the safety lever securely to the LOCK position.
If the blade control and ripper control levers are not locked and are touched by accident, it may lead to serious injury or damage.
- If the safety lever is not set securely to the LOCK position, the lock may not be applied.
Check that it is in the position shown in the diagram.
- When parking the machine or when carrying out maintenance, always lower the blade and ripper to the ground, then set the safety lever to the LOCK position.

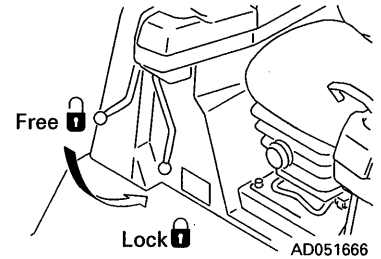

This safety lever is a device to lock the blade control and ripper control levers.

When it is set to the LOCK position, the TILT, RAISE, LOWER, and FLOAT operations are locked.

If the blade control lever is at the FLOAT position and the safety lever is set to the LOCK position, the blade control lever is automatically returned to the HOLD position.

7. BLADE CONTROL LEVER (POWER TILTDOZER)

This lever is used to raise or tilt the blade.

Lifting control

(a) RAISE : ()

(b) HOLD : ()

Blade is stopped and held in this position.

(c) LOWER : ()

(d) FLOAT : ()

Blade will move freely according to external force.

REMARK

- When released from FLOAT position, this lever will not return to HOLD position, so it must be moved back by hand.
- When starting the engine, set the blade control lever to the HOLD position.
If it is at the FLOAT position, the engine will not start.

Tilting control

(A) LEFT TILT : ()

(B) RIGHT TILT : ()

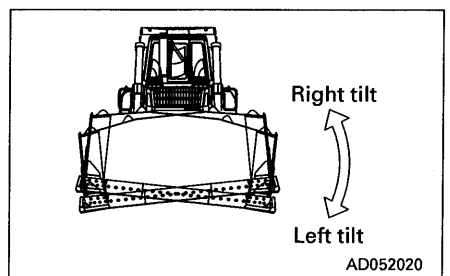
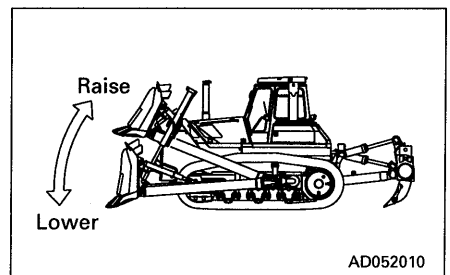
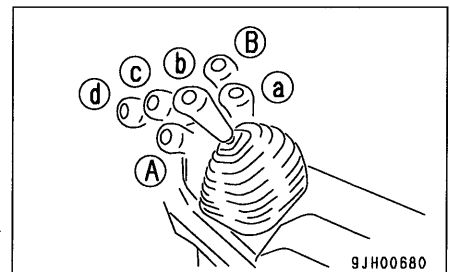

**7. BLADE CONTROL LEVER
(FOR POWER TILT, POWER PITCH DOZER)**

This carries out the blade lift, tilt, and pitch operations.

Lifting control

(a) RAISE : ()

(b) HOLD : ()

Blade is stopped and held in this position.

(c) LOWER : ()

(d) FLOAT : ()

Blade will move freely according to external force.

REMARK

- When released from FLOAT position, this lever will not return to HOLD position, so it must be moved back by hand.
- When starting the engine, set the blade control lever to the HOLD position.
If it is at the FLOAT position, the engine will not start.

Tilting control

(A) LEFT TILT : ()

(B) RIGHT TILT : ()

Pitch control

(C) + (A) REAR PITCH: Min. digging angle (press switch (C), then operate (A))

(C) + (B) FORWARD PITCH: Max. digging angle (press switch (C), then operate (B))

First set the lever to the neutral position, then keep switch (C) in the center of the knob pushed down and carry out the tilt operation to change the cutting angle of the blade.

Precautions when using pitch control



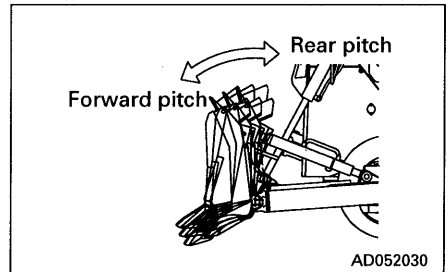
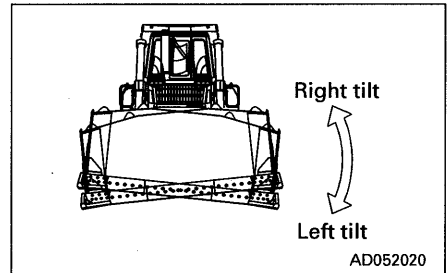
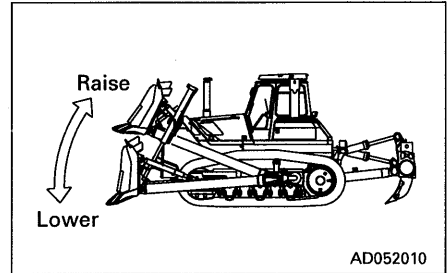
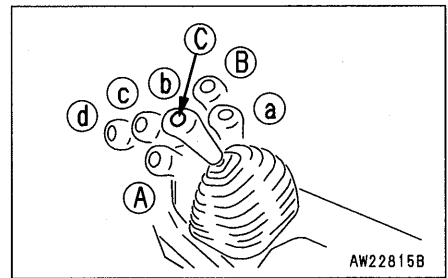

When using the pitch operation, the tilt operation changes as follows.



Pitch condition	Tilt operation	Amount of tilt
Max. forward pitch	Only left tilt operation is possible	Max. 1000 mm (39.4 in)
Forward pitch	Both left and right tilt operations are possible	Compared with standard: LEFT tilt is LARGER RIGHT tilt is SMALLER
Standard pitch		500 mm ((19.7 in) both left and right)
Rear pitch		Compared with standard: LEFT tilt is SMALLER RIGHT tilt is LARGER
Max. rear pitch	Only right tilt operation is possible	Max. 1000 mm (39.4 in)

8. RIPPER CONTROL LEVER (FOR VARIABLE RIPPER)

This is used to operate the ripper.

- Ⓐ RAISE ()
- Ⓑ HOLD (): Ripper is stopped and held in the same position.
- Ⓒ LOWER ()
- Ⓐ Digging angle reduced () : Cutting angle (α) becomes smaller.
- Ⓑ Digging angle increased () : Cutting angle (α) becomes larger.

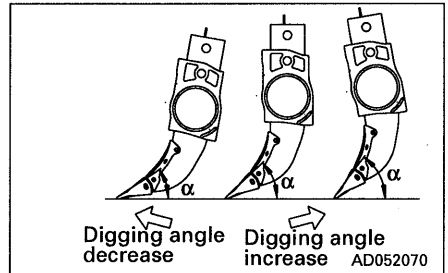
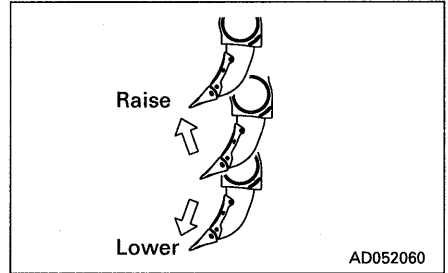
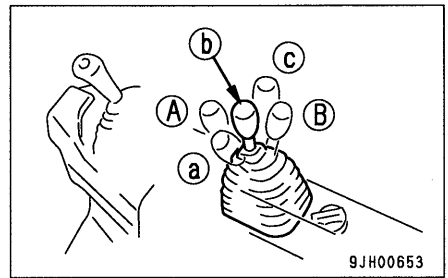

9. PIN PULLER CONTROL SWITCH (FOR GIANT RIPPER)

This is used to operate the pin puller.

- ① PULL OUT: Pin is pulled out.
- ② PUSH IN: Pin is pushed in.

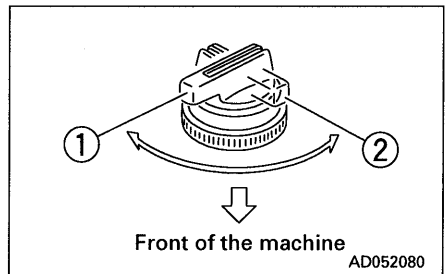

11.4 DUST INDICATOR

This device indicates that the air cleaner element is clogged. For details on how to clean the element, see "24.2 WHEN REQUIRED."

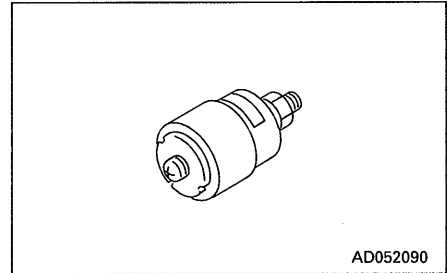
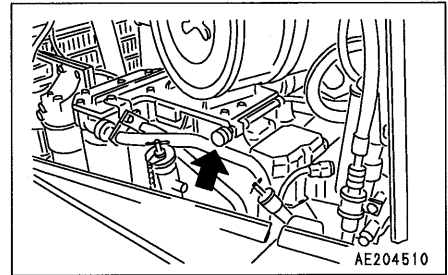

11.5 POWER SOURCE

The cigarette lighter socket can be used as a power source.

NOTICE

The power from the cigarette lighter socket is 24 V. Do not use this as the power source for any 12 V equipment.

The capacity of the cigarette lighter power source is 120 W (24V x 5A).

11.6 FUSE BOX

NOTICE

Before replacing a fuse, be sure to turn off the starting switch.

The fuses protect the electrical equipment and wiring from burning out.

If the fuse becomes corroded, or white powder can be seen, or the fuse is loose in the fuse holder, replace the fuse.

Replace a fuse with another of the same capacity.

- Chassis
When the battery cover is opened, fuse box ① can be found inside.

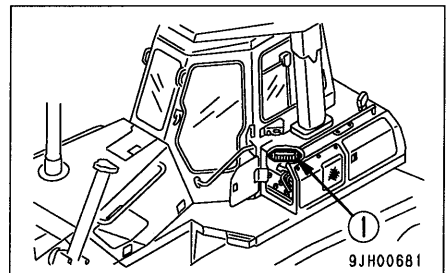

- Cab (machines equipped with cab)
Fuse box ② is installed at the bottom of the overhead panel.

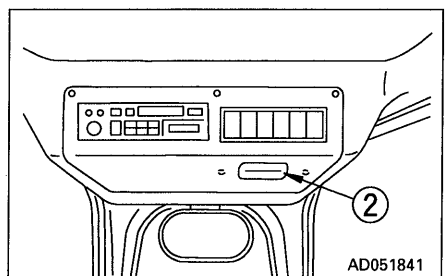

11.6.1 FUSE CAPACITY AND NAME OF CIRCUIT

Fuse box ①

No.	Fuse capacity	Circuit	Remarks
①	15 A	Horn	
②	-	-	
③	20 A	Rear lamp	
④	20 A	Front lamp	
⑤	10 A	Controller, HSS	
⑥	-	-	
⑦	-	-	
⑧	20 A	Pin puller, air conditioner	
⑨	20 A	Backup alarm	
⑩	10 A	Cab, key switch	Power circuit

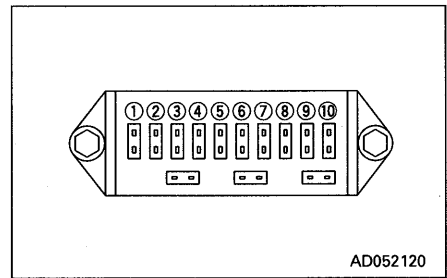

Fuse box ② (machine equipped with cab)

No.	Fuse capacity	Circuit
①	10 A	Radio memory
②	20 A	Radio, lamp, cigarette lighter
③	10 A	Rear wiper
④	10 A	Right door wiper
⑤	10 A	Front wiper
⑥	10 A	Left door wiper

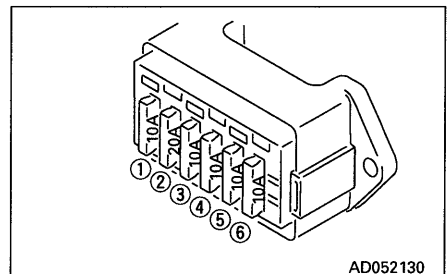

11.7 DOOR-OPEN LOCK (MACHINES EQUIPPED WITH CAB)

Use this when you want to keep the door held open.

1. Push the door against door catch ①. The door will be held by the door catch.
2. To release the door, move lever ② inside the cab to the front of the cab. This will release the catch.

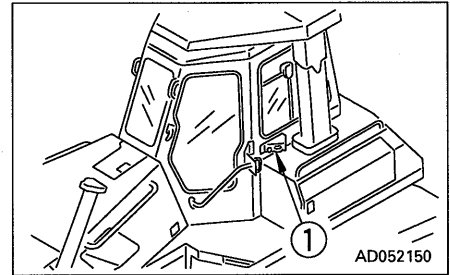

NOTICE

- When keeping the door open, fix it securely to the catch.
- Always close the door when traveling or carrying out operations. Leaving the door open will cause the door to break.
- Keep the door locked open securely.
The door may swing closed because of the vibration.

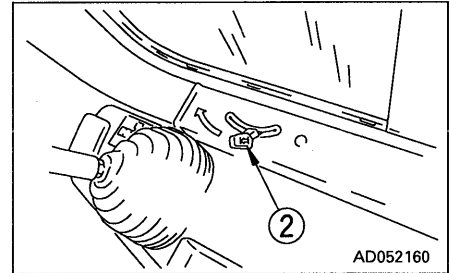

11.8 SASH GLASS INTERMEDIATE LOCK (MACHINES EQUIPPED WITH CAB)

When carrying out operations with the cab sash glass open, use this block to prevent the glass from moving.

- When the lever is at the FREE position, the glass can be opened or closed.
- When the lever is moved to the LOCK (up or down) position, the glass is fixed in position.
- If the glass is not held securely, set the lever in the FREE position and rotate clockwise to strengthen the holding power.
- To reduce the holding power, turn counterclockwise.

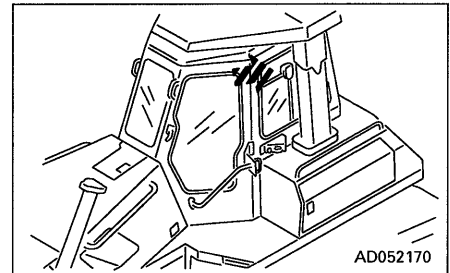

NOTICE

Always close the window when traveling or carrying out operations. Leaving the window open will cause the window to break.

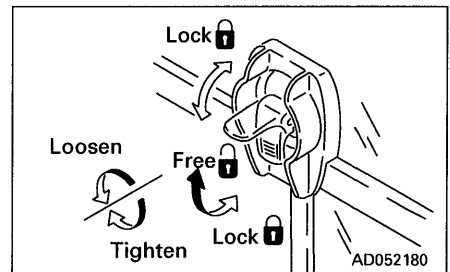

11.9 HOT AND COOL BOX (MACHINES EQUIPPED WITH CAB)

This is at the top of the front panel. It can be used to warm or cool three canned drinks.

This is interconnected with the air conditioner: During heating, it warms up the drinks; during cooling, it cools to the drinks.

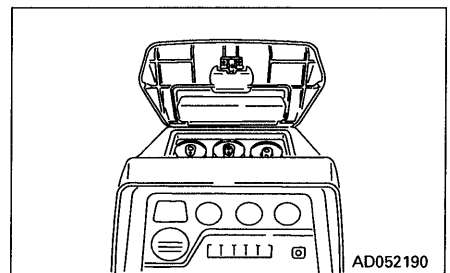

11.10 DOOR POCKET (MACHINES EQUIPPED WITH CAB)

These are on the inside of the left and right doors, and can be used for keeping things. However, do not put tools or other heavy objects in the pocket. If the pocket becomes dirty, turn three clips ①, remove the pocket and wash it.

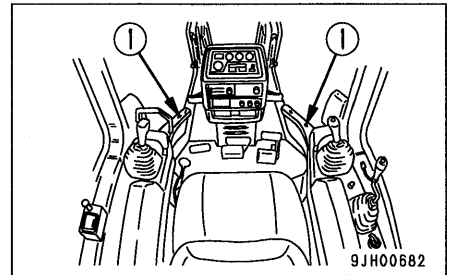

11.11 ASHTRAY (MACHINES EQUIPPED WITH CAB)

This is on the left side of the operator's seat.

Always make sure that you extinguish the cigarette before closing the lid.

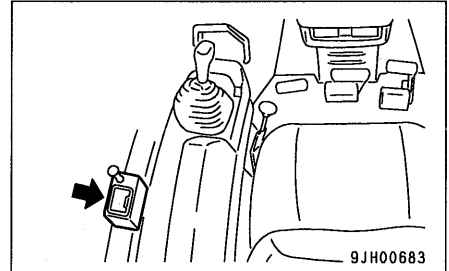

11.12 TOOL BOX

This is inside the right engine side cover. It is used for storing tools.

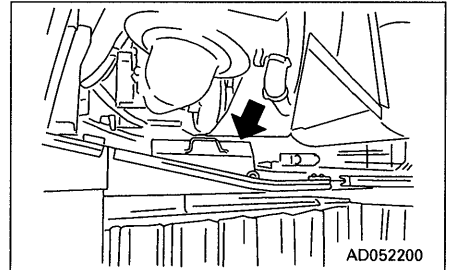

11.13 USING CAR RADIO (MACHINES EQUIPPED WITH CAB, CAR RADIO)

11.13.1 EXPLANATION OF PARTS

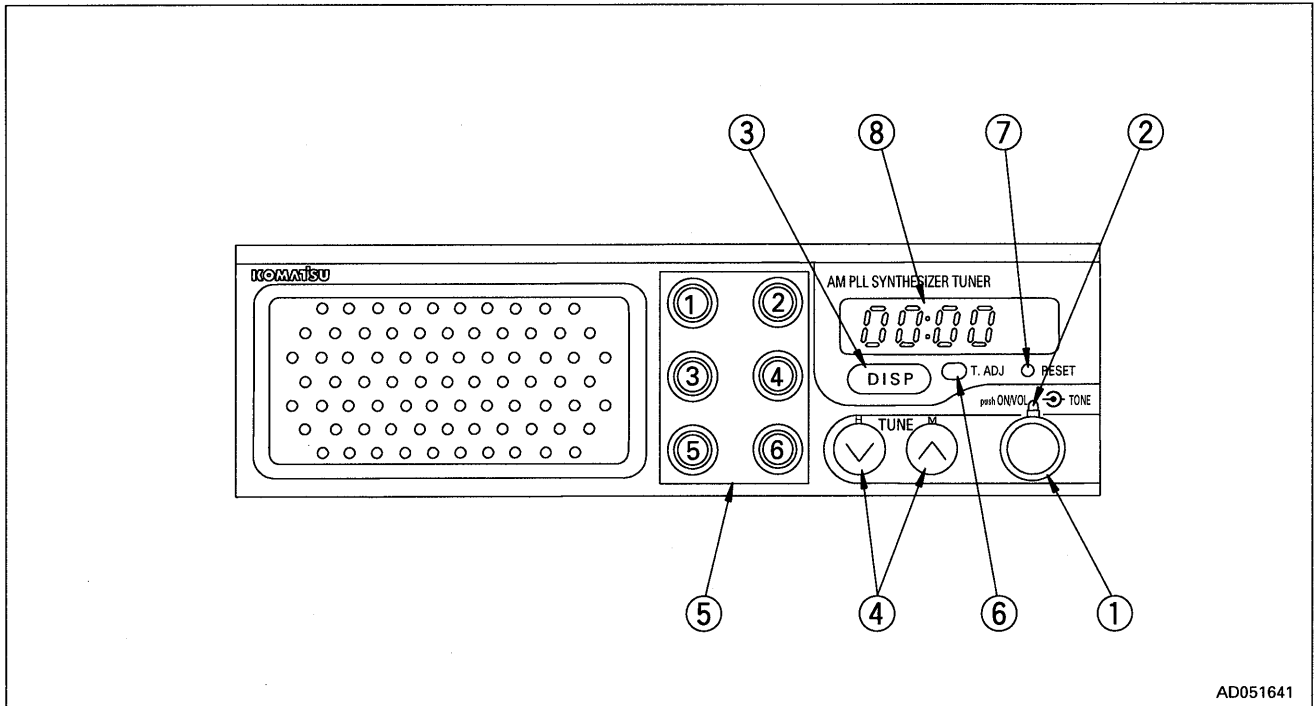

AD051641

1. POWER SWITCH/VOLUME CONTROL KNOB (PUSH ON/VOL)

Push this knob to switch the radio on. The lighting in display area ⑧ will light up and the frequency will be displayed. Press again to switch the power off.

Turn the knob clockwise to increase the sound, and counterclockwise to reduce it.

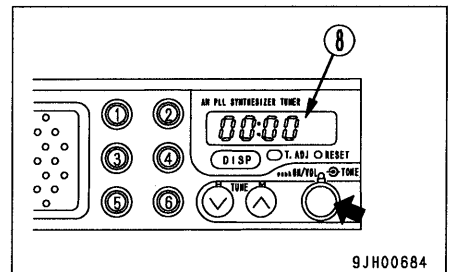

9JH00684

2. TONE CONTROL KNOB (TONE)

Turn this knob clockwise from the center position to emphasize the high sounds, and counterclockwise to emphasize the low sounds.

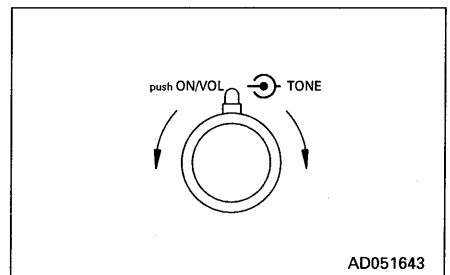

AD051643

3. DISPLAY BUTTON (DISP)

If the display button is pressed when the radio is being used, the frequency of the station being listened to is displayed for 5 seconds.

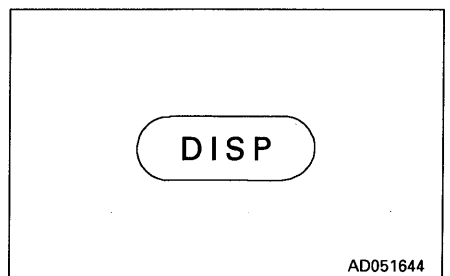

AD051644

4. TUNING/HOUR, MIN ADJUSTMENT BUTTON (TUNE)

This is used to select the station or change the frequency.

If the station UP button \wedge is pressed, the frequency will go up by 9 kHz each time it is pressed; if the station DOWN button \vee is pressed, the frequency will go down 9 kHz each time it is pressed.

If these buttons are kept pressed for more than 2 seconds, the station will be selected automatically.

When adjusting the time, these change the hour display and minute display.

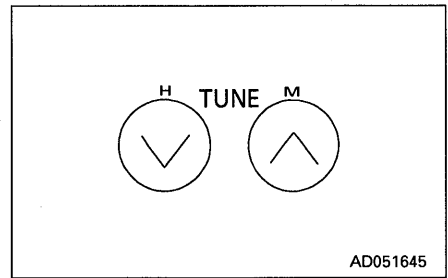

5. PRESET BUTTON (1, 2, 3, 4, 5, 6)

These buttons can be used to program the desired broadcasting stations. It is then possible to select the station at a touch.

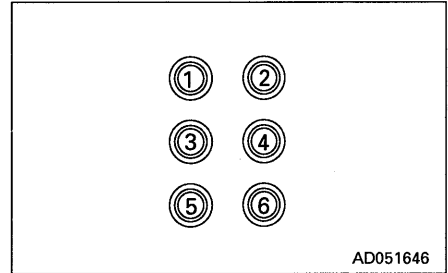

6. TIME ADJUSTMENT BUTTON (T,ADJ)

Press this button to adjust the time.

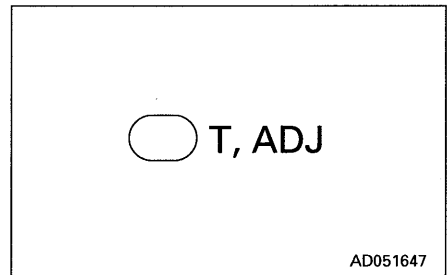

7. TIME RESET BUTTON (RESET)

Press this button to reset to the exact hour.

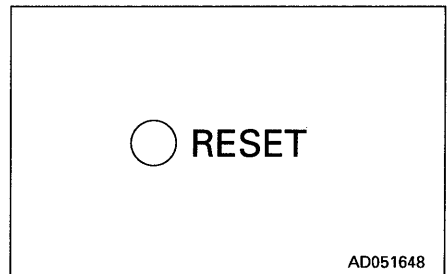

8. DISPLAY

This displays the frequency, time, and preset symbols.

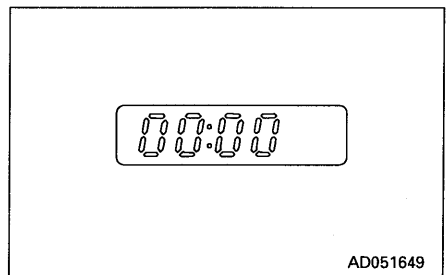

11.13.2 METHOD OF USE

Method of setting preset buttons

1. Press power switch ①. The frequency is displayed in display area ⑧.
2. Use selector button ④ (∧ or ∨) to adjust to the desired frequency.
3. Choose a preset button to use for this station, and keep it pressed for at least 2 seconds to program the button to that frequency.

When the sound suddenly disappears and appears again, the button is programmed, and the preset number is shown in display area ⑧.

After programming the button, press the preset button and release it within approx. 2 sec. The station programmed to that button will be selected for reception.

It is possible to program one station for each preset button.

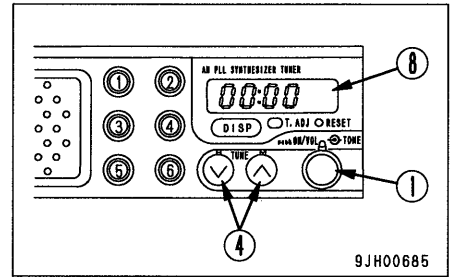

Method of manual tuning

Press the tuning button lightly to adjust to the desired frequency. Each time the button is pressed, the frequency will change by 9 kHz.

∧ button: Select station at higher frequency

∨ button: Select station at lower frequency

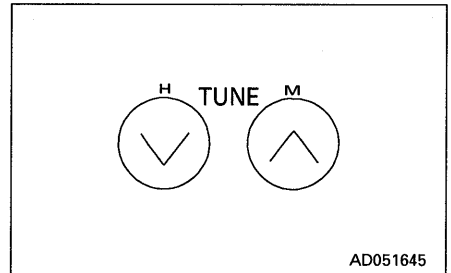

AD051645

Method of automatic tuning

Keep the tuning button pressed for at least 2 seconds and then release it. When reception from a broadcasting station is picked up, the selector will automatically stop at that position.

When searching for the next station, keep the selector button pressed again for at least 2 seconds.

∧ button: Select station at higher frequency

∨ button: Select station at lower frequency

If the reception is weak, and stations are not found, adjust the frequency manually to select the desired station.

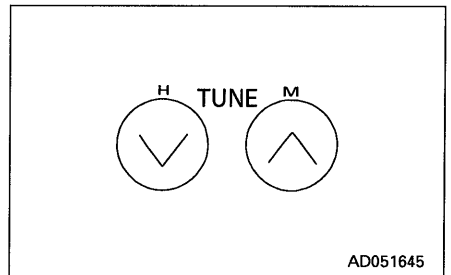

AD051645

Adjusting time

1. Keep T.ADJ button ⑥ pressed, and press H button ①.
The hour display will change, so when it reaches the correct hour, release the button.
2. Keep T.ADJ button ⑥ pressed and press M button ②.
The minute display will change, so when it reaches the correct time, release the button.

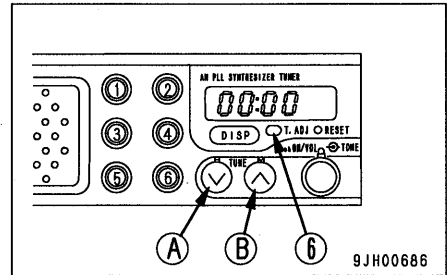
**Method of using RESET button**

If RESET button ⑦ is pressed at the same time as the time signal or standard time, the display will return immediately to the exact hour (○ hour 00 min).

If the display is 01 – 29 min, the display will go back to 0 min.

If the display is 30 – 59 min, the display will advance to 0 min.

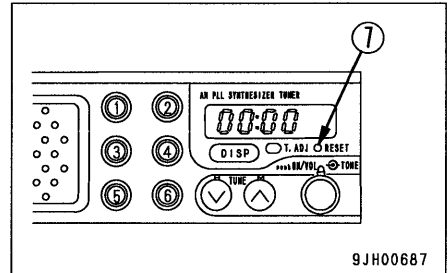
**[Example]**

10:29 → 10:00 (return to exact hour)

10:30 → 11:00 (advances to exact hour)

11.13.3 PRECAUTIONS WHEN USING

- For safety reasons, when operating keep the sound to a level where you can enjoy the sound but still hear the sound from outside vehicles.
- If water gets inside the speaker case or car radio (auto tuning), it may cause a serious problem, so do not let water get on these parts.
- Do not wipe the knobs or buttons or any other parts with any solvent such as benzene or thinner. Always wipe with a soft dry cloth (in cases of extreme dirt, use alcohol on the cloth).

11.14 HANDLING AIR CONDITIONER (MACHINES EQUIPPED WITH CAB)

11.14.1 COOLING OPERATION

When the cooling operation is carried out, the inside of the cab is cooled, and at the same time the drinks inside the hot and cool box can be cooled.

Cooling (RECIRC)

When the control switch and lever are operated as shown in the diagram, a cool breeze is sent out.

Use this position when strong cooling is needed.

- Press switch ②.
- Place levers ① and ④ in the position shown in the diagram.
- Set switch ③ to the desired position.

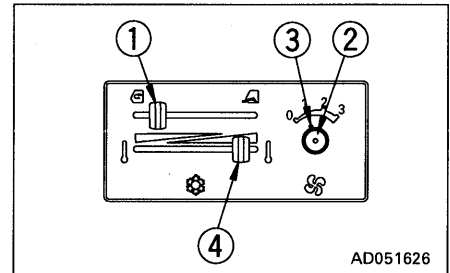

AD051626

Cooling (FRESH)

If the air inside the cab is no longer fresh, set FRESH/RECIRC selector lever ① to FRESH to bring in fresh air. Keep the other switches at the same positions as for cooling (RECIRC).

In this position, the inside of the cab is pressurized to prevent the entry of dust.

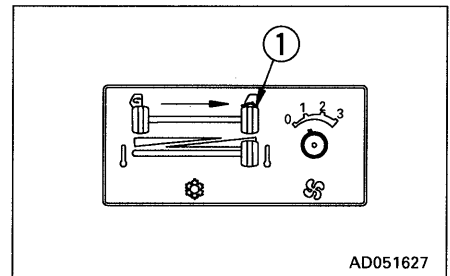

AD051627

REMARK

- If the cooling effect is reduced, set FRESH/RECIRC selector lever ① to RECIRC again. This increases the cooling effect.
- New Freon R134a is used as the refrigerant.
- The tightening torque for the air conditioner gas piping thread is as follows.

Thread size	Tightening torque Nm (kgm)
Discharge 22 x 1.5	19.6 – 24.5 (2 – 2.5)
Liquid 16 x 1.5	11.8 – 14.7 (1.2 – 1.5)
Suction 24 x 1.5	29.4 – 24.3 (3 – 3.5)

11.14.2 HEATING OPERATION

When the heating operation is carried out, the inside of the cab is heated, and at the same time the drinks inside the hot and cool box can be heated.

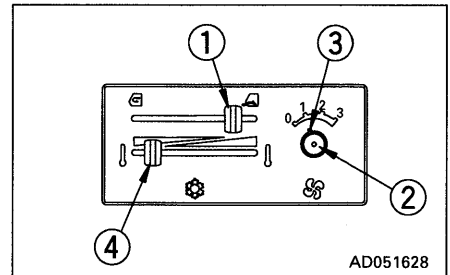

Heating (RECIRC)

When the control switch and lever are operated as shown in the diagram, warm air is sent out. Use this position when strong cooling is needed.

- Place levers ① and ④ in the position shown in the diagram.
- Set switch ③ to the desired position.

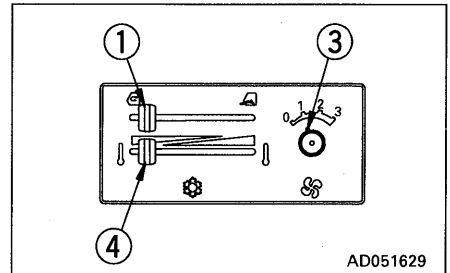

Heating (FRESH)

If the air inside the cab is no longer fresh, set FRESH/RECIRC selector lever ① to FRESH to bring in fresh air. Keep the other switches at the same positions as for heating (RECIRC). In this position, the inside of the cab is pressurized to prevent the entry of dust.

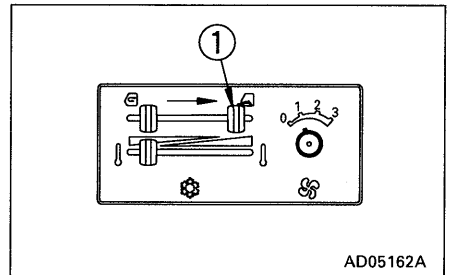

REMARK

If the cab is not heated up sufficiently, turn FRESH/RECIRC selector lever ① back to RECIRC. This increases the heating effect.

Dehumidifying and heating

Push switch ②. When temperature control lever ④ is placed at the central position, dry warm air blows out.

Keep the other switches at the same positions as for heating (FRESH).

REMARK

If this is used in spring and fall on rainy days when the air inside the cab is damp, there is no problem of the windows misting up, and the cab be warmed up to a comfortable temperature.

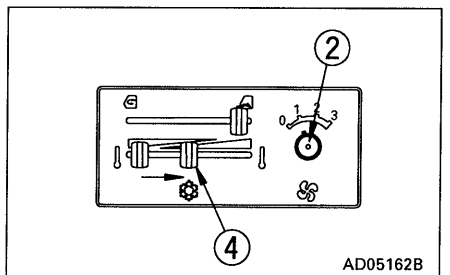

11.14.3 PRECAUTIONS WHEN USING AIR CONDITIONER

Carry out ventilation from time to time when using the cooler.

- If you smoke when the cooler is on, the smoke may start to hurt your eyes, so turn the lever to FRESH to remove the smoke while continuing the cooling.
- When running the air conditioner for a long time, turn the lever to the FRESH position once an hour to carry out ventilation and cooling.

Be careful not to make the temperature in the cab too low.

- When the cooler is on, set the temperature so that it feels slightly cool when entering the cab (5 – 6°C lower than the outside temperature). This temperature difference is considered to be the most suitable for your health, so always be careful to adjust the temperature properly.

Direction of vents when cooling

- If the vents (left and right) in the middle of the dashboard are turned so that cold air plays directly on the cab door glass, moisture may condense on the outside of the cab door glass and reduce the visibility. (This occurs particularly in high temperatures.)

If this happens, turn the vent fully to the rear and raise the air conditioner temperature setting slightly.

11.14.4 INSPECTION DURING OFF-SEASON

Even during the off-season, run the compressor at low speed for several minutes once a week to prevent the loss of the oil film at the lubricated parts of the compressor. (Run the engine at low speed and set the temperature control lever at the central position.)

REMARK

When the ambient temperature is low, if the compressor is suddenly run at high speed, it may cause failure of the compressor.

Note that the system is set so that the compressor will not run when the cooler switch is turned on if the ambient temperature is less than 2 – 6.5°C.

11.14.5 PROCEDURE FOR REPLACING RECEIVER

Replace the receiver once every two years.

After replacing the receiver, add compressor oil. Turn the receiver at an angle and measure the oil remaining inside the receiver, then add the same amount of oil (Denso Oil 6) to fill the receiver.

REMARK

Depending on the condition of use, the replacement interval may be shorter.

REMARK

If the receiver is used when the desiccant has exceeded the water absorption limit, the refrigerant circuit may become clogged and cause failure of the compressor.

Precautions when replacing receiver

- If the receiver is left for more than 15 minutes with the blind cover removed, the moisture in the air will be absorbed, and this will reduce the life of the desiccant. If you remove the blind cover, connect the piping quickly, evacuate the system and fill with refrigerant.
- When removing the refrigerant from the refrigerant circuit, release it gradually from the low pressure side to prevent oil from flowing out.

11.14.6 CLEANING AIR FILTER

If the air filter for the FRESH or RECIRC air intake becomes clogged, the cooling or heating capacity will drop. To prevent this, clean the air filter with compressed air once a week.

For details of the cleaning method, see "24.2 WHEN REQUIRED".

11.14.7 CLEAN AIR CONDITIONER CONDENSER FINS

If the air conditioner condenser fins are clogged, the cooling capacity will drop. To prevent this, clean the air conditioner condenser fins with compressed air.

For details of the cleaning method, see "24.2 WHEN REQUIRED".

11.15 HANDLING HEATER (MACHINES EQUIPPED WITH CAB)

11.15.1 METHOD OF OPERATION

To heat quickly

Set the switches to the position shown in the diagram on the right to carry out heating quickly.

- Set FRESH/RECIRC selector lever ① and temperature control lever ③ to the position in the diagram on the right.
- Set blower switch ② to position 3 (HIGH).

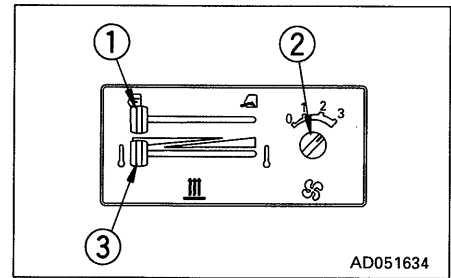

NOTICE

If heating is carried out continuously for a long period with the lever at the RECIRC position, the air inside the cab will become stale, so when the cab is warmed up, always set the FRESH/RECIRC selector lever ① to the FRESH position.

In this position, the inside of the cab is pressurized to prevent the entry of dust.

Normal use

Set each switch to the desired position.

11.15.2 CLEANING AIR FILTER

If the air filter for the FRESH or RECIRC air intake becomes clogged, the heating capacity will drop. To prevent this, clean the air filter with compressed air once a week.

For details of the cleaning method, see "24.2 WHEN REQUIRED".

11.16 HANDLING ACCUMULATOR

WARNING

On machines equipped with an accumulator, for a short time after the engine is stopped, if the work equipment control lever is moved to the LOWER position, the work equipment will move down under its own weight.

After stopping the engine, always place the safety lever in the LOCK position.

The accumulator is filled with high-pressure nitrogen gas, and it is extremely dangerous if it is handled in the wrong way. Always observe the following precautions.

- Never make any hole in the accumulator or expose it to flame or fire.
- Do not weld any boss to the accumulator.
- When disposing of the accumulator, it is necessary to release the gas from the accumulator, so please contact your Komatsu distributor.

The accumulator is a device to store the pressure in the control circuit, and when it is installed, the control circuit can be operated for a short time even after the engine is stopped. Therefore, if the control lever is moved in the direction to lower the work equipment, it is possible for the work equipment to move under its own weight.

The accumulator is installed to the position shown in the diagram on the right.

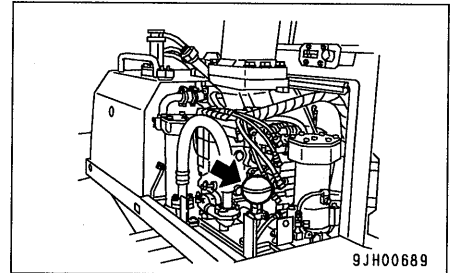

11.16.1 METHOD OF RELEASING PRESSURE IN OPERATING CIRCUIT ON MACHINE EQUIPPED WITH ACCUMULATOR

1. Lower the work equipment and stop the engine.
2. After stopping the engine, operate the control lever fully to the front, rear, left, and right to release the pressure inside the work equipment circuit.

However, the pressure cannot be completely removed, so when removing the work equipment circuit, loosen the screw slowly, and never stand in the direction where the oil spurts out.

11.17 LOCATION OF FIRE EXTINGUISHER

When providing a fire extinguisher, install it in the position shown below.

Position for installing fire extinguisher (select the position)

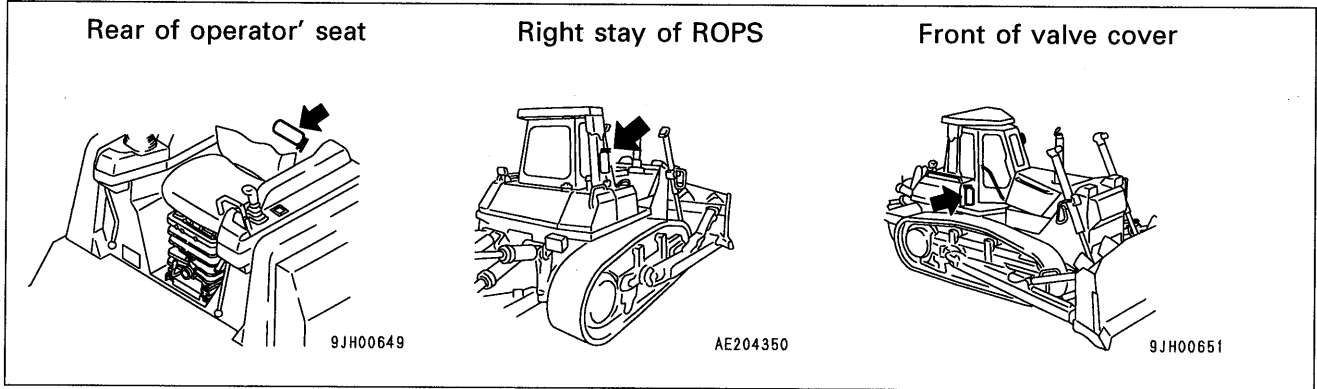

12. OPERATION

12.1 CHECK BEFORE STARTING ENGINE

12.1.1 WALK-AROUND CHECK

 **WARNING**

- **Leakage of oil or fuel, or accumulation of flammable material around high temperature parts, such as the engine muffler or turbocharger, may cause fire.**
Check carefully, and if any abnormality is found, repair it or contact your Komatsu distributor.
- **Do not get on or off the machine from the rear. Using this position is dangerous because it is easy to slip and you cannot be seen from the operator's compartment. Always use the handrail and step at the side when getting on or off the machine.**

When inspecting, if the machine is at an angle, move it to a horizontal place to carry out the check.

Before starting the engine, look around the machine and under the machine to check for loose nut or bolts, or leakage of oil, fuel, or coolant, and check the condition of the work equipment and hydraulic system. Check also for loose wiring, play, and collection of dust at places which reach high temperatures.

Always carry out the items in this section before starting the engine each day.

- 1. Check for damage, wear, play in work equipment, cylinders, linkage, hoses**
Check that there are no cracks, excessive wear, or play in the work equipment, cylinders, linkage, or hoses. If any abnormality is found, repair it.
- 2. Remove dirt and dust from around engine, battery radiator**
Check if there is any dirt or dust accumulated around the engine or radiator. Check also if there is any flammable material (dead leaves, twigs, grass, etc.) accumulated around the battery or high temperature engine parts, such as the engine muffler or turbocharger. Remove all such dirt or flammable material.
- 3. Check for leakage of water or oil around engine**
Check that there is no leakage of oil from the engine or leakage of water from the cooling system. If any abnormality is found, repair it.
- 4. Check for oil leakage of oil from power train case, final drive case, hydraulic tank, hose, joints**
Check that there is no oil leakage. If any abnormality is found, repair the place where the oil is leaking.
Check for leakage of oil from the undercover. Check the ground for traces of oil leakage.

12. OPERATION

- 5. Check the undercarriage (track, sprocket, idler, guard) for damage, wear, loose bolts, or leakage of oil from rollers**
If any damage, wear, or oil leakage is found, repair the problem and tighten the bolts.
- 6. Check for damage to handrail, loose bolts**
Repair any damage and tighten any loose.
- 7. Check for damage to gauges, lamps on instrument panel, loose bolts**
Check that there is no damage to the panel, gauges and lamps. If any abnormality is found, replace the parts. Clean off any dirt on the surface.
- 8. Check for damage to seat belt and mounting clamps**
Check that there is no abnormality in the seat belt or mounting clamps. If there is any damage, replace with new parts.

12.1.2 CHECK BEFORE STARTING

Always carry out the items in this section before starting the engine each day.

CHECK COOLANT LEVEL, ADD WATER

WARNING

Normally, do not open the radiator cap. When checking the cooling water level, check the sub-tank when the engine is cold.

1. Open the engine side cover on the left side of the chassis, and check that the cooling water is between the FULL and LOW marks on sub-tank ①. If the water level is low, add water to the FULL level through the water filler port in sub-tank ①.

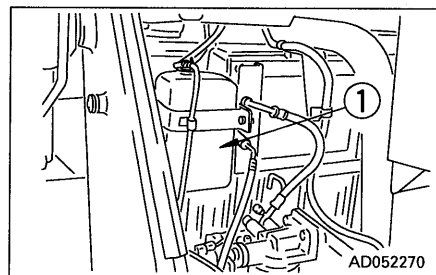

REMARK

In summer, the coolant may overflow from the sub-tank drain hose. This is no problem. It occurs because too much coolant has been added.

2. After adding water, tighten the cap securely.
3. If the sub-tank is empty, check for leakage of water, then add water to the radiator and sub-tank.
4. After adding water, close the engine side cover.

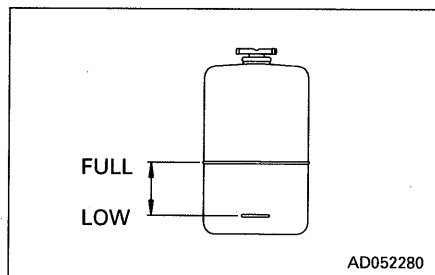

CHECKING WITH MACHINE MONITOR (MONITOR PANEL SPECIFICATION)

1. Turn starting switch ① to the ON position.
2. Check that all monitor lamps light up for 3 seconds, the warning lamp lights up for 2 seconds, and the alarm buzzer sounds for 1 second.

REMARK

- If the lamps do not light up, there may be a failure or disconnection in the monitor, so please contact your Komatsu distributor.
- When carrying out the checks before starting, do not rely only on the monitor. Always carry out all the items listed for periodic maintenance.

Machines equipped with cab

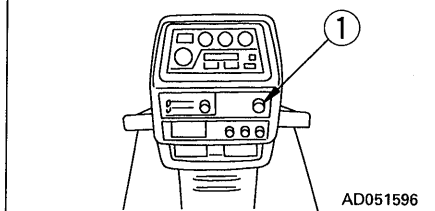

Machines equipped with canopy

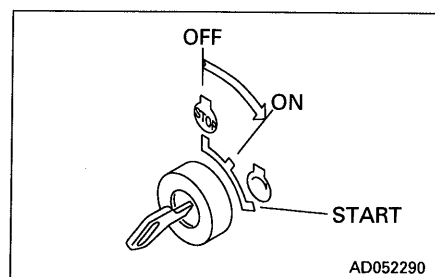
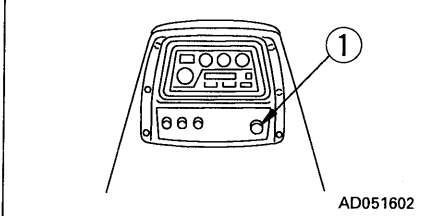

CHECK FUEL LEVEL, ADD FUEL

⚠ WARNING

When adding fuel, never let the fuel overflow. This may cause a fire. If you spill fuel, thoroughly clean up any spillage.

1. Turn the engine starting switch to the ON position and check the fuel level with fuel level gauge ⑥ on the monitor panel. After checking, turn the switch back to the OFF position.
 2. After completing work, fill the fuel tank through oil filler port ⑦.
 3. After adding fuel, tighten the cap securely.
- Fuel capacity: 625 ℓ (165 US gal, 138 UK gal)

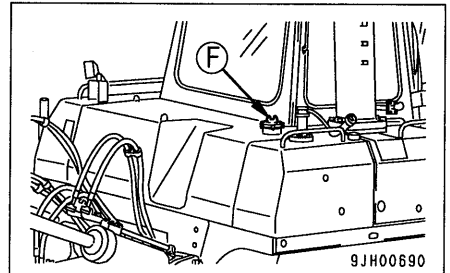
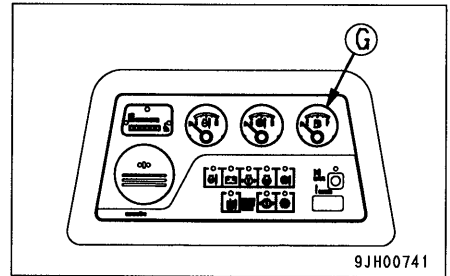

REMARK

If breather hole ① on the cap is clogged, the pressure in the tank will drop and fuel will not flow. Clean the hole from time to time.

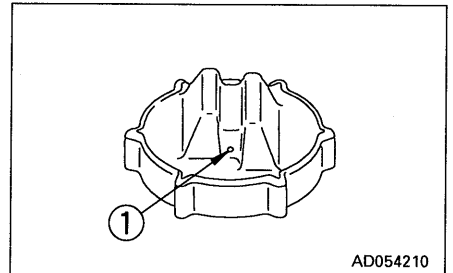

DRAIN WATER, SEDIMENT FROM FUEL TANK

Loosen drain valve ① at the bottom of the fuel tank and drain the sediment and water accumulated at the bottom of the tank together with the fuel.

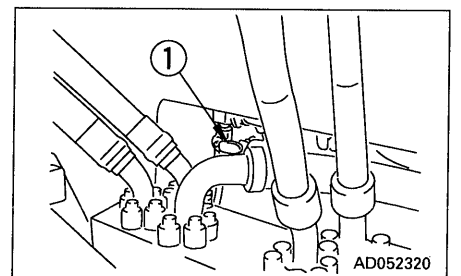
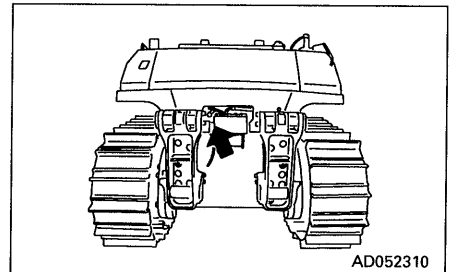

CHECK OIL LEVEL IN ENGINE OIL PAN, ADD OIL

1. Open the engine side cover on the left side of the chassis.
2. Remove dipstick **G** and wipe the oil off with a cloth.
3. Insert dipstick **G** fully in the oil filler pipe, then take it out again.

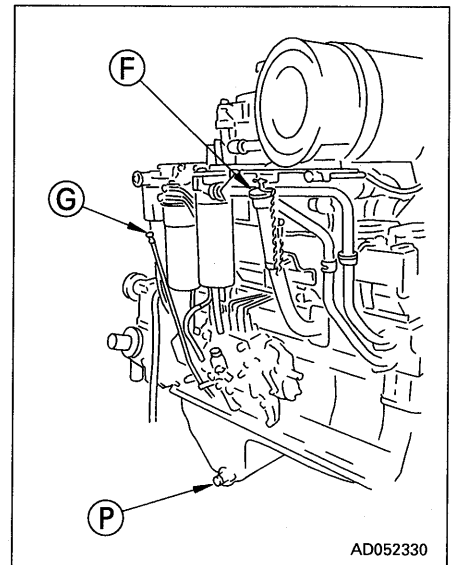

4. The oil level should be between the H and L marks on dipstick **G**.
If the oil level is below the L mark, add engine oil through oil filler **F**.
5. If the oil is above the H mark, drain the excess engine oil from drain plug **P**, and check the oil level again.
6. If the oil level is correct, tighten the oil filler cap securely and close the engine side cover.

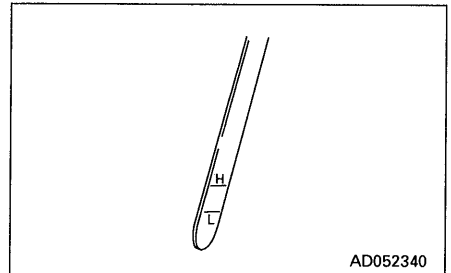
**REMARK**

- Check the oil level with the engine stopped.
- When checking the oil level after the engine has been operated, wait for at least 15 minutes after stopping the engine before checking.
- If the machine is at an angle, make it horizontal before checking.
- When adding oil, remove the dipstick from the holder to release the air inside the crankcase.

12. OPERATION

CHECK OIL LEVEL IN POWER TRAIN CASE, ADD OIL

1. Remove dipstick ③, and wipe the oil off with a cloth.
2. Insert dipstick ③ fully in the oil filler pipe, then take it out again.

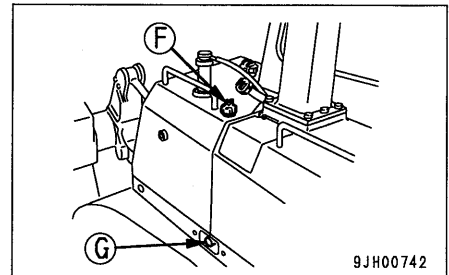

3. The oil level should be between the H and L marks on dipstick ③.
If the oil level is below the L mark, add engine oil through oil filler ⑥.
The oil level is stamped on both sides of the dipstick. One side is used when the engine is stopped and the oil temperature is low (COLD STOP). The other side is used when the engine is idling and the oil temperature is high (HOT IDLING).

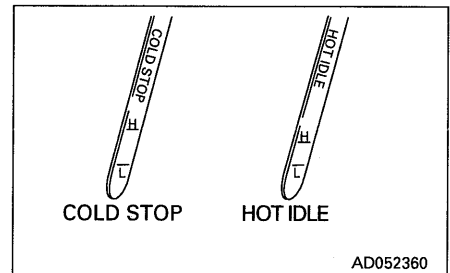

REMARK

When checking the oil level before starting operations, check with the engine stopped and use the dipstick COLD STOP side. It is also possible to check the oil level after the engine has been run and the power train oil temperature is high, but in this case, run the engine at idling and use the dipstick HOT IDLING side.

4. If the oil is above the H mark, remove drain cover ① at the bottom left of the power train case, pull drain hose ② out from the pickup port, then loosen drain plug ③ and drain the excess oil. After draining the oil, check the oil level again.

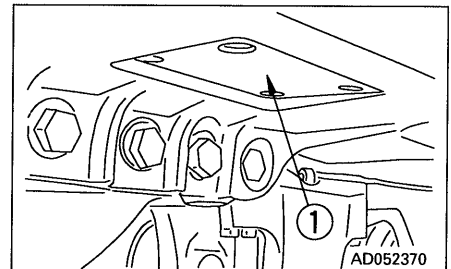

5. If the oil level is correct, tighten the oil filler cap securely.

REMARKS

When checking the oil level, if the machine is at an angle, move it to a horizontal position before carrying out the check.

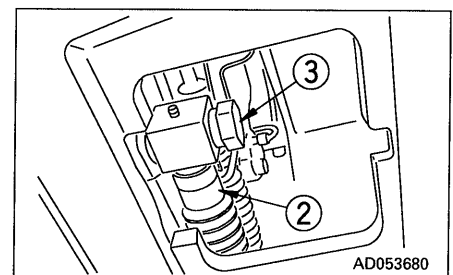

CHECK BRAKE PEDAL TRAVEL

Drive the machine, depress the brake pedal, and check that the machine stops.

CHECK DAMPER CASE OIL LEVEL, ADD OIL

1. Open engine side cover ① on the left side of the machine.
2. Remove dipstick ⑥, and wipe the oil off with a cloth.
3. Insert dipstick ⑥ fully into the dipstick holder, then pull it out again.
4. The oil level should be between the H and L marks on dipstick ⑥.
If the oil is below the L mark, add engine oil through the dipstick holder.
5. If the oil is above the L mark, open inspection cover ② at the bottom center of the power train case, and drain the excess oil from drain plug ④ of the engine damper (this can be seen to the front of the machine through the inspection window). After draining the oil, check the oil level again.

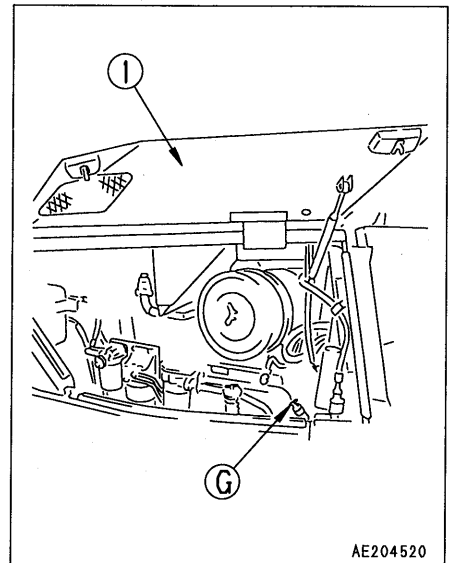
**REMARKS**

- Check the oil level with the engine stopped.
- When checking the oil level, if the machine is at an angle, move it to a horizontal position before carrying out the check.

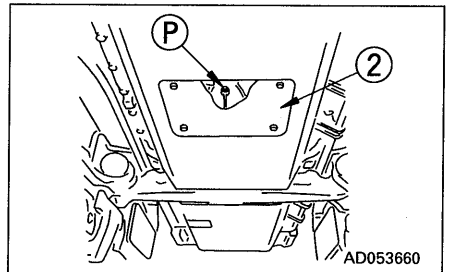

CHECK OIL LEVEL IN HYDRAULIC TANK, ADD OIL

⚠ WARNING

- When removing the oil filler cap, oil may spurt out, so stop the engine and wait for the oil temperature to go down, then turn the cap slowly to release the internal pressure before removing the cap.
- If oil has been added to above the H mark, stop the engine and wait for the hydraulic oil to cool down. Then remove drain plug **P**, loosen drain valve **①**, and drain the excess oil.

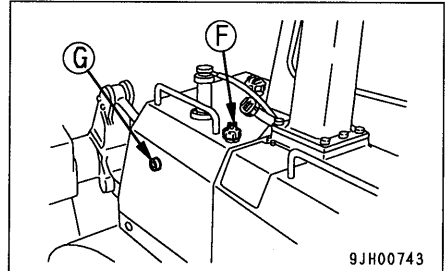
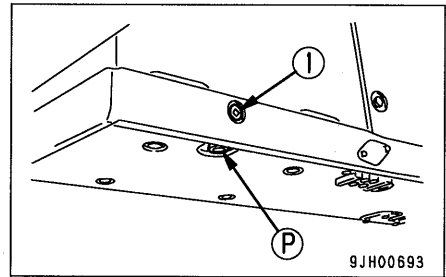

NOTICE

Do not add oil if the level is above the H line. This will damage the hydraulic equipment and cause the oil to spurt out.

1. Lower the blade to the ground, stop the engine and wait for about 5 minutes before checking oil level. If oil level is between H and L in sight gauge **Ⓒ**.
2. If the level is below the L mark, add engine oil through oil filler **F**.

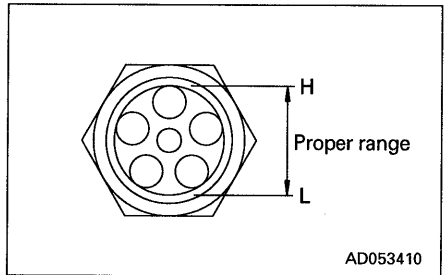

REMARK

When inspecting, if the machine is at an angle, move it to a horizontal place to carry out the check.

CHECK DUST INDICATOR

1. Open the engine side cover on the left side of the chassis, and check that the red piston has not appeared in the transparent portion of dust indicator **①**.
2. If the red piston has appeared, clean or replace the element immediately.
For details of the method of cleaning the element, see "24.2 WHEN REQUIRED".
3. After checking, cleaning, and replacing, press the knob of dust indicator **①** to return the red piston to its original position.

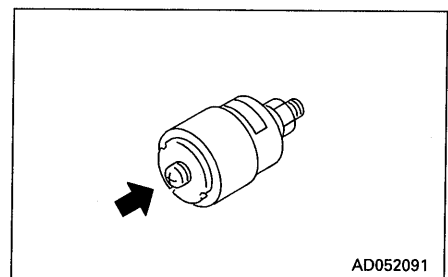
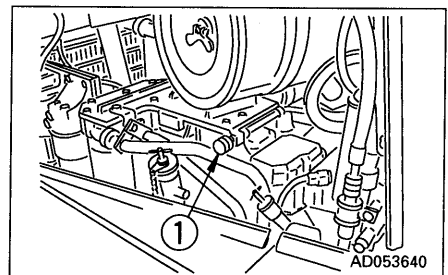

CHECK ELECTRIC WIRINGS

WARNING

- If fuses are frequently blown or if there are traces of short circuit on the electrical wiring, locate the cause and carry out repair.
- Accumulation of flammable material (dead leaves, twigs, grass, etc.) around the battery may cause fire, so always check and remove such material.
- Keep the top surface of the battery clean and check the breather hole in the battery cap. If it is clogged with dirt or dust, wash the battery cap to clean the breather hole.

Check for damage and wrong capacity of the fuse and any sign of disconnection or short circuit in the electric wiring. Check also for loose terminals and tighten any loose parts.

Check the wiring of the "battery", "starting motor" and "alternator" carefully in particular.

When carrying out walk-around checks or checks before starting, always check if there is any accumulation of flammable material around the battery, and remove such flammable material.

Please contact your Komatsu distributor for investigation and correction of the cause.

CHECK THAT LAMPS LIGHT UP

1. Turn the key of starting switch ① to the ON position.
2. Turn the front lamp switch ② and rear lamp switch ③ to the ON position and check that the front lamp and rear lamp light up.

If the lamps do not light up, there is probably a broken bulb or disconnection in the wiring, so contact your Komatsu distributor for repairs.

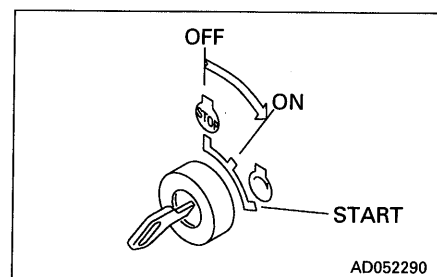
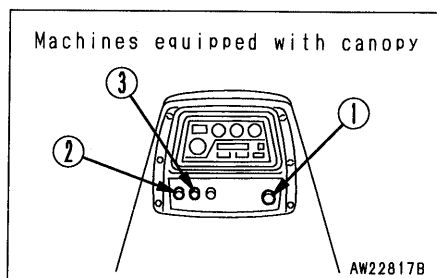
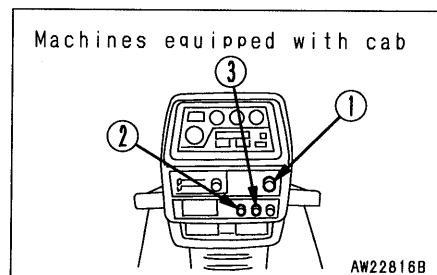

CHECK HORN SOUND

1. Turn the key of starting switch ① to the ON position.

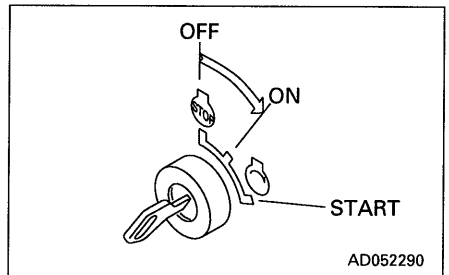
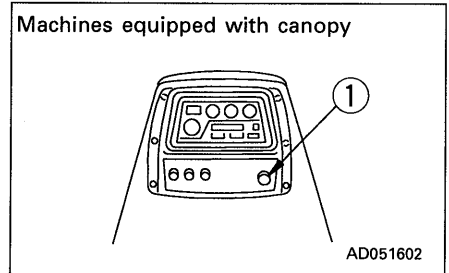
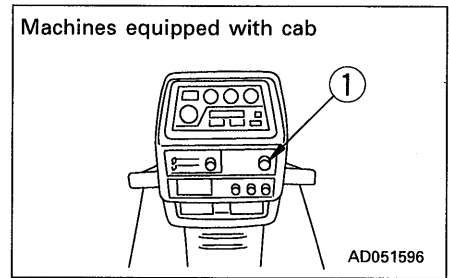

2. Press the horn switch and check that the horn sounds.

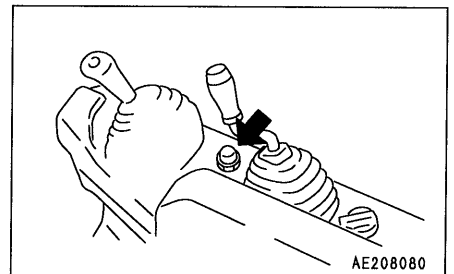

CHECK BACKUP ALARM SOUND

1. Turn the key of starting switch ① to the ON position.

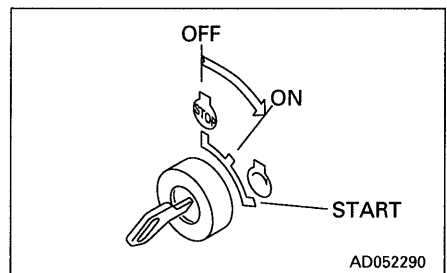
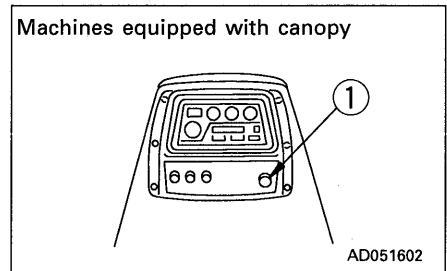
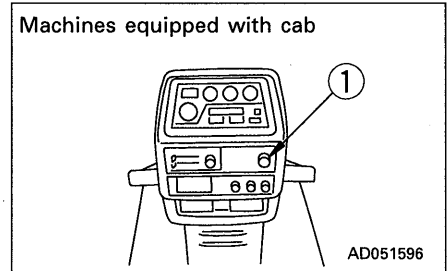

2. Set the joystick to the REVERSE position. The buzzer must sound immediately. The buzzer will continue to sound until the joystick is moved to the NEUTRAL or FORWARD position.

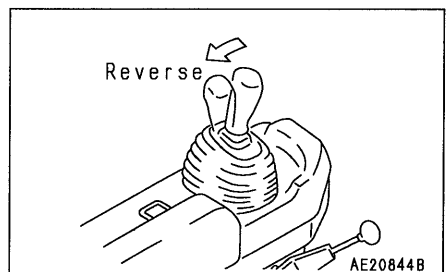
**CHECK SEAT BELT FOR WEAR OR DAMAGE**

Check the belt and mounting clamps, and if they are worn or damaged, replace the seat belt.

CHECK FOR WATER AND SEDIMENT IN WATER SEPARATOR, DRAIN WATER

The water separator separates water mixed in the fuel. If float ② is at or above red line ①, drain the water according to the following procedure:

1. Loosen drain plug ③ and drain the accumulated water until the float reaches the bottom.
2. Tighten drain plug ③.
3. If the air is sucked into fuel line when draining and water, be sure to bleed air in the same manner as for the fuel filter. See "24.5 EVERY 500 HOURS SERVICE".

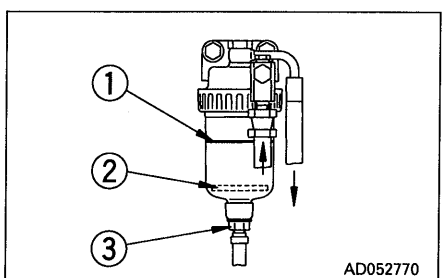

12.1.3 ADJUSTING BEFORE STARTING OPERATION

ADJUSTING OPERATOR'S SEAT

⚠ WARNING

- Adjust the seat position at the beginning of each shift or when operators change.
- Adjust the seat so that the brake pedal can be depressed all the way with the operator's back against the backrest.

- Ⓐ Fore-aft adjustment of seat
Pull up lever ①, set the seat to a position where it is easy to operate, then release the lever.
Fore-aft adjustment: 160 mm (6.3 in) (8 stages)
- Ⓑ Weight adjustment of seat
Turn knob ② under the seat to match the weight adjustment scale with your own weight.
The weight can be adjusted within a range of 55 – 120 kg (121 – 265 lb).

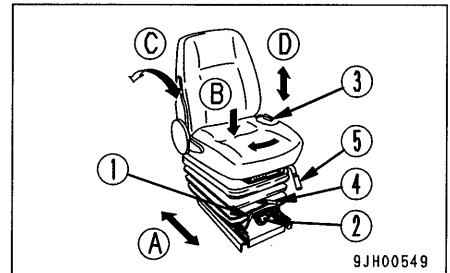

REMARK

If you want to make the seat softer, turn the weight adjustment to a lower weight; if you want to make the seat harder, adjust to a higher weight.

When operating on uneven surfaces, adjust the seat to a harder setting.

- Ⓒ Adjusting reclining angle

NOTICE

When reclining the seat back to the rear, check the space behind, and adjust to a suitable position.

Pull lever ③, set the seatback to a position where it is easy to operate, then release the lever.

- Ⓓ Adjusting vertical height of seat
 Turn lever ④ to adjust the height as follows.
 To make seat HIGHER, turn CLOCKWISE
 To make seat LOWER, turn COUNTERCLOCKWISE
 Do not sit in the seat or apply your weight to the seat when turning the lever: the lever operation will become heavy.
 After adjusting, release the levers and lock them.
 (Vertical adjustment amount: stepless, 50 mm (1.97 in)).
- Ⓔ Adjusting direction of seat
 Pull up lever ⑤ to release the lock, then turn the seat to the right by hand. It is possible to change the direction of the seat to the 15° position.
 After changing the angle of the seat, return the lever securely and lock it in position.
- Adjusting the seat angle to the right is done to make it easier to carry out ripper operations.

ADJUSTING MIRROR (Machines equipped with cab)

Loosen screw ① which is installed on the mirror, and adjust the mirror to the best position to see the mirror from the operator's seat.

Especially for seeing behind the machine, adjust in such a way that you can easily see persons at the rear L.H and R.H corners.

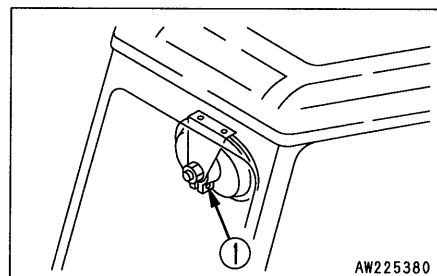

12.1.4 OPERATIONS AND CHECKS BEFORE STARTING ENGINE

WARNING

If the work equipment control levers are touched by accident, the work equipment may move suddenly. When leaving the operator's compartment, always set the safety lever securely to the LOCK position.

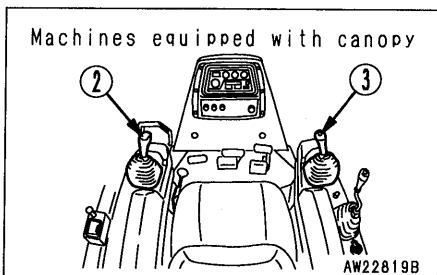
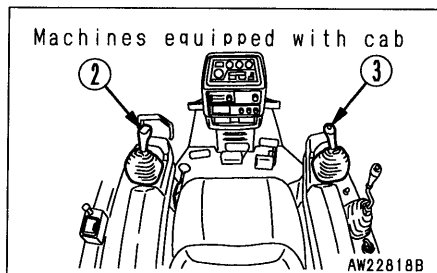
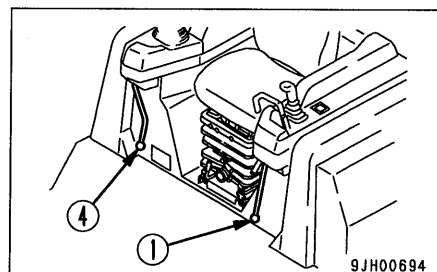

12. OPERATION

1. Check that parking lever ① is locked. If this lever is not at the LOCK position, the engine will not start.
If parking lever ① is placed at the LOCK position, joystick ② is returned to neutral even if it is at the FORWARD (REVERSE) position.

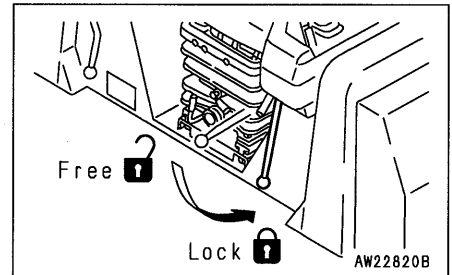

2. Check that joystick ② is at the 1st position.

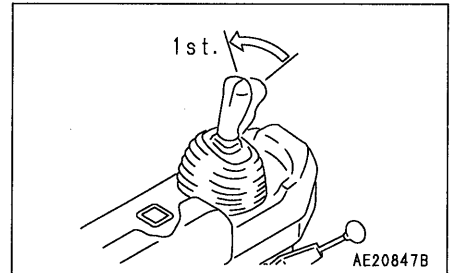

3. Check that the blade is lowered to the ground and that blade control lever ③ is at the HOLD position.

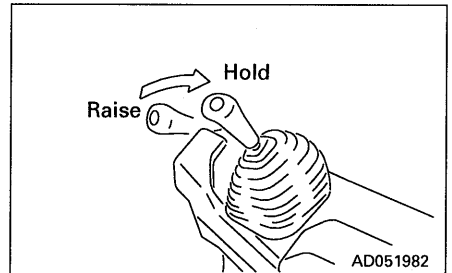

4. Check that the ripper is lowered to the ground.

5. Check that the safety lever ⑥ is locked.

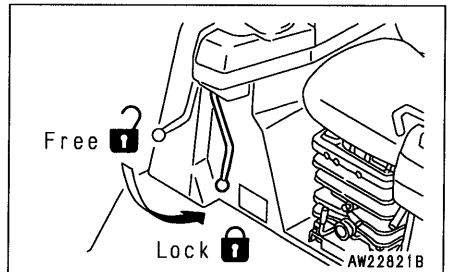

12.2 STARTING ENGINE

12.2.1 NORMAL STARTING

WARNING

Check that there are no persons or obstacles in the surrounding area, then sound the horn and start the engine.

NOTICE

Do not keep the starting motor rotating continuously for more than 20 seconds.

If the engine will not start, wait for at least 2 minutes before trying to start the engine again.

1. Pull fuel control lever ① to a position midway between the low idling and full speed positions.

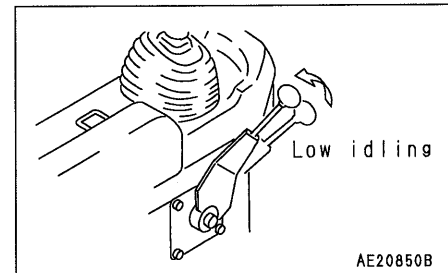
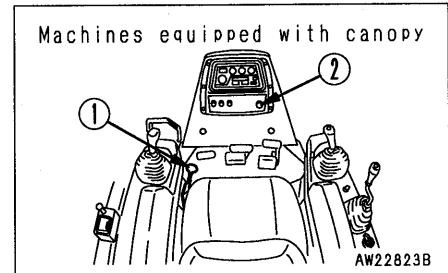
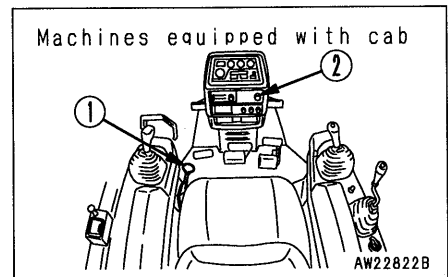

2. Insert the key into starting switch ② and turn the key to the START position. The engine will start.

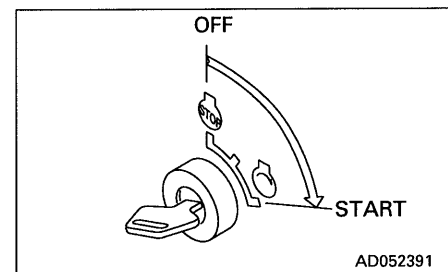

3. When the engine starts, release the key in starting switch ②. The key will return automatically to the ON position.

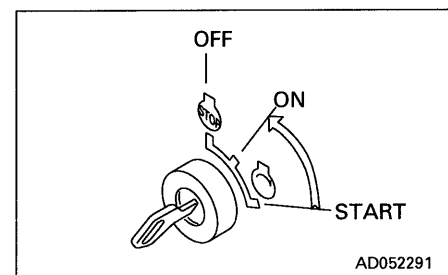

**12.2.2 STARTING IN COLD WEATHER
(MONITOR PANEL SPECIFICATION)**

⚠ WARNING

Never use starting aid fluids as they may cause explosions.

NOTICE

Do not keep the starting motor rotating continuously for more than 20 seconds.

If the engine fails to start, repeat steps 2 and 3 after waiting for about 2 minutes.

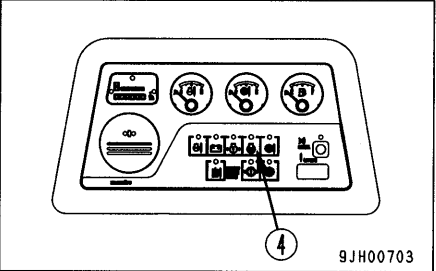
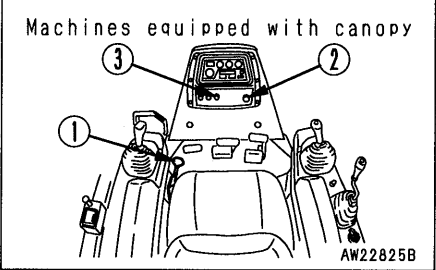
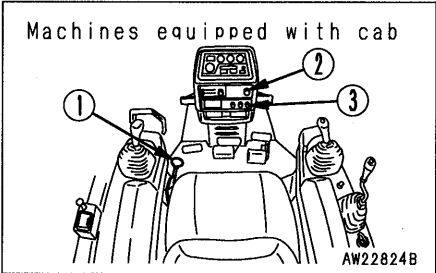

1. Pull fuel control lever ① to the midway position between the LOW IDLING and HIGH IDLING.

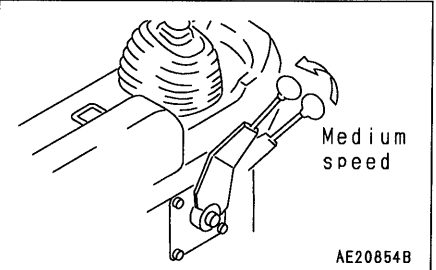

2. Insert the key into starting switch ② and turn the key to the ON position.

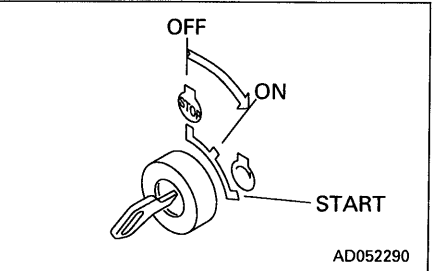

3. Carry out preheating.
There are the following two ways of carrying out preheating.
First use the convenient automatic preheating system.

4. When the engine starts, release the key in starting switch ②. The key will return automatically to the ON position.

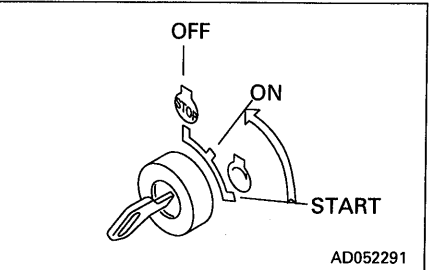

● **Automatic preheating**

- (1) Turn glow switch ③ to the AUTO position.
 When it is turned to the AUTO position, preheating is automatically carried out according to the ambient temperature. Lamp ④ lights up during the preheating operation. When the preheating is completed, lamp ④ will go out.

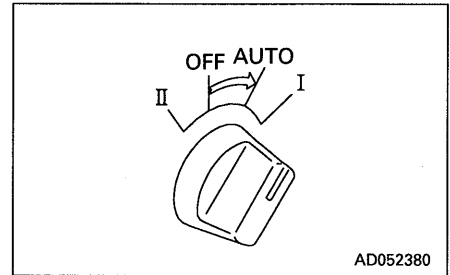

- (2) When the preheating is completed, turn the key in starting switch ② to the START position to start the engine.

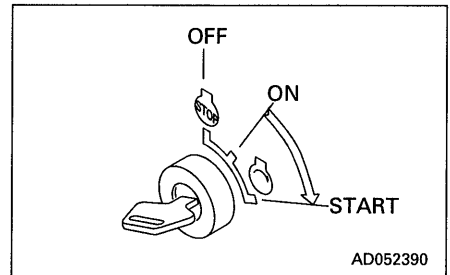

- (3) After starting the engine, return glow switch ③ to the OFF position.

REMARK

If the engine can not start after automatic preheating, start it using manual preheating.

● **Manual preheating**

- (1) Turn glow switch ③ to position I or II.
 Lamp ④ lights up during the preheating operation.
 When the preheating is completed, release the switch. The key will then return automatically to the following position.
 From position I, it will return to AUTO
 From position II, it will return to OFF

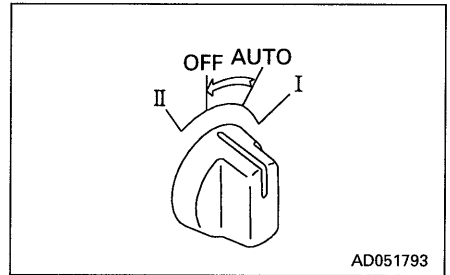

The preheating times are as shown below.

Ambient temperature	Preheat time
0°C to -5°C	-
-5°C to -10°C	15 seconds
-10°C to -20°C	30 seconds
-20°C to -30°C	45 seconds

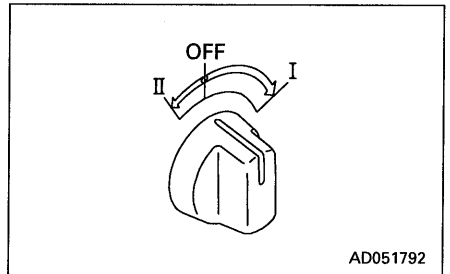

If the preheating time is too long or too short, the engine will not start easily. Observe the correct preheating time.

- (2) When the preheating is completed, turn the key in starting switch ② to the START position to start the engine.

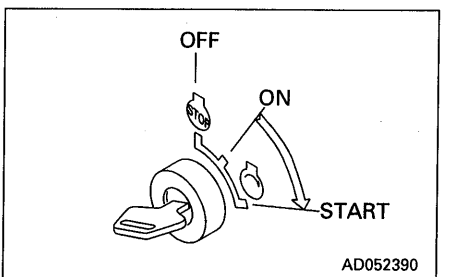

12.3 OPERATIONS AND CHECKS AFTER STARTING ENGINE

After starting the engine, do not immediately start operations. First, carry out the following operations and checks.

NOTICE

Avoid abrupt acceleration until warm-up run is completed.

Do not run the engine at low idling or high idling for more than 20 minutes. If it is necessary to run the engine at idling, apply a load or run at a medium speed from time to time.

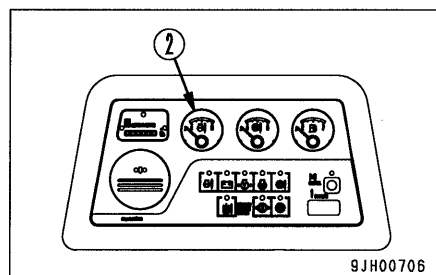
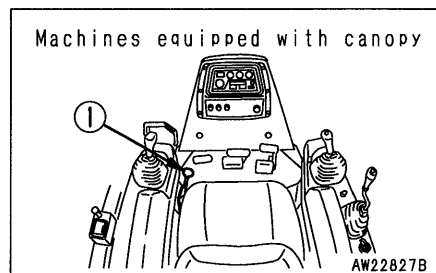
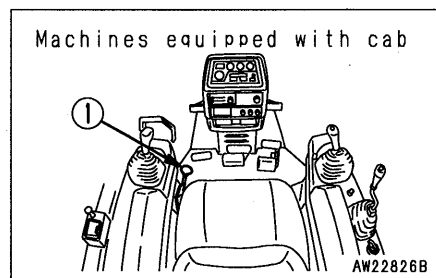

12.3.1 NORMAL OPERATION

1. Pull fuel control lever ① to the midway position between LOW IDLING and HIGH IDLING and run the engine at medium speed for about 5 minutes with no load.
2. After warm-up run is completed, check gauges and caution lamps for proper operation. If any abnormality is found, repair it.
Continue to run the engine at light load until engine water temperature gauge indicator ② falls within the white range.
3. Check that there is no abnormal exhaust gas color, noise, or vibration. If any abnormality is found, repair it.

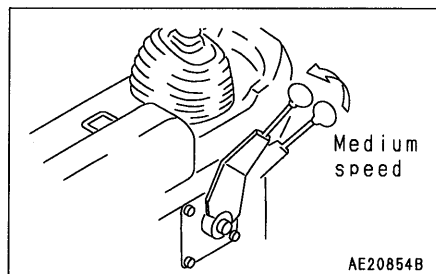

12.3.2 IN COLD AREAS

1. Pull fuel control lever ① to the midway position between the LOW IDLING and HIGH IDLING, and run the engine at medium speed, and continue to run under no load for approx. 10 minutes.

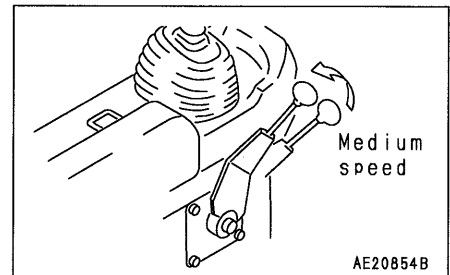

2. Operate blade control lever ③ to the RAISE position, then keep the blade raised to the maximum height and continue to relieve the circuit for 10 minutes.

3. Finally, operate blade control lever ③ and ripper control lever ④ to operate all the blade and ripper cylinders several times. If the oil temperature in the work equipment is not properly raised, there will be a time lag in the response of the work equipment and steering.

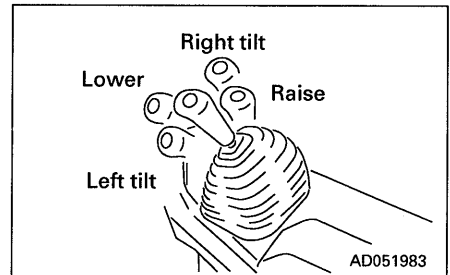

4. After warm-up run is completed, check gauges and caution lamps for proper operation. If any abnormality is found, repair it.

Continue to run the engine at light load until engine water temperature gauge indicator ② falls within the white range.

REMARK

If the oil temperature in the power train is not raised properly, it will take longer to accelerate to the maximum speed.

5. Check that there is no abnormal exhaust gas color, noise, or vibration. If any abnormality is found, repair it.

12.4 MOVING MACHINE

WARNING

- When moving machine, check that the area around the machine is safe, and sound the horn before moving. Clear all personnel from the machine and the area. Clear all obstacles from the path of the machine. Use extreme care when reversing the machine. Note there is an blind spot behind the machine.
- When starting on slopes, always keep brake pedal ② depressed even after releasing parking lever ①.
- When starting the machine up a steep slope, pull fuel control lever ⑦ fully to set the engine to full speed. Then keep brake pedal ② depressed, pull joystick ③ to the 1st speed position, operate joystick ③ in the direction of travel, then release brake pedal ② slowly to allow the machine to start gradually. When the machine starts, release the brake pedal completely.

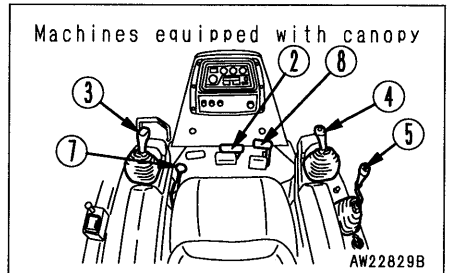
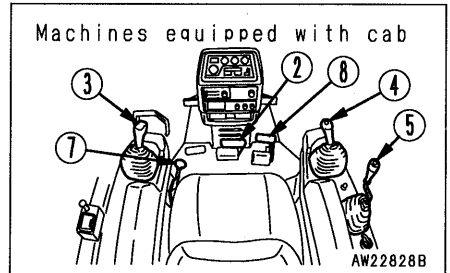
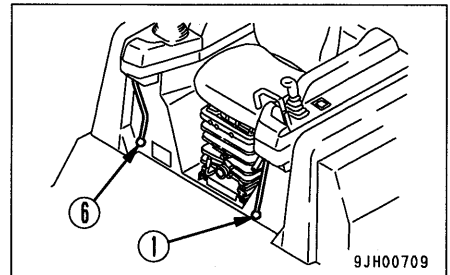

1. Set parking lever ① to the FREE position.

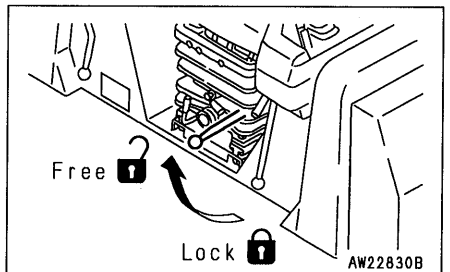

2. Set joystick ③ to the desired position.

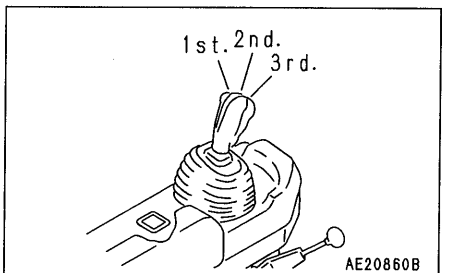

3. Set safety lever ⑥ for blade control lever ④ and ripper control lever ⑤ to the FREE position.

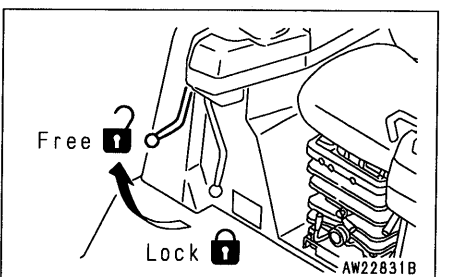

4. Operate blade control lever ④ and ripper control lever ⑤ to the RAISE position, raise the blade 40 – 50 cm (15.8 – 19.7 in) from the ground, and raise the ripper to the maximum height.

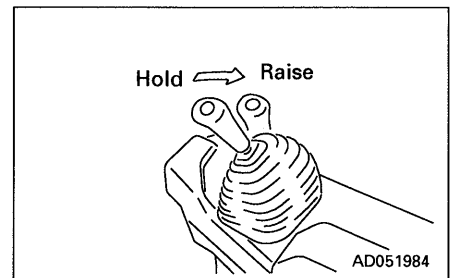

5. Pull fuel control lever ⑦, raise the engine speed, and fully depress the decelerator pedal ⑧.

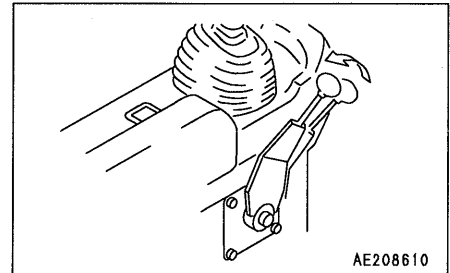

6. Move joystick ③ to the F (FORWARD) or R (REVERSE) position, gradually release the decelerator pedal ⑧ and allow the machine to move off.

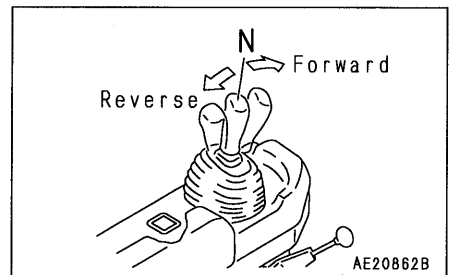

12.5 SHIFTING GEAR

It is possible to change the speed range when traveling, so there is no need to stop the machine when shifting gear.

1. Move joystick ① to the desired gear position to shift gears.

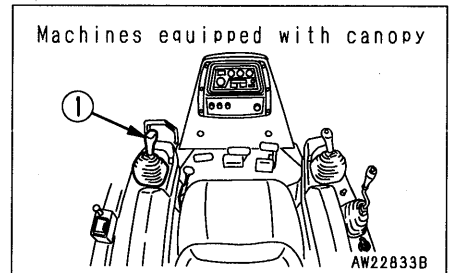
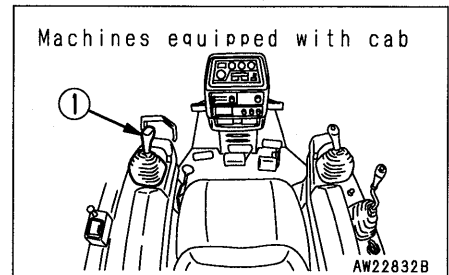

Gear shifting

Rotate the joystick 30° to carry out gear shifting operation.

- Position ①: 1st
- Position ②: 2nd
- Position ③: 3rd

For details of the maximum speed at each speed range, see "25. SPECIFICATIONS".

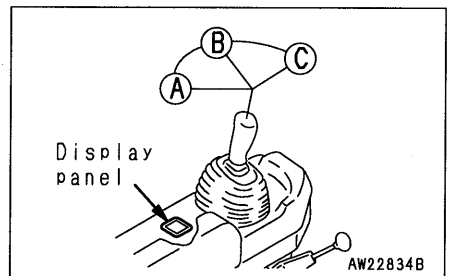

REMARK

When gear shifting operation is carried out, the display panel at the rear of the joystick will display the speed range.

- 1st: ① is displayed on the display panel
- 2nd: ② is displayed on the display panel
- 3rd: ③ is displayed on the display panel

12.6 SHIFTING BETWEEN FORWARD AND REVERSE

CAUTION

There is no need to stop the machine even when switching between FORWARD and REVERSE.

To increase safety, operator comfort, and the life of the transmission, leave the engine running at full speed, and always depress the decelerator pedal to lower the engine speed.

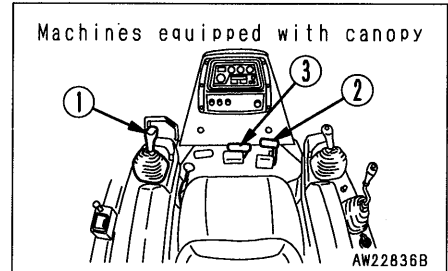
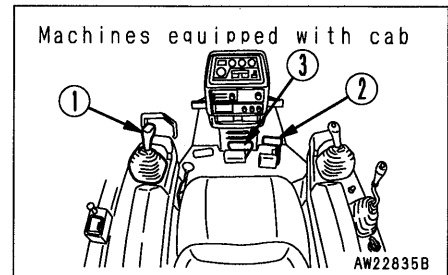

1. Depress decelerator pedal ② and reduce the engine speed.

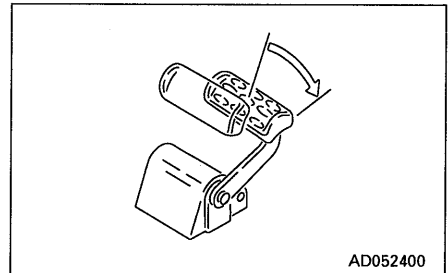

2. Return joystick ① to the neutral position, reduce the speed, then depress brake pedal ③ and stop the machine.

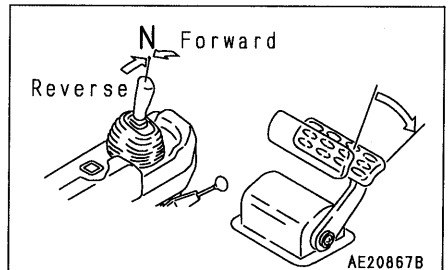

3. After depressing decelerator pedal ②, move joystick ① to the desired position.

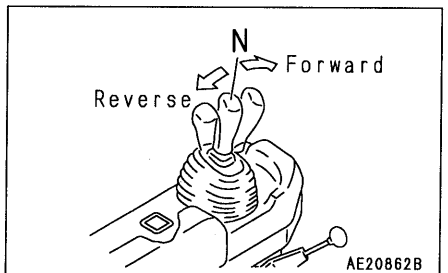

4. Release decelerator pedal ② to raise the engine speed.

REMARK

When the gear shift lever is placed in REVERSE, the REVERSE warning buzzer will sound.

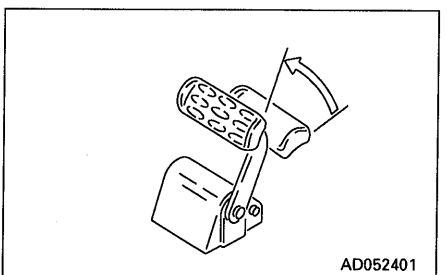

12.7 STEERING MACHINE

WARNING

- Avoid as much as possible turning the machine on a slope. The machine will tend to slip sideways. Particular care should be taken on soft or clay land.
- Never make a pivot turn at high speed.

12.7.1 NORMAL TURNING

WARNING

The feeling of the operation if the operator carries out a counterrotation turn when your head is facing the rear is different from the feeling when facing the front, so never carry out counterrotation turns when facing the rear.

To turn the machine while traveling, incline joystick ① in the direction to turn.

- Turnig to left while traveling forward

NOTICE

If the lever is operated partially to the forward or reverse position and then is operated in the direction of turn, the machine may carry out a counterrotation turn, so operate the lever fully to the forward or reverse position.

If the joystick ① is pushed forward and moved partially to the left (L), the machine will start to turn gradually. After that, the lever can be moved further toward the end of its stroke to give the desired turning radius.

REMARK

If the joystick ① is pushed forward and moved partially to the right, the machine will start to turn gradually to the right. After that, the lever can be moved further toward the end of its stroke to give the desired turning radius.

Do the same when traveling in reverse.

Machines equipped with cab

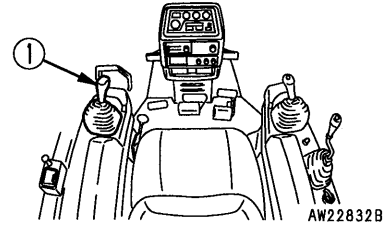

AW22832B

Machines equipped with canopy

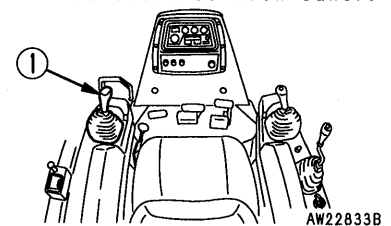

AW22833B

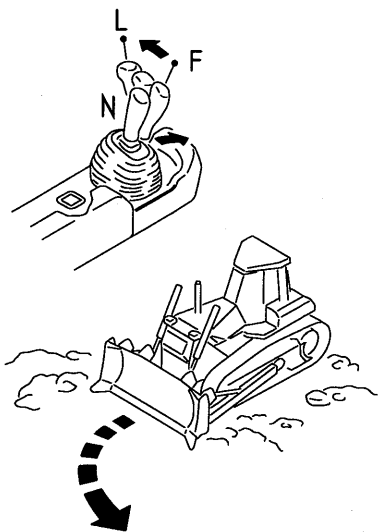

9JH00719

- Carrying out counterrotation turn to left

NOTICE

When carrying out a counterrotation turn, if the load is not equal on the left and right sides, the machine may carry out a pivot, so check the ground conditions and be careful not to hit any obstacles.

If the joystick ① is placed at the N position and is operated partially to the left, the left and right tracks will rotate in opposite directions and the machine will carry out a counterrotation turn smoothly. If the lever is operated fully, the speed of the counterrotation turn will increase.

REMARK

When carrying out a counterrotation turn to the right, move the joystick ① to the right in the same way.

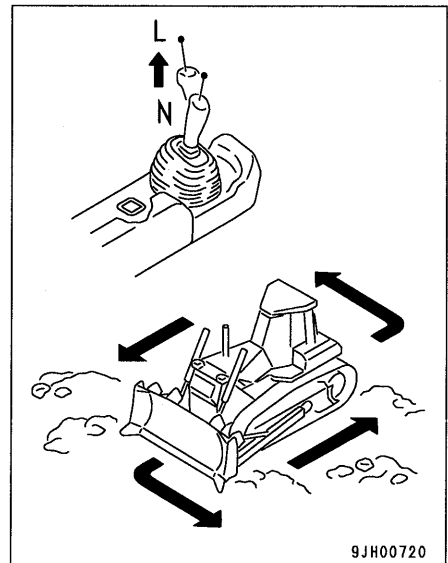
**12.7.2 TURNING WHILE DESCENDING A SLOPE**

With machines that can carry out counterrotation turns, on steep downhill slopes where the machine may travel under its own weight, or on downhill slopes where it is being pushed by a towed machine, the machine will not steer in the opposite direction, so do as follows.

NOTICE

Do not use the counterrotation turn on slopes. The load on the left and right sides will not be uniform, and the machine may turn sharply to one side.

- Making gradual turns to left while traveling forward

If the joystick ① is pushed forward and moved partially to the left (L), the machine turns gradually to the left. (Does not become reverse steering)

REMARK

When making gradual turns to the right, push the joystick ① forward, and move it partially to the right. (Does not become reverse steering)

Do the same when traveling in reverse.

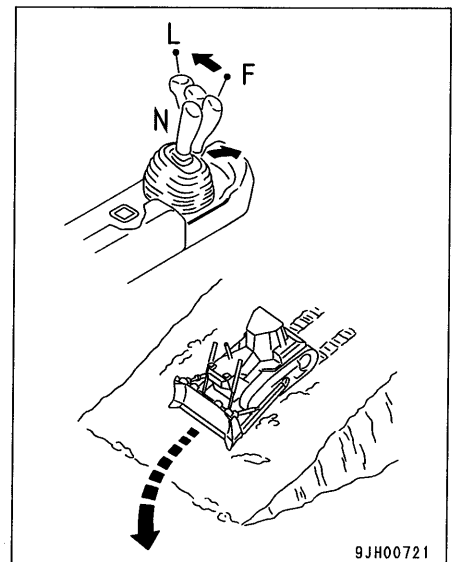

12.8 STOPPING MACHINE

WARNING

- Avoid stopping suddenly. Give yourself ample room when stopping.
- When stopping the machine, select flat hard ground and avoid dangerous places. If it is unavoidably necessary to park the machine on a slope, place the parking lever in the LOCK position and insert blocks underneath the track shoes. As an additional safety measure, thrust the blade into the ground.
- If the work equipment control lever is touched by accident, the work equipment may move suddenly, and this may lead to a serious accident. Before leaving the operator's seat, always operate the safety lever to place it securely at the LOCK position.

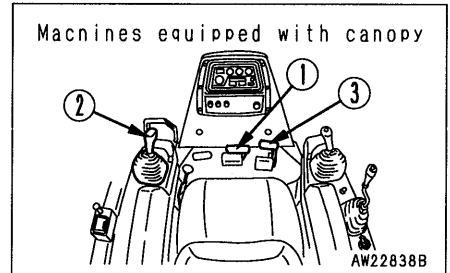
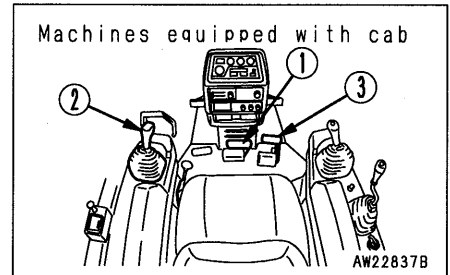

1. Depress brake pedal ① to stop the machine.

NOTICE

If the brake is depressed when the engine speed or travel speed is high, the brake disc may make a slipping sound. Normally, depress decelerator pedal ③ to reduce the engine speed and travel speed before depressing the brake.

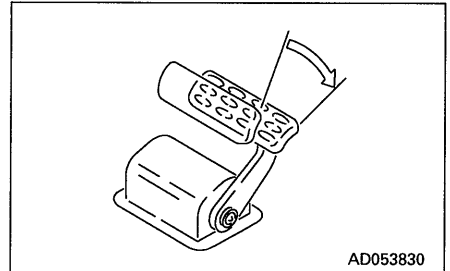

2. Place joystick ② at the neutral position and set the speed range to 1st.

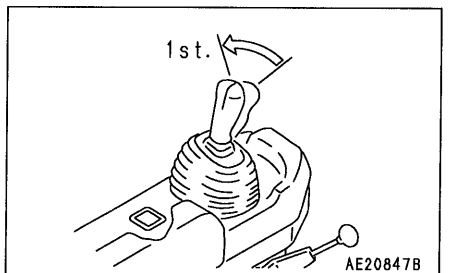
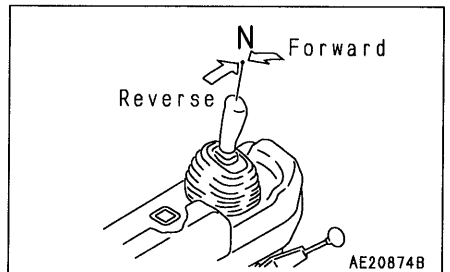

12.9 PRECAUTIONS FOR OPERATION

12.9.1 PERMISSIBLE WATER DEPTH

When operating in water, always keep top surface ① of the track frame above the surface of the water.

Also, be careful that the engine cooling fan will not come in contact with water. The fan can be damaged.

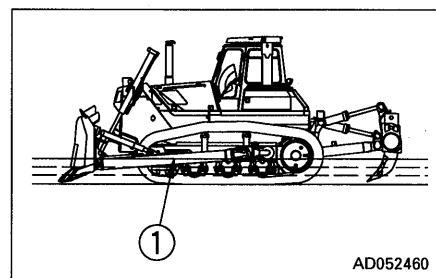

AD052460

12.9.2 PAY ATTENTION TO GAUGES

When the red range lights up on the transmission oil temperature gauge while operating, reduce load and wait for lowering of temperature.

12.9.3 PRECAUTIONS WHEN TRAVELING UP OR DOWN HILLS

Method of using decelerator pedal

When stepping on the decelerator pedal while going uphill, climbing ability will be reduced and the machine will stop. Furthermore, the engine sometimes will stall.

Use engine as brake

Do not move the joystick to the N position.

When traveling down hills of more than 15°, shift down to 1st speed (R1 or F1).

Braking when traveling downhill

While descending a slope using the engine as a brake, also apply the brakes.

Failure to brake may result in overrunning, causing engine trouble.

12.9.4 PRECAUTIONS ON SLOPES

Be careful of fuel level

If the fuel level in the fuel tank becomes low when working on slopes, the engine may suck in air because of the angle of the machine or the swaying of the machine. If this makes the engine stop, so be careful not to let the fuel level in the fuel tank become too low.

Precautions when engine stops on slopes

If the engine stops while working or traveling on a hill, immediately depress the brake pedal to bring the machine to a complete stop.

12.9.5 METHOD OF USING BRAKES

The following actions cause premature damage to the brakes, so avoid such operations.

- Using emergency brake at full speed
- Using brake with engine running at full speed in first gear (F1, R1) (Machine stall condition)

REMARK

Always depress the decelerator pedal to lower the engine speed before actuating the brakes.

12.9.6 IT IS PROHIBITED TO KEEP THE DOOR OPEN DURING OPERATIONS (MACHINES EQUIPPED WITH CAB)

Always keep the door closed when traveling or carrying out operations. If the door is left open, there is danger of damage from obstacles or strong vibration.

12.9.7 IT IS PROHIBITED TO MODIFY THE CAB GLASS IN ANY WAY THAT WILL OBSTRUCT THE VIEW (MACHINES EQUIPPED WITH CAB)

- For safety reasons, do not install anything to the cab glass that will obstruct the view.
- Always keep the glass clean to ensure safety during operations.

12.9.8 PRECAUTIONS FOR BLIND SPOTS CAUSED BY CAB STAY AND ROPS STAY

 **WARNING**

The cab stay and ROPS stay cause blind spots. When operating, always be sure to check carefully that there is no obstacle or worker in the surrounding area.

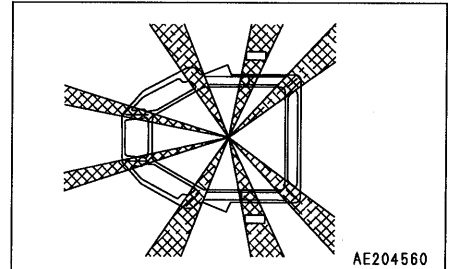

12.10 PARKING MACHINE

WARNING

- Avoid stopping suddenly. Give yourself ample room when stopping.
- When stopping the machine, select flat hard ground and avoid dangerous places. If it is unavoidably necessary to park the machine on a slope, place the parking lever in the LOCK position and insert blocks underneath the track shoes. As an additional safety measure, thrust the blade into the ground.
- If the work equipment control lever is touched by accident, the work equipment may move suddenly, and this may lead to a serious accident. Before leaving the operator's seat, always operate the safety lever to place it securely at the LOCK position.

Machines equipped with cab

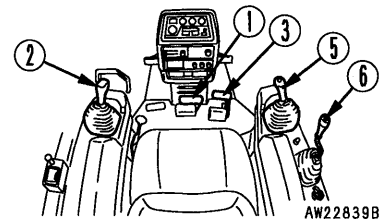

Machines equipped with canopy

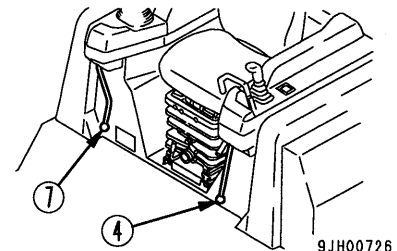
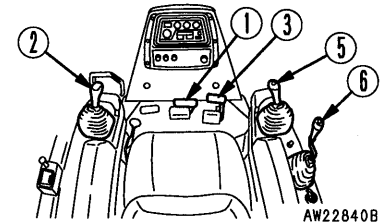

1. Depress brake pedal ① to stop the machine.

NOTICE

If the brake is depressed when the engine speed or travel speed is high, the brake disc may make a slipping sound. Normally, depress decelerator pedal ⑤ to reduce the engine speed and travel speed before depressing the brake.

2. Place joystick ② in NEUTRAL position and set the speed range to 1st.

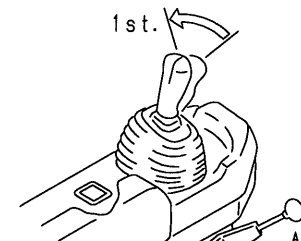
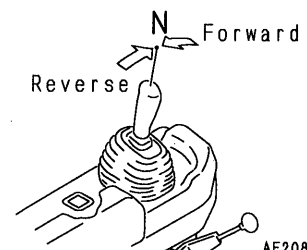
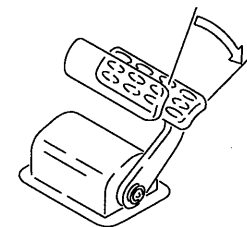

12. OPERATION

3. Operate parking lever ④ to lock the brakes.

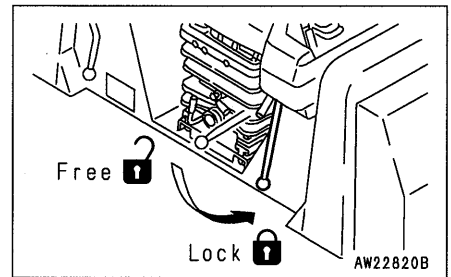

4. Operate blade control lever ⑤ and ripper control lever ⑥ to the LOWER position, and lower the blade and ripper to the ground.
5. Set blade control lever ⑤ and ripper control lever ⑥ to the HOLD position.

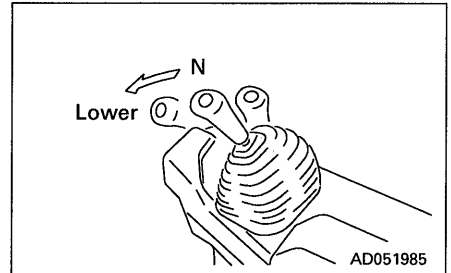

6. Lock blade control lever ⑤ and ripper control lever ⑥ with safety lever ⑦.

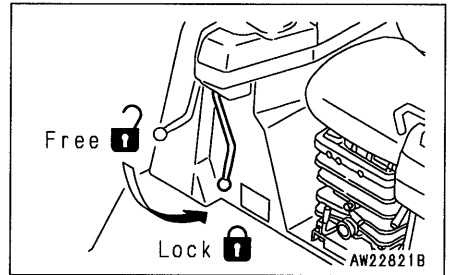

12.11 CHECK AFTER FINISHING WORK

1. Use the meters and caution lamps to check the engine water temperature, engine oil pressure, fuel level, transmission oil level, charge lamp, HSS charge oil pressure, HSS oil level and electronic system.

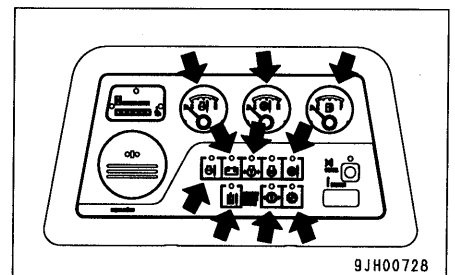

12.12 STOPPING ENGINE

NOTICE

If the engine is abruptly stopped before it has cooled down, engine life may be greatly shortened. Consequently, do not abruptly stop the engine apart from an emergency.

In particular, if the engine has overheated, do not abruptly stop it but run it at low speed to allow it to cool gradually, then stop it.

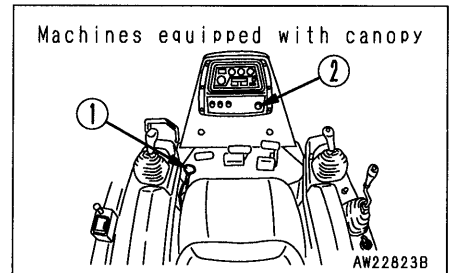
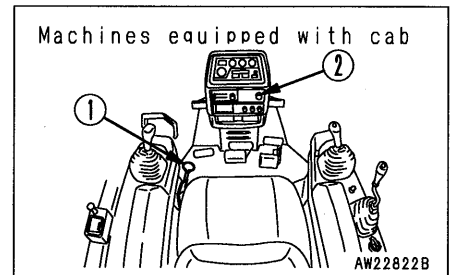

1. Place fuel control lever ① in the low idling position and run the engine at low idling speed for about 5 minutes to allow it to gradually cool down.

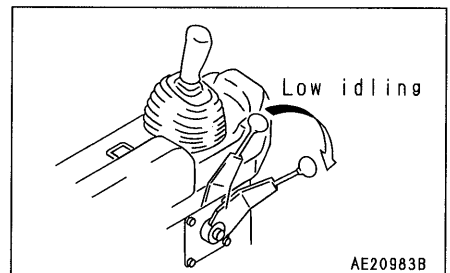

2. Push fuel control lever ① in the engine stop position and stop the engine.
3. Turn the key in starting switch ② to the OFF position and remove the key.

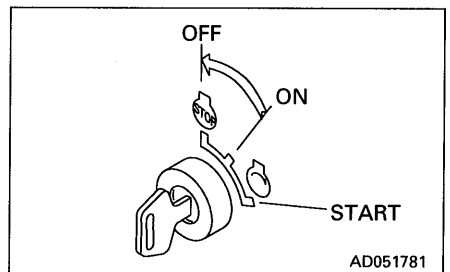

12.13 CHECK AFTER STOPPING ENGINE

1. Walk around the machine and check the work equipment, paint-work, and undercarriage, and check also for leakage of oil or water. If any abnormalities are found, repair them.
2. Fill the fuel tank.
3. Check the engine compartment for paper and debris. Clean out any paper and debris to avoid a fire hazard.
4. Remove any mud stuck to the undercarriage.

12.14 LOCKING

To prevent vandalism, there are locks at the following places. Places that can be locked with the starting switch key.

- Right and left engine side cover ①
- Battery inspection cover ②
- Inspection cover for fuel tank drain valve ③
- Cab door opener ④ (machines equipped with cab)
- Cap with lock ⑤ (option)
 - Radiator cap
 - Fuel tank cap
 - Hydraulic oil tank cap
 - Hydraulic oil tank breather
 - Power train oil filler cap
- Top cover of hood at cab front (air conditioner filter cover) ⑥

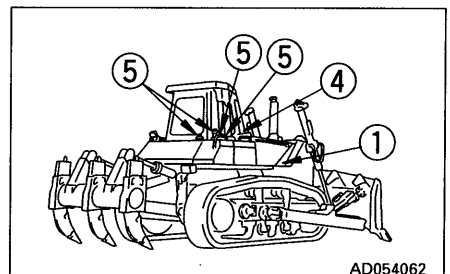
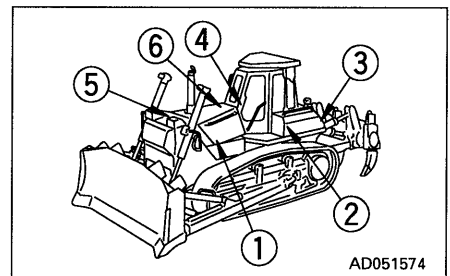

12.15 RIPPER OPERATION

12.15.1 EFFECTIVE METHOD OF USE

- The optimum digging angle for the shank is when the shank is perpendicular to the ground (ripping angle: $45^{\circ} - 50^{\circ}$).
- In comparatively soft rock (seismic velocity: 1200 m/s or below), it is also possible to carry out ripping with the shank tilted to the rear (max. ripping angle).
- On comparatively hard rock, if ripping is carried out with the shank tilted to the rear, there will be excessive wear of the point of tip **A** , and the self-sharpening ability will be lost.
- During ripping operations, if the shoes slip because of boulders or resistance from the bedrock, use the tilt cylinder.
- Choosing a suitable ripper point to match the type of rock is one of the most important elements in using the ripper effectively. Ripper points are available for different types of rock, so select the most suitable ripper point from the list. For details, see "32. PROCEDURE FOR SELECTING RIPPER POINT."

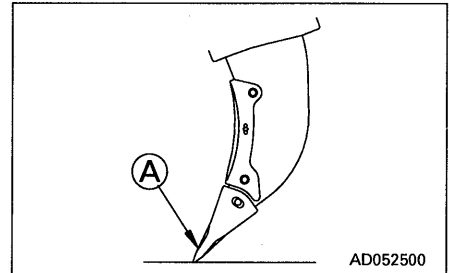
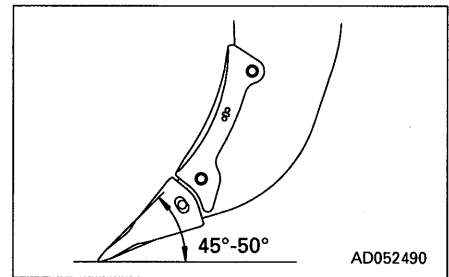

12.15.2 DIGGING UP BOULDERS OR ROCKBED

During ripper operations, if stubborn boulders or rockbed cause the tracks to slip or the travel speed to become slower, operate the tilt cylinder to dig up the boulder/rockbed.

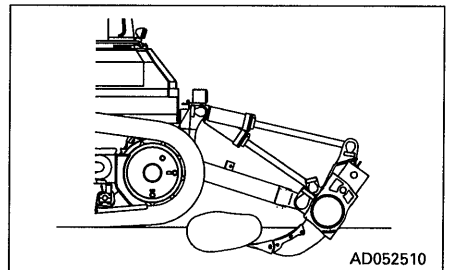

12.15.3 OPERATING ON SLOPES

When using the variable ripper, adjust the length of the tilt cylinder to select dimension L.

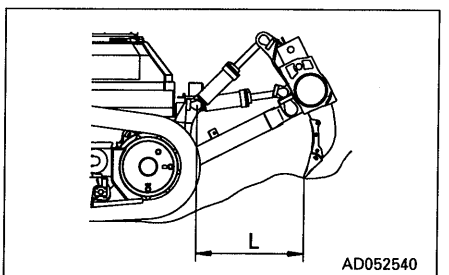
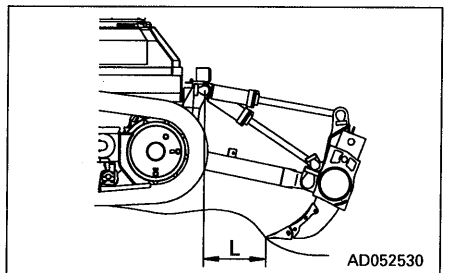

12.15.4 METHOD OF OPERATING PIN PULLER

This is used only on machines equipped with a giant ripper.

1. Stop the machine in a safe place and lower the shank to the ground.
2. Operate the pin puller controller switch and remove the mounting pin.
3. Move the ripper up or down to set to the desired shank position.
4. Operate the pin puller control switch to insert the mounting pin. If the pin does not match the position of the hole in the shank, set the pin puller control switch to the PUSH IN position and slowly move the ripper up or down.
 - When raising the pin position to increase the digging depth, use a long protector to prevent wear of the shank.

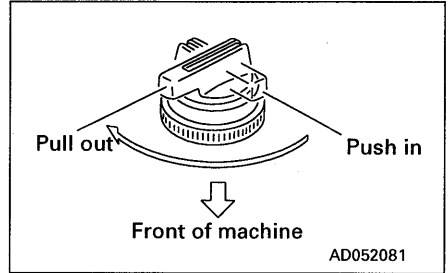
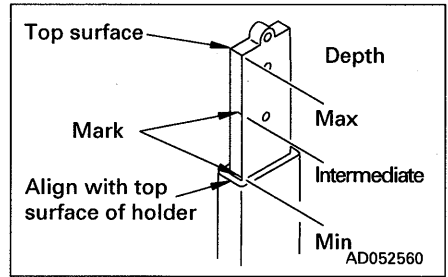

12.16 WORK POSSIBLE USING BULLDOZER

In addition to the following, it is possible to further increase the range of applications by using various attachments.

12.16.1 DOZING

A bulldozer digs and transports dirt in a forward direction. Slope excavation can always be most effectively carried out by proceeding from the top downward.

When dozing toward one side only, operate with angled blade (angledozer only).

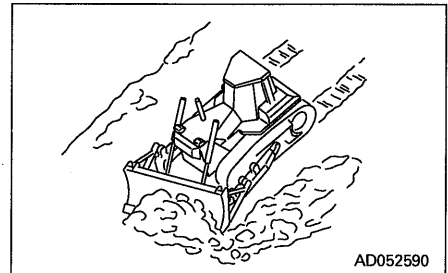
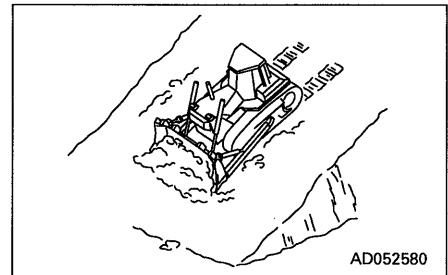

12.16.2 SMOOTHING

NOTICE

Avoid smoothing on rocky or stony ground. It can damage the blade.

When finishing the ground surface to a smooth finish after digging or filling operations, keep a full load of soil in the blade and operate the blade up or down in small movements while traveling forward. When leveling windrows or ruts left by the tracks, set the blade to the FLOAT position, travel at low speed in reverse and drag the blade over the ground surface.

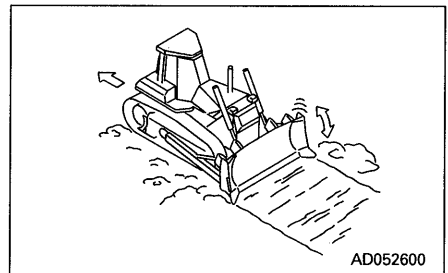

12.16.3 CUTTING INTO HARD OR FROZEN GROUND OR DITCHING

For digging and ditch excavation of hard or frozen ground, tilt the blade. Even hard ground can be dug effectively by a tilted or angled blade.

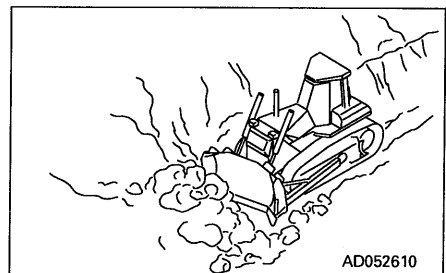

12.16.4 FELLING TREES, REMOVING STUMPS

NOTICE

Do not up root trees or stumps or fell trees by angling or tilting the blade.

For trees with a diameter of 10 – 30 cm (3.9 – 11.8 in), raise the blade high and push 2 or 3 times to fell the tree.

Next, travel in reverse, and dig the corner of the blade into the ground to cut and dig up the roots.

When doing this, never hit the tree at high speed or apply shock to fell the tree.

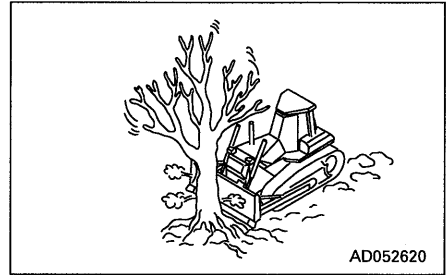

12.16.5 PUSHER OPERATIONS

NOTICE

- When carrying out pusher operations, always install a pusher plate.
- When approaching other machine, depress the decelerator pedal or reduce the travel speed with the fuel control lever and bring the machines gently into contact. When in contact, raise the engine speed gradually and push with full power.

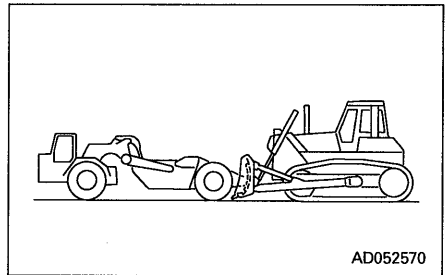

12.17 ADJUSTING POSTURE OF WORK EQUIPMENT

12.17.1 METHOD OF ANGLING BLADE (ANGLEDZER ONLY)

Angle the blade when it is needed to dump the soil on one side.

WARNING

- When adjusting the amount of angling, it is dangerous if the work equipment is moved by mistake. Set the work equipment in a safe condition, then stop the engine and lock the work equipment securely with the safety lever.
- Be careful when removing, arm ②. After arm ② is removed the blade can move freely.

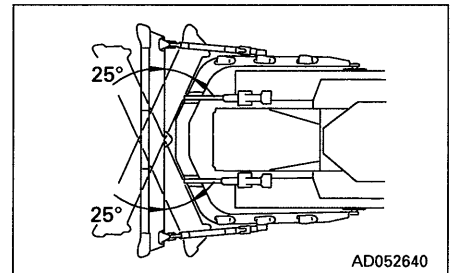

1. Raise the blade 300 – 400 mm (11.8 – 15.8 in) above the ground, then put blocks under the frame so that the blade does not come down.

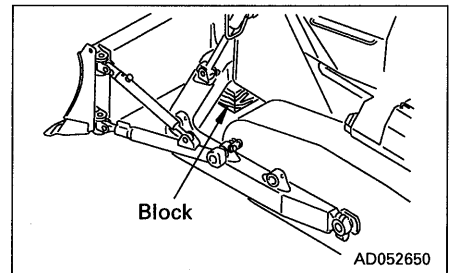

2. Remove pins ① on the left and right sides, then remove arm ② from the frame.

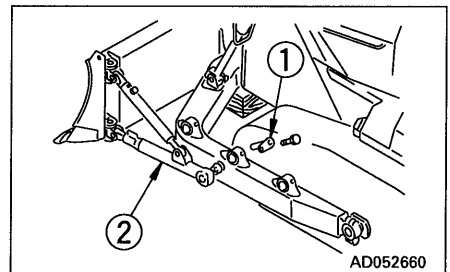

3. Insert arm ② into the desired position on the bracket on top of the frame (3 places on each side), and insert pin ①.

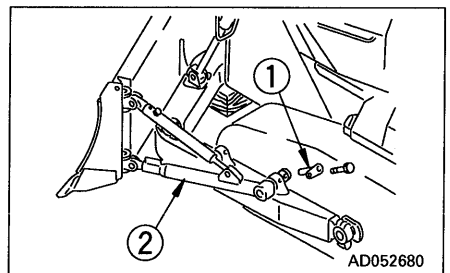

REMARK

When assembling an angle dozer to the C-frame, adjust the clearance of the center joint by adjusting the length of arm ② and brace ③ so that dimension S of center joint ④ is 20 mm (0.8 in).

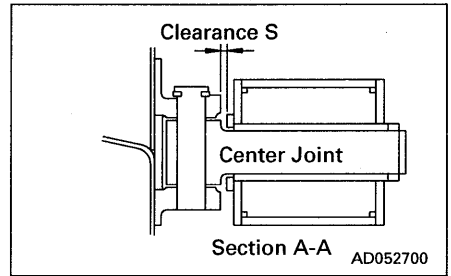
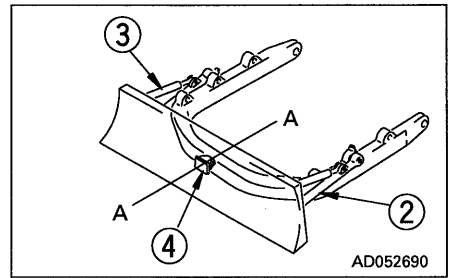

12.17.2 ADJUSTING TILT AMOUNT (ANGLEDZOZER, POWER TILTDOZER, POWER TILT POWER PITCHDOZER)

WARNING

When adjusting the amount of tilt, it is dangerous if the work equipment is moved by mistake. Set the work equipment in a safe condition, then stop the engine and lock the work equipment securely with the safety lever.

1. Angledozer

NOTICE

The maximum amount of tilt is 400 mm (15.8 in).
Be sure not to exceed 400 mm (15.8 in) for the tilt.

1. Raise the blade 300 – 400 mm (11.8 – 15.8 in) above the ground, then put blocks under the frame so that the blade does not come down.

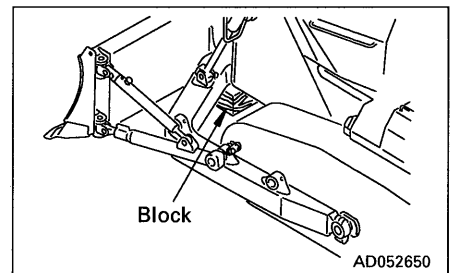
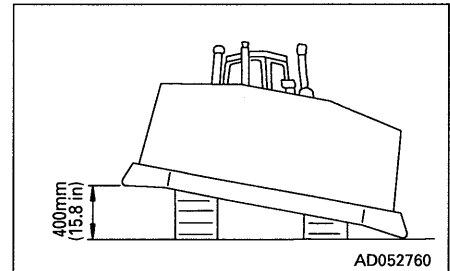

2. Loosen set bolt ① of the brace, insert a suitable bar into hole ② of the brace, and turn it.

REMARK

When rotating the brace with the adjustment bar, carry out the operation with the blade raised from the ground.

Right tilt: Make right side shorter, left side longer

Left tilt: Make left side shorter, right side longer

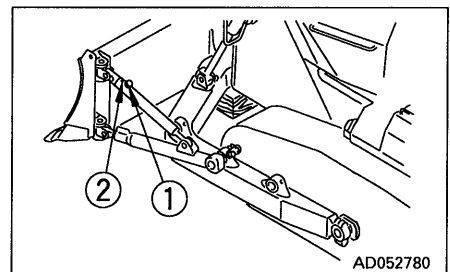

3. Tighten set bolt ①.

NOTICE

The standard value for distance L between the brace joints is 1493 mm (58.8 in), but adjust so that the maximum tilt does not exceed 400 mm (15.8 in). Do not use if the tilt exceeds 400 mm (15.8 in) as this will cause strain on various parts.

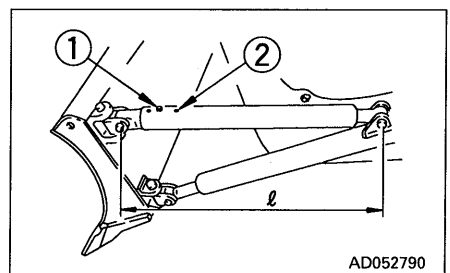

2. Power tiltdozer

NOTICE

The maximum tilt amount is 1000 mm (39.4 in). Be sure not to exceed this value.

1. A tilt of approx. 500 mm (19.7 in) can be obtained by operating the blade control lever.
2. If a greater tilt amount is needed, use adjustment bar ② installed to left brace ① to rotate brace ① and change the brace length. It is possible to tilt to a maximum of 1000 mm (39.4 in).

REMARK

When adjusting the tilt in Steps 1 and 2, carry out the operation with the blade raised from the ground.

NOTICE

The standard value for distance L between the joints is 1389 mm (54.7 in) , but adjust the brace length so that the maximum tilt does not exceed 1000 mm (39.4 in). Do not use if the tilt exceeds 1000 mm (39.4 in) as this will cause strain on various parts.

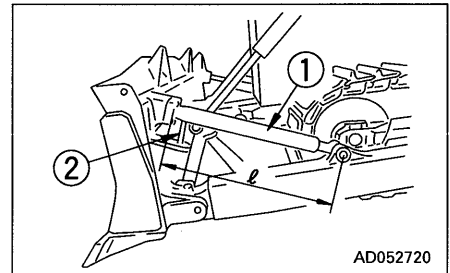
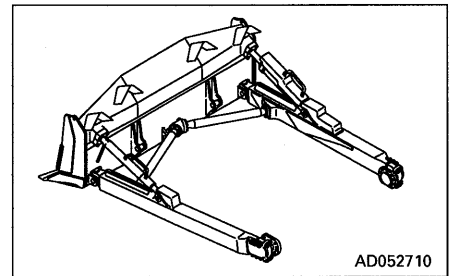

3. Power tilt power pitchdozer

NOTICE

The maximum tilt amount is 1000 mm (39.4 in). Be sure not to exceed this value.

It is possible to tilt to a maximum of 1000 mm (39.4 in) by operating the blade control lever.

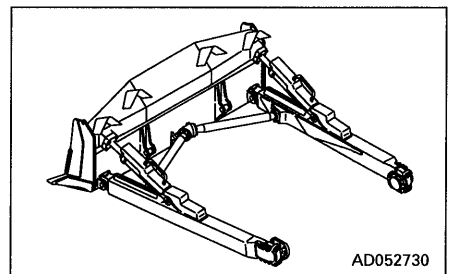

**12.17.3 ADJUSTING RIPPER
ADJUSTING DIGGING DEPTH**

Mounting pin holes are provided in the shank and these are used according to the desired digging depth. For normal use, use the bottom hole, and when particularly deep digging is needed, use the top hole.

To change the digging depth, do as follows.

1. Place a pointed object on the tip of pin ①, then hit with a hammer to remove from the opposite side.
 2. Remove pin ② and change the position of the shank hole.
 3. Insert pin ① partially by hand then knock it in with a hammer.
- The pin is made of one piece, so insert it partially by hand then knock it in with a hammer.
 - When a giant ripper is installed, use the pin puller.
For details, see "12.15.4 METHOD OF OPERATING PIN PULLER".

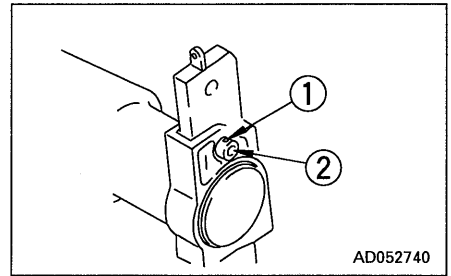

REPLACING POINT AND PROTECTOR

To protect the shank, if the protector and point installed to the tip are worn, replace them.

Place a pin remover on the pin marked by the arrow, then hit with a hammer to remove from the opposite side.

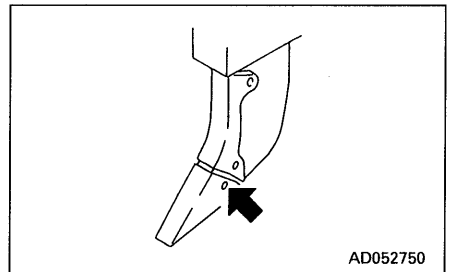

If the wear exceeds the wear limit in the table below, replace the worn parts.

Unit: mm		
	Basic dimension	Wear limit
① Point	335	225
② Protect	115	90

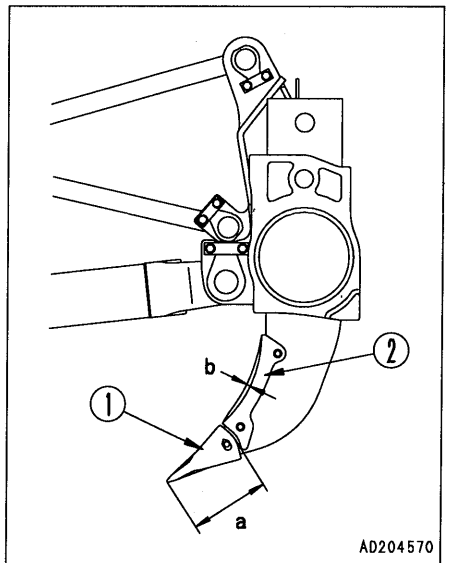

**12.17.3 ADJUST ANGLE OF BLADE EDGE
(ANGLEDZOZER, POWER TILTDOZER, POWER
TILT POWER PITCHDOZER)**

⚠ WARNING

It is dangerous if the work equipment moves by mistake when adjusting angle of the blade edge. Set the work equipment in a stable condition, then stop the engine and apply the locks securely to the safety lever.

Adjust the angle (θ) of the blade edge to match the type of soil.

1. Angledozer

Adjust the cutting angle by changing the distance (l) between the joints so that the length of the brace is the same on the left and right sides.

INCREASE distance (l) to INCREASE angle (θ)
DECREASE distance (l) to DECREASE angle (θ).

The standard for the cutting angle (θ) is 54° .

The standard for the distance (l) between the joints is 1493 mm (58.8 in).

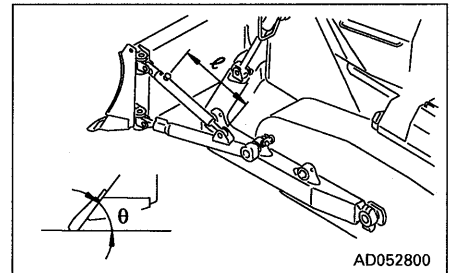

2. Power tilt dozer

Turn the brace with bar handle ① and the distance (l) between the joints to change the cutting angle (θ) as follows.

INCREASE distance (l) to INCREASE angle (θ)
DECREASE distance (l) to DECREASE angle (θ).

The standard for the cutting angle (θ) is 52° .

The standard for the distance (l) between the joints is 1389 mm (54.7 in).

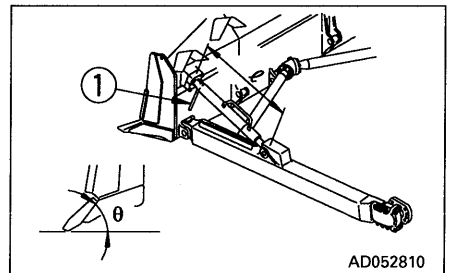

3. Power tilt power pitch dozer

By operating the left and right cylinders, it is possible to change the digging angle by $52 \pm 5^\circ$.

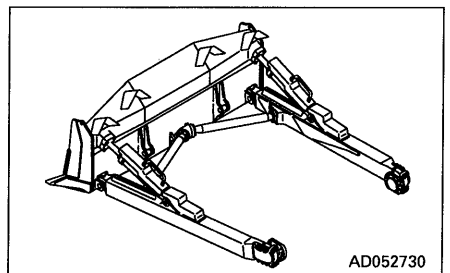

12.18 TIPS FOR LONGER UNDERCARRIAGE LIFE

Undercarriage life greatly varies depending on operation method, inspection and maintenance. For most efficient operation, keep the following point in mind.

12.18.1 OPERATION METHOD

- Select the track shoe that best suits the type of soil to be encountered in service.
Please consult your Komatsu distributor when selecting track shoes.
- Do not allow shoe slipping to occur during operation. If shoe slipping occurs, reduce load to the blade until slipping stops.
- Avoid sudden starts, acceleration or stops, unnecessarily high speeds and sharp turns.
- Always operate machine in a straight line whenever possible. When making turns, be careful not to allow the machine to stay to one side, so operation in both turning directions can be done properly. Make turns with the largest possible radius.
- Prior to operation, clear boulders and obstacles to prevent machine from riding over them while operating.
- On a slope, operate the machine parallel to the inclination of the slope. Do not operate across the slope. Also when stopping the machine on a slope, the machine should face toward the top of the slope.

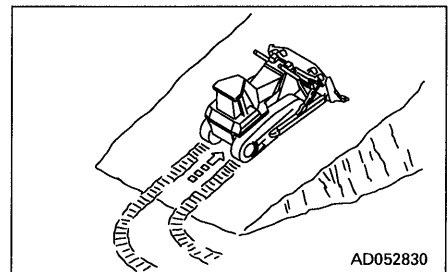

- When ground inclines to left or right during digging operation, do not continue to dig with machine inclined. Move machine back to level ground and start to dig again.
- Do not force the machine to carry out work that exceeds its working capability. Such work includes cases where the idler or sprocket come off the ground when the machine meets obstacles that resist the power of the machine during dozing or ripping operations.

12.18.2 INSPECTION AND ADJUSTMENT

- Properly adjust track tension.
Tension should be measured at clearance **A** shown in the diagram – usually 20 to 30 mm (0.8 to 1.2 in) at this point. For rocky terrain, tighten tracks slightly. In clay or sandy areas, slightly loosen them. (For inspection and adjustment procedures, refer to “24.2 WHEN REQUIRED”).
- Check idler rollers for oil leakage as well as for loose bolts and nuts. If any trouble is detected, repair immediately.

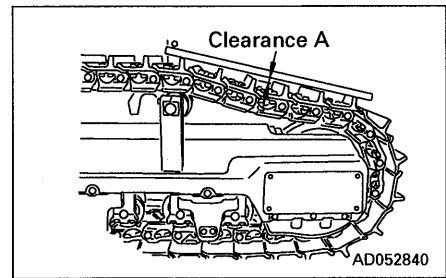

- Check the clearance between the idler guide plate and the track frame. If clearance **B** increases, idler may develop side motion and tracks may come off. (For inspection and adjustment procedures, refer to “24.2 WHEN REQUIRED”).

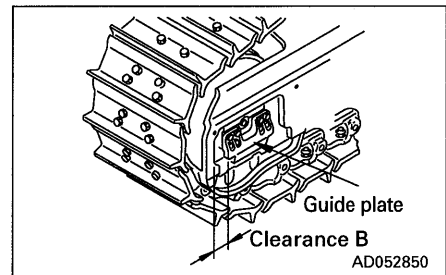

12.18.3 INSPECTION AND REPAIR

Frequent inspection and prompt repair will reduce repair costs.

The following items for inspection will serve as a guide to maintenance service of each undercarriage part. Perform periodical inspection and contact the Komatsu distributor in your area when machine has approached repairable limits and reversing limits.

MEASURING LINK PITCH

1. Insert a wooden block between track shoe and sprocket to take up the slack in track shoes.
2. Measure pitch length of 4 links in stretched portion at more than 2 links away from master pin. Of length obtained, 1/4 is the link pitch.

REMARK

Basic link pitch (P): 228.85 mm (9 in)

Link pitch limit for turning bushing

Heavy-duty: 231.85 mm (9.1 in)

Standard: 233.85 mm (9.2 in)

There is no link window on the master link.

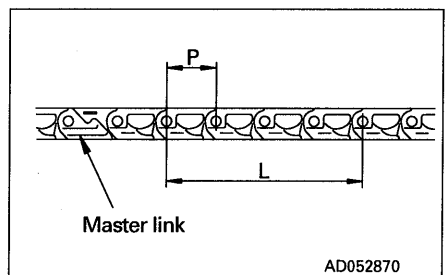
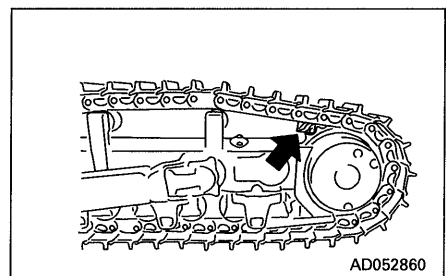

MEASURING HEIGHT OF GROUSER

After taking up slack in track shoes, measure height at center of shoe as shown below.

Standard height (h): 80 mm (3.2 in)

Repair limits: 25 mm (1 in)

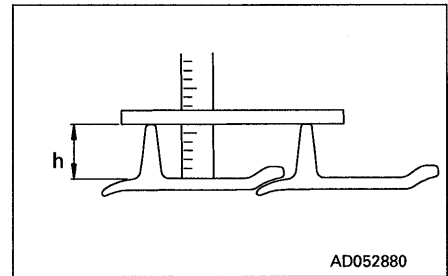
**MEASURING OUTSIDE DIAMETER OF TRACK ROLLER**

1. Measure height (size C) of link tread as shown.
2. Stop machine at position where link tread, whose size C has been measured completely, contacts roller tread. Then measure size B.
3. Calculate outside diameter of tread (size A):

$$A = (B - C) \times 2$$

Standard size (A): 250 mm (9.9 in)

Repair limits: 210 mm (8.3 in)

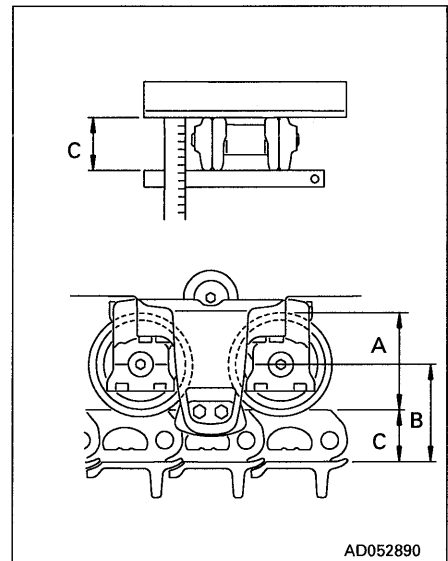

13. TRANSPORTATION

When transporting the machine, observe all related laws and regulations, and be careful to assure safety.

13.1 LOADING, UNLOADING WORK

WARNING

- Make sure the ramp has sufficient width, length and thickness to enable the machine to be safely loaded and unloaded. If the ramp sags appreciably, reinforce it with blocks, etc.
- When loading and unloading the machine, park the trailer on a flat firm roadbed. Keep a fairly long distance between the road shoulder and the machine.
- Remove the mud from the undercarriage to prevent the machine from slipping to the side on slopes. Be sure the ramp surface is clean and free of grease, oil, ice and loose materials.
- Never change the direction of travel when on the ramps. If it is necessary to change direction, drive off the ramps and correct the direction, then drive on to the ramps again.
- Do not use the counterrotation turn.

When loading or unloading, always use ramps or a platform and carry out the operations as follows.

1. Properly apply the brakes on the trailer and insert blocks beneath the tires to ensure that it does not move. Then fix the ramps in line with the centers of the trailer and the machine.
2. Set the machine in line with the ramps, set the joystick to 1st speed, then load or unload the machine at slow travel.
3. Load the machine correctly in the specified position on the trailer.

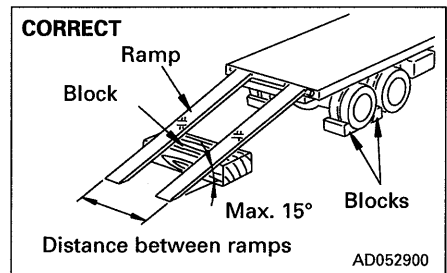

13.2 PRECAUTIONS FOR LOADING

After loading to the specified position, secure the machine as follows.

1. Lower the blade slowly.
2. Lock all the control levers securely with the safety lever.
3. Set the parking lever to the LOCK position.
4. Turn the starting switch to the OFF position, stop the engine, then remove the key.
5. Lock the cab door, left and right engine side covers, and the battery inspection cover.
6. Put blocks under the front and rear of both tracks and secure the machine in position with chains or wire rope of appropriate strength to prevent the machine from moving during transportation. Be particularly careful to tie the machine down securely so that it does not slip to the side.

13.3 METHOD OF LIFTING MACHINE

WARNING

- Never raise the machine with any worker on it.
- Always make sure that the wire rope used for lifting the machine is of ample strength for the weight of the machine.
- Never try to lift the machine in any posture other than the posture given in the procedure below. There is danger that the machine may lose its balance.
- When lifting the chassis, pay attention to the center of gravity and be careful to maintain the balance.

When lifting the machine, carry out the operation as follows on flat ground.

1. Stop the engine and be sure to set the parking lever to the LOCK position.
2. Set the lifting position for the machine as shown in the diagram on the right.

NOTICE

This description of the method for lifting the chassis applies to standard specification machines.

Depending on the attachments and options installed, the method of lifting will differ. In such cases, please contact your Komatsu distributor for advice.

For details of the weight, see "25. SPECIFICATIONS".

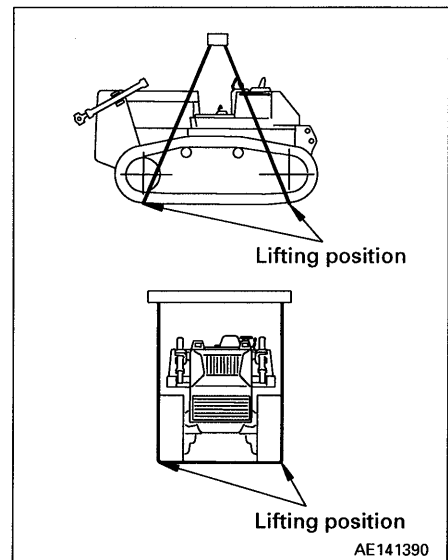

13.4 PRECAUTIONS FOR TRANSPORTATION

WARNING

Determine the route for transporting the machine by taking into account the width, height and weight of the machine.

Obey all state and local laws governing the weight, width and length of a load. Observe all regulations governing wide loads.

Method of transportation

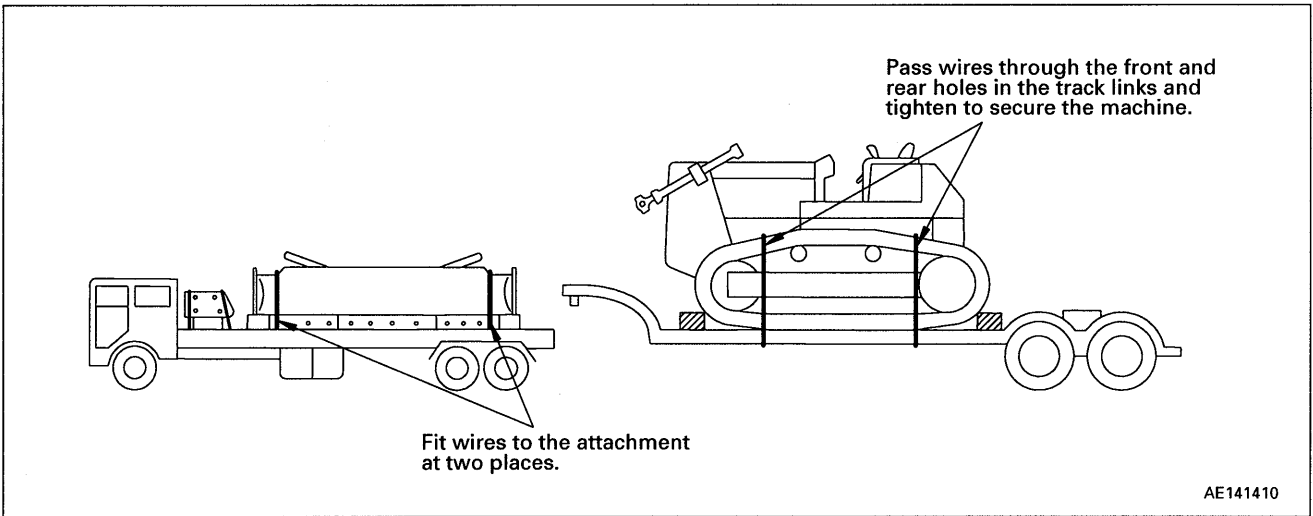

13.5 REMOVAL OF CAB (MACHINES EQUIPPED WITH CAB)

If it is necessary to remove the cab for transportation, disconnect the washer hoses, cab wiring, and washer motor wiring before removing the cab.

1. Push the grommet portion from the hole in the machine cover towards the cab, then remove.
2. Disconnect 4 washer hoses and the wiring (single wires x 2, 4-pin plug x 1).

REMARK

- After removing, cover the washer hoses with a vinyl bag to prevent any dirt or dust from entering.
- Before removing the cab, measure the clearance between the cab and each lever. Note the measurements to use as a standard when installing the cab again.

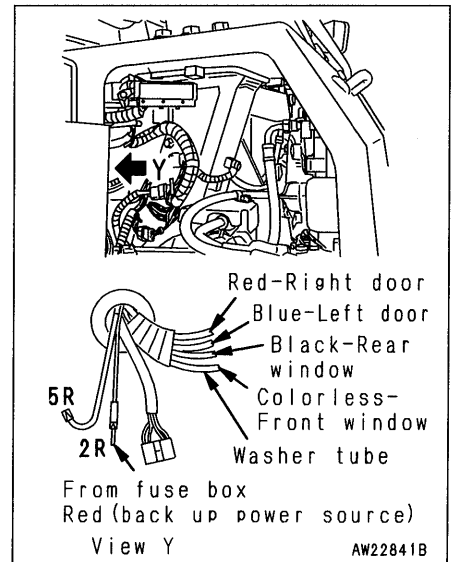

14. COLD WEATHER OPERATION

14.1 PRECAUTIONS FOR LOW TEMPERATURE

If the temperature becomes low, it becomes difficult to start the engine, and the coolant may freeze, so do as follows.

14.1.1 FUEL AND LUBRICANTS

Change to fuel and oil with low viscosity for all components.

For details of the specified viscosity, see "20. USE OF FUEL, COOLANT AND LUBRICANTS ACCORDING TO AMBIENT TEMPERATURE".

14.1.2 COOLANT

 **WARNING**

Keep antifreeze fluid away from an open flame. Never smoke when using antifreeze.

NOTICE

Never use methanol, ethanol or propanol based antifreeze.

Where no permanent antifreeze is available, an ethylene glycol antifreeze without corrosion inhibitor may be used only for the cold season. In this case, clean the cooling system twice a year (in spring and autumn). When refilling the cooling system, add antifreeze in autumn, but do not add any in spring.

Absolutely avoid using any water leak preventing agent irrespective of whether it is used independently or mixed with an antifreeze.

Do not mix one antifreeze with a different brand.

For details of the antifreeze mixture when changing the coolant, see "24.2 WHEN REQUIRED".

Use a Permanent Antifreeze (ethylene glycol mixed with corrosion inhibitor, antifoam agent, etc.) meeting the standard requirements as shown below. With permanent antifreeze, no change of coolant is required for a year. If it is doubtful that an available antifreeze meets the standard requirements, ask the supplier of that antifreeze for information.

Standard requirements for permanent antifreeze.

- SAE J1034
- FEDERAL STANDARD O-A-548D

14.1.3 BATTERY

 **WARNING**

- To avoid gas explosions, do not bring fire or sparks near the battery.
- Battery electrolyte is dangerous. If it gets in your eyes or on your skin, wash it off with large amounts of water, and consult a doctor.

When the ambient temperature drops, the capacity of the battery will also drop. If the battery charge ratio is low, the battery electrolyte may freeze. Maintain the battery charge as close as possible to 100%, and insulate it against cold temperature so that the machine can be started easily the next morning.

Measure the specific gravity and calculate the rate of charge from the following conversion table.

Temp. of fluid Rate of charge	20°C	0°C	-10°C	-20°C
100%	1.28	1.29	1.30	1.31
90%	1.26	1.27	1.28	1.29
80%	1.24	1.25	1.26	1.27
75%	1.23	1.24	1.25	1.26

14.2 AFTER COMPLETION OF WORK

To prevent mud, water, or the undercarriage from freezing and making it impossible for the machine to move on the following morning, always observe the following precautions.

- Mud and water on the machine body should be completely removed. This is to prevent damage to the seal caused by mud or dirt getting inside the seal with frozen drops of water.
- Park the machine on concrete or hard ground. If this is impossible, park the machine on wooden boards.
- Open the drain valve and drain any water collected in the fuel system to prevent it from freezing.
- As the battery capacity drops markedly in low temperatures, cover the battery or remove it from the machine, keep it in a warm place, and install it again the next morning.

14.3 AFTER COLD WEATHER

When season changes and the weather becomes warmer, do as follows.

- Replace the fuel and oil for all parts with oil of the viscosity specified.
For details, see "20. USE OF FUEL, COOLANT AND LUBRICANTS ACCORDING TO AMBIENT TEMPERATURE".
- If for any reason permanent antifreeze cannot be used, and an ethyl glycol base antifreeze (winter, one season type) is used instead, or if no antifreeze is used, drain the cooling system completely, then clean out the inside of the cooling system thoroughly, and fill with fresh water.

15. LONG-TERM STORAGE

15.1 BEFORE STORAGE

When putting the machine in storage for more than one month, do as follows.

- After every part is washed and dried, the machine shall be housed in a dry building. Never leave it outdoors.
In case it is indispensable to leave it outdoors, park the machine on the flat ground and cover it with canvas etc.
- Completely fill the fuel tank, lubricate and change the oil before storage.
- Apply a thin coat of grease to metal surface of the hydraulic piston rods and the idler adjusting rods.
- Disconnect the negative terminals of the battery and cover it, or remove it from the machine and store it separately.
- If the ambient temperature is expected to drop below 0°C, always add antifreeze to the cooling water.
- Place all control levers at the neutral position, operate the safety lever and parking lever to the LOCK position, then move the fuel control dial to the low idling position.

15.2 DURING STORAGE

 **WARNING**

If it is unavoidably necessary to carry out the rustpreventive operation while the machine is indoors, open the doors and windows to improve ventilation and prevent gas poisoning.

- Operate the engine and move the machine for a short distance once a month so that a new film of oil will be coated over movable parts and component surfaces. At the same time, also charge the battery.
- Before operating the work equipment, wipe off the grease on the hydraulic piston rod.

15.3 AFTER STORAGE

NOTICE

If the machine is stored without carrying out the monthly rust prevention operation, request your Komatsu distributor for service.

Carry out the following procedure when taking the machine out of long-term storage.

- Wipe off the grease from the hydraulic cylinder rods.
- Add oil and grease to all places.

16. TROUBLESHOOTING

16.1 AFTER RUNNING OUT OF FUEL

When starting after running out of fuel, fill with fuel and bleed the air from the fuel system before starting.

For details of bleeding the air, see "24.5 EVERY 500 HOURS SERVICE".

16.2 METHOD OF TOWING MACHINE

WARNING

- When towing the machine, use a wire rope that has ample strength for the weight of the machine being towed.
- A shackle must always be used when using a towing hook.
- The wire rope should be horizontal and at a right angle to the track frame.
- Move the machine slowly.

If the machine sinks in mud and cannot get out under its own power, or if being used to tow a heavy object, fit the wire to the towing hook as shown in the diagram on the right, or in the case of machines with a drawbar, fit the wire to the drawbar pin when towing.

NOTICE

The maximum towing capacity for this machine is 29,300 kg (288,371 N).

Always carry out towing operations within the maximum towing capacity.

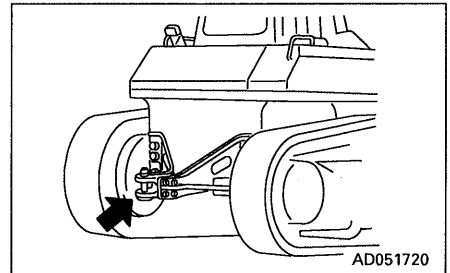
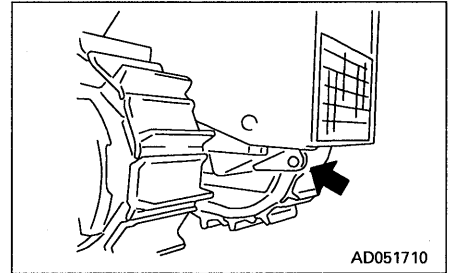

16.3 IF BATTERY IS DISCHARGED

WARNING

- When checking or handling the battery, stop the engine and turn the starting key to the OFF position before starting.
- The battery generates hydrogen gas, so there is danger of explosion. Do not bring lighted cigarettes near the battery, or do anything that will cause sparks.
- Battery electrolyte is dilute sulphuric acid, and it will attack your clothes and skin. If it gets on your clothes or on your skin, wash it immediately off with large amounts of water. If it gets in your eyes, wash it out with fresh water, and consult a doctor.
- When removing the battery, first disconnect the cable from the ground (normally, from the negative \ominus terminal). When installing, install the positive \oplus terminal first. If a tool touches the cable connecting the positive terminal and the chassis, there is danger that it will cause sparks.
- If the terminals are loose, there is danger that the defective contact may generate sparks that will cause an explosion. When installing the terminals, install them tightly.

16.3.1 STARTING ENGINE WITH BOOSTER CABLE

When starting the engine with a booster cable, do as follows:

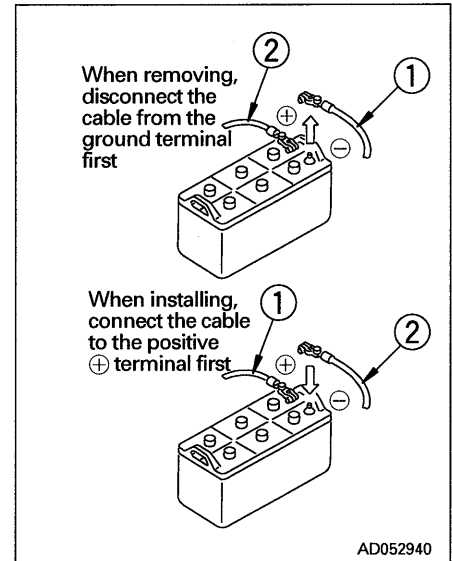

REMOVAL, INSTALLATION OF BATTERY CABLE

1. Open battery cover ① and ②.
2. Before removing the battery, remove the ground cable (normally connected to the negative \ominus terminal). If any tool touches between the positive terminal and the chassis, there is danger of sparks being generated. Loosen the nut of the terminal and remove the wires from the battery.
3. When installing the battery, connect the ground cable last. Insert the hole of the terminal on the battery and tighten the nut. Tightening torque: 9.8 – 19.6 Nm (1.0 – 2.0 kgm, 7.2 – 14.5 lbft)
4. Install battery cover ① and ②.

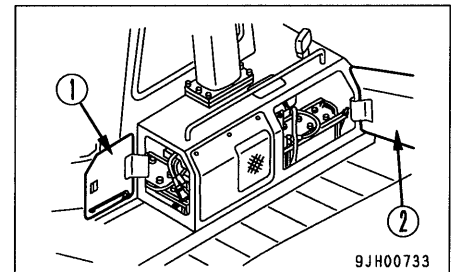

PRECAUTIONS WHEN CONNECTING AND DISCONNECTING BOOSTER CABLE

WARNING

- When starting the engine from another machine, connect the batteries in parallel.
- When connecting the cables, never contact the positive \oplus and negative \ominus terminals.
- When starting the engine with a booster cable, always wear safety glasses.
- Be careful not to let the normal machine and problem machine contact each other. This prevents sparks from generating near the battery which could ignite the hydrogen gas given off by the battery. If hydrogen gas explodes. It could cause serious injury.
- Make sure that there is no mistake in the booster cable connections. The final connection is to the engine block of the problem machine, but sparks will be generated when this is done, so connect to a place as far as possible from the battery.
- Use care when removing the cables from the machine that has been started. Do not allow the cable ends to contact each other or the machine, to avoid hydrogen explosion.

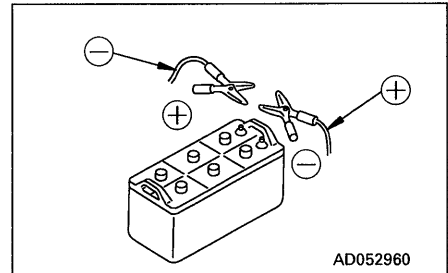

NOTICE

- The size of the booster cable and clip should be suitable for the battery size.
- The battery of the normal machine must be the same capacity as that of the engine to be started.
- Check the cables and clips for damage or corrosion.
- Make sure that the cables and clips are firmly connected.
- Check that the safety lock levers and parking brake levers on both machines are securely at the LOCK position.
- Check that all control levers are at the neutral position.

CONNECTING THE BOOSTER CABLES

Keep the starting switch at the STOP position.

Connect the booster cable as follows, in the order of the numbers marked in the diagram.

1. Make sure that the starting switches of the normal machine and problem machine are both at the OFF position.
2. Connect one clip of booster cable (A) to the positive (+) terminal of the problem machine.
3. Connect the other clip of booster cable (A) to the positive (+) terminal of the normal machine.
4. Connect one clip of booster cable (B) to the negative (-) terminal of the normal machine.
5. Connect the other clip of booster cable (B) to the engine block of the problem machine.

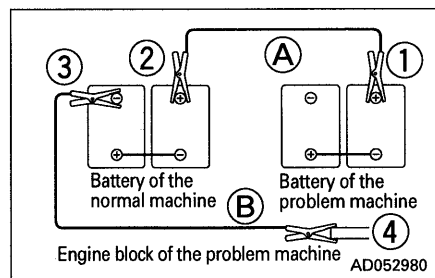
**STARTING THE ENGINE**

1. Make sure the clips are firmly connected to the battery terminals.
2. Start the engine of the normal machine and keep it to run at high idling speed.
3. Turn the starting switch of the problem machine to the START position and start the engine. Refer to "12.2 STARTING ENGINE".

DISCONNECTING THE BOOSTER CABLES

After the engine has started, disconnect the booster cables in the reverse of the order in which they were connected.

1. Remove one clip of booster cable (B) from the engine block of the problem machine.
2. Remove the other clip of booster cable (B) from the negative (-) terminal of the normal machine.
3. Remove one clip of booster cable (A) from the positive (+) terminal of the normal machine.
4. Remove the other clip of booster cable (A) from the positive (+) terminal of the problem machine.

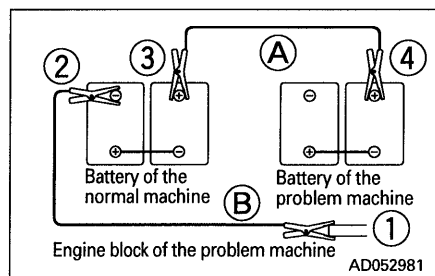

16.4 OTHER TROUBLE

- (): Always contact your Komatsu distributor when dealing with these items.
- In cases of abnormalities or causes which are not listed below, please contact your Komatsu distributor for repairs.

16.4.1 ELECTRICAL SYSTEM

Problem	Main causes	Remedy
Lamp does not glow brightly even when the engine runs at high speed	<ul style="list-style-type: none"> ● Defective wiring ● Defective adjustment of fan belt tension 	<ul style="list-style-type: none"> ● Check, repair loose terminals, disconnections ● Adjust fan belt tension For details, see EVERY 250 HOURS SERVICE
Lamp flickers while engine is running		
Charge lamp does not go out even when engine is running	<ul style="list-style-type: none"> ● Defective alternator ● Defective wiring 	<ul style="list-style-type: none"> ● Replace ● Check, repair
Abnormal noise is generated from alternator	<ul style="list-style-type: none"> ● Defective alternator 	<ul style="list-style-type: none"> ● Replace
Starting motor does not turn when starting switch is turned to ON	<ul style="list-style-type: none"> ● Defective wiring ● Insufficient battery charge ● Safety switch out of adjust 	<ul style="list-style-type: none"> ● Check, repair ● Charge ● Adjust safety switch
Pinion of starting motor keeps going in and out	<ul style="list-style-type: none"> ● Insufficient battery charge 	<ul style="list-style-type: none"> ● Charge
Starting motor turns engine sluggishly	<ul style="list-style-type: none"> ● Insufficient battery charge ● Defective starting motor 	<ul style="list-style-type: none"> ● Charge ● Replace
Starting motor disengages before engine starts	<ul style="list-style-type: none"> ● Defective wiring ● Insufficient battery charge 	<ul style="list-style-type: none"> ● (Check, repair) ● Charge
Automatic preheating is not actuated	<ul style="list-style-type: none"> ● Defective wiring ● Defective glow heater ● Defective timer 	<ul style="list-style-type: none"> ● Check, repair ● Replace ● Replace
Glow signal lamp does not go out	<ul style="list-style-type: none"> ● Defective wiring ● Defective heater relay 	<ul style="list-style-type: none"> ● Check, repair ● Replace
Oil pressure caution lamp does not light up when engine is stopped (starting switch at ON position)	<ul style="list-style-type: none"> ● Defective caution lamp ● Defective caution lamp switch ● Defective wiring 	<ul style="list-style-type: none"> ● Replace ● Replace ● Check, repair
Charge lamp does not light up when engine is stopped (starting switch at ON position)	<ul style="list-style-type: none"> ● Defective charge lamp ● Defective wiring 	<ul style="list-style-type: none"> ● Replace ● Check, repair
Outside of electrical intake air heater is not warm when touched by hand	<ul style="list-style-type: none"> ● Defective wiring ● Disconnection in electrical intake air heater ● Defective operation of heater relay switch 	<ul style="list-style-type: none"> ● Check, repair ● Replace ● Check, repair heater relay switch

16. TROUBLESHOOTING

Problem	Main causes	Remedy
Air conditioner does not work properly	<ul style="list-style-type: none"> ● Blown fuse ● Insufficient battery charge ● Defective air conditioner switch ● Defective blower switch ● Defective compressor 	<ul style="list-style-type: none"> (● Check, repair) ● Charge (● Replace air conditioner switch) (● Replace blower switch) (● Replace)
Blade pitch does not change even when pitch operation is carried out (pitch specification machines only)	<ul style="list-style-type: none"> ● Defective wiring ● Defective switch ● Defective solenoid valve 	<ul style="list-style-type: none"> (● Check, repair) (● Replace) (● Replace)
HSS charge pressure caution lamp does not light up when starting switch is turned ON.	<ul style="list-style-type: none"> ● Defective caution lamp ● Defective wiring ● Defective charge pressure sensor 	<ul style="list-style-type: none"> (● Replace) (● Check, repair) (● Replace)
Electronic system caution lamp does not light up when starting switch is turned ON	<ul style="list-style-type: none"> ● Defective caution lamp ● Defective wiring 	<ul style="list-style-type: none"> (● Replace) (● Check, repair)

16.4.2 CHASSIS

Problem	Main causes	Remedy
When brake pedal is depressed, machine does not stop	<ul style="list-style-type: none"> ● Brakes out of adjust, defective brake oil pressure 	<ul style="list-style-type: none"> (● Check, adjust)
Track comes off	<ul style="list-style-type: none"> ● Track too loose 	<ul style="list-style-type: none"> ● Adjust track tension, see WHEN REQUIRED
Abnormal wear of sprocket	<ul style="list-style-type: none"> ● Track too loose or too tightened 	
Blade, ripper lifting speed is slow or they do not move	<ul style="list-style-type: none"> ● Lack of hydraulic oil ● Work equipment lock lever is at LOCK position 	<ul style="list-style-type: none"> ● Add oil to specified level. See EVERY 250 HOURS SERVICE. ● Set to FREE position
Machine does not turn when steering is operated	<ul style="list-style-type: none"> ● Parking brake is at LOCK position ● Defective lever wiring ● Abnormality in HSS pump ● Abnormality in HSS motor 	<ul style="list-style-type: none"> ● Set to FREE position (● Check, repair) (● Check, replace) (● Check, replace)
Transmission oil pressure does not rise	<ul style="list-style-type: none"> ● Wear, scuffing of gear pump ● Lack of oil in power train case ● Element strainer of oil filter in power train case clogged 	<ul style="list-style-type: none"> (● Check, replace) ● Add oil to specified level. For details, see CHECKS BEFORE STARTING. ● Clean. For details, see EVERY 1000 HOURS SERVICE.
Lack of drawbar pull (travel speed does not rise)	<ul style="list-style-type: none"> ● Lack of engine horsepower 	<ul style="list-style-type: none"> ● See ENGINE
Pickup of travel speed is slow	<ul style="list-style-type: none"> ● Power train oil temperature is low ● Lack of engine horsepower 	<ul style="list-style-type: none"> ● Carry out warming-up operation ● See ENGINE
Machine does not move when joystick is operated to travel position	<ul style="list-style-type: none"> ● Lack of oil in power train case ● Transmission oil pressure does not rise ● Parking brake is at LOCK position 	<ul style="list-style-type: none"> ● Add oil to specified level. See CHECK BEFORE STARTING. ● See "Transmission oil pressure does not rise" above ● Set to FREE position
Machine does not travel in straight line	<ul style="list-style-type: none"> ● Defective adjustment of HSS controller ● Abnormality in HSS pump 	<ul style="list-style-type: none"> (● Adjust) (● Check, replace)
Torque converter overheats (indicator is in red range)	<ul style="list-style-type: none"> ● Lack of oil in power train case ● Transmission oil pressure does not rise ● Excessive load 	<ul style="list-style-type: none"> ● Add oil to specified level. See CHECK BEFORE STARTING ● See "Transmission oil pressure does not rise" above ● Shift down one gear, or reduce load and raise speed during operation

16.4.3 ENGINE

Problem	Main causes	Remedy
Engine oil pressure caution lamp remains alight when engine speed is raised after completion of warm-up	<ul style="list-style-type: none"> ● Engine oil pan oil level is low (sucking in air) ● Clogged oil filter cartridge ● Defective tightening of oil pipe joint, oil leakage from damaged part ● Defective caution lamp 	<ul style="list-style-type: none"> ● Add oil to specified level, see CHECK BEFORE STARTING ● Replace cartridge, see EVERY 250 HOURS SERVICE (● Check, repair) (● Replace lamp)
Steam is emitted from top part of radiator (pressure valve)	<ul style="list-style-type: none"> ● Cooling water level low, water leakage ● Loose fan belt ● Dirt or scale accumulated in cooling system ● Clogged radiator fin or damaged fin ● Defective thermostat ● Loose radiator filler cap (high altitude operation) ● Defective water temperature gauge 	<ul style="list-style-type: none"> ● Add cooling water, repair, see CHECK BEFORE STARTING ● Adjust fan belt tension, see EVERY 250 HOURS SERVICE ● Change cooling water, clean inside of cooling system, see WHEN REQUIRED ● Clean or repair, see WHEN REQUIRED (● Replace thermostat) ● Tighten cap or replace packing (● Replace water temperature gauge)
Indicator of water temperature gauge is in red range on right side of gauge	<ul style="list-style-type: none"> ● Defective thermostat ● Loose radiator filler cap (high altitude operation) ● Defective water temperature gauge 	<ul style="list-style-type: none"> (● Replace thermostat) ● Tighten cap or replace packing (● Replace water temperature gauge)
Indicator of water temperature gauge is in white range on left side of gauge	<ul style="list-style-type: none"> ● Defective thermostat ● Defective water temperature gauge 	<ul style="list-style-type: none"> (● Replace thermostat) (● Replace water temperature gauge)
Engine does not start when starting motor is turned	<ul style="list-style-type: none"> ● Lack of fuel ● Air in fuel system ● Defective fuel injection pump or nozzle ● Starting motor cranks engine sluggishly ● Glow signal does not glow red ● Defective compression <ul style="list-style-type: none"> ○ Defective valve clearance 	<ul style="list-style-type: none"> ● Add fuel, see CHECK BEFORE STARTING ● Repair place where air is sucked in (● Replace pump or nozzle) — See ELECTRICAL SYSTEM (○ Adjust valve clearance)
Exhaust gas is white or blue	<ul style="list-style-type: none"> ● Too much oil in oil pan ● Improper fuel 	<ul style="list-style-type: none"> ● Add oil to specified level, see CHECK BEFORE STARTING ● Change to specified fuel
Exhaust gas occasionally turns black	<ul style="list-style-type: none"> ● Clogged air cleaner element ● Defective nozzle ● Defective compression 	<ul style="list-style-type: none"> ● Clean or replace, see WHEN REQUIRED (● Replace nozzle) (● Adjust valve clearance)
Combustion noise occasionally makes breathing sound	<ul style="list-style-type: none"> ● Defective nozzle 	<ul style="list-style-type: none"> (● Replace nozzle)
Abnormal noise generated (combustion or mechanical)	<ul style="list-style-type: none"> ● Low grade fuel being used ● Overheating ● Damage inside muffler ● Excessive valve clearance 	<ul style="list-style-type: none"> ● Change to specified fuel ● See item "Indicator of water temperature gauge is in red range on right side of gauge". (● Replace muffler) (● Adjust valve clearance)

MAINTENANCE



WARNING

Always hang the DANGER. DO NOT OPERATE! sign in the operator's compartment when carrying out maintenance.

17. GUIDES TO MAINTENANCE

Do not carry out any inspection and maintenance operation that is not given in this manual.

Perform maintenance work on hard, flat ground.

Check service meter

Check the service meter reading every day to see if the time has come for any necessary maintenance to be carried out.

Komatsu genuine replacement parts:

Use Komatsu genuine parts specified in the parts list as replacement parts.

Komatsu genuine oils:

Use Komatsu genuine oils and grease. Choose oils and grease with proper viscosities specified for ambient temperature.

Always use clean washer fluid:

Use automobile window washer fluid and be careful not to let any dirt get into it.

Clean oil and grease:

Use clean oil and grease. Also, keep containers of the oil and grease clean. Keep foreign materials away from oil and grease.

Keeping the machine clean:

Always keep the machine clean. This makes it easier to find parts causing problems. Keep in particular grease fittings, breathers and oil level gauges clean and avoid foreign matters from getting in them.

Be careful of hot water and oil:

Draining hot oils and coolants and removing their filters immediately after the engine stops are hazardous. Allow the engine to cool.

If the oil has to be drained when it is cold, warm up the oil to a suitable temperature (approx. 20 – 40°C) before draining it.

Checking foreign materials in drained oil:

After oil is changed or filters are replaced, check the oil and filters for metallic particles and foreign materials. If large quantities of metallic particles or foreign materials are found, consult your Komatsu distributor.

Fuel strainer:

If your machine is equipped with a fuel strainer, do not remove it while fueling.

Oil change:

Check or change oils in the places where dust is scarce to keep foreign materials away from oils.

Warning tag:

Attach the warning tag to the starting switch or other appropriate control lever to avoid someone who is not aware of the circumstances from starting the engine.

Obey precautions:

During the operation, always obey the precautions on the safety label stuck to the machine.

Welding instructions:

- Turn off the engine starting switch.
- Do not apply more than 200 V continuously.
- Connect grounding the cable within 1 m from the area to be welded.
- Avoid seals or bearings from being between the area to be welded and the position of grounding point.

Fire prevention:

Use nonflammable cleaner or light oil for cleaning parts. Keep flame or cigarette light away from light oil.

Clamp faces:

When O-rings or gaskets are removed, clean the clamp faces and replace the O-rings and gaskets with new ones. Be sure to fit O-rings and gaskets when assembling.

Objects in your pockets:

Keep your pockets free of loose objects which can fall out and drop into the machinery; especially when you work on the machinery while bending over it.

Checking undercarriage:

When working in rocky areas, check for damage to the undercarriage and for looseness, flaws, wear and damage in bolts and nuts. Loosen the track tension a little when working in such areas.

Cleaning machine:

- Do not direct a high-pressure jet directly at the radiator and air conditioner condenser.
- Do not splash water over the electrical equipment.

Pre- and post-work checks:

Before starting work in mud, rain, snow or at seashore, check plugs and valves for tightness. Wash the machine immediately after the work to protect components from rusting.

Lubricate components more frequently than usual. Be sure to lubricate work equipment pins daily if they are submerged in water.

Dusty worksites:

When working at dusty worksites, do as follows:

- Check the air cleaner for clogging more frequently. Clean the air cleaner at shorter intervals than specified.
- Clean the radiator core frequently to avoid clogging.
- Clean and replace the fuel filter frequently.
- Clean electrical components, especially the starting motor and alternator, to avoid accumulation of dust.

Avoid mixing oils:

Never mix oils of different brands. If you have only oil which is a different brand from the one that is used in the machine, do not add it but replace all the oil.

Precautions when opening and closing engine side cover:

- When standing on the track to open the engine side cover, adopt a standing position, hold the side cover with both thumbs, and open it slowly with your other fingers.
- When the engine side cover is open, do not open or close the cab.
Before opening or closing the cab, always close the engine side cover first.

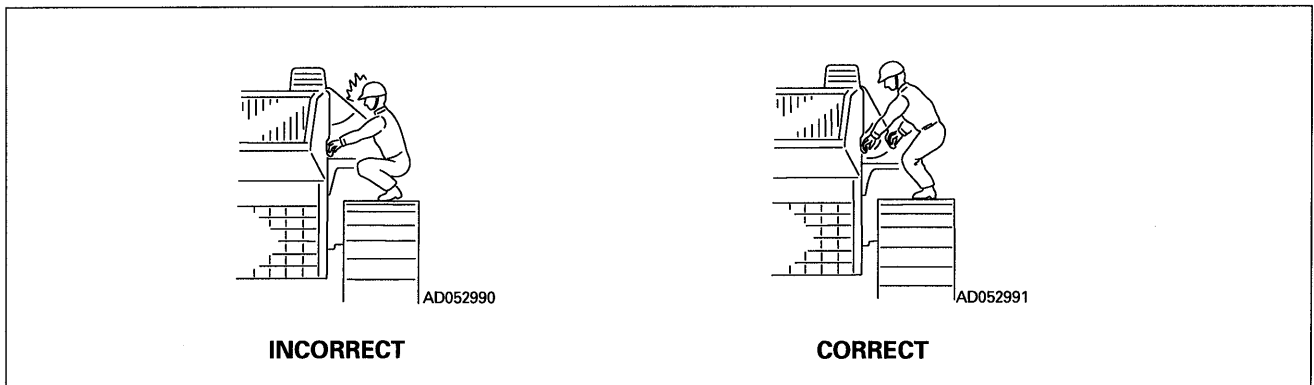

18. OUTLINES OF SERVICE

- Use Komatsu genuine parts for replacement.
- When changing or adding oil, do not use a different type of oil.
- Unless otherwise specified, the oil and coolant used at the time of shipment from the factory are as shown in the table below.

Item	Kind of fluid
Engine oil pan	SAE 15W-40 API classification CD
Damper case Power train case Final drive case	SAE 30 API classification CD
Hydraulic tank	SAE 10W API classification CD
Fuel tank	ASTM D975 No. 2 (However, ASTM D975 No. 1 is used for the winter season (October to March))
Radiator	Komatsu Super Coolant (AF-ACL) 41% added to water

18.1 OUTLINE OF OIL, FUEL, COOLANT

18.1.1 OIL

- Oil is used in the engine and work equipment under extremely severe conditions (high temperature, high pressure), and it deteriorates with use.
Always use oil that matches the grade and temperature for use given in the Operation and Maintenance Manual. Even if the oil is not dirty, always replace the oil after the specified interval.
- Oil corresponds to blood in the human body, so always be careful when handling it to prevent any impurities (water, metal particles, dirt, etc.) from getting in.
The majority of problems with machine are caused by the entry of such impurities.
Take particular care not to let any impurities get in when storing or adding oil.
- Never mix oils of different grades or brands.
- Always add the specified amount of oil.
Having too much oil or too little oil are both causes of problems.
- If the oil in the work equipment is not clear, there is probably water or air getting into the circuit.
In such cases, please contact your Komatsu distributor.
- When changing the oil, always replace the related filters at the same time.
- We recommend you to have an analysis made of the oil periodically to check the condition of the machine. For those who wish to use this service, please contact your Komatsu distributor.

18.1.2 FUEL

- The fuel pump is a precision instrument, and if fuel containing water or dirt is used, it cannot work properly.
- Be extremely careful not to let impurities get in when storing or adding fuel.
- Always use the fuel specified in the Operation and Maintenance Manual.
Fuel may congeal depending on the temperature when it is used (particularly in low temperature below -15°C), so it is necessary to change to a fuel that matches the temperature.
- To prevent the moisture in the air from condensing and forming water inside the fuel tank, always fill the fuel tank after completing the day's work.
- Before starting the engine, or when 10 minutes have passed after adding fuel, drain the sediment and water from the fuel tank.
- If the engine runs out of fuel, or if the filters have been replaced, it is necessary to bleed the air from the circuit.

18.1.3 COOLANT

- River water contains large amounts of calcium and other impurities, so if it is used, scale will stick to the engine and radiator, and this will cause defective heat exchange and overheating.
Do not use water that is not suitable for drinking.
- When using anti-freeze, always observe the precautions given in the Operation and Maintenance Manual.
- Komatsu machines are supplied with Komatsu original anti-freeze in the coolant when the machine is shipped.
This anti-freeze is effective in preventing corrosion of the cooling system.
The anti-freeze can be used continuously for two years or 4000 hours. Therefore, it can be used as it is even in hot areas.
- Anti-freeze is inflammable, so be extremely careful not to expose it to flame or fire.
- The proportion of anti-freeze to water differs according to the ambient temperature.
For details of the mixing proportions, see "24.2.1 CLEAN INSIDE OF COOLING SYSTEM".
- If the engine overheats, wait for the engine to cool before adding coolant.
- If the coolant level is low, it will cause overheating and will also cause problems with corrosion from the air in the coolant.

18.1.4 GREASE

 **WARNING**

Do not carry out greasing when the engine is running.

- Grease is used to prevent twisting and noise at the joints.
- The nipples not included in the maintenance section are nipples for overhaul, so they do not need grease.
If any part becomes stiff after being used for a long time, add grease.
- Always wipe off all of the old grease that is pushed out when greasing. Be particularly careful to wipe off the old grease in places where sand or dirt sticking in the grease would cause wear of the rotating parts.

18.1.5 STORING OIL AND FUEL

- Keep indoors to prevent any water, dirt, or other impurities from getting in.
- When keeping drum cans for a long period, put the drum on its side so that the filler port of the drum can is at the side. (To prevent moisture from being sucked in)
If drum cans have to be stored outside, cover them with a waterproof sheet or take other measures to protect them.
- To prevent any change in quality during long-term storage, be sure to use in the order of first in first out (use the oldest oil or fuel first).

18.1.6 FILTERS

- Filters are extremely important safety parts. They prevent impurities in the fuel and air circuits from entering important equipment and causing problems.
Replace all filters periodically. For details, see the Operation and Maintenance Manual.
However, when working in severe conditions, it is necessary to consider replacing the filters at shorter intervals according to the oil and fuel (sulfur content) being used.
- Never try to clean the filters (cartridge type) and use them again. Always replace with new filters.
- When replacing oil filters, check if any metal particles are stuck to the old filter. If any metal particles are found, please contact your Komatsu distributor.
- Do not open packs of spare filters until just before they are to be used.
- Always use Komatsu genuine filters.

18.2 RELATING TO ELECTRIC SYSTEM

- If the wiring gets wet or the insulation is damaged, the electric system leaks and this could result in hazardous malfunction of the machine.
- Services relating to the electric system are (1) check of fan belt tension, (2) check of damage or wear in the fan belt and (3) check of battery fluid level.
- Never remove or disassemble any electric components installed in the machine.
- Never install any electric components other than these specified by Komatsu.
- Be careful to keep the electric system free of water when washing the machine or when it rains.
- When working on the seashore, carefully clean the electric system to prevent corrosion.
- Never connect any optional power source to the fuse, starting switch, battery relay, etc.

19. WEAR PARTS LIST

Wear parts such as the filter element, cutting edge, etc. are to be replaced at the time of periodic maintenance or before their abrasion limits.

The wear parts should be changed correctly in order to use the machine economically.
For part change, Komatsu genuine parts of excellent quality should be used.

The parts in parentheses are to be replaced at the same time.

Item	Part No.	Part Name	Weight (kg)	Q'ty	Replacement frequency	
Engine oil filter	600-211-1231	Cartridge	-	1	Every 250 hours service	
Power train filter	07063-01100 (07000-72100)	Element (O-ring)	- -	1 (1)	Every 500 hour service	
Fuel filter	600-311-7132	Cartridge	-	1		
Hydraulic tank breather	20Y-60-21470	Cap element	-	1		
Corrosion resistor	600-411-1150	Cartridge	-	1		Every 1000 hours service
Charge filter	07063-51054 (07000-02110)	Element (O-ring)	- -	1 (1)		
Hydraulic oil filter	07063-51100 (07000-02135)	Element (O-ring)	- -	1 (1)	Every 2000 hours service	
Air cleaner	6128-81-7042	Element ass'y	-	1	-	
	600-181-4400	Outer element ass'y	-	1		
Air conditioner	Fresh filter	14X-911-7750	Filter	-	2	-
	Recirc filter	14X-911-7741	Filter	-	1	
Blade	Semi U-blade	195-70-12492	Cutting edge	103.4	1	-
		17A-71-11351	Cutting edge	57	2	
		17M-71-21930	End bit (left)	63	1	
		17M-71-21940	End bit (right)	63	1	
		17A-71-12451	(Bolt)	-	(33)	
		17M-71-21530	(Nut)	-	(33)	
	U-blade	17A-72-12221	Cutting edge	69	2	
		17M-72-21160	Cutting edge	58	2	
		17M-71-21930	End bit (left)	63	1	
		17M-71-21940	End bit (right)	63	1	
		17A-71-12451	(Bolt)	-	(36)	
		17A-71-21530	(Nut)	-	(36)	

Item		Part No.	Part Name	Weight (kg)	Q'ty	Replacement frequency
Blade	Angledozer	175-70-26310	Cutting edge	48.8	1	-
		175-70-21115	Cutting edge	64.1	2	
		175-71-11454	(Bolt)	-	(25)	
		175-71-11530	(Nut)	-	(25)	
		175-70-21126	End bit (left)	37	1	
		175-70-21136	End bit (right)	37	1	
		175-71-11463	(Bolt)	-	(14)	
		175-71-11530	(Nut)	-	(14)	
Ripper	Multi	175-78-31230	Point	15	3	-
		195-78-21320	Protector	13	3	
		09244-02508	(Pin)	-	(9)	
	Giant	175-78-31230	Point	15	1	-
		195-78-21320	Protector	13	1	
		09244-02508	(Pin)	-	3	

NOTICE

When handling parts that weigh more than 25 kg, remember that they are heavy objects, and take the necessary care.

20. USE OF FUEL, COOLANT AND LUBRICANTS ACCORDING TO AMBIENT TEMPERATURE

PROPER SELECTION OF FUEL, COOLANT AND LUBRICANTS

RESERVOIR	KIND OF FLUID	AMBIENT TEMPERATURE								CAPACITY	
		-22 -30	-4 -20	14 -10	32 0	50 10	68 20	86 30	104°F 40°C	Specified	Refill
Engine oil pan	Engine oil								SAE 30	42 ℓ 11.09 US gal 9.24 UK gal	37 ℓ 9.77 US gal 8.14 UK gal
									SAE 10W		
									SAE 10W-30		
									SAE 15W-40		
Damper case									SAE 30	1.5 ℓ 0.40 US gal 0.33 UK gal	1.5 ℓ 0.40 US gal 0.33 UK gal
Power train case									SAE 30	105 ℓ 27.72 US gal 23.1 UK gal	60 ℓ 15.84 US gal 13.20 UK gal
Final drive case (each)								SAE 10W	58 ℓ 15.31 US gal 12.76 UK gal	58 ℓ 15.31 US gal 12.76 UK gal	
Hydraulic system								SAE 10W	126 ℓ 33.26 US gal 27.72 UK gal	87 ℓ 22.99 US gal 19.14 UK gal	
								SAE 10W-30			
								SAE 15W-40			
Fuel tank	Diesel fuel								ASTM D975 No.2	625 ℓ 165 US gal 138 UK gal	-
		※									
Grease fitting	Grease								NLGI No.2	-	-
Cooling system (incl. sub-tank)	Water								Add antifreeze	99 ℓ 26.16 US gal 21.78 UK gal	-

※ ASTM D975 No. 1

REMARK

- When fuel sulphur content is less than 0.5%, change oil in the oil pan every periodic maintenance hours described in this manual.
Change oil according to the following table if fuel sulphur content is above 0.5%.

Fuel sulphur content	Change interval of oil in engine oil pan
0.5 to 1.0%	1/2 of regular interval
Above 1.0%	1/4 of regular interval

- When starting the engine in an atmospheric temperature of lower than 0°C, be sure to use engine oil of SAE10W, SAE10W-30 and SAE15W-40, even though an atmospheric temperature goes up to 10°C more or less in the day time.
- Use API classification CD as engine oil and if API classification CC, reduce the engine oil change interval to half.
- There is no problem if single grade oil is mixed with multigrade oil (SAE10W-30, 15W-40), but be sure to add single grade oil that matches the temperature in the table.
- We recommend Komatsu genuine oil which has been specifically formulated and approved for use in engine and hydraulic work equipment applications.

Specified capacity: Total amount of oil including oil for components and oil in piping.

Refill capacity: Amount of oil needed to refill system during normal inspection and maintenance.

ASTM: American Society of Testing and Material
 SAE: Society of Automotive Engineers
 API: American Petroleum Institute

20. USE OF FUEL, COOLANT AND LUBRICANTS ACCORDING TO AMBIENT TEMPERATURE

No.	Supplier	Engine Oil [CD or CE] SAE10W, 30, 40 10W30, 15W40 (The 15W40 oil marked * is CE.)	Gear Oil [GL-4 or GL-5] SAE80, 90, 140	Grease [Lithium-Base] NLGI No. 2	Anti-freeze Coolant [Ethylene Glycol Base] Permanent Type
1	KOMATSU	EO10-CD EO30-CD EO10-30CD EO15-40CD	GO90 GO140	G2-LI G2-LI-S	AF-ACL AF-PTL AF-PT (Winter, one season type)
2	AGIP	Diesel sigma S Super dieselmulti- grade *Sigma turbo	Rotra MP	GR MU/EP	-
3	AMOCO	*Amoco 300	Multi-purpose gear oil	RYKON premium grease	-
4	ARCO	*Arcofleet S3 plus	Arco HD gear oil	Litholine HEP 2 Arco EP moly D	-
5	BP	Vanellus C3	Gear oil EP Hypogear EP	Energrease LS-EP2	Antifreeze
6	CALTEX	*RPM delo 400 RPM delo 450	Universal thuban Universal thuban EP	Marfak all purpose 2 Ultra-duty grease 2	AF engine coolant
7	CASTROL	*Turbomax *RX super CRD	EP EPX Hypoy Hypoy B Hypoy C	MS3 Spheerol EPL2	Anti-freeze
8	CHEVRON	*Delo 400	Universal gear	Ultra-duty grease 2	-
9	CONOCO	*Fleet motor oil	Universal gear lubricant	Super-sta grease	-
10	ELF	Multiperformance 3C Performance 3C	-	Tranself EP Tranself EP type 2	Glacelf
11	EXXON (ESSO)	Essolube D3 *Essolube XD-3 *Essolube XD-3 Extra *Esso heavy duty Exxon heavy duty	Gear oil GP Gear oil GX	Beacon EP2	All season coolant
12	GULF	Super duty motor oil *Super duty plus	Multi-purpose gear lubricant	Gulfcrown EP2 Gulfcrown EP special	Antifreeze and coolant
13	MOBIL	Delvac 1300 *Delvac super 10W-30, 15W-40	Mobilube GX Mobilube HD	Mobilux EP2 Mobilgrease 77 Mobilgrease special	-

20. USE OF FUEL, COOLANT AND LUBRICANTS ACCORDING TO AMBIENT TEMPERATURE

No.	Supplier	Engine Oil [CD or CE] SAE10W, 30, 40 10W30, 15W40 (The 15W40 oil marked * is CE.)	Gear Oil [GL-4 or GL-5] SAE80, 90, 140	Grease [Lithium-Base] NLGI No. 2	Anti-freeze Coolant [Ethylene Glycol Base] Permanent Type
14	PENNZOIL	*Supreme duty fleet motor oil	Multi-purpose 4092 Multi-purpose 4140	Multi-purpose white grease 705 707L White – bearing grease	Anti-freeze and summer coolant
15	PETROFINA	FINA kappa TD	FINA potonic N FINA potonic NE	FINA marson EPL2	FINA tamidor
16	SHELL	Rimula X	Spirax EP Spirax heavy duty	Alvania EP grease	–
17	SUN	–	Sunoco GL5 gear oil	Sunoco ultra prestige 2EP Sun prestige 742	Sunoco antifreeze and summer coolant
18	TEXACO	*Ursa super plus Ursa premium	Multigear	Multifak EP2 Starplex 2	Code 2055 startex antifreeze coolant
19	TOTAL	Rubia S *Rubia X	Total EP Total transmission TM	Multis EP2	Antigel/antifreeze
20	UNION	*Guardol	MP gear lube LS	Unoba EP	–
21	VEEDOL	*Turbostar *Diesel star MDC	Multigear Multigear B Multigear C	–	Antifreeze

21. STANDARD TIGHTENING TORQUES FOR BOLTS AND NUTS

21.1 INTRODUCTION OF NECESSARY TOOLS

The following tools are needed when carrying out maintenance.

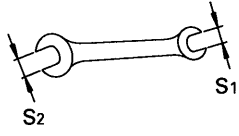
No.	Name of tool	Part No.	Remarks
1	Wrench set	09000-30006	Applicable width across flats ($S_1 - S_2$) 8 mm – 10 mm, 12 mm – 14 mm 13 mm – 17 mm, 19 mm – 22 mm 24 mm – 27 mm, 30 mm – 32 mm
			 AD053370
2	Wrench	09002-03641	36 mm – 41 mm
3	Wrench	09001-04600	Applicable width across flats 46 mm
4	Screwdriver	09033-00190	Interchangeable flat-head and cross-head type
5	Socket wrench set	09020-10284	Applicable width across flats 10 mm, 13 mm 14 mm, 17 mm 19 mm, 22 mm, 24 mm, 27 mm, 30 mm, 32 mm, 36 mm Extension, Handle
6	Filter wrench	09019-08035	For filter cartridges
7	Plier	09036-00150	
8	Hammer	09039-00150	
9	Bar	09055-10390	
10	Gauge	09054-00009	
11	Grease pump	07952-80002	For greasing work
12	Nozzle	07951-11400	For greasing work
13	Grease cartridge	07950-90403	(Lithium base grease, 400 g)

If any of the above tools are broken, please order them from your Komatsu distributor.

When not using the tools, always put them in the tool box on the inside of the battery inspection cover on the left side of the machine.

21.2 TORQUE LIST

Unless otherwise specified, tighten the metric bolts and nuts to the torque shown in the table.

The tightening torque is determined by the width across the flats ⓑ of the nut and bolt.

If it is necessary to replace any nut or bolt, always use a Komatsu genuine part of the same size as the part that was replaced.

Nm (newton meter): $1\text{Nm} \approx 0.1 \text{kgm}$
 $\approx 0.74 \text{lbft}$

Thread diameter of bolt (mm) (a)	Width across flat (mm) (b)	AD054300		
		Nm	kgm	lbft
6	10	13.2 ± 1.4	1.35 ± 0.15	9.73 ± 1.03
8	13	31.4 ± 2.9	3.2 ± 0.3	23.2 ± 2.1
10	17	65.7 ± 6.8	6.7 ± 0.7	48.5 ± 5.0
12	19	112 ± 9.8	11.5 ± 1.0	82.6 ± 7.2
14	22	177 ± 19	18.0 ± 2.0	131 ± 14
16	24	279 ± 29	28.5 ± 3	206 ± 21
18	27	383 ± 39	39 ± 3	282 ± 29
20	30	549 ± 58	56 ± 6	405 ± 43
22	32	745 ± 78	76 ± 8	549 ± 58
24	36	927 ± 98	94.5 ± 10	684 ± 72
27	41	1320 ± 140	135 ± 15	973 ± 100
30	46	1720 ± 190	175 ± 20	1270 ± 140
33	50	2210 ± 240	225 ± 25	1630 ± 180
36	55	2750 ± 290	280 ± 30	2030 ± 210
39	60	3280 ± 340	335 ± 35	2420 ± 250

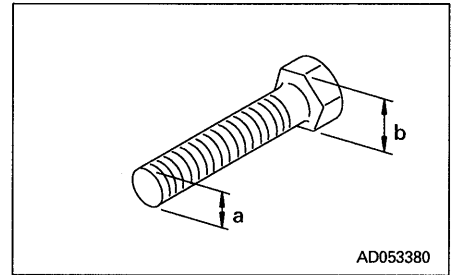

NOTICE

When tightening panels or other parts having tightening fixtures made of plastic, be careful not to use excessive tightening torque: doing so will damage the plastic parts.

22. PERIODIC REPLACEMENT OF SAFETY CRITICAL PARTS

To ensure safety at all times when operating or driving the machine, the user of the machine must always carry out periodic maintenance. In addition, to further improve safety, the user should also carry out periodic replacement of the parts given in the table. These parts are particularly closely connected to safety and fire prevention.

With these parts, the material changes as time passed, or they easily wear or deteriorate. However, it is difficult to judge the condition of the parts simply by periodic maintenance, so they should always be replaced after a fixed time has passed, regardless of their condition. This is necessary to ensure that they always maintain their function completely.

However, if these parts show any abnormality before the replacement interval has passed, they should be repaired or replaced immediately.

If the hose clamps show any deterioration, such as deformation or cracking, replace the clamps at the same as the hoses.

When replacing the hoses, always replace the O-rings, gaskets, and other such parts at the same time.

Ask your Komatsu distributor to replace the critical parts.

SAFETY CRITICAL PARTS

No.	Safety critical parts for periodic replacement	Q'ty	Replacement interval
1	Fuel tank – fuel injection pump	1	Every 2 years or 4000 hours, whichever comes sooner
2	Fuel injection pump – joint (bottom of fuel tank)	1	
3	Fuel injection pump – joint (bottom of fuel tank)	1	
4	Joint (bottom of fuel tank) – fuel tank	1	
5	Joint (bottom of fuel tank) – fuel tank	1	
6	Feed pump – fuel filter	1	
7	Fuel filter – fuel injection pump	1	
8	Power train pump – power train filter	1	
9	Steering case cover – HSS motor gear train	1	
10	Power train filter – transmission control valve	1	
11	Transmission control valve – brake valve	1	
12	Torque converter – oil cooler	1	
13	Oil cooler – transmission case, torque converter case	1	
14	Central pressure detection hose – transmission case, torque converter case	1	
15	Hydraulic tank – charge pump	1	
16	Charge pump – charge filter	1	
17	HSS, PPC charge valve – accumulator	1	
18	HSS, PPC charge valve – hydraulic tank	1	
19	HSS, PPC charge valve – PPC lock valve	1	
20	PPC lock valve – PPC valve (blade)	1	
21	PPC lock valve – PPC valve (ripper)	1	
22	HSS, PPC charge valve – CLSS valve	1	
23	HSS, PPC charge valve – HSS pump	1	
24	PPC relief valve – HSS pump	1	
25	HSS pump – HSS motor	1	

22. PERIODIC REPLACEMENT OF SAFETY CRITICAL PARTS

No.	Safety critical parts for periodic replacement	Q'ty	Replacement interval
26	HSS pump – HSS motor	1	Every 2 years or 4000 hours, whichever comes sooner
27	HSS motor – central drain block	1	
28	Central drain block – hydraulic tank	1	
29	HSS motor – central drain block	1	
30	HSS motor – central drain block	1	
31	HSS pump – central drain block	1	
32	Central drain block – cooler bypass valve	1	
33	HSS pump – cooler bypass valve	1	
34	Cooler bypass valve – oil cooler	1	
35	Cooler bypass valve – oil cooler	1	
36	Oil cooler – cooler bypass valve	1	
37	Oil cooler – cooler bypass valve	1	
38	Cooler bypass valve – hydraulic tank	1	
39	Hydraulic pump – CLSS valve	1	
40	CLSS valve – block (blade lift)	2	
41	Block (blade lift) – blade lift cylinder	4	
42	CLSS valve – divider block (ripper)	1	
43	CLSS valve – divider block (ripper)	1	
44	CLSS valve – divider block (ripper)	1	
45	CLSS valve – divider block (ripper)	1	
46	Divider block (ripper) – ripper lift cylinder	4	
47	Divider block (ripper) – ripper tilt cylinder	4	
48	Seat belt	1	

23. MAINTENANCE SCHEDULE CHART

23.1 MAINTENANCE SCHEDULE CHART

SERVICE ITEM	PAGE
INITIAL 250 HOURS SERVICE (only after the first 250 hours)	
Replace fuel filter cartridge	3-61
Replace power train oil filter element	3-62
Change oil in power train case, wash strainers (power train pump strainer, scavenging pump strainer)	3-63
Change oil in final drive case	3-65
Replace charge filter element	3-68
Change oil in hydraulic tank, replace hydraulic oil filter element	3-69
Check engine valve clearance, adjust	3-70
WHEN REQUIRED	
Clean inside of cooling system	3-23
Check, clean and replace air cleaner element	3-27
Check track tension	3-29
Check and tighten track shoe bolts	3-31
Check electrical intake air heater	3-31
Reverse and replace the end bits and cutting edges	3-32
Replace fan belt	3-34
Clean, check radiator fins	3-34
Replace air conditioner belt	3-35
Clean, check hydraulic cooler fins	3-36
Clean, check air conditioner condenser fins	3-37
Adjust idler clearance	3-37
Check undercarriage oil	3-38
Clean air conditioner air filter (FRESH/RECIRC filter) (Machines equipped with cab)	3-38
Check, adjust air conditioner (Machines equipped with cab)	3-39
Grease door hinge (Machines equipped with cab)	3-39
Check door lock striker (Machines equipped with cab)	3-39
Replace door damper (Machines equipped with cab)	3-40
Check window washer fluid level, add fluid (Machines equipped with cab)	3-40
Bleed air from head end of right pitch cylinder (Power tilt, power pitch dozer only)	3-40
Replace wiper blade (Machines equipped with cab)	3-41

23. MAINTENANCE SCHEDULE CHART

SERVICE ITEM	PAGE
CHECK BEFORE STARTING	
Check coolant level, add water	3-42
Checking with machine monitor (Monitor panel specification)	3-42
Check fuel level, add fuel	3-43
Drain water, sediment from fuel tank	3-43
Check oil level in engine oil pan, add oil	3-44
Check oil level in power train case, add oil	3-45
Check brake pedal travel	3-46
Check damper case oil level, add oil	3-46
Check oil level in hydraulic tank, add oil	3-47
Check dust indicator	3-47
Check electric wirings	3-48
Check that lamps light up	3-48
Check horn sound	3-49
Check backup alarm sound	3-50
Check seat belt for wear or damage	3-50
Check for water and sediment in water separator, drain water	3-51
EVERY 250 HOURS SERVICE	
Lubricating	3-52
Check oil level in final drive case, add oil	3-56
Check level of battery electrolyte	3-57
Check, adjust alternator drive belt tension	3-58
Change oil in engine oil pan, replace engine oil filter cartridge	3-59
Check brake performance	3-60
EVERY 500 HOURS SERVICE	
Replace fuel filter cartridge	3-61
Replace power train oil filter element	3-62
Replace hydraulic tank breather element	3-62

SERVICE ITEM	PAGE
EVERY 1000 HOURS SERVICE	
Change oil in power train case, wash strainers (power train pump strainer, scavenging pump strainer)	3-63
Change oil in final drive case	3-65
Check cab suspension cylinder	3-65
Clean power train case breather	3-66
Grease universal joint (2 places)	3-66
Replace corrosion resistor cartridge	3-67
Check all tightening parts of turbocharger	3-67
Grease tension pulley assembly (1 place)	3-67
Check, clean fuel strainer	3-67
Replace charge filter element	3-68
Grease idler adjustment rod (left, right: 1 place each)	3-68
Check for loose ROPS mount bolts (option)	3-68
EVERY 2000 HOURS SERVICE	
Change oil in hydraulic tank, replace hydraulic oil filter element	3-69
Check play of turbocharger rotor	3-70
Clean, check turbocharger	3-70
Clean engine breather element	3-70
Check alternator, starting motor	3-70
Check engine valve clearance, adjust	3-70
Change oil in damper case, clean damper breather	3-71
Check pivot bearing oil level, add oil	3-72
EVERY 4000 HOURS SERVICE	
Check water pump	3-73
Check fan pulley and tension pulley	3-73
Check vibration damper	3-73

24. SERVICE PROCEDURE

24.1 INITIAL 250 HOURS SERVICE

Carry out the following maintenance only after the first 250 hours.

- **REPLAC FUEL FILTER CARTRIDGE**
- **REPLACE POWER TRAIN OIL FILTER ELEMENT**
- **CHANGE OIL POWER TRAIN CASE, WASH STRAINERS (POWER TRAIN PUMP STRAINER, SCAVENGING PUMP STRAINER)**
- **CHANGE OIL IN FINAL DRIVE CASE**
- **REPLACE CHARGE FILTER ELEMENT**
- **CHANGE OIL IN HYDRAULIC TANK, REPLACE HYDRAULIC OIL FILTER ELEMENT**
- **CHECK ENGINE VALVE CLEARANCE, ADJUST**

For details of the method of replacing or maintaining, see the section on EVERY 500 HOURS, 1000 HOURS AND 2000 HOURS SERVICE.

24.2 WHEN REQUIRED

24.2.1 CLEAN INSIDE OF COOLING SYSTEM

⚠ WARNING

- Soon after the engine has been stopped, the coolant is hot and can cause personal injury. Allow the engine to cool before draining water.
 - Never be under the machine with the engine running. To avoid serious injury, always stop the engine before being under the machine to open the drain valve.
 - Never remove the radiator cap when the engine is at operating temperature. At operating temperature, the coolant is under pressure. Steam blowing up from the radiator could cause personal injury. Allow the engine to cool until the radiator filler cap is cool enough to touch with your hand. Remove the filler cap slowly to relieve pressure.
 - When removing drain plug, avoid pouring coolant on yourself.
 - Antifreeze is flammable, so keep it away from any flame.
- Clean the inside of the cooling system, change the coolant and replace the corrosion resistor according to the table below.

Kind of coolant	Cleaning inside of cooling system and changing coolant	Replacing corrosion resistor
Permanent type antifreeze (All season type)	Every year (autumn) or every 2000 hours whichever comes first	Every 1000 hours and when cleaning the inside of the cooling system and when changing coolant
Non permanent type antifreeze containing ethylene glycol (Winter, one season type)	Every 6 months (spring, autumn) (Drain antifreeze in spring, add antifreeze in autumn)	
When not using antifreeze	Every 6 months or every 1000 hours whichever comes first	

24. SERVICE PROCEDURE

- Use a permanent type of antifreeze.
If, for some reason, it is impossible to use permanent type antifreeze, use an antifreeze containing ethylene glycol.
- Stop the machine on level ground when cleaning or changing the coolant.
- When deciding the ratio of antifreeze to water, check the lowest temperature in the past, and decide from the mixing rate table given below.
It is actually better to estimate a temperature about 10°C (50°F) lower when deciding the mixing rate.

Mixing rate of water and antifreeze

Min. atmospheric temperature	°C	-5	-10	-15	-20	-25	-30
	°F	23	14	5	-4	-13	-22
Amount of antifreeze	ℓ	22.5	30.7	35.6	40.6	45.5	49.5
	US gal	5.94	8.10	9.40	10.72	12.01	13.07
	UK gal	4.95	6.75	7.83	8.93	11.01	10.89
Amount of water	ℓ	76.5	68.3	63.4	58.4	53.5	49.5
	US gal	20.20	18.03	16.84	15.42	14.12	13.07
	UK gal	16.83	15.03	14.04	12.85	11.77	10.89

- We recommend use of an antifreeze density gauge to control the mixing proportions.
- Use city water for the cooling water.
If river water, well water or other such water supply must be used, contact your Komatsu distributor.

- Prepare a container to catch drained coolant: Min. 99 ℓ (26.16 US gal, 21.78 UK gal) capacity.

1. Tighten valve ① of the corrosion resistor.
2. Turn radiator cap ② slowly and remove it.
3. Prepare a container to catch the coolant, then open drain valve ③ at the bottom of the radiator on the right side of the machine and drain the coolant.

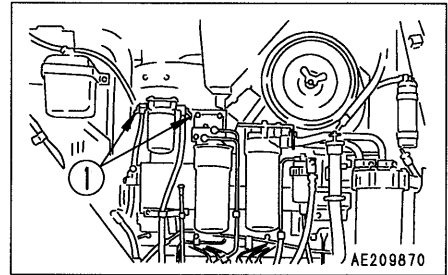

4. After draining the coolant, close drain valve ③ and fill the radiator with tap water.

5. When the radiator is filled with water, open drain valve ③, start the engine, and run at low idling. Keep the engine running at low idling and flush the radiator for 10 minutes.

While flushing the radiator, adjust the incoming flow of water to match the drain flow so that the radiator is always kept full during the flushing operation. Also, be sure that the water supply hose does not slip out of the radiator water filler when flushing.

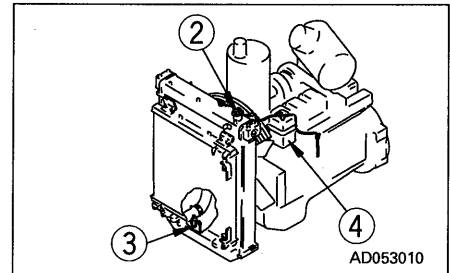

6. After flushing, stop the engine, allow all the water to drain out from drain valve ③, then close drain valve ③.

7. After draining the water, flush the system with a flushing agent. For details of the flushing method, see the instructions on the flushing agent.

8. After flushing, open drain valve ③, drain out all the water, close drain valve ③ and add tap water so that the water level is near the mouth of the water filler.

9. When the water reaches the water filler port, open drain valve ③, start the engine, run at low idling and continue to flush the system until clean water comes out.

While flushing the radiator, adjust the incoming flow of water to match the drain flow so that the radiator is always kept full during the flushing operation. Be sure that the water supply hose does not slip out of the radiator water filler when flushing.

10. When clean water comes out, stop the engine and close drain valve ③.

11. Replace the corrosion resistor and open valve ①. For details on the corrosion resistor replacement method, see "24.6 EVERY 1000 HOURS SERVICE".

12. Add city water until the water overflows from the water filler port.

13. To remove the air in the cooling water, run for five minutes at low idling, then for another five minutes at high idling. (When doing this, leave the radiator cap off.)

24. SERVICE PROCEDURE

14. Drain the cooling water inside sub-tank ④, clean the inside of the sub-tank, then fill again with cooling water to a point midway between the FULL and LOW marks.
15. Stop the engine, wait for 3 minutes, add city water until the water level reaches near the water filler port, then tighten the cap.

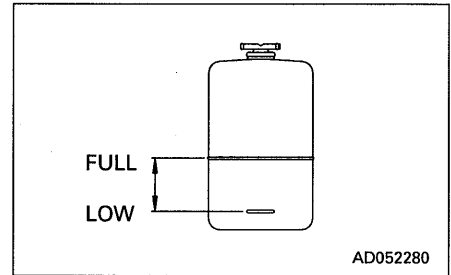

24.2.2 CHECK, CLEAN AND REPLACE AIR CLEANER ELEMENT

⚠ WARNING

- Never clean or replace the air cleaner element with the engine running.
- When using pressure air to clean the element wear safety glasses or goggles to protect the eyes.

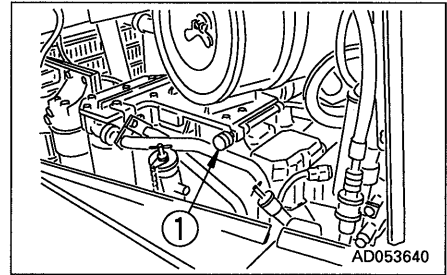

CHECK

If the red piston can be seen in transparent portion ② of dust indicator ①, clean the air cleaner element.

NOTICE

Do not clean the element before the dust indicator becomes red.

If the element is cleaned frequently before the dust indicator becomes red, the performance of the air cleaner is not fully used, but the cleaning efficiency is lowered. In addition, the dust sticking to the element falls on the inner element side more frequently when the element is cleaned.

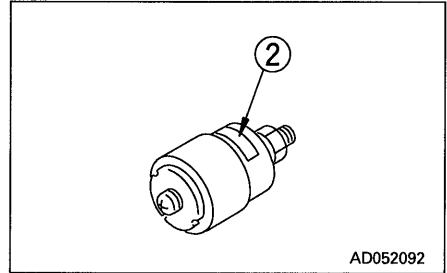

CLEAN, REPLACE OUTER ELEMENT

1. Loosen wing nut ④, then remove the outer element.
2. Clean the air cleaner body interior.
3. Direct dry compressed air (less than 700 kPa (7 kg/cm², 100 psi)) to the element from inside along its folds, then direct it from outside along its folds and again from inside.
 - 1) Remove one seal from the outer element. The number of times the outer element has been cleaned can be seen by the number of removed seals.
 - 2) Replace the outer element which has been cleaned 6 times repeatedly or used throughout a year. Replace the inner element at the same time.
 - 3) Replace the element when the air cleaner clogged warning lamp lights up soon after installing the cleaned element even though it has not been cleaned 6 times.
 - 4) Check inner element mounting nuts for looseness and, if necessary, retighten.
 - 5) Replace seal washer ⑤ or wing nut ④ with new parts if they are broken.

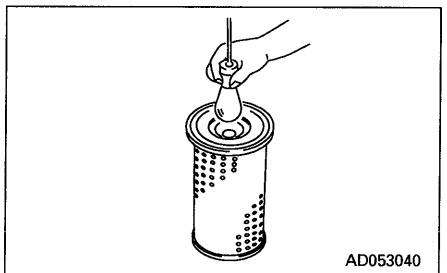
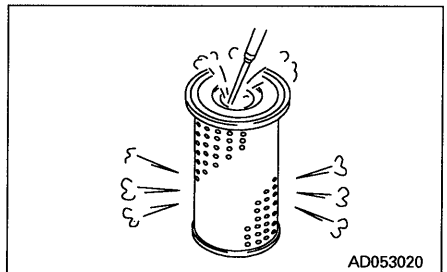
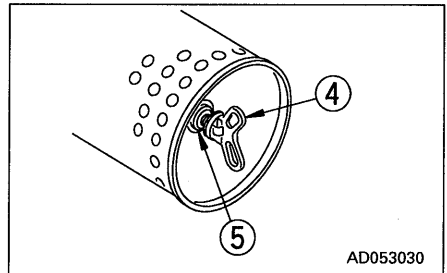

NOTICE

If small holes or thinner parts are found on the element when it is checked with an electric bulb after cleaning and drying, replace the element.

Do not use an element whose folds or gasket or seal are damaged.

When cleaning the element, do not hit it or beat it against something.

4. Set the cleaned element.

REPLACING INNER ELEMENT

1. First remove the outer element, and then remove the inner element.
2. To prevent dust from getting in, use a clean cloth or tape to cover the air connector (outlet side).
3. Clean the air cleaner body interior, then remove the cover installed in Step 2.
4. Fit a new inner element to the connector and tighten it with nuts. Do not clean and reinstall a inner element.
5. Install the outer element.
6. After replacing the element, press button ③ of the dust indicator to return the red piston to its original position.

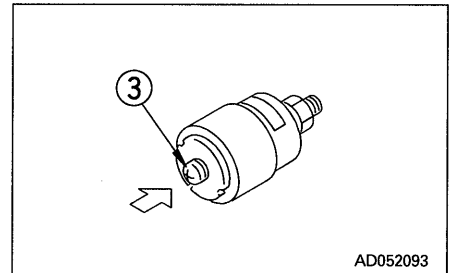

AD052093

24.2.3 CHECK TRACK TENSION

The wear of pins and bushings on the undercarriage will vary with the working conditions and soil properties. It is thus necessary to continually inspect the track tension so as to maintain the standard tension.

Carry out the check and adjustment under the same conditions as when operating (on jobsites where the track becomes clogged with mud, measure with the track clogged with mud).

INSPECTION

Stop the machine on level ground (stop with the transmission in FORWARD without applying the brake). Then place a straight bar on the track shoes between the carrier roller and the idler as shown in the figure, and measure the clearance between the bar and the grouser at the midpoint. If the clearance is 20 – 30 mm (0.79 – 1.18 in), the tension is standard.

If the track tension is not at the standard value, adjust it in the following manner.

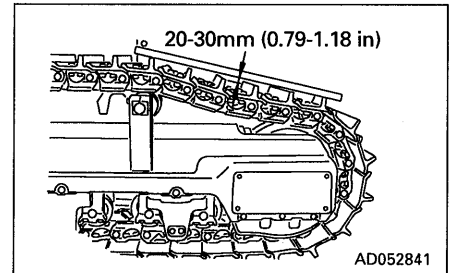

ADJUSTMENT

⚠ WARNING

Grease inside the adjusting mechanism is under high pressure. Grease coming from lubricator ① under pressure can penetrate the body causing injury or death. For this reason, do not loosen lubricator ① more than one turn. Do not loosen any part other than lubricator ①. Furthermore, do not bring your face in front of the grease fitting.

If the track tension is not relieved by this procedure, please contact your Komatsu distributor.

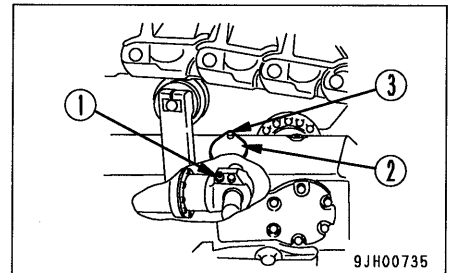

● When increasing tension

1. Remove both bolts ③, then remove cover ②.

NOTICE

- There is a safety label stuck to the rear face of cover ②, so be careful not to damage the safety label.
 - Be careful not to let dirt or soil get in when removing cover ②.
2. Pump in grease through the grease fitting with a grease pump.
 3. To check that the correct tension has been achieved, move the machine backwards and forwards.
 4. Check the track tension again, and if the tension is not correct, adjust it again.
 5. Continue to pump in grease until S becomes 0 mm. If the tension is still loose, the pin and bushing are excessively worn, so they must be either turned or replaced. Please contact your Komatsu distributor.

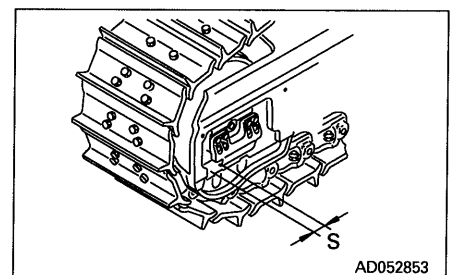

● When loosening tension

⚠ WARNING

It is extremely dangerous to release the grease by any method except the procedure given below. If the track tension is not relieved by this procedure, please contact your Komatsu distributor.

1. Remove both bolts ③, then remove cover ②.

NOTICE

- There is a safety label stuck to the rear face of cover ②, so be careful not to damage the safety label.
- Be careful not to let dirt or soil get in when removing cover ②.

2. Loosen lubricator ① gradually to release the grease.
3. Turn lubricator ① a maximum of one turn.
4. If the grease does not come out smoothly, move the machine backwards and forwards a short distance.
5. Tighten lubricator ①.
6. To check that the correct tension has been achieved, move the machine backwards and forwards.
7. Check the track tension again, and if the tension is not correct, adjust it again.

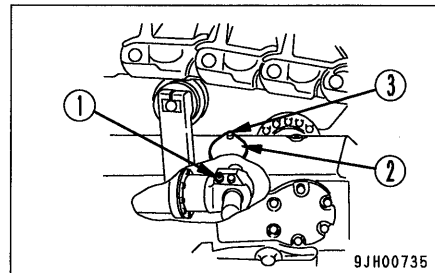

● When removing track

⚠ WARNING

Depending on the situation, the operation to remove the track may be extremely dangerous. Before removing the track, if the procedure above "When loosening tension" does not loosen the track tension, please contact your Komatsu distributor for repair.

24.2.4 CHECK AND TIGHTEN TRACK SHOE BOLTS

If the machine is used with track shoe bolts ① loose, they will break, so tighten any loose bolts immediately.

- **Method for tightening (shoe bolt)**

1. First tighten to a tightening torque of 588 ± 59 Nm (60 ± 6 kgm, 434 ± 43 lbft) then check that the nut and shoe are in close contact with the link contact surface.
2. After checking, tighten a further $120 \pm 10^\circ$.

- **Method for tightening (master link connecting bolt)**

1. First tighten to a tightening torque of 588 ± 59 Nm (60 ± 6 kgm, 434 ± 43 lbft) then check that the link contact surfaces are in close contact.
2. After checking, tighten a further $180 \pm 10^\circ$.

Order for tightening

Tighten the bolts in the order shown in the diagram on the right.

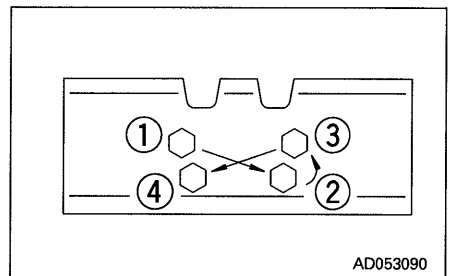
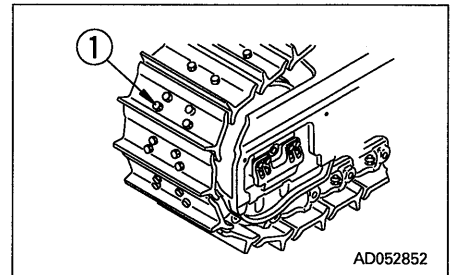

24.2.5 CHECK ELECTRICAL INTAKE AIR HEATER

Before the start of the cold season (once a year), contact your Komatsu distributor to have the electrical intake air heater repaired or checked for dirt or disconnections.

24.2.6 REVERSE AND REPLACE THE END BITS AND CUTTING EDGES

⚠ WARNING

It is dangerous if the work equipment moves by mistake when the cutting edges and end bits are being reversed or replaced. Set the work equipment in a stable condition, then stop the engine and lock the blade control lever securely with the safety lever.

Reverse or replace the end bits and cutting edges before it is worn out to the blade end.

1. Raise the blade to a proper height and apply a block to the frame so as to prevent fall of the blade.
2. Operate the safety lever to the LOCK position.
3. Measure the wear of the end bit and cutting edge in accordance with the wear standards given below.

Wear standards

Unit: mm (in)

Item			Judgement standard	
No.	Measurement point	Work equipment	Standard dimension	Repair limit
1	Height of outside of end bit	A	415 (16.35)	300 (11.82)
		B	292 (11.50)	211 (8.31)
2	Width of end bit	A	662 (26.08)	500 (19.70)
		B	435 (17.14)	360 (14.18)
3	Height of inside of end bit	A	330 (13.00)	260 (10.24)
		B	254 (10.01)	211 (8.31)
4	Height of cutting edge (from center of bolt mounting hole to end face)	A	330 (13.00)	260 (10.24) (To 215 (8.47) after turning)
		B	254 (10.01)	213 (8.39) (To 140 (5.52) after turning)

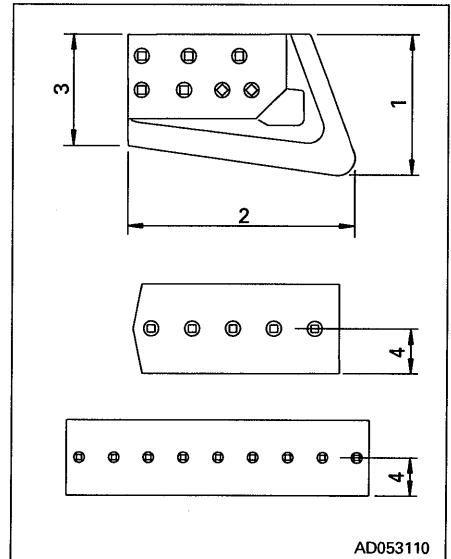

AD053110

The symbols in the work equipment column have the following meaning.

A: Semi-U blade, U blade

B: Angledozer

If the cutting edge and the end bit on both sides are worn out, replace with new one.

If it has been worn out up to the fitting surface, repair the fitting surface and then reverse or replace.

4. Remove the cutting edge and the end bit and clean the mounting surface.
5. Reverse or replace the cutting edge and the end bit when worn out.

Nut tightening torque:

Semi-U blade	1496 ± 162 Nm (152.5 ± 16.5 kgm, 1103 ± 119 lbft)
Angledozer	869 ± 130 Nm (88.6 ± 13.3 kgm, 641 ± 96 lbft)

If bolt ② and nut ① are damaged, replace them with new ones at the same time.

Loosen nuts ①, remove bolts ②, then replace or reverse the cutting edge.

- 1) Install the edge to the blade and tighten temporarily. Lower the blade and push it against the ground to remove the play in bolt ②, then tighten to the correct tightening torque.
- 2) When installing end bit ③, bring top edge ④ of the end bit into tight contact with stopper ⑤, then tighten the bolts.
6. After several hours of running, retighten the nuts.

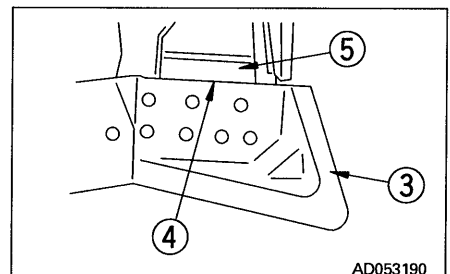
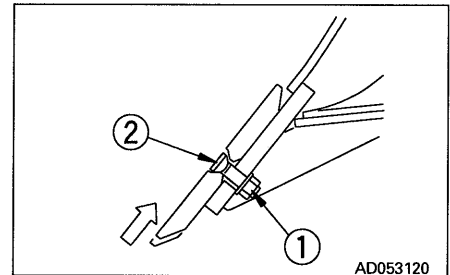

24.2.7 REPLACE FAN BELT

Fit a wrench to the tension pulley, push in the direction of the arrow to remove the V-belt, then replace the V-belt.

REMARK

- An auto-tensioner is installed, so there is no need to carry out any adjustment until the belt is replaced.
- Replace the V-belts as a set.

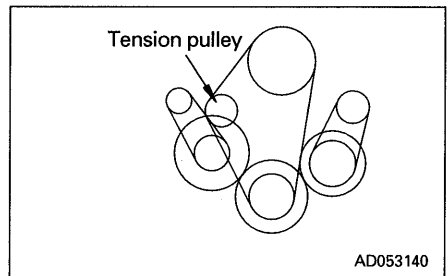
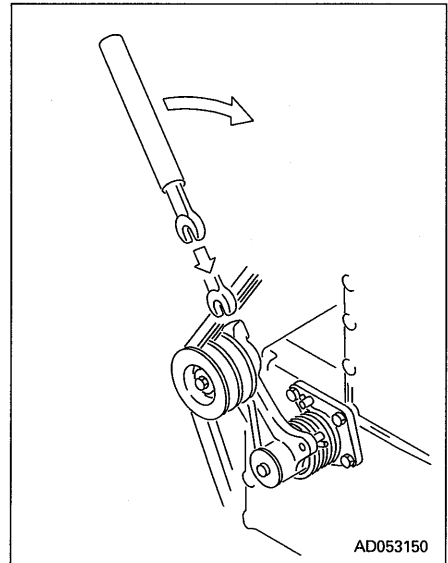

24.2.8 CLEAN, CHECK RADIATOR FINS

WARNING

If compressed air, steam, or water hit your body directly, there is danger of injury. Always wear protective glasses, mask, and safety shoes.

If the radiator fins are clogged or dirty, clean and inspect them.

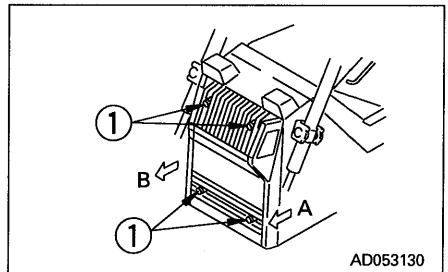

1. Remove bolts ① (4 bolts).
2. Open the A side (hinge side) of the radiator mask. It opens approx. 30 mm (1.18 in).
3. Leave the B side of the radiator mask open.
4. Open the hydraulic cooler. For details of the opening method, see "24.2.10 CLEAN, CHECK HYDRAULIC COOLER FINS".
5. Clean the radiator fins clogged with mud, dust and leaves with compressed air. Steam or water may be used instead of compressed air.

REMARK

Check the rubber hose. If the hose is found to have cracks to be hardened by ageing, replace such hose with new one. Further, loosen hose clamp should also be checked.

- When closing the radiator mask, always push in the A side first, then push in the B side, align the bolt holes, and tighten bolt ①.

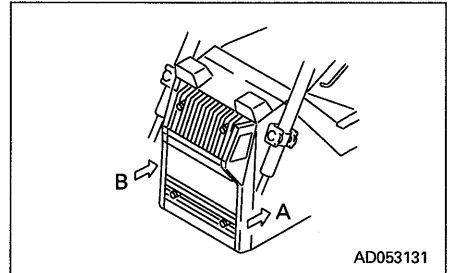
**24.2.9 REPLACE AIR CONDITIONER BELT**

- Loosen 4 bolts ① and jack bolt ②, then move compressor ③ to the side.
- Replace the V-belt.

REMARK

When adjusting the V-belt, do not push the compressor directly with a bar. Use jack bolt ②.

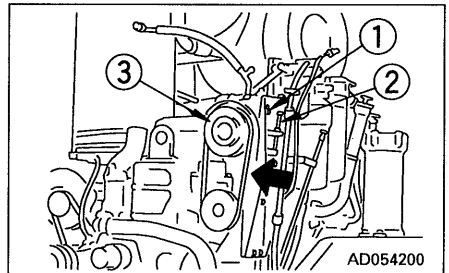

- Tighten jack bolt ② and bolts ①, and apply tension to the V-belt. The standard deflection for the V-belt is approx. 10 mm (0.39 in) when the belt is pushed by thumb (approx. 6 kg (13 lb)) at a point midway between the air compressor pulley and fan pulley.

24.2.10 CLEAN, CHECK HYDRAULIC COOLER FINS

If the hydraulic cooler fins are clogged or there is dirt caught in the fins, clean and check the fins.

1. Open the radiator mask. For details on how to open the radiator mask, see "24.2.8 CLEAN, CHECK RADIATOR FINS".
2. Set the hinge pin in position.
 1. Top
Extend pin bolt ①, and when it penetrates plate ② (welded to the hydraulic cooler) by 8 mm (0.31 in), set nut ⑨ in position.
 2. Bottom
Extend pin bolt ④, and when it penetrates plate ⑤ by 8 mm (0.31 in), set double nut ③ in position.
3. Remove cooler mounting bolts ⑥ (x 4) and ⑦ (x 4), and hose clips ⑧.
4. Open the hydraulic cooler to the hinge side, then clean and check the fins. The hydraulic cooler can be opened approx. 40° .
5. Use compressed air to remove the mud, dirt, and leaves clogging the hydraulic cooler fins. Steam or water may be used instead of compressed air.

REMARK

Inspect the rubber hoses, and replace them if they are cracked or brittle. Check also for loose hose clamps.

6. When fixing the hydraulic cooler in position again:
 1. Fix the hydraulic cooler in position with bolts ⑥ and ⑦, then fix the hose in position with clamp ⑧.
 2. Retract pin bolts ① and ④ and set so that there is a clearance of 5 – 10 mm (0.20 – 0.39 in) at the top from plate ② and at the bottom from plate ⑤.

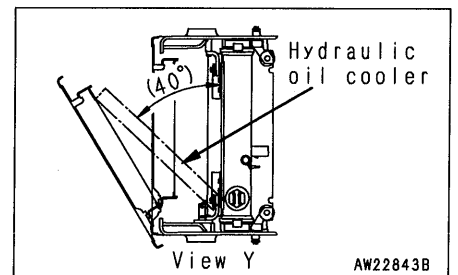
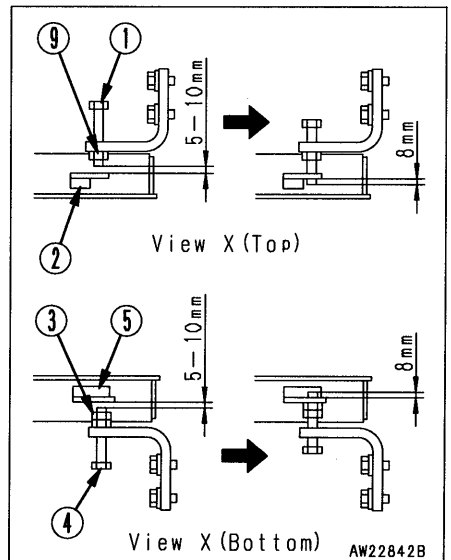
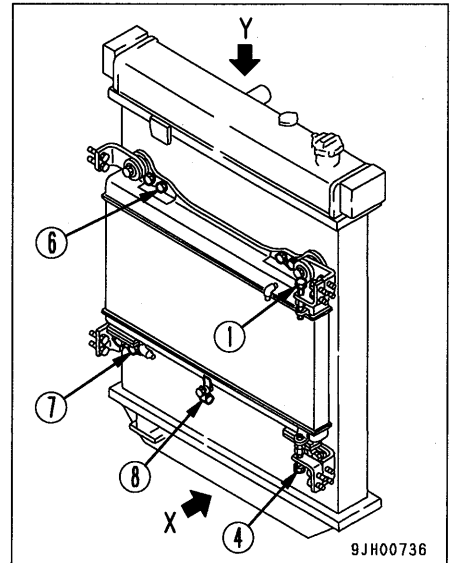

24.2.11 CLEAN, CHECK AIR CONDITIONER CONDENSER FINS

If the air conditioner condenser fins are clogged, clean and check the fins.

1. Remove 3 mounting bolts ① of the upper cover, then remove upper cover ②.
2. Use compressed air to blow off the mud, dirt, or leaves clogging the fins.
3. Install upper cover ② with bolts ①.

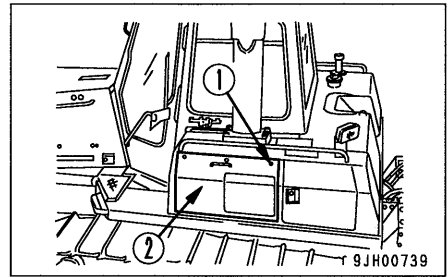

24.2.12 ADJUST IDLER CLEARANCE

Since the idlers are forced to move forward and backward by an external force guide plates ② will be worn out.

Wear of these plates will cause the vibration of idlers from side to side or inclination of the idlers, and running off of track links from the idlers or unevenly worn idler and links may result.

Therefore, adjust the idlers according to the following procedure.

ADJUSTMENT

1. Drive the machine on level ground for 1 – 2 m (3.28 – 6.56 ft), then remove covers ③ (both inside and outside) at the side face of the idler.
2. Measure the clearance A (4 locations: left, right, inside and outside) between the track frame and the guide plate.
3. If the clearance A exceeds 3.0 mm (0.12 in), loosen bolt ①, and pull out the shim to adjust the clearance at one end to 0.5 – 1.0 mm (0.02 – 0.04 in).

REMARK

Thickness of one shim is 1.0 mm (0.04 in).

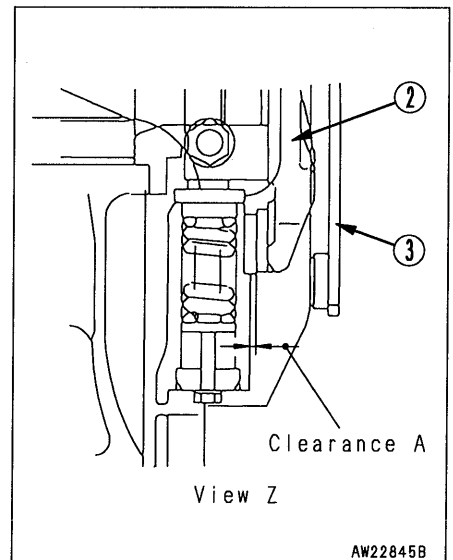
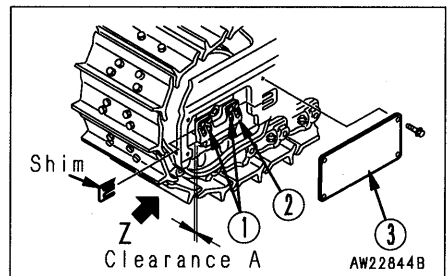

24.2.13 CHECK UNDERCARRIAGE OIL

Stop the machine on level ground, and check for any reduction in the oil at the idler (portion P), track roller (portion Q), bogie shaft (portion Q), and carrier roller (portion R).

1. Loosen seal bolt ① slowly and check if oil oozes out from the thread. If oil oozes out, the oil level has not gone down, so tighten the bolt.
2. If no oil comes out even when seal bolt ① is removed, the oil level is low, so please contact your Komatsu distributor for repair.

REMARK

- On the idler, seal bolt ① cannot be seen unless outside cover is removed.
- There is one bogie shaft seal bolt ① each on the inside and outside.

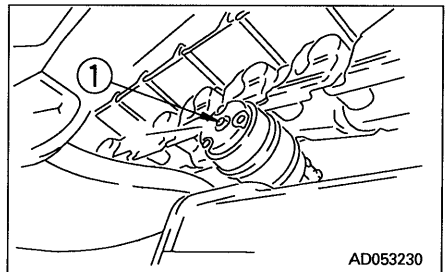
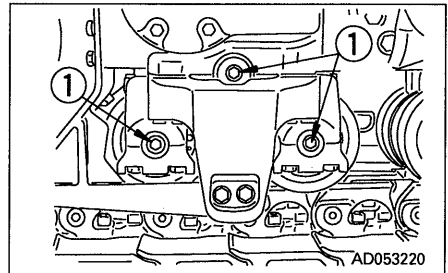
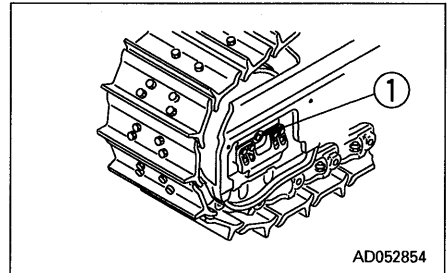
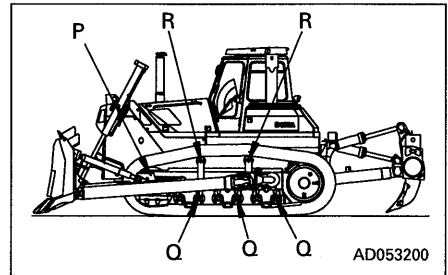

24.2.14 CLEAN AIR CONDITIONER AIR FILTER (FRESH/RECIRC FILTER) (MACHINES EQUIPPED WITH CAB)

If the air conditioner air filter is clogged or there is dirt or dust in it, clean the filter.

1. Open inspection cover ①, open cover ②, then remove FRESH filter ③.
2. Open inspection cover ④ under the front panel, pull up RECIRC filter ⑤, and remove it.
3. Clean filters ③ and ⑤ with compressed air. If there is oil stuck to the filter, or it is extremely dirty, wash it in a neutral agent. After washing it, dry it completely before installing it again. If the clogging of the filter cannot be removed by washing or using compressed air, replace the filter with a new part.

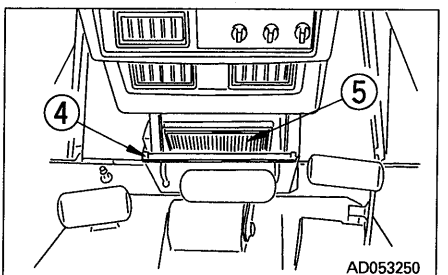
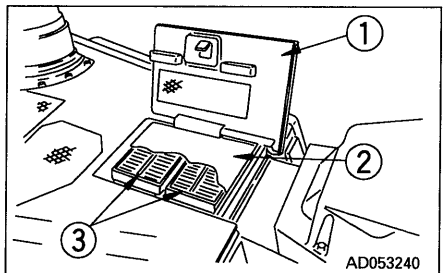

24.2.15 CHECK, ADJUST AIR CONDITIONER (MACHINES EQUIPPED WITH CAB)

CHECKING TENSION OF COMPRESSOR BELT

If the belt is loose, it will slip and the cooling effect will be reduced. From time to time, press a point midway between the drive pulley and compressor pulley with your finger (approx. 6 kg (13 lb)) and check that the tension is 10 mm (0.39 in).

When the belt is new, there will be initial elongation, so always adjust again after 2 or 3 days.

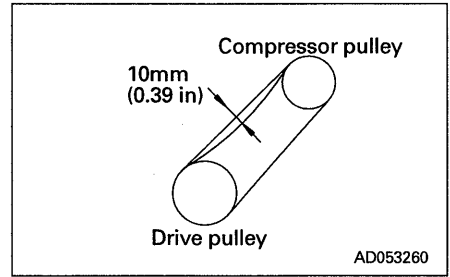

CHECK LEVEL OF REFRIGERANT (GAS)

⚠ WARNING

- When handling refrigerant gas, always follow local laws and regulations.
- The refrigerant used in the cooler is colorless and odorless and does not harm the atmosphere, but if the liquid gets into your eyes or on your hands, it may cause loss of sight or frostbite, so never loosen any part of the refrigerant circuit.

If the level of the refrigerant (gas) is low, the cooling effect will be reduced. Run the engine at high idling, and check the flow of the refrigerant in the refrigerant circuit through the sight glass of the receiver when the cooler is running at high speed.

- No bubbles in refrigerant flow: Correct
- Bubbles in refrigerant flow (bubbles continuously pass through): Refrigerant level low
- Colorless, transparent: No refrigerant

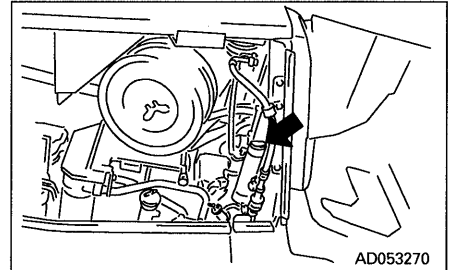

REMARK

When there are bubbles, the refrigerant gas level is low, so contact your refrigerant dealer to have refrigerant added. If the air conditioner is run with the refrigerant gas level low, it will cause damage to the compressor.

New Freon R-134a is used as refrigerant.

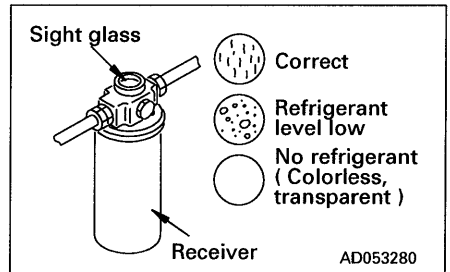

24.2.16 GREASE DOOR HINGE (MACHINES EQUIPPED WITH CAB)

If the door makes a squeaking noise when it is opened or closed, spray lubricant in through the split in the hinge bushing.

If the bushing is worn, replace the hinge.

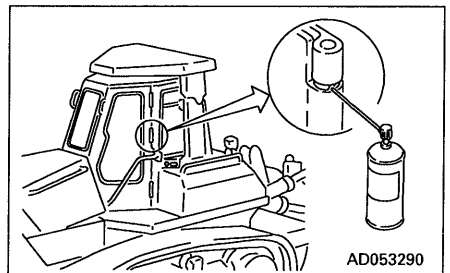

24.2.17 CHECK DOOR LOCK STRIKER (MACHINES EQUIPPED WITH CAB)

If the wear of the doors lock striker exceeds 0.5 mm (0.02 in), replace the striker. If it is used at it is, the play will increase and this may result in breakage of the hinge or door lock.

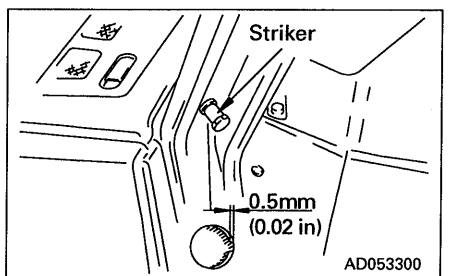

**24.2.18 REPLACE DOOR DAMPER
(MACHINES EQUIPPED WITH CAB)**

If the depth of the door damper rubber groove is less than 2 mm (0.08 in), replace the damper.

There are two dampers each at the top and bottom on the left and right doors.

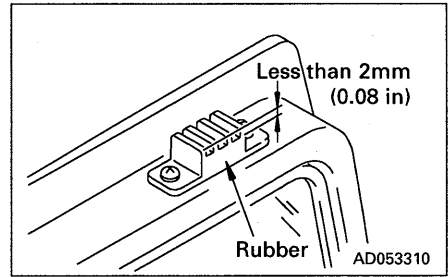

24.2.19 CHECK WINDOW WASHER FLUID LEVEL, ADD FLUID (MACHINES EQUIPPED WITH CAB)

If there is air in the window washer fluid, check the level and add fluid.

Open the battery cover, check the level of the fluid in window washer tank ①, and if it is low, add automobile window washer fluid.

When adding fluid, be careful not to let dirt or dust get in.

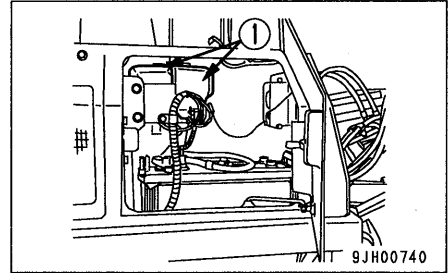

**24.2.20 BLEED AIR FROM HEAD END OF RIGHT PITCH CYLINDER
(POWER TILT, POWER PITCH DOZER ONLY)**

Bleed the air if the work equipment has been removed or repaired.

1. Raise the blade and run the engine at low idling.
2. Operate the left and right tilt 5 – 10 times to bleed the air from the tilt circuit.
3. Operate the forward and rear pitch 5 – 10 times to bleed the air from the bottom end of the right cylinder.
4. Set the left and right cylinders at the neutral position, then carry out the following operations 5 – 10 times to bleed the air from the head end of the right pitch cylinder.

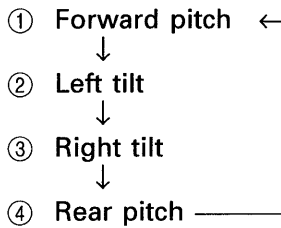

24.2.21 REPLACE WIPER BLADE (MACHINES EQUIPPED WITH CAB)

If the blade is damaged, it will not wipe the window clean, so replace the blade.

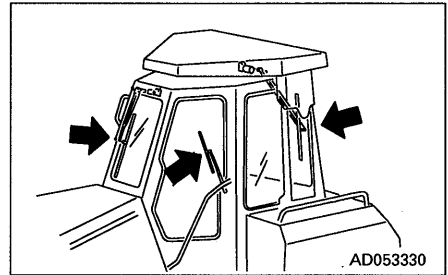

Method of replacement

- Front, rear wiper

1. Remove screw ①, then remove the blade.
2. Install a new blade, then tighten screw ① securely.

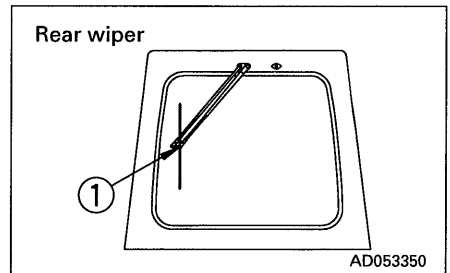
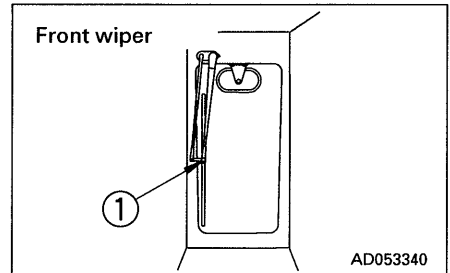

- Door wiper

1. It is hooked at portion (A), so move the blade in the direction of the arrow to remove it.
2. Install the new blade and hook it securely.

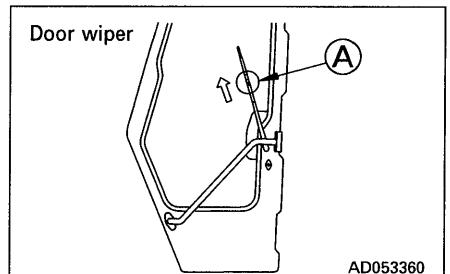

24.3 CHECK BEFORE STARTING

Always carry out the items in this section before starting the engine each day.

24.3.1 CHECK COOLANT LEVEL, ADD WATER

⚠ WARNING

Normally, do not open the radiator cap. When checking the cooling water level, check the sub-tank when the engine is cold.

1. Open the engine side cover on the left side of the chassis, and check that the cooling water is between the FULL and LOW marks on sub-tank ①. If the water level is low, add water to the FULL level through the water filler port in sub-tank ①.

REMARK

In summer, the coolant may overflow from the sub-tank drain hose. This is no problem. It occurs because too much coolant has been added.

2. After adding water, tighten the cap securely.
3. If the sub-tank is empty, check for leakage of water, then add water to the radiator and sub-tank.
4. After adding water, close the engine side cover.

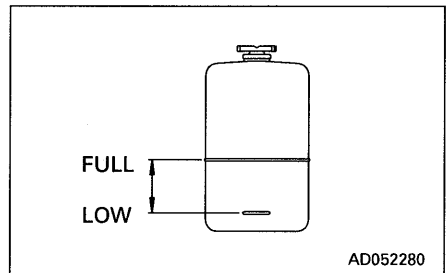
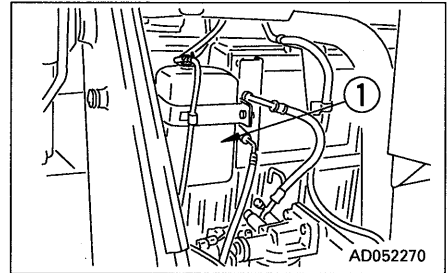

24.3.2 CHECKING WITH MACHINE MONITOR (MONITOR PANEL SPECIFICATION)

1. Turn starting switch ① to the ON position.
2. Check that all monitor lamps light up for 3 seconds, the warning lamp lights up for 2 seconds, and the alarm buzzer sounds for 1 second.

REMARK

- If the lamps do not light up, there may be a failure or disconnection in the monitor, so please contact your Komatsu distributor.
- When carrying out the checks before starting, do not rely only on the monitor. Always carry out all the items listed for periodic maintenance.

Machines equipped with cab

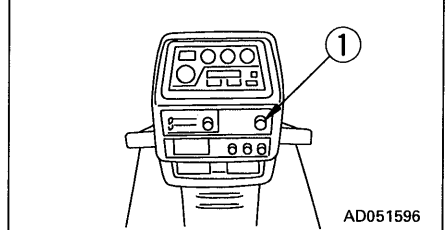

Machines equipped with canopy

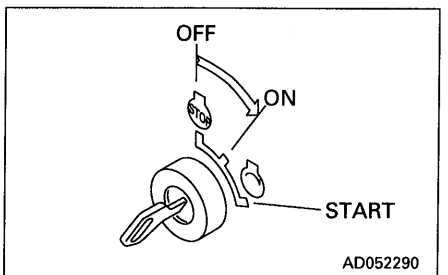
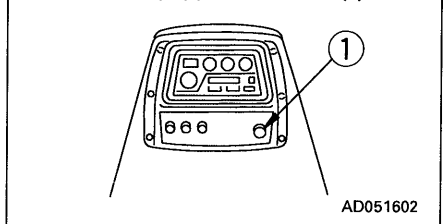

24.3.3 CHECK FUEL LEVEL, ADD FUEL

⚠ WARNING

When adding fuel, never let the fuel overflow. This may cause a fire. If you spill fuel, thoroughly clean up any spillage.

1. Turn the engine starting switch to the ON position and check the fuel level with fuel level gauge ⑥ on the monitor panel. After checking, turn the switch back to the OFF position.
2. After completing work, fill the fuel tank through oil filler port ⑦.
3. After adding fuel, tighten the cap securely.
Fuel capacity: 625 ℓ (165 US gal, 138 UK gal)

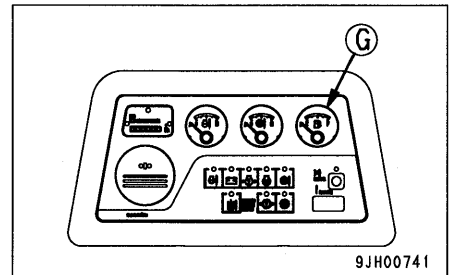

9JH00741

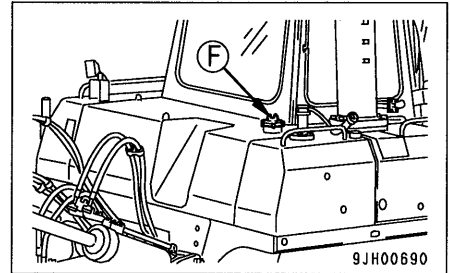

9JH00690

REMARK

If breather hole ① on the cap is clogged, the pressure in the tank will drop and fuel will not flow. Clean the hole from time to time.

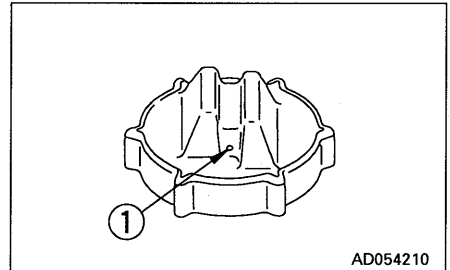

AD054210

24.3.4 DRAIN WATER, SEDIMENT FROM FUEL TANK

Loosen drain valve ① at the bottom of the fuel tank and drain the sediment and water accumulated at the bottom of the tank together with the fuel.

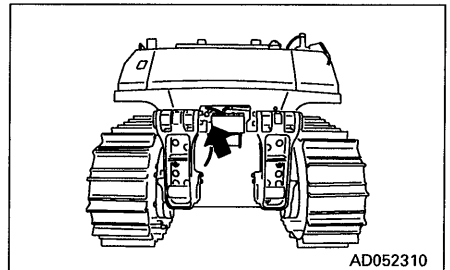

AD052310

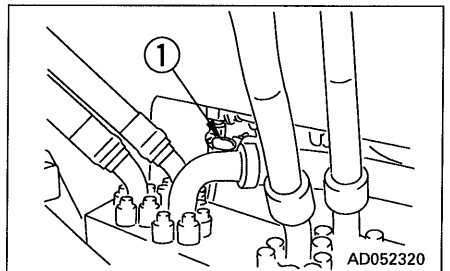

AD052320

24.3.5 CHECK OIL LEVEL IN ENGINE OIL PAN, ADD OIL

1. Open the engine side cover on the left side of the chassis.
2. Remove dipstick **Ⓒ** and wipe the oil off with a cloth.
3. Insert dipstick **Ⓒ** fully in the oil filler pipe, then take it out again.

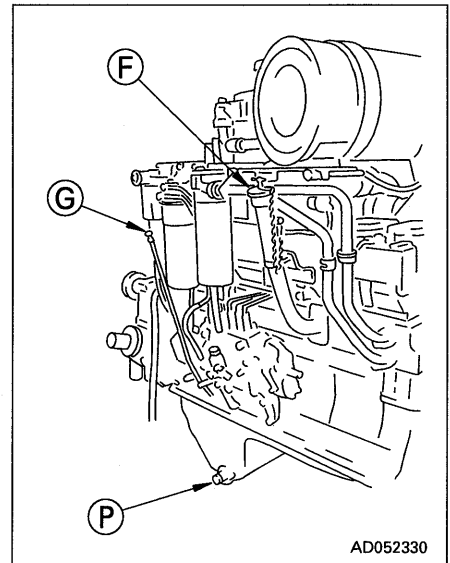

4. The oil level should be between the H and L marks on dipstick **Ⓒ**.
If the oil level is below the L mark, add engine oil through oil filler **Ⓕ**.
5. If the oil is above the H mark, drain the excess engine oil from drain plug **Ⓓ**, and check the oil level again.
6. If the oil level is correct, tighten the oil filler cap securely and close the engine side cover.

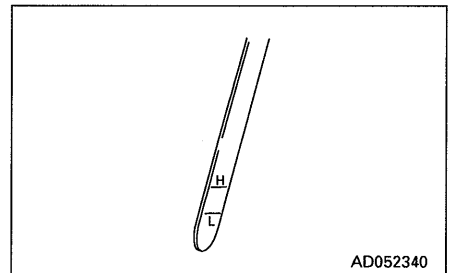

REMARK

- Check the oil level with the engine stopped.
- When checking the oil level after the engine has been operated, wait for at least 15 minutes after stopping the engine before checking.
- If the machine is at an angle, make it horizontal before checking.
- When adding oil, remove the dipstick from the holder to release the air inside the crankcase.

24.3.6 CHECK OIL LEVEL IN POWER TRAIN CASE, ADD OIL

1. Remove dipstick **Ⓒ**, and wipe the oil off with a cloth.
2. Insert dipstick **Ⓒ** fully in the oil filler pipe, then take it out again.

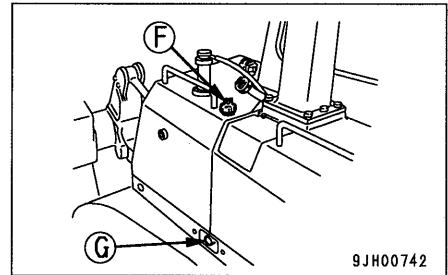

9JH00742

3. The oil level should be between the H and L marks on dipstick **Ⓒ**.

If the oil level is below the L mark, add engine oil through oil filler

Ⓕ.

The oil level is stamped on both sides of the dipstick. One side is used when the engine is stopped and the oil temperature is low (COLD STOP). The other side is used when the engine is idling and the oil temperature is high (HOT IDLING).

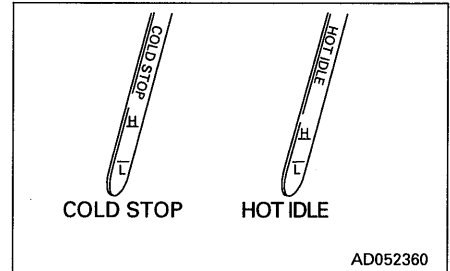

AD052360

REMARK

When checking the oil level before starting operations, check with the engine stopped and use the dipstick COLD STOP side. It is also possible to check the oil level after the engine has been run and the power train oil temperature is high, but in this case, run the engine at idling and use the dipstick HOT IDLING side.

4. If the oil is above the H mark, remove drain cover **①** at the bottom left of the power train case, pull drain hose **②** out from the pickup port, then loosen drain plug **③** and drain the excess oil. After draining the oil, check the oil level again.

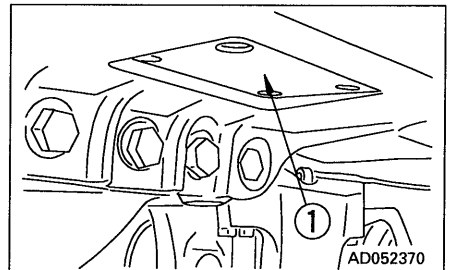

AD052370

5. If the oil level is correct, tighten the oil filler cap securely.

REMARK

When checking the oil level, if the machine is at an angle, move it to a horizontal position before carrying out the check.

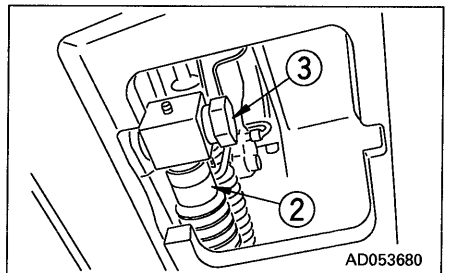

AD053680

24.3.7 CHECK BRAKE PEDAL TRAVEL

Drive the machine, depress the brake pedal, and check that the machine stops.

24.3.8 CHECK DAMPER CASE OIL LEVEL, ADD OIL

1. Open engine side cover ① on the left side of the machine.
2. Remove dipstick ⑥, and wipe the oil off with a cloth.
3. Insert dipstick ⑥ fully into the dipstick holder, then pull it out again.
4. The oil level should be between the H and L marks on dipstick ⑥.
If the oil is below the L mark, add engine oil through the dipstick holder.
5. If the oil is above the L mark, open inspection cover ② at the bottom center of the power train case, and drain the excess oil from drain plug ④ of the engine damper (this can be seen to the front of the machine through the inspection window). After draining the oil, check the oil level again.

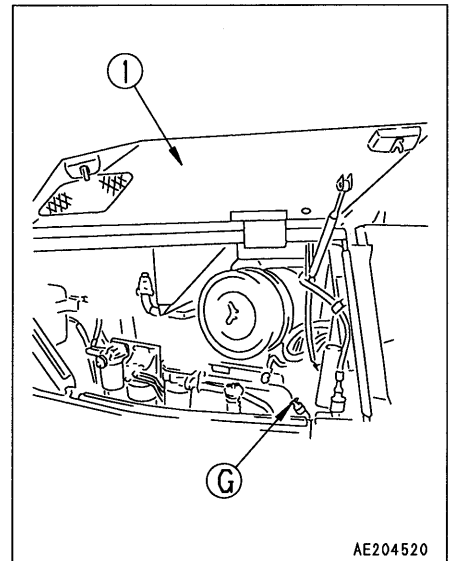

REMARK

- Check the oil level with the engine stopped.
- When checking the oil level, if the machine is at an angle, move it to a horizontal position before carrying out the check.

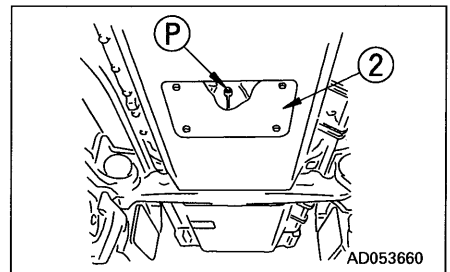

24.3.9 CHECK OIL LEVEL IN HYDRAULIC TANK, ADD OIL

⚠ WARNING

- When removing the oil filler cap, oil may spurt out, so stop the engine and wait for the oil temperature to go down, then turn the cap slowly to release the internal pressure before removing the cap.
- If oil has been added to above the H mark, stop the engine and wait for the hydraulic oil to cool down. Then remove drain plug **P**, loosen drain valve **①**, and drain the excess oil.

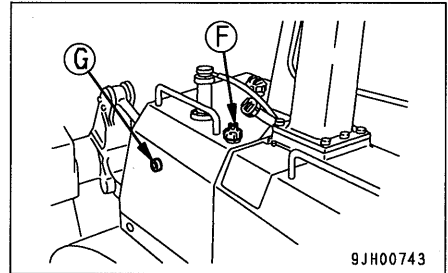
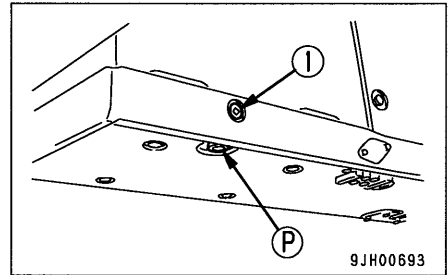

NOTICE

Do not add oil if the level is above the H line. This will damage the hydraulic equipment and cause the oil to spurt out.

1. Lower the blade to the ground, stop the engine and wait for about 5 minutes before checking oil level. If oil level is between H and L in sight gauge **G**.
2. If the level is below the L mark, add engine oil through oil filler **F**.

REMARK

When inspecting, if the machine is at an angle, move it to a horizontal place to carry out the check.

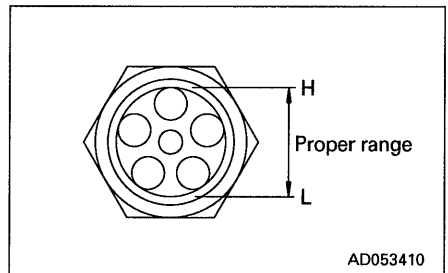

24.3.10 CHECK DUST INDICATOR

1. Open the engine side cover on the left side of the chassis, and check that the red piston has not appeared in the transparent portion of dust indicator **①**.
2. If the red piston has appeared, clean or replace the element immediately.
For details of the method of cleaning the element, see "24.2 WHEN REQUIRED".
3. After checking, cleaning, and replacing, press the knob of dust indicator **①** to return the red piston to its original position.

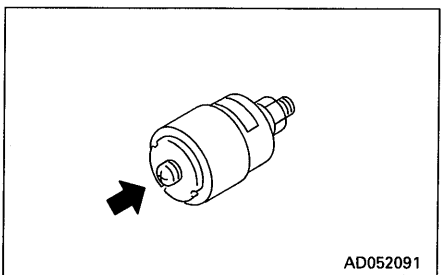
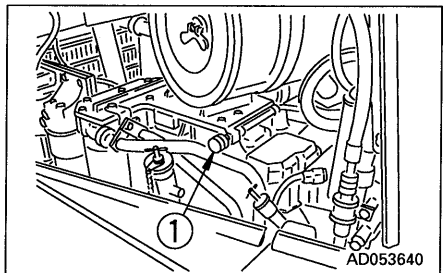

24.3.11 CHECK ELECTRIC WIRINGS

⚠ WARNING

- If fuses are frequently blown or if there are traces of short circuit on the electrical wiring, locate the cause and carry out repair.
- Accumulation of flammable material (dead leaves, twigs, grass, etc.) around the battery may cause fire, so always check and remove such material.
- Keep the top surface of the battery clean and check the breather hole in the battery cap. If it is clogged with dirt or dust, wash the battery cap to clean the breather hole.

Check for damage and wrong capacity of the fuse and any sign of disconnection or short circuit in the electric wiring. Check also for loose terminals and tighten any loose parts.

Check the wiring of the "battery", "starting motor" and "alternator" carefully in particular.

When carrying out walk-around checks or checks before starting, always check if there is any accumulation of flammable material around the battery, and remove such flammable material.

Please contact your Komatsu distributor for investigation and correction of the cause.

24.3.12 CHECK THAT LAMPS LIGHT UP

1. Turn the key of starting switch ① to the ON position.
2. Turn the front lamp switch ② and rear lamp switch ③ to the ON position and check that the front lamp and rear lamp light up.

If the lamps do not light up, there is probably a broken bulb or disconnection in the wiring, so contact your Komatsu distributor for repairs.

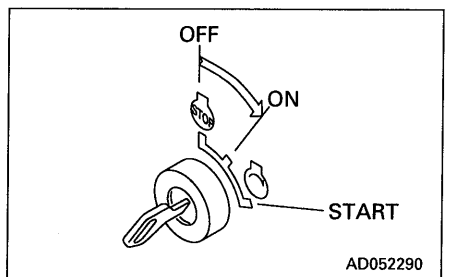
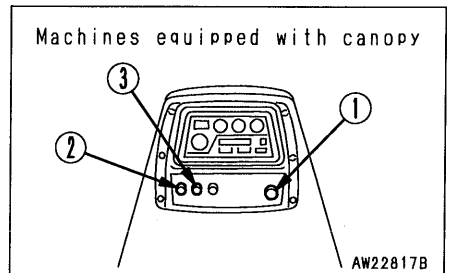
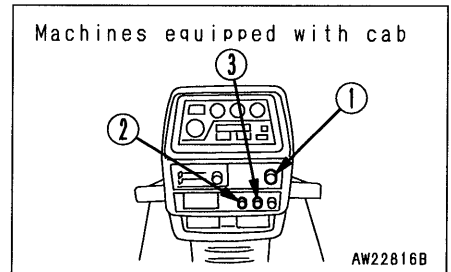

24.3.13 CHECK HORN SOUND

1. Turn the key of starting switch ① to the ON position.

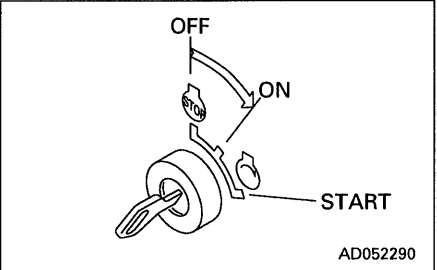
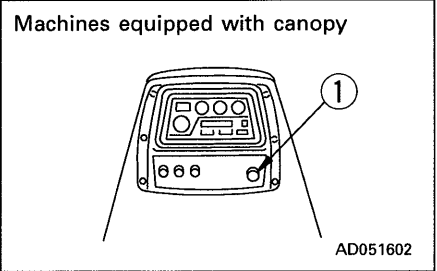
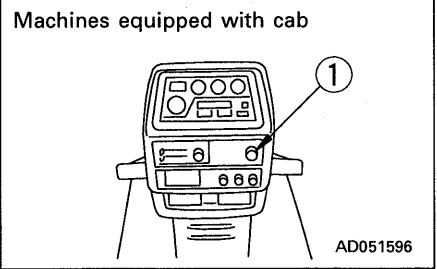

2. Press the horn switch and check that the horn sounds.

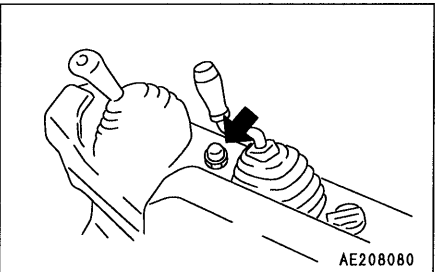

24.3.14 CHECK BACKUP ALARM SOUND

1. Turn the key of starting switch to the ON position.

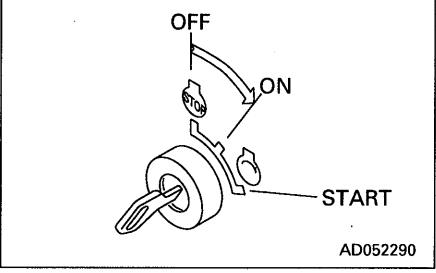
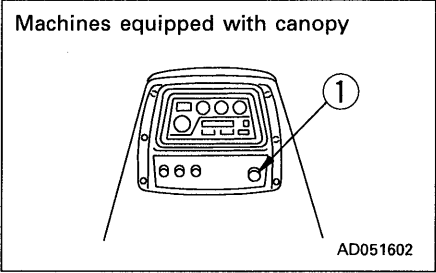
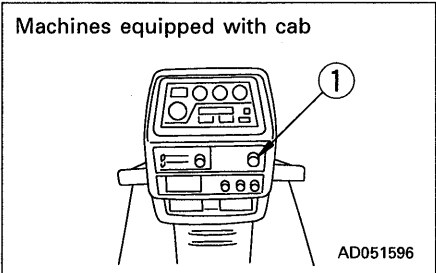

2. Set the joystick to the REVERSE position. The buzzer must sound immediately. The buzzer will continue to sound until the joystick is moved to the NEUTRAL or FORWARD position.

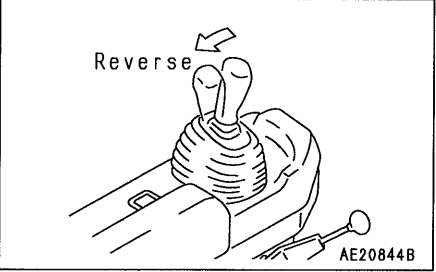

24.3.15 CHECK SEAT BELT FOR WEAR OR DAMAGE

Check the belt and mounting clamps, and if they are worn or damaged, replace the seat belt.

24.3.16 CHECK FOR WATER AND SEDIMENT IN WATER SEPARATOR, DRAIN WATER

The water separator separates water mixed in the fuel. If float ② is at or above red line ①, drain the water according to the following procedure:

1. Loosen drain plug ③ and drain the accumulated water until the float reaches the bottom.
2. Tighten drain plug ③.
3. If the air is sucked into fuel line when draining and water, be sure to bleed air in the same manner as for the fuel filter. See "24.5 EVERY 500 HOURS SERVICE".

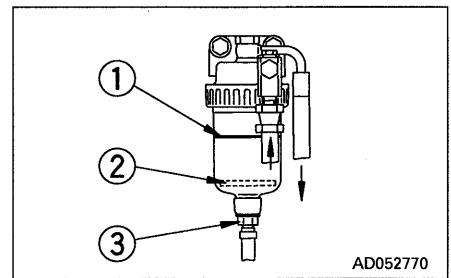

24.4 EVERY 250 HOURS SERVICE

24.4.1 LUBRICATING

1. Lower the work equipment to the ground, then stop the engine.
2. Using a grease pump, pump in grease through the grease fittings shown by arrows.
3. After greasing, wipe off any old grease that was pushed out.

- Grease fan pulley (1 place)
Front of engine side cover (left)

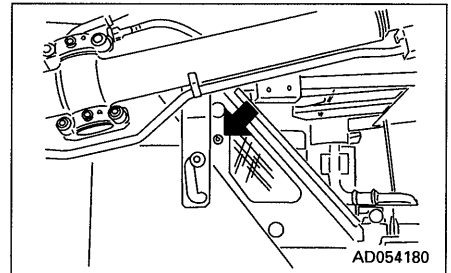

- Grease equalizer bar side pin (4 places)
Two each on the left and right sides of the machine

1. Remove all the sand and soil from the top of the track frame and cover ①.

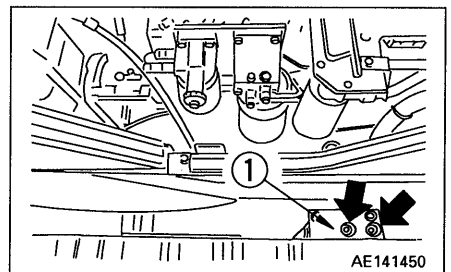

2. Mount the straight frame and remove the red plug from ② between the track frame and track.

3. Add grease from the top of the track.

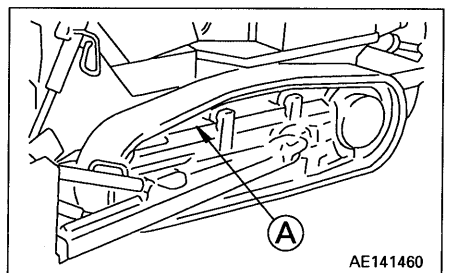

Tools to use

- Grease pump assembly (07952-80002)
- Nozzle (07951-41043) tube type

● Grease equalizer bar center pin (1 place)

1. Open the engine side cover at the left side of the machine, then remove 2 bolts ①.
2. Pull hinged cover ② out and open it.
3. Add grease through the grease fitting marked by the arrow.
4. Return hinged cover ② to its original position, install bolt ① to hold it in position, then close the engine side cover.

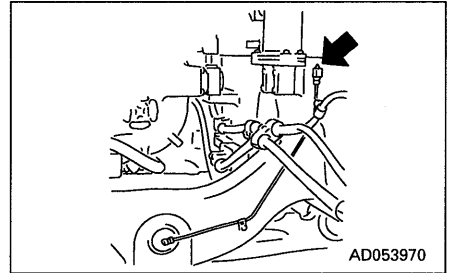
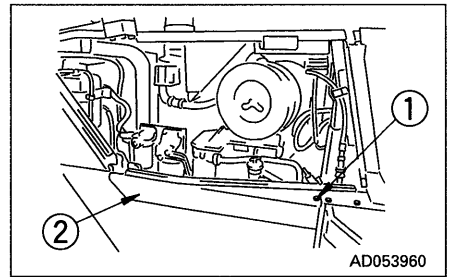

● Power tilt dozer

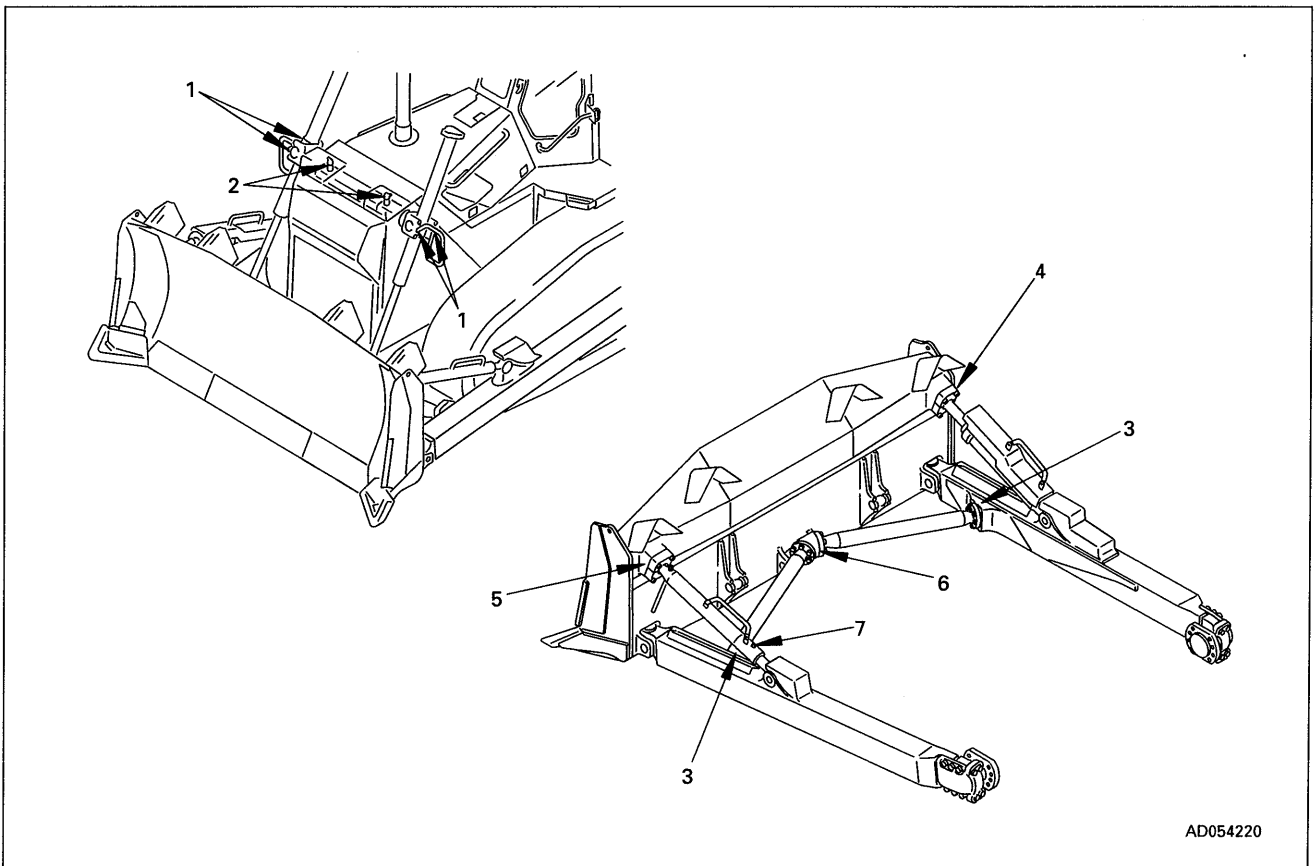

1. Lift cylinder support yoke (4 places)
2. Lift cylinder support shaft (2 places)
3. Blade arm (2 places)
4. Tilt cylinder ball joint (1 place)
5. Tilt brace ball joint (1 place)
6. Blade center link (1 place)
7. Tilt brace thread (1 place)

● Power tilt – Power pitch dozer

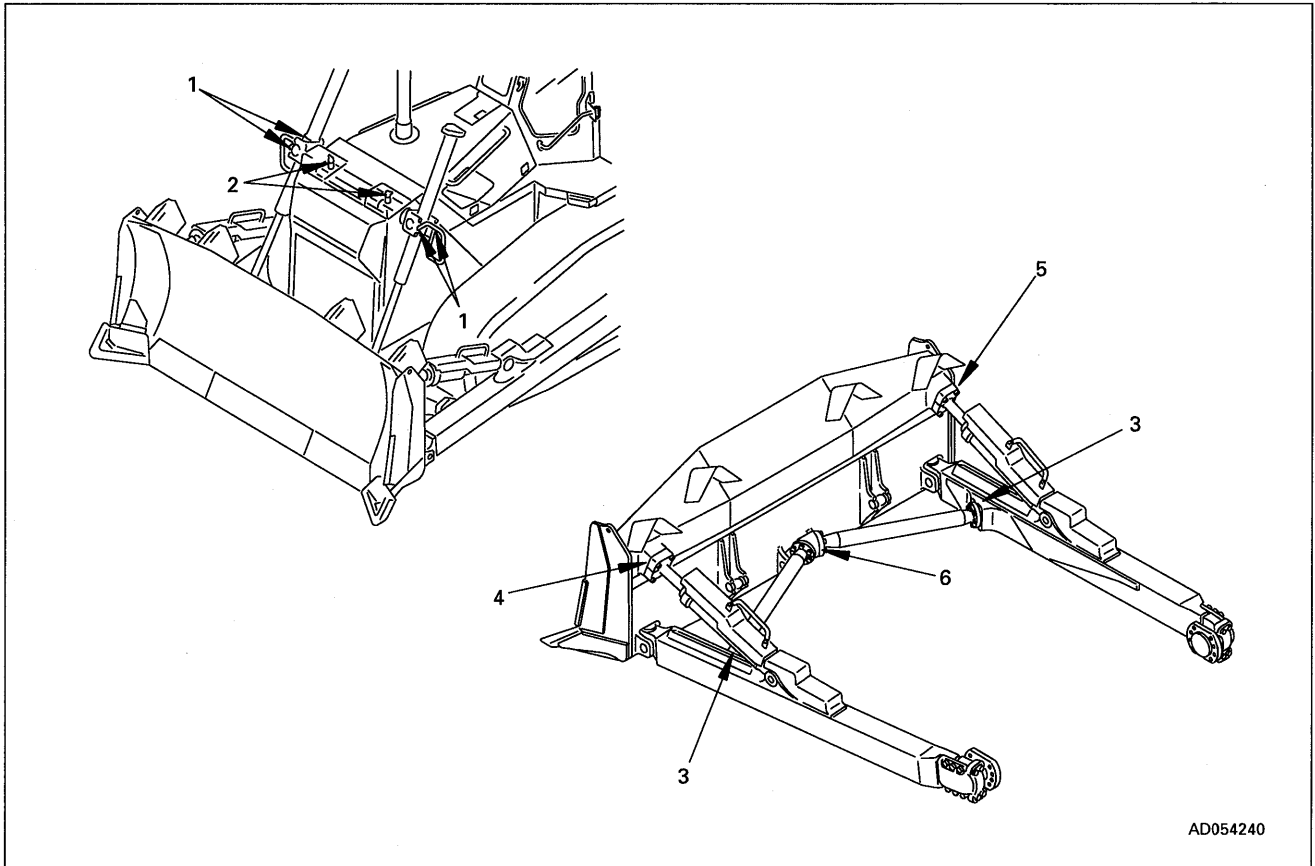

1. Lift cylinder support yoke (4 places)
2. Lift cylinder support shaft (2 places)
3. Blade arm (2 places)
4. Tilt cylinder ball joint (1 place)
5. Pitch cylinder ball joint (1 place)
6. Blade center link (1 place)

● **Angledozer**

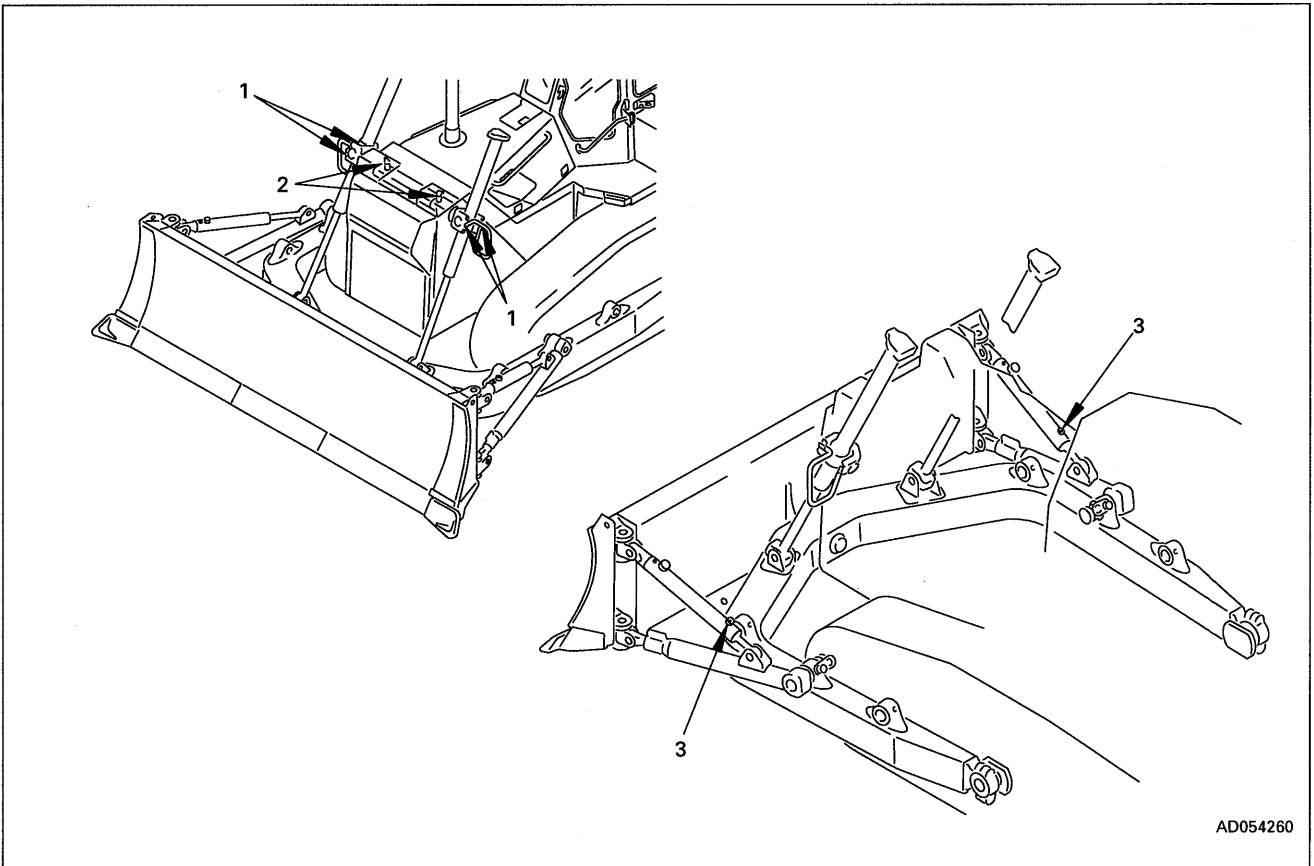

1. Lift cylinder support yoke (4 places)
2. Lift cylinder support shaft (2 places)
3. Tilt brace thread (2 places)

● **Ripper**

1. Tilt cylinder bottom pin (2 places)
2. Lift cylinder bottom pin (2 places)
3. Tilt cylinder rod end pin (2 places)
4. Lift cylinder rod end pin (2 places)
5. Arm pin (front) (2 places)
6. Arm pin (rear) (2 places)

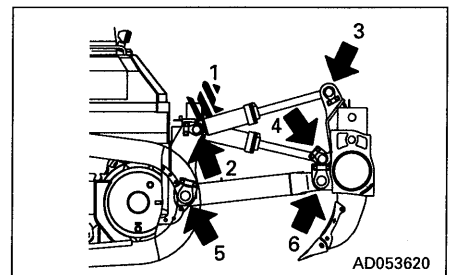

24.4.2 CHECK OIL LEVEL IN FINAL DRIVE CASE, ADD OIL

⚠ WARNING

The oil is at high temperature immediately after the machine has been operated. Wait for the oil to cool down before starting the operation.

1. Stop the machine so that drain plug ① is directly at the bottom.
2. Remove oil level plug ② and check whether the final drive case is filled with oil to lower edge of the plug hole.
3. If the oil level is low, remove plug ③ and add engine oil until it overflows from oil level plug ②.

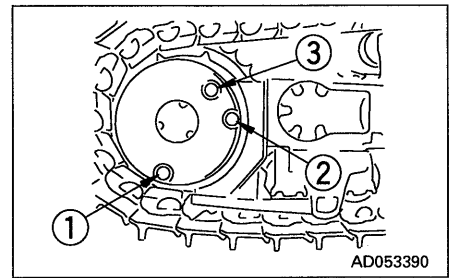

24.4.3 CHECK LEVEL OF BATTERY ELECTROLYTE

Carry out this check before operating the machine.

⚠ WARNING

- To avoid gas explosions, do not bring fire or sparks near the battery.
- Battery electrolyte is dangerous. If it gets in your eyes or on your skin, wash it off with large amounts of water, and consult a doctor.

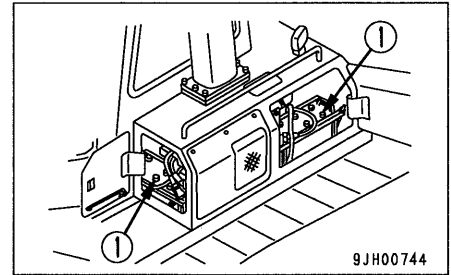

1. Open the battery cover.
2. Remove cap ①, and check that the electrolyte is at the specified level (10 to 12 mm (0.39 to 0.47 in) above the plate). If the electrolyte level is low, add distilled water to the specified level. If the battery electrolyte is spilled, have dilute sulphuric acid added.
3. When adding distilled water to any cell at cap ①, add distilled water also to the other cells.
4. Clean the air hole in the battery cap, then tighten the cap securely.

NOTICE

When adding distilled water in cold weather, add it before starting operations in the morning to prevent the electrolyte from freezing.

24.4.4 CHECK, ADJUST ALTERNATOR DRIVE BELT TENSION

CHECK

The standard deflection for the drive belt is approx. 13 – 16 mm (0.51 – 0.63 in) when pressed by thumb (approx. 10 kg (22.05 lb)) at a point midway between the drive pulley and alternator pulley.

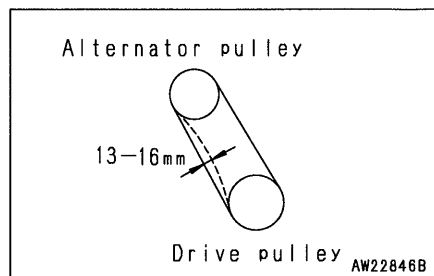

ADJUSTING

1. Loosen 2 cover mounting bolts ⑥ and remove the cover.
2. Loosen bolts and nuts ①, ②, and ⑤, then turn nut ④ and adjust the belt tension.
3. After adjusting, tighten bolts and nuts ①, ②, and ⑤ to secure alternator ③ in position.
4. Install the cover and tighten cover mounting bolts ⑥.
Check that the covers do not contact the rotating portion of the alternator.

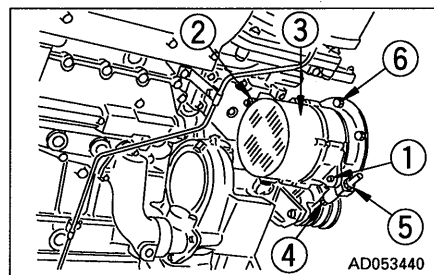

REMARK

- Check for damage to each pulley, wear of the V-groove, and wear of the V-belt. Check in particular that the V-belt does not contact the bottom of the V-groove.
- If the V-belt is elongated and there is no more allowance for adjustment, or if the belt is cracked or cut, replace the belt.
- When adjusting the V-belt, do not push the alternator directly with a bar. Insert a wooden block and push the block with a bar.
- After replacing the V-belt, operate the machine for one hour, then check and adjust again.

24.4.5 CHANGE OIL IN ENGINE OIL PAN, REPLACE ENGINE OIL FILTER CARTRIDGE

WARNING

The oil is at high temperature after the engine has been operated, so never change the oil immediately after finishing operations. Wait for the oil to cool down before changing it.

CAUTION

When draining the oil, do not remove drain plug **P**.

Prepare the following.

- Container to catch drained oil: Min 37 ℓ capacity
- Refill capacity: 37 ℓ (9.77 US gal, 8.14 UK gal)
- Socket wrench, filter wrench.

1. Remove the cover **①** at the bottom of the machine and set a container to catch the oil under the drain plug.
2. To prevent getting oil on yourself, remove drain plug **P** slowly, then loosen drain valve **②** to drain the oil. Do not loosen the drain valve too far, otherwise, the stopper pin inside the valve may be deformed.
3. Check the drained oil, and if there are excessive metal particles or foreign material, please contact your Komatsu distributor.
4. Install drain plug **P** and drain valve **②**.

Tightening torque

Drain plug **P**: 68.6 ± 9.8 Nm (7 ± 1 kgm, 50.6 ± 7.2 lbft)

Drain valve **②**: 63.7 ± 14.7 Nm (6.5 ± 1.5 kgm, 47.0 ± 10.8 lbft)

5. Using a filter wrench, turn filter cartridge **③** counterclockwise to remove it. When doing this, to prevent getting oil on yourself, do not carry out this operation from immediately under the cartridge.
In particular, if this operation is carried out immediately after stopping the engine, a large amount of oil will come out, so wait for 10 minutes before starting the operation.
6. Clean the filter holder, fill the new filter cartridge with engine oil, coat the packing surface and thread with engine oil (or coat it thinly with grease), then install the filter cartridge.
7. When installing the filter cartridge, bring the packing surface into contact with the filter holder, then tighten a further $3/4 - 1$ turn.

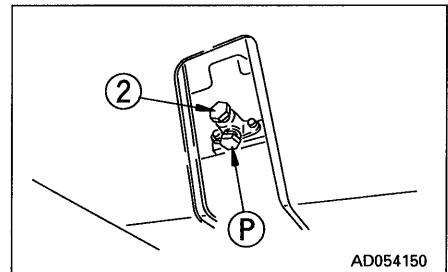
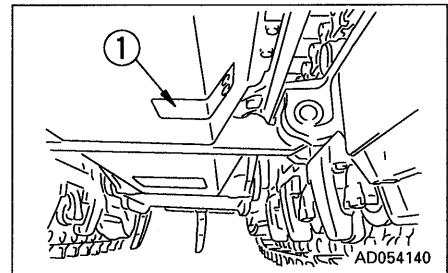
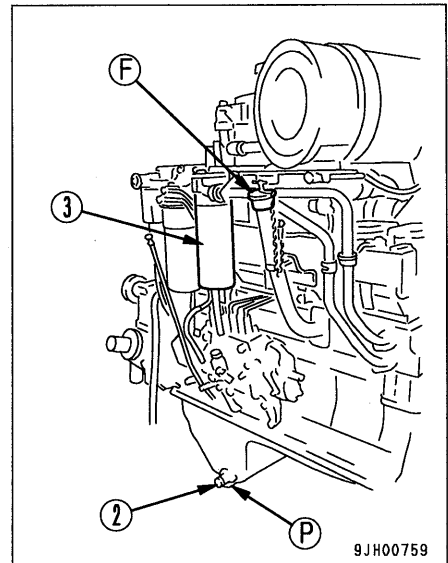

24. SERVICE PROCEDURE

- After replacing the filter cartridge, add engine oil through oil filler (F) until the oil level is between the H and L marks on the dipstick.
- Run the engine at idling for a short time, then stop the engine, and check that the oil level is between the H and L marks on the dipstick. For details, see "24.3 CHECK BEFORE STARTING".

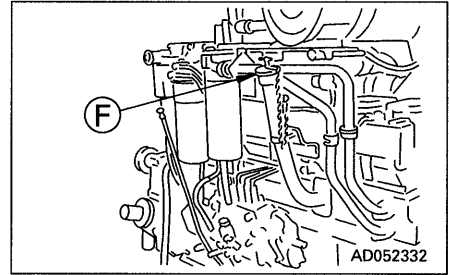

NOTICE

Even if the machine has not been operated for 250 hours, the oil and filter cartridge must be replaced when the machine has been operated for 6 months.

In the same way, even if the machine has not been operated for 6 months, the oil and filter cartridge must be replaced when the machine has been operated for 250 hours.

24.4.6 CHECK BRAKE PERFORMANCE

WARNING

If the machine moves during the following operation, please contact your Komatsu distributor for repairs immediately.

NOTICE

Do not place the joystick in the 1st speed position. Otherwise, it will cause damage to the machine.

Before starting the engine, check that the area around the machine is safe, then do as follows.

- Start the engine.
- Set safety lever (1) to the FREE position then operate blade control lever (2) and ripper control lever (3) to raise the blade and ripper. Leave the safety lever to the FREE position.
- Set parking lever (4) to the FREE position.
- Depress brake pedal (5) and move joystick (6) to the FORWARD 2nd position.
- Operate fuel control lever (7) to raise the engine speed gradually to full throttle.
- Check that the machine does not move. This indicates that brake performance is normal.

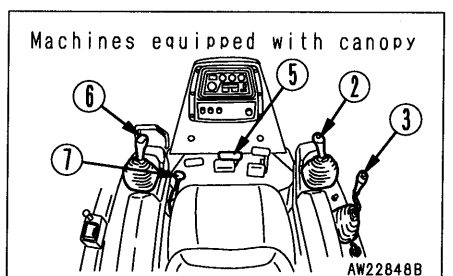
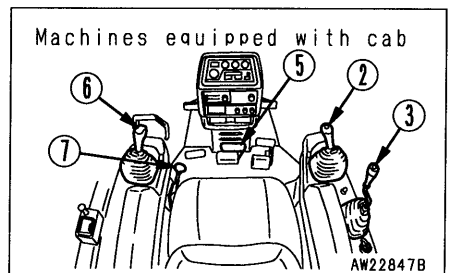
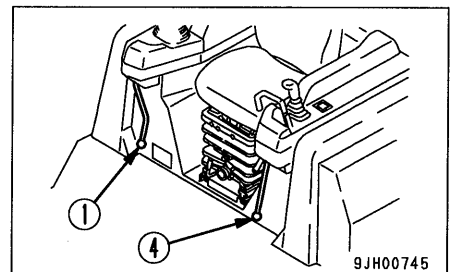

24.5 EVERY 500 HOURS SERVICE

Maintenance for every 250 hours service should be carried out at the same time.

24.5.1 REPLACE FUEL FILTER CARTRIDGE

WARNING

- Engine is at high temperature immediately after the machine has been operated. Wait for engine to cool down before replacing the filter.
- Do not bring fire or sparks near the fuel.

Prepare a filter wrench and a container to catch the fuel.

1. Open the engine side cover at the left side of the machine, remove bolt ③, then open cover ④ to the outside using the hinge at the bottom as the fulcrum.
2. Set the container to catch the fuel under the filter cartridge.
3. Using a filter wrench, turn filter cartridge ① counterclockwise to remove it.
4. Clean the filter holder, fill a new filter cartridge with clean fuel, coat the packing surface with engine oil, then install it to the filter holder.
5. When installing, tighten until the packing surface contacts the seal surface of the filter holder, then tighten it up 1/2 to 3/4 of a turn.
If the filter cartridge is tightened too far, the packing will be damaged and this will lead to leakage of fuel. If the filter cartridge is too loose, fuel will also leak from the packing, so always tighten to the correct amount.
6. Loosen the knob of feed pump ② and operate it 50 – 60 times up and down. This will bleed the air.
7. Push in the knob of feed pump ② and tighten it.
8. After replacing the filter cartridge, start the engine and check that there is no leakage of fuel from the filter seal surface. If there is any leakage of fuel, check the tightening of the filter cartridge. Whenever there is leakage of fuel, follow Steps 1 and 2 to remove the filter cartridge, then check the packing surface for damage or foreign material. If any damage or foreign material is found in the packing, replace the packing with a new part, then repeat Steps 3 – 6 to install the filter cartridge.

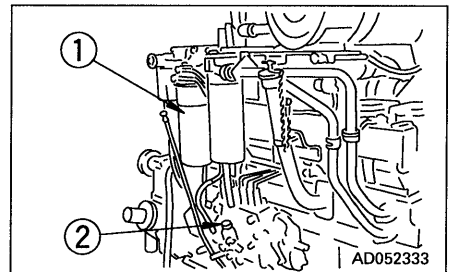
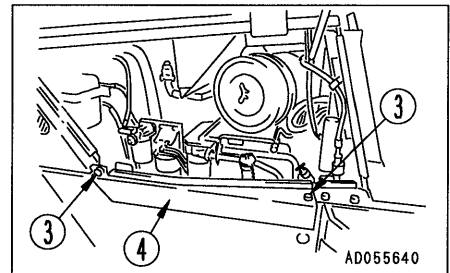

24.5.2 REPLACE POWER TRAIN OIL FILTER ELEMENT

1. Open engine side cover ① at the left side of the machine, remove bolt ②, then open cover ③ to the outside using the hinge at the bottom as the fulcrum.
2. Remove mounting bolt ⑤ of filter ④, then remove cover ⑥.
3. Take out element ⑦.
4. Clean the removed parts and the inside of the case, then install a new element.
Always use a genuine Komatsu element.
5. Close cover ③, tighten bolt ②, then close engine side cover ① on the left side of the machine.

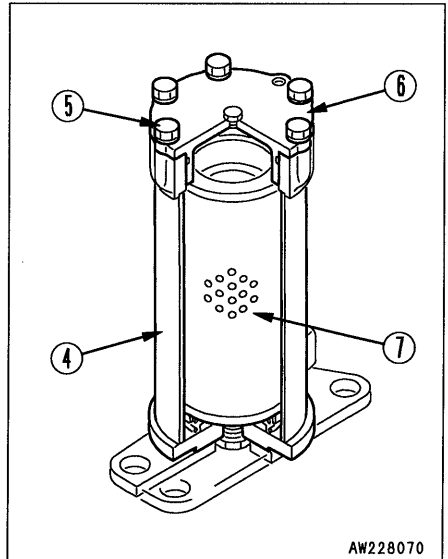
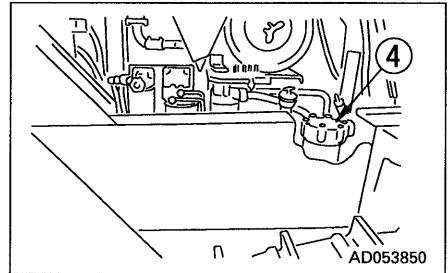
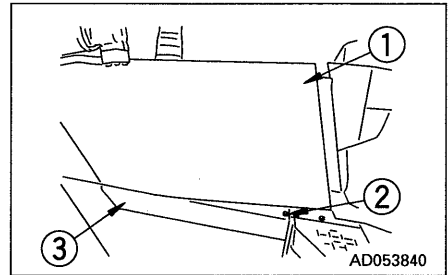

24.5.3 REPLACE HYDRAULIC TANK BREATHER ELEMENT

WARNING

Replace the element when the oil is cold.
When removing breather cap ①, turn it slowly to release the internal pressure before removing it.

1. Remove breather cap ① at the top of the hydraulic tank.
2. Replace element ② inside the cap.

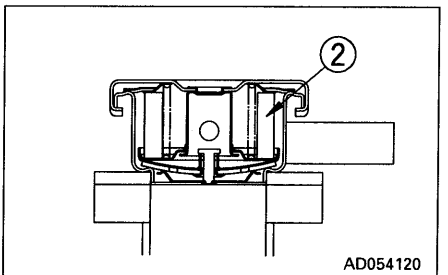
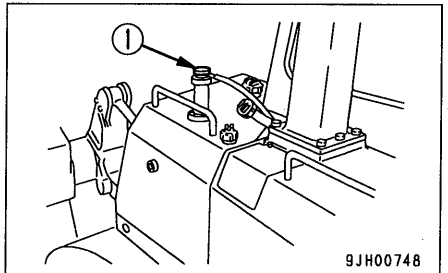

24.6 EVERY 1000 HOURS SERVICE

Maintenance for every 250 and 500 hours service should be carried out at the same time.

24.6.1 CHANGE OIL IN POWER TRAIN CASE, WASH STRAINERS (POWER TRAIN PUMP STRAINER, SCAVENGING PUMP STRAINER)

WARNING

- The oil is at high temperature immediately after operations, so wait for the temperature to go down before starting the operation.
- The undercover is heavy. Do not go directly under the cover when opening or closing it. When removing bolts ⑤, carry out the operation under the cover from the rear to make sure that it is possible to escape at any time.

Prepare the following.

- Container to catch drained oil: Min 60 l capacity
- Refill capacity: 60 l (15.84 US gal, 13.2 UK gal)

1. Remove drain cover ① at the bottom left of the power train case, pull out drain hose ② from the pick-up port, then loosen drain plug P_1 and drain the oil.
After draining the oil, tighten drain plug P_1 .
Do not remove drain plug P_1 .

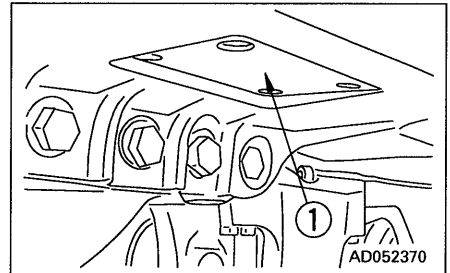

2. Remove inspection cover ③ in the undercover at the bottom rear of the machine as follows.
 - 1) Remove 2 bolts ④ at the front (front of machine).
 - 2) Hold cover ③ in position and gradually remove 2 bolts ⑤ at the rear (rear of machine). (Rain water may flow out when doing this.)
 - 3) Lower cover ③ gradually to open it. (The front of the cover is attached by a hinge.)
If you look up, you can see the strainer at portion P .

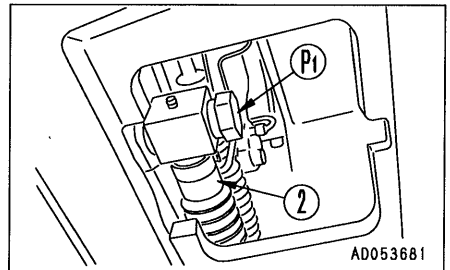

3. Remove drain plug P_2 in the strainer cover, and drain the oil (approx. 4l) collected inside the piping.
4. Loosen mounting bolt ⑥ of the power train strainer, then remove cover ⑦.
5. Remove spring ⑧, then remove strainer ⑨.

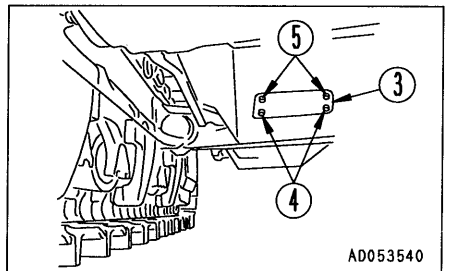

6. Remove any dirt stuck to strainer ⑨, then wash it in clean diesel oil or flushing oil. Wash the removed parts and the inside of the case at the same time.

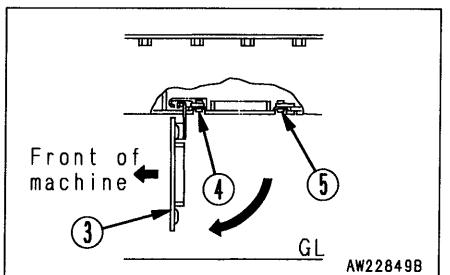

24. SERVICE PROCEDURE

7. Loosen mounting bolt ⑩ of the scavenging pump strainer, then remove cover ⑪.
8. Remove strainer ⑫.
9. Remove any dirt stuck to strainer ⑫, then wash it in clean diesel oil or flushing oil. Wash the removed parts and the inside of the case at the same time.

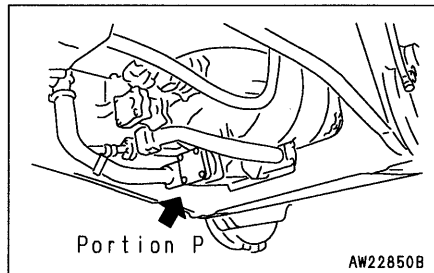

10. Install the strainers to their original positions.
11. Replace the power train filter element.
For details, see REPLACE POWER TRAIN OIL FILTER ELEMENT.

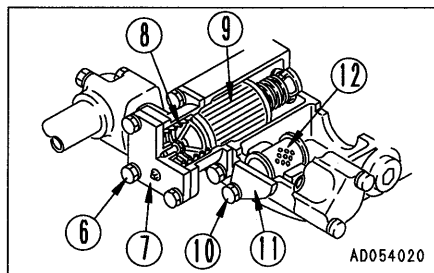

12. Add engine oil through oil filler port ⑥ to the specified level.
13. After adding the oil, check that the oil is at the specified level.
For details, see CHECK OIL LEVEL IN POWER TRAIN CASE, ADD OIL.
If the spring or strainer are damaged, replace them with new parts.

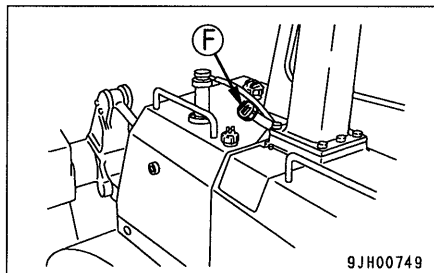

24.6.2 CHANGE OIL IN FINAL DRIVE CASE

⚠ WARNING

The oil is at high temperature immediately after the machine has been operated. Wait for the oil to cool down before starting the operation.

Prepare the following.

- Container to catch drained oil: Min. 58 ℓ capacity
- Refill capacity: each 58 ℓ (15.31 US gal, 12.76 UK gal)

1. Stop the machine so that drain plug ③ is directly at the bottom.
2. Remove oil level plug ② and oil filler plug ①, then remove drain plugs ③ and ④, and drain the oil. After draining the oil, tighten the plugs.
3. Add engine oil to the specified level through the hole in oil filler plug ①.
4. Check that the oil is at the specified level.
For details, see "24.4 EVERY 250 HOURS SERVICE".

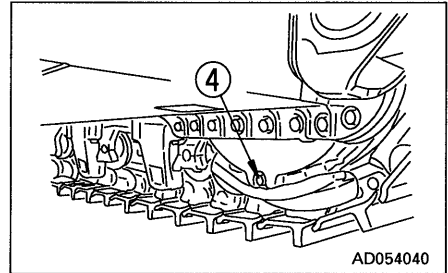
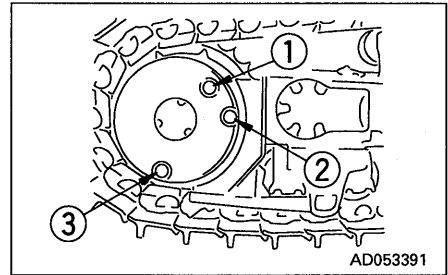

24.6.3 CHECK CAB SUSPENSION CYLINDER

1. Left cylinder ①: Open inspection cover ③ at bottom left of operator's seat
Right cylinder ②: Open inspection cover ④ at bottom right of operator's seat
2. Check that there is no oil leakage from the cylinder rod packing. If there is any oil leakage, please contact your Komatsu distributor.

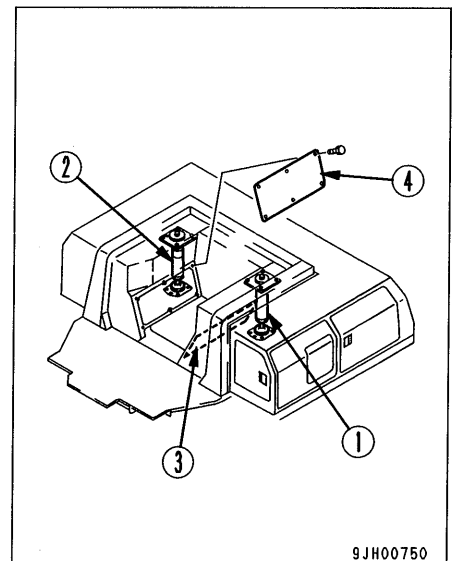

9JH00750

24.6.4 CLEAN POWER TRAIN CASE BREATHER

Remove the breather and wash out dust remaining inside with diesel oil and flushing oil.

Power train case breather (1 place)

Remove the inspection cover ② at bottom right of the operator's seat. Breather ① is installed to the right side of the window (rear side of chassis).

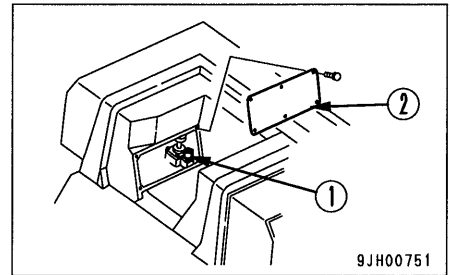

24.6.5 GREASE UNIVERSAL JOINT (2 PLACES)

Apply grease to the grease fittings (2 places) shown by arrows.

⚠ WARNING

The undercover is heavy.
Never try to open or close the cover when directly beneath it.
When removing bolts ②, carry out the work from the rear below the cover so that you can easily get out of the way.

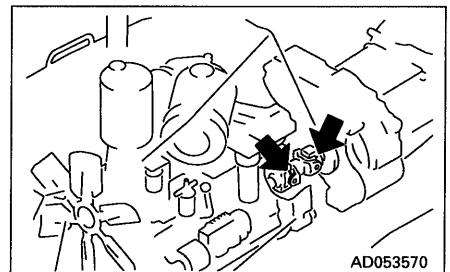

Remove inspection cover ③ of the undercover at the rear bottom of the chassis as follows.

- (1) Remove 2 bolts ① at the front of the machine.
- (2) Support the cover with your elbow while gradually removing 2 bolts ② at the rear of the machine.
- (3) Lower the cover gradually to open it.

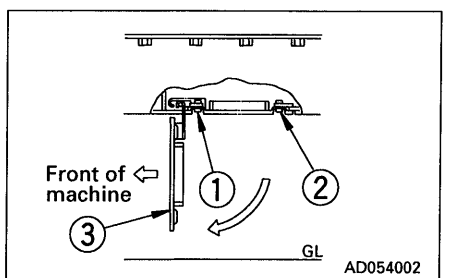
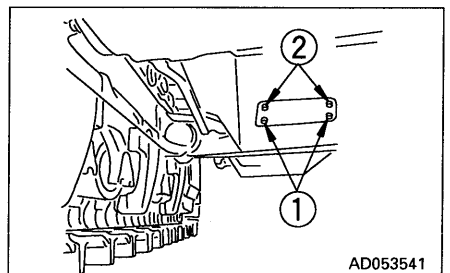

24.6.6 REPLACE CORROSION RESISTOR CARTRIDGE

1. Screw in valve ① at the top of the corrosion resistor.
2. Using a filter wrench, turn cartridge ② to the left, and remove it.
3. Coat the seal surface of the new cartridge with engine oil, then install it to the filter holder.
4. When installing, bring the packing surface into contact with the seal surface of the filter holder, then tighten approx. 2/3 turns.
5. Open valve ①.
Always use a genuine Komatsu cartridge.

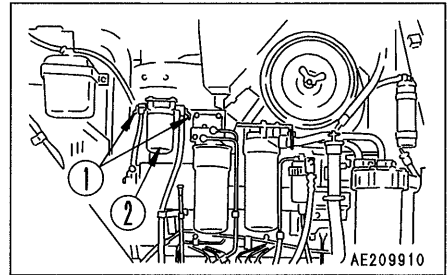
**24.6.7 CHECK ALL TIGHTENING PARTS OF TURBOCHARGER**

Contact your Komatsu distributor to have the tightening portions checked.

24.6.8 GREASE TENSION PULLEY ASSEMBLY (1 PLACE)

Add grease through the grease fitting until grease comes out from the relief valve.

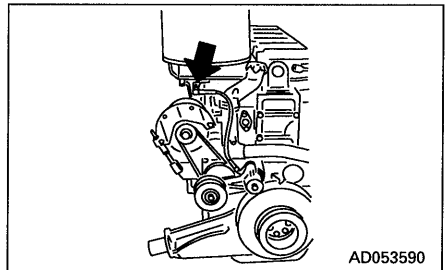
**24.6.9 CHECK, CLEAN FUEL STRAINER**

1. Tighten fuel supply valve ① at the bottom of the fuel tank, remove cap ②, and wash the strainer and strainer case. The strainer forms one unit with the cap.
2. After checking and cleaning, set the strainer in the case, then tighten cap ②.
3. After installing, open fuel supply valve ①.

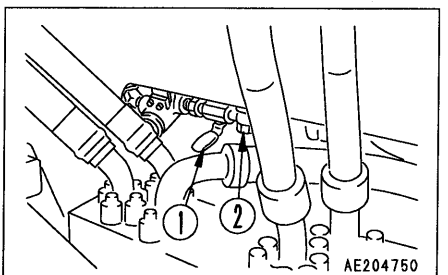
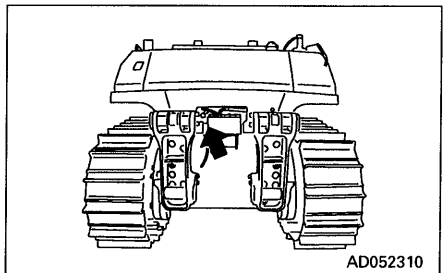

24.6.10 REPLACE CHARGE FILTER ELEMENT

1. Loosen mounting bolt ① and remove inspection cover ②.
2. Loosen mounting bolt ③ and remove filter cover ④.
3. Remove drain plug P (which can be seen from under the fender) and drain the oil.
4. Remove spring ⑤, then take out element ⑥.
5. Clean the removed parts and the inside of filter case ⑦, then install a new element.
- Use a genuine Komatsu element.
6. Install inspection cover ② with bolt ①.

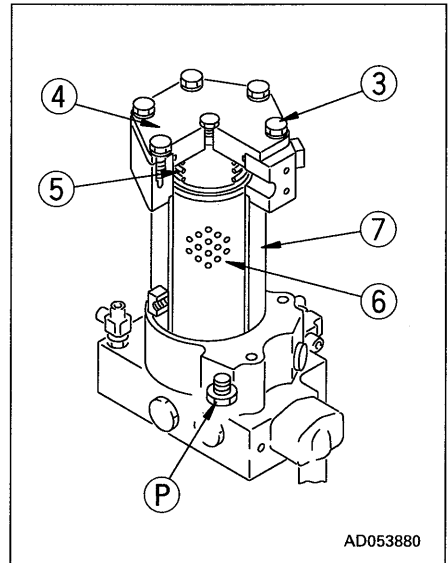
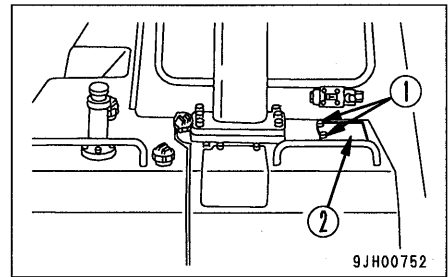

24.6.11 GREASE IDLER ADJUSTMENT ROD (LEFT, RIGHT: 1 PLACE EACH)

1. Remove bolt ②, then remove cover ①.
2. Add grease through the grease fitting marked by the arrow.

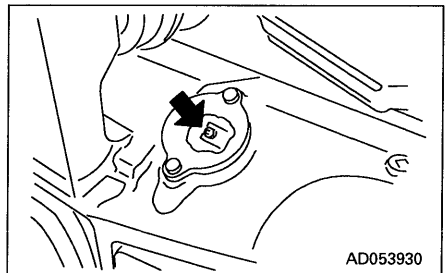
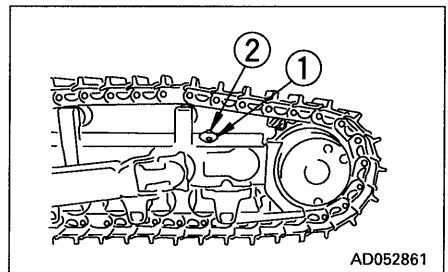

24.6.12 CHECK FOR LOOSE ROPS MOUNT BOLTS (OPTION)

Check for any loose or damaged bolts. If any bolt is loose, tighten to a torque of 926.7 ± 103.0 Nm (94.5 ± 10.5 kgm, 683.5 ± 75.9 lbft). If any bolt is damaged, replace it with a genuine Komatsu bolt.

24.7 EVERY 2000 HOURS SERVICE

Maintenance for every 250, 500 and 1000 hours service should be carried out at the same time.

24.7.1 CHANGE OIL IN HYDRAULIC TANK, REPLACE HYDRAULIC OIL FILTER ELEMENT

WARNING

The oil is at high temperature immediately after the machine has been operated. Wait for the oil to cool down before changing the oil. When removing the oil filler cap, turn it slowly to release the internal pressure, then remove it carefully.

Prepare the following.

- Container to catch drained oil: Min. 87 ℓ capacity
- Refill capacity: 87 ℓ (22.99 US gal, 19.14 UK gal)

1. Lower the blade and ripper on the ground securely, stop the engine and slowly turn the cap of oil filler Ⓕ to release the internal pressure. Then, remove the cap.
2. Remove plug ① at the bottom of the hydraulic tank, loosen drain valve ②, then drain the oil. After draining the oil, tighten drain valve ② and plug ①. When loosening drain valve ②, be careful not to get oil on yourself.
3. Loosen mounting bolt ⑤ of inspection cover ④ of the fuel tank front cover, then remove the inspection cover.
4. Remove mounting bolt ⑦ of hydraulic filter ⑥, then remove cover ⑧.
5. Remove drain plug ③ (which can be seen from under the fender) and drain the oil from the hydraulic filter case. When loosening drain plug ③, be careful not to get oil on yourself.
6. Remove element ⑨.
7. Clean the removed parts and the inside of the case, then install the new element.
Use a genuine Komatsu element.
8. Install drain plug ③.
9. Close filter cover ⑧, then tighten bolt ⑦.
10. Add engine oil through oil filler port Ⓕ to the specified level.
11. After adding oil, check that the oil is at the specified level. For details, see "25.4 EVERY 250 HOURS SERVICE".

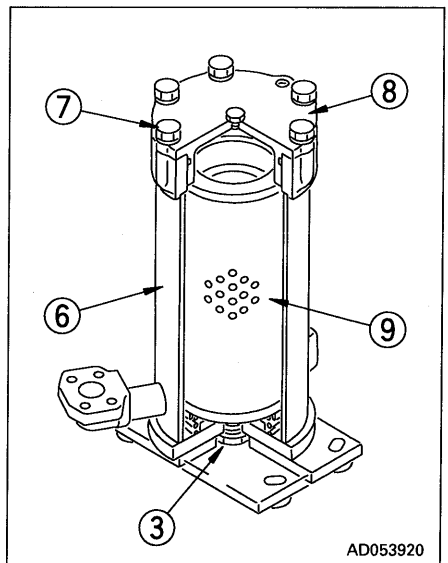
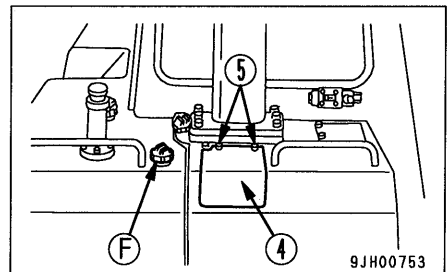
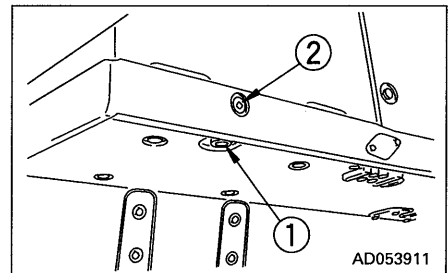

24.7.2 CHECK PLAY OF TURBOCHARGER ROTOR

Contact your Komatsu distributor to have the play checked.

24.7.3 CLEAN, CHECK TURBOCHARGER

Contact your Komatsu distributor for cleaning or inspection.

24.7.4 CLEAN ENGINE BREATHER ELEMENT

1. Wipe off all the dirt around breather ①.
2. Remove breather ①.
3. Wash the whole breather in diesel oil or flushing oil, then blow it dry with compressed air.
4. Replace the breather O-ring with a new part, coat with engine oil, and install it.

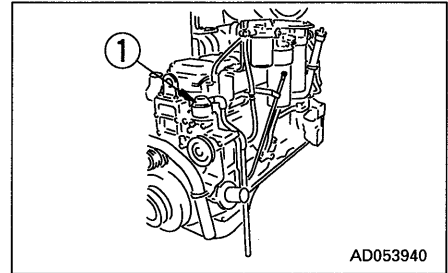

24.7.5 CHECK ALTERNATOR, STARTING MOTOR

The brush may be worn, or the bearing may have run out of grease, so contact your Komatsu distributor for inspection or repair.

If the engine is started frequently, carry out inspection every 1000 hours.

24.7.6 CHECK ENGINE VALVE CLEARANCE, ADJUST

Contact your Komatsu distributor for inspection or adjustment.

24.7.7 CHANGE OIL IN DAMPER CASE, CLEAN DAMPER BREATHER

WARNING

- The oil is at high temperature immediately after the machine has been operated. Wait for the oil to cool down before carrying out maintenance.
- The undercover is heavy. Never open or close the cover when directly underneath it. When removing bolt ④, carry out the operation at the rear of the point immediately under the cover so that it is always possible to escape.

- Container to catch drained oil: Min. 1.5 l capacity
 - Refill capacity 1.5 l (0.40 US gal, 0.33 UK gal)
1. Open engine side cover ① at the left side of the machine.
 2. Remove the undercover ② at the bottom rear of the chassis as follows.
 - (1) Remove 2 bolts ③ at the front of the chassis.
 - (2) Hold cover ① and gradually remove 2 bolts ④ at the rear of the chassis. (Be careful when doing this. Rain water may run out.)
 - (3) Lower cover ② slowly and open it. Drain plug P can be seen at the top.
 3. Remove dipstick G, then remove drain plug P and drain the oil. After draining the oil, tighten drain plug P.
 4. Add engine oil through the holder of dipstick G. After adding the oil, insert dipstick G.
 5. Remove any dirt or dust stuck to breather ⑤, then wash with clean diesel oil or flushing oil. If it cannot be cleaned completely, replace with a new part.
 6. Install undercover ②, then close engine side cover ① at the left side of the machine.

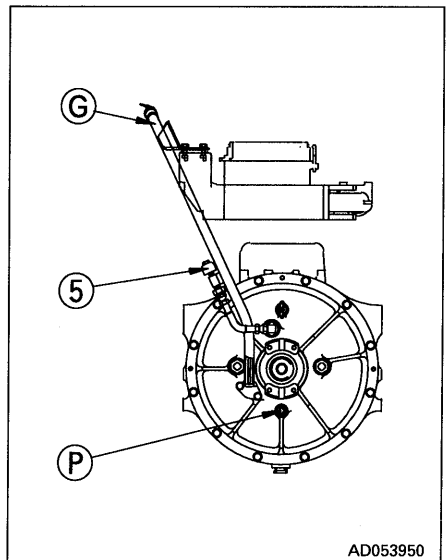
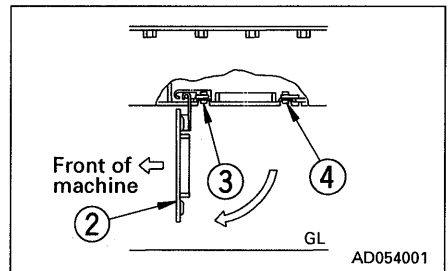
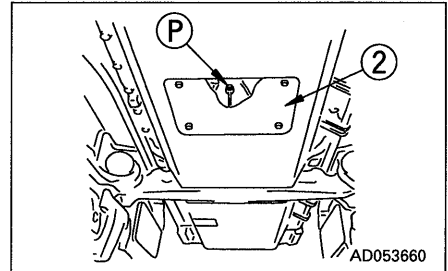
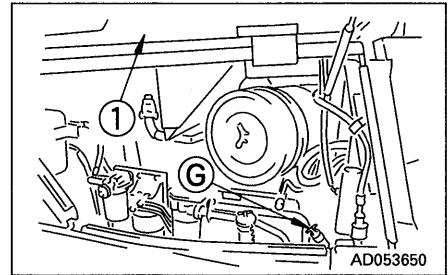

24.7.8 CHECK PIVOT BEARING OIL LEVEL, ADD OIL

1. Remove plug ①.
2. Check that the oil is at the level (25 mm (0.99 in)) in the diagram. If the oil level is low, add engine oil through the hole of plug ①.
3. Install plug ①.

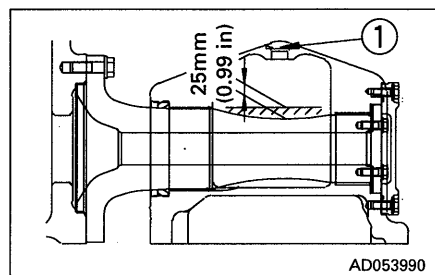
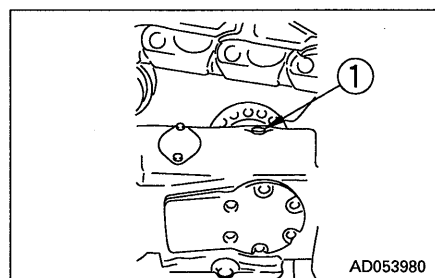

24.8 EVERY 4000 HOURS SERVICE

Maintenance for every 250, 500, 1000 and 2000 hours service should be carried out at the same time.

24.8.1 CHECK WATER PUMP

Check that there is oil leakage, water leakage, or clogging of the drain hole ①. If any abnormality is found, contact your Komatsu distributor for disassembly and repair or replacement.

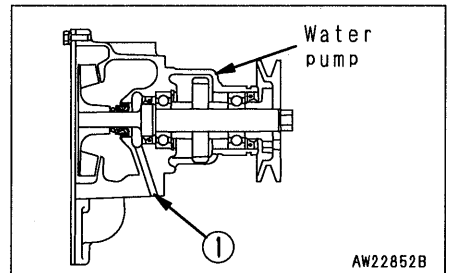
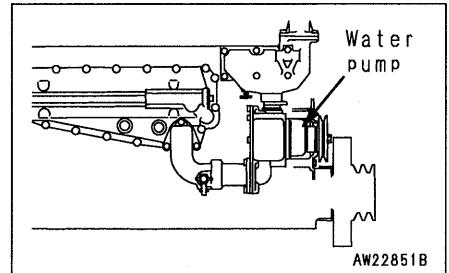

24.8.2 CHECK FAN PULLEY AND TENSION PULLEY

Check the pulley for play or leakage of grease. If any abnormality is found, please contact your Komatsu distributor.

24.8.3 CHECK VIBRATION DAMPER

Check that there are no cracks or peeling in the outside surface of the vibration damper ①.

If any cracks or peeling are found, contact your Komatsu distributor to have the parts replaced.

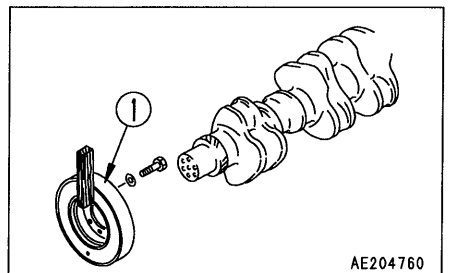

SPECIFICATIONS



25. SPECIFICATIONS

Hydraulic tiltdozer (semi U-dozer)

With hydraulic variable multi-shank ripper, ROPS, cab, 560 mm HD shoe, side cover

WEIGHT			
● Operating weight (without operator)		38500 kg (84890 lb)	
PERFORMANCE			
● Travel speed	Forward	1st	3.5 km/h (2.2 MPH)
		2nd	6.2 km/h (3.9 MPH)
		3rd	10.8 km/h (6.7 MPH)
	Reverse	1st	4.8 km/h (3.0 MPH)
		2nd	8.4 km/h (5.2 MPH)
		3rd	13.9 km/h (8.6 MPH)
ENGINE			
● Model		Komatsu SA6D140E-2 diesel engine	
● Flywheel horsepower		310 HP	
● Max. torque		1610 Nm (164 kgm)/1250 rpm	
● Starting motor		24 V 11 kW	
● Alternator		24 V 35 A	
● Battery		12 V 170 Ah x 2 pieces	

Hydraulic tiltdozer (semi U-dozer)

With hydraulic variable multi-shank ripper, ROPS, cab, 560 mm HD shoe, side cover

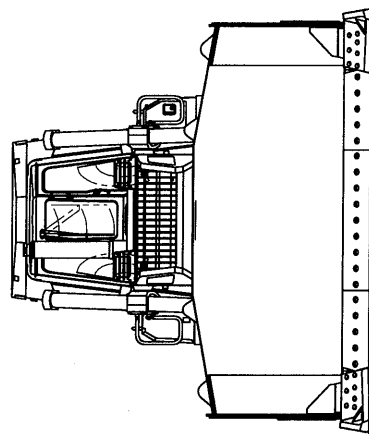
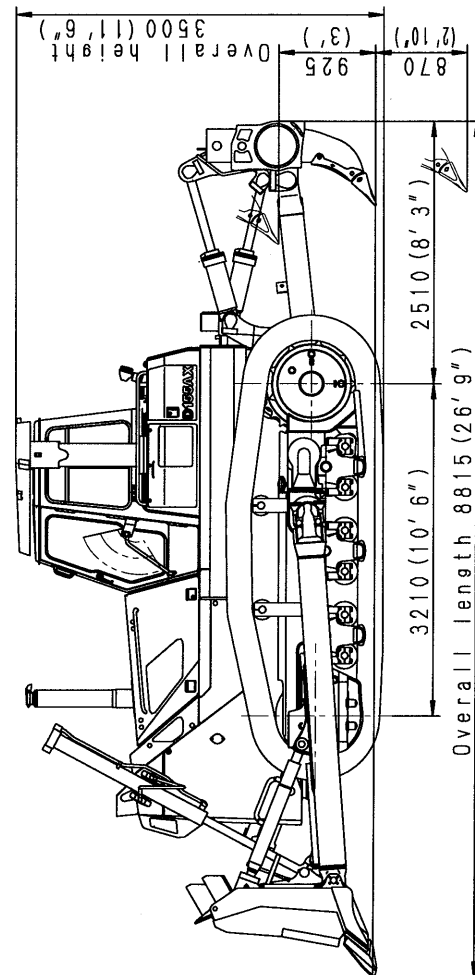
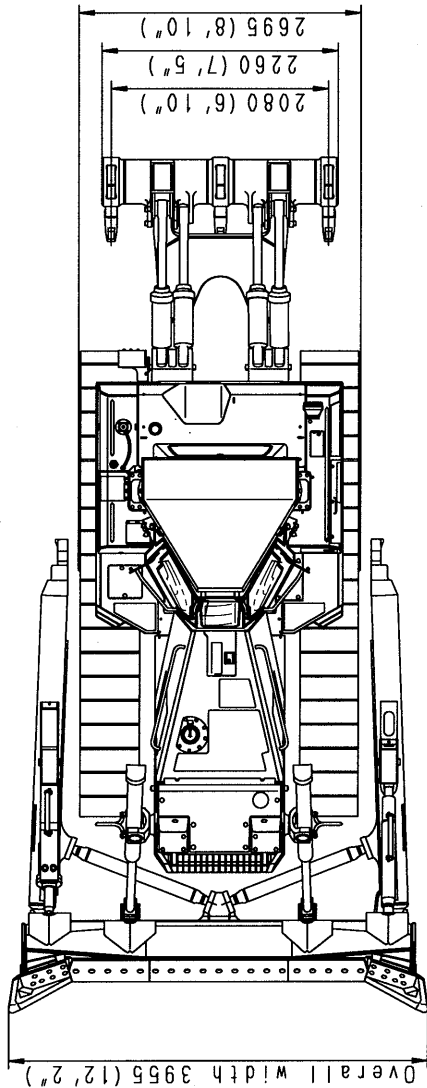

AW22853B

OPTIONS, ATTACHMENTS



26. GENERAL PRECAUTIONS

26.1 PRECAUTIONS RELATED TO SAFETY

If attachments or options other than those authorized by Komatsu are installed, this will not only affect the life of the machine, but will also cause problems with safety.

When installing attachments not listed in this Operation and Maintenance Manual, please contact your Komatsu distributor first.

If you do not contact Komatsu, we cannot accept any responsibility for any accident or failure.

WARNING

Precautions for removal and installation operations

- When removing or installing attachments, obey the following precautions and take care to ensure safety during the operation.
- Carry out the removal and installation operations on a flat, firm ground surface.
- When the operation is carried out by two or more workers, determine signals and follow these during the operation.
- When carrying heavy objects (more than 25 kg (55 lb)), use a crane.
- When removing heavy parts, always support the part before removing it.
When lifting such heavy parts with a crane, always pay careful attention to the position of the center of gravity.
- It is dangerous to carry out operations with the load kept suspended. Always set the load on a stand, and check that it is safe.
- When removing or installing attachments, make sure that they are in a stable condition and will not fall over.
- Never go under a load suspended from a crane.
Always stand in a position that is safe even if the load should fall.

NOTICE

Qualifications are required to operate a crane. Never allow the crane to be operated by an unqualified person.

For details of the removal and installation operations, please contact your Komatsu distributor.

27. INTRODUCTION OF OPTIONAL PARTS AND ATTACHMENTS

27.1 INTRODUCTION OF OPTIONAL PARTS AND ATTACHMENTS

Name	Specifications, use
Track shoes	Wide shoe width 610 mm (24")
	Wide shoe width 660 mm (26")
	Wide shoe width 710 mm (28")
	Heavy-duty shoe width 610 mm (24")
	Heavy-duty shoe width 660 mm (26")
Ripper point	
Reversible fan	
Cap with lock	

Various other optional parts are available, so please contact your Komatsu distributor.

28. USING SEAT BELT

When operating a machine equipped with ROPS, be sure to use the seat belt.

WARNING

- Before fastening the seat belt, inspect the securing brackets and belt for abnormal conditions. Replace any worn or damaged seat belt or the securing brackets.
- Adjust and fasten the seat belt before operating the machine.
- Always use seat belt when operating the machine.
- Fit the seat belt across your lap without twisting.

28.1 FASTEN THE BELT AND REMOVE IT IN THE FOLLOWING MANNER

HANDLING SEAT BELT

WARNING

- Before fitting the seat belt, check that there is no abnormality in the belt mount bracket or mounting belt. If it is worn or damaged, replace the seat belt.
- Even if no abnormality can be seen in the belt, replace the seat belt every 3 years. The date of manufacture of the belt is shown on the back of the belt.
- Adjust the seat belt and fit it before starting operation.
- Always wear the seat belt during operation.
- Fit the seat belt so that it fits across your abdomen and is not twisted.

1. Adjust the seat so that the brake pedal can be depressed all the way with the operator's back against the backrest.
2. After positioning the seat, adjust the tether belt ①. With the seat unoccupied, tense the belt slightly across the seat and install.
3. Sit in the seat, hold tongue ④ of reel ②, and pull the belt out slowly to a length which fully covers your lap.
4. Insert tongue ④ into buckle ③ and push until there is a click. Pull back reel ② until the belt fits securely across your lap. In this condition, the lock is applied to prevent the belt from extending any further.
Fit the seat belt across your lap without twisting.

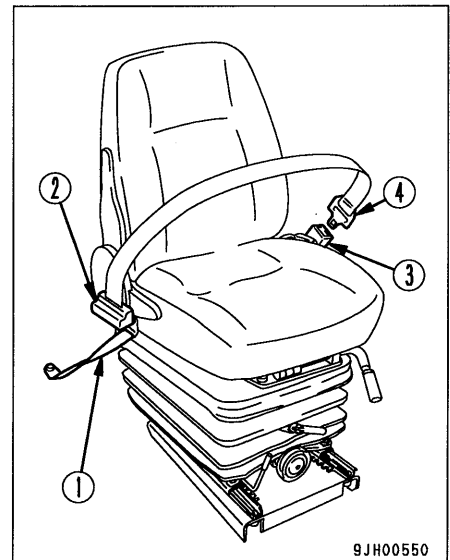

REMARK

If the lock is applied before the tongue is installed into the buckle, return the belt to the reel, then carry out the operation again from the beginning.

5. Tense the belt and check that the lock is applied.
6. To remove the belt, press the red button on buckle ③. The belt will automatically wind in.

Inspect bolts and fittings on the chassis for tightness. Retighten any loose bolts to 19.6 to 29.4 Nm (2 to 3 kgm, 14.5 to 21.7 lbft) torque.

If the seat is scratched or frayed or if any of the fittings are broken or deformed from long service, replace the seat belt immediately.

29. HANDLING HEADREST

29.1 ADJUSTING HEIGHT OF HEADREST

- To make it higher
Hold the headrest and pull it up.

- To make it lower
Keep knob ① pushed down, and push the headrest down to the desired position.
Height adjustment: 60 mm (2.36 in) (2 stages)

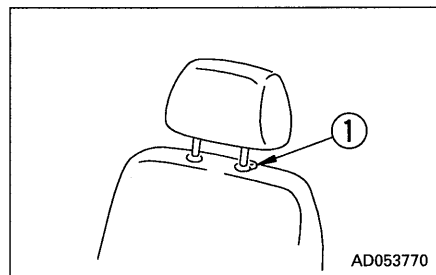
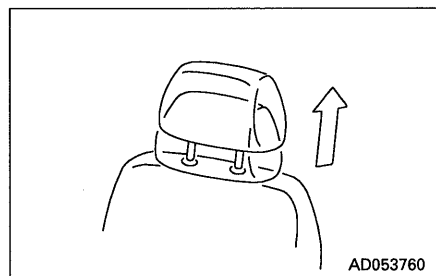

30. HANDLING REVERSIBLE FAN

30.1 REVERSING REVERSIBLE FAN

When reversing the reversible fan in cold weather, do as follows.

1. Loosen bolt ②, then remove cover ① on the right side of the radiator guard. A hole for inserting the tool can be seen.
2. Open engine side cover ③ on the right side of the machine so that the reversing operation can be seen.
3. Insert the tip of the tool into fan blade ④.
4. Push towards the center of the fan, and turn the handle of the tool to reverse the fan blades.
5. Reverse 6 fan blades, but rotate the fan as follows.
 - Use the starting motor to rotate the fan.
 - Loosen the nut of the spring which applies tension to the tension pulley, reduce the belt tension, and rotate by hand. Do not loosen the nut too far or remove it.
 - After completely reversing all the fan blades, tighten the nut to its original position.

REMARK

- When inserting the tool, if the work equipment or any other part is in the way, change the position of bolt ⑤ to extend the tool when using it.
- If the fan is used in the suction direction in temperatures below -30°C , it has the effect of heating or maintaining the battery temperature.
- Use part number 175-900-3910 for the tool.

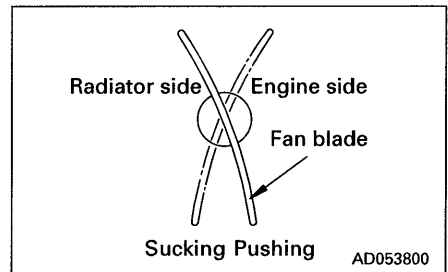
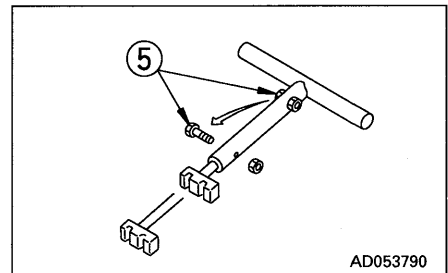
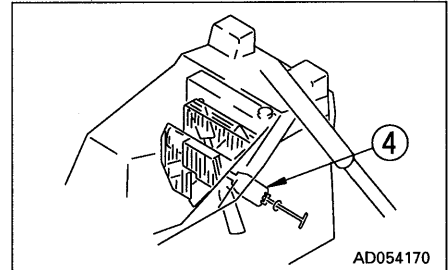
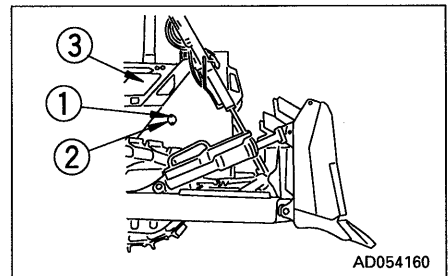

31. HANDLING CAP WITH LOCK

31.1 OPENING AND CLOSING LOCKABLE CAP

Lock-type caps are available for the radiator water filler cap, fuel tank filler cap, power train case oil filler cap, hydraulic tank oil filler cap, and hydraulic tank breather cap. The cap opening and closing method is as follows.

WHEN OPENING CAP

1. Insert the key. Make sure that you have inserted the key fully before turning it. If the key is turned when only partially inserted, it may break.
2. Turn the key counterclockwise to align the match mark on the cap with the rotor groove, then turn the cap slowly. When a click is heard, the lock is released, enabling the cap to be opened.

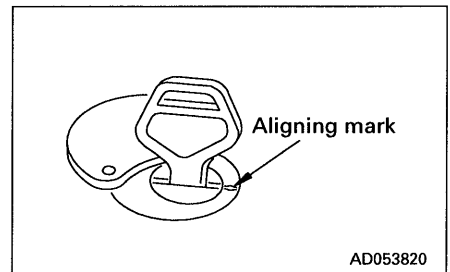
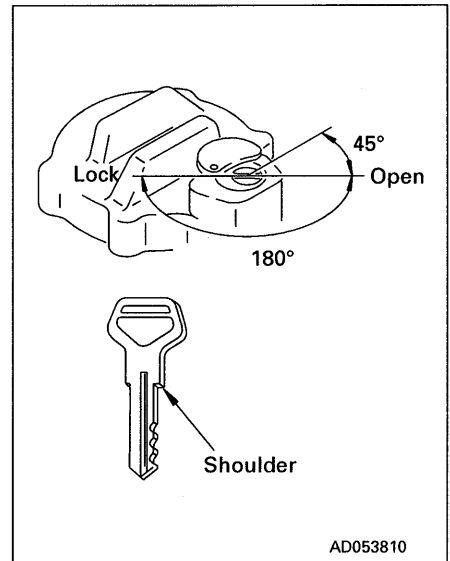

TO LOCK THE CAP

1. Turn the cap into place.
2. Turn the key clockwise and take the key out.

32. PROCEDURE FOR SELECTING RIPPER POINT

32.1 PROCEDURE FOR SELECTING RIPPER POINT

<p>Procedure ①</p> <p>Procedure ② Check wear</p> <p>Procedure ③ Check for cracks or breakage</p>	<pre> graph TD A([Install standard point A]) --> B{Is wear rapid?} B -- No --> A B -- Yes --> C{Is there a high proportion of quartz in rock?} C -- "No (less than 70%) Excessive generation of heat from point (only tip of point wears)" --> D([Install point C]) C -- "Yes (more than 70%) (Whole point wears uniformly)" --> E([Install point B]) D --> F{Does point break when impact force is applied?} E --> G{Does point break when impact force is applied?} F -- No --> A F -- Yes --> H([Install point A]) G -- No --> A G -- Yes --> I([Install point D]) </pre>					
Typical rock	Hardness	Soft ↔ Hard	Soft ↔ Medium hard	Soft ↔ Medium hard ↔ Hard		
	Type of rock	General rock	Sandstone	Basalt, andesite, granite, chert		
	Features	-	<ul style="list-style-type: none"> Very high proportion of quartz (70 – 95%), point wears rapidly 	<ul style="list-style-type: none"> Fairly high proportion of quartz (40 – 70%) Does not form seams or layers, so there is excessive generation of heat from the point, the tip wears rapidly, and ripping is difficult 		
Suitable point	Features	<p>Point A</p> <ul style="list-style-type: none"> Symmetrical shape Yellow Short (can be turned and used) 	<p>Point B</p> <ul style="list-style-type: none"> Non-symmetrical shape Yellow Long 	<p>Point C</p> <ul style="list-style-type: none"> Non-symmetrical shape Red Long 	<p>Point D</p> <ul style="list-style-type: none"> Symmetrical shape Red Long (can be turned and used) 	<p>Point E</p> <ul style="list-style-type: none"> Symmetrical shape Red Short (can be turned and used)
	Shape					
	Part No.	175-78-31230	175-78-34131	175-78-34141	175-78-31293	175-78-31232

D155AX-5 BULLDOZER

Form No. SEAM022500