

Operation & Maintenance Manual

SEAM01542102

D85A,E,P-21

BULLDOZER

SERIAL NUMBERS D85A,E-35001 and up
D85P-3001

KOMATSU

FOREWORD

This manual describes procedures for operation, handling, lubrication, maintenance, checking, and adjustment. It will help the operator or anyone realize peak performance through effective, economical and safe machine operation and maintenance.

- Please read this manual carefully BEFORE operating the machine.
- Please continue studying this manual until proper operation is completely reinforced into personal habit.
- This manual describes the basic techniques. Skill is performed as the operator or anyone get the correct knowledge and performance of the machine.
- Operation, inspection, and maintenance should be carefully carried out, and the safety must be given the first priority. Safety precautions are indicated with  marks and technical precautions with ★ marks in this manual. The safety information contained in this manual is intended only to supplement safety cords, insurance requirements, local laws, rules and regulations.
- Some photographs and illustration pictures are different from your machine as technical improvement is continuously reflected on it. Revision to up-to-date manual's content is performed in later editions.
- This operation & maintenance manual may contain attachments and optional equipment that are not available in your area. Please consult your local Komatsu distributor for those items you may require. Materials and specifications are subject to change without notice.

BREAKING IN YOUR NEW MACHINE

Each machine is carefully adjusted and tested before shipment. However, a new machine requires careful operation during the first 100 hours to break in the various parts.

If a machine is subjected to unreasonably hard use at the initial operation stage, the potential of performance will prematurely deteriorate and the service life will be reduced. A new machine must be operated with care, particularly with regard to the following items.

- After starting, let the engine idle for 5 minutes to allow proper engine warm-up prior to actual operation.
- Avoid operation with heavy loads or at high speeds.
- Sudden starting or acceleration, unnecessarily abrupt braking and sharp turning should be avoided.
- If the machine is delivered without any cooling water in the radiator, flush the cooling system with ample clean water to clean the system, then fill the radiator with cooling water.
- ★ When replacing oil filter elements (cartridges), check their interiors for dirt and dust. If heavily collected, check for possible cause before starting operation.
- ★ Hours of operation are indicated by the service meter.

CONTENTS

OPERATION

GENERAL LOCATIONS AND SPECIFICATIONS	5
INSTRUMENTS AND CONTROLS	6
CHECK BEFORE STARTING	36
OPERATING YOUR MACHINE	41
COLD WEATHER OPERATION	54
BULLDOZER'S WORK	59
HOW TO REVERSE THE REVERSIBLE FAN	60
BLADE ADJUSTMENT	61
REVERSING OF CUTTING EDGE AND REPLACEMENT OF END BIT	64
TIPS FOR LONGER UNDERCARRIAGE LIFE	65

MAINTENANCE

PERIODIC MAINTENANCE	67
MAINTENANCE TABLE	68
OIL FILLER AND LEVEL GAUGE POSITIONS	71
EVERY 250 HOURS SERVICE	72
EVERY 500 HOURS SERVICE	80
EVERY 1000 HOURS SERVICE	82
EVERY 2000 HOURS SERVICE	89
EVERY 4000 HOURS SERVICE	92
WHEN REQUIRED	93
ADJUSTMENT	102
TROUBLE SHOOTING GUIDE	109
SERVICE METER	112
MACHINE AND ENGINE SERIAL NUMBERS	113
FUEL, COOLANT AND LUBRICANTS	114

GENERAL LOCATIONS AND SPECIFICATIONS

- | | |
|------------------|----------------|
| 1. Lift cylinder | 5. Track frame |
| 2. Fuel tank | 6. Frame |
| 3. Track shoe | 7. Idler |
| 4. Sprocket | 8. Blade |

D85A

(): D85E []: D85P

OPERATING WEIGHT:

With tiltdozer

23550 kg (23700 kg) [25900 kg]

With angledozer

23690 kg (23840 kg)

PERFORMANCE

Max. travel speed

Forward 11.8 km/h (11.8 km/h) [10.7 km/h]

Reverse 14.3 km/h (14.3 km/h) [13.3 km/h]

ENGINE

- | | |
|--------------------------------------|------------------------------|
| 1. Model | Komatsu S6D125 diesel engine |
| 2. Flywheel horsepower (at 2000 rpm) | 225 HP |

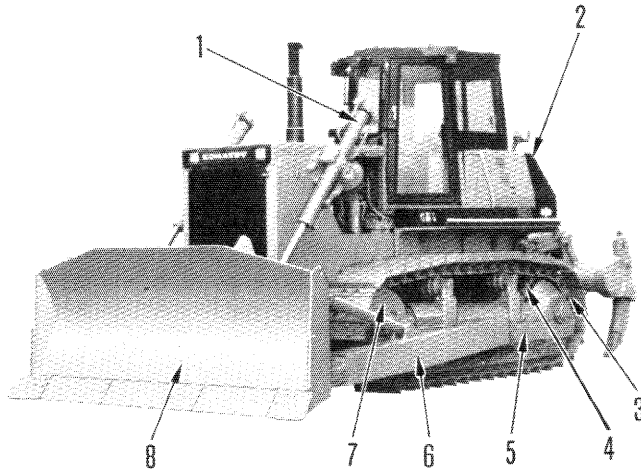

D85A with cab and ripper

NOTE: Specifications are subject to change without notice.

INSTRUMENTS AND CONTROLS

MONITOR PANEL

This monitor system consists of monitor lamp groups (A)(B)(C), meter group (D) and switch group (E).

- Functional check of the machine monitor system

When the starting switch is turned to (I) (ON) before starting the engine, the monitor lamps flash for 3 seconds, the panel lamp lights for 4 seconds, the warning lamp lights for 3 seconds, and the alarm buzzer sounds for 2 seconds. If any monitor lamp does not light up, ask your Komatsu distributor to inspect that monitor lamp.

- ★ The monitor lamps cannot be checked for breakage until 30 seconds after the engine has been stopped.

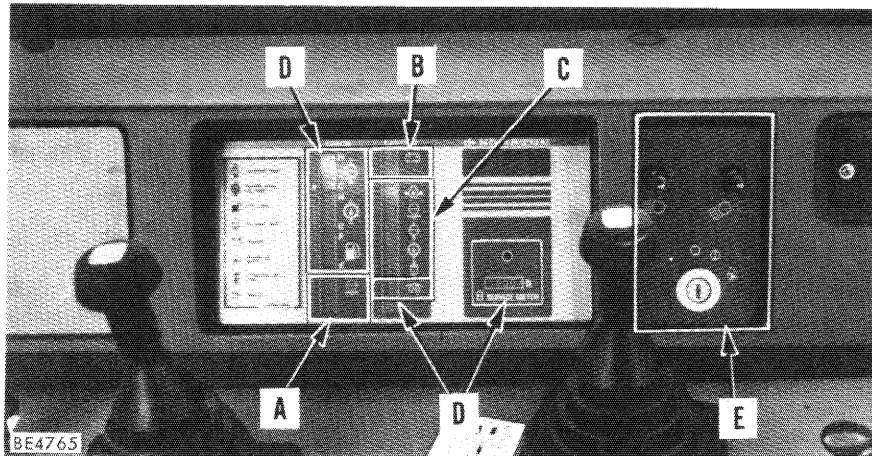

Ⓐ CHECK MONITOR GROUP
(Check items before starting)

If there is any abnormality, the appropriate monitor lamp will flash.

- ★ When the engine is started, these monitor lamps will go off even if there are abnormalities.

Ⓑ CAUTION MONITOR GROUP
(Caution items)

If any abnormality occurs while the engine is running, the appropriate monitor lamp and the warning lamp will flash to indicate the abnormality at the same time.

- ★ Even if any monitor lamp flashes, the machine can operate, but it should be repaired as soon as possible.

Ⓒ CAUTION MONITOR GROUP
(Emergency stop items)

If any abnormality occurs while the engine is running, the appropriate monitor lamp and the warning lamp will flash and the alarm buzzer will sound intermittently at the same time.

- ★ If any monitor lamp flashes, stop the work, and repair it immediately.

Ⓓ METER GROUP

This group consists of engine water temperature gauge, power train oil temperature gauge, fuel gauge, engine preheating monitor lamp and service meter.

Ⓔ SWITCH GROUP

This group consists of starting switch and lamp switches.

A: CHECK MONITOR GROUP
(Check items before starting)

- ★ Do not rely on the “CHECK MONITOR GROUP (Check before starting)” only for the check before starting. Always make the check by referring to the section on “CHECK BEFORE STARTING”.

1. RADIATOR COOLANT LEVEL MONITOR



This monitor indicates a low radiator coolant level.

If the monitor lamp flashes, check the coolant level and add water as required.

- ★ Park the machine on level ground and check the monitor lamps.
- ★ Confirm that these monitor lamps light for about 3 seconds after turning the starting switch to **(ON)**. If any monitor lamp does not light, ask your Komatsu distributor to inspect that monitor lamp.

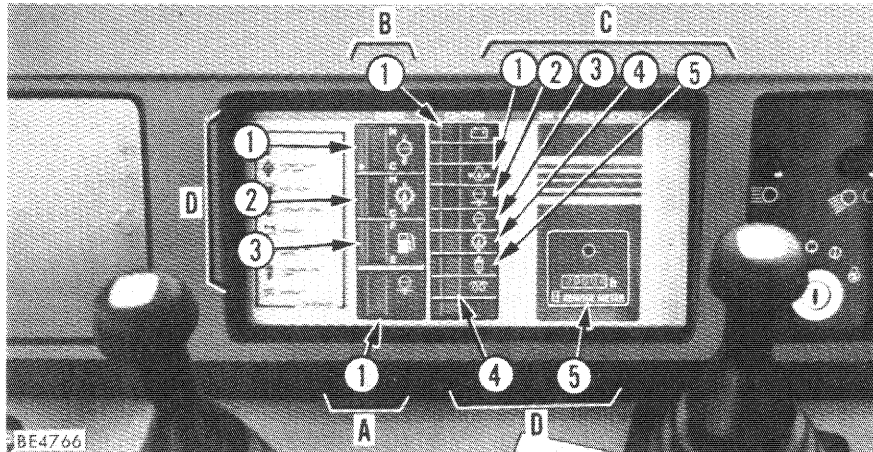

B: CAUTION MONITOR GROUP (Caution items)

- ★ Even if any monitor lamp flashes, the machine can operate, but it should be repaired as soon as possible.

1. CHARGE MONITOR

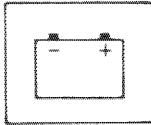

This monitor indicates an abnormality in the charging system while the engine is running.

If the monitor lamp flashes, check the charging circuit.

- ★ Park the machine on level ground and check the monitor lamps.
- ★ Confirm that these monitor lamps light for about 3 seconds after turning the starting switch to **I** (ON). If any monitor lamp does not light, ask your Komatsu distributor to inspect that monitor lamp.
- ★ This monitor lamp lights, when the starting switch is turned to **I** (ON) immediately after the engine is started or immediately before the engine is stopped. It does not indicate an abnormality.

C: CAUTION MONITOR GROUP (Emergency stop items)

- ★ If any monitor lamp flashes, stop the engine or run it at a low speed, and repair it immediately.

1. ENGINE OIL PRESSURE MONITOR

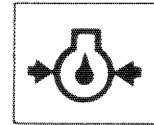

This monitor indicates a low engine oil pressure.

If the monitor lamp flashes, the engine oil pressure is below the lower limit. Immediately stop the engine.

- ★ This monitor lamp flashes and the alarm buzzer sounds, when the starting switch is turned to **I** (ON) immediately after the engine is started or immediately before the engine is stopped. It does not indicate an abnormality.

2. RADIATOR COOLANT LEVEL MONITOR



This monitor indicates a low radiator coolant level.

Check the coolant level when the monitor lamp flashes, stop engine and add water as required.

3. ENGINE COOLING WATER TEMPERATURE MONITOR



This monitor indicates a rise in the cooling water temperature.

When the monitor lamp flashes, run the engine at the low idling speed until the green range of the engine water temperature gauge lights.

4. POWER TRAIN OIL TEMPERATURE MONITOR

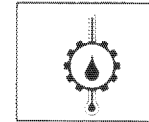

This monitor indicates a rise in the oil temperature of the torque converter outlet.

When the monitor lamp flashes, run the engine at the low idling speed until the green range of the power train oil temperature gauge lights.

- ★ Park the machine on level ground and check the monitor lamps.
- ★ Confirm that these monitor lamps light for about 3 seconds after the starting switch is turned to **(ON)**. If any monitor lamp does not light, ask your Komatsu distributor to inspect that monitor lamp.

5. HYDRAULIC TEMPERATURE MONITOR

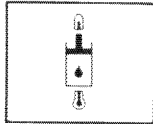

This monitor indicates a rise in the hydraulic temperature.

When the monitor lamp flashes, run the engine at the low idling speed until oil temperature falls.

D: METER GROUP

- ★ While the engine is at rest, turn the starting switch **I** (ON) to see if meter lamps (1), (2), (3) and (4), and the monitor lamp all come on. If they do not light, ask your Komatsu distributor to inspect them.

1. ENGINE COOLING WATER TEMPERATURE GAUGE

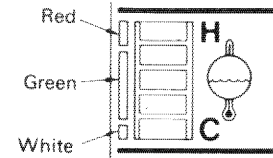

This gauge indicates the temperature of the cooling water. If the temperature is normal during operation, the green range will light. If the red range lights during operation, the alarm buzzer will sound and the engine water temperature monitor lamp will flash at the same time. If this occurs, stop the machine and run the engine at a low idling speed until the green range lights.

2. POWER TRAIN OIL TEMPERATURE GAUGE

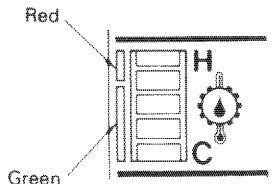

This gauge indicates the oil temperature of the torque converter outlet. If the temperature is normal during operation, the green range will light. If the red range lights during operation, the alarm buzzer will sound and the power train oil temperature monitor lamp will flash at the same time. If this occurs, stop the machine and run the engine at a low idling speed until the green range lights.

3. FUEL GAUGE

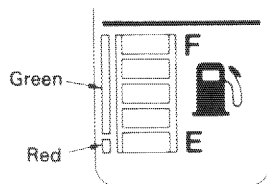

This gauge indicates the amount of fuel in the fuel tank. If there is enough fuel in the tank while the engine is running, the green range lights. If the red range lights, there is less than 80 liters of fuel in the tank.

When the red range lights, add fuel.

4. ENGINE PREHEATING MONITOR LAMP

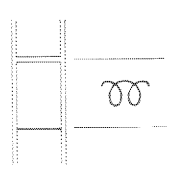

This monitor lamp indicates the pre-heating time required when starting the engine at an ambient temperature below 5°C.

The monitor lamp lights when the starting switch is turned to ● (HEAT) position and flashes after about 36 seconds to show that the pre-heating is completed. (The monitor lamp will go off after about 16 seconds.)

5. SERVICE METER

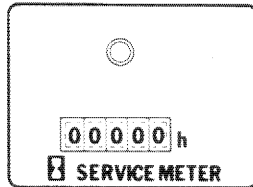

This meter shows the total operation hours of the machine. The service meter advances while the engine is running - even if the machine is not traveling.

Refer to the section "SERVICE METER".

- ★ While engine is running, green pilot lamp on the service meter flashes to show the service meter advances.

E: SWITCHES

1. STARTING SWITCH

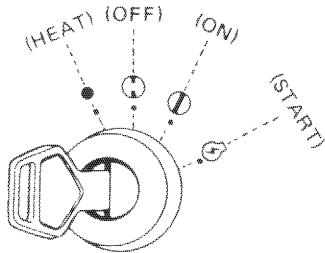

Key insertion-withdrawal position. None of electrical circuits activate.



Charging and lamp circuits activate. Keep key at (ON) after starting.



At this key position, the starting motor will crank the engine. Release key immediately after starting.



Use this position when starting in cold weather.

Release the key to allow it to return automatically to (OFF) and then, without delay, turn it to (START).

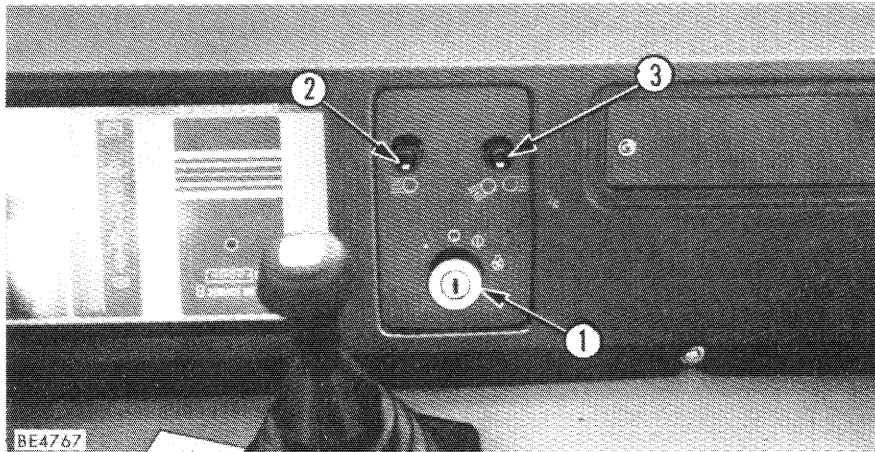

2. HEAD LAMP SWITCH

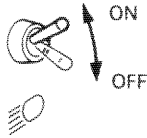

When this switch is turned ON, the head lamp and the panel lamp will light.

3. WORKING LAMP/REAR LAMP SWITCH

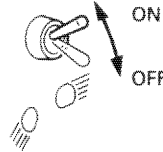

When this switch is turned ON, the working lamps on the R.H. and L.H. fender and the rear lamp will light.

LAMP

1. WARNING LAMP

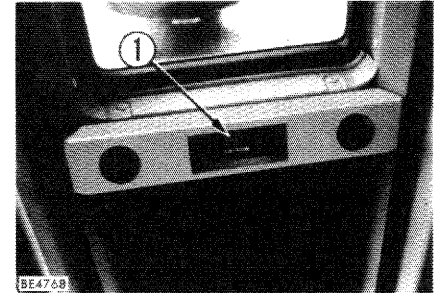

When the monitor lamps of **Ⓑ** and **Ⓒ** caution groups in the machine monitor system flash, this warning lamp flashes at the same time.

When the warning lamp flashes, confirm the location of the abnormality on the monitor panel.

When the monitor lamp in **Ⓒ** caution group is flashing, the alarm buzzer sounds intermittently.

★ When the alarm buzzer sounds, immediately stop work. Then, inspect and repair the faulty part.

SWITCHES

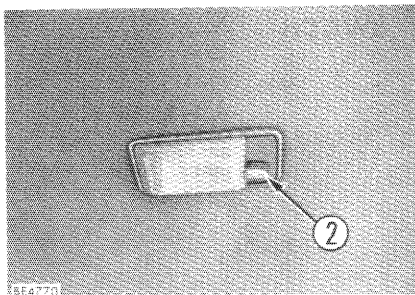
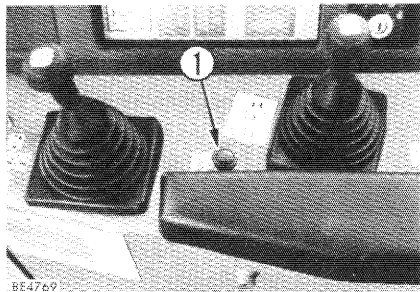

1. HORN SWITCH

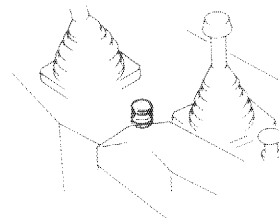

When this switch is pressed, the horn will sound.

2. ROOM LAMP SWITCH

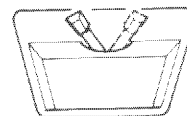

When this switch is moved to ON position, room lamp will light.

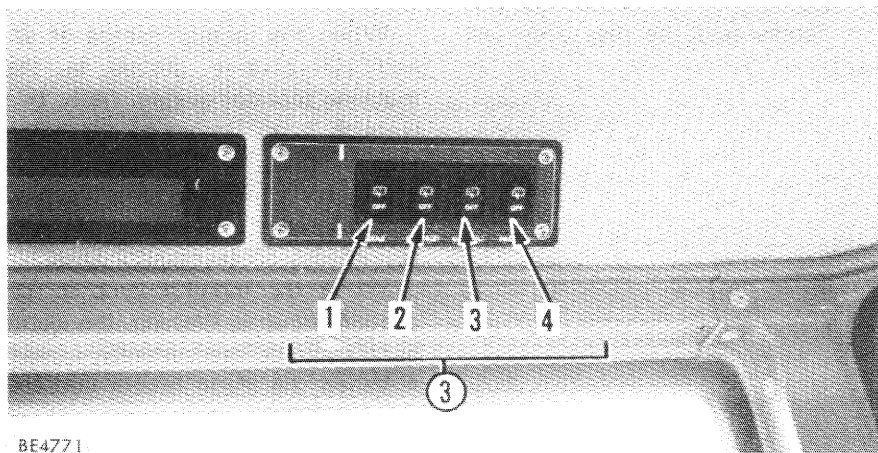

3. WIPER SWITCHES



These switches are used to actuate the following wipers.

- ① Rear window wiper
- ② Door (R.H.) wiper
- ③ Door (L.H.) wiper
- ④ Front window wiper

Each switch can also be used to actuate a window washer. Thus, each switch can be used for the following three purposes.

- Wiping only



- Wiping and washing



- Window washing only

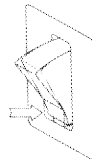

LEVERS AND PEDALS

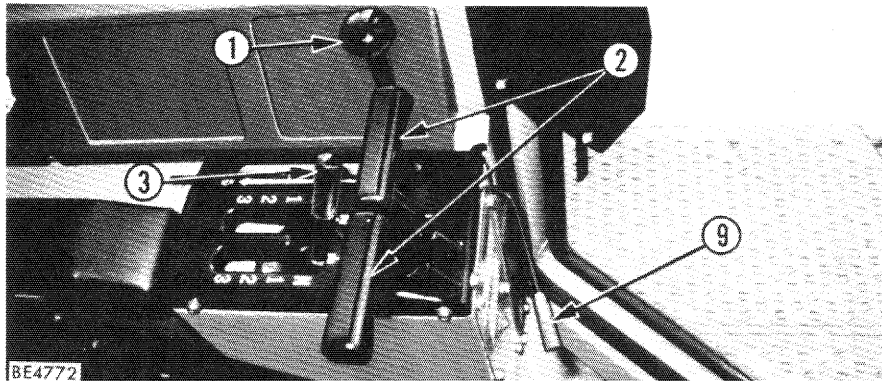

BE4772



BE4773

1. FUEL CONTROL LEVER

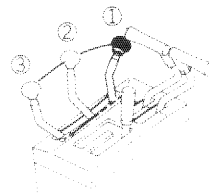

This lever is used to control the engine speed and output.

- ① Engine stop position:
Push the lever fully.
- ② Low idling position:
Pull the lever from engine stop position ① until you feel the operating force falls off.
- ③ Full speed position:
Pull the lever fully from low idling position ② .

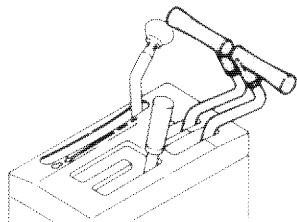
2. STEERING LEVER

To turn the machine gently to one direction, pull the steering lever on the same side halfway.

When the steering lever is further pulled all the way out, the machine will make a sharp pivot turn.

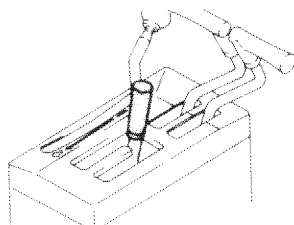
3. GEAR SHIFT LEVER

Three-speed forward and three-speed reverse travel can easily be selected by simply shifting the gear shift lever to any desired speed position.

- ★ Place the gear shift lever in the neutral position before starting the engine.

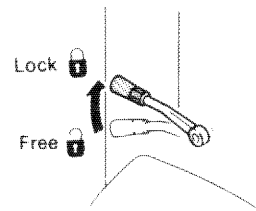
4. BRAKE LOCK LEVER

This device is used to lock the brake pedal when parking. When the pedals are depressed and the lock lever is placed in LOCK, the brake is locked.

To release brakes, depress the brake pedals and set the lever in FREE.

⚠ Whenever machine is parked, lock brake pedals without fail.

5. BLADE CONTROL LEVER

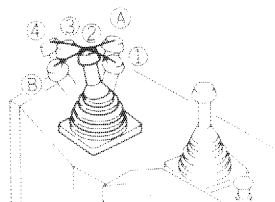

Lever Position

① RAISE ()

② HOLD ()

The blade remains stopped and held position.

③ LOWER ()

④ FLOAT ()

The blade can move freely.

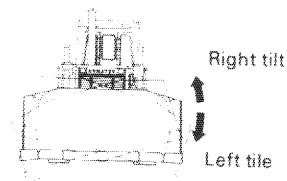
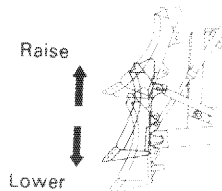

★ When the lever is released while in position ④, it does not spring back to HOLD position. Move it back to the HOLD position by hand.

Ⓐ RIGHT TILT ()

Ⓑ LEFT TILT ()

Blade can be tilted at any position of ① to ③.

★ Ⓐ and Ⓑ are possible only with tildozzer.

★ Lever should be returned quickly to HOLD position at the end of tilt cylinder stroke.

★ Do not operate tilting when blade is at top or bottom position.

6. SAFETY LOCK (For blade control lever)

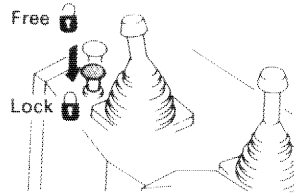

This device is used to lock the blade control lever.

⚠ When parking or servicing the machine, be sure to lower the blade and set the safety lock in LOCK position.

7. RIPPER CONTROL LEVER (For D85A,E)

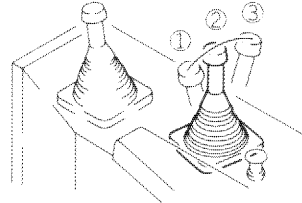

This device is used to operate the ripper.

① RAISE ()

② HOLD ()

The ripper remains stopped and held position.

③ LOWER ()

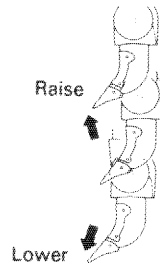

8. SAFETY LOCK (For D85A,E) (For ripper control lever)

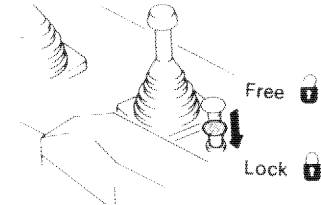

This device is used to lock the ripper control lever.

⚠ When parking or servicing the machine, be sure to lower the ripper and set safety lock in lock position.

9. SAFETY LEVER

(For gear shift lever)

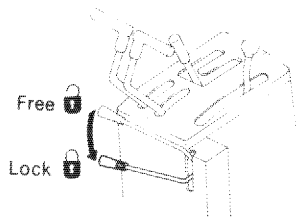

This is the locking device of the gear shift lever.

⚠ When the machine is stopped for a while, be sure to set the gear shift lever in neutral and set the safety lever to **LOCK**.

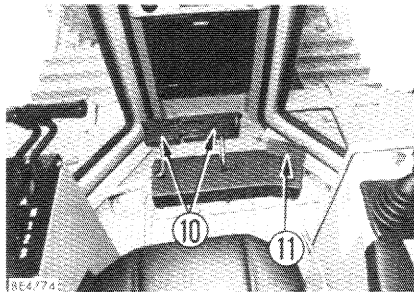

10. BRAKE PEDAL

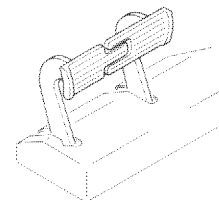

When both brake pedals are depressed simultaneously by stepping on the center area, both right and left brakes are actuated.

If the steering lever is pulled out half-way and the brake pedal on the same side as the lever is depressed at the same time, the machine will make a pivot turn.

⚠ Do not place your foot on pedals unnecessarily.

11. DECELERATOR PEDAL



This pedal is used to decelerate engine speed.

To quickly restore normal engine power during ripper operation, this pedal is designed to be operated in two stages. Normally, the pedal is used at the first stage (800 to 850 rpm). When required, the pedal can be further depressed so the engine runs at low idling speed.

⚠ When arriving at the top of a slope, or when dumping earth from a cliff, the machine will increase its speed with the sudden loss of load. Slow the machine by depressing the decelerator pedal.

DOOR LOCK

This lock is used to lock the door in position when it is opened.

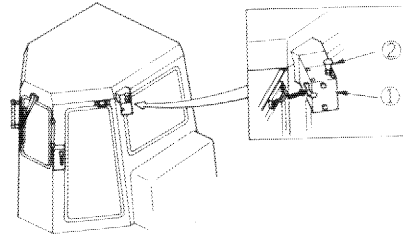

1. When the door is forced against catcher ①, the door will be locked in position.
 2. To release the door, push knob ② above the catcher. The catcher will unlock the door.
- ★ When locking the door in position, be sure to force it firmly against the catcher.

FUSE BOX

The fuse protect the electric devices and wiring from burning out. If any fuse is rusted or coated with white powder, replace it.

- ★ Replace a fuse with another of the same capacity.

⚠ Before replacing a fuse, be sure to turn off the starting switch.

● Fuse box I

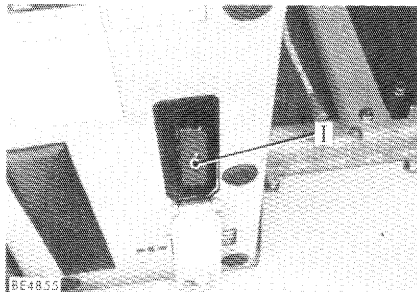

● Fuse box II

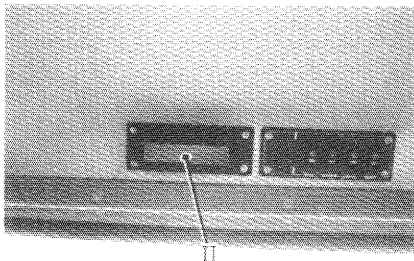

854775

Fuse arrangement and circuit

● Fuse box I

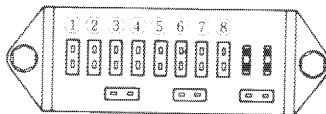

No.	Fuse capacity	Circuit
①	15A	Starting switch
②	15A	Head lamp
③	15A	Working lamp
④	15A	Rear lamp
⑤	15A	Monitor, Horn, Back-up buzzer
⑥	15A	Cab 1
⑦	15A	Cab 2
⑧	15A	Air conditioner

● Fuse box II

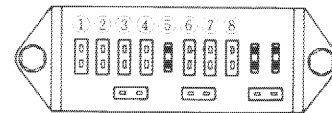

No.	Fuse capacity	Circuit
①	10A	Front window wiper
②	10A	Rear window wiper
③	10A	Door wiper (L.H.)
④	10A	Door wiper (R.H.)
⑤	—	—
⑥	10A	Room lamp
⑦	10A	Cigarette lighter
⑧	10A	Car stereo

DUST INDICATOR

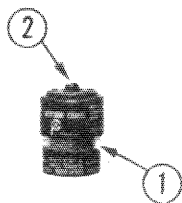

19774

This device indicates clogging of the air cleaner element. When red piston (1) appears in the transparent part of this indicator, the element is clogged. Immediately clean element.

After cleaning, push indicator button (2) to return red piston to original position.

The dust indicator is in engine hood.

CAR STEREO

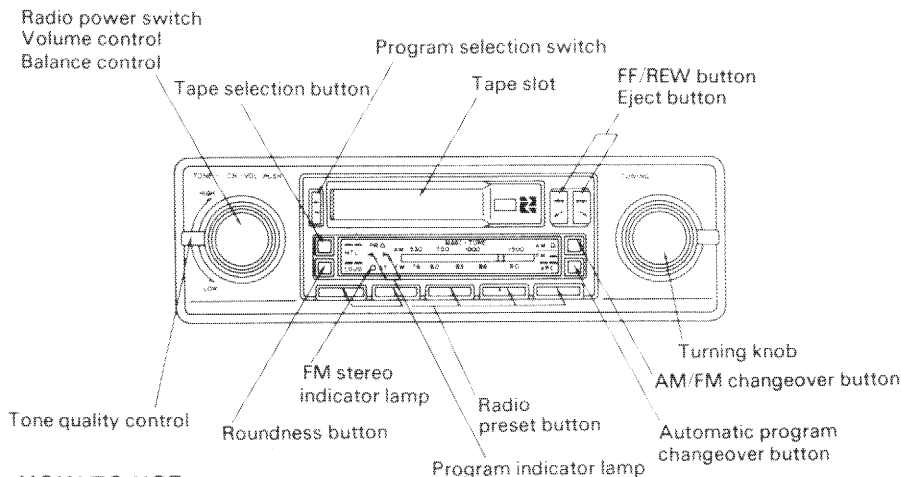

HOW TO USE

To play a cassette tape:

- 1. Power source**
 When the power switch is turned clockwise, power will be supplied to the car stereo.
- 2. Setting**
 When a cassette tape is inserted into the slot, the tape is set, causing the program indicator lamp to light.
- 3. Stopping**
 When both the FF and REW buttons are depressed simultaneously, the cassette will spring out of place and the stereo will stop.

4. Selection of program

1) Automatic selection

When one side of the tape is finished, the tape will change direction so that there is no interruption.

2) Manual selection

When the program selection switch is depressed before one side of the tape is finished, the tape will change direction.

5. Program indicators

The direction in which the tape is moving during PLAY is indicated by two indicators.

6. FF (fast forward),
REW (rewind)

When the FF or REW button is depressed, the button will be locked and the tape will run in fast forward or rewind.

To release the button,

- depress the button which is not depressed, or
- depress both the FF and REW buttons simultaneously (At this time, the cassette tape will spring out of place), or
- wait until the tape finishes playing. (After the button is automatically released, the opposite side of the tape will start playing), or
- depress the program selection button. (After the button is released, the other side of the tape will PLAY.)

7. Volume control

As the volume control knob is turned clockwise, the tape plays louder.

8. Balance control

When the balance control knob is pulled out and turned clockwise, the volume from the R.H. speaker increases. When turned counterclockwise, the volume from the L.H. speaker increases.

9. Tone quality control

When the tone quality control knob is turned clockwise, high tones will be intensified. When turned counterclockwise, the low tones will be intensified.

10. Roundness control

When the roundness control switch is depressed, both the high tones and low tones will be intensified, even if the volume of the sound is low.

11. APC (automatic program changeover button)

The song now playing can be played again from the beginning or the next song can be played again from the beginning.

When listening to the radio (AM/FM):

1. AM/FM changeover

When the changeover button is kept down (—), the radio will receive FM stations.

When the button is raised (■), the radio will receive AM stations.

The button is changed over by simply pressing it.

2. Station selection button

When this button is depressed, the preset station can be heard.

3. Manual turning

The desired station can be selected by turning the turning knob.

4. How to preset a station

- 1) Pull out the button you want to use for the station.
- 2) Turn the turning knob until it is set on the desired station.
- 3) Then push the button back in.



PRECAUTIONS FOR HANDLING THE CAR STEREO

1. When the head gets dirty, clean it with a head cleaning tape.
2. Never touch the head with a magnet, screwdriver, or other hard object.
3. Before using a tape, take up the looseness by lightly turning it outward with a pencil.
4. Store tapes in a case, away from direct sunlight and dust.
5. Do not use C-120 tapes.
6. If the stereo is not going to be used for a long time, take the cassette out of the stereo. Do not leave the cassette in the stereo.
7. This stereo cassette is specified for use at 12V.
Do not remove the converter.



AIR CONDITIONER CONTROL PANEL

① Inside-Outside air selector switch

Use this switch to change over the intake vents when heating or cooling the cab.

- Inside air (RECIRC )
Air is inhaled from inside the cab.
(Generally used for cooling the inside of the cab.)
- Outside air (FRESH )
Air is inhaled from outside the cab.
(Generally used for ventilating and heating the inside of the cab.)

② Vent selector switch

Position of knob	Air outlet	Application
	DEF FOOT (B, C)	Mainly for heating
	FACE FOOT (A, B, C)	Mainly for ventilation
	FACE (A)	Mainly for cooling

● Control panel

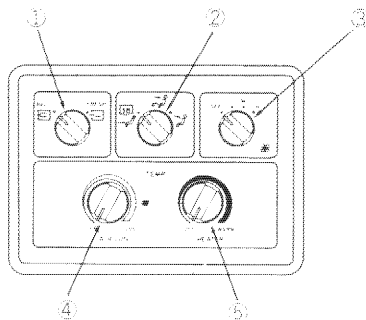

● Vents

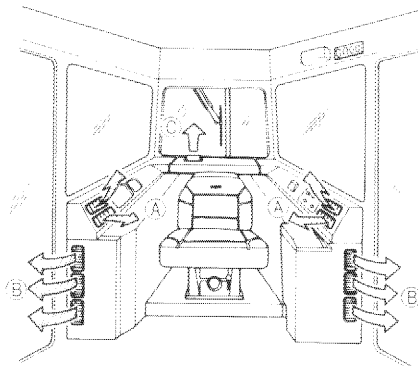

③ Blower switch

This switch is used not only to control the flow of air in cooling and heating, but also as the main switch.

- The air flow is controlled in three ranges, High, Medium, and Low.
- When the switch is turned OFF, the power line is disconnected and the air conditioner stops.

④ Cooler temperature control switch

This switch controls the air temperature in the cooling operation and is also used as the cooler switch.

- The farther this switch is turned clockwise, the lower the temperature of the air coming out of the vent.
- When the switch is OFF, the cooler switch will go off and the cooling function will stop.

⑤ Heater temperature control switch

This switch controls the air temperature in the heating operation.

- The farther this switch is turned clockwise, the higher the temperature of the air coming out of the vent.
- When the switch is in OFF, the water valve will be closed and the heating function will stop.

COOLING OPERATION

● Control switches

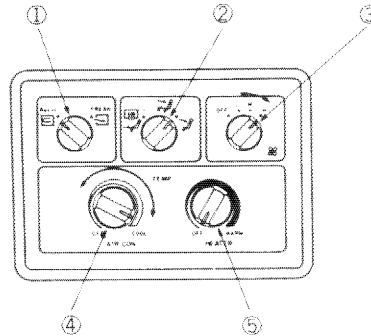

Ordinary cooling

When control switches are used as shown, fresh cool air will be supplied into the cab.

- Set switches ①, ②, and ⑤ in the positions shown.
- Set switches ③ and ④ in the desired positions.

Ventilation and cooling

When the air in the cab gets dirty, move Inside-Outside air changeover switch ② to the outside air (FRESH) position to let outside air into the cab.

The other switches are used in the same manner as in ordinary cooling.

- ★ If ventilation cooling is used for many hours, the cooling effect may not be sufficient. When the cab has been sufficiently ventilated, move Inside-Outside air selector switch ② back to the inside air (RECIRC) position.

HEATING OPERATION

● Control panel

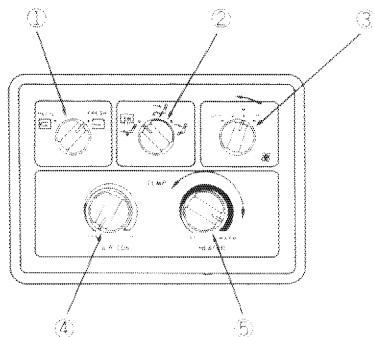

Ordinary heating

When the control switches are used as shown, warm air is supplied into the cab.

- Set switches ①, ②, and ④ in the position shown.
- Set switches ③ and ⑤ in any desired position.

Dehumidifying heating

When cooler temperature control switch ④ is placed in "COOL", dehumidified air will be supplied. The other switches are used in the same manner as in ordinary heating.

- ★ When dehumidifying heating is used when the air in the cab is humid (in spring, autumn, or rainy weather, for example), the cab will be heated comfortably without clouding up the windows.

Precautions for using air conditioner

When cooling, change the air occasionally.

- When smoking and using the cooler, the eyes may begin to hurt.

If this happens, use cooling at "OUTSIDE" for a short time to clear out smoke in the cab.

- When using the air conditioner for a long period, move the knob to RECIRC. + OUTSIDE once every hour to change the air.

When using the cooler, make sure the hot water circuit is completely stopped.

- If hot water is circulating in the heater, it is like having a hot water bottle in the cab. Always make sure the heater temperature switch is at the OFF position.
- When not using the heater for a long period, fully close the hot water outlet and inlet valves at the engine water manifold and the engine oil cooler.

Be careful not to overcool the cab.

- The cab should feel cool when entering there from outside (5°C or 6°C lower than the outside temperature). It is not good for the health to have the temperature in the cab too low. Always give careful consideration to temperature regulation.

INSPECTION AND MAINTENANCE

Clean air filter

If the recirculation air filter or fresh air intake filter become clogged, the cooling or heating capacity will drop.

Clean the air filter with compressed air once a week.

Check tension of compressor belt.

If the belt is loose, it will slip and the air conditioner will not be able to cool properly.

Periodically press the mid-point of the belt with the finger (approx. 10 kg) and check that the deflection is 13 to 17 mm.

When the belt is new, it is particularly liable to stretch, so always adjust it after 2 to 3 days.

Compressor pulley

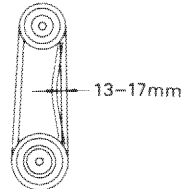

Drive pulley

Check volume of refrigerant (gas)

If there is a lack of refrigerant, the cooling performance will be poor.

When the engine is running at full throttle, and the cooler is running at high speed, check the condition of the refrigerant flowing in the refrigerant circuit by looking at the sight glass (inspection window) in the receiver.

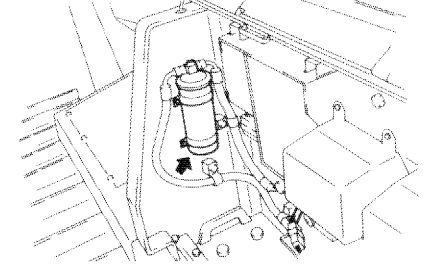

Condition of refrigerant

Sight glass

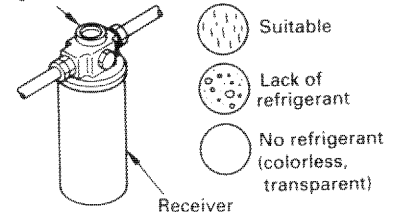

- No bubbles in flowsuitable
- Some bubbles in flow (bubbles pass continuously
.....Lack of refrigerant
- Colorless, transparent
.....No refrigerant
- ★ If there are any bubbles, there is a lack of gas, so have to add refrigerant at a shop.
If the equipment is run when there is lack of gas, it will cause breakage of the compressor.

 **The refrigerant used in the cooler is colorless and odorless, and is harmless when released into the atmosphere. However if it gets in the eyes or on the hands, it will be cause of burn or loss of sight, so never loosen any part of the refrigerant circuit.**

Check during off-season

When the air conditioner is not being used, run the compressor at low speed for a few minutes every week to avoid loss of oil. (Run the engine at low speed with the cooler temperature control switch at LOW COOL.)

- ★ In cold weather, do not run the compressor suddenly at high speed. This may cause failure in the compressor. When the temperature is below 2 to 6.5°C, the low pressure cut-off switch functions to stop the compressor from running even when the cooler temperature control switch is turned on.

OPERATOR'S SEAT

Set operator's seat as follows for maximum comfort.

A: ADJUSTING DIRECTION OF SEAT

If handle (1) is pulled up, the seat can be rotated 15° to right by hand.

B: HEIGHT ADJUSTMENT

To lower seat, turn knob (2) clockwise; to raise, turn counterclockwise. The adjustable amount is 50 mm.

C: FORWARD AND BACKWARD ADJUSTMENT

Set the seat in the desired position by moving lever (3) to left; then release the lever.

The seat can be adjusted forwards or backward 160 mm (in 8 steps).

D: ADJUSTING SEAT ACCORDING TO OPERATOR'S WEIGHT

To obtain the best riding condition, turn knob (4) clockwise for a light operator.

E: TILTING ADJUSTMENT

Set seat in desired position by pulling lever (5) upward, then release lever.

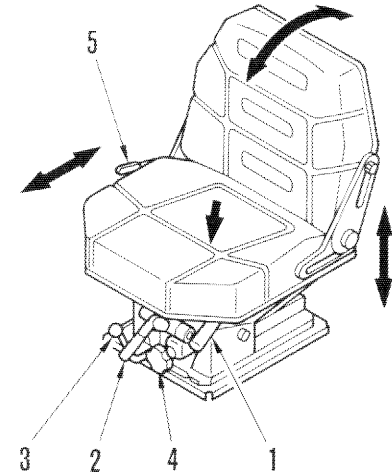

SEAT BELT

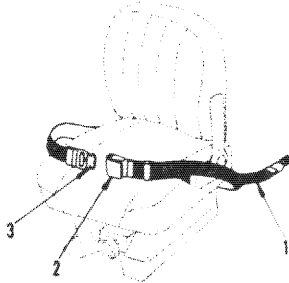

⚠ Before fastening the seat belt, inspect the securing brackets and belt for abnormal conditions.

Fasten the belt and remove it in the following manner.

1. Adjust the seat so that the brake pedal can be depressed all the way with the operator's back against the backrest.
2. After positioning the seat, install the tether belt (1). With the seat unoccupied, tense the belt slightly across the seat and install.

⚠ Check that there are no kinks in the belt.

3. Sit in the seat. Hold buckle (2) and insert (3) into the buckle (2). Check that the belt has locked by pulling it.

4. When removing the belt, raise the tip of the buckle lever to release it.

★ Fasten belt along your body without kinking it. Adjust the lengths of the belt on both the buckle and the insert sides so that the buckle is located at the mid-point of your body front.

Adjust the belt length in the following manner.

- i) To shorten the belt, pull the free end of the belt on either the buckle body or insert side.

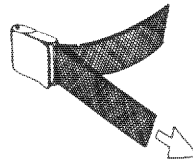

- ii) To lengthen, pull the belt while holding it at a right angle to buckle or insert.

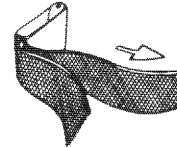

5. When operating a machine equipped with ROPS, be sure to use the seat belt.

★ Inspect bolts and fittings on the chassis for tightness. Retighten any loose bolts to 2 to 3 kgm torque.

★ If the seat belt is scratched or frayed or if any of the fittings are broken or deformed from long service, replace the seat belt immediately.

LOCKING CAP

A locking cap is available as an optional radiator cap, fuel tank cap or hydraulic tank cap. Open and close locking caps as follows:

1. To open the cap

- 1) Insert the key into the cap.

★ Insert the key as far as it will go. If the key is turned before it is inserted all the way, it may break.

- 2) Turn the key counterclockwise and bring the rotor groove in line with the aligning mark on the cap. Turn the cap slowly until a "clicking" sound is made. This releases the lock and allows the cap to be opened.

2. To lock the cap

- 1) Turn the cap into place.
- 2) Turn the key clockwise and take the key out.

★ When the cap is locked (against vandalism), it rotates freely.

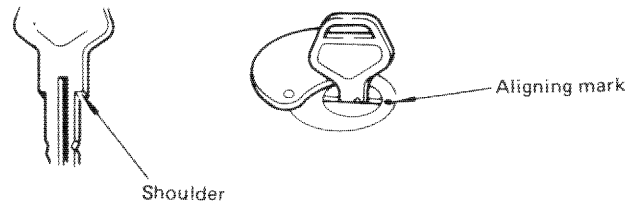
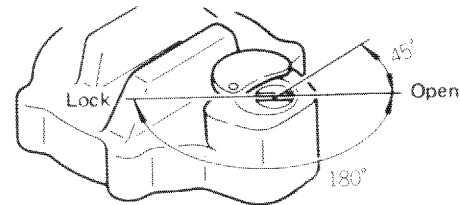

CHECK BEFORE STARTING

Pre-operation checks forestall machine trouble. Never neglect them.

a. WALK-AROUND CHECK

Look around the machine and under the machine to check for loose nut or bolts, collection of dirt, or leakage of oil, fuel, or coolant, and check the condition of the work equipment and hydraulic system. Check also for loose wiring, play, and collection of dust at places which reach high temperatures.

1. Check for oil leak at high pressure hose joints and hydraulic cylinder.
2. Check steering clutch case (incl. transmission, torque converter case) for oil leaks.
3. Check final drive case for oil leaks.
4. Check tightness of track roller support mounting bolt.
5. Check tightness of battery terminal.
6. Check around the engine for water and oil leaks.
7. Check radiator for water leak.

b. CHECK AND REFILL COOLANT

1. Remove radiator cap (1) and check that coolant is above the bottom of strainer as shown below. If necessary, add water.

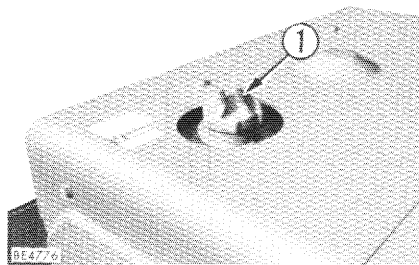
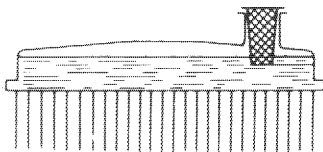

2. To refill the radiator, first stop the engine and pour in water until the water overflows the filler opening. Then, start the engine, check the water level again after a five-minute idling, and add water if necessary.

- ★ If more water than normal is required to fill up to the specified level, coolant is considered to be leaking somewhere. Immediately locate the leak and plug it.
- ★ When checking the coolant level in the radiator, do not depend only on the radiator coolant level monitor.

! Do not remove cap (1) while cooling water is hot. Hot water may spout out.
When removing cap (1), turn it slowly to relieve inner pressure.

c. CHECK OIL LEVEL IN ENGINE OIL PAN

1. Use dipstick (G) to check the oil level.
 2. The oil level should be between mark L and H. If necessary, add oil at oil filler (F).
- ★ The type of lubricant used depends on the ambient temperature. Select according to the table "FUEL, COOLANT AND LUBRICANTS".

- ★ When checking the oil level, park the machine on a level surface, stop the engine and wait for 15 minutes before checking.
- ★ Do not add oil above the H level mark.

- ★ While adding oil, take out the oil level gauge through the gauge guide to bleed the air from the crankcase.
- ★ When checking the engine oil level, do not depend only on the engine oil level monitor.

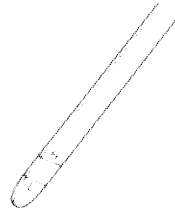
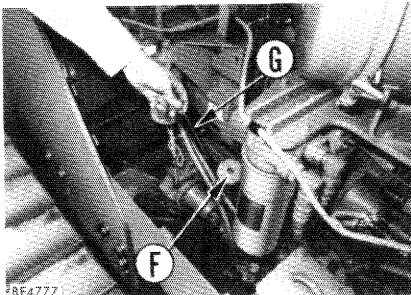

d. CHECK FUEL LEVEL

1. After removing cap, pull out fuel dipstick (G) and check fuel level.
 2. After each operation, fill up the fuel tank through the filler.
- ★ When dozing on a grade, make sure there is plenty of oil in the tank so that the engine fuel line does not become aerated.

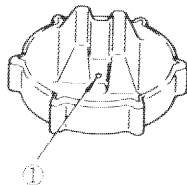

- ★ A clogged cap breather hole (1) may stop the fuel flow to the engine. Check it from time to time and clean.
- ★ Fuel capacity: 480ℓ
- ★ When adding fuel, never let the fuel overflow. This may cause a fire.

e. CHECK OIL LEVEL IN STEERING CLUTCH CASE (INCL. TRANSMISSION AND TORQUE CONVERTER CASE)

Use dipstick (G) to check the oil level. If necessary, add oil at oil filler (F).

- ★ The type of lubricant used depends on the ambient temperature. Select according to the table "FUEL, COOLANT AND LUBRICANTS".
- ★ Stop the engine when checking the oil level.

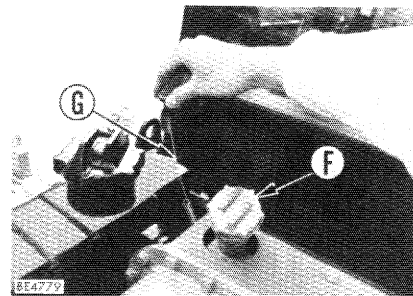
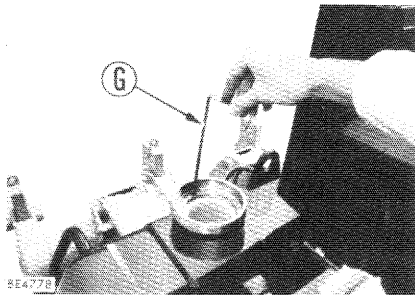

- ★ In case the work is carried out on sloped land of more than 20° declination, supply oil up to H level.

f. FUEL TANK

Loosen valve (1) on the bottom of the tank so that the sediment and mixed water will be drained with fuel.

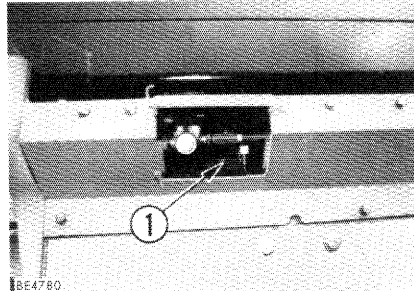

g. CHECK DUST INDICATOR

When the air cleaner element is clogged, the red piston of dust indicator (1) reaches service level and gets locked. In that case, clean the element referring to the section "WHEN REQUIRED".

After cleaning the element, push the button to return the red piston.

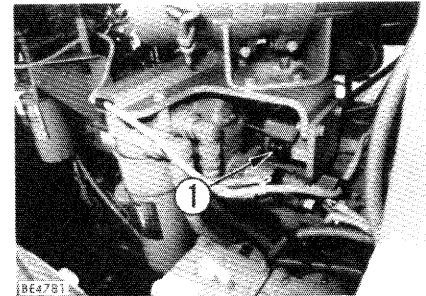

h. CHECK BRAKE PEDAL TRAVEL

The standard travel is 110 to 130 mm while engine idling (Operating force is 15 kg) and approx. 75 mm while engine stopped.

If pedal travel exceeds 190 mm, brake functions inadequately, so adjust it according to the section ADJUSTMENT.

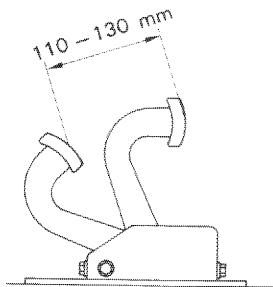

i. CHECK ELECTRICAL WIRING

Check for damage of the fuse and any sign of disconnection or short circuit in the electric wiring. Check also for loose terminals and tighten any loose parts. Check the following points carefully.

- Battery
- Starting motor
- Alternator



If the fuse is damaged or there is any sign of shortcircuiting in the electric wiring, always investigate the cause and correct it.

- ★ Please contact your Komatsu distributor for investigation and correction of the cause.

j. CHECK FOR SEDIMENT AND WATER IN THE WATER SEPARATOR

The water separator separates water mixed in the fuel. If float (2) is at or above red line (1), drain the water. For the draining procedure, see section "WHEN REQUIRED".

- ★ Even if a water separator is installed, be sure to check the fuel tank to remove water and sediment in the fuel.

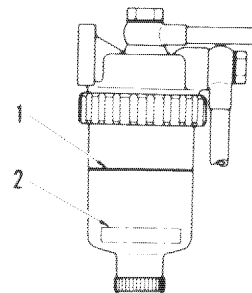

OPERATING YOUR MACHINE

BEFORE STARTING THE ENGINE

- ⚠** Before starting the engine, use a damp cloth to wipe off the dust accumulated on the top surface of the battery.
- ⚠** If the control levers are touched by accident, the work equipment may move suddenly. When leaving the operator's compartment, always set the safety lock securely to the LOCK position.

Before starting the engine, confirm the positions of levers and pedals.

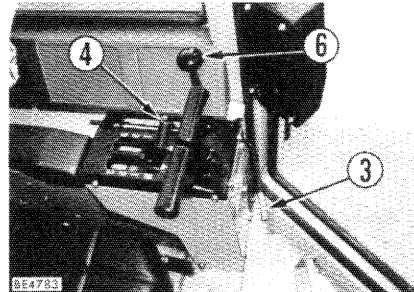
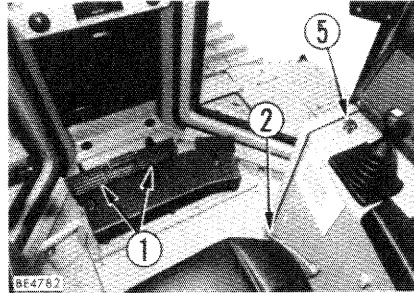

1. Carry out the check before starting items. (For details of the inspection, see "CHECK BEFORE STARTING".
2. Adjust the seat so that brake pedals (1) can be depressed all the way with the operator's back against the backrest.
3. Is brake lock lever (2) in LOCK position?

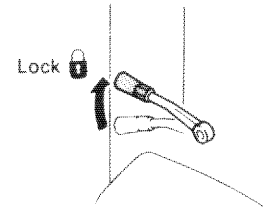

4. Is gear shift lever (4) in N (neutral) position and locked with safety lever (3)?

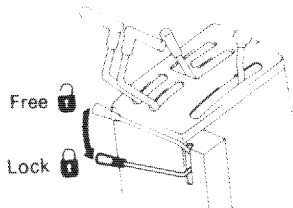

TO START THE ENGINE

Confirm the safety of the surrounding area, then start the engine.

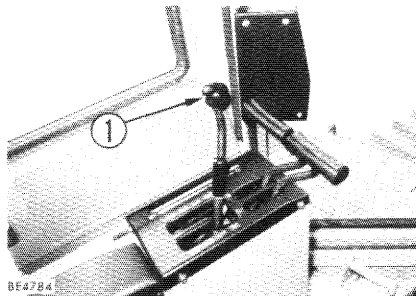

1. Pull fuel control lever (1) to the low idling position.

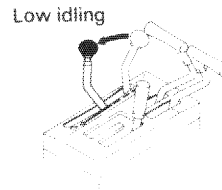

5. Are the blade and the ripper lowered on the ground?
And are safety locks (5) for blade control lever and ripper control lever in LOCK positions?

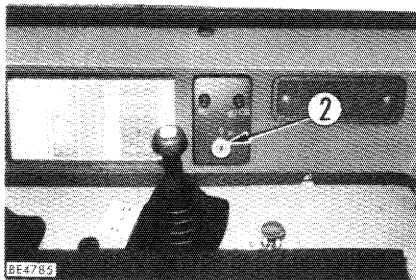
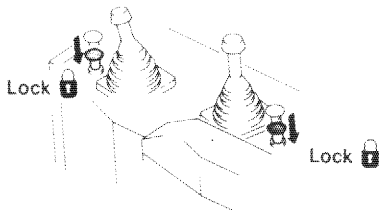

2. Turn starting key (2) to the (START) position.

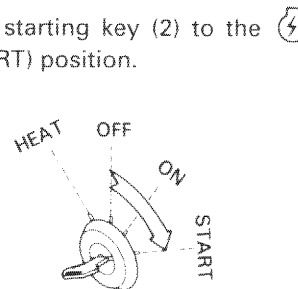

3. When engine is started, release starting key (2) and the key will return automatically to (1) (ON).

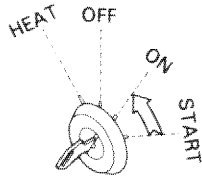

- ★ If engine will not start, repeat the starting procedure after about 2 minutes.
- ★ Do not leave the key in (2) (START) for more than 20 seconds.
- ★ To start engine in cold weather, refer to COLD WEATHER OPERATION.

Special starting

When starting after running out of fuel, fill with fuel, then fill the fuel filter cartridge with fuel and bleed the air from the fuel system before starting.

Refer to FUEL FILTER in EVERY 500 HOURS SERVICE

CHECKS AFTER START-UP

After starting the engine, carry out the following checks prior to machine operation.

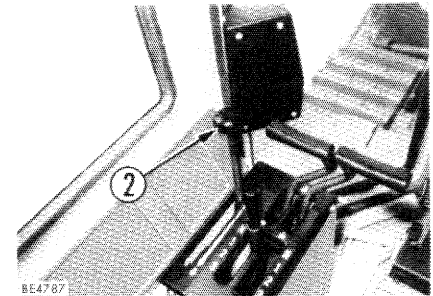
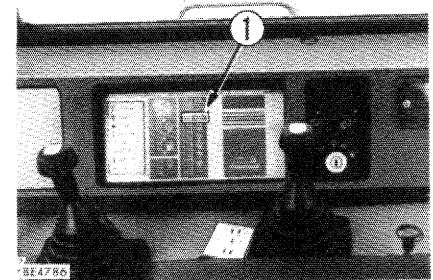

1. Run the engine at low idling speeds and make sure engine oil pressure monitor lamp (1) goes off.
2. Pull fuel control lever (2) and run the engine at medium speed. Then run the engine at no load for about 5 minutes.

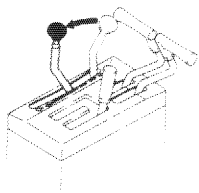

- ★ Do not run the engine at low idling or high idling for more than 20 minutes. If it is necessary to run the engine at idling, apply a load from time to time or raise the engine speed to a midrange speed.

3. After warm-up run is completed, check gauges, monitor lamps for proper operation.
 - ★ Continue to run the engine at light load until the green range of the engine water temperature gauge lights.
4. Check if the exhaust color is normal or whether there is any abnormal noise or vibration.
 - ★ Avoid abruptly accelerating the engine until the completion of warm-up.
 - ★ If the engine oil pressure monitor lamp starts flashing and the buzzer starts sounds intermittently, immediately stop the engine and check for the cause of trouble.

TO MOVE THE MACHINE OFF

Before starting the machine, confirm the safety around the machine, and make a signal.

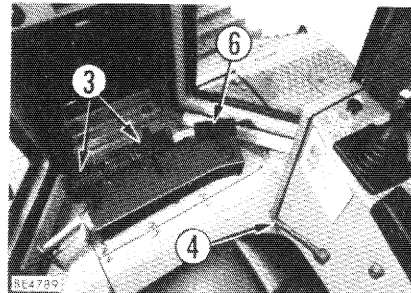
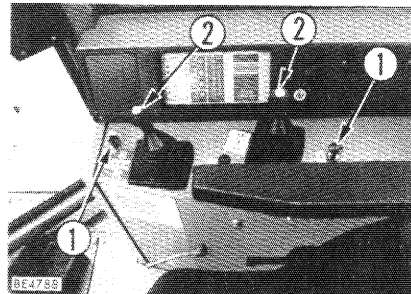

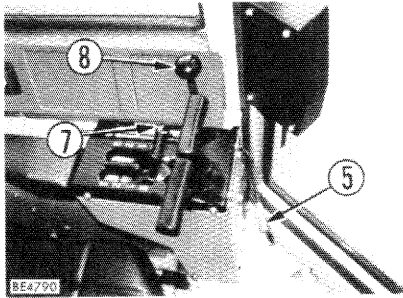

1. Unlock the blade control lever and the ripper control lever with safety locks (1).

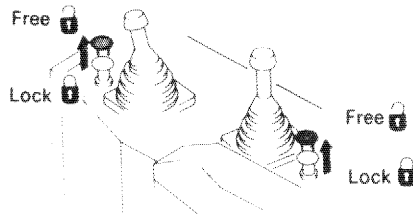

2. Put blade control lever (2) and ripper control lever (2) in RAISE position to raise the blade and ripper 40 to 50 cm off the ground.

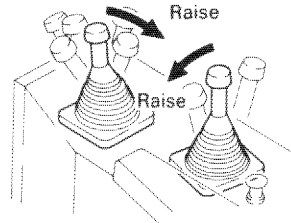

3. Depress intersecting part of both brake pedals (3), place brake lock lever (4) in FREE, and return the brake pedals to home position.

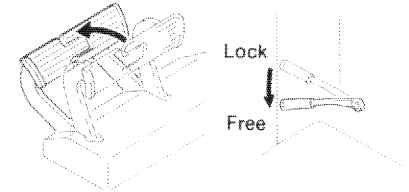

- ⚠** If the machine has to be started on a slope, always unlock brake lock lever (4) and depress the brake pedals continuously.

4. Unlock gear shift lever (7) with safety lever (5).

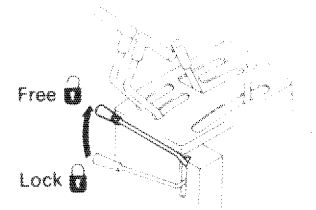

5. Depress decelerator pedal (6) to decrease engine speed so the machine can start off without jerking.



6. Shift gear shift lever (7) in a desired position and start the machine.

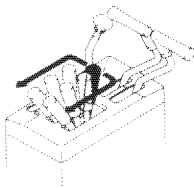

7. Pull fuel control lever (8) to increase engine speed.
★ When the brake pedals are depressed all the way, gradually release them.



⚠ When starting the machine on a steep uphill grade, run the engine at full-throttle and shift the gear shift lever into 1st with brake pedals depressed.

When the machine has started slowly (or track shoes are slipping), propel the machine by slowly releasing brake pedals.

GEAR SHIFTING

There is no need to stop machine to shift gears.

Gears can be shifted into any position by the gear shift lever (1).

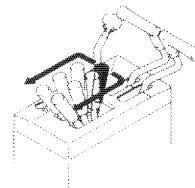
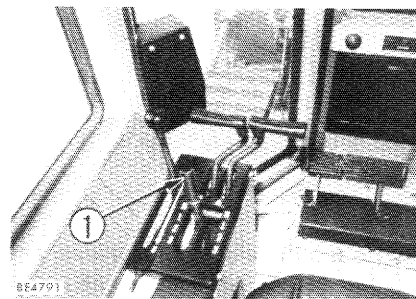

FORWARD-REVERSE SHIFTING

Forward-reverse shifting should be made after reduction of machine speed for safety purpose and preventing shock to machine.

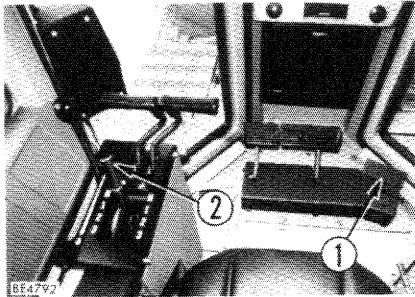

1. Lower the engine speed by depressing decelerator pedal (1).



2. Shift gear shift lever (2) to the desired position.

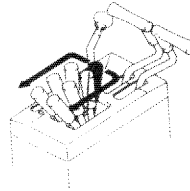

3. Increase engine speed by releasing decelerator pedal (1).



TURNING

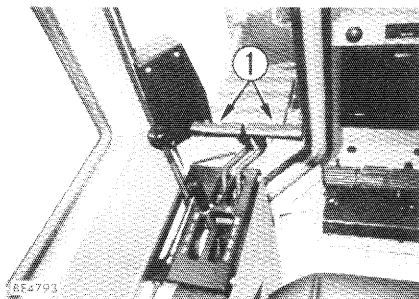

To make a turn while traveling, pull steering lever (1) on the side in which you would like to turn.

- **To make a gradual left turn**

Pull the L.H. steering lever half-way (to the detent). The steering clutch will be disengaged, allowing the machine to make a gradual left turn.

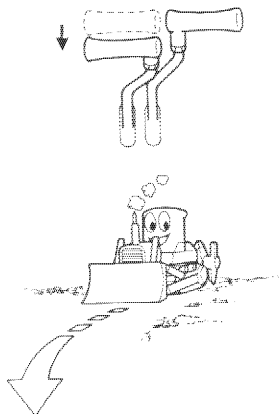

- ★ **To make a gradual right turn, manipulate the R.H. steering lever in the same manner as described above.**

- **To make a pivot left turn**

Pull the L.H. steering lever all the way backward. The steering clutch will be disengaged and the steering brake will be applied.

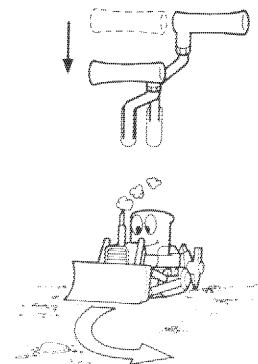

- ★ **To make a pivot right turn, manipulate the R.H. steering lever in the same manner as described above.**

TURNING WHILE DESCENDING A SLOPE

When descending such a sharp slope that the machine will go down of its own weight or when going down a slope with a scraper or the like, you should exercise great care. The machine will turn to the opposite side to that of the pulled lever.

- ⚠** Avoid as much as possible turning the machine on a slope. The machine will tend to slip sideways. Particular care should be taken on soft or clay land.

- **To make a gradual left turn**
Pull the R.H. steering lever half-way to its stroke end. The machine will make a gradual left turn (compensation steering).

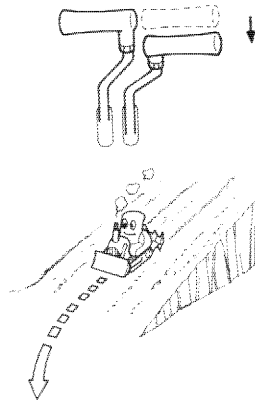

- ★ To make a gradual right turn, manipulate the L.H. steering lever in the same manner as described above.

- **To make a pivot left turn**
Pull the L.H. steering lever all the way backward. Then, the machine will make a pivot left turn (no compensation steering).

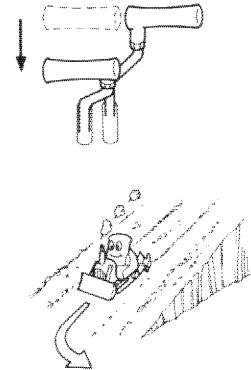

- ★ To make a pivot right turn, manipulate the R.H. steering lever in the same manner as described above.

TO STOP THE MACHINE

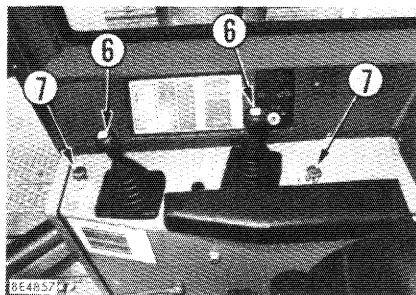
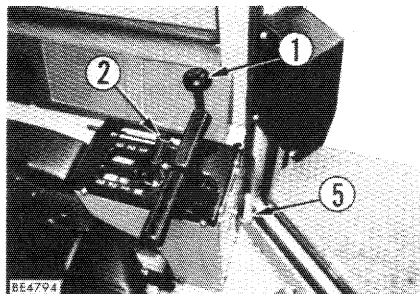

2. Place gear shift lever (2) in N (neutral) position.

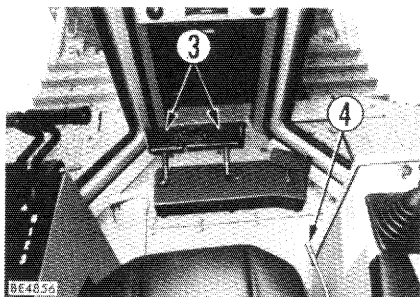
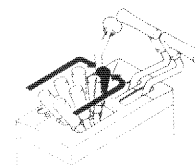

1. Lower engine speed by operating fuel control lever (1).

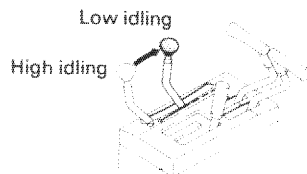

3. Depress intersecting part of both brake pedals (3) to stop the machine and lock the brakes with brake lock lever (4).

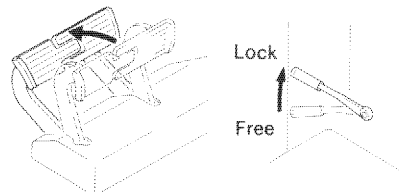

4. Lock gear shift lever (2) with safety lever (5).

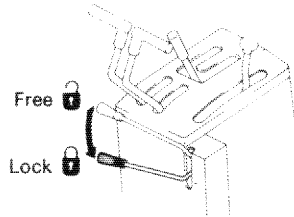

6. Lock blade control lever (6) and ripper control lever (6) with safety locks (7).

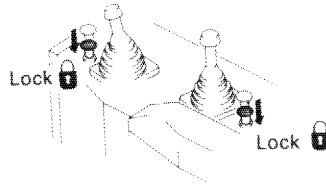

5. Put blade control lever (6) and ripper control lever (6) in LOWER positions to lower blade and ripper to the ground.

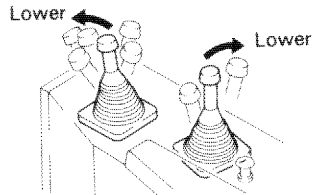

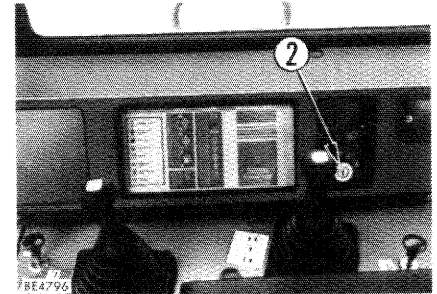
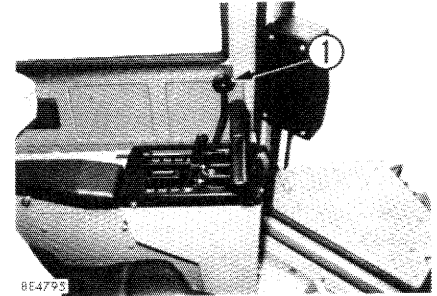

! Always stop the machine on flat, stable ground. Avoid parking in a dangerous place.

TO STOP THE ENGINE

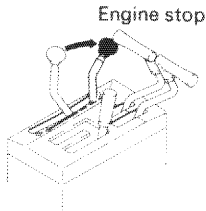

1. Cool the engine by running it at low idling speed for about 5 minutes.
2. Place fuel control lever (1) in engine stop position.



3. Return starting switch key (2) to  (OFF) and remove key.

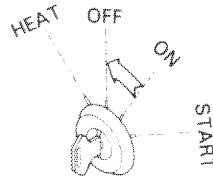

- ★ If engine is stopped abruptly before it cools down, engine life may be greatly shortened.
Never stop engine abruptly except in case of emergency.
- ★ Especially when the engine is overheated, allow the engine to idle without immediate stoppage so that the engine is gradually cooled down to be ready for proper stoppage.

PRECAUTIONS FOR MACHINE OPERATION

PRECAUTIONS DURING OPERATION

Pay attention to gauges

When the red range lights on the power train oil temperature gauge while operating, reduce load and wait for lowering of temperature.

Method of using steering clutch

If the steering clutch one side is used frequently or if many gradual turns are made with steering clutch half-engaged, the steering clutch will wear out in a short time. Design the travel road well and steer the machine properly.

PRECAUTIONS WHEN TRAVELING UP OR DOWN HILLS

Method of using decelerator pedal

When stepping on decelerator pedal while going uphill, climbing ability will be reduced and machine will stop. Furthermore, engine sometimes will stall.

- ★ If the engine stops, the braking effect is reduced, so when using the decelerator pedal, be sure not to make the engine stop. If the decelerator pedal is depressed too much and the machine stops, depress the brake pedal immediately before the engine stops to apply the brake and to hold the machine.

Use engine as a brake

When going downhill, shift gear shift lever into low speed to run engine at slow speed and travel down slope using the engine as a brake.

Braking when traveling downhill

While descending a slope with engine brake, also apply the brakes immediately.

Failure to brake may result in overrunning, causing engine trouble.

Use care, not to shift gears while descending down with a scraper (or the like) mounted, for the engine tends to overrun.

PRECAUTIONS ON SLOPES

Be careful of fuel level

If the fuel level in the fuel tank becomes low when working on slopes, the engine may suck in air because of the angle of the machine or the swaying of the machine. If this makes the engine stop, the braking effect will be reduced, so be careful not to let the fuel level in the fuel tank become too low.

Be careful of oil level

When operating machine on sloped areas of more than 20°, fill every palce with oil to H level.

Precautions when engine stops on slopes

If the engine stops while working or traveling on a hill, immediately depress the brake pedals to bring the machine to a complete stop.

Precautions when making temporary stops

If the machine is stopped on a slope, depress the brake pedal to stop the machine, then lock the brake lock lever securely.

- ★ Never stop the machine on slopes by operating the fuel control lever or the decelerator pedal.

PREMISSIBLE WATER DEPTH

Do not operate machine in such a depth that the center of the idler is submerged. Further, be careful so that the cooling fan will not come in contact with the water.

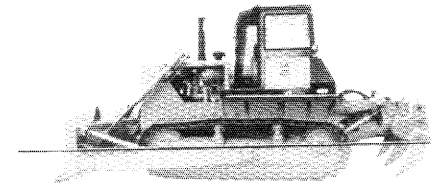

BE4797

COLD WEATHER OPERATION

PREPARATION FOR LOW TEMPERATURE

If the temperature becomes low, it becomes difficult to start the engine, and the coolant may freeze, so do as follows.

FUEL AND LUBRICANTS

Change to fuel and oil with low viscosity for all components.

For details of the specified viscosity, see the TABLE OF FUEL, COOLANT AND LUBRICANTS.

COOLANT

After cleaning inside of the cooling system, add antifreeze to the coolant to prevent the coolant from freezing when the machine is not being used.

★ For details of the antifreeze mixture when changing the coolant, see WHEN REQUIRED.

Care in using Antifreeze

Use a Permanent Antifreeze (ethylene glycol mixed with corrosion inhibitor, antifoam agent, etc.) meeting the standard requirements as shown below. With permanent antifreeze, no change of coolant is required for a year. If it is doubtful that an available antifreeze meets the standard requirements, ask the supplier of that antifreeze for information.

Standard requirements for permanent antifreeze

- SAE J1034
- FEDERAL STANDARD
..... O-A-548D

- ★ Never use methanol, ethanol or propanol based antifreeze.
- ★ Where no permanent antifreeze is available, an ethylene glycol antifreeze without corrosion inhibitor may be used only for the cold season. In this case, clean the cooling system twice a year (in spring and autumn). When refilling the cooling system, add antifreeze in autumn, but do not add any in spring.
- ★ Absolutely avoid using any water leak preventing agent irrespective of whether it is used independently or mixed with an antifreeze.
- ★ Do not mix one antifreeze with a different brand.

 **Antifreeze is flammable, so keep it away from any flame.**

BATTERY

As ambient temperature drops, battery capacity will drop, and electrolyte may sometimes freeze if battery charge is low. Maintain battery at a charge level of approx. 100% and insulate it against cold temperature so that machine can be readily started the next morning.

- ★ Measure specific gravity of fluid and obtain rate of charge from the following conversion table:

Temp. of fluid Rate of charge	20°C	0°C	-10°C	-20°C
100%	1.28	1.29	1.30	1.31
90%	1.26	1.27	1.28	1.29
80%	1.24	1.25	1.26	1.27
75%	1.23	1.24	1.25	1.26

- ★ When electrolyte level is low, add distilled water in the morning before work instead of after the day's work. This is to prevent fluid from freezing at night.

 **To avoid gas explosions, do not bring fire or sparks near the battery.**

 **If the electrolyte gets on your skin or clothes, immediately wash with plenty of clean water.**

TO START THE ENGINE IN COLD WEATHER

Refer to the section ENGINE HANDLING in "OPERATING YOUR MACHINE" for engine starting precautions.

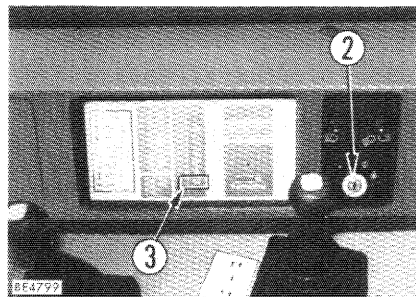
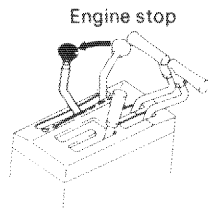
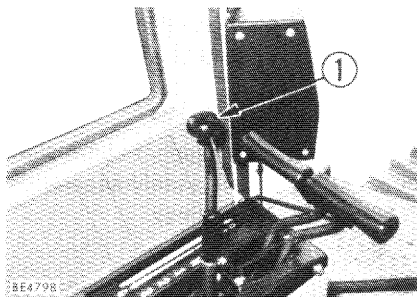

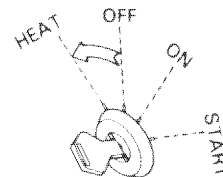

1. Pull fuel control lever (1) a little toward you from low idling position.

2. Turn the starting key (2) to ●(HEAT), and confirm that engine preheating monitor lamp (3) comes on. After about 36 seconds, preheating monitor lamp (3) will flash for about 16 seconds to indicate that preheating is finished.

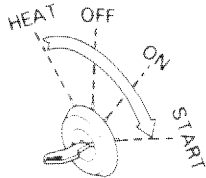

3. After preheating monitor lamp (3) starts to flash, turn the key (2) to  (START) and start the engine.



4. Release the starting key (2), and the key will return automatically to  (ON).

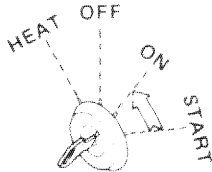

- ★ If the engine does not start up under the above procedure, repeat steps 2 and 3 after waiting for about 2 minutes.

 **Never use starting aid fluids as they may cause explosions.**

CAUTIONS AFTER COMPLETION OF WORK

1. Mud and water on the machine body should be completely removed.

Park the machine on concrete or hard ground. If this is impossible, park the machine on wooden boards. This will prevent the accessories from freezing or the track and undercarriage from freezing to the ground thereby preventing vehicle movement the next morning. Particular attention should be given to water drops collected on the surface of the hydraulic cylinder piston rods. Such droplets must be fully wiped off because if water is frozen to the rod when the cylinder is utilized, the cylinder oil seals may be damaged.

2. Drain water collected in fuel system so that such water may be frozen at night.
3. As battery capacity drops at low ambient temperature, cover the battery or remove it from the machine to be kept warm at night.

AFTER COLD WEATHER

When weather becomes warm, perform the following without fail:

- Replace lubricating oils for various units with the ones specified for warm-weather use.
- If for any reason permanent antifreeze cannot be used, and an ethyl glycol base antifreeze (winter, one season type) is used instead, or if no antifreeze is used, drain the cooling system completely, then clean out the inside of the cooling system thoroughly, and fill with fresh water.

BULLDOZER'S WORK

In addition to the cases given below, the range of uses can be further increased by using various attachments.

DOZING

A bulldozer digs and transports dirt in a forward direction. Slope excavation can always be most effectively carried out by proceeding from the top downward.

When dozing toward one side only, operate with angled blade (angledozer only).

LEVELING

When giving a smooth finish to a surface that has been excavated or made from piled soil, push a full blade of soil and drive forward while operating the blade up and down in small movements. Finally set the blade at FLOAT, and drive at low speed in reverse, dragging the blade across the surface. When doing this, to protect the blade, be careful not to drive over stones or rocks.

CUTTING INTO HARD OR FROZEN GROUND OR DITCHING

For digging and ditch excavation of hard or frozen ground, tilt the blade. Even hard ground can be dug effectively by a tilted or angled blade. If the ground is harder, use a ripper attachment for better efficiency.

FELLING AND UPROOTING

A tree, 10 to 30 cm in diameter, can be felled by giving 2 or 3 pushes with the blade held off the ground. Next back the machine and lower the blade to cut into the earth. Break the roots and push them forward while digging.

Never allow the machine to butt against, or give strong impact to a tree by operating at high speeds.

 **Do not perform severe operations such as uprooting by angling or tilting the blade.**

HOW TO REVERSE THE REVERSIBLE FAN

1. Insert the groove at the end of tool (175-900-3910) into the fan blade (1) and rotate the handle of the tool by pushing it in the direction of fan center. The fan blade can be reversed freely.

★ According to the procedure below, reverse the six fan blades and rotate the fan.

a. Rotate the fan by using the starting motor.

b. Loosen the nut tensing the tension pulley to loosen the belt (but do not remove it). Rotate the fan by hand.

★ After reversing all the blades, tighten and adjust the nut (For adjustment, refer to ADJUSTMENT OF FAN BELT).

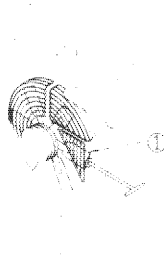

2. How to decide whether to set blades in pushing direction or sucking direction.

When the temperature is below -30°C , set the blades in the sucking direction to improve the heating and keep the battery warm. (Fig. 1)

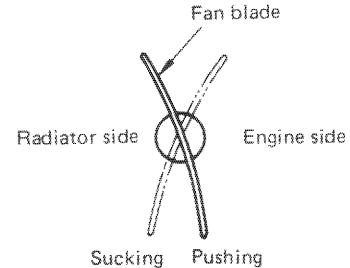

Fig. 1

3. The tool is inserted through the hole for reversing on the left side of the radiator guard. If it contacts the blade cylinder, move the bolt to lengthen the tool as shown in Fig. 2.

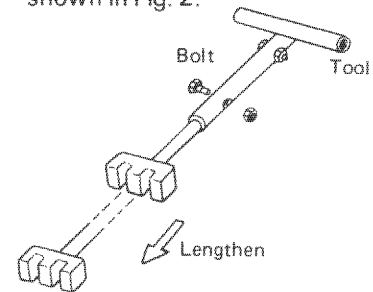

Fig. 2

BLADE ADJUSTMENT

ANGLEDOZER TILTING OF BLADE

Raise the blade 300 to 400 mm off the ground and apply block to the frame.

Loosen set bolt (1) and insert a bar handle into hole (2) in the brace. Turn the brace on one side of the machine in either direction to shorten or lengthen the brace and turn the brace on the opposite side of the machine in the reverse direction. After tilting the blade to any desired height, securely tighten set bolt (1) on each brace.

★ Maximum amount of tilting is 500 mm.

★ The length of brace (ℓ) is normally 1338 mm and the blade can be tilted within a range of 500 mm.

Do not attempt to tilt the blade over 500 mm to prevent arising of an undue condition.

★ When turning brace by using the adjustment rod, keep blade off the ground and tilt it (as required).

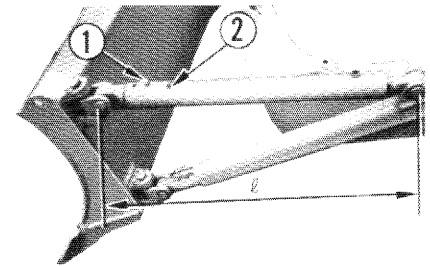
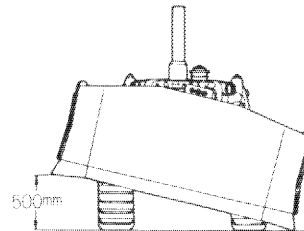

BF4210

ANGLING OF BLADE

Angle of 25° is provided on both sides of the blade.

1. Raise the blade 300 to 400 mm off the ground and apply block to the frame.

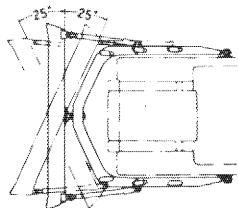

2. Pull out pins (1) on both sides and remove arm (2) from frame.
3. To angle the blade, fit arm (2) to the desired bracket (three brackets for each side of the machine) and lock with pin (1).

⚠ Take care that blade can move freely after removing arm (2).

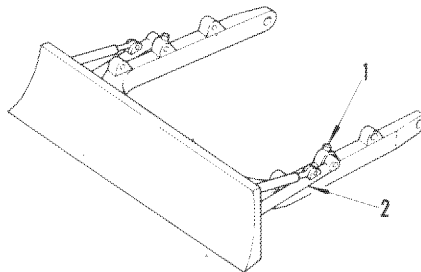

SHIM ADJUSTMENT

Set the standard shim adjustment in the blade cylinder cap to 4 mm.

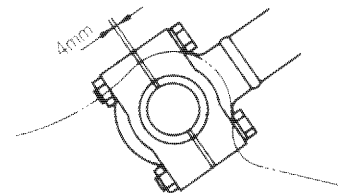

Remove shims to balance the wear of the cap and the ball at the end of the piston rod. The proper clearance to be maintained with the shims is 0.2 to 0.6 mm.

TILTDOZER TILTING OF BLADE

Tilting up to about 425 mm is possible by simply operating the blade control lever, but if required, further tilting up to 500 mm is also possible by changing the length of left brace (1).

- ★ The length of brace (1) is normally 1287 mm and the blade can be tilted within a range of 500 mm. Do not attempt to tilt the blade over 500 mm to prevent arising of an undue condition.

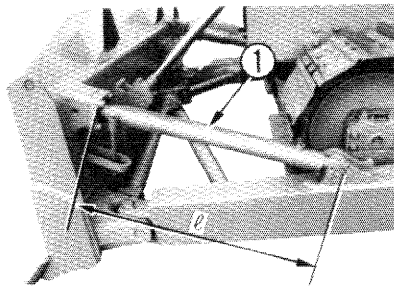

8E4800

SHIM ADJUSTMENT

Adjust the thickness of shim so that the ball joint play in the axial direction (shown by the arrow) does not exceed 1 mm.

1. Remove shim (1) and tighten bolts (2) to eliminate the ball joint play.
 2. Measure clearance (A) and remove bolts (2).
 3. Install shim (1) having its thickness of $(A + 1)$ mm in place with bolts (2).
- ★ Confirm that ball joint can move smoothly after tightening bolts.

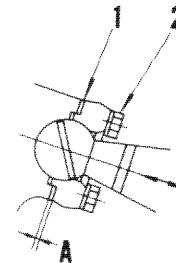
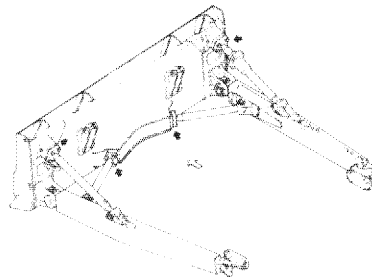

REVERSING OF CUTTING EDGE AND REPLACEMENT OF END BIT

Reverse the cutting edge before it is worn out to the blade end. If, due to neglect to reverse or replace, it has been worn out up to the fitting surface, repair the fitting surface and then reverse or replace.

METHOD OF REVERSING AND REPLACEMENT

1. Raise the blade to a proper height and apply a block to the frame so as to prevent fall of the blade.
2. Remove the cutting edge and the end bit and clean the mounting surface.
3. Reverse the cutting edge when worn out.
 - ★ If the cutting edges on both sides are worn out, replace with new one.
4. When the end bit worn out, replace with new one.
 - ★ Nut tightening torque:
 64 ± 8 kgm
 - ★ After several hours of running, retighten the nuts.

TIPS FOR LONGER UNDERCARRIAGE LIFE

Undercarriage life greatly varies depending on operation method, inspection and maintenance. For most efficient operation, keep the following point in mind.

OPERATION METHOD

- Select the track shoe that best suits the type of soil to be encountered in service.
- Do not allow shoe slipping to occur during operation. If shoe slipping occurs, reduce load until slipping stops.
- Avoid sudden starts, acceleration or stops, unnecessarily high speeds and sharp turns.
- Always operate machine in a straight line whenever possible. When making turns, be careful not to allow the machine to stay to one side, so operation in both turning directions can be done properly. Make turns with the largest possible radius.
- Prior to operation, clear boulders and obstacles to prevent machine from riding over them while operating.
- On a slope, operate the machine parallel to the inclination of the slope. Do not operate across the slope. Also when on a slope, the machine should face toward the top of the slope.
- When ground inclines to left or right during digging operation, do not continue to dig with machine inclined. Move machine back to level ground and start to dig again.
- When idlers or sprockets are lifted due to obstacles during dozing and ripping, do not attempt to force the machine to perform. Because work at this time exceeds machine working capability.

PERIODIC MAINTENANCE

Proper lubrication and maintenance assure trouble-free operation and long machine life. Time and money spent for scheduled periodic maintenance will be amply compensated by prolonged machine operation and reduced operating cost.

All hourly figures given in the following descriptions are based on service meter readings. In practice, however, it is recommended to rearrange all of them into units of days, weeks and months to make the maintenance schedule more convenient. Under rough job site or operating conditions, it is necessary to somewhat shorten the maintenance intervals stated in this manual.

MAINTENANCE TABLE

No.	ITEM	SERVICE	PAGE
CHECK BEFORE STARTING			
a	Walk-around check		36
b	Coolant	Check and supply	36
c	Engine oil pan	Check and supply	37
d	Fuel	Check and supply	38
e	Steering clutch case (incl. transmission, torque converter case)	Check and supply	38
f	Fuel tank	Drain water and sediment	39
g	Dust indicator	Check	39
h	Brake pedal	Check travel	40
i	Electric wiring	Check	40
j	Water separator	Inspect float position	40

No.	ITEM	SERVICE	PAGE
EVERY 250 HOURS SERVICE			
(The Items marked * are carried out after the first 250 hours only for new machines.)			
*	Fuel filter	Replace cartridge	72
*	Steering clutch case (incl. transmission, torque converter case)	Change oil and clean strainer	72
*	Hydraulic tank and filter	Change oil and replace element	72
*	Final drive case	Change oil	72
*	Engine valve clearance	Check and adjust	72
a	Lubricating		72
-1	Fan pulley	Lubricate 1 point	72
-2	Tension pulley	Lubricate 1 point	72
-3	Brace screw	Lubricate 1 point (for tiltdozer)	73
		Lubricate 2 points (for angledozer)	73
-4	Cylinder support shaft	Lubricate 2 points	73
-5	Cylinder support yoke	Lubricate 4 points	74
-6	Tilt cylinder ball joint	Lubricate 1 point (for tiltdozer only)	74

No.	ITEM	SERVICE	PAGE
-7	Brace ball joint	Lubricate 1 point (for tiltdozer only)	74
-8	Arm ball joint	Lubricate 3 points (for tiltdozer only)	74
-9	Oblique arm ball joint	Lubricate 2 points (for tiltdozer only)	74
b	Engine oil pan and filter	Change oil and replace cartridge	75
c	Transmission oil filter and steering clutch oil filter	Replace element	76
d	Final drive case	Check and supply	77
e	Hydraulic tank	Check and supply	77
f	Fuel filter	Drain water and sediment	78
g	Alternator drive belt	Check tension	78
h	Battery electrolyte	Check	79
i	Fuel tank bottom strainer	Clean	79

No.	ITEM	SERVICE	PAGE
EVERY 500 HOURS SERVICE			
a	Fuel filter	Replace cartridge	80
b	Breather	Clean	81
c	Fan belt	Check	81
EVERY 1000 HOURS SERVICE			
a	Lubricating		82
-1	Universal joint	Lubricate 8 points	82
-2	Diagonal brace	Lubricate 2 points	82
-3	Idler adjusting rod	Lubricate 2 points	82
b	Radiator fin	Check and clean	82
c	Steering clutch case (incl. transmission and torque converter case)	Change oil and clean strainer	83
d	Final drive case	Change oil	84
e	Hydraulic tank and filter	Change oil and replace element	85
f	Undercarriage components	Check lubricating condition	86
g	Turbocharger clamping joint	Check and retighten	86

OIL FILLER AND LEVEL GAUGE POSITIONS

1. Cooling water inlet
2. Engine oil pan level gauge
3. Engine oil pan oil filler
4. Transmission case drain plug
5. Engine oil pan drain valve
6. Final drive case oil filler
7. Fuel tank drain valve
8. Fuel tank oil filler
9. Steering clutch case oil filler
10. Hydraulic tank oil filler
11. Hydraulic tank level gauge
12. Cooling water drain valve
13. Hydraulic tank drain valve
14. Steering clutch case drain plug
15. Final drive case drain plug

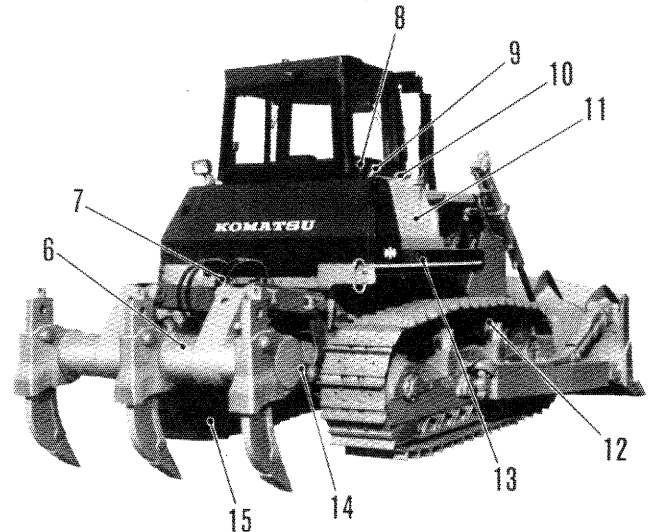
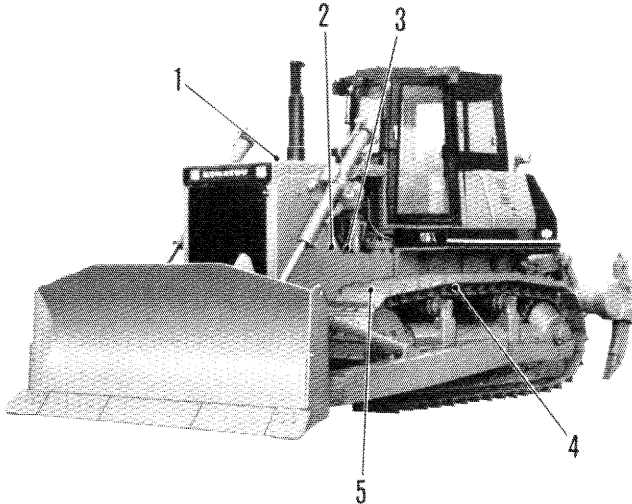

EVERY 250 HOURS SERVICE

Carry out the following mainnance only after the first 250 hours.

- FUEL FILTER, REPLACE CARTRIDGE
- STEERING CLUTCH CASE (INCL. TRANSMISSION AND TORQUE CONVERTER CASE), CHANGE OIL AND CLEAN STRAINER
- HYDRAULIC TANK AND FILTER, CHANGE OIL AND REPLACE ELEMENT
- FINAL DRIVE CASE, CHANGE OIL
- ENGINE VALVE CLEARANCE, CHECK AND ADJUST

For details of the method of replacing or maintaining, see the section on EVERY 500 HOURS, 1000 HOURS AND 2000 HOURS SERVICE.

a. LUBRICATING

Apply grease to the grease fittings shown by arrows.

1. Fan pulley(1 point)

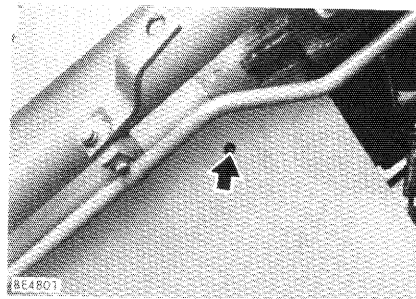

2. Tension pulley (1 point)

Replenish grease till it flows out of relief valve.

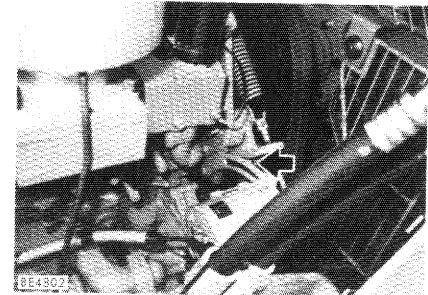

3. Brace screw
(Tiltadozer) (1 point)

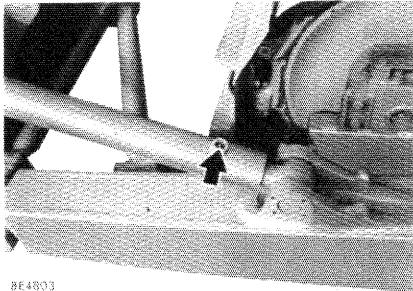

(Angledozer) (2 points)

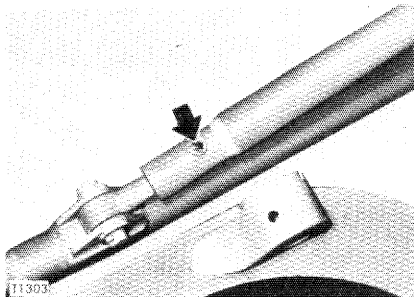

4. Cylinder support shaft (2 points)
(D85A, E)

Replenish grease till it flows out of valve (1) and the rotating section.

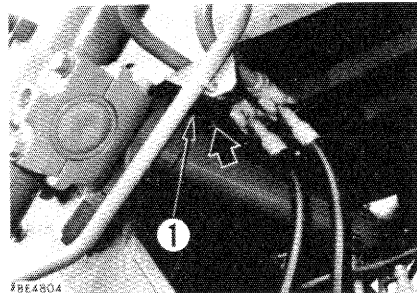

(D85P)

Replenish grease till it flows out the dust seal of the rotating section.

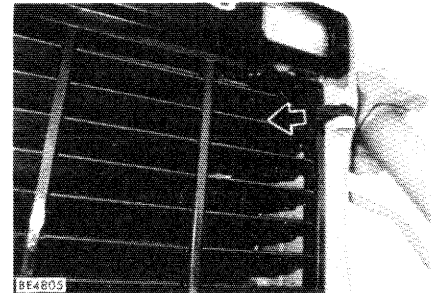

5. Cylinder support yoke (4 points)

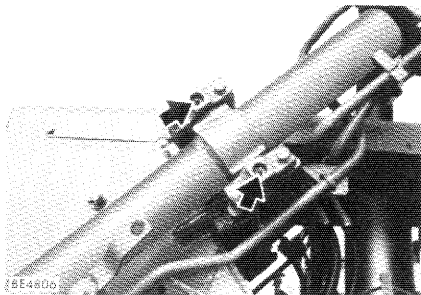

6. Tilt cylinder ball joint (1 point)
(Tiltdozer)

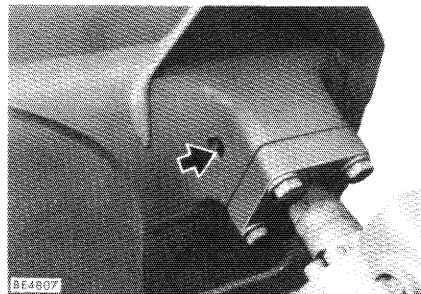

7. Brace ball joint (1 point)
(Tiltdozer)

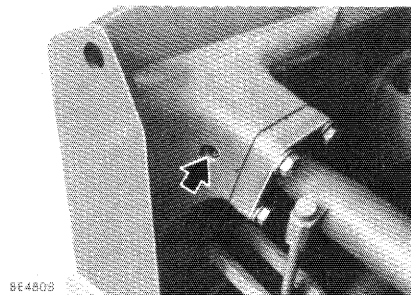

8. Arm ball joint (3 points)
(Tiltdozer)

9. Oblique arm ball joint (2 points)
(Tiltdozer)

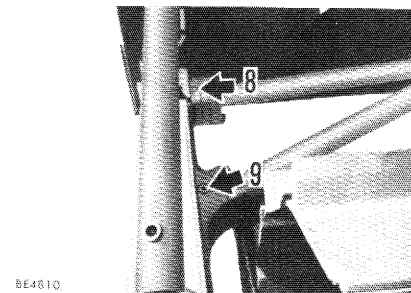
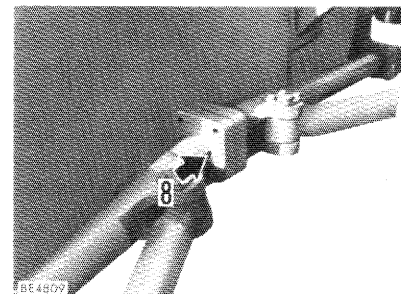

b. ENGINE OIL PAN AND FILTER

1. Remove the cover mounted under machine body.
2. Remove drain plug (1) and loosen drain valve (2). Tighten drain valve (2) and plug (1) after draining oil.
3. Using a filter wrench, remove cartridge (3) of the engine oil filter by turning it counterclockwise.

5. After replacing the cartridge, fill engine oil through oil filler (F). Then idle the engine for a while, and recheck oil level.

★ Refill capacity: 24 ℓ

★ The type of lubricant used depends on the ambient temperature. Select according to the table "FUEL, COOLANT AND LUBRICANTS".

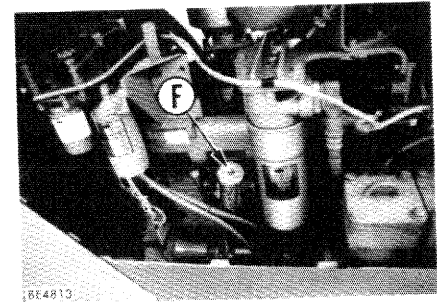
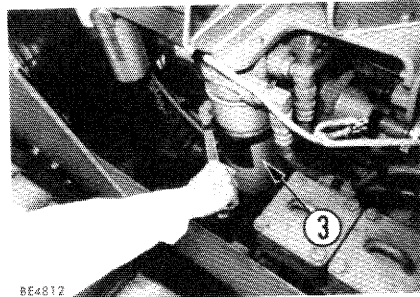
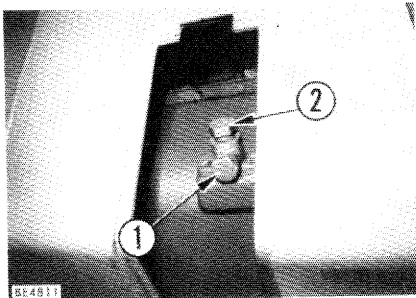

- ★ Use a genuine Komatsu cartridge.
- ★ Change the engine oil every 6 months regardless of service hours.
- ★ Take care not to rotate drain valve (2) so much that the stopper pin in the valve is distorted.
- ★ Tightening torque
 - drain plug (1): 7 ± 1 kgm
 - drain valve (2): 6.5 ± 1.5 kgm
- ★ Before installing a filter cartridge, be sure to fill the cartridge with engine oil.

c. TRANSMISSION OIL FILTER AND STEERING CLUTCH OIL FILTER

1. When bolt (1) is removed and cover (2) is lifted up, the elements and valve can be taken out together with cover (2).

2. Remove wing nuts (4) which are tightening the valve. Take elements (3) out of the filter. Clean the inside of the case and the removed parts, and install new elements in the filter.

- ★ Be sure to use a genuine Komatsu element.

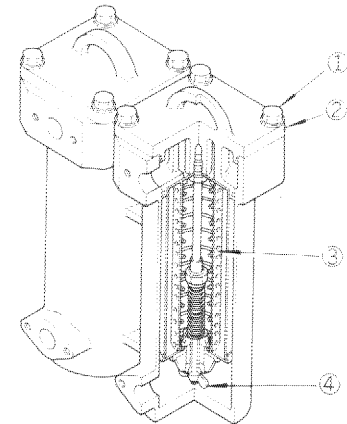
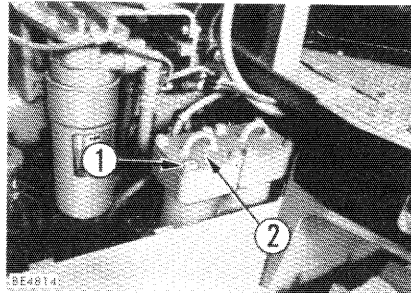

d. FINAL DRIVE CASE

Remove plug (G) and when it is found that the oil is not filled nearly to the lower edge of the plug hole, add engine oil through the plug hole.

- ★ The type of lubricant used depends on the ambient temperature. Select according to the table "FUEL, COOLANT AND LUBRICANTS".
- ★ The maintenance should be made placing the machine on a horizontal plane.

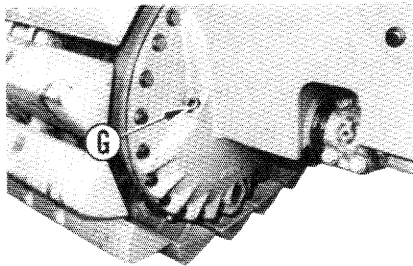

BE4815

e. HYDRAULIC TANK

Lower blade to ground in horizontal position, lower the ripper vertically, put the tip of the shank in contact with the ground, stop the engine and wait for about 5 minutes before checking oil level. If oil level is not between top and bottom of red circle in sight gauge (G), refill tank with engine oil through oil filler (F).

⚠ When oil temperature is high, do not remove the cap. Hot oil sometimes spouts out. When removing the cap, turn it slowly to relieve inner pressure.

- ★ The type of lubricant used depends on the ambient temperature. Select according to the table "FUEL, COOLANT AND LUBRICANTS".
- ★ Conduct the usual inspections required before starting the engine.

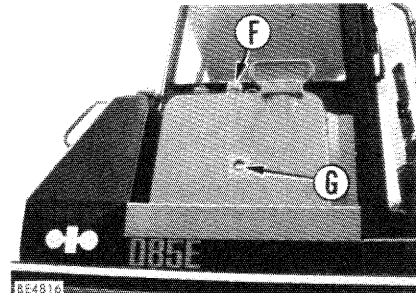

BE4816

f. FUEL FILTER

Loosen the air bleeding plug and remove the drain plug on the bottom of the filter to drain water and sediment accumulated on the bottom of the fuel filter.

After draining, move the feed pump up and down to bleed air. When no air bubbles come out of the air bleeding plug hole, tighten the plug.

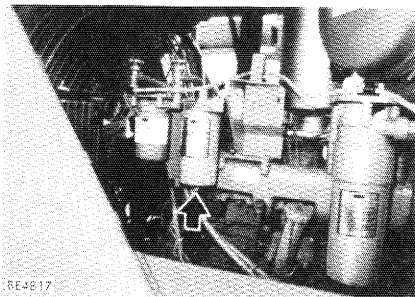

BE4817

g. ALTERNATOR DRIVE BELT

Push the belt at the middle between the crankshaft pulley and the alternator pulley (Approx. 6 kg). If the belt slack is about 10 mm, the belt is considered to have the correct tension.

To adjust, loosen bolt (1) and nut (2) to shift alternator (3).

★ When adjusting the V-belt, do not attempt to push alternator (3) directly with a bar or the like, but use a wood pad to prevent damage to the core.

Alternator pulley

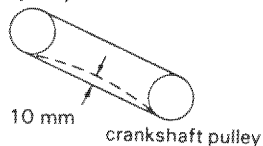

10 mm

crankshaft pulley

- ★ Check each pulley for damage, and V-grooves and V-belt for wear. Particularly, check whether V-belt is in contact with bottom of V-groove through wear.
- ★ Replace belt if it has stretched, leaving no allowance for adjustment, or if there is a cut or crack on belt.
- ★ When the belt is replaced, readjust its tension after running for an hour.

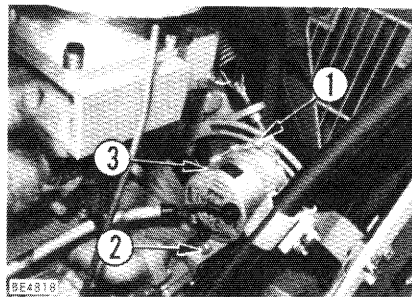

BE4318

h. BATTERY ELECTROLYTE

Add distilled water if battery fluid level is below prescribed level (10 to 12 mm above plates). If electrolyte has been reduced by spilling, have a battery service shop fill battery with dilute sulfuric acid of same strength.

Clean air vent of battery cap when checking fluid level.

★ Do not use metallic funnel for adding fluid.

⚠ To avoid gas explosions, do not bring fire or sparks near the battery.

⚠ If the electrolyte gets on your skin or clothes, immediately wash with plenty of clean water.

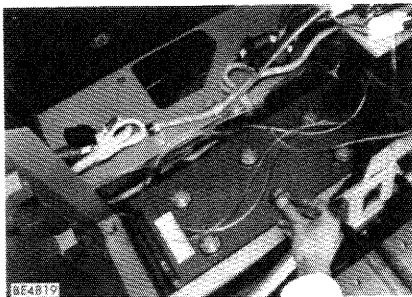

i. FUEL TANK BOTTOM STRAINER

Tighten valve (1) and take strainer out from case removing cap (2).

Clean strainer and strainer case.

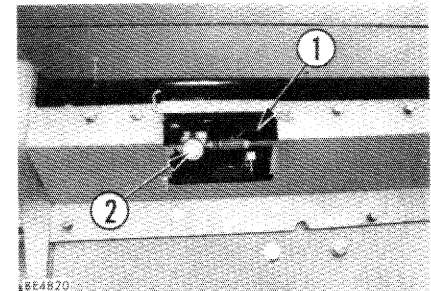

EVERY 500 HOURS SERVICE

a. FUEL FILTER

1. Remove drain plug (P) on the bottom of the filter to drain fuel.
2. Using a filter wrench, remove cartridge (1) by turning it counterclockwise.
3. Fill the new cartridge with fuel and refit it after applying a dab of oil to the gasket face.

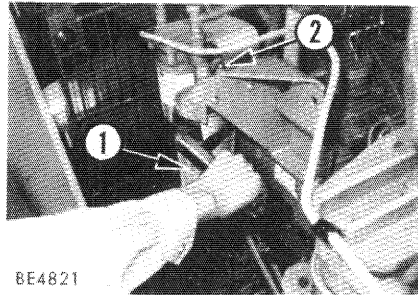

4. After replacing the cartridge, loosen air bleed plug (2).
 5. Loosen the knob of feed pump (3) and move the pump up and down to draw off fuel until air ceases to come out of plug (2).
- ★ To refit the cartridge, place the gasket face in contact with the seal face of the filter stand, then screw up the cartridge 1/2 to 3/4 of a turn.

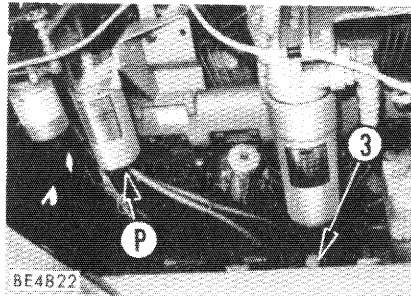

★ Maintenance for every 250 hours should be carried out at the same time.

6. Tighten air vent plug (2), push feed pump knob (3) into place, and tighten it.
- ★ When draining fuel, use a vessel to prevent the oil from spilling.
- ★ After replacing the cartridge, start up the engine and check the filter seal face for possible oil leakage.
- ★ Be sure to use a genuine Komatsu cartridge.

b. BREATHERS

Remove the breather and wash out dust remaining inside with diesel fuel oil.

Steering clutch case (1 point)

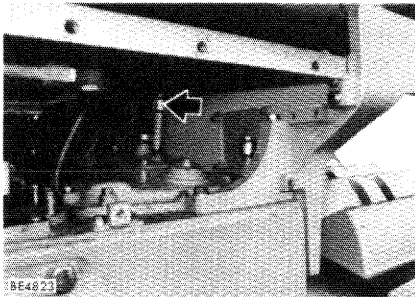

Final drive case (2 points)

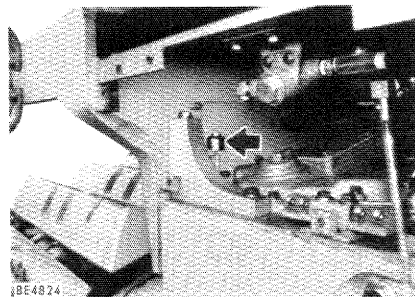

c. FAN BELT

Check the V-belt and when the following conditions exist, exchange the V-belt:

- When the V-belt makes contact with the bottom of the groove in each pulley.
- When the V-belt is worn, and its surface is lower than the outer diameter of the pulley.
- When cracking and peeling of the V-belt occurs.
- ★ For details of the replacement procedure, refer to ADJUSTMENT OF FAN BELT.
- ★ An auto tension is installed, so it is unnecessary to adjust the fan belt.

EVERY 1000 HOURS SERVICE

a. LUBRICATING

Apply grease to grease fittings shown by arrows.

1. Universal joint (8 points)

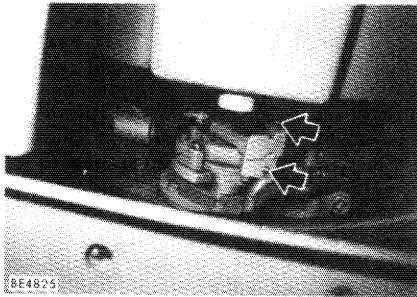

2. Diagonal brace (2 points)

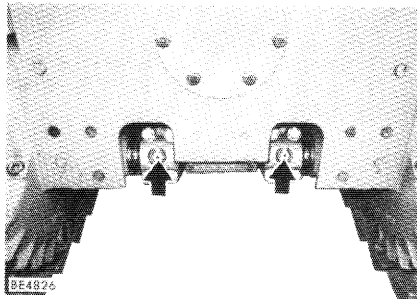

3. Idler adjusting rod (2 points)

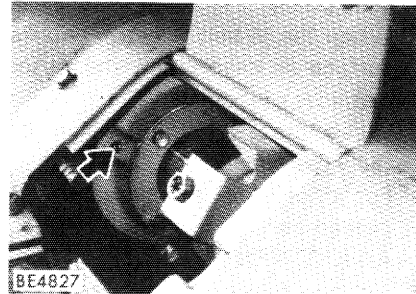

★ Maintenance for every 250 and 500 hours should be carried out at the same time.

b. RADIATOR FINS

Loosen the bolts to open radiator grille (1).

Mud, dust, or leaves blocking the fin shall be blown off by compressed air.

Seam or water may also be employed instead of compressed air.

★ Check the rubber hose on this occasion and replace hose that is cracked or fragile. Further, also inspect loosened hose clamps.

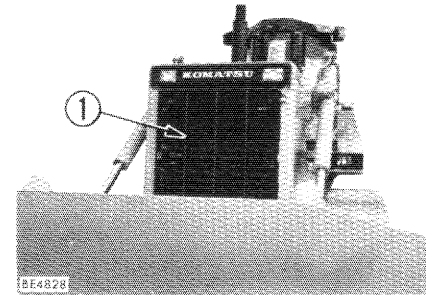

**c. STEERING CLUTCH CASE
(INCL. TRANSMISSION AND
TORQUE CONVERTER CASE)**

1. Remove drain plug (1) under machine body to drain oil.

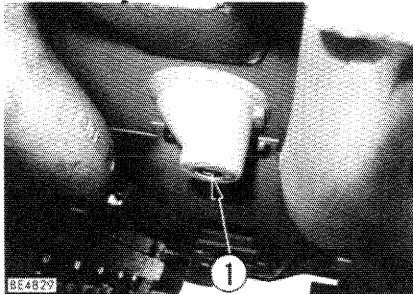

2. Remove the cover and drain plug (2) under machine body to drain oil.

After draining retighten drain plugs (1) and (2).

3. Remove left floor plate, bolt (3) cover (4), steering clutch case strainer (5) and magnet (6).

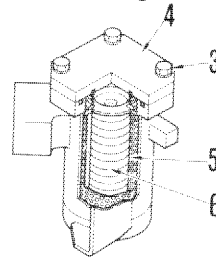

4. Loosen bolt (7) and remove strainer of torque converter together with cover (8).

5. After cleaning the inside of the case, strainer and other parts removed, re-install them in position. If the strainer has been broken, replace it with a new one.

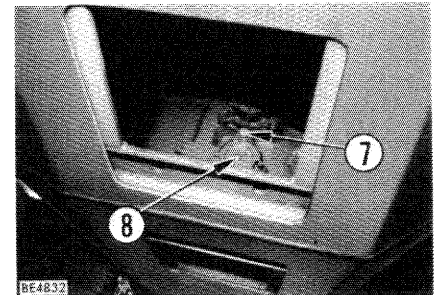
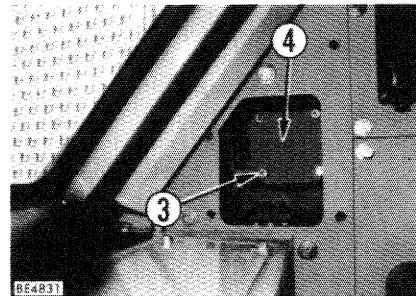
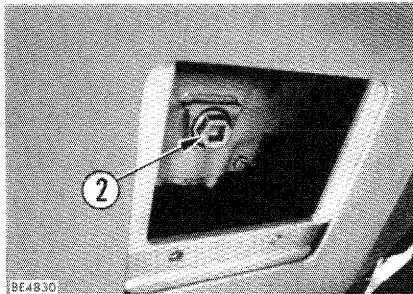

EVERY 1000 HOURS SERVICE

6. After replacement of transmission and steering clutch oil filter element (refer to EVERY 250 HOURS SERVICE), supply the specified amount of engine oil through oil filler (F).

★ Refill capacity: 90 ℓ

★ The type of lubricant used depends on the ambient temperature. Select according to the table "FUEL, COOLANT AND LUBRICANTS".

d. FINAL DRIVE CASE

1. Remove oil filling plug (G) from both sides of machine. Then, remove drain plug (P) to drain oil. After draining, tighten plug (P).
2. Refill prescribed quantity of engine oil through respective oil filling plug (G). (refer to EVERY 250 HOURS SERVICE.)

★ The type of lubricant used depends on the ambient temperature. Select according to the table "FUEL, COOLANT AND LUBRICANTS".

★ Refill capacity for each side

D85A, E:	41 ℓ
D85P:	51 ℓ

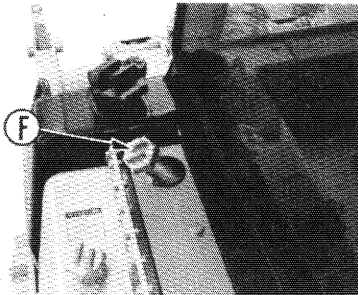

BE4833

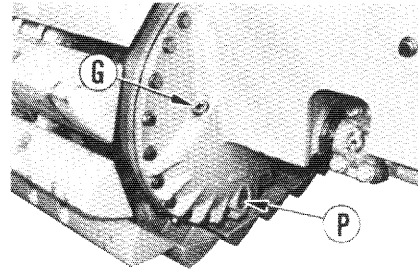

BE4834

e. HYDRAULIC TANK AND FILTER

1. Remove drain plug (1) on the bottom of the tank, and loosen drain valve (2).

After draining oil, tighten valve (2) and plug (1).

2. Remove bolt (3), cover (4) and element (5).
3. Clean the disassembled parts and the interior of the filter, and install a new element.

4. Supply specified amount of oil through oil filler (F). (refer to EVERY 250 HOURS SERVICE)

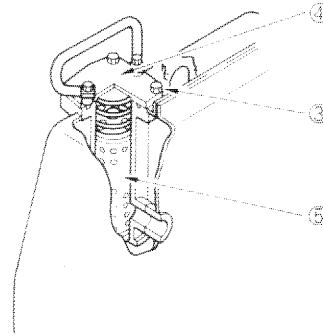

- ★ Refill capacity: 58 ℓ
- ★ The type of lubricant used depends on the ambient temperature. Select according to the table "FUEL, COOLANT AND LUBRICANTS".
- ★ Use genuine Komatsu element.

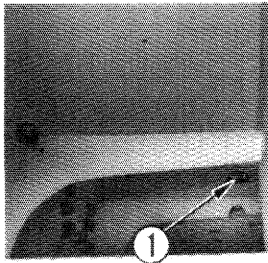

BE4835

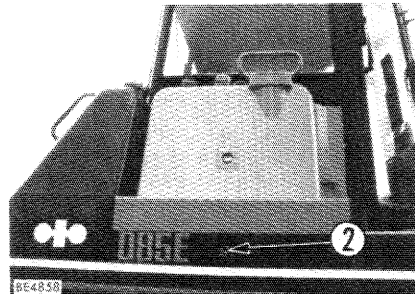

BE4835

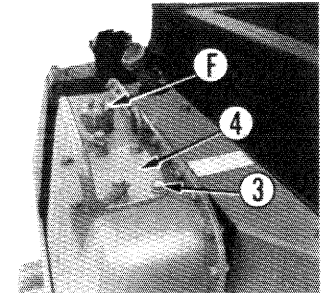

BE4836

f. UNDERCARRIAGE COMPONENTS

Stop machine on level ground and check consumption of oil in track roller, carrier roller and idler.

1. Slowly loosen seal bolt (1) and see if oil oozes out of screw. If oil oozes out, oil is still sufficient. Tighten bolt immediately.
2. If oil does not flow even after seal bolt has been removed, oil amount is insufficient. Request your Komatsu distributor to perform necessary repairs.

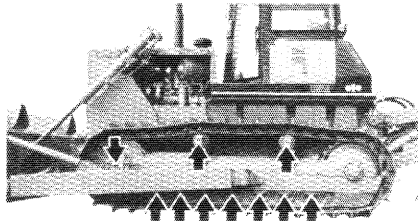

BE4837

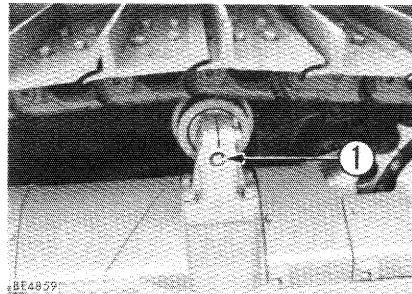

BE4859

g. TURBOCHARGER CLAMPING JOINT

Contact your Komatsu distributor for checking, or proceed as follows:

Periodically inspect all joints for looseness. Tighten when necessary.

- Tightening torque for clamp on turbine housing side:
1.27 to 1.50 kgm
- Tightening torque for clamp on blower housing side:
1.27 to 1.50 kgm
- Tightening torque for exhaust manifold and turbine housing mounting bolts: 6.5 to 7.5 kgm
- Tightening torque for turbocharger oil pipe (inlet): 6.5 to 7.5 kgm
- Tightening torque for turbocharger oil pipe (outlet):
6.5 to 7.5 kgm

h. TURBOCHARGER ROTOR PLAY

Contact your Komatsu distributor for checking, or proceed as follows:

Remove air intake and exhaust pipes from turbocharger.

1. Axial play

Check axial play by moving rotor in axial direction.

Play:

Standard 0.08 to 0.25 mm

2. Radial play

Measure radial play by moving rotor holding both ends by hands in radial direction in parallel.

Play:

Standard 0.08 to 0.18 mm

- ★ If the play is over the limit, consult your Komatsu distributor.
- ★ If the rotor is excessively soiled with dust or carbon or if any oil leakage caused by turbocharger trouble is noted, have the turbocharger repaired by your Komatsu distributor.

i. TENSION PULLEY BRACKET

Apply grease to the grease fitting shown by an arrow. (1 point)

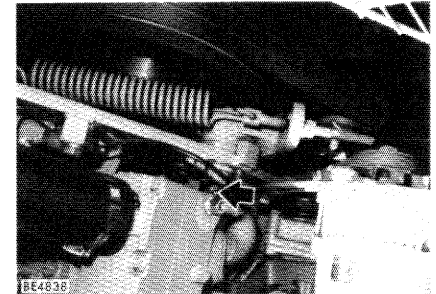

j. CORROSION RESISTOR

1. Close valves (1) (2 points).
2. Using the filter wrench provided, remove cartridge (2) by turning it counterclockwise. Fit a new cartridge after applying a dab of engine oil to the seal face.
 - ★ To fit the cartridge, put the seal face in contact with head, then screw it up about 2/3 of a turn.
3. After replacement, open valves (1).
- ★ Be sure to use a genuine Komatsu cartridge.

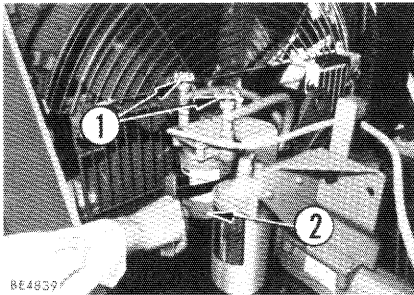

EVERY 2000 HOURS SERVICE

- ★ Maintenance for every 250, 500 and 1000 hours should be carried out at the same time.

a. LUBRICATING

Apply grease to grease fittings shown by arrows.

2. Brake pedal lever shaft (5 points)

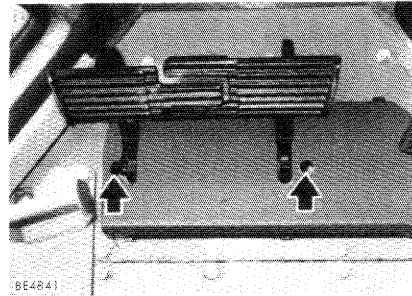

1. Equalizer bar shaft (1 point)

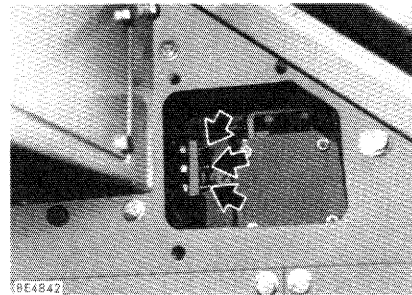
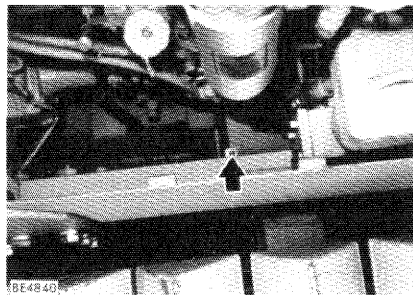

b. ENGINE BREATHER

Take breather (1) out of place and wash the inner element in clean light oil to remove dust from it.

- ★ Before taking the breather out of place, wipe the dust off the surrounding area. When restoring the element to its original position, be sure to coat the new O-ring with engine oil.

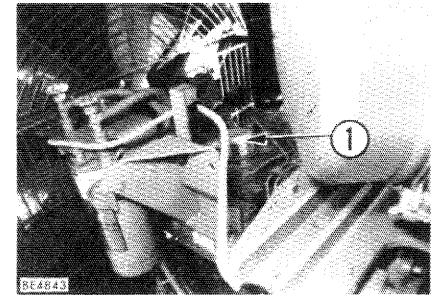

c. TURBOCHARGER

Excessive carbon or oil sludge adhering to the turbocharger blower impeller may deteriorate normal performance of the turbocharger and may sometimes damage it.

Contact your Komatsu distributor.

1. Remove the turbocharger oil supply tube and the drain tube. Then, remove the connection area of the intake manifold and the blower housing so that the blower impeller can be seen.
2. Using light oil, wash the impeller to eliminate carbon adhered on the surface. Do not use wire brushes or the like to prevent damage to the impeller surface.

3. Pour light oil through the turbocharger oil filler. Turn the blower impeller several turns so that foreign materials such as sludge can be washed away.
4. Using your fingers, turn the impeller vigorously for one revolution or more. If there is no sign of interference or catching, the impeller is normal. If the impeller seems to turn heavily, contact your Komatsu distributor to ask for repair or replacement.
5. If the impeller is found normal after this check, supply engine oil to the turbocharger.

d. ALTERNATOR AND STARTING MOTOR

The brush may be worn, or the bearing may have run out of grease, so please contact your Komatsu distributor for inspection or repair.

- ★ If the engine is started frequently, carry out inspection every 1000 hours.

e. ENGINE VALVE CLEARANCE

Ask Komatsu distributor to check engine valve clearance because special tools should be used.

f. ENGINE VIBRATION DAMPER

Check the vibration damper for cracks or separation on rubber surface.

If there are cracks or separation, contact your Komatsu distributor for replacement.

EVERY 4000 HOURS SERVICE

★ Maintenance for every 250, 500, 1000 and 2000 hours should be carried out at the same time.

a. WATER PUMP

Check that there is no play in the pulley, grease leakage, water leakage, or clogging of the drain hole. If any abnormality is found, please contact your Komatsu distributor for disassembly and repair or replacement.

b. FAN PULLEY AND TENSION PULLEY

Check for loose pulley or grease leakage. If any, contact your Komatsu distributor for repair or replacement of the pulley assembly.

WHEN REQUIRED

a. CLEAN INSIDE OF COOLING SYSTEM

Clean the inside of the cooling system, change the coolant, and replace the corrosion resistor, according to the table.

- ★ Stop the machine on level ground when cleaning or changing the coolant.
- ★ Use a permanent type of antifreeze. If, for some reason, it is impossible to use permanent type antifreeze, use an antifreeze containing ethylene glycol.

- ★ Be sure to replace the corrosion resistor cartridge.
- ★ Use city water for the cooling water.
If river water, well water or other such water supply must be used, contact your Komatsu distributor.



Antifreeze is flammable, so keep it away from any flame.

Type of antifreeze solution	Cleaning inside of cooling system and changing coolant	Replacing corrosion resistor
Permanent type antifreeze (All season type)	Every year (autumn) or every 2000 hours whichever comes first	Every 1000 hours and when cleaning the inside of the cooling system and when changing coolant
Non permanent type antifreeze containing ethylene glycol (Winter, one season type)	Every 6 months (spring, autumn) (Drain antifreeze in spring, add antifreeze in autumn)	
When not using antifreeze	Every 6 months or every 1000 hours whichever comes first	

- Add antifreeze in the cooling water.

When deciding the ratio of antifreeze to water, check the lowest temperature in the past, and decide from the mixing rate table given below.

It is actually better to estimate a temperature about 10°C lower when deciding the mixing rate.

Min. atmospheric temperature (°C)	-5	-10	-15	-20	-25	-30
Amount of antifreeze (ℓ)	18.5	24	29	33	36	39.5
Amount of water (ℓ)	60.5	55	50	46	43	39.5

Mixing rate of water and antifreeze

- ★ We recommend use of an antifreeze density gauge to control the mixing proportions.

WHEN REQUIRED

1. Stop the engine, close corrosion resistor valves (1).
2. Turn radiator cap (2) slowly until it comes off.

⚠ If the water temperature is high, do not remove the cap. This is because of the possibility of scalding water spurting out.

When removing cap, turn cap slowly to allow pressure to be relieved.

3. Loosen drain valve (3) at the bottom of radiator and drain plug (4) at the side of oil cooler and drain off the cooling water.
4. Close up drain valve (3) and plug (4) and pour in clean water (ex. city water) up to the vicinity of the water filler.

5. When the water reaches the vicinity of the water filler, put the engine at low idling, open drain valve (3) and plug (4), then pass water through the cooling system until clean water comes out from the drain valve and plug for 10 minutes.
- ★ When flushing, adjust the flow so that water is added at the same rate as the water is drained to keep the radiator always full.

Corrosion resistor

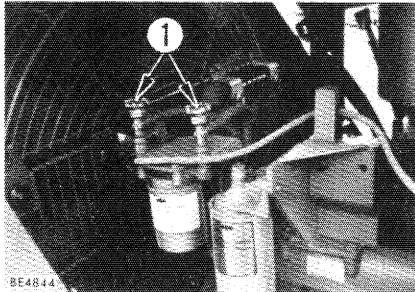

Water filler

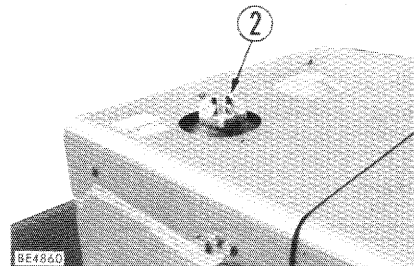

Drain valve (bottom of radiator)

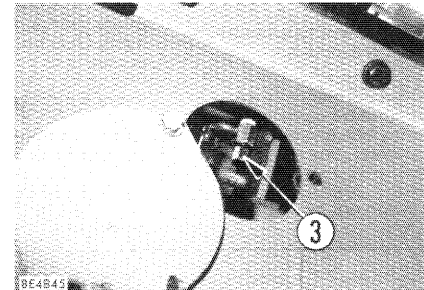

6. After washing the cooling system, stop the engine. Open drain valve (3) and plug (4) to drain water and close drain valve (3) and plug (4).
7. After draining off the cooling water, wash out the cooling system using commercially available detergent. Follow the instructions on the detergent container.

Drain plug (oil cooler)

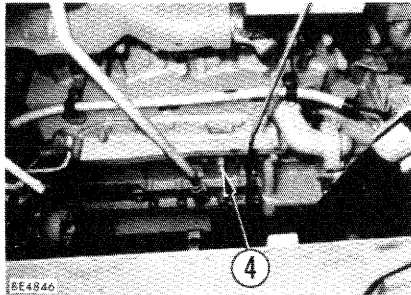

8. After washing the cooling system, drain off all the water, then close up drain valve and plug, and pour in clean water (ex. city water) slowly up to the vicinity of the water filler.
9. When the water reaches the vicinity of the water filler, put the engine at low idling, open the drain valve and plug, then pass water through the cooling system until clean water comes out from the drain valve and plug.
 - ★ When flushing, adjust the flow so that water is added at the same rate as the water is drained to keep the radiator always full.

10. When the water becomes completely clean, stop the engine and close the all drain valve and plug.
11. Replace the corrosion resistor cartridge and open valve (1).
 - ★ For details of replacement of the corrosion resistor, see the maintenance section.
12. Supply water until it overflows from water filler.
13. Run the engine 5 minutes at low idling and then for another 5 minutes at high idling to eliminate air trapped in the cooling system (leave radiator cap off during this operation).
14. Stop the engine and wait for about 3 minutes. Supply cooling water up to the specified level tighten the cap.

b. AIR CLEANER

Checking

Whenever the red piston in dust indicator (1) appears, clean the air cleaner element. Stop the engine when cleaning the element.

Cleaning or replacing outer element

1. Remove bolt (2), cover (3) and the outer element.
2. Clean the air cleaner body interior and the removed cover.
3. Clean and inspect the element. (See the item "Cleaning outer element" for cleaning procedure.) Install the cleaned element.
4. Push button of dust indicator to return red piston.

- ★ Replace the outer element which has been cleaned 6 times repeatedly or used throughout a year. Replace the inner element at the same time.
- ★ Replace seal washer (5) or wing nut (4) if they are broken.

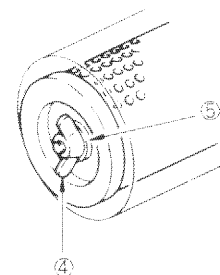
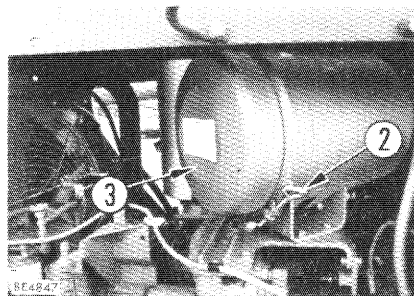
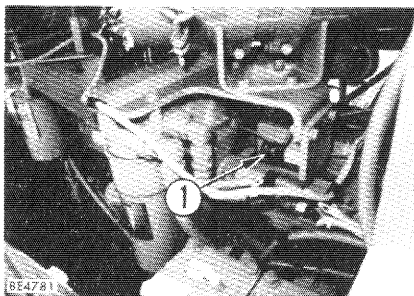

- ★ Replace both inner and outer elements when the dust indicator red piston appears soon after installing the cleaned outer element even though it has not been cleaned 6 times.
- ★ Check inner element mounting nuts for looseness and, if necessary, retighten.

- ★ When tightening bolt (2), you should check that the dimension "A" is 17 ± 2 mm. If the value is not within the above-mentioned range, adjust it using the tool.
- ★ When inspecting or cleaning the air cleaner, remove evacuator valve (6) and clean with compressed air.

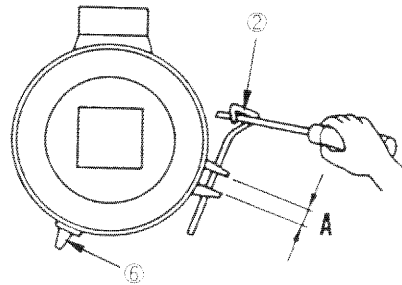

Replacing inner element

1. First remove the cover and the outer element, and then remove the inner element.
2. Cover the air inlet port.
3. Clean the air cleaner body interior. Remove the cover from the air inlet port.
4. Fit a new inner element to the connector and tighten it with nuts.
5. Install the outer element and the cover. Push the dust indicator reset button.

NOTE: Do not attempt to reinstall a cleaned inner element.

⚠ Do not clean or replace the air cleaner element with the engine running.

Cleaning outer element

With compressed air

Direct dry compressed air (less than 7 kg/cm²) to element from inside along its folds, then direct it from outside along its folds and again from inside, and check element.

! When using compressed air, wear safety glasses and other things required to maintain safety.

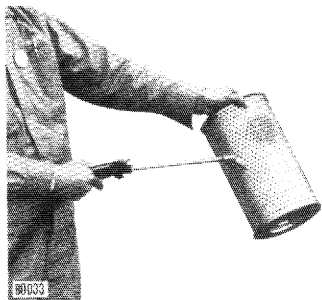

The following methods require spare parts.

With water

Dash city water (less than 3 kg/cm²) on element from inside along folds, then from outside and again from inside. Dry and check it.

With cleaning agent

For removing oils and fats as well as carbon etc. attached on the element, the element may be cleaned in lukewarm solution of mild detergent, then rinsed in clean water and left to drop dry.

★ Drying can be speeded up by blowing dried compressed air (less than 7 kg/cm²) from the inside to the outside of the element.

Never attempt to heat the element.

★ Using warm water (about 40°C) instead of soapy water may also be effective.

- ★ If small holes or thinner parts are found on element when it is checked with an electric bulb after cleaning and drying, replace the element.
- ★ If element is usable, wrap it and store it in dry place.
- ★ Do not use element whose folds or gasket or seal are damaged.
- ★ When cleaning element, do not hit it or beat it against something.



c. TRACK TENSION

Inspection

Without applying brakes, stop the machine on a flat land, and put a straight rod on the carrier roller and the idler as shown on the Photo. When the distance between the rod and the shoe grouser is 20 to 30 mm at the center, the tension is the standard one.

Adjustment

For tightening the tension, pressurize grease through lubricator (1). On the other hand, for loosening the tension, extract grease by reversely rotating plug (2) for "1 rotation" slowly.

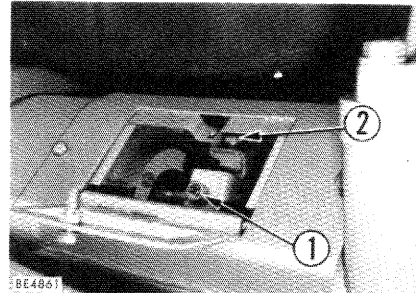
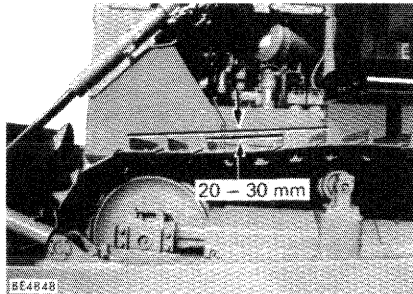

Grease may be pressurized till S will be 0 mm. In case the tension is yet loose after applying pressurized injection of grease till the above-mentioned limit, it indicates that the pin bush is reduced by too much abrasion. So it is necessary either to turn or replace the pin and bushings. Consult your Komatsu distributor for repair.

⚠ Do not loosen plug (2) over one complete rotation. Also, be careful not to loose any part other than plug (2).

If plug (2) or any other part should be loosened excessively, it will be liable to fly out under the high pressure of jammed grease. If grease does not ooze smoothly, try moving the machine back and forth for a short distance.

d. CHECK AND RETIGHTEN TRACK SHOE BOLT

The shoe bolt attaching the track shoe to the link will be broken if it is used as loosened. So, you are required to retighten every time you find a loosened one.

Method for tightening (shoe bolt)

1. First tighten to a tightening torque of 40 ± 4 kgm, then check that the nut and shoe are in close contact with the link contact surface.
2. After checking, tighten a further $120^\circ \pm 10^\circ$.

Method for tightening (master link connecting bolt)

1. First tighten to a tightening torque of 40 ± 4 kgm, then check that the link contact surfaces are in close contact.
2. After checking, tighten a further $130^\circ \pm 10^\circ$.

Tightening sequence

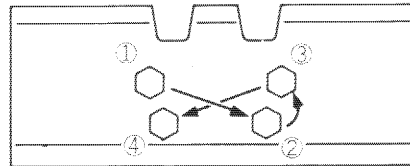

e. ELECTRICAL INTAKE AIR HEATER

Check electrical intake air heater (1) once a year before commencing work in the cold season.

Remove electrical intake air heater (1) from the engine intake connection, and check it for possible open-circuits and dirt.

When inspecting and replacing electrical intake air heater (1), replace the gasket with new ones.

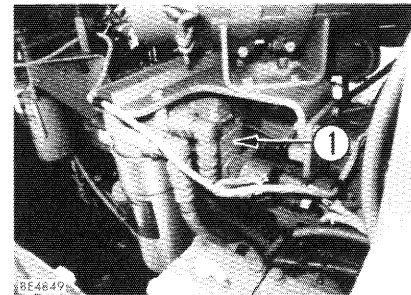

f. WATER SEPARATOR

When float (2) is at or above red line (1), drain the water according to the following procedure:

1. Loosen drain plug (3) and drain the accumulated water until the float reaches the bottom.
2. Tighten drain plug (3).
3. If the air is sucked into fuel line when drain the water, be sure to bleed air in the same manner as for the fuel filter.

(See Fuel Filter Cartridge in EVERY 500 HOURS SERVICE section.)

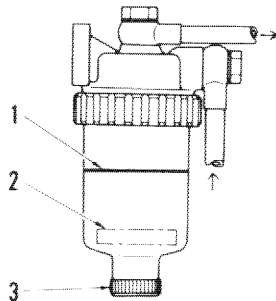

ADJUSTMENT

STEERING BRAKES

When brake lining wears, travel of brake pedal will increase, making steering difficult.

When travel exceed 190 mm, (Be careful, braking force decreased) adjust travel as follows:

Standard travel: 110 – 130 mm

(operating force under engine is low idling 15 kg)

: 75 mm (when engine is stopped.)

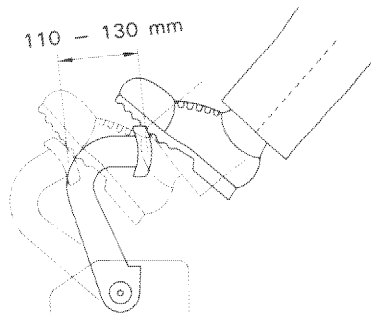

Adjustment

1. After removing rear fender cover, remove inspection cover (1).
2. Tight adjustment bolt (2) to a tightening torque of 5 kgm, so that the lining comes into tight contact with drum. (The contact should be confirmed by depressing the brake pedal.)
3. Then, turn adjustment bolt (2) in reverse direction for 7/6 rotation.

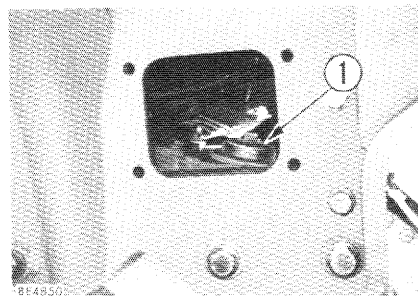

- ★ Adjust so that both left and right pedals will have same travel. If there is a difference in travel between the pedals, brake on one side only will give effective response to pedal action.
- ★ When the A dimension of the brake adjusting bolt becomes smaller than 71 mm, you should replace the lining with new one.

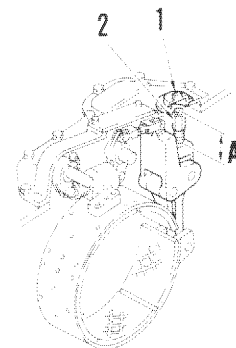

IDLER

Since the idlers are forced to move forward and backward as long as the machine is in operation, the side guides, up-and-down guides, and guide plates will be worn out gradually. Excessive wear of these guides, if left unattended, will cause the vibration of idlers from side to side or inclination of the idlers, and running off of track links from the idlers or unevenly worn idler and links may result. Therefore, it is necessary to adjust the idlers from time to time accord-

ing to the following procedure so that they are always maintained in good running condition:

1. Adjustment of the side guides

Run the machine 1 or 2 meters on level ground to give its tracks even tension and then stop the machine. Check the clearance "A" to the track frame (there are a total of 4 clearances: left, right, top, and bottom for each side guide).

If any clearance exceeds 4 mm, loosen the bolts (1) and remove the required number of shims (2) to adjust the clearance to the standard value of 0.5 to 1.0 mm. The thickness of shim are 0.5 mm and 1.0 mm.

- ★ When loosening the bolts (1), be careful not to turn them more than 3 turns.

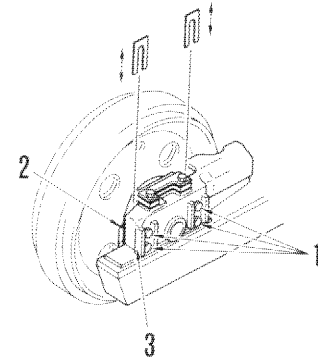
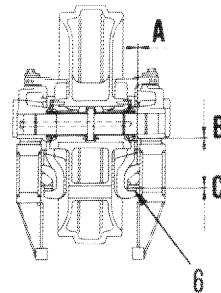
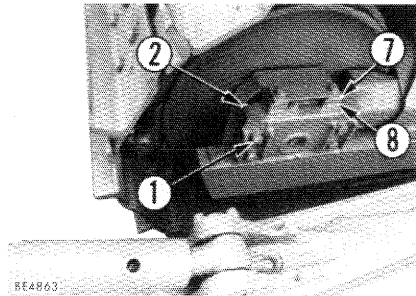

ADJUSTMENT

2. Adjustment of the guide plates and the up-and-down guides
Measure the clearance "B" between the support (3) and guide plate (4) and the clearance "C" between the up-and-down guide (5) and track frame wear plate (6). If the sum of two clearance "B" and "C" exceeds 5 mm, reduce it to 2 mm by deducting the necessary thickness in shims from the extracting shims (7) and adding the same thickness in shims to the extracting shims (8). This adjustment should be performed according to the following procedure:

★ It is normal that the clearance "C" is zero (0 mm).

1) Measure the clearance "B" and subtract 2 mm from the value "B". The result corresponds to the thickness in shims to be adjusted. (In the case of $B = 5$ mm, for instance, the thickness in shims to be adjusted is $5 - 2 = 3$ mm.)

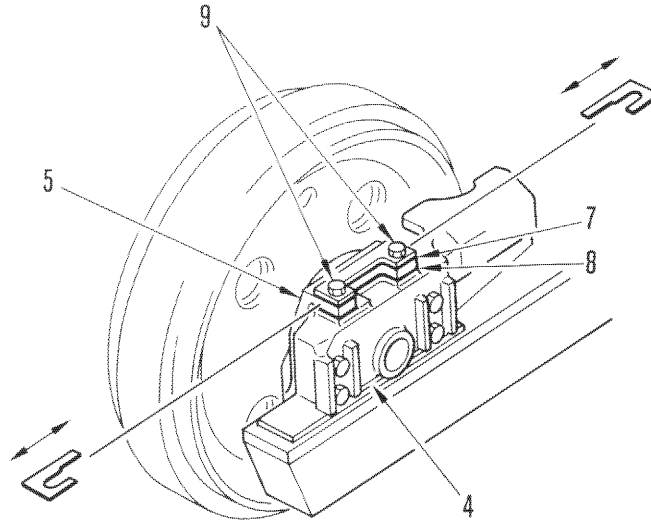

- ★ The succeeding steps 2) and 3) are to release the up-and-down guides, which is necessary to remove a required thickness in shims from the extracting shims (7) and add it to the extracting shims (8).
- 2) Loosen the bolts (9) (there are a total of four inside and outside bolts) until no spring force is felt.
- 3) Loosen the bolts (1), taking care not to loosen them more than 3 turns.
- 4) Pull the up-and-down guide (5) upward with a bar so that the clearance "C" becomes zero (0 mm). Remove the necessary thickness in shims determined by step 1) from the extracting shims (7).
- 5) Add the removed shims (7) to the extracting shims (8). (This procedure must be performed at a total of 8 positions, inside and outside for each of the left-hand and right-hand sides).
- ★ The total number of shims obtained as the sum of shims (7) and (8) should not be varied before and after the adjustment. Careless reduction or addition of the total number of shims would be the cause of improper preload of springs built in the guide. (Both the shims (7) and (8) are composed of several of two kinds of shims, 1 mm thick and 2 mm thick.)
- 6) Tighten the spring set bolts (9).
- 7) Tighten the bolts (1) to a torque of 50 to 62 kgm.
- ★ To maximum quantity of adjustment of 6 mm is allowed for the up-and-down guides.

DECELERATOR PEDAL

When the engine speed is not within the range of 800 to 850 rpm by setting the fuel control lever to 1/2 stroke and depressing the decelerator pedal (clearance A; zero), the following process shall be followed.

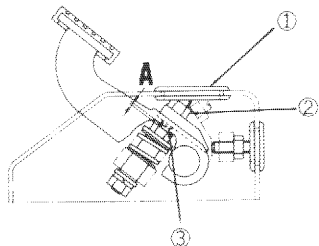

Adjustment

1. Remove grommet (1), loosen lock nut (2), and adjust by rotating screw (3) so that the engine speed will be 800 to 850 rpm at the position of pedal depressed (clearance: zero).
 2. Tighten lock nut (2) after completing the adjustment.
- ★ When the decelerator pedal is forcefully depressed, the spring is forced over so that the engine operates low idling revolution.
 - ★ Tachometer is required for setting the engine revolution with precision. So, you shall consult Komatsu distributor.

FAN BELT

A device is employed by which the tension of the fan belt is kept constant regardless the elongation of the V belt, there is no need for adjustment till the belt is broken. However, when the belt is replaced by new one, you should check that the A dimension is 90 ± 3 mm, and adjust it when the value is not within the abovementioned range.

- ★ When V belts are replaced, you should replace both them at the same time.

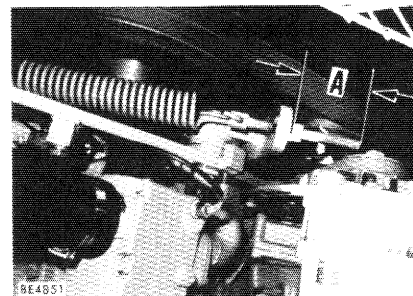

UNDERCARRIAGE

- Properly adjust track tension. Tension should be measured at clearance shown in photograph – usually 20 to 30 mm at this point. For rocky terrain, tighten tracks slightly. In clay or sandy areas, slightly loosen them. (For inspection and adjustment procedures, refer to “WHEN REQUIRED”.)

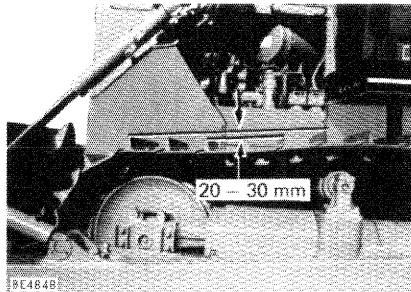

- Check idler rollers for oil leakage as well as for loose bolts and nuts. If any trouble is detected, repair immediately.
- Check idler guide plate for clearance. If clearance increases, idler may develop side motion and tracks may come off.

INSPECTION AND REPAIR

Frequent inspection and prompt repair will reduce repair costs. The following items for inspection will serve as a guide to maintenance service of each undercarriage part. Perform periodical inspection and contact the Komatsu distributor in your area when machine has approached repairable limits and reversing limits.

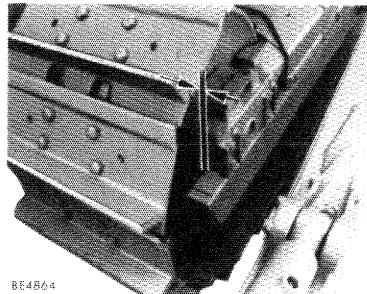

ADJUSTMENT

● Measuring Height of Grouser

After taking up slack in track shoes, measure height at center of shoe as shown below.

- ★ Standard height (H): 72 mm
- ★ Repair limits: 25 mm

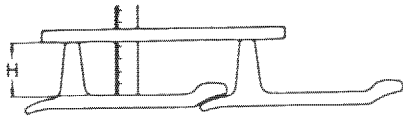

- ★ Standard height (H): 123 mm
- ★ Repair limits: 101 mm

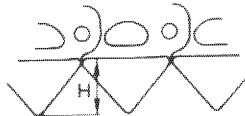

● Measuring Outside Diameter of Track Roller

1. Measure height (size C) of link tread as shown.
2. Stop machine at position where link tread, whose size C has been measured completely, contacts roller tread. Then measure size B.
3. Calculate outside diameter of tread (size A):

$$A = (B - C) \times 2$$

- ★ Standard size (A): 222 mm
- ★ Repair limits: 198 mm

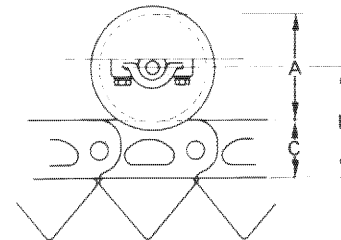
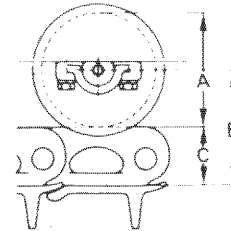
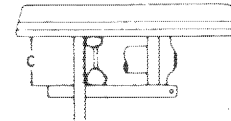

TROUBLE SHOOTING GUIDE

This guide is not intended to cover every condition, however many of the more common possibilities are listed.

ELECTRICAL SYSTEM

Lamp does not glow brightly even when engine runs at high speed.

Lamp flickers while engine runs.

- Check for loose terminals and open-circuit wiring.
- Adjust belt tension.

Charge monitor does not go out even when engine runs at high speed.

- Replace the alternator.
- Check and repair wiring.

Unusual noise is emitted from the alternator.

- Replace the alternator.

Starting motor does not turn when starting switch is turned on.

- Check and repair the wiring.
- Charge the battery.

The pinion of the starting motor keeps going in and out.

- Charge the battery.

Starting motor turns the engine sluggishly.

- Charge the battery.
- Replace the starting motor.

The starting motor disengages before the engine starts up.

- Check and repair the wiring.
- Charge the battery.

The engine preheating monitor does not flash.

- Check and repair wiring.
- Replace the heater relay.
- Replace the monitor.

The engine oil pressure monitor does not light up when engine is stationary (when the starting switch is in ON position.)

- Replace the monitor.
- Replace the monitor switch.

Charge monitor does not light up when the engine is stationary. (When the starting switch is in ON position.)

- Replace the monitor.
- Check and repair the wiring.

Outside the electrical intake air heater is not warm when touched with the hand.

- Check and repair wiring.
- Replace the electrical intake air heater.
- Check and repair the heater switch.

ENGINE

The engine oil pressure monitor flashes when engine speed is raised after completion of warm-up.

- Add the oil to the specified level.
- Replace the oil element.
- Check oil leakage from the pipe or the joint.
- Replace the monitor.

Steam is emitted from the top part of the radiator (the pressure valve).

The radiator cooling water level monitor flashes.

- Supply the cooling water and check leakage.
- Adjust fan belt tension.
- Wash out inside of cooling system.
- Clean or repair the radiator fin.
- Replace the thermostat.
- Tighten the radiator cap firmly or replace the gasket of it.
- Replace the monitor.

The white range of the water temperature gauge lights.

- Replace the water temperature gauge.
- Replace the thermostat.
- Replace the sensor.

The engine does not start when the starting motor is turned over.

- Add fuel.
- Repair where air is leaking into fuel system.
- Replace the injection pump or the nozzle.
- Check the valve clearance.
- Check engine compression pressure.
- Refer to the section of electrical system.

Exhaust gas is white or blue.

- Adjust to specified oil quantity.
- Replace with specified fuel.

Exhaust gas occasionally turns black.

- Clean or replace the air cleaner element.
- Replace the nozzle.
- Check engine compression pressure.
- Clean or replace the turbocharger.

Combustion noise occasionally changes to breathing sound.

- Replace the nozzle.

Unusual combustion noise or mechanical noise.

- Replace with specified fuel.
- Check over-heating.
- Replace the muffler.
- Adjust valve clearance.

CHASSIS

Oil pressure is torque converter fails to rise.

- Check and repair where air is leaking into oil pipe and pipe joint.
- Check and replace gear pump.
- Add oil to transmission case.
- Check and replace transmission filter.

Torque converter is overheats.

- Replace fan belt.
- Refer to the section of engine.
- Clean or replace oil cooler.
- Refer to the item "oil pressure in torque converter fails to rise".

Insufficient tractive force.

- Refer to the section ENGINE.
- Refer to the item "oil pressure in torque converter fails to rise".
- Check and replace steering clutch disc.

Machine doesn't start by engaging the gear shift lever.

- Add oil to steering clutch case.
- Refer to the item "oil pressure in torque converter fails to rise".
- Check and replace gear pump.
- Clean oil strainer.

When steering lever on one side is pulled, machine continues to travel straight forward instead of turning.

- Adjust brake.

Steering clutch lever will drag.

- Adjust steering lever play.
- Add oil to the steering clutch case.

Machine doesn't stop when brake pedal are depressed.

- Adjust brake.

Track comes off.

Sprocket develops abnormal wear.

- Adjust track tension.

Blade rises too slowly or does not rise at all.

- Add oil to hydraulic tank.

SERVICE METER

This meter indicates the integrated work hours. So, use it according to the following instructions.

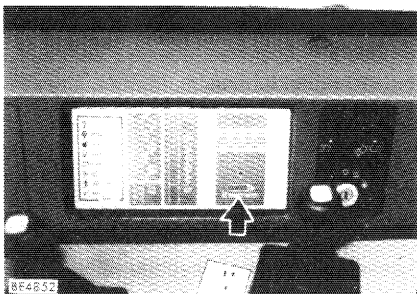

- Record the readings at the start and the end of work, this is the work record of the machine.
- This record will indicate, when periodical maintenance is due.
- It also indicates the integrated working hours when machine problems are encountered.

★ How the meter progresses

The service meter progresses by 1 when the engine is operated for one hour, regardless of the engine speed.

Consequently, if the engine is running, the service meter will advance even if the machine does not move.

- While engine is running, green pilot lamp on the service meter flashes to show the service meter advances.

MACHINE AND ENGINE SERIAL NUMBERS

When calling for service of mechanic or when making replacement parts order, be sure to give your Komatsu distributor the machine and engine serial numbers as well as the service meter reading beforementioned. These numbers are found on the plates shown in the photos below.

- Location of the machine serial number plate

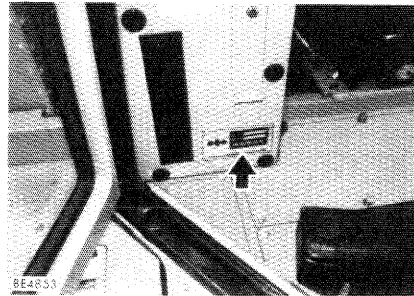

... on the lower part of the right side console box.

- Location of the engine serial number plate

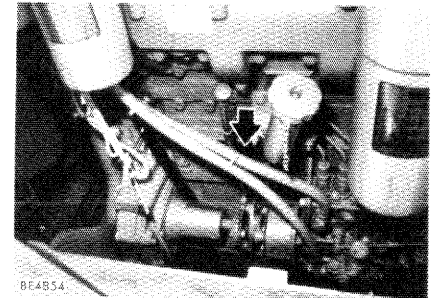

... on the right side of the engine cylinder block, when seen from the fan side.

FUEL, COOLANT AND LUBRICANTS

PROPER SELECTION OF FUEL, COOLANT AND LUBRICANTS

RESERVOIR	KIND OF FLUID	AMBIENT TEMPERATURE					CAPACITY (ℓ)	
		14 -10	32 0	50 10	68 20	86° F 30° C	Specified	Refill
Engine oil pan	Engine oil	SAE 30					30	24
		SAE 10W						
		SAE 10W-30						
		SAE 15W-40						
Steering clutch case (incl. transmission and torque converter case)	Engine oil	SAE 30					122	90
Final drive case (each)		SAE 10W						
		SAE 30					D85A,E: 41	41
Hydraulic tank	Engine oil	SAE 10W					110	58
		SAE 10W-30						
		SAE 15W-40						
Fuel tank	Diesel fuel	※					480	-
		ASTM D975 No. 2						
Cooling system	Water	Add antifreeze					79	-

※ ASTM D975 No. 1

NOTE:

(1) When fuel sulphur content is less than 0.5%, change oil in the oil pan every periodic maintenance hours described in this manual.

Change oil according to the following table if fuel sulphur content is above 0.5%.

Fuel sulphur content	Change interval of oil in engine oil pan
0.5 to 1.0%	1/2 of regular interval
Above 1.0%	1/4 of regular interval

ASTM: American Society of Testing and Material

SAE: Society of Automotive Engineers

API: American Petroleum Institute

- (2) When starting the engine in an atmospheric temperature of lower than 0°C, be sure to use engine oil of SAE10W, SAE10W-30 and SAE15W-40, even though an atmospheric temperature goes up to 10°C more or less in the day time.
- (3) Use API classification CD as engine oil and if API classification CC, reduce the engine oil change interval to half.
- (4) There is no problem if single grade oil is mixed with multigrade oil (SAE10W-30, 15W-40), but be sure to add single grade oil that matches the temperature in the table on the left.
- (5) We recommend Komatsu genuine oil which has been specifically formulated and approved for use in engine and hydraulic work equipment applications.

Specified capacity: Total amount of oil including oil for components and oil in piping.

Refill capacity: Amount of oil needed to refill system during normal inspection and maintenance.

SAFETY AND OPERATION

CONTENTS

SAFETY HINTS . . . 	2
PRECAUTIONS FOR MAINTENANCE	15
HANDLING OF BATTERY	22
STORAGE	25
COOLANT AND LUBRICANTS	27

SAFETY HINTS . . .

OPERATION GENERAL

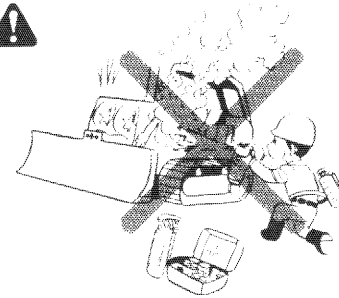
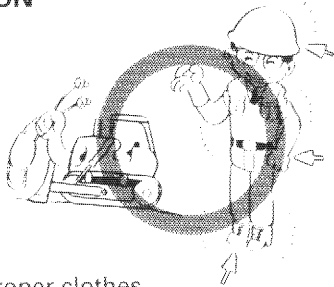

- Wear proper clothes
Loose clothes, ornaments or other things that may possibly contact the control lever or other machine parts must not be worn. Do not let your clothes get caught on protruding parts of the machine. Do not wear oily clothes since they may catch fire.
- Wear well-fitting helmet, safety shoes and working clothes. If the nature of the work requires safety, wear protective goggles or mask, thick gloves, ear plugs or other protection.
- Accidents or injuries are liable to occur when the operator is careless or slack. It is most important to bear safe operation in mind at all times.
- Take care of your health. Do not drive when tired, or after drinking.
- Learn the prohibitions, cautions and rules about work procedures in the work site.
When there is a leader, fix standard signals and always follow these signals when operating.
- If there should be an accident or fire or any other such unexpected mishap, deal with it quickly, using the nearest apparatus.
Learn beforehand the locations of the first aid boxes and fire extinguishers and how to use them. It is also important to know the emergency contact system.
- Learn about the safety devices on your own machine and about how to use them. Confirm that they are correctly attached in the prescribed position.
Such safety devices include:
 - ★ Guards
 - ★ Canopies
 - ★ Protective Devices
 - ★ Roller-Over Protective Structures
 - ★ Seat Belts, etc.

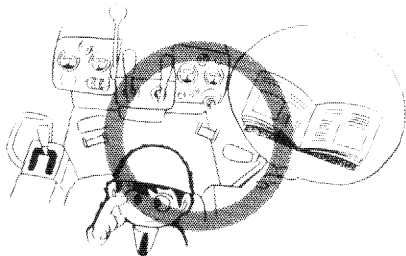

- Read the Operation and Maintenance Manual carefully. Learn how to use the control devices, gauges and warning devices. Be sure you understand the meaning of the caution plates. Remember the check points and checking method for engine oil, fuel, cooling water and hydraulic oil levels.

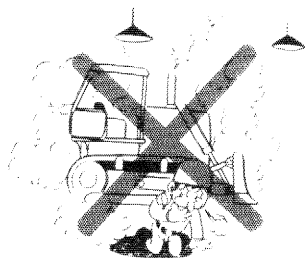

- Exhaust gas is dangerous. When running the engine for long periods in a poorly ventilated area, there is a danger of gas poisoning, so open the windows or doors to ensure a good supply of fresh air.

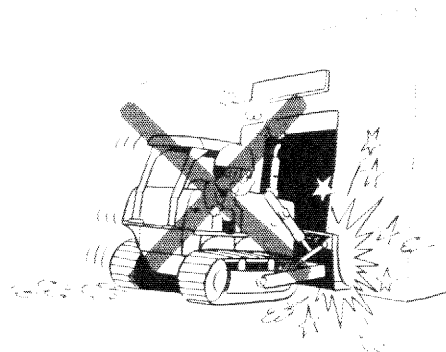

- When operating inside a building always be sure of the clearances of the ceiling, entrances, aisles, etc. and the load limit of the floor.
- Never allow other person than the operator to ride on the machine during operation.

BEFORE STARTING OPERATION

- Examine the lay of the land and the kind of soil at the work site to determine the dangerous points and the best method of operation. Proceed with the work only after making safety arrangements about the dangerous points.
- Inspect leakages from the fuel, lubricating and hydraulic systems. Repair any fuel or oil leakage, and wipe off all dirty oil. Check that the shoe bolts are not loose, and that no other parts are damaged or missing. Machines having such failures should not be operated.

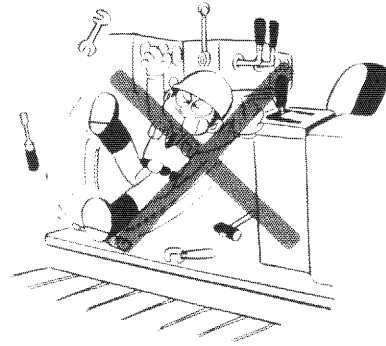
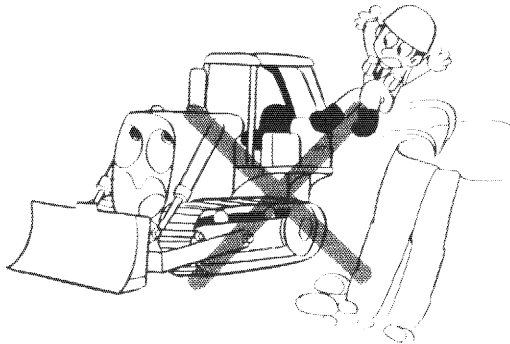

- When getting on or off the machine, use the handrail and step provided. Do not jump up or down from the machine.

- Do not leave parts or tools lying around in the vicinity of or on the floor of the operator's compartment. Keep everything in its proper place.
- Wipe off thoroughly any grease, oil or mud on the step, handrail, floor or control levers. Failure to do this may cause you to slip.
- Check the level of the fuel, lubricants and cooling water. Extinguish cigarettes before checking or replenishing. Check that the radiator cap and each oil filler caps or plugs are firmly tightened.
- Adjust the operator's seat until it is in the most comfortable position for operating. Always sit in the seat while operating. Do not operate the machine from any other position.

- Adjust the seat so that the brake pedal can be depressed all the way with the operator's back against the backrest.
- Before operating the machine, check and fasten the seat belt.
- Inspect the seat belt and fittings, replace any damaged or worn parts.

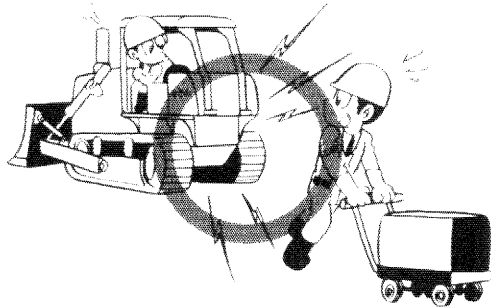

- To ensure the safety of workers near the machine, always sound the horn to warn them before starting the engine and moving the machine. Be particularly careful to check that the rear is clear before backing the machine.
- Combustible objects such as pieces of wood, dead leaves, and pieces of paper may cause fire, so inspect the inside of the engine room and remove them.
- Before starting the engine, confirm that all control levers are in "NEUTRAL" or "HOLD".

AFTER STARTING THE ENGINE

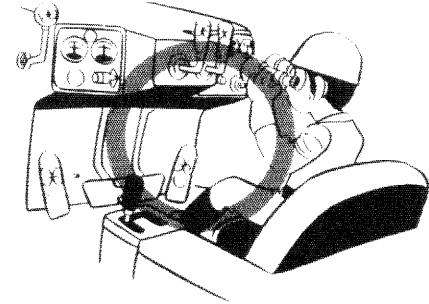

- Confirm that all gauges and warning devices are functioning correctly, and that the gauge readings are within the prescribed range.
- Check the play and travel of each lever and pedal.

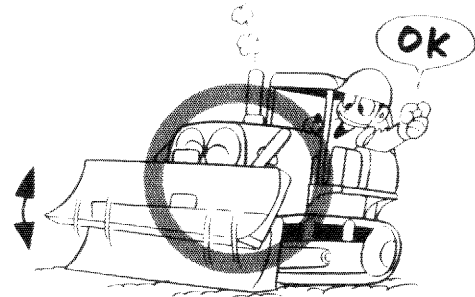

- Operate the blade and ripper to confirm that they are functioning normally.

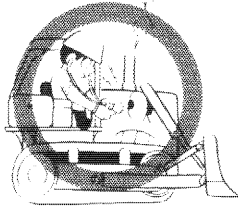

- Move the machine slowly and listen carefully to the engine or gears to confirm that they are not making any unusual noises.
- Operate the gear shift lever to confirm that the travel speeds for forward and reverse are functioning normally. Also carry out a brake test at each travel speed.

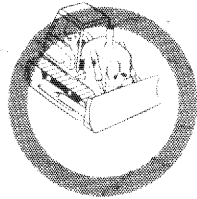

- Choosing a safe place, turn the machine to the left and right to confirm that the steering devices are functioning normally.
- If these tests reveal anything wrong, however slight it may be, contact the man in charge of the machine and operate the machine only after obtaining his permission.

DURING OPERATION

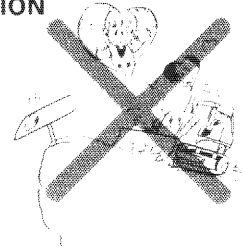

- Always concentrate. It is extremely dangerous to allow yourself to be distracted or to think of other things when operating a machine. In dangerous places, or where there is restricted visibility, it is important to get down from the machine and confirm whether it is safe before continuing work.

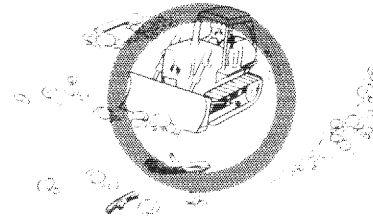

- The work area should be made as flat as possible. If the work area is flat, operation is made much easier and this reduces operator fatigue.

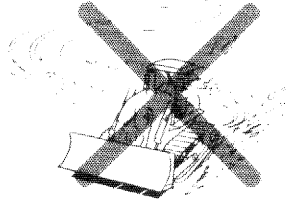

- The machine should always be operated at a speed where it can be correctly controlled. Never do the following:
 - ★ Speeding
 - ★ Sudden starting, sudden braking, sudden turning.
 - ★ Snaking
 - ★ Coasting

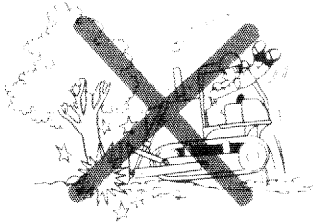

- Be careful of those around you, and always confirm that there is no person or obstacle in the way before traveling or turning the machine.
- Always operate slowly in crowded places. On haul roads or in narrow places, give way to loaded vehicles.

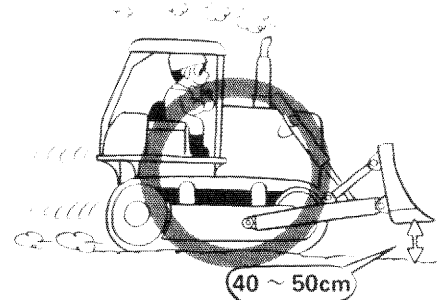

- When traveling the machine, keep the blade 40 to 50 cm above the ground.

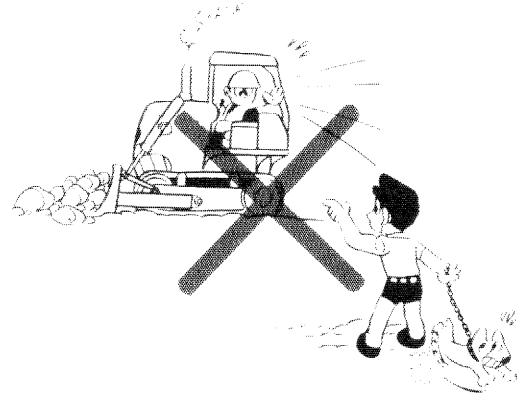

- Do not allow unauthorized persons into the work area.

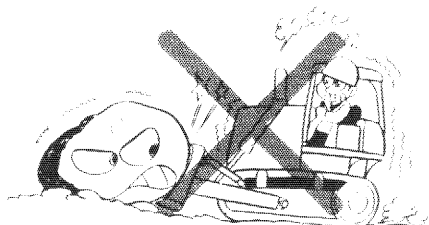

- Always be aware of the operating capacity of the machine. Using the machine to do work beyond its capacity will not only damage the machine, but may even cause unexpected accidents.

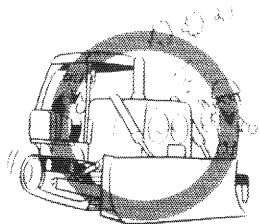

- The machine condition can be judged from many factors. Changes in the gauges, sound, vibration, exhaust gas color or response of the control levers can indicate the occurrence of some disorder. If any disorder occurs, park the machine immediately in a safe place and take appropriate action. Be especially careful in the case of a fuel leak as there is danger of fire.



- If the machine breaks down and needs to be towed, first confirm that the brakes are working properly, and then tow, using a wire rope or any other suitable towing equipment.
- When parking the machine after discontinuing work, put the gear shift lever into "NEUTRAL", apply the brake lock, lower the blade to the ground, and put all safety levers into the "LOCK" position. Never leave the operator's seat without switching the engine off.

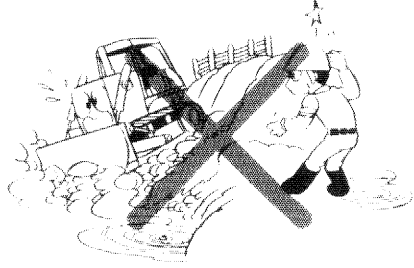

- When continuing operations after rain, remember that conditions will have changed from those before the rain started, so proceed with caution. Be particularly careful when approaching the shoulder of the road or cliffs, as they may have been loosened by the rain.

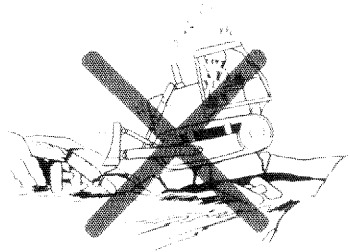

- Check the load limits of bridges before crossing.
- After earthquakes, confirm that the ground is still firm; after blasting, confirm that there are no unexploded charges remaining.

- When operating on uneven ground or in places where there are obstacles, remember the following points:
 - When operating on uneven ground, travel at as low a speed as possible and avoid sudden changes in direction.

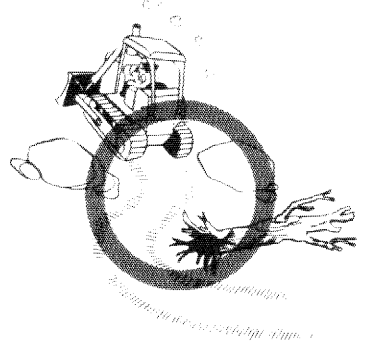

- Wherever possible, avoid traveling over large rocks, fallen trees, tree stumps and other such obstacles. Either use the working equipment to remove them, or travel round them. When it is impossible to avoid traveling over them, put the gear shift lever into a low speed, reduce speed and mount over the obstacle. Just before the front of the machine tips down, reduce speed even more to make the shock of hitting ground as small as possible.

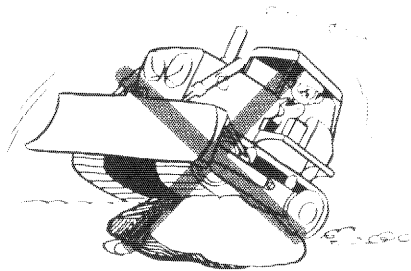

- Never mount over an obstacle at an angle; never disengage one steering clutch to travel over an obstacle.
- When operating at the edge of a cliff or on the shoulder of a road, remember the following points:

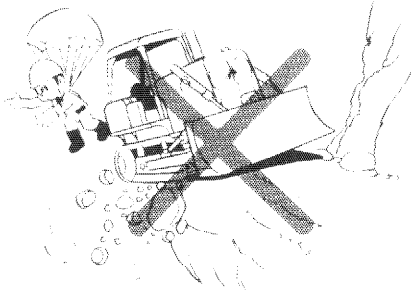

- When operating in a place where there is danger of the machine falling over the side, be doubly careful. Do not approach the edge of the cliff or road shoulder by mistake.

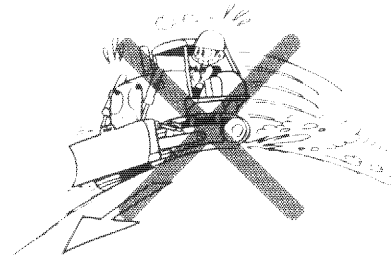

- At the instant when the soil is dumped over the cliff, or when the machine passes the summit of a slope, the machine speed suddenly increases. This is dangerous, so press the decelerator pedal or use the fuel control lever to reduce the speed.

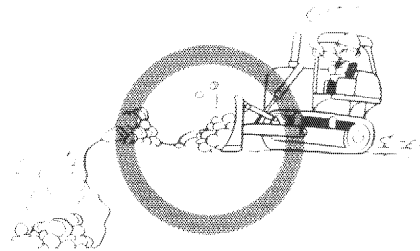

- When dumping soil over a cliff, dump the first excavated soil without dumping it over, and use each succeeding excavated soil to push the previous excavated soil over. Be sure not to approach the edge by mistake.

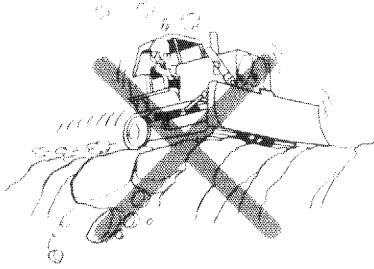

- When working on river embankments or other places made of piled soil, there is the danger that the weight or vibration of the machine may cause the machine to sink into the piled soil, so be extremely careful when operating in such places.
- When operating on slopes, remember the following points:

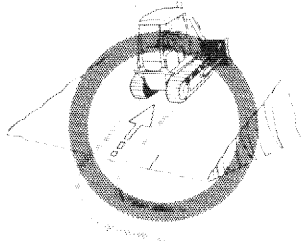

- When traveling on a slope, always travel directly up or down it. Never travel horizontally or diagonally across the slope, as this may cause the machine to roll over or slip sideways.

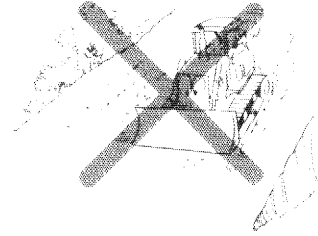

- When going down a slope, use the engine as a brake. If this is not enough to control the speed of the machine, use the steering brake as well. Never coast down a slope with the gear shift lever in "NEUTRAL".

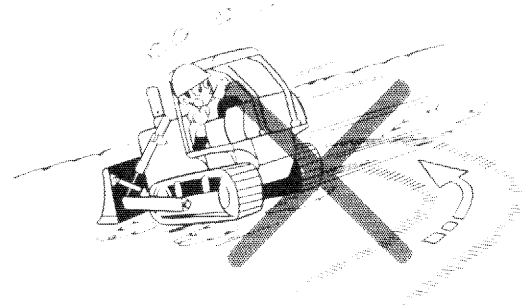

- As far as possible, avoid turning the machine on a slope. It may cause the machine to roll over or slip sideways.

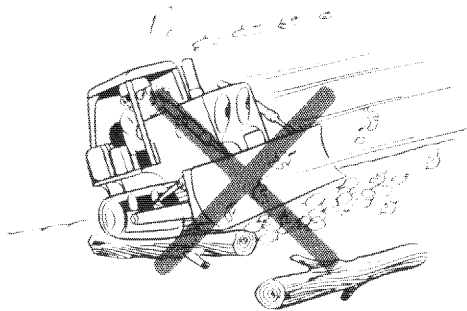

- In forest areas, do not mount fallen trees or logs. Piles of leaves or branches are also very slippery, so proceed with caution.
- Before going up or down a slope, select a travel speed most suited to the slope. Do not change gear on the slope.
- If the engine stalls on a slope, first use the brake to stop the machine, then return the gear shift lever to "NEUTRAL" before starting the engine again.

- When operating in water or in muddy areas, remember the following points:

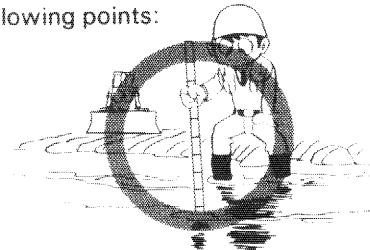

- When operating in water or when crossing shallows, first check the bed soil condition and the depth and flow speed of water, then proceed, taking care not to go beyond the permitted depth.

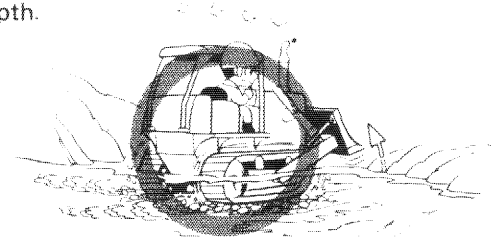

- If the machine gets stuck in mud, it is completely useless to increase the engine speed, causing the tracks to spin, or to rock the machine backwards and forwards. In such a case, raise the blade to reduce the load, and drive out slowly.

- When passing through a narrow space, be careful of the side and overhead clearances. Take special care not to touch any obstacles on either side or overhead. If necessary, have someone outside the machine call out instructions.
- When operating at night, remember the following points:

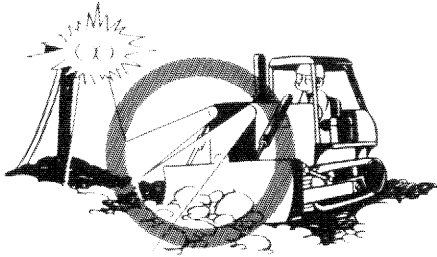

- Be sure to arrange an adequate lighting system.

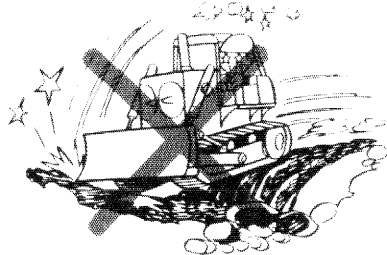

- At night it is very easy to make mistakes in assuming the distance and height of objects and land.

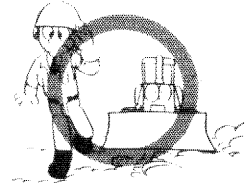

- When operating in fog, mist or smoke, where visibility is bad, be especially careful to confirm first whether operation is safe. When visibility drops below safety level, stop work and wait for the visibility to improve.
- When operating in snow, or cleaning snow, remember the following points:
 - Even slight slopes can cause unexpected side slipping, so in such places, operate with extreme caution.

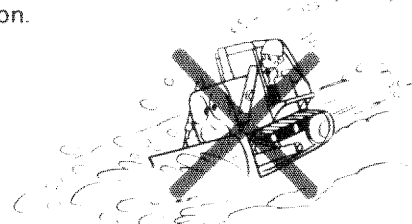

- Never use the steering brake to stop suddenly on slopes. Lowering the working equipment is a far more effective way of stopping.
- During operation, use the seat belt.

PARKING

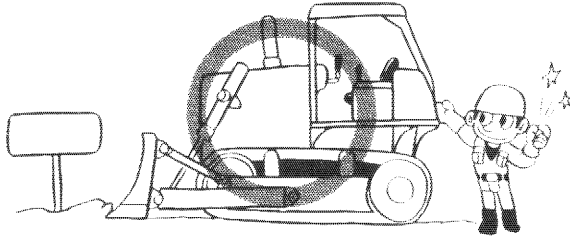

- When parking the machine, park it in a safe place outside the working area, or in the specified place. The following factors should be considered when choosing a parking place: it should be on flat, firm ground where there is no danger of rockfalls, landslides or floods. If the machine has to be parked on a slope, it should be parked facing directly up or down the slope, and chocks should be placed under the tracks. When the machine is facing downhill, lower the blade so that it cuts slightly into the ground to further increase the safety.
- When parking the machine, return the gear shift lever to "NEUTRAL", apply the brake lock, lower the blade to the ground, and put all safety levers in the "LOCK" position. Switch off the engine and remove the key.

PRECAUTIONS FOR MAINTENANCE

GENERAL



- Wear proper clothes
Loose clothes, ornaments or other things that may possibly contact the control lever or other machine parts must not be worn. Do not let your clothes get caught on protruding parts of the machine. Do not wear oily clothes since they may catch fire.
- Wear well-fitting helmet, safety shoes and working clothes. When drilling, grinding or hammering, always wear protective goggles.

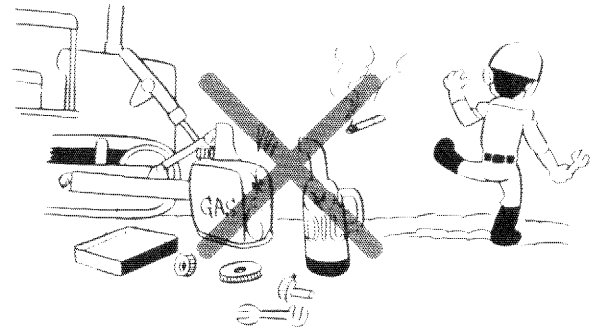

- Fuel or oil are dangerous substances:
Never handle fuel, oil, grease or oily clothes in places where there is any fire or flame.
As preparation in case of fire, always know the location and directions for use of fire extinguishers and other fire-fighting equipment.

PRECAUTIONS FOR MAINTENANCE

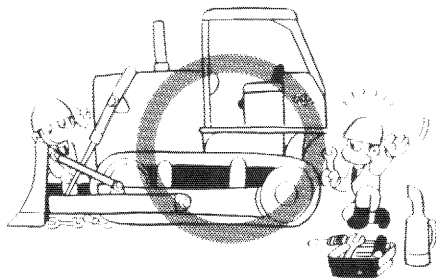

- When working with others, choose a group leader and work according to his instructions. Do not perform any maintenance beyond the agreed work.

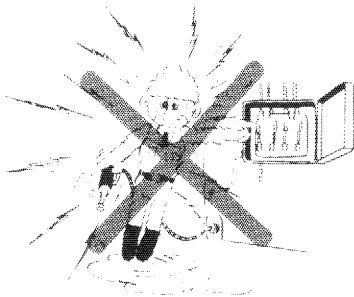

- Do not handle electrical equipment while wearing wet gloves, or in wet places, as this can cause electric shock.
- During maintenance do not allow any unauthorized person to stand near the machine.

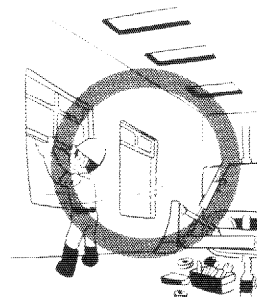

- Exhaust gas is dangerous. When working inside, be particularly careful to have good ventilation.

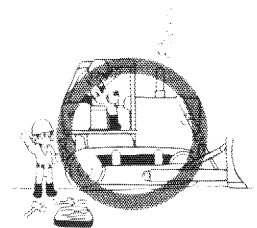

- Unless you have special instructions to the contrary, maintenance should always be carried out with the engine stopped. If maintenance is carried out with the engine running, there must be two men present: one sitting in the operator's seat and the other one performing the maintenance. In such a case, never touch any moving part.

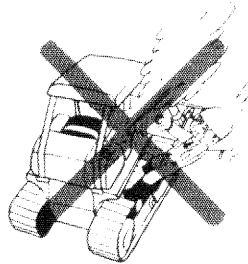

- Always remember that the hydraulic oil circuit is under pressure. When feeding or draining the oil or carrying out inspection and maintenance, release the pressure first.

The procedure for releasing the hydraulic pressure is as follows: lower the blade and ripper to the ground, and stop the engine; move the control levers to each position two or three times and then slowly loosen the oil filler cap.

- Always use Komatsu genuine parts for replacement.
- Always use the grades of grease and oil recommended by Komatsu. Choose the viscosity specified for the ambient temperature.
- Always use pure oil or grease, and be sure to use clean containers.
- When checking or changing the oil, do it in a place free of dust, and prevent any dirt from getting into the oil.

DURING MAINTENANCE

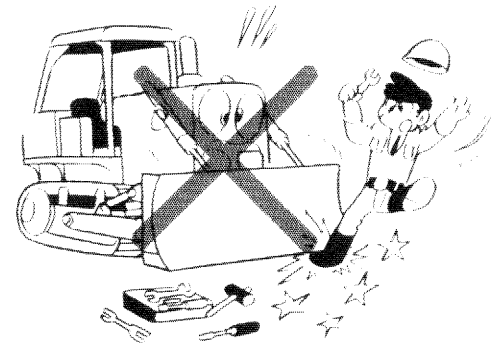

- Park the machine on firm, flat ground. Lower the blade and ripper to the ground and stop the engine. Return the gear shift lever to "NEUTRAL", apply the brake lock and set each control lever to "LOCK". When maintenance has to be carried out with the blade and ripper raised, they must be securely supported by blocks.
- Thoroughly wash the machine. In particular, be careful to clean the filler caps, grease fittings and the area around the dipsticks. Be careful not to let any dirt or dust into the system.

PRECAUTIONS FOR MAINTENANCE

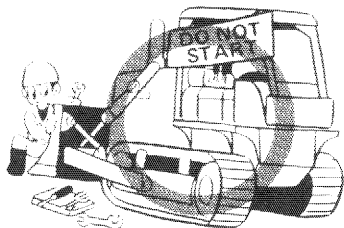

- Hang a caution sign in the operator's compartment (for example "Do not start" or "Maintenance in progress"). This will prevent anyone from starting or moving the machine by mistake.

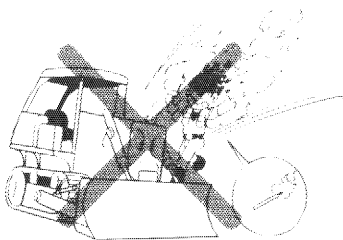

- Flames should never be used instead of lamps. Never use a naked flame to check leaks or the level of oil, fuel, antifreeze or electrolyte.
- Immediately remove any oil or grease on the floor of the operator's compartment, or on the handrail. It is very dangerous if someone slips while on the machine.

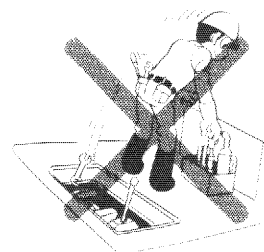

- When check an open gear case there is a risk of dropping things in. Before removing the covers to inspect such cases, empty everything from your pockets. Be particularly careful to remove wrenches and nuts.
- Before draining the oil, warm up it to a temperature of 20 to 40°C.

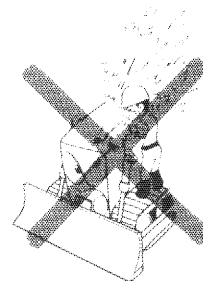

- Be particularly careful when removing the radiator cap or the hydraulic oil tank filler cap. If this is done immediately after using the machine, there is a danger that boiling water or oil may spurt out.

- After replacing oil, filter element or strainer, bleed the air from the circuit.
- When the strainer is located in the oil filler, the strainer must not be removed while adding oil.
- When adding oil or checking the oil level, check that the oil is at the correct level.

When adding oil or fuel, do not let the oil or fuel overflow.

If oil or water are spilled, always wipe it up. Spilled oil or water may cause people to slip; spilled oil may cause fire.

If soil is piled on top of a place where fuel has been spilled, remove the soil.

- After greasing up, always wipe off the old grease that was forced out.
- When changing the oil or filter, check the drained oil and filter for any signs of excessive metal particles or other foreign materials.
- When removing parts containing O-rings, gaskets or seals, clean the mounting surface and replace with new sealing parts.
- When the tracks are removed, never put your fingers between the shoes.

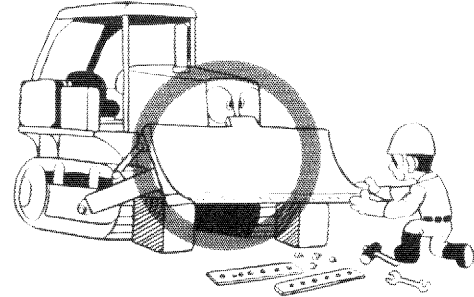

- When handling the cutting edges, always wear gloves.

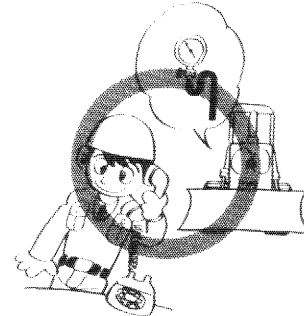

Special measuring apparatus is needed for testing hydraulic pressure.

PRECAUTION FOR MAINTENANCE

- When working on the sea shore, carefully clean all electrical equipment to ensure that it does not corrode.
- Before working in muddy water, rain or snow, check that the various plugs, valves, are properly screwed up. Upon completion of work, wash the machine, then check the various parts of the machine for cracking, scratching, loose or missing nuts and bolts. Also, oil and grease the various parts of the machine.
- When working on rocky ground, be careful of damage to the undercarriage, loose nuts and bolts, cracks, wear and other damage.
- When working in a dusty location, be careful of the following:
 - 1) Inspect the dust indicator to see whether the air cleaner is blocked up. Clean the air cleaner as soon as it becomes dirty.
 - 2) Clean the radiator core so that it does not become blocked up.
 - 3) Clean or replace the fuel filter as soon as it becomes dirty.
 - 4) Clean the electrical equipment, particularly the starting motor and alternator, to prevent accumulation of dust.
- To bleed the air from the hydraulic cylinders or hydraulic piping, run the engine at low idling and do as follows.
 - 1) Operate each hydraulic cylinders 4 to 5 times, stopping 100 mm from stroke end.
 - 2) Next, operate each cylinder 3 to 4 times to the stroke end.
 - ★ If the engine is run at high speed at first, or if the cylinder is moved to the end of its stroke, the air in the cylinder may damage the piston packing, etc.
- Grease fittings are provided at rod ends used in the lever linkage. These rod ends are lubrication-free and require no greasing.

When they stop moving smoothly after being in service for a long time, however, add grease to them.
- When washing the machine, take care not to splash water over the electrical equipment. If it is soaked with water, it may not operate normally.
- After disconnecting the connector, cover it with a vinyl bag to prevent oil or dust from sticking to its contact section.

- When welding, be careful of the following:
 - 1) Turn OFF the power (starting switch).
 - 2) Do not continuously apply more than 200 V.
 - 3) Install the ground cable at least 1 m from the range to be welded.
 - 4) Take care not to install the seals between the grounded point and the range to be welded.
- Before installing a radio to the machine, contact your Komatsu distributor. The machine monitor controller may make operation errors because of interference from the external radio waves.
- Remove all mud and dirt on the steering clutch case which reach high temperatures.

When carrying out other difficult maintenance works, carrying them out carelessly can cause unexpected accidents. If you consider the maintenance is too difficult, always request the Komatsu distributor to carry out it.

HANDLING OF BATTERY

 **Before starting the engine, use a damp cloth to wipe off the dust accumulated on the top surface of the battery.**

PRECAUTIONS FOR CHARGING BATTERY

1. Before charging, disconnect the cable from the negative (-) terminal of the battery. Otherwise, an unusually high voltage will damage the alternator.
2. While charging the battery, remove all battery plugs for satisfactory ventilation.
To avoid gas explosions, do not bring fire or sparks near the battery.
3. If the electrolyte temperature exceeds 45°C, stop charging for a while.
4. Turn off the charge as soon as the battery is charged.
Overcharging the battery may cause followings:
 - 1) Overheating the battery
 - 2) Decreasing the quantity of electrolyte
 - 3) Damaging the electrode plate
5. If the electrolyte gets on your skin or clothes, immediately wash with plenty of clean water.
6. Do not mix up cables (positive (+) to negative (-) or negative (-) to positive (+)), as it will damage the alternator.
7. When inspecting or servicing a battery, be sure to stop the engine and turn the starting switch key to "OFF" position.
8. When performing any service to battery besides checking the electrolyte level or measuring the specific gravity, disconnect cables from the battery.

REMOVAL AND INSTALLATION OF BATTERY

- When removing battery, first disconnect the cable from the ground (normally, from the negative (-) terminal). If a tool touches a cable connecting the positive terminal and the chassis, there is danger of sparks being emitted.
- When installing battery, the ground cable should be connected to the ground terminal as the last step.

STARTING ENGINE WITH A BOOSTER CABLE

When starting up the engine with a booster cable, do as follows:

1. Before connecting the booster cable
 - 1) Size of booster cable and clip should be suitable for the battery size.
 - 2) Check cables and clips for breaks, corroded surfaces, etc.
 - 3) Make sure cables and clips are firmly secured.
 - 4) Keep the starting switch in "OFF" position.
 - 5) The battery of the running engine must be the same capacity as that of engine to be started.

2. Connect the booster cables in the following manner.
 - 1) Connect one clip of booster cable A to the positive (+) terminal of the engine to be started.
 - 2) Connect the other clip to the positive (+) terminal to the engine which is running.
 - 3) Connect one clip of booster cable B to the negative (-) terminal of the engine which is running.
 - 4) Connect the other clip to the engine block to be started.
- ★ Make sure the clips are firmly connected to battery terminals. Then, start the engine.

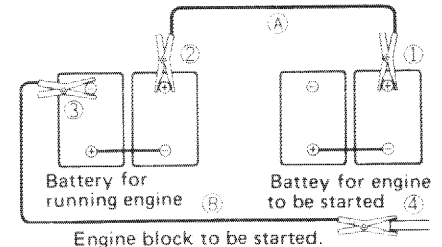

⚠ When connecting the cables, never contact the positive (+) and negative (-) terminals.

⚠ Make sure that the booster cable connections are correct. Connect the booster cable to the engine block as far as possible from the battery.

3. Starting engine

- 1) Turn the starting switch to START position and start up the engine.
- 2) If the engine doesn't start at first, try again after 2 minutes or so.

After the engine has started, the booster cables should be disconnected in the reverse order in which they were connected.

1. Disconnecting the booster cables
 - 1) Disconnect the clip of booster cable B from the engine block which was started.
 - 2) Disconnect the other clip from the negative (-) terminal of the running engine.
- 3) Disconnect the clip of booster cable A from the positive (+) terminal of the running engine.
- 4) Disconnect the other clip from the positive (+) terminal of the engine which was started.

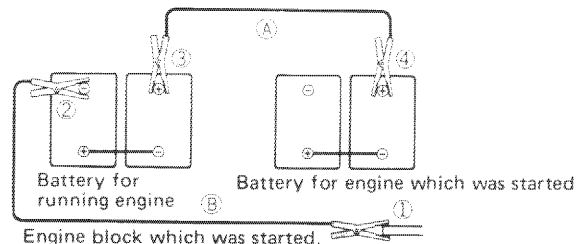

STORAGE

BEFORE STORAGE

To place the machine in storage for an extended period of time, the following measures must be taken to insure that it can be returned to operation with minimum of service.

- After every part is washed and dried, the machine shall be housed in a dry building. Never leave it outdoors.

In case it is indispensable to leave it outdoors, lay wood plates on the ground, and park the machine on the wood plates and cover it with canvas etc.

- Completely fill fuel tank, lubricate and change oil before storage.

- Apply a thin coat of grease to metal surface (hydraulic piston rods and front idler adjusting rods).
- As to batteries, remove the terminals and cover them, or remove them from the machine and store separately.

- When the ambient temperature is anticipated to drop below 0°C, always add antifreeze in the cooling water.
- Set levers and pedals as follows:

★ Gear shift lever	Neutral
★ Fuel control lever	Stop
★ Work equipment lever	Hold
★ Brake pedal	Free
- Put each switch in OFF position.

DURING STORAGE

- Operate the engine and move the machine for a short distance once a month so that new oil film will be coated over movable parts and component surfaces.
- Before operating the working equipment, wipe off the grease on the hydraulic piston rod.



If it is unavoidably necessary to carry out rust-preventive operation while the machine is indoors, open up doors and windows to improve ventilation and prevent the gas poisoning.

AFTER STORAGE

Carry out the following procedure when taking the machine out of long-term storage.

- Wipe off the grease on the hydraulic piston rod.
- Completely fill fuel tank, lubricate and add oil.

- ★ If the machine is stored without carrying out the monthly rust prevention operation, request your Komatsu distributor for service.

COOLANT AND LUBRICANTS

No.	Supplier	Engine Oil [CD or CE] SAE10W, 30, 40 10W30, 15W40 (The 15W40 oil marked * is CE.)	Gear Oil [GL-4 or GL-5] SAE80, 90, 140	Grease [Lithium-Base] NLGI No. 2	Anti-freeze Coolant [Ethylene Glycol Base] Permanent Type
1	KOMATSU	EO10-CD EO30-CD EO10-30CD EO15-40CD	GO90 GO140	G2-LI G2-LI-S	AF-ACL AF-PTL AF PT (Winter, one season type)
2	AGIP	Diesel sigma S Super dieselmulti- grade * Sigma turbo	Rotra MP	GR MU/EP	-
3	AMOCO	* Amoco 300	Multi-purpose gear oil	RYKON premium grease	-
4	ARCO	* Arcofleet S3 plus	Arco HD gear oil	Litholine HEP 2 Arco EP moly D	-
5	BP	Vaneillus C3	Gear oil EP Hypogear EP	Energrease LS-EP2	Antifreeze
6	CALTEX	* RPM delo 400 RPM delo 450	Universal thuban Universal thuben EP	Marfak all purpose 2 Ultra-duty grease 2	AF engine coolant
7	CASTROL	* Turbomax * RX super CRD	EP EPX Hypoy Hypoy B Hypoy C	MS3 Spheerol EPL2	Anti-freeze
8	CHEVRON	* Delo 400	Universal gear	Ultra-duty grease 2	-

COOLANT AND LUBRICANTS

No.	Supplier	Engine Oil [CD or CE] SAE10W, 30, 40 10W30, 15W40 (The 15W40 oil marked * is CE.)	Gear Oil [GL-4 or GL-5] SAE80, 90, 140	Grease [Lithium-Base] NLGI No. 2	Anti-freeze Coolant [Ethylene Glycol Base] Permanent Type
9	CONOCO	* Fleet motor oil	Universal gear lubricant	Super-sta grease	—
10	ELF	Multiperformance 3C Performance 3C	—	Transeif EP Transeif EP type 2	Glacelf
11	EXXON (ESSO)	Essolube D3 * Essolube XD-3 * Essolube XD-3 Extra * Esso heavy duty Exxon heavy duty	Gear oil GP Gear oil GX	Beacon EP2	All season coolant
12	GULF	Super duty motor oil * Super duty plus	Multi-purpose gear lubricant	Gulfcrown EP2 Gulfcrown EP special	Antifreeze and coolant
13	MOBIL	Delvac 1300 * Delvac super 10W-30, 15W-40	Mobilube GX Mobilube HD	Mobilux EP2 Mobilgrease 77 Mobilgrease special	—

No.	Supplier	Engine Oil [CD or CE] SAE 10W, 30, 40 10W30, 15W40 (The 15W40 oil marked * is CE.)	Gear Oil [GL-4 or GL-5] SAE 80, 90, 140	Grease [Lithium-Base] NLGI No. 2	Anti-freeze Coolant [Ethylene Glycol Base] Permanent Type
14	PENNZOIL	* Supreme duty fleet motor oil	Multi-purpose 4092 Multi-purpose 4140	Multi-purpose white grease 705 707L White - Bearing grease	Anti-freeze and summer coolant
15	PETROFINA	FINA kappa TD	FINA potonic N FINA potonic NE	FINA marson EPL2	FINA tamidor
16	SHELL	Rimula X	Spirax EP Spirax heavy duty	Alvania EP grease	-
17	SUN	-	Sunoco GL5 gear oil	Sunoco ultra prestige 2EP Sun prestige 742	Sunoco antifreeze and summer coolant
18	TEXACO	* Ursa super plus Ursa premium	Multigear	Multifak EP2 Starplex 2	Code 2055 startex antifreeze coolant
19	TOTAL	Rubia S * Rubia X	Total EP Total transmission TM	Multis EP2	Antigel/antifreeze
20	UNION	* Guardol	MP gear lube LS	Unoba EP	-
21	VEEDOL	* Turbostar * Diesel star MDC	Multigear Multigear B Multigear C	-	Antifreeze