



OPERATOR'S HANDBOOK

ELECTRONIC
V-MAC® IV
VEHICLE MANAGEMENT
AND CONTROL WITH
CO-PILOT DISPLAY

22196032

© Mack Trucks, Inc. 2014
Printed in U.S.A.

Mack® V-MAC® IV

OPERATOR'S HANDBOOK

22196032



OPERATOR'S HANDBOOK

ELECTRONIC
V-MAC® IV
VEHICLE MANAGEMENT
AND CONTROL WITH
CO-PILOT DISPLAY

22196032
January 2014



Foreword

This manual contains information concerning the operation and function of the Electronic vehicle management and control (V-MAC) IV Vehicle Management and Control with Co-Pilot Display. The information in this manual applies to vehicles built May 2011 and later. Please keep this manual in the vehicle at all times.

Note: Illustrations in this manual are used for reference only and may differ slightly from the actual vehicle. However, key components addressed in this document are represented as accurately as possible.

Mack Trucks, Inc.

Greensboro, NC USA

Order number: PV776-22196032

2014 Mack Trucks, Inc., Greensboro, NC USA

All rights reserved. No part of this publication may be reproduced, stored in retrieval system, or transmitted in any forms by any means, electronic, mechanical, photocopying, recording or otherwise, without the prior written permission of Mack Trucks, Inc.

Contents

Introduction	1
SAFETY INFORMATION.....	2
Service Procedures and Tool Usage.....	3
V-MAC Co-Pilot Operator's Manual	7
SYSTEM OVERVIEW.....	7
System Summary.....	7
SYSTEM COMPONENTS.....	9
Vehicle Electronic Control Unit (VECU).....	9
Engine Control Module (ECM).....	11
INDICATORS, LIGHTS AND DASHBOARD SWITCHES.....	17
Cab and Dashboard Switches.....	17
Electronic Malfunction Indicator.....	19
High Exhaust System Temperature (HEST) Indicator.....	20
Shutdown Warning Indicator.....	21
Engine Derate.....	22
Idle Shutdown Override Switch.....	24
Aftertreatment DPF Smart Switch.....	24
EXHAUST AFTERTREATMENT SYSTEM.....	26
Aftertreatment DPF Regeneration.....	26
Aftertreatment DPF Passive Regeneration.....	27
Aftertreatment DPF Parked Regeneration.....	28
Aftertreatment DPF Inhibit/Stop Regeneration.....	29
Aftertreatment Driver Warning and Inducement.....	37
Aftertreatment DEF Tank Level - Driver Warning & Inducement.....	37
Aftertreatment DEF Quality - Driver Warning & Inducement.....	39
Aftertreatment Tampering - Driver Warning & Inducement.....	41
Misfilling Diesel or Aftertreatment DEF Tanks.....	43
Aftertreatment DPF Regeneration and PTO Operation.....	44
Aftertreatment DPF Regeneration and PTO Engaged.....	45
Aftertreatment System Conditioning (Periodic Heat Mode).....	46
Aftertreatment System Conditioning and PTO Operation.....	47
STARTING THE VEHICLE.....	48
CRUISE AND ENGINE SPEED CONTROL.....	49
Cruise Control.....	50
Engine Speed Control.....	54
Manual Soft Top.....	57
Engine Brake.....	61
ACCESSORY RELAY CONTROL.....	61
PROGRAMMABLE FEATURES.....	62
Cruise 'N Brake Engagement Delay.....	63
Engine High Idle Speed if Stopped.....	63
Engine High Idle Speed in Upper Gears.....	63
Low Idle Adjustment.....	64
Smart Idle Elevated Idle RPM Time.....	65
Idle Shutdown.....	66
Idle Cooldown.....	67

Fan Control	67
Fan Override Switch (Optional).....	68
Daytime Running Lights (DRL) Override Switch (Optional).....	69
Integrated Temp-A- Start (Optional; For Future Support).....	70
Speed Sensor Tamper Detection	70
ELECTRICAL ACCESSORY CONNECTION POINTS	71
Battery Post (BATT)	71
Ignition Post (IGN)	71
Ground Post (GND).....	71
RPM Output	71
Mi/h Output.....	72
SAE/ATA J-1708 Posts (Series Link A and B).....	72
CB Radio Power Jack (CB Radio +) (Located on Dashboard).....	72
CB Radio Ground Jack (CB Radio -) (Located on Dashboard).....	72
INSTRUMENT CLUSTER DISPLAY	73
Dash Cluster Set-Up Programming	73
Instrument Cluster Components	74
Driver Information Display.....	75
CO-PILOT® DISPLAY	76
Introduction and Purpose	76
CO-PILOT SYSTEM OVERVIEW	77
Set-Up Programming	77
CO-PILOT® OPERATIONS	81
Using the Co-Pilot®	81
CO-PILOT SYSTEM OVERVIEW	82
ESC Button	82
Enter (↵) Button	82
Up & Down Buttons	82
CO-PILOT® LAYOUT	83
Screen Types	83
Driver's ID Screens	84
Change Driver ID.....	88
CO-PILOT® START UP SCREENS	90
MACK Logo Intro	90
Theft Deterrent.....	91
GuardDog™ Status	92
Compass Screen	93
Current Conditions.....	94
CO-PILOT® MENU SCREENS	95
Main Menu — Stationary Vehicle	95
Main Menu — Moving Vehicle	96
CO-PILOT® ANYTIME SCREENS	97
Fuel Economy	97
Trip Information.....	98
Gauges.....	100
Black Panel	101
CO-PILOT® STATIONARY SCREENS	102

Fleet Management.....	102
Diagnostics.....	104
Maintenance.....	106
DEL Messages.....	109
Set Up.....	110
CO-PILOT® INTERRUPT SCREENS.....	111
Idle Shutdown Warning.....	111
Driver Overspeed Warning (if Available).....	111
Warning Severe Engine Overspeed.....	112
Engine Brake Overspeed Warning.....	112
Severe Engine & Engine Brake Overspeed Warning.....	113
Maintenance Reminder (for Future Support).....	114
GuardDog™ Monitor.....	114
Low Voltage Disconnect Active.....	115
Inter Wheel Lock.....	115
Smart Idle Active.....	116
Starter Inhibit.....	116
Priority Message in Road Connect (If Available).....	117
Driver Trip Reset.....	117
Trip Advanced.....	118
Idle Cooldown Activated.....	118
Warning Screens.....	119
CO-PILOT® OPTIONAL SYSTEMS SCREENS.....	120
Integrated Temp-A-Start™ (For Future Support).....	120
Road Connect* (if Available).....	121
CO-PILOT® OPERATIONS.....	123
Using the Co-Pilot®.....	123



WARNING

The information in this manual is not all inclusive and cannot take into account all unique situations. Note that some illustrations are typical and may not reflect the exact arrangement of every component installed on a specific chassis.

The information, specifications, and illustrations in this publication are based on information that was current at the time of publication.

No part of this publication may be reproduced, stored in a retrieval system, or be transmitted in any form by any means including (but not limited to) electronic, mechanical, photocopying, recording, or otherwise without prior written permission of MACK TRUCKS, Inc.

2 Introduction

SAFETY INFORMATION

IMPORTANT: Before driving this vehicle, be certain that you have read and that you fully understand each and every step of the driving and handling information in this manual. Be certain that you fully understand and follow all safety warnings.

IT IS IMPORTANT THAT THE FOLLOWING INFORMATION BE READ, UNDERSTOOD AND ALWAYS FOLLOWED.

Cautionary *signal words* (Danger-Warning-Caution) may appear in various locations throughout this manual. Information accented by one of these signal words must be observed to minimize the risk of personal injury to service personnel, or the possibility of improper service methods which may damage the vehicle or cause it to be unsafe. Notes are used to emphasize areas of procedural importance and provide suggestions for ease of repair. The following definitions indicate the use of these advisory labels as they appear throughout the manual:

DANGER

Danger indicates an unsafe practice that could result in serious personal injury or death. A danger advisory banner is in **white** type on a **black** background with a **black** border.

CAUTION

Caution indicates an unsafe practice that could result in damage to the product. A caution advisory is in **black** type on a **white** background with a **black** border.

WARNING

Warning indicates an unsafe practice that could result in personal injury. A warning advisory banner is in **black** type on a **gray** background with a **black** border.

Note: Note indicates a procedure, practice, or condition that must be followed in order for the vehicle or component to function in the manner intended.

Service Procedures and Tool Usage

Anyone using a service procedure or tool not recommended in this manual must first satisfy himself thoroughly that neither his safety nor vehicle safety will be jeopardized by the service method he selects. Individuals deviating in any manner from the instructions provided assume all risks of consequential personal injury or damage to equipment involved.

Also note that particular service procedures may require the use of a special tool(s) designed for a specific purpose. These special tools must be used in the manner described, whenever specified in the instructions.

4 Introduction

DANGER

Before starting a vehicle, always be seated in the driver's seat, place the transmission in neutral, apply the parking brakes, and push in the clutch pedal. Failure to follow these instructions could produce unexpected vehicle movement, which can result in serious personal injury or death.

DANGER

Before working on a vehicle, place the transmission in neutral, set the parking brakes, and block the wheels. Failure to follow these instructions could produce unexpected vehicle movement, which can result in serious personal injury or death.

DANGER

Engine-driven components such as Power Take-Off (PTO) units, fans and fan belts, driveshafts and other related rotating assemblies, can be very dangerous. Do not work on or service engine-driven components unless the engine is shut down. Always keep body parts and loose clothing out of range of these powerful components to prevent serious personal injury. Be aware of PTO engagement or nonengagement status. Always disengage the PTO when not in use.

DANGER

Do not work under a vehicle that is supported only by a hydraulic jack. The hydraulic jack could fail suddenly and unexpectedly, resulting in severe personal injury or death. Always use jackstands of adequate capacity to support the weight of the vehicle.

WARNING

When working on a vehicle by using wireless communication units, it is not always apparent to others that work is in progress on the vehicle. Certain activities, such as activation of certain vehicle components or systems, can cause injury to persons close to the vehicle who are unaware of the ongoing activities. Always keep a connected vehicle under close observation when using wireless communication units and inform other persons in the vicinity of the vehicle about the ongoing activities.

WARNING

The temperature of the exhaust system components during the regeneration process can exceed 500°C (1000°F). Various factors (including ambient air temperature (AAT) and duration of the regeneration process) determine when these components will return to normal operating temperature after regeneration has completed. Be extremely careful around these hot components. Contact with these components can result in serious personal injury.

CAUTION

Before towing the vehicle, place the transmission in neutral and lift the rear wheels off the ground, or disconnect the driveline to avoid damage to the transmission during towing.



CAUTION

When regeneration occurs, the temperature of the exhaust will be elevated. DO NOT park the vehicle with the exhaust outlet under low hanging overhead flammable objects such as trees, awnings, etc., that could be damaged by elevated exhaust temperatures. DO NOT attempt to regenerate inside a garage or enclosed area if the tail pipe is attached to an exhaust ventilation system as the hose material may not be rated for the high temperature.



CAUTION

When the inhibit position is pressed, the DPF switch will remain in a locked position. It is important, therefore, to immediately set the switch back to the neutral position when safe to do so. Failure to set the switch back to the neutral position may result in an engine derate, clogged or damaged DPF.



CAUTION

Failure to perform a regeneration in a timely manner may result in engine derate, clogged Aftertreatment Diesel Particulate Filter (DPF) or damage to the filter.

**REMEMBER, SAFETY . . . IS
NO ACCIDENT!**

6 Introduction

Every possible occurrence that may involve a potential hazard cannot be anticipated. Accidents can be avoided by recognizing potentially hazardous situations and taking necessary precautions. Performing service procedures correctly is critical to technician safety and safe, reliable vehicle operation.

The following list of general shop safety practices can help technicians avoid potentially hazardous situations and reduce the risk of personal injury. **DO NOT** perform any services, maintenance procedures or lubrications until this manual has been read and understood.

- Perform all service work on a flat, level surface. Block wheels to prevent vehicle from rolling.
- **DO NOT** wear loose- fitting or torn clothing. Remove any jewelry before servicing vehicle.
- **ALWAYS** wear safety glasses and protective shoes. Avoid injury by being aware of sharp corners and jagged edges.
- Use hoists or jacks to lift or move heavy objects.
- **NEVER** run engine indoors unless exhaust fumes are adequately vented to the outside.
- Be aware of hot surfaces. Allow engine to cool sufficiently before performing any service or tests in the vicinity of the engine.
- Keep work area clean and orderly. Clean up any spilled oil, grease, fuel, hydraulic fluid, etc.
- Only use tools that are in good condition, and always use accurately calibrated torque wrenches to tighten all fasteners to specified torques. In instances where procedures require the use of special tools which are designed for a specific purpose, use only in the manner described in the instructions.
- Do not store natural gas powered vehicles indoors for an extended period of time (overnight) without first removing the fuel.
- Never smoke around a natural gas powered vehicle.

SYSTEM OVERVIEW

System Summary

The vehicle management and control (V-MAC) IV System is an electronic engine control system consisting of the following major components:

- Engine Control Module (ECM)
- Gauge Driver Module GDM (MRU and LEU models only)
- Instrument Cluster
- Vehicle Electronic Control Unit (VECU)

To enable vehicle management and control (V-MAC) IV to perform its engine management and control functions, the following sensors provide information to the system.

- Air Brake Application Sensor
- Air Suspension Sensor
- Air- Humidity Sensor
- Ambient Air Temperature (AAT) Sensor
- Intake Manifold Pressure (IMP) Sensor
- Intake Manifold Air Temperature Sensor
- Camshaft Position (CMP) Sensor
- Engine Coolant Level (ECL) Sensor
- Engine Coolant Temperature (ECT) Sensor
- Crankshaft Position (CKP) Sensor
- EGR Temperature Aftercooler Sensor
- Crankcase Pressure (CCP) Sensor
- Engine Exhaust Gas Recirculation (EGR) Differential Pressure Sensor
- Front Drive Axle Temperature Sensor
- Fuel Pressure Sensor

8 V-MAC Co-Pilot Operator's Manual

To enable vehicle management and control (V-MAC) IV to perform its engine management and control functions, the following sensors provide information to the system.

- Interior Cab Temperature Sensor (Optional)
- Engine Oil Level (EOL) Sensor
- Engine Oil Temperature (EOT) Sensor
- Engine Oil Pressure (EOP)
- Primary and Secondary Air Pressure Sensor
- Rear Drive Axle Temperature Sensor
- Accelerator Pedal Position (APP) Sensor
- Transmission Oil Temperature Sensor
- Engine Turbocharger Speed Sensor
- Vehicle Speed (Road Speed) Sensor
- Water in Fuel Filter Sensor

The following switches and functions are also monitored to provide information related to driver actions.

- A/C Pressure Switch (Optional)
- Clutch Pedal Position (CPP) Switch
- Engine Brake Low and High Switch (Optional)
- Fan Clutch Override Switch (Optional)
- Idle Shutdown Override Switch (Optional)
- Ignition key
- Power Takeoff (PTO) Switches (Optional)
- Service Brake and Parking Brake Switches
- Set/Resume Switch
- Speed Control On/Off Switch
- Starter Engaged Switch Input (Optional)
- Torque Limiting Switch (Optional)

This manual provides a complete description of the system components, their functions and locations on the vehicle.

SYSTEM COMPONENTS

Vehicle Electronic Control Unit (VECU)

The Vehicle Electronic Control Unit (VECU) is mounted underneath panel D as shown in . (CHU/CXU/GU model shown.)

The Vehicle Electronic Control Unit (VECU) is an electronic control module which provides a wide variety of functions including:

- Cruise Control
- Diagnostic Trouble Code (DTC) Logging
- Differential Locking
- Idle Shutdown
- Maintenance Information
- Road Speed Limiting
- Speed Control
- Theft Deterrence

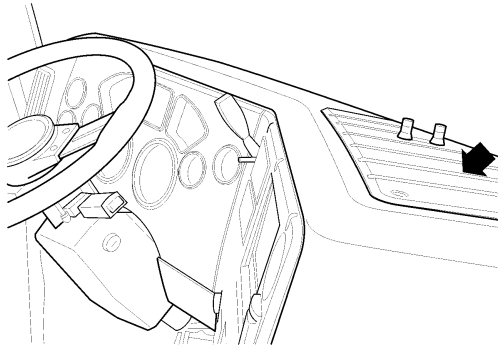

C0035358

VECU Location

10 V-MAC Co-Pilot Operator's Manual

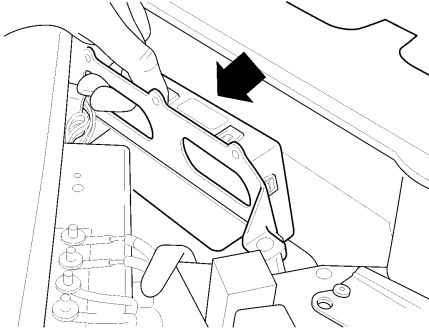

C0035359

VECU

Engine Control Module (ECM)

The Engine Control Module (ECM) is located to the left side of the engine and is mounted to the fuel cooler, which is mounted beneath the inlet manifold (see graph reference). The ECM provides the following information and functions:

- Intake Manifold Pressure (IMP)
- Engine Coolant Level (ECL)
- Engine Coolant Temperature (ECT)
- Customer Road Speed Limiting
- Diagnostic Trouble Code (DTC) Logging
- Engine Oil Pressure (EOP)
- Engine Oil Temperature (EOT)
- Engine Protection
- Engine Shutdown
- Engine Sleep Mode
- Engine Speed (RPM) Control (based on commands from vehicle electronic control unit (VECU))
- Exhaust Aftertreatment System (not all aftertreatment functions are controlled by the ECM)
- Fan Control
- Fuel Control
- Fuel Temperature
- Timing Control
- Vehicle Limiting Speeds

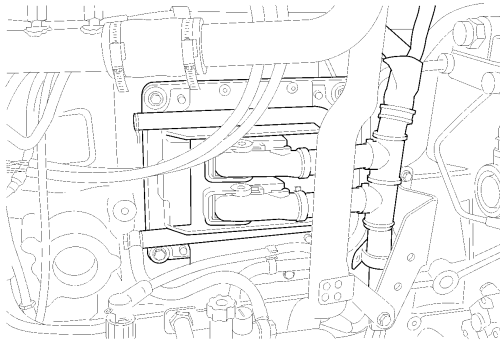

C0035356

Engine Control Module (ECM) Location

12 V-MAC Co-Pilot Operator's Manual

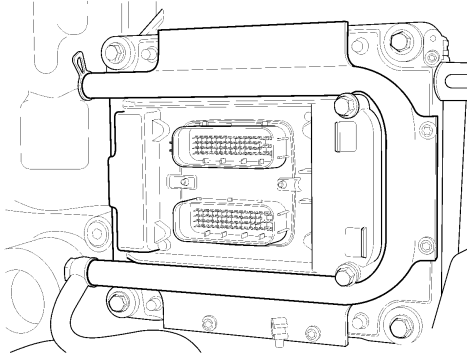

C0035360

Engine Control Module (ECM) (MACK MP7)

Instrument Cluster

The vehicle management and control (V-MAC) IV Instrument Cluster is a one-piece unit composed of gauges and an information display. The Instrument Cluster receives information from the VECU and EECU and then sends information back to the VECU and EECU. Information is displayed when required or requested via a stalk switch (Co-Pilot® only).

The Instrument Cluster provides the following information:

- Air Brake Application (Optional)
- Air Filter Restriction
- Air Suspension Pressure
- Axle Oil Temperature (Optional)
- Brake Wear
- Coolant Temperature (via EECU)
- Engine and Vehicle Speed Display
- Exhaust Temperature (Optional)
- Fuel Level
- High Beam Status
- High Exhaust System Temperature (HEST)
- Integrated Temp-A-Start™ (Optional)
- Interior and Outside Temperature
- Oil Pressure (via EECU)
- Primary and Secondary Air Pressure
- Speedometer and Tachometer Outputs
- Transmission Oil Temperature (Optional)
- Vehicle Distance

14 V-MAC Co-Pilot Operator's Manual

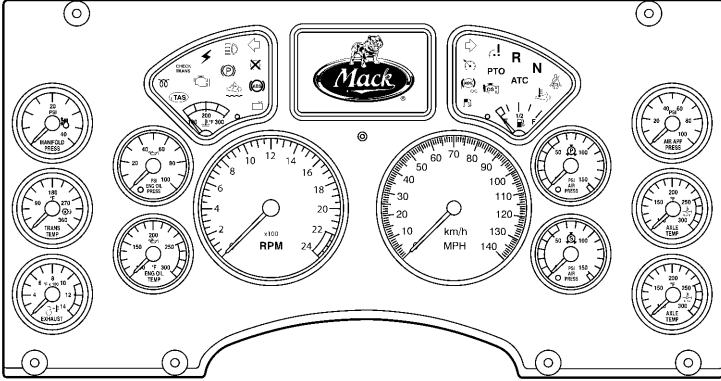

W3036315

Instrument Cluster Module

Gauge Driver Module (GDM)

The vehicle management and control (V-MAC) IV (GDM) is a black box controller used in the LEU and MRU model chassis. The GDM contains a warning light bar, an hour meter located in the tachometer and an odometer located in the speedometer. A separate push button is available to toggle through different functions such as to retrieve fault codes and view trip information.

The GDM provides the following information:

- Air Brake Application
- Air Cleaner Restriction
- Air Suspension Pressure
- Axle Oil Temperature
- Brake Wear
- Engine Coolant Temperature (ECT) (via engine control module (ECM))
- Engine and Vehicle Speed Display
- Engine Exhaust Gas Temperature (EGT)
- Fuel Level
- High Beam Status
- High Engine EGT
- Engine Oil Pressure (via ECM)
- Primary and Secondary Air Pressure
- Speedometer and Tachometer Outputs
- Transmission Oil Temperature
- Vehicle Distance

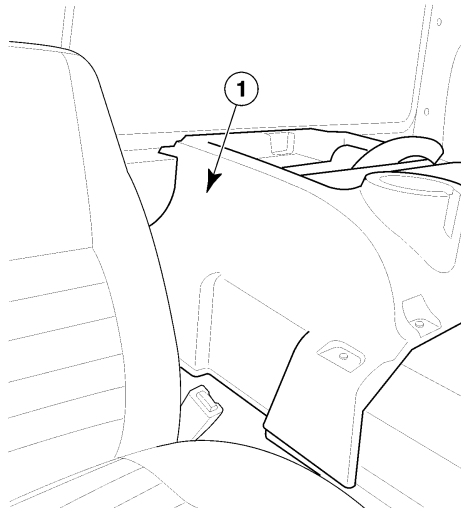

C0035357

Figure 6 — Location of GDM (Passenger Side Against Back of Cab)

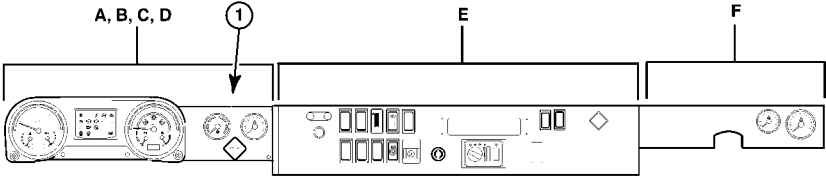

C0035431

Figure 7 — Location of GDM

INDICATORS, LIGHTS AND DASHBOARD SWITCHES

Cab and Dashboard Switches

Various functions of the vehicle management and control (V-MAC) IV system are controlled by the operator through switches located on the dashboard (CHU/CXU/GU model shown in Figure 8). These functions include:

- Cruise Control
- Daytime Running Lights Overrides (Optional)
- Engine Brake Operation (Optional)
- Engine Speed (RPM) Control
- Exhaust Aftertreatment System
- Fan Override (Optional)
- Idle Shutdown Override Operation (Optional)
- Integrated Temp-A-Start™ (Optional)
- PTO Operation

Cruise control and engine speed control functions are explained in this manual in “CRUISE AND ENGINE SPEED CONTROL”, page 49.

In addition to these operator-selectable switches, additional switches provide information to the Vehicle Electronic Control Unit (VECU) through normal driving activities such as applying the service brakes, parking brakes or disengaging the clutch. The location of these switches is as follows:

- Clutch pedal position (CPP) switch
- Parking brake switch, located in line within the parking brake circuit
- Service brake switch, located in line within the brake system

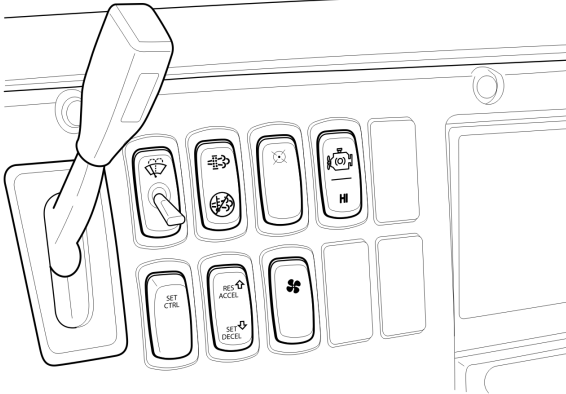

W2076077

Figure 8 — Cab and Dashboard Switches (Example)

Electronic Malfunction Indicator

The electronic malfunction indicator, amber in color, illuminates to alert the driver of an electrical problem with the vehicle management and control (V-MAC) IV system. The vehicle management and control (V-MAC) IV system does a self-test when the ignition key is turned to the ON position. The electronic malfunction indicator stays on while this test is being performed (approximately six seconds). After the self-test is completed, the indicator will turn off and remain off unless a problem is detected by vehicle management and control (V-MAC) IV. If the indicator turns on while the vehicle is being driven, vehicle management and control (V-MAC) IV has detected a problem. In most circumstances, the vehicle will operate even though the indicator is on; however, engine performance may be affected.

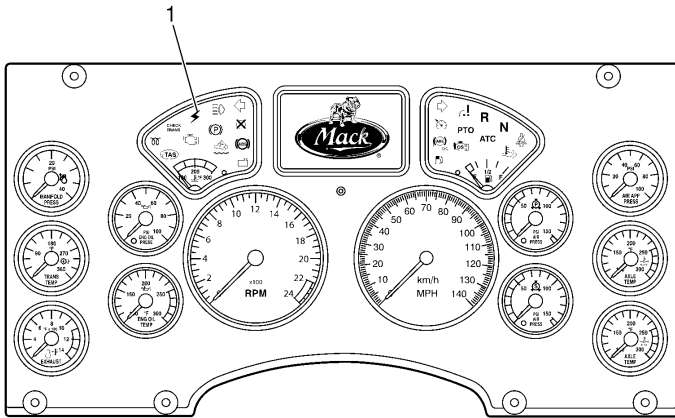

W3036326

Figure 9 — Electronic Malfunction Indicator

High Exhaust System Temperature (HEST) Indicator

The High Exhaust System Temperature (HEST) indicator, amber in color, illuminates to alert the driver when engine exhaust gas temperatures (EGT) are high. The HEST indicator will also illuminate during a aftertreatment diesel particulate filter (DPF) parked regeneration event and will turn off after the regeneration is completed and the exhaust EGT has returned to normal. For additional information about the HEST indicator, please refer to “Aftertreatment DPF Smart Switch”, page 24.

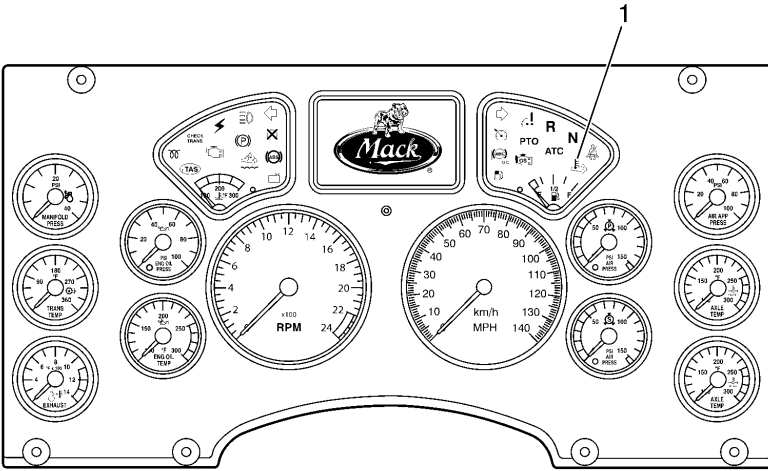

W3036496

Figure 10 — High Exhaust System Temperature (HEST) Indicator

Shutdown Warning Indicator

The Shutdown Warning indicator, red in color, illuminates if the engine coolant level (ECL) is below the minimum level allowed, the engine oil pressure (EOL) is below the minimum allowed, the engine coolant temperature (ECT) or aftertreatment diesel particulate filter (DPF) soot level trigger are above the maximum allowed. Some vehicles also have optional shutdown functions available when the transmission temperature or engine exhaust gas temperatures (EGT) are above maximum allowable limits.

During a shutdown event, vehicle management and control (V-MAC) IV also provides an audible alarm. The alarm will also sound and the red shutdown indicator will turn on when vehicle management and control (V-MAC) IV detects a problem or excessive periods of idling. Shutting the engine down is warranted.

The shutdown warning indicator is usually located on the left-hand side on the dash cluster.

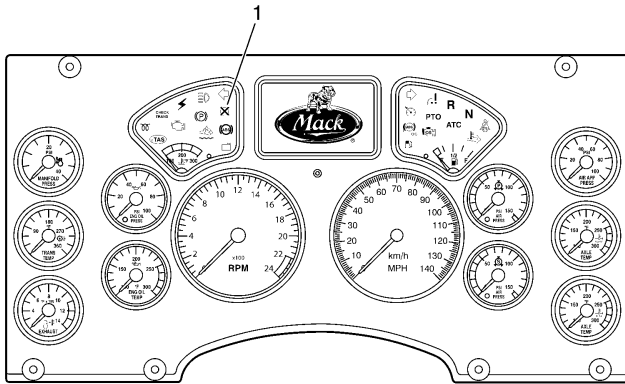

W3036501

1. Engine Shut down Indicator (RED)

Vehicle management and control (V-MAC) IV can be programmed to actually shut down the engine if conditions warrant (low coolant, low EOL, high engine oil temperature (EOT), high ECT, high engine EGT or high automatic transmission oil temperature if so equipped). Shutdown is mandatory for crankcase pressure (CCP). With this option enabled, the engine will automatically shut down within approximately 30 seconds after the red SHUTDOWN indicator turns on and the alarm activates (provided the vehicle is not moving above the road speed threshold).

22 V-MAC Co-Pilot Operator's Manual

Engine Derate

For some conditions (see table below), an engine derate can occur first and if a condition worsens, then an engine shutdown can occur.

CONDITION	ENGINE DERATE	ENGINE SHUTDOWN	INDICATOR LIGHTS
Intake Manifold Air Temperature	Derate starts at 120°C (248°F). Full derate (100%) occurs when temperature is at 140°C (284°F).	No engine shutdown.	No warning indicators.
Engine Turbocharger Compressor Outlet Temperature	Derate starts at 245°C (473°F). Torque is derated down to 100% at 250°C (482°F).	No engine shutdown.	No warning indicators.
Engine Exhaust Gas Recirculation (EGR) Temperature	If temperature exceeds 220°C (428°F) for more than 20 seconds with a 30 second period, derate starts.	No engine shutdown.	No warning indicators.
	If temperature reaches 240°C (464°F), a 100% derate occurs.		
Crankcase Pressure (CCP)	If a change in pressure (difference between the CCP and barometric pressure (BARO)) rises about 5 kPa (0.725 psi) with an offset & 0.5 kPa/s (0.07 psi/s) and stays over 5 kPa (0.725 psi) for more than 80% of the time during 1 second, the engine will fully derate (100%), be forced to idle, and shut down.	Engine shutdown.	Red engine shutdown indicator.
High Engine Coolant Temperature (ECT)	Derate starts at 106.75°C (224.15°F) and ramps down to 12% derate. Torque is kept constant until the temperature reaches 107.25°C (225.05°F).		Amber malfunction indicator lights at 107.2°C (224.96°F).
	Derate starts again at 107.4°C (225.32°F) and ramps down to 32% derate.		Red engine shutdown indicator lights at 108°C (226.4°F).
	Torque is derated down to 100% at 108.4°C (227.12°F).		Engine shutdown if temperature rises to 109°C (228.2°F).

CONDITION	ENGINE DERATE	ENGINE SHUTDOWN	INDI-CATOR LIGHTS
Engine Oil Temperature (EOT)	Derate starts with 10% derate at 129°C (264.2°F) or more for 75% of a 4 second period. At 132°C (269.6°F) a 100% derate occurs.	Engine shutdown if temperature rises to 135°C (275°F).	Amber malfunction indicator lights when temperature is at 129°C (264.2°F).
			Red engine shutdown indicator lights when temperature is at 131°C (267.8°F).
Aftertreatment Diesel Particulate Filter (DPF) Soot	For Catalyzed ATS: Derate starts when soot trigger ratio is 1.4 and continues down to 20% derate.		Amber malfunction indicator lights up when soot trigger ratio is 1.4.
	For Catalyzed ATS: Torque is ramped down to 80% derate when soot trigger ratio is 1.7.		Red engine shutdown indicator lights up when soot trigger ratio is 1.7.
	For Non-Catalyzed ATS: Derate starts when soot trigger ratio is 1.15.		Amber malfunction indicator lights up when soot trigger ratio is 1.15.
	For Non-Catalyzed ATS: Torque is ramped down to 40% derate when soot trigger ratio is 1.20. Full derate occurs when soot trigger ratio is 1.22.		Red engine shutdown indicator lights up when soot trigger ratio is at 1.22.
Engine Turbocharger Wheel	For 11 and 13 liter engines, derate starts at 129,500 RPM. Full derate (100%) occurs at 130,500 RPM. For 16 liter engines, derate starts at 102,500 RPM. Full derate (100%) occurs at 103,500 RPM.	No engine shutdown.	No warning indicators.
* - ATS (Aftertreatment System). Please refer to page 26 for information on the Exhaust Aftertreatment System.			

Idle Shutdown Override Switch

The idle shutdown override switch permits the operator to override an idle shutdown.

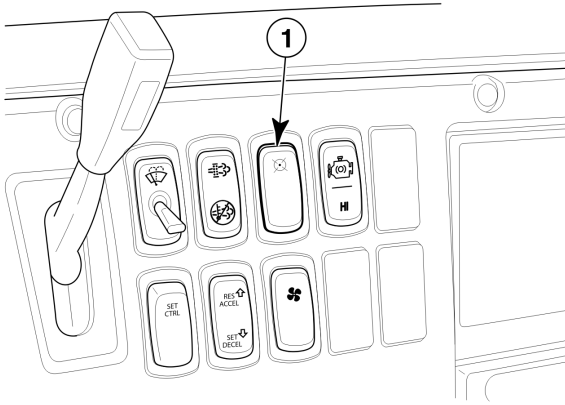

W2076075

Figure 13 — Panel Idle Shutdown Override Switch

Aftertreatment DPF Smart Switch

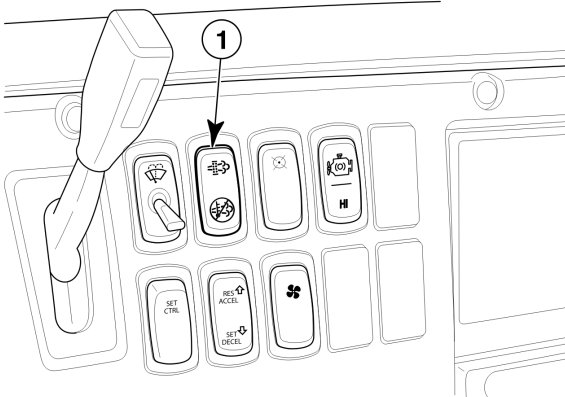

W2076076

Figure 14 — Aftertreatment DPF Smart Switch

The aftertreatment diesel particulate filter (DPF) smart switch is a three-position rocker switch where the UP position is momentary, the MIDDLE position is neutral (standby mode) and the DOWN position is locked. The switch allows the operator to interface with the vehicle's exhaust aftertreatment system.

The switch has several functions as outlined below.

- Indicates that a an aftertreatment DPF regeneration is needed or has started when the icons on the switch are illuminated.
- Indicates that a regeneration has been stopped when the DOWN position of the switch is pressed, locked and illuminated.
- Stops a regeneration event when the DOWN position of the switch is pressed, locked and illuminated.
- Starts an aftertreatment DPF manual regeneration event when the switch is momentarily pressed to the UP position.
- Goes into standby mode and waits for regeneration when the switch is in the MIDDLE position.

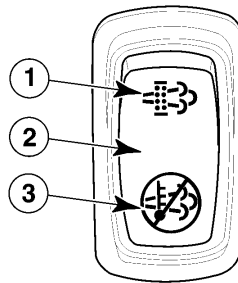

C0035425

Figure 15 — DPF Smart Switch

For additional information on the Aftertreatment DPF Smart Switch and Regeneration, please refer to “EXHAUST AFTERTREATMENT SYSTEM”, page 26.

EXHAUST AFTERTREATMENT SYSTEM

Aftertreatment DPF Regeneration

A DPF in the exhaust is used to meet environmental protection agency (EPA) requirements to help reduce soot and particulate emissions into the atmosphere. The particulates are typically removed by collecting in a DPF, with continuous or periodic regeneration of the filter. The electrical and exhaust aftertreatment system set up of the vehicle will determine when regeneration is required. When regeneration is needed, the icons on the DPF Smart switch will light up momentarily to notify the driver and then shut off during regeneration. The high exhaust system temperature (HEST) indicator will light up on the instrument cluster to warn of high exhaust temperatures (when vehicle speed is less than 8 km/h [**5 mi/h**] or when parked). Depending on the vehicle's aftertreatment setup, regeneration can be performed while moving or when the vehicle is parked. Below is general information about the exhaust aftertreatment systems.

For non-catalyzed exhaust aftertreatment systems

- Vehicle speed must be at least 8 km/h (**5 mi/h**) in order for the passive regeneration to start.
- Icons on the DPF Smart switch will momentarily light up and then shut off during the regeneration.
- HEST indicator on instrument cluster will light up to warn of high exhaust temperatures when vehicle speed is 8 km/h (**5 mi/h**) or less. HEST indicator will shut off when vehicle speed is 16 km/h (**10 mi/h**) or higher.
- Engine speed (RPM) will remain at idle during regeneration (for parked regeneration).

For catalyzed exhaust aftertreatment systems

- Vehicle speed must be at least 40 km/h (**25 mi/h**) in order for the passive regeneration to start.
- Engine coolant temperature (ECT) is 35°C (**95°F**) or higher.
- Icons on the DPF Smart switch will momentarily light up and then shut off during the regeneration.
- HEST indicator on instrument cluster will light up to warn of high exhaust temperatures when vehicle speed is 8 km/h (**5 mi/h**) or less. HEST indicator will shut off when vehicle speed is 16 km/h (**10 mi/h**) or higher.
- Engine speed will ramp up to around 1,100 RPM during regeneration (for parked regeneration).

Aftertreatment DPF Passive Regeneration

Aftertreatment diesel particulate filter (DPF) passive regeneration can be automatic (no operator input needed to start regeneration) or manual (operator input needed to start regeneration). The operator is notified that a regeneration is needed when the icons on the DPF Smart switch illuminate.

Please refer to the instructions below on how to use the DPF Smart switch for passive regenerations.

Passive (Automatic) Regeneration

- 1 When the icons on the DPF Smart switch light up, maintain vehicle speed.
- 2 During regeneration, the icons on the switch will shut off.
- 3 Regeneration will take between 20 and 30 minutes to complete.
- 4 If the regeneration process needs to be stopped and performed at a later time, please refer to “Aftertreatment DPF Inhibit/Stop Regeneration”, page 29 for information.

Moving (Manual) Regeneration (If Available)

- 1 When the icons on the DPF Smart switch light up, maintain vehicle speed and press and hold the top part of the switch momentarily.
- 2 During regeneration, the icons on the switch will shut off.
- 3 Regeneration will take between 20 and 30 minutes to complete.
- 4 If the regeneration process needs to be stopped and performed at a later time, please refer to “Aftertreatment DPF Inhibit/Stop Regeneration”, page 29 for information.

Note: Depending on the vehicle's configuration, it may be possible to perform a parked regeneration if necessary.

Aftertreatment DPF Parked Regeneration

Aftertreatment diesel particulate filter (DPF) parked regeneration allows the operator to start and/or stop the regeneration manually when the vehicle is parked. The operator is notified that a regeneration is needed when the icons on the DPF Smart switch illuminate. The operator should perform the regeneration as soon as possible.

Please refer to the instructions below on how to use the DPF Smart switch for parked regenerations.

- 1 Move the vehicle to a safe location, apply the park brake and allow the engine to idle.

Note: When a regeneration is in process, the engine exhaust gas temperature (EGT) will be elevated. DO NOT park the vehicle with the exhaust outlet under low hanging overhead flammable objects such as trees, awnings, etc., that could be damaged by elevated exhaust temperatures. DO NOT attempt to regenerate inside a garage or enclosed area if the tail pipe is attached to an exhaust ventilation system as the hose material may not be rated for the high temperature.

- 2 Press and hold the top part of the DPF Smart switch momentarily to initiate the regeneration.
- 3 During regeneration, the icons on the switch will shut off. The high exhaust system temperature (HEST) indicator on the instrument cluster will light up to notify of high exhaust temperatures.
- 4 For catalyzed exhaust aftertreatment systems, the engine speed (RPM) will ramp up to around 1,100 RPM. For non-catalyzed exhaust aftertreatment systems, the engine will continue to idle during the regeneration.
- 5 Regeneration will take between 20 and 30 minutes to complete.
- 6 After regeneration has completed and the exhaust temperature has returned to normal, the HEST indicator will shut off.
- 7 If the regeneration process needs to be stopped and performed at a later time, please refer to “Aftertreatment DPF Inhibit/Stop Regeneration”, page 29 for information.



CAUTION

Failure to perform an aftertreatment DPF regeneration in a timely manner after notification may result in engine derate, clogged or damaged DPF, and engine shutdown.

Aftertreatment DPF Inhibit/Stop Regeneration

Aftertreatment diesel particulate filter (DPF) regeneration, whether the moving or parked variety, can be stopped if the vehicle is equipped with a DPF Smart switch (refer to “Aftertreatment DPF Smart Switch”, page 24 for more information). A regeneration should be stopped only when necessary. To stop a regeneration that is in progress, press the DPF Smart switch to the DOWN position. The switch will lock into the DOWN position, and the icon on the bottom of the switch will be illuminated to indicate regeneration has been stopped.

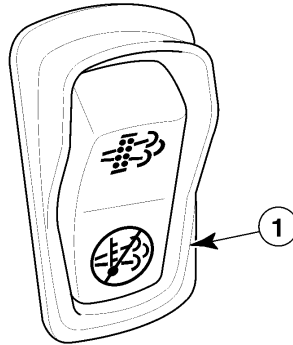



C0035426

Figure 16 — Inhibit/Stop Regeneration

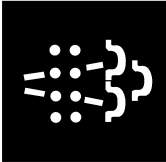
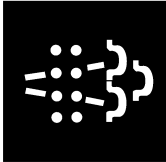
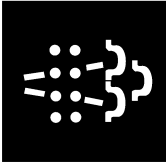
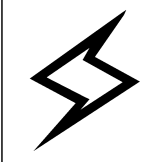
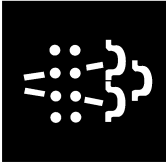

 CAUTION
<p>When the DPF Smart Switch is pressed to the DOWN position, the switch will remain locked in this position and prevent aftertreatment DPF regeneration from occurring. Therefore, it is important to press the switch back to the middle position and to return it to standby mode when safe to do so. Failure to set the switch back to the MIDDLE position may result in engine derate, a clogged Aftertreatment Diesel Particulate Filter (DPF), damage to the filter and engine shutdown.</p>

 CAUTION
<p>Failure to perform a aftertreatment DPF regeneration in a timely manner may result in engine derate, a clogged or damaged DPF, damage to the filter and engine shutdown.</p>

If the operator stops or inhibits regeneration repeatedly, the DPF will begin to clog with soot and engine exhaust gas pressure will increase. Eventually the engine will derate and ultimately shut down. Below is a quick look at the type of regenerations, conditions of the exhaust aftertreatment system and the action to be taken.

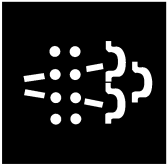
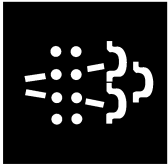
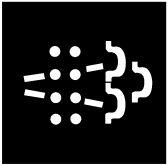
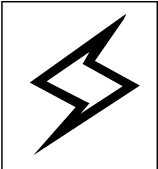
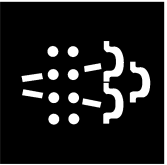

AFTERTREATMENT DPF PASSIVE REGENERATION (AUTOMATIC)						
Soot Load Level	Level 1	Level 2	Level 3		Level 4	
Indicators	(Solid) 	(Flashing) 	(Flashing) 	(Amber) 	(Flashing) 	(Red) 
Aftertreatment System Condition	Regeneration needed. DPF is becoming full.	Regeneration is required. DPF is full.	Aftertreatment System Service Required. Engine Derate Active. Engine Performance is limited. Soot Level High. DPF is overfull.		Aftertreatment System Service Required. Engine Derate Active. Soot Level is Critically High. DPF may be over its maximum capacity. Engine may shut down.	

AFTERTREATMENT SYSTEM PASSIVE REGENERATION (AUTOMATIC)				
Soot Load Level	Level 1	Level 2	Level 3	Level 4
Action to Take	<p>Continue to drive or park the vehicle in a safe location away from overhanging objects (park brake applied) and allow the engine to run and the regeneration to complete.</p> <p>Note: Failure to perform the regeneration will take the Aftertreatment System to Level 2.</p>	<p>Continue to drive or park the vehicle in a safe location away from overhanging objects (park brake applied) and allow the engine to run and the regeneration to complete.</p> <p>Note: Failure to perform the regeneration will take the Aftertreatment System to Level 3.</p>	<p>Perform a parked manual regeneration IMMEDIATELY to avoid further engine derate and damage to the DPF.</p> <p>Note: Failure to perform the regeneration will take the Aftertreatment System to Level 4.</p>	<p>A serious engine problem has occurred. <i>Seek service immediately.</i></p> <p>Note: Parked regeneration is no longer possible for the operator.</p>
Regeneration Condition	<p>If passive regeneration is allowed to run, the following normal processes may be observed.</p> <ul style="list-style-type: none"> • HEST indicator will turn off if vehicle speed is 16 km/h (10 mi/h) or higher. • DPF Smart switch indicator will shut off during the regeneration. • Regeneration takes between 20 and 30 minutes to complete. 			

AFTERTREATMENT SYSTEM PASSIVE REGENERATION (MANUAL) (IF AVAILABLE)						
Soot Load Level	Level 1	Level 2	Level 3		Level 4	
Indicators	(Solid) 	(Flashing) 	(Flashing) 	(Amber) 	(Flashing) 	(Red) 
Aftertreatment System Condition	Regeneration needed. DPF is becoming full.	Regeneration is required. DPF is full.	Aftertreatment System Service Required. Engine Derate Active. Engine Performance is limited. Soot Level High. DPF is overfull.		Aftertreatment System Service Required. Engine Derate Active. Soot Level is Critically High. DPF may be over its maximum capacity. Engine may shut down.	

AFTERTREATMENT SYSTEM PASSIVE REGENERATION (MANUAL) (IF AVAILABLE)

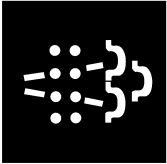
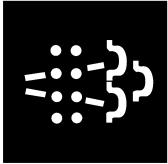
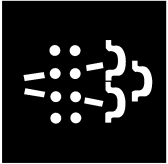
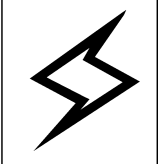
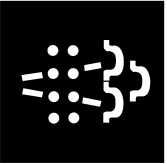
Soot Load Level	Level 1	Level 2	Level 3	Level 4
Action to Take	<p>Continue to drive and hold the top of the DPF Smart switch momentarily. Alternatively, park the vehicle in a safe location away from overhanging objects (park brake applied). Press and hold the top of the DPF Smart switch momentarily.</p> <p>Note: Failure to perform the regeneration will take the Aftertreatment System to Level 2.</p>	<p>Continue to drive or park the vehicle in a safe location away from overhanging objects (park brake applied) and allow the engine to run and the regeneration to complete.</p> <p>Note: Failure to perform the regeneration will take the Aftertreatment System to Level 3.</p>	<p>Perform a parked manual regeneration IMMEDIATELY to avoid further engine derate and damage to the DPF.</p> <p>Note: Failure to perform the regeneration will take the Aftertreatment System to Level 4.</p>	<p>A serious engine problem has occurred. <i>Seek service immediately.</i></p> <p>Note: Parked regeneration is no longer possible for the operator.</p>
Regeneration Condition	<p>If moving manual regeneration is allowed to run, the following normal processes may be observed.</p> <ul style="list-style-type: none"> • HEST indicator will turn off if vehicle speed is 16 km/h (10 mi/h) or higher. • DPF Smart switch indicator will shut off during the regeneration. • Regeneration takes between 20 and 30 minutes to complete. 			

AFTERTREATMENT SYSTEM PARKED REGENERATION (MANUAL)						
Soot Load Level	Level 1	Level 2	Level 3		Level 4	
Indicators	(Solid) 	(Flashing) 	(Flashing) 	(Amber) 	(Flashing) 	(Red) 
Aftertreatment System Condition	Regeneration needed. Aftertreatment Diesel Particulate Filter (DPF) is becoming full.	Regeneration is required. DPF is full.	Aftertreatment System Service Required. Engine Derate Active. Engine Performance is limited. Soot Level High. DPF is overfull.		Aftertreatment System Service Required. Engine Derate Active. Soot Level is Critically High. DPF may be over its maximum capacity. Engine may shut down.	

AFTERTREATMENT SYSTEM PARKED REGENERATION (MANUAL)				
Soot Load Level	Level 1	Level 2	Level 3	Level 4
Action to Take	<p>Park the vehicle in a safe location away from overhanging objects (park brake applied). Press and hold the top of the DPF Smart switch momentarily. Allow the DPF regeneration process to complete.</p> <p>Note: Failure to perform the regeneration will take the Aftertreatment System to Level 2.</p>	<p>Park the vehicle in a safe location away from overhanging objects (park brake applied). Press and hold the top of the DPF Smart switch momentarily. Allow the DPF regeneration process to complete.</p> <p>Note: Failure to perform the regeneration will take the Aftertreatment System to Level 3.</p>	<p>Perform a parked aftertreatment diesel particulate filter (DPF) regeneration IMMEDIATELY to avoid further engine derate and damage to the DPF.</p> <p>Note: Failure to perform the DPF regeneration will take the Aftertreatment System to Level 4.</p>	<p>A serious engine problem has occurred. <i>Seek service immediately.</i></p> <p>Note: Parked DPF regeneration is no longer possible for the operator.</p>

AFTERTREATMENT SYSTEM PARKED REGENERATION (MANUAL)

Aftertreatment diesel particulate filter (DPF) regeneration Condition

If parked manual aftertreatment diesel particulate filter (DPF) regeneration is allowed to run, the following normal processes may be observed.

- Engine speed (RPM) will ramp up to around 1,100 RPM and stay there until the DPF regeneration process is complete.**
- HEST indicator will turn on to warn of high engine exhaust gas temperature (EGT) and will stay on during aftertreatment diesel particulate filter (DPF) regeneration.
- DPF Smart switch indicator will shut off during the aftertreatment diesel particulate filter (DPF) regeneration.
- Aftertreatment diesel particulate filter (DPF) regeneration takes between 20 and 30 minutes to complete.
- HEST indicator will turn off after aftertreatment diesel particulate filter (DPF) regeneration is complete and exhaust temperatures have returned to normal.

** Engine speed ramp up condition for catalyzed exhaust aftertreatment systems



Aftertreatment Driver Warning and Inducement

Aftertreatment DEF Tank Level - Driver Warning & Inducement



Aftertreatment DEF tanks are sized to have no less than two times the diesel fuel tank mileage or one hour range.

The vehicle instrument cluster has an aftertreatment DEF tank level gauge.



Note: Repeated acts of tampering will result in more severe Inducement.

Triggers	Aftertreatment DEF Tank Low Level Indicator	Driver Information Display Screen
100% to 12 % Aftertreatment DEF Tank Level Gauge	None	None
<=12 % Aftertreatment DEF Tank Level Gauge	 <p style="text-align: center; font-size: small;">W2029416</p> <p style="text-align: center;">Solid indicator</p>	DEF Tank Level Low Refill DEF Soon to Prevent Engine Derate
0% Aftertreatment DEF Tank Level Gauge (~1% DEF Remaining)	 <p style="text-align: center; font-size: small;">W2029415</p> <p style="text-align: center;">Blinking indicator</p>	DEF Tank Empty Refill DEF to avoid 5 Mph Limit Engine in Derate





38 V-MAC Co-Pilot Operator's Manual

Triggers	Aftertreatment DEF Tank Low Level Indicator	Driver Information Display Screen
DEF tank empty and refueling event with parking brake applied	 <small>W2029415</small>	Refill DEF Tank Vehicle Speed Limited to 5 Mph
Vehicle Stationary for 20 minutes or Engine re-start (Key OFF, Key ON)	 <small>W2029415</small>	Refill DEF Tank Vehicle Speed Limited to 5 Mph

Aftertreatment DEF Quality - Driver Warning & Inducement

Triggers	Aftertreatment DEF Quality Indicator	Driver Information Display Screen
Good DEF Quality	None	None
Poor DEF Quality DTC Initial Detected	 <small>W3 031 623</small>	SCR Performance Low Engine will Derate in ___ mins
Poor DEF Quality DTC Initial Detected + 1 hours	 <small>W3 031 623</small>	SCR Performance Low Engine In Derate 5 Mph Limit in ___ mins Note: Once this DEF Quality fault occurs the DID timer displays. The timer displays the minutes available before the 5 mph derate occurs. The timer can be cleared using the Escape (ESC) button on the stalk switch control lever. When the vehicle is restarted after shutdown the remaining minutes before derate occurs will reappear. For additional DID information refer to the Driver Information Display Manual.
Poor DEF Quality DTC Initial Detected + 4 hours	 <small>W3 031 623</small>	SCR Performance Low Repair needed 5 Mph limit next Vehicle Stop

40 V-MAC Co-Pilot Operator's Manual

Triggers	Aftertreatment DEF Quality Indicator	Driver Information Display Screen
Refueling Event with Parking Brake ON	 <small>W3 031 623</small>	SCR Performance Low Service SCR System Veh Speed Limited to 5 Mph
Vehicle Stationary for 20 minutes or Engine re-start (Key OFF, Key ON)	 <small>W3 031 623</small>	SCR Performance Low Service SCR System Veh Speed Limited to 5 Mph
Temporary Exit from 8 Km/h (5 mph) Inducement	 <small>W3 031 623</small>	SCR Performance Evaluation Continue Driving. 5 Mph Limit Temporarily Removed
Ignition Key Cycle	 <small>W3 031 623</small>	SCR Performance Low Service SCR System Veh Speed Limited to 5 Mph
First start after the key cycle (one time only)	 <small>W3 031 623</small>	SCR Performance Evaluation Continue Driving. 5 Mph Limit Temporarily Removed

Exit conditions for DEF Quality "8 Km/h (5 mph) road speed limit" Inducement:

Next 1 Engine Starts: Return to 25% torque reduction until there is a proper DEF quality evaluation. If poor DEF quality is detected during the next monitoring cycle then 8 Km/h (5 mph) is resumed after the vehicle is stationary for 20 minutes. After one engine start has been exhausted then a Tech Tool is required to exit the 8 Km/h (5 mph) road speed limit.



With Tech Tool DTC Clearing: Invoke 25% torque reduction until there is a proper DEF quality evaluation. If poor DEF Quality is detected during the next monitoring cycle then 8 Km/h (5 mph) is resumed after the vehicle is stationary for 20 minutes.

Aftertreatment Tampering - Driver Warning & Inducement

When the SCR tampering fault is active for one or more hours a new Driver Information Display screen appears. The text changes for the Driver Information Display (DID) screen associated with this fault are listed in the table below.

Triggers	Aftertreatment Tampering Indicator	Driver Information Display Screen
No Fault	None	None
Tampering Fault Detected Note: For examples of the various SCR sensor tampering types refer to the “SCR Sensor Disconnected Tampering Type” table below.		SCR System Fault Engine will Derate in ____ mins

42 V-MAC Co-Pilot Operator's Manual

Triggers	Aftertreatment Tampering Indicator	Driver Information Display Screen
<p>Driving with Active Fault for + 1 hrs</p>	 <p style="text-align: center;">W3031200</p>	<p>SCR System Fault Engine In Derate 5 Mph Limit in ___ mins</p> <p>Note: Once this SCR tampering fault occurs the DID timer displays. The timer displays the minutes available before the 5 mph derate occurs. The timer can be cleared using the Escape (ESC) button on the stalk switch control lever. When the vehicle is restarted after shutdown the remaining minutes before derate occurs will reappear.</p>
<p>Driving with Active Fault for + 4 hrs</p>	 <p style="text-align: center;">W3031200</p>	<p>SCR System Fault Repair needed 5 Mph limit next Vehicle Stop</p>
<ol style="list-style-type: none"> 1 Refueling Event (> 15 % fuel level increase) with stationary brake 2 Vehicle stationary for 20 minutes (vehicle speed < 1.6 Km/h (1 mph)) 3 Ignition Key Cycle 	 <p style="text-align: center;">W3031200</p>	<p>SCR System Fault Veh Speed Limited to 5 Mph</p>

SCR Sensor Disconnected Tampering Type
Exhaust Temperature Sensors Disconnected
Aftertreatment Control Module (ACM) Disconnected
Aftertreatment NOx Sensor Disconnected
Aftertreatment NOx Sensor Disconnected
DEF Pump Disconnected
DEF Dosing Valve Disconnected
DEF Tank Level Sensor Disconnected
DEF Supply Line to DEF Pump Disconnected
DEF Return Line Blocked or Plugged

Misfilling Diesel or Aftertreatment DEF Tanks

Although diesel fuel and Aftertreatment DEF caps are clearly labeled and filler necks and nozzles are different accidents can happen.

Contamination of fluids by- misfilling of diesel or DEF in the wrong tank may result in vehicle malfunction.

Results of misfilling DEF in Diesel Tank

- Engine may run poorly or not at all
- Injectors may be damaged
- Exhaust system corrosion may occur between turbocharger and Aftertreatment DPF
- On Board Diagnostic (OBD) Diagnostic Trouble Codes (DTC)
- Costly repairs

Results of misfilling diesel in Aftertreatment DEF Tank

- Aftertreatment SCR system may be damaged by Diesel
- SCR Catalyst may be damaged by diesel (chemical damage)
- Emissions may be non-compliant
- On Board Diagnostic (OBD)Diagnostic Trouble Codes (DTC)
- Costly repairs

Aftertreatment DPF Regeneration and PTO Operation

For aftertreatment diesel particulate filter (DPF) regeneration to occur, enough heat must be generated in the diesel oxidation catalyst (DOC). Heat is generated by increasing engine speed (RPM) to around 1,100 RPM on vehicles with a catalyzed aftertreatment system. For vehicles that operate a power takeoff and have a DPF, the PTO must have a maximum rated speed above the minimum RPM listed in the tables below so that aftertreatment diesel particulate filter (DPF) regeneration (whether automatic or manual) can occur when commanded.

Altitude in Meters (Feet)	Ambient Temperature in Degrees C (F)		
	← -30°C (-22°F) →	← 0°C (32°F) →	← 30°C (86°F) →
	Minimum Engine Speed		
Sea Level	1,050 rpm	1,050 rpm	1,050 rpm
1 951 M (6,400 ft)	1,100 rpm	1,100 rpm	1,100 rpm
4 267 M (14,000 ft)	1,300 rpm	1,300 rpm	1,300 rpm

C0035438

Figure 18 – Minimum Engine Speeds for MP7 with Cat DPF

Altitude in Meters (Feet)	Ambient Temperature in Degrees C (F)		
	← -30°C (-22°F) →	← 0°C (32°F) →	← 30°C (86°F) →
	Minimum Engine Speed		
Sea Level	1,300 rpm	1,200 rpm	1,150 rpm
1 463 M (4,800 ft)	1,300 rpm	1,300 rpm	1,200 rpm
3 048 M (10,000 ft)	1,300 rpm	1,300 rpm	1,400 rpm

C0035439

Figure 19 — Minimum Engine Speeds for MP8 with Cat DPF

Altitude in Meters (Feet)	Ambient Temperature in Degrees C (F)		
	← -30°C (-22°F) →	← 0°C (32°F) →	← 30°C (86°F) →
	Minimum Engine Speed		
Sea Level	1,050 rpm	1,050 rpm	1,050 rpm
1 951 M (6,400 ft)	1,100 rpm	1,100 rpm	1,100 rpm
4 267 M (14,000 ft)	1,150 rpm	1,150 rpm	1,150 rpm

C0035442

Figure 20 — Minimum Engine Speeds for MP10 with Cat DPF

Note: For vehicles equipped with a catalyzed DPF, the PTO **must** be activated by a switch that provides both engagement and speed information to the vehicle electronic control unit (VECU) when the PTO is engaged. The vehicle operator must use engine speed control to set engine speed when the PTO is in operation.

Altitude in Meters (Feet)	Ambient Temperature in Degrees C (F)		
	← -30°C (-22°F) →	← 0°C (32°F) →	← 30°C (86°F) →
	Minimum Engine Speed		
Sea Level	750 rpm	750 rpm	750 rpm
1 951 M (6,400 ft)	940 rpm	940 rpm	940 rpm
4 267 M (14,000 ft)	1,250 rpm	1,250 rpm	1,250 rpm

C0035440

Figure 21 — Minimum Engine Speeds for MP7 with Cat DPF Vehicle 21173561

Note: Beginning with 21198958 and newer software, the only requirement for aftertreatment diesel particulate filter (DPF) regeneration on vehicles equipped with an MP7 with non-catalyzed DPF and PTO is no less than 650 RPM. Altitude and temperature are no longer factors for aftertreatment diesel particulate filter (DPF) regeneration and PTO operation.

Aftertreatment DPF Regeneration and PTO Engaged

If aftertreatment diesel particulate filter (DPF) manual stationary regenerations with the power takeoff (PTO) engaged are required, the vehicle must be configured as follows:

- **Set parameter *Enable Manual Regen During PTO (JAC)* to “Yes” or “On” using VCADS.** This parameter can be found in the “Misc. Vehicle Settings” section in Parameter Programming. (A connection to Central Systems is required to set parameter ID JAC.)
- **Initiate Manual Stationary Regeneration using the DPF smart switch.**
- **Ensure the electronic hand throttle (engine speed control) is active.** The engine speed (RPM) must be set to greater than the minimum speeds listed in “Aftertreatment DPF Regeneration and PTO Operation”, page 44.

If the vehicle is not configured as listed above, manual stationary aftertreatment diesel particulate filter (DPF) regeneration with the PTO engaged will not occur. When aftertreatment diesel particulate filter (DPF) regeneration does not take place, the DPF will become soot-loaded, resulting in engine derate and eventual engine shutdown.

Aftertreatment System Conditioning (Periodic Heat Mode)

During periods of extended idling (typically 8 or more hours), the aftertreatment system will accumulate unburned hydrocarbons that are released from a diesel engine. Accumulation of these hydrocarbons can oxidize in the aftertreatment system and can cause damaging temperature spikes and potential hardware failures upon resumed driving or during aftertreatment DPF stationary regeneration events.

Extended idling periods should be limited to less than 24 hours in order to protect the aftertreatment system. However, for customers who idle their vehicles past the 24 hour limit, a periodic heat mode (known as Aftertreatment System Conditioning), was developed for the catalyzed aftertreatment system.

Note: Aftertreatment system conditioning is NOT available on vehicles equipped with a non-catalyzed aftertreatment system.

Aftertreatment system conditioning purges the DPF of accumulated hydrocarbons typically every 8 to 15 hours of extended idling time. The process is accomplished by elevating exhaust temperatures to approximately 100 to 200°C for 5 to 8 minutes, and by ramping up the engine between 1050 and 1400 RPM (dependent on engine model, ambient air temperature (AAT) and altitude).

When aftertreatment system conditioning is active and the engine ramps up, a message will appear on the Co-Pilot® Display indicating that the cycle is active and no driver input is necessary. When the cycle is completed, the engine will ramp down to normal idling speed.

Note: It is recommended that the aftertreatment system conditioning cycle not be interrupted while in progress. If possible, do not step on the throttle, release the park brake or move out of neutral until the cycle is completed (from 5 to 8 minutes).

Aftertreatment System Conditioning and PTO Operation

When the aftertreatment system conditioning cycle becomes active and a power takeoff (PTO) is engaged, the engine speed (RPM) should remain at the PTO set speed, provided the RPM and PTO engage inputs are enabled. The PTO must be activated by a switch to provide PTO engagement and speed input to the vehicle electronic control unit (VECU) (so that the engine control module (ECM) knows the status of the PTO). If these inputs are not enabled and the PTO is engaged, aftertreatment system conditioning will increase RPM when commanded, resulting in damage to the PTO, equipment or to the product being unloaded.

Note: When selecting a PTO on a vehicle with a aftertreatment diesel particulate filter (DPF), it is important that the PTO be specified to have a maximum rated speed above the minimum RPM. Please refer to Figures 18 through 21.

Note: For vehicles equipped with the catalyzed DPF and prolonged periods of engine idle time are required, the engine speed control **should not** be used to increase RPM. The engine must be allowed to idle as normal. If prolonged engine idling is necessary, it is recommended that the ECM be programmed with California Air Resources Board (CARB) 2010 compliant files. Please refer to the *Emission Control Systems for MACK Class 8 Diesel Engines (MACK MP7 and MP8 Engines)* manual for more information.

STARTING THE VEHICLE

The following procedure is used to start and warm up a vehicle management and control (V-MAC) IV engine during any ambient air temperature (AAT) condition:

Note: Release the clutch and make sure the transmission is in neutral before starting the engine.

1 Turn the ignition key to the ON position clockwise. When the “Wait to Start” indicator on the instrument cluster shuts off, fully engage the starter. Release the ignition key as soon as the engine starts.

Note: If the engine does not start immediately, limit cranking periods to 30 seconds to avoid overheating and damaging the starter.

2 After the engine has started, warm the engine until engine coolant temperature (ECT) reaches 60°C (140°F). After reaching 60°C (140°F), the engine can be operated normally.

Note: If the engine does not start immediately, limit cranking periods to 30 seconds to avoid overheating and damaging the starter.

Note: Warm-up time can be reduced by increasing engine idle speed between 1000–1200 RPM by either applying the throttle pedal or by using the variable speed governor (electronic hand throttle) feature. When operating unloaded, the engine may also be warmed by moving the vehicle (after one minute of idling time) with a “light” throttle application only.

Note: Starter Protection will limit cranking time to avoid overheating the starter. If the starter has overheated, it will be forced off until it has cooled.

CRUISE AND ENGINE SPEED CONTROL

With vehicle management and control (V-MAC) IV, the operator has the ability to precisely control engine speed (RPM) and set cruise control speeds, as well as setting the engine low idle speed. These functions are performed by using the speed control switches located on the dashboard. Instructions for setting cruise control and engine speed control are given on the following pages. For an explanation of engine low idle adjustment, refer to “Low Idle Adjustment”, page 64.

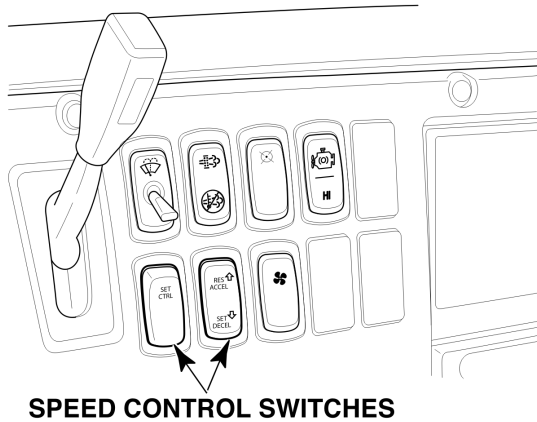

W2076074

Figure 22 — Speed Control Switches

Cruise Control

 **DANGER**

DO NOT use the cruise control in heavy traffic, with ice/snow on the road or during other unfavorable conditions. This may lead to a loss of vehicle control, causing a vehicle crash, personal injury or death.

Engaging Cruise Control

The speed control functions of the vehicle management and control (V-MAC) IV system are very similar to the cruise controls found on most automobiles. The system will maintain a set speed and will allow acceleration and deceleration through the system switches. Cruise control can be enabled or disabled using customer data programming, included in the VCADS software.

To set the cruise control for normal highway operation, the following conditions must be met.

- 1 Vehicle road speed must be above the customer-programmable speed value (15 to 35 mi/h).
- 2 The service and parking brake must not be applied.
- 3 The clutch must be engaged (pedal released).

Once the above conditions are satisfied, activate the cruise control as follows.

- 1 Move the Speed Control ON/OFF switch to the ON position.
- 2 At the desired road speed, press and release the SET switch. The vehicle will maintain at the set speed.

Note: Pressing the top of the Speed Control ON/OFF switch activates, or turns the switch ON. Pressing the bottom of the switch deactivates, or turns the switch OFF.

Note: To shift, simply disengage the clutch, change gears, then re-engage the clutch. Cruise control will resume automatically if programmed to Auto Resume. When double clutching, DO NOT bring the clutch pedal to the fully engaged position.

 **CAUTION**

Transmission gear changes must not be made without the use of the clutch while in the cruise control mode. Failure to use the clutch will cause the engine speed (RPM) to increase to the high idle limit, which may cause severe powertrain damage.

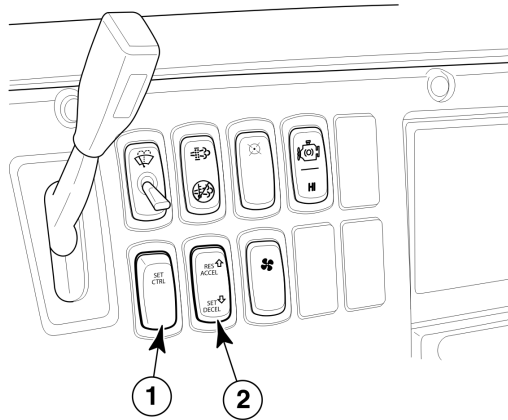

W2076078

Figure 23 — Speed Control On/Off and Set/Decel Switches

Accelerating to a Higher Speed

To accelerate to a higher speed, three methods are available:

1. **Press the accelerator pedal (AP).** This method will accelerate the vehicle for as long as the pedal is pressed. (Release the pedal to return to the speed set previously.)
2. **Press the ACCEL switch.** This method will accelerate the vehicle for as long as the switch is pressed. The new vehicle speed is set when the switch is released. (Press the DECEL switch to decelerate the vehicle. The vehicle will decelerate for as long as the DECEL switch is pressed. The new vehicle speed is set when the switch is released.)

Note: The MAX speed set by the accelerator pedal may be different from that set by the ACCEL switch.

3. The speed can also be “bumped” (known as bump speed) up or down. Tap the ACCEL side to bump up 1 mi/h or tap the DECEL side to bump down 1 mi/h.

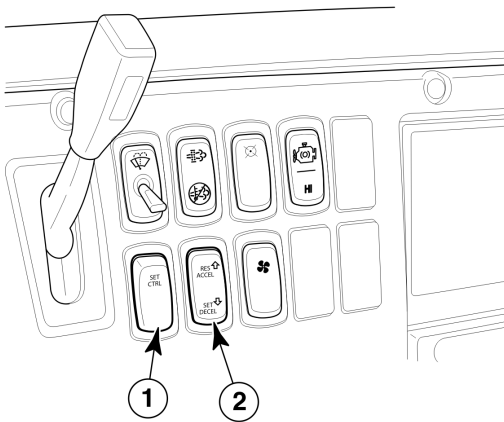

W2076079

Figure 24 — Speed Control On/Off and Resume/Accel Switches

Disengaging Cruise Control

To disengage cruise control, use any one of the following methods:

- 1 **Apply the service brake.** This method will disengage the cruise control while maintaining the set speed in the system memory. To resume the previously set speed, press and release the RESUME switch.
- 2 **Disengage the clutch.** This method will disengage the cruise control while the clutch is disengaged and will resume the speed control when the clutch is re-engaged. This programmable option provides for automatic resume after shifting.
- 3 **Move the Speed Control ON/OFF switch to the OFF position.** This method not only disengages the cruise control but also clears the set speed from the system memory. To reactivate the cruise control, it is necessary to move the switch to the ON position and select a new set speed.

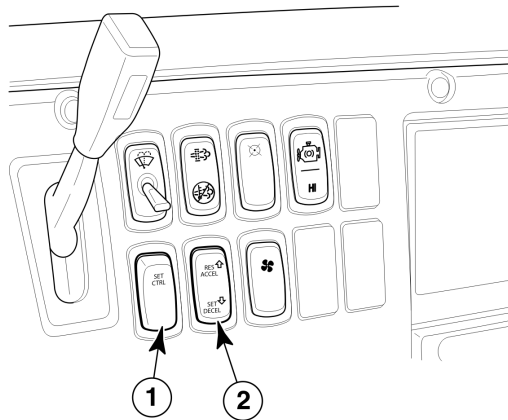

W2076079

Figure 25 — Speed Control ON/OFF Switch

Engine Speed Control

Engine Speed Control Operation

The vehicle management and control (V-MAC) IV system also allows the operator to set and maintain increased engine speeds. The system provides two different speed control functions: Electronic Hand Throttle control and PTO control. Electronic hand throttle (EHT) controls engine speed when PTO is not engaged.

Both systems allow two modes of control:

- 1 Single Speed Control (SSC) increases the engine RPM to a speed preprogrammed into the system memory. This mode is intended for operation of the PTO at maximum efficiency.
- 2 Variable Speed Control (VSC) allows the driver to set any engine RPM within the preprogrammed low and high limits set in the system memory. This mode is primarily intended for general PTO applications and engine warm-up.

Note: Brake conditions are configurable, but the standard setting is park brake on and service brake off to engage.

Single Speed Control (SSC)

To use single speed control functions, the following conditions must be met:

- 1 For power takeoff (PTO) operation, the PTO must be engaged. For electronic hand throttle (EHT) operation, the service brake must be OFF.
- 2 The clutch must be engaged (not pressed).

To activate SSC, move the Speed Control switch to the ON position, then press and release the SET switch. The engine speed (RPM) will jump to the preprogrammed speed. SSC can also be programmed for Auto Set mode. When enabled, simply move the Speed Control switch to the ON position and engage the PTO or activate a customer-defined switch (usually setting the park brake). Engine speed will go to the pre-programmed speed.

Variable Speed Control (VSC)

To use the variable speed control functions, the following conditions must be met:

- 1 The clutch must be engaged.
- 2 The park brake must be set.

To activate VSC, move the Speed Control switch to the ON position. Increase engine RPM using the accelerator pedal (AP). At the desired engine speed (RPM), press and release the SET switch. This speed setting will be maintained.

To increase the RPM, press and hold the ACCEL switch until the desired speed is attained. Or, press the accelerator pedal until the desired speed is attained and then press and release the SET switch.

To decrease engine RPM, press and hold the DECEL switch until the desired speed is reached and then release the switch.

RPM can also be “bumped” up or down. Tap the ACCEL side to increase RPM, or the DECEL side to decrease RPM by the customer-programmed amount (default setting is 50 RPM).

VSC can also be programmed for Auto Set mode. When enabled, simply move the Speed Control switch to the ON position and activate a customer-defined switch (usually setting the parking brake). The RPM will go to the preprogrammed minimum speed.

The “ramp rate” for EHT, and for each PTO in PTO control, can be programmed to increase and decrease in speed to a customer-specified speed by using the ACCEL/DECEL switch.

Disengaging SSC or VSC Functions

To disengage the speed control settings, use any one of the following methods:

- Move the Speed Control switch to the OFF position.
- Disengage the clutch.
- Apply the service brakes.
- Release the parking brake.

Note: When the PTO is engaged on vehicles equipped with SSC, the SSC will take precedence over the VSC.

Note: To reactivate the VSC to the previously set speed, press and release the RESUME switch. If the Speed Control ON/OFF switch is used to disengage the VSC, a new speed must be set. The RESUME switch will work only if the VSC was disengaged by using the clutch or service brake.

Maximum Engine Speed Limit

This mode allows the maximum engine speed (RPM) to be limited, based on preprogrammed speeds, when PTO or Electronic Hand Throttle (EHT) controls are engaged. The engine will not operate beyond these speeds when the control (PTO or EHT) is engaged. The operator has no control over this operation, and cannot change or override these preset limits.

Vehicle Limiting Speed

These programmable modes allow the maximum vehicle speed to be restricted to a preprogrammed speed limit. The driver has no control over this operation, and cannot change or override these preset limits. Another feature of the vehicle limiting speed function is “Lower Gear Road Speed Limit Feature Activation.” This option, when selected, will limit vehicle speed in gears below top gear to a value less than the top gear road speed limit. The purpose of this option is to encourage the operator to operate the vehicle in top gear, where the optimum fuel economy can be achieved.

There are two programmable “top gear” Vehicle Limiting Speeds — one for cruise and the other for use with the accelerator pedal (AP).

Vehicle Limiting Speed can also be limited to separate values for each power takeoff (PTO).

Note: The vehicle limiting speed in cruise control mode can be lower or equal to the vehicle limiting speed in accelerator pedal mode.

High Acceleration Control

Under light load, high vehicle acceleration conditions, the maximum engine acceleration may be limited to prevent wheel slippage. Engine speed (RPM) will be limited to a value just above the rated speed of the engine.

This condition should not prevent the driver from shifting to the next gear. If the engine is limited, it is an indication that wheel slippage conditions may be present and that the driver should drive less aggressively under these lightly loaded conditions.

Manual Soft Top

In accordance with 2014 US Green House Gas regulations, MACK Trucks Inc. is offering optional tamper resistant Vehicle Speed Limits (VSL) with customer selectable configuration.

If a vehicle is configured as a soft top vehicle, it will have an additional vehicle speed limit called Soft Top Speed Limit (STSL) which is higher than the Default Speed Limit (DSL). Normal vehicle operation accumulates a bank of time that allows you to reach STSL. This bank of time is decreased when driving at speeds above DSL.

There are a number of settings defining this function and they are all visible through the cluster. These settings are connected to legal requirements to keep overall vehicle speeds down, and are defined when the vehicle is built. They are valid until the vehicle has reached its expiration mileage after which this functionality is no longer operational and the vehicle goes back to normal road speed limit settings.

The Available Time value can go negative so that ongoing soft top operation will not be aborted if time runs out. The vehicle will not be able to re-enter soft top operation until enough time has been accumulated to make the Available Time value positive again. Also, there is a maximum limit of minutes available for soft top operation for the vehicle's lifetime. If that limit is reached, soft top operation is no longer possible.

58 V-MAC Co-Pilot Operator's Manual

Enabling / How to use

- If:
 - Cruise control is engaged and the vehicle is cruising at the DSL speed
 - Available Time is above zero
 - Accelerator Pedal is pressed

The vehicle will accelerate above DSL. A pop up will be shown indicating that soft top is active and the amount of minutes that are available will start decreasing. If there is no time available, the vehicle will not accelerate and a different pop up will be shown



W3082728

If the cluster does not receive the specified data for a period of 20 seconds, the pop up will disappear.

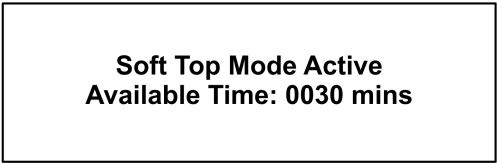

W3082730

If the cluster does not receive the specified data for a period of 20 seconds, the pop up will disappear.



W3082731

If the cluster does not receive the specified data for a period of 20 seconds, the pop up will disappear.

Operation Example: The driver should check the settings in the cluster of his vehicle as this is just an example.

DSL = 93.3 km (58mph)

STSL = 120 km (75mph)

Exp Mileage = 804672 km (500000 miles)

Allowed Time Per Day = 50 minutes

At the start of the soft top operation, let's say there are 20 minutes of soft top operation accumulated in the soft top bank. If the vehicle is back in normal operation after 10 minutes, there will be 10 minutes left in the soft top bank. After an hour of operation the bank of minutes is increased by 5 more minutes and the Available Time value changes to 15. If in this example initial Available Time had been 4 minutes, the resulting time after completion would be -6. Operation above DSL would not be possible until after two more hours of operation (5+5 minutes added). Vehicle Speed Limits (VSL) Manual Soft Top cannot be disabled until the vehicle mileage reaches 804672 km (500000 miles).

Vehicle Speed Limiter

The Vehicle speed limiter data has been split into 3 screens. Up/down keys on stalk switch are used for navigation through the screens.

The following parameters defining this function are all visible in the cluster:

- Soft Top Speed Limit, the soft top operation speed limit
- Default Speed Limit, the normal operation speed limit
- Allowed Time Per Day, the soft top operation time allowed per 10 hour normal operation. Time is accumulated hourly
- Expiration Mileage, the vehicle mileage after which this function is deactivated
- Available Time, the current bank of minutes available for operation in speeds above DSL
- Lifetime Spent In Soft Top Mode, for the legal agencies to verify that the maximum allowed time in soft top has not been exceeded

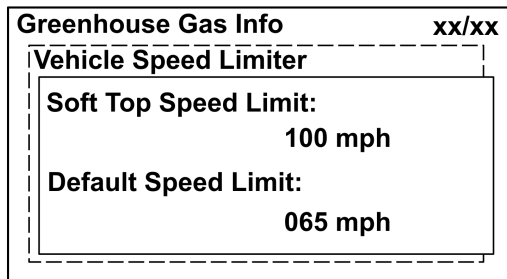

Greenhouse Gas Info	xx/xx
Vehicle Speed Limiter	
Available Time:	0030 mins
Allowed Time Per Day:	0120 mins

W3082726

Greenhouse Gas Info	xx/xx
Vehicle Speed Limiter	
Expiration Milage:	010,025.0 mi
Lifetime Spend in Soft Top	0006 hours

W3082727

Engine Brake

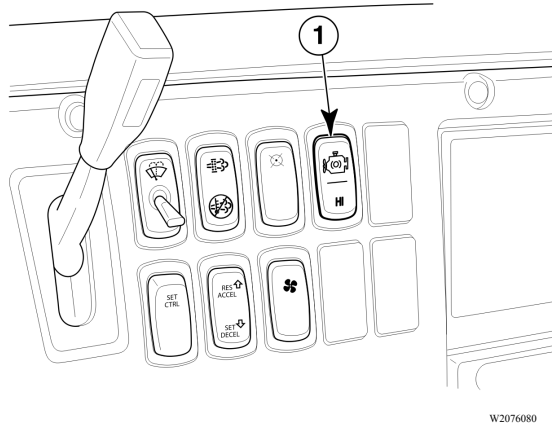

Figure 26 — Engine Brake Switch

To activate the engine brake, move the engine brake switch to the 1st or 2nd ON position. The 1st position activates the engine brake unit for 50% power. The 2nd position provides 100% power. The engine brake switch can be in either 1st or 2nd ON position during speed control operations, but the brake will function only if no fuel is requested by vehicle management and control (V-MAC) IV and engine speed (RPM) is greater than 900 RPM. To disengage the brake, move the switch to the OFF position, or press the accelerator pedal (AP).

Note: The engine brake will not engage until the engine oil temperature (EOT) has reached 52°C (125°F).

ACCESSORY RELAY CONTROL

After an idle shutdown, vehicle management and control (V-MAC) IV will deactivate all the ignition power bus relays, but the engine control module (ECM) power relay will remain active in order to reduce current draw from the battery after the engine has stopped.

PROGRAMMABLE FEATURES

The vehicle management and control (V-MAC) IV system allows operating parameters of certain system functions to be programmed. These functions include the following:

- Audible Alarm
- Auto Start (*r*TAS) [Optional; Future Support]
- Auxiliary Engine Stop (Optional)
- Cruise Control Maximum Speed
- Cruise Control Minimum Speed
- Driveline Parameters
- Daytime Running Lights
- Driver Display Parameters
- Electronic Hand Throttle (EHT) Control Parameters
- Engine Brake Delay in Cruise
- Engine Governor Parameters
- Engine Protection Parameters
- Engine Sleep Mode
- Engine Speed Control Parameters
- High Idle Speed
- Fan Control
- Fuel Economy Incentive Parameters
- Idle Cooldown
- Idle Shutdown
- Low Idle Settings
- Lower Gear Road Speed Limit
- ON/OFF Fan Control
- Overspeed Logging
- Power Takeoff (PTO) Control Parameters
- Tamper Detection
- Vehicle Limiting Speed Settings
- Vehicle Security Level
- Driver Personal Overspeed Alarm

To change operating parameters, a computer is used and requires that it is running the VCADS software. In addition, a datalink adapter is also required as an interface between the scan tool and the vehicle management and control (V-MAC) IV system.

Note: If the rear tire sizes are changed, or the rear axle ratios are changed, you must contact your local MACK TRUCKS dealer. Failure to notify your local MACK TRUCKS dealer of these changes may cause inaccurate speedometer readings.

Cruise 'N Brake Engagement Delay

With the cruise 'n brake engagement delay feature, engagement of the engine speed (RPM) is delayed in cruise control to reduce engine brake cycling. The brake will engage 3.2 km/h (**2 mi/h**) above the cruise set speed. The engine brake operates normally when cruise is not being used.

Engine High Idle Speed if Stopped

Maximum engine speed (rpm) can be adjusted by using VCADS software. The possible high idle settings range from 600 to 2,600 RPM. However, the engine speed will not go below low idle and will not exceed the OEM high idle (usually 2,100 or 2,150 RPM).

Engine High Idle Speed in Upper Gears

Sets the maximum engine RPM if the gear ratio is less than 1.5. This feature is intended to improve fuel economy by limiting efficient high speed engine operation.

Low Idle Adjustment

Note: On chassis equipped with an automatic transmission, the speed control switches cannot be used to adjust engine low idle speed. Attempting to set low idle in this manner will cause the vehicle electronic control unit (VECU) to enter the reprogramming mode resulting in the idle speed dropping to 550 RPM (650 RPM for non-catalyzed exhaust aftertreatment system), but it will not be possible to set a new idle speed. If the reprogramming mode is entered, simply turn the speed control switch OFF, and idle speed will return to the originally set speed. Resetting low idle speed on a chassis equipped with an automatic transmission requires a scan tool running the VCADS software. Consult the *VCADS User's Guide* for additional information.

This section explains the procedure to reset the low idle speed using the Speed Control switches.

The vehicle management and control (V-MAC) IV system allows the low idle to be set within the range of 550 to 700 RPM (650–700 RPM for non-catalyzed exhaust aftertreatment system). This provides flexibility to set the low idle to the smoothest engine speed for the vehicle.

There are two steps required to reset the low idle speed. The first step places the vehicle management and control (V-MAC) IV system into the low-idle adjust mode. In this mode, vehicle management and control (V-MAC) IV is ready to accept the new idle speed.

The second step is to actually tell vehicle management and control (V-MAC) IV what the new idle speed will be.

The first phase in the process is meeting the requirements listed below.

- 1 The vehicle management and control (V-MAC) IV system must have the Low-Idle Adjust option enabled in the customer data space. This function can be disabled by the customer.
- 2 Be sure there are no active faults in the system.
- 3 The vehicle must be stationary.
- 4 The parking brake must be applied.
- 5 The accelerator pedal (AP) must be at the idle position (not pressed).
- 6 The Speed Control ON/OFF switch must be turned ON and OFF 3 times within two seconds. At this point, the idle speed will drop to 550 RPM, and vehicle management and control (V-MAC) IV will now be ready to accept a new speed. Be sure to leave the ignition key in the ON position.

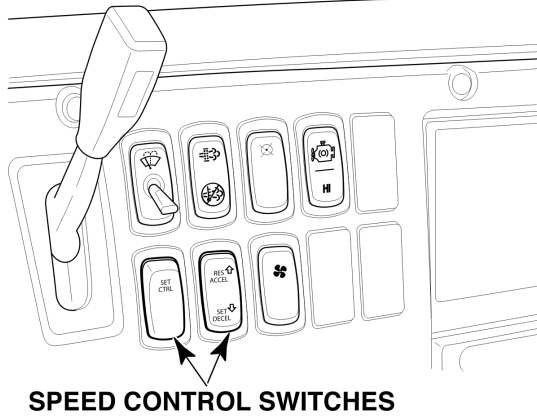

W2076074

Figure 27 — Speed Control Switches

Note: If the idle speed does not drop to 550 RPM after meeting the requirements listed, there may be other possible problems which will not allow the idle to be reset. Refer to the vehicle management and control (V-MAC) IV Service Manual for troubleshooting procedures.

To complete the resetting of the idle speed, continue as follows:

- 1 Depress and hold the accelerator pedal until the desired engine speed is reached.
- 2 Use the speed control switches to adjust idle speed.
- 3 Depress and release the clutch pedal to store idle speed.

This speed is now locked into vehicle management and control (V-MAC) IV as the low idle speed.

Note: To detect a drop when resetting the idle, it is recommended that the low idle speed be set to a speed greater than 500 RPM.

Smart Idle Elevated Idle RPM Time

This feature will discontinue a ramp up for a period of time when the engine speed (RPM) reaches its target. The range of time can be set between 0 and 1092 minutes, with a default setting of 30 minutes.

Idle Shutdown

This feature will shut off the engine after it has been idle for a specified period. The time period is customer programmable using the VCADS software. An alarm will warn 30 seconds (a programmable time frame) before the engine will shut down. The idle shutdown override switch can be used during this 30 second period to override idle shutdown or the service brake or accelerator pedal (AP) can be applied. Once the engine shuts down, the engine can be re-started by turning the ignition key to the Start position.

If Idle Shutdown with sleeper mode is enabled, the shutdown can be cancelled if the idle shutdown override switch, service brakes, or AP are pressed *while the Shutdown Indicator is on*. Idle shutdown will be active again after the vehicle has been moved and parked. Some options only allow sleeper mode if the ambient air temperature (AAT) requires heating or air conditioning. If the ambient temperatures are out of range, the amber electronic malfunction indicator will illuminate and the idle shutdown function can be overridden. If AAT is within range, idle shutdown remains active and the red shutdown indicator will illuminate as a warning (refer to the *VCADS User's Guide* for more information about possible idle shutdown settings).

Note: Idle shutdown will not occur during an aftertreatment diesel particulate filter (DPF) regeneration. If the idle shutdown timer requests a shutdown during aftertreatment diesel particulate filter (DPF) regeneration, the engine will not shut down until after regeneration has been completed.

Note: The California Air Resources Board (CARB) requires 2010 model year vehicles to be equipped with engines having tamper-resistant software which limits the time that the engine can idle at speeds above low idle (550–700 RPM). At speeds above low idle, and with a power takeoff (PTO) engaged, idle time will be limited to 5 minutes, after which the engine will revert back to low idle. Vehicles equipped with a Clean Idle engine are identified by a label which is affixed to the left front corner of the hood on conventional models (CXU, CHU and GU), and the lower portion of the driver's side door on cab-over models (MRU and LEU).

Idle Cooldown

This feature provides a means of cooling down the engine and turbocharger. If the idle cooldown option is enabled using VCADS software and the system senses that the turbocharger may be hot, the engine will not shut down when the vehicle stops, the parking brake is set and the ignition key is turned to the OFF position. This feature allows the driver to lock the truck and walk away while still providing adequate cooldown. All switched accessories will then turn off once the engine has stopped. If this option is set, the engine can be shut down immediately by cycling the ignition key or by pressing the shutdown override switch.

The idle cooldown timer is set to 3.5 minutes as soon as the engine load exceeds 25%, provided that the engine has been running at least 60 seconds. After the load drops below 25% (the lowest trigger is 35% for 2 minutes), the timer begins counting down. If the key switch is turned off before the timer expires, the engine will continue to run until the timer reaches zero.

If a pyrometer is installed, the idle cooldown function will use the pyrometer reading, shutting the engine down when the temperature drops below 232°C (450°F), or after 3.5 minutes, whichever comes first.

The default for this option is set at OFF from the factory.

Note: The parking brake must be on for the idle cooldown function to work.

Fan Control

The ON/OFF fan clutch (when equipped) can be controlled by vehicle management and control (V-MAC) IV. The following options for ON/OFF fan control are available and can be programmed using the personal computer running VCADS software:

- Minimum fan ON time for high-freon pressure while vehicle is parked
- Enable optional fan override with override switch while vehicle is parked
- Enable optional fan override with override switch while vehicle is moving
- Optional fan override time while vehicle is moving
- Optional fan engagement while a power takeoff (PTO) is engaged (not available for all software levels)

Both electronic viscous and HDMS fans provide constant variable fan speed for optimum cooling. The optional engagements and overrides available with the ON/OFF fan control are also available with the electronic viscous fan.

Fan Override Switch (Optional)

With the fan override switch, the operator has the option of overriding the preset parameters for fan engagement to engage the fan when necessary. The fan may be engaged while the vehicle is moving or while parked. Enabling the fan override option, and the parameters for override time limits, are customer programmable using a personal computer running the VCADS software. For fan override with the vehicle moving, the time limit may be set between 1 and 25 minutes; with the vehicle parked, there is no time limit.

The operator may disengage the fan (cancel the override) after 30 seconds by pressing the override switch a second time. The operator cannot interfere with fan operation (override) if the fan is engaged due to coolant temperature, inlet air temperature or Freon pressure. If the fan is manually engaged with the fan override switch and engine speed exceeds a preset overspeed, vehicle management and control (V-MAC) IV will cancel the override to disengage the fan.

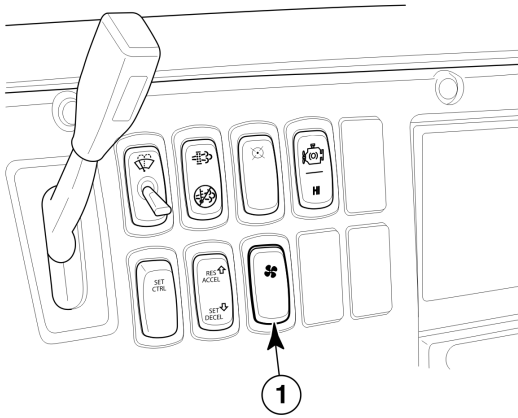

W2076081

Figure 28 — Fan Override Switch

Daytime Running Lights (DRL) Override Switch (Optional)

Daytime Running Lights (DRL) come standard on all MACK vehicles and can be optioned with or without an override switch. When the DRL override switch has been specified, different conditions can be selected that cause the DRL to automatically activate. DRL can be automatically turned on when the parking brake is released, the engine is running or both. Only one of these choices may be selected. Using DRL will illuminate the low beam headlamp bulbs at a slightly reduced intensity. The DRL function will monitor high beams as well. If the high beams are activated, the DRL will be temporarily turned off until high beam use ceases.

DRLs offer additional safety when driving in low light conditions when the operator may not normally turn the headlights on. Having headlights on at all times makes the vehicle easier to spot in bad weather, dusk or shade or when there is glare. DRL offer the ability for drivers to give a courtesy flash as a signal when it is safe to merge into another lane on the highway. Turning DRL off temporarily for slowly rolling through weigh stations or when waiting in line to receive bill and weighing tickets is convenient.

When the operator presses the DRL override switch, the headlamps will go out if below the DRL speed threshold and flash if above the DRL speed threshold for a designated period of time (customer programmable in VCADS). It is also possible to toggle the headlamps back on if necessary.

Integrated Temp-A- Start (Optional; For Future Support)

Integrated Temp-A-Start (*i* TAS) is a fully integrated vehicle management and control (V-MAC) IV system designed to improve fuel economy by reducing unnecessary engine idling. When *i* TAS is enabled via a dash switch, the system will automatically start and stop the engine to maintain a minimum engine coolant temperature (ECT), minimum battery voltage, or a comfortable cab and sleeper interior. *i* TAS voltage and temperature settings are fully programmable through either VCADS software, and via the Co-Pilot instrument cluster display (if available and enabled).

Note: Safety overrides will prevent the system from activating if the transmission is in gear, the hood is up, or the parking brake is released.

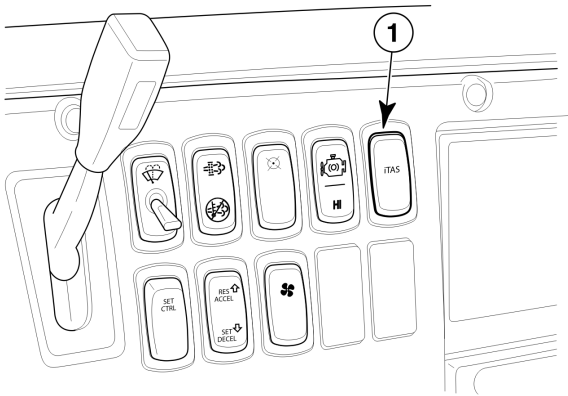

W2076082

Figure 29 — Integrated Temp-A-Start Switch

Speed Sensor Tamper Detection

Speed sensor tamper detection is used to monitor and stop unauthorized tampering of the vehicle speed limiting function in order to gain additional top speed. If tampering is detected, the vehicle operator will be notified by a diagnostic trouble code (DTC). Engine power will be limited to a programmed percentage and will continue until the issue has been corrected.

Note: Torque limiting will be inhibited if a driveshaft power takeoff (PTO) is enabled and active.

ELECTRICAL ACCESSORY CONNECTION POINTS

This MACK chassis is electrically ready for convenient installation of electrical accessories. Use the designated battery post (+12 V), ground post, CB jack, buffered RPM outputs, buffered mi/h outputs, and the SAE/ATA J-1708 post located on the electrical equipment panel for the installation of any electrical accessories. Each connection point is described below.

Battery Post (BATT)

This is a +12 volt, unswitched battery power connection. It can be used to power external devices that require power at all times, even when the ignition key is turned OFF. This source is protected by a 15-amp circuit breaker.

Ignition Post (IGN)

This is a +12 volt, switched battery power connection. It can be used to power external devices that require power only when the ignition key is ON. This source is protected by a 15-amp circuit breaker.

Ground Post (GND)

This is a ground connection. It can be used as a power return (–) connection for external devices.

RPM Output

This is a 50% duty cycle, 5-volt transistor-transistor logic (TTL) compatible, square-wave signal that is calibrated to provide a standard pulse rate of 12 pulses per engine revolution.

Note: Transistor-transistor logic compatible of this output may be affected by other devices connected to this output. Maximum rated current of the TTL output is 10 mA. Total current draw of all devices connected to this output must not exceed 10 mA at 4 volts.

Mi/h Output

This is a 50% duty cycle, 5-volt TTL-compatible, square-wave signal that is calibrated to provide a standard pulse rate of 30,000 pulses per mile.

Note: TTL compatibility of this output may be affected by other devices connected to this output. Maximum rated current of the TTL output is 10 mA. Total current draw of all devices connected to this output must not exceed 10 mA at 4 volts.

SAE/ATA J-1708 Posts (Series Link A and B)

This is a serial communication interface. It conforms to the SAE/ATA J-1708 Recommended Practice for Serial Data Communications Between Microcomputer Systems In Heavy Duty Vehicle Applications.

CB Radio Power Jack (CB Radio +) (Located on Dashboard)

This is a +12 volt, switched battery power connection. It is used to power the vehicle's CB radio. It is protected by a 15- amp circuit breaker and will supply power only when the ignition key is in the ON position.

CB Radio Ground Jack (CB Radio -) (Located on Dashboard)

This is a ground connection. It is used as a power return (-) connection for the vehicle's CB radio.

See the following illustrations for the CTP and CXP electrical accessory connection points for electrical equipment panels.

INSTRUMENT CLUSTER DISPLAY

The instrument cluster display is an in-dash component that lets the driver monitor information supplied by vehicle management and control (V-MAC) IV and also permits the driver to change functions to accommodate his needs. The instrument cluster display is user friendly and prompts the driver with messages on the driver information display.

Dash Cluster Set-Up Programming

Some features and functions listed in this section can be customized to meet company or driver's needs. vehicle management and control (V-MAC) IV can be programmed by the dealer or customer using VCADS software to make these features available through the instrument cluster.

Instrument Cluster Components

The dash cluster consists of the following eight major components: function light indicators, electronic malfunction indicator, engine shutdown indicator, driver information display, low fuel indicator, gauges, speedometer and tachometer, on board diagnostic (OBD) fault and warning indicators. Although not a part of the dash cluster components, but nevertheless part of the dash cluster tool, is the stalk switch (for Co-Pilot® only) located on the right side of the steering column.

The following illustration shows the instrument cluster display (Co-Pilot® shown).

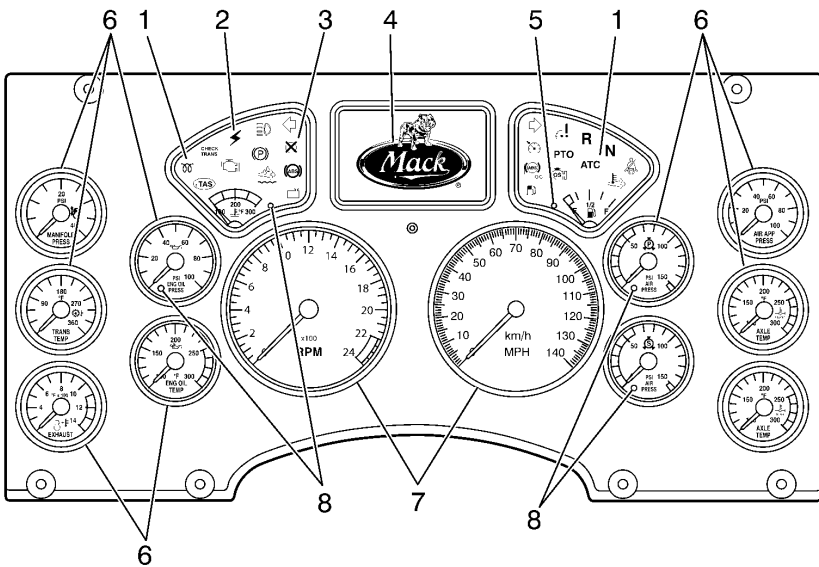

W3036320

Figure 30 — Instrument Cluster Components

- | | |
|-------------------------------------|-------------------------------|
| 1. Function Light Indicators | 5. Low Fuel Indicator |
| 2. Electronic Malfunction Indicator | 6. Gauges |
| 3. Engine Shutdown Indicator | 7. Speedometer and Tachometer |
| 4. Driver Information Display | 8. Warning Indicators |

Driver Information Display

There are two types of driver information displays available for MACK TRUCKS vehicles: basic display or Co-Pilot® Display. The basic display provides limited information (current conditions, trip information and diagnostic information). The Co-Pilot® Display provides the driver with such information as time, temperature, trip mileage, trip fuel, warning information and diagnostic trouble codes (DTCs). The driver information display also contains a menu where the driver can access and adjust functions such as maintenance, dash cluster self-test, alarm sound, lighting level, time, language choice, and units of measure (for Co-Pilot® only). Both driver displays are located in the center of the dash cluster and easily accessible to the driver.

To enter the driver information display, press and hold the **Enter** (↵) button on the stalk switch.

CO-PILOT® DISPLAY

Introduction and Purpose

The Co-Pilot is an in-dash computer that lets the vehicle operator monitor information supplied by the vehicle management and control (V-MAC) IV electronic control system and enhance the functions of V-MAC by entering requested information with the stalk switch. The Co-Pilot is very “user friendly” and prompts the operator with messages on the display screen.

Beginning with Co-Pilot, features include the following:

- Fuel Economy Information
- GuardDog™
- Driver Trip and Fleet Trip Information
- Speedometer Information
- Gauge Information
- Electronic Faults
- Driver Messages
- Cluster Diagnostics
- Maintenance Monitoring (if available)
- Integrated Temp-A-Start (if available)
- Set-Up (languages, units, driver overspeed alarm, date, display lighting)

CO-PILOT SYSTEM OVERVIEW

Set-Up Programming

Many Co-Pilot features and functions listed in this Operator's Guide can be customized to meet individual company or operator needs. V-MAC can easily be programmed by the dealer or customer using MACK's scan tool with VCADS software to make these features available through the Co-Pilot.

If your Co-Pilot does not display any of the features listed in this Operator's Guide, please consult your dealer or appropriate fleet management personnel for V-MAC set-up reprogramming as required. Programmable Co-Pilot features include:

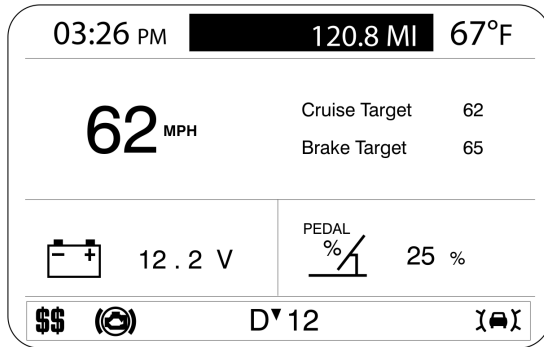

W3075372

Home Screen

78 V-MAC Co-Pilot Operator's Manual

Table 4 Programmable Co-Pilot Features

Feature	Function/Selections	Factory Default Settings
Bill of Lading	Enter in Bill of Lading number	N/A
Change Driver	Change to a new Driver	Enabled
Drain Water (optional and for possible future support)	Drains the sediment bowl automatically from menu command	Enabled automatically if the option is ordered
Driver Overspeed Alarm (for future support)	Set personal vehicle speed threshold alarm	
Integrated Temp-A-Start (optional)	Program settings	If ordered, there are several parameters here.
Maintenance Reset	Reset Maintenance items	Disabled
DEL Messages	Driver enters in Driver Event Logging Messages	Disabled
Next Fleet Trip	Enter the next fleet trip	Disabled
Reset Driver Trip	Reset Driver Trip information	Enabled
Set Display Settings	• Set Co-Pilot time and date	N/A
	• Set language	English
	• Set display lighting, brightness and contrast	N/A
	• Set units of measure	English units of measure
Theft Deterrent (optional)	Enter theft code password	Disabled
Hours of Service (for future support)	—	—

The following illustration shows the areas of the Co-Pilot® Current Conditions screen.

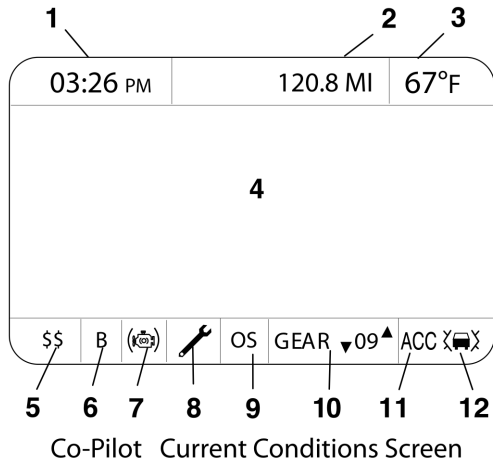

W3075369

Figure 36 — Co-Pilot Current Conditions Screen

- | | |
|---------------------------|--|
| 1. Time | 7. Engine Brake |
| 2. Mileage | 8. Maintenance |
| 3. Ambient Air Temp (AAT) | 9. Overspeed/Idle |
| 4. Information Area | 10. Gear (with automated transmission) |
| 5. Sweet Spot Indicator | 11. Active Cruise Control |
| 6. Bonus/Penalty | 12. MACK Road Stability Advantage
Target Detected |

The stalk switch (for Co-Pilot® display only) is located on the right side of the steering column and contains three depressible buttons: *ESC*, *Enter* (↵) and *Up & Down*. The stalk switch is used to access, navigate, view and change information available in the driver information display (Co-Pilot® display).

- The Esc or Escape button (1) is used to return to the previous menu or display, or to cancel a setting or operation.
- The Enter button (3) is used to display a list of menus, open a menu, and select a chosen value.
- The Up arrow (2) is used to scroll up through a menu and to increase numerical values.
- The Down arrow (2) is used to scroll down through a menu and to decrease numerical values.

The following illustration shows the stalk switch.

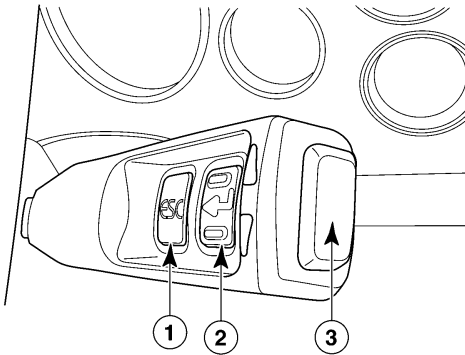

C0035377

Figure 37 — Stalk Switch (Co-Pilot Only)

CO-PILOT® OPERATIONS

This chapter is intended as a general overview to operations.

Using the Co-Pilot®

Note: Turn the ignition key to the ON position before operating the Co-Pilot®.

When the ignition key is turned to the ON position, the Co-Pilot® automatically turns on. The MACK Logo Intro screen appears for several seconds and is usually followed by the last Anytime screen that was active prior to power-down. If Vehicle Management and Control (V-MAC) IV is programmed to “get driver” at key-on, then the CHANGE DRIVER screen will appear. Messages on the screen will prompt the driver to press the **Enter** (↵) button to accept the driver ID or use the Co-Pilot® stalk switch to enter a password.

Remember to press and hold the **Enter** (↵) button before beginning a trip to make the stationary MAIN MENU screen appear.

Note: If the screen is black, press the **Enter** (↵) button on the stalk switch to turn it on.

Note: It is also possible to retrieve engine hours and odometer readings with the ignition OFF; simply press and hold the **Enter** (↵) button on the stalk switch.

CO-PILOT SYSTEM OVERVIEW

ESC Button

The *ESC* (Escape) button on the stalk switch takes the Co-Pilot back to the previous screen or level in the menu.

Note: The *ESC* button does not function at Start-Up.

Enter (↵) Button

The *Enter* (↵) button on the stalk switch selects the highlighted menu items during menu selection. During Start-Up and when moving the vehicle, the *Enter* (↵) button is also used to confirm or acknowledge a pop-up screen. Sometimes, the *Enter* (↵) button takes the Co-Pilot display back to the previous screen.

Up & Down Buttons

The *Up & Down* buttons at the end of the stalk switch allow the user to highlight the various available menu items. Sometimes, these buttons are used to enter information into the displays.

- **Up Button** — Once at the top of the menu items that can be selected, pressing the *Up* button will take the Co-Pilot display to the last item in the menu.
- **Down Button** — Once at the bottom of the menu items that can be selected, pressing the *Down* button will take the Co-Pilot display to the first item in the menu.

CO-PILOT® LAYOUT

Screen Types

The Co-Pilot® contains six types of display screens:

- **Start-Up Screens** — A group of screens that appear when the vehicle management and control vehicle management and control (V-MAC) IV system is energized. Individual Start-Up screens are discussed in more detail in .
- **Menu Screens** — A group of screens that appear with a menu selection depending on whether the vehicle is stationary or moving. Individual Menu Screens are discussed in more detail in .
- **Anytime Screens** — A group of screens that can be displayed to a driver at any time (whether the vehicle is moving or stationary). Individual Anytime Screens are discussed in more detail in .
- **Stationary Screens** — A group of screens that is only accessible when the vehicle is stationary (Vehicle Speed = 0). These screen choices disappear from the stationary MAIN MENU screen when the vehicle begins moving and are replaced with the last anytime screen. Individual Stationary Screens are discussed in more detail in .
- **Interrupt Screens** — A group of special screens that appears during start-up or operation to notify the driver of certain critical information. When an Interrupt screen appears, the driver must do one of three things:
 - 1 Key-in the requested information.
 - 2 Press the **Enter** (↵) button to acknowledge the screen and turn off the warning and/or alarm.
 - 3 Take appropriate action to correct the condition that triggered the alarm.

For example, if the DRIVER ROAD SPEED ALARM screen appears, decelerate until the vehicle speed drops below the limit which triggered the alarm.

Individual Interrupt Screens are discussed in more detail in .

- **Optional Systems Screens** — A group of special screens that are accessible depending upon availability. Individual Option Systems Screens are discussed in more detail in .

Driver's ID Screens

The following screens allow a driver specific ID to be entered via the Driver Information Display. This option allows various vehicle information to be recorded for the driver associated with the driver ID. The ID can be changed from the Driver Information Display (DID) using the stalk switch control lever.

If the vehicle has the Driver ID feature, when the vehicle is started the Enter Driver ID screen appears in the DID. The operator enters the appropriate driver ID at that time.

- 1 The first number will be highlighted in the DID screen. Use the up and down arrows of the stalk switch control lever to scroll to the appropriate number.
- 2 Once the correct number is found, press the **Enter** button on the stalk switch control lever.
- 3 The next number in the Driver ID sequence is highlighted. Enter all the numbers for the Driver ID using these steps.

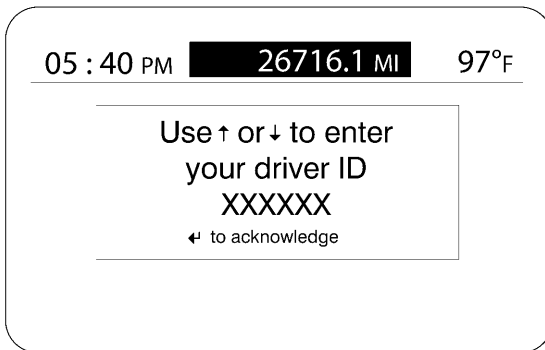

Once the Driver ID has been entered press the **Enter** button on the stalk switch control lever. The **Command Accepted** screen displays. Press **Enter** again.

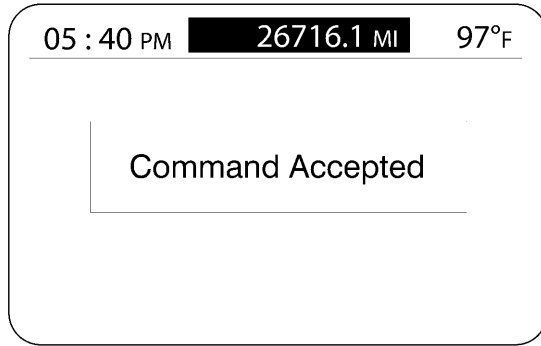

W3067469

If driver does not enter the Driver ID after starting the vehicle the **Enter Driver ID** screen displays. The Driver ID should be entered at the next vehicle stop. This screen will display every 30 minutes until the proper ID is entered. There is also an audible warning emitted until the Driver ID is entered as well.

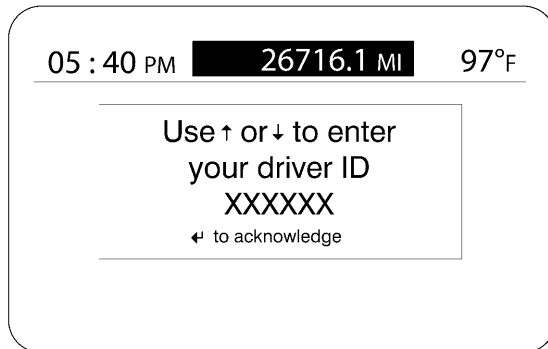

W3067466

86 V-MAC Co-Pilot Operator's Manual

Once the Driver ID has been entered press the **Enter** button on the stalk switch control lever. The **Command Accepted** screen displays. Press **Enter** again.

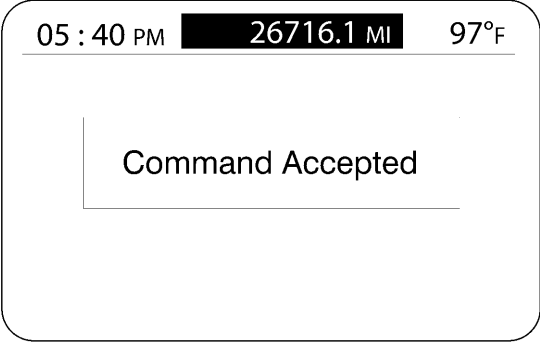

W3067469

If there is a system issue with confirming the Drivers ID the **ERROR Driver Number Not Available** screen displays.

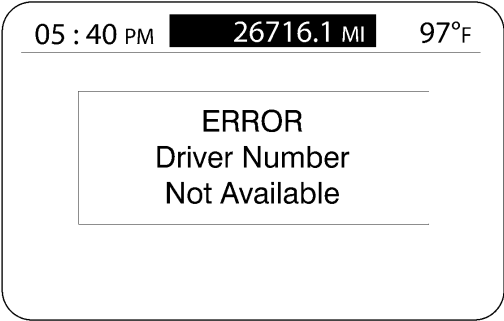

W3067470

If driver does not enter the Driver ID the **Driver ID not Entered** screen displays. The Driver ID should be entered at the next vehicle stop. This screen will display every 30 minutes until the proper ID is entered. There is also an audible warning emitted until the Driver ID is entered as well.

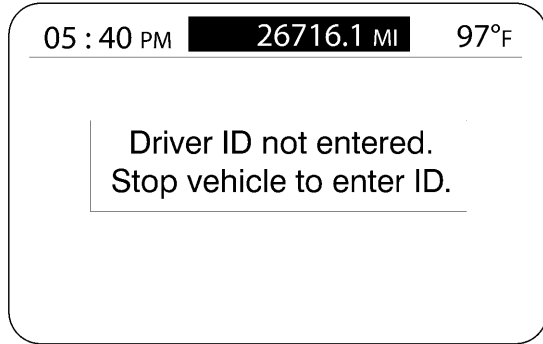

W3067468

If the Driver ID is entered and the vehicle is turned off for less than 10 minutes then the Current Driver ID screen displays. Enter the Driver ID and press **Enter**. The Driver ID will be verified via the vehicle ECU.

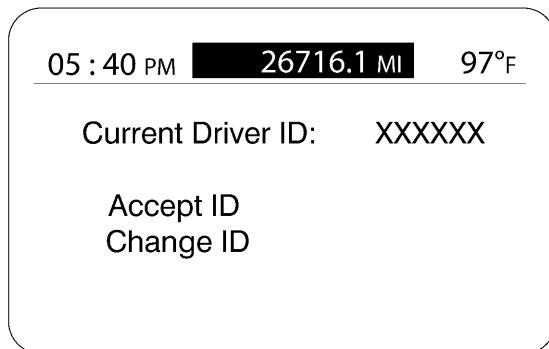

W3067467

Change Driver ID

To change the current Driver ID, use the Up and Down arrows and Enter button on the stalk switch control lever.

From the main DID screen scroll to **Fleet Management**. Press **Enter**. Then scroll to **Change Driver ID**. Press **Enter**.

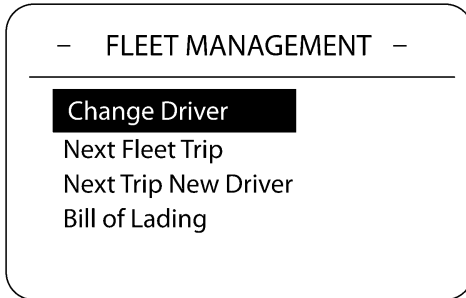

Fleet Management Submenu Screen

W0069618

The **Enter Driver ID** screen displays. Enter the new Driver ID.

- 1 The first number will be highlighted in the DID screen. Use the up and down arrows of the stalk switch control lever to find the appropriate number.
- 2 Once the correct number is found, press the **Enter** button on the stalk switch control lever.
- 3 The next number in the Driver ID sequence is highlighted.

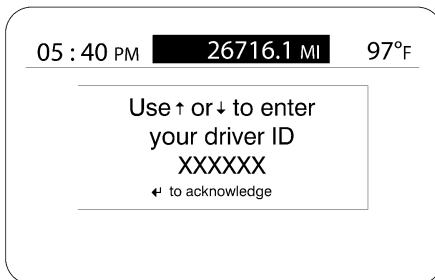

W3067466

The **Change OK...** screen displays. The DID will interface with the Vehicle ECU. Then all information is sent for confirmation via MACK Link to a vehicles main office. The new Driver ID is received and confirmed.

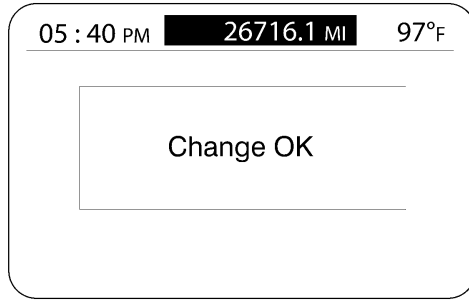

W3067471

Press the **ESC** button to return to the main screen.

If there is a system issue with confirming the Drivers ID the **ERROR Driver Number Not Available** screen displays.

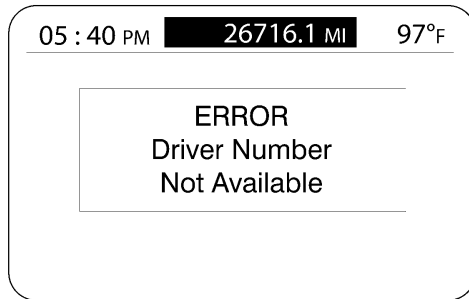

W3067470

CO-PILOT® START UP SCREENS

When the vehicle powers up, the Co-Pilot® display will illuminate Start-Up screens. Depending on the vehicle's options, the following screens will appear:

- MACK Logo Intro
- Theft Deterrence (if equipped)
- GuardDog (if equipped)
- Current Conditions
- Compass Screen

MACK Logo Intro

The MACK LOGO INTRO screen is displayed for six seconds when the vehicle ignition key is turned to the ON position. It is for viewing purposes only.



MACK Logo Intro

C0035444

Figure 38 — MACK Logo Intro

Theft Deterrent

The THEFT DETERRENT screen, if programmed, will appear after the MACK LOGO INTRO screen. Messages prompt the driver to enter a password. If an incorrect password is entered after a predetermined number of attempts, access is denied and the vehicle will shut down and not allow engine start until the correct password is entered.

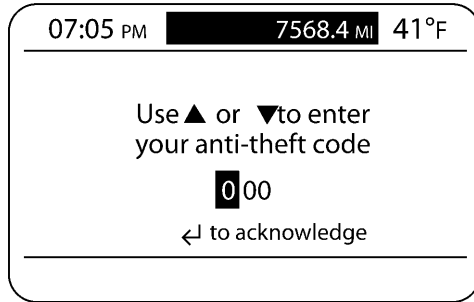

W3036585

Figure 39 — Theft Deterrent Screen

GuardDog™ Status

The GUARDDOG™ STATUS screen, if equipped, will appear after the MACK LOGO INTRO screen and the THEFT DETERRENT screen (if programmed). The screen waits to acquire data from the truck and will display maintenance items needing service. For more GuardDog™ screens, please refer to the “CO-PILOT® STATIONARY SCREENS”, page 102 and “CO-PILOT® INTERRUPT SCREENS”, page 111.

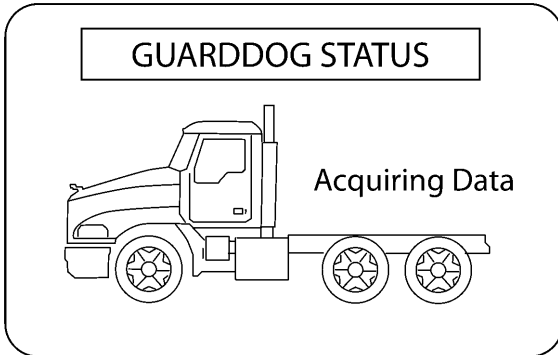

GuardDog™ Status Screen (Acquiring Data)

C005383

GuardDog Status Screen (Acquiring Data)

Compass Screen

The Compass Screen will appear after the Guard Dog if equipped, The way to enter this is MENU → Gauges →VIEW Other Gauges.

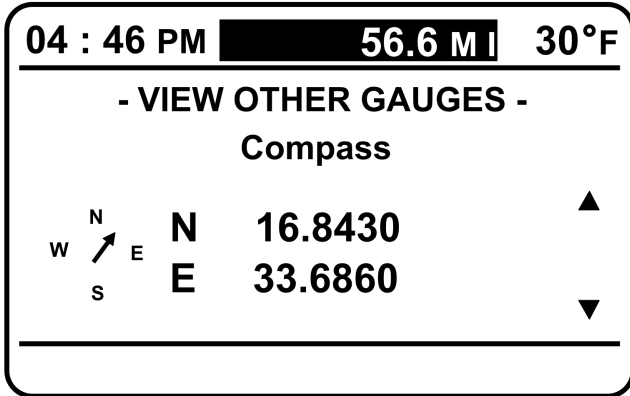

W3083580

Current Conditions

The CURRENT CONDITIONS screen will appear after the MACK LOGO INTRO screen or after the THEFT DETERRENT and GUARDDOG STATUS INTRO screens (if equipped and programmed). When the truck is stationary, the time, mileage, outside temperature and battery voltage are displayed. When the vehicle is moving, in addition to the above items, sweet spot information (when the engine is being operated at its most efficient range), bonus or penalty mode (alerts the driver if vehicle speed and cruise maximum speed can be increased or decreased for the best fuel economy), and gear state will also appear. The information area of this screen will remain blank unless an interrupt screen appears or the driver starts up the Co-Pilot main menu.

Note: The appearance of the GEAR indicator (see) is only displayed with an automated manual transmission.

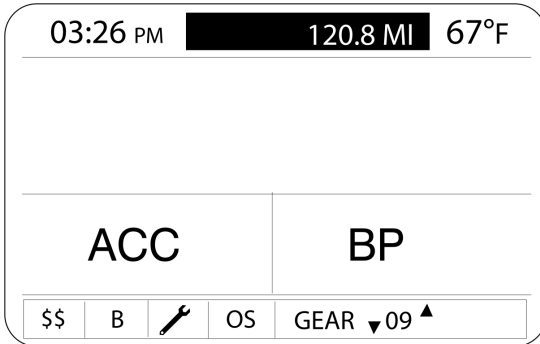

W3075370

Figure 41 — Current Conditions Screen

CO-PILOT® MENU SCREENS

Main Menu — Stationary Vehicle

The MAIN MENU screen consists of two screens for a stationary vehicle: stationary MAIN MENU 1 screen and stationary MAIN MENU 2 screen.

To cause the stationary MAIN MENU 1 screen to appear, press and hold the stalk switch **Enter** (↵) button when in the CURRENT CONDITIONS screen (see). To cause the stationary MAIN MENU 2 screen to appear, scroll down on the stalk switch **Up & Down** button.

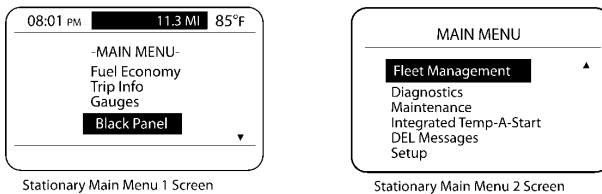

W3036587

Figure 42 — Stationary Main Menu Screens

From these two menus, the driver can access the following information supplied in a submenu structure:

- Fuel Economy (Anytime and Stationary Screens)
- Trip Information (Anytime and Stationary Screens)
- Gauges (Anytime and Stationary Screens)
- Fleet Management (Stationary Screens)
- Diagnostics (Stationary Screens)
- Maintenance (Stationary Screens)
- Integrated Temp-A-Start (if available; for future support)
- Driver Event Messages (Stationary Screens)
- Settings (Stationary Screens)

Note: To view any of the above submenus from the stationary Main Menu screens, use the stalk switch **Up & Down** button to highlight an item and then press the stalk switch **Enter** (↵) button to make your selection.

Also included in the stationary MAIN MENU 1 is the selection of a black-out panel. Detailed information on these submenus and their screens is available in and .

Main Menu — Moving Vehicle

The MAIN MENU screen consists of one screen for a moving vehicle: moving MAIN MENU screen.

To cause the moving MAIN MENU screen to appear, press the stalk switch **Enter (↵)** button when in the CURRENT CONDITIONS screen (see).

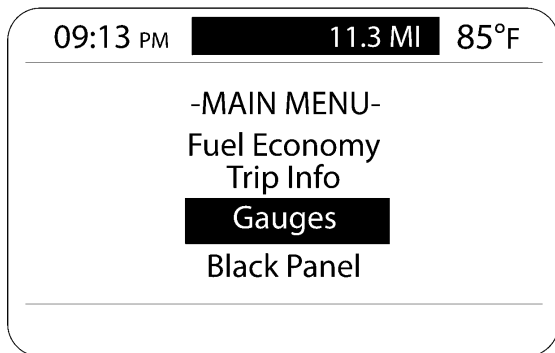

Moving Main Menu Screen

W3036590

Figure 43 — Moving Main Menu Screen

From this menu, the driver can access the following information supplied in a submenu structure:

- Fuel Economy (Anytime and Stationary Screens)
- Trip Information (Anytime and Stationary Screens)
- Gauges (Anytime and Stationary Screens)

Note: To view any of the above submenus from the moving Main Menu screen, use the stalk switch **Up & Down** button to highlight an item and then press the stalk switch **Enter (↵)** button to make your selection.

Also included in the moving MAIN MENU screen is the selection of a black-out panel. Detailed information on these submenus and their screens is available in

CO-PILOT® ANYTIME SCREENS

Co-Pilot® Anytime screens include the following main screens:

- Fuel Economy
- Trip Information
- Digital Gauges
- Black Panel

To navigate through the screens, remember the following:

- Use the stalk switch **Up & Down** button to scroll and highlight an item, scroll to the next screen, or enter a value.
- Use the **Enter (↵)** button to select a screen, enter a value, accept a change or return to the previous screen.
- Use the **ESC** button to return to the previous screen.

Fuel Economy

The FUEL ECONOMY submenu screen is displayed by selecting Fuel Economy from the moving MAIN MENU screen (see) or from the stationary MAIN MENU 1 screen (see) and press the **Enter (↵)** button. These screens show the current “trip” average fuel economy, the “instantaneous” fuel economy on the scale and the “Bonus” and “Penalty” incentive modes (only when equipped with this feature).

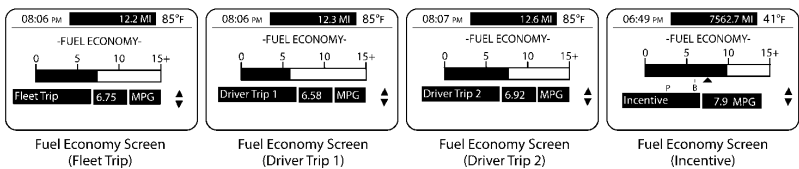

W3036612

Figure 44 — Fuel Economy Screens

Trip Information

- The TRIP INFORMATION submenu screen is displayed by selecting **Trip Info** from the moving MAIN MENU screen (see) or from the stationary MAIN MENU 1 screen (see) and then pressing the **Enter (↵)** button.

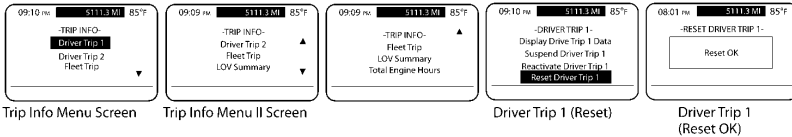

W3036614

Figure 45 — Trip Information Screens

The TRIP INFORMATION submenu screen contains the following screens:

- Driver Trip 1 and Driver Trip 2** — Displays information such as date and time, distance, maximum RPM and mi/h, average mi/h and MPG, idle time, cruise time and time spent in “sweet spot,” engine brake time and power takeoff (PTO) time. These screens also allow the current driver trip information to be reset if desired, or to suspend and activate a current driver trip. When two drivers are driving a scheduled trip, and driver 1 has completed the trip segment, the Driver Trip 1 segment must be ended. To end the trip, the first driver should select “Suspend OK” from the Driver Trip 1 screen (see). When Driver 2 is ready to begin his trip segment, he should select “Activate OK” from the Driver Trip 2 screen (see).
- Fleet Trip** — Displays trip number, driver ID, Bill of Lading number, start date and time, total date and time, total distance and fuel, maximum RPM and mi/h, average mi/h and MPG, idle time, cruise time and time spent in “sweet spot,” engine brake time and PTO time.
- Life of Vehicle (LOV) Trip Summary** — Displays the life of vehicle trip information.
- Total Engine Hours** — Displays the total engine hours for the vehicle.

The following table displays the available LOV trip information.

Average Fuel Economy	PTO Time
Average Vehicle Speed	Sweet Spot Time
Cruise Time	Total Fuel Used
Engine Brake Time	Vehicle Highest Speed
Engine Highest RPM	Vehicle Time
Idle Time	Total Time

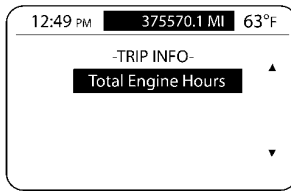

Trip Info (Total Engine Hours) Screen

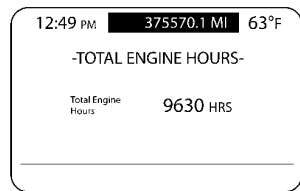

Total Engine Hours Screen

W3036620

Figure 46 — Trip Info Screens

Gauges

The GAUGES submenu screen, selected from the moving MAIN MENU screen (see) or from the stationary MAIN MENU 1 screen (see) provides the speedometer value and sensor information. To view the screens of the Gauges submenu, highlight “Gauges” with the stalk switch *Up & Down* button and then press the *Enter* (↵) button to select the screen.

The GAUGES submenu screen contains the following screens:

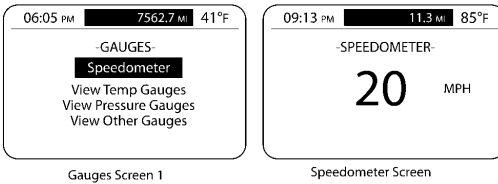

W3036622

Figure 47 — View Gauges Screens

- **Speedometer** — Allows the user to view the current speedometer value.
- **View Temp Gauges** — Displays engine coolant temperature (ECT), engine oil temperature (EOT), engine exhaust gas temperature (EGT), transmission oil temperature, rear front axle temperature, and rear axle temperature sensor information.
- **View Pressure Gauges** — Displays engine oil pressure (EOP), intake manifold pressure (IMP), and air suspension pressure sensor information.
- **View Other Gauges** — Displays engine RPM, engine load percent and throttle position percent sensor information.

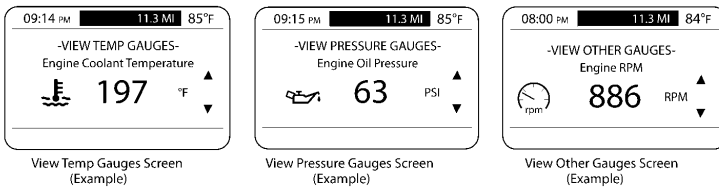

W3036624

Figure 48 — View Gauges Screens

Note: Sensors that are not standard and have not been ordered will not appear on the screens.

Black Panel

- The BLACK PANEL screen is used to black out the Co-Pilot® display. Highlight “Black Panel” from the moving MAIN MENU screen or stationary MAIN MENU 1 screen, and then press the stalk switch **Enter** (↵) button to select it.
- To restore the Co-Pilot® display, press the **Enter** (↵) button again.

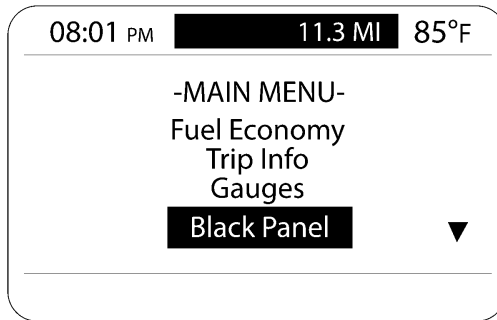

Main Menu Screen — Black Panel Selected

W3036626

Figure 49 — Black Panel Selected

CO-PILOT® STATIONARY SCREENS

Co-Pilot® Stationary screens include the following main screens:

- Fuel Economy
- Trip Information
- Digital Gauges
- Black Panel
- Fleet Management
- Diagnostics
- Maintenance (if available)
- DEL (Driver Event Logging) Messages
- Set Up (Display)
- Integrated Temp-A-Start (if available; for future support).

To navigate through the screens, remember the following:

- Use the stalk switch **Up & Down** button to scroll and highlight an item, scroll to the next screen, or enter a value.
- Use the **Enter (↵)** button to select a screen, enter a value, accept a change or return to the previous screen.
- Use the **ESC** button to return to the previous screen.

Fleet Management

- The FLEET MANAGEMENT submenu screen is accessed from the stationary MAIN MENU 2 screen (see). To view the screens of the FLEET MANAGEMENT submenu, highlight “Fleet Management” with the stalk switch **Up & Down** button and then press the **Enter (↵)** button to select the screen.

The FLEET MANAGEMENT submenu screen contains the following main screens:

- **Change Driver**

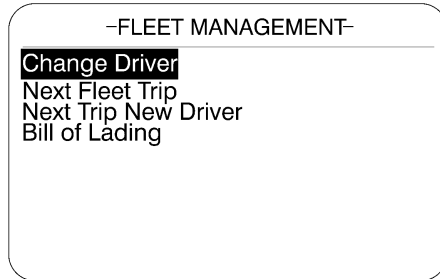

W3065134

— Allows the user to change drivers. There are three ways to change driver entries:

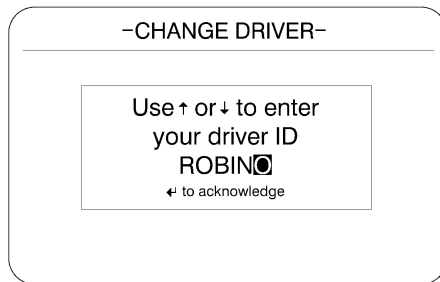

W3065133

- 1 Enter driver ID using the stalk switch **Up & Down** button to type in the driver identification number.
- 2 Pick an ID from the list using the stalk switch **Up & Down** button.
- 3 Enter the theft ID using the stalk switch **Up & Down** button.

- **Fleet Trip**

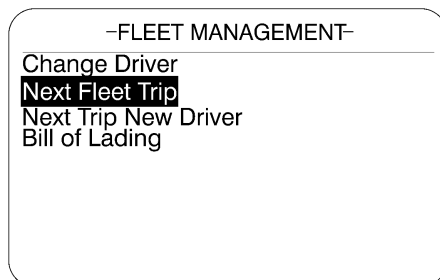

Diagnostics

The Diagnostics submenu screen is accessed from the stationary MAIN MENU 2 (see). To view the screens of the DIAGNOSTICS submenu, highlight “Diagnostics” with the stalk switch *Up & Down* button and then press the *Enter* (↵) button to select the screen.

The DIAGNOSTICS submenu screen contains the following main screens:

- **Cluster Diagnostics** — Allows the user to test bulbs, pointers on gauges, graphics and alarms associated with the cluster.
- **Hardware/Software Part Numbers** — Allows the user to view the hardware and software part numbers of the engine control module (ECM), anti-lock braking system (ABS) electronic control unit (ECU), instrument cluster and vehicle ECU.

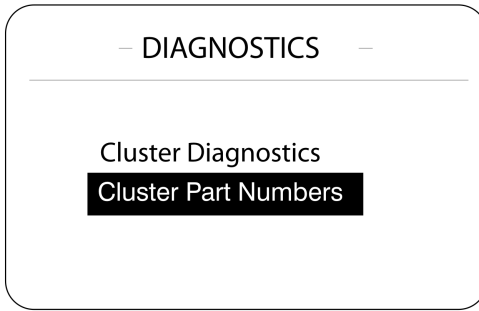

Diagnostics Submenu Screen

W3075371

Figure 51 — Diagnostics Submenu Screens

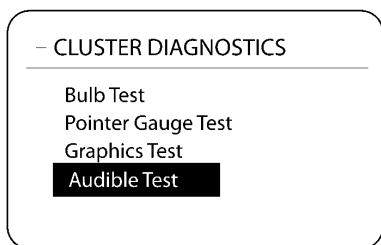

Cluster Diagnostics Screen

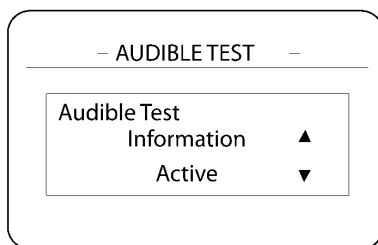

Audible Test Screen

W3036629

Figure 52 — Diagnostics Submenu Screens

Maintenance

The MAINTENANCE submenu screen is accessed from the stationary MAIN MENU 2 screen (see) . To view the screens of the MAINTENANCE submenu, highlight “Maintenance” with the stalk switch **Up & Down** button and then press the **Enter** (↵) button to select the screen.

The MAINTENANCE submenu screen contains the following main screens:

Displays the maintenance schedule for various maintenance items, such as engine oil and coolant change. Maintenance items are displayed on the screen one at a time as shown in . Maintenance items, when enabled in VCADS or MACKtraq, can be reset after maintenance has been performed. If maintenance has not been performed, resetting the maintenance item will be prohibited.

Maintenance Monitor

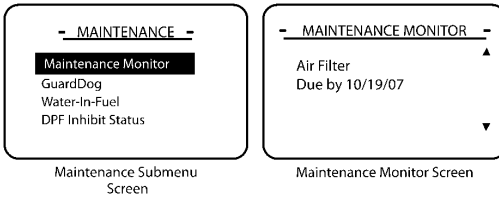

C0035402

Figure 53 — Maintenance Screens

GuardDog™ (optional; must be enabled)

GuardDog™, an active maintenance monitoring system, uses sensor readings to show the status of routine maintenance requirements. If the vehicle is equipped with the GuardDog™ system, Co-Pilot will display GuardDog™ related maintenance items under the following conditions:

- When the vehicle is started
- During driving as individual maintenance items become due
- Manually through the GuardDog™ Status screen

After power-up initiation and the MACK LOGO screen appearance, the Co-Pilot will display the ACQUIRING DATA screen. After activation on this screen, if no maintenance item is due, the GUARDDOG™ NO MAINTENANCE ITEMS DUE screen will appear. However, if more than one maintenance item requires service, the GUARDDOG™ MAINTENANCE interrupt screen (see) will appear. To view the due maintenance items, select the GUARDDOG™ STATUS screen.

The GUARDDOG™ STATUS screen will display a list of GuardDog™ items and the corresponding condition will be shown as “low,” “check,” or “OK.”



C0035403

Figure 54 — GuardDog™ Maintenance Screens

Note: The oil level indicator takes between 15 and 20 seconds to provide data. If the engine is started within this time period with no valid oil level reading, the Co-Pilot will display the message, “Unable to obtain the oil level data. Engine started too soon.”

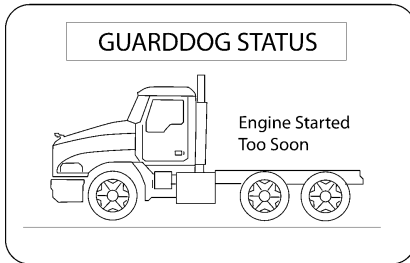

GuardDog™ Status Screen

W3036651

Figure 55 — Guard Dog Status Screen

Note: If GuardDog™ is not installed, all GuardDog™ menu selections will be unavailable.

Water-in-Fuel (WIF) [if equipped]

Allows the user to send a “drain water” command to the EMS module. If the Water in Fuel sensor detects liquid in the water-separator bowl, the WIF indicator on the instrument cluster will illuminate to notify the driver.

DPF Inhibit Status

Indicates why the aftertreatment diesel particulate filter (DPF) regeneration was not started. To view the DPF Inhibit Status list in the MAINTENANCE submenu, highlight “DPF Inhibit Status” with the stalk switch *Up & Down* button and the press the *Enter* (↵) button to view.

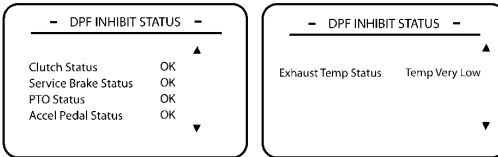

DPF Inhibit Status Screens (Example)

C0035430

Figure 56 — DPF Inhibit Status Screen

DEL Messages

The DEL MESSAGES submenu screen is accessed from the stationary MAIN MENU 2 screen (see). The DEL MESSAGES submenu contains a list of driver event logging messages. A driver may choose to log a driver event logging message depending on the driver's activity. For example, if the driver is going to leave a terminal, the driver would select the LEAVE TERMINAL message.

To view the list of driver event logging messages in the DEL MESSAGES submenu, highlight “Messages” with the stalk switch *Up & Down* button and then press the *Enter* (↵) button to select the message to log.

Note: The DEL MESSAGES submenu is optional and will only appear if enabled in VCADS software or MACKtraq.

The DEL MESSAGES submenu contains the following driver event logging messages:

- Leave Terminal
- Arrive Terminal
- Load Pick Up
- Load Delivery
- Leave Job Site
- Arrive Job Site

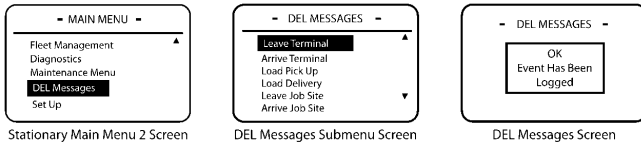

C0035404

Figure 57 — DEL Messages Screens

Set Up

The SET UP submenu screen is accessed from the stationary MAIN MENU 2 screen (see).

To view the SET UP submenu, highlight “Set Up” with the stalk switch *Up & Down* button and then press the *Enter* (↵) button to select the screen.

The SET UP submenu screen contains the following main screens:

- **Language** — Permits the user to change language selections. The default setting is English.
- **Units** — Allows the user to change the unit of measure for temperature, distance, fuel, and pressure.
- **Driver Over Speed Alarm** (if available and for future support) — Allows the user to designate a personal speed limit. If this speed is exceeded, an alarm will sound and an Overspeed warning interrupt screen will appear to warn the driver.
- **Date and Time** — Permits the user to set time and date, decide to use a 12 hour or 24 hour clock display and to configure the way the date will display (i.e., days, months, years).
- **Display Light** — Allows the user to modify the panel display of the Co-Pilot.

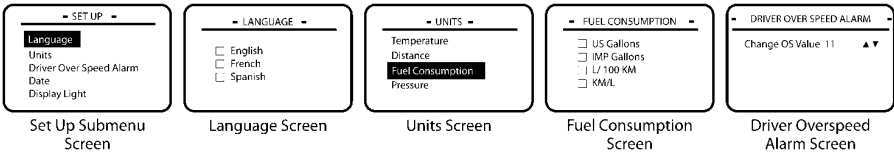

C0035405

Figure 58 — Set Up Submenu Screens

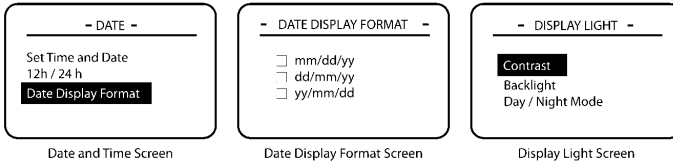

C0035406

Figure 59 — Set Up Submenu Screens

CO-PILOT® INTERRUPT SCREENS

Idle Shutdown Warning

The IDLE SHUTDOWN WARNING screen displays a timer warning and an alarm sounds to inform the driver that the vehicle is going to shut down until the condition goes away or the driver acknowledges the warning by pressing the **Enter** (↵) button.



Idle Shutdown Warning Screen

W3036652

Figure 60 — Idle Shutdown Warning Screen

Driver Overspeed Warning (if Available)

The DRIVER OVERSPEED WARNING screen appears and an alarm sounds when the driver exceeds a speed threshold. This screen is displayed until the driver acknowledges the warning and alarm by pressing the **Enter** (↵) button or decelerates below the threshold. The alarm will sound again if the threshold is exceeded.

Warning Severe Engine Overspeed

The WARNING SEVERE ENGINE OVERSPEED screen appears and an alarm sounds when the driver exceeds the Severe Engine Overspeed threshold. This screen is displayed until the driver decelerates below the threshold.

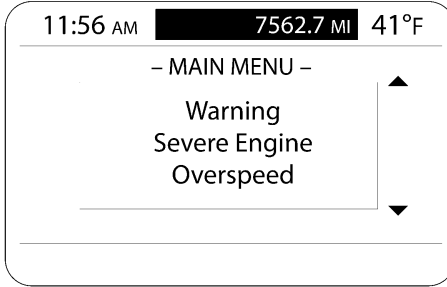

Warning: Severe Engine Overspeed Screen

W3036653

Figure 61 — Warning: Severe Engine Overspeed Screen

Engine Brake Overspeed Warning

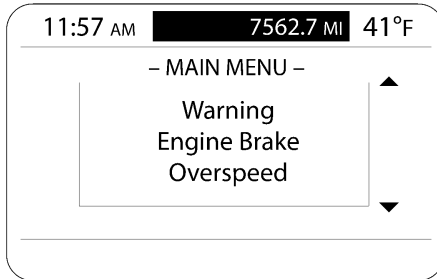

Warning: Engine Brake Overspeed Screen

W3036654

Figure 62 — Warning: Engine Brake Overspeed Screen

The WARNING: ENGINE BRAKE OVERSPEED screen is displayed and an alarm sounds if the driver operates the engine speed over the engine brake speed threshold. This screen is displayed until the driver acknowledges the warning and alarm by pressing the **Enter** button and correcting the situation.

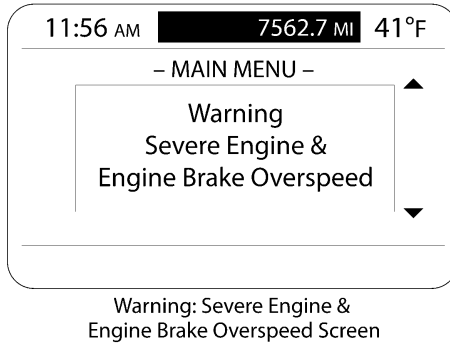

W3036655

Figure 63 — Warning: Severe Engine and Brake Overspeed Screen

Severe Engine & Engine Brake Overspeed Warning

The WARNING: SEVERE ENGINE & ENGINE BRAKE OVERSPEED screen is displayed and an alarm sounds if the driver operates above the Severe Engine and Engine Brake Overspeed thresholds.

This screen is displayed until the driver acknowledges the warning and alarm by pressing the **Enter** button and correcting the situation.

Maintenance Reminder (for Future Support)

The MAINTENANCE REMINDER screen appears and an alarm sounds if a maintenance item, such as engine oil change, becomes due. The screen shows the item needing maintenance and the message “Check Maintenance Log.” If more than one maintenance item becomes due at the same time, the screen becomes scrollable so that the driver can press the **Down** button on the stalk switch to see other items needing maintenance.

Press the **Enter (↵)** button to acknowledge the reminder and return to the previous screen. The MAINTENANCE REMINDER screen will appear again at the next power-up until the maintenance is performed and the Maintenance Log is reset.

GuardDog™ Monitor

The GUARDDOG MONITOR Interrupt screens appear and an alarm sounds if a GuardDog™ related maintenance item becomes due. The screens display the maintenance item needing service. Press the **Enter (↵)** button to acknowledge the warning and take the appropriate action to correct the condition that triggered the message.

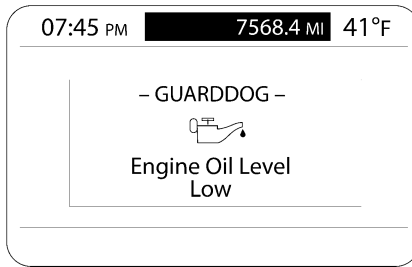

GuardDog™ Monitor Screen

W3036656

Figure 64 — GuardDog™ Monitor Screen Engine Oil level Low

Low Voltage Disconnect Active

The LOW VOLTAGE DISCONNECT ACTIVE screen appears when a low voltage disconnect has been detected by the V-MAC system. The driver should acknowledge this message by pressing the **Enter** (↵) button and turn off unnecessary accessory functions that may have caused low voltage.

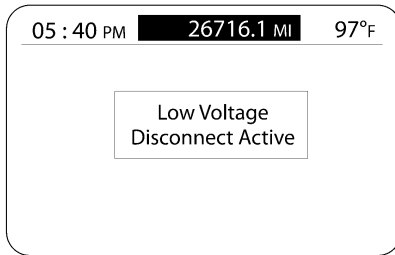

Low Voltage Disconnect Active Screen

W3036657

Figure 65 — Low Voltage Disconnect Active Screen

Inter Wheel Lock

The INTER WHEEL LOCK screen appears when the Inter Wheel lock switch has been engaged by the driver. The driver should acknowledge the message by pressing the **Enter** (↵) button and turn off the Inter Wheel lock by pressing the Inter Wheel lock switch when not needed.

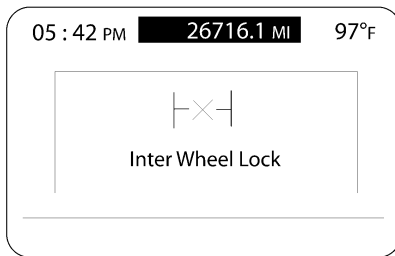

Inter Wheel Lock Screen

W3036658

Figure 66 — Inter Wheel Lock Screen

Smart Idle Active

The SMART IDLE ACTIVE screen appears to alert the driver that the Smart Idle system is active and will not stop idling until the voltage threshold has been satisfied. The driver should acknowledge the message by pressing the **Enter** (↵) button.

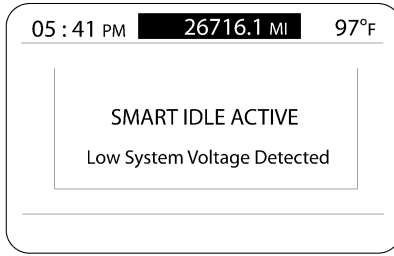

Smart Idle Active Screen

W3036659

Figure 67 — Smart Idle Active Screen

Starter Inhibit

The STARTER INHIBIT screen appears to alert the driver that the starter will not engage until the cool down period has been met. The driver should acknowledge the message by pressing the **Enter** (↵) button.

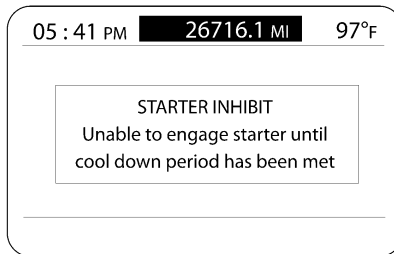

Starter Inhibit Screen

W3036660

Figure 68 — Starter Inhibit Screen

Priority Message in Road Connect (If Available)

The PRIORITY MESSAGE IN ROAD CONNECT screen appears when an important message in the Road Connect system is sent to the driver. The driver should acknowledge the message by pressing the **Enter** (↵) button, and read the message at the next scheduled stop.

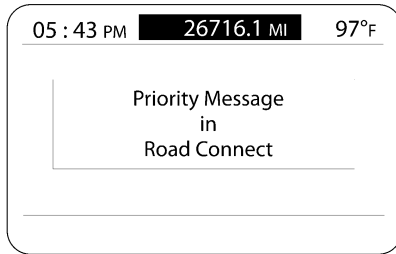

Priority Message in Road Connect Screen

W3036661

Figure 69 — Priority Message in Road Connect Screen

Driver Trip Reset

The RESET screens are activated when the Reset Driver Trip option is selected from the TRIP INFO screen.

If no option to reset the selected driver trip exists, the ERROR NOT AUTHORIZED screen will appear. When the reset is complete, the RESET OK screen will appear.

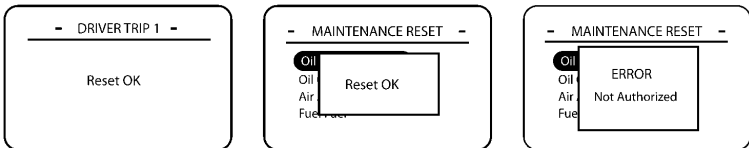

Driver Trip Reset OK Screen

Maintenance Reset OK Screen

Error Not Authorized Screen

C0035411

Figure 70 — Driver Trip Reset Screen

Trip Advanced

The TRIP ADVANCED screen appears whenever the driver advances to the next fleet trip.

To advance to the next fleet trip, the driver must select “Next Fleet Trip” from the FLEET MANAGEMENT submenu.

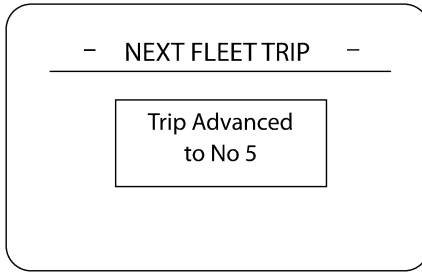

Next Fleet Trip Screen

C0035413

Figure 71 — Next Fleet Trip Screen

Idle Cooldown Activated

The IDLE COOLDOWN ACTIVATED screen appears when the driver turns the ignition key to the OFF position, *Idle Cooldown* is enabled in VCADS, and the turbocharger exceeds a certain temperature.

Cycle the ignition key to override the function and shut down the vehicle immediately.

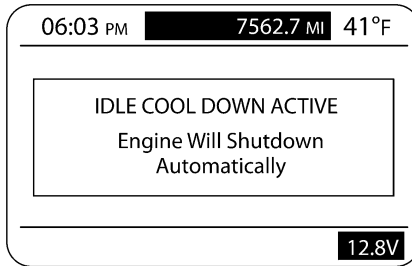

Idle Cool Down Active Screen

C0035415

Figure 72 — Idle Cooldown Active Screen

Warning Screens

When certain conditions exist, warning screens will appear to alert the driver. For example, if the vehicle has a low fuel quantity, the low fuel indicator will illuminate on the cluster display and the Co-Pilot will display the LOW FUEL WARNING screen. The driver should acknowledge these screens by pressing the **Enter** (↵) button and then ensure that the condition has been resolved, such as filling the fuel tank.

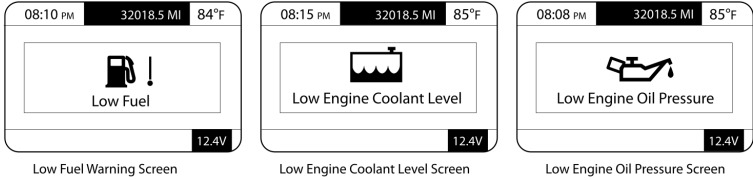

Low Fuel Warning Screen

Low Engine Coolant Level Screen

Low Engine Oil Pressure Screen

270429d

W0033148

Figure 73 — Example of Warning Screens

CO-PILOT® OPTIONAL SYSTEMS SCREENS

The vehicle management and control (V-MAC) IV system provides optional functions that the driver can access through the Co-Pilot (if available and enabled). The Co-Pilot Optional Systems screens include the following main screens:

- Integrated Temp-A-Start™ (for future support)
- Hours of Service (for future support; information not available at time of printing)
- Road Connect (optional)
- Accuload (for future support; information not available at time of printing)

To navigate through the screens, remember the following:

- Use the stalk switch **Up & Down** button to scroll and highlight an item, scroll to the next screen, or enter a value.
- Use the **Enter** (↵) button to select a screen, enter a value, accept a change or return to the previous screen.
- Use the **ESC** button to return to the previous screen.

Integrated Temp-A-Start™ (For Future Support)

Integrated Temp-A-Start™ (*i*TAS™) saves fuel by reducing the amount of time spent idling to keep the vehicle's batteries charged, the engine warm and the cab or sleeper comfortable. Once the optional *i*TAS™ feature is activated via a dash switch, the system will automatically start and stop the vehicle's engine. Safety overrides prevent the system from activation if the transmission is in gear, the hood is up or the parking brake is released. *i*TAS™ voltage and temperature target settings are fully programmable through either VCADS software or, if enabled, via the Co-Pilot display.

The *i*TAS™ submenu screen is selected from the stationary MAIN MENU 2 screen. To view the screens of the *i*TAS™ submenu, highlight “*i*TAS” with the stalk switch **Up & Down** button and then press the **Enter** (↵) button to select the screen.

The *i*TAS™ submenu screen contains the following screens:

- ***i*TAS Status** — Allows the user to view the current status of the *i*TAS system and to turn on or turn off some of the status items.
- ***i*TAS Settings** — Allows the user to set what conditions need to be monitored.

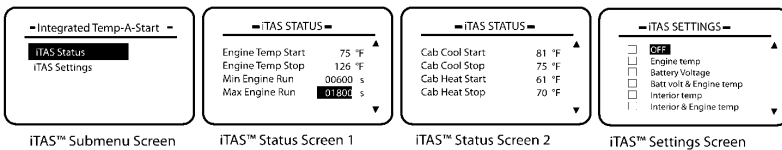

C0035416

Figure 74 — Integrated Temp-A-Start Screens

Road Connect* (if Available)

Road Connect* is an advanced fleet management system that uses satellite communication and the Internet to provide uninterrupted truck information. The Road Connect system provides the following main services depending on package selected.

- Diagnostic Trouble Code (DTC) Monitoring
- Fuel Taxes Online
- Mileage Guide
- My Locations
- Notifications
- Two-Way Messaging
- Vehicle Information
- Vehicle Tracking

The Road Connect submenu screen is selected from the anytime MAIN MENU 1 screen if enabled. To view the screens of Road Connect, highlight “Road Connect” with the stalk switch *Up & Down* button and then press the *Enter* (↵) button to select the screen.

The Road Connect submenu screen contains the following screens:

- **Read Message** — Allows the user to view received messages when the vehicle is stationary.
- **Send Message**— Allows the user to send pre-defined messages or free text messages when the vehicle is stationary.
- **Other Info** — Displays general operational information about the Road Connect system.

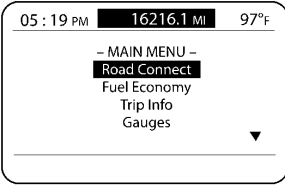

Road Connect (Main Menu)

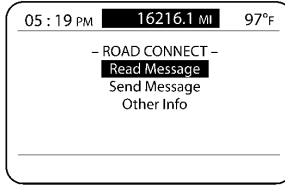

Road Connect Submenu Screen

W3036663

For more information about Road Connect, please refer to the *Road Connect Driver's Handbook* (when available).

*ROAD CONNECT is a service mark owned by First Advantage Tax Consulting Services, LLC. First Advantage offers a complementary line of fleet management services. Contact First Advantage at www.fadv.com for additional details.

CO-PILOT® OPERATIONS

This chapter is intended as a general overview to operations.

Using the Co-Pilot®

Note: Turn the ignition key to the ON position before operating the Co-Pilot®.

When the ignition key is turned to the ON position, the Co-Pilot® automatically turns on. The MACK LOGO INTRO screen (refer to Figure 40) appears for several seconds and is usually followed by the last Anytime screen that was active prior to power-down. If vehicle management and control (V-MAC) IV is programmed to “get driver” at key-on or for theft deterrence (refer to Figure 41), then the CHANGE DRIVER screen (refer to Figure 52) will appear. Messages on the screen will prompt the driver to press the **Enter** (↵) button to accept the driver ID or use the Co-Pilot® stalk switch to enter a password.

Remember to press and hold the **Enter** (↵) button before beginning a trip to make the stationary MAIN MENU screen appear.

Note: If the screen is black, press the **Enter** (↵) button on the stalk switch to turn it on.

Note: It is also possible to retrieve engine hours and odometer readings with the ignition OFF; simply press and hold the **Enter** (↵) button on the stalk switch.

