

GHG17 DD Medium Duty Operators Manual



13400 Outer Drive, West, Detroit, Michigan 48239-4001
Telephone: 313-592-5000
www.demanddetroit.com

Specifications are subject to change without notice. Detroit Diesel Corporation is registered to ISO 9001:2001.

Copyright © Detroit Diesel Corporation. All rights reserved. Detroit Diesel Corporation is a Daimler company.

Printed in U.S.A.

Table of Contents

California Proposition 65 Warning and Engine Idle Notice	5
Forward	6
Introduction.....	6
Non-Genuine and Rebuilt Component Quality Alert.....	6
Personnel Requirements.....	6
Engine Conversions and Modifications.....	7
Acronyms and Abbreviations.....	7
To the Operator	9
To the Operator.....	9
Caution Summary	11
Caution Summary.....	11
Engine Identification	19
Engine Components - GHG17 Medium Duty Platform.....	19
Engine Model and Serial Number Designation.....	22
First Time Start Preparations	26
System Checks.....	26
Starting the Engine.....	29
Cold Weather Operation.....	30
Detroit Diesel Electronic Control System Operation	32
Detroit Diesel Electronic Control System Operation.....	32
Detroit Diesel Electronic Control System Features	35
Changing the Idle Speed.....	35
Stop Engine Override Option.....	35
Engine Brake.....	35
Anti-Lock Braking Systems.....	36
Engine Protection.....	36
California Engine Idle Limiting.....	36
Idle Shutdown Timer.....	37
Engine Systems	38
Engine Systems.....	38
GHG17 Medium Duty Aftertreatment System	40
GHG17 Medium Duty Aftertreatment System.....	40
Diesel Exhaust Fluid Information	41
Diesel Exhaust Fluid Information.....	41
Aftertreatment Device Operating Requirements	42
Aftertreatment Device Operating Requirements.....	42
Diesel Exhaust Fluid Tank	43
Diesel Exhaust Fluid Tank.....	43
Aftertreatment Maintenance	44
Aftertreatment Maintenance.....	44
Performing a Parked Regeneration - GHG17	45
Performing a Parked Regeneration - GHG17.....	45
Diesel Particulate Filter Service Record	47

Service Record.....	47
Instrument Panel Lamps.....	48
Instrument Panel Lamps.....	48
Diesel Exhaust Fluid Level Warning Lamps.....	52
Diesel Exhaust Fluid Level Warning Lamps.....	52
Aftertreatment System Driver Notifications and Actions.....	53
Aftertreatment System Driver Notifications and Actions.....	53
Diesel Exhaust Fluid Post-Run Indicator Lamp.....	56
DEF Post-Run Indicator Lamp.....	56
Preventive Maintenance Intervals.....	57
Preventive Maintenance Intervals.....	57
GHG17 Medium Duty Preventive Maintenance Tables.....	61
DD5 Short Haul.....	61
DD5 Long Haul.....	62
DD5 Severe Service.....	63
DD8 Short Haul.....	64
DD8 Long Haul.....	65
DD8 Severe Service.....	66
Routine Preventive Maintenance.....	68
Routine Preventive Maintenance.....	68
Monitoring the Lubricating Oil.....	68
Monitoring the Lubricating Oil Filter.....	69
Monitoring the Cooling System.....	70
Checking for Coolant Leaks.....	70
Inspection of the Radiator.....	71
Monitoring the Fuel Filters.....	72
Adjusting the Valve Lash.....	72
Monitoring the Belt Tensioner.....	73
Poly-V-Belt Inspection.....	73
Inspection of the Air Intake System.....	75
Monitoring the Air Cleaner.....	75
Monitoring the Exhaust System.....	76
Monitoring the Aftertreatment System.....	76
Inspection of the Air Compressor.....	76
Monitoring the Fuel and Fuel Tank.....	76
Inspection of Hoses and Fittings for Fuel Leaks.....	77
Inspection of the Turbocharger and Charge Air Cooler.....	78
Inspection of the Battery.....	78
Steam Cleaning the Engine.....	79
Inspection of the Battery-Charging Alternator.....	80
Checking the Vibration Damper.....	80
How to Procedures.....	82
How to Select Lubricating Oil.....	82
How to Replace the Lubricating Oil and Oil Filter.....	83
How to Select Diesel Fuel.....	85

How to Replace the Fuel Filters.....	87
Engine Out of Fuel – How to Restart.....	92
How to Clean an Engine.....	93
Cleaning/Flushing the Cooling System.....	94
Coolant Selections and Maintenance.....	95
Coolant Fill Options.....	96
Coolants for Detroit™ Engines.....	97
Maintenance.....	99
Appendix A - Definitions.....	105
Appendix B - General Coolant Information.....	106
Appendix C - Detroit™ Cooling System Maintenance Products.....	108
Customer Assistance.....	111
Using Road Service in the U.S. or Canada.....	111
Availability of Detroit™ Service Outlets.....	111
Detroit Genuine Coolant Engine Products.....	113
Detroit Genuine Coolant Engine Products.....	113
Engine Oil Capacities.....	115
Engine Oil Capacities.....	115

California Proposition 65 Warning and Engine Idle Notice

 **WARNING:** Breathing diesel engine exhaust exposes you to chemicals known to the State of California to cause cancer and birth defects or other reproductive harm.

- Always start and operate the engine in a well-ventilated area.
- If in an enclosed area, vent the exhaust to the outside.
- Do not modify or tamper with the exhaust system.
- Do not idle the engine except as necessary.

For more information go to www.P65warnings.ca.gov/diesel.

d990086
38351

Forward

Introduction

This manual is intended for use by the operator of a Detroit™ engine used in On-Highway Vehicle applications.

Non-Genuine and Rebuilt Component Quality Alert

Electronic engine controls have aided engine manufacturers to meet the stringent emission requirements of the U.S. Environmental Protection Agency (EPA) and the California Air Resources Board (CARB) and also in meeting the ever-increasing performance demands of the customer.

Maintenance procedures must be followed in order to continue satisfactory engine performance and durability and to ensure engine coverage under the manufacturer's warranty. Many of these maintenance procedures ensure that the engine complies with applicable emissions standards. Proper maintenance procedures, using specific components engineered to comply with emissions regulations, may be performed by an authorized Detroit™ distributor or dealer, an independent outlet or the operator / owner. The owner is responsible for determining the suitability of components to maintain emissions compliance during the engine's useful emission life.

Detroit™ cautions that the indiscriminate rebuilding of precision components, without the benefit of specifications, specialized equipment, and knowledge of the electronic operating system, will jeopardize performance or lead to more serious problems, and can take the engine outside of compliance with U.S. EPA or CARB emissions standards.

There are several other components in an engine, such as turbocharger, camshaft, piston, fuel doser valve, fuel doser block, diesel particulate filter (DPF) and diesel exhaust fluid pump that are specifically designed and manufactured to exacting standards for emissions compliance. It is important that these components, if replaced, modified or substituted, can be verified to ensure that the engine remains in compliance with emissions standards. The use of inadequately engineered, manufactured or tested components in repair or rebuild of the engine may be in violation of the federal Clean Air Act and applicable U.S. EPA or CARB regulations.

Furthermore, modern engines exhibit operating parameters which require the use of proper fluids, such as fuel, coolant and lubricating oil, to maintain long engine life. The use of fluids that do not meet Detroit™ specifications may result in premature wear or engine failure.

Personnel Requirements

Work on the engine should be carried out only by skilled technicians who have been instructed in the specific skills necessary for the type of work being performed.

Engine Conversions and Modifications

The function and safety of the engine could be affected if unauthorized modifications are made to it. Detroit™ will not accept responsibility for any resulting damage.

Tampering with the fuel injection system and engine electronics could also affect engine power output or exhaust emission levels. Compliance with the manufacturer's settings and with statutory environmental protection regulations cannot then be guaranteed.

Acronyms and Abbreviations

Table 1.

Acronyms and Abbreviations			
ACM	Aftertreatment Control Module	kW	Kilowatt
API	American Petroleum Institute	L	Liter
ATD	Aftertreatment Device	lb	Pound
ATF	Automatic Transmission Fluid	m	Meter
ATS	Aftertreatment System	MCM	Motor Control Module
CAC	Charge Air Cooler	MIL	Malfunction Indicator Lamp
CAN	Controller Area Network	mpg	Miles per Gallon
CARB	California Air Resources Board	mph	Miles per Hour
CEL	Check Engine Light	NHTSA	National Highway Traffic Safety Administration
CPC	Common Powertrain Controller	NOAT	Nitrited Organic Acid Technology
DDC	Detroit Diesel Corporation	NOx	Nitrogen Oxide
DDEC	Detroit Diesel Electronic Controls	OAT	Organic Acid Technology
DEF	Diesel Exhaust Fluid	OBD	On Board Diagnostic

Acronyms and Abbreviations			
DOC	Diesel Oxidation Catalyst	OEM	Original Equipment Manufacturer
DPF	Diesel Particulate Filter	oz	Ounce
DTC	Diagnostic Trouble Code	psi	Pounds per Square Inch
ECM	Electronic Control Module	PTO	Power Takeoff
ECT	Engine Coolant Temperature	qt	Quart
EGR	Exhaust Gas Recirculation	regen	Regeneration
ELC	Extended Life Coolant	rpm	Revolutions per Minute
EPA	Environmental Protection Agency	SAE	Society of Automotive Engineers
FMCSA	Federal Motor Carrier Safety Administration	SCA	Supplemental Coolant Additive
GAWR	Gross Axle Weight Rating	SCR	Selective Catalyst Reduction
GHG	Greenhouse Gas	SEL	Stop Engine Light
GHG14	Greenhouse Gas and Fuel Efficiency Regulations	SEO	Stop Engine Override
GVWR	Gross Vehicle Weight Rating	S/N	Serial Number
HEST	High Exhaust System Temperature	SRS	Synchronous Reference Sensor
in.	Inch	SRT	Standard Repair Time
inH2O	Inches of Water	TCM	Transmission Control Module
inHg	Inches of Mercury	TDC	Top Dead Center
ISO	International Organization for Standardization	TPS	Throttle Position Sensor
k	Kilo (1000)	TRS	Timing Reference Sensor
kg	Kilogram	VIN	Vehicle Identification Number
km	Kilometer	VSG	Variable Speed Governor
km/h	Kilometers per Hour	VSS	Variable Speed Sensor
kPa	Kilopascal		

To the Operator

To the Operator

This manual contains instructions on the safe operation and preventive maintenance of your Detroit™ engine used in vehicle applications. Maintenance instructions cover routine engine services such as lubricating oil and filter changes in enough detail to permit self-servicing, if desired.

The operator should become familiar with the contents of this manual before operating the engine or carrying out maintenance procedures.

Power-driven equipment is only as safe as the person operating the controls. You are urged, as the operator of this diesel engine, to keep fingers and clothing away from the revolving belts, drive shafts, and pulleys on the engine installation.

Throughout this manual **CAUTIONS** and **WARNINGS** regarding personal safety and **NOTICES** regarding engine performance or service life will appear. To avoid personal injury and ensure long engine service life, always heed these instructions.

Whenever possible, it will benefit you to rely on an *authorized* Detroit™ service outlet for all your service needs from maintenance to major parts replacement. Authorized service outlets worldwide stock factory-original parts.

The information and specifications in this publication are based on the information in effect at the time of approval for printing. Contact an authorized Detroit™ service outlet for information on the latest revision. The right is reserved to make changes at any time without obligation.

Detroit™ engines are built in accordance with sound technological principles and based on state-of-the-art technology.

Despite this, the engine may constitute a risk of damage to property or injury to persons if it is not used for its intended purpose.

The engine should not be modified or converted in an incorrect manner or the safety instructions included in this manual disregarded.

Keep this Operator Manual with the engine installation at all times. It contains important operating, maintenance, and safety instructions.

NOTICE: Failure to maintain the cooling system at required concentrations will result in severe damage to the engine cooling system and related components. Refer to the "Coolant Selections and Maintenance" section.

Table 2.

WARRANTY
The applicable engine warranty is contained in the booklet "Warranty Information for Detroit™ Engines," available from authorized Detroit™ service outlets.

Trademark Information

DDC®, Detroit™, DDEC®, Optimized Idle®, Diagnostic Link®, BlueTec®, POWER Trac®, POWER COOL®, and POWER GUARD® are registered trademarks of Detroit Diesel Corporation. All other trademarks used are the property of their respective owners.

Caution Summary

Caution Summary

The following cautions must be observed by the operator of the vehicle or equipment in which this engine is installed and/or by those performing basic engine preventive maintenance. Failure to read and heed these cautions and exercise reasonable care for personal safety and the safety of others when operating the vehicle/equipment or performing basic engine preventive maintenance may result in personal injury and engine and/or vehicle/equipment damage.

Engine Operation

Observe the following cautions when operating the engine.



WARNING: PERSONAL INJURY

To avoid injury from loss of vehicle/vessel control, the operator of a DDEC equipped engine must not use or read any diagnostic tool while the vehicle/vessel is moving.



WARNING: HOT EXHAUST

During parked regeneration the exhaust gases will be extremely HOT and could cause a fire if directed at combustible materials. The vehicle must be parked outside.



CAUTION: LOSS OF VEHICLE CONTROL

To avoid injury from the loss of vehicle control, do not use cruise control under these conditions:

- When it is not possible to keep the vehicle at a constant speed (on winding roads, in heavy traffic, in traffic that varies in speed, etc.).
- On slippery roads (wet pavement, ice- or snow-covered roads, loose gravel, etc.).



WARNING: PERSONAL INJURY

Diesel engine exhaust and some of its constituents are known to the State of California to cause cancer, birth defects, and other reproductive harm.

- Always start and operate an engine in a well ventilated area.
- If operating an engine in an enclosed area, vent the exhaust to the outside.
- Do not modify or tamper with the exhaust system or emission control system.



WARNING: PERSONAL INJURY

To avoid injury from engine shutdown in an unsafe situation, ensure the operator knows how to override the stop engine condition on a DDEC-equipped unit.



CAUTION: LOSS OF VEHICLE CONTROL

To avoid injury from loss of vehicle control, do not activate the Engine Brake system under the following conditions:

- On wet or slippery pavement, unless the vehicle is equipped with ABS (anti-lock braking system) and you have had prior experience driving under these conditions.
- When driving without a trailer (bobtailing) or pulling an empty trailer.
- If the tractor drive wheels begin to lock or there is fishtail motion after the Engine Brake is activated, deactivate the brake system immediately if this occurs.



WARNING: BODILY INJURY

To avoid injury from an explosion, do not use ether or starting fluid on engines equipped with a manifold (grid) heater.

Preventive Maintenance

Observe the following cautions when performing preventive maintenance.



WARNING: PERSONAL INJURY

To avoid injury when working near or on an operating engine, remove loose items of clothing and jewelry. Tie back or contain long hair that could be caught in any moving part causing injury.

**WARNING: PERSONAL INJURY**

To avoid injury when working on or near an operating engine, wear protective clothing, eye protection, and hearing protection.

**WARNING: HOT OIL**

To avoid injury from hot oil, do not operate the engine with the rocker cover(s) removed.

**WARNING: FIRE**

To avoid injury from fire, contain and eliminate leaks of flammable fluids as they occur. Failure to eliminate leaks could result in fire.

**CAUTION: USED ENGINE OIL**

To avoid injury to skin from contact with the contaminants in used engine oil, wear protective gloves and apron.

**WARNING: PERSONAL INJURY**

To avoid injury when using caustic cleaning agents, follow the chemical manufacturers usage, disposal, and safety instructions.

**WARNING: PERSONAL INJURY**

To avoid injury from hot surfaces, wear protective gloves, or allow engine to cool before removing any component.

**WARNING: PERSONAL INJURY**

To avoid injury, use care when working around moving belts and rotating parts on the engine.

**WARNING: FIRE**

To avoid injury from combustion of heated lubricating-oil vapors, stop the engine immediately if an oil leak is detected.



WARNING: PERSONAL INJURY

To avoid injury from contact with rotating parts when an engine is operating with the air inlet piping removed, install an air inlet screen shield over the turbocharger air inlet. The shield prevents contact with rotating parts.



WARNING: HOT COOLANT

To avoid scalding from the expulsion of hot coolant, never remove the cooling system pressure cap while the engine is at operating temperature. Wear adequate protective clothing (face shield, rubber gloves, apron, and boots). Remove the cap slowly to relieve pressure.



WARNING: FIRE

To avoid injury from fire, do not smoke or allow open flames when working on an operating engine.



WARNING: FIRE

To avoid injury from fire from a buildup of volatile vapors, keep the engine area well ventilated during operation.



WARNING: PERSONAL INJURY

To avoid injury from rotating belts and fans, do not remove and discard safety guards.



WARNING: PERSONAL INJURY

To avoid injury from slipping and falling, immediately clean up any spilled liquids.

Compressed Air

Observe the following cautions when using compressed air.



WARNING: EYE INJURY

To avoid injury from flying debris when using compressed air, wear adequate eye protection (face shield or safety goggles) and do not exceed 276 kPa (40 psi) air pressure.

Cooling System

Observe the following cautions when servicing the cooling system.



WARNING: HOT COOLANT

To avoid scalding from the expulsion of hot coolant, never remove the cooling system pressure cap while the engine is at operating temperature. Wear adequate protective clothing (face shield, rubber gloves, apron, and boots). Remove the cap slowly to relieve pressure.



WARNING: PERSONAL INJURY

To avoid injury from slipping and falling, immediately clean up any spilled liquids.

Electrical System

Observe the following cautions when jump starting an engine, charging a battery, or working with the vehicle/application electrical system.



WARNING: ELECTRICAL SHOCK

To avoid injury from electrical shock, do not touch battery terminals, alternator terminals, or wiring cables while the engine is operating.



WARNING: Battery Explosion and Acid Burn

To avoid injury from battery explosion or contact with battery acid, work in a well ventilated area, wear protective clothing, and avoid sparks or flames near the battery. If you come in contact with battery acid:

- Flush your skin with water.
- Apply baking soda or lime to help neutralize the acid.
- Flush your eyes with water.
- Get medical attention immediately.



WARNING: PERSONAL INJURY

To avoid injury from accidental engine startup while servicing the engine, disconnect/disable the starting system.

Air Intake System

Observe the following cautions when working on the air intake system.



WARNING: PERSONAL INJURY

To avoid injury from hot surfaces, wear protective gloves, or allow engine to cool before removing any component.



WARNING: PERSONAL INJURY

To avoid injury from contact with rotating parts when an engine is operating with the air inlet piping removed, install an air inlet screen shield over the turbocharger air inlet. The shield prevents contact with rotating parts.

Lubricating Oil and Filters

Observe the following cautions when replacing the engine lubricating oil and filter.



WARNING: PERSONAL INJURY

To avoid injury from slipping and falling, immediately clean up any spilled liquids.



WARNING: FIRE

To avoid injury from combustion of heated lubricating-oil vapors, stop the engine immediately if an oil leak is detected.



WARNING: FIRE

To avoid injury from fire, do not smoke or allow open flames when working on an operating engine.



WARNING: FIRE

To avoid injury from fire from a buildup of volatile vapors, keep the engine area well ventilated during operation.

Fuel System

Observe the following cautions when fueling the vehicle or working with the fuel system.



WARNING: FIRE

To avoid injury from fire, keep all potential ignition sources away from diesel fuel, including open flames, sparks, and electrical resistance heating elements. Do not smoke when refueling.

**WARNING: PERSONAL INJURY**

To prevent the escape of high pressure fuel that can penetrate skin, ensure the engine has been shut down for a minimum of 10 minutes before servicing any component within the high pressure circuit. Residual high fuel pressure may be present within the circuit.

**WARNING: FIRE**

To avoid increased risk of a fuel fire, do not mix gasoline and diesel fuel.

**WARNING: FIRE**

To avoid injury from fire caused by heated diesel-fuel vapors:

- Keep those people who are not directly involved in servicing away from the engine.
- Stop the engine immediately if a fuel leak is detected.
- Do not smoke or allow open flames when working on an operating engine.
- Wear adequate protective clothing (face shield, insulated gloves and apron, etc.).
- To prevent a buildup of potentially volatile vapors, keep the engine area well ventilated during operation.

Aftertreatment System

Observe the following cautions when servicing the Aftertreatment System (ATS). Be advised that these two labels are attached to the Aftertreatment Device (ATD).

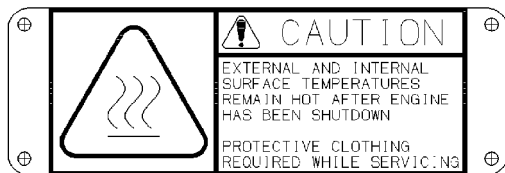

47158

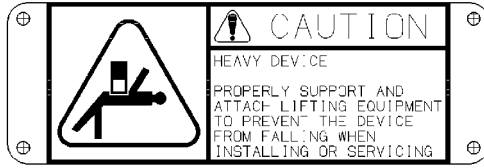

47157

Engine Identification

Engine Components - GHG17 Medium Duty Platform

GHG17 Medium Duty Platform engine components are shown below:

DD5 Engine Components

For general views of the Detroit™ DD5 engine and major components, see the following:

Table 3.

DD5 Left Side View	
	
<ol style="list-style-type: none"> 1. Water Pump 2. Coolant Thermostat 3. Fuel Rail 4. Hydrocarbon Doser Block 5. High Pressure Fuel Pump 	<ol style="list-style-type: none"> 6. Single-Stage Air Compressor 7. Motor Control Module (MCM) 8. Fuel Filter Module 9. Exhaust Gas Recirculation (EGR) Valve
d010182	

Table 4.



DD8 Engine Components

For general views of the Detroit™ DD8 engine and major components, see the following:

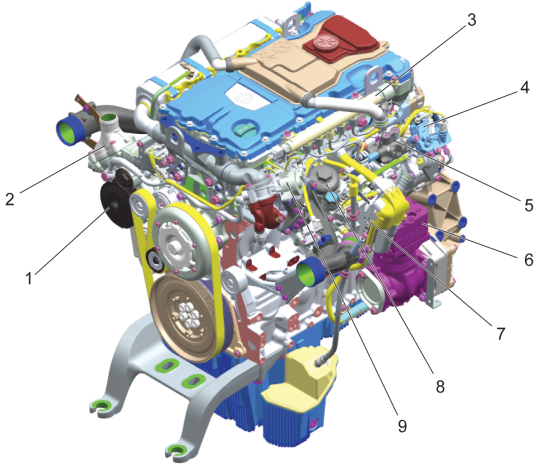
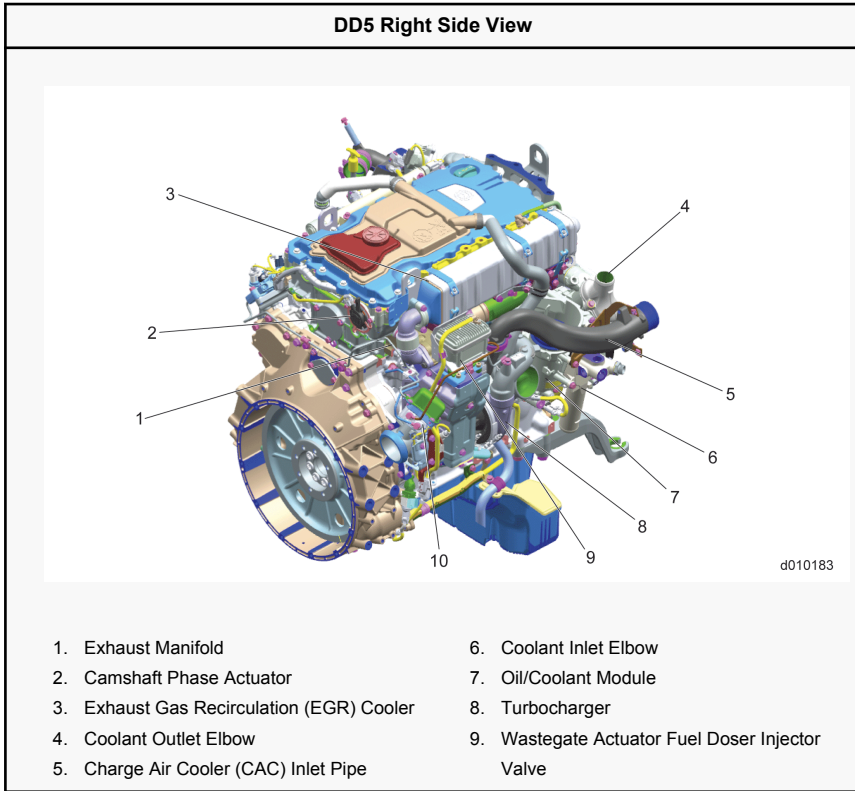
Table 5.

Table 6.



Engine Model and Serial Number Designation

The following information covers the DD5 engine model number, serial number and certification label.

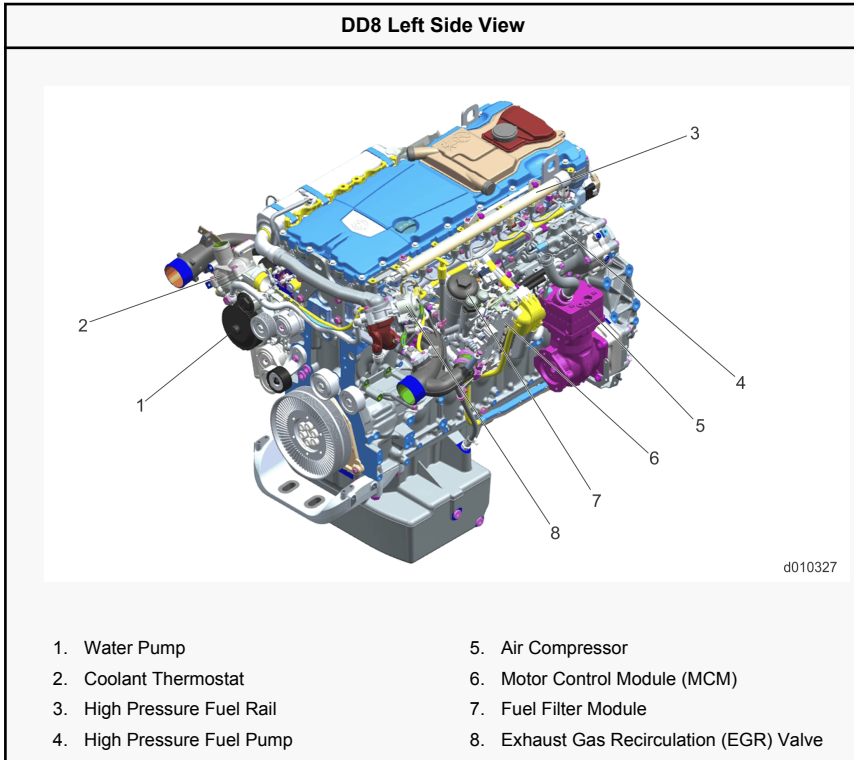
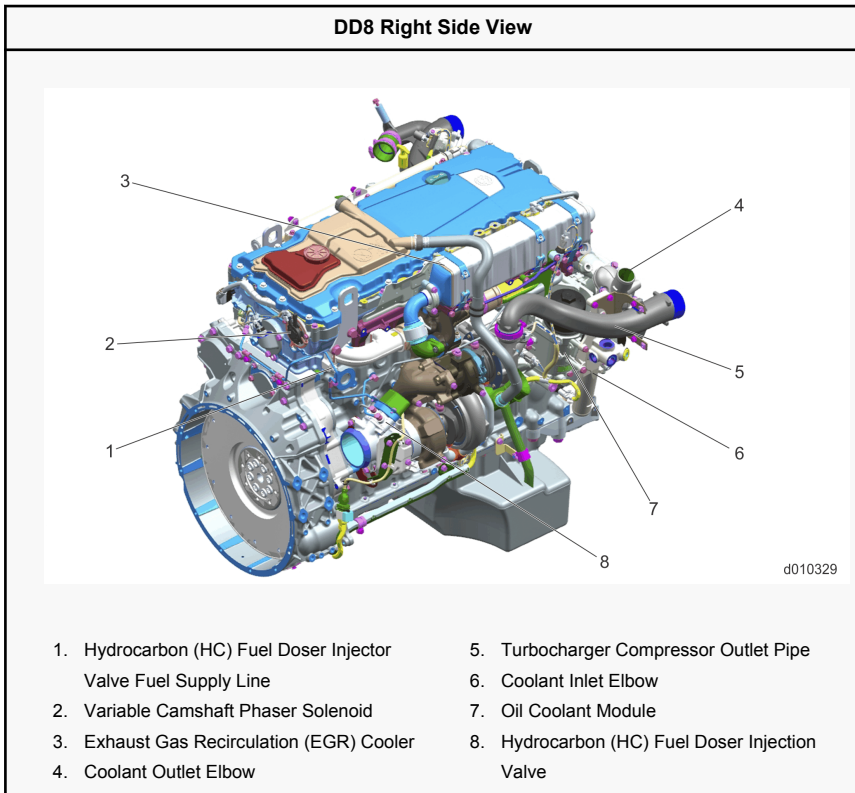
Engine Model and Serial Number

The fourteen-digit engine model and manufacturing serial number is etched on a pad located on the left front of the engine cylinder block, above the date and time of manufacture. Using 934913C0043228 as an example:

- 934 = engine model (Medium Duty 4-cyl, for MDEG NAFTA = DD5)
- 913 = application/high level identifier
- C = assembly plant (C for Mannheim, S for Detroit)
- 0043228 = serial number

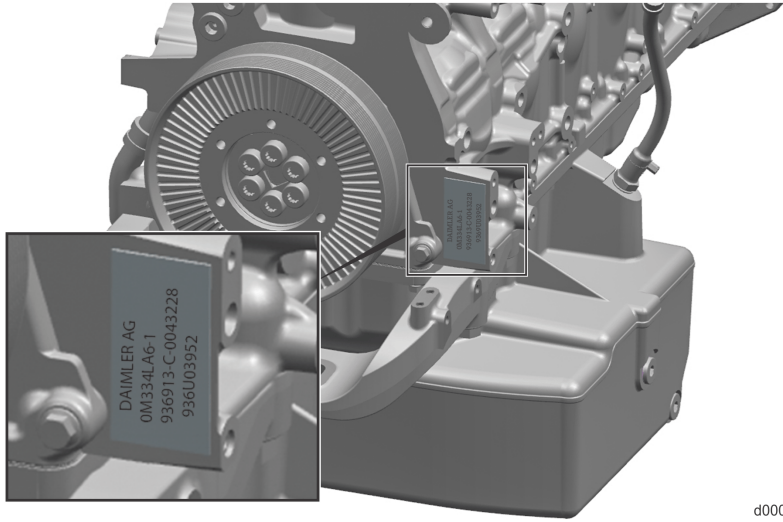

d000061

Figure 6. Engine Model and Serial Number Location
Engine Model Breakdown

- 934 - DD5
- 936 - DD8

Engine Certification Label

An engine certification label is attached to the engine rocker cover. This label certifies that the engine conforms to federal and state emissions regulations for its application. It gives the operating conditions under which certification was made.

The following illustration is a GHG17 engine certification label.

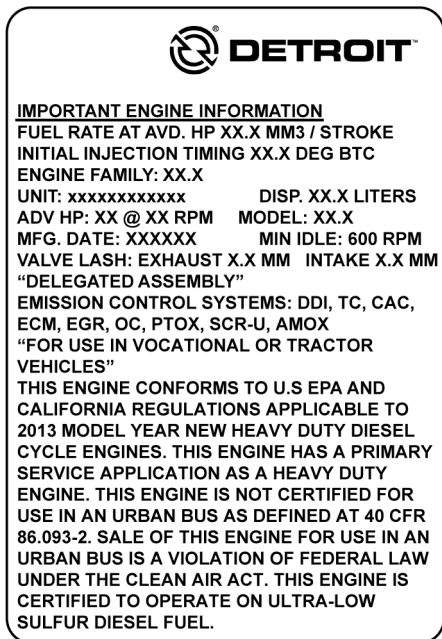

d990003d

Figure 7. GHG17 Engine Certification Label

First Time Start Preparations

System Checks

Perform the following system checks before starting.

Checking the Cooling System

Check the cooling system as follows:

1. Make sure all drain cocks in the cooling system are installed (drain cocks are often removed for shipping) and are closed tightly.
2. Fill the coolant overflow surge tank with Detroit™ Genuine Coolant until coolant level stays between the low and full coolant marks on the tank.
3. Entrapped air must be purged after filling the cooling system. To do this, allow the engine to warm up with the pressure cap removed. With the transmission in neutral, increase engine speed to 1000 rpm and add coolant to the surge tank as required.
4. Check to make sure the front of the radiator and charge air cooler (if equipped) are unblocked and free of debris.

Checking and Monitoring the Oil Level

Check the oil level as follows:



WARNING: PERSONAL INJURY

To avoid injury from slipping and falling, immediately clean up any spilled liquids.

NOTICE: Do not add oil if the oil reading is in the crosshatch area on the dipstick. There are approximately 4.0 L (4.2 qt) from the fill mark to the full mark. Overfilling the oil pan can cause engine damage.

NOTE: If the engine operating temperature is below 60°C (140°F), the engine must be on a level surface and then shut down for 60 minutes for an accurate oil level reading. Otherwise, the engine must be brought up to an operating temperature of 60°C (140°F), parked on a level surface and then shut down for 20 minutes for an accurate oil level reading.

1. Check the oil level daily with the engine stopped and on a level surface. If the engine has just been stopped and is warm, wait approximately 20 minutes to allow the oil to drain back into the oil pan before checking.

2. Add oil to maintain the correct level on the dipstick. Use only the heavy-duty oils recommended in the "How to Replace the Lubricating Oil and Oil Filter" section in this manual.

NOTE: If the dipstick has a positive locking device such as a lever or twist-lock design, this must be disengaged before pulling the dipstick out of the guide tube.

3. Remove the dipstick from the guide tube. Use a shop rag to wipe off the end of the dipstick.
4. Wait 15 seconds to allow any crankcase pressure to dissipate through the guide tube and let the oil level settle in the oil pan.
5. Reinstall the dipstick and make sure it is fully inserted into the guide tube.
6. Remove the dipstick and read the oil level dipstick.
7. The figure shows a comparison between the bends on the dipstick and a crosshatch pattern on a conventional dipstick. Note the exact area noted on the bends. For example, the 'maximum' oil level will be at the **BOTTOM** of bend (1). For the 'minimum' oil level, it is noted at the **TOP** of bend (2). If the oil level is below the 'minimum' bend, add oil to bring it up the 'maximum' level. Do **NOT** fill beyond the maximum fill level on the dipstick, since overfilling may result in high oil consumption and possible severe engine damage.

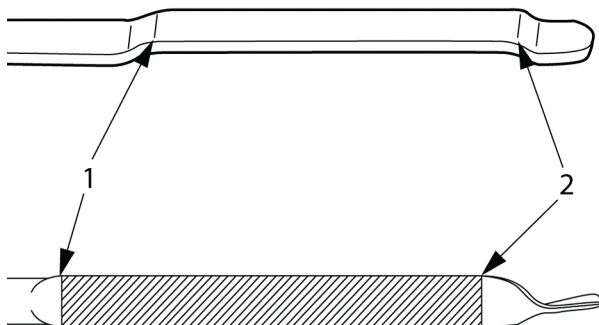

42141

Fuel System Checks

Make sure the fuel shutoff valve (if used) is open. Fill the tanks with the recommended fuel. Keeping tanks full reduces water condensation and helps keep fuel cool, which is important to engine performance. Full tanks also reduce the chance for microbe (black slime) growth. For fuel recommendations, Refer to section "How to Select Diesel Fuel".

NOTICE: Prolonged use of the starting motor and engine fuel pumps to prime the fuel system can result in damage to the starter, fuel pumps, and injectors.

If the shutoff valve is even partially closed, it may cause erratic engine operation due to an inadequate supply of fuel to the fuel pump.

NOTICE: NEVER use ether as a starting aid to run the engine. Doing so will result in injector damage.

If an external starting aid is used, such as a starting fluid, the heat generated by the external fuel source will cause the injector tips to be damaged when the fuel cools them. The injector piston and bushing can be scored from running without lubrication.

To ensure prompt starting and even running, the fuel system must be primed if air has entered the fuel system. Priming is done by operating the manual hand priming pump located on the frame-mounted fuel filter or connecting an external priming pump to the priming port on the fuel filter module. Authorized Detroit™ service outlets are properly equipped for this type of service.

Priming is required if the fuel system has been serviced.

Drain off any water that has accumulated. Water in fuel can seriously affect engine performance and may cause engine damage.

Adding Fuel

When adding fuel, pay attention to the following:

NOTICE: Always use Ultra-Low Sulfur Fuel (ULSF) with 15 PPM sulfur content or less, based on ASTM Standard D2622 test procedure. Higher sulfur levels will damage the engine Aftertreatment System (ATS).

- Add winter or summer grade fuel according to the season of the year.
- Work in the cleanest conditions possible.
- Prevent water from entering the fuel tank.

For further information, Refer to Section "How to Select Diesel Fuel".

Checking Other Engine and ATS Related Parts

Check the engine compartment as follows:

- Make sure the transmission is filled to the proper level with the fluid recommended by the gear manufacturer. Do not overfill.
- The Diesel Exhaust Fluid (DEF) must be checked and filled regularly with DEF meeting Detroit™ quality specification.
- Make sure cable connections to the storage batteries are clean and tight.
- Check for cracks in the battery cases (1), for tightness of the cable clamps (2) at the terminals, and for corrosion of the terminals (3). Service or replace as

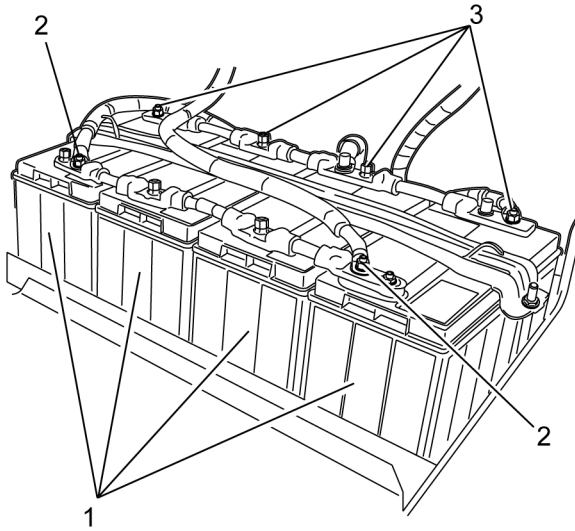

needed.

d540077

- To provide corrosion protection, apply dielectric grease liberally to the terminal pads.

Starting the Engine

1. Place the transmission in neutral, and set the parking brake.

NOTICE: To prevent serious starter motor damage, release the ignition switch immediately after the engine has started.

2. Turn on the ignition switch.
3. Wait for the engine system indicator lights on the instrument panel to go out.
4. With foot off the accelerator pedal, start the engine.
5. If the engine does not start after 20 seconds, stop. Try again after waiting about 60 seconds.

NOTICE: Do not increase engine speed if the oil pressure gauge indicates no oil pressure. Shut down the engine within approximately ten seconds to avoid engine damage. Check to determine the cause of the problem.

NOTE: Do not place the engine under full load until it reaches operating temperature. Colder engine temperatures will cause the engine to preset idle up to 900 rpm. Even at a high idle condition, you do not have to wait for engine warm up and return to normal 600 rpm idle to drive the truck.

6. Monitor the oil pressure gauge immediately after starting the engine.

Cold Weather Operation

Special precautions must be taken during cold weather. To protect your engine, special cold weather handling is required for fuel, engine oil, coolant, and batteries.

NOTICE: To avoid engine damage, DO NOT use any type of aerosol spray, e.g., ether, starting fluid or brake cleaner to aid in starting the engine.

For engines with a grid heater:



WARNING: BODILY INJURY

To avoid injury from an explosion, do not use ether or starting fluid on engines equipped with a manifold (grid) heater.

Temperatures below -20°C (-4°F) may require a block heater and oil pan heater.

Winter Fronts

Winter fronts on DD engines are seldom necessary due to the modern design of the engine cooling system. The coolant thermostat is on the outlet side of the cooling system on the DD Platform engine and regulates coolant flow to the radiator into the engine. The thermostat regulates coolant flow to control the temperature of the coolant within the coolant circuit. The following benefits are a result from regulating the coolant at the inlet temperature side of the engine:

- Reduced thermal cycling of the engine
- Operating temperature is reached faster
- Improved vehicle heating because of better temperature regulation

Further information on the thermostat function may be found in the Coolant Thermostat section of the *GHG17 Medium Duty Workshop Manual* (DDC-SVC-MAN-0194).

Use of a winter front on a DD Platform engine, particularly those that are fully closed, **will** cause performance issues and is not recommended on DD Platform engines. Winter fronts can result in the following:

- Excessive fan run time due to higher Charge Air Cooler (CAC) outlet temperatures resulting from low air flow through the CAC
- Increased fuel consumption
- Failure of the DEF system heaters to turn on when needed due to incorrect temperature calculations resulting in fault codes, poor performance of the Aftertreatment System, and power reduction
- Failure of critical emission equipment that will result in vehicle speed inducement to a maximum of 5 mph

Use of a winter front should be avoided as this has been shown to cause false fault codes with the engine and aftertreatment system. This has also been linked to specific component failures that will cause vehicle downtime and lost productivity.

There are two specific situations where a winter front may be temporarily needed:

- To improve cab heating while idling under extreme cold ambient temperature
- When the ambient temperature remains below -30°C (-22°F) **and** the engine is unable to maintain running coolant temperature of 80°C (175°F) during normal over-the-road operation

If either of the above situations is encountered, then a winter front may be temporarily used. A minimum of 25% of the grill must be open in sectioned stripes that run perpendicular to the charge air cooler tube flow direction. This assures even cooling across each tube and reduces header-to-tube stress and possible failure.

Detroit Diesel Electronic Control System Operation

Detroit Diesel Electronic Control System Operation

NOTE: This engine is equipped with DDEC software. This software generally assures optimal engine performance. The installation of software upgrades may cause minor changes in features and engine performance.

Since the DDEC system is electronic, a battery is required to operate the computer. The system operates at 12 volts. However, in the event of a power supply malfunction, the system will continue to operate at reduced voltage. When this occurs, the AWL (Check Engine) will come on.

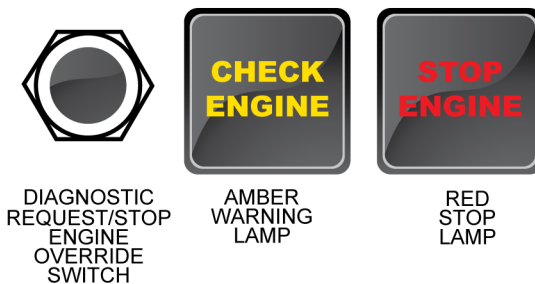

47471

The engine will only operate at reduced rpm until the battery voltage reaches a point where the MCM will no longer function and the engine shuts down.

Should the AWL (Check Engine) come on for any reason, the vehicle can still be operated and the driver can proceed to the required destination. *This condition should be reported to an authorized Detroit™ distributor or dealer.*

NOTICE: When the RSL (Stop Engine) comes on, the system has detected a major malfunction in the engine that requires immediate attention. **It is the operator's responsibility to shut down the engine to avoid serious damage.**

The engine can be configured to give a warning only, to ramp down (reduce power) or to shut down. Ramp down will reduce engine rpm to a predetermined speed, but will not shut down the engine. With the 30-second shutdown option, the engine will begin a 30-second, stepped power down sequence until it shuts down completely.

The "Stop Engine Override" feature can be activated in the case where the vehicle is operating in a critical location.

Stop Engine Override Switch

This feature allows the operator to override the automatic Stop Engine sequence.

This is done by pressing the Stop Engine Override Switch every 15 to 20 seconds to prevent engine shutdown from occurring.

NOTE: Continuously holding down the Stop Engine Override Switch will not prevent the engine shutdown sequence. You must continue to reset the automatic shutdown system by pressing the Stop Engine Override Switch at intervals of approximately 15 to 20 seconds.

It takes 30 seconds from the time the automatic shutdown sequence begins until engine shutdown. Therefore, the operator **must** press the override switch just prior to engine shutdown and continue to do so until the vehicle can be brought to a stop in a safe location.

Immediate Speed Reduction

The immediate speed reduction option will bring engine rpm back to a predetermined speed, but will not shut down the engine.

The engine should not be restarted after it has been shut down by the engine protection system, unless the problem has been located and corrected.

Red Stop Lamp

The conditions that will cause the RSL (Stop Engine) to come on are:

- High coolant temperature
- Loss of coolant
- High oil temperature
- Low oil pressure
- Auxiliary shutdown

Whenever the AWL (Check Engine) or the RSL comes on, the DDEC 10 system will determine where the problem is and will then store this information in its memory.

If the malfunction is intermittent, the lights will come on and go off as the computer senses the changing engine condition.

Detroit Diesel Electronic Control System Features

Changing the Idle Speed

The idle speed range of the DD Platform engine is 600 to 900 rpm if the parameters in the CPC are set to the default range. Change the idle speed as follows:

1. Turn the cruise control switch to the ON position.
2. To increase the idle speed, push the RSM/ACC switch until the idle reaches the desired rpm.
3. To decrease the idle speed, push the SET/CST switch until the idle reaches the desired rpm.

Stop Engine Override Option

The Stop Engine Override Option is used for a momentary override. The electronic engine control system will record the number of times the override is activated after an engine fault occurs.

Engine Brake

The engine brake is enabled by a dash-mounted ON/OFF Switch with a separate intensity switch to select (HI/MED/LO or, in some cases HI/LO) braking power.



CAUTION: LOSS OF VEHICLE CONTROL

To avoid injury from loss of vehicle control, do not activate the Engine Brake system under the following conditions:

- On wet or slippery pavement, unless the vehicle is equipped with ABS (anti-lock braking system) and you have had prior experience driving under these conditions.
- When driving without a trailer (bobtailing) or pulling an empty trailer.
- If the tractor drive wheels begin to lock or there is fishtail motion after the Engine Brake is activated, deactivate the brake system immediately if this occurs.

NOTICE: Do not attempt to "double clutch" the transmission while the engine brake system is turned on. Shifting gears without pressing the clutch or using the engine brake to reduce engine rpm may result in serious powertrain damage.

The engine brake will only operate when the accelerator pedal is fully released. Disengaging the clutch will prevent the engine brake from operating.

The engine brake will supply braking power even when in Cruise Control. The Motor Control Module will control the amount of engine braking with respect to the Cruise Control set speed. The maximum amount of braking (HI/MED/LO) is selected with the dash or steering wheel switches.

Anti-Lock Braking Systems

Vehicles equipped with ABS have the ability to turn the engine brake OFF if a wheel-slip condition is detected. The engine brake will automatically turn itself ON once the wheel slip is no longer detected.

The DDEC system will deactivate the engine brake system when the engine speed falls below a preset rpm or when the vehicle slows down to a preset speed, depending on DDEC programming. This prevents stalling the engine. The engine brake can also be used with vehicle Cruise Control turned ON.

Engine Protection

The electronic engine control protection system monitors all engine sensors, electronic components, and recognizes system malfunctions. If a critical fault is detected, the AWL (Check Engine) and RSL (Stop Engine) illuminate. The malfunction codes are logged into the MCM's memory.

The standard parameters which are monitored for engine protection are low coolant level, high coolant temperature, low oil pressure, and high oil temperature.



WARNING: PERSONAL INJURY

To avoid injury from engine shutdown in an unsafe situation, ensure the operator knows how to override the stop engine condition on a DDEC-equipped unit.

NOTICE: Engines equipped with the power down/shutdown option have a system override button or switch to allow engine operation for a short period of time. Using the override button so the engine does not shut down in 30 seconds but operates for an extended period may result in engine damage.

This system features a 30-second, stepped-power shutdown sequence, or an immediate speed reduction without shutdown in the event a major engine malfunction occurs, such as low oil pressure, high oil or coolant temperature, or low coolant level.

California Engine Idle Limiting

All 2010 and newer Detroit™ engines built with the California (50-state) EPA certification are allowed to idle indefinitely when idle speed is below 900 rpm.

For California (50-state) EPA certification engines that idle above 900 rpm, the California Engine Idle Limiting feature is enabled. The engine will generally shut down after five minutes of continuous idling when the transmission is in neutral or park and the parking brake is set or after 15 minutes when the transmission is in neutral or park and the parking brake is not set. The automatic shutdown feature that is applied above 900 rpm is required for all California certified engines with the exception of engines used in specific vehicle types which the state of California has determined to be exempt from the idle shutdown requirement. These include buses, school buses, recreational vehicles, medium duty vehicles, military tactical vehicles, and authorized emergency vehicles as they are defined by the state of California. Owners of these vehicle types that wish to have the shutdown feature disabled should consult with California authorities to determine if their vehicles qualify for the exemption.

Non-California (49-state) EPA certification engines (non-California engines) have the automatic shutdown feature enabled.

In California and Opt-in states, extended idling above 900 rpm is not allowed unless the engine is performing a parked DPF regeneration or engaged in PTO operations such as pumping, hydraulics, etc.

Idle Shutdown Timer

This feature is an optional 1-80 minute idle shutdown system. Its purpose is to conserve fuel by eliminating excessive idling and allowing a turbocharger cool-down period. To activate the shutdown, the transmission must be in neutral with the vehicle parking brakes set and the engine in idle or fast-idle mode.

Engine Systems

Engine Systems

The engine systems are as follows:

Fuel System

The fuel system consists of DDEC control system, fuel injectors, high pressure fuel rail, low and high pressure pumps, fuel filter module, prefilter, final filter, and the necessary connecting fuel lines.

Lubrication System

The lubrication system consists of an oil pump, oil cooler, cartridge-style oil filter, pressure regulator valve, and oil pressure sensor. Clean, pressurized oil is fed to all components via passages in the engine block and cylinder head.

Air System

Outside air enters the engine through the air filter, is drawn to the turbocharger, is then compressed, forced through the air-to-air charge cooler (heat exchanger) and is cooled. Next, it flows to the intake manifold and into the cylinders, where it mixes with atomized fuel from the injectors.

For optimum engine protection from dust and other airborne contaminants, service the dry-type air cleaners when the maximum allowable air restriction has been reached.

Cooling System

A radiator/thermo-modulated fan cooling system is used on the engine. This system has a centrifugal-type coolant pump to circulate coolant within the engine. Two thermostats located in the oil/coolant module attached to the right side of the cylinder block controls the flow of coolant. The coolant module incorporates the oil cooler, oil filter, and coolant pump.

Electrical System

The electrical system consists of a starting motor, starting switch, battery-charging alternator, storage batteries, and necessary wiring.

Exhaust System

Hot exhaust gas from the exhaust manifolds is used to drive the turbocharger.

Exhaust Gas Recirculation System

The Exhaust Gas Recirculation (EGR) system consists of an EGR cooler and EGR valve. The EGR valve allows hot exhaust gas to enter the EGR cooler. Heat is extracted from the exhaust gas, resulting in cooler exhaust gas to the cylinders. EGR lowers the temperature of the exhaust from the engine, therefore, reducing exhaust gas emissions to acceptable levels.

The purpose of the Exhaust Gas Recirculation System (EGR) is to reduce engine exhaust gas emissions in accordance with EPA regulations.

The EGR system has been optimized to dramatically cut NOx formation by routing a measured amount of exhaust flow to the cylinders to lower combustion temperatures. Lower temperatures result in lower NOx levels without the negative effects of retarding engine timing. The EGR valve has been moved to the top of the engine for improved serviceability.

Engines for on-highway EPA 2007 regulation applications use a cooled EGR system along with an Aftertreatment System to meet the emission standards.

GHG17 Medium Duty Aftertreatment System

GHG17 Medium Duty Aftertreatment System

The GHG17 Medium Duty Aftertreatment System (ATS) is an airless dosing system. The ATS consists of a Diesel Oxidation Catalyst (DOC), Diesel Particulate Filter (DPF), Selective Catalytic Reduction (SCR) hydrolysis Chamber, SCR catalyst, Aftertreatment Control Module (ACM), a tank for Diesel Exhaust Fluid (DEF), a DEF pump, and an airless DEF dosing unit. The Selective Catalytic Reduction (SCR) system consists of an Aftertreatment Control Module (ACM), a tank for Diesel Exhaust Fluid (DEF), a DEF pump, an airless DEF dosing unit, and an SCR module. DEF is pumped to the airless dosing unit through a high pressure DEF line at 10 bar (145 psi). The DEF dosing unit injects a fine mist of atomized DEF into the SCR hydrolysis chamber to produce a chemical reaction. This chemical reaction converts nitrogen oxide (NO_x), present in the exhaust stream, into water vapor and nitrogen.

Diesel Exhaust Fluid Information

Diesel Exhaust Fluid Information

The Selective Catalytic Reduction (SCR) aftertreatment system for this engine requires Diesel Exhaust Fluid (DEF) to maintain exhaust emissions at levels compliant with emissions standards. DEF is a simple, non-toxic and inexpensive pre-mixed fluid composed of 2/3 pure water and 1/3 automotive grade urea. The following sections provide information regarding DEF availability, specifications, handling and storage, and certain SCR anti-tampering features.

Diesel Exhaust Fluid Availability

DEF is available in bulk quantities at roadside truck stop service centers. DEF is also available in various container sizes at Detroit™ service outlets, truck dealerships, and many truck service centers. DEF is available in container sizes as small as 2.5 gallons for convenient storage in your vehicle for emergency use. For locations where DEF may be purchased, call the Detroit™ Customer Service Center at 1-800-445-1980.

Diesel Exhaust Fluid Specifications

DEF is manufactured to strict quality standards to ensure proper emissions control. Only DEF that meets DIN70700 or ISO 22241-1 specifications can be used. The American Petroleum Institute has developed a quality certification program to ensure the quality of DEF available at service outlets.

Diesel Exhaust Fluid Handling and Storage

When stored at temperatures between 10° and 90° F (minus 12° and 32° C), DEF has a minimum shelf life of 12 months. For best shelf life it is recommended that Diesel Exhaust Fluid (DEF) containers be stored in a controlled environment.

Diesel Exhaust Fluid System Anti-Tampering Feature

The diagnostic system monitors for faults in DEF system components and monitors the DEF supply pressure. If the diagnostics detect that components critical to the Selective Catalytic Reduction (SCR Catalyst) or DEF supply system are disconnected (which could indicate tampering), or if the diagnostics detect abnormal system pressures indicative of DEF supply blockage, the warning lamp will illuminate and the control system will initiate time and mileage counters. If the sensors detect that the SCR system has been tampered with, the MIL illuminates to warn the driver, and the engine performance is limited, with a 55 mph (90 km/h) speed limit. If the system fault is not corrected, the STOP engine light illuminates and a 5 mph (8 km/h) speed limit will be applied during non-driving conditions. Similar warnings and penalties will result when insufficient urea quantity is present.

Aftertreatment Device Operating Requirements

Aftertreatment Device Operating Requirements

NOTICE: Not following the operating requirements may result in damage to the Aftertreatment Device (ATD) or accelerated ash plugging of the diesel particulate filter.

NOTICE: Do not use kerosene or fuel blended with used lube oil.

Oxidation of particulate matter is the key to filter performance. This requires that the catalyzing agent (platinum-coated passages) provide optimum enhancement to the oxidation process. The following requirements must be met; otherwise the Aftertreatment Device (ATD) warranty may be compromised:

- Use Ultra-Low Sulfur Diesel Fuel (ULSD) with 15 ppm sulfur content or less, based on ASTM D2622 test procedure.
- Lube oil must have a sulfated ash level less than 1.0 wt %, currently referred to as API FA-4, CK-4 and CJ-4 oil. Detroit™ currently recommends DFS 93K223 (API FA-4) for optimal fuel economy, however, DFS 93K222 (API CK-4) may also be used.

Diesel Exhaust Fluid Tank

Diesel Exhaust Fluid Tank

The Diesel Exhaust Fluid (DEF) tank holds the DEF supply. The filler neck has a smaller diameter (19 mm) than the filler neck of the diesel fuel tank and is fitted with a magnetic insert so that diesel fuel cannot be mistakenly added to the DEF tank. The DEF you should use with your Detroit™ product will be API (American Petroleum Institute) certified and meet the specifications ISO 22241-1 and DIN70700. These are two widely accepted standards in use for qualifying DEF for use in exhaust aftertreatment systems. DEF (Diesel Exhaust Fluid) will be sold at over 2,500 locations throughout North America. These locations include:

- Detroit™ Distributors
- Freightliner® Truck Dealers
- Western Star® Truck Dealers
- Travel Centers of America® Truck Stops
- Petro® Stopping Centers
- Pilot Travel Centers®
- Additional Diesel Exhaust Fluid (DEF) sales locations can be found at www.afdc.energy.gov/afdc/locator/def/

If diesel fuel is added to the DEF tank or DEF is added to the diesel fuel tank, immediately contact your Certified Detroit™ Service Center for further instructions.

Aftertreatment Maintenance

Aftertreatment Maintenance

A high amount of black smoke emitting from the vehicle or illumination of the Amber Warning Lamp or Red Stop Lamp are indications of a system problem. Should this occur, consult your local Detroit™ Service Center.

Illumination of the Malfunction Indicator Lamp (MIL) Lamp indicates a failure of an emissions control device. The MIL may illuminate along with other ATS warning lamps. Call for service to repair the fault.

Illumination of the Diesel Particulate Filter (DPF) Regeneration Lamp indicates that a parked regeneration is required.

There is a need to periodically remove accumulated ash, derived from engine lube oil, from the filter. This ash does not oxidize in the filter during the regeneration process and must be removed through a cleaning procedure. All Detroit™ ATD equipped engines will illuminate a dashboard warning lamp indicating the need for ash cleaning.

Performing a Parked Regeneration - GHG17

Performing a Parked Regeneration - GHG17

Perform a Parked Regeneration as follows:



WARNING: ENGINE EXHAUST

To avoid injury from inhaling engine exhaust, always operate the engine in a well-ventilated area. Engine exhaust is toxic.



WARNING: HOT EXHAUST

During parked regeneration the exhaust gases will be extremely HOT and could cause a fire if directed at combustible materials. The vehicle must be parked outside.

NOTE: Under factory default settings, when the Diesel Particulate Filter (DPF) Regeneration Lamp is not illuminated, the regeneration request switch is disabled.

NOTE: The driver **MUST** stay with the vehicle throughout the regeneration process.

NOTE: Not all vehicles may be equipped with a Regeneration Request Switch due to application or user specification.

NOTE: The procedure will take approximately 30 to 45 minutes (depending on engine type and the amount of soot accumulated in the DPF).

When the parked regeneration request is accepted, the Diesel Particulate Filter (DPF) Regeneration lamp will turn ON one time for one second and then turn off for the remainder of the parked regeneration. The High Exhaust System Temperature (HEST) lamp will flash for one second every ten seconds and eventually become solid when the tailpipe temperature is above 525°C (977°F).

The engine speed may vary during parked regeneration (depending on engine displacement, exhaust temperature and the amount of soot accumulated in the DPF). The regeneration is complete when the engine returns to idle and the DPF lamp remains OFF. The HEST lamp will remain ON, but the vehicle may be driven.

NOTE: A parked regeneration will STOP and the engine will return to low idle if any of the following happens:

- The key is turned to the OFF position
- The vehicle is put into gear
- The clutch is cycled
- The parking brake is released

NOTE: If the HEST LAMP is FLASHING, regeneration is in process and the system is coming up to temperature.

1. Keep engine at idle (cannot be in Fast Idle or PTO Mode). Put transmission in neutral (if equipped with an automatic transmission).
2. Set park brake.
3. Hold DPF Switch to the ON position for five seconds and then release (engine speed will increase and DPF lamp will go out).



d140101

Diesel Particulate Filter Service Record

Service Record

It is mandatory that customers or distributors maintain a proper record of the particulate filter servicing and cleaning. This record is an agent to warranty considerations. The record must include information such as:

- Date of cleaning or replacement
- Vehicle mileage at the time of cleaning or replacement
- Particulate filter part number and serial number(s)

Instrument Panel Lamps

Instrument Panel Lamps

The instrument panel lamps are explained below:

Amber Warning Lamp

Table 7.

Lamp	Lamp Name	Description	Results
	Amber Warning Lamp (AWL)	Indicates a fault with the engine controls.	Vehicle can be driven to end of shift. Call for service.
Lamp Solid		Lamp Flashing	
<ul style="list-style-type: none"> • At the start of every ignition cycle (bulb check). • When an electronic system fault occurs. (Fault should be diagnosed as soon as possible.) 		<ul style="list-style-type: none"> • Flashes last 90 seconds before idle shutdown if programmed for override. • Flashes when idle shutdown or the optimized idle shutdown occurs. 	

Red Stop Lamp

Table 8.

Lamp	Lamp Name	Description	Results
	Red Stop Lamp (RSL)	Indicates a major engine fault that may result in engine damage. Engine derate and/or shutdown sequence will be initiated.	Move the vehicle to the nearest safe location and shut down the engine. Call for service.
Lamp Solid		Lamp Flashing	
<ul style="list-style-type: none"> At the start of every ignition cycle (bulb check). A potential engine damaging fault is detected. 		<ul style="list-style-type: none"> Flashes when engine protection shutdown occurs. 	

Diesel Particulate Filter Regeneration Lamp

Table 9.

Lamp	Lamp Name	Description	Results
	Diesel Particulate Filter Regeneration Lamp	Solid yellow indicates a regeneration is required. Blinking yellow, derate and/or shutdown are possible as soot load continues to increase. Lamp will shut off during parked regeneration.	Lamp Solid - regeneration is required. Lamp Flashing - regeneration is required immediately.
Lamp Solid		Lamp Flashing	
<ul style="list-style-type: none"> At the start of every ignition cycle (bulb check). Regeneration is required. 		<ul style="list-style-type: none"> When a regeneration is required immediately (if the lamp flashing is ignored), a derate and/or shutdown could occur. 	

High Exhaust System Temperature Lamp

Table 10.

Lamp	Lamp Name	Description	Results
	High Exhaust System Temperature (HEST) Lamp	Lamp is yellow. Indicates exhaust temperature is above a preset limit and unit is operating at low vehicle speed (below 5 mph [8 kph]). When the engine speed is elevated for a parked regeneration, lamp will flash once every 10 seconds.	Vehicle can be driven. Lamp solid for an extended period (Longer than 40 Minutes) - call for service.
Lamp Solid		Lamp Flashing	
<ul style="list-style-type: none"> At the start of every ignition cycle (bulb check). Vehicle speed is less than 5 mph and the Diesel Particulate Filter (DPF) outlet temperature is greater than 525° C (977° F). 		Flashes every 10 seconds when the Selective Catalytic Reduction (SCR Catalyst) is not up to temperature	

Malfunction Indicator Lamp**Table 11.**

Lamp	Lamp Name	Description	Results
	Malfunction Indicator Lamp (MIL)	Yellow lamp Indicates a failure of an Emission Control device. May illuminate at the same time as the Amber Warning Lamp.	Vehicle can be driven to end of the shift. Call for service.
Lamp Solid		Lamp Flashing	
<ul style="list-style-type: none"> At the start of every ignition cycle (a bulb check) For any emission related fault (light out when the fault is inactive) 		Never flashes	

Fuel Filter Restriction Sensor Lamp: Fuel Filter Failed

Table 12.

Lamp	Lamp Name	Description	Results
	Fuel Filter Restriction Sensor (FFRS) Lamp	Yellow lamp indicates that the fuel filter is restricted and needs to be serviced. May illuminate at the same time as the Malfunction Indicator Lamp (MIL) and Amber Warning Lamp (AWL)	Service soon
Lamp Solid		Lamp Flashing	
<ul style="list-style-type: none"> At the start of every ignition cycle (a bulb check). Fuel filter needs service. 		<ul style="list-style-type: none"> Never 	

Water-In-Fuel Lamp (WIF)

Table 13.

Lamp	Lamp Name	Description	Results
	Water-In-Fuel (WIF) Lamp	Yellow lamp indicates that the fuel water separator has reached its capacity and needs to be drained.	Engine water separator must be drained or an engine derate will occur.
Lamp Solid		Lamp Flashing	
<ul style="list-style-type: none"> At the start of every ignition cycle (a bulb check). Water separator has reached its maximum capacity. 		<ul style="list-style-type: none"> Never 	

Diesel Exhaust Fluid Level Warning Lamps

Diesel Exhaust Fluid Level Warning Lamps

A four light bar segment indicates the Diesel Exhaust Fluid (DEF) level in 25% increments. Low DEF levels will trigger a decrease in the engine's performance. The use of improper DEF fluid will trigger a decrease in the engine's performance. In an empty or an ignored state and the diesel fuel tank is filled without filling the DEF tank, the vehicle's speed will be limited to 5 mph until DEF is detected in the DEF tank.

DETROIT
DIESEL CORPORATION

DIESEL EXHAUST FLUID (DEF) INDICATOR LAMPS

- The light bar indicates the level of fluid in the DEF tank.
- Low DEF levels will trigger a decrease in engine performance.
- The use of improper fluid will trigger a decrease in engine performance.
- In the empty and ignored state, vehicle speed will be limited to 5 mph until DEF is detected in the tank.

DEF level is very low
Solid

DEF level is EMPTY
Flashing
Vehicle speed limited to 55 mph / engine derated

DEF level is EMPTY and IGNORED
Flashing
STOP ENGINE
Vehicle speed limited to 5 mph / engine derated

ULTRA LOW SULFUR DIESEL FUEL ONLY

Low DEF warning light

Light bar shows DEF level

DDC-SVC-07M-030-2012 Specifications are subject to change without notice. Detroit and the Talking Arrow logo are registered trademarks of the Detroit Diesel Corporation. Copyright © 2012, Detroit Diesel Corporation. All rights reserved. Detroit Diesel is a Banner company.

BLUETEC

d140339

Figure 8. Driver Card

Aftertreatment System Driver Notifications and Actions

Aftertreatment System Driver Notifications and Actions

High Exhaust System Temperature Lamp

Table 14.

Instrument Panel Lamp	Notifications and Description	Driver Action
	<ul style="list-style-type: none"> • High Exhaust System Temperature (HEST) lamp • SOLID: Exhaust is at high temperature and vehicle is at low speed or parked. • FLASHING: A parked regeneration is in process and the system is not up to temperature. 	<ul style="list-style-type: none"> • No change in driving style required. • When parked, keep vehicle at a safe distance from people and flammable materials or vapors.

Malfunction Indicator Lamp

Table 15.

Instrument Panel Lamp	Notifications and Description	Driver Action
	<ul style="list-style-type: none"> • Malfunction Indicator Lamp (MIL) • Indicates a failure of an emission control device. May illuminate at the same time as the Check Engine Lamp (CEL). 	<p>Vehicle can be driven to end of shift. If the MIL remains on after three drive cycles, call for service.</p>



Diesel Particulate Filter Regeneration Lamp

Table 16.

Instrument Panel Lamp	Notifications and Description	Driver Action
	<ul style="list-style-type: none"> • Diesel Particulate Filter (DPF) regeneration lamp • SOLID: Indicates that a regeneration may be needed. • FLASHING: Indicates that a parked regeneration is required as soon as possible. • Diesel Particulate Filter (DPF) is reaching system limits. 	<p>Perform a parked regeneration OR bring the vehicle to highway speeds to enable an automatic regeneration of the filter. Reference model year specific section: "Performing a Parked Regeneration".</p>

Diesel Particulate Filter Regeneration Lamp and the Check Engine Lamp

Table 17.

Instrument Panel Lamp	Notifications and Description	Driver Action
 	<ul style="list-style-type: none"> • Diesel Particulate Filter (DPF) regeneration lamp / Check Engine Lamp (CEL) • ENGINE DERATED • Indicates the Diesel Particulate Filter (DPF) has reached system limits. 	<ul style="list-style-type: none"> • A parked regeneration must be performed. Reference model year specific section: "Performing a Parked Regeneration". • If the parked regeneration exits and the lamps remain on, repeat the parked regeneration. If the second attempt fails, call for service.

Diesel Particulate Filter Regeneration Lamp, Check Engine Lamp, and the Stop Engine Lamp

Table 18.

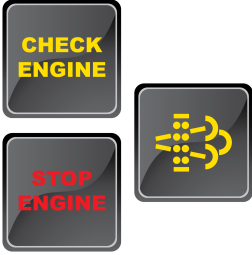
Instrument Panel Lamp	Notifications and Description	Driver Action
	<ul style="list-style-type: none"> • Diesel Particulate Filter (DPF) regeneration lamp / Check Engine Lamp (CEL) / Stop Engine Lamp (SEL) • ENGINE SHUTDOWN • Indicates the Diesel Particulate Filter (DPF) has exceeded system limits. 	<ul style="list-style-type: none"> • A parked regeneration must be performed. Reference model year specific section: "Performing a Parked Regeneration". • If the parked regeneration exits and the lamps remain on, repeat the parked regeneration. If the second attempt fails, call for service. • Note: Engine can be restarted but a parked regeneration must be initiated within 30 seconds or the engine will shutdown.

Diesel Exhaust Fluid Post-Run Indicator Lamp

DEF Post-Run Indicator Lamp

An indicator system is required on vehicles equipped with a Negative Battery Disconnect switch. The Post-Run Indicator lamp is controlled by the Aftertreatment Control Module (ACM) and the Aftertreatment System (ATS). The Post-Run Indicator lamp is located on the negative battery disconnect switch. If the ignition is switched off while the ATS is at an elevated temperature, the ACM activates the Post-Run cycle to cool the Diesel Exhaust Fluid (DEF) doser. The Post-Run cycle will be interrupted if the Negative Battery Disconnect is switched off. The lamp will illuminate if a Post-Run cycle is in progress, which informs the operator to delay the Negative Battery Disconnect until the Post-Run Lamp is off, except in an emergency situation.

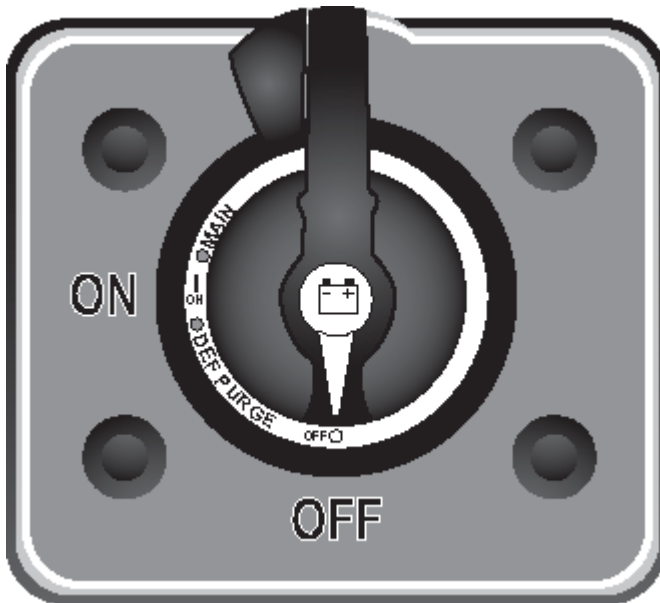

Preventive Maintenance Intervals

Preventive Maintenance Intervals

The following guide establishes preventive maintenance intervals. These recommendations should be followed as closely as possible to obtain long life and optimum performance from your engine. When performed on a regular basis, changing the engine oil, coolant, and filters is the least costly way of obtaining safe and reliable vehicle operation. Added benefits and savings occur when you check that the valves, fuel injectors, oil and cooling circuits are in good working order during oil changes.

The intervals shown apply only to the maintenance functions described. These functions should be coordinated with other regularly scheduled maintenance.

Scheduled Maintenance Intervals

Before placing your new vehicle in service, determine the correct maintenance schedule application for your intended use of the vehicle.

Schedule Use

Complete each maintenance operation at the required interval. The intervals are based on a collaboration of field and fleet data. For a more accurate analysis of when fluids should be changed, such as engine oil, refer to DDCSN for publication Engine Requirements; Lubricating Oil, Fuel and Filters (DDC-SVC-BRO-0001) and publication Coolant Selections for Detroit™ Engines (DDC-SVC-BRO-0002), available from authorized Detroit™ distributors and dealers.

Each maintenance table shows which maintenance operation must be performed at the recommended interval (in miles, kilometers, and hours).

NOTE: Failure to maintain the coolant at required concentrations will result in severe damage to the engine cooling system and related components. Refer to the "Coolant Selections and Maintenance" section.

Cooling System Flush and Fill

Coolant Flush and Fill - Proper maintenance of the cooling system is vital to its performance and longevity. The cooling system must, on a constant basis, deal with cavitation, temperature / pressure swings, and continuous threats on the additive package. Once the additives have been depleted from the coolant, it will only be a matter of time until the engine components suffer. Refer to section "Cooling System Fill Procedure".

Cooling System Inspection - Inspect the cooling system as follows:

**WARNING: HOT COOLANT**

To avoid scalding from the expulsion of hot coolant, never remove the cooling system pressure cap while the engine is at operating temperature. Wear adequate protective clothing (face shield, rubber gloves, apron, and boots). Remove the cap slowly to relieve pressure.

1. Inspect the radiator, condenser, coolant pump, engine oil cooler, freeze plugs, and heat exchanger for damage and leaks.
2. Check all cooling system pipes and hoses for damage and leaks; ensure these components are positioned to avoid chafing and are securely fastened.
3. Check the outside of the radiator and condenser for blockage. Check fins for damage; straighten them if necessary.

Valve Lash Checking and Adjustment

Valve lash checking and adjustment should be performed per the maintenance intervals prescribed under the proper service category for the engine. All three service categories (Severe, Short Haul, and Long Haul) require a 'first time' valve lash adjustment at a shorter interval. After the initial adjustment, all other adjustments are based on the same mileage intervals. Proper valve lash clearance allows the engine to produce the best possible performance with the lowest emissions. Valve lash adjustments should be performed by an authorized Detroit™ maintenance or repair facility.

Drive Belts

DD Platform engines utilize a specially designed Ethylene Propylene Diene Monomer (EPDM) belt material which is exclusive to the Original Equipment Manufacturer (OEM) component. Replacement with an aftermarket part may lead to shortened maintenance intervals and excessive noise.

Drive belts wear differently based on environmental conditions and vehicle duty cycle. If the vehicle is operated in extremely hot or cold climates, or is exposed to significant dust/debris/road salt, lifetime of the belts may be significantly reduced.

Fuel Filters

The prefilter is housed within the fuel filter module. The prefilter element filters particles down to 100 microns and is snapped into the prefilter cap. The final filter is housed within the fuel filter module. The final filter has the task of filtering out particles down to two microns. The final fuel filter snaps into the fuel filter cap on DD5 engines and twists into the cap on DD8 engines.

Air System

The air cleaner restriction indicator (filter minder) should be inspected per the maintenance intervals or more often if the engine is operated under severely dusty conditions. Replace the element if the filter minder has reached maximum allowable restriction. Refer to OEM literature for further details on filter minders.

NOTICE: Do not allow the air inlet restriction to exceed maximum allowable restriction.

Table 19.

Air Cleaner Restriction	
GHG17 Medium Duty Platform	4.5 kPa (18 in. H ₂ O)

A clogged air cleaner element will cause excessive air intake restriction and reduced air supply to the engine resulting in increased fuel consumption, inefficient engine operation, aftertreatment failure and reduced engine life. High intake restriction will also cause oil pullover from the turbocharger into the charge air system.

Inspect the entire air system for leaks daily. Look especially for torn air inlet piping or boots and loose or damaged clamps. Have worn or damaged parts repaired or replaced. Retighten loose connections.

Air Cleaner Replacement - Dry type air cleaner elements should be replaced when the maximum allowable air intake restriction has been reached.

Air-to-Air Charge Cooler - Periodically inspect the air-to-air charge cooler for buildup of dirt, mud, etc. and wash off using a mild soap solution. Check the charge cooler, ductwork, and flexible connections for leaks and have repaired or replaced, as required.

Exhaust System

The exhaust manifold retaining bolts and other connections should be inspected for leaks. The exhaust pipe rain cap, if so equipped, should be checked for proper operation. With the introduction of an Aftertreatment system, the sealing of the exhaust system is critical and should be inspected regularly.

Air Compressor

The air compressor incorporates three of the major systems of a diesel engine (air, lubrication, and coolant). Proper inspection of air compressor would include inspecting for air, oil, and coolant leaks. Due to inadequate internal sealing, air compressors, when failed, can produce excessive crankcase pressure or allow an engine to ingest oil.

Aftertreatment System (ATS)

There is a need to periodically remove accumulated ash, derived from engine lube oil, from the filter. This ash does not oxidize in the filter during the regeneration process and must be removed through a cleaning procedure. All Detroit™ ATS-equipped engines will illuminate a dashboard warning lamp indicating the need for ash cleaning.

Vibration Damper

The viscous vibration damper should be inspected periodically and replaced if dented or leaking. Heat from normal engine operation may, over a period of time, cause the fluid within the damper to break down and lose its dampening properties. For this reason, the viscous vibration damper must be replaced at time of normal major engine overhaul, regardless of apparent condition.

GHG17 Medium Duty Preventive Maintenance Tables

DD5 Short Haul

Short Haul service applies to vehicles that annually travel up to 60,000 miles (96,000 km), average between 10.1 and 11.9 miles per gallon and operate under normal conditions. Examples of Short Haul service are operation primarily in cities and densely populated areas, local transport with infrequent freeway travel, or a high percentage of stop-and-go travel.

Table 20.

DD5: Short Haul Maintenance Intervals GHG17 with ULSD Fuel GHG17 Using DFS 93K222(CK-4) or 93K223(FA-4) Approved Oils	
Lubricating Oil	Replace every 45,000 mi (72,000 km) (1,500 hrs) (18 months)*
Lubricating Oil Filter	Replace every 45,000 mi (72,000 km) (1,500 hrs) (18 months)*
Coolant - Standard Life	Maintain every 45,000 miles (72,000 km) (1,500 hrs) (12 months)* Replace every 300,000 miles (482,000 km) (3,000 hrs) (24 months)*
Coolant - Extended Life	Maintain every 90,000 miles (145,000 km) (1,500 hrs) (12 months)* Replace every 600,000 miles (965,000 km) (6,000 hrs) (48 months)*
Fuel Filters (frame and engine)	Replace every 45,000 mi (72,000 km) (1,500 hrs) (18 months)*
Valve Lash Adjustment	Adjust every 90,000 mi (145,000 km) (3,000 hrs) (36 months)*
Belts	Inspect every 45,000 miles (72,000 km) (1,500 hrs) (18 months)* Replace every 135,000 mi (217,000 km) (4,500 hrs) (54 months)*
Air System	Inspect every 45,000 mi (72,000 km) (1,500 hrs) (18 months)*
Air Cleaner	Refer to vehicle maintenance procedures
Exhaust System	Inspect every 45,000 mi (72,000 km) (1,500 hrs) (18 months)*

DD5: Short Haul Maintenance Intervals GHG17 with ULSD Fuel GHG17 Using DFS 93K222(CK-4) or 93K223(FA-4) Approved Oils	
Aftertreatment Devices	Inspect external hardware and connections every 6 months or at oil change intervals.*
Diesel Particulate Filter	A Check Engine Light will illuminate when ash requires removal. Normal DPF ash clean interval is 190,000 to 225,000 mi (306,000 to 362,000 km) (6300 to 7500 hrs) Detroit DPF Cleaning Process (Liquid Cleaning)**
DEF Pump Filter	Replace every 500,000 miles (805,000 km) (10,000 hrs) (3 years)*
Air Compressor	Inspect every 45,000 mi (72,000 km) (1,500 hrs) (18 months)*
*Whichever comes first. **Detroit highly recommends replacing the DPF with a Detroit™ genuine DPF to ensure maximum replacement life. • Currently, only Detroit™ Fuel Filter/Water Separator & Davco 245 or Racor 6600 are the only frame-mounted filtration systems compatible for Detroit™ Engines. • Refer to "Routine Preventive Maintenance" for a description of all items.	

DD5 Long Haul

Long Haul service (over-the-road transport) applies to vehicles that annually travel more than 60,000 miles (96,000 km) and average greater than 12.0 miles per gallon with minimal city stop-and-go operation. Examples of Long Haul service are regional delivery that is mostly freeway mileage, interstate transport, and any road operation with high annual mileage.

Table 21.

DD5: Long Haul Maintenance Intervals GHG17 with ULSD Fuel GHG17 Using DFS 93K222(CK-4) or 93K223(FA-4) Approved Oils	
Lubricating Oil	Replace every 50,000 mi (80,000 km) (1,700 hrs)*
Lubricating Oil Filter	Replace every 50,000 mi (80,000 km) (1,700 hrs)*
Coolant - Standard Life	Maintain every 50,000 miles (80,000 km) (1,700 hrs) (12 months)* Replace every 300,000 miles (482,000 km) (3,400 hrs) (24 months)*
Coolant - Extended Life	Maintain every 100,000 miles (161,000 km) (1,700 hrs) (12 months)* Replace every 600,000 miles (965,000 km) (6,800 hrs) (48 months)*
Fuel Filters (frame and engine)	Replace every 50,000 mi (80,000 km) (1,700 hrs)*
Valve Lash Adjustment	Adjust every 100,000 mi (161,000 km) (3,300 hrs) *
Belts	Inspect every 150,000 miles (241,000 km) (5,000 hrs)* Replace every 150,000 miles (241,000 km) (5,000 hrs)*
Air System	Inspect every 50,000 mi (80,000 km) (1,700 hrs)*
Air Cleaner	Refer to vehicle maintenance procedures

DD5: Long Haul Maintenance Intervals GHG17 with ULSD Fuel GHG17 Using DFS 93K222(CK-4) or 93K223(FA-4) Approved Oils	
Exhaust System	Inspect every 50,000 mi (80,000 km) (1,700 hrs)*
Aftertreatment Devices	Inspect external hardware and connections every 6 months or at oil change intervals. *
Diesel Particulate Filter	A Check Engine Light will illuminate when ash requires removal. Normal DPF ash clean interval is approximately 225,000 mi (362,000 km) (7,500 hrs) Detroit DPF Cleaning Process (Liquid Cleaning)**
DEF Pump Filter	Replace every 500,000 miles (805,000 km) (10,000 hrs) (3 years)*
Air Compressor	Inspect every 50,000 mi (80,000 km) (1,700 hrs)*
*Whichever comes first.	
**Detroit highly recommends replacing the DPF with a Detroit™ genuine DPF to ensure maximum replacement life.	
<ul style="list-style-type: none"> • Currently, only Detroit™ Fuel Filter/Water Separator & Davco 245 or Racor 6600 are the only frame-mounted filtration systems compatible for Detroit™ Engines. • Refer to "Routine Preventive Maintenance" for a description of all items. 	

DD5 Severe Service

Severe service applies to vehicles that average below 10.0 miles per gallon or that operate under severe conditions. Examples of Severe Service are idle time over 40%, load factor over 55%, operation on extremely poor roads or under heavy dust accumulation; constant exposure to extreme hot, cold, salt-air, or other extreme climates; frequent short-distance travel; construction-site operation; or farm operation. Only one of these conditions is necessary to categorize an application as Severe service.

Table 22.

DD5: Severe Service Maintenance Intervals GHG17 with ULSD Fuel GHG17 Using DFS 93K222(CK-4) or 93K223(FA-4) Approved Oils	
Lubricating Oil	Replace every 35,000 mi (56,000 km) (1,000 hrs) (12 months)*
Lubricating Oil Filter	Replace every 35,000 mi (56,000 km) (1,000 hrs) (12 months)*
Coolant - Standard Life	Maintain every 35,000 miles (56,000 km) (1,000 hrs) (12 months)* Replace every 300,000 miles (482,000 km) (2,000 hrs) (24 months)*
Coolant - Extended Life	Maintain every 70,000 miles (113,000 km) (1,000 hrs) (12 months)* Replace every 600,000 miles (965,000 km) (4,000 hrs) (48 months)*
Fuel Filters (frame and engine)	Replace every 35,000 mi (56,000 km) (1,000 hrs) (12 months)*
Valve Lash Adjustment	Adjust every 113,000 km (70,000 miles) (2,300 hrs) (24 months)*
Belts	Inspect every 35,000 miles (56,000 km) (1,000 hrs) (12 months)* Replace every 105,000 miles (170,000 km) (3,000 hrs) (36 months)*

DD5: Severe Service Maintenance Intervals GHG17 with ULSD Fuel GHG17 Using DFS 93K222(CK-4) or 93K223(FA-4) Approved Oils	
Air System	Inspect every 35,000 mi (56,000 km) (1,000 hrs) (12 months)*
Air Cleaner	Refer to vehicle maintenance procedures
Exhaust System	Inspect every 35,000 mi (56,000 km) (1,000 hrs) (12 months)*
Aftertreatment Devices	Inspect external hardware and connections every 6 months or at oil change intervals.*
Diesel Particulate Filter	A Check Engine Light will illuminate when ash requires removal. Normal DPF ash clean interval is less than 190,000 mi (306,000 km) (6,300 hrs) Detroit DPF Cleaning Process (Liquid Cleaning)**
DEF Pump Filter	Replace every 500,000 miles (805,000 km) (10,000 hrs) (3 years)*
Air Compressor	Inspect every 35,000 mi (56,000 km) (1,000 hrs) (12 months)*
*Whichever comes first. **Detroit highly recommends replacing the DPF with a Detroit™ genuine DPF to ensure maximum replacement life. • Currently, only Detroit™ Fuel Filter/Water Separator & Davco 245 or Racor 6600 are the only frame-mounted filtration systems compatible for Detroit™ Engines. • Refer to "Routine Preventive Maintenance" for a description of all items.	

DD8 Short Haul

Short Haul service applies to vehicles that annually travel up to 60,000 miles (96,000 km), average between 6.5 and 8.5 miles per gallon and operate under normal conditions. Examples of Short Haul service are operation primarily in cities and densely populated areas, local transport with infrequent freeway travel, or a high percentage of stop-and-go travel.

Table 23.

DD8: Short Haul Maintenance Intervals GHG17 with ULSD Fuel GHG17 Using DFS 93K222(CK-4) or 93K223(FA-4) Approved Oils	
Lubricating Oil	Replace every 55,000 mi (88,000 km) (1,800 hrs) (18 months)*
Lubricating Oil Filter	Replace every 55,000 mi (88,000 km) (1,800 hrs) (18 months)*
Coolant - Standard Life	Maintain every 55,000 miles (88,000 km) (1,800 hrs) (12 months) * Replace every 300,000 miles (480,000 km) (3,600 hrs) (24 months) *
Coolant - Extended Life	Maintain every 110,000 miles (177,000 km) (1,800 hrs) (12 months) * Replace every 600,000 miles (965,000 km) (7,200 hrs) (48 months) *
Fuel Filters (frame and engine)	Replace every 55,000 mi (88,000 km) (1,800 hrs) (18 months)*
Valve Lash Adjustment	Adjust every 110,000 miles (177,000 km) (3,600 hrs) (36 months)*

DD8: Short Haul Maintenance Intervals GHG17 with ULSD Fuel GHG17 Using DFS 93K222(CK-4) or 93K223(FA-4) Approved Oils	
Belts	Inspect every 55,000 miles (88,000 km) (1,800 hrs) (18 months)* Replace every 150,000 miles (241,000 km) (5,000 hrs) (54 months)*
Air System	Inspect every 55,000 miles (88,000 km) (1,800 hrs) (18 months)*
Air Cleaner	Refer to vehicle maintenance procedures
Exhaust System	Inspect every 55,000 miles (88,000 km) (1,800 hrs) (18 months)*
Aftertreatment Devices	Inspect external hardware and connections every 6 months or at oil change intervals.*
Diesel Particulate Filter	A Check Engine Light will illuminate when ash requires removal. Normal DPF ash clean interval is every 150,000 miles (241,000 km) (5,000 hrs) * Detroit DPF Cleaning Process (Liquid Cleaning)**
DEF Pump Filter	Replace every 500,000 miles (805,000 km) (10,000 hrs) (3 years)*
Air Compressor	Inspect every 55,000 miles (88,000 km) (1,800 hrs) (18 months)*
<p>*Whichever comes first. **Detroit highly recommends replacing the DPF with a Detroit™ genuine DPF to ensure maximum replacement life.</p> <ul style="list-style-type: none"> • Currently, only Detroit™ Fuel Filter/Water Separator & Davco 245 or Racor 6600 are the only frame-mounted filtration systems compatible for Detroit™ Engines. • Refer to "Routine Preventive Maintenance" for a description of all items. 	

DD8 Long Haul

Long Haul service (over-the-road transport) applies to vehicles that annually travel more than 60,000 miles (96,000 km) and average greater than 8.5 miles per gallon with minimal city stop-and-go operation. Examples of Long Haul service are regional delivery that is mostly freeway mileage, interstate transport, and any road operation with high annual mileage.

Table 24.

DD8: Long Haul Maintenance Intervals GHG17 with ULSD Fuel GHG17 Using DFS 93K222(CK-4) or 93K223(FA-4) Approved Oils	
Lubricating Oil	Replace every 60,000 miles (96,000 km) (2,000 hrs)*
Lubricating Oil Filter	Replace every 60,000 miles (96,000 km) (2,000 hrs)*
Coolant - Standard Life	Maintain every 60,000 miles (96,000 km) (2,000 hrs)* Replace every 300,000 miles (480,000 km) (3,600 hrs) *
Coolant - Extended Life	Maintain every 120,000 miles (193,000 km) (2,000 hrs)* Replace every 600,000 miles (965,000 km) (7,200 hrs)*
Fuel Filters (frame and engine)	Replace every 60,000 miles (96,000 km) (2,000 hrs)*
Valve Lash Adjustment	Adjust every 120,000 miles (193,000 km) (4,000 hrs)*

DD8: Long Haul Maintenance Intervals GHG17 with ULSD Fuel GHG17 Using DFS 93K222(CK-4) or 93K223(FA-4) Approved Oils	
Belts	Inspect every 60,000 miles (96,000 km) (2,000 hrs)* Replace every 150,000 miles (241,000 km) (5,000 hrs)*
Air System	Inspect every 60,000 miles (96,000 km) (2,000 hrs)*
Air Cleaner	Refer to vehicle maintenance procedures
Exhaust System	Inspect every 60,000 miles (96,000 km) (2,000 hrs)*
Aftertreatment Devices	Inspect external hardware and connections every 6 months or at oil change intervals. *
Diesel Particulate Filter	A Check Engine Light will illuminate when ash requires removal. Normal DPF ash clean interval is every 150,000 miles (241,000 km) (5,000 hrs)* Detroit DPF Cleaning Process (Liquid Cleaning)**
DEF Pump Filter	Replace every 500,000 miles (805,000 km) (10,000 hrs) (3 years)*
Air Compressor	Inspect every 60,000 miles (96,000 km) (2,000 hrs)*
*Whichever comes first. **Detroit highly recommends replacing the DPF with a Detroit™ genuine DPF to ensure maximum replacement life. • Currently, only Detroit™ Fuel Filter/Water Separator & Davco 245 or Racor 6600 are the only frame-mounted filtration systems compatible for Detroit™ Engines. • Refer to "Routine Preventive Maintenance" for a description of all items.	

DD8 Severe Service

Severe service applies to vehicles that average below 6.5 miles per gallon or that operate under severe conditions. Examples of Severe Service are idle time over 40%, load factor over 55%, operation on extremely poor roads or under heavy dust accumulation; constant exposure to extreme hot, cold, salt-air, or other extreme climates; frequent short-distance travel; construction-site operation; or farm operation. Only one of these conditions is necessary to categorize an application as Severe service.

Table 25.

DD8: Severe Service Maintenance Intervals GHG17 with ULSD Fuel GHG17 Using DFS 93K222(CK-4) or 93K223(FA-4) Approved Oils	
Lubricating Oil	Replace every 45,000 miles (72,000 km) (1,500 hrs) (12 months)*
Lubricating Oil Filter	Replace every 45,000 miles (72,000 km) (1,500 hrs) (12 months)*
Coolant - Standard Life	Inspect every 45,000 miles (72,000 km) (1,500 hrs) (12 months)* Replace every 300,000 miles (480,000 km) (3,000 hrs) (24 months)*
Coolant - Extended Life	Inspect every 90,000 miles (145,000 km) (1,500 hrs) (12 months)* Replace every 600,000 miles (965,000 km) (6,000 hrs) (48 months)*

DD8: Severe Service Maintenance Intervals GHG17 with ULSD Fuel GHG17 Using DFS 93K222(CK-4) or 93K223(FA-4) Approved Oils	
Fuel Filters (frame and engine)	Replace every 45,000 miles (72,000 km) (1,500 hrs) (12 months)*
Valve Lash Adjustment	Adjust every 90,000 miles (145,000 km) (3,000 hrs) (24 months)*
Belts	Inspect every 45,000 miles (72,000 km) (1,500 hrs) (12 months)* Replace every 135,000 miles (217,000 km) (4,500 hrs) (36 months)*
Air System	Inspect every 45,000 miles (72,000 km) (1,500 hrs) (12 months)*
Air Cleaner	Refer to vehicle maintenance procedures
Exhaust System	Inspect every 45,000 miles (72,000 km) (1,500 hrs) (12 months)*
Aftertreatment Devices	Inspect external hardware and connections every 6 months or at oil change intervals.*
Diesel Particulate Filter	A Check Engine Light will illuminate when ash requires removal. Normal DPF ash clean interval is every 150,000 miles (241,000 km) (5,000 hrs)* Detroit DPF Cleaning Process (Liquid Cleaning)**
DEF Pump Filter	Replace every 500,000 miles (805,000 km) (10,000 hrs) (3 years)*
Air Compressor	Inspect every 45,000 miles (72,000 km) (1,500 hrs) (12 months)*
<p>*Whichever comes first.</p> <p>**Detroit highly recommends replacing the DPF with a Detroit™ genuine DPF to ensure maximum replacement life.</p> <ul style="list-style-type: none"> • Currently, only Detroit™ Fuel Filter/Water Separator & Davco 245 or Racor 6600 are the only frame-mounted filtration systems compatible for Detroit™ Engines. • Refer to "Routine Preventive Maintenance" for a description of all items. 	

Routine Preventive Maintenance

Routine Preventive Maintenance

This section describes the items listed in the maintenance interval tables. The Daily instructions apply to routine or daily starting of the engine. They do not apply to a new engine or one that has been operated for a considerable period of time.

Monitoring the Lubricating Oil

Perform the following maintenance on the lubricating oil:

1. Check the oil level daily with the engine stopped and on a level surface. If the engine has just been stopped and is warm, wait approximately 20 minutes to allow the oil to drain back into the oil pan before checking.

NOTE: The dipstick has a positive locking device such as a lever or twist-lock design that must be disengaged before pulling the dipstick out of the guide tube. Use a shop rag to wipe off the end of the dipstick. Wait 15 seconds to allow any crankcase pressure to dissipate through the guide tube and let the oil level settle in the oil pan.

2. Add the proper grade of oil to maintain the correct level on the dipstick. Remove the dipstick from the guide tube. Before adding lubricating oil, refer to "How to Select Lubricating Oil."

NOTICE: Do NOT fill beyond the maximum fill level on the dipstick, since overfilling may result in high oil consumption and possible severe engine damage.

NOTE: If the engine operating temperature is below 60° C (140° F), the engine must be on a level surface and then shut down for 60 minutes for an accurate oil level reading. Otherwise, the engine must be brought up to an operating temperature of 60° C (140° F), parked on a level surface and then shut down for 20 minutes for an accurate oil level reading.

3. Reinstall the dipstick and make sure it is fully inserted into the guide tube. Remove the dipstick and read the oil level dipstick.

NOTICE: Do not add oil if the oil reading is in the crosshatch area on the dipstick. There are approximately 4.0 L (4.2 qts) from the minimum mark to the maximum mark on the dipstick. Overfilling the oil pan can cause engine damage.

NOTICE: If the oil level is constantly above normal and excess oil has not been added to the crankcase, consult with an authorized Detroit service outlet for the cause. Fuel or coolant dilution of lubricating oil can result in serious engine damage.

4. Check the oil level daily. With the engine stopped, use the oil dipstick and measure the oil level on crosshatch area on the dipstick. Figure below shows Maximum oil level (1) and Minimum oil level (2). If the oil reading is in the crosshatch area or between the bends of the dipstick, then the oil is at the proper level for engine operation.

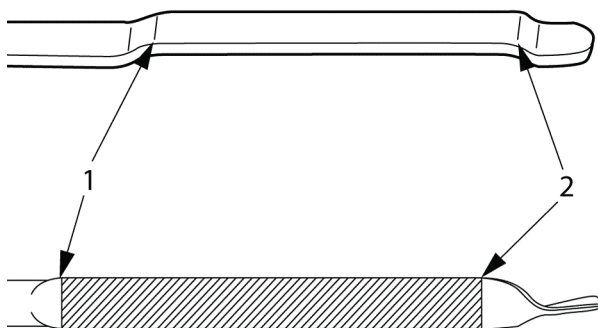

42141

5. Add the proper grade of oil to maintain the satisfactory range on the dipstick. All diesel engines are designed to use some oil, so the periodic addition of oil is normal. Before adding lubricating oil, refer to "How to Select Lubricating Oil."

Monitoring the Lubricating Oil Filter

The engines are equipped with a single cartridge-style oil filter (3) that is part of the oil/coolant module (4). Incorporated into the housing is a drain back port which allows residual oil to be returned to the oil pan when the filter is removed. This design, including the cartridge-style element, allows for a more environmentally safe oil change.

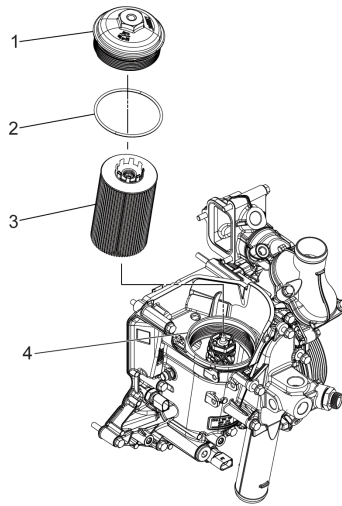

d180080

Perform the following maintenance on the lubricating oil filter:

1. Replace the oil filters when recommended by the appropriate maintenance table. Refer to section "GHG17 Medium Duty Preventive Maintenance Tables".
2. Make a visual check of all lubricating oil lines for wear and/or chafing. If any indication of wear is evident, replace the oil lines and correct the cause.
3. Check for oil leaks after starting the engine.

Monitoring the Cooling System

The cooling system must be *full* for proper operation of the engine.



WARNING: HOT COOLANT

To avoid scalding from the expulsion of hot coolant, never remove the cooling system pressure cap while the engine is at operating temperature. Wear adequate protective clothing (face shield, rubber gloves, apron, and boots). Remove the cap slowly to relieve pressure.

1. Check the coolant level daily and maintain it at the full level.
2. Add coolant as required, but do not overfill. Before adding coolant, refer to "How to Select Coolant" for the listing of required intervals using the recommended coolants

Checking for Coolant Leaks

Perform daily visual checks for cooling system leaks. Look for an accumulation of coolant when the engine is running and when it is stopped.

NOTE: Coolant leaks may be more apparent on a engine when it is cold.



WARNING: PERSONAL INJURY

To avoid injury before starting and running the engine, ensure the vehicle is parked on a level surface, parking brake is set, and the wheels are blocked.

Coolant Inhibitors

The inhibitors in antifreeze solutions must be replenished with an approved corrosion inhibitor supplement when indicated by testing the coolant. Refer to section "How to Select Coolant" for the listing of required intervals using the recommended coolants for required test intervals, inhibitor levels, and approved inhibitors.

NOTICE: Coolant must be inhibited with the recommended Supplemental Coolant Additives listed in this manual. Failure to check and maintain Supplemental Coolant Additive levels at required concentrations will result in severe damage (corrosion) to the engine cooling system and related components.

The cooling system is protected by a Supplemental Coolant Additive element. In addition, the engine can be equipped with a coolant filter/inhibitor system as an installed option or as an after-sale item.

Coolant Drain Interval

A coolant system properly maintained and protected with supplemental coolant inhibitors can be operated up to the intervals listed. At these intervals the coolant must be drained and disposed of in an environmentally responsible manner according to state and/or federal Environmental Protection Agency (EPA) recommendations.

Inspection of the Radiator

Inspect the radiator as follows:

1. Inspect the exterior of the radiator core every 30,000 miles (50,000 km) or 12 months.

**WARNING: EYE INJURY**

To avoid injury from flying debris when using compressed air, wear adequate eye protection (face shield or safety goggles) and do not exceed 276 kPa (40 psi) air pressure.

NOTE: It may be necessary to clean the exterior of the radiator more frequently if the engine is being operated in extremely dusty or dirty areas.

2. If necessary, clean the exterior using a quality grease solvent, such as mineral spirits, and dry with compressed air. Do not use fuel oil, kerosene, or gasoline.
3. If the low coolant level sensor is installed in the top tank of the radiator, test for proper operation every 100,000 miles (160,000 km) or 12 months, whichever comes first. Authorized Detroit™ distributors are properly equipped to perform this service.

Monitoring the Fuel Filters

Monitoring the Two-Filter Fuel System Filters

NOTICE: Fuel filter elements will turn black over time. This is normal for DD5/DD8 only. Do not replace filters solely because of this condition. Replace filters between normal service intervals only if required by troubleshooting.

The engine is equipped with a prefilter that filters down to 100 microns, a coalescer/final filter that separates water (DD8 only, the DD5 is not equipped with a water coalescing filter), and filters down to two microns.. When servicing these elements, both filters should be changed at the same time. Both elements are located within the fuel filter module located on the left side of the engine.

NOTE: Filter change intervals may be shortened to conform with established preventive maintenance schedules, but should never be extended.

1. Replace the fuel filters using the Preventative Maintenance Tables.

Adjusting the Valve Lash

NOTE: Proper valve lash clearance allows the engine to produce the best possible performance with the lowest emissions. Valve lash adjustments should be performed by an authorized Detroit™ maintenance or repair facility.

Perform a valve lash adjustment as scheduled for the appropriate engine duty cycle.

Monitoring the Belt Tensioner

DD Platform engines are equipped with an automatic tensioning device. No adjustment or periodic maintenance is required.

Poly-V-Belt Inspection

Periodically inspect the belts based on the damage guide below. If any damage is noted, replace both belts (Fan and Accessory Belts). A precision wear gauge, available from Gates®, is the preferred method of determining belt wear.

Table 26.







Poly-V-Belt Inspection Concerns	
ABRASION	CHUNK-OUT
 <p>d130019</p>	 <p>d130020</p>
IMPROPER INSTALL	CRACKING
 <p>d130021</p>	 <p>d130022</p>

Table 27.

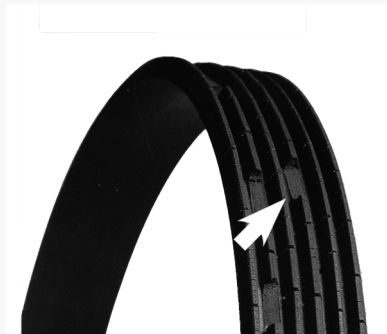
Poly-V-Belt Inspection Concerns	
PILLING	UNEVEN RIB WEAR
 <p style="text-align: right;">d130023</p>	 <p style="text-align: right;">d130024</p>
MISALIGNMENT	GRAVEL PENETRATION
 <p style="text-align: right;">d130025</p>	 <p style="text-align: right;">d130026</p>

Inspection of the Air Intake System

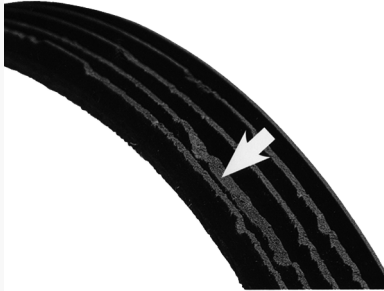
Perform the following maintenance on the Air Intake System:

1. Inspect all the connections in the air system to make sure they are tight and leak-free.
2. Check all hoses and ducting for punctures, deterioration, or other damage and replace, if necessary.

Monitoring the Air Cleaner

Replace dry-type air cleaner elements when the maximum allowable air intake restriction has been reached.

1. Check the air cleaner restriction gauge (filter minder) daily.
2. Check the gaskets for deterioration and replace, if necessary.
3. Inspect the entire air system for leaks daily. Look especially for torn air inlet piping or boots and loose or damaged clamps. Have worn or damaged parts repaired or replaced. Retighten loose connections.

Monitoring the Exhaust System

Inspect the Exhaust System as follows:

1. Check the exhaust manifold retaining bolts and other connections for tightness.
2. Check the exhaust pipe rain cap for proper operation, if so equipped.

Monitoring the Aftertreatment System

NOTE: All Detroit™ Aftertreatment System (ATS) - equipped engines will illuminate a dashboard warning lamp indicating the need for ash cleaning.

Periodically the accumulated ash derived from the engine's lubricating oil needs to be removed from the ATS. This ash does not oxidize in the filter during the regeneration process and must be removed through a cleaning procedure.

Inspection of the Air Compressor

The air compressor incorporates three of the major systems of a diesel engine (air, lubrication, and cooling). Inspect the air compressor looking for air, oil, and coolant leaks.

Monitoring the Fuel and Fuel Tank

To prevent fuel and fuel tank problems, the following measures are recommended:

1. Keep the fuel tank filled to reduce condensation.
2. Before adding fuel, Refer to section "How to Select Diesel Fuel"
3. Refill the tank at the end of each day's operation to prevent condensation from contaminating the fuel. Condensation formed in a partially filled tank promotes the growth of microorganisms that can clog fuel filters and restrict fuel flow.
4. To prevent microbe growth, add a biocide to the fuel tank or primary fuel supply only as needed.

5. Open the drain at the bottom of the fuel tank every 30,000 miles (50,000 kilometers) to drain off any water and/or sediment.



WARNING: PERSONAL INJURY

To avoid injury from improper use of chemicals, follow the chemical manufacturer's usage, handling, and disposal instructions. Observe all manufacturer's cautions.

NOTICE: Never use galvanized steel fuel tanks, fittings, pipes, or supply lines. The fuel reacts chemically with the zinc coating to form powdery flakes that can quickly clog the fuel filters and damage the fuel pumps and injectors.

6. Every 120,000 miles (200,000 kilometers) or 12 months, tighten all fuel tank mountings and brackets. At the same time, check the seal in the fuel tank cap, the breather hole in the cap, and the condition of the flexible fuel lines. Repair or replace the parts, as necessary.

Inspection of Hoses and Fittings for Fuel Leaks

A pre-start inspection of hoses and fuel lines is recommended. Make a visual check for fuel leaks at all engine-mounted fuel lines and connections, and at the fuel tank suction and return lines. Since fuel tanks are susceptible to road hazards, leaks in this area may best be detected by checking for an accumulation of fuel under the tank.



WARNING: HOT OIL

To avoid injury from hot oil, do not operate the engine with the rocker cover(s) removed.

NOTE: Leaks are not only detrimental to machine operation, but they can also result in added expense caused by the need to replace lost fluids

Inspection of Hoses and Fittings

Check hoses daily as part of the pre-start inspection.

- Examine hoses for leaks, and check all fittings, clamps and ties carefully.
- Make sure hoses are not resting on or touching shafts, couplings, heated surfaces including exhaust manifolds, sharp edges, or other obvious hazardous areas.
- Since all machinery vibrates and moves to a certain extent, clamps and ties can fatigue with age. To ensure continued proper support, inspect fasteners frequently and tighten or replace them as necessary.
- If fittings have loosened or cracked, or if hoses have ruptured or worn through, take corrective action immediately.

Inspection of Hoses with Extended Service Life

A hose has a finite service life. With this in mind, inspect hoses as follows:

NOTE: Fire-resistant fuel and lubricating oil hose assemblies do not require automatic replacement after five years of service or at major overhaul, but should be inspected carefully before being put back into service.

1. Thoroughly inspect all hoses at least every 500 operating hours (1,000 hours for fire-resistant fuel and lubricating oil hoses) and/or annually. Look for cover damage and/or indications of twisted, worn, crimped, brittle, cracked or leaking lines. Hoses with their outer cover worn through or with damaged metal reinforcements should be considered unfit for further service.
2. Replace all hoses in and out of machinery during major overhaul and/or after a maximum of five (5) years of service.

Inspection of the Turbocharger and Charge Air Cooler

Inspect turbocharger and charge air cooler as follows:

1. Visually inspect the turbocharger mountings, intake and exhaust ducting, and connections for leaks daily.
2. Check the lubricating oil inlet and outlet lines for leaks or restrictions to oil flow.



WARNING: PERSONAL INJURY

To avoid injury from hot surfaces, wear protective gloves, or allow engine to cool before removing any component.

3. Check the turbocharger for unusual noise or vibration and, if excessive, stop the engine and do not operate until the cause is determined.
4. Periodically inspect the air-to-air charge air cooler for buildup of dirt, mud, or other debris. Clean as necessary.
5. Check the charge air cooler, duct work, and flexible connections for leaks and repair or replace as required.

Inspection of the Battery

Inspect the battery as follows:



WARNING: PERSONAL INJURY

To avoid injury from accidental engine startup while servicing the engine, disconnect/disable the starting system.

1. Check for cracks in the battery cases (1), for tightness of the cable clamps (2) at the terminals, and for corrosion of the terminals (3). Service or replace as needed.

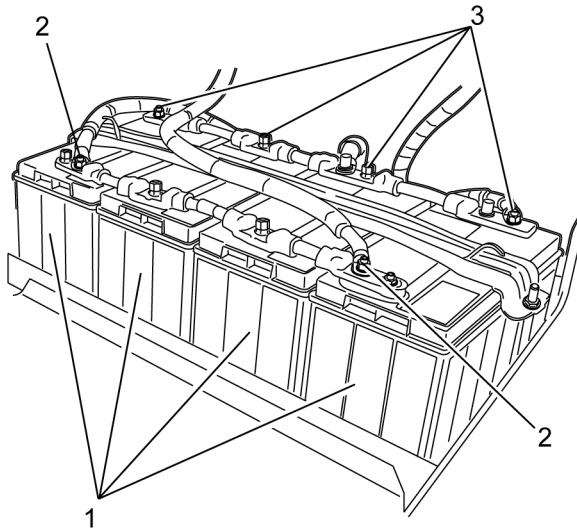

d540077

2. Keep the terminal surface clean.
3. Inspect the cables, clamps and hold-down brackets regularly. Clean and reapply a light coating of petroleum jelly when needed. Have corroded or damaged parts replaced.
4. If the engine is to be out of service for more than 30 days, remove the batteries and store in a cool, dry place.
 - a. Keep batteries fully charged, if possible.
 - b. Replace any battery that fails to hold a charge.
5. Periodically check battery connections for corrosion and tightness.
 - a. If necessary, remove connections and wire brush any corrosion from terminals and cable ends.
 - b. Replace damaged wiring.

Steam Cleaning the Engine

NOTICE: Do not apply steam or solvent directly to the battery-charging alternator, starting motor, DDEC components, sensors or other electrical components, as damage may result.

The engine and engine compartment should be steam cleaned every 60,000 miles (100,000 km) or 2,000 hours, whichever comes first.

Inspection of the Battery-Charging Alternator

Precautions must be taken when working on or around the alternator. The diodes and transistors in the alternator circuit are very sensitive and can be easily destroyed. To avoid equipment damage, the following conditions must be met:



WARNING: Battery Explosion and Acid Burn

To avoid injury from battery explosion or contact with battery acid, work in a well ventilated area, wear protective clothing, and avoid sparks or flames near the battery. If you come in contact with battery acid:

- Flush your skin with water.
 - Apply baking soda or lime to help neutralize the acid.
 - Flush your eyes with water.
 - Get medical attention immediately.
-
- Avoid grounding the output terminal. Grounding an alternator output wire or terminal (which is always hot, regardless of whether or not the engine is running) and accidentally reversing the battery polarity will result in equipment damage.
 - Do not reverse battery connections.
 - Never disconnect the battery while the alternator is operating. Disconnecting the battery can result in damage to the battery diodes. In applications which have two sets of batteries, switching from one set to the other while the engine is running will momentarily disconnect the batteries.
 - If a booster battery is to be used, batteries must be connected correctly (negative to negative, positive to positive).
 - Never use a fast charger with the batteries connected or as a booster for battery output.

For information on the alternator assembly, contact an authorized distributor, depending on manufacturer.

Check the alternator as follows:

1. Inspect the terminals for corrosion and loose connections and wiring for damage and frayed insulation. Have wiring repaired or replaced, as required.
2. Check torque on alternator mounting bolts and bracketing every 30,000 miles (50,000 km). Re-tighten if necessary.

Checking the Vibration Damper

Check the vibration damper as follows:

1. Inspect the viscous vibration damper periodically and replace if dented or leaking.

2. Heat from normal engine operation may, over a period of time, cause the fluid within the damper to break down and lose its dampening properties. For this reason, replace the viscous vibration damper at time of normal major engine overhaul, regardless of apparent condition.

How to Procedures

How to Select Lubricating Oil

Refer to DDC-SVC-BRO-0001 for more information.

Detroit Fluids Specification (DFS) DFS 93K223 (API FA-4) or DFS 93K222 (API CK-4) oils are recommended for use in the engine.

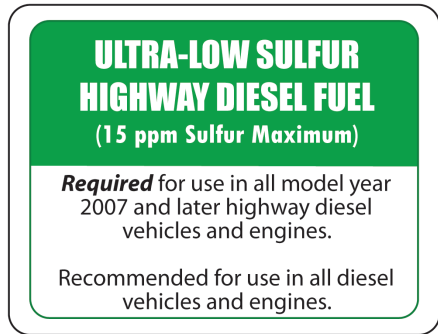

d470246c

For optimal fuel economy, use DFS 93K223 approved API FA-4 engine oil.

Cold Weather Starting

NOTICE: Monograde oils should not be used in the engine, regardless of API service classification. Monograde oils gel at lower ambient temperatures, reducing lubricant flow, and do not provide adequate lubricity at higher engine operating temperatures resulting in severe engine damage.

For picking a lubricant for low temperature applications refer to the section "How to Select Lubricating Oil". See **DDC-SVC-BRO-0001**.

Use of Synthetic Oils

NOTE: Synthetic oil does not permit extension of recommended oil drain intervals.

Synthetic oils may be used in Detroit™ engines provided they are approved by a *DFS*. The use of synthetic oils does not necessarily ensure the extension of the recommended oil drain intervals beyond the limits.

Use of Supplemental Additives

Lubricants meeting the Detroit™ specifications outlined in this publication already contain a balanced additive treatment. Supplemental additives are generally not necessary and can even be harmful. These additives may be marketed as either oil treatments or engine treatments and are discouraged from use in Detroit™ engines.

Engine damage resulting from the use of such materials is not covered by your Detroit™ warranty. Detroit™ will not provide statements beyond this publication relative to their use.

How to Replace the Lubricating Oil and Oil Filter

The oil filter is an integral part of the lubrication system. Proper filter selection and maintenance are important to satisfactory engine performance and service life. The filter should be used to maintain a clean system, not to clean up a contaminated system. The maintenance intervals for the appropriate duty cycle are listed in tables in this manual.

Change the oil and replace the lubricating oil filter as follows:

NOTE: If the used oil was contaminated by fuel or coolant, it may be necessary to take the vehicle to a certified Detroit Service Center. The Service Center may drain the oil and then remove the oil pan, oil pump, and oil pump intake manifold to drain the remaining oil held back by the backflow valve. It is important to remove all contaminated oil from the engine.

NOTE: Change the engine oil only when the engine oil temperature is approximately 60°C (140°F). Changing cold oil will result in extended drain times.



WARNING: PERSONAL INJURY

To avoid injury, never remove any engine component while the engine is running.

1. Place the transmission in neutral, and set the parking brake.

NOTICE: Use care to prevent foreign objects from entering the filter housing.

2. Clean outside of the oil filter housing.

3. Using a 36-mm socket, unscrew the oil filter cap and filter and allow the oil to drain into the housing. After draining is complete, remove the assembly from the housing.
4. Remove the filter element by pressing and twisting the side and detaching it from the cap.
5. Remove the oil filter O-ring and discard. Lightly coat a new O-ring with clean engine oil and install it on the filter cap.
6. Check the filter housing for any debris and remove if necessary.
7. Insert a new filter element into the oil filter cap.
8. Insert the filter element and cap assembly into the housing. Torque the cap to 40 to 50 N·m (30 to 37 lb·ft).
9. Drain oil from the oil pan. Place a suitable receptacle, 19 L (20 qt) or more, beneath the oil drain plug on the underside of the oil pan.
10. Carefully unscrew the oil drain plug, and allow the oil to drain out.
11. Discard the plug seal ring.

NOTE: There are several variations of plugs and plug locations on the oil pan. The plugs can be either M22 plugs or plastic bottom drain plugs depending on oil pan configuration. The sealing washer for the M22 plug must be replaced once removed. The plastic bottom drain plug must also be replaced once removed. These components are included in the oil filter kit released for service.

12. Install the oil pan drain plug with a new O-ring and torque the plug.
 - Install the M22 oil pan drain plug, if removed, with a new seal washer and torque the plug to 45 N·m (33 lb·ft) for plastic oil pans and 65 N·m (48 lb·ft) for aluminum oil pans.
 - Install a new plastic oil drain plug, if removed, and torque the plug to 4 N·m (3 lb·ft).

NOTICE: Do not add oil if the oil reading is between the crosshatch area on the dipstick. There are approximately 4.0 L (4.2 qt) from the fill mark to the full mark. Overfilling the oil pan can cause engine damage.

13. Add new engine oil through the oil fill tube in the following amount; Refer to section "Engine Oil Capacities". Verify the oil level reading is between the full and fill marks on the dipstick.



WARNING: PERSONAL INJURY

To avoid injury before starting and running the engine, ensure the vehicle is parked on a level surface, parking brake is set, and the wheels are blocked.



WARNING: ENGINE EXHAUST

To avoid injury from inhaling engine exhaust, always operate the engine in a well-ventilated area. Engine exhaust is toxic.

NOTICE: If no oil pressure is shown after approximately 10 seconds, stop the engine and determine the cause. Running the engine with no oil pressure could result in engine damage.

14. Start the engine with the accelerator pedal in the idle position (600 rpm). Monitor the oil pressure gauge or indicator lamp. Keep the engine running at idling speed (600 rpm) until the oil pressure reading is 345 kPa (50 psi) or more.

NOTICE: Do not add oil if the oil reading is between the crosshatch area on the dipstick. There are approximately 4.0 L (4.2 qt) from the fill mark to the full mark. Overfilling the oil pan can cause engine damage.

NOTE: If the engine operating temperature is below 60°C (140°F), the engine must be on a level surface and then shut down for 60 minutes for an accurate oil level reading. Otherwise, the engine must be brought up to an operating temperature of 60°C (140°F), parked on a level surface and then shut down for 20 minutes for an accurate oil level reading.

15. Check the filter housing for signs of leakage.
16. Stop the engine. Check the oil level again per the following guidelines. If necessary, add oil no more than 4.0 L (4.2 qt) at a time up to the maximum fill level on the oil dipstick.

How to Select Diesel Fuel

All DD Platform engines are designed to operate on Ultra-Low Sulfur Diesel (ULSD) fuel. For optimal fuel system performance, Detroit Diesel recommends Top Tier Diesel (see figure below).

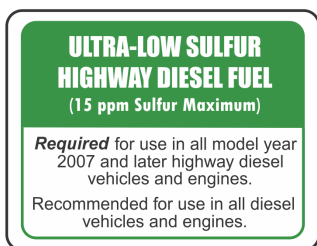

d990371

For optimum engine operation and maximum service life, diesel fuels meeting the property requirements listed in the table below are recommended for use.

Quality

NOTICE: Use only Ultra-Low Sulfur Diesel (ULSD) fuel (15 PPM sulfur content maximum), based on ASTM Standard D 2622 test procedure. Using fuel other than ULSD will damage the Aftertreatment Device.

Fuel quality is an important factor in obtaining satisfactory engine performance, long engine life, and acceptable exhaust emission levels. In general, fuels meeting the properties of ASTM Standard D 975 (grades 1-D and 2-D) have provided satisfactory performance.

The fuels used must be clean, completely distilled, stable, and non-corrosive. For more information regarding the significance of these properties and selection of the proper fuel.

Fuel Contamination

Generally, fuel contamination occurs as the result of improper fuel handling. The most common types of contamination are water, dirt, and microbial growth "black slime". The formation of varnishes and gums resulting from poor stability or extended storage "stale fuel" also affects fuel quality. The best treatment for contamination is prevention by maintaining a clean storage system and choosing a reputable fuel supplier.

Supplemental additives are not recommended due to potential injector system or engine damage. Our experience has been that such additives increase operating costs without providing benefit.

The use of supplemental fuel additives does not necessarily void the engine warranty. However, repair expenses which result from fuel system or engine component malfunctions or damage attributed to their use will not be covered.

Biodiesel ¹ General recommendations and guidelines

Detroit™ supports biodiesel as a renewable fuel. Biodiesel fuels are mono alkali esters of long chain fatty acids commonly referred to as Fatty Acid Methyl Esters (FAME) and are derived from renewable resources through a chemical process called transesterification.

Detroit™ approves the use of biodiesel fuel blends as follows:

- DD Family of Engines - Biodiesel blends up to 5% are allowed
- MBE900/4000 Engines - Biodiesel blends up to 5% are allowed
- S60 Engines - Biodiesel blends up to 20% are allowed*

*Engines built prior to MY 2004 may contain materials that are not compatible with biodiesel blends. Biodiesel blends above 5% are not recommended ².

For most recent information go to [DDCSN.com \(https://ddcsn-ddc.freightliner.com/cps/rde/xbcr/ddcsn/Detroit_Bio_Fuel_Position_Statement.pdf\)](https://ddcsn-ddc.freightliner.com/cps/rde/xbcr/ddcsn/Detroit_Bio_Fuel_Position_Statement.pdf).

Prohibited Additives

The following fuel additives are not allowed and **MUST NOT** be mixed with diesel fuel:

NOTICE: Do not burn used lubricating oil in fuel. It will cause the diesel particulate filter to prematurely plug with ash.

- **Used Lubricating Oil** Do not use fuel blended with used lubricating oil. Detroit™ specifically prohibits the use of used lubricating oil in diesel fuel. Used lubricating oil contains combustion acids and particulate materials which can severely erode fuel injector components, resulting in loss of power and increased exhaust emissions. In addition, the use of drained lubricating oil will increase maintenance requirements due to filter plugging and combustion deposits.



WARNING: FIRE

To avoid increased risk of a fuel fire, do not mix gasoline and diesel fuel.

NOTICE: Detroit™ will not be responsible for any detrimental effects resulting from adding drained lubricating oil or gasoline to the diesel fuel.

- **Gasoline** The addition of gasoline to diesel fuel will create a serious fire hazard. The presence of gasoline in diesel fuel will reduce fuel cetane number and increase combustion temperatures. Drain and clean tanks which contain a mixture of gasoline and diesel fuel as soon as possible.
- **Fuel Additives with Sulfur or Sulfated Ash** Do not use non-approved fuel additives containing sulfur or sulfated ash.

How to Replace the Fuel Filters

NOTICE: If you have just changed the engine oil and filter, you **MUST** start the engine and confirm proper oil pressure before changing the fuel filters. If no oil pressure is shown after approximately 10 seconds, stop the engine and determine the cause. Running the engine with no oil pressure could result in engine damage. Start the engine with the accelerator pedal in the idle position. Monitor the oil pressure gauge or indicator lamp. Keep the engine running at idling speed until the oil pressure reading is 345 kPa (50 psi) or more.

NOTICE: Fuel filter elements will turn black over time. This is normal for DD5/DD8 only. Do not replace filters solely because of this condition. Replace filters between normal service intervals only if required by troubleshooting.

NOTE: If you are replacing all fuel filters, it is not necessary to run the engine and test for leaks after installing each individual fuel filter. However, if repairing a leak at one filter, complete that repair and test the system for leaks after priming the fuel system.

Filters are an integral part of the fuel system. Proper filter selection and maintenance are important to satisfactory engine operation and service life. Filters should be used to maintain a clean system, not to clean up a contaminated system. The scheduled maintenance intervals for the appropriate duty cycles are listed in this manual.



WARNING: PERSONAL INJURY

To prevent the escape of high pressure fuel that can penetrate skin, ensure the engine has been shut down for a minimum of 10 minutes before servicing any component within the high pressure circuit. Residual high fuel pressure may be present within the circuit.

NOTICE: At cold temperatures (-40° C or -40° F), DO NOT remove the filter elements from the caps unless the intent is to replace the filter elements. Repeated removals at cold temperatures may break the filter element tabs.

Removal of the Fuel Prefilter

Remove the prefilter as follows:

1. Using a 36 mm socket, unscrew the prefilter cap.
2. Pull the cap and prefilter straight up and out of the fuel filter housing.
3. Remove the prefilter (1) from the prefilter cap (2) by placing the filter on a solid surface and apply pressure on prefilter cap (2) at an angle.

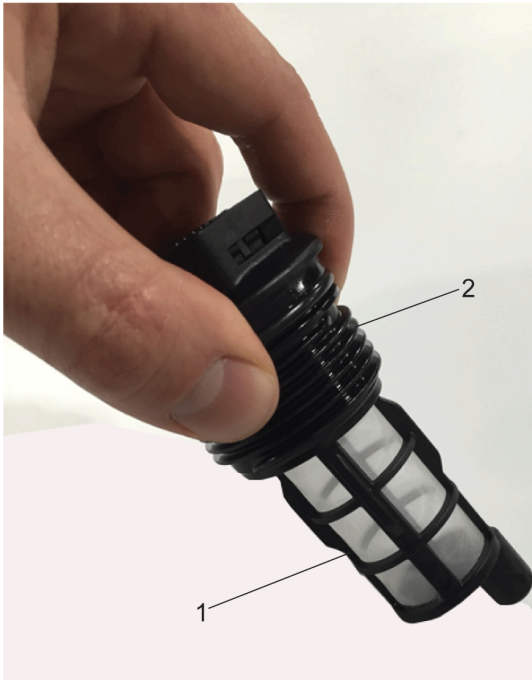

d470327

4. Discard the prefilter.
5. Inspect inside the housing for any large debris; clean housing as needed.
6. Discard the prefilter cap seal ring.

Installation of the Fuel Prefilter

Install the fuel prefilter as follows:

NOTE: If a filter service is being performed, replace all other filters before priming.

1. Install a new prefilter cap seal ring on to the prefilter cap.
2. Snap new prefilter into the prefilter cap.
3. Apply a thin coat of petroleum-based lithium grease to the prefilter cap seal ring and the prefilter seals (1).



4. Install the prefilter into the fuel filter module.
5. Torque prefilter cap to 25 to 30 N·m (19 to 22 lb·ft).

NOTE: If a filter service is being performed, replace all other filters before priming.

6. Once all required filters have been changed, prime the fuel system. Refer to section "Priming the Fuel System".

Removal of the Final Filter

Remove the final filter as follows:

NOTICE: The fuel filter element may discolor over time. This is normal operation and the filters should not be replaced on that basis alone.

1. Shut off the engine, apply the parking brake, chock the wheels, and perform any other applicable safety steps.



CAUTION: ELECTRICAL SHOCK

To avoid injury from electrical shock, use care when connecting battery cables. The magnetic switch studs are at battery voltage.

2. Disconnect the batteries. Refer to OEM procedures.
3. Open the hood.
4. Using a 36mm socket, unscrew the final filter cap.

NOTICE: Do not tilt the final filter when removing it from the housing. Possible damage to the final filter or stand pipe may occur.

5. Pull the cap and final filter (1) straight up and allow the fuel to drain back.

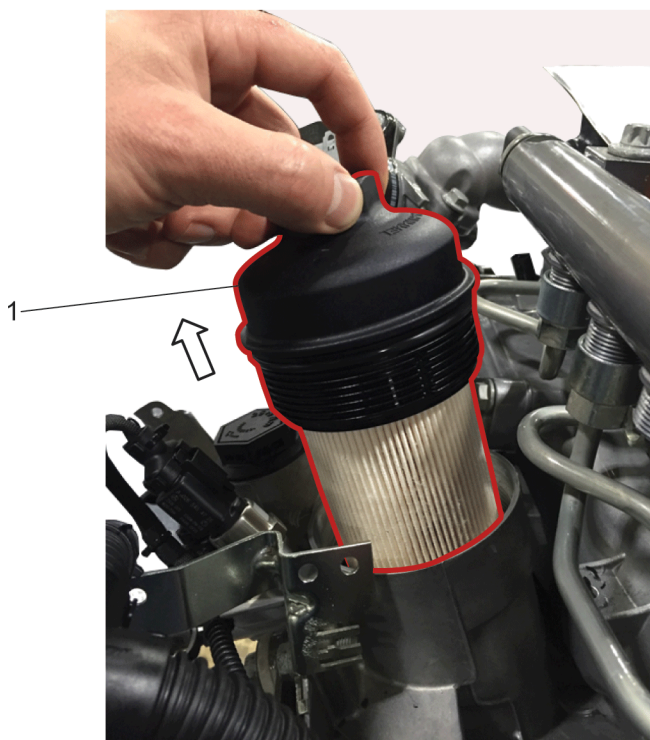

d470330

6. Discard the final filter.
7. Inspect inside the housing for any large debris; clean housing as needed.
8. Discard final filter cap seal ring.

Installation of the Final Filter

Install the final filter as follows:

1. Install a new seal ring (1) on to final filter cap.
2. Snap (For DD5) or twist (For DD8) a new final filter into the final filter cap.
3. Apply a light coat of Parker super O-lube or petroleum-based lithium grease to the final filter cap seal ring (1) and drain back port seal ring (2).



d470331

4. Install the final filter into the fuel filter module.
5. Torque the final filter cap to 25 to 30 N·m (19 to 22 lb·ft).

NOTE: If a filter service is being performed, replace all other filters before priming.

6. Once all required filters have been changed, prime the fuel system. Refer to section "Priming the Fuel System".

Engine Out of Fuel – How to Restart

NOTICE: Prolonged use of the starting motor to prime the fuel system can result in damage to the starter.

Use the following procedure to prime the fuel system:

NOTE: If a vehicle is on uneven ground, more fuel may be required.

1. Fill the fuel tank with the recommended grade of fuel. If only partial filling is possible, add a minimum of 10% of the total tank volume of fuel to the tank. For example, a 150-gallon tank would require a minimum of 15 gallons of fuel.
2. Operate the frame-mounted or engine mounted hand primer for 45 strokes.
3. Turn on the ignition switch.
4. Wait for the engine system indicator lights on the instrument panel to go out.
5. With the accelerator pedal in the idle position, start the engine.
6. Crank engine for 20 seconds.

NOTE: The starting cycle can be repeated up to three times.

7. If engine does not start, allow for a 60-second cool down and repeat previous step.
8. Monitor the oil pressure gauge or indicator lamp. Keep the engine running at an idling speed until a stable oil pressure reading of 345 kPa (50 psi) or more is maintained for one minute.
9. Check for leaks.
10. Allow the engine to reach operating temperature of 60° C (140° F).

NOTICE: Increasing engine speed above idle before oil pressure has stabilized may cause severe engine damage.

11. Increase engine speed to 1500 rpm for ONE (1) minute.
12. Reduce engine speed and run at idle for ONE (1) additional minute.
13. Shut down the engine.
14. Check for leaks.
15. If engine still fails to start, contact an authorized Detroit™ repair facility.

How to Clean an Engine

Observance of all environmental protection regulations is required. Use high-pressure equipment as follows:



CAUTION: EYE INJURY

To avoid injury from flying debris, wear a face shield or goggles.

NOTICE: To prevent damage to engine components, keep the water moving at all times while cleaning. Never direct water onto electrical components, plug connectors, seals or flexible hoses.

Information on suitable cleaning and protective products is available from any authorized dealer. Note the equipment manufacturer's operating instructions.

Use the following minimum working distance between the high-pressure nozzle and the surface being cleaned:

- Approximately 28 in. (700 mm) for circular pattern jets
- Approximately 12 in. (300 mm) for 25-degree flat jets and dirt cutters

Power clean the engine as follows:

1. Allow engine to cool down to room temperature before spraying the engine.

NOTICE: Avoid all of the electrical connections with direct water or steam spray or damage can result.

2. Thoroughly clean the entire engine using a steam cleaner or high pressure washer with mild soap and warm water.



WARNING: EYE INJURY

To avoid injury from flying debris when using compressed air, wear adequate eye protection (face shield or safety goggles) and do not exceed 276 kPa (40 psi) air pressure.

NOTE: Do not use compressed air or pressurized water to clean or dry the engine if any part of the engine is disassembled.

3. Once the engine is clean, blow the electrical connectors dry with compressed air to remove most of the standing water.
4. Allow the engine to dry completely before making any kind of repair.
5. When reassembling, ensure that there is no standing water in any electrical connectors before seating the plug.

Cleaning/Flushing the Cooling System

Collect the used coolant, cleaning solutions, and washing liquids and dispose of them in an environmentally responsible manner.

Degrease as follows:



WARNING: HOT COOLANT

To avoid scalding from the expulsion of hot coolant, never remove the cooling system pressure cap while the engine is at operating temperature. Wear adequate protective clothing (face shield, rubber gloves, apron, and boots). Remove the cap slowly to relieve pressure.

1. First remove debris (such as dust, insects) from the fins of the radiator grille.



WARNING: EYE INJURY

To avoid injury from flying debris when using compressed air, wear adequate eye protection (face shield or safety goggles) and do not exceed 276 kPa (40 psi) air pressure.

NOTICE: Clean at moderate air pressures only to avoid damaging the radiator grille fins.

2. Remove the debris by blowing them through with compressed air or spraying them out with water. Work from the rear of the radiator (in the opposite direction of the normal cooling air flow).
3. Drain the coolant when the engine is cold. Refer to section "Cooling System Drain Procedure". For detailed procedures, see the vehicle/chassis maintenance manual. For types of coolant, refer to the How to Select Coolant section for the listing of required intervals using the recommended coolants.
4. If the HVAC unit is connected to the cooling system, open the regulating valves all the way.
5. Fill the cooling system with a 5% solution of 50 grams per liter (1.6 ounces per quart) of water of a mildly alkaline cleaning agent. Refer to section "Coolant Selections and Maintenance".
6. Run the engine at moderate speed until the thermostat starts to open. The thermostat starts to open at 83°C (181°F) and is fully open at 95°C (203°F). Then run it for about five minutes longer. Shut down the engine and allow it to cool to approximately 50°C (112°F).
7. Drain all the cleaning solution.
8. Flush the cleaning solution from the cooling system. Immediately after draining the cleaning solution, flush the system with clean water.
9. Once the clean water has drained, fill the system again with clean water.
10. Run the engine at moderate speed until the thermostat starts to open. The thermostat starts to open at 83°C (181°F) and is fully open at 95°C (203°F). Then run it for about five minutes longer. Shut down the engine and allow it to cool to approximately 50°C (112°F).
11. Drain the hot water.
12. Fill the cooling system with new coolant. For detailed procedures, see the vehicle/chassis maintenance manual. For types of coolant, refer to section "How to Select Coolant" for the listing of required intervals using the recommended coolants.

Coolant Selections and Maintenance

This section covers selection of the required coolant for the engine.

Extended Life Coolants

Extended Life Coolant (ELC) contain Organic Acid Technology (OAT) which provide corrosion protection and inhibit liner cavitation. These coolants require less maintenance over the useful life of the engine.

ELC antifreeze coolants are commercially available from Detroit™ (recommended) and other manufacturers as either concentrated or pre-mixed formulations. Concentrated antifreeze coolants should be mixed at 50% (50% antifreeze/50% water). All ELC's used must also meet Detroit 93K217 specification. Detroit™ requires that these types of coolants to be free of nitrite and phosphate. Detroit™ has found that ELC's containing nitrite may lead to a breakdown of the coolant and subsequent damage to the cooling system.

These types of coolants should not be mixed with Standard Life Coolants. If an ELC antifreeze coolant and SLC antifreeze coolants are mixed, damage may not result, but the long-life advantages of the ELC antifreeze coolant will be lost. In this event, the coolant should be re-inhibited with OAT inhibitors and confirmed by analysis or else it must be maintained as an SLC antifreeze coolant.

SLC Antifreeze Coolants

Standard Life Coolant (SLC) contain inhibitor salts, including nitrites, to prevent liner cavitation. These coolants require interval testing to maintain inhibitor concentration.

SLC antifreeze coolants are commercially available from Detroit™ (recommended) and other manufacturers as either concentrated or as pre-mixed antifreeze. Concentrated antifreeze coolants should be mixed at 50% (50% antifreeze/50% water). All fully formulated coolants used must also meet Detroit 93K217 specification.

NOTE: Fully formulated antifreeze does not require a dosage of Supplemental Coolant Additive (SCA) at initial use.

Coolant Fill Options

The coolants recommended for use in Detroit™ engines are listed in Table "DD Platform Coolant Fill Options". This publication will give a complete explanation of their use.

NOTICE: Required specifications for water, Ethylene Glycol (EG), Propylene Glycol (PG), inhibitor packages, and inhibitor concentration are included in the appendix of this publication. To avoid possible engine damage from inadequate or over-concentrated coolant, this publication should be read thoroughly before replacing or topping-off coolant.

Table 28.

DD Platform Coolant Fill Options		
Engine Series	Coolant Fill Options	Product
DD Platform	Ethylene Glycol based antifreeze coolant + SLC corrosion inhibitors	Detroit Power Cool or refer to 93K217 list of approved coolants at DDCSN-DDC.Freightliner.com
	Propylene Glycol based antifreeze coolant + SLC corrosion inhibitors	No Detroit™ product available. Refer to 93K217 list of approved coolants at DDCSN-DDC.Freightliner.com
	Ethylene Glycol based antifreeze coolant + ELC inhibitors	Detroit Power Cool Plus or refer to 93K217 list of approved coolants at DDCSN-DDC.Freightliner.com
	Propylene Glycol based antifreeze coolant + ELC inhibitors	No Detroit™ product available. Refer to 93K217 list of approved coolants at DDCSN-DDC.Freightliner.com

Additional approved coolant products can be found on the Approved Coolant List (Detroit 93K217) list at [DDCSN-DDC Freightliner.com \(https://ddcsn-ddc.freightliner.com/cps/rde/xchg/ddcsn/\)](https://ddcsn-ddc.freightliner.com/cps/rde/xchg/ddcsn/).

Coolants for Detroit™ Engines

Coolants for Detroit™ Engines

The intent of this bulletin is to provide the requirements, directions, and information required to ensure cooling system protection for Detroit™ engines. These recommendations are general rules and reflect years of experience, technology research, and product development. Specific concerns not covered by this publication should be addressed to your local Detroit™ representative. The coolant used in Detroit™ engines must meet **Detroit 93K217 Specifications** with the following basic requirements:

- Provide an adequate heat transfer medium.
- Protect against cavitation damage to both cylinder liners and water pumps.
- Provide a corrosion/erosion-resistant environment.
- Prevent formation of scale or sludge deposits.

- Be compatible with cooling system hose and seal materials.
- Provide adequate freeze protection.

The rest of this section will describe the requirements for the proper usage of the water, antifreeze, and corrosion inhibitors. It will also describe the coolants and additives that are not recommended by Detroit™ and have been proven harmful to Detroit™ engines.

Coolants NOT Permitted

The following coolants are not to be used in Detroit™ engines:

- **Automotive/Passenger car-type coolants** must not be used in Detroit™ engines because they offer no liner pitting protection. Also, these types of coolants generally contain high levels of phosphates and silicates.
- **Methyl alcohol-based antifreeze** must not be used in Detroit™ engines because of its effects on the nonmetallic components of the cooling system and its low boiling point.
- **Methoxy propanol-based antifreeze** must not be used in Detroit™ engines because it is not compatible with fluorocarbon elastomer seals found in the cooling system.
- **Glycol-based coolants formulated for Heating/Ventilation/Air Conditioning (HVAC)** must not be used in Detroit™ engines. These coolants generally contain high levels of phosphates, which will form deposits on hot internal engine surfaces, reduce heat transfer, and cause water pump seal leaks.
- **Waterless-type coolants** must not be used.
- **Nitrite Organic Acid Technology (NOAT)** must **not** be used in Detroit™ engines because with poor maintenance components become more vulnerable.

Non-Formulated Additives NOT Permitted

The following additives should not be used in Detroit™ engines:

- **Soluble Oils:** Soluble oil additives are not approved for use in Detroit™ engine cooling systems. A small amount of oil adversely affects heat transfer. For example, a 1.25% concentration of soluble oil increases the fire deck temperature 6%. A 2.50% concentration increases the fire deck temperature 15%. The use of soluble oil additives may result in engine overheating and/or failure.
- **Chromates:** Chromate additives are not approved for use in Detroit™ engine cooling systems. Chromate additives can form chromium hydroxide, commonly called “green slime.” This, in turn, can result in engine damage due to poor heat transfer. Cooling systems operated with a chromate-inhibited coolant must be chemically cleaned with Detroit™ Genuine Coolant **Twin Pack** cooling system cleaner/conditioner (or equivalent sulfamic acid/sodium carbonate cleaner) and flushed.
- **Phosphate Inhibitors:** Phosphate has tendency to form deposits on surfaces transferring high heat which ultimately affect cooling capabilities. Phosphate deposits on water pump seals will result in coolant leakage across seal faces.

Maintenance

Maintenance

This section describes procedures needed to maintain the proper coolant level and concentration.

Topping Off Coolant

The coolant level should be checked daily and at each service interval. If topping off is necessary, add coolant which is identical to the initial-fill coolant. ELCs should be topped-off with a coolant of the same formulation; SLCs should also be topped-off with a coolant of the same formulation.

Coolant Maintenance Intervals

The following tables contain the coolant maintenance intervals.

Required Service Intervals DD5, DD8

Table 29.

Extended Life Coolant Maintenance Intervals:					
Service Application	Efficient Long Haul ¹	Long Haul ²	Short Haul ³	Severe ⁴	Action Required
Engine Series					
DD5	Not Applicable	Every 100,000 miles (161,000 km) or 1 year ⁵	Every 90,000 miles (145,000 km) or 1 year ⁵	Every 70,000 miles (113,000 km) or 1 year ⁵	Refer to section "Extended Life Coolant Additive Maintenance Procedures"
1. Efficient Long Haul is not applicable to the DD5 engine.					
2. Long Haul service (over-the-road transport) applies to vehicles that annually travel more than 60,000 miles (96,000 km) and average greater than 12.0 miles per gallon with minimal city stop-and-go operation. Examples of Long Haul service are: regional delivery that is mostly freeway mileage, interstate transport, and any road operation with high annual mileage.					
3. Short Haul service applies to vehicles that annually travel up to 60,000 miles (96,000 km) and average between 10.1 and 11.9 miles per gallon and operate under normal conditions. Examples of Short Haul service are: operation primarily in cities and densely populated areas, local transport with infrequent freeway travel, or a high percentage of stop-and-go travel.					
4. Severe service applies to vehicles that average below 10.0 miles per gallon or that operate under severe conditions. Examples of Severe Service are: idle time over 40%, load factor over 55%, operation on extremely poor roads or under heavy dust accumulation; constant exposure to extreme hot, cold, salt-air, or other extreme climates; frequent short-distance travel; construction-site operation; or farm operation. Only one of these conditions needs be met to categorize an application as Severe Service.					
5. Whichever comes first.					

Table 30.

Extended Life Coolant Maintenance Intervals:					
Service Application	Efficient Long Haul ¹	Long Haul ²	Short Haul ³	Severe ⁴	Action Required
Engine Series					
DD8	Not Applicable	Every 120,000 miles (193,000 km) or 1 year ⁵	Every 110,000 miles (177,000 km) or 1 year ⁵	Every 72,000 miles (145,000 km) or 1 year ⁵	Refer to section "Extended Life Coolant Additive Maintenance Procedures"
1. Efficient Long Haul is not applicable to the DD5 engine.					
2. Long Haul service (over-the-road transport) applies to vehicles that annually travel more than 60,000 miles (96,000 km) and average greater than 8.5 miles per gallon with minimal city stop-and-go operation. Examples of Long Haul service are: regional delivery that is mostly freeway mileage, interstate transport, and any road operation with high annual mileage.					
3. Short Haul service applies to vehicles that annually travel up to 60,000 miles (96,000 km) and average between 6.5 and 8.5 miles per gallon and operate under normal conditions. Examples of Short Haul service are: operation primarily in cities and densely populated areas, local transport with infrequent freeway travel, or a high percentage of stop-and-go travel.					
4. Severe service applies to vehicles that average below 10.0 miles per gallon or that operate under severe conditions. Examples of Severe Service are: idle time over 40%, load factor over 55%, operation on extremely poor roads or under heavy dust accumulation; constant exposure to extreme hot, cold, salt-air, or other extreme climates; frequent short-distance travel; construction-site operation; or farm operation. Only one of these conditions needs be met to categorize an application as Severe Service.					
5. Whichever comes first.					

Table 31.

Standard Life Coolant Maintenance Intervals:					
Service Application	Efficient Long Haul ¹	Long Haul ²	Short Haul ³	Severe ⁴	Action Required
Engine Series					
DD5	Not Applicable	Every 50,000 miles (80,000 km) or 1 year ⁵	Every 45,000 miles (72,000 km) or 3,000 hours or 1 year ⁵	Every 35,000 miles (56,000 km) or 1,000 hours or 1 year ⁵	Refer to section "Standard Life Coolant Additive Maintenance Procedures"
1. Efficient Long Haul is not applicable to the DD5 engine.					
2. Long Haul service (over-the-road transport) applies to vehicles that annually travel more than 60,000 miles (96,000 km) and average greater than 12.0 miles per gallon with minimal city stop-and-go operation. Examples of Long Haul service are: regional delivery that is mostly freeway mileage, interstate transport, and any road operation with high annual mileage.					
3. Short Haul service applies to vehicles that annually travel up to 60,000 miles (96,000 km) and average between 10.1 and 11.9 miles per gallon and operate under normal conditions. Examples of Short Haul service are: operation primarily in cities and densely populated areas, local transport with infrequent freeway travel, or a high percentage of stop-and-go travel.					
4. Severe service applies to vehicles that average below 10.0 miles per gallon or that operate under severe conditions. Examples of Severe Service are: idle time over 40%, load factor over 55%, operation on extremely poor roads or under heavy dust accumulation; constant exposure to extreme hot, cold, salt-air, or other extreme climates; frequent short-distance travel; construction-site operation; or farm operation. Only one of these conditions needs be met to categorize an application as Severe Service.					
5. Whichever comes first.					

Table 32.

Standard Life Coolant Maintenance Intervals:					
Service Application	Efficient Long Haul ¹	Long Haul ²	Short Haul ³	Severe ⁴	Action Required
Engine Series					
DD8	Not Applicable	Every 60,000 miles (96,000 km) or 2,000 hours or 1 year ⁵	Every 55,000 miles (88,000 km) or 1,800 hours or 1 year ⁵	Every 45,000 miles (72,000 km) or 1,500 hours or 1 year ⁵	Refer to section "Standard Life Coolant Additive Maintenance Procedures"
1. Efficient Long Haul is not applicable to the DD5 engine.					
2. Long Haul service (over-the-road transport) applies to vehicles that annually travel more than 60,000 miles (96,000 km) and average greater than 8.5 miles per gallon with minimal city stop-and-go operation. Examples of Long Haul service are: regional delivery that is mostly freeway mileage, interstate transport, and any road operation with high annual mileage.					
3. Short Haul service applies to vehicles that annually travel up to 60,000 miles (96,000 km) and average between 6.5 and 8.5 miles per gallon and operate under normal conditions. Examples of Short Haul service are: operation primarily in cities and densely populated areas, local transport with infrequent freeway travel, or a high percentage of stop-and-go travel.					
4. Severe service applies to vehicles that average below 10.0 miles per gallon or that operate under severe conditions. Examples of Severe Service are: idle time over 40%, load factor over 55%, operation on extremely poor roads or under heavy dust accumulation; constant exposure to extreme hot, cold, salt-air, or other extreme climates; frequent short-distance travel; construction-site operation; or farm operation. Only one of these conditions needs be met to categorize an application as Severe Service.					
5. Whichever comes first.					

Table 33.

Coolant Drain interval:		
Engine Series	ELC	SLC
DD5, DD8	600,000 miles (965,606 km), 4 years or engine overhaul	300,000 miles (482,803 km) or 2 years

Extended Life Coolant Additive Maintenance Procedures

The concentration of ELC corrosion inhibitors will gradually deplete, at a much slower rate than SLC corrosion inhibitors, during normal engine operation. Corrosion inhibitor limits are established by the coolant manufacturer. Therefore Detroit™ recommends following the manufacturer's recommendations as to minimum and maximum limits.

Freeze Point Check

To best measure the quality of anti-freeze coolant, a check of the freeze point (glycol concentration), by refractometer, should be performed at each service interval to ensure anti-freeze levels are within specification. Detroit™ requires a freeze point of -34°F (+/-10°F) to guarantee optimal engine protection. The exception would be certain regions that require a freeze point of -60°F to protect against colder climates.

Laboratory Testing

Laboratory testing is the best practice for determining ELC coolant quality and will provide vital information regarding the engine performance. A factory coolant analysis program is available through authorized Detroit™ service outlets. To verify coolant acceptability, submit a sample for coolant analysis according to Table "Extended Life Coolant".

However, a laboratory meeting ISO 17025 requirements may be used in place of the Detroit™ Genuine Parts Program laboratory.

OAT Detection Strips

OAT Detection Strips that monitor the organic acid levels can be used to test the concentration of corrosion inhibitors in the anti-freeze coolant. Detroit™ recommends consultation with your coolant manufacturer's technical representative for proper application.

ELC Enhancers/Extenders

ELC enhancers/extenders can be used to extend the life of the coolant. These products should be added to your anti-freeze coolant when corrosion inhibitors fall below manufacturer's recommendations. Detroit™ recommends consultation with your coolant manufacturer's technical representative for proper application.

Drain, Flush, and Refill Procedure (See Appendix C for Product Part number)

When coolant has reached the end of life, it is recommended to properly clean your cooling system of any scale, deposits or any other contaminants that may reduce the efficiency of the heat transfer. The coolant must be drained completely including the block, radiator, and HVAC system. Next, flush the system with fresh, clean water. Replace drain fittings. Mix required amount of Penray 2010 cleaner in a 5-gallon pail of water and pour into radiator inlet. Fill system completely with clean water. Re-circulate cleaning solution by idling engine for 2 hours after top hose is hot. Temperature should be 88° to 95°C (190 to 203°F) to allow the thermostat to open.

Drain cleaning solution from the system. **The radiator, block and HVAC system must both be drained.** Flush with clean water (through the radiator inlet) for 3 to 5 minutes. Replace drain fittings. Mix required Penray 2011 in a 5-gallon pail and pour into radiator inlet (1 pound per 4 gallons cooling system capacity). Fill system completely with clean water. Re-circulate the Penray 2011 conditioning solution by

idling engine for 15 minutes after the top hose is hot (thermostat opens if it wasn't removed). Drain the Penray 2011 solution from the system. **The radiator, block and HVAC system must both be drained.** Flush with clean water for 3-5 minutes. Keep flushing as long as water looks "rusty" or "turbid." Replace drain fittings. Recharge cooling system with the appropriate ratio of clean water and the proper antifreeze for your application.

Standard Life Coolant Additive Maintenance Procedures

The concentrations of SLC inhibitors will gradually deplete during normal engine operation. SCAs replenish the protection for cooling system components and must be added to the cooling system on an as needed basis. Below are test procedures that will assist in determining the inhibitor concentration.

Appendix A - Definitions

Antifreeze:

A substance that is added to the water in a vehicle's cooling system that lowers the freeze point to prevent freezing. The two most common antifreezes are ethylene glycol (EG) and propylene glycol (PG).

Coolant:

A fluid that transfers heat from the engine by circulation.

Extended Life Coolant (ELC): AKA - Long-Life Coolant or Organic Acid Technology:

These types of coolants have been formulated to extend the service interval of the coolant. Example of ELC is Power Cool Plus.

Fully Formulated:

Antifreeze that contains all the necessary inhibitors to protect a diesel engine and does not, therefore, require a pre-charge of Supplemental Coolant Additive before its first use.

Initial-Fill:

The coolant that is used in a new or rebuilt engine, or used any time the cooling system is emptied and then refilled with new coolant.

Standard Life Coolant (SLC): AKA - Fully-Formulated or Conventional Coolant:

These types of coolants use supplemental coolant additives (SCA) to protect against corrosion or mechanical wear. Example of SLC is Power Cool.

Supplemental Coolant Additive:

An additive used in a preventive maintenance program to prevent corrosion, cavitation, and the formation of deposits.

Appendix B - General Coolant Information

SLC Antifreeze Coolants

These products are available as Fully Formulated and Phosphate-Free. They are commercially available from Detroit™ (recommended) and other manufacturers as either concentrated antifreeze or as pre-mixed antifreeze. The pre-mixed antifreeze is ready to use, while the concentrated coolant must be mixed with water prior to use. All fully formulated coolants used must also meet Detroit 93K217 specification.

NOTE: Fully formulated antifreeze does not require a dosage of Supplemental Coolant Additive (SCA) at initial use.

ELC Antifreeze Coolants

EG and PG based antifreeze coolants contain Organic Acid Technology (OAT). These coolants require less maintenance over the useful life of the engine.

ELC antifreeze coolants are available as either concentrated or pre-mixed formulations. Concentrated antifreeze coolants should be mixed at 50% (50% antifreeze/50% water). **These types of coolants should not be mixed with SLCs.** If an ELC antifreeze coolant and SLC antifreeze coolants are mixed, damage may not result, but the long-life advantages of the ELC antifreeze coolant will be lost. In this event, the coolant should be re-inhibited with OAT inhibitors and confirmed by analysis or else it must be maintained as an SLC antifreeze coolant.

Water-Only Coolants (Series 50, 55 and 60 only)

In warm climates where freeze protection is not required, water only with corrosion inhibitors is approved for use. Water-only systems need to be treated with the proper dosage of corrosion inhibitors. Detroit™-approved SCA or ELC corrosion inhibitors must be added to the water to provide required corrosion and cavitation erosion protection.

Mixing Ethylene Glycol or Propylene Glycol Antifreeze and Water

It is highly recommended to use a pre-mixed 50/50 antifreeze coolant. However, if a concentrated Ethylene Glycol or Propylene Glycol antifreeze is purchased, mix the antifreeze with water meeting the required quality standards and fill the cooling system. See water requirement below for quality standards. If a pre-diluted coolant is purchased, simply fill the cooling system.

For best overall performance, a coolant consisting of 50% concentration of antifreeze (50% antifreeze, 50% water) is recommended. An antifreeze concentration of over 60% (60% antifreeze, 40% water) is **not recommended** due to poor heat transfer, reduced freeze protection, and possible silicate dropout. An antifreeze concentration below 40% (40% antifreeze, 60% water) offers too little freeze and/or corrosion protection and is **not recommended**.

WATER REQUIREMENTS

Distilled or de-ionized water, which eliminates the adverse effects of minerals in tap water, is preferred. High levels of dissolved chlorides, sulfates, magnesium, and calcium in some tap water causes scale deposits, sludge deposits and/or corrosion. These deposits have been shown to result in water pump failures and poor heat transfer, resulting in overheating. If tap water is used, the mineral content in the water must be below the maximum concentration listed in the table below.

Table 34.

Maximum Mineral Concentration in Water		
Minerals	Maximum Concentration	
	Parts per Million	Grains per Gallon
Chlorides	40	2.5
Sulfates	100	5.8
Total Dissolved Solids	340	20
Magnesium + Calcium Content	170	10

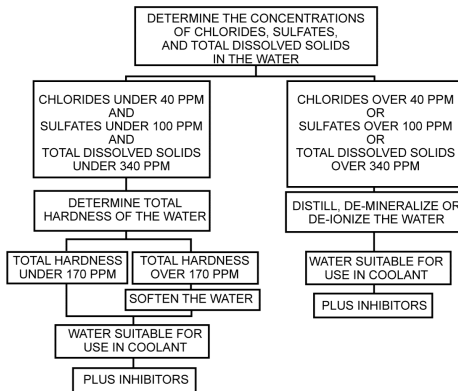

20868a

Figure 9. Procedure To Evaluate The Quality Of Water

Recycled Antifreeze

Antifreeze coolant made with ethylene or propylene glycol recycled by reverse osmosis, distillation, and ion exchange and properly re-inhibited to meet ASTM D6471 or D6472 requirements has been demonstrated to provide service equivalent to virgin antifreeze. Recycled antifreeze coolants of these types are preferred. However, suppliers of these recycled glycols must provide evidence the product is free of contaminants listed below:

- Acetates

- Acetone
- Ammonia
- Boron
- Ethanol
- Formates
- Glycolates
- Ketones
- Nitrate
- Nitrite
- Phenols
- Phosphorus
- Silicon
- Toluene

Other recycled coolants, especially coolants recycled through filtration processes, are **not recommended**.

Appendix C - Detroit™ Cooling System Maintenance Products

Table 35.

Detroit™ Extended Life Coolant (Ethylene Glycol-based)		
Coolant Type	Part Number	Description
Concentrate	OWI 23539616	One Gallon Jug - 4 Per Case (Canada)
	OWI 23519397	One Gallon Jug - 6 Per Case
	OWI 23519394	55-Gallon Drum
Pre-Diluted (50:50)	OWI 2359617	One Gallon Jug - 4 Per Case (Canada)
	OWI 23519396	One Gallon Jug - 6 Per Case
	OWI 23519398	55-Gallon Drum
	OWI 2359084	275-Gallon Tote (Canada)

Table 36.

Detroit Genuine Coolant Plus Extender (for use with Detroit Genuine Coolant Plus)		
Coolant Type	Part Number	Description
IEG Detroit™ Genuine Coolant; Series 50 and Series 60	OWI 23519400	One Quart Bottle - 6 Per Case

Table 37.

Detroit™ Standard Life Coolant (Ethylene Glycol-based)		
Coolant Type	Part Number	Description
Concentrate	OWI 23539622	One Gallon Jug - 4 Per Case (Canada)
	OWI 23512138	One Gallon Jug - 6 Per Case
	OWI 23512139	55-Gallon Drum
	OWI 23513503	Bulk Delivery - 1000 Gallon min.
Pre-Diluted (50:50)	OWI 23539623	One Gallon Jug - 4 Per Case (Canada)
	OWI 23528203	One Gallon Jug - 6 Per Case
	OWI 23518918	55-Gallon Drum
	OWI 23538603	275-Gallon Tote

Table 38.

Detroit™ Genuine Coolant 2000 Supplemental Coolant Additives (SCA)		
Coolant Type	Part Number	Description
IEG Detroit™ Genuine Coolant	PIC 23507858	Pint Bottle - 12 Per Case
	PIC 23507860	5-Gallon Pail
	PIC 23507861	55-Gallon Drum

Table 39.

Detroit™ Genuine Coolant 3000 SCAs		
Coolant Type	Part Number	Description
IEG Detroit™ Genuine Coolant	PIC 23507854	Pint Bottle - 12 Per Case
	PIC 23507855	Half Gallon Jugs - 6 Per Case
	PIC 23507856	5-Gallon Pail
	PIC 23507857	55-Gallon Drum

Table 40.

Detroit Genuine Coolant 3000 SCA Filters (Series 50 and Series 60 Engines Only)		
Coolant Type	Part Number	Description
IEG Detroit™ Genuine Coolant	23507545	4 Ounce (1 Pint Equivalent)
	23508425	8 Ounce (2 Pint Equivalent)
	23508426	12 Ounce (3 Pint Equivalent)
	23507189	16 Ounce (4 Pint Equivalent)
	23508427	32 Ounce (8 Pint Equivalent)
	23508428	53 Ounce (13 Pint Equivalent)

Table 41.

Detroit Genuine Coolant Cooling System Cleaners		
Coolant Type	Part Number	Description
All Types	PIC 201549	Twin pack - 2 Per Case
Standard Life Coolant Only	PIC 200164	One-Half Gallon Jug - 6 Per Case
	PIC 200105	5-Gallon Pail
	PIC 200155	55-Gallon Drum

Table 42.

Detroit Genuine Fluid Analysis Products		
Coolant Type	Part Number	Description
Standard Life Coolant	DDE 23516921	U.S. SLC Test Kit
Extended Life Coolant	DDE 23539088	U.S. ELC Test Kit

Customer Assistance

Using Road Service in the U.S. or Canada

The satisfaction and goodwill of the owners of Detroit™ engines are of primary concern to Detroit™ and its distributor/dealer organizations. Contact the Customer Support Center at **1-800-445-1980**.

If you require road service for any reason in the U.S. or Canada, you may call the 1-800-445-1980 customer assistance phone number. An operator will assist you in determining what type of service is required. Not all problems are engine related and not all problems are covered by engine or vehicle warranties. **YOU MAY BE RESPONSIBLE FOR REPAIR EXPENSES.**

Before calling Customer Assistance, please do the following:

- Check the coolant level.
- Check the fuel level.
- Check the DDEC fuses.
- Check for fuel leaks.
- Make sure manual shutoff valve (if installed) on the fuel filter adaptor or fuel supply line is open.
- Check the oil level on the dipstick.
- Check the diagnostic codes.

If you call, have the following information available:

- Engine serial number
- Vehicle make, model, and VIN
- Odometer mileage (kilometers) or hour meter hours
- Vehicle owner/company name

Availability of Detroit™ Service Outlets

As the owner of a Detroit™ product, you have a complete network of Detroit™ service outlets in the U.S. and Canada, plus many outlets worldwide that are prepared to meet your parts and service needs:

- Service by trained personnel
- Sales team to help determine your specific power requirements
- In many areas, emergency service 24 hours a day
- Complete parts support
- Product information and literature

We recognize however, that despite the best intentions of everyone concerned, misunderstandings may occur. Normally, any situation that arises in connection with the sale, operation or service of your product will be handled by the authorized

service outlet in your area (in the U.S. and Canada, check the Yellow Pages or the service locator at www.demanddetroit.com for Detroit™ service outlet nearest you).

Detroit Genuine Coolant Engine Products

Detroit Genuine Coolant Engine Products

Maintenance of the cooling system requires the chemical makeup of the system to be balanced.

Detroit Genuine Fully Formulated Inhibited Ethylene Glycol Coolants

The part numbers and sizes of concentrated and pre-blended 50:50 Detroit Genuine Coolants are listed in the following Tables.

Table 43.

Detroit Genuine Fully Formulated Inhibited Ethylene Glycol Coolants		
Coolant Type	Part Number	Description
Concentrated	23512138	One Gallon Jug – 6 Per Case
	23512139	55 Gallon Drum
	23529295	330 Gallon Tote
	23512140	Bulk Delivery – 1,000 Gallon Min.
Pre-blended 50:50	23528203	One Gallon Jug – 6 Per Case
	23518918	55 Gallon Drum
	23528544	330 Gallon Tote
	23513503	Bulk Delivery – 1,000 Gallon Min.

Detroit Genuine Supplemental Coolant Additive Need Release Filters

Detroit Genuine Supplemental Coolant Additive Need Release Filters are shown below.

Table 44.

Detroit Genuine Supplemental Coolant Additive Need Release Filters		
Coolant Type	Part Number	Description
Detroit Genuine Inhibited Ethylene Glycol Coolant	NF2091	For 0 – 8 Gallon Systems
	23516489	For 8 – 20 Gallon Systems

Detroit Genuine Cooling System Cleaners

Detroit Genuine Cooling System Cleaners are shown below.

Table 45.

Detroit Genuine Cooling System Cleaners		
Coolant Type	Part Number	Description
On-Line Cleaner	200164	One-Half Gallon Jug – 6 Per Case
	200105	5 Gallon Pail
	200155	55 Gallon Drum
Twin Pack	201549	Twin Pack – 2 Per Case

Detroit Genuine Fluid Analysis Products

Detroit Genuine Fluid Analysis Products are shown below.

Table 46.

Detroit Genuine Fluid Testing and Analysis Products		
Application	Part Number	Description
Indicates Nitrite, Molybdate & Glycol Levels	23519401	3-Way Coolant Test Strips (Single Foil Packs)
Indicates Nitrite, Molybdate & Glycol Levels	23519402	3-Way Coolant Test Strips (Bottle of 50)
Indicates Nitrite, Molybdate & Glycol Levels	23522774	3-Way Coolant Test Strips (Bottle of 10)
Complete Inhibited Ethylene Glycol Coolant Analysis	23516921	Coolant Analysis Bottle (Carton of 6)
Organic Coolant Analysis	23539088	Laboratory Coolant Analysis

Engine Oil Capacities

Engine Oil Capacities

Consult with a Detroit distributor to obtain the proper engine oil filters.

The engine oil capacities for the DD5 and DD8 applications are listed in the following table. Contact your local Detroit service center if you need more specific information.

NOTE: There are approximately 4.0 L (4.2 qts) of oil represented from the fill mark to the full mark.

NOTICE: Overfilling the oil pan can cause engine damage.

Table 47.

Engine Oil Capacities		
Medium Duty Engines	DD5	DD8
Total Dry Engine Oil Volume	19.5 L (20.6 qt)	28.5 L (30.1 qt)
Oil and Filter Change	17.5 L (18.5 qt)	25.5 L (26.9 qt)
Remaining in Engine after Oil Drain (Includes Filter Removal)	2.0 L (2.1 qt)	3.0 L (3.2 qt)
Dip Stick Min. to Max. Range	4.0 L (4.2 qt)	4.0 L (4.2 qt)
Sump Oil Volume	16.5 L (17.4 qt)	24.5 L (25.9 qt)