



OPERATOR'S HANDBOOK

ELECTRONIC
V-MAC® IV
VEHICLE MANAGEMENT
AND CONTROL WITH
CO-PILOT® DISPLAY

21968603

© Mack Trucks, 2013

Mack® V-MAC® IV

OPERATOR'S HANDBOOK

21968603



OPERATOR'S HANDBOOK

ELECTRONIC
V-MAC® IV
VEHICLE MANAGEMENT
AND CONTROL WITH
CO-PILOT® DISPLAY

21968603
January 2013



Foreword

This manual contains information concerning the operation and function of the Electronic Vehicle Management and Control (V-MAC) IV Vehicle Management and Control with Co-Pilot Display. The information in this manual applies to vehicles built January 2013 and later. Please keep this manual in the vehicle at all times.

Note: Illustrations in this manual are used for reference only and may differ slightly from the actual vehicle. However, key components addressed in this document are represented as accurately as possible.

Mack Trucks

Wacol, QLD, Australia

Order number: PV776-21968603

©2013 Mack Trucks Wacol, QLD, Australia

All rights reserved. No part of this publication may be reproduced, stored in retrieval system, or transmitted in any forms by any means, electronic, mechanical, photocopying, recording or otherwise, without the prior written permission of Mack Trucks.

Contents

Introduction	1
SAFETY INFORMATION.....	2
Service Procedures and Tool Usage.....	3
V-MAC Co-Pilot Operator's Manual	7
SYSTEM OVERVIEW.....	7
System Summary.....	7
SYSTEM COMPONENTS.....	9
Vehicle Electronic Control Unit (VECU).....	9
Engine Control Module (ECM).....	11
INDICATORS, LIGHTS AND DASHBOARD SWITCHES.....	15
Cab and Dashboard Switches.....	15
Electronic Malfunction Indicator.....	16
High Exhaust System Temperature (HEST) Indicator.....	17
Shutdown Warning Indicator.....	18
Engine Derate (For Mack Engines Only).....	19
Aftertreatment DPF Smart Switch (If Equipped).....	21
EXHAUST AFTERTREATMENT SYSTEM.....	23
Aftertreatment DPF Regeneration, Cummins ISX.....	23
Aftertreatment DPF Passive Regeneration, Cummins ISX.....	24
Aftertreatment DPF Parked Regeneration, Cummins ISX.....	25
Aftertreatment DPF Inhibit/Stop Regeneration.....	26
Aftertreatment DPF Regeneration and PTO Operation (Cummins ISX).....	32
STARTING THE VEHICLE.....	32
CRUISE AND ENGINE SPEED CONTROL.....	33
Cruise Control.....	33
Engine Speed Control.....	38
Engine Brake.....	41
ACCESSORY RELAY CONTROL.....	41
PROGRAMMABLE FEATURES.....	42
Cruise 'N Brake Engagement Delay.....	44
Engine High Idle Speed if Stopped.....	44
Engine High Idle Speed in Upper Gears.....	44
Low Idle Adjustment.....	44
Smart Idle Elevated Idle RPM Time.....	46
Idle Shutdown.....	46
Speed Sensor Tamper Detection.....	47
ELECTRICAL ACCESSORY CONNECTION POINTS.....	48
Battery Post (BATT).....	48
Ignition Post (IGN).....	48
Ground Post (GND).....	48
RPM Output.....	48
Km/h Output.....	49
SAE/ATA J-1708 Posts (Series Link A and B).....	49
CB Radio Power Jack (CB Radio +) (Located on Dashboard).....	49
CB Radio Ground Jack (CB Radio -) (Located on Dashboard).....	49

INSTRUMENT CLUSTER DISPLAY	50
Dash Cluster Set-Up Programming	50
Instrument Cluster Components	51
Driver Information Display.....	53
Diagnostic Trouble Codes (DTCs)	54
Electronic Dash Display	54
CO-PILOT® DISPLAY	58
Introduction and Purpose	58
CO-PILOT SYSTEM OVERVIEW	59
Set-Up Programming	59
CO-PILOT® OPERATIONS.....	63
Using the Co-Pilot®	63
CO-PILOT SYSTEM OVERVIEW	64
ESC Button	64
Enter (↵) Button	64
Up & Down Buttons	64
CO-PILOT® LAYOUT	65
Screen Types	65
Driver's ID Screens	66
Change Driver ID.....	70
CO-PILOT® START UP SCREENS	72
MACK Logo Intro	72
Current Conditions.....	73
CO-PILOT® MENU SCREENS	74
Main Menu — Stationary Vehicle	74
Main Menu — Moving Vehicle	75
CO-PILOT® ANYTIME SCREENS	77
Fuel Economy	77
Trip Information.....	78
Gauges.....	80
Black Panel	81
CO-PILOT® STATIONARY SCREENS	82
Diagnostics.....	83
Maintenance.....	84
DEL Messages	85
Set Up.....	86
CO-PILOT® INTERRUPT SCREENS	87
Idle Shutdown Warning	87
Driver Overspeed Warning (if Available).....	87
Warning Severe Engine Overspeed.....	88
Engine Brake Overspeed Warning.....	89
Severe Engine & Engine Brake Overspeed Warning.....	90
Maintenance Reminder (for Future Support).....	90
Low Voltage Disconnect Active	91
Inter Wheel Lock	91

Smart Idle Active	92
Starter Inhibit	92
Driver Trip Reset	93
Trip Advanced.....	94
Idle Cooldown Activated	94



WARNING

The information in this manual is not all inclusive and cannot take into account all unique situations. Note that some illustrations are typical and may not reflect the exact arrangement of every component installed on a specific chassis.

The information, specifications, and illustrations in this publication are based on information that was current at the time of publications part of this publication may be reproduced, stored in a retrieval system, or be transmitted in any form by any means including (but not limited to) electronic, mechanical, photocopying, recording, or otherwise without prior written permission of MACK Trucks.

2 Introduction

SAFETY INFORMATION

IMPORTANT: Before driving this vehicle, be certain that you have read and that you fully understand each and every step of the driving and handling information in this manual. Be certain that you fully understand and follow all safety warnings.

IT IS IMPORTANT THAT THE FOLLOWING INFORMATION BE READ, UNDERSTOOD AND ALWAYS FOLLOWED.

Cautionary *signal words* (Danger-Warning-Caution) may appear in various locations throughout this manual. Information accented by one of these signal words must be observed to minimize the risk of personal injury to service personnel, or the possibility of improper service methods which may damage the vehicle or cause it to be unsafe.

Notes are used to emphasize areas of procedural importance and provide suggestions for ease of repair. The following definitions indicate the use of these advisory labels as they appear throughout the manual:

DANGER

Danger indicates an unsafe practice that could result in serious personal injury or death. A danger advisory banner is in **white** type on a **black** background with a **black** border.

CAUTION

Caution indicates an unsafe practice that could result in damage to the product. A caution advisory is in **black** type on a **white** background with a **black** border.

WARNING

Warning indicates an unsafe practice that could result in personal injury. A warning advisory banner is in **black** type on a **gray** background with a **black** border.

Note: Note indicates a procedure, practice, or condition that must be followed in order for the vehicle or component to function in the manner intended.

Service Procedures and Tool Usage

Anyone using a service procedure or tool not recommended in this manual must first satisfy himself thoroughly that neither his safety nor vehicle safety will be jeopardized by the service method he selects. Individuals deviating in any manner from the instructions provided assume all risks of consequential personal injury or damage to equipment involved.

Also note that particular service procedures may require the use of a special tool(s) designed for a specific purpose. These special tools must be used in the manner described, whenever specified in the instructions.

4 Introduction

DANGER

Before starting a vehicle, always be seated in the driver's seat, place the transmission in neutral, apply the parking brakes, and push in the clutch pedal. Failure to follow these instructions could produce unexpected vehicle movement, which can result in serious personal injury or death.

DANGER

Before working on a vehicle, place the transmission in neutral, set the parking brakes, and block the wheels. Failure to follow these instructions could produce unexpected vehicle movement, which can result in serious personal injury or death.

DANGER

Engine-driven components such as Power Take-Off (PTO) units, fans and fan belts, driveshafts and other related rotating assemblies, can be very dangerous. Do not work on or service engine-driven components unless the engine is shut down. Always keep body parts and loose clothing out of range of these powerful components to prevent serious personal injury. Be aware of PTO engagement or nonengagement status. Always disengage the PTO when not in use.

DANGER

Do not work under a vehicle that is supported only by a hydraulic jack. The hydraulic jack could fail suddenly and unexpectedly, resulting in severe personal injury or death. Always use jackstands of adequate capacity to support the weight of the vehicle.

WARNING

When working on a vehicle by using wireless communication units, it is not always apparent to others that work is in progress on the vehicle. Certain activities, such as activation of certain vehicle components or systems, can cause injury to persons close to the vehicle who are unaware of the ongoing activities. Always keep a connected vehicle under close observation when using wireless communication units and inform other persons in the vicinity of the vehicle about the ongoing activities.

WARNING

The temperature of the exhaust system components during the regeneration process can exceed 500°C (1000°F). Various factors (including ambient air temperature (AAT) and duration of the regeneration process) determine when these components will return to normal operating temperature after regeneration has completed. Be extremely careful around these hot components. Contact with these components can result in serious personal injury.

CAUTION

Before towing the vehicle, place the transmission in neutral and lift the rear wheels off the ground, or disconnect the driveline to avoid damage to the transmission during towing.



CAUTION

When regeneration occurs, the temperature of the exhaust will be elevated. **DO NOT** park the vehicle with the exhaust outlet under low hanging overhead flammable objects such as trees, awnings, etc., that could be damaged by elevated exhaust temperatures. **DO NOT** attempt to regenerate inside a garage or enclosed area if the tail pipe is attached to an exhaust ventilation system as the hose material may not be rated for the high temperature.



CAUTION

Failure to perform a regeneration in a timely manner may result in engine derate, clogged Aftertreatment Diesel Particulate Filter (DPF) or damage to the filter.



CAUTION

When the inhibit position is pressed, the DPF switch will remain in a locked position. It is important, therefore, to immediately set the switch back to the neutral position when safe to do so. Failure to set the switch back to the neutral position may result in an engine derate, clogged or damaged DPF.

**REMEMBER,
SAFETY . . . IS NO ACCIDENT!**

6 Introduction

Every possible occurrence that may involve a potential hazard cannot be anticipated. Accidents can be avoided by recognizing potentially hazardous situations and taking necessary precautions. Performing service procedures correctly is critical to technician safety and safe, reliable vehicle operation.

The following list of general shop safety practices can help technicians avoid potentially hazardous situations and reduce the risk of personal injury. **DO NOT** perform any services, maintenance procedures or lubrications until this manual has been read and understood.

- Perform all service work on a flat, level surface. Block wheels to prevent vehicle from rolling.
- **DO NOT** wear loose- fitting or torn clothing. Remove any jewelry before servicing vehicle.
- **ALWAYS** wear safety glasses and protective shoes. Avoid injury by being aware of sharp corners and jagged edges.
- Use hoists or jacks to lift or move heavy objects.
- **NEVER** run engine indoors unless exhaust fumes are adequately vented to the outside.
- Be aware of hot surfaces. Allow engine to cool sufficiently before performing any service or tests in the vicinity of the engine.
- Keep work area clean and orderly. Clean up any spilled oil, grease, fuel, hydraulic fluid, etc.
- Only use tools that are in good condition, and always use accurately calibrated torque wrenches to tighten all fasteners to specified torques. In instances where procedures require the use of special tools which are designed for a specific purpose, use only in the manner described in the instructions.
- Do not store natural gas powered vehicles indoors for an extended period of time (overnight) without first removing the fuel.
- Never smoke around a natural gas powered vehicle.

SYSTEM OVERVIEW

System Summary

The Vehicle Management and Control (V-MAC) IV System is an electronic engine control system consisting of the following major components:

- Engine Control Module (ECM)
- Instrument Cluster
- Vehicle Electronic Control Unit (VECU)

To enable Vehicle Management and Control (V-MAC) IV to perform its engine management and control functions, the following sensors (if available and fitted) provide information to the system.

- Air Brake Application Sensor
- Air Suspension Sensor
- Air- Humidity Sensor
- Ambient Air Temperature (AAT) Sensor
- Intake Manifold Pressure (IMP) Sensor
- Intake Manifold Air Temperature Sensor
- Camshaft Position (CMP) Sensor
- Engine Coolant Level (ECL) Sensor
- Engine Coolant Temperature (ECT) Sensor
- Crankshaft Position (CKP) Sensor
- Crankcase Pressure (CCP) Sensor
- Engine Exhaust Gas Recirculation (EGR) Differential Pressure Sensor
- Front Drive Axle Temperature Sensor
- Fuel Pressure Sensor
- Engine Oil Level (EOL) Sensor
- Engine Oil Temperature (EOT) Sensor
- Engine Oil Pressure (EOP)
- Primary and Secondary Air Pressure Sensor
- Rear Drive Axle Temperature Sensor
- Accelerator Pedal Position (APP) Sensor
- Transmission Oil Temperature Sensor
- Engine Turbocharger Speed Sensor
- Vehicle Speed (Road Speed) Sensor
- Water in Fuel Filter Sensor

8 V-MAC Co-Pilot Operator's Manual

The following switches and functions are also monitored to provide information related to driver actions.

- A/C Pressure Switch (Optional)
- Clutch Pedal Position (CPP) Switch
- Engine Brake Low and High Switch (Optional)
- Ignition key
- Power Takeoff (PTO) Switches (Optional)
- Service Brake and Parking Brake Switches
- Set/Resume Switch
- Speed Control On/Off Switch
- Starter Engaged Switch Input (Optional)
- Torque Limiting Switch (Optional)

This manual provides a complete description of the system components, their functions and locations on the vehicle.

SYSTEM COMPONENTS

Vehicle Electronic Control Unit (VECU)

The VECU is mounted underneath panel D as shown in the graphic's below.

The VECU is an electronic control module which provides a wide variety of functions including:

- Cruise Control
- Diagnostic Trouble Code (DTC) Logging
- Differential Locking
- Idle Shutdown
- Maintenance Information
- Road Speed Limiting
- Speed Control

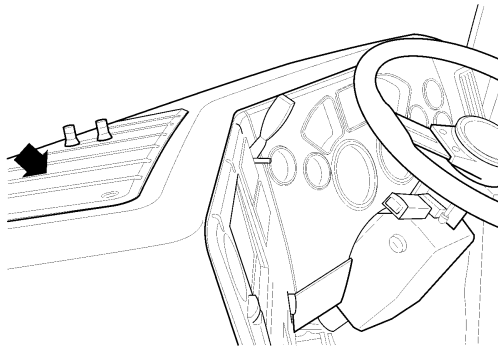

W3060890

VECU Location

10 V-MAC Co-Pilot Operator's Manual

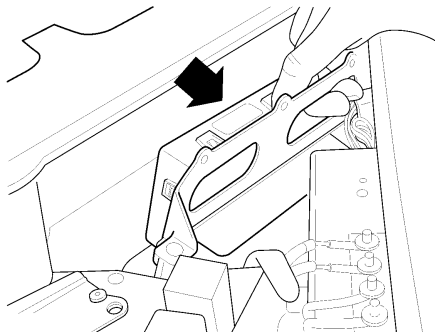

W3060892

VECU

Engine Control Module (ECM)

The ECM is an electronic control unit (ECU) located to the left side of the engine and is mounted to the fuel cooler, which is mounted beneath the inlet manifold. The ECM provides the following information and functions:

- Intake Manifold Pressure (IMP)
- Engine Coolant Level (ECL)
- Engine Coolant Temperature (ECT)
- Customer Road Speed Limiting
- Diagnostic Trouble Code (DTC) Logging
- Engine Oil Pressure (EOP)
- Engine Oil Temperature (EOT)
- Engine Protection
- Engine Shutdown
- Engine Speed (RPM) Control (based on commands from Vehicle Electronic Control Unit (VECU))
- Exhaust Aftertreatment System
- Fan Control
- Fuel Control
- Fuel Temperature
- Timing Control
- Vehicle Limiting Speeds

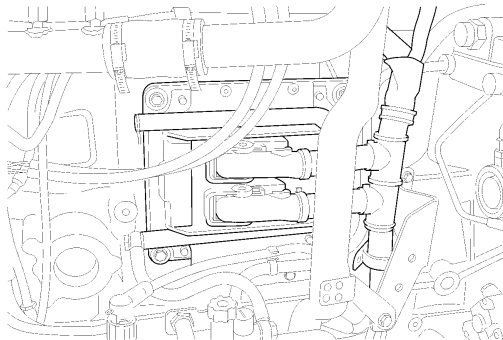

C0035356

Engine Control Module (ECM) Location

12 V-MAC Co-Pilot Operator's Manual

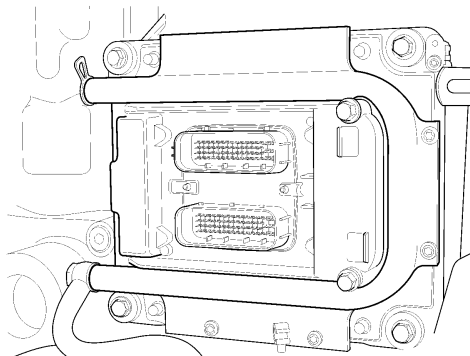

C0035360

Engine Control Module (ECM) (MACK MP7)

Instrument Cluster

The Vehicle Management and Control (V-MAC) IV Instrument Cluster is a one-piece unit composed of gauges and an information display. The Instrument Cluster receives information from the VECU and EECU and then sends information back to the VECU and EECU. Information is displayed when required or requested via a stalk switch (Co-Pilot® only).

The Instrument Cluster provides the following information:

- Air Brake Application (Optional)
- Air Suspension Pressure
- Axle Oil Temperature (Optional)
- Coolant Temperature (via ECM)
- Engine and Vehicle Speed Display
- Exhaust Temperature (Optional)
- Fuel Level
- High Beam Status
- High Exhaust System Temperature (HEST)
- Outside Temperature
- Oil Pressure (via ECM)
- Primary and Secondary Air Pressure
- Speedometer and Tachometer Outputs
- Transmission Oil Temperature (Optional)
- Vehicle Distance

14 V-MAC Co-Pilot Operator's Manual

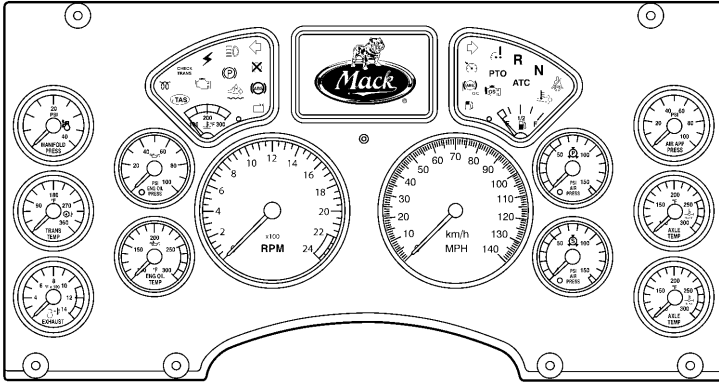

W3036315

Instrument Cluster Module

Note: The instrument cluster module shown is meant as an example only. The display features vary depending on the emission options for the vehicle.

INDICATORS, LIGHTS AND DASHBOARD SWITCHES

Cab and Dashboard Switches

Various functions of the Vehicle Management and Control (V-MAC) IV system are controlled by the operator through switches located on the dashboard. These functions include:

- Cruise Control
- Engine Brake Operation (Optional)
- Engine Speed (RPM) Control
- Exhaust Aftertreatment System
- PTO Operation

Cruise control and engine speed control functions are explained in this manual in “CRUISE AND ENGINE SPEED CONTROL”, page 33.

In addition to these operator-selectable switches, additional switches provide information to the Vehicle Electronic Control Unit (VECU) through normal driving activities such as applying the service brakes, parking brakes or disengaging the clutch. The location of these switches is as follows:

- Clutch Pedal Position (CPP) switch
- Parking brake switch, located in line within the parking brake circuit
- Service brake switch, located in line within the brake system

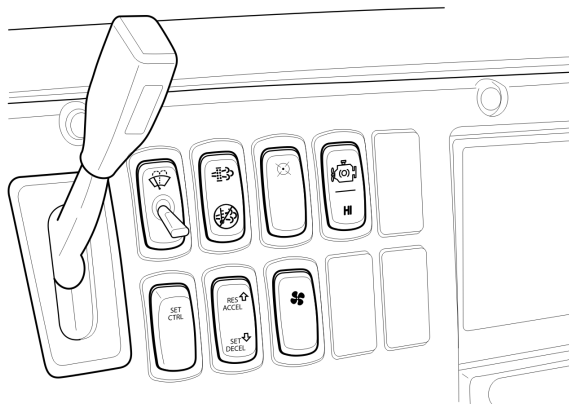

W2076077

Cab and Dashboard Switches (Example)

16 V-MAC Co-Pilot Operator's Manual

Electronic Malfunction Indicator

The electronic malfunction indicator, amber in color, illuminates to alert the driver of an electrical problem with the Vehicle Management and Control (V-MAC) IV system. The V-MAC IV system does a self-test when the ignition key is turned to the ON position. The electronic malfunction indicator stays on while this test is being performed (approximately six seconds). After the self-test is completed, the indicator will turn off and remain off unless a problem is detected by (V-MAC) IV. If the indicator turns on while the vehicle is being driven, (V-MAC) IV has detected a problem. In most circumstances, the vehicle will operate even though the indicator is on; however, engine performance may be affected.

For an explanation of fault code activation and interpretation, and a complete listing of these codes, please refer to “Diagnostic Trouble Codes (DTCs)”, page 54 of this manual.

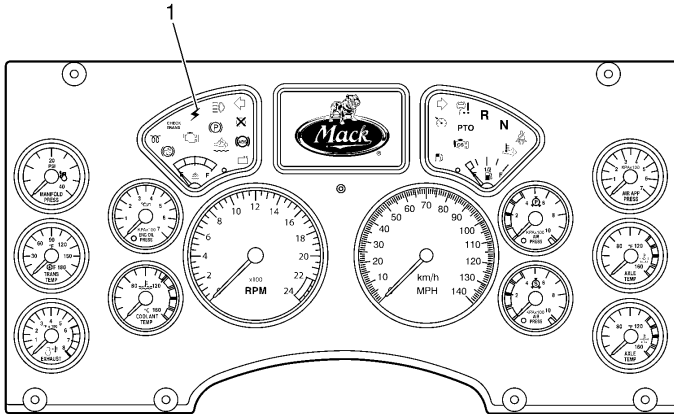

W3061049

Electronic Malfunction Indicator

High Exhaust System Temperature (HEST) Indicator

The High Exhaust System Temperature (HEST) indicator, amber in color, illuminates to alert the driver when engine Exhaust Gas Temperatures (EGT) are high. The HEST indicator will also illuminate during an aftertreatment Diesel Particulate Filter (DPF) parked regeneration event and will turn off after the regeneration is completed and the EGT has returned to normal. For additional information about the HEST indicator, please refer to “Aftertreatment DPF Smart Switch (If Equipped)”, page 21.

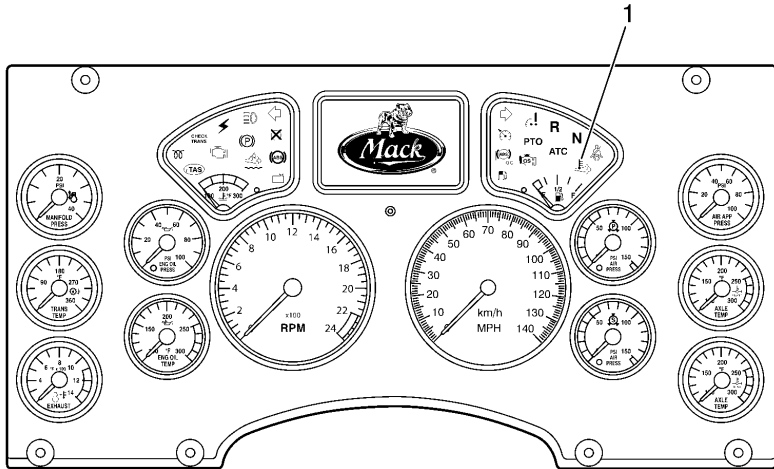

W3036496

High Exhaust System Temperature (HEST) Indicator

Shutdown Warning Indicator

The Shutdown Warning indicator, red in color, illuminates if the Engine Coolant Level (ECL) is below the minimum level allowed, the Engine Oil Pressure (EOL) is below the minimum allowed, the Engine Coolant Temperature (ECT) or aftertreatment Diesel Particulate Filter (DPF) soot level trigger are above the maximum allowed. Some vehicles also have optional shutdown functions available when the transmission temperature or engine Exhaust Gas Temperatures (EGT) are above maximum allowable limits.

During a shutdown event, V-MAC IV also provides an audible alarm. The alarm will also sound and the red shutdown indicator will turn on when V-MAC IV detects a problem or excessive periods of idling. Shutting the engine down is warranted.

The shutdown warning indicator is usually located on the left-hand side on the dash cluster.

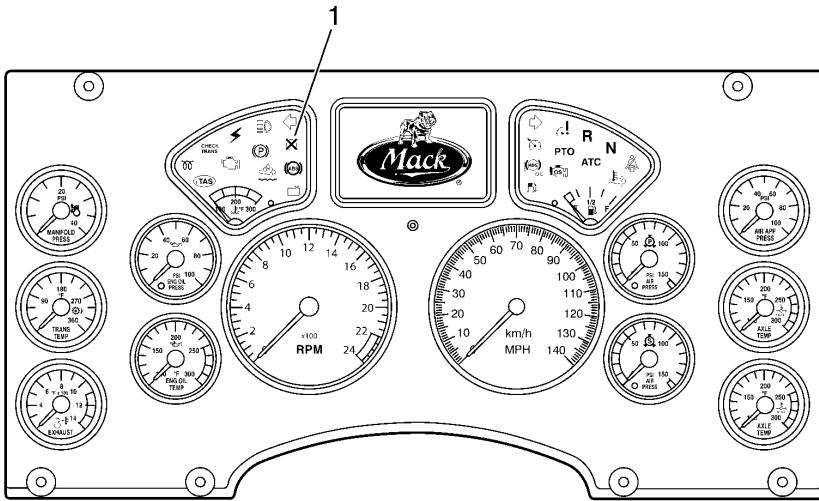

W3036501

Engine Shutdown Warning Indicator (Red)

V-MAC IV can be programmed to actually shut down the engine if conditions warrant (low coolant, low EOL, high Engine Oil Temperature (EOT), high ECT, high engine EGT or high automatic transmission oil temperature if so equipped). Shutdown is mandatory for Crankcase Pressure (CCP). With this option enabled, the engine will automatically shut down within approximately 30 seconds after the red SHUTDOWN indicator turns on and the alarm activates (provided the vehicle is not moving above the road speed threshold).

Engine Derate (For Mack Engines Only)

For some conditions (see table below), an engine derate can occur first and if a condition worsens, then an engine shutdown can occur.

Note: For Cummins engine information refer to the Cummins engine operator manual or a Cummins dealer

CONDITION	ENGINE DERATE	ENGINE SHUTDOWN	INDICATOR LIGHTS
Intake Manifold Air Temperature	Derate starts at 120°C (248°F). Full derate (100%) occurs when temperature is at 140°C (284°F).	No engine shutdown.	No warning indicators.
Engine Turbocharger Compressor Outlet Temperature	Derate starts at 245°C (473°F). Torque is derated down to 100% at 250°C (482°F).	No engine shutdown.	No warning indicators.
Engine Exhaust Gas Recirculation (EGR) Temperature	If temperature exceeds 220°C (428°F) for more than 20 seconds with a 30 second period, derate starts.	No engine shutdown.	No warning indicators.
	If temperature reaches 240°C (464°F), a 100% derate occurs.		
Crankcase Pressure (CCP)	If a change in pressure (difference between the CCP and barometric pressure (BARO) rises about 5 kPa (0.725 psi) with an offset & 0.5 kPa/s (0.07 psi/s) and stays over 5 kPa (0.725 psi) for more than 80% of the time during 1 second, the engine will fully derate (100%), be forced to idle, and shut down.	Engine shutdown.	Red engine shutdown indicator.
High Engine Coolant Temperature (ECT)	Derate starts at 106.75°C (224.15°F) and ramps down to 12% derate. Torque is kept constant until the temperature reaches 107.25°C (225.05°F).		Amber malfunction indicator lights at 107.2°C (224.96°F).
	Derate starts again at 107.4°C (225.32°F) and ramps down to 32% derate.		Red engine shutdown indicator lights at 108°C (226.4°F).
	Torque is derated down to 100% at 108.4°C (227.12°F).		Engine shutdown if temperature rises to 109°C (228.2°F).

20 V-MAC Co-Pilot Operator's Manual

CONDITION	ENGINE DERATE	ENGINE SHUTDOWN	INDICATOR LIGHTS
Engine Oil Temperature (EOT)	Derate starts with 10% derate at 129°C (264.2°F) or more for 75% of a 4 second period. At 132°C (269.6°F) a 100% derate occurs.	Engine shutdown if temperature rises to 135°C (275°F).	Amber malfunction indicator lights when temperature is at 129°C (264.2°F).
			Red engine shutdown indicator lights when temperature is at 131°C (267.8°F).
Aftertreatment Diesel Particulate Filter (DPF) Soot	For Catalyzed ATS: Derate starts when soot trigger ratio is 1.4 and continues down to 20% derate.		Amber malfunction indicator lights up when soot trigger ratio is 1.4.
	For Catalyzed ATS: Torque is ramped down to 80% derate when soot trigger ratio is 1.7.		Red engine shutdown indicator lights up when soot trigger ratio is 1.7.
	For Non-Catalyzed ATS: Derate starts when soot trigger ratio is 1.15.		Amber malfunction indicator lights up when soot trigger ratio is 1.15.
	For Non-Catalyzed ATS: Torque is ramped down to 40% derate when soot trigger ratio is 1.20. Full derate occurs when soot trigger ratio is 1.22.		Red engine shutdown indicator lights up when soot trigger ratio is at 1.22.
Engine Turbocharger Wheel	For MP8 engines, derate starts at 129,500 RPM. Full derate (100%) occurs at 130,500 RPM.	No engine shutdown.	No warning indicators.
* - ATS (Aftertreatment System). Please refer to page 26 for information on the Exhaust Aftertreatment System.			

Aftertreatment DPF Smart Switch (If Equipped)

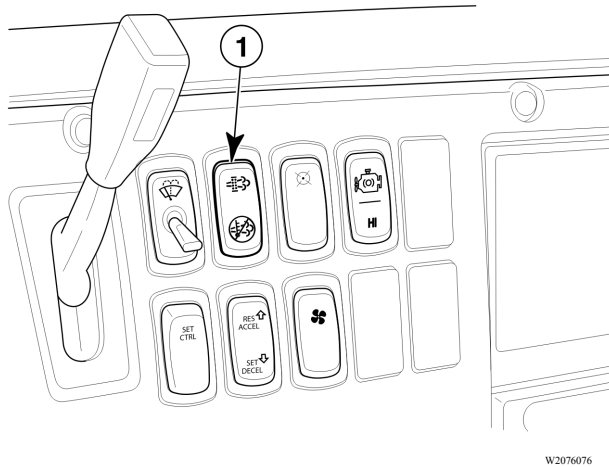

Aftertreatment DPF Smart Switch

The aftertreatment Diesel Particulate Filter (DPF) smart switch is a three-position rocker switch where the UP position is momentary, the MIDDLE position is neutral (standby mode) and the DOWN position is locked. The switch allows the operator to interface with the vehicle's exhaust aftertreatment system.

The switch has several functions as outlined below.

- Indicates that a an aftertreatment DPF regeneration is needed or has started when the icons on the switch are illuminated.
- Indicates that a regeneration has been stopped when the DOWN position of the switch is pressed, locked, and illuminated.
- Stops a regeneration event when the DOWN position of the switch is pressed, locked, and illuminated.
- Starts an aftertreatment DPF manual regeneration event when the switch is momentarily pressed to the UP position.
- Goes into standby mode and waits for regeneration when the switch is in the MIDDLE position.

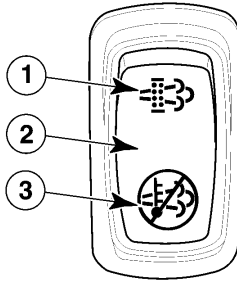

C0035425

DPF Smart Switch

For additional information on the Aftertreatment DPF Smart Switch and Regeneration, please refer to “EXHAUST AFTERTREATMENT SYSTEM”, page 23.

EXHAUST AFTERTREATMENT SYSTEM

Aftertreatment DPF Regeneration, Cummins ISX

A DPF in the exhaust is used to meet emission requirements to help reduce soot and particulate emissions into the atmosphere. The particulates are typically removed by collecting in a DPF, with continuous or periodic regeneration of the filter. The electrical and exhaust aftertreatment system set up of the vehicle will determine when regeneration is required. When regeneration is needed, the icons on the DPF Smart switch will light up momentarily to notify the driver and then shut off during regeneration. The High Exhaust System Temperature (HEST) indicator will light up on the instrument cluster to warn of high exhaust temperatures (when vehicle speed is less than 8 km/h [**5 mi/h**], depending on engine setting, or when parked). Depending on the vehicle's aftertreatment setup, regeneration can be performed while moving or when the vehicle is parked. Below is general information about the exhaust aftertreatment systems.

For catalyzed exhaust aftertreatment systems

- Engine Coolant Temperature (ECT) is 35°C (**95°F**) or higher.
- Icons on the DPF Smart switch will momentarily light up and then shut off during the regeneration.
- HEST indicator on instrument cluster will light up to warn of high exhaust temperatures when vehicle speed is 8 km/h (**5 mi/h**) or less, depending on engine setting.
- Engine speed will increase to around 1,100 RPM during regeneration (for parked regeneration).

Aftertreatment DPF Passive Regeneration, Cummins ISX

Aftertreatment Diesel Particulate Filter (DPF) passive regeneration is automatic (no operator input needed to start regeneration). The operator is notified that a regeneration is needed when the icons on the DPF Smart switch illuminate.

Please refer to the instructions below on how to use the DPF Smart switch for passive regenerations.

Passive (Automatic) Regeneration

- 1 When the icons on the DPF Smart switch light up, maintain vehicle speed.
- 2 During regeneration, the icons on the switch will shut off.
- 3 If the regeneration process needs to be stopped and performed at a later time, please refer to “Aftertreatment DPF Inhibit/Stop Regeneration”, page 26 for information.

Aftertreatment DPF Parked Regeneration, Cummins ISX

Aftertreatment Diesel Particulate Filter (DPF) parked regeneration allows the operator to start and/or stop the regeneration manually when the vehicle is parked. The operator is notified that a regeneration is needed when the icons on the DPF Smart switch illuminate. The operator should perform the regeneration as soon as possible.

Please refer to the instructions below on how to use the DPF Smart switch for parked regenerations.

- 1 Move the vehicle to a safe location, apply the park brake and allow the engine to idle.

Note: When a regeneration is in process, the engine exhaust gas temperature (EGT) will be elevated. DO NOT park the vehicle with the exhaust outlet under low hanging overhead flammable objects such as trees, awnings, etc., that could be damaged by elevated exhaust temperatures. DO NOT attempt to regenerate inside a garage or enclosed area if the tail pipe is attached to an exhaust ventilation system as the hose material may not be rated for the high temperature.

- 2 Press and hold the top part of the DPF Smart switch momentarily to initiate the regeneration.
- 3 During regeneration, the icons on the switch will shut off. The High Exhaust System Temperature (HEST) indicator on the instrument cluster will light up to notify of high exhaust temperatures.
- 4 For catalyzed exhaust aftertreatment systems, the engine speed (RPM) will ramp up to around 1,100 RPM.
- 5 Regeneration can take between 45 and 90 minutes to complete.
- 6 After regeneration has completed and the exhaust temperature has returned to normal, the HEST indicator will shut off.
- 7 If the regeneration process needs to be stopped and performed at a later time, please refer to “Aftertreatment DPF Inhibit/Stop Regeneration”, page 26 for information.



CAUTION

Failure to perform an aftertreatment DPF regeneration in a timely manner after notification may result in engine derate, clogged or damaged DPF, and engine shutdown.

Aftertreatment DPF Inhibit/Stop Regeneration

Aftertreatment Diesel Particulate Filter (DPF) regeneration, whether the moving or parked variety, can be stopped if the vehicle is equipped with a DPF Smart switch (refer to “Aftertreatment DPF Smart Switch (If Equipped)”, page 21 for more information). A regeneration should be stopped only when necessary. To stop a regeneration that is in progress, press the DPF Smart switch to the DOWN position. The switch will lock into the DOWN position, and the icon on the bottom of the switch will be illuminated to indicate regeneration has been stopped.

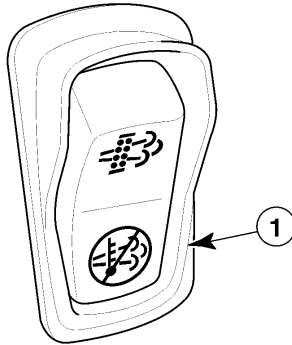

C0035426

Inhibit/Stop Regeneration



CAUTION



When the DPF Smart Switch is pressed to the DOWN position, the switch will remain locked in this position and prevent aftertreatment DPF regeneration from occurring. Therefore, it is important to press the switch back to the middle position and to return it to standby mode when safe to do so. Failure to set the switch back to the MIDDLE position may result in engine derate, a clogged Aftertreatment Diesel Particulate Filter (DPF), damage to the filter and engine shutdown.



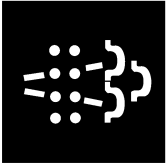
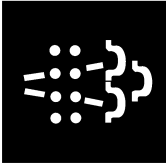
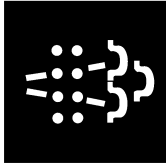
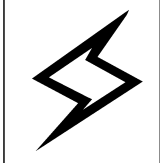
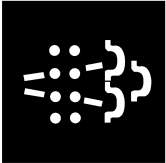

CAUTION

Failure to perform a aftertreatment DPF regeneration in a timely manner may result in engine derate, a clogged or damaged DPF, damage to the filter and engine shutdown.

If the operator stops or inhibits regeneration repeatedly, the DPF will begin to clog with soot and engine exhaust gas pressure will increase. Eventually the engine will derate and ultimately shut down. Below is a quick look at the type of regenerations, conditions of the exhaust aftertreatment system and the action to be taken.

AFTERTREATMENT DPF PASSIVE REGENERATION (AUTOMATIC)						
Soot Load Level	Level 1	Level 2	Level 3		Level 4	
Indicators	(Solid)	(Flashing)	(Flashing)	(Amber)	(Flashing)	(Red)
						
Aftertreatment System Condition	Regeneration needed. DPF is becoming full.	Regeneration is required. DPF is full.	Aftertreatment System Service Required. Engine Derate Active. Engine Performance is limited. Soot Level High. DPF is overfull.		Aftertreatment System Service Required. Engine Derate Active. Soot Level is Critically High. DPF may be over its maximum capacity. Engine may shut down.	
Note: The Regeneration Symbol is the DPF smart switch not the cluster warning light.						

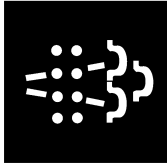
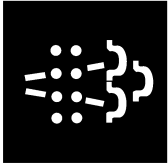
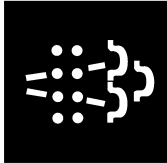
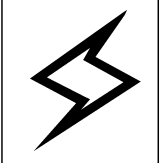
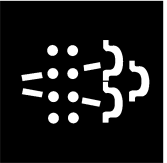
AFTERTREATMENT SYSTEM PASSIVE REGENERATION (AUTOMATIC)				
Soot Load Level	Level 1	Level 2	Level 3	Level 4
Action to Take	<p>Continue to drive or park the vehicle in a safe location away from overhanging objects (park brake applied) and allow the engine to run and the regeneration to complete.</p> <p>Note: Failure to perform the regeneration will take the Aftertreatment System to Level 2.</p>	<p>Continue to drive or park the vehicle in a safe location away from overhanging objects (park brake applied) and allow the engine to run and the regeneration to complete.</p> <p>Note: Failure to perform the regeneration will take the Aftertreatment System to Level 3.</p>	<p>Perform a parked manual regeneration IMMEDIATELY to avoid further engine derate and damage to the DPF.</p> <p>Note: Failure to perform the regeneration will take the Aftertreatment System to Level 4.</p>	<p>A serious engine problem has occurred. <i>Seek service immediately.</i></p> <p>Note: Parked regeneration is no longer possible for the operator.</p>
Regeneration Condition	<p>If passive regeneration is allowed to run, the following normal processes may be observed.</p> <ul style="list-style-type: none"> • DPF Smart switch indicator will shut off during the regeneration. 			

AFTERTREATMENT SYSTEM PARKED REGENERATION (MANUAL)						
Soot Load Level	Level 1	Level 2	Level 3		Level 4	
Indicators	(Solid) 	(Flashing) 	(Flashing) 	(Amber) 	(Flashing) 	(Red) 
Aftertreatment System Condition	Regeneration needed. Aftertreatment Diesel Particulate Filter (DPF) is becoming full.	Regeneration is required. DPF is full.	Aftertreatment System Service Required. Engine Derate Active. Engine Performance is limited. Soot Level High. DPF is overfull.		Aftertreatment System Service Required. Engine Derate Active. Soot Level is Critically High. DPF may be over its maximum capacity. Engine may shut down.	

AFTERTREATMENT SYSTEM PARKED REGENERATION (MANUAL)

Soot Load Level	Level 1	Level 2	Level 3	Level 4
Action to Take	<p>Park the vehicle in a safe location away from overhanging objects (park brake applied). Press and hold the top of the DPF Smart switch momentarily. Allow the DPF regeneration process to complete.</p> <p>Note: Failure to perform the regeneration will take the Aftertreatment System to Level 2.</p>	<p>Park the vehicle in a safe location away from overhanging objects (park brake applied). Press and hold the top of the DPF Smart switch momentarily. Allow the DPF regeneration process to complete.</p> <p>Note: Failure to perform the regeneration will take the Aftertreatment System to Level 3.</p>	<p>Perform a parked aftertreatment Diesel Particulate Filter (DPF) regeneration IMMEDIATELY to avoid further engine derate and damage to the DPF.</p> <p>Note: Failure to perform the DPF regeneration will take the Aftertreatment System to Level 4.</p>	<p>A serious engine problem has occurred. <i>Seek service immediately.</i></p> <p>Note: Parked DPF regeneration is no longer possible for the operator.</p>

AFTERTREATMENT SYSTEM PARKED REGENERATION (MANUAL)

Aftertreatment Diesel Particulate Filter (DPF) regeneration Condition

If parked manual aftertreatment Diesel Particulate Filter (DPF) regeneration is allowed to run, the following normal processes may be observed.

- Engine speed (RPM) will increase to around 1,100 RPM and stay there until the DPF regeneration process is complete.**
- HEST indicator will turn on to warn of high engine exhaust gas temperature (EGT) and will stay on during aftertreatment Diesel Particulate Filter DPF regeneration.
- DPF Smart switch indicator will shut off during the aftertreatment Diesel Particulate Filter (DPF) regeneration.
- Aftertreatment Diesel Particulate Filter (DPF) regeneration can take between 45 and 90 minutes to complete.
- HEST indicator will turn off after aftertreatment Diesel Particulate Filter DPF regeneration is complete and exhaust temperatures have returned to normal.

** Engine speed will increase condition for catalyzed exhaust aftertreatment systems

Aftertreatment DPF Regeneration and PTO Operation (Cummins ISX)

The PTO must be disengaged for aftertreatment Diesel Particulate Filter (DPF) regeneration to occur.

STARTING THE VEHICLE

The following procedure is used to start and warm up a Vehicle Management and Control (V-MAC) IV engine during any Ambient Air Temperature (AAT) condition:

Note: Release the clutch and make sure the transmission is in neutral before starting the engine.

1 Turn the ignition key to the ON position clockwise. When the “Wait to Start” indicator on the instrument cluster shuts off, fully engage the starter. Release the ignition key as soon as the engine starts.

Note: If the engine does not start immediately, limit cranking periods to 30 seconds to avoid overheating and damaging the starter.

2 After the engine has started, warm the engine until Engine Coolant Temperature (ECT) reaches 60°C (140°F). After reaching 60°C (140°F), the engine can be operated normally.

Note: If the engine does not start immediately, limit cranking periods to 30 seconds to avoid overheating and damaging the starter.

Note: Warm-up time can be reduced by increasing engine idle speed between 1000–1200 RPM by either applying the throttle pedal or by using the variable speed governor (electronic hand throttle) feature. When operating unloaded, the engine may also be warmed by moving the vehicle (after one minute of idling time) with a “light” throttle application only.

Note: Starter Protection will limit cranking time to avoid overheating the starter. If the starter has overheated, it will be forced off until it has cooled.

CRUISE AND ENGINE SPEED CONTROL

With Vehicle Management and Control (V-MAC) IV, the operator has the ability to precisely control engine speed (RPM) and set cruise control speeds, as well as setting the engine low idle speed. These functions are performed by using the speed control switches located on the dashboard. Instructions for setting cruise control and engine speed control are given on the following pages. For an explanation of engine low idle adjustment, refer to “Low Idle Adjustment”, page 44.

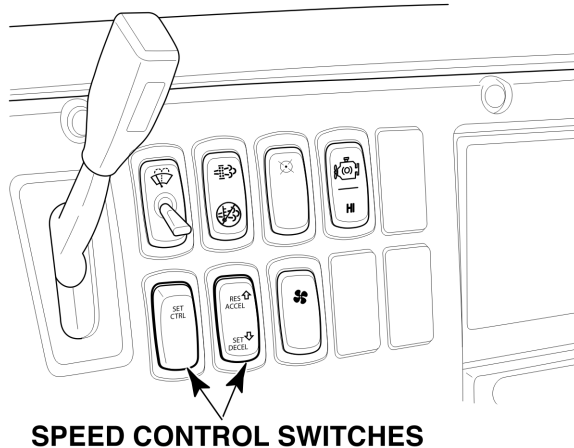

W2076074

Speed Control Switches

Cruise Control

Engaging Cruise Control

The speed control functions of the V-MAC IV system are very similar to the cruise controls found on most automobiles. The system will maintain a set speed and will allow acceleration and deceleration through the system switches. Cruise control can be enabled or disabled using customer data programming, included in the VCADS software.

To set the cruise control for normal highway operation, the following conditions must be met.

- 1 Vehicle road speed must be above the customer-programmable speed value (15 to 35 mi/h).
- 2 The service and parking brake must not be applied.
- 3 The clutch must be engaged (pedal released).

Effective August 11, 2008, a change was made to the Vehicle Electronic Control Unit (VECU) software which affects the cruise control. As an added test to ensure that the service brake switch is functional, the vehicle operator must press and release the brake pedal after the engine has been started. This test verifies that the service brake switch is functioning. The test also confirms that the cruise control will deactivate when the service brakes are applied. If the brake pedal is not depressed after starting the engine, the cruise control will not function. This change affects both newly manufactured vehicles, and vehicles on which the VECU has been reprogrammed.

Note: For vehicles manufactured prior to August 11, 2008 the VECU has been reprogrammed.

Once the above conditions are satisfied, activate the cruise control as follows.

- 1 Move the Speed Control ON/OFF switch to the ON position.
- 2 At the desired road speed, press and release the SET switch. The vehicle will maintain at the set speed.

Note: Pressing the top of the Speed Control ON/OFF switch activates, or turns the switch ON. Pressing the bottom of the switch deactivates, or turns the switch OFF.

Note: To shift, simply disengage the clutch, change gears, then re-engage the clutch. Cruise control will resume automatically if programmed to Auto Resume. When double clutching, DO NOT bring the clutch pedal to the fully engaged position.



CAUTION

Transmission gear changes must not be made without the use of the clutch while in the cruise control mode. Failure to use the clutch will cause the engine speed (RPM) to increase to the high idle limit, which may cause severe powertrain damage.

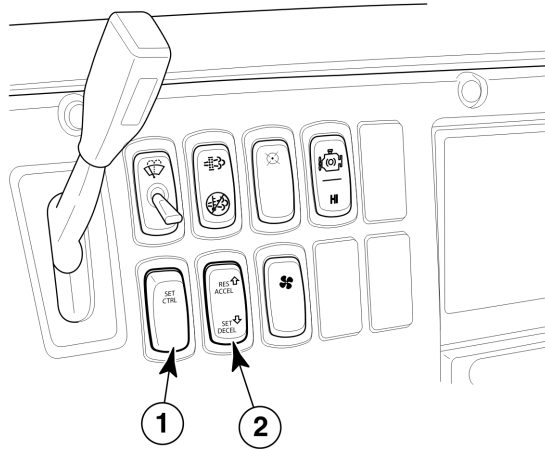

W2076078

Speed Control On/Off and Set/Decel Switches

Accelerating to a Higher Speed

To accelerate to a higher speed, three methods are available:

1. **Press the Accelerator Pedal (AP).** This method will accelerate the vehicle for as long as the pedal is pressed. (Release the pedal to return to the speed set previously.)
2. **Press the ACCEL switch.** This method will accelerate the vehicle for as long as the switch is pressed. The new vehicle speed is set when the switch is released. (Press the DECEL switch to decelerate the vehicle. The vehicle will decelerate for as long as the DECEL switch is pressed. The new vehicle speed is set when the switch is released.)

Note: The MAX speed set by the accelerator pedal may be different from that set by the ACCEL switch.

3. The speed can also be “bumped” (known as bump speed) up or down. Tap the **ACCEL** side to bump up 1 mi/h or tap the **DECEL** side to bump down 1 mi/h.

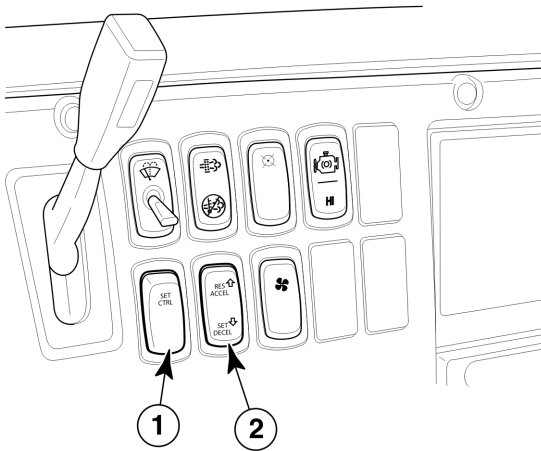

W2076079

Speed Control On/Off and Resume/Accel Switches

Disengaging Cruise Control

To disengage cruise control, use any one of the following methods:

- 1 **Apply the service brake.** This method will disengage the cruise control while maintaining the set speed in the system memory. To resume the previously set speed, press and release the RESUME switch.
- 2 **Disengage the clutch.** This method will disengage the cruise control while the clutch is disengaged and will resume the speed control when the clutch is re-engaged. This programmable option provides for automatic resume after shifting.
- 3 **Move the Speed Control ON/OFF switch to the OFF position.** This method not only disengages the cruise control but also clears the set speed from the system memory. To reactivate the cruise control, it is necessary to move the switch to the ON position and select a new set speed.

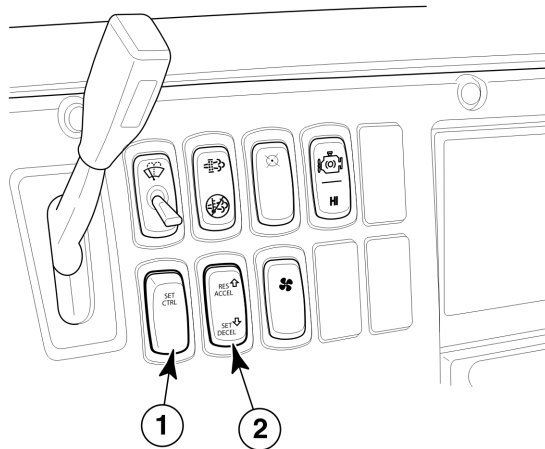

W2076079

Speed Control ON/OFF Switch

Engine Speed Control

Engine Speed Control Operation

The Vehicle Management and Control (V-MAC) IV system also allows the operator to set and maintain increased engine speeds. The system provides two different speed control functions: Electronic Hand Throttle control and PTO control. Electronic Hand Throttle (EHT) controls engine speed when PTO is not engaged.

Both systems allow two modes of control:

- 1 Single Speed Control (SSC) increases the engine RPM to a speed preprogrammed into the system memory. This mode is intended for operation of the PTO at maximum efficiency.
- 2 Variable Speed Control (VSC) allows the driver to set any engine RPM within the preprogrammed low and high limits set in the system memory. This mode is primarily intended for general PTO applications and engine warm-up.

Note: Brake conditions are configurable, but the standard setting is park brake on and service brake off to engage.

Single Speed Control (SSC)

To use single speed control functions, the following conditions must be met:

- 1 For Power Takeoff (PTO) operation, the PTO must be engaged. For Electronic Hand Throttle (EHT) operation, the service brake must be OFF.
- 2 The clutch must be engaged (not pressed).

To activate SSC, move the Speed Control switch to the ON position, then press and release the SET switch. The engine speed (RPM) will jump to the preprogrammed speed. SSC can also be programmed for Auto Set mode. When enabled, simply move the Speed Control switch to the ON position and engage the PTO or activate a customer-defined switch (usually setting the park brake). Engine speed will go to the preprogrammed speed.

Variable Speed Control (VSC)

To use the variable speed control functions, the following conditions must be met:

- 1 The clutch must be engaged.
- 2 The park brake must be set.

To activate VSC, move the Speed Control switch to the ON position. Increase engine RPM using the accelerator pedal (AP). At the desired engine speed (RPM), press and release the SET switch. This speed setting will be maintained.

To increase the RPM, press and hold the ACCEL switch until the desired speed is attained. Or, press the accelerator pedal until the desired speed is attained and then press and release the SET switch.

To decrease engine RPM, press and hold the DECEL switch until the desired speed is reached and then release the switch.

RPM can also be “bumped” up or down. Tap the ACCEL side to increase RPM, or the DECEL side to decrease RPM by the customer-programmed amount (default setting is 50 RPM).

VSC can also be programmed for Auto Set mode. When enabled, simply move the Speed Control switch to the ON position and activate a customer-defined switch (usually setting the parking brake). The RPM will go to the preprogrammed minimum speed.

The “ramp rate” for EHT, and for each PTO in PTO control, can be programmed to increase and decrease in speed to a customer-specified speed by using the ACCEL/DECEL switch.

Disengaging SSC or VSC Functions

To disengage the speed control settings, use any one of the following methods:

- Move the Speed Control switch to the OFF position.
- Disengage the clutch.
- Apply the service brakes.
- Release the parking brake.

Note: When the PTO is engaged on vehicles equipped with SSC, the SSC will take precedence over the VSC.

Note: To reactivate the VSC to the previously set speed, press and release the RESUME switch. If the Speed Control ON/OFF switch is used to disengage the VSC, a new speed must be set. The RESUME switch will work only if the VSC was disengaged by using the clutch or service brake.

Maximum Engine Speed Limit

This mode allows the maximum engine speed (RPM) to be limited, based on preprogrammed speeds, when PTO or Electronic Hand Throttle (EHT) controls are engaged. The engine will not operate beyond these speeds when the control (PTO or EHT) is engaged. The operator has no control over this operation, and cannot change or override these preset limits.

Vehicle Limiting Speed

These programmable modes allow the maximum vehicle speed to be restricted to a preprogrammed speed limit. The driver has no control over this operation, and cannot change or override these preset limits. Another feature of the vehicle limiting speed function is “Lower Gear Road Speed Limit Feature Activation.” This option, when selected, will limit vehicle speed in gears below top gear to a value less than the top gear road speed limit. The purpose of this option is to encourage the operator to operate the vehicle in top gear, where the optimum fuel economy can be achieved.

There are two programmable “top gear” Vehicle Limiting Speeds — one for cruise and the other for use with the Accelerator Pedal (AP).

Vehicle Limiting Speed can also be limited to separate values for each Power Takeoff (PTO).

Note: The vehicle limiting speed in cruise control mode can be lower or equal to the vehicle limiting speed in accelerator pedal mode.

High Acceleration Control

Under light load and high vehicle acceleration conditions, the maximum engine acceleration may be limited to prevent wheel slippage. Engine speed (RPM) will be limited to a value just above the rated speed of the engine.

This condition should not prevent the driver from shifting to the next gear. If the engine is limited, it is an indication that wheel slippage conditions may be present and that the driver should drive less aggressively under these lightly loaded conditions.

Engine Brake

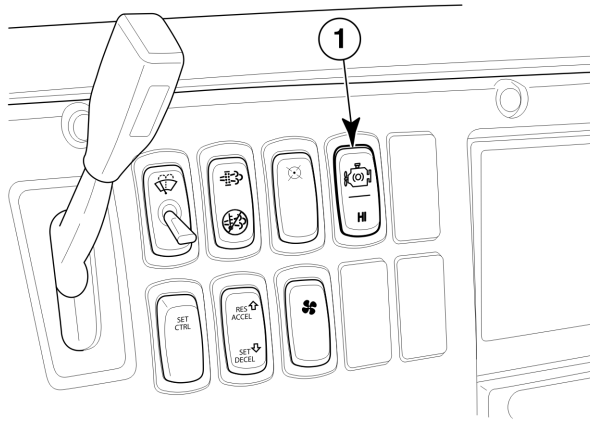

W2076080

Engine Brake Switch

To activate the engine brake, move the engine brake switch to the 1st or 2nd ON position. The 1st position activates the engine brake unit for 50% power. The 2nd position provides 100% power. The engine brake switch can be in either 1st or 2nd ON position during speed control operations, but the brake will function only if no fuel is requested by Vehicle Management and Control (V-MAC) IV and engine speed (RPM) is greater than 900 RPM. To disengage the brake, move the switch to the OFF position, or press the Accelerator Pedal (AP).

Note: The engine brake will not engage until the Engine Oil Temperature (EOT) has reached 52°C (125°F).

ACCESSORY RELAY CONTROL

After an idle shutdown, V-MAC IV will deactivate all the ignition power bus relays, but the Engine Control Module (ECM) power relay will remain active in order to reduce current draw from the battery after the engine has stopped.

PROGRAMMABLE FEATURES

The Vehicle Management and Control (V-MAC) IV system allows operating parameters of certain system functions to be programmed. These functions include the following:

- Audible Alarm
- Auto Start (*r*TAS) [Optional; Future Support]
- Auxiliary Engine Stop (Optional)
- Cruise Control Maximum Speed
- Cruise Control Minimum Speed
- Driveline Parameters
- Driver Display Parameters
- Electronic Hand Throttle (EHT) Control Parameters
- Engine Brake Delay in Cruise
- Engine Governor Parameters
- Engine Protection Parameters
- Engine Sleep Mode
- Engine Speed Control Parameters
- High Idle Speed
- Fan Control
- Fuel Economy Incentive Parameters
- Idle Cooldown
- Idle Shutdown
- Low Idle Settings
- Lower Gear Road Speed Limit
- ON/OFF Fan Control
- Overspeed Logging
- Power Takeoff (PTO) Control Parameters
- Tamper Detection
- Vehicle Limiting Speed Settings
- Vehicle Security Level
- Driver Personal Overspeed Alarm

To change operating parameters, a computer is used and requires that it is running the VCADS software. In addition, a datalink adapter is also required as an interface between the scan tool and the Vehicle Management and Control (V-MAC) IV system.

Note: If the rear tire sizes are changed, or the rear axle ratios are changed, you must contact your local MACK Truck dealer. Failure to notify your local MACK Truck dealer of these changes may cause inaccurate speedometer readings.

Cruise 'N Brake Engagement Delay

With the cruise 'n brake engagement delay feature, engagement of the engine speed (RPM) is delayed in cruise control to reduce engine brake cycling. The brake will engage 3.2 km/h (2 mi/h) above the cruise set speed. The engine brake operates normally when cruise is not being used.

Engine High Idle Speed if Stopped

Maximum engine speed (RPM) can be adjusted by using VCADS software. The possible high idle settings range from 600 to 2,600 RPM. However, the engine speed will not go below low idle and will not exceed the OEM high idle (usually 2,100 or 2,150 RPM).

Engine High Idle Speed in Upper Gears

Sets the maximum engine RPM if the gear ratio is less than 1.5. This feature is intended to improve fuel economy by limiting efficient high speed engine operation.

Low Idle Adjustment

Note: On chassis equipped with an automatic transmission, the speed control switches cannot be used to adjust engine low idle speed. Attempting to set low idle in this manner will cause the Vehicle Electronic Control Unit (VECU) to enter the reprogramming mode resulting in the idle speed dropping to 550 RPM (650 RPM for non-catalyzed exhaust aftertreatment system), but it will not be possible to set a new idle speed. If the reprogramming mode is entered, simply turn the speed control switch OFF, and idle speed will return to the originally set speed. Resetting low idle speed on a chassis equipped with an automatic transmission requires a scan tool running the VCADS software. Consult the *VCADS User's Guide* for additional information.

This section explains the procedure to reset the low idle speed using the Speed Control switches.

The Vehicle Management and Control (V-MAC) IV system allows the low idle to be set within the range of 550 to 700 RPM (650–700 RPM for non-catalyzed exhaust aftertreatment system). This provides flexibility to set the low idle to the smoothest engine speed for the vehicle.

There are two steps required to reset the low idle speed. The first step places the V-MAC IV system into the low-idle adjust mode. In this mode, V-MAC IV is ready to accept the new idle speed.

The second step is to actually tell Vehicle Management and Control (V-MAC) IV what the new idle speed will be.

The first phase in the process is meeting the requirements listed below.

- 1 The V-MAC IV system must have the Low-Idle Adjust option enabled in the customer data space. This function can be disabled by the customer.
- 2 Be sure there are no active faults in the system.
- 3 The vehicle must be stationary.
- 4 The parking brake must be applied.
- 5 The Accelerator Pedal (AP) must be at the idle position (not pressed).
- 6 The Speed Control ON/OFF switch must be turned ON and OFF 3 times within two seconds. At this point, the idle speed will drop to 550 RPM, and V-MAC IV will now be ready to accept a new speed. Be sure to leave the ignition key in the ON position.

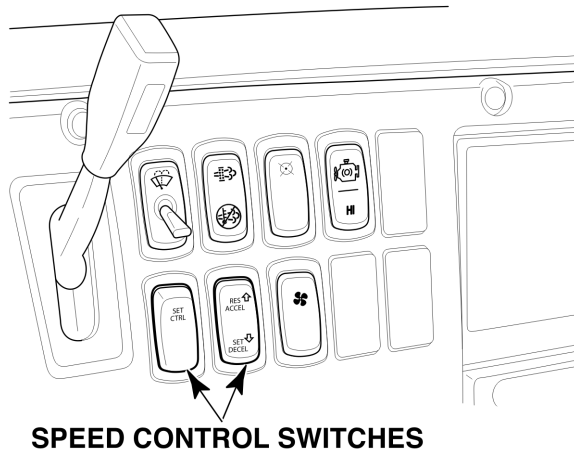

W2076074

Note: If the idle speed does not drop to 550 RPM after meeting the requirements listed, there may be other possible problems which will not allow the idle to be reset. Refer to the Vehicle Management and Control (V-MAC) IV Service Manual for troubleshooting procedures.

To complete the resetting of the idle speed, continue as follows:

- 1 Depress and hold the accelerator pedal until the desired engine speed is reached.
- 2 Use the speed control switches to adjust idle speed.
- 3 Depress and release the clutch pedal to store idle speed.

This speed is now locked into V-MAC IV as the low idle speed.

Note: To detect a drop when resetting the idle, it is recommended that the low idle speed be set to a speed greater than 500 RPM.

Smart Idle Elevated Idle RPM Time

This feature will discontinue a ramp up for a period of time when the engine speed (RPM) reaches its target. The range of time can be set between 0 and 1092 minutes, with a default setting of 30 minutes.

Idle Shutdown

This feature will shut off the engine after it has been idle for a specified period. The time period is customer programmable using the VCADS software. An alarm will warn 30 seconds (a programmable time frame) before the engine will shut down. The idle shutdown override switch can be used during this 30 second period to override idle shutdown or the service brake or Accelerator Pedal (AP) can be applied. Once the engine shuts down, the engine can be re-started by turning the ignition key to the Start position.

Note: Idle shutdown will not occur during an aftertreatment Diesel Particulate Filter (DPF) regeneration. If the idle shutdown timer requests a shutdown during aftertreatment Diesel Particulate Filter (DPF) regeneration, the engine will not shut down until after regeneration has been completed.

Speed Sensor Tamper Detection

Speed sensor tamper detection is used to monitor and stop unauthorized tampering of the vehicle speed limiting function in order to gain additional top speed. If tampering is detected, the vehicle operator will be notified by a diagnostic trouble code (DTC). Engine power will be limited to a programmed percentage and will continue until the issue has been corrected.

Note: Torque limiting will be inhibited if a driveshaft Power Takeoff (PTO) is enabled and active.

ELECTRICAL ACCESSORY CONNECTION POINTS

This MACK chassis is electrically ready for convenient installation of electrical accessories. Use the designated battery post (+12 V), ground post, CB jack, buffered RPM outputs, buffered mi/h outputs, and the SAE/ATA J-1708 post located on the electrical equipment panel for the installation of any electrical accessories. Each connection point is described below.

Battery Post (BATT)

This is a +12 volt, unswitched battery power connection. It can be used to power external devices that require power at all times, even when the ignition key is turned OFF. This source is protected by a 15-amp circuit breaker.

Ignition Post (IGN)

This is a +12 volt, switched battery power connection. It can be used to power external devices that require power only when the ignition key is ON. This source is protected by a 15-amp circuit breaker.

Ground Post (GND)

This is a ground connection. It can be used as a power return (–) connection for external devices.

RPM Output

This is a 50% duty cycle, 5-volt Transistor-Transistor Logic (TTL) compatible, square-wave signal that is calibrated to provide a standard pulse rate of 12 pulses per engine revolution.

Note: Transistor-transistor logic compatible of this output may be affected by other devices connected to this output. Maximum rated current of the TTL output is 10 mA. Total current draw of all devices connected to this output must not exceed 10 mA at 4 volts.

Km/h Output

This is a 50% duty cycle, 5-volt TTL-compatible, square-wave signal that is calibrated to provide a standard pulse rate of 30,000 pulses per mile.

Note: TTL compatibility of this output may be affected by other devices connected to this output. Maximum rated current of the TTL output is 10 mA. Total current draw of all devices connected to this output must not exceed 10 mA at 4 volts.

SAE/ATA J-1708 Posts (Series Link A and B)

This is a serial communication interface. It conforms to the SAE/ATA J-1708 Recommended Practice for Serial Data Communications Between Microcomputer Systems In Heavy Duty Vehicle Applications.

CB Radio Power Jack (CB Radio +) (Located on Dashboard)

This is a +12 volt, switched battery power connection. It is used to power the vehicle's CB radio. It is protected by a 15- amp circuit breaker and will supply power only when the ignition key is in the ON position.

CB Radio Ground Jack (CB Radio -) (Located on Dashboard)

This is a ground connection. It is used as a power return (-) connection for the vehicle's CB radio.

See the following illustrations for the CTP and CXP electrical accessory connection points for electrical equipment panels.

INSTRUMENT CLUSTER DISPLAY

The instrument cluster display is an in-dash component that lets the driver monitor information supplied by Vehicle Management and Control (V-MAC) IV and also permits the driver to change functions to accommodate his needs. The instrument cluster display is user friendly and prompts the driver with messages on the driver information display.

Dash Cluster Set-Up Programming

Some features and functions listed in this section can be customized to meet company or driver's needs. V-MAC IV can be programmed by the dealer or customer using VCADS software to make these features available through the instrument cluster.

Instrument Cluster Components

The dash cluster consists of the following eight major components: function light indicators, electronic malfunction indicator, engine shutdown indicator, driver information display, low fuel indicator, gauges, speedometer and tachometer, On Board Diagnostic (OBD) fault and warning indicators. Although not a part of the dash cluster components, but nevertheless part of the dash cluster tool, is the stalk switch (for Co-Pilot® only) located on the right side of the steering column.

The following illustration shows the instrument cluster display (Co-Pilot® shown).

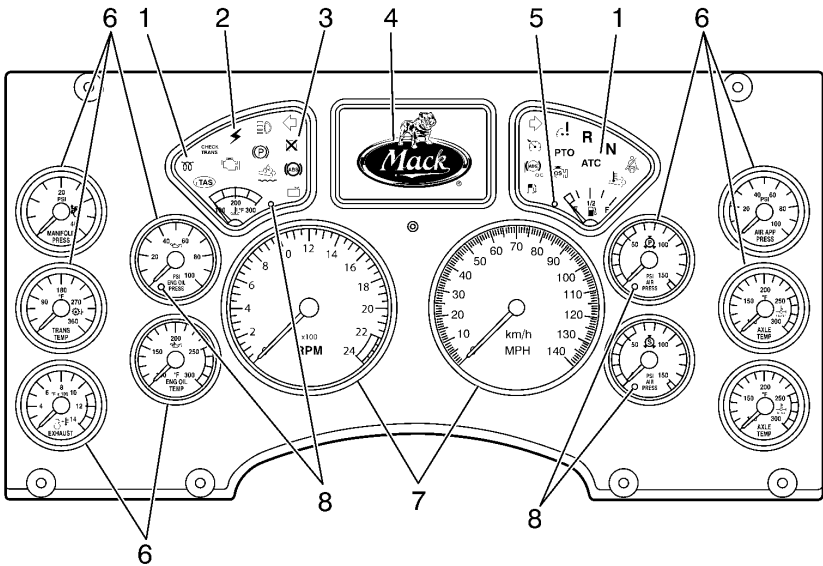

W3036320

Instrument Cluster Components

Note: The instrument cluster displayed is meant as a general representation only. A vehicle's specific instrument cluster is dependent on the emission equipment installed.

- | | |
|-------------------------------------|-------------------------------|
| 1. Function Light Indicators | 5. Low Fuel Indicator |
| 2. Electronic Malfunction Indicator | 6. Gauges |
| 3. Engine Shutdown Indicator | 7. Speedometer and Tachometer |
| 4. Driver Information Display | 8. Warning Indicators |

The following illustration shows the stalk switch.

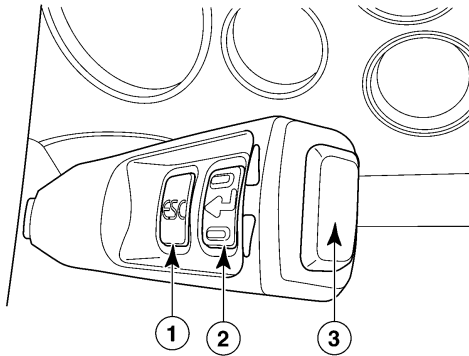

C0035377

Instrument Cluster Components

The stalk switch (for Co-Pilot® display only) is located on the right side of the steering column and contains three depressible buttons: *ESC*, *Enter* (⬆) and *Up & Down*. The stalk switch is used to access, navigate, view and change information available in the driver information display (Co-Pilot® display).

Driver Information Display

The driver information display available for MACK Trucks, vehicles is the Co-Pilot® Display. The Co-Pilot® Display provides the driver with such information as time, temperature, trip mileage, trip fuel, warning information and Diagnostic Trouble Codes (DTCs). The driver information display also contains a menu where the driver can access and adjust functions such as maintenance, dash cluster self-test, alarm sound, lighting level, time, language choice, and units of measure. Both driver displays are located in the center of the dash cluster and easily accessible to the driver.

To enter the driver information display, press and hold the **Enter** (↵) button on the stalk switch.

For more information regarding the driver information display, please refer to “CO-PILOT® DISPLAY”, page 58.

Diagnostic Trouble Codes (DTCs)

Electronic Dash Display

DTCs are used for isolating and troubleshooting any active faults in the Vehicle Management and Control (V-MAC) IV system. Active DTCs can be quickly viewed on the electronic dash display (Co-Pilot) in the following format:

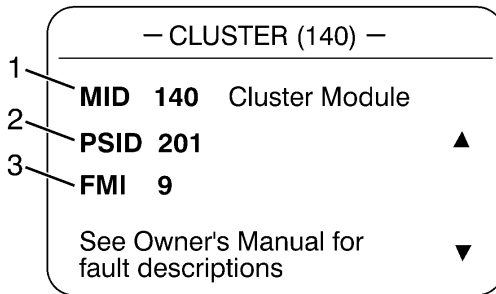

W3036575

DTC Indicator (J1587)

- 1 MID — Messenger Identifier Code
- 2 PID, PPID, PSID or SID — Parameter Identifier, Proprietary Parameter Identifier, Proprietary Subsystem Identifier or Subsystem Identifier Code
- 3 FMI — Failure Mode Identifier

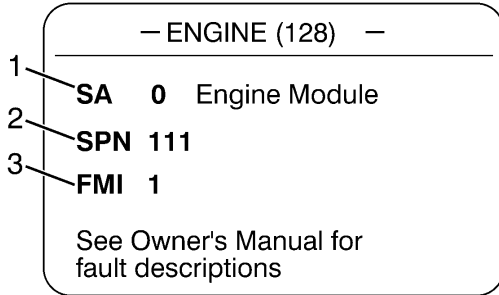

W3036576

DTC Indicator (J1939)

- 1 SA — Source Address
- 2 SPN — Suspect Parameter Number
- 3 FMI — Failure Mode Identifier

The Active DTC screens, indicate that there is an active PID 84 fault from transmitter 128 with an FMI of 4.

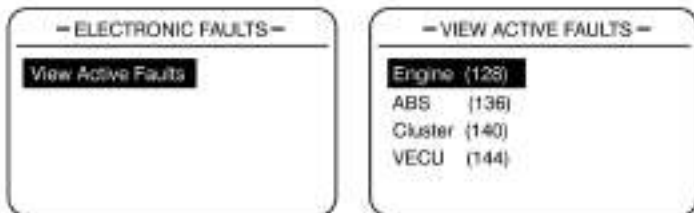

W3078076

Active DTC Screens

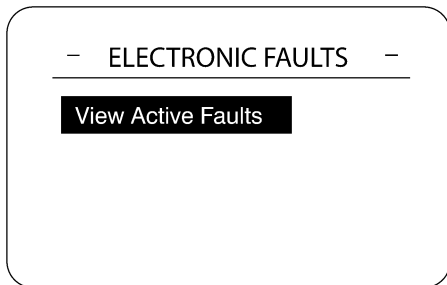

W3067831

Select View Active Fault Screen

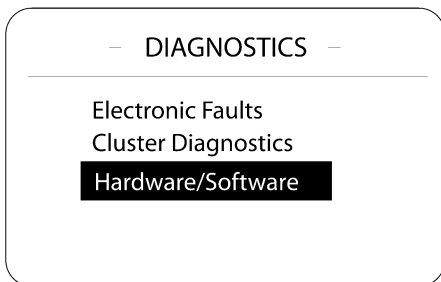

W3067829

Diagnostic Submenu Screen

To view the DTCs (the vehicle must be stationary), turn the ignition key to the ON position and do the following (refer to Figure 33):

- 1 Press the **Enter** (↵) button on the Stalk Switch. The Co-Pilot main menu will appear.
- 2 Use the **Up & Down** button to highlight the Diagnostics menu.
 - 1 Press the **Enter** (↵) button to enter the Diagnostics menu.
 - 2 Use the **Up & Down** button to highlight Electronic Faults.
 - 3 Press the **Enter** (↵) button to enter the Electronic Faults menu.
- 4 You can view both active and inactive fault codes (refer to Figure 33, Figure 35, and Figure 36).
 - 1 To view active fault codes, use the **Up & Down** button to highlight Active Faults and then press the **Enter** (↵) *button to select*.

Note: Clearing inactive fault codes is only possible if you have Owner-Operating programming access.
- 2 To exit the Co-Pilot, press the **Enter** (↵) button and then press the **ESC** button twice to return to the main menu.

For more detail and graphic presentation on viewing DTC, please refer to “CO-PILOT® DISPLAY”, page 58.

CO-PILOT® DISPLAY

Introduction and Purpose

The Co-Pilot is an in-dash computer that lets the vehicle operator monitor information supplied by the Vehicle Management and Control (V-MAC) IV electronic control system and enhance the functions of V-MAC by entering requested information with the stalk switch. The Co-Pilot is very “user friendly” and prompts the operator with messages on the display screen.

Beginning with Co-Pilot, features include the following:

- Fuel Economy Information
- Driver Trip and Fleet Trip Information
- Speedometer Information
- Gauge Information
- Electronic Faults
- Driver Messages
- Cluster Diagnostics
- Maintenance Monitoring (if available)
- Set-Up (languages, units, driver overspeed alarm, date, display lighting)

CO-PILOT SYSTEM OVERVIEW

Set-Up Programming

Many Co-Pilot features and functions listed in this Operator's Guide can be customized to meet individual company or operator needs. V-MAC can easily be programmed by the dealer or customer using MACK's scan tool with VCADS software to make these features available through the Co-Pilot.

If your Co-Pilot does not display any of the features listed in this Operator's Guide, please consult your dealer or appropriate fleet management personnel for V-MAC set-up reprogramming as required. Programmable Co-Pilot features include:

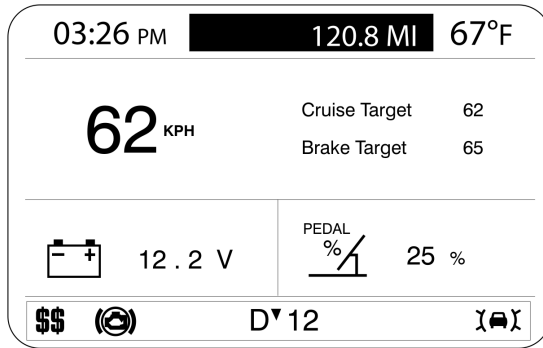

60 V-MAC Co-Pilot Operator's Manual

Table 4 Programmable Co-Pilot Features

Feature	Function/Selections	Factory Default Settings
Bill of Lading	Enter in Bill of Lading number	N/A
Change Driver	Change to a new Driver	Enabled
Drain Water (optional and for possible future support)	Drains the sediment bowl automatically from menu command	Enabled automatically if the option is ordered
Driver Overspeed Alarm (for future support)	Set personal vehicle speed threshold alarm	
Integrated Temp-A-Start (optional)	Program settings	If ordered, there are several parameters here.
Maintenance Reset	Reset Maintenance items	Disabled
DEL Messages	Driver enters in Driver Event Logging Messages	Disabled
Next Fleet Trip	Enter the next fleet trip	Disabled
Reset Driver Trip	Reset Driver Trip information	Enabled
Set Display Settings	• Set Co-Pilot time and date	N/A
	• Set language	English
	• Set display lighting, brightness and contrast	N/A
	• Set units of measure	English units of measure
Hours of Service (for future support)	—	—

The following illustration shows the areas of the Co-Pilot® Current Conditions screen.

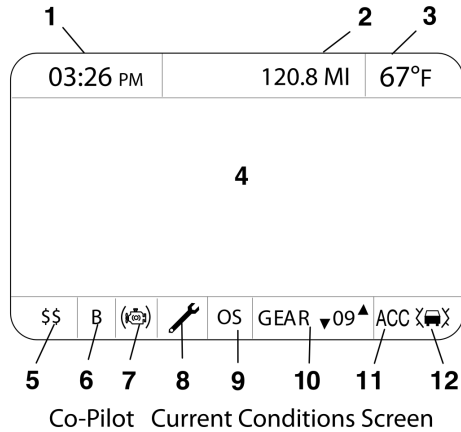

W3075369

Co-Pilot Current Conditions Screen

- | | |
|---------------------------------|---|
| 1. Time | 7. Engine Brake |
| 2. Mileage | 8. Maintenance |
| 3. Ambient Air Temp (AAT) | 9. Overspeed/Idle |
| 4. Information Area | 10. Gear (with automated transmission) |
| 5. Sweet Spot Indicator | 11. Active Cruise Control (If Fitted) |
| 6. Bonus/Penalty (If Available) | 12. Active Cruise Control Target Detected (If Fitted) |

62 V-MAC Co-Pilot Operator's Manual

The stalk switch is located on the right side of the steering column and contains three depressible buttons: **ESC Enter** (↵) and **Up & Down**. The stalk switch is used to access, navigate, view and change information available in the driver information display (Co-Pilot® only).

- The Esc or Escape button (1) is used to return to the previous menu or display, or to cancel a setting or operation.
- The Enter button (3) is used to display a list of menus, open a menu, and select a chosen value.
- The Up arrow (2) is used to scroll up through a menu and to increase numerical values.
- The Down arrow (2) is used to scroll down through a menu and to decrease numerical values.

The following illustration shows the stalk switch.

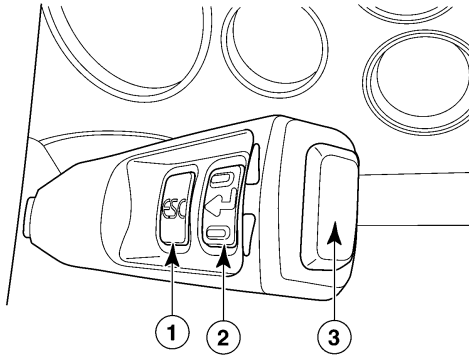

C0035377

Stalk Switch (Co-Pilot Only)

CO-PILOT® OPERATIONS

This chapter is intended as a general overview to operations.

Using the Co-Pilot®

Note: Turn the ignition key to the ON position before operating the Co-Pilot®.

When the ignition key is turned to the ON position, the Co-Pilot® automatically turns on. The MACK Logo Intro screen appears for several seconds and is usually followed by the last Anytime screen that was active prior to power-down. If Vehicle Management and Control (V-MAC) IV is programmed to “get driver” at key-on, then the CHANGE DRIVER screen will appear. Messages on the screen will prompt the driver to press the **Enter (↵)** button to accept the driver ID or use the Co-Pilot® stalk switch to enter a password.

Remember to press and hold the **Enter (↵)** button before beginning a trip to make the stationary MAIN MENU screen appear.

Note: If the screen is black, press the **Enter (↵)** button on the stalk switch to turn it on.

Note: It is also possible to retrieve engine hours and odometer readings with the ignition OFF; simply press and hold the **Enter (↵)** button on the stalk switch.

CO-PILOT SYSTEM OVERVIEW

ESC Button

The *ESC* (Escape) button on the stalk switch takes the Co-Pilot back to the previous screen or level in the menu.

Note: The *ESC* button does not function at Start-Up.

Enter (↵) Button

The *Enter* (↵) button on the stalk switch selects the highlighted menu items during menu selection. During Start-Up and when moving the vehicle, the *Enter* (↵) button is also used to confirm or acknowledge a pop-up screen. Sometimes, the *Enter* (↵) button takes the Co-Pilot display back to the previous screen.

Up & Down Buttons

The *Up & Down* buttons at the end of the stalk switch allow the user to highlight the various available menu items. Sometimes, these buttons are used to enter information into the displays.

- **Up Button** — Once at the top of the menu items that can be selected, pressing the *Up* button will take the Co-Pilot display to the last item in the menu.
- **Down Button** — Once at the bottom of the menu items that can be selected, pressing the *Down* button will take the Co-Pilot display to the first item in the menu.

CO-PILOT® LAYOUT

Screen Types

The Co-Pilot® contains six types of display screens:

- **Start-Up Screens** — A group of screens that appear when the vehicle management and control vehicle management and control (V-MAC) IV system is energized. Individual Start-Up screens are discussed in more detail in .
- **Menu Screens** — A group of screens that appear with a menu selection depending on whether the vehicle is stationary or moving. Individual Menu Screens are discussed in more detail in .
- **Anytime Screens** — A group of screens that can be displayed to a driver at any time (whether the vehicle is moving or stationary). Individual Anytime Screens are discussed in more detail in .
- **Stationary Screens** — A group of screens that is only accessible when the vehicle is stationary (Vehicle Speed = 0). These screen choices disappear from the stationary MAIN MENU screen when the vehicle begins moving and are replaced with the last anytime screen. Individual Stationary Screens are discussed in more detail in .
- **Interrupt Screens** — A group of special screens that appears during start-up or operation to notify the driver of certain critical information. When an Interrupt screen appears, the driver must do one of three things:
 - 1 Key-in the requested information.
 - 2 Press the **Enter** (↵) button to acknowledge the screen and turn off the warning and/or alarm.
 - 3 Take appropriate action to correct the condition that triggered the alarm.

For example, if the DRIVER ROAD SPEED ALARM screen appears, decelerate until the vehicle speed drops below the limit which triggered the alarm.

Individual Interrupt Screens are discussed in more detail in .

- **Optional Systems Screens** — A group of special screens that are accessible depending upon availability.
Individual Option Systems Screens are discussed in more detail in .

Driver's ID Screens

The following screens allow a driver specific ID to be entered via the Driver Information Display. This option allows various vehicle information to be recorded for the driver associated with the driver ID. The ID can be changed from the Driver Information Display (DID) using the stalk switch control lever.

If the vehicle has the Driver ID feature, when the vehicle is started the Enter Driver ID screen appears in the DID. The operator enters the appropriate driver ID at that time.

- 1 The first number will be highlighted in the DID screen. Use the up and down arrows of the stalk switch control lever to scroll to the appropriate number.
- 2 Once the correct number is found, press the **Enter** button on the stalk switch control lever.
- 3 The next number in the Driver ID sequence is highlighted. Enter all the numbers for the Driver ID using these steps.

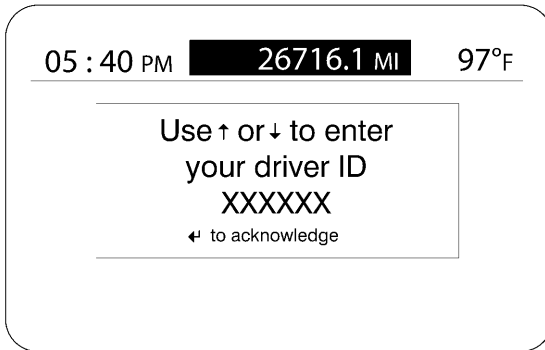

Once the Driver ID has been entered press the **Enter** button on the stalk switch control lever. The **Command Accepted** screen displays. Press **Enter** again.

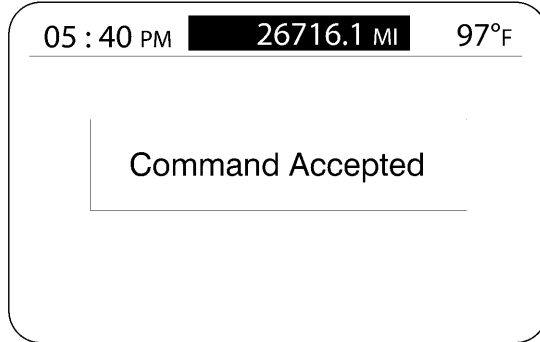

W3067469

If driver does not enter the Driver ID after starting the vehicle the **Enter Driver ID** screen displays. The Driver ID should be entered at the next vehicle stop. This screen will display every 30 minutes until the proper ID is entered. There is also an audible warning emitted until the Driver ID is entered as well.

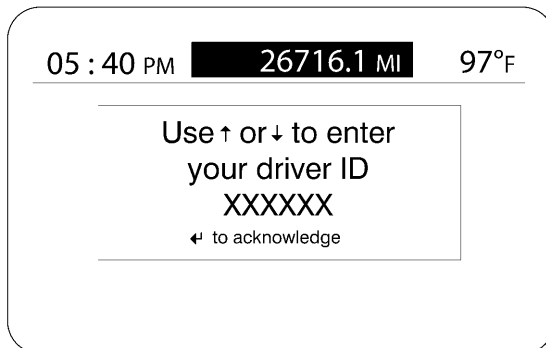

W3067466

68 V-MAC Co-Pilot Operator's Manual

Once the Driver ID has been entered press the **Enter** button on the stalk switch control lever. The **Command Accepted** screen displays. Press **Enter** again.

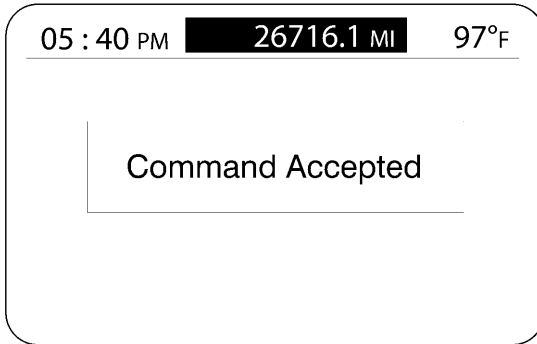

W3067469

If there is a system issue with confirming the Drivers ID the **ERROR Driver Number Not Available** screen displays.

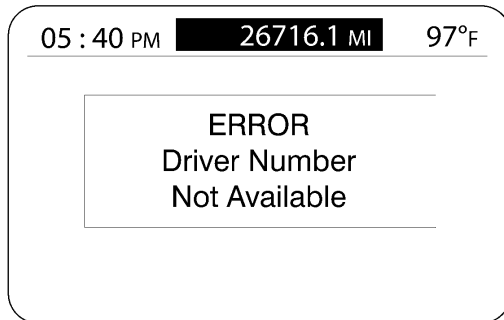

W3067470

If driver does not enter the Driver ID the **Driver ID not Entered** screen displays. The Driver ID should be entered at the next vehicle stop. This screen will display every 30 minutes until the proper ID is entered. There is also an audible warning emitted until the Driver ID is entered as well.

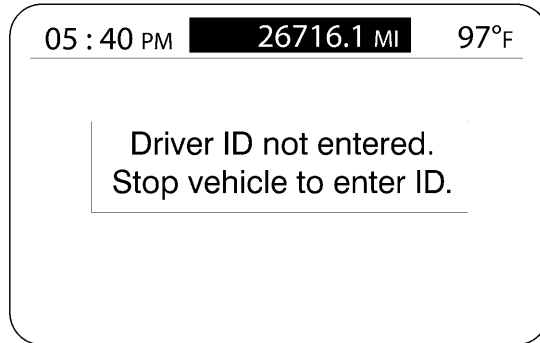

W3067468

If the Driver ID is entered and the vehicle is turned off for less than 10 minutes then the Current Driver ID screen displays. Enter the Driver ID and press **Enter**. The Driver ID will be verified via the vehicle ECU.

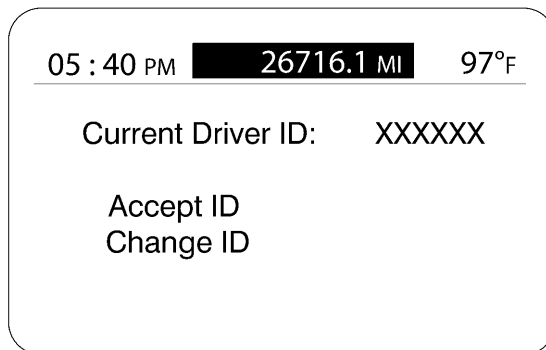

W3067467

Change Driver ID

To change the current Driver ID, use the Up and Down arrows and Enter button on the stalk switch control lever.

From the main DID screen scroll to **Fleet Management** . Press **Enter**. Then scroll to **Change Driver ID**. Press **Enter**.

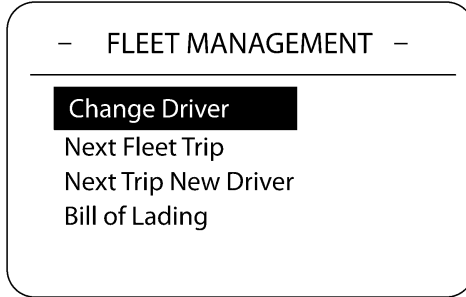

Fleet Management Submenu Screen

W0069618

The **Enter Driver ID** screen displays. Enter the new Driver ID.

- 1 The first number will be highlighted in the DID screen. Use the up and down arrows of the stalk switch control lever to find the appropriate number.
- 2 Once the correct number is found, press the **Enter** button on the stalk switch control lever.
- 3 The next number in the Driver ID sequence is highlighted.

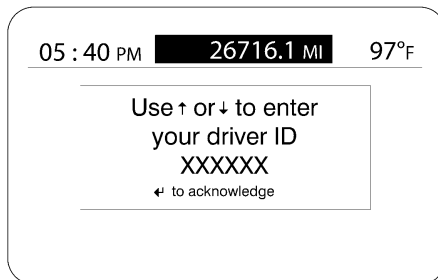

W3067466

The **Change OK...** screen displays. The DID will interface with the Vehicle ECU. Then all information is sent for confirmation via MACK Link to a vehicles main office. The new Driver ID is received and confirmed.

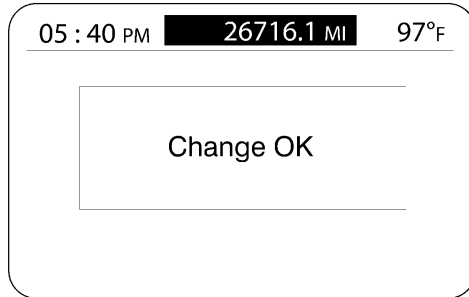

W3067471

Press the **ESC** button to return to the main screen.

If there is a system issue with confirming the Drivers ID the **ERROR Driver Number Not Available** screen displays.

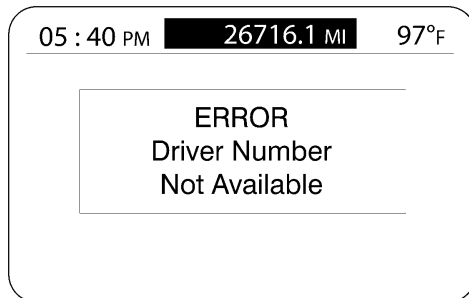

W3067470

CO-PILOT® START UP SCREENS

When the vehicle powers up, the Co-Pilot® display will illuminate Start-Up screens. Depending on the vehicle's options, the following screens will appear:

- MACK Logo Intro
- Current Conditions

MACK Logo Intro

The MACK Logo Intro screen is displayed for six seconds when the vehicle ignition key is turned to the ON position. It is for viewing purposes only.



MACK Logo Intro

C0035444

MACK Logo Intro

Current Conditions

The CURRENT CONDITIONS screen will appear after the MACK LOGO INTRO screen. When the truck is stationary, the time, mileage, outside temperature and battery voltage are displayed. When the vehicle is moving, in addition to the above items, sweet spot information (when the engine is being operated at its most efficient range), bonus or penalty mode (alerts the driver if vehicle speed and cruise maximum speed can be increased or decreased for the best fuel economy), and gear state will also appear. The information area of this screen will remain blank unless an interrupt screen appears or the driver starts up the Co-Pilot main menu.

Note: The appearance of the GEAR indicator is only displayed with an automated manual transmission.

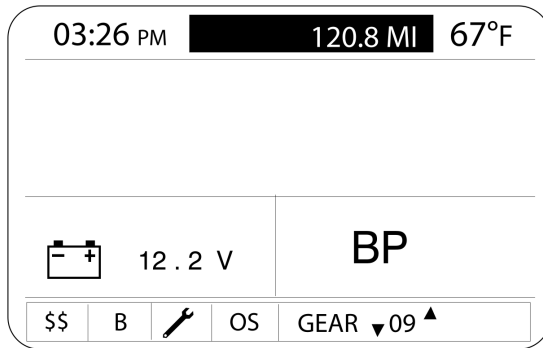

W3078075

Current Conditions Screen

CO-PILOT® MENU SCREENS

Main Menu — Stationary Vehicle

The MAIN MENU screen consists of two screens for a stationary vehicle: stationary MAIN MENU 1 screen and stationary MAIN MENU 2 screen.

To cause the stationary MAIN MENU 1 screen to appear, press and hold the stalk switch **Enter** (↵) button when in the CURRENT CONDITIONS screen. To cause the stationary MAIN MENU 2 screen to appear, scroll down on the stalk switch **Up & Down** button.

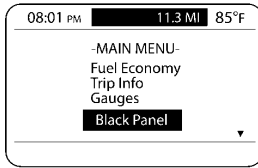

Stationary Main Menu 1 Screen

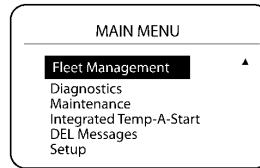

Stationary Main Menu 2 Screen

W3036587

Stationary Main Menu Screens

From these two menus, the driver can access the following information supplied in a submenu structure:

- Fuel Economy (Anytime and Stationary Screens)
- Trip Information (Anytime and Stationary Screens)
- Gauges (Anytime and Stationary Screens)
- Fleet Management (Stationary Screens)
- Diagnostics (Stationary Screens)
- Maintenance (Stationary Screens)
- Driver Event Messages (Stationary Screens)
- Settings (Stationary Screens)

Note: To view any of the above submenus from the stationary Main Menu screens, use the stalk switch **Up & Down** button to highlight an item and then press the stalk switch **Enter (↵)** button to make your selection.

Also included in the stationary MAIN MENU 1 is the selection of a black-out panel. Detailed information on these submenus and their screens is available in and .

Main Menu — Moving Vehicle

The MAIN MENU screen consists of one screen for a moving vehicle: moving MAIN MENU screen.

To cause the moving MAIN MENU screen to appear, press the stalk switch **Enter (↵)** button when in the CURRENT CONDITIONS screen.

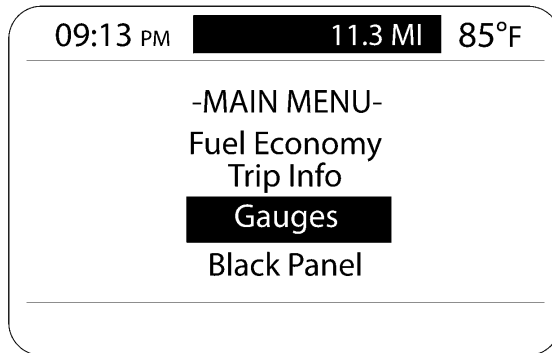

Moving Main Menu Screen

W3036590

Moving Main Menu Screen

76 V-MAC Co-Pilot Operator's Manual

From this menu, the driver can access the following information supplied in a submenu structure:

- Fuel Economy (Anytime and Stationary Screens)
- Trip Information (Anytime and Stationary Screens)
- Gauges (Anytime and Stationary Screens)

Note: To view any of the above submenus from the moving Main Menu screen, use the stalk switch **Up & Down** button to highlight an item and then press the stalk switch **Enter (↵)** button to make your selection.

Also included in the moving MAIN MENU screen is the selection of a black-out panel. Detailed information on these submenus and their screens is available in

CO-PILOT® ANYTIME SCREENS

Co-Pilot® Anytime screens include the following main screens:

- Fuel Economy
- Trip Information
- Digital Gauges
- Black Panel

To navigate through the screens, remember the following:

- Use the stalk switch **Up & Down** button to scroll and highlight an item, scroll to the next screen, or enter a value.
- Use the **Enter (↵)** button to select a screen, enter a value, accept a change or return to the previous screen.
- Use the **ESC** button to return to the previous screen.

Fuel Economy

The FUEL ECONOMY submenu screen is displayed by selecting Fuel Economy from the moving MAIN MENU screen or from the stationary MAIN MENU 1 screen and press the **Enter (↵)** button. These screens show the current “trip” average fuel economy, the “instantaneous” fuel economy on the scale and the “Bonus” and “Penalty” incentive modes (only when equipped with this feature).

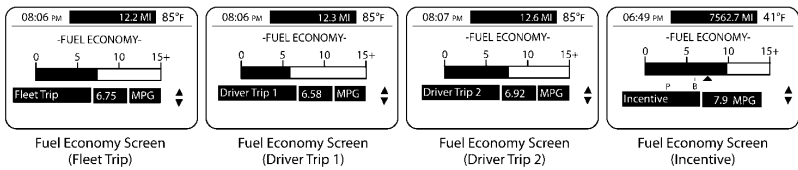

W3036612

Fuel Economy Screens

Trip Information

- The TRIP INFORMATION submenu screen is displayed by selecting **Trip Info** from the moving MAIN MENU screen or from the stationary MAIN MENU 1 screen and then pressing the **Enter (↵)** button.

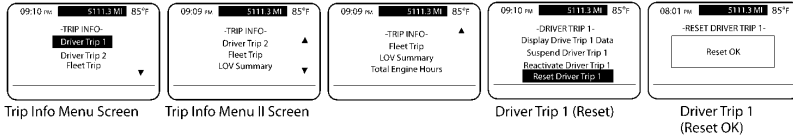

W3036614

Trip Information Screens

The TRIP INFORMATION submenu screen contains the following screens:

- Driver Trip 1 and Driver Trip 2** — Displays information such as date and time, distance, maximum RPM and mi/h, average mi/h and MPG, idle time, cruise time and time spent in “sweet spot,” engine brake time and power takeoff (PTO) time. These screens also allow the current driver trip information to be reset if desired, or to suspend and activate a current driver trip.

When two drivers are driving a scheduled trip, and driver 1 has completed the trip segment, the Driver Trip 1 segment must be ended. To end the trip, the first driver should select “Suspend OK” from the Driver Trip 1 screen. When Driver 2 is ready to begin his trip segment, he should select “Activate OK” from the Driver Trip 2 screen.

- Fleet Trip** — Displays trip number, driver ID, Bill of Lading number, start date and time, total date and time, total distance and fuel, maximum RPM and mi/h, average mi/h and MPG, idle time, cruise time and time spent in “sweet spot,” engine brake time and PTO time.
- Life of Vehicle (LOV) Trip Summary** — Displays the life of vehicle trip information.
- Total Engine Hours** — Displays the total engine hours for the vehicle.

The following table displays the available LOV trip information.

Average Fuel Economy	PTO Time
Average Vehicle Speed	Sweet Spot Time
Cruise Time	Total Fuel Used
Engine Brake Time	Vehicle Highest Speed
Engine Highest RPM	Vehicle Time
Idle Time	Total Time

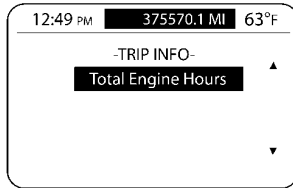

Trip Info (Total Engine Hours) Screen

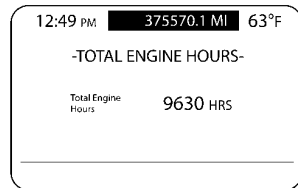

Total Engine Hours Screen

W3036620

Trip Info Screens

Gauges

The GAUGES submenu screen, selected from the moving MAIN MENU screen or from the stationary MAIN MENU 1 screen provides the speedometer value and sensor information. To view the screens of the Gauges submenu, highlight “Gauges” with the stalk switch *Up & Down* button and then press the *Enter* (↵) button to select the screen.

The GAUGES submenu screen contains the following screens:

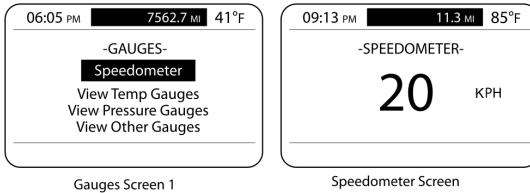

W3077547

View Gauges Screens

- **Speedometer** — Allows the user to view the current speedometer value.
- **View Temp Gauges** — Displays Engine Coolant Temperature (ECT), Engine Oil Temperature (EOT), engine Exhaust Gas Temperature (EGT), transmission oil temperature, rear front axle temperature, and rear axle temperature sensor information.
- **View Pressure Gauges** — Displays Engine Oil Pressure (EOP), Intake Manifold Pressure (IMP), and air suspension pressure sensor information.
- **View Other Gauges** — Displays engine RPM, engine load percent and throttle position percent sensor information.

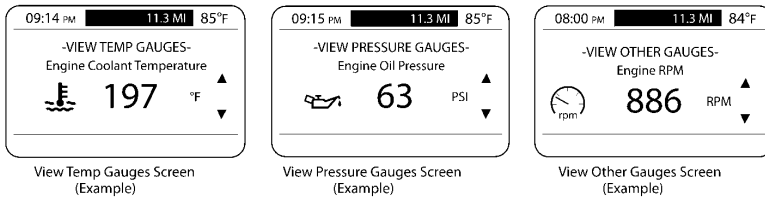

W3036624

View Gauges Screens

Note: Sensors that are not standard and have not been ordered will not appear on the screens.

Black Panel

- The BLACK PANEL screen is used to black out the Co-Pilot® display. Highlight “Black Panel” from the moving MAIN MENU screen or stationary MAIN MENU 1 screen, and then press the stalk switch **Enter** (↵) button to select it.
- To restore the Co-Pilot® display, press the **Enter** (↵) button again.

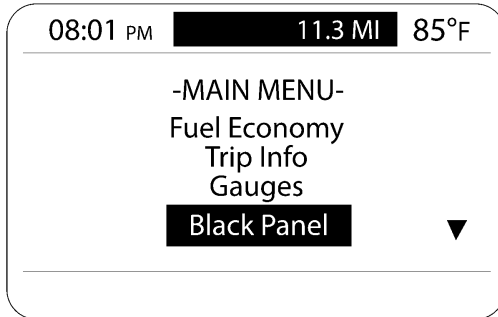

Main Menu Screen — Black Panel Selected

W3036626

Black Panel Selected

CO-PILOT® STATIONARY SCREENS

Co-Pilot® Stationary screens include the following main screens:

- Fuel Economy
- Trip Information
- Digital Gauges
- Black Panel
- Diagnostics
- Maintenance (if available)
- Set Up (Display)

To navigate through the screens, remember the following:

- Use the stalk switch **Up & Down** button to scroll and highlight an item, scroll to the next screen, or enter a value.
- Use the **Enter** (↵) button to select a screen, enter a value, accept a change or return to the previous screen.
- Use the **ESC** button to return to the previous screen.

Diagnostics

The Diagnostics submenu screen is accessed from the stationary MAIN MENU 2. To view the screens of the DIAGNOSTICS submenu, highlight “Diagnostics” with the stalk switch **Up & Down** button and then press the **Enter (↵)** button to select the screen.

The DIAGNOSTICS submenu screen contains the following main screens:

- **Electronic Faults** — Allows the user to view active and inactive Diagnostic Trouble Codes (DTCs) as well as clear inactive DTCs according to the controlling Engine Control Module (ECM), and other DTC identifiers.
- **Cluster Diagnostics** — Allows the user to test bulbs, pointers on gauges, graphics and alarms associated with the cluster.
- **Hardware/Software Part Numbers** — Allows the user to view the hardware and software part numbers of the Engine Control Module (ECM), Anti-lock Braking System (ABS) Electronic Control Unit (ECU), instrument cluster and vehicle ECU.

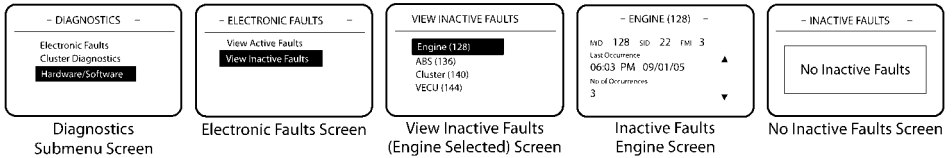

C0035399

Diagnostics Submenu Screens

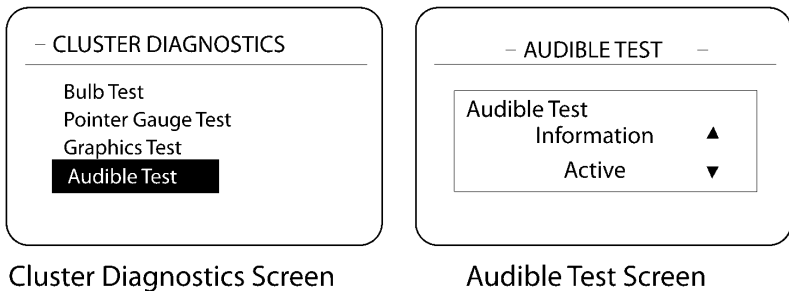

W3036629

Diagnostics Submenu Screens

Maintenance

The MAINTENANCE submenu screen is accessed from the stationary MAIN MENU 2 screen. To view the screens of the MAINTENANCE submenu, highlight “Maintenance” with the stalk switch *Up & Down* button and then press the *Enter* (↵) button to select the screen.

The MAINTENANCE submenu screen contains the following main screens:

Displays the maintenance schedule for various maintenance items, such as engine oil and coolant change. Maintenance items are displayed on the screen one at a time as shown in . Maintenance items, when enabled in VCADS or MACKtraq, can be reset after maintenance has been performed. If maintenance has not been performed, resetting the maintenance item will be prohibited.

Maintenance Monitor

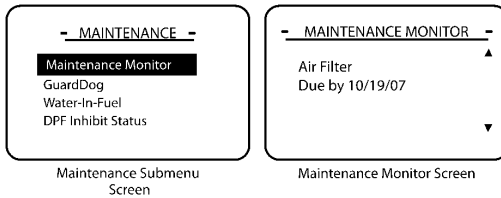

C0035402

Maintenance Screens

Water-in-Fuel (WIF) [if equipped]

Allows the user to send a “drain water” command to the EMS module. If the Water in Fuel sensor detects liquid in the water-separator bowl, the WIF indicator on the instrument cluster will illuminate to notify the driver.

DEL Messages

The DEL MESSAGES submenu screen is accessed from the stationary MAIN MENU 2 screen. The DEL MESSAGES submenu contains a list of driver event logging messages. A driver may choose to log a driver event logging message depending on the driver's activity. For example, if the driver is going to leave a terminal, the driver would select the LEAVE TERMINAL message.

To view the list of driver event logging messages in the DEL MESSAGES submenu, highlight "Messages" with the stalk switch **Up & Down** button and then press the **Enter** (↵) button to select the message to log.

Note: The DEL MESSAGES submenu is optional and will only appear if enabled in VCADS software or MACKtraq.

The DEL MESSAGES submenu contains the following driver event logging messages:

- Leave Terminal
- Arrive Terminal
- Load Pick Up
- Load Delivery
- Leave Job Site
- Arrive Job Site

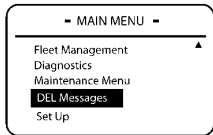

Stationary Main Menu 2 Screen



DEL Messages Submenu Screen



DEL Messages Screen

C0035404

DEL Messages Screens

Set Up

The SET UP submenu screen is accessed from the stationary MAIN MENU 2 screen.

To view the SET UP submenu, highlight “Set Up” with the stalk switch *Up & Down* button and then press the *Enter* (↵) button to select the screen.

The SET UP submenu screen contains the following main screens:

- **Language** — Permits the user to change language selections. The default setting is English.
- **Units** — Allows the user to change the unit of measure for temperature, distance, fuel, and pressure.
- **Driver Over Speed Alarm** (if available and for future support) — Allows the user to designate a personal speed limit. If this speed is exceeded, an alarm will sound and an Overspeed warning interrupt screen will appear to warn the driver.
- **Date and Time** — Permits the user to set time and date, decide to use a 12 hour or 24 hour clock display and to configure the way the date will display (i.e., days, months, years).
- **Display Light** — Allows the user to modify the panel display of the Co-Pilot.

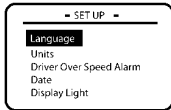

Set Up Submenu Screen

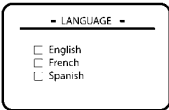

Language Screen

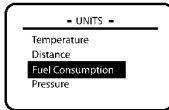

Units Screen

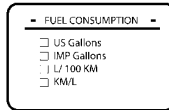

Fuel Consumption Screen

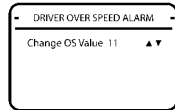

Driver Overspeed Alarm Screen

C0035405

Set Up Submenu Screens

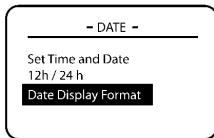

Date and Time Screen

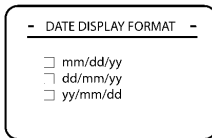

Date Display Format Screen

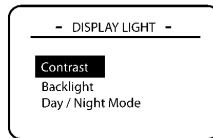

Display Light Screen

C0035406

Additional Set Up Submenu Screens

CO-PILOT® INTERRUPT SCREENS

Idle Shutdown Warning

The IDLE SHUTDOWN WARNING screen displays a timer warning and an alarm sounds to inform the driver that the vehicle is going to shut down until the condition goes away or the driver acknowledges the warning by pressing the **Enter (↵)** button.

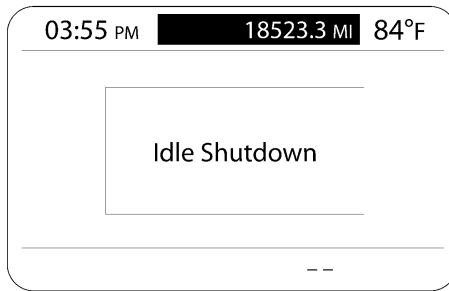

Idle Shutdown Warning Screen

W3036652

Idle Shutdown Warning Screen

Driver Overspeed Warning (if Available)

The DRIVER OVERSPEED WARNING screen appears and an alarm sounds when the driver exceeds a speed threshold. This screen is displayed until the driver acknowledges the warning and alarm by pressing the **Enter (↵)** button or decelerates below the threshold. The alarm will sound again if the threshold is exceeded.

Warning Severe Engine Overspeed

The WARNING SEVERE ENGINE OVERSPEED screen appears and an alarm sounds when the driver exceeds the Severe Engine Overspeed threshold. This screen is displayed until the driver decelerates below the threshold.

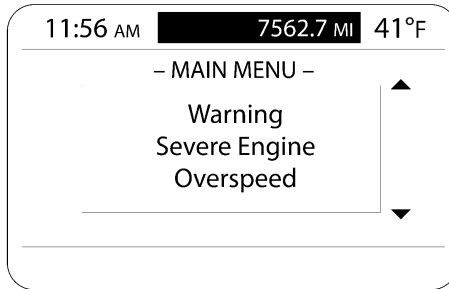

Warning: Severe Engine Overspeed Screen

W3036653

Warning: Severe Engine Overspeed Screen

Engine Brake Overspeed Warning

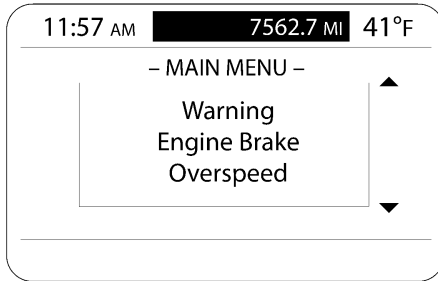

Warning: Engine Brake Overspeed Screen

W3036654

Warning: Engine Brake Overspeed Screen

The WARNING: ENGINE BRAKE OVERSPEED screen is displayed and an alarm sounds if the driver operates the engine speed over the engine brake speed threshold. This screen is displayed until the driver acknowledges the warning and alarm by pressing the **Enter** button and correcting the situation.

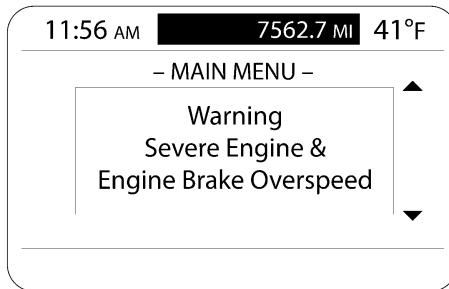

Warning: Severe Engine & Engine Brake Overspeed Screen

W3036655

Warning: Severe Engine and Brake Overspeed Screen

Severe Engine & Engine Brake Overspeed Warning

The WARNING: SEVERE ENGINE & ENGINE BRAKE OVERSPEED screen is displayed and an alarm sounds if the driver operates above the Severe Engine and Engine Brake Overspeed thresholds.

This screen is displayed until the driver acknowledges the warning and alarm by pressing the **Enter** button and correcting the situation.

Maintenance Reminder (for Future Support)

The MAINTENANCE REMINDER screen appears and an alarm sounds if a maintenance item, such as engine oil change, becomes due. The screen shows the item needing maintenance and the message “Check Maintenance Log.” If more than one maintenance item becomes due at the same time, the screen becomes scrollable so that the driver can press the **Down** button on the stalk switch to see other items needing maintenance.

Press the **Enter** (↵) button to acknowledge the reminder and return to the previous screen. The MAINTENANCE REMINDER screen will appear again at the next power-up until the maintenance is performed and the Maintenance Log is reset.

Low Voltage Disconnect Active

The LOW VOLTAGE DISCONNECT ACTIVE screen appears when a low voltage disconnect has been detected by the V-MAC system. The driver should acknowledge this message by pressing the **Enter** (↵) button and turn off unnecessary accessory functions that may have caused low voltage.

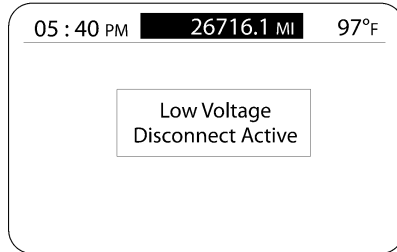

Low Voltage Disconnect Active Screen

W3036657

Low Voltage Disconnect Active Screen

Inter Wheel Lock

The INTER WHEEL LOCK screen appears when the Inter Wheel lock switch has been engaged by the driver. The driver should acknowledge the message by pressing the **Enter** (↵) button and turn off the Inter Wheel lock by pressing the Inter Wheel lock switch when not needed.

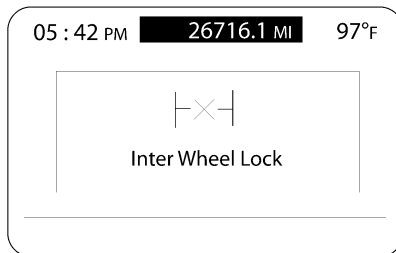

Inter Wheel Lock Screen

W3036658

Inter Wheel Lock Screen

Smart Idle Active

The SMART IDLE ACTIVE screen appears to alert the driver that the Smart Idle system is active and will not stop idling until the voltage threshold has been satisfied. The driver should acknowledge the message by pressing the **Enter** (↵) button.

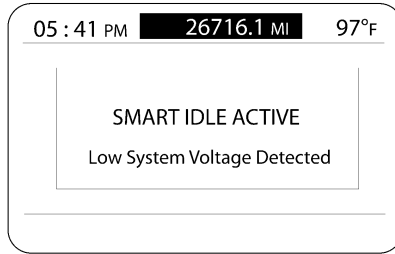

Smart Idle Active Screen

W3036659

Smart Idle Active Screen

Starter Inhibit

The STARTER INHIBIT screen appears to alert the driver that the starter will not engage until the cool down period has been met. The driver should acknowledge the message by pressing the **Enter** (↵) button.

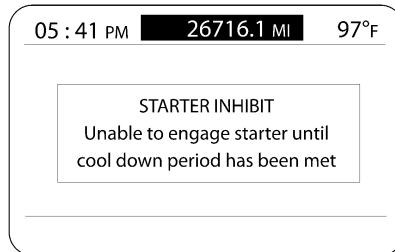

Starter Inhibit Screen

W3036660

Starter Inhibit Screen

Driver Trip Reset

The RESET screens are activated when the Reset Driver Trip option is selected from the TRIP INFO screen.

If no option to reset the selected driver trip exists, the ERROR NOT AUTHORIZED screen will appear. When the reset is complete, the RESET OK screen will appear.

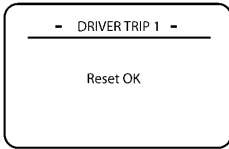

Driver Trip Reset OK Screen

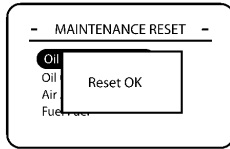

Maintenance Reset OK Screen

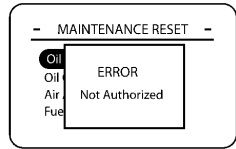

Error Not Authorized Screen

C0035411

Driver Trip Reset Screen

Trip Advanced

The TRIP ADVANCED screen appears whenever the driver advances to the next fleet trip.

To advance to the next fleet trip, the driver must select “Next Fleet Trip” from the FLEET MANAGEMENT submenu.

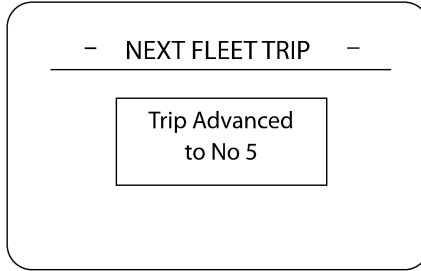

Next Fleet Trip Screen

C0035413

Next Fleet Trip Screen

Idle Cooldown Activated

The IDLE COOLDOWN ACTIVATED screen appears when the driver turns the ignition key to the OFF position, *Idle Cooldown* is enabled in VCADS, and the turbocharger exceeds a certain temperature.

Cycle the ignition key to override the function and shut down the vehicle immediately.

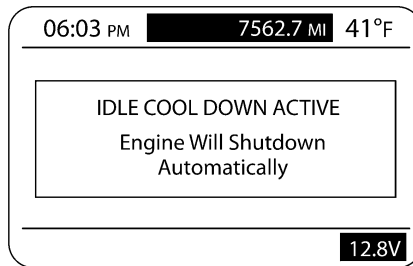

Idle Cool Down Active Screen

C0035415

Idle Cooldown Active Screen

