

# PACCAR TRANSMISSIONS

## TX-8

8 Speed  
Transmission

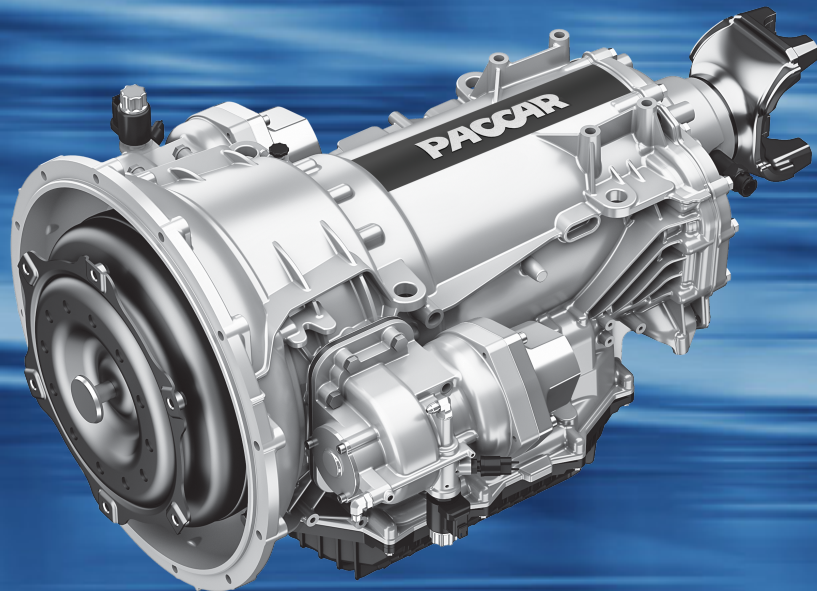

# Operator's Manual



<b>Safety</b>	<b>1</b>
<b>Features</b>	<b>2</b>
<b>Indications and Controls</b>	<b>3</b>
<b>Operation</b>	<b>4</b>
<b>Maintenance</b>	<b>5</b>
<b>Information</b>	<b>6</b>

## © 2021 PACCAR Inc. - All Rights Reserved

This manual illustrates and describes the operation of features or equipment which may be either standard or optional on this vehicle. This manual may also include a description of features and equipment which are no longer available or were not ordered on this vehicle. Please disregard any illustrations or descriptions relating to features or equipment which are not on this vehicle. PACCAR reserves the right to discontinue, change specifications, or change the design of its vehicles at any time without notice and without incurring any obligation. The information contained in this manual is proprietary to PACCAR. Reproduction, in whole or in part, by any means is strictly prohibited without prior written authorization from PACCAR Inc.



# Chapter 1 | SAFETY

Using this Manual.....	5
Safety Alerts.....	5
Illustrations.....	6
General Safety Instructions.....	6
Repairs.....	9

## Using this Manual

Please take the time to get acquainted with your vehicle by reading this Operator's Manual. We recommend that you read and understand this manual from beginning to end before you operate this equipment. This manual contains useful information for the safe and efficient operation of this equipment. It also provides service information, with an outline for performing safety checks and basic preventive maintenance inspections. We have tried to present the information needed to learn about functions, controls, and operation—and to present it as clearly as possible. Occasionally, you may need to reference this manual, and we hope you find it easy to use.

	<b>NOTE</b>
After you've read this manual, it should be stored in the cab for convenient reference and remain with this truck when sold.	

Your vehicle may not have all the features or options mentioned in this manual.

Therefore, you should pay careful attention to the instructions that pertain to just your vehicle. In addition, if your vehicle is equipped with special equipment or options not discussed in this manual, consult your dealer or the manufacturer of the equipment.

There are several tools built into this manual to help you find what you need quickly and easily; first is the Table of Contents. Located at the front of the manual, this table arranges the subject matter into chapters, which can be quickly referenced using the numbers shown in the outer margin. The first page of each chapter presents a list of the major subjects contained in that chapter. Cross-referenced citations can also help you find information. If more information on the current subject is located elsewhere in the manual, a cross-reference may be provided, such as "see [Safety Alerts](#) on page 5."

Finally, you'll find a helpful index at the back of the manual, which lists the subjects covered, alphabetically. All information contained in this manual is based on the latest production information available at the time of publication. Kenworth Truck Company reserves the

right to make changes at any time without notice.

## Safety Alerts

Read and follow all of the safety alerts contained in this manual. They are there for your protection and information. These alerts can help you avoid injury to yourself, your passengers, and help prevent costly damage to the vehicle. Safety alerts are highlighted by safety alert symbols and signal words such as WARNING, CAUTION, or NOTE. **Do not** ignore any of these alerts.

### Warnings



The safety message following this symbol and signal word provides a warning against operating procedures that could cause death or injury. They could also cause equipment or property damage. The alert will identify the hazard, how to avoid it, and the probable consequence of not avoiding the hazard. Example:

**WARNING**

Hot engine oil can be dangerous. You could be burned. Let the engine oil cool down before changing it. Failure to comply may result in death, personal injury, equipment or property damage.

**Cautions**

The safety message following this symbol and signal word provides a caution against operating procedures that could cause equipment or property damage. The alert will identify the hazard, how to avoid it, and the probable consequence of not avoiding the hazard.

Example:

**CAUTION**

Continuing to operate your vehicle with insufficient oil pressure will cause serious engine damage. Failure to comply

may result in equipment or property damage.

**Notes**

The message following this symbol and signal word provides important information that is not safety related but should be followed. The alert will highlight things that may not be obvious and is useful to your efficient operation of the vehicle.  
Example:

**NOTE**

Pumping the accelerator will not assist in starting the engine.

**Illustrations**

Some of the illustrations found in this manual are generic, and may not look exactly like the parts or assemblies you find installed on your vehicle.

When an illustration differs from what you see physically present on your vehicle, the language describing the procedure will still be correct for your application.

**General Safety Instructions****WARNING**

Improper practices, carelessness, or ignoring any warnings may cause property damage, personal injury, or death.

**WARNING**

Manually rotating the crankshaft requires a trained technician and specialty tools. DO NOT pull or pry on the fan in an attempt to rotate the crankshaft. Applying force to the fan can damage the fan blades or cause premature fan failure. Failure to comply with the approved procedure may result in property damage, personal injury, or death.



Before performing any repair, read and understand all of the safety precautions and warnings. The following is a list of general safety precautions that must be followed to provide personal safety. Failure to follow these instructions may cause death or injury. Special safety precautions are included in the procedures when they apply.

Keep in mind that even a well maintained vehicle must be operated within the range of its mechanical capabilities and the limits of its load ratings. See the Weight Ratings label on the driver's door edge.

Every new vehicle is designed to conform to all Federal Motor Vehicle Safety Standards applicable at the time of manufacture. Even with these safety features, continued safe and reliable operation depends greatly upon regular vehicle maintenance. Follow the maintenance recommendations found in the Preventive Maintenance section. This will help preserve your investment.

Make sure your vehicle is in top working condition before heading out on the road, it is the responsible driver's duty to do so. Inspect the vehicle according to the Driver's Check List.

- Work areas should be dry, well lit, well ventilated, free from clutter,

loose tools, parts, ignition sources and hazardous substances.

- Wear protective glasses and protective shoes when working.
- Wear protective gloves when working with hot liquids or surfaces.
- DO NOT wear loose-fitting or torn clothing. Tie back and/or tuck in long hair. Remove all jewelry when working.
- Before beginning any repair, disconnect the battery (negative [-] cable) and discharge any capacitors.
- Put a "DO NOT OPERATE" tag in the operator's compartment or on the controls.
- Allow the engine to cool before slowly loosening the coolant fill cap to relieve the pressure from the cooling system.

 **WARNING**

Removing the fill cap on a hot engine can cause scalding coolant to spray out and burn you badly. If the engine has been in operation within the previ-

ous 30 minutes, be very careful in removing the fill cap. Protect face, hands, and arms against escaping fluid and steam by covering the cap with a large, thick rag. DO NOT try to remove it until the surge tank cools down or if you see any steam or coolant escaping. Always remove the cap very slowly and carefully. Be ready to back off if any steam or coolant begins to escape. Failure to comply may result in death, personal injury, equipment or property damage.

- Always use wheel chocks or proper jack stands to support the vehicle or vehicle components before performing any service work. DO NOT work on anything that is supported only by lifting jacks or a hoist. Before resting a vehicle on jack stands, be sure the stands are rated for the load you will be placing on them.
- Before removing or disconnecting any lines, fittings, or related items, relieve all pressure in the air, oil, fuel, and cooling systems. Remain alert for possible pressure when disconnecting any device from a

- system that contains pressure. High pressure oil or fuel can cause death or personal injury.
- Always wear protective clothing when working on any refrigerant lines and make sure that the workplace is well ventilated. Inhalation of fumes can cause death or personal injury. To protect the environment, liquid refrigerant systems must be properly emptied and filled using equipment that prevents the release of refrigerant gas. Federal law requires capturing and recycling refrigerant.
- When moving or lifting any heavy equipment or parts, make sure to use proper techniques and assistance. Ensure all lifting devices such as chains, hooks, or slings are in good condition and are of the correct load capacity. Make sure all lifting devices are positioned correctly.
- Corrosion inhibitors and lubricating oils may contain alkali. DO NOT get the substance in eyes and avoid prolonged or repeated contact with skin. DO NOT swallow. If ingested, seek immediate medical attention. DO NOT induce vomiting. In case of contact, immediately wash skin with soap and water. In case of harmful contact, immediately contact a physician. Always keep any chemicals OUT OF REACH OF CHILDREN.
- Naphtha and Methyl Ethyl Ketone (MEK) are flammable materials and must be used with caution. Follow the manufacturer's instructions to ensure safety when using these materials. Always keep any chemicals OUT OF REACH OF CHILDREN.
- When working on the vehicle, be alert for hot parts on systems that have just been turned off, exhaust gas flow, and hot fluids in lines, tubes, and compartments. Contact with any hot surface may cause burns.
- Always use tools that are in good condition. Make sure you have the proper understanding of how to use the tools before performing any service work. Use only genuine replacement parts from PACCAR.
- Always use the same fastener part number (or equivalent) when replacing items. DO NOT use a fastener of lesser quality if replacements are necessary. (e.g., DO NOT replace a SAE 10.9 grade with 8.8 grade fastener.)
- Always torque fasteners and fuel connections to the required specifications. Overtightening or under-tightening can allow leakage.
- Close the manual fuel valves prior to performing maintenance and repairs, and when storing the vehicle inside.
- DO NOT perform any repair when impaired, tired, fatigued, or after consuming alcohol or drugs that can impair your functioning.
- Some state and federal agencies in the United States of America have determined that used engine oil can be carcinogenic and can cause reproductive toxicity. Avoid inhalation of vapors, ingestion, and prolonged contact with used engine oil.
- DO NOT connect the jump starting or battery charging cables to any ignition or governor control wiring. This can cause electrical damage to the ignition or governor.

- Coolant is toxic. If not reused, dispose of coolant in accordance with local environmental regulations.

**CAUTION**

Corrosive chemicals can damage the engine. DO NOT use corrosive chemicals on the engine. Failure to comply may result in equipment or property damage.

**California Proposition 65 Warning**

- Diesel engine exhaust and some of its constituents are known to the State of California to cause cancer, birth defects, and other reproductive harm.
- The catalyst substrate located in the Diesel Particulate Filter (DPF) contains vanadium pentoxide, which has been determined by the State of California to cause cancer. Always wear protective clothing and eye protection when handling the catalyst assembly. Dispose of the catalyst in accordance with local regulations. If catalyst material gets into the eyes,

immediately flood eyes with water for a minimum of 15 minutes. Avoid prolonged contact with skin. In case of contact, immediately wash skin with soap and water. In case of harmful contact, immediately contact a physician.

- Other chemicals in this vehicle are also known to the State of California to cause cancer, birth defects or other reproductive harm.
- Battery posts, terminals, and related accessories contain lead and lead compounds, chemicals known to the State of California to cause cancer and reproductive harm. Wash hands after handling.

**Repairs****WARNING**

DO NOT attempt repair work without sufficient training, service manuals, and the proper tools. You could be killed or injured, or you could make your

vehicle unsafe. Perform only those tasks you are fully qualified to do.

**WARNING**

Modifying your vehicle can make it unsafe. Some modifications can affect your vehicle's electrical system, stability, or other important functions. Before modifying your vehicle, check with your dealer to make sure it can be done safely. Improper modifications can cause death or personal injury.

**CAUTION**

The installation of electronic devices to the On Board Diagnostics (OBD) connector, the vehicle Controller Area Network (CAN), or their associated wiring is not permitted. Doing so can adversely affect vehicle performance and/or cause fault codes to be recorded. The OBD connector is provided for temporary connection of service tools and for diagnostic purposes only.

Your dealer's service center is the best place to have your vehicle repaired. You can find dealers all over the country with the equipment and trained personnel to get you back on the road quickly—and keep you there.

Your vehicle is a complex machine. Anyone attempting repairs on it needs good mechanical training and the proper tools. However, all warranty repairs must be performed by a PACCAR Powertrain distributor. If you aren't an experienced mechanic, or don't have the right equipment, please leave all repairs to a PACCAR Powertrain distributor. They are the ones best equipped to do the job safely and correctly.

### **Maintenance Manuals**

If you do decide to do any complex repair work, you'll need the maintenance manuals. Order them from your PACCAR Powertrain distributor. Please provide your Chassis Serial Number when you order, to be sure you get the correct manuals for your vehicle. Allow about four weeks for delivery. There will be a charge for these manuals.

### **Final Chassis Bill of Material**

A complete, non-illustrated computer printout listing of the parts used to custom-build your vehicle is available through the dealer from whom you purchased your vehicle.



## Chapter 2 | FEATURES

Auto-neutral.....	13
Adaptive Driving Mode.....	13
Adaptive Starting Gear.....	13
Auto-park (option).....	13
Engine Overspeed and Underspeed Protection.....	14
Hill Start Aid (option).....	14
LOW Mode.....	14
Neutral Idle Control Plus (NIC+).....	15
Parking Pawl (option).....	15

## Auto-neutral

The Auto-neutral feature will automatically shift the transmission into Neutral if it is left in a forward or reverse mode (such as LOW, Drive, or Reverse) and the parking brake is set.



### NOTE

If Auto-neutral has been activated, the transmission will not shift into Drive (**D**) or Reverse (**R**) until the shifter is first moved to Neutral (**N**) before selecting another transmission mode.

## Adaptive Driving Mode

Adaptive Driving will adjust the transmission shift schedule based on driving conditions, improving fuel economy and performance. This feature incorporates feedback such as road slope, vehicle weight, and speed to determine when to smoothly and efficiently shift between gears. Adaptive Driving Mode then remembers these determinations for future shifting decisions.

The feedback used to determine an ideal shift schedule also helps protect the transmission from shift selections falling outside the acceptable range for the intended gear. If road slope and vehicle weight (when compared to the drivetrain ratio and engine torque) would invalidate the intended gear, the shift will be denied. Adaptive Driving Mode is always on.

## Adaptive Starting Gear

The Adaptive Starting Gear feature automatically selects a start gear based on vehicle weight and road grade. This gear can be changed, however, using the up/downshift request procedure as long as the selection still falls into a gear that allows the vehicle to launch without causing damage to the transmission.



### NOTE

If the driver attempts to select a non-neutral mode without applying the service brake, the transmission will not shift into gear. If this is attempted, the driver will need to re-select Neutral (**N**)

and then press the service brake before a new mode can be selected.



### NOTE

If vehicle weight drops (the operator removes load), Adaptive Starting Gear will continue using the same starting gear employed prior to lightening the load and will require a 30-second key cycle (or if equipped with a parking pawl, remaining in Park for one minute) to adapt to the new vehicle weight.

## Auto-park (option)

This feature prevents unintentional rolling should the operator forget to place the vehicle in Park. If equipped with a parking pawl, Auto-park will automatically place the transmission in Park (**P**) if the operator moves the ignition switch to **OFF** while the vehicle is stationary.



NOTE

If Auto-park has been activated, the transmission will not exit Park (P) until the shifter is first moved to P before selecting another transmission mode.

## Engine Overspeed and Underspeed Protection

The transmission system will upshift, if necessary, to prevent damage during an engine overspeed condition and will also downshift to prevent engine lug (driving in a high gear at low rpm) and a potential stall during an engine underspeed condition. Engine Overspeed Protection is active in Drive (D), Manual, and LOW modes; however, Engine Underspeed Protection is only active when in Drive (D) mode or Manual mode.

### Hill Start Aid (option)

Hill Start Aid prevents unwanted vehicle movement on steep grades when transitioning from the brake to throttle

pedal. Hill Start Aid can be disabled using the Hill Start Aid Disable switch (see [Hill Start Aid Disable Switch](#)).

Hill Start Aid activates by default on a road grade of 3% and whenever Neutral Idle Control Plus (NIC+) is active.

### LOW Mode

LOW mode should be used any time you want to limit upshifting, hold lower gears, or improve engine braking through lower gear selection. For example, when driving down long grades or when coming to a stop.

- Selects lowest available gear for start gear. The starting gear cannot be changed in LOW mode.



NOTE

If the driver attempts to select a non-neutral mode without applying the service brake, the transmission will not shift into gear. If this is attempted, the driver will need to re-select Neutral (N) and then press the service brake before a new mode can be selected.

- If LOW is selected while moving, the transmission will not upshift

(except in conditions requiring overspeed protection – see [Engine Overspeed and Underspeed Protection](#) on page 14). The transmission system will downshift at the earliest opportunity to enable higher than normal engine RPM to provide maximum engine braking.



WARNING

On slippery surfaces minimize engine braking in LOW mode. Excessive engine braking at higher engine RPM could cause a loss of traction and vehicle control.



NOTE

This transmission initiates upshifts from Drive (D), Manual, and LOW modes for engine overspeed protection.



## Neutral Idle Control Plus (NIC+)

	<b>NOTE</b>
NIC+ is only available for vehicles equipped with air brakes.	

This transmission will shift into neutral when the vehicle is stationary, and the service or parking brake is applied. NIC+ absolves the engine from providing power to the drivetrain when the vehicle has stopped, saving fuel and reducing the braking effort required by the operator to keep the vehicle stationary. When the parking or service brake is released, the transmission gradually, and automatically, shifts back into gear, allowing the vehicle to creep forward normally.

### Parking Pawl (option)

This transmission may be equipped with a park setting that prevents the vehicle from rolling. The parking pawl is activated using the gear shift lever and can also be engaged (by spring force) when the vehicle

is at a standstill and the ignition switch is turned to **OFF**. The parking pawl uses the pawl to lock the transmission output that engages in the meshing of the output shaft. This locks the rear wheels by means of the driveshaft.

### Parking Pawl Manual Release (option)

Transmissions with a Park mode are also equipped with a way to disengage the parking pawl directly at the transmission. Using the manual release places the transmission in neutral and is useful when the transmission won't respond to gearing requests (for example, when the engine won't start) and the vehicle must be rolled. See [Manually Releasing the Parking Pawl](#) on page 24.

	<b>NOTE</b>
Activating the parking pawl manual release will allow the vehicle to roll if the Parking Brake is not set. Make sure that the vehicle is prepared to be rolled, or that the Parking brake is set, prior to activating the manual release.	

## Chapter 3 | INDICATIONS AND CONTROLS

3

Digital Display.....	17
Gearshift Lever.....	18
Hill Start Aid Disabled Warning Light (option).....	20
Hill Start Aid Disable Switch (option).....	20
Power Take-off (PTO) Switch (option).....	20

## Digital Display

### Primary Gauges View

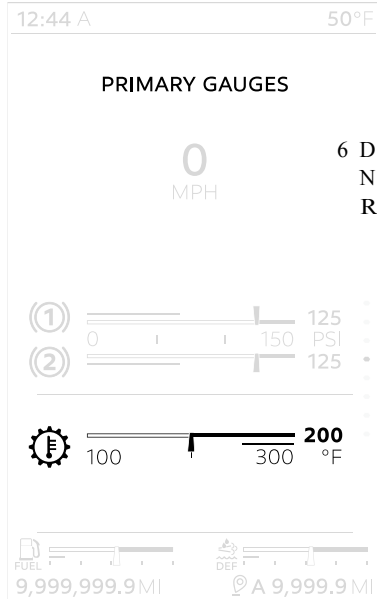

The digital display shows the following indications related to the transmission:

- M 6 D  
▲ N Transmission Gear Display
- R
- ⚙️ Transmission Temperature

### Transmission Gear Display

- M 6 D
- ▲ N
- R

The Transmission Gear Display is located on the Digital Display.  
The following indications appear next to **D** (Drive), when the feature or condition is active:

- 1 – 8 Current Gear
- AN Auto Neutral
- L LOW Mode
- M Manual Mode

- Shift Position Unknown

The following indications appear next to **R** (Reverse), when the feature or condition is active:

- 1 Multi-reverse Gear
- Shift Position Unknown

The following indications appear generally in the Gear Display when the feature or condition is active:

- !≡ Critical Error

### Transmission Oil Temperature Gauge



The Transmission Temperature Gauge indicates the temperature of the oil in the

transmission. Watch this gauge to know when the transmission is overheating and if so, have it checked by an authorized service representative.

3

## Gearshift Lever

The gearshift is located on the right-hand side of the steering column and can perform the following transmission functions:

- Switch transmission modes
- Upshift and Downshift
- Activate Manual mode

### Transmission Modes

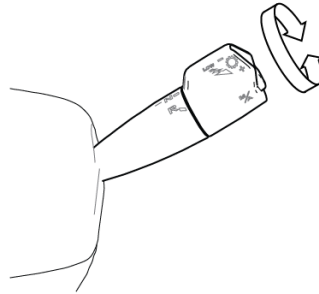

Select the transmission mode by rotating the lever outer knob. There is a position for Drive (**D**), Neutral (**N**), and Reverse (**R**) and for some vehicles Park (**P**). Rotating the knob to the Park (**P**) or Reverse (**R**) position while the vehicle is moving forward, or to the Park (**P**) or Drive (**D**) position while the vehicle is moving backward, will not change the transmission mode to those selections. The Digital Display will indicate the corresponding mode.



### NOTE

Vehicles without a Park (**P**) mode must be in Neutral (**N**) to start the engine.

### Upshifting and Downshifting

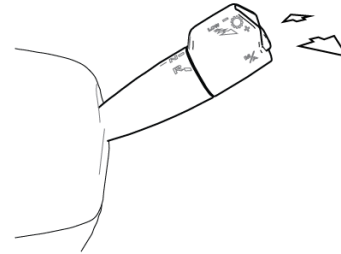

The transmission gear can be selected manually to accommodate the driving needs of the operator. The Transmission Mode must be in Drive (**D**) to manually select the gear. When in Automatic mode

- Pushing or pulling the lever will briefly upshift or downshift the transmission gear respectively (about four seconds); after which, the transmission will return to the ideal gearing for the current vehicle speed and engine use.
- Pushing and holding the lever away will engage the LOW Mode (see LOW Mode Operation).

When in Manual mode

- Pulling the lever towards the driver will upshift (+).
- Pushing the lever away will downshift (-).
- Pushing and holding the lever away will engage the LOW Mode (see LOW Mode Operation).

The selected gear will appear beside the transmission mode on the Transmission Gear Display (see [Transmission Gear Display](#) on page 17 ).

### Manual and Automatic Mode

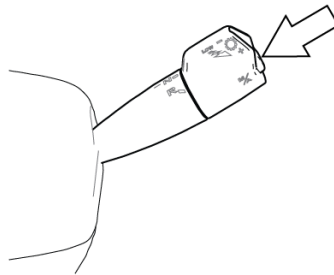

Pressing this button places the transmission in Manual mode. Manual mode allows the operator to select the gear (See [Upshifting and Downshifting](#) on page 18 ).

To activate, put the gear selector in the **D** (drive) mode and then depress the Manual Mode Button. When Manual mode is selected, **M** is shown in the Transmission Gear Display (See [Transmission Gear Display](#) on page 17).

### Manual Mode

Use Manual mode when driving conditions make it preferable to select a particular gear instead of allowing the transmission to select it automatically.

The operator manually selects the start gear and uses the up/downshift request to change gears. The system will hold the current gear until another upshift or downshift request is made, except when the conditions for a *Transmission Manual Override* occur (see *Transmission Manual Override*).



#### NOTE

Multiple upshift or downshift requests may be allowed when the up/downshift request procedure is performed multiple times in succession. Each push or pull of the gear shift lever equals one gear change request.

For optimal vehicle performance, it is recommended the vehicle be operated in Automatic mode.

### Transmission Manual Override

If the vehicle is being back-driven and the engine is approaching a higher than acceptable engine operation range, the

transmission system will override the **Manual** position and perform an upshift.



The transmission initiates upshifts from **Manual** for engine overspeed protection.

If the start gear is changed and it causes the engine to lug at takeoff, the transmission system will override **Manual** mode and perform a downshift.

## Hill Start Aid Disabled Warning Light (option)



This warning means that the Hill Start Aid feature is disabled. This may be due to use of the Hill Start Aid Disable switch (see [Hill Start Aid Disable Switch](#)) or due to a fault with the Hill Start Aid feature.

## Hill Start Aid Disable Switch (option)

Two-position Switch



Positions:

1. **OFF** (temporary position)
2. (center, resting position)

**OFF** Pressing the switch up temporarily disables the Hill Start Aid feature. Disabling Hill Start Aid presents both a Popup and a warning light (see [Hill Start Aid Warning Light](#)).

Hill Start Aid automatically turns back on after the first successful launch.

## Power Take-off (PTO) Switch (option)

Two-position Switch



Positions:

1. **ON**
2. **OFF**

**ON** The up position enables the PTO, starting the PTO activation process.

**OFF** The down position disables the PTO.

This vehicle may be equipped with a dash-mounted switch that controls PTO engagement/disengagement. When the operator activates the switch for the PTO, the status indicator light (located on the switch) will immediately illuminate even though PTO engagement may not have occurred. If the PTO is engaged and the operator turns the switch **OFF**, the PTO status indicator light (located on the switch)

will turn off immediately even though PTO disengagement may not have occurred.



**CAUTION**

Increasing engine rpm before the PTO is actually engaged could prevent the PTO from engaging and/or cause PTO damage.

# Chapter 4 | OPERATION

How to Check Transmission Fluid.....	23
How to Add Transmission Fluid.....	23
How to Drain the Transmission.....	24
LOW Mode Operation.....	24
Manually Releasing the Parking Pawl.....	24
Snow/Ice Operation.....	25
Start-Up and Power Down.....	25
Transmission Power Take-off (PTO) (option).....	26
Vehicle Towing.....	27



## How to Check Transmission Fluid

- Clean cloth or paper towel
1. Park vehicle on level surface, engage parking brake, and start engine.
  2. Idle engine at 600 rpm to 800 rpm until transmission temperature reaches 104°F ( 40°C).

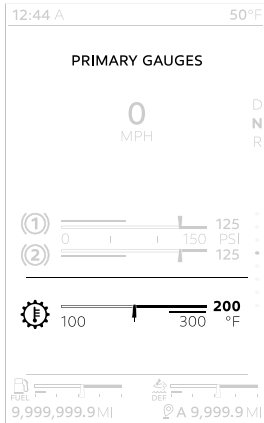

3. Unlatch hood hold-downs, and open hood.

4. Find the red-handled transmission fluid dipstick, located drivers-side, outward of the engine.
  5. Twist and remove dipstick, and wipe clean using towel or cloth.
  6. Reinsert dipstick fully and remove again.
- Be careful, fluid may be hot!
7. Check fluid level in the Warm range.

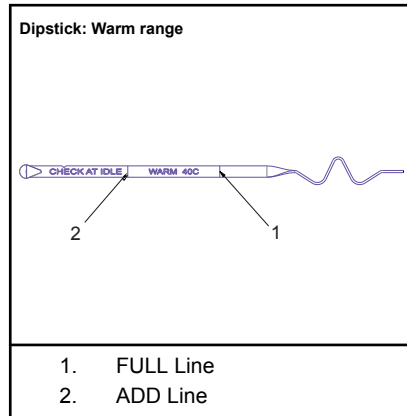

### NOTE

Observe markings at end of dipstick. Your dipstick has a full and add line for three temperature ranges: hot, warm, and cold. The hot and cold ranges are on one side, the warm range on the other.

8. If fluid level is not at the full line, add transmission fluid (see [How to Add Transmission Fluid](#)).
9. Close hood and latch hood hold-downs.

## How to Add Transmission Fluid

- Clean cloth or paper towel
- Automatic Transmission Fluid (See [Lubricant Specifications](#) on page 40)
- 3/4" (18mm) Wrench
- Funnel

- O-ring (new)

**Fill Location**

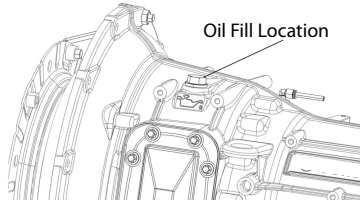

1. Remove transmission oil fill plug at Oil Fill Location.
2. Using a funnel, add a small amount of fluid at fill location.

**i NOTE**

DO NOT add fluid into dipstick housing.

3. Find the red-handled transmission-fluid dipstick, located drivers-side, outward of the engine.
4. Twist and remove dipstick, and wipe clean using a towel or cloth.
5. Continue to fill, and then check, until fluid level on dipstick indicates FULL.

**i NOTE**

DO NOT fill past the FULL line.

6. Apply oil to new O-ring and replace O-ring at fill location.
7. Clean, then replace plug at fill location, tightening plug to 44.3 lb-ft (60 N·m).

Dispose of cloth/towel and old O-ring properly.

## How to Drain the Transmission

Draining lubricating fluid from the transmission should only be performed during fluid replacement or a repair. Take your vehicle to a PACCAR Powertrain distributor for maintenance processes that require draining transmission lubricant. See [TX-8 Transmission Lubricant Capacities](#) on page 40 and [Lubricant Specifications](#) on page 40 for more information on the amount and type of lubricant required for this transmission.

## LOW Mode Operation

The vehicle must be in Drive (**D**) to activate LOW Mode.

1. Push and hold the gear-shift lever away until "L" appears on the Transmission Gear Display.

The vehicle will remain in LOW Mode until the operator either

- Presses the Manual Mode Button (see [Manual and Automatic Mode](#) on page 19)
- Pushes the gear-shift lever away until "L" is removed from the Transmission Gear Display (see [Upshifting and Downshifting](#) on page 18)
- Shifts into Neutral (**N**) and then into Drive (**D**)

## Manually Releasing the Parking Pawl

Releasing the parking pawl manually, at the transmission, requires use of the Manual Release Lever. This procedure should not be performed without this lever.

- Manual Release Lever (only available as a service part)

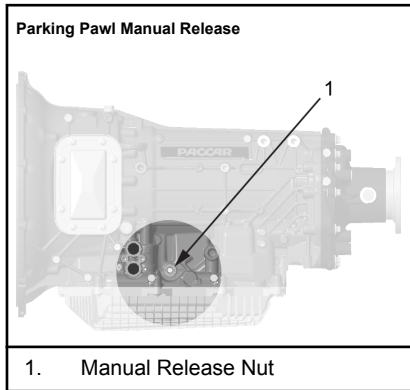

Located at the midpoint, driver's side of the transmission.

1. Remove nut and washer at Parking Pawl Release (1).
2. Attach Manual Release Lever and tighten nut (only two threads) (max torque – 7 lb-ft (9.5 N·m)).

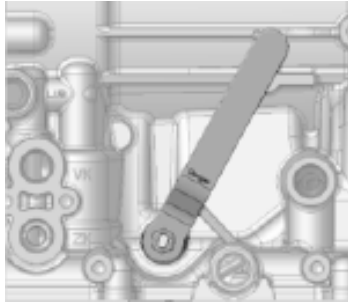

3. Turn lever clockwise until lever hits stopping surface (maximum actuation torque – 11.8 lb-ft (16 N·m)).
4. Reapply nut and washer then tighten nut.

Until the manual release lever is repositioned to allow the Parking Pawl to engage, Park mode will not be available.

## Snow/Ice Operation

This transmission is designed to work in coordination with the ATC system to ensure optimal operation. However, if the driver observes low friction road conditions (such as snow, rain, ice) and does not want the transmission to shift, risking wheel

slippage, the driver should select Manual mode. Manual mode holds the current gear position under most operating conditions—the transmission will only shift when the driver uses the up/downshift request. Once road conditions improve, the driver should revert back to Drive mode.

## Start-Up and Power Down

### Starting the Engine

The information provided in this topic is intended to enhance or amend the engine start-up procedure located in the engine operator's and chassis operator's manuals specific for your vehicle. Familiarize yourself with the information in this topic, and then make the appropriate adjustments to those procedures, if necessary, when starting the engine. If *Anti-Theft* is enabled, the first time you turn the ignition switch to **START**, you will need to enter the Passcode.

- When instructed to set the transmission mode (shift lever) to Neutral (**N**), if your vehicle has a Park setting, Park (**P**) must be selected.



**NOTE**

The engine will not start if Neutral (or Park) is not selected on the gear-shift lever.

- When instructed to set the transmission mode or gear, press the service brake while selecting a new transmission mode using the gear-shift lever.

**Engine Shutdown**

The information provided in this topic is intended to enhance or amend the Engine Shutdown Procedure, Stopping the Vehicle, and Final Stopping Procedures located in the Engine Operator's Manual and Chassis Operator's Manual specific for your vehicle. Familiarize yourself with the information in this topic, and make the appropriate adjustments to those procedures, if necessary, when shutting down the engine.

- If your vehicle has a Park setting, when instructed to set the transmission mode to Neutral (**N**), Park (**P**) or Neutral (**N**) may be selected. The Gear Display will

reflect the appropriate transmission mode: **N** or **P**.



**NOTE**

If the gear display does not show a solid **N** (or **P**), the appropriate gear has not yet been obtained.



**NOTE**

Neutral (or Park) should always be reached before initiating power down, except in cases of emergency.

**Transmission Power Take-off (PTO) (option)**

The transmission may have a PTO installed. Engaging the PTO differs if it is operating in either a mobile or a stationary application.

**Stationary PTO Operation**

The PTO is geared to the transmission torque converter, so the PTO will run at speeds proportional to engine rpm.

- Bring the vehicle to a complete stop and apply the parking brake.



**WARNING**

Apply parking brake and follow vehicle manufacturer parking instructions. Failure to follow these instructions could cause unintended vehicle movement resulting in death, serious injury or damage to property.

- Select **N** (or **P**) on the Gear Shift lever.
- Select the transmission PTO switch.
- Raise engine speed as required to operate PTO.



**NOTE**

Use the transmission PTO switch to disengage the PTO.

## Vehicle Towing

When towing the vehicle, the output shaft of the transmission must not be allowed to spin or turn. If the vehicle is towed with the drive wheels still in contact with the road surface, the vehicle axle shafts or driveline must be removed or disconnected.



### CAUTION

Always follow proper manufacturer towing procedures. Failure to follow proper towing procedures could result in damage to the transmission.

# Chapter 5 | MAINTENANCE

Automatic Transmission Maintenance.....	29
What is Preventative Maintenance?.....	30
Troubleshooting.....	35

## Automatic Transmission Maintenance

An automatic transmission is a complex and expensive vehicle component requiring operational attention and proper maintenance to ensure long-lasting performance. This performance is impacted greatly by the quality of its lubricating fluid, which reduces friction between its many parts, facilitates gear shifting, and cools down the transmission components.

The chief factor that affects the durability of a lubricating fluid is temperature. When the operating temperature of the transmission increases, this fluid begins to break down, degrading its lubricating properties. Without proper lubrication, friction between components increases, breaking them down and building up sludge in the transmission. This will eventually result in transmission failure, requiring it to be replaced.

A transmission's peak operating temperature can be defined as its maximum general operating temperature and is determined by how the transmission is used. The "hard use" associated with

some truck applications — such as the stop-and-go conditions of CITY DELIVERY, or the hauling of heavy loads and trailer use associated with many VOCATIONAL and highway applications — will increase this peak operating temperature, and hasten the break down of the transmission lubricant.

Therefore, **it is essential** that proper lubrication maintenance is performed for the operational temperature specific for your transmission use.

Operational temperature data for this transmission can be collected by your PACCAR Powertrain distributor technician early in the truck's life (collected during the first 5,000 miles of operation (see First 3,000 – 5,000 mi interval)). The value of this data will depend on whether this early temperature data – which is based on truck application – is representative of how the vehicle will be used for the life of the truck.

### NOTE

If vehicle application changes significantly, the vehicle should be re-evaluated for a new peak operational temperature, and if necessary, observe the maintenance intervals associated with the new peak temperature.

Once the peak operating temperature is known, the appropriate maintenance tables can be observed. If the peak operating temperature has not been determined, assume the 95°C peak operating temperature intervals.

Unlike engine oil, transmission fluid serves as both a lubricant and a hydraulic fluid. The hydraulic pressure needed to shift gears smoothly (and avoid gear slippage) requires that the operator maintain transmission fluid in the proper range (see [How to Check Transmission Fluid](#) on page 23). The operator should check their transmission fluid regularly, required as part of their weekly checks (see Weekly Checks in your chassis operator's manual).

## What is Preventative Maintenance?

Preventive maintenance begins with the daily checks. Routine vehicle checks can help avoid many large, expensive, and time consuming repairs. The vehicle will operate better, be safer, and last longer. Neglect of recommended maintenance can void your vehicle's warranty. Some maintenance operations demand skills and equipment you may not have. For such situations, please take your vehicle to a PACCAR Powertrain distributor.



### WARNING

Before attempting any procedures in the engine compartment, stop the engine and let it cool down. Hot components can burn skin on contact. Failure to comply may result in death, personal injury, equipment or property damage.



### WARNING

If the engine must be operating to inspect, be alert and cautious around the engine at all times. Failure to comply may result in death, personal injury, equipment or property damage.



### WARNING

If work has to be done with the engine running, always (1) set the parking brake, (2) block the wheels, and (3) ensure that the shift lever or selector is in Neutral. Failure to comply may result in death, personal injury, equipment or property damage.



### WARNING

Exercise extreme caution to prevent neckties, jewelry, long hair or loose clothing from getting caught in the fan blades or another moving engine parts. Failure to comply may result in death, personal injury, equipment or property damage.



### WARNING

Always support the vehicle with appropriate safety stands if it is necessary to work underneath the vehicle. A jack is not adequate for this purpose. Failure to comply may result in death, personal injury, equipment or property damage.



### WARNING

When working underneath the vehicle without appropriate safety stands but with the wheels on the ground (not supported), make sure that (1) the vehicle is on hard level ground, (2) the parking brake is applied, (3) all wheels are blocked (front and rear) and (4) remove the ignition key so that the engine cannot be started. Failure to comply may result in death, personal injury, equipment or property damage.





**WARNING**

NEVER start or let the engine run in an enclosed, unventilated area. Exhaust fumes from the engine contain carbon monoxide, a colorless and odorless gas. Carbon monoxide can be fatal if inhaled. Failure to comply may result in property damage, personal injury, or death.

The following pages contain a table of maintenance tasks with the related intervals for each task on the right side of the table. The top of the table displays a guide to a maintenance interval and its schedule. Some tasks are dependent on the vehicle application. These tasks are shown as separate tasks and will have the words ON-HIGHWAY, OFF-HIGHWAY, CITY DELIVERY, or VOCATIONAL after

the description. These tasks are differentiated because they are dependent on the vehicle's operating environment:

- ON-HIGHWAY – Applications where the vehicle is only used on paved roads during normal operation.
- OFF-HIGHWAY – Applications where the vehicle may be driven off the pavement on a regular basis, even if it is an infrequent basis and/or for a brief time period.
- CITY DELIVERY – Applications where frequent start and stopping is required during normal operation, and the highway is used infrequently and for short periods of time.
- VOCATIONAL – Applications based on truck configuration and use and not on operating

environment. Vocational vehicle components must meet the requirements needed for its specific application (such as delivery, construction, fire service, refuse, and busing). A truck can be Vocational in addition to other application types with the earliest and more limiting maintenance requirements observed.

Please contact a PACCAR Powertrain distributor if there are questions regarding which interval to follow. Consult the supplier for specific recommendations where discrepancies develop between the recommendations in the following maintenance tables and the component supplier recommendations.

**Peak Operational Temperature:  
221°F (105°C)**

**First 3,000-5,000 mi / 4,800-8,000 km**

Main and Auxiliary Transmission

- Take vehicle to a PACCAR Powertrain distributor to determine the peak operating temperature for specific vehicle application. This temperature will determine which transmission maintenance intervals should be used for this vehicle (see [Automatic Transmission Maintenance](#) on page 29).

**Every 60,000 mi / 96,000 km / 6 mos**

Oil Cooler

- Clean the fins (air-to-oil type) and body. Check the hose condition and for leaks: replace as required. (Refer to Cooling System Maintenance in your chassis operator's manual maintenance instructions.)

**Every 37,000 mi / 60,000 km / 3 yr**

Main and Auxiliary Transmission – (VOCATIONAL and OFF-HIGHWAY)

- Drain lubricant while warm. Flush each unit with clean flushing oil and refill. Contact your PACCAR Powertrain distributor to drain the transmission.

**Every 74,000 mi / 120,000 km / 4 yr**

Main and Auxiliary Transmission – (CITY DELIVERY)

- Drain lubricant while warm. Flush each unit with clean flushing oil and refill. Contact your PACCAR Powertrain distributor to drain the transmission.

**Every 111,000 mi / 180,000 km / 4 yr**

Main and Auxiliary Transmission – (ON-HIGHWAY)

- Drain lubricant while warm. Flush each unit with clean flushing oil and refill. Contact your PACCAR Powertrain distributor to drain the transmission.

**Peak Operational Temperature:  
203°F (95°C)**

**First 3,000-5,000 mi / 4,800-8,000 km**

Main and Auxiliary Transmission

- Take vehicle to a PACCAR Powertrain distributor to determine the peak operating temperature for specific vehicle application. This temperature will determine which transmission maintenance intervals should be used for this vehicle (see [Automatic Transmission Maintenance](#) on page 29).

**Every 60,000 mi / 96,000 km / 6 mos**

Oil Cooler

- Clean the fins (air-to-oil type) and body. Check the hose condition and for leaks: replace as required. (Refer to Cooling System Maintenance in your chassis operator's manual maintenance instructions.)

Main and Auxiliary Transmission – (VOCATIONAL and OFF-HIGHWAY)

- Drain lubricant while warm. Flush each unit with clean flushing oil and refill. Contact your PACCAR Powertrain distributor to drain the transmission.

**Every 120,000 miles / 193,000 km / 4 yr**

Main and Auxiliary Transmission – (CITY DELIVERY)

- Drain lubricant while warm. Flush each unit with clean flushing oil and refill. Contact your PACCAR Powertrain distributor to drain the transmission.

**Every 224,000 miles / 360,000 km / 4 yr**

Main and Auxiliary Transmission – (ON-HIGHWAY)

- Drain lubricant while warm. Flush each unit with clean flushing oil and refill. Contact your PACCAR Powertrain distributor to drain the transmission.

**Peak Operational Temperature:  
185°F (85°C)**

**First 3,000-5,000 mi / 4,800-8,000 km**

Main and Auxiliary Transmission

- Take vehicle to a PACCAR Powertrain distributor to determine the peak operating temperature for specific vehicle application. This temperature will determine which transmission maintenance intervals should be used for this vehicle (see [Automatic Transmission Maintenance](#) on page 29).

**Every 60,000 mi / 96,000 km / 6 mos**

Oil Cooler

- Clean the fins (air-to-oil type) and body. Check the hose condition and for leaks: replace as required. (Refer to Cooling System Maintenance in your chassis operator's manual maintenance instructions.)

**Every 111,000 mi / 180,000 km / 3 yr**

Main and Auxiliary Transmission – (VOCATIONAL and OFF-HIGHWAY)

- Drain lubricant while warm. Flush each unit with clean flushing oil and refill. Contact your PACCAR Powertrain distributor to drain the transmission.

**Every 223,000 mi / 360,000 km / 4 yr**

Main and Auxiliary Transmission – (CITY DELIVERY)

- Drain lubricant while warm. Flush each unit with clean flushing oil and refill. Contact your PACCAR Powertrain distributor to drain the transmission.

**Every 335,000 mi / 540,000 km / 4 yr**

Main and Auxiliary Transmission – (ON-HIGHWAY)

- Drain lubricant while warm. Flush each unit with clean flushing oil and refill. Contact your PACCAR Powertrain distributor to drain the transmission.

## Troubleshooting

### Diagnostics

In the event there is a problem with this transmission, there are three primary tasks the driver should perform:

1. Note the driving condition under which the problem occurred.
2. Note the condition of the transmission under which the problem occurred (such as operation mode (Drive, Manual, LOW), current gear, and engine speed).
3. Reset system.

### Transmission Reset Procedure

In some cases, proper transmission operation can be restored by “resetting” the Transmission Control Module (TCM). Use the following procedure to reset the TCM.

1. Continue to drive the vehicle to a safe location before selecting Neutral (N).

	<b>NOTE</b>
Once Neutral (N) is selected, a gear engagement may not be allowed depending on the specific problem.	

2. Place the Transmission Driver Interface Device in Neutral (N).
3. Set the vehicle parking brake.

	<b>WARNING</b>
Apply parking brake and follow vehicle manufacturer parking instructions. Failure to follow these instructions could cause unintended vehicle movement resulting in death, serious injury or damage to property.	

4. Turn the vehicle ignition switch to **OFF**.

5. Wait at least 2 minutes.
6. Restart the engine.
7. If the problem continues, contact a service facility to have the vehicle and transmission system evaluated.

### Roadside Assistance

Call toll-free to talk to someone at the PACCAR Customer Center:

- Kenworth customers call: **1-800-KW-Assist (1-800-592-7747)** | Peterbilt customers call: **1-800-4Peterbilt (800-473-8372)**
- Open 24-7-365 days a year.
- They can help you get roadside assistance.
- They have a custom mapping system which locates PACCAR Powertrain distributors and Independent Service Providers (ISPs) near you and lists types of services offered, hours of operation and contact information.
- They can assist with jump and pull starts, tires, trailers, fines and permits, chains, towing, hazardous clean-up, out of fuel (roadside),

mechanical repairs and preventive maintenance services.

- They have multilingual agents and access to a translation service to ensure quality assistance for customers in any language.
- They can't answer your warranty questions, but can get you in contact with a PACCAR Powertrain distributor who can.
- The PACCAR Customer Center service is FREE.



## Chapter 6 | INFORMATION

Proper Transmission Lubrication.....	39
General Model Information.....	39
TX-8 Transmission Lubricant Capacities.....	40
Lubricant Specifications.....	40



## Proper Transmission Lubrication

Proper lubrication procedures are key to a good all-around maintenance program. If the lubricant is not doing its job or if the lubricant level is ignored, all other maintenance procedures are not going to keep the transmission running or assure long transmission life.

Transmission internal parts are amply lubricated if these procedures are closely followed:

1. Maintain lubricant level and inspect regularly.
2. Follow maintenance intervals (see [What is Preventative Maintenance?](#) on page 30).
3. Use the correct grade and type of lubricant, see [Lubricant Specifications](#) on page 40.
4. Buy lubricant from an approved dealer.

## General Model Information

### Model Nomenclature

Following is a nomenclature tree that describes the multiple configurations of the transmission model numbers:

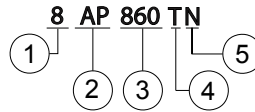

- 1 Number of Gears
- 2 Automatic Powershift
- 3 Maximum Engine Torque (lb•ft)
- 4 Application  
T = Truck  
B = Bus  
P = Pickup
- 5 North America

### Transmission Identification Tag

All transmissions are identified by the model and serial number. This information is stamped on the transmission identification tag and affixed to the case.

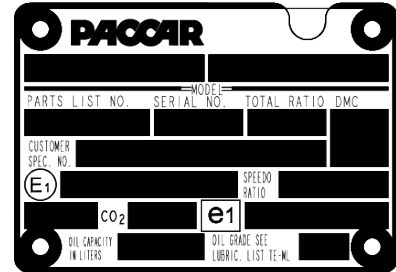

### NOTE

Do not remove or destroy the transmission identification tag.

The blank spaces provided below are for recording transmission identification data. Have these reference numbers handy when ordering replacement parts or requesting service information:

Transmission  
Model

Transmission Serial  
Number

\_\_\_\_\_

\_\_\_\_\_

## TX-8 Transmission Lubricant Capacities

The oil capacities listed here reflect the approximate total amount required to maintain transmission lubrication in the operating range for the stated vehicle and hood configuration. The oil capacity listed on the transmission label plate is the amount needed to fill the transmission *only* and does not include the additional amount needed for hosing and/or an oil cooler.

### Medium Duty

Hood Type	Pints (US)	Liters
Standard	37.8	17.9
Aero	37.8	17.9
Vocational	40.0	18.9

Transmissions equipped with Power Take-off (PTO) have larger capacities than those listed here.

## Lubricant Specifications

PACCAR approves the use of **ZF-Ecofluid Life Plus** synthetic transmission fluid for the TX-8 transmission.

Use of ZF-Ecofluid Life Plus

- Saves fuel
- Reduces operating and maintenance costs
- Increases shift comfort
- Is environmentally friendly
- Works in both hot and cold climates



### NOTE

The maintenance intervals contained in this manual assume the use of ZF-Ecofluid Life Plus. Use of another lubricant invalidates the extended oil change intervals presented.



# Index

## A

Adaptive Driving Mode [13](#)  
Adaptive Starting Gear [13](#)  
Adding Fluid, *See* How to Add Transmission Fluid  
Auto-neutral [13](#)  
Auto-park [13](#)  
Automatic Mode, *See* Manual and Automatic Mode  
Automatic Transmission Maintenance [29](#)

## C

Changing gears, *See* Gearshift Lever  
Checking Transmission Fluid, *See* How to Check Transmission Fluid

## D

Diagnostics [35](#)  
Digital Display  
    Transmission Gear Display [17](#)  
    Transmission Temperature Gauge [17](#)  
DNRP, *See* Transmission Modes

## E

Emergency Release, *See* Manually Releasing the Parking Pawl  
Engine Overspeed and Underspeed Protection [14](#)  
Engine Overspeed Protection [14](#)  
Engine Shutdown [26](#)  
Engine Underspeed Protection [14](#)

## F

Final Chassis Bill of Material [10](#)

## G

Gear Display [17](#)  
Gear stick, *See* Gearshift Lever  
Gearshift Lever [18](#)  
General Safety Instructions [6](#)

## H

Hill Hold Disable Switch [20](#)  
Hill Start Aid [14](#)  
Hill Start Aid Disabled Warning Light [20](#)  
How to Add Transmission Fluid [23](#)  
How to Check Transmission Fluid [23](#)  
How to Drain the Transmission [24](#)

## I

Identification Tag [39](#)  
Illustrations [6](#)

## L

LOW Mode [14](#)  
LOW Mode Operation [24](#)

Lubricant Specifications [40](#)

## M

Maintenance Manuals [10](#)  
Manual and Automatic Mode [19](#)  
Manual Mode [19](#)  
Manually Releasing the Parking Pawl [24](#)  
Model Nomenclature [39](#)

## N

Neutral Idle Control, *See* Neutral Idle Control Plus  
Neutral Idle Control Plus (NIC+) [15](#)

## O

Override [19](#)

## P

Parking Pawl [15](#)  
Parking Pawl Manual Release [15](#)  
Parking Pawl Release, *See* Manually Releasing the Parking Pawl  
**Peak Operational Temperature: 185°F (85°C)**  
Every 111,000 mi / 180,000 km / 3 yr [34](#)  
Every 223,000 miles / 360,000 km / 4 yr [34](#)  
Every 335,000 miles / 540,000 km / 4 yr [34](#)  
Every 60,000 mi / 96,000 km / 6 mos [31](#), [33](#), [34](#)  
First 3,000-5,000 mi / 4,800-8,000 km [31](#), [33](#), [34](#)  
**Peak Operational Temperature: 203°F (95°C)**  
Every 120,000 miles / 193,000 km / 4 yr [33](#)  
Every 223,000 miles / 360,000 km / 4 yr [33](#)  
Every 60,000 mi / 96,000 km / 6 mos [31](#), [33](#), [34](#)  
First 3,000-5,000 mi / 4,800-8,000 km [31](#), [33](#), [34](#)

**Peak Operational Temperature: 221°F (105°C)**

Every 111,000 mi / 180,000 km / 4 yr [31](#)  
Every 37,000 mi / 60,000 km / 3 yr [31](#)  
Every 60,000 mi / 96,000 km / 6 mos [31](#), [33](#), [34](#)  
Every 74,000 mi / 120,000 km / 4 yr [31](#)  
First 3,000-5,000 mi / 4,800-8,000 km [31](#), [33](#), [34](#)

Power Take-off (PTO) [26](#)  
Preventative Maintenance [30](#)  
Proper Transmission Lubrication [39](#)

## R

Repairs [9](#)  
Roadside Assistance [36](#)

## S

Safety Alerts [5](#)  
Shifter, *See* Gearshift Lever  
Shutting Down the Engine, *See* Engine Shutdown  
Starting the Engine [25](#)  
Stationary PTO Operation [26](#)

## T

Transmission Gear Display [17](#)  
Transmission Modes [18](#)  
Transmission Oil Temperature Gauge [17](#)  
Transmission Reset Procedure [36](#)  
Troubleshooting [35](#)  
TX-8 [13](#)

## U

Upshifting and Downshifting [18](#)  
Using this Manual [5](#)

**V**

Vehicle Towing [27](#)



**PACCAR**<sup>inc</sup>  
Powertrain  
P.O. Box 1518  
Bellevue, WA 98009

Y53-1331