

M O D E L

# 579

---





<b>Safety</b>	<b>1</b>
<b>Emergency</b>	<b>2</b>
<b>Controls</b>	<b>3</b>
<b>Driving</b>	<b>4</b>
<b>Maintenance</b>	<b>5</b>
<b>Information</b>	<b>6</b>

## © 2021 PACCAR Inc. - All Rights Reserved

This manual illustrates and describes the operation of features or equipment which may be either standard or optional on this vehicle. This manual may also include a description of features and equipment which are no longer available or were not ordered on this vehicle. Please disregard any illustrations or descriptions relating to features or equipment which are not on this vehicle. PACCAR reserves the right to discontinue, change specifications, or change the design of its vehicles at any time without notice and without incurring any obligation. The information contained in this manual is proprietary to PACCAR. Reproduction, in whole or in part, by any means is strictly prohibited without prior written authorization from PACCAR Inc.





# Chapter 1 | SAFETY

Using this Manual.....	6
Safety Alerts.....	6
Illustrations.....	7
General Safety Instructions.....	7
Data Recorder.....	10
Environmental Protection Agency.....	10
Repairs.....	11
Additional Sources of Information.....	12
Cab Access.....	12
How to Access the Upper Bunk.....	14
Deckplate Access.....	19
How to open the hood.....	20
Seat.....	23
What to do before starting the vehicle.....	32
Vehicle Loading.....	34
Visual inspection while approaching the vehicle.....	34

Daily Checks.....	35
Weekly Checks.....	36
Systems Check.....	37

## Using this Manual

Please take the time to get acquainted with your vehicle by reading this Operator's Manual. We recommend that you read and understand this manual from beginning to end before you operate this equipment.

This manual contains useful information for the safe and efficient operation of this equipment. It also provides service information, with an outline for performing safety checks and basic preventive maintenance inspections. We have tried to present the information you'll need to learn about functions, controls, and operation—and to present it as clearly as possible. We hope you'll find this manual easy to use. There will be times when you need to take this manual out of the glovebox. When you do, please be sure to return it when you are finished using it.

### NOTE

After you've read this manual, it should be stored in the cab for convenient reference and remain with this truck when sold.

Your vehicle may not have all the features or options mentioned in this manual. Therefore, you should pay careful attention to the instructions that pertain to just your vehicle. In addition, if your vehicle is equipped with special equipment or options not discussed in this manual, consult your dealer or the manufacturer of the equipment.

There are several tools built into this manual to help you find what you need quickly and easily; first is the Quick Table of Contents. Located at the front of the manual, this table lists the main subjects covered and gives section numbers where you can find these subjects. Use the Quick Table of Contents to find information on a large subject and then use the detailed table of contents found on the first page of each chapter. Cross-referenced citations also help you get the information you need. If some other part of the manual contains further information on the subject you are reading about, we'll indicate that in a cross-reference like this: (See [Safety Alerts](#) on page 6).

Finally, you'll find a helpful Subject Index. It's in the back of the manual and alphabetically lists the subjects covered. All information contained in this manual is based on the latest production information

available at the time of publication. Peterbilt Motors Company reserves the right to make changes at any time without notice.

## Safety Alerts

Read and follow all of the safety alerts contained in this manual. They are there for your protection and information. These alerts can help you avoid injury to yourself, your passengers, and help prevent costly damage to the vehicle. Safety alerts are highlighted by safety alert symbols and signal words such as "WARNING," "CAUTION," or "NOTE." DO NOT ignore any of these alerts.

### Warnings



The safety message following this symbol and signal word provides a warning against operating procedures which could cause death or injury. They could also cause equipment or property damage. The alert will identify the hazard, how to avoid it, and

the probable consequence of not avoiding the hazard.

Example:

	<b>WARNING</b>
<p>Hot engine oil can be dangerous. You could be burned. Let the engine oil cool down before changing it. Failure to comply may result in death, personal injury, equipment or property damage.</p>	

### Cautions



The safety message following this symbol and signal word provides a caution against operating procedures which could cause equipment or property damage. The alert will identify the hazard, how to avoid it, and the probable consequence of not avoiding the hazard.

Example:

	<b>CAUTION</b>
<p>Continuing to operate your vehicle with insufficient oil pressure will cause serious engine damage. Failure to comply may result in equipment or property damage.</p>	

### Notes



The message following this symbol and signal word provides important information that is not safety related but should be followed. The alert will highlight things that may not be obvious and is useful to your efficient operation of the vehicle.

Example:

	<b>NOTE</b>
<p>Pumping the accelerator will not assist in starting the engine.</p>	

## Illustrations

Some of the illustrations throughout this manual are generic and will not look exactly like the engine or parts used in your application. The illustrations can contain symbols to indicate an action required and/or an acceptable or unacceptable condition.

The illustrations are intended to show repair or replacement procedures. The procedure will be the same for all applications, although the illustrations may differ.

## General Safety Instructions

	<b>WARNING</b>
<p>Improper practices, carelessness, or ignoring any warnings may cause property damage, personal injury, or death.</p>	

**WARNING**

Manually rotating the crankshaft requires a trained technician and specialty tools. DO NOT pull or pry on the fan in an attempt to rotate the crankshaft. Applying force to the fan can damage the fan blades or cause premature fan failure. Failure to comply with the approved procedure may result in property damage, personal injury, or death.

Before performing any repair, read and understand all of the safety precautions and warnings. The following is a list of general safety precautions that must be followed to provide personal safety. Failure to follow these instructions may cause death or injury. Special safety precautions are included in the procedures when they apply.

Keep in mind that even a well maintained vehicle must be operated within the range of its mechanical capabilities and the limits of its load ratings. See the Weight Ratings label on the driver's door edge. Every new vehicle is designed to conform to all Federal Motor Vehicle Safety Standards applicable at the time of manufacture. Even with these safety

features, continued safe and reliable operation depends greatly upon regular vehicle maintenance. Follow the maintenance recommendations found in the Preventive Maintenance section. This will help preserve your investment. Make sure your vehicle is in top working condition before heading out on the road, it is the responsible driver's duty to do so. Inspect the vehicle according to the Driver's Check List.

- Work areas should be dry, well lit, well ventilated, free from clutter, loose tools, parts, ignition sources and hazardous substances.
- Wear protective glasses and protective shoes when working.
- DO NOT wear loose-fitting or torn clothing. Tie back and/or tuck in long hair. Remove all jewelry when working.
- Before beginning any repair, disconnect the battery (negative [-] cable) and discharge any capacitors.
- Put a "DO NOT OPERATE" tag in the operator's compartment or on the controls.
- Allow the engine to cool before slowly loosening the coolant fill cap

to relieve the pressure from the cooling system.

**WARNING**

Removing the fill cap on a hot engine can cause scalding coolant to spray out and burn you badly. If the engine has been in operation within the previous 30 minutes, be very careful in removing the fill cap. Protect face, hands, and arms against escaping fluid and steam by covering the cap with a large, thick rag. DO NOT try to remove it until the surge tank cools down or if you see any steam or coolant escaping. Always remove the cap very slowly and carefully. Be ready to back off if any steam or coolant begins to escape. Failure to comply may result in death, personal injury, equipment or property damage.

- Always use wheel chocks or proper jack stands to support the vehicle or vehicle components before performing any service work. DO NOT work on anything that is supported only by lifting jacks or a hoist. Before resting a vehicle on jack stands, be sure the stands are

- rated for the load you will be placing on them.
- Before removing or disconnecting any lines, fittings, or related items, relieve all pressure in the air, oil, fuel, and cooling systems. Remain alert for possible pressure when disconnecting any device from a system that contains pressure. High pressure oil or fuel can cause death or personal injury.
- Always wear protective clothing when working on any refrigerant lines and make sure that the workplace is well ventilated. Inhalation of fumes can cause death or personal injury. To protect the environment, liquid refrigerant systems must be properly emptied and filled using equipment that prevents the release of refrigerant gas. Federal law requires capturing and recycling refrigerant.
- When moving or lifting any heavy equipment or parts, make sure to use proper techniques and assistance. Ensure all lifting devices such as chains, hooks, or slings are in good condition and are of the correct load capacity.
- Make sure all lifting devices are positioned correctly.
- Corrosion inhibitors and lubricating oils may contain alkali. DO NOT get the substance in eyes and avoid prolonged or repeated contact with skin. DO NOT swallow. If ingested, seek immediate medical attention. DO NOT induce vomiting. In case of contact, immediately wash skin with soap and water. In case of harmful contact, immediately contact a physician. Always keep any chemicals OUT OF REACH OF CHILDREN.
- Naphtha and Methyl Ethyl Ketone (MEK) are flammable materials and must be used with caution. Follow the manufacturer's instructions to ensure safety when using these materials. Always keep any chemicals OUT OF REACH OF CHILDREN.
- When working on the vehicle, be alert for hot parts on systems that have just been turned off, exhaust gas flow, and hot fluids in lines, tubes, and compartments. Contact with any hot surface may cause burns.
- Always use tools that are in good condition. Make sure you have the proper understanding of how to use the tools before performing any service work. Use only genuine replacement parts from PACCAR.
- Always use the same fastener part number (or equivalent) when replacing items. DO NOT use a fastener of lesser quality if replacements are necessary. (e.g., DO NOT replace a SAE 10.9 grade with 8.8 grade fastener.)
- Always torque fasteners and fuel connections to the required specifications. Overtightening or under-tightening can allow leakage.
- Close the manual fuel valves prior to performing maintenance and repairs, and when storing the vehicle inside.
- DO NOT perform any repair when impaired, tired, fatigued, or after consuming alcohol or drugs that can impair your functioning.
- Some state and federal agencies in the United States of America have determined that used engine oil can be carcinogenic and can cause reproductive toxicity. Avoid

inhalation of vapors, ingestion, and prolonged contact with used engine oil.

- DO NOT connect the jump starting or battery charging cables to any ignition or governor control wiring. This can cause electrical damage to the ignition or governor.
- Coolant is toxic. If not reused, dispose of coolant in accordance with local environmental regulations.



### CAUTION

Corrosive chemicals can damage the engine. DO NOT use corrosive chemicals on the engine. Failure to comply may result in equipment or property damage.

### California Proposition 65 Warning

- Diesel engine exhaust and some of its constituents are known to the State of California to cause cancer, birth defects, and other reproductive harm.
- The catalyst substrate located in the Diesel Particulate Filter (DPF)

contains vanadium pentoxide, which has been determined by the State of California to cause cancer. Always wear protective clothing and eye protection when handling the catalyst assembly. Dispose of the catalyst in accordance with local regulations. If catalyst material gets into the eyes, immediately flood eyes with water for a minimum of 15 minutes. Avoid prolonged contact with skin. In case of contact, immediately wash skin with soap and water. In case of harmful contact, immediately contact a physician.

- Other chemicals in this vehicle are also known to the State of California to cause cancer, birth defects or other reproductive harm.
- Battery posts, terminals, and related accessories contain lead and lead compounds, chemicals known to the State of California to cause cancer and reproductive harm. Wash hands after handling.

## Data Recorder

California Vehicle Code - Section 9951 - Disclosure of Recording Device

Your vehicle may be equipped with one or more recording devices commonly referred to as "event data recorders" (EDR) or "sensing and diagnostic modules" (SDM). If you are involved in an accident, the device(s) may have the ability to record vehicle data that occurred just prior to and/or during the accident. For additional information on your rights associated with the use of this data, contact:

- The California Department of Motor Vehicles - Licensing Operations Division
- <http://www.dmv.ca.gov/>

## Environmental Protection Agency

Some of the ingredients in engine oil, hydraulic oil, transmission and axle oil, engine coolant, diesel fuel, air conditioning refrigerant (R12, R134a, and PAG oil), batteries, etc., may contaminate the



environment if spilled or not disposed of properly.

**WARNING**

Diesel engine exhaust and some of its constituents are known to the State of California to cause cancer, birth defects, and other reproductive harm. Other chemicals in this vehicle are also known to the State of California to cause cancer, birth defects or other reproductive harm. This warning requirement is mandated by California law (Proposition 65) and does not result from any change in the manner in which vehicles are manufactured.

Contact your local government agency for information concerning proper disposal.

**Repairs****WARNING**

DO NOT attempt repair work without sufficient training, service manuals, and the proper tools. You could be kil-

led or injured, or you could make your vehicle unsafe. Perform only those tasks you are fully qualified to do.

**WARNING**

Modifying your vehicle can make it unsafe. Some modifications can affect your vehicle's electrical system, stability, or other important functions. Before modifying your vehicle, check with your dealer to make sure it can be done safely. Improper modifications can cause death or personal injury.

**CAUTION**

The installation of electronic devices to the On Board Diagnostics (OBD) connector, the vehicle Controller Area Network (CAN), or their associated wiring is not permitted. Doing so can adversely affect vehicle performance and/or cause fault codes to be recorded. The OBD connector is provided for temporary connection of service tools and for diagnostic purposes only.

Your dealer's service center is the best place to have your vehicle repaired. You can find dealers all over the country with the equipment and trained personnel to get you back on the road quickly—and keep you there.

Your vehicle is a complex machine. Anyone attempting repairs on it needs good mechanical training and the proper tools. However, all warranty repairs must be performed by an authorized service facility. If you aren't an experienced mechanic, or don't have the right equipment, please leave all repairs to an authorized service facility. They are the ones best equipped to do the job safely and correctly.

**Maintenance Manuals**

If you do decide to do any complex repair work, you'll need the maintenance manuals. Order them from your authorized dealer. Please provide your Chassis Serial Number when you order, to be sure you get the correct manuals for your vehicle. Allow about four weeks for delivery. There will be a charge for these manuals.

### Final Chassis Bill of Material

A complete, non-illustrated computer printout listing of the parts used to custom-build your vehicle is available through the dealer from whom you purchased your vehicle.

## Additional Sources of Information

Major component suppliers also supply operation manuals specific to their products. Additional manuals and other pieces of literature are included in the glove box literature package. Look for information on products such as the engine, driver's seat, transmission, axles, wheels, tires, ABS/ESC, radio, fifth wheel, lane departure, and adaptive cruise control. If you are missing these pieces of literature, ask your dealer for copies. Another place to learn more about trucking is from local truck driving schools. Contact one near you to learn about courses they offer. Federal and state agencies such as the department of licensing also have information. The Interstate Commerce Commission can give you information

about regulations governing transportation across state lines.

### Cab Access



#### WARNING

Always reinstall steps before entering the cab or accessing the deck plate. Without steps you could slip and fall. Failure to comply may result in personal injury or death.



#### WARNING

Keep steps clean. Clean any fuel, oil, or grease off the steps before entering the cab or accessing the deck plate. Stepping on a slippery surface can cause a fall which may result in death or personal injury.

Be careful whenever you get into or out of your vehicle's cab. Always maintain at least three points of contact with your hands on the grab handles and your feet on the steps. The following picture shows

the best way to enter and exit a Conventional Cab.



#### WARNING

Jumping out of the cab or getting into the cab without proper care is dangerous. You could slip and fall, which could lead to death or personal injury. Keep steps clean. Clean any fuel, oil, or grease off of the steps before entering the cab. Use the steps and grab handles provided, and always keep at least three points of contact between your hands and feet and the truck. Look where you are going.



### How to Lock and Unlock the Cab Doors

The vehicle has one key for cab doors, ignition, and the optional sleeper luggage compartment. Frame-mounted tool box locks and locking fuel tank caps each have separate, individual keys.



### WARNING

To help lessen the chance and/or severity of death or personal injury in case of an accident, always lock the doors while driving. Along with using the lap shoulder belts properly, locking the doors helps prevent doors from inadvertently opening and occupants from being ejected from the vehicle.

To lock or unlock the doors from outside the cab:

1. • Rotate the key toward the rear of the vehicle to lock (clockwise), or
- Rotate the key toward the front of the vehicle (counter clockwise) to unlock.

### Remote Keyless Entry (Option)

Remote Keyless Entry (RKE) is a system that adds security and convenience to your vehicle. The system will lock or unlock cab doors with the key fob. The system will alert you with parking lights when the selected doors are locked or unlocked. The system includes two key fobs that provide

secure rolling code technology that prevents someone from recording the entry signal.



### NOTE

FCC ID: L2C0031T IC: 3432A-0031T  
 FCC ID: L2C0032R IC: 3432A-0032R  
 This device complies with Part 15 of the FCC Rules and with RSS-210 of Industry Canada. Operation is subject to the following two conditions (1) This device may not cause harmful interference, and (2) This device must accept any interference received, including interference that may cause undesired operation. Changes or modifications not expressly approved by the party responsible for compliance could void the user's authority to operate the equipment. The term IC: before the radio certification number only signifies that Industry Canada technical specifications were met.

### Operate Door Locks using Remote Keyless Entry

Open doors will not lock using the key fob. The key fob should be within 30 ft. (9 m) of

1

the vehicle and should not be in proximity of other RF sources such as television, radio or cell phone transmitters.

To unlock the cab doors:

1. Press the **UNLOCK** button once. The driver's door will unlock and the parking lights will come on for 40 seconds.
2. Quickly press the **UNLOCK** button a second time within 5 seconds to unlock the passenger door.
3. Press the **LOCK** button. The doors will lock and the parking lights will come on for 2 seconds.

## How to Access the Upper Bunk

### Upper Bunk Ladder

This vehicle may be equipped with an upper bunk ladder. The ladder enables you to conveniently climb into the upper bunk without stepping on the lower bunk. The ladder can be unfolded when needed. The ladder folds up into the upper bunk structure when not in use, while driving, or when accessing the lower bunk. The

ladder can be folded up into the upper bunk.

Ladder Folded and Latched

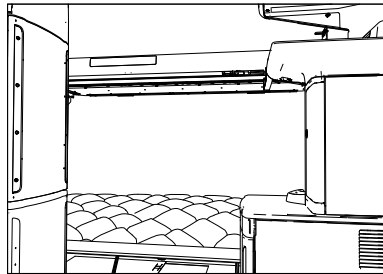

Ladder Partially Unfolded

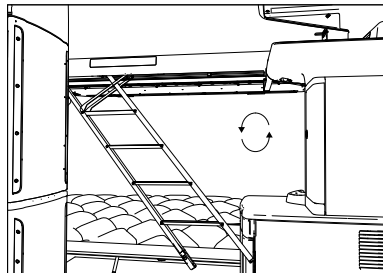

Ladder Unfolded

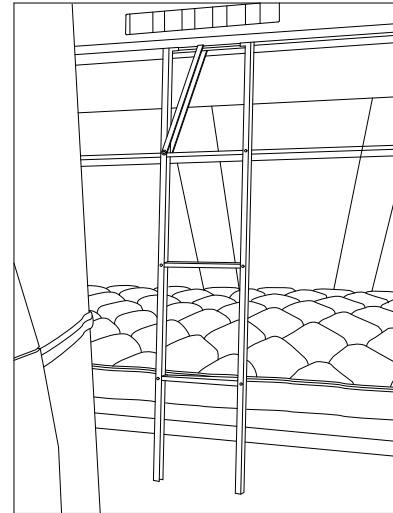

### How to Unfold the Upper Bunk Ladder

It is important to follow all specified safety instructions when unfolding the upper bunk ladder.

**WARNING**

DO NOT attempt to fold or unfold the ladder while an occupant is in the lower bunk. Allow the lower bunk occupant to vacate the bunk before folding or unfolding the ladder. Failure to do so may result in personal injury.

**CAUTION**

Upper bunk must be in down position before folding and unfolding the ladder. Always lower the upper bunk before folding and unfolding the ladder. Failure to do so may result in property damage.

**CAUTION**

Lower bunk must be in down position before folding and unfolding the ladder. Failure to do so may result in property damage.

**CAUTION**

Make sure floor area is clear prior to folding and unfolding the ladder. There should be nothing between the ladder leg and floor carpet when the ladder is unfolded. Failure to do so may result in property damage.

1. Ensure the lower bunk is in the down position.
2. Lower the upper bunk.
3. Locate the release latch on the driver's side front edge of the upper bunk.
4. Release the ladder by pulling the latch out.

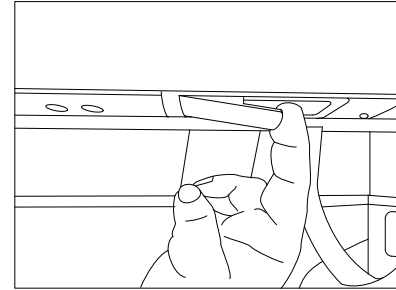
**Unlatching the ladder**

5. Position your left hand, open palm, beside the latch to control the unfolding action of the ladder as it separates from the bunk structure. Maintain contact with your left hand, open palm, in the same position until the ladder is completely unfolded.
6. When the ladder is about half way unfolded, position your right hand, open palm, on the upper right side of the ladder to help guide the ladder into position.

1



**WARNING**

DO NOT grip the ladder while folding and unfolding it. Always use an open hand when folding and unfolding the ladder to prevent injuries and pinching of fingers. Failure to comply may result in personal injury.

Apply pressure in opposite directions to ensure smooth operation of the ladder.

**Hand Positions to Unfold the Ladder**

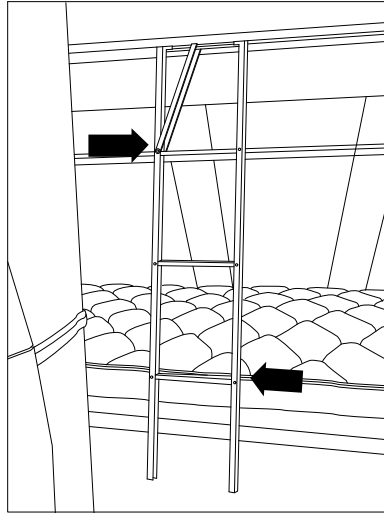

7. Make sure the ladder is completely unfolded against the internal stop. The ladder should be vertical at this point.



**CAUTION**

Do not attempt to open the lower bunk when the ladder is unfolded and vertical. Failure to comply may result in property damage.



**CAUTION**

Never attempt to pull the bottom of the ladder forward when the ladder is in the down position. Failure to comply may result in property damage.



**CAUTION**

Never attempt to fold or force the ladder toward the passenger side of the vehicle once the ladder has reached vertical position and is against the internal stop inside the upper bunk. Doing so can cause damage to the ladder.

## How to Climb In and Out of the Upper Bunk



### WARNING

Make sure the ladder is fully open before climbing up or down the ladder. The ladder should be against internal stops and vertical before using it. Failure to do so may result in death or personal injury.



### WARNING

Never use the ladder while the vehicle is in motion. Always fold and stow the ladder before moving the vehicle. Failure to comply may result in death or personal injury.



### WARNING

Do not exceed the weight limit of 320 lb on the ladder. Failure to comply may result in personal injury or death.



### WARNING

Never climb a damaged, bent, or broken ladder. Doing so may result in personal injury.



### WARNING

Never allow multiple people on the ladder at the same time. Only one person on the ladder at any time. Failure to comply may result in personal injury.

Make sure the ladder is in the unfolded position.

1. Face the ladder when climbing up or down.

Face the ladder

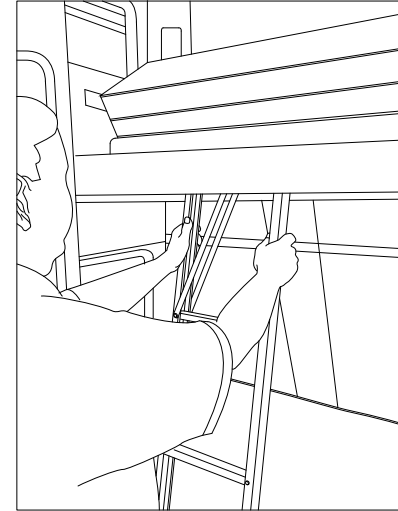

2. Maintain a firm grip when climbing up or down the ladder. Use the ladder and grab handles provided, and always keep at least three points of contact between your hands and feet and the truck. Always face toward the bunk when entering or exiting the upper bunk and look where you are going.

1

3. As you get higher on the ladder, maintain contact with the sleeper upper grab handles as you get onto the upper bunk.

Upper Grab Handles

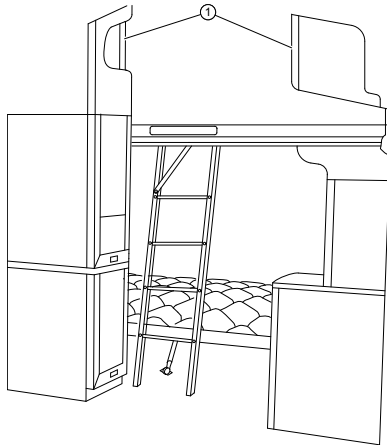

1. Upper Grab Handles

### How to Fold the Upper Bunk Ladder

#### WARNING

DO NOT attempt to fold or unfold the ladder while an occupant is in the lower bunk. Allow the lower bunk occupant to vacate the bunk before folding or unfolding the ladder. Failure to do so may result in personal injury.

#### CAUTION

Lower bunk must be in down position before folding and unfolding the ladder. Failure to do so may result in property damage.

1. Ensure that the lower bunk is in the down position.
2. Position your left hand, open palm, against the lower left side of the ladder. Maintain contact with your left hand, open palm, in the same position until the ladder is completely folded.
3. Position your right hand, open palm, against the upper right side

of the ladder. Maintain contact with your left hand, open palm, in the same position until the ladder is approximately half-way folded.

Hand Positions to Fold the Ladder





 **WARNING**

DO NOT grip the ladder while folding and unfolding it. Always use an open hand when folding and unfolding the ladder to prevent injuries and pinching of fingers. Failure to comply may result in personal injury.

 **CAUTION**

Lower bunk must be in down position before folding and unfolding the ladder. Always fold the ladder before raising the lower bunk. Failure to do so may result in property damage.

Apply pressure in opposite directions to ensure smooth operation of the ladder.

 **WARNING**

Right hand must be clear of the ladder when it is approximately half-way folded. Failure to do so may result in personal injury.

- 4. Use the right hand to apply pressure to the left and

simultaneously use the left hand to apply pressure to the right. The ladder will begin to fold up.

- 5. When the ladder is approximately half-way folded, remove your right hand from the right side of the ladder.
- 6. Continue to push with your left hand until the ladder has been folded into the upper bunk structure.
- 7. Secure the latch.

 **CAUTION**

Make sure the ladder is fully closed while the vehicle is in motion. Failure to do so may result in property damage.

### Deckplate Access

 **WARNING**

Always reinstall steps before entering the cab or accessing the deck plate.

Without steps you could slip and fall. Failure to comply may result in personal injury or death.

 **WARNING**

Keep steps clean. Clean any fuel, oil, or grease off the steps before entering the cab or accessing the deck plate. Stepping on a slippery surface can cause a fall which may result in death or personal injury.

 **WARNING**

When you are climbing onto and off the deck plate, maintain at least three points of contact with your hands on the grab handles and your feet on the steps. Always face toward the vehicle when entering or exiting the cab and look where you are going. Failure to comply may result in death or personal injury.

1

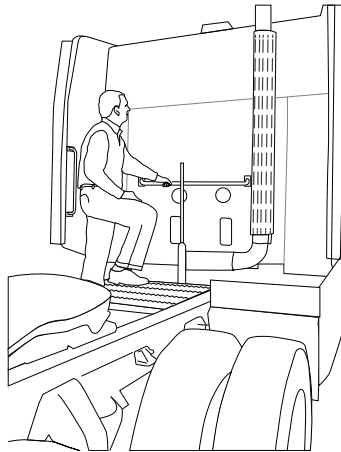
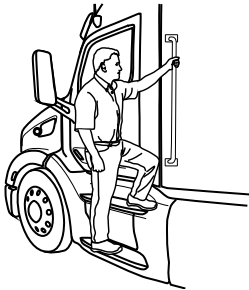

**WARNING**

When stepping onto a surface to enter the cab or access the deck plate, only use the steps and grab handles installed and designed for that purpose. Failure to use the proper steps and grab handles could cause a fall which may result in death or personal injury.



**NOTE**

Any alteration (adding bulkheads, headache racks, tool boxes, etc.) behind the cab that affects the utilization of installed grab handles, deck plates, or frame access steps should comply with Federal Motor Carrier Safety Regulation 399.

mating side is on the cab or quarter fenders.



**WARNING**

Before opening or closing the hood, make sure your footing is secure and stable. Failure to do so may cause the hood to open or close uncontrollably which may result in death or personal injury.

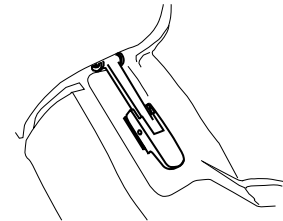

## How to open the hood

Access the engine by opening the hood. The hood is typically held in the closed position by a latch system. The latches are typically mounted on the hood and the

**CAUTION**

A hood not latched securely could open during operation and cause vehicle damage. Be sure to latch the hood securely.

**WARNING**

A pivoting hood could hurt someone or be damaged itself. Before opening or closing the hood, be sure there are no people or objects in the way. Failure to stand in a position of safety can cause death or personal injury.

1. Release the latches

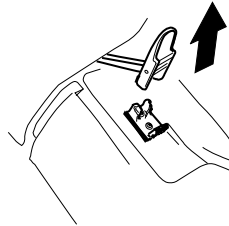
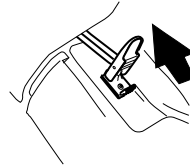

2. Put one or both hands on the top of the hood front. Tilt the hood forward by pulling at the top of the hood keeping your feet on the ground for stability. Keep pulling on the hood until you are certain that the hood hold open device is engaged.

**Close the Hood**

The hood hold-open device will only be engaged if the vehicle hood is fully open. Once it is fully open, the latch will automatically engage and will need to be disengaged by the operator. The release lever for the hood hold-open device is located near the front hinge of the hood.

1

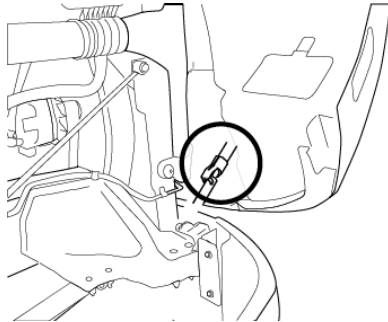

Pull the lever out to disengage the hood hold-open device.

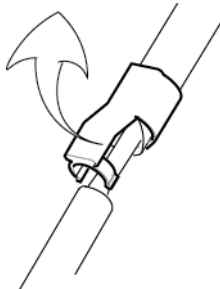

When closing the hood, be sure that you maintain the same point of contact (top of hood) to control the movement of the hood as it closes. Gently lower the hood into place to avoid damage to the hood or cab.

**! WARNING**

DO NOT let go of the hood while it closes. Close the hood in a controlled manner which requires hands firmly grasping the hood and feet on a stable, non-slip, surface. Failure to control the hood as it closes may result in death or personal injury

**! WARNING**

Always ensure the hood hold open latch is engaged to keep the hood fully open any time anyone gets under the hood for any reason. Failure to do so may cause the hood to close uncontrollably which may result in death or personal injury.

**! WARNING**

Before closing the hood, be sure the area is clear—no people or objects are in the way. Failure to do so may result in death or personal injury.

### Under Hood Air Intake?

The option for under hood intake is a switch on the dash that allows the operator to use air from under the hood in the event the air filter housing's inlet is blocked by snow or ice.

**! WARNING**

DO NOT open the under hood air door with hands. This door is held closed with a spring which may pull the door closed unexpectedly. Failure to comply may result in personal injury.

**! CAUTION**

Only operate the under hood intake air switch when outside temperatures are below 32°F (0°C). Engaging the under hood air intake while temperatures are above freezing may result in engine damage.

The switch is directly wired to a solenoid on the air filter housing. This air solenoid (normally closed) will engage when signaled which will supply air to a piston. This air pressure will overcome a spring

which holds a door closed inside the air filter housing. Fully engaged, the door will open and air will enter from under the hood instead of the opening on the side of the hood.

## Seat

This seat has up to ten different controls that maximize the driver's comfort. Lumbar (and bolster support if available) are provided for superior support to the back during operation. Lower support is standard and the optional functions include upper lumbar and bolster functions. Pressing on the "+" symbol of the button will add support in the area. Pressing the opposite side of the button will release pressure and will reduce support in the area.



The seats in this vehicle are equipped with a switch that locks out the fore-aft isolator function in the seat. When locked, the seat will not move back and forth. It will be rigidly fixed and only allowed to move up and down with the vehicle's movements. This vehicle may be equipped with a swivel function on the passenger seat. This function allows the passenger seat to rotate and face towards the inside of the cab.



### WARNING

Always ensure that the passenger seat is locked into the forward facing position when the vehicle is in motion. Locking the swivel seat into the forward facing position maximizes visibility to the surrounding area. Failure to comply creates a safety hazard that may result in death or personal injury.



### WARNING

DO NOT use the swivel function while a passenger is in the seat and the vehicle is in motion. The seat belt will not provide proper protection if the passenger is not facing forward and the vehicle is in an accident. Failure to comply may result in death or personal injury.

1

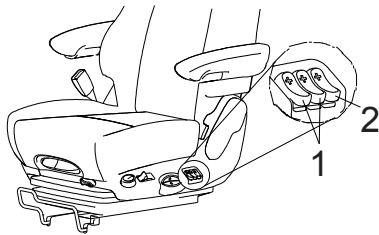

1. Lower and Upper Lumbar Adjustment
2. Bolster Adjustment (option)

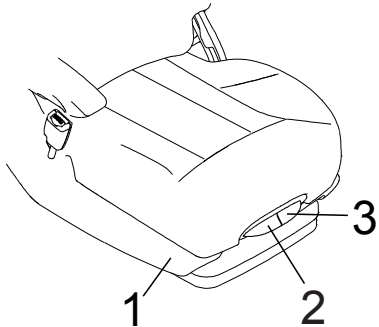

1. Seat heater/cooler
2. Seat thigh support up/down
3. Seat bottom angle adjustment

**CAUTION**

DO NOT use the seat heater for more than 10 minutes at a time. Always turn off the seat heaters when they are not needed. Overuse of the seat heater may decrease the capacity of the vehicle's batteries and may result in poor starting and potential equipment damage.

**WARNING**

This seat may be equipped with a seat heater or ventilation system. There is a possibility that some people may suffer heat-induced burns or excessive cooling when using the system. DO NOT use either of these systems if you have a diminished ability to sense temperature, a reduced ability to feel pain, or have sensitive skin.

**WARNING**

When using the seat heater or ventilation system, DO NOT place anything on the seat that insulates against heat or cooling, such as a blanket, cushion, or similar item. This may cause the seat heater or ventilation system to overheat, which may cause a heat-induced burn or may damage the seat.

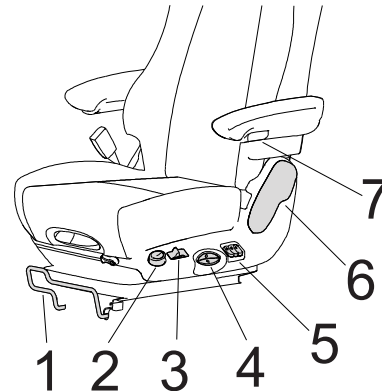

1. Seat fore/aft
2. Express down
3. Suspension stiffness

4. Seat height
5. Lumbar and Bolster (Bolster is an optional feature)
6. Recline
7. Armrest angle

**WARNING**

DO NOT drive or ride with your seat back in the reclined position. You could be injured by sliding under the seat belts in a collision. Failure to comply may result in personal injury or death.

**Passenger Seat Swivel (Option)**

This vehicle may be equipped with a swivel function on the passenger seat. This function allows the passenger seat to rotate and face towards the inside of the cab.

**WARNING**

Always ensure that the passenger seat is locked into the forward facing position when the vehicle is in motion.

Locking the swivel seat into the forward facing position maximizes visibility to the surrounding area. Failure to comply creates a safety hazard that may result in death or personal injury.

**WARNING**

DO NOT use the swivel function while a passenger is in the seat and the vehicle is in motion. The seat belt will not provide proper protection if the passenger is not facing forward and the vehicle is in an accident. Failure to comply may result in death or personal injury.

**How to adjust a seat****WARNING**

DO NOT adjust the driver's seat while the vehicle is moving. The seat could move suddenly and unexpectedly and can cause the driver to lose control of the vehicle. Make all adjustments to the seat while the vehicle is stopped. After adjusting the seat and before

driving off, always check to ensure that the seat is firmly latched in position. Failure to comply may result in personal injury, death, equipment or property damage.

**WARNING**

Before driving or riding in a vehicle, ensure that there is adequate head clearance at maximum upward travel of seat. Injury may occur if head clearance is not adequate. Failure to comply may result in personal injury or death.

1. Set the seat's fore/aft position via the bar located below the seat cushion. This is a mechanical latch that does not involve any electric or air operated devices to control adjustment.
2. Set the seat height via the large switch on the left side of the seat cushion. This switch is located in the center of the seat pad and uses air to adjust the seat height.
3. Adjust the thigh support by toggling the switch located immediately

under the seat bottom cushion and above the fore/aft position adjustment lever.

4. Adjust the seat bottom angle using the switch next to the thigh support.
5. Adjust the seat back recline angle using the large lever situated near the seat belt buckle.
6. Adjust the lumbar support by using the switch bank located on the side the seat cushion between the up/down adjustment switch and the seat recline adjustment lever.
7. Adjust the steering wheel.
8. Adjust the cab side mirrors.

### Safety Restraint Belts

Safety belts have proven to be the single most effective means available for reducing the potential for either death or personal injury in motor vehicle accidents. The combination lap/shoulder belt is equipped with a locking mechanism. The system adjusts automatically to a person's size and movements as long as the pull on the belt is slow. Hard braking or a collision locks the belt. The belt will also lock when driving up or down a steep hill or in a sharp curve.

Unbelted riders could be thrown into the windshield or other parts of the cab or could be thrown out of the cab. They could strike another person. Injuries can be much worse when riders are unbelted. Always observe user warnings pertaining to safety belts. Your vehicle is equipped with a seat belt indicator lamp located on the dash.



#### WARNING

DO NOT drive vehicle without your seat belt and your passengers' belts fastened. Riding without a safety belt properly fastened can lead to injury or death in an emergency.



#### WARNING

DO NOT use the swivel function while a passenger is in the seat and the vehicle is in motion. The seat belt will not provide proper protection if the passenger is not facing forward and the vehicle is in an accident. Failure to comply may result in death or personal injury.

### Correct Use of Restraint

#### Correct Placement of Lap Belt

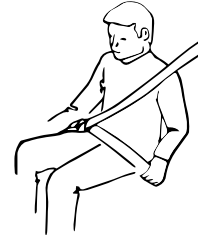

#### Correct Placement of Shoulder Belt





**Incorrect Use of Restraint**

Lap Belt Too High on the Hip

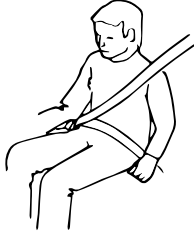

Shoulder Belt Incorrectly Under the Arm



Safety Restraint Belt Twisted

**During Pregnancy**

Pregnant women should always wear combination lap/shoulder belts. The lap belt portion must be worn snugly and as low as possible across the pelvis. To avoid pressure on the abdomen, the belt must never pass over the waist. A properly worn seat belt may significantly reduce the risks to woman and baby in the event of a crash.

**Safety Restraint Tips**

- DO NOT wear a belt over rigid or breakable objects in or on your clothing, such as eye glasses, pens, keys, etc., as these may cause injury in an accident.
- Any authorized person sleeping in your vehicle while it is moving should use the bunk restraint.
- Any authorized person sitting in the sleeper area on the sofa bed (if equipped) while it is moving should wear a seat belt.
- A responsible operator sees to it that everyone in the vehicle rides or sleeps safely. The operator is responsible to inform any passengers or co-drivers how to

- properly use the seat belts and bunk restraint in the vehicle.
- DO NOT strap in more than one person with each belt.
- Keep seat belt and bunk restraint buckles free of any obstruction that may prevent secure locking.
- Damaged or worn belts in the cab or sleeper subjected to excessive stretch forces from normal wear, must be replaced. They may not protect you if you are in an accident.
- Any belts or restraints that have been subjected to an accident should be inspected for any loose (attaching) hardware or damaged buckles.
- If belts show damage to any part of assembly, such as webbing, bindings, buckles or retractors, they must be replaced.
- DO NOT allow safety belts (seat or bunk) to become damaged by getting caught in door, bunk, or seat hardware, or rubbing against sharp objects.
- All belts must be kept clean or the retractors may not work properly.
- Never bleach or dye seat or bunk restraint belts: chemicals can weaken them. Do, however, keep them clean by following the care label on the belts. Let them dry completely before allowing them to retract or be stowed away.
- Make sure the seat belts and bunk restraint of the unoccupied passenger seat or bunk is fully wound up on its retractor or is stowed, so that the belt or restraint tongue is in its properly stowed position. This reduces the possibility of the tongue becoming a striking object in case of a sudden stop.
- DO NOT modify or disassemble the seat belts or bunk restraint in your vehicle. They will not be available to keep you and your passengers safe.
- If any seat belt or bunk restraint is not working properly, see an authorized dealer for repair or replacement.

### How to Use Lap/Shoulder Belt

Follow these steps to fasten your seat belt and be sure anyone riding with you does the same.



#### WARNING

Proper seat belt adjustment and use is important to maximize occupant safety. Failure to wear or adjust the safety belt properly may result in death or personal injury.

To fasten the belt:

1. Grasp the belt tongue.
2. Pull belt in a continuous slow motion across your chest and lap.
3. Insert belt tongue into buckle on inboard side of seat.
4. Push down until the tongue is securely locked with an audible click.
5. Pull belt to check for proper fastening and adjustment.
  - a. Pull shoulder section to make sure belt fits snugly across the chest and pelvis.

- b. There should be less than one inch (25 mm) gap between the body and the belt.
- c. The shoulder belt must be positioned over the shoulder, it must never rest against the neck or be worn under the arm.
- d. Make sure any slack is wound up on the retractor and that the belt is not twisted.

If the belt is locked, lean the body back to remove any tension in the belt. After releasing the belt, allow the belt to retract completely by guiding the belt tongue until the belt comes to a stop.

To unfasten the belt, push the release button on the buckle and the belt should spring out of the buckle. The seat belt indicator will turn off once the driver's seat

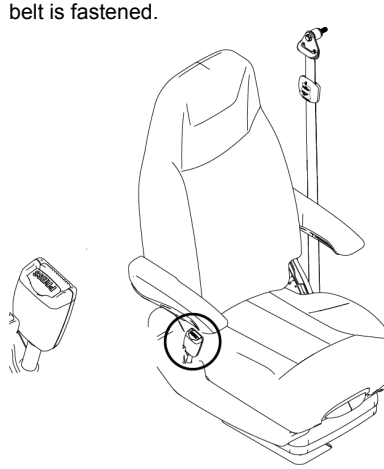

### Tether Belts

Make sure that the tether belt is attached to the cab floor and seat frame. It should be routed through the buckle on each side. Often the attachments are made using a split-type hook. Make sure both halves of the hook are around the anchor bracket.



### WARNING

DO NOT remove, modify, or replace the tether belt system with a different tether system. A failed or missing tether belt could allow the seat base to fully extend in the event of an accident. Failure to comply may result in death or personal injury.



### WARNING

Failure to adjust external tether belts properly can cause excessive movement of the seat in an accident. Tether belts should be adjusted so that they are taut when the seat is in its most upward and forward position. Failure to comply may result in death or personal injury.

Adjust an external tether by either lengthening or shortening the strap. To lengthen it:

1. Turn the buckle to a right angle to the webbing.
2. Then pull the buckle.

3. To shorten the tether, pull on the strap.

### Komfort Latch Feature

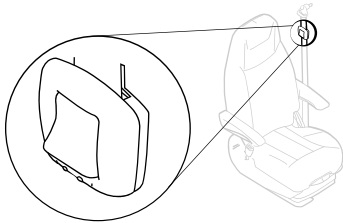

#### WARNING

DO NOT set the Komfort Latch with too much slack. Too much slack may reduce the effectiveness of the seat belt. Failure to comply may result in death or personal injury.

To eliminate cinching, simply activate the Komfort Latch device located on the seat belt webbing at the appropriate time:

1. Adjust the seat to its proper driving position.
2. Latch the seat belt.
3. If available, adjust the seat belt height adjuster to a comfortable driving position.
4. While seated appropriately, push the "on" button to engage the Komfort Latch.
5. Lean forward in the seat until you hear a "click."
6. Return to normal driving position, and the Komfort Latch maintains the preset amount of tension relief.

More information and video tutorials can be found at: <http://www.clicktugsnug.com/>  
To disengage the mechanism unbuckle the seat belt and then press the **OFF** button of the Komfort Latch or tug on the shoulder strap.

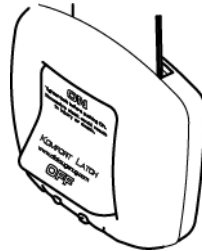

### Belt Damage and Repair

Damaged belts in the cab must be replaced. Belts that have been stretched, cut, or worn out may not protect you in an accident.

If any seat belt is not working properly, see an Authorized Service Center for repair or replacement.

For further information on seat belts and seat belt maintenance, see [Safety Restraint System - Inspection](#) on page 249.

### Sleeper Bunks and Restraints

This vehicle comes equipped with a bunk restraint for the primary lower bunk and the optional upper bunk. These restraints should be used whenever the bunks are occupied by a person while the vehicle is in motion. The sleeper bunk restraint is intended to reduce the risk of being thrown from the bunk in a crash. This device is not designed to hold the occupant in a fixed position on the bunk and may not prevent all injuries in the event of a crash.

**WARNING**

Be sure the restraint system is used when anyone is occupying the sleeper while the vehicle is moving. In an accident, an unrestrained person lying in a sleeper bunk could be seriously injured. He or she could be thrown from the bunk. Failure to comply may result in death, personal injury, equipment or property damage.

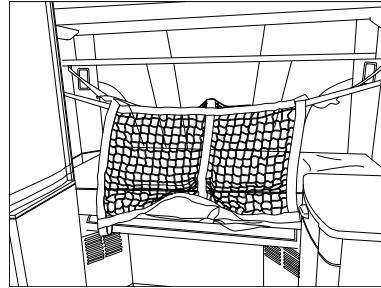
**Lower Bunk Sleep Restraints****WARNING**

Any loose items on the upper or lower bunk should be moved to a secured place before driving the vehicle. Failure to comply may result in death, personal injury, equipment or property damage.

Per FMCSR 392.60 - Unauthorized Persons Not to be Transported. Federal law prohibits the transportation of persons in commercial vehicles unless they are specifically authorized in writing by the motor carrier. See the cited FMCSR for a

**Lower Bunk****WARNING**

Always keep the lower bunk in its horizontal, latched, position while the vehicle is moving. If left open, stored items could become loose during an accident and strike you, causing death or personal injury.

Before you move the vehicle, check to be sure the lower bunk is in the down position.

**Upper Bunk****WARNING**

Be sure the latch that holds the upper bunk in the folded position is working properly so the bunk will not fall down. Pull on the bunk to be sure it is latched securely. If the bunk falls, you could be injured. Failure to comply may result in death, personal injury, equipment or property damage.

1

complete description of the regulation and exemptions.

#### Upper Bunk Sleep Restraints

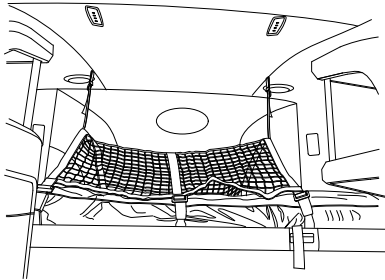

#### Upper Rear Sleeper Storage

Your vehicle may be equipped with an upper storage shelf that extends over the lower bunk and across the rear of the sleeper. The following warning applies:



#### WARNING

Overhead compartments are not intended for personnel use or for items exceeding their designed weight limits. Exceeding the weight limits may cause the shelf to collapse and/or items may

fall out in a sudden stop which may lead to death or personal injury.

Compartments in the cab and sleeper are provided for storage of necessary items used during operation. The storage areas above the door are designed to hold a combined total not exceeding 14 lbs (6 kg) per compartment and the other overhead compartments (including those in the optional sleeper) should hold a combined total not exceeding 5 lbs (2.2 kg) per compartment.

## What to do before starting the vehicle

### Safe Vehicle Operation

Be sure to perform pre-trip inspections before starting and operating the vehicle. For your safety, as well as those around you, be a responsible driver:

- If you drink alcohol, do not drive.
- Do not drive if you are tired, ill, or under emotional stress.

Safe driving is only possible with the proper concentration on the driving task. Keep distraction to a minimum to improve your concentration. Examples of

distractions may include radio controls, GPS navigation controls, cellular telephone calls, cellular text messages, reading or reaching for something on the floor.

Minimizing your distractions will improve safe driving and will help avoid an accident involving death or personal injury.

Be aware of local regulations that may prohibit the use of cellular telephones while driving. In addition to being an unsafe practice, it may be against local or federal ordinances to use cellular devices while operating the vehicle.

Much has gone into the manufacturing of your vehicle including advanced engineering techniques, rigid quality control, and demanding inspections. These manufacturing processes will be enhanced by you, the safe driver, who observes the following:

- Knows and understands how to operate the vehicle and all its controls
- Maintains the vehicle properly
- Uses driving skills wisely.

This manual is not a training manual. It cannot tell you everything you need to know about driving your vehicle. For that you need a good training program or truck driving school. If you have not been trained, get the proper training before you

drive. Only qualified drivers should drive this vehicle.

For more information, refer to Department of Transportation Regulation 392.7, which states that interstate commercial motor vehicles are not to be driven unless the driver is sure that certain parts and accessories are in working order.

Do not drink alcohol and drive. Your reflexes, perceptions, and judgment can be affected by even a small amount of alcohol. You could have a serious or even fatal accident, if you drive after drinking. DO NOT drink and drive or ride with a driver who has been drinking.



### WARNING

The use of alcohol, drugs, and certain medications can impair perception, reactions, and driving ability. These circumstances can substantially increase the risk of an accident. Failure to comply may result in property damage, personal injury, or death.



### WARNING

DO NOT text and drive. Your reaction time, perceptions, and judgment can be affected while texting or using any other form of mobile messaging while driving. Failure to comply may result in death, personal injury, equipment or property damage.

### Emergency Equipment

It is good practice to carry an emergency equipment kit in your vehicle. One day, if you have a roadside emergency, you will be glad the following items are with you:

- Window scraper
- Snow brush
- Container or bag of sand or salt
- Emergency light
- Warning triangles
- Small shovel
- First aid kit
- Fire extinguisher
- Vehicle recovery hitches.

### Drivers Checklist

To keep your vehicle in top shape and maintain a high level of safety for you, your passengers, and your load, make a thorough inspection every day before you drive. You will save maintenance time later, and the safety checks could help prevent a serious accident. Please remember, too, that Federal Motor Carrier Safety Regulation 392.7 requires a pre-trip inspection and so do commercial trucking companies.

You are not expected to become a professional mechanic. The purpose of your inspections is to find anything that might interfere with the safe and efficient transportation of yourself, any passengers, and your load. If you do find something wrong and cannot fix it yourself, have an authorized dealer or qualified mechanic repair your vehicle right away. The following operations are to be performed by the driver. Performing these checks and following the maintenance procedures in this manual will help keep your vehicle running properly.

## Vehicle Loading



### WARNING

DO NOT exceed the specified load rating. Overloading can result in loss of vehicle control, either by causing component failures or by affecting vehicle handling. Exceeding load ratings can also shorten the service life of the vehicle. Failure to comply may result in death or personal injury.



### WARNING

An unevenly distributed load or excessive load over one axle can adversely affect the braking and handling of your vehicle, which could result in an accident. Even if your load is under the legal limits, be sure it is distributed evenly. Failure to comply may result in death, personal injury, equipment or property damage.

The Gross Vehicle Weight Rating (GVWR) or the maximum front and rear Gross Axle Weight Ratings are determined by the

components installed from the factory on to the vehicle and their designed specifications. (Axle weight ratings are listed on the driver's door edge.)

<b>GVWR</b>	Gross Vehicle Weight Rating. This is the <b>MAXIMUM WEIGHT</b> your vehicle is allowed to carry, including the weight of the empty vehicle, loading platform, occupants, fuel, and any load. Never exceed the GVWR of your vehicle.
<b>GCW</b>	Gross Combination Weight (GCW). This is the actual combined weight of your vehicle and its load: vehicle, plus trailer(s), plus cargo.
<b>GAWR</b>	Gross Axle Weight Rating. This is the total weight that one axle is designed to transmit to the ground. You will find this number listed on the driver's door edge.
<b>Load Distribution</b>	Be sure any load you carry is distributed so that no axle has to support more than its GAWR.

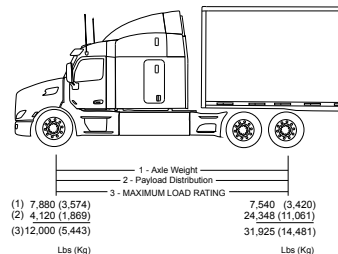

1. Axle Weight
2. Payload Distribution
3. Maximum Load Rating

Be sure that the load on the vehicle is distributed evenly across each axle so that no axle has to support more than its rated GAWR. In total, the vehicle and its load should not exceed the GAWR for each axle and must not exceed the GCW.

## Visual inspection while approaching the vehicle

While approaching the vehicle, inspect the general appearance of the vehicle and its surroundings for any signs of needed attention.



**NOTE**

If equipped with a three-piece roof fairing, **DO NOT DRIVE WITH ROOF FAIRING FOLDED DOWN**, since the marker lamps will not be effective in that position.

Perform these basic inspection steps before operating the vehicle.

1. Check the overall appearance and condition. Are windows, mirrors, and lights clean and unobstructed?
2. Is the air-intake opening clear of obstructions?
3. Check beneath the vehicle. Are there signs of fuel, oil, or water leaks?
4. Check for damaged, loose, or missing parts. Are there parts showing signs of excessive wear or lack of lubrication? Have a qualified mechanic examine any questionable items and repair them without delay.
5. Check your load. Is it secured properly?

**Daily Checks****NOTE**

These checks are in addition to, not in place of, Federal Motor Carrier Safety Regulations. These regulations may be purchased by writing to: Superintendent of Documents U.S. Government Printing Office Bookstore 710 N. Capitol St. N.W. Washington, DC 20402, or [ContactCenter@gpo.gov](mailto>ContactCenter@gpo.gov).

**Engine**

- Engine oil
- Engine coolant
- Power steering fluid
- Engine belt
- Fuel filter (water separator) [Fuel System](#) on page 274
- Windshield washer fluid
- Battery cables - check the condition of the battery and alternator cables for signs of chafing or rubbing. Make sure that all clamps (straps) holding the

cables are present and in good working order.

- Hood latch
- Brake lines and hoses
- Steering components - check pitman arm, drag link, tie rod, steering shaft and power steering hoses, etc., for loose, broken, or missing parts.
- Hydraulic clutch fluid

**Chassis and Cab Exterior**

- Lamps - are any exterior lamps cracked or damaged? Perform an exterior lamp test. See [Exterior Lighting Self-Test](#) on page 107 for more information.
- Is the air-intake opening clear of obstructions?
- Window and mirrors - clean and adjusted?
- Tires, wheels and hubs [Tires](#) on page 292 [Wheels](#) on page 295 and [Systems Check](#) on page 37
- Suspension components - check for loose or missing fasteners. Check damage to springs or other suspension parts such as cracks, gouges, distortions, bulges or chafing.

- Brake lines and hoses - check lines, linkages, chambers, parking and service brake operation.
  - Air system - [Air System](#) on page 234
  - Steps and grab handles
  - Frame mounted tanks (fuel, diesel exhaust fluid, etc) - check underneath the vehicle for signs of fluid leaks. If any are found, correct before operating the vehicle. Is the tank fill cap secure? Are the tank straps tight? Is the strap webbing in place?
  - Trailer connections - are they secure and the lines clear? If they are not being used, are they stored properly? Is the trailer spare wheel secure and inflated? Is the landing gear up and the handle secured?
  - Fifth wheel - Is the kingpin or the sliding fifth wheel locked?
- Cab Interior**
- Seat - adjust the seat for easy reach of controls and visibility.
  - Seat belts - fasten and adjust safety restraint belts (which may include restraints in the sleeper).
  - Steering column - adjust for easy reach and visibility.
  - Mirrors - check and readjust mirrors if necessary.
  - Lamps - turn ignition key to the ON position to allow the bulb check and the systems check to test the truck systems. Perform an Exterior Light Self-Test
  - Instruments - check all instruments (see [Systems Check](#) on page 37)
  - Windshield - check operation of windshield wipers and washers.
  - Horn - check operation of horn.
  - Fuel - check vehicle's fuel level. Is there enough fuel?
  - Diesel exhaust fluid - check level. Is there enough fluid?
  - Air conditioning filters in the cab and/or sleeper - check the condition of the sleeper air conditioning air filter. Keep the sleeper floor area behind the passenger front seat clear of debris and pet hair. The sleeper air conditioner draws air from this area and excessive dirt or pet hair may shorten the service life of the sleeper air conditioning air filter.

## Weekly Checks



### NOTE

These checks are in addition to, not in place of, Federal Motor Carrier Safety Regulations. These regulations may be purchased by writing to: Superintendent of Documents U.S. Government Printing Office Bookstore 710 N. Capitol St. N.W. Washington, DC 20402, or [ContactCenter@gpo.gov](mailto:ContactCenter@gpo.gov).

### Engine

- Belts
- Hoses
- Clamps
- Radiator
- Air filter and its housing
- Engine Aftertreatment system components
- Exhaust pipes
- Engine air pre-cleaner (option) - For vocational vehicles with optional engine air pre-cleaner, check the purge valve at the bottom of the hood mounted

engine air pre-cleaner for any obstructions. Make sure the purge valve will open and close as needed to purge dirt and water from the engine intake air.

- Automatic transmission fluid (where applicable) - Check level, after the engine has warmed up to operating temperature.

### Chassis and Cab Exterior

- Battery - check battery and terminals.
- Hood supports and guides are properly lubricated.
- Wheel cap nuts - are they all in place and torqued properly - tighten if necessary. [Wheels](#) on page 295
- Controls and wiring - check for condition and adjustment
- Steering components - check pitman arm, drag link, intermediate shaft U-joint pinch bolt, tie rod, steering shaft and power steering hoses, etc., for loose, broken, or missing parts.
- Cab air conditioner fresh air filter - check for condition and cleanliness.

- PACCAR 20k Front Axle Kingpin Joint Grease/Tie Rod Ends (option) (VOCATIONAL USE) - For vocational vehicles with this axle, grease with Heavy-Duty Multipurpose Lithium Based: #1 or #2 grade, every 50 hours. (Refer to [Front Axle and Suspension](#) on page 275 for maintenance instructions.)

## Systems Check

### System Check Display

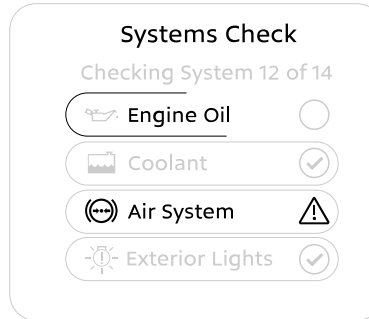

Systems Check evaluates each monitored system and displays its progress for the operator. The Systems Check will appear when the Exterior Lighting Self-Test (ELST) is activated, or when viewing the Notifications sub-menu.

Systems Check can be interrupted at any time by

- Pressing **Select**
- Switching the ELST switch to OFF
- Turning the ignition key to OFF or ACC
- Releasing the Parking Brake.

The Systems Check can also present the following optional features.

### Tire Pressure Monitoring System (TPMS) (option)

One of the systems the vehicle monitors is the Tire Pressure Monitoring System (TPMS).

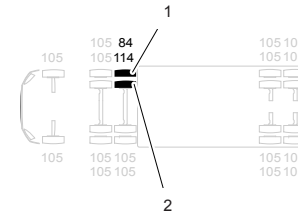

TPMS shows individual tire pressures for each location and will change the color of the tire:

- Outlined – Tire pressure not available
- Gray – Nominal
- Amber – High or low pressure
- Red – Very low or high pressure, or high temperature

To read about tires and recommended maintenance practices, see [Tires](#) on page 292.

#### System Check Display with TPMS

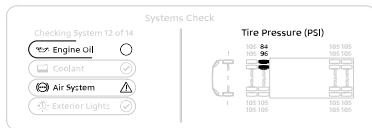

Once the Systems Check has completed, the results will display in a summary. A detailed explanation of this summary can be viewed by accessing the Menu after a Systems Check has completed.

#### Driver Rewards (option)

If enabled, the Driver Rewards score for Fuel Economy, Engine Idle Time, or both Fuel Economy and Engine Idle Time are

shown, as well as general driving tips that can improve brake saving and fuel economy (see [Driver Rewards](#)).

#### Driver Performance Assistant (DPA) (option)

If enabled, The Driver Performance Assistant score for Braking Habits is shown, as well as general driving tips that can improve brake saving and fuel economy (see [DPA](#)).



## Chapter 2 | EMERGENCY

Roadside Assistance.....	41
Low Air Alarm .....	41
Stop Engine Light.....	42
Low Oil Pressure.....	42
Engine is Overheating.....	42
How to Inspect and Replace a Fuse.....	44
Where are the Fuses Located?.....	46
How to Jump Start a Battery.....	46
How to Recover a Vehicle.....	48

## Roadside Assistance

Call toll-free to talk to someone at the PACCAR Customer Center.



### 1-800-4Peterbilt (800-473-8372)

The Customer Call Center is open 24/7-365 days a year and staffed with trained personnel (English and other languages if necessary), free of charge, to provide total roadside assistance. Their custom mapping system can locate the nearest Authorized dealers and Independent Service Providers (ISPs) based on the vehicle's location. In addition, the customer center can dispatch services for jump and pull starts, tires, trailers, fines and permits, chains, towing, hazardous clean-up, out of fuel (roadside), mechanical repairs, and preventive maintenance services. If they can't answer a specific question, they will direct you to a representative who can.

## Low Air Alarm



If this alarm turns on while parked or driving, be sure to perform these tasks:



### WARNING

If the air pressure falls below 60 psi (414 kPa) the spring brakes may stop the vehicle abruptly, which could cause an accident resulting in personal injury or death. Observe the gauges. If the warning alert comes on, do not continue to drive the vehicle until it has been properly repaired or serviced.



### NOTE

The instrument cluster gauges may appear, if hidden from view, change brightness and change color to bring attention to a particular system.

1. Slow down carefully.
2. Move a safe distance off the road and stop.
3. Place the transmission in neutral (park with automatic transmissions, if equipped) and set the parking brake.
4. Turn OFF the engine.
5. Turn ON the emergency flasher and use other warning devices to alert other motorists.

If the light and alarm do not turn off at start-up, DO NOT try to drive the vehicle until the problem is found and fixed.

## Stop Engine Light



This warning light illuminates when the engine has a serious problem. This is an emergency and the vehicle should be safely stopped at the soonest opportunity.



### WARNING

This should be considered an emergency. You should stop the vehicle as safely as possible and turn OFF the ignition. The vehicle must be serviced and the problem corrected before driving again. Failure to do so may cause severe engine or Diesel Particulate Filter damage, or cause an accident which may result in death or personal injury.

## Low Oil Pressure



### CAUTION

Continuing to operate your vehicle with insufficient oil pressure will cause serious engine damage. Failure to comply may result in equipment or property damage.

It is important to maintain oil pressure within acceptable limits. If oil pressure drops below the minimum psi (kPa) the oil pressure gauge will illuminate and change color. Additionally, the Stop Engine Lamp will turn red.



### NOTE

The instrument cluster gauges may appear, if hidden from view, change brightness and change color to bring attention to a particular system.

1. Slow down carefully.

2. Move a safe distance off the road and stop.
3. Place the transmission in neutral (park with automatic transmissions, if equipped) and set the parking brake.
4. Turn OFF the engine.
5. Turn ON the emergency flasher and use other warning devices to alert other motorists.
6. Wait a few minutes to allow oil to drain into the engine oil pan, and then check the oil level.
7. Add oil if necessary. If the problem persists, contact an authorized dealer as soon as possible.

## Engine is Overheating





**CAUTION**

The cooling system may overheat if the engine coolant is at the minimum level. A sudden loss of coolant, caused by a split hose or broken hose clamp could also lead to an overheat condition. Always inspect to ensure hoses and clamps are not cracked, worn, or loose. Failure to comply may result in equipment or property damage.

**NOTE**

The system may also temporarily overheat during severe operating conditions such as:

- Climbing a hill on a hot day
- Stopping after high-speed/high-load driving
- Debris blocking air flow through the cooling module (radiator)

If the engine coolant temperature warning lamp comes on and the audible alarm sounds showing an overheat condition, or if you have any other reason to suspect the

engine may be overheating, DO NOT TURN OFF THE ENGINE unless a low water warning device indicates a loss of coolant.

Follow these steps if the engine coolant temperature is rising, or the temperature is already above normal, and there are no other warning alarms displayed in the instrument cluster.

**NOTE**

The instrument cluster gauges may appear, if hidden from view, change brightness and change color to bring attention to a particular system.

1. Reduce engine speed, or stop. When stopped, place the transmission in neutral (N) and set the parking brake. Keep the engine running.

**WARNING**

To reduce the chance of personal injury, vehicle damage, and/or death from overheated engines, which can result in a fire, never leave the engine

idling without an alert driver present. If the engine does overheat, as indicated by the engine coolant temperature lamp, immediate action is required to correct the condition. Continued unattended operation of the engine, even for a short time, may result in serious engine damage or a fire. Failure to comply may result in death, personal injury, equipment or property damage.

**WARNING**

Removing the fill cap on a hot engine can cause scalding coolant to spray out and burn you badly. If the engine has been in operation within the previous 30 minutes, be very careful in removing the fill cap. Protect face, hands, and arms against escaping fluid and steam by covering the cap with a large, thick rag. DO NOT try to remove it until the surge tank cools down or if you see any steam or coolant escaping. Always remove the cap very slowly and carefully. Be ready to back off if any steam or coolant begins to escape. Failure to comply may result in death, personal injury, equipment or property damage.

**NOTE**

Keep the engine running at idle speed unless a warning icon turns on that requires the engine to be shut off.

2. Check to ensure the Oil Pressure Gauge reads normal.

3. Make sure the engine fan is turning by switching the **Engine Fan Switch** from AUTO to MAN (Manual).
4. Idle the engine to see if this reduces the coolant temperature. If the temperature does not begin to drop, shut off the engine and contact your nearest authorized dealer.
5. If the temperature begins to return to normal, allow the engine to idle 3 to 5 minutes before shutting it off. This allows the engine to cool gradually and uniformly.
6. If overheating came from severe operating conditions, the temperature should have cooled by this time. If it has not, stop the engine and let it cool before checking to see if the coolant is low.
7. Be sure the vehicle is parked on level ground or the readings may be incorrect. Check the coolant level at the coolant surge tank.

Check the coolant level after each trip when the engine has cooled. The coolant level should be visible within the surge tank. Add coolant if necessary.

## How to Inspect and Replace a Fuse

Turn the ignition off and turn all lights off. Locate the fuses in either the cab, sleeper, or main power fuse box.

All the electrical circuits have fuses to protect them from a short circuit or overload. If something electrical on your chassis stops working, the first thing you should check for is a blown fuse.

**WARNING**

DO NOT replace a fuse with a fuse of a higher rating. Doing so may damage the electrical system and cause a fire. Failure to comply may result in death, personal injury, equipment or property damage.

**CAUTION**

Never patch fuses with aluminum foil or wire. This may cause serious damage elsewhere in the electrical circuit, and it may cause a fire.

**CAUTION**

If a circuit keeps blowing fuses, have the electrical system inspected for a short circuit or overload by an authorized dealer as soon as possible. Failure to do so could cause serious damage to the electrical system and/or vehicle.

**CAUTION**

Before replacing a fuse, turn OFF all lights and accessories and remove the ignition key to avoid damaging the electrical system.

1. Turn off all lights and accessories and remove the ignition key to avoid damaging the electrical system.
2. Determine from the chart on the fuse panel which fuse controls that component.
  - If the circuit has a fuse, remove that fuse and see if it is blown.
  - If the circuit has a polyswitch, have your electrical system

inspected by an authorized dealer.

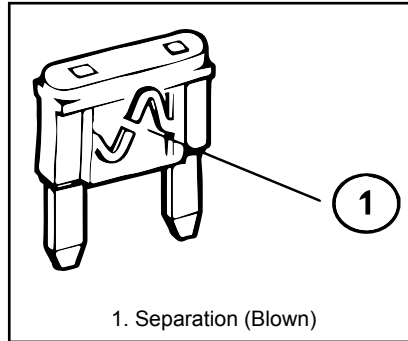
**Blown Fuse**

1. Separation (Blown)

3. If it is blown, replace it with a fuse of the same rating. If a fuse of the same rating is not available, a fuse of a lower rating may be temporarily substituted. You can also use a fuse from a circuit you can do temporarily without (for example an accessory circuit or radio).

**CAUTION**

When replacing a failed polyswitch (circuit breaker), always use an approved polyswitch (circuit breaker) with a current rating equal to or less than the polyswitch (circuit breaker) being replaced. Only use the approved Type II modified reset polyswitch (circuit breaker). NEVER use a Type I (automatic reset) or Type III (manual reset) polyswitch (circuit breaker). A fuse with a current rating equal to or less than the polyswitch (circuit breaker) being replaced can also be used.

**CAUTION**

Always close and latch the engine compartment fuse box cover. A latched cover ensures a water tight seal which can prevent damage to electrical components.

## Where are the Fuses Located?

Fuses for the cab are located in the fuse panel behind the drivers side kick panel. Main power relays are located on the power distribution center, in the engine compartment, mounted to the front wall of the cab.

Fuses for the optional sleeper are located on a separate fuse box accessible through the luggage compartment door.

## How to Jump Start a Battery



### WARNING

Batteries contain acid that can burn and gases that can explode. Ignoring safety procedures may result in death, personal injury, equipment or property damage.



### WARNING

Never jump start a battery near fire, flames, or electrical sparks. Batteries generate explosive gases that could explode. Keep sparks, flame, and lighted cigarettes away from batteries. Failure to comply may result in death, personal injury, equipment or property damage.



### WARNING

When jump starting using a battery charger/booster, verify that the battery charger/booster is set to the same jump start voltage and amperage specifications as the vehicle electrical system and batteries (i.e., if the vehicle electrical system is a 12 volt system, the jump start voltage on the battery charger/booster shall be set at no higher than a 12 volt setting). Failure to comply may cause an explosion and/or fire resulting in death, personal injury, and/or equipment or property damage.



### WARNING

Heed all warnings and instructions of the jumper cable manufacturer. Failure to comply may result in death, personal injury, equipment or property damage.



### CAUTION

Applying a higher voltage booster battery will cause expensive damage to sensitive electronic components, such as relays, and the radio. Failure to comply may result in equipment damage.



### CAUTION

Improper hook-up of jumper cables or not following these procedures can damage the alternator or cause serious damage to both vehicles.

**CAUTION**

Vehicles equipped with an Engine Start Module (ESM) should not be jumped using the ESM Starter terminal (S+). Failure to comply may result in arcing or battery damage.

1. Remove any jewelry that may come in contact with the battery terminals.
2. Select a jumper cable that is long enough to attach to both vehicles in a way that ensures neither vehicle touches each other.
3. Position the two vehicles together, but do not allow them to touch.
4. Turn OFF all lights, heater, radio, and any other accessory on both vehicles.
5. Set the parking brake.
6. Shift the transmission into park position or neutral for manual transmissions.
7. If either vehicle is equipped with battery disconnects ensure they are in the **OFF** position prior to connecting the two vehicles.

8. Attach one end of a jumper cable to the **positive (+)** terminal of the discharged (dead) battery. This will have a large red + or P on the battery case, post, or clamp.

**NOTE**

If your vehicle is equipped with an Engine Start Module (ESM), attach the positive (+) cable to the vehicle battery and not the ESM Starter terminal (S+). See the Maxwell Installation Guide and User Manual for additional information about LED status conditions, maintenance, and troubleshooting.

9. Attach the other end of the same cable to the **positive (+)** terminal of the good (booster) battery.
10. Attach the remaining jumper cable **FIRST** to the negative (-) terminal (black or N) of the good battery.
11. Attach the other end of the negative cable to the negative (-) terminal of the dead battery.

**NOTE**

Always connect positive (+) to positive (+) and negative (-) to negative (-).

12. If either vehicle is equipped with battery disconnects, ensure that they are in the **ON** position.
13. Start the vehicle that has the good battery first.
  - Let it run for 5 minutes, or
  - If charging a system containing an Engine Start Module (ESM), let it run for 15 minutes. Briefly pressing the Push-to-Test button on the ESM will indicate the ESM's charge state. When the status LED presents a solid green light the ESM is sufficiently charged.
14. Start the vehicle that has the discharged (dead) battery.

The engine should start. If the engine fails to start, do not continue to crank the starter. Instead, contact the nearest authorized dealer.

**WARNING**

When disconnecting jumper cables, make sure they do not get caught in any moving parts in the engine compartment. Failure to comply may result in death, personal injury, equipment or property damage.

Reverse the above procedure exactly when removing the jumper cables. With engine running, disconnect jumper cables from both vehicles in the exact reverse order, making sure to first remove the negative cable from the vehicle with the discharged battery.

**How to Recover a Vehicle****CAUTION**

Remove the drive axle shafts or lift the driving wheels off the ground before towing the vehicle. Towing the vehicle with either the wheels on the ground or

the axle shafts in the axles will cause damage to the axle gears.

**CAUTION**

If your vehicle has a Meritor axle with a driver-controlled main differential lock, install the caging bolt before removing the axles for towing, see How to Manually Lock a Differential. Installing the caging bolt prevents damage by locking internal axle components in position.

**CAUTION**

Connect recovery rigging only to hitches intended for that purpose. DO NOT attach to bumpers or brackets. Use only equipment designed for this purpose. Failure to comply may result in equipment damage.

**WARNING**

Before towing a vehicle, test your air brakes to ensure that you have properly connected and inspected the recovery vehicle's brake system. Failure to do so could lead to a loss of vehicle control which may result in an accident involving death or personal injury.

All lubricating and clutch application oil pressure is provided by an engine-driven pump, which will not work when the engine is stopped. You could seriously damage your vehicle by towing it with the driveline connected and the drive wheels on the ground. Worse, when vehicles are towed, either by wrecker or piggyback, the lubricant in the top front of the drive axle will drain to the rear. This will leave the top components dry. The resulting friction may damage them. Always remove the main drive axle shafts before towing your vehicle.

1. Review and understand all the cautions and warnings of this section.
2. Disconnect the drive axle shafts and cover the open hubs. This is

necessary because if the transmission is driven by the driveshaft (rear wheels on the ground), no lubricant will reach the gears and bearings, causing damage to the transmission. .

See [How to Prepare the Axles for Towing](#) on page 52

3. Connect the towing chain or cable using best recovery practices .

See [Best Practices for Recovery Rigging](#) on page 55

4. Make sure the recovered vehicle's parking brakes are released. .

See [Manually Release the Parking Brake](#) on page 49

5. If you desire to use the recovered vehicle's brakes, ensure that the vehicle's air system is connected to that of the recovery vehicle. Ensure that any air line that has been removed from a driver-controlled main differential lock is firmly capped to prevent loss of air pressure from the recovery vehicle if it is supplying air pressure. If you don't desire to use the recovered vehicle's brakes, ensure that you cage the spring brakes before attempting to move the vehicle.

See [How to Manually Lock a Differential](#) on page 53

6. Follow state/provincial and local laws that apply to vehicles in tow.
7. Do not tow vehicles at speeds in excess of 55 mph (90 km/h).

For additional information concerning heavy duty truck recovery, refer to the following Technology & Maintenance Council (TMC) literature.

- Recommended Practice #602–A — “Front Towing Devices For Trucks and Tractors”
- Recommended Practice #602–B — “Recovery Attachment Points For Trucks, Tractors, and Combination Vehicles”
- Recommended Practice #626 — “Heavy Duty Truck Towing Procedures”

Copies of these can be obtained from the following address: Technology & Maintenance Council 950 N. Glebe Road (703) 838-1763 Arlington, VA 22203 Email: [tmc@trucking.org](mailto:tmc@trucking.org) Website: <http://tmc.truckline.com>

## Manually Release the Parking Brake

There may be times when there is not enough air pressure, or the engine's air compressor is not able to produce enough pressure, to release the parking brakes. In such cases, the parking brakes (or Spring Brakes) can be manually released.



### WARNING

DO NOT drive vehicle with malfunctioning brakes. If one of the brake circuits becomes inoperative, braking distances will increase substantially and handling characteristics while braking will be affected. You could lose control of your vehicle or cause an accident. Have it towed to the nearest dealer or qualified repair facility for repair. Failure to comply may result in property damage, personal injury, or death.



**WARNING**

DO NOT operate a vehicle when the spring brakes have been manually released. Driving a vehicle after its spring brakes are manually released is extremely dangerous. The brakes may not function. Failure to comply may result in death, personal injury, equipment or property damage.



**WARNING**

DO NOT disassemble a spring brake chamber. These chambers contain a powerful spring that is compressed. Sudden release of this spring may result in death or personal injury.



**WARNING**

Releasing the spring brakes on an unsecured vehicle could lead to an accident. The vehicle could roll, which may result in death, personal injury, equipment or property damage. Always secure the vehicle with wheel chocks,

chains, or other safe means to prevent rolling before manually releasing the spring brakes.

To move a vehicle immobilized by the spring brakes due to loss of air pressure in the brake system, perform the following procedure:

1. Remove the cap from the spring chamber

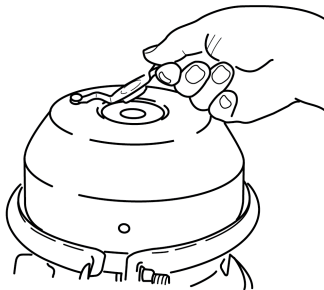

2. Remove the release stud assembly from the side pocket, and remove the release nut and washer from the release stud.

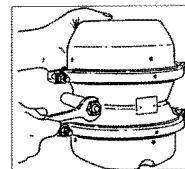

3. Slide out the release stud.

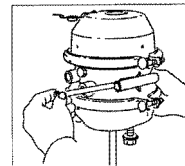

4. Insert the release stud through the opening in the spring chamber where the cap was removed. Insert it into the pressure plate. Turn the release stud 1/4 turn clockwise in the pressure plate. This secures the cross pin into the cross pin area of the pressure plate and locks it into the manual release position.



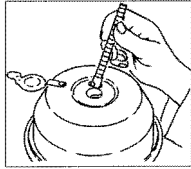

5. Assemble the release stud washer and nut on the release stud.

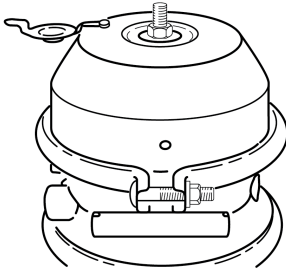

6. With a wrench, turn the release stud assembly nut until the compression spring is 90-95 percent caged. While doing this, check to make sure the push rod (adapter push rod or service push rod) is retracting. DO NOT over-

torque the release stud assembly. (S-Cam-type maximum: 50 lb-ft (68 N·m), Wedge-type maximum: 30 lb-ft (41 N·m)). The spring brake is now mechanically released.

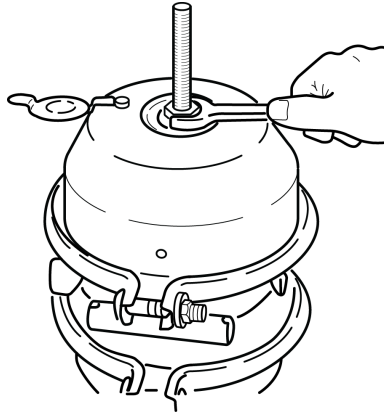

### Recovery Hitch

A removable recovery hitch is a device that attaches to the sockets in the front bumper in the event that the vehicle needs to be recovered. These hitches are designed for short distance and intermittent duty to help pull a vehicle. These hitches are not

designed to be used as towing devices for long distance.

Specially designed hitches are required to recover your vehicle. The recovery hitches attach to the frame. Two hitch assemblies, made up of the following parts, are recommended for the proper recovery of your vehicle:

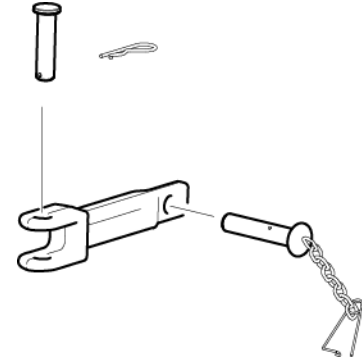

If your vehicle is not equipped with the proper recovery hitch assembly, contact an authorized dealer to obtain the proper equipment.

**WARNING**

DO NOT use parts from other trucks or materials from other sources to repair a hitch or to replace a missing hitch. The parts provided for recovery are made of high strength materials and are specifically designed for vehicle recovery. Failure to use the correct factory equipment may result in an accident involving death or personal injury.

**CAUTION**

Connect recovery rigging only to hitches intended for that purpose. DO NOT attach to bumpers or brackets. Use only equipment designed for this purpose. Failure to comply may result in equipment damage.

**How to use a Recovery Hitch****CAUTION**

Recovery pull maximums assume the tow rigging evenly distributes the load between both recovery hitches. See examples in Recovery Rigging for details. Serious damage to the vehicle may occur if rigging is not connected properly.

**CAUTION**

When recovering ditched or bogged vehicles, stay well below Maximum Capacities. Even at loads below maximum, the physical strain of recovering a vehicle could damage axles, suspensions, fifth wheels, etc.

Use the following procedure to install the Vehicle Recovery Hitches. See Recovery Hitch Assembly illustration for part identification.

1. Check the square sockets behind lower bumper for obstructions, clear if necessary.

2. With lock pins removed, insert the hitches through the bumper and into the square hitch socket.
3. Align the hole in the tow hitch with the square hitch socket hole.
4. Insert the lock pin into the square hitch socket hole and through the hole in the tow hitch until the lock tab is within the square hitch socket.
5. Rotate the lock pin 90 degrees to secure the pin in place.
6. Ensure that the tow pin and lock clip are installed before using the hitch.
7. Remove the hitches and store all parts after recovering the vehicle.

**How to Prepare the Axles for Towing**

If the vehicle is going to be towed from the front axle and using the rear axle for support, then the axle shafts should be prepared [removed] so that minimal damage is made to the differential during the towing process.

Ensure that the recovered vehicle does not have an open air line. An open air line on the recovered vehicle will cause a leak in the air system of the recovery vehicle if

both vehicles' brake systems are connected. This could cause a loss of system air, which can cause the service brakes not to function, resulting in the sudden application of the spring brakes causing wheel lock-up, loss of control, or overtake by following vehicles.

**WARNING**

An open air line on the recovered vehicle will cause a leak in the air system of the recovery vehicle if both vehicles' brake systems are connected. This could cause a loss of system air, which can cause the service brakes not to function, resulting in the sudden application of the spring brakes causing wheel lock-up, loss of control, or overtake by following vehicles. You could be in an accident involving personal injury or death. Ensure that any air line that has been removed from a driver-controlled main differential lock is firmly capped to prevent loss of air pressure from the recovery vehicle if it is supplying air pressure.

1. Lift driving wheels off the ground or remove the driveline and axle shafts before towing the vehicle.

**CAUTION**

Failure to lift the driving wheels off the ground or remove the driveline and axle shafts before towing the vehicle could seriously damage your vehicle. All lubricating and clutch application oil pressure is provided by an engine-driven pump, which does not work when the engine is stopped. When vehicles are towed either by wrecker or piggyback, lubricant in the top front of the drive axle will drain to the rear. This will leave the top components dry, resulting in friction that will seriously damage these components.

2. If the vehicle has driver controlled differential lock, then manually lock the differential.
3. Remove drive axle shafts.
4. Cover the open ends of the hubs to prevent dirt and debris from entering the axle.

**CAUTION**

Water, dirt, and other material can enter an open hub or axle. This can contaminate the axle fluid and cause possible damage to components. Ensure that the hubs are covered with plastic whenever a drive axle shaft is removed.

**How to Manually Lock a Differential**

Follow these procedures if the vehicle has a driver controlled differential lock. Always lock the differential when the axles are being removed to aid in re-installation. This procedure should be done before the axle shafts are removed.

**CAUTION**

Failure to install the caging bolt when towing vehicles with driver-control main differential lock can result in damage by failing to lock internal components in position.



**WARNING**

An open air line on the recovered vehicle will cause a leak in the air system of the recovery vehicle if both vehicles' brake systems are connected. This could cause a loss of system air, which can cause the service brakes not to function, resulting in the sudden application of the spring brakes causing wheel lock-up, loss of control, or overtake by following vehicles. You could be in an accident involving personal injury or death. Ensure that any air line that has been removed from a driver-controlled main differential lock is firmly capped to prevent loss of air pressure from the recovery vehicle if it is supplying air pressure.



**CAUTION**

A recovered vehicle will have no operational brake system. Additionally, the rear axle spring brakes will probably be applied.

- If you desire to use the recovered vehicle's brakes, ensure that the vehicle's air system is connected to that of the recovery vehicle. Also ensure that any air line that has been removed from a driver-controlled main differential lock is firmly capped to prevent loss of air pressure from the recovery vehicle.
- If you don't want to use the recovered vehicle's brakes, ensure that you cage the spring brakes before attempting to move the vehicle.

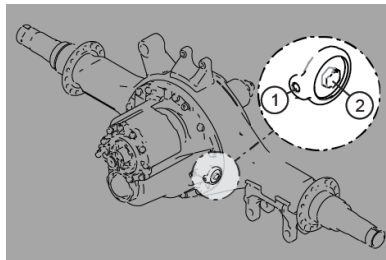

1. Remove the air line and firmly cap the air line from the vehicle. (2)
2. Remove the caging bolt from its storage hole. (1)
3. Screw the caging bolt into the air line hole. (2)

4. When fully engaged, a 0.25-0.5 in. (6.35-12.7 mm) space will remain between the air cylinder and the bolt head. This action will lock the differential by pushing a piston into a "lock" position.

**Recovery Hitch Capacities**

The maximum rated loads for vehicle recovery varies depending on the direction or angle of pull. These capacities are listed in the table below and are for the two hitches working together, simultaneously.

Direction of Pull	Maximum Capacity lbs. (kg)
Directly forward	80,000 (36,000)
Directly vertical or horizontally to the side	14,600 (6,600)
45 degrees in any direction	20,000 (9,000)

## Best Practices for Recovery Rigging



### CAUTION

Recovery pull maximums assume the tow rigging evenly distributes the load between both recovery hitches. See examples in Recovery Rigging for details. Serious damage to the vehicle may occur if rigging is not connected properly.



### CAUTION

When recovering ditched or bogged vehicles, stay well below Maximum Capacities. Even at loads below maximum, the physical strain of recovering a vehicle could damage axles, suspensions, fifth wheels, etc.

## Recovery Rigging Options

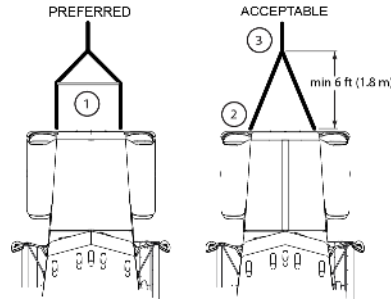

Use a double chain or cable setup that distributes the load equally to both hitches (see either example in Recovery Rigging Options illustration):

- Never loop a single chain or cable through both hitches, also known as reeving (not shown).
- Use a spreader or equalizer bar to distribute the load on both hitches (1), or
- If no spreader bar is available, connect the main tow chain or cable no closer than 6 ft. (1.8 m) from the vehicle: (2) to (3).
- Secure the towed vehicle using two additional chains or cables (see *Safety Chains*) (not shown).

## Returning to Service After Recovering

Once the vehicle is recovered, the axles need to have oil added to prevent gear damage during operation.

1. Into the pinion cage, add 1 pint (.47 liter) of lubricant or into the interaxle differential, add 2 pints (.94 liter) of approved lubricant.
2. After adding the specified type and amount of lubricant, drive the vehicle. It should be unloaded. Drive 1 to 2 miles (1.5 to 3 km) at a speed lower than 25 mph (40 km/h). This will thoroughly circulate the lubricant through the assembly.
3. If the parking brakes were manually released, they will need to be modified back to their normal operating condition.
4. If the differential lock was manually locked, then the caging bolt needs to be put back in its storage location and the differential lock air line needs to be re-installed in its normal position.

Add lubricant back to the axles after recovering the vehicle and before putting it back into service.

## What to do if the Vehicle is Stuck in Sand, Mud, Snow or Ice



### WARNING

DO NOT spin the wheels faster than 35 mph (55 km/h). Spinning a tire at speedometer readings faster than 35 mph (55 km/h) can be dangerous. Tires can explode from spinning too fast. Under some conditions, a tire may be spinning at a speed twice that shown on the speedometer. Any resulting tire explosion could cause injury or death to a bystander or passenger, as well as extensive vehicle damage: including tire, transmission, and/or rear axle malfunction.

These suggestions are provided to improve the ability to free a vehicle if the vehicle gets stuck in sand, mud, snow, or ice:

- Move the gearshift lever or selector from First to Reverse
- Apply light pressure on the accelerator pedal while the transmission is in gear
- Remove your foot from the accelerator while shifting
- Do not race the engine

- For best traction and safety, avoid spinning the wheels

Follow these practices to avoid transmission damage:

- Always start vehicle in motion with the shift lever in first gear.
- Be sure that transmission is fully engaged in gear before releasing the clutch pedal (manual only).
- Do not shift into reverse while the vehicle is moving.
- If the vehicle needs to be recovered from being stuck, do not permit the vehicle to be towed for long distances without removing the driveshaft.

If tire chains are needed, make sure they are installed on both sides of the driving axle. Installing chains on only one side of the axle can cause equipment damage.



### CAUTION

Chains on the tires of only one tandem axle can damage the driveline U-joints and the inter-axle differential. Repairs could be costly and time-consuming.

Failure to comply may result in equipment damage.

## Towing the Vehicle

A dealer or commercial towing service will have the necessary equipment to safely tow the vehicle and should be able to make arrangements to limit any damage to the vehicle. The towing service and the dealer should be aware of towing regulations and safety precautions.

The towing service will ensure that the following precautions are taken:

- Use of a safety chain system
- Abide by all local towing regulations
- Ensure that the towing device does not contact any surfaces that could be damaged while in transit
- If towing from the front, ensure that the rear axles are prepared for towing
- If towing from the rear, ensure that all body components such as roof, side, and chassis fairings are secured properly to avoid damage while in transit

**WARNING**

Secure the roof, side, and chassis fairings while towing from the rear. An unsecured fairing may come off of the vehicle during transit. Failure to secure the fairings while towing may cause an injurious accident resulting in death or personal injury.

## Chapter 3 | CONTROLS

### 3

Instrument Cluster.....	60
Peterbilt Digital Display Controls.....	62
Peterbilt Digital Display.....	63
Selecting a View.....	66
Configure Settings.....	72
Drive Summary.....	77
Driver Rewards (option).....	77
Driver Performance Assistant (option).....	78
Bulb Check.....	79
Guide to the Warning Symbols.....	81
Optional Gauges.....	92
Dash Switches.....	93
Ignition Key Switch.....	107
Exterior Lighting Self-Test.....	107
Steering Column Controls.....	108
Steering Wheel Controls.....	112



---

Door Mounted Mirror Controls.....	113
Heating and Air Conditioning.....	114
Sleeper Alarm Clock.....	123
Cab Accessories.....	124

## Instrument Cluster

For information on using the dash and instrument cluster options while driving,

see the paragraphs that follow. Please remember that each vehicle is custom-made. Your instrument panel may not look exactly like the one in the pictures that follow. We have tried to describe the most

common features and controls available. You can pick out the parts that apply to you and read them to be fully informed on how your particular vehicle operates.

3

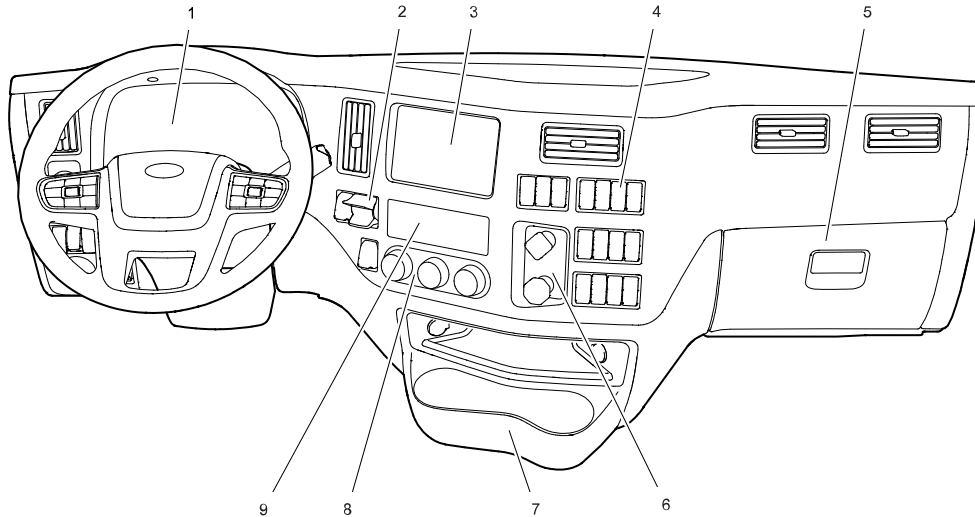

1. Peterbilt Digital Display
2. Compact Trailer Valve
3. Navigation/ Infotainment (or Optional Gauges)
4. Switches
5. Glovebox
6. Parking Brakes
7. Cupholders
8. Air Conditioning
9. Radio

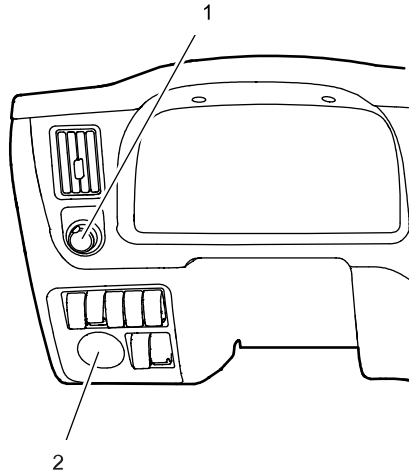

1. Additional Switches
2. Ignition Switch

## Peterbilt Digital Display Controls

3

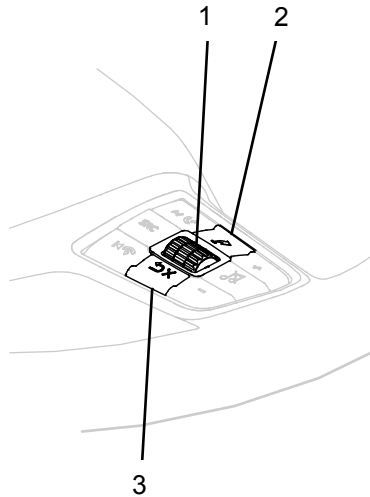

1. Scroll Wheel
2. Shortcut
3. Back/Cancel

The controls located on the right pod of the steering wheel are used to select Drive

View, navigate and select items in the Menu, and view Popup messages. The shortcut button will access items that are configured in the settings, [Shortcuts](#) on page 76.

### Scroll Wheel

Use the Scroll Wheel to navigate through menus and press down to select menu options, change settings when in the menu, and switch between Views.

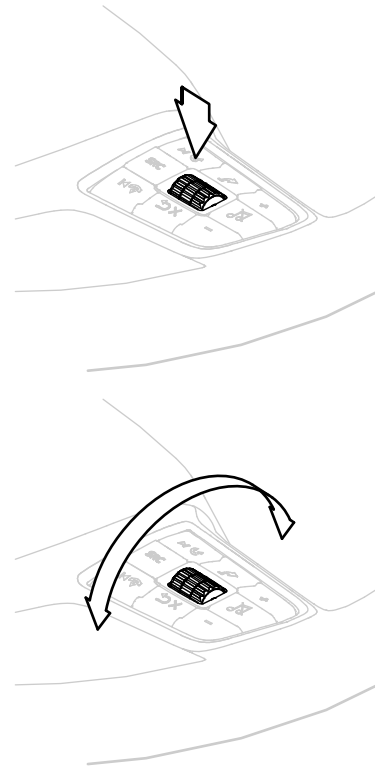

For example, press down and then scroll to access the clock menu. Then press down and scroll again to adjust the clock values. Press down to select the menu:

**Menu Example: main Menu**

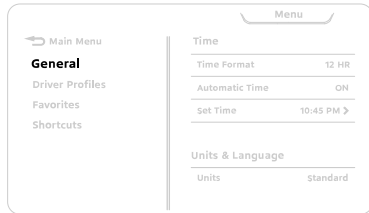

Press again to select the sub-menu:

**Menu Example: Settings**

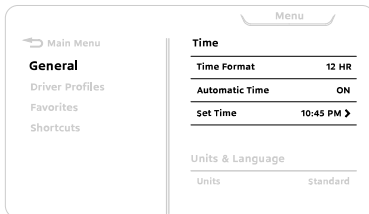

Use the Scroll Wheel to scroll through the values then press down to select.

**Menu Example Set Function**

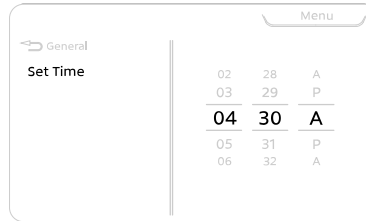

**Back**

Use the **Back** button to return to the previous menu, suppress a popup , or cancel a selection. *Popups* on page 81.

**Peterbilt Digital Display**

The digital display will stay visible during all driving situations and in some parked situations. When the parking brake is set

the following actions will wake the display, making it visible:

- Opening (or keeping open) the cab doors
- Using steering wheel switches
- Tapping the brake
- Turning the ignition switch to ON, ACC, or START
- Starting the engine.

If after 20 seconds none of these actions are taken, the display will darken to conserve power, but will awaken if any wake action is performed. If the Anti-Theft option is active and you attempt to start the engine, a passcode prompt will appear; the engine cannot be started until the correct passcode is entered (see *Anti-Theft* on page 76).

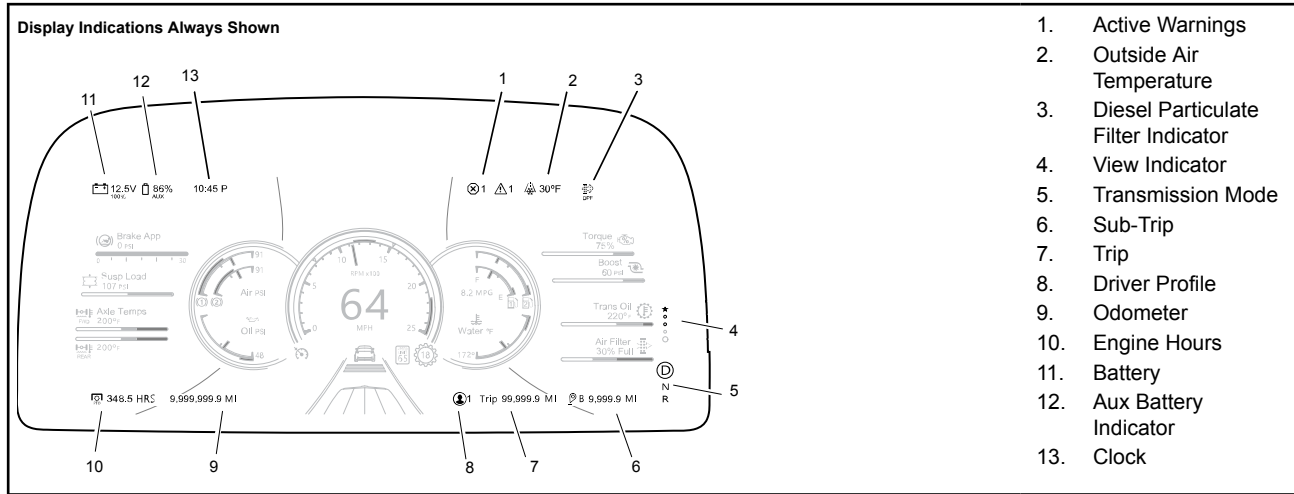

1. Active Warnings
2. Outside Air Temperature
3. Diesel Particulate Filter Indicator
4. View Indicator
5. Transmission Mode
6. Sub-Trip
7. Trip
8. Driver Profile
9. Odometer
10. Engine Hours
11. Battery
12. Aux Battery Indicator
13. Clock

**Active Warnings**

Red or amber popups are counted and the total is displayed by the active warning indicator. In addition, these counts are also presented in

- Systems Check
- The Notifications Sub-menu
- A Drive Summary

The numbers may change without user interaction if individual warnings are intermittent, time based, self correcting, or the situation is rectified.

**Outside Air Temperature**

Outside Air Temperature monitors the ambient temperature outside the truck. The display will alert the driver to high and low temperature conditions. When the

outside temperature approaches freezing (36°F or 2°C) an icon will appear next to the temperature (snowflake for freezing and thermometer for high) and a chime will sound. The system's unit of measure (Fahrenheit or Celsius) can be changed by navigating to the settings menu. The outside air temperature display uses a sensor (located at the bottom of the driver's side mirror assembly) to measure outside air temperature only. It is not

capable of displaying the temperature of the road surface on either the temperature display or the snowflake icon. Additionally, the outside air temperature reading may be affected by exposure to direct sunlight.

### View Indicator

The View Indicator identifies which view is currently selected:

- Favorites (if enabled)
- Minimized
- Minimized with Advance Driving Assistance (Optional)
- Basic
- Enhanced

### Drive, Neutral, and Reverse Indicator

The Drive, Neutral, and Reverse Indicator reflects the shifter position of an Automatic Transmission. Manual transmissions and certain automatic transmissions do not provide feedback to the display. Instead, the transmission shifter indicates the gear condition.

### Sub-trip Odometer

The Trip Odometer can be split into smaller segments called Sub-trips. Start a Sub-trip by pressing **Trip** on the steering wheel. The maximum distance that the sub-trip will show is 9,999.9 at which point it will start over at zero. When it maxes out, the current sub-trip ends and begins a new one. Sub-trip information is also found in the settings menu [Trip Summary](#) on page 72.

### Trip Odometer

The Trip Odometer shows how far the vehicle has gone traveled since last it was reset. The maximum distance that can be shown on the Trip Odometer is 99,999.9 at which point the operator needs to reset. Press **Trip** to set. Press and hold **Trip** to reset (Item 1 in following image).

Left Switch Pod

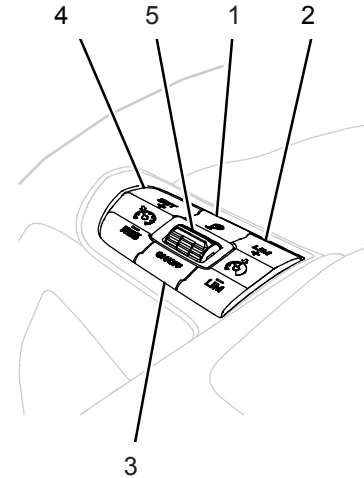

1. Trip marker
2. Limiter control
3. Cruise control ON/OFF
4. Cruise control set/resume
5. Toggle switch

The operator may also use the trip summary to view the same information [Trip Summary](#) on page 72.

### Driver Profile Indicator

The number following the icon indicates which driver is active when Driver Profiles are enabled. For information on Driver Profiles, [Choosing the Active Driver Profile](#) on page 74.

### Odometer

The odometer displays the total distance your vehicle has traveled. The maximum distance that can be shown on the odometer is 9,999,999.9. The odometer will roll over to zero if maximum mileage is achieved.

### Engine Hours

Engine hours will display the total number of hours the engine has been operated. The maximum hours that can be shown are 99,999.9 before the counter rolls over to zero.

### Battery Voltage

The Battery Voltage indicator shows the battery icon, voltage, and the state of

charge. The battery icon will be replaced with the Low Voltage Disconnect (LVD) icon when Low Voltage Disconnect is active. The battery icon is gray when operating normally, but changes to amber to indicate a low voltage condition and red to indicate a high or very low voltage condition.

### Clock

The clock can be displayed in a 12-hour or 24-hour format. Clock settings can be altered in the Settings Sub-menu.

### Transmission Gear Display

Vehicles with PACCAR or Eaton automated transmissions will show the transmission mode, current gear, and diagnostic information associated with the transmission. Vehicles with manual transmissions will show the current gear. This display does not apply for vehicles with Allison transmissions.

## Selecting a View

The instrument cluster has 5 views for the operator to use.

- Favorites
- Minimized
- (Optional) Minimized with Advanced Driver Assistant
- Basic View
- Enhanced View

Each view is identified by a specific view indicator on the right side of the display area.

### Minimized View

A combination speedometer and tachometer will show in the center of the Minimized View.

### Speedometer and Tachometer

Vehicle and engine speed are presented at the center of the display. Units for vehicle speed can be changed to either Standard or Metric in the Digital Display menu (see [Units and Language](#) on page 72) or by using the steering wheel **Shortcut** button (see [Peterbilt Digital Display Controls](#) on page 62).

### Minimized View with Driver Assistance (Option)



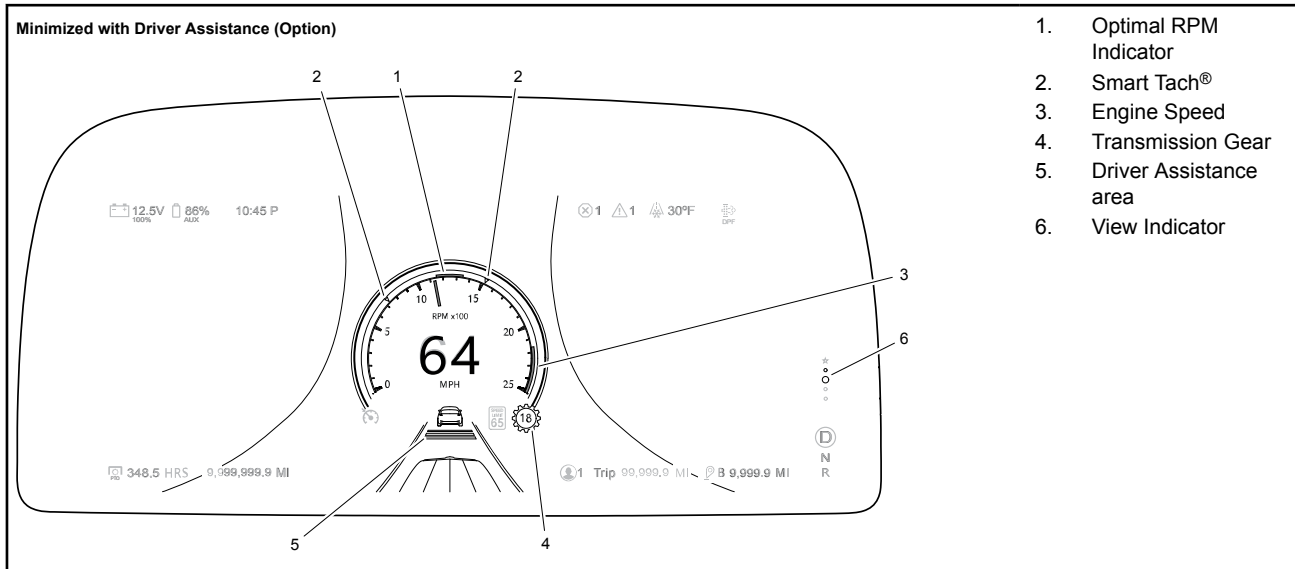

1. Optimal RPM Indicator
2. Smart Tach®
3. Engine Speed
4. Transmission Gear
5. Driver Assistance area
6. View Indicator

### **Adaptive Cruise Control Notification (option)**



This indication at vehicle start means it is equipped with Adaptive Cruise Control (ACC) and Collision Mitigation. These features work together to improve driver safety and enhance the driving experience. When Cruise Control is active, ACC will accelerate and slow the truck to maintain a chosen distance from a detected forward vehicle. Collision Mitigation will attempt to

prevent a forward collision when advancing at speeds greater than 15 mph (24 kph). Please review the ACC section of this manual, and the manufacturer's manual, prior to driving this vehicle.

### **Basic View and Enhanced View**

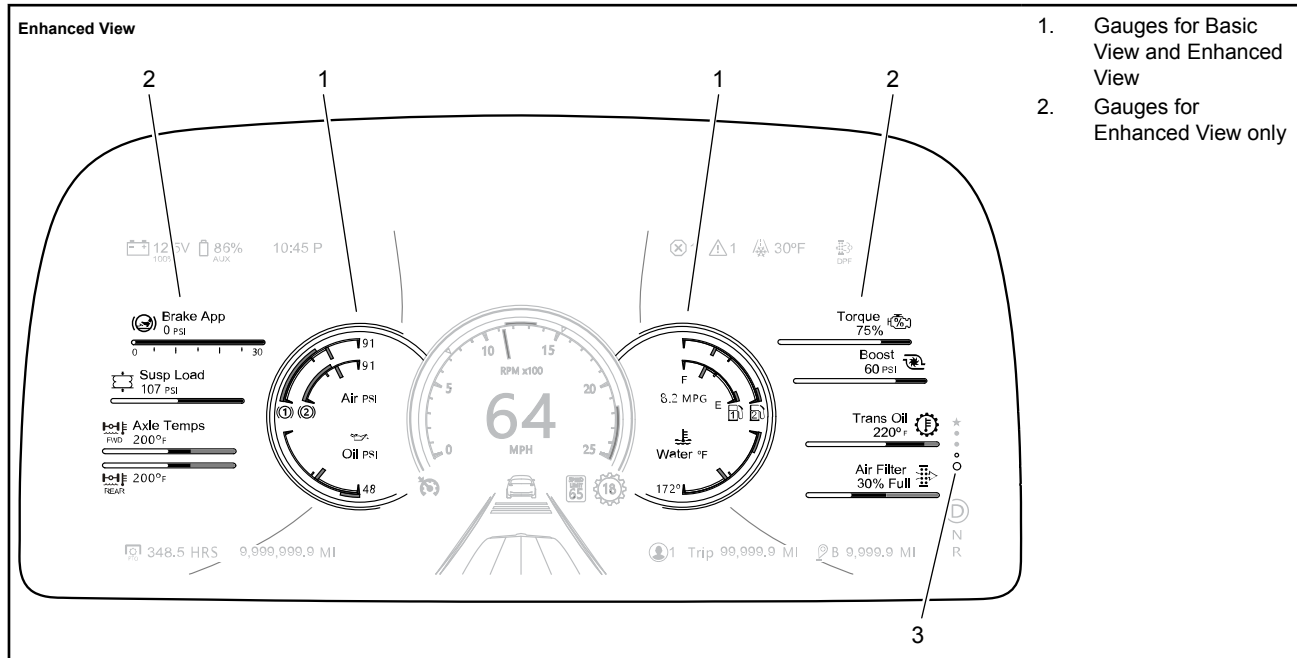

1. Gauges for Basic View and Enhanced View
2. Gauges for Enhanced View only

3

**Basic View**

This view combines the instrumentation presented in Minimized View with gauges such as Fuel and DEF level.

**Enhanced View**

This view includes all the gauges present in the Basic View, adding gauges on the left and right in the display. Enhanced View

is designated by the bottom icon in the View Indicator.

### Gauges

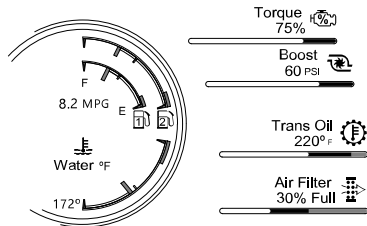

Gauge locations may be customizable and the gauge can react depending on the readout indicated. (*Favorites* on page 75) Some gauges are a flat bar rather than a typical dial gauge.

#### **i** NOTE

The instrument cluster gauges may appear, if hidden from view, change brightness and change color to bring attention to a particular system.

### Diesel Exhaust Fluid (DEF)

The diesel exhaust fluid gauge shows the approximate amount of DEF fluid in the DEF tank.

#### DEF Level Gauge

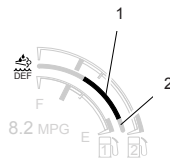

#### **⚠** CAUTION

Use Diesel Exhaust Fluid only. Failure to do so may damage components of the Diesel Particulate Filter (DPF).

Besides empty and full, the gauge also indicates 1/4, 1/2, and 3/4 of total capacity. DEF fluid is required to meet certain emission requirements. A warning icon and popup message will appear when the DEF level is low. Do not allow your DEF tank to remain empty. Please refer to your emission supplemental manual for more details about DEF fluid.

#### **i** NOTE

The instrument cluster gauges may appear, if hidden from view, change brightness and change color to bring attention to a particular system.

### Fuel Level

#### Fuel Level Gauge

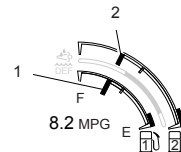

The Fuel gauge(s) indicate the fuel level.

#### **⚠** WARNING

DO NOT carry additional fuel containers in your vehicle. Fuel containers, either full or empty, may leak, explode, and cause or feed a fire. Failure to comply may result in death or personal injury.

**WARNING**

Diesel fuel in the presence of an ignition source could cause an explosion. A mixture of gasoline or alcohol with diesel fuel increases this risk of explosion. DO NOT remove a fuel tank cap near an open flame. Use only the fuel and/or additives recommended for your engine. Failure to comply may result in death, personal injury, equipment or property damage.

**CAUTION**

Use only Ultra Low Sulfur Diesel (ULSD) Fuel, as recommended by engine manufacturers. If you need further information on fuel specifications, consult the Engine Operation and Maintenance Manual.

**NOTE**

For Export vehicles, the fuel gauges will not state: ULTRA LOW SULFUR DIESEL FUEL ONLY.

**NOTE**

This vehicle may be manufactured with different fuel systems and different draw tube locations. Because of this and the amount of road crown, it is recommended that you do not operate your vehicle with less than one-quarter of your truck's fuel capacity. Allowing the fuel level to go below one-quarter of capacity could result in the lack of fuel to keep the engine running. In addition, you will want to keep the fuel tanks at least half-full to reduce condensation of moisture in the tanks. This moisture can damage the engine.

**NOTE**

The instrument cluster gauges may appear, if hidden from view, change brightness and change color to bring attention to a particular system.

**Favorites View (optional)**

Vehicles with Favorites View will allow the operator to customize the arrangement of many of the gauges. Using the Favorites View requires the operator to **Scroll** to select the Minimized View. Once the Minimized view is showing, **Scroll** up once more to the star icon the View Indicator. See [Favorites](#) on page 75 to customize the Favorites view.

## Configure Settings

Menu Example: main Menu

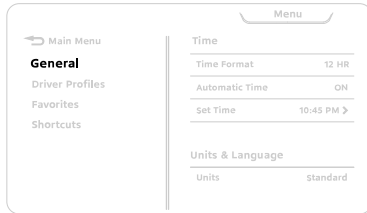

The following Menus

- Notifications
- Trip Summary
- Settings
- Truck Information

are accessible when

1. The Parking Brake is set
2. All active popup messages are viewed and suppressed
3. Press the **Select** button

These menus allow the operator to configure settings on the vehicle.

### Notifications

Notifications display system messages related to the condition of your vehicle. It displays

- Tire Pressure Monitoring System (TPMS) (optional)
- Active messages
- Systems Check

### Trip Summary

Presents a summary of details such as fuel economy and distance of the trip, collected during the main trip and/or Sub-trips. These details will be collected until the Trip is reset, or the max trip distance (99,999.9 miles for main, 9,999.9 for Sub-Trips) is reached.

### Settings

Settings allows the operator to customize the Display.<sup>1</sup>

### General

#### Time

This menu allows the operator to customize the clock.

**Automatic Time (optional)** When enabled, trucks with Automatic Time will receive time zone appropriate data.

**24-Hour Time** Choose between 12 or a 24 hour format. AM or PM (A or P) shall only be displayed in 12-hour time format.

**Set Time** Set Time is available when Automatic Time isn't enabled. Set the clock to indicate your local time.

### Units and Language

#### Units

Use this setting to change the units of measurement between Standard, Metric (Bar), and Metric (PSI).

#### Language

Use this setting to change the language.

### Features

Features allows the operator to enable optional features on the vehicle to customize their experience.

### Predictive Cruise Overshoot

Configure the Predictive Cruise Control Overshoot through this menu item. See [Predictive Cruise Control \(Option\)](#) on page

<sup>1</sup> If Anti-Theft is enabled, Settings will not be accessible until the correct Passcode is entered.

148 for more details about Overshoot and Predictive Cruise Control.

### LVD Setup

Change the LVD battery voltage set point for LVD to turn on [Low Voltage Disconnect \(LVD\) \(option\)](#) on page 257.

### Trailer Detection (Option)

The trailer outputs on your vehicle will detect a connected trailer when this feature is enabled. The operator will be notified when a trailer connection is not detected.

### Digital RPM (optional)

Provides a digital numeric readout of the engine speed in the speedometer.

### Windshield Wiper Interlock

This activates the headlights when the windshield wipers are turned on.

### Dark Cabin

Dark Cabin prevents cab interior lights from turning on when a cab door is opened.

## Shutdown Timer



### WARNING

Never idle your vehicle for prolonged periods of time if you sense that exhaust fumes are entering the cab. Investigate the cause of the fumes and correct it as soon as possible. If the vehicle must be driven under these conditions, drive only with the windows open. Failure to repair the source of the exhaust fumes may result in death, personal injury, equipment or property damage.



### CAUTION

DO NOT allow your engine to idle, at low rpm (400-600 rpm), longer than five minutes. Long periods of idling after the engine has reached operating temperatures can decrease engine temperature and cause gummed piston rings, clogged injectors, and possible engine damage from lack of lubrication. The normal torsional vibrations

generated can also cause transmission wear.



### CAUTION

Do not stay in the vehicle with the engine running or idling for more than 10 minutes with the vehicle's Heater and A/C ventilation system in RECIRC or at LOW FAN SPEED. Even with the ventilation system on, running the engine while parked or stopped for prolonged periods of time is not recommended.



**CAUTION**

Prolonged periods of idling can result in lower than optimal engine/transmission operating temperatures which could cause increased rates of wear. **Do not allow the engine to operate at idle for extended periods at temperatures at or below 160F/71C.** To help prevent this from occurring on PACCAR engines, an idle shutdown feature can be programmed to shut the engine down after a period of low idle operation with no driver activity. A flashing warning lamp will inform the driver of an impending shutdown. Failure to comply may result in equipment or property damage.



**NOTE**

If you are required to idle your vehicle for long periods of time, install an auxiliary heater or automatic idle control. These auxiliary devices can reduce

fuel consumption and save you money.

When active, the Shutdown Timer will keep the engine running for a period of time after the ignition switch is placed in the OFF position. This allows the driver to exit the cab while sustaining power to the cab interior. Normally, this would require the key to remain in the ignition, potentially leaving the cab unlocked and accessible. When the timer reaches zero, the engine stops, removing power from certain electrical loads. The timer counts down in the Drive Summary.

The Shutdown Timer is enabled or disabled in the Display menu and can be set for up to 30 minutes. This setting can be changed in the Settings Sub-menu or while counting down, in the Drive Summary, using the Scroll and Select (See [How to Set the Shutdown Timer](#) on page 140). The Shutdown Timer setting may be limited to less than 30 minutes (See Greenhouse Gas Certified Configuration). If your truck has the Engine Idle Shutdown Timer (EIST) option and it is set for a

shorter shutdown time, the Engine will shutdown at the shorter timer setting.

**Driver Profiles**

This feature saves customizations made as a Driver Profile. Turning Driver Profiles ON for the first time will load current customizations into Driver Profile 1 and make it the active profile. The profile can be changed in this menu.

The active Driver Profile can also be changed after setting the park brake and then pressing **Back**.<sup>2</sup> Changes to Driver Profile will be auto-saved while making customizations. They will not be lost when turning the feature off.



**NOTE**

The last used active profile, including any changes to that profile, will remain the profile until a new one is selected.

**Choosing the Active Driver Profile**

Press **Back** when the parking brake is set to change the active Driver Profile.

<sup>2</sup> The ignition key may need to be cycled back to OFF and then ON to access the Driver Profiles Settings.



## Favorites

To disable Favorites, contact your authorized dealer. Vehicles with Favorites View enabled allow the operator to create a customized arrangement of all but centrally located gauges. To change the Favorites configuration, stop the truck, set the parking brake and

- Access Favorites via the Settings Sub-menu. OR
- **Scroll** to Favorites (represented by a star in the View Indicator) and press **Select**.

## Adding a Gauge to Favorites

The truck must have the Parking Brake set to add a gauge. You must be in the Edit Your Favorites menu to perform this procedure.

Adding a gauge requires that the gauge is not already assigned a location in Favorites View. If you want to move a gauge already assigned, you must first remove that gauge [Removing a Gauge from Favorites](#) on page 76.

1. **Scroll** the list until you locate the desired gauge or compound gauge.

Edit Your Favorites (Center of Screen)

Continue editing Favorites  
or save configuration

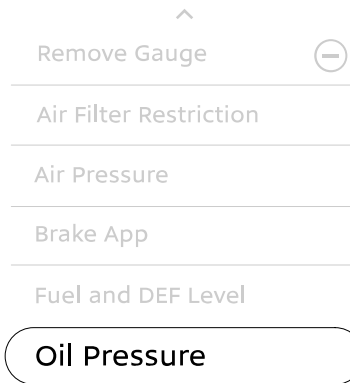

If the gauge you want to position is already present in the Favorites View (either as a single or compound gauge) it will not appear as a menu option.

2. **Select** to choose the gauge you want to position.
3. **Scroll** through the valid locations (this can include positions currently

holding a gauge, which may be replaced) and target that position.

If a position is not valid, the display will read "Not Available."

Edit Your Favorites (Left-side of image)

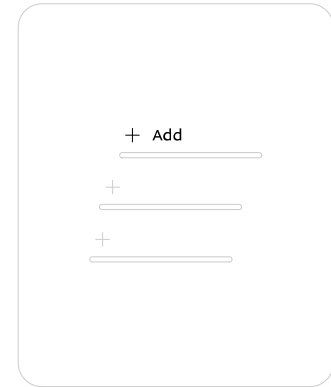

4. **Select** to Add or Replace the gauge.

Navigate and **Select** "Save Configuration" when all gauges have been arranged. The Display will read "Your favorites configuration has been saved." Press **Back** to exit Editing Favorites.

### Removing a Gauge from Favorites

The Parking Brake must be set and at least one gauge must be in the Favorites View to remove a gauge.

The Speedometer/Tachometer, Fuel, and Air pressure gauges located at the Display center cannot be removed. If the gauge you want to remove is part of a multiple gauge group, the whole group must be removed.

1. **Select** "Remove Gauge."
2. **Scroll** to highlight the gauge to be removed and **Select**.

Navigate and **Select** "Save Configuration" if this is the last change you want to make to Favorites View. The Display will read "Your favorites configuration has been saved." Press **Back** to exit Editing Favorites.

### Shortcuts

Use the Shortcuts option to assign one of the following features to the **Shortcut** button.

- Dark Cabin – Toggles Dark Cabin On/Off.
- Digital RPM – Provides a numeric read-out of RPM within the speedometer.

- Dual Speedometer – Shows a compound Speedometer with both Standard and Metric Values. .
- Favorites – Selects the Favorites View on the Display.
- Metric Units – Switches all measured units used on the Display between Standard and Metric.

### Anti-Theft

Anti-Theft prevents starting the engine and accessing the settings sub-menu. If Anti-Theft does not show in the settings sub-menu, see your authorized dealer to install Anti-Theft.

If Anti-Theft is enabled, turning the ignition switch to START prompts the operator to enter the passcode. Once the correct passcode is entered, you have five minutes to start the engine or the passcode must be re-entered.<sup>3</sup>

To enable or disable Anti-Theft, change Anti-Theft (ON/OFF) in the settings sub-menu and enter the current passcode.

### How to Enter the Passcode

The ignition key and the current Passcode are required.

The default passcode is set to 0000 at the factory. Please see an authorized dealer if a custom passcode is needed. With the anti-theft feature turned off, the operator will not need a passcode to start the engine.

1. Using the **Scroll** , scroll to the first number in the code then press **Select**.

**Anti-theft first digit**

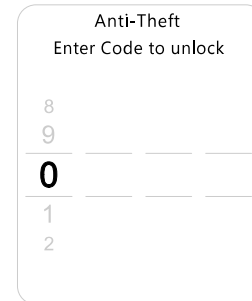

The next digit will be selected.

<sup>3</sup> The five minute timer can be postponed in one minute intervals using any steering wheel switch.

2. **Scroll** to the number you want for this digit and press **Select**. The next digit will be selected.
3. Continue this process until all four digits have been chosen.

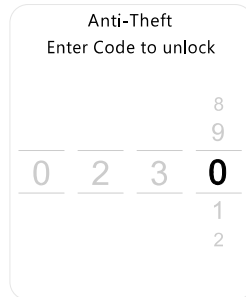
**Anti-theft last digit**

The display will read "Turn Key to Start Engine."

**Truck Information**

Truck information stores specifications and data about the vehicle.

- Chassis
- Engine
- Anti-lock Brake System

- Transmission
- GHG Vehicle Speed Limits
- Remote Station Interlocks
- Predictive Cruise Control option
- Adaptive Cruise Control (ACC) option
- Power Take Off (PTO) option

Information specific to these categories will be shown in the Truck Information Sub-menu.

**Drive Summary**

The Drive Summary presents information about the most recent leg of travel and is shown when the ignition key is turned to "off." The Drive Summary consists of

- Critical and Non-critical Issues (see [Systems Check](#))
- Shut Down Timer (if active) (see [Shut Down Timer](#))
- TPMS (option) (see [Tire Pressure Monitoring System \(TPMS\) \(option\)](#) on page 37)
- Driver Rewards (option) (see [Driver Rewards](#))
- Driver Performance Assistant (option) (see [DPA](#))

- Three customer-selected reports (i.e. Idle Time, Fuel Economy)

The Drive Summary collects information since the last time the engine was off for at least two hours. When insufficient information has been collected, Drive Summary will show dashes for the monitored component or report. Customer-selected reports can be changed at your local dealership.

**Driver Rewards (option)**

If enabled, Driver Rewards raises or lowers the vehicle's max-allowable speed based on whether a programmed, fuel economy goal is met. This goal is defined by the customer and can be based on fuel consumption, engine idle time, or both fuel consumption and idle time. The driver is assigned a score based on how successfully they meet or exceed this goal. Driver Rewards is only available for vehicles equipped with a PACCAR MX engine.

The fuel consumption goal is met by reducing the amount of fuel used over a given distance. This is achieved by

- Driving slower

- Minimize Speed Changes
- Accelerating gently
- Coasting in gear
- Using the Cruise Control
- Maintaining optimal tire pressure.
- Reducing the trailer gap
- Running a Warmer Cab.
- Turning off extra electrical loads

The engine idle time goal is met by reducing the time the engine idles (running the engine when the vehicle is not in motion).

The Driver Rewards score is based on driving habits. This score is compared to the goal and a max-speed bonus or penalty is determined. The Driver Rewards score is shown during a Systems Check and in the Driver Summary. When there is a bonus or penalty, it appears below the Cruise Control (CC) indicator on the dash, and the max-allowed speed shows to the right of the CC indicator. Driving habits that reduce fuel use will earn the operator a higher max speed; habits that consume more fuel will lower the max speed. Driver Rewards will never grant a bonus that exceeds programmed federal emission regulated or customer defined speed limits. During the Systems Check, the Driver Rewards and DPA features offer general

driving tips that can increase fuel economy and brake savings. These features also provide feedback in the Driver Summary based on a driver's specific driving habits. This advice if followed can improve future Driver Rewards and DPA scores. Driver Rewards has three customer-determined modes of activation: only when CC is in use, when CC is not being used, or at all times. The Driver Rewards goal and the amount of penalty or bonus is also customer-determined and should be based on reasonable expectations for a known route of travel. The Driver Rewards goal should be reconsidered if the manner of vehicle use or the vehicle route changes significantly.

To enable or disable Driver Rewards, or change the mode of activation, reward amounts, or set a new Driver Rewards goal, contact your dealership.

### **Driver Performance Assistant (option)**

If enabled, the Driver Performance Assistant (DPA) determines how skillfully the operator uses coasting and the engine brake when reducing vehicle speed.

Coasting and engine brake use, instead of frequent, aggressive use of the service brakes, can extend brake life and increase fuel economy. The DPA assigns the driver a score based on their braking habits and provides suggestions on how to improve these habits. The DPA feature is only available for vehicles equipped with a PACCAR MX engine.

The driver's DPA score is determined by comparing their braking and coasting habits against a customer-defined goal for braking use and coasting. A score that meets or exceeds this goal will award positive feedback in the Driver Summary. During the Systems Check, the DPA and Driver Rewards features offer general driving tips that can increase fuel economy and brake savings. These features also provide feedback in the Driver Summary based on a driver's specific driving habits. This advice if followed can improve future DPA and Driver Rewards scores (see Driver Rewards).

To enable or disable the DPA or set a new DPA goal, contact your dealership.

## Bulb Check

When the ignition switch is turned ON multiple warning icons will be displayed in a sequence to test each warning light indicator. The total sequence should take no more than 10 seconds to complete. Have your instrumentation system checked by a qualified service technician if does not successfully complete.

### Audible Alarm

The audible alarm will sound in conjunction with most warning lights. These events include but are not limited to headlight on, fifth wheel, stop engine, primary/secondary air, and driver door open warnings.

### Optional Icons

Additional icons may be operational depending on individual vehicle specifications.



#### NOTE

Some optional lights may illuminate even though your vehicle is not equipped with that particular feature.

### Physical Telltales

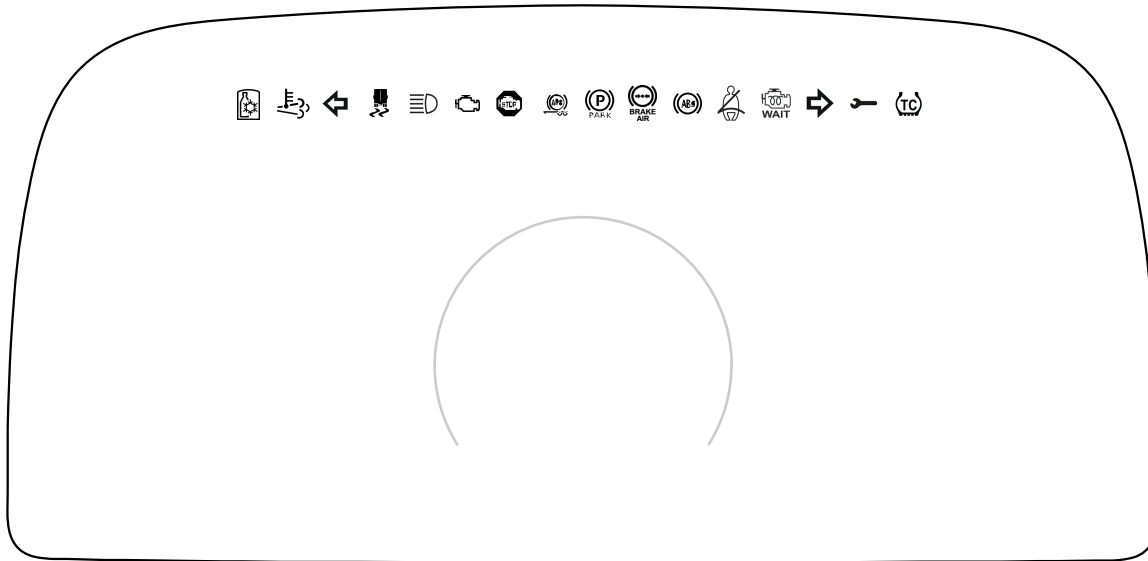

3

These physical telltales will always appear across the top of the display.

most signify that the monitored component requires operator attention.

### Dedicated Telltales

Dedicated Telltales always appear in the same location throughout the screen. Some are visible only when active, but

## Dynamic Telltales

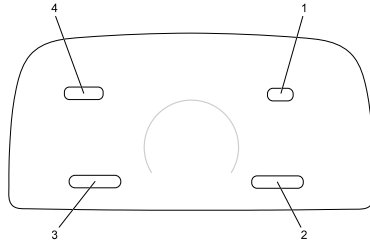

These dynamic telltales appear on the display in the rows indicated. A dynamic telltale communicates the status of a monitored component, which may require the operator to respond or take action.

## Active Warnings

Red or amber popups are counted and the total is displayed by the active warning indicator. In addition, these counts are also presented in

- Systems Check
- The Notifications Sub-menu
- A Drive Summary

The numbers may change without user interaction if individual warnings are intermittent, time based, self correcting, or the situation is rectified.

## Popups

Popup: Red Oil Temp



A Popup displays information from the vehicle computer. Certain types of Popups are indicated by the Warning Indicator in the display area.

Multiple Popups will appear in the display as a stack of messages. Suppressible Popups are those that will move out of the stack when driving. All are suppressible when the Parking Brake is set.

The Menu will not be accessible until all Popups have been Suppressed.

## Viewing and Suppressing Popups

A Popup can be read and Suppressed by pressing the Scroll Wheel. Some situations may require pressing **Back/Cancel** instead. For example, the popup in the following image is suppressed by pressing the Scroll Wheel (indicated with a down arrow) OR by pressing the **Back/Cancel** (indicated with an X below the roller).

Suppressable Popup Message

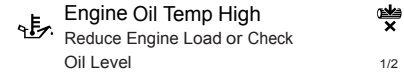

## Guide to the Warning Symbols

The warning lamps and audible alarm may indicate a system malfunction. Check the lamps frequently, and respond promptly as soon as you see one go on. These lamps could save you from a serious accident. Additionally, gauges may become visible, may change colors, or may change brightness to raise awareness to the operator.

When multiple warning symbols are shown on the instrument cluster, they will appear at first and then minimize. When minimized they will be represented in the active warnings area of the display. A triangle represents a warning registered and a diamond represents a check message.



**WARNING**

DO NOT ignore a warning lamp or audible alarm. These signals tell you something is wrong with your vehicle. It could be a failure in an important system, such as the brakes, which could lead to an accident causing

death or injury. Have the appropriate system checked immediately.

Check messages are provided to give the operator additional information regarding systems that require attention due to a system malfunction and/or operating conditions that may hinder safe and proper performance of the vehicle. The system will emit a chime to alert the operator that a

message is appearing on the cluster. Some messages can be managed by the operator while others may require an authorized dealer repair. In the following table is a list of warning lamp/indicator symbols that appear in the instrument cluster. Each symbol has a unique name, color when illuminated, and whether the symbol is standard (STD) or optional (OPT).

3

Symbol Name	Color	Standard or Optional
<i>ADAS Camera Fault</i> on page 84	Yellow	OPT
<i>Axle, Stability Control (Option)</i> on page 84	Yellow	STD
<i>Axle, Traction Control</i> on page 85	Yellow	STD
<i>Brakes, Antilock Brake System</i> on page 86	Yellow	STD
<i>Brakes, Low Air</i> on page 86	Red	STD
<i>Brake, Park Brake</i> on page 86	Red	STD
<i>Brakes, Trailer Antilock Brake System</i> on page 86	Yellow	STD
Cab, Door Ajar	Amber	STD
<i>Differential, Inter-Axle Lock</i> on page 87	Yellow	OPT
<i>Dump Truck, Body Up</i> on page 87	Red	OPT



Symbol Name	Color	Standard or Optional
<i>Dump Truck, Gate</i> on page 87 Dump Truck, Gate	Yellow	OPT
<i>Diesel Particulate Filter (DPF) Warning Light</i> on page 88 Emissions, Derate	Yellow	STD
<i>Emissions, High Exhaust System Temperature</i> on page 88	Amber	STD
<i>Emissions, Malfunction Indicator Light</i> on page 88	Yellow	STD
<i>Engine, Check Engine</i> on page 89	Yellow	STD
<i>Engine, Engine Block Heater</i> on page 89	Yellow	OPT
<i>Engine, Low Coolant Level</i> on page 89	Yellow	STD
<i>Engine, Overspeed Air Shutdown</i> on page 89	Red	OPT
<i>Engine, Retarder (Brake)</i> on page 89	Green	OPT
<i>Engine, Stop Engine</i> on page 89	Red	STD
<i>Engine Wait-to-Start Light</i> on page 89	Yellow	OPT
<i>Fifth Wheel Slide Unlocked</i> on page 90	Red	OPT
<i>Fifth Wheel Locked</i> on page 90	Red	OPT
<i>Fifth Wheel Unlocked</i> on page 91	Red	OPT
<i>Lane Departure Warning (LDW)</i> on page 91	Yellow	OPT
<i>Lane Departure Warning (LDW) Fault</i> on page 91	Yellow	OPT

Symbol Name	Color	Standard or Optional
<i>Lights, High Beam</i> on page 91	Blue	STD
<i>Fast Idle Control</i> on page 91	Yellow	OPT
<i>Refrigerator</i> on page 91	Green	OPT
Seat Belt Fasten	Red	STD
Suspension, Lift Axle	White	OPT
<i>Tire Inflation (TPMS)</i> on page 91	Yellow	OPT
<i>Transmission, Auxiliary</i> on page 92	Yellow	OPT
<i>Transmission, Check</i> on page 92	Red	OPT
<i>Turn Signal, Left</i> on page 92	Green	STD
<i>Turn Signal, Right</i> on page 92	Green	STD

**ADAS Camera Fault**



This amber warning light appears when a fault occurs with the camera used by the various Advanced Driver Assist (ADAS) features: Lane Departure Warning (LDW), Lane Keeping Assist (LKA), and Adaptive Cruise Control (ACC). The LDW and

optional LKA features are both dependent on the ADAS camera, and both will be disabled when this warning occurs. In addition to issues internal to the camera, please read the topic [Lane Departure Warning \(LDW\)](#) on page 150 for conditions which may limit camera performance, resulting in an ADAS Camera Fault.

**Axle, Stability Control (Option)**

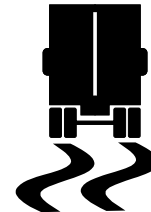

Calculates the driver's intended path of travel from wheel speed and steering angle sensors, then compares calculations to the actual direction of travel. The system uses individual wheel brakes to re-adjust the path of the vehicle.

- The Stability Control Icon (ESC or Electronic Stability Control) illuminates during the Bulb Check when the ignition is turned ON. It turns off after a few seconds if no system problems are detected. If a problem is detected, the ESC Warning lamp will turn on and stay on.
- Illuminates when the ESC system is regulating individual wheel brakes to correct the vehicle's direction of travel. (Refer to Advanced ABS with Stability Control for more information.)



### WARNING

If this chassis is equipped with an Electronic Stability Control (ESC) and is modified (e.g. adding or removing an axle, converting from a truck to a tractor, converting from a tractor to a truck, changing the body, lengthening

of the wheelbase and/or frame, relocating frame components, or modifying pneumatic or electrical ABS/ESC harnesses) the ESC must be evaluated by a qualified technician. If you have any questions, contact your authorized dealer. Failure to comply may result in property damage, personal injury, or death.



### NOTE

For more information about the stability control system installed on your vehicle, please refer to additional material supplied with this operator manual, included in your glove box informational packet.

### Axle, Traction Control



Monitors wheel speed for poor traction. If a wheel begins to slip due to poor traction, it

may reduce engine power or apply brakes in an effort to regain traction.

- Illuminates during the Bulb Check when the ignition is turned ON. It turns off after a few seconds if no system problems are detected. If an ATC problem is detected, the ATC warning light will turn on and stay on.
- Illuminates when the ATC is regulating wheel spin and turns off after the traction control event has ended.
- Flashes continuously when the ATC/Deep Snow & Mud switch is turned on, indicating that this feature is active.



**WARNING**

If this chassis is equipped with an Electronic Stability Control (ESC) and is modified (e.g. adding or removing an axle, converting from a truck to a tractor, converting from a tractor to a truck, changing the body, lengthening of the wheelbase and/or frame, relocating frame components, or modifying pneumatic or electrical ABS/ESC harnesses) the ESC must be evaluated by a qualified technician. If you have any questions, contact your authorized dealer. Failure to comply may result in property damage, personal injury, or death.



**NOTE**

For more information about the stability control system installed on your vehicle, please refer to additional material supplied with this operator manual, included in your glove box information packet.

3

**Brakes, Antilock Brake System**



Illuminates during the bulb check. Have the ABS system checked by an authorized dealer if the ABS Warning Lamp stays on for more than 3 seconds.

- Illuminates during normal operating conditions to indicate a problem with the ABS system.
- Illuminates when a problem exists with Automatic Traction Control (ATC).

**Brake, Park Brake**



Illuminates in the status indicator when parking brakes are applied.

**Brakes, Low Air**



Illuminates when system air pressure falls below 60 psi.

**Brakes, Trailer Antilock Brake System**



Illuminates during the bulb check and the tractor/truck is connected with a ABS equipped trailer. Illuminates during normal operating conditions to indicate a problem with the Trailer ABS System. This should be checked by an authorized dealer as soon as possible.

 **NOTE**

Tractors/Trucks and trailers built after 03/01/2001 must be able to turn on an In-Cab Trailer ABS Warning Light (per U.S. FMVSS121). The industry chose Power Line Communication (PLC) as the standard method to turn it on. On trailers built prior to 03/01/2001 verify trailer ABS system status via the required external warning light mounted on the trailer. The indicator light on the trailer should be yellow and identified with the letters ABS.

- Variable Road Speed Limiter (optional)
- When a Cruise Control function is enabled, a white indicator will appear. When a Cruise Control function has been activated, the indicator will change from white to green. For more information on use of the various Cruise Control functions, see Cruise Control, Adaptive Cruise Control, Predictive Cruise Control, and Variable Road Speed Limiter.

**Differential, Inter-Axle Lock**



Illuminates when the inter-axle differential switch is ON thus locking the inter-axle differential. This powers the forward rear and the rear rear differentials equally. When the switch is turned off (inter-axle differential unlocked) the engine power is allowed to flow to any of the four drive tires based on the differential effect (mostly to the forward rear differential). This feature is standard on all tandem axles.

**Cruise Control**



This indicator shows the operator which Cruise Control function is currently enabled or active. This includes

- Cruise Control
- Adaptive Cruise Control (optional)
- Predictive Cruise Control (optional)

 **NOTE**

Tractors/Trucks and trailers built after 03/01/2001 must be able to turn on an In-Cab Trailer ABS Warning Light (per U.S. FMVSS121). The industry chose Power Line Communication (PLC) as the standard method to turn it on. On trailers built prior to 03/01/2001 verify trailer ABS system status via the required external warning light mounted on the trailer. The indicator light on the trailer should be yellow and identified with the letters ABS.

**Dump Truck, Body Up**



Illuminates when Truck Dump Body is up.

**Dump Truck, Gate**



Illuminates when Truck Dump gate is open.

**Diesel Particulate Filter (DPF) Warning Light**

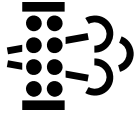



This icon and related message will appear when the DPF needs to be regenerated and then also during the regeneration cycle. This may also appear if the system is attempting to automatically regenerate while the vehicle is in Power Take Off operation mode.

Engine aftertreatment system includes a diesel particulate filter and DPF warning light.

**Emissions, High Exhaust System Temperature**



 <b>WARNING</b>
If this light is on, do not park in an area of combustible vapors or materials. You must keep combustibles at least 5 ft. (1.5 m) away from the exhaust (outlet) stream as it exits the tail pipe while the HEST light is illuminated. Always park your vehicle outside. Failure to do so could ignite an explosion or harm bystanders which could result in serious injury.

 <b>WARNING</b>
If this lamp is on, do not park in an area where people are close by. You must keep combustibles at least 5 ft. (1.5 m) away from the exhaust outlet while the HEST lamp is illuminated. Failure to do so could result in serious injury.

 <b>WARNING</b>
If this lamp is on, temperature of the tailpipe, exhaust pipes, the diesel par-

ticular filter (DPF)/selective catalytic reduction (SCR) device and surrounding components including enclosures and steps becomes elevated during engine operation or any regeneration event and can cause serious burns to the skin. Allow adequate cooling time before approaching, working on or near any part of the exhaust system or surrounding components.

Illuminates when the exhaust gas temperature and exhaust components become extremely hot.

**Emissions, Malfunction Indicator Light**



Illuminates when an engine emissions failure has occurred. The vehicle can be safely driven but should be serviced to correct the problem. The situation should not be considered an emergency. In some cases, the Malfunction Indicator Light will activate in conjunction with the High Exhaust Temperature, Diesel Particulate Filter (DPF), and Diesel Exhaust Fluid (DEF) Warning Lights.

**Engine, Check Engine**

Illuminates when a non emissions related problem exists, but the vehicle can still be safely driven. Vehicle should be serviced to correct the problem but the situation should not be considered an emergency.

**Engine, Engine Block Heater**

Illuminates when the engine block heater is turned on.

**Engine, Low Coolant Level**

Illuminates with an audible alarm indicating critically low coolant level. The vehicle must be serviced to correct the problem but the situation should not be considered an emergency.

**Engine, Overspeed Air Shutdown**

Illuminates when the Engine overspeed air shutdown system is activated.

**Engine, Retarder (Brake)**

Illuminates when the engine retarder (compression brake or exhaust brake) switch is turned on.

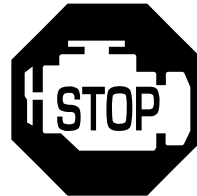
**Engine, Stop Engine**

Illuminates and an audible alarm tone will sound when a major engine system problem exists.

**WARNING**

If the Stop Engine warning light illuminates, it means you have a serious engine system problem. This should be considered an emergency. You should stop the vehicle as safely as possible and turn OFF the ignition. The vehicle must be serviced and the problem corrected before driving again. Failure to comply may result in death, personal injury, equipment or property damage.

**Engine Wait-to-Start Light**

This warning icon will appear when the system needs some time before attempting to start the engine. The light will illuminate at key ON, and will stay on for a period of up to 30 seconds.





**NOTE**

The length of time the 'Wait-To-Start' lamp remains illuminated depends on the ambient temperature. The lower the ambient temperature, the longer the lamp will be illuminated.

Once the Wait-to-Start light turns off, turn the key to the starting position to start the engine.

You may see this appear if the system has detected a situation where the starter is too hot and needs to cool down. Alternatively, you may see it when the engine grid heater is on and needs some time to warm up.



**NOTE**

Some engines are equipped with an engine starting motor protection feature. If the starting motor is engaged for 30 or more seconds, without the engine starting, the starter will be locked out from operating, allowing for proper cooling of the starting motor. During this time, the 'Wait-To-Start' lamp will flash for 2 minutes. Once the

lamp stops flashing, the starting motor will be allowed to function.

**Emissions, Engine Derate**



**Fifth Wheel Slide Unlocked**



Illuminates when fifth wheel slide switch is activated. Indicates fifth wheel can move.



**WARNING**

DO NOT move the fifth wheel while the tractor-trailer is in motion. Your load could shift suddenly, causing you to lose control of the vehicle. Never operate the vehicle with the switch in the UNLOCK position. Always inspect the fifth wheel after you lock the switch to be sure the fifth wheel slide lock is engaged. Failure to comply may result

in death, personal injury, equipment or property damage.



**NOTE**

Vehicles having an air slide fifth wheel have a fifth wheel slider lock controlled by a switch on the instrument panel. By placing the switch in the unlock position you can slide the fifth wheel to various positions to adjust weight distribution.

**Fifth Wheel Locked**



Illuminates when the fifth wheel is in the locked position.



**Fifth Wheel Unlocked**



Illuminates when the fifth wheel is in the unlocked position. Indicates the king pin is disengaged.

**Lights, High Beam**



Illuminates when the high beams are on. This icon will flash with audible alarm if the headlights are left ON when the door is opened and the key switch is OFF. In addition, this icon will flash, but without an audible alarm, if there is a problem with the low beam headlights or the low beam headlight wiring. In such event, the high beam headlights will turn on at 50% normal brightness.

**Lane Departure Warning (LDW)**



Illuminates when LDW system is not able to track the vehicle's position within the lane.

	<p>NOTE</p>
<p>For vehicles equipped with Lane Departure Warning, please refer to Lane Departure Warning Driver's Guide for additional information.</p>	

**Lane Departure Warning (LDW) Fault**



This amber warning light will appear when a fault occurs in the Lane Departure Warning (LDW) system. If this occurs, the LDW feature will be disabled.

**Fast Idle Control**

The display will show the Fast Idle Control (FIC) indicator when enabled or activated. The indicator shows the set RPM value.

See [Indicators around the speedometer](#) on page 135.

**Refrigerator**



Illuminates to indicate that the refrigerator is on and ignition is off.

**Seat Belt Fasten**



Illuminates when the ignition key is turned on as a reminder to fasten your seat belt.

**Tire Inflation (TPMS)**



Illuminates when tire pressures need to be checked.

**Transmission, Auxiliary**

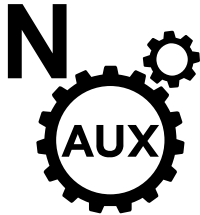

Illuminates to indicate auxiliary transmission is in neutral.

**Transmission, Check**



Illuminates when transmission has recorded a fault code.

**Turn Signal, Left**



Blinks when the left turn signal or the hazard light function is operating.

**Turn Signal, Right**



Blinks when the right turn signal or the hazard light function is operating.

**Optional Gauges**

For vehicles with a telematic navigation screen, optional gauges will be part of the screen functions. Please refer to the navigation system supplement for further details about its functions and how it works. Some vehicles may have optional analog gauges installed at the factory in place of the navigation screen.

**Drive Axle Temperature Gauge (Forward and Rear)**



These gauges indicate the temperature of the lubricant in your vehicle's axle(s). These temperatures will vary with the kind

of load you are carrying and the driving conditions you encounter. Maximum axle temperature may vary, depending upon the axle and type of lubricant. Very high temperatures signal a need to have your axle lubrication checked.



**CAUTION**

Driving with very hot temperatures in your rear drive axles can cause serious damage to axle bearings and seals. Have your axle lubrication checked if you notice a sign of overheating.

Depending on the vehicle configuration, there may be a single gauge for more than just the forward and rear driver. The icon will have an "X" over the representative axle to indicate which axle's temperature is being displayed in the gauge.

**Manifold Pressure Gauge**

This gauge indicates the pressure in the intake manifold. The pressure in the manifold is directly related to the turbo output and is related to the engine power output.



If the pressure indicated by your manifold pressure gauge goes down, there may be something wrong with your engine. Have it checked by a qualified service person.

## Dash Switches

This custom vehicle will have a wide variety of switch-controlled equipment. However, this particular vehicle may not have every switch identified in this section of the operator manual. Some air device

switches on the dash may require that the vehicle either be at a specific speed, have park brakes set, or another device to be on or off for the air device to operate. The instrument display will show information regarding what needs to change in order for the air device to operate as expected. The following table provides a complete list of icons that may be found on the switch.

Title	Standard or Optional
Axle, Differential Lock - Tridrive	OPT
Axle, Diff-Lock - Dual	OPT
Axle, Diff-Lock - Forward Rear	OPT
Axle, Diff-Lock - Rear Rear	OPT
Axle, Diff-Lock - Single Rear	OPT
Axle, Diff-Lock - Steer	OPT
Axle, Inter-Axle Differential Locked (Tandem)	OPT
Axle, Two Speed	OPT
Back Up Alarm Mute	OPT
Batteries, Low Voltage Disconnect (LVD)	STD
Brakes, ABS Off-Road	OPT
Brakes, Parking Brake Valve	STD

Title	Standard or Optional
Brake, Trailer Hand	STD
Cab Dimmer Switch	STD
Dump Truck Gate	OPT
Electric Steer, Assist Effort	OPT
Engine, Fan Override	OPT
Engine, Heater	OPT
Engine, Overspeed Air Shutdown (Test)	OPT
Engine, Overspeed Air Shutdown (Manual)	OPT
Engine, Remote Throttle	OPT
Engine, Under Hood Air Intake	OPT
Exhaust, Diesel Particulate Filter (DPF) Regeneration	STD
Fifth Wheel Slide	OPT
Fuel Heater	OPT
Generic Air, Accessory	OPT
Generic, Spare	OPT
Ignition Key Switch	STD
Lane Departure Warning (LDW) Disable	OPT
Lights, Auto Headlamp	STD

Title	Standard or Optional
Lights, Auxiliary	OPT
Lights, Beacon	OPT
Lights, Daytime Running (Override)	OPT
Lights, Dome	STD
Lights, Exterior Lights Self Test	STD
Lights, Flood	OPT
Lights, Flood ISO 3732 Spare	OPT
Lights, Fog	OPT
Lights, Hazard	STD
Lights, Headlight and Parking Lights	STD
Lights, Marker/Clearance/Cab	STD
Lights, Marker/Clearance/Trailer	OPT
Lights, Park Light	STD
Lights, Spot	OPT
Mud and Snow Traction Control	STD
Pintle Hook	OPT
Power Take-off (PTO)	OPT
Power Take-off (PTO), Forward	OPT

Title	Standard or Optional
Power Take-off (PTO), Rear	OPT
Suspension, Air Retention	OPT
Suspension, Axle, Pusher	OPT
Suspension, Axle, Tag	OPT
Suspension, Dump	OPT
Suspension, Third Axle Lift	OPT
Trailer Air Supply	STD
Trailer, Axle (3rd Axle) Lift	OPT
Trailer, Axle Lift Forward	OPT
Trailer, Axle Lift Rear	OPT
Trailer, Belly Dump	OPT
Trailer, Belly Dump Gate Center	OPT
Trailer, Belly Dump Gate Front	OPT
Trailer, Belly Dump Gate Rear	OPT
Trailer, Dump Gate	OPT
Trailer, Hotline	OPT
Trailer, Suspension Air Dump	OPT
Transmission, Transfer Case	OPT

Title	Standard or Optional
Transmission, Transfer Case Two-Speed	OPT
Winch Clutch	OPT

**Axle, Differential Lock - Tridrive**



Tridrives will have these axle differential lock controls and are 2 separate switches. **FRONT** will control the forward rear and **REAR** will control the center/rear-rear axle differential. In addition, a vehicle with Tridrive will have an interaxle differential lock switch.

**Axle, Diff-Lock - Dual**



Turn switch on to engage Front and Rear Axle Diff Lock.

**Axle, Diff-Lock - Forward Rear**



Turn switch on to engage Forward Rear Axle Diff Lock.

**Axle, Diff-Lock - Rear Rear**



Turn switch on to engage Rear Rear Axle Diff Lock.

**Axle, Diff-Lock - Single Rear**



Turn switch on to engage Single Rear Axle Diff Lock.

**Axle, Diff-Lock - Steer**



Turn switch on to engage Front Axle Diff Lock.

**Axle, Inter-Axle Differential Locked (Tandem)**



Turn switch on to engage Inter-Axle Differential Lock.

**Axle, Two Speed**



If equipped, the two speed axle switch allows you to select axle high and low ranges. The low range (Off) provides maximum torque for operating off-highway. The high range (On) is a faster ratio for highway speeds.

**Back Up Alarm Mute**



Turn switch on to mute Back Up Alarm.

	<p><b>NOTE</b></p>
<p>The mute function use is discouraged. Only use mute when legally required.</p>	

**Batteries, Low Voltage Disconnect (LVD)**



If your vehicle is equipped with a Low Voltage Disconnect (LVD) feature, the LVD is integrated into the main load center.

**Brakes, ABS Off-Road**



Turn switch on to engage ABS Off-Road mode.

**Brakes, Parking Brake Valve**



Pull yellow knob to activate parking brakes.

**Brake, Trailer Hand**



This dash mounted switch provides air pressure to apply the trailer brakes only. It operates independently of the foot treadle valve.

**Cab Dimmer Switch**



This switch is used to alter the brightness of the instrument panel lights.



**NOTE**

The Headlight Switch is an ON or OFF switch. The panel lights are on full intensity during the day and dim when headlights are on.

**Dump Truck Gate**

Turn switch on to open Dump Truck Gate.

**Engine, Fan Override**

The optional engine fan switch allows you to control the engine fan manually or automatically.

**Engine, Heater**

Turn switch on to activate the Engine Heater.

**Engine, Remote Throttle  
PUMP  
MODE**

Turn switch on to activate Remote Throttle Control.

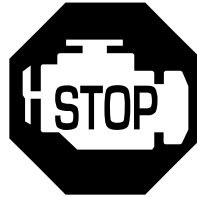
**Engine, Overspeed Air Shutdown  
(Manual)**

Turn switch on to engage the Engine Overspeed Air Shutdown system. A system reset will be required before re-starting engine. See EOAS system manufacturer's instruction manual for details.

**Engine, Overspeed Air Shutdown  
(Test)**

Hold down switch and increase engine RPM to test that Engine Overspeed Air Shutdown system functions correctly. A system reset will be required before restarting engine. See EOAS system manufacturer's instruction manual for details.

**Engine, Under Hood Air Intake**

This switch opens a door in the engine air filter housing so that the air is taken from under the hood instead of outside air. This switch can be useful when starting the vehicle in cold weather conditions.





**CAUTION**

Only operate the under hood intake air switch when outside temperatures are below 32°F (0°C). Engaging the under hood air intake while temperatures are above freezing may result in engine damage.

**Exhaust, Diesel Particulate Filter (DPF) Regeneration**

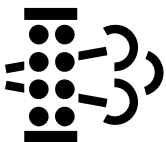

Manually controls the diesel particulate filter (DPF) regeneration process. Refer to Engine Aftertreatment Controls Operator's Manual for additional information.

**Fifth Wheel Slide**



Turn switch on to unlock Fifth Wheel Slide mechanism. The switch is guarded to protect you from accidentally activating or releasing the lock.



**WARNING**

DO NOT move the fifth wheel while the tractor-trailer is in motion. Your load could shift suddenly, causing you to lose control of the vehicle. Never operate the vehicle with the switch in the UNLOCK position. Always inspect the fifth wheel after you lock the switch to be sure the fifth wheel slide lock is engaged. Failure to comply may result in death, personal injury, equipment or property damage.



**NOTE**

Vehicles having an air slide fifth wheel have a fifth wheel slider lock controlled by a switch on the instrument panel. By placing the switch in the unlock position you can slide the fifth wheel to various positions to adjust weight distribution.

**Fuel Heater**



Turn switch on to activate Fuel Heater.

**Generic Air, Accessory**



Provides accessory air to the end of the frame connection when switch is turned on.



**NOTE**

The generic air accessory switch is designed by the original equipment manufacturer to reset when the ignition power is turned off. When ignition is turned off, this circuit will exhaust air pressure.

**Generic, Spare SPARE SPARE**

Turn switch on to power customer installed accessory.

### Ignition Key Switch

The ignition key switch located to the left of the steering column has four positions: ACC (Accessories), OFF, ON, and START. See also [Ignition Key Switch](#) on page 107.

Assist until the LDW system is re-enabled.

### Lane Departure Warning (LDW) Disable



The Lane Departure Warning (LDW) Disable switch disables both audible and visual Lane Departure Warning alerts for 15 minutes (or until the next ignition key cycle) after which time LDW will automatically re-enable. This switch will not affect any audible or visual alerts for the Adaptive Cruise Control (ACC) feature. This switch lights up green when active.

 **NOTE**  
Disabling Lane Departure Warning (LDW) will also disable Lane Keeping

### Lights, Automatic



The Automatic Light switch - when activated - will illuminate the exterior lights of the vehicle when a low light condition is detected, and will extinguish the lights when the lighting conditions brighten. (Do NOT confuse this feature with "automatic high beam control").

When *Parked* with the ignition switch in the ON position and Auto Switch enabled, the vehicle will turn on the following lights when a low light condition is detected:

- Park Lamps
- Tail Lamps
- License plate lamps

When *Driving* and Auto Switch enabled, the vehicle will turn on the following lights when a low light condition is detected:

- Low Beam Headlamps
- Park Lamps
- Position Lamps
- Tail Lamps

- Marker Lamps
- Clearance lamps
- Identification lamps
- License plate lamps.

### Lights, Auxiliary



Turn switch on for Auxiliary Lights.

### Lights, Beacon



Turn switch on for Beacon Light(s).

### Lights, Daytime Running (Override)



This switch overrides the normal operation of the Day Time Running Light (DRL) system. During normal operation, the DRL

will turn on lights when the headlights are turned off, engine is on, and the park brakes are disengaged. The override switch will turn the DRL off in these instances. The DRL is also turned off when the headlights are turned ON.



**WARNING**

DO NOT use daytime running lights (DRL) during periods of darkness or reduced visibility. DO NOT use DRL as a substitute for headlights or other lights during operations that require lighting of your vehicle. Failure to comply may result in personal injury, property damage or death.

If the headlight switch is turned OFF, the DRL system engages automatically after the engine starts and you release the parking brake. If the headlight switch is ON, the DRL system is overridden, and headlights operate normally. Also, the DRL is temporarily turned off during engine cranking.

**Lights, Dome**



Turn switch on for Cab Dome Lights.

**lights, Exterior lights Self Test**



This switch will begin a sequence of turning on and off exterior lights so that the operator can verify functionality. See [Exterior Lighting Self-Test](#) on page 107.

**Lights, Flood**



Turn switch on for cab mounted Flood Lights.

**Lights, Flood (Spare)**



Turn switch on for trailer mounted Flood Lights.

**Lights, Fog**



Turn switch on for Fog Lights.



**NOTE**

Across the U.S.A. and Canada, State/ Provincial requirements vary as to when high beams and fog lights can and cannot be used together. Some states allow only four lights to be used together, while some allow more. How your lights are arranged will affect whether you can operate headlights and fog lights concurrently always comply with the state or provincial requirements where you are driving.

**Lights, Hazard**

This switch operates the emergency flashers. With the switch in the ON position, the emergency flasher makes all four turn signals (front and rear) flash simultaneously. The flasher works independently of the ignition switch. You should always use the flasher if the vehicle is disabled or parked under emergency conditions.

**WARNING**

Use your Hazard Warning Light System any time you have to stop off the road or on the side of the road, day or night. A hard-to-see vehicle can result in an injury or accident. Another vehicle could run into you if you do not set your flashers and follow the placement of emergency signals per FMCSR 392.22.

**Lights, Headlight**

Turn switch for park/marker lights and headlights. When the headlights are ON, the dash lights, side, and tail lights are also on. Headlights will turn on if the windshield wipers are turned on. Manually turning the headlights on and then off will override this function until the next time the vehicle is turned on.

**CAUTION**

If you have confirmed there is a problem in the low beam wiring circuit, proceed with caution to the next available exit/turnoff and safely pull your vehicle completely off the road and call for assistance. Driving your vehicle with the headlamps on high beam (at reduced intensity) for a prolonged period could lead to an injury accident. Contact your nearest dealer to have the problem corrected as soon as possible.

If the vehicle has LED headlights, the operator can turn on the mirror heat switch

to heat up the lens of the headlights and remove any condensation. See [Door Mounted Mirror Controls](#) on page 113 for the mirror heat switch location.

**Lights, Marker/Clearance**

Turn switch on to control Cab and Vehicle Marker/Clearance lights.

**NOTE**

An interrupt switch for the trailer marker lights is mounted on the end of the turn signal lever.

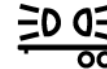
**Lights, Marker/Clearance/Trailer**

Turn switch on to control trailer marker/clearance lights separately from the vehicle marker/clearance lights.

**Lights, Park Light**



Turn switch on for Park Lights. When the Park Lights are on the dash lights, side and tail lights are also on.

**Lights, Spot**



Turn switch on for Spot Light.

**Mud and Snow Traction Control**



Momentarily push switch in to engage Traction Control (TC).

**Pintle Hook**



Turn switch on to remove the slack from the Tow Hook.

**Power Take-off (PTO)**



This vehicle may be equipped with a dash mounted switch that controls PTO engagement/disengagement. When the operator activates the switch for the PTO, the status indicator light (located on the switch) will immediately illuminate even though PTO engagement may not have occurred. If the PTO is engaged and the operator turns the switch OFF, the PTO status indicator light (located on the switch) will go out immediately even though PTO disengagement may not have occurred.



**NOTE**

Actual PTO engagement/disengagement may be delayed momentarily since it is controlled by the air system and mechanical movement.



**CAUTION**

Increasing engine rpm before the PTO is actually engaged could prevent the PTO from engaging and/or cause PTO damage.

**Power Take-off (PTO), Forward**



Your vehicle may be equipped with a dash mounted switch that controls forward PTO engagement/disengagement.

**Power Take-off (PTO), Rear**



Your vehicle may be equipped with a dash mounted switch that controls the rear PTO engagement/disengagement.

**Suspension, Axle, Pusher**



Turn switch on to lower Single or Forward Pusher Axle.

**Suspension, Axle, Tag**





Turn switch on to lower tag axle.

**Suspension, Dump**



Turn switch on to deflate suspension air bags. The switch is guarded to protect you from accidentally deflating the suspension.

 <b>WARNING</b>
<p>DO NOT operate the Air Suspension Deflate Switch (Dump Valve) while driving. Sudden deflation while your vehicle is moving can affect handling and control and could lead to an accident. Use this switch only when your vehicle is not moving.</p>

 <b>CAUTION</b>
<p>Operating a vehicle with air suspension bags either overinflated or underinflated may cause damage to drive-line components. If a vehicle must be operated under such conditions, do not exceed 5 mph (8 km/h). Failure to comply may result in equipment damage.</p>

**Suspension, Air Retention**



**Suspension, Third Axle Lift**



Turn switch on to raise Third Axle.

**Trailer Air Supply**



The red octagonal knob controls the air supply to the trailer.

**Trailer, Axle (3rd Axle) Lift**



Turn switch ON to lift 3rd Trailer Axle.

**Trailer, Axle Lift Forward**



Turn switch on to lift Forward Trailer Axle.

**Trailer, Axle Lift Rear**



Turn switch on to lift Rear Trailer Axle.

**Trailer, Belly Dump**



Turn switch on to open Trailer Belly Dump.

**Trailer, Dump Gate**



Turn switch on to open Trailer Dump Gate.

**Trailer, Belly Dump Gate Center**



Turn switch on to open Trailer Center Belly Dump Gate.

**Trailer, Belly Dump Gate Front**



Turn switch on to open Trailer Front Belly Dump Gate.

**Trailer, Belly Dump Gate Rear**



Turn switch on to open Trailer Rear Belly Dump Gate.

**Trailer, Hotline**



Turn switch on to supply electrical power to trailer accessories.

**Trailer, Suspension Air Dump**

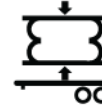

Turn switch on to deflate trailer air suspension.

**Transmission, Transfer Case**



Turn switch on to shift the transfer case.



## Transmission, Transfer Case Two-Speed



Turn switch on to shift the two-speed transfer case.

## Winch Clutch



Turn switch on to engage winch clutch.

## Ignition Key Switch

The ignition key switch located to the left of the steering column has four positions: ACC (Accessories), OFF, ON, and START.



**OFF:** In this position all accessories are OFF (except those listed below) and you can remove the key.

The following lights and accessories have power when the key is in the OFF position:

- brake lights
- emergency hazard flasher
- dome and courtesy lamps (on doors)
- electric horn
- cigarette lighter
- tail lights
- marker lamps
- headlights
- radio station memory
- instrument lights
- auxiliary power

- instrument panel memory settings

**ACC (Accessory):** With the key in this position you can play the radio, defrost mirrors (if equipped with mirror heat) or use other accessories.

**ON:** In the ON position all circuits are energized. Panel warning lights will light and the buzzer will sound until (1) the engine is started, (2) normal oil operating pressure is reached, and (3) air brake system pressure is above 65 psi (441 kPa). In this position, the ignition key cannot be removed.

**START:** Turn the key to this position to start your engine. Release the key after the engine has started.

## Exterior Lighting Self-Test

When the feature is engaged, via a switch on the dash, it will illuminate the:

- Park lights
- Side marker lights
- Hazard/turn signals
- Low beam headlamps
- First set of fog/driving lights

The test will turn those lights off and then illuminate the:

- Park lights
- Side marker lights
- High beam headlamps
- Stop/Brake lights

After turning these lights off, the system will resume testing the first set of lights. The light test will eventually stop on its own. The operator may interrupt the test by turning the vehicle off or pressing the switch a second time while the test is running. The operator can verify light functionality by visibly watching the lights from outside the vehicle or by observing the instrument cluster for lighting-related warnings. The ELST will also start the Systems Check ([Systems Check](#) on page 37).

### Test the Exterior Lights

To start the Exterior Light Self Test (ELST) feature:

1. Park the vehicle and set the parking brakes.
2. Insert the key into the ignition and turn the key to the ON position. Allow the vehicle to run through bulb check.

3. Press the momentary switch on the dash to start the ELST.



### Steering Column Controls

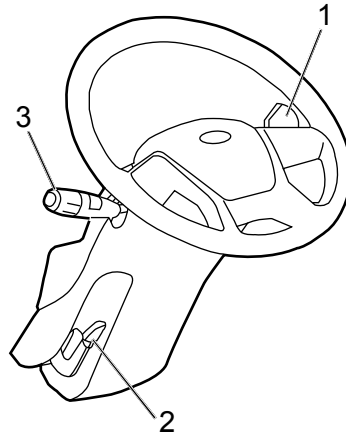

1. Engine brake (optional transmission shifter)

2. Tilt/telescope lever
3. Turn signal/wiper/lights

The turn signal lever is mounted on the left side of the steering column. The lever controls several functions: turn signal, high beam, and windshield wiper control. The turn signal lever will only operate when the key is in the ignition in the ACC position.

### Tilt/Telescoping Steering Wheel

Depending on your vehicle's configuration, you may have either a tilt/telescoping feature.

- The tilt feature allows forward and rearward movement of the wheel.
- The telescoping feature allows you to move the wheel up and down.



### WARNING

Make all adjustments to the steering mechanism while the vehicle is stopped. Adjusting the Tilt Telescoping Steering Wheel while the vehicle is in motion could cause loss of control. You would not be able to steer properly and could have an accident resulting in death or personal injury.

## How to Spray Windshield Washer Fluid

This vehicle is equipped with a function to wash the windshield and simultaneously engage the wipers.



### CAUTION

If the electric pump is operated for a long period (more than 15 seconds) with a dry reservoir, the pump motor may be damaged.

If you need to use the windshield washer:

1. Push the **Turn Signal Lever Outer Knob** in.

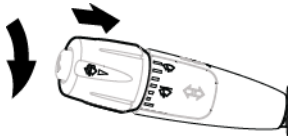

- Press and hold will activate the washer fluid and wipers.
- Instant press and release will activate the washer fluid only.

## Operate the Windshield Wipers

This vehicle is equipped with a two speed, intermittent windshield wiper system. The windshield wiper system is integrated with the exterior lights so that the low beam headlights will turn on when the windshield wipers turn on.



### WARNING

Clean blades regularly with a damp cloth to remove road film and wax buildup. DO NOT drive with worn or dirty wiper blades. They can reduce visibility, making driving hazardous which may lead to an accident resulting in death or personal injury.



### CAUTION

DO NOT use antifreeze or engine coolant in the windshield washer reservoir, damage to seals and other components will result.

To override this function, turn the headlights on and then off again. Permanently overriding this functionality is attainable via the Settings Menu in the

instrument cluster display. Go to **Settings > Wiper Interlock** and turn this value to OFF.

Avoid running the wiper blades over a dry windshield to prevent scratching the glass. Spray on washer fluid first. A scratched windshield will reduce visibility. A seven-position rotary wiper switch (located on the turn signal lever) operates the windshield wipers and washer. If you need to use the windshield wipers:

1. Rotate the end of the turn signal lever to change the wiper mode from off to on.
2. Rotate the outer knob of the turn stalk lever to adjust the wiper speed.

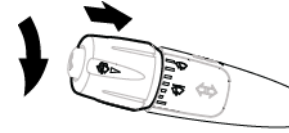

- Four levels of intermittent speeds
- Low wiper speed
- High wiper speed

### How to Flash Marker and Clearance Lights

A button on the end of the Signal Turn stalk will momentarily flash the marker and clearance lights when pushed.



### How to Momentarily Flash High Beams

The "flash to pass" high beam function is operated by the same steering column lever for the turn signals. The high beam flash to pass will work if the headlights are not on.

1. Gently push the turn signal lever, away from the steering wheel.

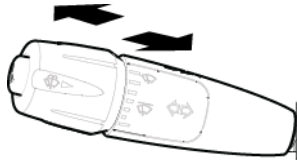

2. The lever will automatically return when the lever is released.

The blue indicator light in the instrument panel will momentarily turn ON and the

high beams will flash. The high beams will not remain on if the lever is still pressed.



#### NOTE

Continued pressing of the high beam flash will not keep the high beams on.

### How to Turn on High Beams

The high beam function is operated by the same steering column lever for the turn signals. High beams will not turn on if the headlights are turned off.

1. Gently pull the **Turn Signal** lever toward the steering wheel until you hear the switch click and the beam changes.

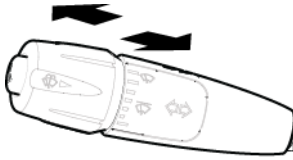

2. To return to previous beam, pull the **Turn Signal** lever towards the steering wheel again.

The blue indicator light in the instrument panel will turn ON when the high beams turn on.

### How to Use the Turn Signal

The lever-action turn signal/high beam switch is located on the left side of the steering column. The ignition key must be turned to ON for the signal/switch to operate.



#### NOTE

If the vehicle turn signals and turn signal indicators in the dash gauge cluster ever begin flashing at an accelerated rate (115 cycles per minute) when the turn signal lever is in the OFF (center) position, or when a Right/Left turn has been selected, the problem may be related to a failed turn signal switch or turn signal module. In either case, the problem is not a failed bulb. Contact your nearest authorized dealer to have the problem corrected as soon as possible.

1. Push the **Signal stalk** lever up to engage the RIGHT turn signal and

down to engage the LEFT turn signal.

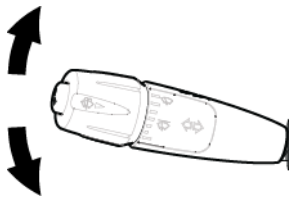

2. Release the signal stalk.
3. The turn signal will cancel when the turn is complete.

An audible beep is associated with each time a turn indicator is activated.



### WARNING

After you complete a turn, shut the system off by returning the lever to the "OFF" (center) position. Failure to shut off a turn signal could confuse other drivers and result in an accident. An indicator lamp in the instrument panel will flash until the turn signal is turned off.

## How to Adjust Tilt/Telescoping Steering Column



### WARNING

Make all adjustments to the steering mechanism while the vehicle is stopped. Adjusting the Tilt Telescoping Steering Wheel while the vehicle is in motion could cause loss of control. You would not be able to steer properly and could have an accident resulting in death or personal injury.

1. Push and hold the **Tilt Telescoping** lever down fully.
2. Push or pull the steering wheel to the desired height and angle.
3. Push the **Tilt Telescoping** lever back into the locked position.

## Controls on the Right Hand of the Steering Column

The lever on the right hand side of the steering column will operate the engine brake for vehicles with manual transmissions and Allison Automatic transmissions.

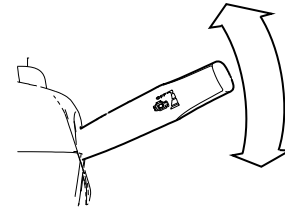

## Vehicles with a PACCAR Transmission

This vehicle may be equipped with the PACCAR Transmission. The lever on the right hand side of the steering column will operate the transmission functions in addition to operating the engine brake.

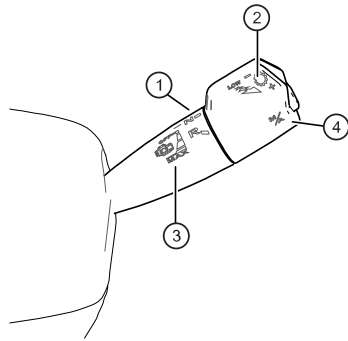

1. Transmission **D - N - R** Function
2. Up (+) and Down (-) Shift and **Low** Mode
3. Engine Brake and **Max** Mode
4. Manual (**M**)/Automatic (**A**) Mode Button

## Steering Wheel Controls

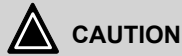

### CAUTION

Under no circumstances should you attempt to service the steering wheel, clockspring, or any of the electrical wiring in the multiplex system, or any steering components (steering column, steering driveline or steering gear). Tampering with these components may result in an inoperable multiplex system.

The steering wheel contains controls for commonly used functions so that the operator does not have to take their hands off of the steering wheel to operate. These controls are also used to interface with the display.

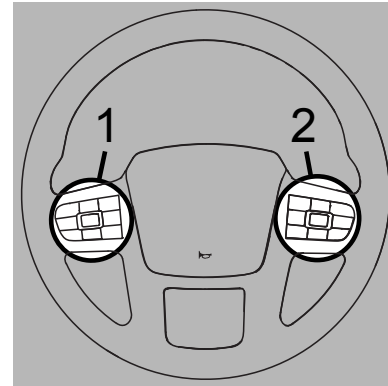

1. Left switch pod
2. Right switch pod

Switches on the left side of the horn pad, including the toggle switch, manage vehicle speed functions, cruise control, and optional features such as the variable road speed limiter (VRSL), adaptive cruise control (ACC), and predictive cruise control (PCC). See [Cruise Control](#) on page 142. Switches on the right side control infotainment (see [Cab Accessories](#) on page 124) and navigate and configure the instrument cluster (see ) (see [Peterbilt Digital Display Controls](#) on page 62).

**City Horn**

Depressing the horn pad in the center of the steering wheel activates the electric horn. Look for this symbol on the center pad of the steering wheel.  
To use the electric horn, press the button in the center of the steering wheel, which is the standard location for electric horns. Your vehicle may be equipped with optional air horns. To operate, pull on the lanyard extending from the overhead header panel.

**Door Mounted Mirror Controls**

If your vehicle is equipped with power mirrors, the mirror controls will be located on the driver-side door pad. Mirrors can be adjusted in four directions. To provide good visibility, adjust the mirror so the side of your vehicle appears in the inboard part of the mirror.

	<b>NOTE</b>
<p>If your vehicle is equipped with digital side-view mirrors (option) refer to the PACCAR Digital Vision System with Mirrors operator's manual.</p>	

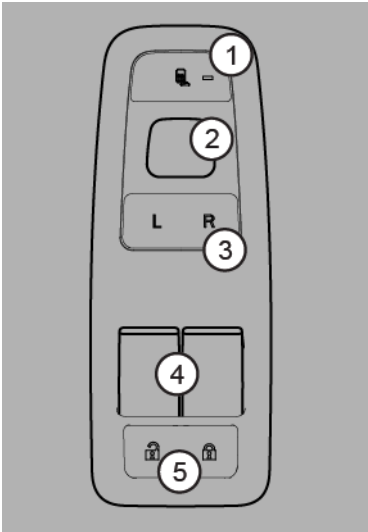

1. Mirror heat

- 2. Mirror adjust
- 3. Left or right mirror adjust selector
- 4. Window controls
- 5. Door lock control

**Mirror Heat Switch**

Your vehicle may be equipped with optional heated mirrors. Mirror heat is controlled by the mirror heat switch button. If the vehicle has optional hood-mounted heated mirrors, this switch will also activate heat to those mirrors. If the vehicles has optional LED headlights, this switch will also activate heat to those headlights.

**Power Mirror Switch**

If your vehicle is equipped with power mirrors, the directional controls for both mirrors are located near the top of the driver-side door trim pad.

**Power Door Lock Switch**

Power door lock rocker switches are located on the door pads. To lock or unlock both cab doors as well as a sleeper door, depress any door lock switch at the end that displays a closed or open padlock symbol, respectively, on the switch face.

### Power Window Switch

Power window rocker switches are located on the door pads. Depress the switch to open the window or pull up on the switch to close the window. Release the switch to stop window movement. The driver-side window has an express down feature. Pushing on the switch all the way down until the switch bumps will activate the express down feature. Release the button and the window will continue to open until it is completely open.

### How to Use Power Mirror Adjustment Switches



#### WARNING

Adjusting the mirrors while driving may cause you to take your eyes off the road, which could result in an accident. Adjust all mirrors before driving. Failure to do so could lead to serious injury or property damage.



#### WARNING

Convex mirrors can distort images and make objects appear smaller and farther away than they really are. You could have an accident if you are too close to another vehicle or other object. Keep plenty of space between your vehicle and others when you turn or change lanes. Remember that other objects are closer than they may appear.

1. Move the **Mirror Selector** switch (3) to the right or left from the neutral center position to select the desired mirror for adjustment.
2. Depress the **Mirror Directional Control** pad (2) in one of its four arrow directions to adjust the mirror in/out or up/down.
3. To provide good visibility, adjust the mirror so the side of your vehicle appears in the inboard part of the mirror.
4. After mirror adjustments have been completed, return the **Mirror Selector** switch back (3) to the center (neutral) position to prevent

unintentional adjustments to the mirrors.

## Heating and Air Conditioning

This vehicle's heating and air conditioning system operates in four distinct modes: manual, automatic, semi-automatic, and maximum defrost. Each mode provides the driver with the greatest level of comfort and convenience.

The recommended mode for all conditions that do not require windshield defrosting is the automatic mode. This mode is capable of maintaining cab comfort under various driving conditions without driver interaction. The cab heater and air conditioner controls are located together in the center of the dash just to the right of the steering column. The sleeper heater and air conditioner controls are located in the sleeper cabinet.



**WARNING**

DO NOT drive with visibility reduced by fog, condensation, or frost on the windshield. Your view may be obscured, which may result in death, personal injury, equipment or property damage. For clear visibility and safe driving it is extremely important for you to follow the instructions pertaining to the function and use of the ventilation/heating and defogging/defrosting system. If in doubt, consult your dealer. Maximum heating output and fast defrosting can be obtained only after the engine has reached operating temperature.

**WARNING**

Exhaust fumes from the engine contain carbon monoxide, a colorless and odorless gas. DO NOT breathe the engine exhaust gas. A poorly maintained, damaged or corroded exhaust system can allow carbon monoxide to enter the cab. Entry of carbon monoxide into the cab is also possible from other ve-

hicles nearby. Failure to properly maintain your vehicle could cause carbon monoxide to enter the cab, resulting in death or personal injury.

**WARNING**

Never idle your vehicle for prolonged periods of time if you sense that exhaust fumes are entering the cab. Investigate the cause of the fumes and correct it as soon as possible. If the vehicle must be driven under these conditions, drive only with the windows open. Failure to repair the source of the exhaust fumes may result in death, personal injury, equipment or property damage.

**CAUTION**

Do not stay in the vehicle with the engine running or idling for more than 10 minutes with the vehicle's Heater and A/C ventilation system in RECIRC or at LOW FAN SPEED. Even with the ventilation system on, running the engine while parked or stopped for pro-

longed periods of time is not recommended.

**NOTE**

Keep the engine exhaust system and the vehicle's cab ventilation system properly maintained. It is recommended that the vehicle's exhaust system and cab be inspected (1) By a competent technician every 15,000 miles (24,000 km) (2) Whenever a change is noticed in the sound of the exhaust system (3) Whenever the exhaust system, underbody, or cab is damaged.

**NOTE**

If you are required to idle your vehicle for long periods of time, install an auxiliary heater or automatic idle control. These auxiliary devices can reduce fuel consumption and save you money.



**NOTE**

If you are parked next to idling vehicles, move your vehicle or do not stay in your vehicle for prolonged periods of time.

**Air Conditioner Controls**

3

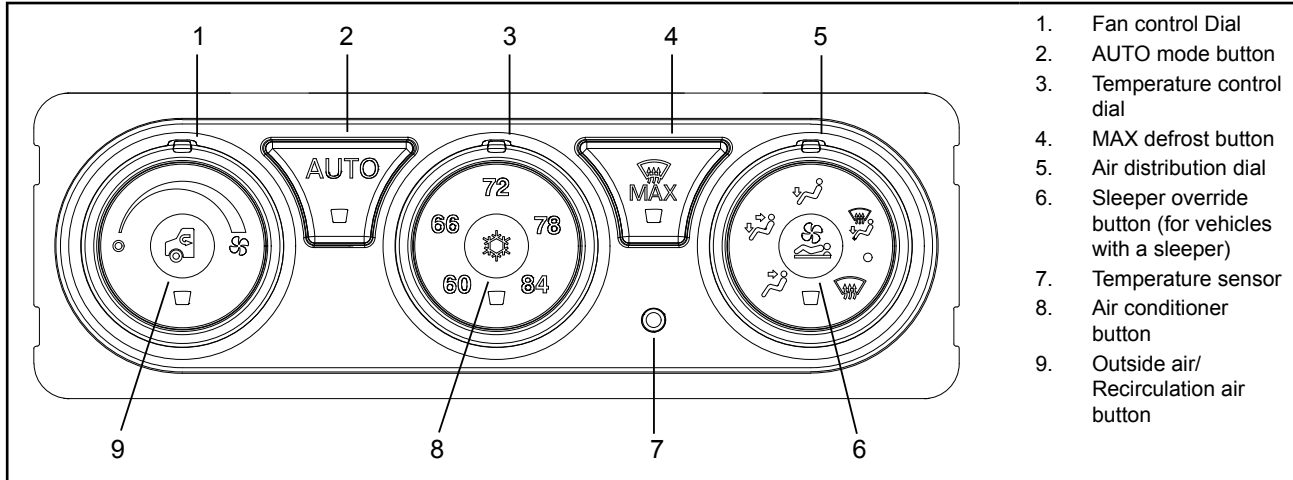

1. Fan control Dial
2. AUTO mode button
3. Temperature control dial
4. MAX defrost button
5. Air distribution dial
6. Sleeper override button (for vehicles with a sleeper)
7. Temperature sensor
8. Air conditioner button
9. Outside air/Recirculation air button

### Air Conditioning Functions

Short Description: These symbols for the air conditioner operate various system functions.

### Symbols for the air conditioning control panel



Image	Function
	The source of air entering the cab can be set to either outside air or recirculation air using the button inside the fan speed control dial. Recirculated air is automatically selected in defrost modes.
	The fan speed is adjusted by rotating the dial clockwise to increase speed or counterclockwise to decrease speed.
<b>AUTO</b>	Automatic air conditioner function









Image	Function
	The button inside the temperature control dial engages the A/C compressor. When activated the indicator on the button will illuminate. During AUTO mode, the A/C button indicator will remain illuminated at all times even though the compressor may be cycling.
	Max defrost function
	Power to the sleeper HVAC unit can be toggled using the button inside the air distribution dial. When activated, the indicator on the button illuminates. The sleeper HVAC unit will function to the settings of the sleeper control.
	Floor Vents

Image	Function
	Defrost Vents (and Fresh air intake)
	Panel and Floor Vents
	Panel Vents
	Floor and Defrost Vents (and Fresh air intake)

### How to Manually Control the Cab Air Conditioner

<b>Temperature Control Set Point</b>	The cab temperature is set using the temperature control dial. The operating range is 60°F (16°C) and 84°F (28°C). Adjustments are made in two degree increments.
<b>Air Conditioner</b>	The button inside the temperature control dial engages the A/C compressor. When activated the indicator on the button will illuminate. During AUTO mode, the A/C button indicator will remain illuminated at all times even though the compressor may be cycling.

**i** NOTE

Fan Control Dial must also be in the ON position for A/C to be on. A/C engages automatically in AUTO, defrost, and floor/defrost.

3

The air conditioner defaults to Manual mode when turned on. The fan speed, air temperature, and air outlets are selected using the dials on the controller.

1. To adjust the fan speed, turn the **Fan Control** dial clockwise to increase speed or counterclockwise to decrease speed.
2. To adjust the temperature setting, turn the **Temperature Control** dial to the desired temperature. The system automatically adjusts the outlet air temperature to achieve the desired cab temperature.
3. Push the **Air Conditioner** button if the air temperature needs to be colder, this button will manually turn on the compressor



4. To adjust the air distribution, turn the **Air Distribution** dial to distribute cab air as indicated by the dial graphics.
5. Press the **Recirculation** button to use cab air instead of outside air.



The temperature of the air from the vents will fluctuate as the vehicle works to achieve the chosen cab temperature. When idling for short periods of time, keep the fan ON and turn OFF **recirculation**. For vehicles with a sleeper, the cab control can be used to activate/deactivate the sleeper HVAC using the button inside the mode dial.

**Auto Mode for the Air Conditioner**

The Auto Mode will manipulate the air distribution, air temperature, fan speed, A/C compressor, and cab air recirculation to achieve the comfort level selected on the temperature dial. Depending on the specific environmental conditions, the air temperature can be slightly higher or lower than the set point. This is a normal function of the AUTO mode and is not to be mistaken for a malfunctioning system. The

button that enables automatic mode is labeled **AUTO**.

**AUTO**

The system will remain in automatic mode until the driver adjusts the dials on the control. Adjust the temperature knob and the system will respond to obtain the selected comfort level as quickly as possible.

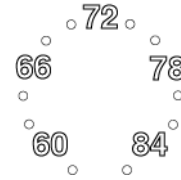

The cab temperature is set using the temperature control dial. The operating range is 60°F (16°C) and 84°F (28°C). Adjustments are made in two degree increments.

The AUTO function uses a sun light sensor to measure the amount of sunlight entering the cab. This sensor is located at the base of the windshield on the driver's side of the instrument panel. Do not block this sensor.

**Semi-automatic Mode**

During AUTO mode, the operator may override any setting and operate in a semi-

automatic mode. This can be done via the dials and/or buttons on the HVAC control. In Semi-automatic mode, the AUTO button indicator will cease to be illuminated. Instead, the indicator of the adjusted setting will illuminate. For example, if the driver adjusts the fan dial while in AUTO mode, the fan dial indicator will illuminate and fan speed will adjust to the setting of the dial. However, the temperature and air outlet settings will continue to function automatically. Similarly, if user adjusts the air distribution setting while in AUTO mode, the air distribution dial indicator will illuminate and the distribution will adjust to the setting of the dial. The fan and temperature settings will continue to function automatically.

### Economy Function

An economy function is also available in Semi-automatic mode. In this mode, the system will operate in AUTO mode without the use of the A/C compressor. The operator may select economy by initiating AUTO mode and then pressing the A/C button to disengage the compressor. The indicators for A/C compressor and AUTO mode do not illuminate while operating in economy mode.

### How to Operate Automatic Cab Air Conditioner

Follow these steps to activate the Auto Mode:

1. Press the **AUTO** button.
2. Rotate the **Temperature Control** dial to the desired temperature.

The system will achieve the comfort level associated with the temperature selected. Cab temperature can be slightly higher or lower than the selected temperature, which is a normal when in **AUTO** mode and should not be mistaken for a system malfunction.

### MAX Defrost Mode

The heating and air conditioning system provides for one touch windshield defrosting. Certain driving conditions will cause fog or ice to form on the windshield. By pressing the **MAX** defrost button, the system will automatically adjust the blower speed, recirculation, air temperature, and air outlet distribution to maximize clearing of the windshield. The system will remain in this mode until the driver presses the button again or adjusts the dials.



The air temperature in MAX defrost mode will be set to the warmest temperature setting. This setting helps to clear the windshield of ice and fog more quickly. Outside air mode and the air conditioner compressor are also active to maximize performance. The A/C compressor and recirculation switches are disabled in MAX Defrost.

### Sleeper Control Panel

Vehicles with optional sleeper units will have a control panel next to the bunk to

operate various functions from the comfort of the sleeper bed.

**Sleeper Control Panel**

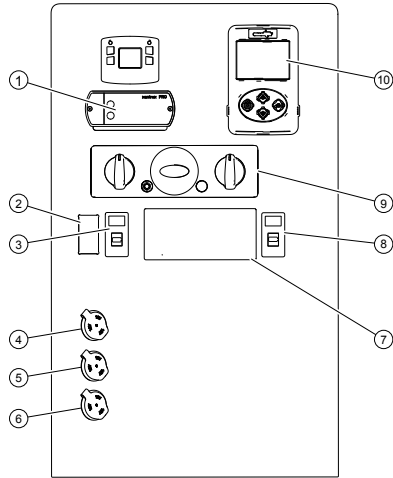

1. Inverter Control Module (Depending on options selected)
2. Point Light Switch (Depending on options selected)
3. Cab Door Lock Switch

4. 12V Power Port OR Cigarette Lighter (Depending on options selected)
5. 12V Power Port
6. 12V Power Port OR USB Charging Port (Depending on options selected)
7. Digital Alarm Clock OR Digital Alarm Clock with Sleeper Audio Controls (Depending on options selected)
8. Dome Light Switch
9. HVAC Controls
10. SmartAir/Fuel Fired Heater Controls (Depending on options selected)

Optional alert switch not shown.

**Alert Switch**

**Alert Switch**



The alert switch is an optional switch mounted in the sleeper control panel. The truck's exterior lights will start flashing and the city horn will sound when this switch is pressed.

**Sleeper Heater and Air Conditioner Controls (Option)**

Unlike the cabin air temperature controls, the sleeper temperature control will alter the air temperature based on the knob setting.

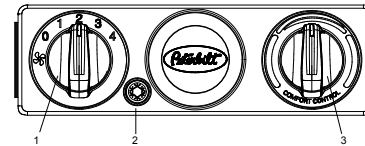



1. Air speed
2. Compressor
3. Temperature adjustment

The temperature control is not keyed to specific temperatures. Turning counterclockwise means cooler than it is now. Clockwise means warmer than it is now. Once the desired temperature is reached, the system will maintain it automatically. A separate switch on the dash HVAC unit will send power to the "bunk" or sleeper control unit. The button on the cab HVAC unit must be pressed and in the ON mode to use the sleeper controls.

Power to the sleeper HVAC unit can be toggled using the button inside the air

distribution dial. When activated, the indicator on the button illuminates. The sleeper HVAC unit will function to the settings of the sleeper control.

	<b>NOTE</b>
<p>On the Cab Control Unit, the sleeper enable switch must be pressed to turn ON power to the sleeper control unit. In addition, if air conditioning is requested in the sleeper, the air conditioner switch on the cab control unit will be turned ON and fan in the cab heater and air conditioning unit will be turn on low (if it was OFF) automatically.</p>	

	<b>NOTE</b>
<p>The sensor is located on the sleeper HVAC control panel and measures the sleeper air temperature at the panel. There will be a time delay between temperature control adjustment and sleeper air temperature change. Also, be careful of any heat source which could affect the air temperature by the</p>	

<p>sensor. Avoid hanging items (shirt, jacket, hat, etc.) which could block the airflow to the sensor.</p>
--

### Air Conditioner Operating Tips

	<b>CAUTION</b>
<p>During extreme cold weather, DO NOT blow hot defroster air onto cold windshields. This could crack the glass. Turn the Air Flow Control Dial to Defrost and adjust the fan speed accordingly while the engine warms. If the engine is already warm, move the Temperature Control Dial to "cool," then gradually increase the temperature when you see that the windshield is starting to warm up. Failure to comply may result in equipment damage.</p>	

### Defrosting and Defogging the Windshield

The cab windshield and side windows can be cleared of ice and fog in two ways. The first is to use the **MAX** defrost mode. The second is to manually adjust the air distribution dial to the defrost position.

The manual defrost/defogging mode differs from the **MAX** defrost mode by allowing the driver to select an air temperature other than full heat. This allows the driver to maintain a constant cab temperature while defrosting the windshield. However, note that performance may be reduced.

- Adjust the fan speed to high by rotating the fan control dial clockwise.
- Set the air distribution dial to the defrost mode setting. This automatically engages the outside air and the air conditioner compressor.
- Adjust the temperature dial to add heat as needed.

For maximum performance, adjust the temperature to maximum heat by rotating the temperature dial clockwise. The driver may also use the floor/defrost setting on the air control

### For Maximum Cooling

- Adjust the fan speed to high by rotating the fan control dial clockwise.
- Set the air distribution dial to the panel setting.

- Adjust the air temperature to maximum cool by rotating the temperature dial counterclockwise.
- Engage the air conditioner compressor by pressing the air conditioner button.
- Set the air source to recirculation mode by pressing the outside air/recirculation air button. The button indicator light should be illuminated.

**For Maximum Heating**

- Adjust the fan speed to high by rotating the fan control dial clockwise.
- Set the air distribution dial to the floor setting.
- Adjust the air temperature to maximum heat by rotating the temperature dial clockwise.



The engine must be at operating temperature for maximum heating. If operating in AUTO mode, heating airflow is not allowed until the engine warms

sufficiently to provide required coolant temperatures.

**Air Dehumidification**

The air conditioner system can be used to reduce the humidity level of the cab and clear fog from the windshield.

- Adjust fan speed to the desired airflow setting.
- Engage the air conditioner compressor by pressing the air conditioner button.
- Set the air source to outside air mode by pressing the outside air/recirculation air button. The button indicator light should NOT be illuminated.



The A/C compressor may not engage when the outside temperature is below 34°F (1°C).

**Cab Air Distribution**

Equal distribution of air is important in maintaining a constant cab interior temperature. For best performance, all

vents should remain open to allow AUTO mode to function properly. To maintain the selected cab temperature, AUTO mode may provide an air temperature from the vents that differs from the temperature set point. To ensure proper operation, it is recommended that the driver redirects the air instead of adjusting the temperature set point or closing the vent. The system may have difficulties in obtaining the desired cabin temperature if the temperature setting is repeatedly changed. The mode of air distribution inside the cab is set using the air distribution dial. Five icons on the dial indicate the primary mode options. The driver may also select a secondary mode in between the primary modes indicated by points on the dial. Airflow is provided to the side windows in all modes.

**Outside Air/Recirculation Air**

Selecting air recirculation mode completely isolates the cab interior from the outside air. This mode is helpful in preventing dust, pollen, and odors from entering the cab. Additionally, recirculation mode can reduce the amount of time needed to cool down the vehicle while in maximum cool down. Note that the mode may increase fogging on the windshield. A coarse air filter is



provided for recirculation air and is located under the IP. The outside air mode provides for 100% outside air into the cab. This mode is helpful with windshield defogging. A pleated air filter located under hood provides filtration for dust, pollen, and debris. If equipped, your vehicle may also provide for ember filtration or fine particulate filtration.

## Sleeper Alarm Clock

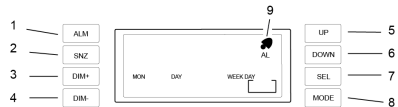

1. Alarm - press to turn on the alarm
2. Snooze - press to snooze the alarm bell
3. Dimmer/brighter - press to make display brighter
4. Dimmer/darker - press to make display less bright
5. Increase value of setting
6. Decrease value of setting
7. Select - press to choose the setting being changed while adjusting the either the time or the alarm

8. Time and Alarm value setting - press to change time/date and or alarm setting
9. Active alarm icon - alarm is activated when this icon appears

### Turning the Alarm On/Off

Press the **ALM** button to turn the alarm on and off. The icon (9) will illuminate when the alarm is active. When time reaches the set time the alarm will ring. If the **SNZ** button is not pressed, the alarm will continue ringing for 15 minutes then will automatically stop. Pressing any other button except **SNZ** (2) will turn the alarm off.

### Snooze Operation

When the alarm is ringing press the **SNZ** button (2) to silence the alarm for 9 minutes. The small bell icon (9) will flash until the alarm is shut off. The **SNZ** button can be used as many times as desired.

### Dim Control Operation

Press the DIM+ or DIM- buttons (3, 4) to change the brightness of the display.

### Set the Sleeper Alarm Clock Time

1. Press the **MODE** button until the screen begins flashing.
2. Use the **UP** and **DOWN** buttons to adjust the value.
3. Press the **SEL** button to adjust the next setting and use the **UP** and **DOWN** buttons to change the value.
4. Repeat this for all settings. The alarm clock will scroll in the following order each time you press the **SEL** button.
  - Year
  - Month
  - Day
  - Hours
  - Minutes
5. Press the **MODE** button once you have set the minutes which will exit and save your settings.

### Set the Sleeper Clock Alarm

1. Press the **MODE** button twice until the screen displays the AL icon.
2. Use the **UP** and **DOWN** buttons to adjust the setting.
3. Press the **SEL** button to adjust the next setting and use the **UP** and

**DOWN** buttons to change the setting.

4. Repeat this for all areas. The alarm clock will scroll in the following order each time you press the **SEL** button.
  - Hours
  - Minutes
5. To exit and save your settings, press the **MODE** button once you have set the minutes.

3

## Cab Accessories

### Radio (Option)

Your vehicle has one of two stereo systems. An AM/FM stereo receiver is standard equipment and may have a combination of CD, satellite radio, USB media, or Bluetooth. A stereo system integrated with GPS navigation and telematics is also available (option). For instructions on how to operate your particular radio, see the supplemental operating manual for those units. Controls for the infotainment system are located on the Right Switch Pod of the steering wheel.

Right Switch Pod (Infotainment)

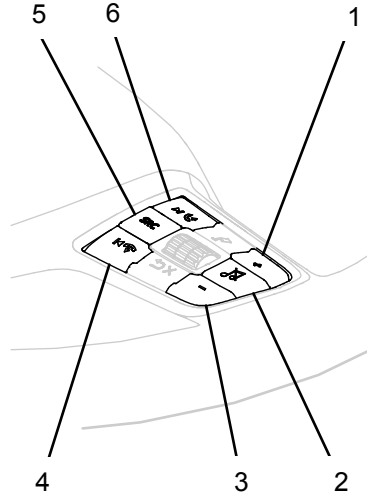

1. Volume increase
2. Mute
3. Volume decrease
4. Previous/cancel
5. Media source
6. Next track

### Cigarette Lighter and Ashtray (Option)



NOTE

The 12V accessory power port will operate with the ignition key in either the OFF, ACC (accessory), or ON position.

This vehicle comes standard with two cupholders and power ports located in the center of the dashboard. This vehicle may have the optional ashtray insert (for the cupholder) and the optional cigarette lighter instead of a power port. To operate, push in on the knob end of the lighter. After a few moments, the lighter will automatically pop out, glowing hot and ready to use. After use, insert the lighter back into the socket without pushing all the way in. The socket of the cigarette lighter may be used to operate 12V, 15 amp appliances, such as a hand spotlight or small vacuum cleaner.

**CAUTION**

Do not attempt to operate a cigarette lighter using the 12V power port receptacle. A cigarette lighter inserted into the 12V power port will heat up and be expelled into the cab, potentially causing personal injury, fire, and property damage.

**WARNING**

DO NOT place paper or other combustible substances in an ashtray, it could cause a fire. Keep all burnable materials, besides smoking materials, out of the ashtray. Failure to comply may result in death, personal injury, equipment or property damage.

**WARNING**

DO NOT exceed the voltage/ampere capacity of the accessory power port. It could result in a fire. Follow all warnings and instructions in the operator's manual for the appliance you are

using. Failure to comply may result in death, personal injury, equipment or property damage.

**Glove Box**

A glove box is provided to store important documents, the vehicle literature set (including this Operator's Manual), and other related materials. You can choose from a variety of other interior storage options to store your personal supplies or small tools:

- center console
- map pocket on the door
- overhead storage compartments

**WARNING**

DO NOT drive with the glove box open, it can be dangerous. In an accident or sudden stop, you or a passenger could be thrown against the cover and be injured. To reduce the risk of personal injury during an accident or sudden stop, keep the glove box closed when the vehicle is in motion.

**WARNING**

DO NOT carry loose objects in your cab, it can be dangerous. In a sudden stop, or even going over a bump in the road, they could fly through the air and strike you or a passenger. You could be injured or even killed. Secure all loose objects in the cab before moving the vehicle. Carry any heavy objects such as luggage in the exterior storage compartment and close it securely.

**Appliances**

If your vehicle is equipped with a television, or other appliance, be sure they are compatible with your vehicle's electrical system. Secure them in the cab so they cannot come loose in a sudden stop.



**WARNING**

In a sudden stop or collision a heavy object in your cab could strike you or anyone with you. You could be injured or even killed. Secure any appliance (such as a radio, or TV) you add to your sleeper or cab.

restrictions could result in a traffic infraction.



**WARNING**

Only glance at the system monitor while driving. Prolonged periods of viewing while driving could result in an accident involving death or personal injury.

responsibility to operate the vehicle in a safe and legal manner. Failure to comply may result in death, personal injury, equipment or property damage.



**WARNING**

Ensure the volume level of all audio devices is set to a level that still allows you to hear outside traffic and emergency vehicles. Failure to comply may result in death, personal injury, equipment or property damage.



**WARNING**

DO NOT program the telematic system while driving. Always stop your vehicle when programming or changing the settings on the telematic system. Programming the system while driving can cause you to take your eyes off the road, which could result in an accident involving death, personal injury or equipment damage.



**CAUTION**

DO NOT rely on the telematic system to route you to the closest emergency services. Not all emergency services are in the database.



**WARNING**

Verify legal weight and height restrictions for the route suggested by the telematic system. Failure to verify height restrictions could lead to causing death, personal injury or property damage. Failure to verify weight re-



**WARNING**

Regardless of how and where the navigation system directs you, it is your

**Vehicle Telematic System**

Your vehicle may be equipped with an onboard telematics system. This system is a Global Positioning Satellite (GPS)-linked computer. It receives input from multiple sources to locate your vehicle. Read and understand the Supplemental Telematics and Navigation System Owner's Manual and observe the Warnings, Cautions, and Notes that follow before using the system.

**NOTE**

The map database is the most current available at the time of production. The database is designed to provide you with route suggestions and does not take into account the relative safety of a suggested route or of factors that may affect the time required to reach your destination. See the Supplemental Navigation System Owner's Manual for more information.

**Using the Telematic System**

Screen Display On/Off

1. Press and hold the **Power/Light** button for approximately 1 second.
2. After the display has been turned on, the following Warning/Informational screen will appear.

**Warning/Informational Screen****WARNING**

**DO NOT let this device distract you while driving. Always concentrate on your driving. Distractions could cause an accident resulting in injuries to you or others.**

**IMPORTANT**

**Disclaimer:** Map data may be inaccurate and navigation routes may not be available for larger size vehicles. Regardless of how and where the navigation system directs you, it is your responsibility to operate the vehicle in a safe and legal manner. **Note:** Before using this system, read the Owner's Manual and learn how it operates. Some functions of this system will not

**WARNING**

**DO NOT let this device distract you while driving. Always concentrate on your driving. Distractions could cause an accident resulting in injuries to you or others.**

operate when the truck is moving.

Warning/Informational Screen: DO NOT let this device distract you while driving. Always concentrate on you driving. Distractions could cause an accident resulting in injuries to you or others.

3. After reading the information, touch the **T** in the upper right corner of the screen with your finger indicating you acknowledge and understand the information. The menu screen will automatically appear next.

4. To turn the system off, press and hold the **Power/Light** button for 3 seconds.

**Disclaimer:** The vehicle manufacturer is not responsible for erroneous map data, incorrect routing or any downtime or other damages associated with or arising out of the use of the Navigation System.

### Passenger Side 'Down' Mirror



#### NOTE

If your vehicle is equipped with digital side-view mirrors (option) refer to the PACCAR Digital Vision System with Mirrors operator's manual.

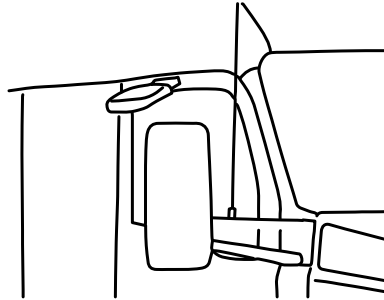

A mirror is located above the passenger door that provides a quick view of the blind spot created by the passenger door.

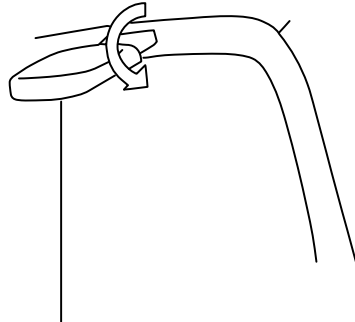

Loosen the screws on the top of the mirror to rotate the mirror up or down to get the

desired view. Tighten the screws when the position is correct.



## Chapter 4 | DRIVING

4

Starting and Operating.....	131
Starting and Warming Up.....	131
Engine Operations.....	135
Driver Assistance.....	142
Transmission.....	153
Brakes.....	160
Axle and Suspension.....	170
Trailer Operations.....	178
Driving Tips and Techniques.....	182
What to Consider when using a Sleeper Bunk.....	185
Stopping the Vehicle.....	186



## Starting and Operating

Since each vehicle is custom-equipped, all engine operation instructions in this manual are general. You will want to consult the manual for your engine to find out details about your specific engine's needs. You may need to use a slightly different procedure from the one outlined here.

### Systems Check Summary

#### System Check Display with TPMS

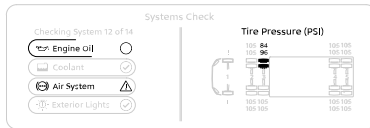

Once the Systems Check has completed, the results will display in a summary. A detailed explanation of this summary can be viewed by accessing the Menu after a Systems Check has completed.

### Anti-theft

When enabled, the engine cannot be started until the correct passcode has been entered.



Be aware that enabling Anti-theft will require drivers that share this vehicle to enter a passcode prior to starting the Engine, entering the Settings sub-menu (where Anti-theft can be disabled), or altering the Favorites View.

If after five minutes the engine hasn't been started, the passcode must be reentered – this precaution can be postponed in one minute intervals by using any steering wheel switch. If Anti-theft is disabled and then re-enabled in Settings, the passcode used prior to being disabled is still the passcode. Anti-theft allows for only one passcode per vehicle.

## Starting and Warming Up

### How to Start Vehicle in Normal Weather



#### CAUTION

Never operate the starter motor while the engine is running. The starter and flywheel gears could clash or jam, severely damaging them.



#### NOTE

Some starters are equipped with over-crank protection. Check the Engine Operation and Maintenance Manual for details.

When the outside temperature is above 50°F (10°C), you can use the following procedure. If Anti-Theft is enabled, the first time you turn the ignition switch to START, you will need to enter the Passcode.

1. Set the parking brake.
2. Put your main transmission in Neutral.

3. Disengage (depress) the clutch (with manual transmission).
4. Turn the ignition switch to START.



**NOTE**

If Anti-Theft is enabled, you will need to enter the Passcode in order to start the engine (see Anti-Theft).

5. If the engine does not start within 30 seconds, release the ignition switch. To avoid overtaxing the starter motor or the batteries, don't use the starter for more than 30 seconds. Let the starter motor cool and the batteries recover for two minutes before trying again. If the engine still won't start after a couple of tries, check the fuel lines for possible fuel starvation or air leaks. Starting failure may mean fuel is not reaching the injectors.
6. As soon as the engine starts, begin to watch the oil pressure gauge. Check your engine manufacturer's manual for the right pressure for your engine. If the oil pressure doesn't rise within a few seconds, stop the engine. Find out what is wrong before restarting the engine.

7. Slowly engage (release) the clutch after the engine has started.
8. Wait for the oil pressure gauge to reach normal operating pressure before operating the vehicle or idling faster than 1,000 rpm.

**Tips to Remember When Starting Vehicle in Cold Weather**

If you follow a few simple guidelines, you will extend the service life of your engine:

- Keep the electrical system in top condition.
- Use the best quality fuel of the recommended grade.
- Use recommended engine lubricating oil.
- For manual transmissions and auxiliary transmissions, leave the transmission in neutral and allow the transmission lubricating oil to warm up (approximately 3-5 minutes) before operating vehicle.

**Engine Block Heater (Option)**

To preheat the engine before starting, plug the optional engine block heater into a properly grounded AC electrical source.

DO NOT start the engine with the heater plugged in.



**WARNING**

Engine block heaters can cause fires which may result in property damage, personal injury, or death if not properly maintained and operated. Regularly inspect the engine block heater wiring and connector for damaged or frayed wires. DO NOT use the heater if there are any signs of problems. Contact your authorized dealer or the manufacturer of the heater if you are in need of repairs or information.



**CAUTION**

Always unplug heater before starting the engine. Damage to the cooling system could occur if the heater is not turned OFF (unplugged).

Depending on engine make, when the temperature falls below -10°F (-24°C), the block heater is required.

**Engine, Under Hood Air Intake**

This switch opens a door in the engine air filter housing so that the air is taken from under the hood instead of outside air. This switch can be useful when starting the vehicle in cold weather conditions.

**CAUTION**

Only operate the under hood intake air switch when outside temperatures are below 32°F (0°C). Engaging the under hood air intake while temperatures are above freezing may result in engine damage.

**Engine Warm Up**

Engine warm-up allows oil film to be established between pistons and liners, shafts and bearings while your engine gradually reaches operating temperature.

1. After you've started your engine, idle it at approximately 600 rpm while you check:
  - Oil pressure
  - Air pressure
  - Alternator output
2. After a few minutes of idling at 600 rpm, increase your idle speed to 900 or 1,000 rpm. Continue your warm-up. This procedure allows oil to warm and flow freely while pistons, liners, shafts, and bearings expand slowly and evenly. In extremely cold temperatures, you may have to increase idle speed.
3. Continue the engine warm-up until the coolant temperature reaches at least 130°F (54°C). At this temperature, you can use partial throttle. Wait until the coolant temperature is at least 160°F (71°C) before operating at full throttle.

**NOTE**

Under most circumstances, idling your engine for long periods merely wastes fuel. In severe arctic weather conditions, however, you may need longer idling to be sure all parts of your engine are fully lubricated.

**NOTE**

In colder climates where the temperature is often below freezing, the warm-up for turbocharged engines is especially important. Chilled external oil lines leading to the turbocharger will slow the oil flow until the oil warms, reducing oil available for the bearings. Watch the engine oil temperature or pressure gauge for a warming trend before increasing engine idle speed (rpm).



**WARNING**

Exhaust fumes from the engine contain carbon monoxide, a colorless and odorless gas. DO NOT breathe the engine exhaust gas. A poorly maintained, damaged, or corroded exhaust system can allow carbon monoxide to enter the cab. Entry of carbon monoxide into the cab is also possible from other vehicles nearby. Failure to properly maintain your vehicle could cause carbon monoxide to enter the cab, resulting in personal injury or death.



**WARNING**

Never idle your vehicle for prolonged periods of time if you sense that exhaust fumes are entering the cab. Investigate the cause of the fumes and correct it as soon as possible. If the vehicle must be driven under these conditions, drive only with the windows open. Failure to repair the source of the exhaust fumes may result in death, personal injury, equipment or property damage.



**WARNING**

To reduce the chance of personal injury, vehicle damage, and/or death from overheated engines, which can result in a fire, never leave the engine idling without an alert driver present. If the engine does overheat, as indicated by the engine coolant temperature lamp, immediate action is required to correct the condition. Continued unattended operation of the engine, even for a short time, may result in serious engine damage or a fire. Failure to comply may result in death, personal injury, equipment or property damage.



**CAUTION**

The use of a winterfront can result in excessive coolant, engine oil, and intake air temperatures, which may lead to overheating and possible engine damage.



**CAUTION**

DO NOT allow your engine to idle, at low rpm (400-600 rpm), longer than five minutes. Long periods of idling after the engine has reached operating temperatures can decrease engine temperature and cause gummed piston rings, clogged injectors, and possible engine damage from lack of lubrication. The normal torsional vibrations generated can also cause transmission wear.



**NOTE**

Keep the engine exhaust system and the vehicle's cab ventilation system properly maintained. It is recommended that the vehicle's exhaust system and cab be inspected (1) By a competent technician every 15,000 miles (24,140 km); (2) Whenever a change is noticed in the sound of the exhaust system; or (3) Whenever the exhaust system, underbody, or cab is damaged.

**NOTE**

If you are parked next to idling vehicles, move your vehicle or do not stay in your vehicle for prolonged periods of time.

**How to Warm Up the Transmission**

In cold weather (below 32°F (0°C), you may find shifting sluggish when you first start up. Transmission warm-up is especially important at this time, but it is always a good idea to warm-up your transmission before starting out on the road.

To warm-up the transmission lubricating oil during engine warm-up, with a single transmission (manual and automatic):

1. Put the transmission in Neutral.
2. Release the clutch pedal (manual only) and operate the transmission in neutral for 3 to 5 minutes prior to operating the transmission in either forward or reverse range.
3. If you have a two-transmission combination:
  - a. Put the main transmission in gear.

- b. Put the auxiliary transmission in Neutral. This will allow the transmission countershaft to turn, agitating the oil and warming it.

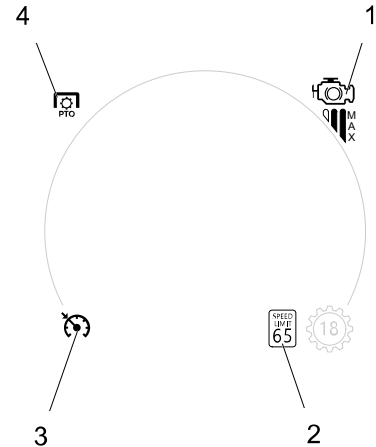
**Engine Operations****Indicators around the speedometer****Indicators around the Speedometer**

1. Engine Brake
2. Speed Limit (Option – see Lane Departure)
3. Cruise Control, Adaptive Cruise (Option), Predictive Cruise (Option)

4. Power Take Off

**Speed Limit**



Vehicles have the ability to recognize traffic signs for speed limits (both US and Canada). The indicator may change color if the vehicle is traveling faster than a posted speed limit. If traveling on a road with MPH speed limit signs and then the road crosses a border and subsequent signs are in KPH (such as crossing the US/Canada border), the display will not change to KPH until at least 3 traffic signs have been scanned.

4

**Engine Brake Operation**

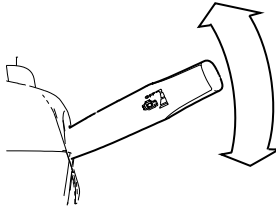

Moving the lever clockwise will engage the engine brake. Increase the amount of engine brake by moving the lever further clockwise. Each position has a corresponding level of engine brake.

Position	Amount of Engine Brake
Off	0%
1	33%
2	66%
3	100%

**Engine Brake Operation for a Vehicle with Automated Transmission**

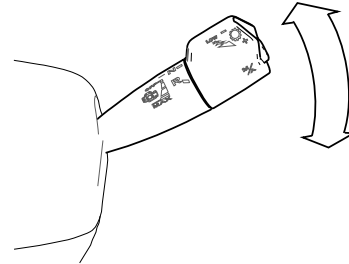

Position	Amount of Engine Brake
Off	0%
1	33%
2	66%

Position	Amount of Engine Brake
3	100%
4*	100% AND will engage transmission low gear
*This position is momentary and will revert back to position 3 when the lever is released.	

The corresponding engine brake level (or MAX mode) will be illuminated in the instrument cluster.

### Engine Brake Operation for a Vehicle with Automated Transmission

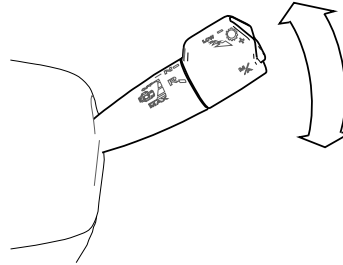

Moving the lever clockwise will engage the engine brake. Increase the amount of engine brake by moving the lever further clockwise. Each position has a corresponding level of engine brake.

Position	Amount of Engine Brake
Off	0 %
1	33%

Position	Amount of Engine Brake
2	66%
3	100%
4*	100% AND will engage transmission low gear
	* This position is momentary and will revert back to position 3 when the lever is released.

The corresponding engine brake level (or MAX mode) will be illuminated in the instrument cluster.

#### Related tasks

#### How to Activate MAX Mode

Vehicles with PACCAR automated or Eaton Endurant transmission have a MAX mode. Use this operation when the situation requires 100% engine brake and additional resistance from using the low gear of the transmission.

1. Move the **Transmission Shifter** to the 3rd position, representing 100% engine brake.
2. Pull the **Transmission Shifter** down once more and allow the

shifter to move back up to the previous location

MAX mode is now active and the instrument display will show the indicator in the view.

### How to Deactivate MAX Mode

Vehicles with automated transmissions will have the engine brake function integrated with the transmission controls. Follow these steps to deactivate **MAX** engine brake mode.

1. Accelerate with the throttle pedal.
2. Upshift, *Up or Down Shifting* on page 158 see .
3. Wait for the transmission coast down gear to engage.
4. Reduce engine brake level.
5. Re-initiate **MAX** mode.
6. Select Neutral **N**, see *Drive Neutral Reverse Selector* on page 158.
7. Select **LOW** mode.

### Engine Brake Indicator

Engine Brake Icon (1 bar)



Engine Brake Icon (3 bar+MAX)



The vertical bars represent the amount of engine brake, up to and including MAX mode. When Engine Braking is active, the indicator will change from white to green.

### How to change Fast Idle Control (FIC) Speed

The truck must be stationary, the transmission in Neutral, and the Park Brake set.



**CAUTION**

Do not let the engine RPM operate beyond the maximum governed RPM. Operating the engine above the maximum governed RPM may result in Engine damage.

1. Press the Cruise Control **ON/OFF**. The white FIC indicator will appear near the Speedometer/ Tachometer, indicating the FIC is enabled.
2. To set the FIC speed

- Press **RES –** to resume last used FIC speed, or
- Use the Accelerator to increase RPM, then press **SET +**, or
- Press and hold **SET +** to increase and set the new FIC speed, or
- Press and hold **RES –** to reduce FIC speed, then press **SET +**.

The FIC indicator will turn green, signifying that the FIC is activated.

### How to Start the PTO

PTO **Mode** can be activated in a number of different ways. If your vehicle is equipped with the **MX engine**, PTO Mode is typically activated by **engaging a PTO**, or by using the Dash PTO Mode Control Switch. For the **Cummins engine**, PTO Mode is typically activated by engaging a PTO, or by setting the Cruise Control Switch to ON but while the *vehicle is stationary*. The following information below provides the basic process of enabling and activating PTO engine speed control, and what the operator should observe during this process.



**NOTE**

Actual PTO engagement/disengagement may be delayed momentarily since it is controlled by the air system and mechanical movement.

**CAUTION**

Increasing engine rpm before the PTO is actually engaged could prevent the PTO from engaging and/or cause PTO damage.

1. Toggle the **PTO ON/OFF** switch, or the Dash PTO Mode Control Switch, to the ON position. Text indicating PTO engagement and/or PTO Mode control location will appear inside the speedometer. (Vehicles equipped with a PACCAR or Eaton automated transmission will display the letters AN in the transmission gear indicator when the PTO is engaged).
2. Press the Cruise Control (CC) **ON/OFF** switch to enable PTO speed control operations. A white

speed control enabled icon will appear.

3. Optional: If your PTO has designated PTO presets located on the dash:
  - If you have dash mounted PTO preset switches, toggle the desired **PTO Preset** switch, or
  - Using the dash mounted **PRESET Increment and Decrement** switch, cycle through the PTO presets to select the desired preset.

PTO Speed Control is now active. Vehicles with an MX engine will display a green PTO indicator with a target PTO engine speed.
4. Optional: If you don't have dash mounted PTO preset switches, press the **SET +** and **RES -** buttons located on the steering wheel to command a desired engine speed. PTO Speed Control is now active. Vehicles with an MX engine will display a green PTO indicator with a target PTO engine speed.
5. To increase or decrease PTO engine speed use a combination of short and long presses of the **SET**

**+ and RES -** buttons located on the steering wheel (the cruise control buttons when the vehicle is moving).

Vehicles powered with PACCAR MX Engines will display the PTO engine speed above the PTO indicator.

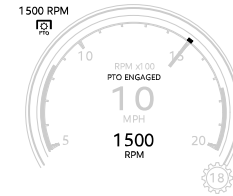
**PTO Active Gauge****Engine Fan Control**

The engine fan switch on the dash has a manual and an automatic mode. In the manual mode, the engine fan will engage until the switch is back into automatic mode. In automatic mode, the engine fan operation is controlled by the engine computer.



**WARNING**

DO NOT work on or near the fan with the engine running. Anyone near the engine fan when it turns on could be injured. If it is set at MANUAL, the fan will turn on any time the ignition key switch is turned to the ON position. In AUTO, it could engage suddenly without warning. Before turning on the ignition or switching from AUTO to MANUAL, be sure no workers are near the fan. Failure to comply may result in death or personal injury.



**CAUTION**

DO NOT operate the engine fan in the MANUAL position for extended periods of time. The fan hub was designed for intermittent operation. Sustained operation will shorten the fan hub's service life as well as reduce fuel economy.



**CAUTION**

The fan or equipment near it could be damaged if the fan turns on suddenly when you do not expect it. Keep all tools and equipment away from the fan.

**Using a Winterfront**



**CAUTION**

The use of a winterfront can result in excessive coolant, engine oil, and intake air temperatures, which may lead to overheating and possible engine damage.



**CAUTION**

A winterfront should only be used at temperatures below 40°F (4°C). Use of a winterfront above 40°F (4°C) can decrease life of cooling module components. Remove winterfront as soon

as the ambient temp reaches 41°F (5°C). The use of a winterfront above 40°F (4°C) can result in excessive coolant, engine oil, and intake air temperatures, which may lead to overheating and possible engine or coolant module damage and emissions non-compliance.

The winterfront is designed to minimize the temperature differences across the radiator and reduce the possibility of cooling module damage. Aftermarket winterfronts may not provide the proper airflow distribution and could cause cooling module damage.

**How to Set the Shutdown Timer**

The Shut Down Timer must first be enabled. Enabling the shutdown timer is located in the Settings Sub-menu. Follow these steps to turn on the engine idle shutdown timer. The shutdown timer will default to 5 minutes (or the last value used) and can be set up to 30 minutes unless limited by the Engine Shutdown System ([Clean Idle](#) on page 316)

**WARNING**

Never idle your vehicle for prolonged periods of time if you sense that exhaust fumes are entering the cab. Investigate the cause of the fumes and correct it as soon as possible. If the vehicle must be driven under these conditions, drive only with the windows open. Failure to repair the source of the exhaust fumes may result in death, personal injury, equipment or property damage.

**CAUTION**

DO NOT idle the engine for excessively long periods. Long periods of idling, more than 10 minutes, can cause poor engine performance.

1. Using the **Scroll Wheel**, target the number of minutes and press **Select**.
2. **Back** to return to the Settings menu.

**Engine Aftertreatment System**

This vehicle has an Engine Aftertreatment System (EAS), to control vehicle exhaust emissions. The Engine Aftertreatment system consist of a Diesel Particulate Filter (DPF), Selective Catalyst Reduction (SCR), DPF Switch and warning lights. The DPF will trap soot from the engine exhaust gases. The SCR uses Diesel Exhaust Fluid to reduce the levels of NOx in the engine exhaust. The EAS will periodically clean (regenerate) the DPF.

Your vehicle may be equipped with an additional feature designed to alert a remote operator that the aftertreatment system requires a regeneration. When the EAS detects a heavily loaded DPF it will sound the city horn for 10 seconds while continuously flashing the vehicle

headlamps. The operator can resolve and reset the alert by performing a parked regeneration. Alternatively, the notification can be dismissed by pressing the clutch or the service brake. Dismissing the alert does not reset it, the next alert will occur at the next higher soot level if a parked regeneration is never performed.

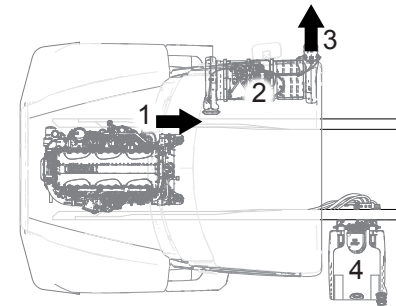
**Engine Aftertreatment System Detail**

1. Hydrocarbon doser from turbo
2. Aftertreatment unit (DPF, DEF doser and SCR)
3. Filtered/treated exhaust
4. Diesel exhaust fluid (DEF) tank

Please refer to the Engine Aftertreatment System Supplement provided with the

vehicle for more detailed description of functionality and warnings.

## Driver Assistance

Driver Assistance (or Advanced Driver-assistance Systems (ADAS)) defines a variety of electronic features which assist the operator while driving. These features use automated technology to improve operator and vehicle safety by alerting the operator (and in some cases taking actions) to the driving environment. The Driver Assistance features use electronic and hardware improvements in order to accomplish this task: cameras, radar, sensors, driving automation, and in-cab notifications.

The features described in this section should supplement the explanations, warnings, and preventative maintenance information located in the ADAS OEM operator's manuals for the equipment particular to the vehicle. It is important that the operator familiarize themselves with the OEM manuals associated with their ADAS equipment prior to driving the vehicle.

4

### ZF WABCO™ Advanced Driver-assistance Systems (ADAS)

Product	Feature
ZF WABCO™ OnLane ALERT	Lane Departure Warning (LDW)
ZF WABCO™ OnGuard ACTIVE	Adaptive Cruise Control (ACC)
	Collision Mitigation

### Bendix™ Advanced Driver-assistance Systems (ADAS)

Product	Feature
Bendix™ Wingman Advanced	Adaptive Cruise Control (ACC)
	Collision Mitigation
Bendix™ Wingman Fusion	Adaptive Cruise Control (ACC)
	Collision Mitigation

Product	Feature
	Speed Limit Recognition
	Highway Departure Braking
	Lane Departure Warning (LDW)

### Cruise Control



#### WARNING

DO NOT operate the cruise control when operating on road surfaces with poor traction (wet, icy, or snow covered roads) or in heavy traffic. Accelerations caused by the normal operation of the cruise control could cause you to lose control of the vehicle resulting in an injury accident.

Cruise control functions and features may vary depending upon which engine you have. For a specific explanation of your cruise control, see the cruise control or

engine manual included with your vehicle. This vehicle's electronic system will perform a 'rationality check' every time the vehicle is started. This check is to ensure that the service brakes are working before allowing cruise control to function. This safety feature is designed to ensure that a driver is able to cancel the cruise set speed by using the service brake pedal. The system will not allow cruise control operation if it does not pass the 'rationality check.' The display will prompt you to press the service brake pedal if it has not been pressed since the vehicle has been started. In vehicles with Eaton transmissions, the cruise control switches may be located on the shift control knob. The left switch pod on the steering wheel contain buttons for the cruise control.

Left Switch Pod

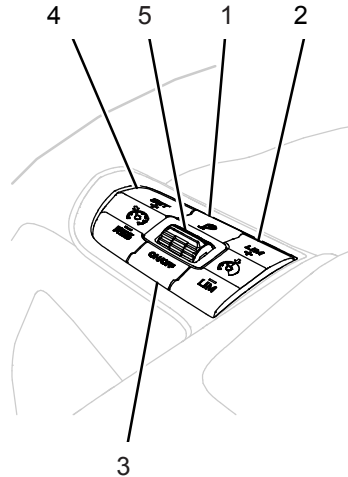

1. **Trip**
2. Variable Road Speed Limiter (VRSL) **LIM+** and **LIM-**
3. Cruise Control **ON/OFF**
4. Cruise Control (CC) **SET+** and **RES-**

## 5. Toggle

The switches on the left side of horn pad manage vehicle speed functions like cruise control and variable road speed limiter (option). If the vehicle has adaptive cruise control (option), predictive cruise control (option), etc., the toggle switch is also used to operate that system.

## Cruise Control Indicator



This indicator shows the operator which Cruise Control function is currently enabled or active. This includes:

- Cruise Control
- Adaptive Cruise Control (optional)
- Predictive Cruise Control (optional)



PCC not offered on 1.9m models.

The indicator will appear white when the system is on and it will appear green when the cruise control set speed is active. For

more information see [Cruise Control](#) on page 142.

### How to Use Set Cruise Control Speed When Driving

These instructions DO NOT apply to Adaptive Cruise Control. While the buttons are also used to control PTO operations, these instructions are specifically for vehicle speed. The vehicle speed must be greater than 19 mph (30 kph) for PACCAR powered vehicles or 30 mph (49 kph) for Cummins powered vehicles and the engine speed must be over 1,100 rpm for the cruise set speed to work.

To Set the Cruise Speed

1. Turn the cruise function on by using the ON/OFF button  
The cruise icon will appear in the display.



2. Accelerate the vehicle via accelerator pedal to the desired cruise speed.
3. Press the "SET +" button to set the cruise speed.



#### NOTE

Cruise Control may not hold the set speed going down hills. If the speed increases going down a hill, use the brakes to slow down. This will cancel Cruise Control.

The cruise set speed will appear in the display.

### How to Change Cruise Set Speed

The vehicle cruise control must be ON and the cruise speed engaged.

1. To increase vehicle speed
  - Press or long press **SET +** until you reach the desired speed, or
  - Use the Accelerator Pedal to reach the desired speed, and then press the **Set +**
2. To decrease vehicle speed, press or long press **RES -** until you achieve the desired speed, and then press **SET +**.

The new cruise speed can be seen next to the Cruise Control Indicator.

### Canceling and Resuming Cruise Control

There are four ways to cancel the set speed in cruise control:

1. Tap the brake pedal
2. Tap the clutch pedal
3. Turn the cruise control system OFF (ON/OFF button on steering wheel)
4. Press the Variable Road Speed Limit buttons

Using the brake or clutch pedal to cancel set speed allows the operator to use the RESUME feature. Pressing the "- RES" button will resume the vehicle speed previously set.

Pressing ON/OFF once will deactivate cruise control, and pressing it twice will turn off the system. When turning the system OFF, the previous set speed is removed from memory. The operator will have to manually reset the vehicle's cruise speed.

### Variable Road Speed Limiter (option)

The Variable Road Speed Limiter (VRSL) prevents the vehicle from exceeding a chosen vehicle speed limit. This limit is selected by the operator and can be changed while driving. VRSL uses various braking methods to enforce the limit

including ignoring further input from the accelerator pedal, but will only use engine braking if available and enabled.

VRSL replaces the Cruise Control indicator when active and will show the VRSL limit to the right of the indicator. This limit is shown in gray but turns white when actively limiting vehicle speed. MX engines, additionally, show "LIMITED" on the speedometer.

When active, the VRSL speed limit can be changed using the **LIM+** and **LIM-** buttons in the right, steering wheel switch pod. See How to Set the Variable Road Speed Limiter. Enabling VRSL will disable Cruise Control.

VRSL can be canceled by

- A long press of the Cruise Control **ON/OFF**.
- Stopping then parking the vehicle.
- Activating the PTO (option) (MX engine only).

**How to Set the Variable Road Speed Limiter**

The Variable Road Speed Limiter (VRSL) cannot establish a limit while the parking brake is set or the PTO is in operation. The minimum VRSL setting is 25 mph (40 kph). Enabling VRSL will disable Cruise Control if Cruise Control is active.

1. Press the Cruise Control **ON/OFF** button in the left, steering wheel switch pod.



Indicates that the VRSL feature is awaiting input.

2. Press, or press and hold, **LIM+** or **LIM-** to incrementally, or continuously, raise or lower the VRSL limit.

The green VRSL indicator will replace the Cruise Control indicator, indicating that VRSL is enabled. VRSL (like Cruise Control) will use the current vehicle speed as the VRSL limit until changed.

Pressing either **LIM+** or **LIM-** will adjust the VRSL limit while this feature is active.

**Adaptive Cruise Control (Option)**

 **WARNING**

The driver must remain alert, react appropriately, and use safe driving practices

ces while using this Driver Assistance feature. Ultimate responsibility for safe operation of the vehicle remains with the driver at all times. Failure to do so may result in death, personal injury, or property damage.

 **WARNING**

The driver must remain visually aware of the roadway and traffic and not rely solely on Drivers Assistance features to identify and respond to the variety of vehicles or objects sharing the road. The driver must read the ADAS operator's manual associated with this feature and understand its limitations prior to driving the vehicle. Failure to do so may result in death, personal injury, or property damage.



**WARNING**

Driver Assistance features respond differently to specific road, weather, and traffic conditions. The operator must read the ADAS operator's manual associated with this feature and understand how it responds to these specific conditions prior to driving the vehicle. Failure to do so may result in death, personal injury, or property damage.

4

Following Distance Five Bars



When Cruise Control is active, ACC will accelerate and slow the truck to maintain a chosen distance from a detected forward vehicle. Collision Mitigation will attempt to prevent a forward collision when advancing at speeds greater than 15 mph (24 kph). Please review the ACC section of this manual, and the manufacturer's manual, prior to driving this vehicle.

**Adaptive Cruise Display**

The display area for Active Cruise will contain dynamic visuals related to whether a tracked vehicle is in front and the amount of following distance set for Active Cruise. It will show an outline of a car in the display area when the radar is tracking a vehicle. Once it locks on to a tracked vehicle, it will display horizontal bars to represent the amount of following distance from the tracked vehicle. Once it locks and tracks a target vehicle, the system will adjust the speed to accommodate the speed of the tracked vehicle in front of it.

No Tracked Vehicle



The operator can set the amount of following distance from the tracked vehicle. There are five preset distances to choose from, represented by horizontal bars between the hood and the forward car. One bar represents the nearest following distance.

Following Distance One Bar

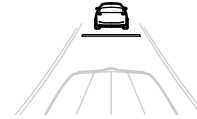

Five bars represents a farther distance.

Following Distance Five Bars



See [Set ACC Following Distance](#) on page 146.

**Set ACC Following Distance**

Follow these steps to adjust the following distance for Adaptive Cruise Control:

1. Press the **Toggle** until the following distance bars illuminate in the view.

If the vehicle has Predictive Cruise Control, you may have to press multiple times to cycle through the other settings for PCC.

2. Rotate the **Toggle** up or down to choose the amount of following distance.
3. Push the **Toggle** again to set the following distance.



### Following Distance Alerts

The display will be white when the tracked vehicle in front is at a proper following distance. If the following distance decreases (less than 1.5 seconds), the following distance bars will turn amber. When the following distance decrease more (0.5 seconds), the following distance bars will turn red.

### Object Detected Alert

When Collision Mitigation instrumentation detects a roadway object not recognized as a vehicle, the following graphic will show in the Driver Assistance area of the Digital Display:

Adaptive Cruise - Object Detected



Because ACC doesn't classify the forward object as a vehicle, Collision Mitigation braking will not occur (see Collision Mitigation); instead, this graphic is accompanied by an audible alert, allowing the operator to decide how to best respond to the detected object.

For more information on the characteristics of the Adaptive Cruise Control feature, please read the ADAS OEM Operator's Manual specific for your vehicle.

### Collision Mitigation



#### WARNING

The driver must remain alert, react appropriately, and use safe driving practices while using this Driver Assistance feature. Ultimate responsibility for safe operation of the vehicle remains with the driver at all times. Failure to do so may result in death, personal injury, or property damage.



#### WARNING

The driver must remain visually aware of the roadway and traffic and not rely solely on Drivers Assistance features to identify and respond to the variety of vehicles or objects sharing the road. The driver must read the ADAS operator's manual associated with this feature and understand its limitations prior to driving the vehicle. Failure to do so

may result in death, personal injury, or property damage.



#### WARNING

Driver Assistance features respond differently to specific road, weather, and traffic conditions. The operator must read the ADAS operator's manual associated with this feature and understand how it responds to these specific conditions prior to driving the vehicle. Failure to do so may result in death, personal injury, or property damage.

Collision Mitigation (also Automated Emergency Braking) will attempt to prevent or lessen the impact of a forward collision where Collision Mitigation has determined impact with a vehicle is likely. Although the Driver Assistance instrumentation can detect a non-vehicular, forward object, only a recognized vehicle can trigger Collision Mitigation.

Unlike Adaptive Cruise Control (ACC), Collision Mitigation is always on (at speeds greater than 15mph) and does not depend on Cruise Control being active. When Collision Mitigation determines that a forward vehicular impact is likely, Collision

Mitigation will apply the service brakes and present the following warning in the Driver Assistance area of the display (see Minimized View with Driver Assistance) along with an audible warning:

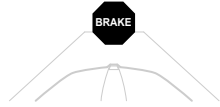

Additionally, this popup will appear instructing the operator to take control:



Collision Mitigation should not be used to stop or slow the vehicle without operator intervention. A Collision Mitigation braking event will temporarily disable both ACC and standard Cruise Control, requiring these features to be reactivated by the operator.

Collision Mitigation will continue to slow the vehicle until the potential for a collision has been averted, whether the potential collision be the vehicle that triggered the braking event or another forward vehicle the system has determined may likely result in an impact. The operator can cancel the braking event by using either

the accelerator pedal or the service brake. This lets Collision Mitigation know that the triggering event has been acknowledged. To prevent abuse of this emergency braking feature, after three Collision Mitigation braking events, ACC and Collision Mitigation will be disabled until the next time the ignition switch is cycled. This is to prevent using Collision Mitigation irresponsibly or in a manner for which it was not intended. Please read the ADAS operator's manual specific for your vehicle to become familiar with the limitations of Collision Mitigation (Automated Emergency Braking).

### Predictive Cruise Control (Option)



Predictive Cruise Control (PCC) uses satellite technology and GPS maps to look at upcoming roads to dynamically calculate optimal fuel-efficient speed over a given terrain.



### NOTE

There are many other factors that may influence the overall fuel economy of your vehicle (i.e., head wind and slope terrain, etc.).

Predictive Cruise Control operates similarly to standard cruise control. With PCC, vehicle speed is maintained without holding down the accelerator and can be used at 19 mph (30 km/h) or more. PCC will also actively recalculate and change the target cruising speed for best fuel economy rather than maintaining a constant set speed. The range of the PCC target cruise speed is defined by an overshoot and undershoot speed values. These values are adjustable by the operator.

**NOTE**

Adaptive Cruise Control (ACC) has the ability to override Eco cruise. This is because ACC is designed to decelerate the vehicle to match the speed of traffic in front of the ACC equipped truck.

**PCC Behavior**

As the vehicle approaches the top of a hill, PCC will decrease the vehicle speed (up to 8% below the set speed) to prevent the vehicle from exceeding the set speed while traveling downhill. This will result in a smoother, more fuel efficient ride as the vehicle approaches the crest of the hill. Once over the crest, momentum takes over and the system allows a predetermined amount of speed over the set speed. PCC can also activate Neutral Coast (NC) mode. NC mode disengages the vehicle's driveline, reducing fuel consumption while maintaining overall vehicle speed. Once the vehicle can no longer maintain speed while coasting, NC is deactivated and the driveline re-engages.

If the driver has activated one of the vehicle's retarder systems (Engine,

transmission, or driveline), the vehicle speed may increase until it reaches the cruise control set speed plus the retarder offset. For more information about engine retarders, see your vehicle Operator's Manual.

If the vehicle drops outside the speed range, PCC will accelerate the vehicle back to the minimum PCC speed.

As the vehicle reaches flat ground after the hill, PCC will maintain the set-speed until the crest of the next hill.

If the vehicle is equipped with Adaptive Cruise Control (ACC) and senses traffic slowing, it will overrule PCC and slow the vehicle. This event will cancel PCC only if the service brakes are required to slow the vehicle. If the service brakes are not used by ACC to maintain a safe following distance, PCC will remain engaged and resume automatically after the ACC event.

**NOTE**

PCC was calibrated using a loaded vehicle. Your results may vary, depending on your vehicle's configuration.

**PCC Interrupt**

There are three conditions that will automatically deactivate PCC:

- If there is no data for the current road.
- If the GPS signal is lost.
- If the PCC system detects a fault.

When this happens, the vehicle will revert to standard cruise control. This CC state will be standard cruise control which will maintain the same cruise speed that was selected for PCC.

Once the system regains GPS signal and road data, PCC will resume.

**NOTE**

PCC Map coverage will include most interstate and state highways. If you happen to leave a supported roadway, the PCC will deactivate. Standard cruise control will automatically step in to maintain the vehicle speed.

**Troubleshooting**

The display will show a message if it detects an error with the PCC system. PCC faults may result from the unavailability of map, slope, vehicle

position, etc. To effectively diagnose and clear the fault codes, the truck must be taken to your local dealership.

### Fuel Economy Savings Not Achieved

Certain conditions may cause the optimal vehicle speed, calculated by PCC, to be overruled. For example, PCC will be overruled in the following scenarios:

- Greenhouse Gas functionality
- Adaptive Cruise Control Following Event (if equipped)
- Adaptive Cruise Control Error State (if equipped)

### Disabling Predictive Cruise Control

To disable PCC and enable standard cruise control, the truck must be taken to an authorized dealer.

### Software Information

The PCC ECU Software version and Map Data Version number can be found in the Menu [Truck Information](#) on page 77. . It may take up to two minutes for this information to be displayed after the truck has been keyed-on.

### PCC Controls

PCC uses the same buttons as Cruise Control. See [Cruise Control](#) on page 142.

### PCC Undershoot

Follow these steps to adjust the undershoot value for Predictive Cruise Control:

1. Press the **Toggle** twice.

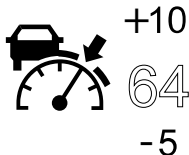

The bottom value below the set speed will illuminate.

2. Rotate the **Toggle** up or down to set the value.
3. Push the **Toggle** again to confirm the value.

If you want to set the Overshoot value, see [Predictive Cruise Overshoot](#) on page 72.

### Lane Departure Warning (LDW)



#### WARNING

The driver must remain alert, react appropriately, and use safe driving practices while using this Driver Assistance feature. Ultimate responsibility for safe operation of the vehicle remains with the driver at all times. Failure to do so may result in death, personal injury, or property damage.



#### WARNING

The driver must remain visually aware of the roadway and traffic and not rely solely on Drivers Assistance features to identify and respond to the variety of vehicles or objects sharing the road. The driver must read the ADAS operator's manual associated with this feature and understand its limitations prior to driving the vehicle. Failure to do so may result in death, personal injury, or property damage.

**WARNING**

Driver Assistance features respond differently to specific road, weather, and traffic conditions. The operator must read the ADAS operator's manual associated with this feature and understand how it responds to these specific conditions prior to driving the vehicle. Failure to do so may result in death, personal injury, or property damage.

Using a windshield-mounted, forward facing camera, the Lane Departure Warning (LDW) feature monitors the road for lane markings and alerts the driver when the vehicle departs its lane without the use of the turn signal. Lane departure warning is only active at speeds greater than 37 MPH (60 km/h).

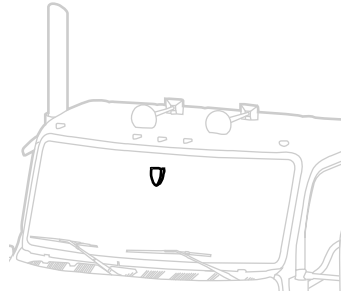

LDW is not available when the system cannot accurately detect lane markings; therefore, the camera should be clear of potential obstructions for the LDW feature to operate properly.

The following lists some conditions that can limit the performance of the features that use the camera:

- Buildup of dirt, mud, water, snow, ice, bugs, etc. on the windshield. These should be able to be resolved with proper use of the windshield washer/wiper system as the camera is intentionally installed in the wiper path.

- Windshield damage directly in front of the camera. This should be fixed as soon as possible.
- Items on the windshield like stickers, paint, window tint, etc. These should not be placed in front of the camera.
- Items on the exterior of the truck such as aftermarket visors, wind deflectors, hood ornaments, car racks, crane booms / hooks / buckets, snowplows, mirrors, etc.

The Driver Assistance area of the Digital Display indicates if the LDW system recognizes lane markings as follows:

- White lines indicate detected lanes.
- Gray lines indicate where the road is monitored for lane markings, but none are detected.
- Black lines mean that the LDW feature is disabled.
- A yellow line indicates an active lane departure event.

A lane departure event occurs when the vehicle tire crosses a lane marking without

the use of the turn signal. A lane departure event is accompanied by an audible alert.

**Lane Departure Active Warning Left**



The LDW feature provides audible and visual alerts only and does not attempt to correct the vehicle's position in the lane. The operator can temporarily disable LDW (disabling audible and visual alerts) by using the dash mounted Lane Departure Warning Disable switch (See [Lane Departure Warning Disable](#)). For more information on Lane Departure Warning, see the ADAS OEM operator's manual specific for your vehicle.

**Highway Departure Braking (option)**



**WARNING**

The driver must remain alert, react appropriately, and use safe driving practices while using this Driver Assistance feature. Ultimate responsibility for safe operation of the vehicle remains with

the driver at all times. Failure to do so may result in death, personal injury, or property damage.



**WARNING**

The driver must remain visually aware of the roadway and traffic and not rely solely on Drivers Assistance features to identify and respond to the variety of vehicles or objects sharing the road. The driver must read the ADAS operator's manual associated with this feature and understand its limitations prior to driving the vehicle. Failure to do so may result in death, personal injury, or property damage.



**WARNING**

Driver Assistance features respond differently to specific road, weather, and traffic conditions. The operator must read the ADAS operator's manual associated with this feature and understand how it responds to these specific conditions prior to driving the vehicle.

Failure to do so may result in death, personal injury, or property damage.

Highway Departure Braking (HDB) will slow the vehicle when the feature determines the vehicle has unintentionally left the roadway. HDB is only active at speeds above 37 mph (60 kph). When the midpoint of the vehicle crosses the solid white, outside lane line (also called the Fog Line) without use of the turn signal or hazards, HDB presumes an unplanned road departure and applies the service brakes. HDB will not bring the vehicle to a stop on its own (however, see Collision Mitigation), but is capable of reducing vehicle speed by up to 30 mph (48 kph). The digital display will notify the operator of a Highway Departure Braking event with a popup and show this graphic in the Driver Assistance area accompanied by an audible alert:



HDB works along with Lane Departure Warning (LDW). LDW can warn of a

highway departure prior to the braking action taken during a HDB event (see Lane Departure Warning).

The operator can acknowledge and cancel a Highway Departure Braking (HDB) event by

- Applying the service brake and braking more than that applied by HDB.
- Pressing the accelerator pedal and pressing more than 90% of the pedal range.
- Activating the turn signal.
- Activating the hazards.
- Steering the vehicle back into the lane.

To prevent abuse of this feature, after six Highway Departure Braking events, HDB will be disabled until the next time the ignition switch is cycled. This is to prevent using HDB irresponsibly or in a manner for which it was not intended. Please read the ADAS OEM operator's manual specific for your vehicle for more information about Highway Departure Braking.

### Speed Limit Recognition

Using the forward camera of your Driver Assistance instrumentation, your vehicle can read most North American speed limit

signs. The detected, posted speed limit is presented on the display using a road sign located in the Driver Assistance area (see Minimized View with Driver Assistance):



When vehicle speed exceeds the posted speed limit by 5 mph (8 kph) or more, the operator is notified using alternating red and blue "cop" lights, indicating above the sign on the display. This is accompanied by an audible alert. Please read the ADAS OEM operator's manual specific for your vehicle for more information about Speed Limit Recognition.

## Transmission

### Transmission Tips

#### Riding the Clutch

The clutch is not a footrest. DO NOT drive with your foot resting on the clutch pedal. It will allow your clutch to slip, causing excessive heat and wear, damage could result.

### Release Bearing Wear

When you must idle your engine for any period of time, shift your transmission to neutral and disengage the clutch (take your foot OFF of the pedal). This helps prevent unnecessary wear to your clutch release bearing, and is less tiring for you, too.

### More Tips

- Always use the clutch when making upshifts or downshifts.
- Always select a starting gear that will provide sufficient gear reduction for the load and terrain.
- Never downshift when the vehicle is moving too fast.
- Never slam or jerk the shift lever to complete gear engagement.
- Never coast with the transmission in neutral and the clutch disengaged. To provide smooth gear engagements while shifting, use proper coordination between shift lever and clutch.
- Double clutching is a very effective means to increase the service life of your transmission. Double clutching refers to a technique where the clutch pedal is used twice per shift instead of once. It

also requires that you adjust the engine rpm in the middle of the shift which ultimately synchronizes the gears during shifting.

Synchronizing reduces wear on the gears.

### Operating Manual Transmissions

The transmission shift pattern for your vehicle may be located on the shift control knob. In addition to understanding the shift pattern and its location, you should read the transmission manufacturer's manual provided with your vehicle before operating the vehicle. After making sure the vehicle's oil and air pressure are correct and all other parts and systems are in proper working condition:

1. For vehicles with a clutch pedal, locate the clutch pedal and engage the clutch brake.
2. Shift into a low gear.



#### CAUTION

Always use first gear or a low speed range to start the vehicle in motion. The use of a higher gear or speed range forces undue strain on the en-

gine, clutch, and other transmission components, and may cause damage.

3. Evaluate the road surface conditions and terrain your vehicle is on. Select a gear low enough to let your vehicle start forward with the throttle at idle.
4. Push the parking brake valve handle (yellow) against the dash panel to release the brakes.
5. Release the clutch pedal (manual only), then gradually accelerate to permit smooth starting.
6. DO NOT allow your vehicle to roll (even a little) in the opposite direction during clutch engagement. If you need to start up on an incline, apply your service brakes before you release the parking brake. Then release your service brakes as you engage the clutch and apply throttle.

For further instructions on operating your transmission, see the transmission manufacturer's Driver/Operator's Instruction Manual.

If you want to shift directly into any gear other than first or reverse, depress the clutch pedal only far enough to release the clutch. Fully depressing the pedal applies

the clutch brake and could cause gear hang-up.

If you have a misaligned gear condition in your vehicle's transmission and cannot start, gradually release the clutch, allowing the drive gear teeth to line up properly. Then the drive gear can roll enough to allow the teeth to line up properly and complete the shift. The best engine performance and maximum economy is obtained if gears are properly selected. This efficiency is achieved by always selecting gears within optimum engine rpm, which is where maximum torque and power are obtained.

Shift carefully in a new vehicle. The transmission may be a little stiff at first. Avoid gear clashing, by closely following these procedures. When you are operating a new vehicle or one that has been exposed to cold weather, you want the transmission lubricant (fluid) to circulate and coat the contacting surfaces of the gears. Metal contacting metal in moving parts may seriously damage your transmission, do not drive in one gear for long periods of time until the transmission lubricant has a chance to coat all contacting surfaces.



- Always select a starting gear that will provide sufficient gear reduction for the load and terrain.
- Never downshift when the vehicle is moving too fast.
- Never slam or jerk the shift lever to complete gear engagement.
- Never coast with the transmission in neutral and the clutch disengaged.

### How to Use the Hydraulic Clutch



#### CAUTION

Be careful not to apply the clutch brake while the vehicle is moving. The purpose of the clutch brake is to stop the transmission so that you can shift into a starting gear without grinding gears. Applying the clutch brake when the vehicle is moving causes a braking effect on the drivetrain and shortens the service life of the clutch brake.



#### CAUTION

DO NOT push the clutch pedal completely to the floor when shifting while the vehicle is in motion. Using the clutch brake while shifting a vehicle in motion will damage the clutch brake. A non functioning clutch brake will make shifting very difficult when the vehicle is stationary.

1. Depress the clutch pedal past the first 1/2 in. (13 mm) for approximately 5 1/2 in. (139.7 mm) of total pedal travel.
2. Depress the clutch pedal another 1/2 in. (13 mm) to engage the clutch brake.

The clutch brake is used for stopping transmission gears, allowing you to easily shift into first gear or reverse without grinding gears. The clutch brake is not necessary when shifting into other gears while in motion.

If the clutch pedal is pressed completely to the floor and the transmission is not shifting, then it is time to have the clutch adjusted or serviced.

If the transmission has a butt-tooth condition and you cannot engage a gear, gradually release the clutch. Then the drive gear can roll enough to allow the teeth to line up properly and complete the shift. The clutch is not a footrest. Do not drive with your foot resting on the clutch pedal. It will allow your clutch to slip, causing excessive heat and wear, damage could result.

When you must idle your engine for any period of time, shift your transmission to neutral and disengage the clutch (take your foot OFF of the pedal). This helps prevent unnecessary wear to your clutch release bearing, and it is less tiring for you, too.

- Always use the clutch when making upshifts or downshifts.
- Never coast with the transmission in neutral and the clutch disengaged.
- To provide smooth gear engagements while shifting, use proper coordination between shift lever and clutch.

### How to Shift Using Double Clutch Method

Double clutching is easier on the transmission and on the engine, helping

match your vehicle's engine speed with driveline speed to achieve clash-free shifts. The manual transmission in your vehicle is not equipped with gear synchronizers. Whether you are upshifting or downshifting, it is best to double clutch. To double clutch:

1. Push the clutch pedal down to disengage the clutch.
2. Move the gear shift lever to neutral.
3. Release the pedal to engage the clutch. This lets you control the rpm of the transmission mainshaft gears, allowing you to match the rpm of the mainshaft gears to those of the output shaft.
  - Upshifts: let the engine and gears slow down to the rpm required for the next gear.
  - Downshifts: press accelerator, increase engine and gear speed to the rpm required in the lower gear.
4. Now quickly press the pedal to disengage the clutch and move the gear shift lever to the next gear speed position.
5. Release the pedal to engage the clutch.

### Automated Transmissions

This vehicle may have a PACCAR or Eaton automated transmission. It remains important to completely understand how to operate the transmission to optimize its efficiency. Please read the manual for the automated transmission included with your vehicle.

Not all automated transmissions have a "park" position, so you will need to apply the parking brake before leaving the cab.

 **WARNING**

If your vehicle has an automated transmission, be aware that it can roll backwards when stopped on a hill or grade, or when starting from a stop on a hill or grade. Failure to comply may result in death, personal injury, equipment or property damage. Observe the following guidelines: (1) When stopped on a hill or grade, press the brake pedal. (2) When starting from a stop on a hill or grade, quickly remove your foot from the brake pedal and firmly press on the accelerator pedal.

 **WARNING**

DO NOT leave the cab of your vehicle without applying the parking brake. The truck could roll and cause an accident resulting in death or personal injury. Always apply the parking brake before you leave the cab.

### Hill Hold



The hill hold feature is available as an option with certain automated transmissions. This feature holds the vehicle while on a hill to allow the operator to release the service brakes and press the accelerator. This feature will hold the vehicle if the vehicle is attempting to go up a hill from a stop in either drive or reverse.

### Shift Configuration

Some transmissions are equipped with more than one shifting configuration to match various operating conditions. Please read the automated transmission manual

included with your vehicle for instructions on how to change shift configurations.

## Transmission Gear Display

**Gear Display Icon (gear number)**



This indicator will show the transmission mode and current gear.. This does not apply to vehicles with Allison Automatic transmissions.

- Max mode
- Low gear mode
- Manual Mode
- Neutral Coast
- Driver Shift Aid
- Configuration 2

Inside the gear icon, the indicator normally show the current gear number and may at times show:

- **AN** - Auto Neutral
- **CA** - Clutch Abuse
- **GI** - Grease Service Interval
- **!** - Error State

**Gear Display Icon (Error State)**



This icon indicates an error in the transmission.. Attempt to reset the transmission by turning off the vehicle. After two minutes, restart the engine and see if the same icon appears in the display. Please contact your nearest Authorized dealership if the condition persists.

## Controls for Vehicles with an Eaton Automated or a PACCAR Transmission

This vehicle may be equipped with either an Eaton Automated or a PACCAR Transmission. The Automated or PACCAR Transmission controls are located on the right hand side of the steering column.

## Using the Manual - Automatic Button

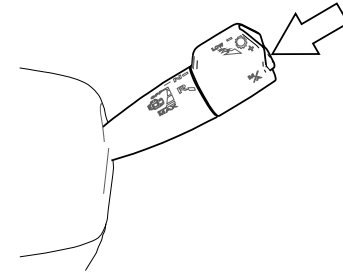

This button will put the transmission into manual mode. Manual mode will allow the operator to select the gear. See [Up or Down Shifting](#) on page 158.

To activate, put the gear selector in the **D** (drive) mode and then depress the **M/A** button. The instrument cluster will display the corresponding selection in the transmission mode area of the display. See [Drive, Neutral, and Reverse Indicator](#) on

page 65 and [Peterbilt Digital Display](#) on page 63.

**Gear Display Icon (Gear shift assist)**



### Up or Down Shifting

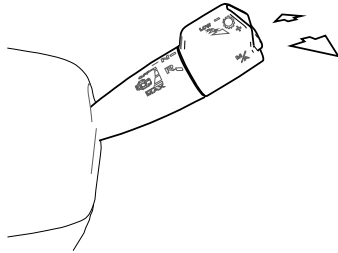

When in the Manual mode, the transmission gears can be manually selected by pushing or pulling on the lever. Pushing the lever forward will down shift. Pushing and holding the lever forward will engage the LOW gear range. Pulling the lever towards the driver will upshift the transmission.

Some vehicles may have a feature that prompts the operator to shift for optimal fuel economy.

If the prompt appears in the instrument cluster, use the manual gear selector lever to change gears.

**Gear Display Icon (Gear shift assist)**



The instrument cluster will illuminate with the corresponding gear.

**Gear Display Icon (gear number)**



### Drive Neutral Reverse Selector

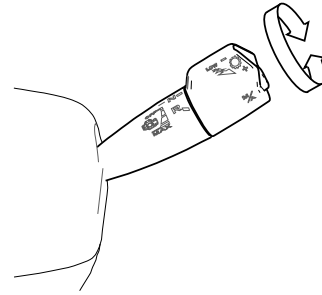

Transmission mode is selected by rotating the lever outer knob. There is a position for Drive (**D**), Neutral (**N**), and Reverse (**R**). The Digital Display will indicate the corresponding mode. See [Drive, Neutral, and Reverse Indicator](#) on page 65 and [Peterbilt Digital Display](#) on page 63.



#### NOTE

Selector (the transmission) must be in Neutral (**N**) to start the truck.

## Auto Neutral

### Gear Display Icon (Auto Neutral)



The Auto Neutral feature will automatically shift to Neutral if the vehicle is left in forward or reverse mode and the parking brake is set. The driver must then select the desired forward or reverse mode with the service brake applied.

### Neutral Coast Mode

Neutral Coast Mode allows the transmission to disengage the driveline by pulling out of gear on slight downhill grades, where little to no engine power is required, when the vehicle is in cruise control and the transmission is in Drive mode.

- When Neutral Coast Mode is active, the engine will drop to idle speed and the transmission will disengage.
- The gear display may flash a gear number or indicate Neutral when Neutral Coast Mode is active.
- If a flashing number is indicated in the gear display, this represents the gear that the transmission will

select when it is necessary to engage a gear.

- The transmission will exit Neutral Coast Mode and reengage an appropriate gear under any of the following conditions:
  - Vehicle brake is applied
  - Driver depresses accelerator pedal
  - Cruise control is canceled
  - A mode other than Drive is selected
  - Driver performs upshift/downshift requests
  - Cruise high or low set speeds are exceeded
  - Maximum vehicle grade is exceeded
  - Request by an adaptive cruise system

## Clutch Abuse Protection

The clutch can overheat and slip with improper use. Select the lowest possible start gear for the application.

- If moving slowly is required, select 1st or R1.
- Use the Service Brake and let Hill Start Aid assist you when launching on an incline.
- Do NOT use the throttle to hold the vehicle on an incline. (Use Service Brake).
- Do NOT use the throttle to stop roll back on an incline after Hill Start Aid disengages. (Use Service Brake and then relaunch).

### Gear Display Icon (Clutch Abuse)



If the clutch does start to overheat, the display will show "CA" along with a warning tone. Full clutch actuation must be completed quickly. If not, the system will either open the clutch if not on the throttle or close the clutch if on the throttle. If the abuse continues, the system will open the clutch and take away throttle control for a short period of time to allow the clutch to cool down.

### Automatic Transmissions

An automatic transmission makes shifting much easier. It remains important to completely understand how to operate the transmission to optimize its efficiency. Please read the manual for your automatic transmission included with your vehicle.



#### WARNING

DO NOT leave the cab of your vehicle without applying the parking brake. The truck could roll and cause an accident resulting in death or personal injury. Always apply the parking brake before you leave the cab.

### Auxiliary Transmission

If you have an auxiliary transmission, see your transmission manufacturer's manual for its proper operation.

## Brakes

### Air Brake System



#### WARNING

DO NOT drive through water deep enough to wet brake components, as it may cause the brakes to work less efficiently than normal. The vehicle's stopping distance may be longer than expected, and the vehicle may pull to the left or right when brakes are applied, which could contribute to an accident involving death or personal injury.

Compressed air is delivered to the brake system through the valve at the brake pedal and is controlled with various valves and braking circuits. The brake system is designed with separate front, rear, and (when applicable) trailer circuits so that if one circuit is compromised and loses air, the other circuits will not be affected. Safety valves in each circuit will protect the other circuits in the event that a circuit loses air.

The air compressor on the engine will typically provide 100-130 psi (690-896 kPa) to the air tanks. The vehicle is also designed with an air dryer, which removes moisture from the compressed air in order to protect all components in the air system. The brake system may be further enhanced by additional devices such as brake proportioning valves, antilock braking systems, or sensors designed to let you know if your brake pads need to be serviced. Certain conditions may result in the brake surfaces getting wet. Brake surfaces that are wet do not perform as well as when they are dry. There may be situations where wet brake surfaces cannot be avoided. In such situations, apply the brakes while in motion, to dry the brake surfaces.

Certain conditions may result in your brake surfaces becoming overheated (above 800°F or 427°C). Overheated brakes will damage linings and drum surfaces, ultimately decreasing brake performance. Refer to Retarders and Descending a grade to avoid overheating the brakes.

## Parking Brake

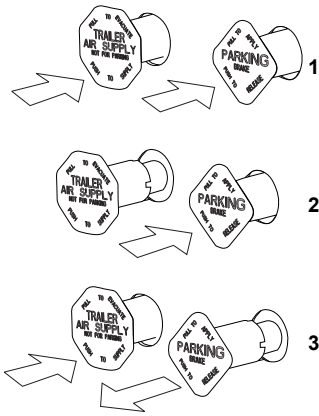

1. Normal run position
2. Trailer park with vehicle released
3. System park or trailer charge with vehicle parked

Parking brakes work in reverse action of the regular brakes. When the parking brakes are engaged, air is exhausted from the spring chambers, which allows the spring to engage the brakes. This design also provides a safety function if a brake

circuit has a leak and loses air. In such a scenario, the parking brakes will apply. The vehicle's parking brake controls are the yellow diamond shaped knob on your dash board. If the vehicle is equipped to tow a trailer, then there will be an additional red octagon shaped knob for the trailer parking brakes. Parking brakes will be engaged when either of these knobs are pulled OUT. (If one knob is pulled out, the other knob will automatically pop out.) Pushing IN a knob will disengage the respective parking brakes. If you push in the yellow knob only, you will disengage the vehicle's parking brakes but will not disengage the trailer parking brakes (if applicable). Either knob will pop back out if the system pressure is not above 60 psi (414 kPa). The instrument panel display will provide a message any time the parking brakes (vehicle or the trailer) are set and the vehicle is put into motion.

## Engage Trailer Hand Brakes

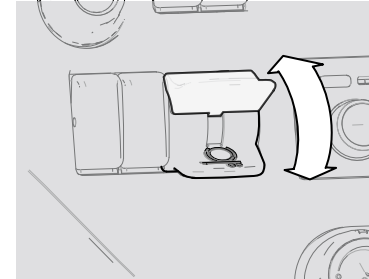

Press the lever down to engage the Trailer Hand Brakes. Push the lever back up to release the Trailer Hand Brakes.

## Automatic Traction Control



Your truck/tractor ABS is equipped with an automatic traction control (ATC) feature. This feature is controlled by a switch on the dash. Do not allow the traction control lamp to remain on continuously for an extended length of time. Extended continuous use of the ATC can cause overheating of the drive wheel brakes. Engine torque or vehicle

speed should be reduced to eliminate wheel spin and prevent excessive application of the ATC system. Except for checking for proper illumination of the ABS and traction control warning lamps when first starting the vehicle, and for monitoring these lamps while driving, no special operating procedures are required. For detailed system description, see literature for your specific ABS that was provided with your vehicle.

### Antilock Brake Systems (ABS)

This vehicle may be equipped with an ABS, which reduces the possibility of wheel lock-up. If a wheel is about to lock during braking, the ABS will automatically adjust air pressure to the brake chambers on the appropriate wheel(s) to prevent wheel lock-up. The ABS is automatically turned on when the ignition switch is turned on.



#### WARNING

The antilock brake system is a critical vehicle safety system. For the safety of you and others around you, have the vehicle submitted for periodic preventive maintenance checks as well as

having any suspected problems immediately checked by an authorized dealer. Failure to properly maintain your brake system can lead to serious accidents. Failure to comply may result in property damage, personal injury, or death.



#### WARNING

DO NOT rely on an antilock brake system that is functioning improperly. You could lose control of the vehicle resulting in a severe accident, causing personal injury or death. If your ABS lamp goes on while you are driving or stays on after the self-check, your anti-lock system might not be working. The ABS may not function in an emergency. You will still have conventional brakes, but not antilock brakes. If the lamp indicates a problem, have the ABS checked.

Vehicles without ABS are typically equipped with a bobtail brake proportioning system. When a trailer is not connected, the drive axle brake application pressure will automatically be limited by the proportioning system. When driven in a

bobtail mode, these tractors will require greater brake pedal application to provide the equivalent braking to a bobtail tractor not equipped with a proportioning system.

### Trailer ABS Power Line Communication (PLC)

North American on-highway vehicles are equipped with a separate electrical circuit to power the ABS on towed vehicle(s). In most cases, the ABS power will be supplied through the Auxiliary circuit on the primary 7-way trailer light line connector. If the vehicle was manufactured with a switchable Auxiliary circuit for trailer accessories, an additional 7-way connector would have been provided for trailer ABS power. In either case, the ABS power line on the vehicle will be PLC equipped.



#### CAUTION

DO NOT splice into the non-switchable Auxiliary circuit on the primary 7-way trailer light line. Doing so may cause the trailer ABS to malfunction. This circuit is dedicated for trailer ABS power. To add a switchable auxiliary circuit, contact a dealership.



**NOTE**

Tractors/Trucks and trailers built after 03/01/2001 must be able to turn on an In-Cab Trailer ABS Warning Light (per U.S. FMVSS121). The industry chose Power Line Communication (PLC) as the standard method to turn it on. On trailers built prior to 03/01/2001 verify trailer ABS system status via the required external warning light mounted on the trailer. The indicator light on the trailer should be yellow and identified with the letters ABS.

For doubles or triples, the lamp does not distinguish between trailers. An ABS problem in any of the trailers will activate the Trailer ABS Warning Lamp. If you change the intended service in any way (e.g., number of axles, multiple trailers, add switchable trailer accessories, etc.) from the date the vehicle was manufactured, you should contact your trailer manufacturer and/or trailer antilock brake manufacturer to determine if the power available at the 7-way trailer light line is adequate. Failure to do so might result in insufficient power to the trailer

ABS system, which may affect its operation.

**CAUTION**

The center pin of the 7-way trailer light line may be constantly powered for ABS. Make sure it will not accidentally turn on trailer equipment.

**Special Trailer ABS Without PLC (Option)**

If a trailer does not have PLC, but it does have ABS that is powered through an optional second trailer connector (ISO 3731) and that trailer ABS is designed to control the Trailer ABS Warning Lamp in the cab and the vehicle has been ordered with the option to turn on this lamp for these types of trailers, then this lamp will turn on when that trailer ABS has a system problem. This should be checked by a dealer as soon as possible. The Trailer ABS Warning Lamp will not turn on for the power-on test when connected to these types of trailers.

**NOTE**

Very few trailers built before 03/01/2001 have this option. Trailers built after 03/01/2001 are built with PLC technology.

**Advanced ABS with Stability Control**

Advanced ABS with Stability Control is a feature that reduces the risk of rollovers and other loss of control situations. For vehicles towing trailers, the feature can reduce the risk of a trailer jackknifing. During operation, the system constantly compares performance models to the vehicle's actual movement, using the wheel speed sensors of the ABS system, as well as lateral, yaw, and steering angle sensors. If the vehicle shows a tendency to leave an appropriate travel path, or if critical threshold values are approached, the system will intervene to assist the driver.

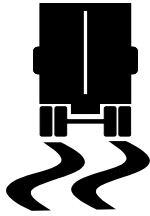

4

Electronic Stability Control may reduce the vehicle speed automatically. To minimize unexpected deceleration and reduce the risk of a collision the operator must:

- Avoid aggressive driving maneuvers, such as sharp turns or abrupt lane changes at high speeds, which might trigger the stability system.
- Always operate the vehicle safely, drive defensively, anticipate obstacles and pay attention to road, weather, and traffic conditions. ABS, ATC, and ESC stability systems are no substitute for prudent, careful driving.

### Roll Stability

### A Real World Example of How the System Operates

Excessive speed for road conditions creates forces that exceed the threshold at which a vehicle is likely to roll over on a higher-friction surface. The system automatically reduces engine torque and applies the service brakes (based on the projected rollover risk) to reduce the vehicle speed, thereby reducing the tendency to roll over.

#### Roll Stability Example

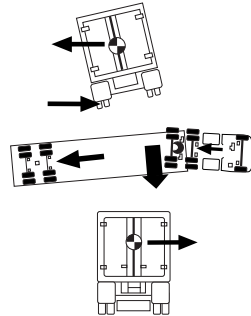

### Yaw Stability

Yaw stability counteracts the tendency of a vehicle to spin about its vertical axis.

During operation, if the friction between the road surface and the tires is not sufficient to oppose lateral (side) forces, one or more of the tires can slide, causing the truck/tractor to spin. These yaw events are referred to as either "under-steer" (where there is a lack of vehicle response to steering input due to tire slide on the steer axle) or "over-steer" (where the tractor's rear end slides out due to tire slide on the rear axle) situation. Generally, shorter wheelbase vehicles (tractors, for instance) have less natural yaw stability, while longer wheelbase vehicles (straight trucks, for instance) have greater natural yaw stability. Factors that influence yaw stability are: wheelbase, suspension, steering geometry, weight distribution front to rear, and vehicle track width.

### Yaw Control

Yaw Control responds to a wide range of low- to high-friction surface scenarios including rollover, jackknife and loss of control. In the case of vehicle slide (over-steer or understeer situations), the system will reduce the throttle and then brake one or more of the "four corners" of the vehicle (in addition to potentially applying the trailer brakes), thus applying a counterforce to better align the vehicle with an

appropriate path of travel. For example, in an over-steer situation, the system applies the "outside" front brake; while in an under-steer condition, the "inside" rear brake is applied.

### A Real World Example of How Yaw Control Operates

Excessive speed exceeds the threshold, creating a situation where a vehicle is likely to spin and, where applicable, jackknife. The system reduces engine throttle and selectively applies brakes to reduce the vehicle speed, thereby reducing the tendency to jackknife.

#### Yaw Control Example

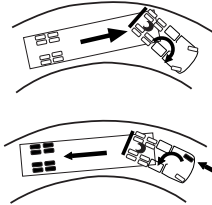

### Automatic Traction Control



Your truck/tractor ABS has an automatic traction control (ATC) feature. This feature is controlled by a switch. This feature is monitored by a warning lamp located on the switch. The Traction Control warning lamp will briefly illuminate and then go out when the ignition switch is first turned on. The traction control warning lamp will illuminate whenever the ATC system detects drive wheel spin. The lamp will remain illuminated as long as wheel spin is detected and the ATC system is applying the drive wheel brakes or reducing engine torque. Engine torque or vehicle speed should be reduced to eliminate wheel spin and prevent excessive application of the ATC system.

Except for checking for proper illumination of the ABS and traction control warning lamps when first starting the vehicle, and for monitoring these lamps while driving, no special operating procedures are required. For detailed system description, see literature for your specific ABS that was provided with your vehicle.

This feature helps improve traction when vehicles are on slippery surfaces or surfaces with poor traction (i.e. mud or snow) by reducing drive wheel overspin. Automatic traction control works automatically in two different ways:

- If a drive wheel starts to spin, ATC applies air pressure to brake the wheel. This transfers engine torque to the wheels with better traction.
- If all drive wheels spin, ATC reduces engine torque to provide improved traction.

ATC turns itself on and off, you do not have to select this feature. If drive wheels spin during acceleration, the ATC Warning Lamp comes on, indicating wheel spin control is active. Do not allow the ATC Warning Lamp to remain on continuously for an extended length of time. Extended, continuous use of the ATC can cause overheating of the drive wheel brakes.

### Deep Snow and Mud Switch

A deep snow and mud switch is included with Automatic Traction Control (ATC). The Deep Snow and Mud feature is helpful during acceleration. This function increases available traction on extra soft surfaces like snow, mud, or gravel, by slightly increasing the permissible wheel

spin. When this function is in use, the ATC Warning Lamp blinks continuously.

### Off-Road ABS Function Switch (Optional)

Your vehicle may be equipped with a separate switch to activate an Off-Road ABS function. This function is NOT to be used for On-Highway driving but is intended to be used to improve stopping performance in Off-Highway conditions (e.g., loose gravel and mud). The Off-Road ABS function is accomplished by allowing a "wedge" of material to build-up in front of momentarily locked wheels.

- Changes the ABS control limits to allow for a more aggressive ABS function while off-road.
- Improves vehicle control and helps reduce stopping distances in off-road conditions or on poor traction surfaces such as loose gravel, sand, and dirt.
- Allows retarders to function independently of the ABS function.
- If your vehicle does not have an engine retarder, the Off-Road ABS switch will function the same.



#### WARNING

While the off road mode can improve vehicle control and shorten stopping distances, some steering ability may be reduced on certain surfaces resulting from the momentarily sliding tires. Always operate your vehicle at safe operating speeds. Failure to do so may cause you to lose control of the vehicle and could result in an accident or personal injury.



#### CAUTION

Never drive your vehicle on improved roads/highways with the Off-Road ABS function turned on. When you drive your vehicle onto an improved road surface or highway, immediately turn off the Off-Road ABS switch. Failure to do so will cause the ABS system to not function properly in an ABS event under 25 mph (40 km/h) and could result in an accident or personal injury.

The ABS lamp flashes slowly during off-road mode engagement. This is done to alert you of a modification to the ABS control software. At speeds above 25 mph (40 km/h), the ABS controller operates in the normal on-highway mode. At speeds between 10 and 25 mph (16 and 40 km/h), the ABS control software is modified to allow short periods (0.25 seconds) of locked-wheel cycles. At speeds below 10 mph (16 km/h), the ABS control software is turned off to allow locked wheels. When the Off-Road ABS function is enabled, the Retarder Disable output is turned off. That is, the engine retarders are left to function without ABS intervention. For additional information, see the Off-Road ABS pamphlet in your vehicle's glove box.

#### Effectiveness and Limitations

ESC is designed and optimized for trucks and for tractors that tow single trailers. If a tractor equipped with ESC is used to power multiple trailer combinations (known as "doubles" or "triples") the effectiveness of the ESC system may be greatly reduced.

**WARNING**

Exercise extreme care when towing doubles or triples with a vehicle equipped with Electronic Stability Program. Excessive speed and aggressive maneuvers, such as sharp turns, sudden steering inputs or abrupt lane changes should be avoided because these maneuvers could cause loss of vehicle control possibly resulting in an accident involving death or personal injury.

Additionally, the ESC stability system's effectiveness may be greatly reduced if:

- The load shifts due to improper retention, accident damage or the inherently mobile nature of some loads (for example, hanging meat, live animals or partially laden tankers).
- The vehicle has an unusually high or offset center of gravity (CG).
- One side of the vehicle drops off the pavement at an angle that is too large to be counteracted by a reduction in speed.
- The vehicle is used to haul double or triple trailer combinations.

- If very rapidly winding steering inputs are inputted at high speeds.
- There are mechanical problems with suspension leveling of the tractor or trailer resulting in uneven loads.
- The vehicle is maneuvering on a high banked road creating either additional side forces due to the weight (mass) of the vehicle or a deviation between expected and actual yaw rates.
- Gusty winds are strong enough to cause significant side forces on the vehicle and any towed vehicles.

To maximize the effectiveness of ESC:

- Loads must be properly secured and evenly distributed at all times.
- Drivers need to exercise extreme caution at all times, and avoid sharp turns, sudden steering inputs or abrupt lane changes at high speeds, particularly if:
  - The vehicle hauls loads that could shift
  - The vehicle or load has a high or offset center of gravity (CG) when loaded
  - The vehicle tows doubles or triples

The ESC system was specifically calibrated and validated only for your vehicle's original factory-built configuration. If your vehicle's chassis components are altered (for example; a wheelbase extension or reduction, tag axle addition or removal, tractor to truck conversion or steering system component change) the ESC system must be disabled immediately by a qualified mechanic.

**WARNING**

Failure to disable ESC "Electronic Stability Control" when modifying a vehicle could result in a loss of vehicle control possibly resulting in an accident involving death or personal injury.



**WARNING**

For vehicles equipped with ESC (Electronic Stability Control) do not replace the vehicle's steering wheel with an after-market or different part number than originally supplied. Using a different steering wheel could cause ESC to malfunction causing a loss of vehicle control possibly resulting in an accident involving death or personal injury.

Whenever maintenance or repair work is performed to the steering mechanism, linkage, gear, adjustment of the wheel track, or if the steering angle sensor is replaced or the steering wheel is changed or re-centered, the Steering Angle Sensor must be re-calibrated.



**WARNING**

If the Steering Angle Sensor is not re-calibrated, the Yaw Control system will not function properly. An uncalibrated sensor could result in a loss of control of your vehicle which can lead to an

accident involving death or personal injury.

**Towing Doubles Or Triples May Reduce The Effectiveness Of Stability Systems**

ESC is designed and optimized for trucks and for tractors that tow single trailers. If a tractor equipped with ESC is used to power multiple trailer combinations (known as "doubles" or "triples") the effectiveness of the ESC system may be greatly reduced.



**WARNING**

Exercise extreme care when towing doubles or triples with a vehicle equipped with Electronic Stability Program. Excessive speed and aggressive maneuvers, such as sharp turns, sudden steering inputs or abrupt lane changes should be avoided because these maneuvers could cause loss of vehicle control possibly resulting in an accident involving death or personal injury.

Additionally, the ESC stability system's effectiveness may be greatly reduced if:

- The load shifts due to improper retention, accident damage or the inherently mobile nature of some loads (for example, hanging meat, live animals or partially laden tankers).
- The vehicle has an unusually high or offset center of gravity (CG).
- One side of the vehicle drops off the pavement at an angle that is too large to be counteracted by a reduction in speed.
- The vehicle is used to haul double or triple trailer combinations.
- If very rapidly winding steering inputs are inputted at high speeds.
- There are mechanical problems with suspension leveling of the tractor or trailer resulting in uneven loads.
- The vehicle is maneuvering on a high banked road creating either additional side forces due to the weight (mass) of the vehicle or a deviation between expected and actual yaw rates.
- Gusty winds are strong enough to cause significant side forces on the vehicle and any towed vehicles.

To maximize the effectiveness of ESC:

- Loads must be properly secured and evenly distributed at all times.
- Drivers need to exercise extreme caution at all times, and avoid sharp turns, sudden steering inputs or abrupt lane changes at high speeds, particularly if:
  - The vehicle hauls loads that could shift
  - The vehicle or load has a high or offset center of gravity (CG) when loaded
  - The vehicle tows doubles or triples

The ESC system was specifically calibrated and validated only for your vehicle's original factory-built configuration. If your vehicle's chassis components are altered (for example; a wheelbase extension or reduction, tag axle addition or removal, tractor to truck conversion or steering system component change) the ESC system must be disabled immediately by a qualified mechanic.

**WARNING**

Failure to disable ESC "Electronic Stability Control" when modifying a vehi-

cle could result in a loss of vehicle control possibly resulting in an accident involving death or personal injury.

**WARNING**

For vehicles equipped with ESC" Electronic Stability Control" do not replace the vehicle's steering wheel with an aftermarket or different part number than originally supplied. Using a different steering wheel could cause ESC to malfunction causing a loss of vehicle control possibly resulting in an accident involving death or personal injury.

Whenever maintenance or repair work is performed to the steering mechanism, linkage, gear, adjustment of the wheel track, or if the steering angle sensor is replaced or the steering wheel is changed or re-centered, the Steering Angle Sensor must be re-calibrated.

**WARNING**

If the Steering Angle Sensor is not re-calibrated, the Yaw Control system will

not function properly. An uncalibrated sensor could result in a loss of control of your vehicle which can lead to an accident involving death or personal injury.

**Retarders**

Various retarders are available, which function against the engine, driveline, or transmission. These are devices that use your engine's power to slow down your vehicle. They reduce brake wear and tear and the need for continuous brake use, which can lead to your service brakes overheating. Ideally, you should always slow your vehicle with your retarder (where permitted by law) and use your service brakes only for stopping completely. Operating this way will greatly prolong the life of your brakes.



**WARNING**

DO NOT use the vehicle's engine compression brake or exhaust brake in any situation that requires an immediate stop and/or in situations of poor traction (such as wet, icy, or snow covered roads). Trying to use the engine compression brake or exhaust brake instead of the service brakes may cause a loss of vehicle control, which may result in an accident involving death or personal injury.



**WARNING**

The service brakes must be used in an emergency. The retarder alone might not stop you fast enough to prevent an accident. Failure to comply may result in death, personal injury, equipment or property damage.

The retarder is NOT intended as the primary brake for the vehicle, nor is it an emergency brake. The retarder only helps the service brakes by using pressure to slow the drivetrain. Use the service brakes for quick stops. Do not use the retarder

when operating on road surfaces with poor traction (such as wet, icy, or snow covered roads or gravel). Retarders can cause the wheels to skid on a slippery surface. We recommend that you do not use your engine retarder to slow down when you are bobtailing or pulling an empty trailer.



**WARNING**

Using an engine retarder can cause a wheel lockup. The trailer is not loading the tires enough to give the traction you may need. When you are bobtail or unloaded, you can have a serious accident if your wheels lock suddenly during braking. You could be killed or injured. DO NOT use your retarder when you are driving bobtail or with an unloaded trailer.

This vehicle may have a transmission retarder. Take your foot off the throttle and operate the retarder switch. When you do not need full retarder effect, you can apply it intermittently (off and on) to cause gradual or partial slowing. Continuous application of your retarder will cause your hydraulic fluid to get hotter. Intermittent application will help prevent overheating.



**WARNING**

DO NOT rely on your automatic transmission hydraulic retarder to stop your vehicle. If your engine shuts down, the vehicle's retarder will cease to operate which may lead to an accident involving death or personal injury. Always be ready to suddenly apply the service brakes.

## Axle and Suspension

### Differential Lock



The vehicle may be equipped with switches to lock the either of the rear axle differentials. Depending on how the vehicle is specified, a combination of individual



switches may be available that can lock the interaxle driveline and/or any combination of the forward rear or rear-rear driving axles. The interaxle differential switch allows each axle to turn independently. In certain situations, engaging the interaxle differential lock relieves stress on the rear axles and reduces tire wear. Engaging this switch will also provide better traction in slippery or loose gravel conditions. In the LOCK position, continuous operation on paved, dry surfaces, put stress on the axles, and can possibly damage the internal gears. The switch has a guard to prevent accidental operation of the switch. Locking the differentials is typically used during ice or snow conditions and without tire chains, unpaved roads that have loose sand, mud or uneven surfaces. Look ahead and predict when the differential needs to be locked. Stop the vehicle and lock the differentials before approaching. While using the differential in the locked position, do not exceed 25 mph (40 km/h). When disengaging the differential lock, reduce the throttle to prevent drivetrain damage.

**WARNING**

DO NOT put the differential lock in the LOCK position while the wheels are spinning freely (slipping), you could lose control of the vehicle or cause axle damage. Switch to LOCK only when the wheels are not spinning. Failure to comply may result in death, personal injury, equipment or property damage.

**Dual Range (Two-Speed) Rear Axle**

Your vehicle may be equipped with a two-speed or dual range axle (option). The low range provides maximum torque for hauling heavy loads or traveling over rough terrain. The high range is a faster ratio for highway speeds and general over-the-road conditions. A switch on the accessory switch panel controls the dual range rear axle. You will notice that the switch has a guard to protect you from activating it

accidentally. Always park your vehicle with the range selector in LOW.

Important tips on operating a dual range axle with inter-axle differential:

- Shift the axle with the inter-axle differential in the unlocked position only.
- When you are driving with poor traction, lock the differential. When you have the differential locked, drive with the axle in LOW range only.
- When you are driving on a surface with good traction, keep the inter-axle differential unlocked. You can drive with the axle in the LOW or HIGH range.
- Always UNLOCK the inter-axle differential before shifting the axle speed range.



**WARNING**

Never shift the axle when moving downhill. Engine driveline disengagement may occur, eliminating engine retardation and allowing the wheels to spin faster than the current speed of the engine. This may require severe braking to slow the vehicle down and can result in an accident. Failure to comply may result in death, personal injury, equipment or property damage.



**CAUTION**

If you shift the axle range with the inter-axle differential in LOCK, you could seriously damage the axles. Never shift the axle range with the differential locked.

Proper shifting of the axle depends on the synchronization of engine/driveline and wheel speed. When you shift the axle, the connection between the engine and wheels is momentarily disengaged while the gearing is synchronized. Normally when the axle is shifted the speed of the engine,

axle, and wheels adjust, allowing for proper gear engagement. When going downhill the wheels will not slow down, but will tend to speed up, which makes gear synchronization almost impossible. As a result, the axle is neither in HIGH nor LOW range and all engine/driveline retardation is lost. Without engine retardation it is more difficult to slow the vehicle down and greater stress is put on the brake system.



**CAUTION**

To avoid damaging your vehicle shift the axle at slower travel speeds until you are used to driving with a dual range axle.

**How to Operate Two-Speed Axle - Low to High**

These steps should be used if operating a two-speed axle in LOW range on rough terrain and preparing to drive on an improved surface.

When you go from rough terrain to highway driving, shift the axle to the HIGH range following this procedure:

1. Be sure the differential is UNLOCKED.
2. Maintain your vehicle speed (accelerator depressed) and move the Range Selector lever to HIGH.
3. Keep driving with the accelerator depressed until you want the axle to shift.
4. To make the axle shift, release the accelerator until the axle shifts. You are now in the HIGH axle range for highway speeds. Shift the transmission normally to reach your desired cruising speed.

**How to Operate Two-Speed Axle - High to Low**

These steps should be used if operating a two-speed axle in HIGH range on improved roads and preparing to drive on rough terrain.

When you go from highway driving to rough terrain, shift the axle to the LOW range following this procedure:

1. Maintain vehicle speed (accelerator depressed) and move the Range Selector lever to LOW.
2. Keep driving with the accelerator depressed until you want the axle to downshift.

- To make the axle downshift, release and depress the accelerator quickly to increase the engine rpm. The axle will shift to LOW range.
- You are now in the LOW axle range for rough terrain and heavy loads. Shift the transmission normally to maintain the desired speed.

### Auxiliary Axle

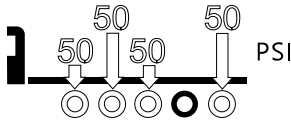

Adjustable auxiliary axles (commonly known as Pusher or Tag axles) can add to the productivity of the vehicle by increasing the load capabilities of the vehicle when they are in the deployed (down) position. There are different configurations of axles with different functionality (liftable versus steerable). Without the extra axle, the excessive weight can reduce the service life of vehicle components such as, but not limited to, the frame rail, axles, suspension and brakes. Operation of the auxiliary axles includes the proper maintenance of the system and

calibration of its controls. Operating the auxiliary axles will also require a firm understanding of the Gross Axle Weight Rating (GAWR) and the load that is being carried.

The vehicle will have switches on the dash to control the position of the auxiliary axles. In certain situations, however, the system will override the controls to protect the axle system. For Self Steering Lift Axles, the axle will raise when the park brakes are applied or if the vehicle is placed in reverse. For Non-Steer Lift Axles, the axle will only automatically raise if the park brakes are applied and there are no park brakes on the lift axle. Non-Steer Lift Axles do not automatically raise when the vehicle is placed in reverse.

Operating the auxiliary liftable axles must be performed in a manner that does not exceed the axle creep rating. Axle creep ratings are weight and speed limits that are allowed while the vehicle is fully loaded (in excess of the vehicle's standard GAWR) and the axle is in its up position. Axle creep ratings are assigned by the axle manufacturer and are based on axle model and intended service of the vehicle. Contact an authorized dealership if you are unable to identify the axle creep rating of this vehicle.

- Liftable/steerable (axle lift calibration required)
- Liftable/non-steerable (axle lift calibration required)
- Non-liftable (some suspensions require dump valve calibration)



### WARNING

DO NOT operate or park the vehicle with auxiliary axles in the down/loaded position when vehicle is unladen, or is being unloaded. Raise or dump air into driver controlled auxiliary axle(s) prior to unloading vehicle. Failure to do so can result in loss of vehicle control or roll-away that may result in personal injury, property damage or death.

### Auxiliary Axle Pressure Regulator

Vehicles with liftable auxiliary axles will have knobs available to adjust the pressure in the auxiliary axle suspension. These knobs are in addition to the tag and pusher axle switches that control the axle position.

Adding more pressure to the auxiliary axle will increase the pressure the auxiliary axle pushes down. Increasing pressure will

decrease load on the drive axles and will decrease traction. Decreasing pressure will transfer more weight to the drive axles and will result in more traction from the drive axles.

Deflate the auxiliary axle suspension before coupling or uncoupling a trailer. After the trailer is coupled or uncoupled, then increase pressure to balance traction and axle load requirements. Inflate air springs of the auxiliary axles to the desired pressure after coupling to a loaded trailer while still maintaining proper traction of the drive axles.

Adjust the pressure regulator control knob to a lower pressure until desired traction is obtained. By reducing air pressure at pusher or tag axle, load will be transferred to drive axles. Do not overload drive axles. Always deflate air springs of the auxiliary axles before attempting to unload vehicle. This allows maximum traction of the drive axles to control the vehicle.

Depending on the suspension, various calibrations may be required. Contact your authorized dealer or axle/suspension manufacturer for specific calibration procedures.

Some suspensions require dump valve calibration. For example, some dead axles do not lift, but the air can be dumped out of

them to unload them when empty. Air pressure is controlled via an adjustable regulator. These axles need to be calibrated for load.

Contact your authorized dealer or axle/suspension manufacturer for dump valve calibration procedures.

**Axle Creep Rating**

Vehicles outfitted with auxiliary axles and full truck configuration will have an axle creep rating which defines how much load is allowed when the vehicle has a full load and maneuvering the vehicle, at very slow speeds, with auxiliary axles in the up position. In these situations, the load exceeds the gross axle weight rating of the axles.

Operator's using vehicles equipped with liftable auxiliary axles must consider creep ratings when any liftable axle is unloaded or in the raised position. Liftable auxiliary axles should only be raised (or unloaded) to improve maneuverability in an off-road use or when vehicle is unloaded.



**WARNING**

NEVER operate the vehicle with more pressure in the lift axles than is neces-

sary to carry the load, as determined by the calibration procedure described. Failure to do so can result in loss of traction and stability at the steer and/or drive axles and can result in increased braking distance, which could cause loss of vehicle control resulting in an accident. Failure to comply may result in death, personal injury, equipment or property damage.



**NOTE**

Axle Creep ratings MUST NOT be exceeded.



**CAUTION**

Always lower the axles as soon as possible after receiving a load. Never exceed 5 mph (8 km/h) when driving with a load with the auxiliary axle(s) raised/unloaded. Failure to lower the axle(s) can overload the frame and remaining axles, and could cause equipment damage.

**CAUTION**

DO NOT modify the air system and/or control functionality on a factory installed auxiliary axle(s). Modifying the factory operation of the pusher and/or tag axle(s) will void your warranty, and can cause equipment damage.

**CAUTION**

A change in tire size on either the auxiliary axles or the drive/steer axles can change the calibration of the auxiliary axles. If tires are installed with a different loaded radius, the calibration procedure must be repeated. Failure to do so can cause equipment damage.

Contact your dealer or axle manufacturer to determine what the creep rating is for your particular axle(s) and configuration. Creep ratings are generally limited to the following:

- Tandem rear axles only
- Straight trucks only
- Maximum spring mount centers per axle manufacturers specifications

- Maximum tire static loaded radius (SLR) per axle manufacturers specifications

### Pusher or Tag Suspension Calibration

Perform this procedure at or near a weight scale. Procedure can be performed while parked on the weight scale if scale is available. To obtain the desired axle load distribution, you must correlate the suspension air gauge pressure to the actual axle load by scaling the axle weight(s) and adjusting the pressure to obtain the desired load. Once the desired load or load range is achieved, document the pressure-to-load ratio or setting for future use.

**NOTE**

This procedure must be performed prior to placing the vehicle into service.

Add: Perform this procedure at or near a weight scale. Procedure can be performed while parked on the weight scale if scale is available.

**Setting the Pressure-to-Load Ratio**

To obtain the desired axle load distribution, you must correlate the suspension air gauge pressure to the actual axle load by scaling the axle weight(s) and adjusting the pressure to obtain the desired load. Once the desired load or load range is achieved, document the pressure-to-load ratio or setting for future use.

These instructions are general in nature. For more specific instructions, review the pusher or tag suspension manufacturers maintenance manual or contact the nearest authorized dealer.

1. Park the loaded vehicle on a level surface with the wheels blocked.
2. Release vehicles spring brakes. (Do not release for Lifiable/Non-Steerable pusher or tag axles)
3. Lower the pusher/tag axles with the **Axle Lift Control** flip valve. (For some non-lifiable axles, inflate air suspension)
4. Adjust the amount of load on each axle by turning the **Pressure Regulator** clockwise to increase the load, or counterclockwise to decrease the load. (The suspension manufacturer may publish pre-established Pressure-to-Load Ratio Pressure Settings to

assist you in achieving an estimated ground load).

- After setting the pressure to obtain the desired axle load, verify proper ground loading with the weight scale.

**i** NOTE

Exceeding local, state, or federal weight limits may result in citations. Contact your local commercial weight enforcement office for limits in your area.

**i** NOTE

Steerable-pusher and/or tag axle(s) will raise when the transmission is shifted into reverse or when the parking brakes are applied.

**Air Suspension Ride Height**

Vehicles equipped with rear or front air suspensions have their ride height and axle (pinion) angle(s) preset at the factory. These are precision settings and should not be altered. Incorrectly adjusted ride

height may result in improper interaxle U-joint working angles. This can result in premature driveline wear and driveline vibration.

If it becomes necessary to reset the ride height, you may temporarily set it by following the next procedure. Proper ride height measurement and values are shown in the illustration and table below.

**⚠ CAUTION**

Completing this procedure will enable you to safely reach the nearest authorized dealer or repair facility to have ride height and pinion angle reset using the proper equipment and technique. Do this as soon as possible to avoid potential driveline damage.

**i** NOTE

Suitable wheel chocks are at a minimum an 18-inch (46 cm) long 4x4.

- Park the vehicle, engage the parking brakes and clock the wheels.

- Locate the air suspension ride height valve.

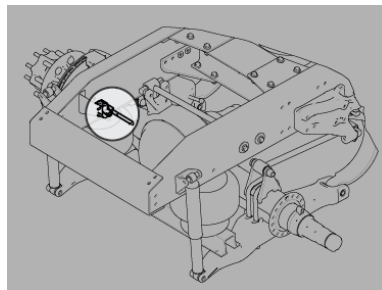

- Ensure that the tractor is fully laden during this procedure. Do not use these procedures on a vehicle that is not laden (bobtail).
- Ensure the air supply and delivery plumbing of the height control valve is consistent with the following illustrations.
- Loosen the fasteners mounting the height control valve to its bracket.

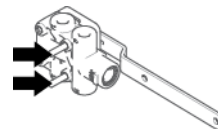

6. Rotate the valve either clockwise or counterclockwise until air pressure in the air springs provides the ride height specified for that suspension. Measure the ride height from the bottom of the frame rail to the approximate centerline of the rearmost drive axle hub:
  - For tandem axles, make the vertical measurement at the centerline of the suspension.
  - For a single axle, make the measurement in front of the axle, in the area forward of the tires but not past the suspension bracket.
7. When at the correct ride height, ensure that the height control valve lever is in the neutral position, then install either the built-in alignment pin or a 1/8 in. (3 mm) dowel.

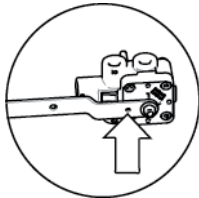

8. Torque the mounting fasteners to 55-75 lb-in. (6.2-8.5 N·m).
9. Remove the alignment pin or dowel.
10. Repeat Steps 2 through 6 above for the right-hand valve on vehicles with a dual-valve system.

### Air Ride Height Data

These are factory settings for ride height of the rear air suspension.

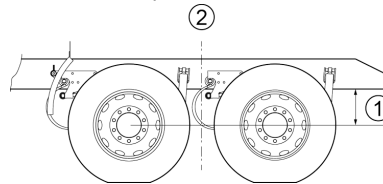

1. Ride height
2. Centerline of suspension

Single Axle	Laden Ride Height -in. (mm)
Air Trac	11.00 (279)
Low Air Leaf	6.50 (165)

Single Axle	Unladen Ride Height -in. (mm)
Air Trac	11.39 (289)
Low Air Leaf	6.75 (171)

Tandem Axle	Laden Ride Height -in. (mm)
Air Leaf	11.70 (297)
Air Trac	11.00 (279)
Low Air Leaf	8.50 (216)
Low Low Air Leaf	6.50 (165)
FLEX Air	8.50 (216)

Tandem Axle	Unladen Ride Height -in. (mm)
Air Leaf	12.0 (305)
Air Trac	11.38 (289)
Low Air Leaf	8.75 (222)
Low Low Air Leaf	6.75 (171)
FLEX Air	8.75 (222)

### What to do if an Air Spring Ruptures

If an air spring has ruptured, drive the vehicle to a safe stop off the highway to investigate the problem.



#### WARNING

DO NOT continue to drive with ruptured air springs. The air loss can cause the spring brakes to apply allowing your brakes to drag and burn up the linings, which could lead to an accident causing death or personal injury. DO NOT continue to operate the vehicle in this condition.



#### WARNING

DO NOT drive the vehicle if the air pressure is less than 100 psi (690 kPa). Driving the vehicle with less than 100 psi (690 kPa) could make the brakes unsafe to use which could cause an accident involving death or personal injury.



#### CAUTION

Operating a vehicle with air suspension bags either overinflated or underinflated may cause damage to drive-line components. If a vehicle must be operated under such conditions, do not exceed 5 mph (8 km/h). Failure to comply may result in equipment damage.

You can get to a repair facility by removing the height control link connected to the axle and to the suspension air valve control arm. This will cause the air valve control arm to center in the closed position. Removing the link will allow the air system of the truck to operate normally so that the vehicle can be driven to a service center.

### Suspension Air Pressure Gauge & Switch

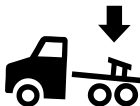

Your vehicle may have an air suspension and a deflation switch which allows the air

in the suspension to be exhausted from a switch on the dash. The normal purpose of this feature is to allow you to lower the vehicle for loading. A guard on the switch prevents you from accidentally deflating the suspension.

The Suspension Air Pressure gauge (optional) indicates the amount of air pressure in the air suspension springs in pounds per square inch (psi). Air pressure in the spring is related to the rear axle load. The greater the rear axle load, the greater the air pressure in the air bags. Therefore, the air pressure displayed will vary, depending upon the rear axle load.

## Trailer Operations

### How to Lock the Kingpin

Ensure that the fifth wheel lock is in the unlocked position.



**WARNING**

Always inspect the fifth wheel for proper locking after coupling the tractor to a trailer. Failure to properly couple the tractor to a trailer (the kingpin is engaged in a closed lock jaw with the lock jaw secured by a closed plunger) may cause trailer separation which could result in an accident involving death or personal injury.

To lock the fifth wheel around the kingpin:

1. Ensure trailer brakes are locked and the landing gear is down.
2. Back the tractor fifth wheel into the trailer kingpin to engage and lock.

**JOST Fifth Wheel Indication**



*If equipped with JOST fifth wheel*

3. Pull the tractor forward to ensure the kingpin has been locked in place.

4. Set the tractor parking brake.
5. Connect the tractor brake air and electric lines to the trailer.

Conduct a pre-trip inspection prior to releasing the brakes, raising the landing gear, and driving the vehicle.

### How to Release the Kingpin Remotely (option)

**CAUTION**

Do not deflate the rear suspension before unlocking the fifth wheel. Deflating the rear suspension before unlocking the fifth wheel could cause difficulty during uncoupling and result in damage to the fifth wheel and kingpin.

1. Set both the vehicle and trailer parking brakes.
2. Lower the landing gear.
3. Disconnect the tractor brake air and electric lines from the trailer.
4. Flip up cover, then press and hold the **Kingpin Release** switch for 3 seconds. A countdown timer popup will appear on the display, and the

unlock symbol on the **Kingpin Release** switch will illuminate. The popup will inform the operator when to release the switch.

**JOST Fifth Wheel Indication**



*If equipped with JOST Fifth Wheel*

**NOTE**

The fifth wheel will not unlock unless the vehicle is stopped and the parking brake is set. In this situation, a red-colored popup appears, informing the operator that kingpin release is not available and to set the parking brake. This will require restarting this procedure.

5. Release the switch. The unlock symbol on the **Kingpin Release** switch will turn off.
6. Ease tractor forward enough for the kingpin to clear the fifth wheel (about 12 to 18 inches).



**NOTE**

Do not drive tractor free of trailer.

7. If the tractor has a rear air suspension, deflate (dump) the rear suspension enough so that the fifth wheel will smoothly separate from the trailer.

**Suspension Dump Symbol**



8. Ease tractor forward, clearing the trailer.
9. If the rear suspension was deflated, return rear suspension to its normal height.

**How to Release the Kingpin Manually**



**CAUTION**

Do not deflate the rear suspension before unlocking the fifth wheel. Deflating the rear suspension before unlocking the fifth wheel could cause difficulty during uncoupling and result in damage to the fifth wheel and kingpin.



**NOTE**

The specific method required to operate the fifth wheel release handle will depend on the fifth wheel manufacturer and model. The operator should be familiar with this method prior to attempting this procedure.

To release the kingpin and separate tractor from trailer

1. Position the tractor and trailer in a straight line on firm, level ground.
2. Set both the tractor and trailer parking brakes.
3. Exit cab and lower the trailer landing gear.

4. Disconnect brake air and electric lines from trailer, and secure lines.
5. Unlock the fifth wheel release handle if necessary, then unlock the fifth wheel.



**NOTE**

Operating the release handle and unlocking the fifth wheel will depend on the fifth wheel manufacturer.

6. Return to cab and release tractor parking brake.
7. Ease tractor forward enough for the kingpin to clear the fifth wheel (about 12 to 18 inches).



**NOTE**

Do not drive tractor free of trailer.

8. If the tractor has a rear air suspension, deflate (dump) the rear suspension enough so that the

fifth wheel will smoothly separate from the trailer.

#### Suspension Dump Symbol

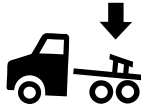

9. Ease tractor forward, clearing the trailer.
10. If the rear suspension was deflated, return rear suspension to its normal height.

#### Air-Controlled Sliding Fifth Wheel (option)



Vehicles that have an air-controlled sliding fifth wheel have a fifth wheel slider lock controlled by a switch on the accessory switch panel. To operate this type of lock, move the switch to the appropriate position. By placing the switch in the **UNLOCK** position, you can slide the fifth wheel to various positions to adjust weight distribution. There is a guard on this switch

to protect you against accidentally activating or releasing the lock.



#### WARNING

Do not move the fifth wheel while the tractor-trailer is in motion. Your load could shift suddenly, causing you to lose control of the vehicle, which can result in an accident. Never operate the vehicle with the switch in the **UNLOCK** position. Always inspect the fifth wheel after you lock the switch to be sure the fifth wheel lock is engaged. Failure to comply may result in property damage, personal injury, or death.

#### How to Slide the Fifth Wheel



#### WARNING

DO NOT move the fifth wheel while the tractor-trailer is in motion. Your load could shift suddenly, causing you to lose control of the vehicle. Never operate the vehicle with the switch in the **UNLOCK** position. Always inspect the fifth wheel after you lock the switch

to be sure the fifth wheel slide lock is engaged. Failure to comply may result in death, personal injury, equipment or property damage.



#### WARNING

Do not attempt to slide the fifth wheel until all persons and obstacles are clear of the vehicle.



#### NOTE

This procedure assumes a connected trailer. The trailer kingpin must be locked within the fifth wheel when changing slide positions.

1. Position the tractor and trailer in a straight line on firm, level ground.
2. Place the tractor in neutral, and set the tractor and trailer parking brakes.
3. Unlock the slide by repositioning the Fifth Wheel Slide switch.



**CAUTION**

Ensure the tractor and trailer brakes are engaged prior to sliding the fifth wheel. Failure to engage the brakes could result in uncontrolled sliding of the fifth wheel and possibly damage components on the tractor or trailer.

Fifth Wheel Slide Symbol



4. Inspect and verify that locking plungers have fully withdrawn from the fifth wheel slide tracks.
  - a. If locking plungers did not fully withdraw, move tractor slightly to reposition plungers and reinspect.
  - b. If plungers are still not fully withdrawn, lower the landing gear and deflate the rear suspension (if available) to lessen pressure on the slide.

Suspension Dump Symbol



5. Release the tractor parking brake, but keep the trailer brakes engaged.
6. Slowly ease tractor forward or backward, and stop at the desired position.
7. Lock the slide by returning the Fifth Wheel Slide switch to its previous position.
8. Inspect and verify that the locking plungers are fully inserted into the fifth wheel slide tracks.
  - a. If the locking plungers are not fully inserted in the track, move the tractor slightly to reposition plungers and reinspect.



**WARNING**

Do not operate the vehicle unless the locking plungers are

fully inserted into the fifth wheel slide track. Operating the vehicle while the plungers are not fully inserted could lead to the slide moving unexpectedly, resulting in a loss of vehicle control and potentially causing property damage, serious injury, or death.

9. If the landing gear was lowered, raise the landing gear.
10. If the rear suspension was deflated, return rear suspension to its normal height.

## Driving Tips and Techniques

This section covers additional driving tips and techniques on how to drive your vehicle more efficiently.

## Coasting



### WARNING

DO NOT coast with the transmission in neutral or with the clutch pedal depressed, it is a dangerous practice. Coasting in neutral may result in damage to your drivetrain when you try to re-engage the transmission. You could lose control of the vehicle which can lead to an accident involving death or personal injury.

Do not coast with the transmission in neutral or with the clutch pedal depressed. Besides being illegal and dangerous, coasting is also expensive. It causes premature failure or damage to the clutch and transmission and overloads the brake system. Coasting with the transmission in neutral also prevents proper transmission component lubrication. During coasting the transmission is driven by the rear wheels, and the countershaft gear (which lubricates the transmission components by oil splash) will only be turning at idle speed.

## Descending a Grade



### WARNING

DO NOT hold the brake pedal down too long or too often while going down a steep or long grade. This could cause the brakes to overheat and reduce their effectiveness. As a result, the vehicle will not slow down at the usual rate. To reduce the risk of an accident which could cause death or personal injury, before going down a steep or long grade, reduce speed and shift the transmission into a lower gear to help control your vehicle speed. Failure to follow procedures for proper downhill operation could result in loss of vehicle control.

## Engine Overspeed



### CAUTION

To avoid engine damage, do not let the engine rpm go beyond the maximum governed rpm. Engine damage may result if overspeed conditions occur.



### NOTE

Often these recommendations are secondary to maintaining an adequate and safe speed relative to the surrounding traffic and road conditions.

Operate the engine within the optimum engine rpm range and do not allow the rpm to exceed the maximum governed speed.

See your Engine Operation and Maintenance manual for information regarding engine rpm. When the engine is used as a brake to control vehicle speed (e.g., while driving down a grade), do not allow the engine rpm to exceed maximum governed speed. Under normal load and road conditions operate the engine in the lower end of the range.

The tachometer is an instrument that aids in obtaining the best performance of the engine and manual transmission, serving as a guide for shifting gears. Refer to the Engine Operation and Maintenance manual for optimum engine rpm.

- If the engine rpm moves beyond the maximum governed speed, indicating an overspeed condition, apply the service brake or shift to a

- higher gear to bring engine rpm within the optimum speed range.
- When driving downhill: shift to a lower gear, use the engine brake (if so equipped), and use the service brake, keeping the engine speed below 2,100 rpm.

When the engine speed reaches its maximum governed speed, the injection pump governor cuts off fuel to the engine. However, the governor has no control over the engine rpm when it is being driven by the vehicle's transmission, for example, on steep downgrades. Apply service brakes or shift to a higher gear. Fuel economy and engine performance are also directly related to driving habits:

- The best results in trip time and fuel economy are obtained while driving the vehicle at a steady speed.
- Shift into higher or lower gears (or apply the service brake) to keep engine rpm near the lower end of the optimum operating range.
- Avoid rapid acceleration and braking.

 <b>WARNING</b>
<p>DO NOT look at the Instrument Cluster Display for prolonged periods while the vehicle is moving. Only glance at the monitor briefly while driving. Failure to do so can result in the driver not being attentive to the vehicle's road position or situation, which could lead to an accident and possible death, personal injury, or equipment damage.</p>

The Instrument cluster display provides information to help the driver optimize vehicle efficiency. See [Optimal Engine Speed Indicator](#) on page 185 for more information. A driver will find the section describing Trip Information and the rpm detail useful.

### Fuel Consumption

The vehicle's fuel consumption is connected to five important factors: maintenance, driving habits, general condition of the road, traffic conditions, and vehicle load.

Proper maintenance will keep the vehicle running like new even after long periods of

use. The driver must perform the daily and weekly checks of the vehicle. Maintenance factors affecting fuel consumption:

- Air and/or fuel filters partially clogged
- Engine valves out of adjustment
- Injection pump improperly synchronized
- Injection nozzles defective or uncalibrated
- Improperly inflated tires
- Wheel bearings improperly adjusted
- Clutch improperly adjusted or worn (slipping)
- Fuel leaks

Wrong driving habits must be corrected and the recommendations on economic driving should be followed. Driving factors affecting fuel consumption:

- Excessive speed and unnecessary fast acceleration
- Long periods of idling
- Driving with foot resting on the (manual transmission) clutch pedal

## General Condition

Other factors affecting fuel consumption are related to loads and the type of roads on which the vehicle operates. It is not always possible to choose the most adequate road, but the ideal road is the one that allows a steady speed in high gear, without requiring frequent braking and acceleration. The following general conditions can affect fuel consumption:

- Overload
- Unbalanced load
- Very high load
- Inadequate roads
- Traffic conditions

## Optimal Engine Speed Indicator

The tachometer displays a green bar just below the most efficient engine speed for the vehicle.

The placement and size of this bar is dependent on the engine as installed at the factory. The driver's general goal should be to select a gear that keeps the tachometer needle positioned over the green light as much as possible during steady state driving. In addition to proper maintenance and good driving habits, this visual cue can help minimize the fuel consumption.

## What to Consider when using a Sleeper Bunk

If your vehicle has an upper and lower bunk, the upper bunk can be folded up out of the way to provide you with more dressing area in the sleeper cab. The lower bunk has storage underneath it to stow your luggage and other belongings. The upper bunk weight limit is 320 lb (145 kg).



### WARNING

Always keep the lower bunk in its down (latched) position while the vehicle is moving. If left open, stored items could become loose during an accident and strike you. Before you move the vehicle, check to be sure the lower bunk is latched securely. Failure to comply may result in death or personal injury.



### WARNING

Be sure the latch that holds the upper bunk in the folded position is working properly so the bunk will not fall down. If the bunk falls, you could be injured.



### WARNING

Any loose items on the upper or lower bunk should be moved to a secured place before driving the vehicle. Failure to comply may result in death, personal injury, equipment or property damage.



### WARNING

Be sure the restraint system is used when anyone is occupying the sleeper while the vehicle is moving. In an accident, an unrestrained person lying in a sleeper bunk could be seriously injured. He or she could be thrown from the bunk. Failure to comply may result in death, personal injury, equipment or property damage.



**WARNING**

Be sure no one ever rides in the upper bunk. That person could be thrown out in an accident and could be very seriously injured. The upper bunk is not equipped with a restraint system. DO NOT use the upper bunk while you are moving. Failure to comply may result in death, personal injury, equipment or property damage.

The sleeper restraint is stored in a compartment on the rear sleeper cab wall. [Sleeper Bunks and Restraints](#) on page 30, for more information on cab/seat restraint systems.



**WARNING**

Failure to properly use the sleeper restraint when an individual is located in the sleeper bunk and the vehicle is moving can result in death or personal injury.

**To Lower Upper Bunk**

Pull on the lanyard in the upper left corner of the bunk to release the bunk.

**To Raise Upper Bunk**

This will free it from the anchored position and allow you to lower the bunk.

Fold the upper bunk up and push it against the retaining latch until you hear a click. Pull on the bunk to be sure it is latched securely.

**Upper Bunk Ladder Considerations**

If your vehicle is equipped with the upper bunk ladder, ensure that you follow the safety tips as detailed in [How to Access the Upper Bunk](#) on page 14.

**Stopping the Vehicle**

A hot engine stores a great amount of heat. It doesn't cool down immediately after you shut it off. Always cool your engine down before shutting it off. You will greatly increase its service life. Idle the engine at 1,000 rpm for five minutes. Then low idle for 30 seconds before shutdown. This will allow circulating coolant and lubricating oil to carry away heat from the cylinder head, valves, pistons, cylinder liners, turbocharger, and bearings. This way you can prevent serious engine damage that may result from uneven cooling.

**Turbocharger**

This cooling-down practice is especially important on a turbocharged engine. The turbocharger contains bearings and seals that are subjected to hot exhaust gases. While the engine is operating, heat is carried away by circulating oil. If you stop the engine suddenly, the temperature of the turbocharger could rise as much as 100°F (55°C) above the temperature reached during operation. A sudden rise in temperature like this could cause the bearings to seize or the oil seals to loosen.

**Refueling**

Air space in your fuel tanks allows water to condense there. To prevent this condensation while you are stopped, fill your tanks to 95 percent of capacity. When refueling, add approximately the same amount to each fuel tank on vehicles with more than one tank.



**WARNING**

DO NOT carry additional fuel containers in your vehicle. Fuel containers, either full or empty, may leak, explode, and cause or feed a fire. Failure to comply may result in death or personal injury.

**WARNING**

Diesel fuel in the presence of an ignition source could cause an explosion. A mixture of gasoline or alcohol with diesel fuel increases this risk of explosion. DO NOT remove a fuel tank cap near an open flame. Use only the fuel and/or additives recommended for your engine. Failure to comply may result in death, personal injury, equipment or property damage.

**CAUTION**

Use only Ultra Low Sulfur Diesel (ULSD) Fuel, as recommended by en-

gine manufacturers. If you need further information on fuel specifications, consult the Engine Operation and Maintenance Manual.

If your vehicle is equipped with fuel shut off valves for the take-off and return lines, they are located on the fuel lines entering the top of the fuel tank. Fuel shut off valves for the fuel crossover line are on the bottom of the fuel tank, at the crossover line connection.

**Final Stopping Procedures**

Your vehicle will be easier to start driving when you are ready, and it will be safer for anyone who might be around it. Please remember, too, that in some states it is illegal to leave the engine running and the vehicle unattended.

**WARNING**

Using the trailer hand brake or air brakes to hold a parked vehicle is dangerous. Because they work with air pressure, these brakes could come loose. Your vehicle could roll, causing an accident involving death or person-

al injury. Always set the parking brakes. Never rely on the trailer hand brake or truck air brakes to hold a parked vehicle.

**WARNING**

Lift axles that are not equipped with parking brakes should be fully raised when parking the vehicle. Lift axles, that are not equipped with parking brakes, left in the down position while parked, in certain cases, could cause the parked vehicle to roll, causing an accident involving death or personal injury.

1. Set the parking brake before leaving the driver's seat. To hold your vehicle while it is parked, DO NOT rely on:
  - Air Brakes
  - Hand Control Valve for Trailer Brakes
  - Engine Compression
2. If you are parked on a steep grade, block the wheels.

4

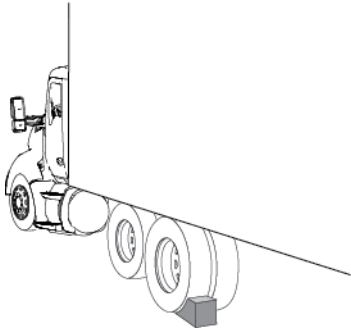

3. Drain water from the air reservoirs. While the engine and air supply system are still warm, drain moisture from the air reservoirs. Open the reservoir drains just enough to drain the moisture. Don't deplete the entire air supply. Be sure to close the drains before leaving the vehicle.

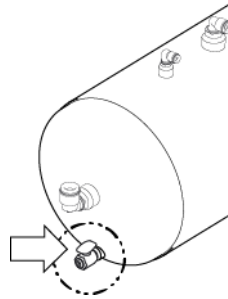

4. Secure the vehicle. Close all the windows and lock all the doors.



# Chapter 5 | MAINTENANCE

New Vehicle Maintenance Schedule.....	193
First Day.....	193
First 50-100 mi / 80-160 km.....	194
First 500 mi / 800 km.....	194
First 2,000 mi / 3,218 km.....	194
First 3,000-5,000 mi / 4,800-8,000 km.....	195
Maintenance Schedule.....	196
At first 15,000 mi / 24,000 km or at first PM.....	197
Component Specific Intervals.....	201
Every 15,000 mi / 24,000 km / Monthly.....	205
Every 25,000 mi / 40,000 km / 6 Months.....	210
Every 30,000 mi / 48,000 km.....	211
Every 60,000 mi / 96,000 km / 6 Months.....	215
Every 120,000 mi / 192,000 km / Annually.....	224
Every 240,000 mi / 384,000 km.....	229
Every 300,000 mi / 480,000 km / 6,750 Hours / 3 Years.....	230

Every 500,000 mi / 800,000 km / 5 years.....	231
Every 750,000 mi / 1,200,000 km/ 24,000 Hours / 8 years.....	231
Lubricants.....	232
Checking Oil Level.....	233
Air System.....	234
Dual Air System Function Test.....	236
Air Dryer Maintenance.....	236
Air Tanks.....	238
Air Gauges and Air Leaks.....	238
Air Compressor.....	240
Brake System.....	241
Cab Maintenance.....	243
Cab Structure, Doors and Hoods.....	249
Safety Restraint System - Inspection.....	249
Cooling System Maintenance.....	252
Electrical System.....	256
Engine Maintenance.....	266
Frame.....	273
Fuel System.....	274

Front Axle and Suspension.....	275
Heater and Air Conditioner Maintenance.....	278
Noise and Emission Control.....	280
Diesel Exhaust Fluid (DEF) Tank Straps.....	283
Rear Axle and Suspension.....	284
Steering System.....	289
Driveline.....	291
Tires.....	292
Wheels.....	295
Windshield Wiper/Washer.....	298
Transmission Maintenance.....	298
Hydraulic Clutch.....	299
Specification Reference Charts.....	300

## New Vehicle Maintenance Schedule First Day

First Day
Perform a total vehicle alignment once a body is installed on the truck chassis.
Steering U-joint Pinch Bolt <ul style="list-style-type: none"> <li>Refer to <a href="#">Steering Shaft Bolt Torque Specifications</a> on page 291 for maintenance instructions.</li> </ul>
Front Suspension - U-bolts <ul style="list-style-type: none"> <li>Check the general condition and the tightness of the nuts. Tighten the U-bolts using a calibrated torque wrench to the specified torque value. (Refer to <a href="#">Suspension U-Bolts, Grade 8</a> on page 307 for maintenance instructions.)</li> </ul>
Front Suspension - SOFTEK® NXT (Hendrickson) - Shock Absorbers <ul style="list-style-type: none"> <li>Inspect for leaking, body damage, and damaged or worn bushings. Replace as required. Check the shock mounting stud torque. (Refer to <a href="#">Front Axle and Suspension</a> on page 275 for maintenance instructions.)</li> </ul>
Front Suspension - SOFTEK® NXT (Hendrickson) - Spring Pins and Shackles <ul style="list-style-type: none"> <li>Inspect for worn parts and excessive joint clearance. Shim or replace as required. (Refer to <a href="#">Front Axle and Suspension</a> on page 275 for maintenance instructions.)</li> </ul>
Front Suspension - SOFTEK® NXT (Hendrickson) - Ride Height <ul style="list-style-type: none"> <li>Inspect that ride height is within specifications. (Refer to <a href="#">Air Suspension Ride Height</a> for maintenance instructions)</li> </ul>
Front Axle - SOFTEK® NXT (Hendrickson) - Axle Clamp Through Bolts <ul style="list-style-type: none"> <li>Check the tightness of the through bolts at the bolt head. Tighten the fasteners using a calibrated torque wrench to the specified torque value. (Refer to the Hendrickson operator's manual for torque specifications.)</li> </ul>

## First 50-100 mi / 80-160 km

### First 50-100 mi / 80-160 km<sup>4</sup>

#### Wheel Mounting

- Refer to [Wheels](#) on page 295 for maintenance instructions.

## First 500 mi / 800 km

### First 500 mi / 800 km<sup>5</sup>

#### Front Axle U-Bolt Torque

- Refer to [Suspension U-Bolts, Grade 8](#) on page 307 for maintenance instructions.

#### Charge Air Cooler and Air Intake Pipe Clamps

- Retorque fasteners. Refer to [Pipe and Hose Clamp Torque Values](#) on page 269 for maintenance instructions.

## First 2,000 mi / 3,218 km

---

<sup>4</sup> Ensure that all maintenance intervals leading up to this point are repeated during this interval prior to the completion of those listed here.

<sup>5</sup> Ensure that all maintenance intervals leading up to this point are repeated during this interval prior to the completion of those listed here.



**First 2,000 mi / 3,218 km<sup>6</sup>**

Rear Suspension Fasteners

- Refer to [Rear Axle and Suspension](#) on page 284 for maintenance instructions.

**First 3,000-5,000 mi /  
4,800-8,000 km**

**First 3,000-5,000 mi / 4,800-8,000 km<sup>7</sup>**

Transmission Lubrication

- For Fuller transmission, refer to [Fuller Transmission Lubrication](#) on page 299 for maintenance instructions.
- For Allison transmission, refer to [Allison Transmission Lubrication](#) on page 299 for maintenance instructions.

Axle Lubrication.

- For Meritor axle, refer to [Meritor Axle Lubrication](#) on page 287 for maintenance instructions.
- For Eaton/Dana axle, refer to [Eaton/Dana Axle Lubrication](#) on page 286 for maintenance instructions.

<sup>6</sup> Ensure that all maintenance intervals leading up to this point are repeated during this interval prior to the completion of those listed here.

<sup>7</sup> Ensure that all maintenance intervals leading up to this point are repeated during this interval prior to the completion of those listed here.

## Maintenance Schedule

Preventive maintenance program begins with the daily and weekly routine checks [Daily Checks](#) on page 35. Routine vehicle checks can help avoid many large, expensive, and time consuming repairs. The vehicle will operate better, be safer, and last longer. Neglect of recommended maintenance can void your vehicle's warranty. Some maintenance operations demand skills and equipment you may not have. For such situations, please take your vehicle to an authorized Service Center.



### WARNING

Before attempting any procedures in the engine compartment, stop the engine and let it cool down. Hot components can burn skin on contact. Failure to comply may result in death, personal injury, equipment or property damage.



### WARNING

If the engine must be operating to inspect, be alert and cautious around the engine at all times. Failure to comply may result in death, personal injury, equipment or property damage.



### WARNING

If work has to be done with the engine running, always (1) set the parking brake, (2) block the wheels, and (3) ensure that the shift lever or selector is in Neutral. Failure to comply may result in death, personal injury, equipment or property damage.



### WARNING

Exercise extreme caution to prevent neckties, jewelry, long hair or loose clothing from getting caught in the fan blades or another moving engine parts. Failure to comply may result in death, personal injury, equipment or property damage.



### WARNING

Always support the vehicle with appropriate safety stands if it is necessary to work underneath the vehicle. A jack is not adequate for this purpose. Failure to comply may result in death, personal injury, equipment or property damage.



### WARNING

When working underneath the vehicle without appropriate safety stands but with the wheels on the ground (not supported), make sure that (1) the vehicle is on hard level ground, (2) the parking brake is applied, (3) all wheels are blocked (front and rear) and (4) remove the ignition key so that the engine cannot be started. Failure to comply may result in death, personal injury, equipment or property damage.



**WARNING**

NEVER start or let the engine run in an enclosed, unventilated area. Exhaust fumes from the engine contain carbon monoxide, a colorless and odorless gas. Carbon monoxide can be fatal if inhaled. Failure to comply may result in property damage, personal injury, or death.



**WARNING**

Disconnect the battery ground cable whenever you work on the fuel system or the electrical system. When you work around fuel, do not smoke or work near heaters or other fire hazards. Keep an approved fire extinguisher near to you. Failure to comply may result in death, personal injury, equipment or property damage.

The following pages contain a table of maintenance tasks with the related intervals for each task on the right side of the table. The top of the table displays a guide to a maintenance interval and its schedule. Some tasks are dependent on

the vehicle application. These tasks will be shown as separate tasks and will have the words "ON HIGHWAY", "CITY DELIVERY" or "OFF-HIGHWAY" after the description. These tasks are differentiated because they are dependent on the vehicle's operating environment. On highway is defined for applications where the vehicle is NOT used off of a paved road during normal operation. City Delivery is defined for applications where frequent start and stopping is required during normal operation and the highway is used infrequently and for short periods of time. Off highway is defined for applications where the vehicle may be driven off the pavement on a regular basis, even if it is an infrequent basis and/or for a brief time period. Please contact an authorized service dealership if there are questions regarding which interval to follow. Consult the supplier for specific recommendations where discrepancies develop between these recommendations in this table and component supplier recommendations.

- Engine lubricating oil change intervals aren't listed here. Refer to your engine's operating manual for recommendations. For specific information on maintenance

procedures consult your vehicle maintenance manual.

- The initial fill of drive axle lubricant must be changed before the end of the first scheduled maintenance interval. See the axle manufacturer's operator's manual for recommended lubrication specifications and service intervals.
- The initial fill of lubricant in manual transmissions must be changed before the end of the first maintenance interval. See the transmission manufacturer's operator's manual for recommended lubrication specifications and service intervals.
- If your vehicle is equipped with an automatic transmission, consult the owner's manual for it that came with your vehicle to obtain lubricant check and change intervals.

**At first 15,000 mi / 24,000 km or at first PM**

At first 15,000 mi / 24,000 km or at first PM <sup>8</sup>
<p>Front Suspension U-bolts</p> <ul style="list-style-type: none"> <li>(ON HIGHWAY) Check the general condition and the tightness of the nuts. Tighten the nuts to the specified torque value as required; (Refer to <a href="#">Suspension U-Bolts, Grade 8</a> on page 307 for maintenance instructions.)</li> <li>(VOCATIONAL) Check the general condition and the tightness of the nuts. Tighten the U- bolts after the first day or two of operation. Then tighten the nuts to the specified torque value as required; (Refer to <a href="#">Suspension U-Bolts, Grade 8</a> on page 307 for maintenance instructions.)</li> </ul>
<p>Drive Axle (SISU) - Axle Housing</p> <ul style="list-style-type: none"> <li><a href="#">Drive Axle (SISU) Oil Servicing</a> on page 289</li> <li><a href="#">Drive Axle (SISU) Inspection</a> on page 289</li> <li><a href="#">Drive Axle (SISU) Inspection</a> on page 289</li> </ul>
<p>Rear Suspension - U-bolts</p> <ul style="list-style-type: none"> <li>Check the torque. Tighten to specified torque value as required.(Refer to <a href="#">Suspension U-Bolts, Grade 8</a> on page 307 for maintenance instructions.)</li> </ul>
<p>Rear Suspension - Mounting Brackets and Fasteners</p> <ul style="list-style-type: none"> <li>Check the condition and the fastener torque. Tighten to the specified torque value as required; (Refer to <a href="#">Rear Axle and Suspension</a> on page 284 for maintenance instructions.)</li> </ul>
<p>Main and Auxiliary Transmission (including Eaton Automated or PACCAR Transmission) - Main and Auxiliary Transmission and Transfer Case</p> <ul style="list-style-type: none"> <li>Inspect for visible damage, signs of overheating, and leaks. (Refer to <a href="#">Transmission Maintenance</a> on page 298 for maintenance instructions.)</li> </ul>

<sup>8</sup> Ensure that all maintenance intervals leading up to this point are repeated during this interval prior to the completion of those listed here.

At first 15,000 mi / 24,000 km or at first PM <sup>8</sup>
<p>Main and Auxiliary Transmission (including Eaton Automated or PACCAR Transmission) - Main and Auxiliary Transmission (OFF HIGHWAY)</p> <ul style="list-style-type: none"> <li>• Drain lubricant while warm. Flush each unit with clean flushing oil. (Refer to <a href="#">Transmission Maintenance</a> on page 298 for maintenance instructions.)</li> </ul>
<p>Auxiliary Transmission - Cotta Transfer Case TR2205 Fabco Transfer Case TC142/TC143/ TC170/ TC270 Marmon-Harrington Transfer Case MVG2000/ MVG2000SD</p> <ul style="list-style-type: none"> <li>• Initial oil change: Drain oil while warm: flush case with gear oil-compatible fluid, clean magnetic drain plug, and refill. Do not flush the case with any solvent.</li> </ul>
<p>Cooling - Hoses</p> <ul style="list-style-type: none"> <li>• Check the radiator and heater hoses for leaks. (Refer to <a href="#">Cooling System Maintenance</a> on page 252 for maintenance instructions.)</li> </ul>
<p>Cooling - Fan Clutch</p> <ul style="list-style-type: none"> <li>• Check for air leaks. Check the fan drive bearings (turn the sheave in both directions to check for worn hub bearings.)(Refer to <a href="#">Engine Fan</a> on page 270 for maintenance instructions.)</li> </ul>
<p>Cooling - Solenoid Valve</p> <ul style="list-style-type: none"> <li>• Check the fan drive for proper engagement and disengagement. (Refer to <a href="#">Engine Fan</a> on page 270 for maintenance instructions.)</li> </ul>
<p>Power Steering - Reservoir (ON HIGHWAY)</p> <ul style="list-style-type: none"> <li>• Drain, replace the filter, and refill; (Refer to <a href="#">Check Power Steering Fluid Level</a> on page 290 for maintenance instructions.)</li> </ul>

<sup>8</sup> Ensure that all maintenance intervals leading up to this point are repeated during this interval prior to the completion of those listed here.

At first 15,000 mi / 24,000 km or at first PM <sup>8</sup>
<p>Power Steering - Reservoir (OFF HIGHWAY)</p> <ul style="list-style-type: none"> <li>• Drain, replace the filter, and refill. (Refer to <a href="#">Check Power Steering Fluid Level</a> on page 290 for maintenance instructions.)</li> </ul>
<p>Steering Components - Drag link Tube Clamp and Ball Socket</p> <ul style="list-style-type: none"> <li>• Check the torque: tighten to specified torque value as required. (Refer to <a href="#">Steering System</a> on page 289 for maintenance instructions.)</li> </ul>
<p>Steering Components - Pitman Arm Clamp Bolt and Nut</p> <ul style="list-style-type: none"> <li>• Check the torque: tighten to specified torque value as required. (Refer to <a href="#">Steering System</a> on page 289 for maintenance instructions.)</li> </ul>
<p>Steering Components - Steering Intermediate Shaft</p> <ul style="list-style-type: none"> <li>• Check the torque on the pinch bolt and nut. (Refer to <a href="#">Steering Shaft Bolt Torque Specifications</a> on page 291 for maintenance instructions.)</li> </ul>
<p>Steering Components - Steering Intermediate Shaft U-joints (ON HIGHWAY)</p> <ul style="list-style-type: none"> <li>• Lubricate [EP NLGI #2 HD grease, -10 to 325°F (-23 to 163°C) range]. (Refer to <a href="#">Steering System</a> on page 289 for maintenance instructions.)</li> </ul>
<p>Steering Components - Steering Intermediate Shaft U-joints (OFF HIGHWAY or CITY DELIVERY)</p> <ul style="list-style-type: none"> <li>• Lubricate [EP NLGI #2 HD grease, -10 to 325°F (-23 to 163°C) range]. (Refer to <a href="#">Steering System</a> on page 289 for maintenance instructions.)</li> </ul>
<p>Steering Components - Drag link and Tie Rod Arm Ball Sockets (ON HIGHWAY, OFF HIGHWAY or CITY DELIVERY)</p> <ul style="list-style-type: none"> <li>• Lubricate (EP NLGI #2 lithium-based, HD grease.) (Refer to <a href="#">Steering System</a> on page 289 for maintenance instructions.)</li> </ul>

<sup>8</sup> Ensure that all maintenance intervals leading up to this point are repeated during this interval prior to the completion of those listed here.

**At first 15,000 mi / 24,000 km or at first PM<sup>8</sup>**

Fuel and Tanks - Fuel Tank Straps

- Check the strap tightness: tighten to proper torque value as required; aluminum tank - 30 lb-ft (41 N·m) cylindrical steel tank - 8 lb-ft (11 N·m.) (Refer to [Fuel Tank](#) on page 275 for maintenance instructions.)

Driveshafts - Models SPL-90, 1710 and 1810 Slip Member and U-joints

- Lubricate\*

Driveshafts - Models SPL- 140/140HD/170/170HD/250/250HD Slip Members and U- joints (OFF HIGHWAY)

- Lubricate\*

Electrical and Lights - Fuel and Diesel Exhaust Fluid Tank Sending Unit

- Check the mounting screws and electrical connections for worn or damaged wires and connectors. (Refer to [Diesel Exhaust Fluid \(DEF\) Tank Straps](#) on page 283 for maintenance instructions.)

## Component Specific Intervals

These maintenance tasks should be reviewed at each maintenance interval. They are not specific to one interval.

<sup>8</sup> **Ensure that all maintenance intervals leading up to this point are repeated during this interval prior to the completion of those listed here.**

\* Use only Spicer Driveshaft approved lubricants when greasing Spicer U-joints.

Component Specific Intervals <sup>9</sup>
Drive Axle (Dana) - Axle Housing <a href="#">Drive Axle - Dana</a> on page 286
Drive Axle (Meritor Line Haul / ON HIGHWAY) <a href="#">Drive Axle - Meritor</a> on page 287
Drive Axle (Meritor City Delivery / OFF HIGHWAY) <a href="#">Drive Axle - Meritor</a> on page 287
<p>Front Axle - Vocational (PACCAR) - Kingpin Bushings, Thrust Bearings, and Tie Rod Ball Ends (OFF-HIGHWAY)</p> <ul style="list-style-type: none"> <li>Lubricate with approved grease. Weekly regardless of mileage. (Refer to <a href="#">Front Axle and Suspension</a> on page 275 for maintenance instructions.)</li> </ul>
<p>Front Axle - Vocational (PACCAR) - Steering Knuckle Spindles, Thrust Bearings, Kingpins, Drawkeys, Tie Rod Ends, Steering Stops, and Bushings (OFF-HIGHWAY)</p> <ul style="list-style-type: none"> <li>Inspect for wear and damage and for endplay. Shim or replace as required. Weekly regardless of mileage. (Refer to <a href="#">Front Axle and Suspension</a> on page 275 for maintenance instructions.)</li> </ul>
<p>Eaton Automated or PACCAR Transmission (Only) - Lubrication (OFF-HIGHWAY)</p> <ul style="list-style-type: none"> <li>Perform maintenance on the air dryer - 360,000 miles/576,000 km (Refer to <a href="#">Air Dryer Maintenance</a> on page 236 for maintenance instructions.)</li> <li></li> <li>Drain lubricant while warm. Flush each unit with clean flushing oil. (Refer to <a href="#">Transmission Maintenance</a> on page 298 for maintenance instructions.)</li> </ul>
<p>Air Intake - Air filter</p> <ul style="list-style-type: none"> <li>Replace the engine intake air filter element. Every 12 months or when required by air restriction indicator or required by the engine manufacturers operator manual. (Refer to <a href="#">Air Intake System</a> on page 271 for maintenance instructions.)</li> </ul>

<sup>9</sup> Ensure that all maintenance intervals leading up to this point are repeated during this interval prior to the completion of those listed here.



Component Specific Intervals <sup>9</sup>
<p>Clutch - Clutch Hydraulic Fluid</p> <ul style="list-style-type: none"> <li>• Replace fluid and bleed system. 240,000 mi (384,000 km) or 2 years, whichever occurs first. (Refer to <a href="#">Hydraulic Clutch</a> on page 299 for maintenance instructions.)</li> </ul>
<p>Tires and Wheels - Tires</p> <ul style="list-style-type: none"> <li>• Check inflation pressure. Weekly "cold" using calibrated gauge. (Refer to <a href="#">Tires</a> on page 292 for maintenance instructions.)</li> </ul>
<p>Driveshafts - Models SPL-90, 1710 and 1810 slip member and U-joints</p> <ul style="list-style-type: none"> <li>• Inspect. U-joint inspections should be performed every time a vehicle comes in for scheduled maintenance.</li> </ul>
<p>Driveshafts - Models SPL-100 slip member and U-joints</p> <ul style="list-style-type: none"> <li>• Inspect. U-joint inspections should be performed every time a vehicle comes in for scheduled maintenance.</li> </ul>
<p>Driveshafts - Models SPL-140/140HD/170/170HD/250/250HD slip members and U-joints (ON HIGHWAY and LINEHAUL)</p> <ul style="list-style-type: none"> <li>• Inspect. U-joint inspections should be performed every time a vehicle comes in for scheduled maintenance.</li> </ul>
<p>Driveshafts - Models SPL-140/140HD/170/170HD/250/250HD slip members and U-joints (ON HIGHWAY and LINEHAUL)</p> <ul style="list-style-type: none"> <li>• Inspect. U-joint inspections should be performed every time a vehicle comes in for scheduled maintenance.</li> </ul>
<p>Driveshafts - Models SPL-140XL/170XL/250XL slip members and U-joints (OFF HIGHWAY)</p> <ul style="list-style-type: none"> <li>• Lubricate. 350,000 mi (560,000 km) 1st interval and then every 100,000 mi (160,00 km) after that.</li> </ul>
<p>Driveshafts - Models SPL-140XL/170XL/250XL slip members and U-joints (ON HIGHWAY and LINE HAUL)</p> <ul style="list-style-type: none"> <li>• Inspect. U-joint inspections should be performed every time a vehicle comes in for scheduled maintenance.</li> </ul>

<sup>9</sup> Ensure that all maintenance intervals leading up to this point are repeated during this interval prior to the completion of those listed here.

\* Use only Spicer Driveshaft approved lubricants when greasing Spicer U-joints.

Component Specific Intervals <sup>9</sup>
<p>Driveshafts - Models SPL-140XL/170XL/ 250XL slip members and U-joints (OFF HIGHWAY and CITY)</p> <ul style="list-style-type: none"> <li>Inspect. U-joint inspections should be performed every time a vehicle comes in for scheduled maintenance.</li> </ul>
<p>Aftertreatment System - Diesel particulate filter</p> <ul style="list-style-type: none"> <li>Clean filter. Refer to the <i>Engine Maintenance Manual</i>.</li> </ul>
<p>Aftertreatment System - Diesel exhaust fluid supply module</p> <ul style="list-style-type: none"> <li>Replace filter. Refer to the <i>Engine Maintenance Manual</i>.</li> </ul>
<p>Air - Air dryer (ON HIGHWAY)</p> <ul style="list-style-type: none"> <li>360,000 miles/576,000 km (Refer to <a href="#">Air Dryer Maintenance</a> on page 236 for maintenance instructions.)</li> </ul>
<p>Air - Air Dryer (Oil- Coalescing Desiccant Cartridge)</p> <ul style="list-style-type: none"> <li>Annually regardless of mileage. (Refer to <a href="#">Air Dryer Maintenance</a> on page 236 for maintenance instructions.)</li> </ul>
<p>Engine - Basic Engine Maintenance and service interval recommendations are detailed in the engine manufacturer's Operations and Maintenance Manual included with the vehicle. The engine manufacturer's recommendations vary depending engine model. Information is also available from authorized dealers, the engine manufacturer's authorized service centers, and the engine manufacturer's web site.</p>
<p>Safety - Three-point Safety Belt System</p> <ul style="list-style-type: none"> <li>Inspect. 20,000 miles/32,000km If the vehicle is exposed to severe environmental or working conditions, more frequent inspections may be necessary. (Refer to <a href="#">Safety Restraint System - Inspection</a> on page 249 for maintenance instructions.)</li> </ul>

<sup>9</sup> Ensure that all maintenance intervals leading up to this point are repeated during this interval prior to the completion of those listed here.

## Every 15,000 mi / 24,000 km / Monthly

Every 15,000 mi / 24,000 km / Monthly <sup>10</sup>
<p>Frame - Fifth Wheel</p> <ul style="list-style-type: none"> <li>Check the kingpin lock and plate for wear and function: lubricate (NLGI #2 grease.) (Refer to <a href="#">Fifth Wheel Monthly Maintenance</a> on page 274 for maintenance instructions.)</li> </ul>
<p>Front Axle - SOFTEK® NXT (Hendrickson) - Kingpin Bearings (OFF HIGHWAY or CITY DELIVERY)</p> <ul style="list-style-type: none"> <li>Multipurpose Grease NLGI Grade 2</li> </ul>
<p>Front Suspension - Spring Pins</p> <ul style="list-style-type: none"> <li>Check for proper function. (Refer to <a href="#">Front Axle and Suspension</a> on page 275 for maintenance instructions.)</li> </ul>
<p>Front Suspension - U-bolts (OFF HIGHWAY)</p> <ul style="list-style-type: none"> <li>Check the general condition and the tightness of the nuts. Tighten the U- bolts after the first day or two of operation. Then tighten the nuts to the specified torque value as required. (Refer to <a href="#">Suspension U-Bolts, Grade 8</a> on page 307 for maintenance instructions.)</li> </ul>
<p>Front Suspension - SOFTEK® NXT (Hendrickson) - Leaf Spring Bushing Threaded (optional) (LINE HAUL, CITY DELIVERY and OFF HIGHWAY)</p> <ul style="list-style-type: none"> <li>EP Chassis Grease NLGI Grade 2</li> </ul>

<sup>10</sup> Ensure that all maintenance intervals leading up to this point are repeated during this interval prior to the completion of those listed here.

Every 15,000 mi / 24,000 km / Monthly <sup>10</sup>
<p>Drive Axle - Vocational (PACCAR) - Axle Assembly</p> <ul style="list-style-type: none"> <li>• Check oil level</li> <li>• Visually inspect for damage or leaks.</li> </ul>
<p>Drive Axle - Vocational (PACCAR) - Breather</p> <ul style="list-style-type: none"> <li>• Check the operation. If the cap doesn't rotate freely, replace.</li> </ul>
<p>Drive Axle (Meritor City Delivery / OFF HIGHWAY) - Axle Housing</p> <ul style="list-style-type: none"> <li>• Check the "cold" fill level at the differential carrier plug for a pinion angle of less than 7 degrees, or at the axle bowl plug for a pinion angle of greater than 7 degrees. Tighten the plug to 35-50 lb-ft (47-68 N·m.) (Refer to <a href="#">Drive Axle - Meritor</a> on page 287 for maintenance instructions.)</li> <li>• Visually inspect for damage or leaks. (Refer to <a href="#">Drive Axle - Meritor</a> on page 287 for maintenance instructions.)</li> </ul>
<p>Drive Axle (Meritor City Delivery / OFF HIGHWAY) - Breather</p> <ul style="list-style-type: none"> <li>• Check the operation. If the cap doesn't rotate freely, replace. (Refer to <a href="#">Drive Axle - Meritor</a> on page 287 for maintenance instructions.)</li> </ul>
<p>Drum Brakes (All) - Slack Adjusters</p> <ul style="list-style-type: none"> <li>• Check the push rod travel and check the control arm for cracks. Adjust at reline. (Refer to <a href="#">Auto Slack Adjuster</a> on page 242 for maintenance instructions.)</li> <li>• Lubricate (NLGI #2 grease.)</li> </ul>
<p>Drum Brakes (All) - Brake Air System</p> <ul style="list-style-type: none"> <li>• Check air lines and fittings for leaks. Adjust routing as required to prevent chafing. Check tank mounting and condition. (Refer to <a href="#">How to Check the Compressed Air System for Leaks</a> on page 239 for maintenance instructions.)</li> </ul>

<sup>10</sup> Ensure that all maintenance intervals leading up to this point are repeated during this interval prior to the completion of those listed here.

Every 15,000 mi / 24,000 km / Monthly <sup>10</sup>
<p>Hub, Drum, and Hubcap - Hubcaps</p> <ul style="list-style-type: none"> <li>• Clean the sight window. Check the center plug, mounting flange, and fill plug for leaks and for proper installation. Replace broken or damaged parts. Check the lubricant level and add as required. (Refer to <a href="#">Wheels</a> on page 295 for maintenance instructions.)</li> </ul>
<p>Main and Auxiliary Transmission (including Eaton Automated or PACCAR Transmission) - Main and Auxiliary Transmission and Transfer Case</p> <ul style="list-style-type: none"> <li>• Inspect for visible damage, signs of overheating, and leaks. (Refer to <a href="#">Transmission Maintenance</a> on page 298 for maintenance instructions.)</li> </ul>
<p>Auxiliary Transmission - Cotta Transfer Case TR2205 Fabco Transfer Case TC142/TC143/ TC170/ TC270</p> <ul style="list-style-type: none"> <li>• Inspect: Check oil level, inspect for leaks and any visible damage.</li> </ul>
<p>Marmon-Harrington Transfer Case MVG2000/ MVG2000SD</p> <ul style="list-style-type: none"> <li>• Replace/clean the air filter pre-cleaner, if equipped.</li> </ul>
<p>Air Intake - Pre-Cleaner</p> <ul style="list-style-type: none"> <li>• Inspect for cuts, irregular wear, missing lugs, sidewall damage, etc. (Refer to <a href="#">Air Intake System</a> on page 271 for maintenance instructions.)</li> </ul>
<p>Tires and Wheels - Tires</p> <ul style="list-style-type: none"> <li>• Inspect the wheel disc for any cracks or surface irregularities. Inspect the rim edge and bead seat area for damage. Replace any damaged wheels - DO NOT ATTEMPT TO REPAIR. (Refer to <a href="#">Tires</a> on page 292 for maintenance instructions.)</li> </ul>

<sup>10</sup> Ensure that all maintenance intervals leading up to this point are repeated during this interval prior to the completion of those listed here.

Every 15,000 mi / 24,000 km / Monthly <sup>10</sup>
<p>Tires and Wheels - Disc Wheels</p> <ul style="list-style-type: none"> <li>Inspect the mounting ring, rim gutter, side ring, and lock ring for damage: replace as required. (Refer to <a href="#">Wheels</a> on page 295 for maintenance instructions.)</li> </ul>
<p>Tires and Wheels - Demountable Rims</p> <ul style="list-style-type: none"> <li>Check the tightness of the fasteners and tighten the fasteners to the specified torque as required. (Refer to <a href="#">Wheels</a> on page 295 for maintenance instructions.)</li> </ul>
<p>Tires and Wheels - Wheel Nuts and Studs</p> <ul style="list-style-type: none"> <li>Inspect for damaged hex corners, stripped or damaged threads, and excessive corrosion: clean or replace as required. (Refer to <a href="#">Wheels</a> on page 295 for maintenance instructions.)</li> </ul>
<p>Power Steering - Reservoir</p> <ul style="list-style-type: none"> <li>Check the fluid level. (Refer to <a href="#">Check Power Steering Fluid Level</a> on page 290 for maintenance instructions.)</li> </ul>
<p>Power Steering - Power Assist Cylinder</p> <ul style="list-style-type: none"> <li>Lubricate (EP NLGI #2 lithium-based, moly-filled, HD grease.) (Refer to <a href="#">Steering System</a> on page 289 for maintenance instructions.)</li> </ul>
<p>Steering Components - Drag link and Tie Rod Arm Ball Sockets (OFF HIGHWAY or CITY DELIVERY)</p> <ul style="list-style-type: none"> <li>Lubricate (EP NLGI #2 lithium-based, HD grease.). (Refer to <a href="#">Steering System</a> on page 289 for maintenance instructions.)</li> </ul>
<p>Fuel and Tanks - Fuel Tank Steps</p> <ul style="list-style-type: none"> <li>Check for snug fit of side plates against tank and tank straps. Check for damaged or broken steps, missing bolts, and missing grommet between tank and side plate. Replace missing or damaged parts and adjust for fit as required. (Refer to <a href="#">Fuel Tank</a> on page 275 for maintenance instructions.)</li> </ul>

<sup>10</sup> Ensure that all maintenance intervals leading up to this point are repeated during this interval prior to the completion of those listed here.

Every 15,000 mi / 24,000 km / Monthly <sup>10</sup>
<p>Driveshafts - Models SPL-90, 1710 and 1810 Slip Member and U-joints</p> <ul style="list-style-type: none"> <li>Lubricate</li> </ul>
<p>Driveshafts - Model SPL-100 Slip Member and U-joints</p> <ul style="list-style-type: none"> <li>Check the condition of the cables, cushion clamps, nylon tie straps, and routing. Replace a cushion clamp if the rubber has deteriorated. Repair or tighten terminals, and secure cables to prevent chafing. Replace damaged cables (cuts, cracks, or excessive wear.) (Refer to <a href="#">Batteries</a> on page 261 for maintenance instructions.)</li> </ul>
<p>Battery Boxes, Tool Boxes, and Steps - Battery Cables Battery Boxes, Tool Boxes, and Steps - Batteries (OFF-HIGHWAY)</p> <ul style="list-style-type: none"> <li>Check for cracks and damage, electrolyte level, condition of terminals, and tightness of hold downs. (Refer to <a href="#">Batteries</a> on page 261 for maintenance instructions.)</li> </ul>
<p>Battery Boxes, Tool Boxes, and Steps - Battery Box and Tray (OFF-HIGHWAY)</p> <ul style="list-style-type: none"> <li>Check the box integrity. Clean the drain tube and check for acid leaks. Check condition of all equipment mounted under the box. (Refer to <a href="#">Batteries</a> on page 261 for maintenance instructions.)</li> </ul>
<p>Battery Boxes, Tool Boxes, and Steps - Battery Cable Fasteners</p> <ul style="list-style-type: none"> <li>Check battery cable fasteners and tighten as necessary to 10-15 lb-ft (13.6-20.3 N·m) as specified on the battery label. (Refer to <a href="#">Batteries</a> on page 261 for maintenance instructions.)</li> </ul>
<p>Electrical and Lights - Warning Lights in Light Bar</p> <ul style="list-style-type: none"> <li>Check at the ignition start position to verify bulb check and systems check function. (Refer to <a href="#">Bulb Check</a> on page 79 for maintenance instructions.)</li> </ul>

<sup>10</sup> **Ensure that all maintenance intervals leading up to this point are repeated during this interval prior to the completion of those listed here.**

\* Use only Spicer Driveshaft approved lubricants when greasing Spicer U-joints.

Every 15,000 mi / 24,000 km / Monthly <sup>10</sup>
Electrical and Lights - Turn, Stop, Reverse Lights and Signals <ul style="list-style-type: none"><li>• Visual check. (Refer to <a href="#">Daily Checks</a> on page 35).</li></ul>
Electrical and Lights - Power Supply Harnesses (engine, Transmission, etc.) <ul style="list-style-type: none"><li>• Check for worn or damaged insulation, corroded terminals, frayed wires, and oil or fluid leaks on the connectors or wiring. (Refer to <a href="#">Electrical System</a> on page 256 for maintenance instructions.)</li></ul>
Heating and Air Conditioning - Air Conditioner <ul style="list-style-type: none"><li>• Operate the system. (Refer to <a href="#">Heater and Air Conditioner Maintenance</a> on page 278 for maintenance instructions.)</li></ul>
Heating and Air Conditioning - Cabin Fresh Air Filter (ON HIGHWAY) <ul style="list-style-type: none"><li>• Inspect and clean, replace if necessary. (Refer to <a href="#">How to Replace Air Conditioner Filter</a> on page 280 for maintenance instructions.)</li></ul>
Heating and Air Conditioning - Cabin Fresh Air Filter (OFF-HIGHWAY) <ul style="list-style-type: none"><li>• Inspect and clean, replace if necessary. (Refer to <a href="#">How to Replace Air Conditioner Filter</a> on page 280 for maintenance instructions.)</li></ul>
Aftertreatment System - System <ul style="list-style-type: none"><li>• Check for leaks and proper support. (Refer to <a href="#">Noise and Emission Control</a> on page 280 for maintenance instructions.)</li></ul>

## Every 25,000 mi / 40,000 km / 6 Months

---

<sup>10</sup> Ensure that all maintenance intervals leading up to this point are repeated during this interval prior to the completion of those listed here.



<b>Every 25,000 mi / 40,000 km / 6 Months</b>
<p>Front Axle - Linehaul (PACCAR) - Kingpin Joint Grease/Tie Rod Ends</p> <ul style="list-style-type: none"> <li>• Heavy-Duty Multipurpose Lithium Based: #1 or #2 Grade. (Refer to <a href="#">Front Axle and Suspension</a> on page 275 for maintenance instructions.)</li> </ul>
<p>Front Suspension - SOFTEK NXT (Hendrickson) - Shock Absorbers</p> <ul style="list-style-type: none"> <li>• Inspect for leaking, body damage, and damaged or worn bushings. Replace as required. Check the shock mounting stud torque. (Refer to <a href="#">Front Axle and Suspension</a> on page 275 for maintenance instructions.)</li> </ul>
<p>Front Suspension - SOFTEK NXT (Hendrickson) - Spring Pins and Shackles</p> <ul style="list-style-type: none"> <li>• Inspect for worn parts and excessive joint clearance. Shim or replace as required. (Refer to <a href="#">Front Axle and Suspension</a> on page 275 for maintenance instructions.)</li> </ul>
<p>Front Suspension - SOFTEK NXT (Hendrickson) - U-bolts</p> <ul style="list-style-type: none"> <li>• Check the general condition and the tightness of the nuts. (Refer to <a href="#">Front Axle and Suspension</a> on page 275 for maintenance instructions.)</li> </ul>
<p>Front Axle - SOFTEK® NXT (Hendrickson) - Axle Clamp Through Bolts</p> <ul style="list-style-type: none"> <li>• Check the tightness of the through bolts at the bolt head. (Refer to the Hendrickson operator's manual for torque specifications.)</li> </ul>

**Every 30,000 mi / 48,000 km**

Every 30,000 mi / 48,000 km <sup>11</sup>
<p>Front Suspension - Spring Pins</p> <ul style="list-style-type: none"> <li>Lubricate with approved grease. (Refer to <a href="#">Front Axle and Suspension</a> on page 275 for maintenance instructions.)</li> </ul>
<p>Drive Axle - Linehaul (PACCAR) - Axle Assembly</p> <ul style="list-style-type: none"> <li>Check oil level and inspect for leaks.</li> <li>Visually inspect for damage or leaks.</li> </ul>
<p>Drive Axle - Linehaul (PACCAR) - Breather</p> <ul style="list-style-type: none"> <li>Check the operation. If the cap doesn't rotate freely, replace.</li> </ul>
<p>Drive Axle - Vocational (PACCAR) - Axle Assembly</p> <ul style="list-style-type: none"> <li>Drain and replace MINERAL BASE lubricant. Drive Axle (Meritor Line Haul / ON HIGHWAY) - Axle Housing                             <ul style="list-style-type: none"> <li>Check the "cold" fill level at the differential carrier plug for a pinion angle of less than 7 degrees, or at the axle bowl plug for a pinion angle of greater than 7 degrees. Tighten the plug to 35-50 lb-ft (47-68 N·m.) (Refer to <a href="#">Drive Axle - Meritor</a> on page 287 for maintenance instructions.)</li> <li>Visually inspect for damage or leaks. (Refer to <a href="#">Drive Axle - Meritor</a> on page 287 for maintenance instructions.)</li> </ul> </li> </ul>
<p>Drive Axle (Meritor Line Haul / ON HIGHWAY) - Breather</p> <ul style="list-style-type: none"> <li>Check the operation. If the cap doesn't rotate freely, replace. (Refer to <a href="#">Drive Axle - Meritor</a> on page 287 for maintenance instructions.)</li> </ul>
<p>Drum Brakes (All) - Brake Treadle Valve</p> <ul style="list-style-type: none"> <li>Clean the area around the treadle, boot, and mounting plate. Check the pivot and mounting plate for integrity. Check the plunger boot for cracks. Lubricate roller pin, pivot pin, and plunger (NLGI #2 grease.) (Refer to <a href="#">Drum Brake Inspection</a> on page 243 for maintenance instructions.)</li> </ul>

<sup>11</sup> Ensure that all maintenance intervals leading up to this point are repeated during this interval prior to the completion of those listed here.

Every 30,000 mi / 48,000 km <sup>11</sup>
<p>Drum Brakes (All) - Brake Lining</p> <ul style="list-style-type: none"> <li>Inspect: replace as required. (Refer to <a href="#">Drum Brake Inspection</a> on page 243 for maintenance instructions.)</li> </ul>
<p>Hub, Drum, and Hubcap - Hubs (non-LMS)</p> <ul style="list-style-type: none"> <li>Check the bearing endplay and adjust as required. (Refer to <a href="#">Wheels</a> on page 295 for maintenance instructions.)</li> </ul>
<p>Hub, Drum, and Hubcap - Hub Seals (all)</p> <ul style="list-style-type: none"> <li>Check for leaks: replace as required. (Refer to <a href="#">Wheels</a> on page 295 for maintenance instructions.)</li> </ul>
<p>Hub, Drum, and Hubcap - Brake Drums</p> <ul style="list-style-type: none"> <li>Inspect for visible cracks, heat checking, galling or scoring of the braking surface, and for severe corrosion on the outside surface. Check for out-of-round or oversize condition [0.080 in. (2 mm) more than the original diameter]. Replace as required. (Refer to <a href="#">Brake System</a> on page 241 for maintenance instructions.)</li> </ul>
<p>Main and Auxiliary Transmission (including Eaton Automated or PACCAR Transmission) - Main and Auxiliary Transmission and Transfer Case</p> <ul style="list-style-type: none"> <li>Check the drain plugs for tightness. (Refer to <a href="#">Transmission Maintenance</a> on page 298 for maintenance instructions.)</li> </ul>
<p>Main and Auxiliary Transmission (including Eaton Automated or PACCAR Transmission) - Main and Auxiliary Transmission</p> <ul style="list-style-type: none"> <li>Check the oil level: refill as required. (Refer to <a href="#">Transmission Maintenance</a> on page 298 for maintenance instructions.)</li> </ul>
<p>Clutch - Clutch Release Bearing</p> <ul style="list-style-type: none"> <li>Lubricate. (Refer to <a href="#">Hydraulic Clutch</a> on page 299 for maintenance instructions.)</li> <li>Inspect and adjust when necessary (no adjustment required for SOLO type clutches.) (Refer to <a href="#">Hydraulic Clutch</a> on page 299 for maintenance instructions.)</li> </ul>

<sup>11</sup> Ensure that all maintenance intervals leading up to this point are repeated during this interval prior to the completion of those listed here.

Every 30,000 mi / 48,000 km <sup>11</sup>
<p>Cooling - Extended Life Coolant (ELC)</p> <ul style="list-style-type: none"> <li>• Check coolant/antifreeze condition. (Refer to <a href="#">Cooling System Maintenance</a> on page 252 for maintenance instructions.)</li> </ul>
<p>Steering Components - Steering Intermediate Shaft U-joints (OFF HIGHWAY or CITY DELIVERY)</p> <ul style="list-style-type: none"> <li>• Lubricate [EP NLGI #2 HD grease, -10 to 325°F (-23 to 163°C) range]. (Refer to <a href="#">Steering System</a> on page 289 for maintenance instructions.)</li> </ul>
<p>Steering Components - Drag link and Tie Rod Arm Ball Sockets (ON HIGHWAY)</p> <ul style="list-style-type: none"> <li>• Lubricate (EP NLGI #2 lithium-based, moly-filled, HD grease.) (Refer to <a href="#">Steering System</a> on page 289 for maintenance instructions.)</li> </ul>
<p>Fuel and Tanks - Fuel Tank Straps <a href="#">Fuel Tank</a> on page 275</p>
<p>Electrical and Lights - Fuel and Diesel Exhaust Fluid Tank Sending Unit</p> <ul style="list-style-type: none"> <li>• Check the mounting screws and electrical connections for worn or damaged wires and connectors. (Refer to <a href="#">Diesel Exhaust Fluid (DEF) Tank Straps</a> on page 283 for maintenance instructions.)</li> </ul>
<p>Heating and Air Conditioning - Heater and Air Conditioner</p> <ul style="list-style-type: none"> <li>• Perform the checks per <a href="#">Heater and Air Conditioner Maintenance</a> on page 278</li> </ul>
<p>Air - Air Compressor Governor</p> <ul style="list-style-type: none"> <li>• Replace air strainer. (Refer to <a href="#">Air Compressor</a> on page 240 for maintenance instructions.)</li> </ul>
<p>Air - Air Lines</p> <ul style="list-style-type: none"> <li>• Check condition and routing to prevent chafing. (Refer to <a href="#">Air Compressor</a> on page 240 for maintenance instructions.)</li> </ul>

<sup>11</sup> Ensure that all maintenance intervals leading up to this point are repeated during this interval prior to the completion of those listed here.

**Every 30,000 mi / 48,000 km<sup>11</sup>**

Air - Air Dryer

- Perform the checks listed; (Refer to [Air Dryer Maintenance](#) on page 236 for maintenance instructions.)

**Every 60,000 mi / 96,000 km / 6 Months**

**Every 60,000 mi / 96,000 km / 6 Months<sup>12</sup>**

Frame - Fifth Wheel

- Inspect fifth wheel operation. (Refer to [Fifth Wheel Monthly Maintenance](#) on page 274 for maintenance instructions.)

Frame - Engine Mounting

- Inspect engine mounts every 60,000 miles (96,000 km.) (Refer to [Engine Mounting](#) on page 272 for maintenance instructions.) Contact an authorized vehicle OEM dealership if engine mounts need servicing.

Front Axle - Vocational (PACCAR) - Steer Axle Wheel Ends: Oil Bath (Adjusted)

- Synthetic SAE 75W-140, SAE 50.
- Mineral Oil SAE 75W, 75W-90, 75W-140, 80W-90, 85W-140. (Refer to [Front Axle and Suspension](#) on page 275 for maintenance instructions.)

<sup>11</sup> **Ensure that all maintenance intervals leading up to this point are repeated during this interval prior to the completion of those listed here.**

<sup>12</sup> **Ensure that all maintenance intervals leading up to this point are repeated during this interval prior to the completion of those listed here.**

Every 60,000 mi / 96,000 km / 6 Months <sup>12</sup>
<p>Front Axle - Vocational (PACCAR) - Steer Axle Semi-fluid (Adjusted)</p> <ul style="list-style-type: none"> <li>Semi-Fluid Synthetic Grease: Delo SF, Mobil SCH 007. (Refer to <a href="#">Front Axle and Suspension</a> on page 275 for maintenance instructions.)</li> </ul>
<p>Front Axle - Vocational (PACCAR) - Steer Axle Grease Pack (Adjusted)</p> <ul style="list-style-type: none"> <li>Heavy-Duty Multipurpose Lithium Base: #2 Grade. (Refer to <a href="#">Front Axle and Suspension</a> on page 275 for maintenance instructions.)</li> </ul>
<p>Front Axle - SOFTEK® NXT (Hendrickson) - Kingpin Bearings and Tie Rod Ends (LINE HAUL)</p> <ul style="list-style-type: none"> <li>Multipurpose Grease NLGI Grade 2</li> </ul>
<p>Front Axle - SOFTEK® NXT (Hendrickson) - Axle Clamp Through Bolts</p> <ul style="list-style-type: none"> <li>Check the tightness of the through bolts at the bolt head. Tighten fasteners using a calibrated torque wrench to the specified torque value. (Refer to the Hendrickson operator's manual for torque specifications.)</li> </ul>
<p>Front Suspension - Front Spring</p> <ul style="list-style-type: none"> <li>Inspect for cracked leaves, worn bushings, and excessive corrosion. (Refer to <a href="#">Front Axle and Suspension</a> on page 275 for maintenance instructions.)</li> </ul>
<p>Front Suspension - Spring Pins and Shackles</p> <ul style="list-style-type: none"> <li>Inspect for worn parts and excessive joint clearance. Shim or replace as required. (Refer to <a href="#">Front Axle and Suspension</a> on page 275 for maintenance instructions.)</li> </ul>
<p>Front Suspension - Shock Absorbers</p> <ul style="list-style-type: none"> <li>Inspect for leaking, body damage, and damaged or worn bushings. Replace as required. Check the shock mounting stud torque. (Refer to <a href="#">Front Axle and Suspension</a> on page 275 for maintenance instructions.)</li> </ul>

<sup>12</sup> Ensure that all maintenance intervals leading up to this point are repeated during this interval prior to the completion of those listed here.

Every 60,000 mi / 96,000 km / 6 Months <sup>12</sup>
<p>Front Suspension U-bolts - U-bolts (ON HIGHWAY and VOCATIONAL)</p> <ul style="list-style-type: none"> <li>• Check the general condition and the tightness of the nuts. Tighten the U-bolts using a calibrated torque wrench to the specified torque value. (Refer to <a href="#">Suspension U-Bolts, Grade 8</a> on page 307 for maintenance instructions.)</li> </ul>
<p>Front Suspension - SOFTEK® NXT (Hendrickson) - Ride Height</p> <ul style="list-style-type: none"> <li>• Inspect that ride height is within specifications. (Refer to Air Suspension Ride Height for maintenance instructions)</li> </ul>
<p>Drive Axle - Linehaul (PACCAR) - Axle Assembly</p> <ul style="list-style-type: none"> <li>• Drain and replace MINERAL BASE lubricant.</li> </ul>
<p>Drive Axle (Dana) - Axle Housing</p> <ul style="list-style-type: none"> <li>• Visually inspect for damage or leaks. (Refer to <a href="#">Drive Axle - Dana</a> on page 286 for maintenance instructions.)</li> <li>• Check oil level. Check "cold." Torque the drain plug. (Refer to <a href="#">Drive Axle - Dana</a> on page 286 for maintenance instructions.)</li> </ul>
<p>Drive Axle (Dana) - Air Shift Unit</p> <ul style="list-style-type: none"> <li>• Check the lubricant level. (Refer to <a href="#">Drive Axle - Dana</a> on page 286 for maintenance instructions.)</li> </ul>
<p>Drive Axle (Dana) - Lube Pump (OFF HIGHWAY)</p> <ul style="list-style-type: none"> <li>• Remove the magnetic strainer and inspect for wear particles. Wash in solvent and dry in air. (Refer to <a href="#">Drive Axle - Dana</a> on page 286 for maintenance instructions.)</li> </ul>
<p>Drive Axle (Dana) - Lube Filter (OFF HIGHWAY)</p> <ul style="list-style-type: none"> <li>• Change. (Refer to <a href="#">Drive Axle - Dana</a> on page 286 for maintenance instructions.)</li> </ul>
<p>Drive Axle (Dana) - Magnetic Drain Plug and Breather (OFF HIGHWAY)</p> <ul style="list-style-type: none"> <li>• Clean or replace. (Refer to <a href="#">Drive Axle - Dana</a> on page 286 for maintenance instructions.)</li> </ul>

<sup>12</sup> Ensure that all maintenance intervals leading up to this point are repeated during this interval prior to the completion of those listed here.

Every 60,000 mi / 96,000 km / 6 Months <sup>12</sup>
<p>Drive Axle (SISU)</p> <ul style="list-style-type: none"> <li>• <a href="#">Drive Axle (SISU) Oil Servicing</a> on page 289</li> <li>• <a href="#">Drive Axle (SISU) Inspection</a> on page 289</li> <li>• <a href="#">Drive Axle - SISU Breather and Brakes</a> on page 288</li> </ul>
<p>Rear Suspension - U-bolts</p> <ul style="list-style-type: none"> <li>• Check the torque. Tighten to specified torque value as required. (Refer to <a href="#">Suspension U-Bolts, Grade 8</a> on page 307 for maintenance instructions.)</li> </ul>
<p>Drum Brakes (All) - Brake Camshaft Bearing</p> <ul style="list-style-type: none"> <li>• Check for excessive camshaft play in the axial and radial directions. Max allowable play is 0.003 in. Lubricate (NLGI #2 grease.) (Refer to <a href="#">Drum Brake Inspection</a> on page 243 for maintenance instructions.)</li> </ul>
<p>Drum Brakes (All) - Brake Air System</p> <ul style="list-style-type: none"> <li>• Clean or replace the inline filters. (Refer to <a href="#">Air System</a> on page 234 for maintenance instructions.)</li> </ul>
<p>Disc Brakes (Bendix®) - Brake Pads</p> <ul style="list-style-type: none"> <li>• Inspect: replace as required. (Refer to <a href="#">How to inspect brake pads on disc brakes</a> on page 242 for maintenance instructions.)</li> </ul>
<p>Disc Brakes (Bendix®) - Brake Disc/rotor</p> <ul style="list-style-type: none"> <li>• Inspect for visible cracks, heat checking, galling, or scoring of surface. Check for runout (max allowable is 0.002 in.) (Refer to <a href="#">Air Disc Brakes</a> on page 242 for maintenance instructions.)</li> </ul>
<p>Disc Brakes (Bendix®) - Caliper Sliding Function</p> <ul style="list-style-type: none"> <li>• Ensure caliper slides freely with no obstructions or excessive play. (Refer to <a href="#">Air Disc Brakes</a> on page 242 for maintenance instructions.)</li> </ul>

<sup>12</sup> Ensure that all maintenance intervals leading up to this point are repeated during this interval prior to the completion of those listed here.



Every 60,000 mi / 96,000 km / 6 Months <sup>12</sup>
<p>Disc Brakes (Bendix®) - Caliper Slide Pins</p> <ul style="list-style-type: none"> <li>Inspect protective caps of the guide pins for damage or cracking. (Refer to <a href="#">Air Disc Brakes</a> on page 242 for maintenance instructions.)</li> </ul>
<p>Disc Brakes (Bendix®) - System Operation</p> <ul style="list-style-type: none"> <li>Check operation: inspect as per manufacturer's service literature. (Refer to <a href="#">Air Disc Brakes</a> on page 242 for maintenance instructions.)</li> </ul>
<p>Hub, Drum, and Hubcap - LMS Hubs (Dana)</p> <ul style="list-style-type: none"> <li>Inspect for leaks. Check the bearing endplay and adjust as required. (Refer to <a href="#">Wheels</a> on page 295 for maintenance instructions.)</li> </ul>
<p>Main and Auxiliary Transmission (including Eaton Automated or PACCAR Transmission) - Mounting Brackets and Fasteners</p> <ul style="list-style-type: none"> <li>Check the condition of the fasteners and their torque. Tighten to the specified torque value as required. (Refer to <a href="#">Frame Fastener Torque Requirements</a> on page 306 for maintenance instructions.)</li> </ul>
<p>Main and Auxiliary Transmission (including Eaton Automated or PACCAR Transmission) - Oil Cooler</p> <ul style="list-style-type: none"> <li>Clean the fins (air-to-oil type) and body. Check the hose condition and for leaks: replace as required. (Refer to <a href="#">Cooling System Maintenance</a> on page 252 for maintenance instructions.)</li> </ul>
<p>Main and Auxiliary Transmission (including Eaton Automated or PACCAR Transmission) - Main and Auxiliary Transmission (OFF HIGHWAY)</p> <ul style="list-style-type: none"> <li>Drain lubricant while warm. Flush each unit with clean flushing oil. (Refer to <a href="#">Transmission Maintenance</a> on page 298 for maintenance instructions.)</li> </ul>

<sup>12</sup> Ensure that all maintenance intervals leading up to this point are repeated during this interval prior to the completion of those listed here.

Every 60,000 mi / 96,000 km / 6 Months <sup>12</sup>
<p>Auxiliary Transmission - Cotta Transfer Case TR2205 Fabco Transfer Case TC142/TC143/ TC170/ TC270 Marmon-Harrington Transfer Case MVG2000/ MVG2000SD</p> <ul style="list-style-type: none"> <li>Initial oil change: Drain oil while warm: flush case with gear oil-compatible fluid, clean magnetic drain plug, and refill. Do not flush the case with any solvent.</li> <li>Change oil.</li> </ul>
<p>Air Intake - Air Intake Piping, Mounting, and Charge Air Cooler</p> <ul style="list-style-type: none"> <li>Check the system for broken pipes, leaks, joint integrity, cleanliness, and proper support. (Refer to <a href="#">Air Intake System</a> on page 271 for maintenance instructions.)</li> </ul>
<p>Cooling - Hoses</p> <ul style="list-style-type: none"> <li>Check the radiator and heater hoses for leaks. (Refer to <a href="#">Cooling System Maintenance</a> on page 252 for maintenance instructions.)</li> </ul>
<p>Cooling - Fan Clutch</p> <ul style="list-style-type: none"> <li>Check for air leaks. Check the fan drive bearings (turn the sheave in both directions to check for worn hub bearings.) (Refer to <a href="#">Engine Fan</a> on page 270 for maintenance instructions.)</li> </ul>
<p>Cooling - Solenoid Valve</p> <ul style="list-style-type: none"> <li>Check the fan drive for proper engagement and disengagement. (Refer to <a href="#">Engine Fan</a> on page 270 for maintenance instructions.)</li> </ul>
<p>Power Steering - Reservoir (OFF HIGHWAY)</p> <ul style="list-style-type: none"> <li>Drain, replace the filter, and refill. (Refer to <a href="#">Check Power Steering Fluid Level</a> on page 290 for maintenance instructions.)</li> </ul>

<sup>12</sup> Ensure that all maintenance intervals leading up to this point are repeated during this interval prior to the completion of those listed here.

**Every 60,000 mi / 96,000 km / 6 Months<sup>12</sup>**

Power Steering - Steering Gear

- Check the lash of the sector shaft: adjust as required. (Refer to [Steering System](#) on page 289 for maintenance instructions.)
- Grease the trunnion bearing (EP NLGI #2 lithium-based, moly-filled, HD grease.) (Refer to [Steering System](#) on page 289 for maintenance instructions.)
- Grease the input shaft seal (EP NLGI #2 lithium-based, moly-filled, HD grease.) (Refer to [Steering System](#) on page 289 for maintenance instructions.)

Power Steering - Hoses and Tubes

- Check for leaks and chafing. (Refer to [Steering System](#) on page 289 for maintenance instructions.)

Steering Components - Drag link Tube Clamp and Ball Socket

- Check the torque: tighten to specified torque value as required. (Refer to [Steering System](#) on page 289 for maintenance instructions.)

Steering Components - Pitman Arm Clamp Bolt and Nut

- Check the torque: tighten to specified torque value as required. (Refer to [Steering System](#) on page 289 for maintenance instructions.)

Steering Components - Steering Intermediate Shaft

- Check the torque on the pinch bolt and nut. (Refer to [Steering Shaft Bolt Torque Specifications](#) on page 291 for maintenance instructions.)

Steering Components - Steering Intermediate Shaft U-joints (ON HIGHWAY)

- Lubricate [EP NLGI #2 HD grease, -10 to 325°F (-23 to 163°C) range]. (Refer to [Steering System](#) on page 289 for maintenance instructions.)

<sup>12</sup> Ensure that all maintenance intervals leading up to this point are repeated during this interval prior to the completion of those listed here.

Every 60,000 mi / 96,000 km / 6 Months <sup>12</sup>
<p>Fuel and Tanks - Fuel Tanks</p> <ul style="list-style-type: none"> <li>Inspect tanks, brackets, hoses, and fittings for correct location, tightness, abrasion damage, and leaks: repair or replace as required. (Refer to <a href="#">Fuel Tank</a> on page 275 for maintenance instructions.)</li> </ul>
<p>Driveshafts - Models SPL- 140/140HD/170/170HD/250/250HD Slip Members and U- joints (ON HIGHWAY and LINEHAUL)</p> <ul style="list-style-type: none"> <li>Lubricate*</li> </ul>
<p>Battery Boxes, Tool Boxes, and Steps - Batteries (ON HIGHWAY and LINE HAUL)</p> <ul style="list-style-type: none"> <li>Check for cracks and damage, electrolyte level, condition of terminals, and tightness of hold downs. Refer to <a href="#">Batteries</a> on page 261 for maintenance instructions.</li> </ul>
<p>Battery Boxes, Tool Boxes, and Steps - Battery Box and Tray (ON HIGHWAY and LINE HAUL)</p> <ul style="list-style-type: none"> <li>Check the box integrity. Clean the drain tube and check for acid leaks. Check condition of all equipment mounted under the box. Check the drain tube and check for acid leaks. Check condition of all equipment mounted under the box. (Refer to <a href="#">Batteries</a> on page 261 for maintenance instructions.)</li> </ul>
<p>Electrical and Lights - Alternator</p> <ul style="list-style-type: none"> <li>Check operation and output. (Refer to <a href="#">Alternator</a> on page 265</li> <li>Check tightness of the pulley nut. (Refer to <a href="#">Install Engine Belt</a> on page 269 for maintenance instructions.)</li> <li>Check the tension of the drive belt. (Refer to <a href="#">Install Engine Belt</a> on page 269 for maintenance instructions.)</li> <li>Check tightness of the terminal hex nuts. (Refer to <a href="#">Install Engine Belt</a> on page 269 for maintenance instructions.)</li> </ul>
<p>Electrical and Lights - Starter</p> <ul style="list-style-type: none"> <li>Check torque on hex nuts. (Refer to <a href="#">Electrical System</a> on page 256 for maintenance instructions.)</li> </ul>

<sup>12</sup> **Ensure that all maintenance intervals leading up to this point are repeated during this interval prior to the completion of those listed here.**

\* Use only Spicer Driveshaft approved lubricants when greasing Spicer U-joints.

Every 60,000 mi / 96,000 km / 6 Months <sup>12</sup>
<p>Electrical and Lights - ECM Connector</p> <ul style="list-style-type: none"> <li>• Check the tightness of the ECM connector. (Refer to <a href="#">Electrical System</a> on page 256 for maintenance instructions.) for maintenance instructions.)</li> </ul>
<p>Electrical and Lights - Wheel Sensors</p> <ul style="list-style-type: none"> <li>• Check for damaged sensors and connectors, and worn or frayed wires. (Refer to <a href="#">Electrical System</a> on page 256 for maintenance instructions.)</li> </ul>
<p>Electrical and Lights - Power Supply Harnesses (engine, Transmission, etc.)</p> <ul style="list-style-type: none"> <li>• Check for worn or damaged insulation, corroded terminals, frayed. Wash to remove excess grease. (Refer to <a href="#">Electrical System</a> on page 256 for maintenance instructions.)</li> </ul>
<p>Cab Structure, Doors and Hoods - Body and Cab Hold down Bolts, <a href="#">Cab Structure, Doors and Hoods</a> on page 249</p>
<p>For Cab Structure, Doors, Hoods – Hinges and Latch (EXCLUDING door hinges)</p> <ul style="list-style-type: none"> <li>• Lubricate with silicone spray. (Refer to <a href="#">Cab Structure, Doors and Hoods</a> on page 249 for maintenance instructions.)</li> </ul>
<p>Heating and Air Conditioning - Condenser</p> <ul style="list-style-type: none"> <li>• Clear any debris from the front of the condenser. (Refer to <a href="#">Heater and Air Conditioner Maintenance</a> on page 278 for maintenance instructions.)</li> </ul>
<p>Aftertreatment System - Diesel Exhaust Fluid Tank</p> <ul style="list-style-type: none"> <li>• Inspect the tank, straps, brackets, hoses and fittings for abrasion damage, leaks, tightness and fully engaged connectors. (Refer to <a href="#">Diesel Exhaust Fluid (DEF) Tank Straps</a> on page 283 for maintenance instructions.)</li> </ul>

<sup>12</sup> Ensure that all maintenance intervals leading up to this point are repeated during this interval prior to the completion of those listed here.

**Every 60,000 mi / 96,000 km / 6 Months<sup>12</sup>**

Air - System

- Lubricate. (Refer to [Air System](#) on page 234 for maintenance instructions.)

Air - Inline Filters

- Replace elements or clean with solvent. (Refer to Replace Engine Air Filter for maintenance instructions.)

## 5

### Every 120,000 mi / 192,000 km / Annually

**Every 120,000 mi / 192,000 km / Annually<sup>13</sup>**

Frame - Frame Fasteners

- Check for tightness: tighten to the specified torque value as required. (Refer to [Frame Fastener Torque Requirements](#) on page 306 for maintenance instructions.)

Frame - Crossmembers and Mounting Brackets

- Inspect for cracks and loose fasteners. Replace or tighten to the specified torque value as required. (Refer to [Frame Fastener Torque Requirements](#) on page 306 for maintenance instructions.)

---

<sup>12</sup> Ensure that all maintenance intervals leading up to this point are repeated during this interval prior to the completion of those listed here.

<sup>13</sup> Ensure that all maintenance intervals leading up to this point are repeated during this interval prior to the completion of those listed here.

Every 120,000 mi / 192,000 km / Annually <sup>13</sup>
Front Axle - Linehaul (PACCAR) - Steer Axle Wheel Ends: Oil Bath (Adjusted) <ul style="list-style-type: none"> <li>• Synthetic SAE 75W-140, SAE 50W. (Refer to <a href="#">Front Axle and Suspension</a> on page 275 for maintenance instructions.)</li> </ul>
Front Axle - Linehaul (PACCAR) - Steer Axle Wheel Ends: Oil Bath (Adjusted) <ul style="list-style-type: none"> <li>• Mineral Oil SAE 75W, 75W-90, 75W-140, 80W-90, 85W-140. (Refer to <a href="#">Front Axle and Suspension</a> on page 275 for maintenance instructions.)</li> </ul>
Front Axle - Linehaul (PACCAR) - Steer Axle Semi-fluid (Adjusted) <ul style="list-style-type: none"> <li>• Semi-Fluid Synthetic Grease: Delo SF, Mobil SCH 007. (Refer to <a href="#">Front Axle and Suspension</a> on page 275 for maintenance instructions.)</li> </ul>
Front Axle - Linehaul (PACCAR) - Steer Axle Grease Pack (Adjusted) <ul style="list-style-type: none"> <li>• Heavy-Duty Multipurpose Lithium Base: #2 Grade. (Refer to <a href="#">Front Axle and Suspension</a> on page 275 for maintenance instructions.)</li> </ul>
Front Axle - Vocational (PACCAR) - Steer Axle Wheel Ends: Oil Bath LMS <ul style="list-style-type: none"> <li>• Synthetic SAE 75W-90. (Refer to <a href="#">Front Axle and Suspension</a> on page 275 for maintenance instructions.)</li> </ul>
Drive Axle - Linehaul (PACCAR) - Axle Shaft <ul style="list-style-type: none"> <li>• Tighten the rear axle flange nuts to the specified torque value.</li> </ul>
Drive Axle - Vocational (PACCAR) - Axle Shaft <ul style="list-style-type: none"> <li>• Tighten the rear axle flange nuts to the specified torque value.</li> </ul>

<sup>13</sup> Ensure that all maintenance intervals leading up to this point are repeated during this interval prior to the completion of those listed here.

Every 120,000 mi / 192,000 km / Annually <sup>13</sup>
<p>Drive Axle (Dana) - Air Shift Unit</p> <ul style="list-style-type: none"> <li>Remove the housing cover and drain the lubricant. Wash the parts thoroughly and dry in air. (Refer to <a href="#">Drive Axle - Dana</a> on page 286 for maintenance instructions.)</li> </ul>
<p>Drive Axle (Dana) - Breather</p> <ul style="list-style-type: none"> <li>Clean or replace. (Refer to <a href="#">Drive Axle - Dana</a> on page 286 for maintenance instructions.)</li> </ul>
<p>Drive Axle (Dana) - Lube Pump (ON HIGHWAY)</p> <ul style="list-style-type: none"> <li>Remove the magnetic strainer and inspect for wear particles. Wash in solvent and dry in air. (Refer to <a href="#">Drive Axle - Dana</a> on page 286 for maintenance instructions.)</li> </ul>
<p>Drive Axle (Dana) - Lube Filter (ON HIGHWAY)</p> <ul style="list-style-type: none"> <li>Change. (Refer to <a href="#">Drive Axle - Dana</a> on page 286 for maintenance instructions.)</li> </ul>
<p>Drive Axle (Dana) - Magnetic Drain Plug and Breather (ON HIGHWAY)</p> <ul style="list-style-type: none"> <li>Clean or replace. (Refer to <a href="#">Drive Axle - Dana</a> on page 286 for maintenance instructions.)</li> </ul>
<p>Drive Axle (Meritor Line Haul / ON HIGHWAY) - Lubricant Filter</p> <ul style="list-style-type: none"> <li>Change the filter. (Refer to <a href="#">Drive Axle - Meritor</a> on page 287 for maintenance instructions.)</li> </ul>
<p>Drive Axle (Meritor Line Haul / ON HIGHWAY) - Input Shaft and Pinion Shaft</p> <ul style="list-style-type: none"> <li>Check and adjust the endplay. (Refer to <a href="#">Drive Axle - Meritor</a> on page 287 for maintenance instructions.)</li> </ul>
<p>Drive Axle (Meritor Line Haul / ON HIGHWAY) - Axle Shaft</p> <ul style="list-style-type: none"> <li>Tighten the rear axle flange nuts to the specified torque value. (Refer to <a href="#">Drive Axle - Meritor</a> on page 287 for maintenance instructions.)</li> </ul>

<sup>13</sup> Ensure that all maintenance intervals leading up to this point are repeated during this interval prior to the completion of those listed here.



Every 120,000 mi / 192,000 km / Annually <sup>13</sup>
<p>Drive Axle (Meritor Line Haul / ON HIGHWAY) - Interaxle Differential</p> <ul style="list-style-type: none"> <li>• Check the operation. (Refer to <a href="#">Drive Axle - Meritor</a> on page 287 for maintenance instructions.)</li> </ul>
<p>Drive Axle (Meritor City Delivery / OFF HIGHWAY) - Lubricant Filter</p> <ul style="list-style-type: none"> <li>• Change the filter. (Refer to <a href="#">Drive Axle - Meritor</a> on page 287 for maintenance instructions.)</li> </ul>
<p>Drive Axle (Meritor City Delivery / OFF HIGHWAY) - Input Shaft and Pinion Shaft</p> <ul style="list-style-type: none"> <li>• Check and adjust the endplay. (Refer to <a href="#">Drive Axle - Meritor</a> on page 287 for maintenance instructions.)</li> </ul>
<p>Drive Axle (Meritor City Delivery / OFF HIGHWAY) - Axle Shaft</p> <ul style="list-style-type: none"> <li>• Tighten the rear axle flange nuts to the specified torque value. (Refer to <a href="#">Drive Axle - Meritor</a> on page 287 for maintenance instructions.)</li> </ul>
<p>Drive Axle (Meritor City Delivery / OFF HIGHWAY) - Interaxle Differential</p> <ul style="list-style-type: none"> <li>• Check the operation. (Refer to <a href="#">Drive Axle - Meritor</a> on page 287 for maintenance instructions.)</li> </ul>
<p>Drive Axle (SISU)</p> <ul style="list-style-type: none"> <li>• <a href="#">Drive Axle (SISU) Oil Servicing</a> on page 289 for maintenance instructions.)</li> <li>• <a href="#">Drive Axle - SISU Breather and Brakes</a> on page 288</li> <li>• <a href="#">Drive Axle - SISU Breather and Brakes</a> on page 288</li> </ul>
<p>Rear Suspension - Frame and Crossmembers Bolts</p> <ul style="list-style-type: none"> <li>• Check the torque. Tighten to specified torque value as required. (Refer to <a href="#">Rear Axle and Suspension</a> on page 284 for maintenance instructions.)</li> </ul>

<sup>13</sup> Ensure that all maintenance intervals leading up to this point are repeated during this interval prior to the completion of those listed here.

Every 120,000 mi / 192,000 km / Annually <sup>13</sup>
<p>Rear Suspension - Mounting Brackets and Fasteners</p> <ul style="list-style-type: none"> <li>• Check the condition and the fastener torque. Tighten to the specified torque value as required. (Refer to <a href="#">Suspension U-Bolts, Grade 8</a> on page 307 for maintenance instructions.)</li> </ul>
<p>Hub, Drum, and Hubcap - Hubs (non-LMS) with Standard Seals</p> <ul style="list-style-type: none"> <li>• Clean the components and check for excessive wear or damage. Change the oil and seal. (Refer to <a href="#">Wheels</a> on page 295 for maintenance instructions.)</li> </ul>
<p>Cooling - Extended Life Coolant (ELC)</p> <ul style="list-style-type: none"> <li>• Perform lab analysis. If lab analysis shows coolant is unsuitable for continued use: Flush, drain, and refill. Add ELC Extender. (Refer to <a href="#">Cooling System Maintenance</a> on page 252 for maintenance instructions.)</li> </ul>
<p>Power Steering - Reservoir (ON HIGHWAY)</p> <ul style="list-style-type: none"> <li>• Drain, replace the filter, and refill. (Refer to <a href="#">Check Power Steering Fluid Level</a> on page 290 for maintenance instructions.)</li> </ul>
<p>Steering Components - Steering Linkage</p> <ul style="list-style-type: none"> <li>• Check all joints for excessive lash: replace as required. (Refer to <a href="#">Steering System</a> on page 289 for maintenance instructions.)</li> </ul>
<p>Fuel and Tanks - Fuel Tank Breathers</p> <ul style="list-style-type: none"> <li>• Check for proper function: clean the drain hoses. (Refer to <a href="#">Fuel Tank</a> on page 275 for maintenance instructions.)</li> </ul>
<p>Driveshafts - Models SPL-140XL/ 170XL/250XL Slip Members and U- joints (OFF HIGHWAY and CITY)</p> <ul style="list-style-type: none"> <li>• Lubricate</li> </ul>
<p>Cab Structure, Doors and Hoods - Body and Cab Hold down Bolts, <a href="#">Cab Structure, Doors and Hoods</a> on page 249</p>

<sup>13</sup> **Ensure that all maintenance intervals leading up to this point are repeated during this interval prior to the completion of those listed here.**

\* Use only Spicer Driveshaft approved lubricants when greasing Spicer U-joints.

Every 120,000 mi / 192,000 km / Annually <sup>13</sup>
<p>Heating and Air Conditioning - Heater and Air Conditioner</p> <ul style="list-style-type: none"> <li>• Full operational and diagnostic check. (Refer to <a href="#">Heater and Air Conditioner Maintenance</a> on page 278 for maintenance instructions.)</li> </ul>
<p>Heating and Air Conditioning - Sleeper Air Filter</p> <ul style="list-style-type: none"> <li>• Inspect and clean, replace if necessary. (Refer to <a href="#">Sleeper HVAC Air Filter</a> on page 280 for maintenance instructions.)</li> </ul>
<p>Heating and Air Conditioning - Recirculation Cab Air Filter (ON HIGHWAY)</p> <ul style="list-style-type: none"> <li>• Please contact an authorized dealer when the service interval is required to inspect the cabin recirculation air filter. (Refer to <a href="#">Replace the Recirculation Air Filter</a> on page 280 for maintenance instructions.)</li> </ul>
<p>Heating and Air Conditioning - Recirculation Cab Air Filter (OFF-HIGHWAY)</p> <ul style="list-style-type: none"> <li>• Please contact an authorized dealer when the service interval is required to inspect the cabin recirculation air filter. (Refer to <a href="#">Replace the Recirculation Air Filter</a> on page 280 for maintenance instructions.)</li> </ul>
<p>Air - Air Dryer (OFF HIGHWAY)</p> <ul style="list-style-type: none"> <li>• Replace cartridge. (Refer to <a href="#">Air Dryer Maintenance</a> on page 236 for maintenance instructions.)</li> </ul>

## Every 240,000 mi / 384,000 km

<sup>13</sup> Ensure that all maintenance intervals leading up to this point are repeated during this interval prior to the completion of those listed here.

**Every 240,000 mi / 384,000 km<sup>14</sup>**

Drive Axle - Vocational (PACCAR) - Axle Assembly

- Drain and replace SYNTHETIC BASE lubricant.

Hub, Drum, and Hubcap - Hubs (non-LMS) with Outrunner Seals

- Clean the components and check for excessive wear or damage. Change the oil and seal. (Refer to [Wheels](#) on page 295 for maintenance instructions.)

**5**

**Every 300,000 mi / 480,000 km / 6,750 Hours / 3 Years**

**Every 300,000 mi / 480,000 km / 6,750 Hours / 3 Years<sup>15</sup>**

Cooling - Extended Life Coolant (ELC)

- Replace blank water filter, if applicable. (Refer to [Cooling System Maintenance](#) on page 252 for maintenance instructions.)

Hub, Drum, and Hubcap - LMS Hubs (Dana) with Mineral Lubricant

- [Wheels](#) on page 295

---

<sup>14</sup> Ensure that all maintenance intervals leading up to this point are repeated during this interval prior to the completion of those listed here.

<sup>15</sup> Ensure that all maintenance intervals leading up to this point are repeated during this interval prior to the completion of those listed here.

## Every 500,000 mi / 800,000 km / 5 years

Every 500,000 mi / 800,000 km / 5 years <sup>16</sup>
Front Axle - Linehaul (PACCAR) - Steer Axle Wheel Ends: Oil Bath LMS <ul style="list-style-type: none"> <li>• Synthetic SAE 75W-90. (Refer to <a href="#">Front Axle and Suspension</a> on page 275 for maintenance instructions.)</li> </ul>
Drive Axle - Linehaul (PACCAR) - Axle Assembly <ul style="list-style-type: none"> <li>• Drain and replace SYNTHETIC BASE lubricant.</li> </ul>
Hub, Drum, and Hubcap - LMS Hubs (Dana) with Synthetic Lubricant <ul style="list-style-type: none"> <li>• Service the bearings, seals and oil. This interval may be different depending on the results of the regular inspection. (Refer to <a href="#">Wheels</a> on page 295 for maintenance instructions.)</li> </ul>

## Every 750,000 mi / 1,200,000 km / 24,000 Hours / 8 years

<sup>16</sup> Ensure that all maintenance intervals leading up to this point are repeated during this interval prior to the completion of those listed here.

<b>Every 750,000 mi / 1,200,000 km/ 24,000 Hours / 8 years<sup>17</sup></b>
Cooling - Extended Life Coolant (ELC) <ul style="list-style-type: none"> <li>Flush, drain, and refill with new coolant. (Refer to <a href="#">Cooling System Maintenance</a> on page 252 for maintenance instructions.)</li> </ul>
Main and Auxiliary Transmission (including Eaton Automated or PACCAR Transmission) - Main and Auxiliary Transmission (ON HIGHWAY) <ul style="list-style-type: none"> <li>Drain lubricant while warm. Flush each unit with clean flushing oil. (Refer to <a href="#">Transmission Maintenance</a> on page 298 for maintenance instructions.)</li> </ul>

5

## Lubricants

Schedule service more frequently if you are operating under severe conditions such as extreme heat or cold, with very heavy loads, off-road, etc. For any special service requirements, consult your service manuals and your lubricant supplier. Please remember: one key to keeping your truck running at top economy and prolonging its life is proper lubrication servicing. Neglecting this essential aspect of vehicle care can cost time and money in the long run.

**WARNING**

Handle lubricants carefully. Vehicle lubricants (oil and grease) can be poisonous and cause sickness, personal injury, or death. They can also damage the paint on the vehicle.

therefore, drain (or remove) old lubricants from the unit before refilling it.

**CAUTION**

DO NOT mix different types of lubricants. Mixing lubricants (oil and grease) of different brands or types could damage vehicle components;

### Engine

Proper engine lubrication depends on the outside temperatures where you will be driving. Use the oil recommended for the conditions you are most likely to be operating in. You will find a complete engine lubrication service guide in the Engine Operation Manual that came with your vehicle. The engine operator manual contains specific maintenance tasks that you or a qualified service technician need to perform to maintain the engine.

<sup>17</sup> Ensure that all maintenance intervals leading up to this point are repeated during this interval prior to the completion of those listed here.

**! WARNING**

Exhaust fumes from the engine contain carbon monoxide, a colorless and odorless gas. DO NOT breathe the engine exhaust gas. A poorly maintained, damaged, or corroded exhaust system can allow carbon monoxide to enter the cab. Entry of carbon monoxide into the cab is also possible from other vehicles nearby. Failure to properly maintain your vehicle could cause carbon monoxide to enter the cab, resulting in personal injury or death.

**! WARNING**

Never idle your vehicle for prolonged periods of time if you sense that exhaust fumes are entering the cab. Investigate the cause of the fumes and correct it as soon as possible. If the vehicle must be driven under these conditions, drive only with the windows open. Failure to repair the source of the exhaust fumes may result in death, personal injury, equipment or property damage.

**i NOTE**

Keep the engine exhaust system and the vehicle's cab ventilation system properly maintained. It is recommended that the vehicle's exhaust system and cab be inspected (1) By a competent technician every 15,000 miles (24,140 km); (2) Whenever a change is noticed in the sound of the exhaust system; or (3) Whenever the exhaust system, underbody, or cab is damaged.

**i NOTE**

Use only an exact replacement DPF in exhaust systems. Using a noncompliant DPF as a replacement could violate these standards and also void the emission system's warranty.

**Driveline Universal Joints**

Refer to the Spicer Universal Joints and Driveshafts service manual and lubrication specifications.

**Non-PACCAR Transmissions, Axles and Hubs**

For all non-PACCAR brands, see the manufacturer's operator's manual for recommended lubrication specifications and maintenance intervals.

**Checking Oil Level**

For oil reservoir with side filler plugs (transmission, axles, steering gear boxes, transfer cases, etc.) the oil must be level with the filler opening. Use care when checking the oil level with a finger. Just because you can reach the oil level with a finger does not mean the oil level is correct.

Improper Oil Level



Correct Oil Level



## Air System

The operation of the vehicle's braking system and many vehicle accessories depends upon the storage and application of a high-pressure air supply.



### WARNING

DO NOT attempt to modify, alter, repair or disconnect any component of the air system. Repairs or modifications to the air system, other than what is described in this section, should only be performed by an authorized dealer. Failure to comply may result in personal injury or death.



### WARNING

Prior to the removal of any air system component, always block and hold the vehicle by a secure means other than the vehicle's own brakes. Depleting air system pressure may cause the vehicle to roll unexpectedly resulting in an accident causing personal injury or death. Keep hands away from cham-

ber push rods and slack adjusters, they may apply as system pressure drops.



### WARNING

After completing any repairs to the air system, always test for air leaks and check the brakes for safe operation before putting the vehicle in service. Failure to comply may result in property damage, personal injury, or death.



### WARNING

Never connect or disconnect a hose or line containing air pressure. It may whip as air escapes. Never remove a component or pipe plug unless you are certain all system pressure has been depleted. Failure to comply may result in property damage, personal injury, or death.



### WARNING

Never exceed recommended air pressure and always wear safety glasses when working with air pressure. Never look into air jets or direct them at anyone. Failure to comply may result in property damage, personal injury, or death.



### WARNING

Never attempt to disassemble a component until you have read and understood the recommended procedures. Some components contain powerful springs, and injury can result if not properly disassembled. Use only proper tools, and observe all precautions pertaining to use of those tools. Failure to comply may result in property damage, personal injury, or death.





**WARNING**

Completely bypassing a Bendix® air dryer will bypass the system's pressure protection valves. This could lead to loss of air pressure or damage to the vehicle's air system, which could cause an accident involving death or personal injury. Always adhere to the manufacturer's procedure if it is necessary in an emergency to temporarily bypass a Bendix® air dryer. Failure to comply may result in death, personal injury, equipment or property damage.



**WARNING**

If a different air dryer brand or model is installed on the vehicle other than what was originally installed, it could cause the air system to not perform correctly unless the full air system design is reviewed and modifications made to comply with Federal Motor Vehicle Safety Standards (FMVSS) 121 AirBrake Systems. Failure to abide by this warning and maintain compliance to FMVSS 121 could

cause loss of vehicle control and may lead to death or serious personal injury.



**WARNING**

If the supply and service air tanks are not drained at the recommended frequency, water could enter the air lines and valves. This could cause corrosion or blockage, which could compromise the brake system safety and potentially cause an accident. Failure to comply may result in property damage, personal injury, or death.

Your vehicle's compressor takes outside air and compresses it, usually to 100-120 psi (689-827 kPa). The compressed air then goes to the reservoirs to be stored until needed. When you operate your air brakes, the stored compressed air flows into the chambers where it is used to apply your truck and trailer brakes. That is why, when you push down on your brake pedal, you don't feel the same amount of pressure on the pedal that you do when you apply the brakes on your car. All you are doing on your truck is opening an air valve to allow air to flow into the brake

chambers. Contamination of the air supply system is the major cause of problems in air-operated components such as brake valves, and suspension height control valves. To keep contaminants to the lowest possible level, follow these maintenance procedures.

**Daily Checks**

- Drain moisture from the supply and service air tanks.
- Operate air devices to circulate lubricant within the unit.

**Periodically**

- Clean filter screens ahead of the valves by removing the screens and soaking them in solvent. Blow them dry with pressurized air before reinstalling them.

**Twice a Year**

- Maintain the air compressor to prevent excessive oil bypass. See your maintenance manual for details.
- Replace worn seals in valves and air motors as needed.

## Dual Air System Function Test

Conduct this test at least every 3 months or if there is any indication of a potential problem.

Park the vehicle on level ground and block the wheels. Have an assistant open drain valves and, where required, observe brake action at the wheels. If a malfunction occurs during this test, do not move the vehicle until the problem has been corrected. Engine should be Off with the key switch to the ON or RUN position.

 NOTE

Tractor air system must be connected to trailer.

## Air Dryer Maintenance

 NOTE

Because no two vehicles operate under identical conditions, maintenance and maintenance intervals will vary. Experience is a valuable guide in determining the best maintenance interval for any one particular operation.

 NOTE

A small amount of oil in the system may be normal and should not, in itself, be considered a reason to replace the desiccant cartridge. Oil stained desiccant can function adequately.

Every 900 operating hours or 25,000 miles (40,000 km) or every 3 months check for moisture in the air brake system by opening air tanks, drain cocks, or valves and checking for presence of water. A tablespoon of water found in the air tank would point to the need for a desiccant cartridge change. However, the following conditions can also cause water

accumulation and should be considered before replacing the desiccant cartridge.

- Air usage is exceptionally high and not normal for a highway vehicle. This may be due to accessory air demands or some unusual air requirement that does not allow the compressor to load and unload (compressing and non-compressing cycle) in a normal fashion or it may be due to excessive leaks in the air system.
- In areas where more than a 30°F (17°C) range of temperature occurs in one day, small amounts of water can accumulate in the air brake system due to condensation. Under these conditions, the presence of small amounts of moisture is normal and should not be considered as an indication that the dryer is not performing properly.
- An outside air source has been used to charge the air system. This air did not pass through the drying bed.

**Maintenance**

 **CAUTION**

Replace oil-coalescing desiccant air dryer cartridge every 1 year regardless of mileage. Only use oil-coalescing desiccant replacement cartridge when replacing. Failure to perform this maintenance task will void the PACCAR Transmission warranty and may result in expensive transmission damage.

Replace (non-oil-coalescing) desiccant cartridge:

- On-highway operation replace every 2-3 years, 350,000 miles (560,000 km) or 10,800 hours.
- High duty cycle usage such as transit bus, refuse hauler, dump truck, cement mixers and off-highway operation replace every 1 year, 100,000 miles (160,000 km) or 3,600 hours.

 **NOTE**

Review the warranty policy before performing any maintenance procedures. An extended warranty may be voided if unauthorized maintenance is performed during this period.

**Bendix® AD-HF Series Air Dryer**

Your vehicle may be equipped with a Bendix® AD-HF series air dryer. Any air dryer replacement should be made with an identical component.

 **WARNING**

Use of an air dryer brand or model that differs from what was originally installed could cause the air system to not perform correctly unless the full air system design is reviewed and modifications are made to comply with Federal Motor Vehicle Safety Standard (FMVSS) 121 Air Brake Systems. Failure to abide by this warning and maintain compliance with FMVSS 121

could cause loss of vehicle control and may lead to serious personal injury or death.

The AD-HF Series air dryer has incorporated into its design various components that have typically been installed separately on the vehicle (see below for components/areas affected):

- Pressure protection valves
- Safety valve
- Solenoid valves and plumbing
- Plumbing of the front and rear service air tanks
- Plumbing to accessory systems

These components are required to meet the Federal Motor Vehicle Safety Standards (FMVSS 121 - Air Brake Systems). As the Warning above states, any other type of air dryer installed in the place of an AD-HF Series will require changes, modifications and/or additions to your vehicle's air system to maintain compliance with FMVSS 121.

## Air Tanks

### WARNING

If the supply and service air tanks are not drained at the recommended frequency, water could enter the air lines and valves. This could cause corrosion or blockage, which could compromise the brake system safety and potentially cause an accident. Failure to comply may result in property damage, personal injury, or death.

### CAUTION

DO NOT use penetrating oil, alcohol, brake fluid, or wax-based oils in the air system. These fluids may cause severe damage to air system components.

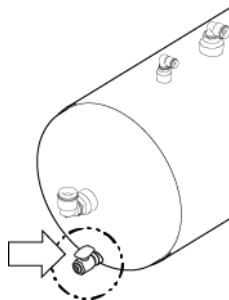

To eject moisture from the air system tanks, pull the line that is connected to the moisture ejection valve. Continue pulling until the air comes out free of water.

### Daily

The supply and service air tanks, must be drained on a daily basis. Operate air devices daily to circulate lubricants within the unit.

### Periodically

Clean filter screens ahead of the valves by removing the screens and soaking them in solvent. Blow them dry with pressurized air before reinstalling them.

- Maintain the air compressor to prevent excessive oil bypass

- Replace worn seals in valves and air motors as they are needed. Your authorized dealer carries rebuild kits for most units

## Air Gauges and Air Leaks

### WARNING

DO NOT operate the vehicle if leakage in the air system is detected. Conduct the following procedure and contact an authorized dealer (or any other properly equipped service center) if a leak is detected. Failure to check the brakes or follow these procedures could cause a system failure, increasing the risk of an accident and may result in personal injury, property damage, or death.

If your vehicle is equipped with air brakes, it has two separate, additional air systems: Primary and Secondary. Each air system is monitored by a gauge indicating system pressure in either pounds per square inch (psi), and/or kilopascals (kPa).

The Primary gauge indicates pressure in the rear braking system:

**Primary Air Pressure Gauge**



The Secondary gauge indicates pressure in the front braking system:

**Secondary Air Pressure Gauge**



The Primary and Secondary Air Pressure gauges are shown in the Primary Gauges View on the Digital Display.<sup>18</sup>

At start-up, the Primary and Secondary Air Pressure gauges may indicate red, and the Low Air System Pressure alarm may sound until the minimum operational pressure setpoint of 65 psi (448 kPa) is reached.<sup>19,20</sup> If the tanks are empty, this can take up to two minutes. If these gauges

- Remain red

- Turn red
  - Indicate below 65 psi (448 kPa)
- Or the Low Air System Pressure Alarm
- Turns on
  - Does not turn off

do not attempt to drive the vehicle until the problem is found and fixed: system pressure is too low for normal brake operation.

	<b>NOTE</b>
Park brakes lock up at 60 psi (414 kPa), the audible alarm will sound at 65 psi (448 kPa).	

**How to Check the Compressed Air System for Leaks**

	<b>WARNING</b>
DO NOT operate the vehicle if leakage in the air system is detected. Conduct the following procedure and contact an authorized dealer (or any other properly equipped service center) if a leak is detected. Failure to check the brakes or follow these procedures could cause a system failure, increasing the risk of an accident and may result in personal injury, property damage, or death.	

Use this procedure to check the compressed air system due to the following:

- After maintenance
- When an air system component is replaced
- When a leak is suspected

<sup>18</sup> The model 520 Right-hand Stand-up uses additional physical gauges for Primary and Secondary Air Pressure.  
<sup>19</sup> The model 520 Right-hand Stand-up also indicates low air pressure using a warning light in the physical gauges.  
<sup>20</sup> The Low Air System Pressure alarm is not active when the engine is off.

- Periodically, to ensure system integrity

To check for Air System leaks

- Start the engine if not already running.
- Scroll** to either the Basic or Enhanced View to monitor Primary and Secondary Air Pressures: see (1) of Enhanced View.

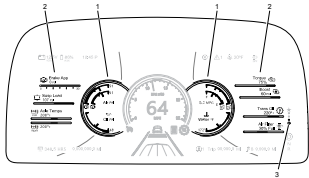

- Build up air pressure in the system until the system cutout setpoint or until 120 psi (827 kPa) is reached.
- Turn the Ignition Switch to OFF (stopping the engine) and then back to the ON position, but don't start the engine. The Basic or Enhanced View will appear.
- Release the service brakes, and observe the rate of air pressure drop. This rate should not exceed 2.0 psi (14 kPa) per minute.

- Start the engine and build up air pressure again.
- Turn the Ignition Switch to OFF (stopping the engine) and then back to the ON position, but don't start the engine.
- Apply the brakes fully, holding the pedal down for five minutes. The pressure drop should not exceed 3.0 psi (21 kPa) per minute.
- If you detect excessive leakage (air pressure loss greater than 3.0 psi (21 kPa) after five minutes of brake application), a leakage test should be made at the air line connections and at all air brake control units. These tests should determine where air is escaping.

### Air Compressor

All compressors, regardless of make or model, run continuously while the engine is running. System pressure is controlled by the governor. The governor acts in conjunction with the unloading mechanism in the compressor cylinder block to start and stop compression of air. The compressor is unloaded when the system

pressure reaches 120 psi (827 kPa) and compression is reestablished when system pressure falls to 100 psi (690 kPa).

### Preventive Maintenance

The following service checks are provided for your information only and should be performed by a certified mechanic. Contact your dealer or the engine manufacturer's Maintenance Manual for further information on servicing air compressors. After completing any repairs to the air system, always test for air leaks, and check the brakes for safe operation before putting the vehicle in service. Below is a list of areas to maintain for the air compressor:

- Inspect compressor air filter element, if so equipped, and replace element if clogged. Check compressor mounting and drive for alignment and belt tension. Adjust if necessary.
- Remove compressor discharge valve cap nuts and check for presence of excessive carbon. If excessive carbon is found, clean or replace the compressor cylinder head. Also, check compressor discharge line for carbon, and clean or replace the discharge line if necessary.

- Disassemble compressor and thoroughly clean and inspect all parts. Repair or replace all worn or damaged parts, or replace compressor with a factory exchange unit.

complies with the respective portions of FMVSS 121. A tractor shall not be operated or configured as a truck, nor shall a truck be operated or configured as a tractor, without significant modifications to the air brake system in order to retain compliance with FMVSS 121. Contact your dealer for instructions.

types are so related to one another that a seemingly unimportant change in one may result in a change in how well the brakes work for you on the road. If parts do not work together properly, you could lose control of your vehicle, which could cause a serious accident.

## Brake System

To learn more about brakes, see the Index, under Brakes.



### WARNING

DO NOT work on the brake system without the parking brake set and wheels chocked securely. If the vehicle is not secured to prevent uncontrolled vehicle movement, it could roll and cause damage to the vehicle, serious personal injury, or death.



### CAUTION

The air brake system of this vehicle was configured for ONE of the following operations: tractor or truck, and



### WARNING

DO NOT use brake linings with a thickness below the specified minimum. Such linings will have lining rivets exposed that can damage the brake drum and reduce brake efficiency, which could cause death, personal injury or system failure.



### WARNING

DO NOT use any replacement part in the brake system unless it conforms exactly to original specifications. A nonconforming part in your vehicle's brake system could cause a malfunction resulting in an accident causing death or personal injury. Sizes and

Brake adjustment and brake balance must be set carefully to (1) make the most efficient use of the forces available for braking and (2) allow equal stopping forces at all wheels. Once a brake system is set to specifications, changing any one of its components or any combination of components may cause the system to not work as well. All parts have to work together to perform as they should. Any replacement components in your brake system should be exactly equal to the original components. Any changes from the original specifications can affect the whole system. All of the following areas are interrelated and must conform to original specifications:

- Tire size
- Drum brakes
- Cam radius
- Wedge angle

- Drum radius
- Brake linings
- Brake chambers
- Slack adjusters
- Disc brakes
- Disc rotors

All vehicle operators should check their brakes regularly.

### Air Disc Brakes

This vehicle may have disc brakes instead of drum brakes.

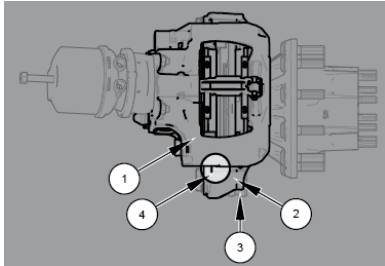

1. Brake caliper
2. Caliper mounting flange
3. Brake rotor
4. Inspection notches

### How to inspect brake pads on disc brakes

To inspect the brake pads:

1. Park on level ground and chock the wheels.
2. Temporarily release the parking brakes.
3. Looking from the ground up at the bottom of the caliper and rotor, compare the relative position of two notches; one located on the caliper and the other on the carrier.
4. Take a measurement from between these two notches and compare them to the specifications to determine if the pads need to be replaced.

Have a qualified mechanic perform a detailed inspection if the notches are not found. The pads and rotors should be measured and compared against the manufacturers specifications located in the brake manufacturer's service manual.

### Inspect Disc Brake Caliper for Running Clearance

Regularly inspect caliper for Running Clearance:

1. Stop the vehicle on level ground and let the brakes cool down. Hot

brake calipers can burn skin on contact.

2. Chock the wheels.
3. Temporarily release the parking brakes.
4. Grab the caliper and move it. This movement is Running Clearance.
5. Proper Running Clearance is 0.08 in. (2 mm) of movement of the brake caliper (approximately the thickness of a nickel) in the inboard/outboard direction.

Have a qualified mechanic provide further inspection if the caliper does not move or appears to move more than the specified clearance

### Auto Slack Adjuster

The auto slack adjuster is a mechanism to maintain the correct amount of space between the braking surface and the friction material.



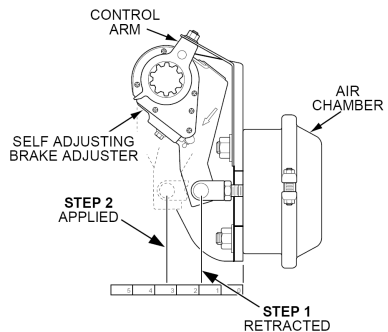

1. Retracted position, no brake pedal applied
2. Applied position, brake pedal engaged

### Drum Brake Inspection

Have brake drum linings inspected by a qualified mechanic for wear at regular intervals according to the maintenance schedule. In severe service or off-highway applications inspect the linings more frequently. In addition, periodically check the brake chamber stroke. Replace the slack adjuster if proper stroke cannot be maintained.

Operational checks of automatic slack adjusters

1. Start the vehicle and get the air system up to normal operating pressure. Do not apply the parking brake.
2. Apply pressure to the brake pedal and measure the distance the air chamber pushrod traveled.
3. Compare the results to the specification to determine if the automatic slack adjusters need replacing.

**⚠ WARNING**

Manual adjustment of automatic slack adjusters is a dangerous practice that could have serious consequences. It gives the operator a false sense of security about the effectiveness of the brakes. Contact the Service Department at your dealership if the stroke exceeds specifications. A stroke exceeding specifications may indicate a problem with the slack adjuster or the brake foundation.

### Automatic Slack Adjuster Stroke Specification

Chamber Type	Stroke
36 (rear brakes)	1.5-2.5 in. (38-57 mm)
30 (rear brakes)	1.5-2 in. (38-51 mm)
16, 20 and 24 (front brakes)	1-1.75 in. (25.4-44.4 mm)

### Cab Maintenance

Cab exterior, interior, frame and engine compartment components need maintenance to ensure longevity and safe operations. A clean vehicle also allows leaks to be detected easier.



**WARNING**

Always allow hot surfaces to cool down before attempting to work near them. Failure to comply may result in personal injury or death.



**WARNING**

Handle cleaning agents carefully. Cleaning agents may be poisonous. Keep them out of the reach of children. Failure to comply may result in property damage, personal injury, or death.



**WARNING**

DO NOT use gasoline, kerosene, naphtha, nail polish remover or other volatile cleaning fluids. They may be toxic, flammable or hazardous in other ways. Failure to comply may result in personal injury, property damage or death.



**WARNING**

DO NOT clean the underside of chassis, fenders, wheel covers, etc. without protecting your hands and arms. You may cut yourself on sharp edged metal parts. Failure to comply may result in personal injury, property damage, or death.



**WARNING**

Moisture, ice, and road salt on brakes may affect braking efficiency. Test the brakes carefully after each vehicle wash. Failure to comply may result in death, personal injury, equipment or property damage.

**Vehicle Cleaning**

- Observe all caution labels
- Always read directions on the container before using any product
- Do not use any solution that can damage the body paint
- Most chemical cleaners are concentrates that require dilution

- Only use spot removing fluids in well ventilated areas
- Any vehicle is subjected to deterioration from multiple causes (i.e. industrial fumes, ice, snow, corrosive road salt, etc..)

**Exterior and Engine Compartment**

Corrosive materials used to remove ice, snow and dust from the road can collect on the entire vehicle with concentrated accumulations throughout the underbody and engine compartment. If these materials are not removed, accelerated corrosion (rust) can occur on underbody parts such as fuel lines, frame rails, floor pan, electrical and exhaust system, even though they have been provided with corrosion protection.

At least every spring, flush these materials from the entire vehicle, including the underbody and engine compartment, with plain water using light water pressure. On vehicles used in applications and/or areas that experience high usage of, or exposure to, corrosive materials, cleaning of the entire vehicle should be done more frequently. If desired, your dealer can do this service for you.



**CAUTION**

Do not direct high pressure water onto seals or flexible hoses. Water may enter the part which will contaminate the system lubricants and fluids. To prevent damage to these components, keep a gentle flow of water moving at all times. Failure to comply may result in equipment damage.



**CAUTION**

Do not direct high pressure water onto electrical components, plug connectors, seals or flexible hoses on the engine. Failure to comply can accelerate corrosion and degrade electrical component which may cause a fire or equipment damage.

To prevent rust, keep chromed parts clean and protected with wax at all times, especially in winter conditions when the roads are salted.

- If necessary, use a commercial chrome cleaner to remove light rust.

- Chrome surfaces are best cleaned with fresh water. Wipe dry to preserve their luster. A commercial chrome cleaner will remove light rust. After cleaning, wax flat surfaces and apply a thin coat of rust preventive lubricant around bolts or other fasteners.
- Clean aluminum wheels and bumpers with cool water. Tar-remover will get rid of heavy deposits of road grime. To prevent spotting, wipe aluminum surfaces dry after washing.
- Under corrosive conditions, such as driving on salted roads, clean aluminum parts with steam or high-pressure water from a hose. A mild automotive soap solution will help. Rinse thoroughly.

To maintain the tailpipe's quality finish, wash the tailpipe with a soft cloth, mild automotive soap, and water or glass cleaner. A non-abrasive chrome polish can be used sparingly on hard-to-clean areas. DO NOT clean your high-heat chrome using scouring pads, abrasive chrome polish, highly acidic chemical cleaners or any other abrasive cleaners. Even high quality stainless steel parts can rust under prolonged exposure to salt

water, especially when the salt-laden moisture is held against the metal surface by road grime. It is important to frequently clean salty moisture and grime from stainless steel surfaces.

- If surface rust is encountered, wash the surface and use a commercial polishing compound to clean off the rust, followed by a coating of wax.
- Never use steel wool when cleaning stainless steel. Minute particles of the steel wool can become embedded in the surface of the stainless steel part and cause rust staining.

**Weather Stripping**

Frequent washing of the vehicle is required to remove road grime and contaminants that can stain and oxidize paint and accelerate corrosion of plated and polished metal surfaces. Waxing offers added protection against staining and oxidation. Do not apply wax in the hot sun and do not friction burn the paint with a buffing machine. Occasionally spray weather-stripping on doors and windows with silicone compound to help preserve resiliency. This is especially useful in

freezing weather to prevent doors and windows from sticking shut with ice.



**NOTE**

To allow enough time for your truck's finish to cure, wait at least thirty days after the date of manufacture before waxing.

**Cleaning Interior Vinyl and Upholstery**



**NOTE**

Strong cleaning agents such as hand sanitizer, solvents, paint thinners, window cleaner and gasoline/ diesel fuel must never be used on your vehicle's interior. Repeated exposure to chemicals such as sunscreen, insect repellents containing DEET, or brake fluid may cause accelerated wear, tackiness or discoloration of interior surfaces.

Wipe vinyl upholstery and lining with a good commercial upholstery cleaner. Do not use acetone or lacquer thinner. Clean

fabric upholstery with upholstery shampoo specially formulated for this purpose.

- First remove loose dirt, dust or debris with a vacuum cleaner.
- Use a soft brush to loosen caked-on dirt before vacuuming it away.
- Wipe the fabric surface with a slightly damp cloth and dry the seat fabric thoroughly. If the fabric is still dirty, wipe using a mixture of mild soap and lukewarm water, then dry thoroughly.
- If the stain does not come out use an upholstery shampoo specially formulated for this purpose. Test the cleaner on a hidden place to make sure it does not harm the fabric. Follow the instructions on the container.

Other interior surfaces may be cleaned using a mixture of mild soap and lukewarm water, or an automotive interior cleaner, used on its intended surface (i.e. use leather conditioner on leather surfaces, etc.).

Avoid frequent or repeated use of the following products on interior surfaces:

- Alcohol-based cleaners (including hand sanitizer)
- Methanol-based cleaners

- Bleach
- Acetone
- Any other strong solvent
- Abrasive cleaners
- Sunscreen

**How to Wash the Exterior of the Vehicle**

Your dealer has a number of vehicle-care products and can advise you on which ones to use for cleaning the exterior and interior of your vehicle.



**WARNING**

Handle cleaning agents carefully. Cleaning agents may be poisonous. Keep them out of the reach of children. Failure to comply may result in property damage, personal injury, or death.



**WARNING**

DO NOT use gasoline, kerosene, naphtha, nail polish remover or other volatile cleaning fluids. They may be toxic, flammable or hazardous in other ways. Failure to comply may result in personal injury, property damage or death.



**WARNING**

DO NOT clean the underside of chassis, fenders, wheel covers, etc. without protecting your hands and arms. You may cut yourself on sharp edged metal parts. Failure to comply may result in personal injury, property damage, or death.



**WARNING**

Moisture, ice, and road salt on brakes may affect braking efficiency. Test the brakes carefully after each vehicle wash. Failure to comply may result in

death, personal injury, equipment or property damage.



**CAUTION**

DO NOT aim the water jet directly at door locks or latch. Tape the key holes to prevent water from seeping into the lock cylinders. Water in lock cylinders should be removed with compressed air. To prevent locks from freezing in the winter, squirt glycerin or lock deicer into the lock cylinders.



**NOTE**

To allow enough time for your truck's finish to cure, wait at least thirty days after the date of manufacture before waxing.

1. Begin by spraying water over the dry surface to remove all loose dirt before applying the car wash solution.



**CAUTION**

Do not direct high pressure water onto seals or flexible hoses. Water may enter the part which will contaminate the system lubricants and fluids. To prevent damage to these components, keep a gentle flow of water moving at all times. Failure to comply may result in equipment damage.



**CAUTION**

Do not direct high pressure water onto electrical components, plug connectors, seals or flexible hoses on the engine. Failure to comply can accelerate corrosion and degrade electrical component which may cause a fire or equipment damage.

- Do not wash the vehicle in direct sunshine.
  - Do not spray water directly into the cab vents.
2. Using soapy water, wash the vehicle with a clean soft cloth or a soft brush made for automotive cleaning.

- Use cool water and a mild, automotive-type soap. Strong industrial detergents, cleaning agents and household-type soaps are not recommended and may damage the vehicle's paint.
  - Do not use stiff brushes, paper towels, steel wool, or abrasive cleaning compounds because they will scratch painted, plated, and polished metal surfaces.
3. Rinse painted surfaces with gentle water pressure frequently while washing to flush away dirt that might scratch the finishes during the washing operation.
  4. Hose dirt and grime from the entire chassis.



**CAUTION**

Do not direct high pressure water onto seals or flexible hoses. Water may enter the part which will contaminate the system lubricants and fluids. To prevent damage to these components, keep a gentle flow of water moving at

all times. Failure to comply may result in equipment damage.



**CAUTION**

Do not direct high pressure water onto electrical components, plug connectors, seals or flexible hoses on the engine. Failure to comply can accelerate corrosion and degrade electrical component which may cause a fire or equipment damage.

5. Wipe everything dry with a chamois to avoid water spots. To prevent water spotting, dry off the cosmetic surfaces with a clean cloth or chamois.
6. Remove road tar with an automotive-type tar remover or mineral spirits.
7. After cleaning and drying the entire vehicle, apply a quality automotive wax to protect the vehicle's finish.

**Cab HVAC Fresh Air Filter Replacement**

The fresh air filter for the cab HVAC is located in the air intake housing that is

mounted to the firewall in the passenger side rear corner of the engine compartment. The filter can be replaced without using any tools.

1. Tilt the hood open.
2. Locate the air intake housing at the passenger side rear corner of the engine bay, below the rain tray.

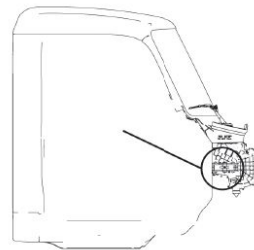

3. Locate the filter cover labeled "OPEN" with an arrow pointing towards the rear of the vehicle. Slide the filter cover towards the rear of the vehicle, until you are able to remove the cover.

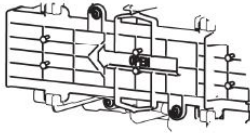

4. Remove and inspect the filter, referring to the maintenance interval schedule.
5. Install the new air filter into its housing, taking care to align the airflow direction indicated on the filter element with the airflow direction that's marked on the air intake housing.
6. Replace the filter cover on the air intake housing and slide the cover toward the front of the vehicle. An audible "snap" sound can be heard when the cover is correctly installed. If the snap feature is damaged there are two screw features that may be used to secure the cover.
7. Close and secure the vehicle's hood.

### Care of Display Screens on the Dashboard

To clean the screen, dampen a clean, soft, lint-free cloth with water only. A mild glass cleaner that does not contain alcohol or ammonia may also be used. Cleaners that contain alcohol and/or ammonia will eventually dry-out, crack and "yellow" the screen. Wipe the screen gently back and forth. You can also use a commercial cleaner especially designed for LCD screens.

### Cab Structure, Doors and Hoods

Lubricate the lower hood pivot (only if lube fittings are present.)

### Safety Restraint System - Inspection



#### WARNING

Failure to properly inspect and maintain restraint systems can lead to injury or loss of life. Without periodic inspection and maintenance to detect unsafe conditions, seat restraint components can wear out or not protect you in an accident.



**WARNING**

It is important to remember that any time a vehicle is involved in an accident, the entire seat belt system must be replaced. Unexposed damage caused by the stress of an accident could prevent the system from functioning properly the next time it is needed. Failure to comply may result in death or personal injury.

5

**Seat Belt Inspection Points**

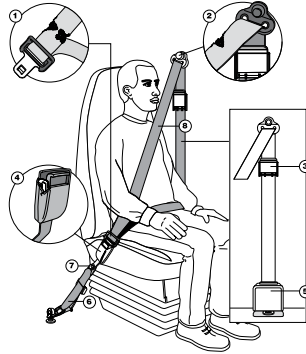

1. Web cut or frayed or extremely worn at latch area
2. Web cut or frayed at D-loop web guide
3. Comfort Clip cracked or damaged
4. Buckle casting broken
5. Retractor Web Storage for damage (located behind trim panel)
6. Tethers for web wear and proper tightness of mounting hardware

7. Mounting hardware for corrosion, proper tightness of bolts and nuts
8. Web for deterioration, due to exposure to the sun

Factors contributing to reduced seat belt life:

- Heavy trucks typically accumulate twice as many miles as the average passenger car in a given time period.
- Seat and cab movement in trucks causes almost constant movement of the belt due to ride characteristics and seat design. The constant movement of the belt inside the restraint hardware and the potential for the belt to come in contact with the cab and other vehicle parts, contributes to the wear of the entire system.
- Environmental conditions, such as dirt and ultraviolet rays from the sun, will reduce the life of the seat belt system.

Due to these factors, the three-point safety belt system installed in your vehicle requires thorough inspection every 20,000 miles (32,000 km). If the vehicle is exposed to severe environmental or working conditions, more frequent inspections may



be necessary. Any seat belt system that shows cuts, fraying, extreme or unusual wear, significant discoloration due to UV (ultraviolet) exposure, abrasion to the seat belt webbing, or damage to the buckle, latch plate, retractor hardware, or any other obvious problem should be replaced immediately, regardless of mileage.

### Inspection Guidelines

Follow these guidelines when inspecting for cuts, fraying, extreme or unusual wear of the webbing, and damage to the buckle, retractor, hardware, or other factors. Damage to these areas indicates that belt system replacement is necessary.

 <b>WARNING</b>
<p>Replace the entire belt system (retractor and buckle side) if replacement of any one part is necessary. Unexposed damage to one or more components could prevent the system from functioning properly the next time it is needed. Failure to comply may result in death or personal injury.</p>

1. Check the web wear in the system. The webbing must be closely

examined to determine if it is coming into contact with any sharp or rough surfaces on the seat or other parts of the cab interior. These areas are typical places where the web will experience cutting or abrasion. Cuts, fraying, or excessive wear would indicate the need for replacement of the seat belt system.

2. The pillar web guide (D-loop) is the area where almost constant movement of the seat belt webbing occurs because of relative movement between the seat and cab.
3. Check the Komfort Latch for cracks or possible damage and check for proper operation.
4. Check buckle and latch for proper operation and to determine if latch plate is worn, deformed, or damaged.
5. Inspect the retractor web storage device, which is mounted on the floor of the vehicle, for damage. The retractor is the heart of the occupant restraint system and can often be damaged if abused, even unintentionally. Check operation to ensure that it is not locked up and

that it spools out and retracts webbing properly.

6. If tethers are used, be sure they are properly attached to the seat and, if adjustable, that they are adjusted in accordance with installation instructions. Tethers must also be inspected for web wear and proper tightness of mounting hardware.
7. Mounting hardware should be evaluated for corrosion, and for tightness of bolts and nuts.
8. Check web in areas exposed to ultraviolet rays from the sun. If the color of the web in these areas is gray to light brown, the physical strength of the web may have deteriorated due to exposure to the sun's ultraviolet rays. Replace the system.

Once the need for replacement of the seat belt has been determined, be certain it is only replaced with an authorized PACCAR Parts replacement seat belt. If the inspection indicates that any part of the seat belt system requires replacement, the entire system must be replaced. An installation guide is attached to every replacement belt. Utilize the proper guide for your type of seat, and follow the

instructions very closely. It is vitally important that all components be reinstalled in the same position as the original components that were removed and that the fasteners be torqued to specification. This will maintain the design integrity of the mounting points for the seat belt assembly. Contact your dealer if you have any questions concerning seat belt replacement.

5

## Cooling System Maintenance

The cooling system in your vehicle was factory filled with extended life coolant that meets or exceeds all ASTM D6210 and Caterpillar EC-1 requirements. PACCAR recommends only using a 50:50 mixture of distilled water and ELC when cooling system service is required. A 50:50 mixture of ELC and distilled water will provide freeze protection down to -34°F (-36.7°C), which is adequate for most locations in North America. For extremely cold operating conditions, a 60:40 mixture (coolant/water ratio) can be used to provide freeze protection down to -62°F (-52.2°C).

Unless otherwise optioned, factory fill coolant is an ethylene glycol, nitrated organic acid technology (NOAT) extended life coolant (ELC) formulation at a 50:50 coolant-to-distilled water mixture. The factory fill exceeds ASTM D6210 and Caterpillar EC-1 requirements. Maintaining coolant chemistry and freeze protection is critical to engine and cooling system component health and longevity.



### WARNING

Coolant is toxic. DO NOT get the fluid in eyes. If contact occurs, flood eyes with large amounts of water for 15 minutes. Avoid prolonged or repeated contact with skin. In case of contact, immediately wash skin with soap and water. DO NOT take internally. If swallowed, seek immediate medical attention. DO NOT induce vomiting. Failure to comply may result in death, personal injury, equipment or property damage.



### CAUTION

The engine cooling system has very specific maintenance and inspection requirements. Failure to follow requirements can damage the engine. Engine damage can include but is not limited to freezing, boiling, corrosion, pitted cylinder liners. This information is found in the engine manufacturers owner's manual. It is the owner's responsibility to follow all requirements listed in the engine manufacturers owner's manual.



### NOTE

Coolant is harmful to the environment. Unused coolant must be stored as a toxic hazardous material in leakproof containers. Used coolant must be processed as industrial chemical waste. Please follow HAZMAT guidelines with both used and unused coolants.



**CAUTION**

Use of non-genuine PACCAR coolant filters can cause severe engine damage.

**Concentration**

Check the level of freeze/boil-over protection, which is determined by the glycol concentration. Use a glycol refractometer to determine glycol level. Add coolant to obtain the coolant/water ratio required to provide the protection you need. A 50:50 mix of coolant and water is adequate for most applications. For extremely cold operating conditions, the ratio can be adjusted to a higher concentration of coolant.



**NOTE**

Maximum recommended ELC concentration is 60% ELC and 40% water by volume (a 60:40 coolant mixture). The minimum recommended concentration is 40%.

**Glycol Concentration Level**

Level	Desired Coolant / Water Ratio	Freeze Point °F (°C)
Recommended Levels	40%	-12 (-24)
	45%	-23 (-31)
	50%	-34 (-37)
	55%	-50 (-46)
	60%	-62 (-52)

**Condition**

Perform a visual inspection of the coolant. It should have no cloudiness or floating debris. Determine the chemical inhibitor concentration level by using an extended life coolant specific test kit or test strips. Inhibitor concentration level determines corrosion protection. If you are concerned about possible coolant quality, contamination, or mechanical problems, submit a coolant sample for analysis. Improper maintenance may cause coolant

degradation and could result in damage to the cooling system and engine components. Consult your dealer or the coolant manufacturer's representative for recommended extended life coolant test kits, test strips, and laboratory sample procedures.

**Coolant Extender**

Add extended life coolant extender, if necessary, according to the corrosion inhibitor concentration required. **DO NOT** add coolant extender to nitrite-free coolant.

**Checking Coolant Level**

Check the coolant level daily. When adding coolant, avoid mixing different brands and formulations. If the coolant is mixed with more than 25% of a different formulation, engine corrosion damage could occur. If mixing exceeds 25% of total system volume, it is recommended to flush and refill the system completely with one type of coolant.

**Coolant Filter**

Your engine may be equipped with a coolant filter. It is a "blank filter" and does not contain chemicals or time-release additives. Replace it only with a blank filter at the interval specified in your engine's

operator's manual. Never use filters that contain supplemental coolant additives (SCAs) in an ELC-filled system. Consult your engine operator's manual for information on the coolant filter and service procedures.

**CAUTION**

Use of non-genuine PACCAR coolant filters can cause severe engine damage.

**Cooling System Sealing Additives and Soluble Oils**

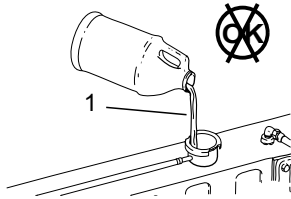

1. Do not use soluble oils or sealing additives.

**CAUTION**

The use of sealing additives or soluble oils in the cooling system can cause damage to the engine. These additives can plug various areas of the radiator, EGR system and oil cooler. The plugging of the cooling system can hamper heat transfer, causing internal engine damage. DO NOT use sealing additives or soluble oils in the cooling system. The use of sealing additives can:

- Build up in coolant low-flow areas
- Plug the radiator and oil cooler
- Damage the water pump seal
- Damage heat transfer surfaces
- Damage seals and hoses
- Corrode brass and copper

Failure to comply may result in equipment or property damage.

**Inspect Coolant Level**

Inspect the vehicle's coolant surge tank for proper coolant level. Add coolant if the level in the tank is below the line marked **MIN.**

The minimum fluid level is determined by the line on the surge tank indicated by the letters "MIN." This indicator is located below the fill cap. The cooling system will need to be filled if the level is not above the "MIN" line, regardless of engine temperature.

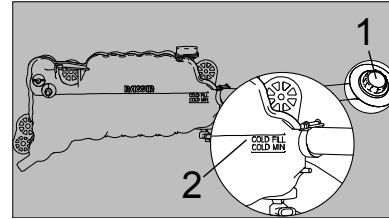

1. Fill location
2. Fill line

**Radiator Hoses**

Perform these maintenance procedures according to the Preventative Maintenance Schedule.

1. Check the following radiator hose conditions:
  - Deterioration/signs of leaking
  - Hose clamp torque

### How to Add Coolant to the Cooling System

Use a solution of half ethylene glycol antifreeze and half water for best heater performance. Do not use more than 60 percent concentration of antifreeze, as a shortened heater life will result.



#### WARNING

DO NOT remove the coolant fill cap while the engine is hot. Scalding steam and fluid under pressure may escape and cause serious burns. Failure to comply may result in personal injury or death.



#### NOTE

If frequent topping off is necessary and there are no visible signs of coolant leaks when the engine is cold, check for leaks with the engine operating at normal temperature.



#### NOTE

DO NOT use the pressure cap to fill the surge tank with fluid.



#### NOTE

DO NOT overfill a cooling system. Excess coolant may result in overflow, loss of antifreeze, and reduced corrosion protection.

#### 1. Bulkhead Mounted Coolant Surge Tank

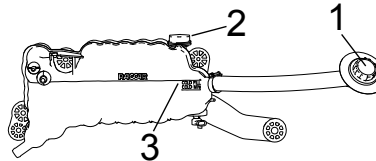

1. Turn off the engine and let it cool for a minimum of 10 minutes.
2. If your cooling system is built with an air bleed valve in the upper engine coolant pipe, open the air bleed valve before filling the surge tank.

3. Close any open coolant drain valves in the lower engine coolant pipe.
4. Remove the surge tank fill cap (1). DO NOT remove the surge tank pressure cap (2).
5. Fill the system with premixed coolant through the surge tank fill port. Pour coolant at a steady rate until it reaches the lower of the two lines indicated by either "COLD MIN" or "MIN" on the surge tank. Wait for one minute after adding coolant. If the coolant level drops, add coolant until it returns to the lower line.
6. Close the air bleed valve if opened earlier in this procedure.
7. Start the engine and maintain an idle at low rpm.
8. While the engine is idling air will purge from the cooling system via the surge tank's coolant fill port, which will lower the coolant level in the surge tank. Continue to fill the surge tank until the coolant level remains approximately 1/2 in. (13 mm) above the "MIN" line. This may take up to 2 minutes,

- depending on the outside temperature.
9. Maintain a low idle until the thermostat opens and the operating temperature stabilizes. A sign that the thermostat has opened is when the upper coolant pipe gets hot on the bottom side indicating hot coolant is now running through it.
  10. Add coolant to the surge tank until the coolant remains 1/2 in. (13 mm) above the "MIN" level.
  11. Operate the engine at high idle for 10 minutes. Afterward, add coolant to the surge tank until the coolant remains 1/2 in. (13 mm) above the "COLD FULL" line.
  12. Reinstall the surge tank fill cap.

Check the coolant level before and after each trip. Add coolant as necessary. Coolant may not immediately appear at the correct level after the radiator has been filled. Air may be trapped in the cooling system, which will affect the coolant level until the air is purged.

After servicing the cooling system, continue monitoring it for 3-5 days. The coolant level in the surge tank will lower when air trapped in the cooling system is

purged. During each pre-trip inspection you should inspect recently serviced components of the cooling system for signs of coolant leaks.



**NOTE**

If the coolant frequently needs top-ping-up or there are any signs of coolant leakage, consult a PACCAR Service dealer.

## Electrical System



**WARNING**

Battery posts, terminals and related accessories contain lead and lead compounds, chemicals known to the State of California to cause cancer and reproductive harm. Wash hands after handling.



**WARNING**

Before attempting any work on the batteries or electrical system, remove all jewelry. If metal jewelry or other metal comes in contact with electrical circuits, a short circuit may occur causing you to be injured, as well as electrical system failure and damage.



**CAUTION**

DO NOT modify or improperly repair the vehicles electrical system or power distribution box. All electrical repairs should be performed by an authorized dealer. Improper repair or modifications will void your warranty and/or cause serious damage to your vehicle.

### Engine Aftertreatment System Power Requirements

The engine aftertreatment system uses battery power for up to 10 minutes after the ignition is turned off. After the ignition turns off, the engine aftertreatment system circulates DEF to help cool down the fluid

and prevent overheating. For situations where the battery will be disconnected (i.e. for service or maintenance of the vehicle), please wait 10 minutes before disconnecting battery power.

 <b>CAUTION</b>
<p>Wait at least 10 minutes after the key switch is turned OFF before disconnecting battery power. The system uses battery power to circulate DEF and prevent overheating of the DEF system. Failure to comply may result in property damage.</p>

### Low Voltage Disconnect (LVD) (option)

The Low Voltage Disconnect (LVD) may increase battery life and avoid depleting the battery below the minimum charge needed to start the engine by shutting off non-vital battery loads.

When battery voltage drops below the LVD setting, LVD starts a two-minute countdown. If battery voltage remains

below the LVD setting and the engine is not started, when the countdown ends, all non-vital battery loads (hotel loads) will be shut off. The LVD setting is adjusted in the Settings sub-menu of the Digital Display. When battery voltage drops below the LVD setting

1. An amber LVD Popup notification occurs, accompanied by an audible warning. This starts the two-minute countdown.
2. Thirty seconds before the countdown ends, the Battery Voltage indicator is replaced by the amber (or red) LVD telltale<sup>21</sup>. The LVD popup notification will turn red and will be accompanied by a continuous audible warning.



3. When the two-minute countdown has ended, the LVD "Hotel Loads Disconnected" Popup appears, and

LVD shuts off all loads connected through the LVD system.

The LVD condition will not clear until battery voltage increases above the LVD setting or the engine is started. Electrical loads shut off by LVD

- Cab dome lamps
- Cab accessories
- Spare LVD wiring for customer added accessories

 <b>WARNING</b>
<p>DO NOT use the Spare Battery A and B circuits or other circuits that are controlled by the LVD to power electronic engine controls, ABS circuits, or safety/work related lighting. Before adding any device to the vehicle's electrical system, consult your nearest authorized dealer or read the contents of TMC RP136. Failure to do so may cause equipment damage or lead to personal injury.</p>

<sup>21</sup> On the 15 inch display, LVD telltale color depends on the severity of battery depletion.

**i** NOTE

The determination of what circuits/loads that were connected to the LVD was based upon the recommendation from Technology and Maintenance Council (TMC) of the American Trucking Association. To review the recommended practice, see TMC RP-136.

**i** NOTE

LED headlights (option) are not serviceable. If you experience a LED headlight failure, contact your nearest dealer to have the problem corrected as soon as possible.

**i** NOTE

All LVD circuits are color-coded blue on the central electrical panel cover label.

### How to Replace Headlight Bulbs

This procedure is for all halogen bulbs housed in the headlight assembly. Bulb replacements should be performed with the vehicle parked and the parking brake set. See [Vehicle Light Bulb Specifications](#) on page 310 for correct replacement bulbs.

Access Door

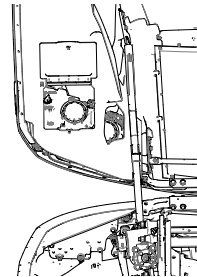
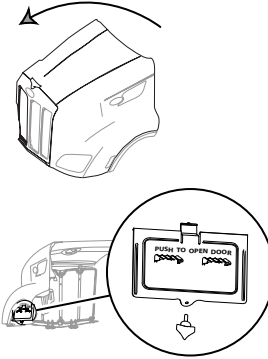

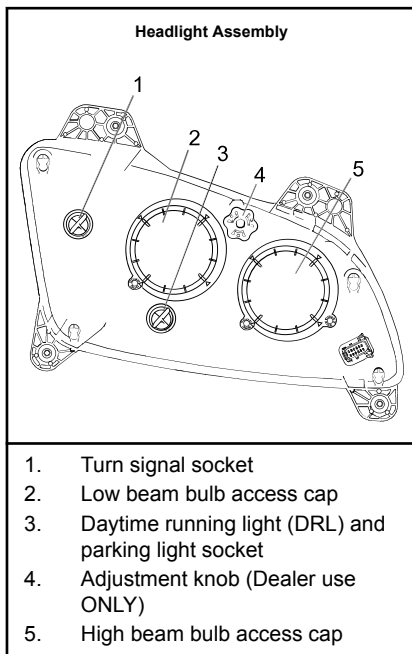

**CAUTION**

When replacing a halogen bulb, do not touch the globe with your fingers. Oils or other contaminants on the skin can result in early bulb failure.

1. Open the hood and secure it in the open position.
2. Locate and open the access panel on the inside of the fender liner (see Access Door graphic).
3. If replacing the low or high beam bulb, unscrew and remove the access cap covering that bulb: (2) or (5).
4. Unlock bulb from behind by turning socket (and its wired connector) a quarter-turn counterclockwise, then withdraw bulb and socket from seat.
5. Pull bulb from socket and insert replacement. Dispose of old bulb. *Do not touch bulb globe with fingers.*
6. Reinsert bulb and socket by lining up the tab on the socket with the slot in the headlight housing, then insert and turn clockwise to lock.

7. Replace access cap if removed earlier in this procedure.
8. Replace the access panel, then close and secure the hood.

**Final Checks**

- After everything is reconnected, check the replaced light for operation.
- Have your headlights periodically checked for proper alignment by dealer.
- Keep your headlights clean using only mild soap and water (see Maintaining Headlight Performance). A dirty headlight reduces performance and creates glare.

**Aiming Headlights**

The headlights were properly aimed at the factory to meet safety specifications. If the headlights need to be adjusted, please have an authorized dealership aim the headlights.

**Fuses, Circuit Breakers and Relays**

Fuses, circuit breakers, and relays are located in the Power Distribution Center (PDC) to the left of the steering column,

behind the clutch pedal. Additional fuses are located in the engine compartment (driver's side firewall) and also in the sleeper (driver's side of vehicle) under the bunk storage compartment. Refer to the fuse labels affixed at each fuse panel location (generally under the fuse panel cover) for information about the location and amp ratings of each circuit.

### Altering the Electrical System

Refer to a wiring diagram for your chassis before adding electrical options to ensure proper electrical system performance.



#### WARNING

DO NOT replace a fuse with a fuse of a higher rating. Doing so may damage the electrical system and cause a fire. Failure to comply may result in property damage, personal injury, or death.



#### WARNING

Never install a circuit breaker/polyswitch in a location indicated for "fuse only." Using a polyswitch (circuit breaker) in a fuse-only circuit may

cause the circuit to overheat when a short exists, which could lead to equipment damage and/or personal injury.



#### NOTE

Polyswitches/circuit breakers are allowed in certain locations as indicated by the label on the fuse box. In these applications, a fuse may be used instead of a circuit breaker.



#### CAUTION

Follow all manufacturers' circuit protection recommendations for the components and wires being added. Failure to comply may result in equipment damage.



#### NOTE

If you are unfamiliar with proper electrical repair practices and procedures, see your authorized dealer for assistance.

### Vehicle CAN Bus

Your vehicle is equipped with a CAN bus electrical system. Because of how the electrical system is designed it is important that any accessories added after the vehicle is built are installed only on the K-CAN or the S-CAN. These dedicated CANs are provided on the driver's side of the cab, near to the interior fuse panel. Access to the K-CAN and S-CANs is provided by two RP1226 connectors. DO NOT tap into, connect to, tamper with, or splice into any CAN network other than the K-CAN or the S-CAN. Connecting to an unapproved CAN network may trigger CAN fault codes.



#### CAUTION

Connecting to an unapproved CAN network may trigger CAN fault codes. The manufacturer will not warrant failures or damage caused to CAN network components when the failure or damage is a result of improper connections to the CAN network.

**CAUTION**

The use of scotch locks, scraped off insulation, and electrical tape are not approved CAN connection techniques. These are the source of numerous CAN faults.

Scotch locks

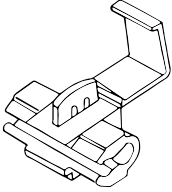

**Batteries**

Regular attention to the charging system will help prolong the service life of the batteries.

**WARNING**

Batteries contain acid that can burn and gases that can explode. Ignoring safety procedures may result in death, personal injury, equipment or property damage.

**WARNING**

Never remove or tamper with battery caps. Ignoring this could allow battery acid to contact eyes, skin, fabrics, or painted surfaces. Failure to comply may result in property damage, personal injury, or death.

**CAUTION**

DO NOT store other items in the battery box. Failure to comply could result in damage to the truck and/or batteries.

**CAUTION**

Properly secure battery tie downs and battery box cover when reinstalling batteries after service. DO NOT over tighten. Over tightening can crack the battery case which can lead to equipment damage.

**CAUTION**

The Diesel Exhaust Fluid (DEF) system recirculates fluid to the doser to prevent damage from heat after key off. If your vehicle is equipped with battery disconnect switches do NOT disconnect battery power within TEN minutes of switching the ignition key off. Failure to comply may result in vehicle or property damage.

Here are some common causes of battery failure:

Overcharge: this condition results from improper voltage regulator adjustment. It results in overheating of the battery, warped plates, and evaporation of electrolyte.

**Undercharge:** the voltage regulator is malfunctioning, the drive belt is slipping, or your vehicle has undergone long periods of idling or short distance driving. These conditions result in battery plates becoming covered with a hard coating.

**Vibration:** loose battery hold-downs may cause battery plate failure.

**Short Circuits:** these discharge the battery by draining electricity.

**Dirty or Loose Connections:** improper connections may stop the flow of electrical power to and from the battery.

### Battery Charging



#### WARNING

Batteries can injure you severely. They contain acid, produce poisonous and explosive gases, and supply levels of electric current high enough to cause burns. A spark or flame near a battery on charge may cause it to explode with great force. Never remove or tamper with the battery caps. Failure to comply may result in property damage, personal injury, or death.

Except for using small trickle charges to maintain battery condition, you should

have your vehicle's batteries charged by a qualified service facility. To help reduce the risk of personal injuries, follow these guidelines carefully when recharging a battery:

- Before attempting any service in the electrical installation, disconnect the battery negative cable.
- Allow no sparks or open flame anywhere near the charging area.
- Charge a battery only in a well-ventilated area, such as outdoors or in a fully open garage which contains no pilot lights or other flames. Gases generated during the charging process must be allowed to escape.
- Always make sure the battery charger is OFF before connecting or disconnecting the cable clamps.
- To avoid short circuits, damage to the vehicle, or personal injury, never place metal tools or jumper cables on the battery or nearby. Metal that accidentally comes in contact with the positive battery terminal or any other metal on the vehicle (that is in contact with the

positive terminal), could cause a short circuit or an explosion.

### Charging Reminders

- Use protective eyewear
- Keep all batteries away from children
- Never reverse battery poles
- Never attempt to place the vehicle in motion, or run the engine with batteries disconnected
- Keep the battery clean and dry
- Look for any signs of damage
- Battery terminals should not be coated with improper grease. Use a commercially available, noncorrosive, non-conductive terminal coating, or petroleum jelly.
- Never use a fast charger as a booster to start the engine. This can seriously damage sensitive electronic components such as relays, radio, etc., as well as the battery charger. Fast charging a battery is dangerous and should only be attempted by a competent mechanic with the proper equipment.

### Under Cab Battery Access

The battery compartment is located on the left side of the vehicle, under the cab access steps.

1. Remove the six bolts that are located in the two cab access step plate.
2. Remove battery cover for access.

### In Cab Battery Access

Your vehicle may be equipped with Absorbed Glass Mat (AGM) batteries located in the cab under the passenger's seat. The glass mat in AGM batteries are designed to absorb the battery acid inside the battery that can leak or spill out in conventional batteries. This design feature allows batteries to be positioned in any orientation without risk of leaking.

To access the batteries:

1. Enter the cab.
2. Remove six fasteners securing the passenger side seat base to the battery box assembly.
3. Remove the seat and seat base as one unit to gain access to the batteries.
4. Installation is the reverse of removal.

### Cranking Battery Specification

Category	Specification
Group	31
Stud Type	Threaded
Cold Crank Amps	650
Voltage	12 V
Reserve Capacity	160 minutes
General	Maintenance free

### Removing Batteries

After accessing the batteries, follow these steps to remove them from the vehicle.

 <b>CAUTION</b>
<p>Wait at least 10 minutes after the key switch is turned OFF before disconnecting battery power. The system uses battery power to circulate DEF and prevent overheating of the DEF system. Failure to comply may result in property damage.</p>

1. Be sure all switches on the vehicle are turned OFF
2. Wait 10 minutes after turning ignition off before disconnecting the batteries
3. Disconnect negative (-) ground cable first
4. Disconnect positive (+) cable
5. Unscrew the holding plate bolts with an open end wrench

 <b>NOTE</b>
<p>Always dispose of automotive batteries in a safe and responsible manner. Contact your authorized dealer for disposal standards. Call your local authorized recycling center for information on recycling automotive batteries.</p>

Follow the procedures below to reinstall batteries on the vehicle and replace parts removed for access.

### Installing Batteries

Follow the procedure below to reinstall main batteries on the vehicle:



**NOTE**

Always dispose of automotive batteries in a safe and responsible manner. Contact your authorized dealer for disposal standards. Call your local authorized recycling center for information on recycling automotive batteries.



**NOTE**

Make sure to reconnect the ground (negative) cable last.



**WARNING**

Battery replacement may alter or disturb battery cable routing. Check to insure battery cables are free from any point of chaffing. Failure to comply may result in death, personal injury, equipment or property damage.

1. Place batteries in vehicle and tighten bolt of holding plate
2. Reconnect positive cable

3. Reconnect ground (negative) ground cable

**Replace Battery Box Cover**



**WARNING**

Always reinstall steps before entering the cab or accessing the deck plate. Without steps you could slip and fall. Failure to comply may result in personal injury or death.



**WARNING**

Fairings not installed properly could come loose and cause other motorists to have an injury accident. It is important that fairings be installed properly. Failure to comply may result in death, personal injury, equipment or property damage.

1. Replace battery cover.
2. Install two bolts in step strut. Torque to 24-32 lb-ft (33-43 N·m).
3. Install fairing and install four bolts. Torque to 6-7 lb-ft (8-9 N·m).

4. Install steps by installing two bolts in each step. Torque to 24-32 lb-ft (33-43 N·m).

**Slow Battery Charging**



**WARNING**

Charger cables must be connected positive to positive (+ to +) and negative to negative (- to -). If connected improperly, batteries could explode. Failure to comply may result in property damage, personal injury, or death.



**WARNING**

Always make sure the battery charger is OFF before connecting or disconnecting the cable clamps. To reduce the danger of explosions and resulting death or personal injury, do not connect or disconnect charger cables while the charger is operating.

 <b>NOTE</b>
Some vehicles may have an ultra capacitor mounted in the battery box. These devices have a similar shape to a battery but have two positive posts and one negative posts. Do not attach battery chargers to these devices to recharge the vehicles batteries. Connect directly to the conventional two post charging batteries to charge them.

 <b>NOTE</b>
Follow the instructions that come with your battery charger.

1. Access the battery terminals, the batteries do not have to be removed from the vehicle.
2. Make sure the battery charger is turned off.
3. Disconnect the battery cables.
4. Connect charger cables.
5. Start charging the battery at a rate not over 6 amperes. Normally, a battery should be charged at no

more than 10 percent of its rated capacity.

6. After charging, turn OFF charger and disconnect charger cables.

### Alternator

Take the following precautions to avoid burning out alternator diodes:

- DO NOT start the engine with alternator disconnected (connections removed) from the circuit.
- Before welding, disconnect all electronic connections to the vehicle batteries.
- Remove battery power cable and insulate it from the vehicle.
- DO NOT run the engine with the batteries disconnected.
- DO NOT disconnect the battery cables or alternator connection cables with the engine running
- Never turn the ignition switch from the ON position to the START position with the engine running.
- When charging the battery (installed in the vehicle) disconnect the battery cables.

- DO NOT reverse the cables of the alternator, starter motor, or battery.
- DO NOT polarize the alternator. The alternator should not be polarized like a generator. To ensure correct polarity, use a test lamp or a voltmeter.

### Remote Keyless Entry

The system will lock or unlock cab doors with the key fob. The system will alert you with parking lights when the selected doors are locked or unlocked. There are two key fobs provided with the system which provide secure rolling code technology that prevents someone from recording the entry signal.

If you have issues with a key fob, replace the battery and reprogram the key fob. In some situations, the key fob may need to be replaced and in others, a fuse may have failed that could render both key fobs inoperative. Contact your dealer for help if a key fob does not work and it is not because of a bad battery.

The key fob uses one CR2032, 3V battery. Batteries should last approximately three years, depending on use. Consistently reduced range is an indicator that the battery needs replacement. Batteries are

available at most discount, hardware, and drug stores. The battery can be accessed by removing the cover of the key fob. After a new battery is installed, the key fob may need to be reprogrammed to pair with the vehicle.

Quantity	Type
1	CR2032

### How to replace key fob battery

If the key fob will not unlock the doors, replace the battery.

1. Remove the cover of the key fob.
2. Replace the battery and dispose of the old battery.
3. Check to see if the key fob is still paired to the vehicle. If not, reprogram the key fob.

### Programming Key Fobs

The key fob may need to be paired with the truck when the battery is replaced or when the key fob has not been used for an extended period of time.

1. Turn the ignition switch to the ON position.
2. Open the driver and passenger doors.
3. Press and hold the passenger door's unlock button for 5 seconds, then release the button.
4. Within 3 seconds press and hold the passenger door's lock button for 5 seconds, then release the button. At this time you should hear the vehicle cycle the locking system by unlocking, then relocking the doors. (This indicates that the door module has entered "learning mode.")
5. Within the next 10 seconds, press and hold the key fob's lock button for 5 seconds, (you should hear the vehicle lock the doors) then press and release the unlock button.
6. Once programming is complete (or the 10 seconds from Step 5 has passed), the vehicle will cycle the locking system twice (unlock, lock, unlock, lock). This process should be repeated for each fob to be paired with the module. A maximum of five key fobs may be paired to a single module.

## Engine Maintenance

These topics relate to the operator maintenance tasks for the engine. Information provided here is in addition to information contained in the Engine Operator Manual supplied with the vehicle.



### WARNING

Exhaust fumes from the engine contain carbon monoxide, a colorless and odorless gas. DO NOT breathe the engine exhaust gas. A poorly maintained, damaged, or corroded exhaust system can allow carbon monoxide to enter the cab. Entry of carbon monoxide into the cab is also possible from other vehicles nearby. Failure to properly maintain your vehicle could cause carbon monoxide to enter the cab, resulting in personal injury or death.





**WARNING**

NEVER start or let the engine run in an enclosed, unventilated area. Exhaust fumes from the engine contain carbon monoxide, a colorless and odorless gas. Carbon monoxide can be fatal if inhaled. Failure to comply may result in property damage, personal injury, or death.



**WARNING**

Never idle your vehicle for prolonged periods of time if you sense that exhaust fumes are entering the cab. Investigate the cause of the fumes and correct it as soon as possible. If the vehicle must be driven under these conditions, drive only with the windows open. Failure to repair the source of the exhaust fumes may result in death, personal injury, equipment or property damage.



**NOTE**

Keep the engine exhaust system and the vehicle's cab ventilation system properly maintained. It is recommended that the vehicle's exhaust system and cab be inspected (1) By a competent technician every 15,000 miles (24,140 km); (2) Whenever a change is noticed in the sound of the exhaust system; or (3) Whenever the exhaust system, underbody, or cab is damaged.

**Check Engine Oil Level**



**WARNING**

Hot engine oil can be dangerous. You could be burned. Let the engine oil cool down before changing it. Failure to comply may result in death, personal injury, equipment or property damage.



**NOTE**

It takes approximately 15 minutes for all the oil to run into the sump when the engine is warm. If the level is checked immediately after switching off the engine, the dipstick will show a low oil level.

1. Make sure that the vehicle frame rail is standing on a flat and level surface.
2. Make sure that the vehicle is horizontal, both lengthwise and crosswise. Check this carefully on a vehicle with air suspension. Note that the engine may be inclined up to 4 degrees, depending on the vehicle model and wheelbase.
3. Twist the dipstick handle to unlock it, then pull the dipstick out of the holder.

5

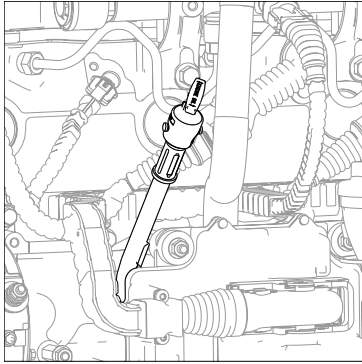

4. Wipe the dipstick clean with a lint-free cloth.
5. Place the dipstick back into the holder.
6. Pull the dipstick out again and check the oil level. The oil level should always be between the two marks on the dipstick.

#### Engine Oil Dip Stick Markings

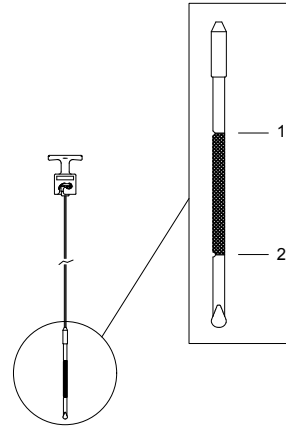

1. High oil level (1)
2. Low oil level (2)
7. Reinstall the dipstick and twist to lock it in place.

#### Topping Up the Engine Oil

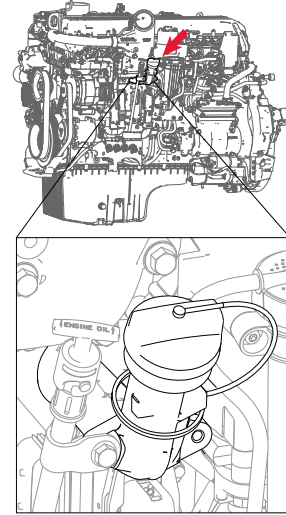

1. Top up with oil, if necessary, via the filler opening. Use the correct grade in the correct quantity. For oil replacement, please see engine Operator's Manual included with this chassis.
2. After topping up, wait 1 minute and check the oil level again.

- Reinstall the oil fill cap and twist to lock it in place.

### Pipe and Hose Clamp Torque Values

Torque specifications for engine parts.

Application	Type of Clamp	lb-in.	N•m
Radiator and Heat Exchanger Hoses	Constant Torque CT-L	90-110	10.2-12.5
Heater Hoses	Constant Tension	not required	not required
Air Intake Pipes	Hi Torque HTM-L	100-125	11.3-14.2
Plastic Air Intake Pipes	Constant Torque CT-L	88	10.0
Charge Air Intake Hoses	Flex Seal	70-100	7.9-11.3
	B9296	50-60	6-7
Fuel, Oil and Water Heat Exchangers (for hoses less than 9/16 in. diameter).	Miniature 3600L	10-15	1.1-1.7

### Install Engine Belt

You can extend the reliability and service life of your vehicle's drive belts with proper attention to installation and maintenance. Neglect could cause belt failure. The result could be the loss of the electrical or air system as well as possible engine damage from overheating.



#### NOTE

See the engine manufacturer's operator's manual for further information on replacing engine drive belts.

The images below may not appear like the configuration of the vehicle. The procedure

is still the same. Follow this procedure to install an accessory drive belt:

- Route the new belt around the pulleys, and then rotate the automatic tensioner so that the idler pulley swings toward the belt routing. The following figure shows an example of the rotation direction to release the tensioner.

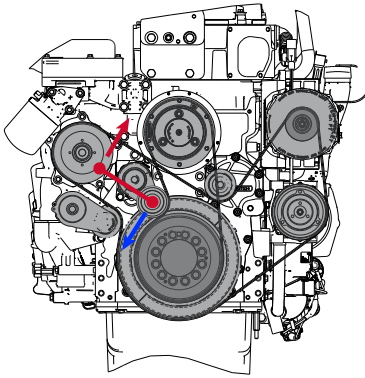

2. Slip the belt around the idler pulley attached to the automatic tensioner.
3. Release the automatic tensioner.
4. Check the belt alignment on each pulley. The belt must fall between the flanges of each pulley.

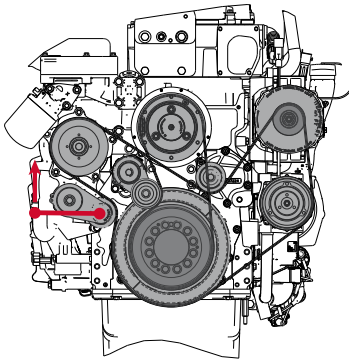

### Engine Fan



#### WARNING

DO NOT work on or near the fan with the engine running. Anyone near the engine fan when it turns on could be injured. If it is set at MANUAL, the fan will turn on any time the ignition key switch is turned to the ON position. In AUTO, it could engage suddenly without warning. Before turning on the ignition or switching from AUTO to MANUAL, be sure no workers are near the fan. Failure to comply may result in death or personal injury.

Follow these guidelines to check your engine fan:

- With the engine shut off, check the fan hub bearings for looseness, loss of lubricant, and any abnormal

conditions (e.g. fan belt misaligned or excessive wear/damage, etc.).

- With the engine idling and the hood open, stand at the front of the vehicle. Listen for any noises coming from the fan hub. Bearings that have lost lubricant and are dry will typically emit a squeal or a growl when the engine is at operating temperature and the fan clutch is engaged. If noise is detected, have the fan bearings inspected by an authorized dealership.

### Engine Fan Blade

Verify that there is enough fan blade clearance with the fan shroud. The recommended distance around the fan shroud is 1 in. (25 mm) from front edge of any fan blade-to-radiator side member. Minimum clearance is 3/4 in. (19 mm).

- Rear edge of any blade must be no closer than 3/8 in. (9 mm) to the nearest engine component. If this cannot be obtained, the fan spacer or fan is incorrectly placed.
- The leading edge of any fan blade must be 1 in. (25 mm) from the inside edge of the shroud.

## Air Intake System

Engine heat, vibration, and age combine to loosen air intake connections and cause cracks in the tubing and elbows. Leaks in the intake system allow abrasive dust to enter the engine and quickly cause expensive damage. During your daily walk-around inspection, carefully check all tubing, elbows, clamps, supports, and fasteners for condition and tightness. Check the charge-air-cooler for air leaks annually. The air leaks can be caused by cracked tubes or header. For service see your authorized dealer.



### CAUTION

DO NOT use air intake pipes and connections as a step or to pull yourself up. This could loosen the connections and open the system to unfiltered air which could damage the engine.

## Turbocharger



### WARNING

DO NOT operate engine with turbocharger intake piping disconnected. A suction is created when the engine is running. This suction could draw your hand or anything else near it into the impeller fan. You could be injured. Always keep the intake piping connected when you will be running the engine.

When servicing the air intake and exhaust systems on a turbocharged engine, check the items listed below:

### Lubricating System

Check the oil lines, housing, and connections. Look for leaks, damage, or deterioration. Leaks could mean you have damaged oil lines or oil seals.

### Manifold

With the engine operating, check for leaking manifold or flange gaskets.

### High Frequency Vibration

Vibration may indicate turbo rotor imbalance. Have your dealer investigate

this immediately. If you detect any deficiencies, take the vehicle to an authorized dealer for servicing. Delay could lead to severe and expensive damage to your vehicle.

## How to Replace the Engine Air Filter

Engine air filter replacement should be performed with the vehicle parked, the ignition **OFF**, and the parking brake set.

1. Open the hood to access the engine air cleaner, located on top of the engine.
2. Using a wrench, loosen to disengage the (4) bolts securing the filter housing cap to the filter housing.
3. Pull the air filter housing cap away from the main enclosure to access the filter.
4. Visually inspect the filter housing, enclosure, and hardware for damage.  
*If damaged, replace the air cleaner.*
5. Gently, pull filter directly out of the filter housing, taking care to not drop or tap filter on housing during removal.

*Loose dirt and dust trapped in the filter can fall into the cleaner, which can lead to engine damage.*

6. Inspect, and if necessary (and using **ONLY** a clean, damp cloth) clean out any debris inside the filter housing. Be careful to not push any contaminate into the engine inlet.
7. Visually inspect the new filter prior to installation. There should not be any damage to the filter media or gaskets, such as dents, dings, cracks, or holes.
8. Install new filter element, then inspect element for a good seal and proper alignment.
9. Install the filter housing cap and tighten the bolts to 88 in-lb (10 n·m) max. **DO NOT** use the housing cap to drive the filter into position.
10. Verify housing cap is secure.

Close and secure hood.

### Air Filter Restriction Indicator (Option)

An Air Filter Restriction Indicator may be installed on the air filter housing or air induction piping for access to clean, filtered air.

As the filter plugs and restriction increases, a red indicator will appear in a window on the indicator. When red appears, the air filter should be replaced. The indicator can be reset by pressing the button at the end of the indicator.

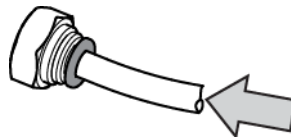
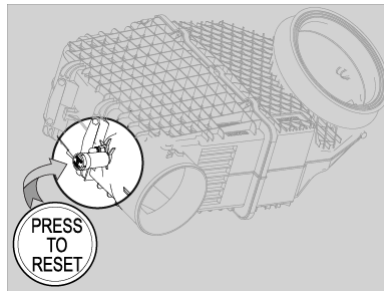

PUSH  
(EMPUJAR;  
POUSSER)

### Exhaust System

The exhaust system is part of the noise and emission control system. Periodically

check the exhaust system for wear, exhaust leaks, and loose or missing parts. For details on how to maintain the emissions components in the exhaust system, see "Noise and Emission Control" in your vehicle operator's manual. Please refer to the engine operator's manual for more details on how to maintain the emissions components in the exhaust system.

### Engine Mounting



#### CAUTION

DO NOT re-torque or reuse existing flange head bolts. These bolts are factory set to the specified torque. If bolts are loose or damaged, they must be replaced with the new bolts. Failure to comply may result in property damage.

Periodic Inspection: Inspect engine mounts every 60,000 miles (96,000 km). Check for the following:

- Inspect both mount and leg fasteners. Check for loose or broken bolts. Replace as necessary.

- Check mount and leg for fractures, breaks or deformation. Replace as necessary.
- Check for complete insertion of motor mount. Replace as necessary.
- New leg to mount flange head bolts should be torqued to 210-230 lb-ft (284-311 N·m).

## Frame



### WARNING

DO NOT cut, splice or weld frame rails or drill through the top or bottom flanges of the rails. These operations could affect frame rail strength leading to a failure resulting in an accident. Rail failures resulting from such modifications are not warrantable. Failure to comply may result in property damage, personal injury, or death.



### WARNING

Frame welding is NOT recommended. The high heat of welding nullifies the special heat treatment of the rails, greatly reducing the tensile strength of the frame rail. If a frame member becomes cracked from overloading, fatigue, surface damage, or a collision, the only permanent repair is to replace the damaged frame member with a new part.

### Emergency Welding

In an emergency, a temporary repair may be performed. Observe the following precautions to protect electronic systems during welding operations. Emergency welding procedures are further explained in the maintenance manuals. Please refer to the ordering information on the back cover to obtain a maintenance manual. In the event of emergency welding of a frame rail and when welding any other part of your truck or any component attached to your truck, observe the following precautions before welding:

- Disconnect all electronic devices. It is not possible to list all of the

electronics that could be affected, but a few examples include the following: alternator, engine Electronic Control Unit (ECU), transmission ECU, ABS ECU, navigation devices, diagnostic devices, and monitoring devices.

- Disconnect battery cables and insulate them from the vehicle.
- Do not use the ECU or engine ground stud for the ground of the welding probe.
- Ensure that the ground connection for the welder is as close to the weld point as possible. This ensures maximum weld current and minimum risk to damage of electrical components on the vehicle.

### Painting

Do not electrostatically paint your truck or any component on your truck without first removing all of the electronic components from the truck. It is not possible to list all of the electronics that could be affected, but a few examples include the alternator, engine Electronic Control Unit (ECU), transmission ECU, ABS ECU, navigation

devices, diagnostic devices, and monitoring devices.

### Fifth Wheel Monthly Maintenance

- Refer to specific manufacturer's literature for any special instructions
- Steam clean the fifth wheel
- Check lock guard operation using a commercial lock tester
- Clean and oil all moving parts
- Lubricate the lock mechanism with a lithium-base grease
- All grease fittings (especially those which grease the top surface of the fifth wheel)

### Fifth Wheel Bi-Annual Maintenance

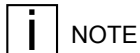

**NOTE**

Whenever possible, torque all frame fasteners on the nut end, not the bolt head.

- Refer to specific manufacturer's literature for any special instructions.

- Remove fifth wheel from vehicle. Refer to the Shop Manual, "Fifth Wheel Removal."
- Steam clean the fifth wheel and mounting brackets.
- Check all moving parts for excessive wear or damage. Replace all worn or broken parts.
- Complete two-month service procedure.
- Install fifth wheel. Refer to the Shop Manual, "Fifth Wheel Installation."

Tighten all frame fasteners with a torque wrench. See [Frame Fastener Torque Requirements](#) on page 306.

### Sliding Fifth Wheels

Lubricate bearing surface of support bracket through the grease fittings on the side of the fifth wheel plate. Use a water resistant lithium-base grease.



**NOTE**

The plate must be lifted up slightly to relieve the weight of the bracket while applying grease.

## Fuel System

### Location of Fuel Shut-off Valves

Fuel shut-off valves for the fuel crossover line are on the bottom of the secondary fuel tank, at the crossover line connection. They are optional on the primary fuel tank.

### Specification

Use only diesel fuel as recommended by engine manufacturers.



**WARNING**

Diesel fuel in the presence of an ignition source could cause an explosion. A mixture of gasoline or alcohol with diesel fuel increases this risk of explosion. DO NOT remove a fuel tank cap near an open flame. Use only the fuel and/or additives recommended for your engine. Failure to comply may result in death, personal injury, equipment or property damage.





**CAUTION**

If anyone ever pours gasoline into your fuel tank, drain the entire system. Otherwise, the pump and engine will be damaged. DO NOT try to dilute the gasoline by adding diesel fuel (see Warning above).

**Fuel Filters**

See Engine Manufacturer's Operator Manual provided with this chassis.

**Fuel Tank**

Check the strap tightness: tighten to proper torque value as required; aluminum tank - 30 lb-ft (41 N·m) cylindrical steel tank - 8 lb-ft (11 N·m.)

**Front Axle and Suspension**

**Axle Lubrication**

Refer to the axle manufacturer's operator's manual for lubrication specifications and service intervals.

**Kingpin Lubrication**

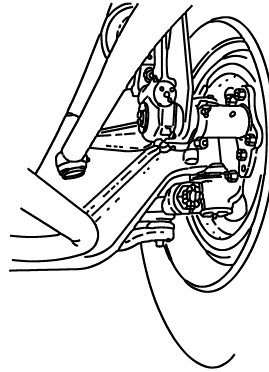

Lubricate with approved lubricant. Lubricate knuckle thrust bearings, knuckle pins, and tie rod ends. Lack of lubrication causes premature wear and hard steering. Lubrication schedule may be shortened if necessary.

**Suspension Lubrication**

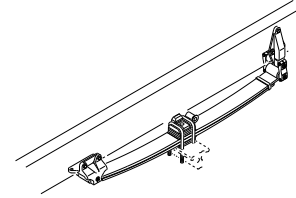

Each standard spring anchor pin has a grease fitting. Pressure lubricate spring pins as specified. At regular intervals, the spring leaves may be lubricated with a rust-inhibiting oil applied with a spray gun or brush. Depending on your suspension, lubricate all spring pins until grease flows out of both ends of the bushing. Look for signs of rust or water in the flushed grease. If a pin will not accept grease, it should be removed, cleaned, and inspected.



**CAUTION**

DO NOT spray the suspension with chemical products or mineral oil; it can cause damage to the bushings.

### Inspection

For all vehicles, mandatory maintenance procedures include retightening all U-bolts and inspecting the suspension for loose, damaged, or abnormally worn fasteners. Visually inspect the shock absorbers, the rubber bushings, the leaf springs, and that the suspension is aligned and functioning properly. Mono leaf spring suspensions should also have their rear shackle brackets checked for proper alignment. Even with proper maintenance, however, the service life of leaf springs are affected by many factors: fatigue, vehicle gross weight, type of load, road conditions, and vehicle speed. Check for cracks, wear marks, splits, or other defects on the surface of the spring. Defective parts must be replaced. Because repaired springs cannot be fully restored to their original service life, replace the complete assembly if cracks or other defects are detected.

### Wheel Alignment

For driving safety and comfort, and to prolong the life of your vehicle, it is important to have wheels correctly aligned. Check tire wear frequently. Uneven tire wear is a sign that the wheels may be misaligned. If you see uneven wear, take

your vehicle to an authorized dealer familiar with aligning wheels on your vehicle.

### Suspension U-Bolts

It is important that U-bolts remain tight. Severe use of your vehicle will cause them to loosen faster, and all vehicles need to have their U-bolts checked and tightened regularly. Be sure someone with the proper training and the right tools checks and tightens the U-bolts on your vehicle. New springs can settle in after service, relieving the tension on the U-bolts. Loose U-bolts can cause leaf spring breakage, axle misalignment, hard steering, and abnormal tire wear. All vehicles should have suspension U-bolts tightened after the first 500 miles (800 km) of operation. Re-torque the front spring pinch bolts and shackle pinch bolts.



#### WARNING

DO NOT operate the vehicle if the suspension U-bolts are not properly tightened. Loose U-bolts will cause the axle to not be properly secured to the suspension, which could cause loss of

vehicle control and an accident. Loose U-bolts can also cause uneven tire wear and poor alignment. Failure to comply may result in death, personal injury, equipment or property damage.

U-bolts are difficult to tighten unless you have the right equipment. If you cannot tighten them correctly yourself, be sure to have them checked and tightened regularly by an authorized mechanic. Tighten U-bolt nuts to the specified torque value with the vehicle loaded to its normal gross weight. See [Suspension U-Bolts, Grade 8](#) on page 307 specifications for torque values applying to U-bolts and nuts.



**WARNING**

DO NOT replace U-bolts and nuts with common U-bolts or standard nuts. These parts are critical to vehicle safety. If the wrong U-bolts or nuts are used, the axle could loosen or separate from the vehicle and cause a serious accident. Use only U-bolts and nuts of SAE Grade 8 specification or better. Failure to comply may result in death, personal injury, equipment or property damage.

**PACCAR 20k Front Axle Lubrication**

Proper lubrication practices are important in maximizing the service life of the steer axle assembly.

**Kingpins, Thrust Bearings, and Tie Rod Ends**

**On-Highway Applications - Standard**

- Pressure lubricate every 6 months or 25,000 miles (40,000 km).

- A more frequent lubrication cycle is required for axles used in on/off-highway, refuse, or other severe service applications. Use heavy-duty, multipurpose lithium base (#2 grade) grease.



**NOTE**

DO NOT mix with sodium-based grease.

PACCAR 20k Front Axle Lube Points

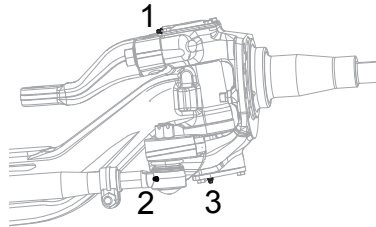

1. Upper kingpin bearing
2. Tie rod end
3. Lower kingpin bearing



**NOTE**

If it is difficult to grease either the upper or lower bearing, try greasing the bearings with the vehicle jacked up and supported on axle stands to improve grease flow and flush contamination.

**Oil Bath**

Lubricate wheel end assembly with a drive axle lubricant that meets MIL-L-2105D specifications. Either SAE 80W-90 mineral based or 75W-90 synthetic gear oil is acceptable. Check the lubricant level at each greasing interval. Maintain the lubrication fluid level at centerline of axle or fill line on hub cap. Always check fluid level on flat ground.



**CAUTION**

Never mix oil bath and grease-packed wheel ends. Mixing oil and grease will reduce the effectiveness of both lubricants and may cause damage to the wheel ends.

## Heater and Air Conditioner Maintenance

The combination heater-air conditioner provides comfort for those in the cab through accurate control of the cab environment in all weather conditions. Regular attention to the items below will help you keep the heater-air conditioner unit running well. Keep the vehicle's ventilation system, engine exhaust system, and cab joints properly maintained. It is recommended that the vehicle's exhaust system and cab be serviced by a competent technician as follows:

- Inspected every 15,000 miles
- Whenever a change is noticed in the sound of the exhaust system
- Whenever the exhaust system, vehicle underbody, or cab is damaged

To allow for proper operation of the vehicle ventilation system, proceed as follows:

- Keep the inlet grille at the base of the windshield clear of snow, ice, leaves, and other obstructions at all times.

- Keep the exhaust pipe area clear to help reduce the buildup of exhaust gas under the vehicle.
- Check the drain tube of the fresh air inlet for trapped water before assuming that there is a leak in the heating system.

### Special Precautions



#### WARNING

Excessive heat may cause the pressurized components of the air conditioning system to explode. Never weld, solder, steam clean, or use a blow torch near any part of the air conditioning system. Failure to comply may result in death, personal injury, equipment or property damage.



#### WARNING

Air conditioning refrigerant can be hazardous to your health. DO NOT expose yourself to leaking refrigerant for prolonged periods near excessive heat, open flames, or without proper

ventilation. Failure to do so may result in death or personal injury.

If a refrigerant leak develops in the presence of excessive heat or an open flame, hazardous gases may be generated. If you become aware of a refrigerant leak on your vehicle have your system serviced immediately and observe the following precautions: Stay away from the hot engine until the exhaust manifold has cooled. Do not permit any open flame in the area. Even a match or a cigarette lighter may generate a hazardous quantity of poisonous gas. Do not smoke in the area. Inhaling gaseous refrigerant through a cigarette may cause violent illness.

**Heater**

 **CAUTION**

During extreme cold weather, DO NOT blow hot defroster air onto cold windshields. This could crack the glass. Turn the Air Flow Control Dial to Defrost and adjust the fan speed accordingly while the engine warms. If the engine is already warm, move the Temperature Control Dial to "cool," then gradually increase the temperature when you see that the windshield is starting to warm up. Failure to comply may result in equipment damage.

- Check all heater controls for full-range operation.
- Check hoses, connections, and heater core for condition and leaks.

**Air Conditioner**

 **WARNING**

The air conditioning system is under pressure. If not handled properly during servicing, it could explode. Any servicing that requires depressurizing

and recharging the air conditioning system must be conducted by a qualified technician with the right facilities to do the job. Failure to comply may result in death, personal injury, equipment or property damage.

 **WARNING**

Wear eye protection any time you blow compressed air. Small particles blown by compressed air could injure your eyes.

- Listen to the compressor and drive clutch for noise and vibration. If you find problems, have the system checked thoroughly. A malfunctioning clutch usually indicates trouble elsewhere in the system.
- Check the evaporator core, filter, and condenser core for debris restricting air flow. Clean if necessary. Small particles may be removed with compressed air blown through the core in the opposite direction of normal air flow.

- Check the engine belt for condition and proper tension.
- Check all hoses for kinks, deterioration, chafing, and leaks. Adjust kinked or chafing hoses to eliminate restrictions and prevent further wear.
- Check all components and connections for refrigerant leaks. If you discover a leak, do not try to tighten a connection. Tightening a connection may cause a leak to worsen. Have a qualified technician correct the problem.

 **NOTE**

A leaking evaporator or condenser core cannot be repaired; it must be replaced.

Have the air conditioning system fully serviced annually by your authorized dealer. Qualified service technicians will have to evacuate and recharge the system.

### How to Replace Air Conditioner Filter

Inspect and clean cab air filter element every 3-6 months of service. Depending on the operating environment, if air flow from the air conditioner and heater is less efficient or windows fog easier, you may need to replace the cab air filter.

1. Tilt the hood open.
2. Locate air intake housing at passenger rear corner of vehicle under the rain tray.
3. Locate filter cover labeled "OPEN" with an arrow pointing rearward in vehicle. Slide filter cover rearward in vehicle until you are able to remove the cover.
4. Remove and inspect filter referring to maintenance interval schedule.
5. Replace filter in housing taking care to align the airflow direction that is indicated on the side of the side of the filter element with the airflow direction that is clearly marked on the air intake housing.
6. Replace the filter cover on the air intake housing and slide the cover forward in vehicle. An audible snap sound can be heard when the cover is correctly in place. If the

snap feature is damaged there are two screw features that may be utilized to retain the cover in place.

7. Close and secure hood of vehicle.

### Replace the Recirculation Air Filter

Please contact an authorized dealer when the service interval is required to inspect the cabin recirculation air filter.

### Sleeper HVAC Air Filter

1. Lift the sleeper bunk to expose the sleeper HVAC module.
2. Find the retention tab at the side of the filter element and move it to release the filter. Moving this tab will allow the filter to be removed in an upward direction.
3. Align the airflow direction that is indicated on the side of the filter element such that it points into the HVAC housing.
4. Insert the filter and make sure the retention tab has re-engaged to secure the filter.
5. Close the bunk.

## Noise and Emission Control

There are specific components on the vehicle that are designed to meet certain Environmental Protection Agency (EPA) emissions and noise regulations. To maintain conformance with the regulations, these components need to be functional and properly maintained.

### Noise Emission Warranty

Peterbilt warrants to the first person who purchases this vehicle for purposes other than resale and to each subsequent purchaser that this vehicle as manufactured by Peterbilt, was designed, built, and equipped to conform at the time it left Peterbilt's control with all applicable U.S. EPA Noise Control Regulations. This warranty covers this vehicle as designed, built, and equipped by Peterbilt, and is not limited to any particular part, component, or system of the vehicle manufactured by Peterbilt. Defects in design, assembly, or in any part, component, or system of the vehicle as manufactured by Peterbilt, which, at the time it left Peterbilt's control, caused noise

emissions to exceed Federal standards, are covered by this warranty for the life of the vehicle.

### Tampering with Noise Control System

Federal law prohibits the following acts or the causing thereof:

1. The removal or rendering inoperative by any person other than for purposes of maintenance, repair, or replacement, of any device or element of design incorporated into any new vehicle for the purpose of noise control prior to its sale or delivery to the ultimate purchaser or while it is in use, or
2. The use of the vehicle after such device or element of design has been removed or rendered inoperative by any person. Among those acts presumed to constitute tampering are the acts listed below:

<b>Air Intake System</b>	Removing or rendering inoperative the air filter housing/silencers or intake piping
<b>Engine Cooling System</b>	Removing or rendering the fan clutch inoperative Removing the fan shroud

**Engine** Removing or rendering engine speed governor inoperative so as to allow engine speed to exceed manufacturer's specifications  
Modifying ECU parameters

**Exhaust System** Removing or rendering inoperative exhaust system components

**Fuel System** Removing or rendering engine speed governor inoperative, allowing engine speed to exceed manufacturer's specifications  
Removing of air signal attenuator on engines equipped with this device  
Removing of diesel exhaust fluid tank and system

**Inner Fender Shields and Cab Skirts** Removing shield or skirts  
Cutting away parts of shields, skirts or damaged or loose portions of shields or skirts

**Noise Insulating Blankets** Removing noise insulators from engine block or from around the oil pan  
Cutting holes in, or cutting away part of noise insulators  
Removing hood-mounted noise insulation

### Inspecting Noise and Emission Components

If, during periodic inspection and maintenance of other systems and components, it is found that parts of the noise control system require attention, we recommend that those parts be inspected at more frequent intervals to assure adequate maintenance and performance. The following instructions are based on inspection of the noise control system at regular intervals as indicated in the [Noise Control System - Maintenance Log](#) on page 282.

#### Air Intake System

- Do all checks and maintenance procedures listed in this manual under engine air intake system and air filter housing.
- Check the induction tubing, elbow connections, clamps, brackets, and fasteners for deterioration, cracks, and security.
- If you find an air leak anywhere between the air filter housing and the engine, repair that leak immediately.



**CAUTION**

Air leaks cause excessive noise and may result in serious damage to the engine. If you do not repair them the engine damage will not be covered by your warranty. Repair all air leaks as soon as you find them.

**Engine Mounted Noise Insulators**

- Check condition. Is the insulator secure? How you do this will depend on the method of attaching the noise insulators on the engine and around the oil pan (bolts, snap fasteners, or straps). Tighten loose fasteners and repair or replace any worn or damaged fasteners.
- Check insulators around fasteners and stress points, especially where they may be affected by engine vibration. Repair any cracked or damaged mounting points. Use suitable reinforcing plates to ensure that the insulators will remain in position.

**Exhaust System**

- Check for exhaust leaks, which would indicate a leaking manifold

gasket; replace gasket if necessary.

- Check cap screws for tightness, including those at the flanges. Refer to the engine manufacturer's service manual for proper tightening sequence and torque values.

**Joints and Clamps**

- Check for leaks, and tighten as necessary. Check for deterioration or dents in pipes and clamps which could allow exhaust to escape.
- Replace any serviceable joints, flexible pipes and gaskets at the service intervals.

**Selective Catalysts Reduction (SCR)**

- Check SCR canister filter, clamps and mounting brackets. Tighten if necessary. Inspect SCR canister for signs of rust or corrosion.

**Exhaust Piping**

- Check exhaust piping for rust, corrosion, or damage. Replace deteriorated piping before holes appear. If piping is perforated at any point, temporary patching or lagging is acceptable until you can have permanent repairs made. On turbocharged engines, check joints

at flanges and mounting brackets for tightness.

**Diesel Particulate Filter (DPF)**

- Check DPF, clamps, and mounting brackets. Tighten if necessary. Inspect DPF for signs of rust or corrosion.
- Check internal baffling. You can do this by listening for rattling sounds while tapping on the (DPF with a rubber mallet or revving the engine up and down through its normal operating range.

DEF Tank (See Aftertreatment System manual)

Exhaust Tail Pipe

Engine Fan and Shroud

Hood Insulation Blanket

Inner Fenders Shields and Cab Skirts

**Noise Control System - Maintenance Log**

To ensure your vehicle's noise control requirements are maintained, record maintenance checks. Use the following log sheet and retain copies of documents regarding maintenance services performed and parts replaced on the vehicle.



Component	Recommended Interval (Miles)	Date & R.O. No.	Repair Facility & Location	Work Performed	Date & R.O. No.	Repair Facility & Location	Work Performed
Exhaust System Routing Integrity	25,000						
Shutters Shrouds	25,000						
Hood Insulation Blanket	10,000						
Engine Mounted Hose Insulators Fasteners	10,000						
Inner Fender Shields	50,000						
Cab Skirts Fasteners	50,000						
Air Intake System Integrity Element	5,000						
Clutch-type Fan Drive	10,000						

### Diesel Exhaust Fluid (DEF) Tank Straps

During normal operation of the truck, the DEF tank straps may relax. Inspect the

spring on top of the strap. If more than 1/2" (12.7mm) of the spring is exposed, the bolt will need to be re-torqued between 70 – 80 in-lbs. (7.9 – 9 Nm). This distance (1) is measured from the washer at the end of the spring to the edge of the tube at the top of the straps.

5

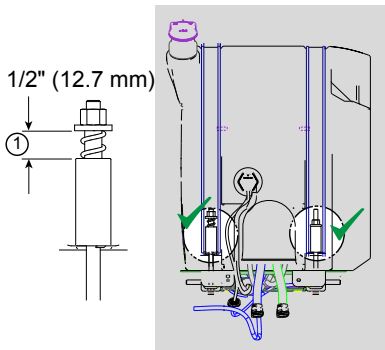

See Engine Operator's Manual for DEF filter maintenance interval.

## Rear Axle and Suspension

Your vehicle's suspension, by design, requires a minimal amount of maintenance. However, suspensions in over-the-road operations require periodic inspection to ensure trouble-free performance.



### WARNING

DO NOT work on the vehicle without the parking brake set and wheels

blocked securely. If the vehicle is not secured to prevent uncontrolled vehicle movement, it could roll and may result in death, personal injury, equipment or property damage.



### WARNING

DO NOT operate the vehicle if the suspension U-bolts are not properly tightened. Loose U-bolts will cause the axle to not be properly secured to the suspension, which could cause loss of vehicle control and an accident. Loose U-bolts can also cause uneven tire wear and poor alignment. Failure to comply may result in death, personal injury, equipment or property damage.



### WARNING

Failure to maintain the specified torque values or to replace worn parts can cause component system failure, possibly resulting in an accident. Improperly tightened (loose) suspension U-bolts can lead to unsafe vehicle conditions, including: hard steering, axle

misalignment, spring breakage or abnormal tire wear. Failure to comply may result in death, personal injury, equipment or property damage.



### CAUTION

DO NOT spray the suspension with chemical products or mineral oil; it can cause damage to the bushings.



### NOTE

Failure to follow these recommendations could void warranty.

## Visual Inspection

For all vehicles, mandatory maintenance procedures include retightening of U-bolts and complete inspection. Even with proper maintenance, however, many factors affect the service life of springs and suspension components: fatigue, vehicle gross weight, type of load, road conditions, and vehicle speed. All vehicles need to have their U-bolts checked and tightened regularly, but severe use of your vehicle can cause them to loosen faster. It is important that U-bolts

remain tight. Be sure someone with proper training and the right tools checks and tightens the U-bolts on your vehicle. After the first 500 miles (800 km) of operation, periodically inspect the suspension as noted below:

- Visually check for loose or missing fasteners, cracks in hanger, or axle connection brackets
- Check that springs are centered in hangers and in good condition
- Check for cracks, wear marks, splits, or other defects on the surface of the spring
- Replace defective parts. Because repaired springs cannot be fully restored to their original service life, replace the complete assembly if cracks or other defects are detected
- After replacement of any part or discovery of loose components, check the torque of all fasteners
- New springs settle-in after the vehicle's initial service, causing the U-bolts to become loose

### Rear Suspension Fasteners

To maintain the performance of the air suspension, check fastener torque values

after the first 2,000 miles (3,200 km) of service and every 60,000 miles (96,000 km) thereafter. Torque recommendations apply to fasteners supplied and installed by vehicle manufacture. The values listed at the back of this chapter (See [Suspension U-Bolts, Grade 8](#) on page 307 and [Frame Fastener Torque Requirements](#) on page 306), are for cadmium plated or phosphate and oil fasteners only.

### Rear Suspension U-Bolts

U-bolts are difficult to tighten unless you have the right equipment. If you cannot tighten them correctly yourself, be sure to have them checked and tightened regularly by an authorized mechanic.

 <b>NOTE</b>
<p>To ensure an accurate torque reading, use properly maintained and calibrated torque wrenches. Clean the nut and bolt. No dirt, grit, or rust should be present.</p>

 <b>WARNING</b>
<p>DO NOT operate the vehicle if the suspension U-bolts are not properly tightened. Loose U-bolts will cause the axle to not be properly secured to the suspension, which could cause loss of vehicle control and an accident. Loose U-bolts can also cause uneven tire wear and poor alignment. Failure to comply may result in death, personal injury, equipment or property damage.</p>

 <b>NOTE</b>
<p>Whenever possible, torque all frame fasteners on the nut end, not the bolt head.</p>

Load the vehicle to its normal gross weight before tightening U-bolts. Loading the vehicle ensures proper adjustment of the U-bolt and spring assembly.



**WARNING**

DO NOT replace U-bolts and nuts with common U-bolts or standard nuts. These parts are critical to vehicle safety. If the wrong U-bolts or nuts are used, the axle could loosen or separate from the vehicle and cause a serious accident. Use only U-bolts and nuts of SAE Grade 8 specification or better. Failure to comply may result in death, personal injury, equipment or property damage.

5

**Rear Axle Lubrication**

See the axle manufacturer's operator's manual for lubrication specifications and service intervals.

Check oil level with the vehicle parked on level ground and the fluid warm. The level should be even with the bottom of the filler hole.

**Rear Axle Alignment**

Continual road shock and load stresses may force the rear axles out of alignment.

If you detect rapid tire wear on the rear axles, you may have misaligned axles. If you suspect rapid tire wear, have your rear axle alignment checked and adjusted by an authorized dealer.

Suspension alignment should be checked when any one of the following conditions exist:

- Total vehicle alignment required after a body has been installed on truck chassis.
- Discovery of loose suspension fasteners (Loose, defined as any torque below the recommended torque value)
- Discovery of elongated holes in a suspension component
- Bushing replacement
- Excessive or abnormal tire wear
- Immediately after post body installation (See First Day in the Maintenance Chapter)

**Drive Axle - Dana**

Drain the lubricant while warm. Flush each unit with clean flushing oil. Change the lubricant.

**Eaton/Dana Axle Lubrication**

- The original mineral-based lubricant must be drained within 3,000-5,000 miles (4,800-8,000 km) on all Eaton axles. This initial change is very important because it flushes out break-in contaminants that might otherwise cause premature wear.
- No initial drain is required on Eaton axles that are factory filled with an Eaton-approved synthetic lubricant.
- Mineral-based lubes must be drained within the first 5,000 miles (8,000 km) if converting to an Eaton-approved synthetic lube.
- Change the lubricant within the first 5,000 miles (8,000 km) of operation after a carrier head replacement, regardless of the lubricant type.
- Refer to the *Eaton Field Maintenance Manual* for a particular axle for lubricant specifications.
- See your dealer for Eaton-approved lubricant brands.
- Refer to the chart below for lubricant change interval.

Type of Lubricant	On-Highway Mi. (km)	Maximum Change Interval	On/Off Highway Severe Service Mi. (km)	Maximum Change Interval
Mineral-Based	120,000 (192,000)	Yearly	60,000 (96,000)	Yearly
Eaton-Approved Synthetic	240,000 (384,000)	2 Years	120,000 (192,000)	Yearly
Eaton-Approved Synthetic in axle with extended drain interval option	350,000 (560,000)			

**Meritor Axle Lubrication**

**Drive Axle - Meritor**

Drain and replace the lubricant.

	NOTE
Axles utilized in 100% off-highway use are not eligible for Meritor's Advanced Lube Rear Drive Axle program.	

Under Meritor's Advanced Lube Rear Drive Axle program, the axles listed below are exempt from an initial lubricant change:

**Available Advanced Lube Axles**

RS-19-145	RS-26-180	RT-40-145P	RT-46-160
RS-21-145	RS-30-180	SQ-100A	RT-46-160P
RS-23-160	RT-34-145	SQ-100AP	RT-52-160

RS-23-161	RT-34-145P	RT-44-145	RT-52-160P
RS-17-145	RS-23-180	RT-40-145	RT-44-145P

Meritor rear axles that do not appear on the list above will continue to require an initial drain at 3,000-5,000 miles (4,800-8,000 km).

- Refer to the *Meritor Field Maintenance Manual* for a particular axle for lubricant specifications.

- See your dealer for Meritor-approved lubricant brands.
- Refer to the following chart for lubricant change intervals:

Application	Type Of Lubricant	Mileage Interval
On Highway	Synthetic	240,000 mi. (384,000 km)
	Synthetic with Pump and Filter	500,000 mi. (800,000 km)
	Mineral Base	120,000 mi. (192,000 km)
City Delivery	Synthetic	120,000 mi. (192,000 km)
	Synthetic with Pump and Filter	240,000 mi. (384,000 km)
	Mineral Base	120,000 mi. (192,000 km)
Off Highway	Synthetic	120,000 mi. (192,000 km)
	Synthetic with Pump and Filter	120,000 mi. (192,000 km)
	Mineral Base	120,000 mi. (192,000 km)

- Change the lubricant filter every 120,000 miles (192,000 km). Top off the lubricant level with a similar lubricant

**Drive Axle - SISU Breather and Brakes**

1. Check the breather for proper operation.

2. Overhaul the brakes: degrease all moving parts, check the bushings and seals for wear.

**Drive Axle (SISU) Inspection**

1. Check the wheel bearing hubs and adjust if necessary.
2. Visually inspect for damage or leaks.

**Drive Axle (SISU) Oil Servicing**

Change the oil in the differential carrier and the hubs, and clean the magnetic oil drain plugs.

**Drive Axle - SISU Lube Filter**

Clean the suction filter for the optional pressure lubrication system.

**Steering System**

 **WARNING**

DO NOT operate the vehicle if the steering system is not working properly. You could lose control of your vehicle if the steering system is not in good working condition, which could result in a serious accident. For driving safety, visually check the steering gear and

components. Frequent checks are important for driving safety, especially after traveling over rough roads. Failure to comply may result in personal injury, property damage, or death.

 **WARNING**

If this chassis is equipped with an electronic stability system (ESC) and any part of the steering system (e.g., linkage, steering driveline, column, front end alignment, etc) is repaired, removed, or disassembled in any way, or if the steering angle sensor is replaced, the steering angle sensor must be recalibrated. Any repairs or adjustments to any part of the steering system must be performed by an authorized dealer. Failure to comply may result in personal injury, property damage, or death.

Hydraulic fluid (under low pressure) provides the power to operate the steering gear. It also serves to lubricate moving parts and remove heat. A loss of steering efficiency will occur if too much heat builds up in the system.

If the steering feels unbalanced from side-to-side while turning, check for the following possible causes:

- Unequal tire pressures
- Vehicle overloaded or unevenly distributed load
- Wheels out of alignment
- Wheel bearings improperly adjusted

If you cannot correct the problem, check with an authorized dealer.

Your vehicle is equipped with integral power steering. The system includes an engine-driven fluid pump, a fluid reservoir, the steering gear, and connecting hoses. Because of the hydraulic power assist, little effort is required to turn the steering wheel. When no input is applied through the steering wheel, the steering gear will return to the neutral position. If, for any reason, the power assist system goes out, steering the vehicle is still possible but it will require much greater effort.

Visually check the following parts:

- Crosstube: Is it straight?
- Drag link tube clamp: Check for looseness or interference
- Ball joints and steering U-joints: Check for looseness

- Steering wheel for excessive free-play. Check the simplest probable causes first: (A) unequal tire pressures; (B) loose cap nuts; (C) bent cross-tube; or (D) lack of lubrication

If these checks do not reveal the problem, or if you correct them and still have a steering problem, take your vehicle to an authorized dealer for evaluation.

### Check Power Steering Fluid Level

#### CAUTION

When adding fluid, be sure to use fluid of the same type. While many fluids have the same description and intended purpose, they should not be mixed due to incompatible additives. Mixing incompatible fluids may lead to equipment damage.

#### NOTE

Before removing reservoir cap, wipe the outside of the cap so that no dirt or debris falls into the reservoir.

Check the fluid level. Use the following procedure:

1. Park the vehicle on level ground and turn the engine off.
2. Open the hood.
3. Check the fluid level on the reservoir.

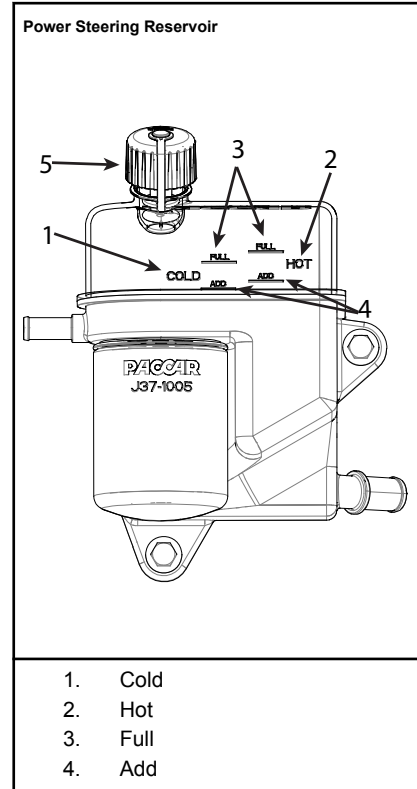



5. Fill cap

- If you check the fluid with the engine and steering system COLD, the fluid level should be above the Add indicator level and should generally not exceed the middle point between the Add and Full level indicators.
  - If you check the fluid with the engine and steering system WARM, the fluid should NOT exceed the Full level indicator and should generally not drop below the middle point between the HOT Full and Add level indicators.
4. To add fluid, open the fill cap to the power steering reservoir and then add fluid until the fluid level is in the middle of the appropriate Minimum and Maximum level indicators.
5. Reinstall the reservoir fill cap and close the hood.

**Steering Shaft Bolt Torque Specifications**

The steering (intermediate shaft) U-joint pinch bolt should be tightened on the first day or two of operation, then checked weekly (see Weekly Checks). The following are common torque specifications for most steering shafts.

**Steering U-joint Pinch Bolt**

Fastener Size	Torque Spec. lb-ft (N•m)
7/16 -in.	37-43 (50-58)

**Pitman Arm Clamp Bolt**

Fastener Size	Torque Spec. lb-ft (N•m)
3/4 -in.	300-320 (406-433)

 **WARNING**

If this chassis is equipped with an Electronic Stability Control (ESC) and is modified (e.g. adding or removing an axle, converting from a truck to a tractor, converting from a tractor to a truck, changing the body, lengthening of the wheelbase and/or frame, relocating frame components, or modifying pneumatic or electrical ABS/ESC harnesses) the ESC must be evaluated by a qualified technician. If you have any questions, contact your authorized dealer. Failure to comply may result in property damage, personal injury, or death.

**Driveline**

See the driveshaft manufacturer's operator's manual for lubrication specifications and service intervals.



**WARNING**

Improper lubrication of U-joints can cause them to fail prematurely. The driveshaft could separate from the vehicle and result in an accident. Make sure lubricant is purged at all four ends of each U-joint and loosen caps if necessary. Also, regularly inspect U-joints for excessive wear or movement, and repair or replace as necessary. Failure to comply may result in death, personal injury, equipment or property damage.

5

**Tires**

Your tires are a very important part of your vehicle's whole braking system. How fast you can stop depends mostly on how much friction you get between the road and your tires. In addition, keeping your tires in good condition is essential to the safe, efficient operation of your vehicle. Regular, frequent inspection and the right care will give you the assurance of safe and reliable tire

operation. Here are some tips on maintaining your tires.

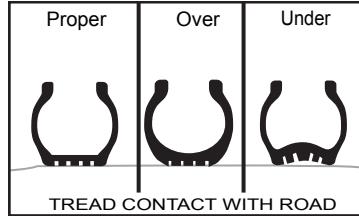

**WARNING**

DO NOT repair damaged tires unless you are fully qualified and equipped to do so. Wheel and tire assemblies cannot be worked on without proper tools and equipment, such as: safety cages or restraining devices. Have all tire repairs performed by an expert. Stand away from the tire assembly while the expert is working. Failure to do this may result in death or injury.

**Checking Inflation Pressure**

Low pressure is a tire's worst enemy. Underinflation allows tires to flex improperly, causing high temperatures to build up. Heat causes early tire damage

such as flex break, radial cracks, and ply separation. Low pressure may affect control of your vehicle, especially at the front wheels. Most tire wear problems are caused by underinflation as the result of slow leaks, so check tire pressure regularly. Lower tire pressure does not provide better traction on ice or snow. Give your tires a visual test every day, and check inflation with a gauge every week:

- When checking tire pressure, inspect each tire for damage to sidewalls, cuts, cracks, uneven wear, rocks between duals, etc. If a tire appears underinflated, check for damage to the wheel assembly. Don't forget to check between dual wheels. If you find wheel damage, have an expert tire service repair it.
- Maximum tire pressure will be indicated on the sidewall of a tire.
- Check pressure only when the tires are cool. Warm or hot tires cause pressure buildup and will give you an inaccurate reading. So never deflate a warm tire to the specified pressure.



**WARNING**

DO NOT operate a vehicle with under-inflated tires. The extra heat caused by underinflation can cause sudden tire failure such as a tire fire or blow out, which can cause an accident resulting in death or personal injury. Low pressure may affect control at the front wheels, which could result in an accident involving death or personal injury. Keep your tires inflated to the manufacturer's recommended air pressure.



**WARNING**

DO NOT attempt to raise the vehicle to remove or install a damaged tire and wheel assembly if you are not fully qualified and not equipped with the proper tools and equipment. DO NOT attempt to reinflate a tire that has been run flat. Obtain expert help. A person can be seriously injured or killed if using the wrong service methods. Truck tires and wheels should be serviced only by trained personnel using proper

equipment. Follow OSHA regulations per section 1910.177.



**NOTE**

Follow all warnings and cautions contained within the tire and wheel manufacturers literature.

**Overloaded Tires**

Overloading your truck is as damaging to your tires as underinflation. The following chart shows how neglect or deliberate abuse can affect the life of your tires.

**Effects of Load and Pressure on Tire Life**

Vehicle Load	Tire Pressure	Expected Total Tire Mileage
Normal	Normal	Normal
20% Over	20% Low	70%
40% Over	30% Low	50%

Vehicle Load	Tire Pressure	Expected Total Tire Mileage
60% Over	35% Low	40%
80% Over	45% Low	30%
100% Over	55% Low	25%

**Overinflated Tires**

Overinflating the tires reduces the tread contact area with the road surface, concentrating all of the vehicle weight on the center of the tread. This causes premature wear of the tire.



**WARNING**

Overinflated tires can cause accidents. They wear more quickly than properly inflated tires and are more subject to punctures, cracks, and other damage. They could fail and cause you to lose control of your vehicle resulting in an accident causing death or personal injury. Be sure all tires are inflated correctly according to the manufacturer's recommendations.

sizes will adversely affect the road holding ability of both types of tires and can lead to loss of vehicle control and causing death or personal injury.



**WARNING**

DO NOT install regrooved or reinforcement repaired tires on steering axles. They could fail unexpectedly and cause you to lose control of your vehicle resulting in an accident causing death or personal injury.

original tires. Doing so could lead to unintentional overloading of the tire, which could cause a failure resulting in loss of vehicle control and an accident. Failure to comply may result in death, personal injury, equipment or property damage.



**NOTE**

To prolong your tires' life and make them safer, have their radial and lateral run-out checked at your dealer. And of course you should have your tires balanced anytime you change a tire.

5

**Matching Tires**

Be sure to buy matched tires for your vehicle, especially on the rear axles. Mismatched tires can cause stress between axles and cause the temperature of your axle lubricant to get too hot. Matched tires will help your driveline last longer and will give you better tire mileage.



**WARNING**

DO NOT mismatch tires, it can be dangerous. Never mix tires of different design such as steel belted radials and bias ply tires, etc. Mixing tire types and

**Replacing Tires**

Front: Replace front tires when less than 4/32 -in. of tread remains. Check at three places equally spaced around the tire. Drive Axles or Trailers: Replace tires on drive axles or trailers when less than 2/32 -in. of tread depth remains in any major groove. Check at three places equally spaced around the tire.



**WARNING**

DO NOT replace original equipment tires with load ratings less than the

**Tire Chains**

If you need tire chains, install them on both sides of each driving axle.



**NOTE**

To prolong your tires' life and make them safer, have their radial and lateral run-out checked at your dealer. And of course you should have your tires balanced anytime you change a tire.

### Speed Restricted Tires



#### WARNING

This vehicle is equipped with speed restricted tires. Check each tire's sidewall and/or tire manufacturer's data book for maximum rated speed. The vehicle should not be operated at speeds in excess of the maximum rated speed. Failure to comply with these speed restrictions could cause sudden tire failure, which can result in property damage or personal injury.

### Greenhouse Gas Certified Tires



#### NOTE

The tires installed on this vehicle at the factory as original equipment are certified for Greenhouse Gas and Fuel Efficiency regulations. Replacement tires must be of an equal or larger loaded drive tire size and an equal or lower rolling resistance level (TRRL or Crr). Consult with your tire supplier(s) for appropriate replacement tires.

In order to limit the rolling resistance of the tires and optimize fuel economy, the maintenance procedures specified by the tire manufacturer must be followed. Please see Vehicle Emissions Limited Express Warranty for warranty on greenhouse gas certified tires.

### Wheels

After the vehicle travels about 50 to 100 miles (80 to 160 km), wheel mountings seat in and will lose some initial torque. Check hub/wheel mountings after this initial period and retighten. Threads should be clean and dry. Do not lubricate wheel nuts or studs.



#### WARNING

Never use oil or grease on studs or nuts; improper torque readings will result, which could cause improper wheel clamping and could lead to a wheel failure resulting in an accident. Failure to comply may result in death, personal injury, equipment or property damage.

### Wheel Replacement with Disc Brake Option



#### WARNING

Use only the wheel brand, size and part number originally installed. Use of a different wheel brand or size could cause valve stem to interfere with a brake component which could lead to loss of vehicle control. Failure to comply may result in death, personal injury, equipment or property damage.

Vehicles equipped with front disc brakes are fitted with wheels designed specifically for disc brake applications. If it ever becomes necessary to replace an original equipment wheel, the replacement wheel must be the same brand and size as the take-off wheel. On vehicles equipped with 22.5 in. disc wheels, installing the wrong replacement wheel could result in the wheel valve stem making contact with the disc brake assembly. When installing any replacement wheel, always inspect the tires/wheels to ensure there is adequate clearance between other vehicle components. With the hood open, check for clearance between the wheel and disc brake assembly. Use a hydraulic jack to

raise the front of the vehicle off the ground to allow the wheel to spin freely. While rotating the wheel, check to ensure there is adequate clearance between the wheel and disc brake assembly.



**WARNING**

Improperly mounting and demounting tire and rim assemblies is dangerous. Failure to observe proper precautions could cause the tire rim assembly to burst explosively, causing death or personal injury. See the wheel manufacturer's literature for the proper way to mount and demount your tires and rims. Follow their precautions exactly.



**WARNING**

Always ensure the hood hold open latch is engaged to keep the hood fully open any time anyone gets under the hood for any reason. Failure to do so may cause the hood to close uncontrollably which may result in death or personal injury.



**WARNING**

Always support the vehicle with appropriate safety stands if it is necessary to work underneath the vehicle. A jack is not adequate for this purpose. Failure to comply may result in death, personal injury, equipment or property damage.

**Disc Wheels**



**WARNING**

Use the correct components and tools when working on wheels. Grooves in the wheel disc or other damage to the disc can weaken the wheel and cause it to eventually come off. This could cause you to lose control of your vehicle, and may result in an accident. Failure to comply may result in property damage, personal injury, or death.

The end of the wheel wrench must be smooth. Burrs on the end of the wrench can tear grooves in the disc. These grooves may lead to cracks in the disc, and can cause it to fail.

**Wheel Bearings**

Service the bearings, seals and oil. This interval may be different depending on the results of the regular inspection. 350,000 mi (560,000 km). For safe, reliable operation and adequate service life, your wheel bearings must be adjusted properly at the recommended intervals. Contact your authorized dealer to make sure the wheel bearings are properly adjusted.

## Tightening Wheel Cap Nuts



### WARNING

Tighten wheel cap nuts properly. If they are not tightened properly, wheel nuts could eventually cause the wheel to become loose, to fail, and/or to come off while the vehicle is moving, possibly causing loss of control and may result in death, personal injury, equipment or property damage.

### Hub Piloted Disc Wheels

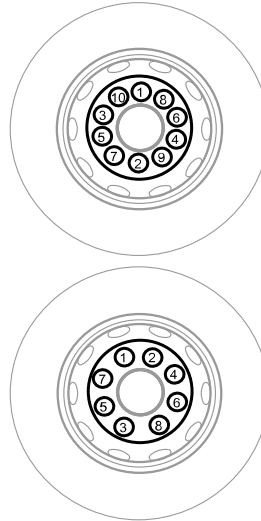

Proper wheel torque can best be obtained on level ground. Install lug nuts and finger-tighten in the numerical sequence as shown below. This procedure will ensure that the wheel is drawn evenly against the hub. Contact an authorized dealer for information on the proper installation procedure for the wheels on your truck.

This is a job you may not be able to do yourself. You need the right torquing equipment to do it.

### Stud Piloted Disc Wheels

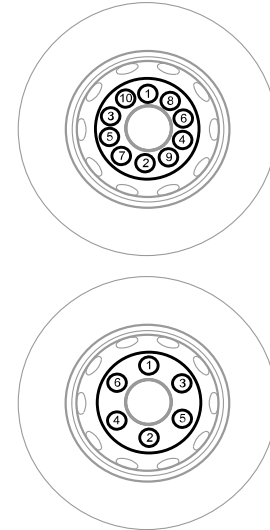

## Windshield Wiper/Washer

The windshield wiper system is designed to be maintenance-free. Check wiper blades annually, every 60,000 miles (96,000 km), or when they begin to show signs of wear.



### CAUTION

DO NOT use antifreeze or engine coolant in the windshield washer reservoir, damage to seals and other components will result.

### Washer Reservoir

Daily: Check reservoir water level, located in the engine compartment. If necessary, refill to the proper level.

### How to Refill the Washer Fluid Reservoir

1. Park the vehicle and apply the parking brakes
2. Open the hood and secure it in the open position

3. Locate the washer fluid reservoir and open the filler cap. It will be located in one of two places:
  1. Passenger side (RH) in front of the steer tire - 2.4 Gallons (9 Liters) capacity
  2. Drivers side (LH) on top of the radiator - 2.0 Gallons (7.6 Liters) capacity
4. Fill the reservoir with windshield washer fluid and replace the cap
5. Close and secure the hood

### How to Refill the Washer Fluid Reservoir



### CAUTION

DO NOT use antifreeze or engine coolant in the windshield washer reservoir, damage to seals and other components will result.

1. Park the vehicle and apply the parking brakes.
2. Open the hood and secure it in the open position.
3. Locate the washer fluid reservoir located on the passenger side (RH)

of the engine compartment, in front of the steer tire, and open the filler cap.

4. Fill the 2.4 Gallons (9 Liters) reservoir with windshield washer fluid and replace the cap.
5. Close and secure the hood.

## Transmission Maintenance

See the transmission manufacturer's operator's manual for lubrication specifications and service intervals.



### CAUTION

When adding oil, types and brands of oil should not be intermixed because of possible incompatibility, which could decrease the effectiveness of the lubrication or cause component failure.

Vehicles configured with Eaton Automated or a PACCAR transmission must maintain the oil coalescing desiccant cartridge of the air dryer as part of transmission maintenance.





**CAUTION**

Replace oil-coalescing desiccant air dryer cartridge every 1 year regardless of mileage. Only use oil-coalescing desiccant replacement cartridge when replacing. Failure to perform this maintenance task will void the PACCAR Transmission warranty and may result in expensive transmission damage.

**Fuller Transmission Lubrication**

Fuller transmissions are designed so that the internal parts operate in a bath of oil circulated by the motion of gears and shafts. Grey iron parts have built-in channels where needed to help lubricate bearings and shafts. All parts will be amply lubricated if these procedures are closely followed:

1. Maintain oil level; check it regularly.
2. Change oil regularly.
3. Use the correct grade and type of oil.
4. Buy oil from a reputable dealer.

**Lubrication Change and Inspection Off-Highway Use**

Refer to the Eaton Fuller transmission manual for servicing information.

**Highway Use**

- Refer to the Eaton Fuller transmission manual for servicing information.
- Refer to the oil change vs. temperature chart that follows for special oil change information. The "intermittent peak temperature" is the maximum temperature observed for a short time in a fully loaded vehicle performing normally.

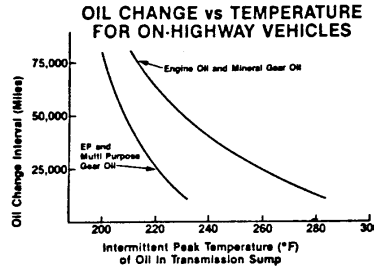

**CAUTION**

Exceeding the recommended oil change intervals may be harmful to the life of the transmission and the transmission oil cooler.

**Allison Transmission Lubrication**

- Refer to your transmission manual (furnished separately) for lubrication information.
- Refer to the Allison Transmission manual for servicing information.

**Hydraulic Clutch**

The clutch pedal position is factory set and does not require adjustment.

### Clutch Hydraulic Fluid

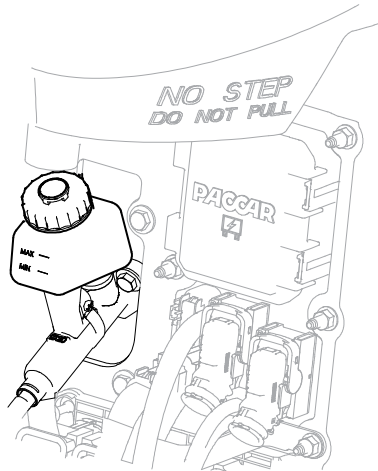

Visually inspect the clutch fluid from the reservoir. There are molded lines with the letters MIN to indicate minimum fluid level and MAX to indicate the maximum fluid level recommended for proper operation.

Be sure to maintain the fluid between the MIN and MAX levels indicated on the plastic reservoir. If the fluid level repeatedly goes below the MIN line, then it is time to have your clutch adjusted or the hydraulic system inspected for service. To replace the fluid, locate the drain fitting on the air solenoid mounted to the transmission housing. Open this fitting and allow fluid to drain out of the system. Once all the fluid is drained out, close the fitting and fill the system through the master cylinder reservoir in the engine compartment. Once the system is full, then purge the system of air by simultaneously pressing on the pedal and opening the fitting to allow air to escape. Close the fitting when fluid starts coming out. Then refill the reservoir. Repeat this until all air has been purged from the system. Replace with the recommended fluid per [Lubrication Specification Chart](#) on page 302.

#### Clutch Adjustment

Some clutches are self-adjusting, however; there are manually adjusted clutches that

will require the operator to know when to adjust the clutch. The clutch will need adjustment when your clutch pedal stroke seems to get longer and its effectiveness at a seamless shift becomes less. Another sign of the clutch needing adjustment is the level of the fluid in the reservoir. If the hydraulic fluid is not leaking, but the fluid level is getting lower, then the clutch may need to be adjusted. Please take the vehicle to an authorized dealership to have the clutch adjusted. See the clutch manufacturer's Service Manual for the proper adjustment procedures.

## Specification Reference Charts

### Pipe and Hose Clamp Torque Values

Torque specifications for engine parts.

Application	Type of Clamp	lb-in.	N·m
Radiator and Heat Exchanger Hoses	Constant Torque CT-L	90-110	10.2-12.5

Application	Type of Clamp	lb-in.	N•m
Heater Hoses	Constant Tension	not required	not required
Air Intake Pipes	Hi Torque HTM-L	100-125	11.3-14.2
Plastic Air Intake Pipes	Constant Torque CT-L	88	10.0
Charge Air Intake Hoses	Flex Seal	70-100	7.9-11.3
	B9296	50-60	6-7
Fuel, Oil and Water Heat Exchangers (for hoses less than 9/16 in. diameter).	Miniature 3600L	10-15	1.1-1.7

**Wheel Cap Nut Torque Specifications**

At the first scheduled lube interval, have all wheel cap nuts torqued to their specified

value. After that, check wheel cap nuts at least once a week. Contact an authorized dealer for information on the proper installation procedure for the wheels on your truck.

This is a job you may not be able to do yourself. You need the right torquing equipment to do it.

Wheel and Nut Configuration	Stud Size	Torque for Two Piece Flanged Cap Nuts	
		lb-ft	N•m
Hub-Piloted Disc-Type Wheel w/Two Piece Flanged Cap Nuts: Steel or Aluminum Wheel PHP-10; Budd Uni-Mount-10; WDH-8	M22-1.5	450-500	610-680

Wheel and Nut Configuration	Stud Size	Torque for Two Piece Flanged Cap Nuts	
		lb-ft	N•m
Stud Backnuts (when used)	3/4-16	175-200	240-270
	1-14	175-300	240-410
Cast Spoke Wheel Assembly Rim Clamp Nut Torque	1/2 in. Dia.	80-90	110-120
	5/8 in. Dia.	160-185	220-250
	3/4 in. Dia.	225-245	305-335

\*Consult manufacturer or lubricant supplier for special details.

### Lubrication Specification Chart

	<b>NOTE</b>
<p>The responsibility for meeting these specifications, the quality of the product, and its performance in service rests with the lubricant supplier.</p>	

### Lubricant Symbol Key

Type	Application
ATF	MD3 or MERCON®-approved automatic transmission fluid

Type	Application
BB	High temperature ball bearing grease. Chevron SRI Mobile Grease HP, Texaco Multifax 2
CB	Engine oil for mild to moderate requirements
CC/CD	Engine oil for severe requirements (MIL-L-2104B /MIL-L-45199B) w/ 1.85 % max. sulfated ash
CD	Engine oil meeting API "Five engine test sequence"
CD50	SAE 50W synthetic transmission fluid
CE	Engine oil meeting severe duty service requirements for direct-injection turbocharged
CK-4/ CJ-4	Engine oil for PACCAR MX and Cummins EGR engines
CL	Multipurpose chassis grease
EP	Extreme Pressure Lubricant (Lithium 12-hydroxystearate base NLGI 2)
GL	Straight mineral gear lubricant
HD	Hypoid Gear Oil, A.P.I. - GL-5, SAE 75W-90FE synthetic gear lubricant
HT	High Temperature grease (Timken Spec. 0-616)
MP	Multipurpose gear lubricant (MIL-L-2105B)
DOT3	Brake Fluid

### Component Lubrication Index

Application	Type
Steering Column	CL
Alternator Bearing	BB (1)
Fan Hub	BB (1)
Power Steering Reservoir	ATF
Steering Drag Link	CL
Steering Knuckles	CL
Spring Pins	CL
Clutch Release Bearings	BB
Brake Shoe Anchor Pins	HT
Brake Cam Bearings	HT
Slack Adjusters	CL
Starter Bearings	CC
Turbocharger Aneroid	CC
Water Pump	BB (1)
Suspension Fittings (other than threaded pins and bushings)	EP

Application	Type
Steering Axle: Grease Fittings on Steering Arm; Tie Rod Ends; Drag Link; King Pins	EP
Steering Shaft Grease Fittings	EP
Brake Treadle Hinge and Roller	Engine oil
Lock Cylinders	Lock lubricant
Door Hinges	Do not lubricate
Door Latches and Striker Plates	Polyethylene grease stick
Door Weatherstrip	Silicone lubricant
Hub-piloted Aluminum Wheels	Coat the wheel pilot or hub pads with Freylube #3 lubricant (light colored) or Chevron Zinc lube. Do not get lubricant on the face of the wheel or the hub.
Manual Transmission Hydraulic Clutch	DOT3 (Brake Fluid)
(1) Consult manufacturer or lubricant supplier for special details.	

### Frame Fastener Torque Requirements



#### CAUTION

Incorrectly tightening the fasteners may result in failure of the fastener or incorrect clamp loads. Fastener failure may lead to frame failure. Failure to comply may result in equipment or property damage.

- Use a torque wrench for final tightening of these fasteners. Due to the coating on the threads of these bolts, be aware that if an impact gun is used to tighten the fasteners, they may over-torque and break.
- When torquing, the nut must rotate slightly before achieving the torque value. If the nut does not rotate, the fastener is over-torqued and should be replaced.
- To achieve correct clamp loads, the frame fasteners must be torqued with the nut. The intended clamp load may not be achieved if the nut is held and torque is applied to the bolt.

### Where Nylon lock-nuts (AKA, "ESNA" or "nyloc") are indicated in the following tables



#### NOTE

The torque values and instructions found in the following section apply ONLY to Nylon locknuts (right image). They do NOT apply to the all-metal lock-nut type (left image).



- Use only lock-nut with nylon insert.
- Lubricate nylon insert nut lightly with SAE 20W or 30W oil.
- Tighten all frame fasteners with a torque wrench.



#### NOTE

The following values are applicable to fasteners on the FRAME and DO NOT APPLY to u-bolts for the suspension.

### Standard Grade 8 UNF or UNC Nylon Lock-Nuts

Tightening Specification lb-ft (N•m)	Fastener Size (-in.)
16-22 (22-30)	5/16
30-40 (41-54)	3/8
55-65 (75-88)	7/16
80-90 (109-122)	1/2
115-140 (156-190)	9/16
165-195 (224-265)	5/8
290-340 (394-462)	3/4
380-460 (517-626)	7/8
700-830 (952-1,129)	1



Tightening Specification lb-ft (N•m)	Fastener Size (-in.)
990-1,170 (1,346-1,591)	1-1/8
1,380-1,630 (1,877-2,217)	1-1/4

Metric Fastener Size (with NYLON insert nuts)	Tightening Specification lb-ft (N•m)
M5	6-9 (8-12)
M6	7-11 (9-15)
M8	17-23 (23-31)

**Where fasteners with all-metal lock-nuts are indicated in the following table**

 <b>NOTE</b>
The torque values and instructions with the following table apply <b>ONLY</b> to

all-metal lock nuts (left image) but do NOT apply to Nylon lock-nuts (right image).

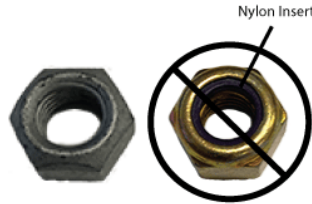

- Do NOT lubricate all-metal lock-nuts.
- Bolts and washers can be reused, but nuts can only be reused once. If in doubt, install new nuts.
- If a bolt must be replaced the nut installed on it must also be replaced.
- Fasteners must be torqued from the nut to achieve correct clamp load.

Metric Fastener Size (with all METAL Lock-nuts)	Tightening Specification lb-ft (N•m)
M10	29-41 (39.4-55.6)
M12	51-69 (69.1-93.5)
M16	125-165 (169.5-223.7)
M20	230-300 (311.8-406.8)

### Suspension U-Bolts, Grade 8

Tighten all U-bolts with a torque wrench. Torque requirements in the table below apply to PACCAR proprietary suspensions using Protec Torque/TEXO coated U-bolts, only. For all other suspensions, follow the manufacturer's recommended torque values. PACCAR proprietary suspension u-bolts must be tightened in a specific sequence. Take your vehicle to an authorized dealer to tighten the U-bolts on your vehicle.

**Torque for Grade 8 U-Bolts**

Peterbilt Front Suspension U-bolts		
U-Bolt Size Diameter (-in.)	Torque (lb-ft)	Torque (N•m)
3/4	260-290	353-393
7/8	370-415	502-563
For all non-PACCAR suspension systems, see the manufacturer's operator's manual for torque specifications.		

Peterbilt Rear Suspension U-bolts		
Rear Suspension Type	U-Bolt Diameter	Torque lb-ft (N•m) <sup>22</sup>
Low Air Leaf (U-bolt, spring)	M22 x 1.5	375-475 (508-644)

Peterbilt Rear Suspension U-bolts		
Rear Suspension Type	U-Bolt Diameter	Torque lb-ft (N•m)
Flex Air	M22 x 1.5	325-375 (440-508)
Tandem Low Air Leaf	M22 x 1.5	375-475 (508-644)
Air Leaf (U-bolt, spring)	1.0 -in. NF	450-550 (610-746)
Air-Trac	1.0 -in. NF	450-550 (610-746)
13.5K Taper Leaf (Axle U-bolt)	¾ -in. 16 UNF	275-320 (373-434)
18K Taper Leaf (Axle U-bolt)	¾ -in. 16 UNF	275-320 (373-434)

Peterbilt Rear Suspension U-bolts		
Rear Suspension Type	U-Bolt Diameter	Torque lb-ft (N•m)
18K Air Leaf (Axle U-bolt)	¾ -in. 16 UNF	275-320 (373-434)
For all non-PACCAR suspension systems, see the manufacturer's operator's manual for torque specifications.		

	<b>NOTE</b>
The values shown here are for suspension U-bolts and should not be applied to bolts and fasteners for the frame.	

22

**Torques listed are for primed (or non-oiled) U-bolts.**

**Rear Suspension Fasteners**

**Air-Trac Fastener Torque Values**

Fastener	Fastener Name	lb•ft (N•m)
M16	Tracking rod bolts	155–195 (210–264)
0.75 NF	Spring center bolt	165–210 (224–285) <sup>23</sup>
M16 0.75 NF	Radius rod bolts (forward)	155–195 (210–264)
	Radius rod bolts (at axle)	250–350 (339–475)
M16	Frame bracket bushing bolts	50–65 (68–88)

Fastener	Fastener Name	lb•ft (N•m)
1.0 NF	U-bolt <sup>24</sup>	Refer to section on Suspension U-Bolts, Grade 8.
0.5 UNC	Air bag stud nut	40–50 (54–68)
M16	Tracking rod bolts	155–195 (210–264)

Fastener	Fastener Name	Torque lb•ft (N•m)
M22 x 1.5	U-bolt, spring <sup>25</sup>	Refer to section on Suspension U-Bolts, Grade 8.
0.5 UNC	Air bag stud nut	40–50 (54–68)
M16	Tracking rod bolts	155–195 (210–264)

**Low Air Leaf Torque Values**

Low Air Leaf Torque values apply to both single and tandem axles.

Fastener	Fastener Name	Torque lb•ft (N•m)
M20 x 2.5	Bar pin bolts	325–425 (441–576)

<sup>23</sup> Torque requirement applies at subassembly of airspring support and leaf spring only.

<sup>24</sup> See owners manual for torque tightening sequence.

<sup>25</sup> Contact your dealer for torque tightening procedure.

**Flex Air Fastener Torque Values**

Fastener	Fastener Name	Torque lb-ft (N•m)
M16	Drive bracket - frame bolts	155–195 (210–264)
	Drive bracket - link spring bolt	
	Drive bracket - radius rod bolt	
	Drive beam - shock bolt (lower)	
	Shock bracket - shock bolt (upper)	

Fastener	Fastener Name	Torque lb-ft (N•m)
	Tracking rod bolts (all)	
M10	Air spring support beam bolts	36–51 (49–69)
0.88 - 14 UNF	Drive beam - link spring bolt	380–460 (515–624)
0.88 - 14 UNF	Radius rod bracket bolt	380–460 (515–624)
M22 x 1.5	U-bolt <sup>26</sup>	Refer to section on Suspension U-Bolts, Grade 8.
0.5 UNC	Air bag stud nut	40–50 (54–68)

**Vehicle Light Bulb Specifications**

Bulb Location	Type of Bulb	Notes
Low beam halogen	H11–LL: 12 volts, 55 Watts (SAE)	(Long life version not required)
Low beam LED	N/A	Non-serviceable
High beam halogen	HB3A – LL: 12 volts, 60 Watts (SAE)	(Long life version not required)
High beam LED	N/A	Non-serviceable
Daytime running/ position/turn signal	4157K: 12 volts 28.5 Watts (SAE)	N/A
LED Side marker	N/A	LED

<sup>26</sup> Contact your dealer for torque tightening procedure.

<b>Bulb Location</b>	<b>Type of Bulb</b>	<b>Notes</b>
Rear tail/ turn signal	N/A	LED
Interior map/ dome/ indirect light	N/A	LED

## Chapter 6 | INFORMATION

Consumer Information.....	313
Vehicle Identification Labels.....	313
Clean Idle.....	316
Greenhouse Gas Certified Configuration.....	317
Vehicle Emissions Limited Express Warranty.....	320

## Consumer Information

### How to Order Replacement Parts

Replacement parts may be obtained from an authorized dealership. When you order, it is **IMPORTANT** that you have the following information ready:

- Your name and address
- Serial number of the truck
- The name of the part you need
- The name and number of the component for which the part is required
- The quantity of parts you need
- How you want your order shipped

### National Highway Traffic and Safety Administration (NHTSA)

If you believe that your vehicle has a defect, which could cause a crash or could cause death or personal injury, you should immediately inform the National Highway Traffic Safety Administration (NHTSA) in addition to notifying the vehicle manufacturer. If NHTSA receives similar complaints, it may open an investigation, and if it finds that a safety defect exists in a group of vehicles, it may order a recall and

remedy campaign. However, NHTSA cannot get involved in individual problems between you, your dealer, and vehicle manufacturer. Contacting NHTSA is possible through telephone, written mail and email. NHTSA also has a website where you can input your comments directly to them on the web. Please use any of the four ways to contact NHTSA:

Toll Free 1-888-327-4236 (800-424-9153  
TTY) 8:00 a.m. to 10:00 p.m. EST  
Monday-Friday

Office of Defects Investigations/CRD  
NV5-216 1200 New Jersey Ave. SE  
Washington, D.C. 20590

[www.safercar.gov](http://www.safercar.gov)

email: [nhtsa.webmaster@dot.gov](mailto:nhtsa.webmaster@dot.gov)

### Transport Canada

Canadian customers who wish to report a safety-related defect to Transport Canada, Defect Investigations and Recalls, may telephone the toll free hotline 1-800-333-0510, or contact Transport Canada by mail at:

Transport Canada, ASFAD Place de Ville  
Tower C 330 Sparks St. Ottawa, ON K1A  
0N5

For additional road safety information,  
please visit the Road Safety website at:  
<http://www.tc.gc.ca>

## Vehicle Identification Labels

Each vehicle completed by Peterbilt Motors Company uses a vehicle identification number (VIN) that contains the model year designation of your vehicle. The practice is in compliance with 49 CFR 565, Code of Federal Regulations.

The full, 17-digit VIN is located on the Weight Rating Data Label. The label is located on the driver's side door edge or on the driver's side door frame.

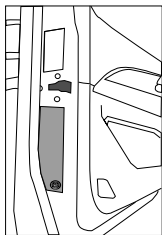
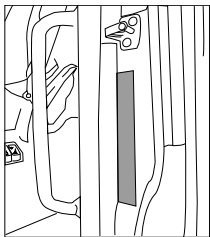

6

### Chassis Number

The Chassis Number refers to the last six characters of the VIN. This number will allow your dealer to identify your vehicle. You will be asked for this number when you bring it in for service. Chassis Number Locations

- Right frame rail, top flange, about 3 ft. from the front end

- Back of cab, left-hand rear panel, lower edge
- Tire, Rim, and Weight Rating Data label (truck)
- Components and Weights label
- Noise Emission label
- Paint Identification label

### Certification Labels

Your vehicle information and specifications are documented on labels. As noted below, each label contains specific information pertaining to vehicle capacities and specifications that you should be aware of.

### Components and Chassis Weight Label

The Components and Chassis Weight Label is located on either the driver's side door edge or on the driver's side door frame. It includes chassis number, chassis weight and gross weight, plus model information for the vehicle, engine, transmission, and axles.

### Tire, Rim and Weight Rating Data Label

The Tire, Rim, and Weight Rating Data Label is located on the driver's side door

edge or on the driver's side door frame. It contains the following information:

- GVWR - Gross Vehicle Weight Rating
- GAWR FRONT, INTERMEDIATE and REAR - Gross Axle Weight Ratings for Front, Intermediate and Rear Axle
- TIRE/RIM SIZES AND INFLATION PRESSURES - Tire/Rim Sizes and Cold Pressure Minimums
- VIN including CHASSIS NUMBER.

The components of your vehicle are designed to provide satisfactory service, if the vehicle is not loaded in excess of either the gross vehicle weight rating (GVWR), or the maximum front and rear gross axle weight ratings (GAWRs).



### WARNING

DO NOT exceed the specified load rating. Overloading can result in loss of vehicle control, either by causing component failures or by affecting vehicle handling. Exceeding load ratings can also shorten the service life of the vehicle. Failure to comply may result in death or personal injury.



	<p><b>NOTE</b></p>
<p>GVW is the TOTAL SCALE WEIGHT the vehicle is designed to carry. This includes the weight of the empty vehicle, loading platform, occupants, fuel, and any load.</p>	

**Noise Emission Label**

The Noise Emission Label is located in the driver's side door frame. It contains information regarding U.S. noise emission regulations, chassis number, and date of manufacture.

**Paint Identification Label**

The Paint Identification Label contains the paint colors used by the factory to paint your vehicle. It lists frame, wheels, cab interior and exterior colors. This label is located inside the glove box.

**Federal Safety Standard Certification Label**

The NHTSA regulations require a label certifying compliance with Federal Safety Standards, for United States and U.S. Territories, be affixed to each motor vehicle and prescribe where such label may be located. This certification label, which

indicates the date of manufacture and other pertinent information, is located on the driver's side door edge or on the driver's side door frame.

**Component Identification**

Each of the major components on your vehicle has an identification label or tag. For easy reference, record component numbers such as, model, serial, and assembly number.

Engine	For further information, please refer to the Engine Operation and Maintenance Manual.
Transmission	For both manual and automatic transmissions, the identification number is stamped on a tag affixed to the right rear side of the transmission case.
Clutch	Enclosed in clutch housing. Location depends on manufacturer.
Steer Axle	The front axle serial number is stamped on a plate located on the center of the axle beam.
Axle Specification Number	Usually stamped on the right rear side of the axle housing. This number identifies the complete axle.
Axle Housing Number	Usually located on the left forward side of the housing arm. This tag identifies the axle housing.

Axle Differential Carrier Identification	Usually located on the top side of the differential carrier. The following information is either stamped, or marked with a metal tag: Model No., Production Assembly No., Serial No., Gear Ratio, and Part Number.
--	--

## Clean Idle

To comply with CARB emissions requirements, your vehicle will either have the Certified Clean Idle label or an Engine Shutdown System (ESS). Some vehicles, however, are exempt from these requirements because of their configurations (for example: fire truck service).

Your vehicle may have either of these labels affixed to the vehicle to identify that its engine meets the strict low exhaust emission regulations instituted by the state of California (and other states that have chosen to adopt CARB emissions requirements). Trucks with this type of engine will not require an Engine Shutdown System and will be allowed to idle continuously. It is important that you do not remove or deface this label. Do not block it from view. Please contact your authorized dealership if you need to replace this label. The dealership will be

able to help you to determine whether or not your vehicle's engine may be a candidate for a Certified Clean Idle label if it did not already have the label. If you have a PACCAR PX-7 or PX-9 engine, your label will look like the image below.



If you have a Cummins engine, your label will look like the image below.



## Engine Shutdown System

If the vehicle's engine does not meet the low exhaust emission standard it will have an Engine Shutdown System (ESS) to meet limited idle regulations implemented by CARB and some additional states. These regulations require that the engine have an automatic system to restrict the idle time on certain vehicles. An Engine Shutdown System will shut down the engine after 5 minutes if the vehicle idles with the park brake set and the transmission in 'neutral' or 'park'. The ESS will also allow the vehicle 15 minutes of idle time if the driver does not set the park brake and shifts the transmission to 'neutral' or 'park'. The ESS, however, will not shut down the engine if the engine is operating in Power Take Off (PTO) mode, if the engine coolant is below 60 degrees Fahrenheit, or if the engine is performing a parked regeneration. The check engine light will alert you when the ESS shutdown timer reaches the last 30 seconds before the engine shuts down. The last 30 seconds prior to engine shutdown is the

only time the driver may reset the idle time by pressing on the accelerator. More detailed information may be available in the Engine Operator's Manual provided with your vehicle.

ject to fines and penalties. Please contact the vehicle manufacturer for further information about this vehicle's certified configuration.

regulatory subcategory

## Greenhouse Gas Certified Configuration

This vehicle includes Greenhouse Gas (GHG) regulated parameters and technologies. A Vehicle Emission Control Information label is located on the driver's door with codes that partially identify the vehicle's GHG certified configuration. In addition to the Vehicle Emission Control Information label, other technologies that reduce GHG emissions and regulated parameters included in the vehicle's GHG certified configuration are described in this section.

	<b>NOTE</b>
Modifying a vehicle's certified configuration without good engineering judgment or PACCAR's approval may be a violation of the Clean Air Act and sub-	

### Vehicle Emission Control Information Label Descriptions

Label Identifiers	Label Identifier Descriptions
Family Name	Describes the vehicle's certified manufacturer, regulatory category, and regulatory subcategory
Emission Controls	Describes regulated emission control devices installed on the vehicle
Compliance Statement	Describes the vehicle's compliance standards
Regulatory Subcategory	Describes the vehicle's certified

Emission Controls	Emission Control Descriptions
ARF	Aerodynamic roof fairing
ARFR	Adjustable height aerodynamic roof fairing
ATS	Aerodynamic side skirt and/or fuel tank fairing
AFF	Aerodynamic front fairing
AREF	Aerodynamic rear fairing
TGR	Gap reducing fairing
LRRA	Low rolling resistance tires (all)

LRRD	Low rolling resistance tires (drive)
LRRS	Low rolling resistance tires (steer)
VSL	Vehicle speed limiter
VSLS	Soft-top vehicle speed limiter
VSLE	Expiring vehicle speed limiter
VSLD	Vehicle speed limiter with both soft-top and expiration
IRT	Engine shutoff system
IRT5	Engine shutoff after 5 minutes or less of idling
IRTE	Expiring engine shutoff
ADVH	Vehicle includes advanced hybrid

	technology components
ADVO	Vehicle includes other advanced-technology components
INV	Vehicle includes innovative (off-cycle) technology
ATI	Automatic tire inflation system
TPMS	Tire pressure monitoring system

**GHG Regulated Technology Not On the Emission Control Information Label**

Technology	Compliance Requirements
Wheel-Related Weight Reduction	Wheel-related weight reduction benefits may be included in this vehicles certified

	configuration. Changing aluminum wheels to a steel wheels may be a violation of the Clean Air Act and subject to fines and penalties.
Nonwheel-Related Weight Reduction	Nonwheel-related weight reduction benefits may be included in this vehicles certified configuration. Changing aluminum material to steel material may be a violation of the Clean Air Act and subject to fines and penalties.

**Other Technologies** This vehicle may be equipped with factory installed automatic engine shutdown (AES), neutral idle, start-stop systems, intelligent controls (Predictive Cruise Control and Neutral Coast), or extended idle reduction systems (Engine Idle Shutdown Timer, Engine Auto Start, Sleeper APUs, Fuel-Fire Sleeper Heater System). Disabling or modifying any GHG regulated technology may be a violation of the Clean Air Act and subject to fines and penalties.

**GHG Regulated Powertrain Parameters Not On the Emission Control Information Label**

<b>Powertrain Components</b>	<b>Regulated Parameters</b>
Engine	Engine idle speed, torque, horsepower, and governed RPM
Transmission	Lock up gear, number of gears, and torque converter
Axle	Configuration and drive axle ratio

**GHG Regulated Aerodynamic Performance**

The vehicle needs to stay in as-built aerodynamic performance unless good engineering judgment shows that the modification will improve safety or will not increase greenhouse gases.

**GHG Regulated Certified Tires**

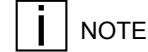

The tires installed on this vehicle at the factory as original equipment are certified for Greenhouse Gas and Fuel Efficiency regulations. Replacement tires must be of an equal or larger loaded drive tire size and an equal or lower rolling resistance level (TRRL or Crr). Consult with your tire supplier(s) for appropriate replacement tires.

In order to limit the rolling resistance of the tires and optimize fuel economy, the maintenance procedures specified by the tire manufacturer must be followed. Please see Vehicle Emissions Limited Express Warranty for warranty on greenhouse gas certified tires.

**GHG Regulated Air Conditioning Leakage Standards**

Loss of refrigerant from the air conditioning systems may not exceed a total leakage rate of 11.0 grams per year or a percent leakage rate of 1.50 percent per year, whichever is greater. This vehicle was built to meet this air conditioning leakage

standards. Any modification of the air conditioning system must comply with leakage rates defined in SAE J2727.



**NOTE**

Modifying a vehicle's certified configuration without good engineering judgment or PACCAR's approval may be a violation of the Clean Air Act and subject to fines and penalties. Please contact the vehicle manufacturer for further information about this vehicle's certified configuration.

6

## Vehicle Emissions Limited Express Warranty

### Original Equipment Tires

PACCAR Inc. warrants the tires installed as original equipment on this vehicle only against defects in materials and workmanship which cause the vehicle to fail to comply with applicable U.S. and Canadian greenhouse gas emission limits ("Warrantable Emissions Failures"). This vehicle emissions limited express warranty

relating to original equipment tires is valid for two (2) years or 24,000 miles (38,000 km), whichever occurs first. YOUR SOLE AND EXCLUSIVE REMEDY AGAINST PACCAR Inc. IS LIMITED TO THE REPAIR OR REPLACEMENT OF ORIGINAL EQUIPMENT TIRES, SUBJECT TO PACCAR'S TIME AND MILEAGE LIMITATIONS LISTED ABOVE. This Vehicle Emissions Limited Express Warranty relating to original equipment tires begins on the date of delivery of the vehicle to the first purchaser or lessee and accrued time and mileage is calculated when the vehicle is brought in for correction of the Warrantable Emissions Failures relating to the original equipment tires. PACCAR MAKES NO OTHER VEHICLE EMISSIONS WARRANTIES RELATING TO THE ORIGINAL EQUIPMENT TIRES, EXPRESS OR IMPLIED. WHERE PERMITTED BY LAW, PACCAR EXPRESSLY DISCLAIMS ANY WARRANTY OF MERCHANTABILITY OR FITNESS FOR A PARTICULAR PURPOSE RELATING TO VEHICLE EMISSIONS. PACCAR AND THE SELLING DEALER SHALL NOT BE LIABLE FOR INCIDENTAL OR CONSEQUENTIAL DAMAGES INCLUDING, BUT NOT LIMITED TO:

LOSS OF INCOME OR LOST PROFITS;  
VEHICLE DOWNTIME;  
COMMUNICATION EXPENSES;  
LODGING AND/OR MEAL EXPENSES;  
FINES; APPLICABLE TAXES OR BUSINESS COSTS OR LOSSES;  
ATTORNEY'S FEES; AND ANY LIABILITY YOU MAY HAVE IN RESPECT TO ANY OTHER PERSON OR ENTITY RELATING TO WARRANTABLE EMISSIONS FAILURES. This Vehicle Emissions Limited Express Warranty relating to original equipment tires is limited to emissions compliance only. The tires are separately warranted by their manufacturer for defects in materials and workmanship other than those which cause non-compliance with U.S. and Canadian GHG regulations, subject to limitations and conditions contained within the tire manufacturer's warranty agreement. You are responsible for the safe operation and maintenance of the vehicle and its tires. PACCAR does not warrant wear and tear of the tires.

### Greenhouse Gas (GHG) Components Other Than Tires

This GHG vehicle Warranty applies to the vehicle (hereafter, vehicle) certified with the US Environmental Protection Agency.

## Your Warranty Rights and Obligations

This vehicle is warranted for components that directly impact the manufacturers GHG certification with the US Environmental Protection Agency. PACCAR must warrant these components for the periods of time listed below provided there has been no abuse, neglect or improper maintenance of the vehicle. If a GHG-related part on your vehicle is found to have a defect in material or assembly, the part will be repaired or replaced by PACCAR.

### Manufacturer's Warranty Coverage

This warranty coverage is provided for five years or 100,000 miles (160,000 km), whichever occurs first, from the date of delivery of the vehicle to the first purchaser or first lessee. Where a Warrantable Condition exists, PACCAR will diagnose and repair the vehicle, parts and labor included, at no cost to the first purchaser or first lessee and each subsequent purchaser or lessee. This warranty does not override any extended warranty purchased to cover specific vehicle components.

## Owner's Warranty Responsibilities

The vehicle owner is responsible for performing required maintenance that is listed in your engine and vehicle Operator's Manuals. The owner is responsible for presenting the vehicle to a service location as soon as a problem exists. Any warranty repairs should be completed in a reasonable amount of time. Retain all receipts covering maintenance on this equipment. PACCAR cannot deny warranty solely for the lack of receipts or for the failure to ensure the performance of all scheduled maintenance. PACCAR may deny warranty coverage if a vehicle component has failed due to abuse, neglect, improper maintenance, unapproved modifications (both physical components and computer programming) or using non-Original Equipment replacement parts. If there are any questions regarding these warranty rights and responsibilities, please contact the vehicle OEM manufacturer at the customer center telephone number provided with the vehicle operating instructions. Prior to the expiration of the applicable warranty, Owner must give notice of any warranted failure to an authorized PACCAR dealer and deliver the vehicle to such facility for repair. Owner is responsible for incidental

costs such as: communication expenses, meals, lodging incurred by Owner or employees of Owner as a result of a Warrantable Condition. Owner is responsible for downtime expenses, cargo damage, fines, all applicable taxes, all business costs, and other losses resulting from a Warrantable Condition. Owner is responsible for maintaining all emissions related engine and vehicle computer program settings in accordance with manufacturer specifications. This responsibility includes GHG specific settings that may not be altered before the GHG-related expiration mileage has been reached for each system. Owner is responsible for maintaining all physical parts related to GHG-regulations in the as-built configuration and in proper working order for the full regulatory useful life of 435,000 miles (700,000 km) or 10 years for Class 8 vehicles, 185,000 miles (300,000 km) or 10 years for Class 5-7.

### Replacement Parts

PACCAR recommends that any service parts used for maintenance, repair or replacement of GHG components be new or genuine approved rebuilt parts and assemblies. The use of non-genuine engine or vehicle replacement parts that

are not equivalent to the PACCAR engine or OEM vehicle manufacturer's original part specification as built from the factory may impair the engine and vehicle emissions control system from working or functioning effectively, and may jeopardize your GHG warranty coverage. In addition, genuine vehicle or engine parts must be replaced with the same material and function as the part assembled on the vehicle from the factory. The owner may elect to have maintenance, replacement or repair of the emission control parts performed by a facility other than an authorized PACCAR dealer and may elect to use parts other than new or genuine approved rebuilt parts and assemblies for such maintenance, replacement or repair; however, the cost of such service or parts and subsequent failures resulting from such service or parts may not be fully warranted if the manufacturer determines that the replacement part is not of similar material and function as the OEM part assembled to the vehicle at the factory.

### **PACCAR Responsibilities**

The warranty coverage begins when the vehicle is delivered to the first purchaser or first lessee. Repairs and service performed by any authorized PACCAR dealer using

new or genuine approved rebuilt parts and assemblies will utilize replacement parts that are selected and installed to support the GHG compliance certification. PACCAR will repair parts found by PACCAR to be defective without charge for parts or labor (including diagnosis which results in determination that there has been a failure of a warranted part).

### **Warranty Limitations**

Sole and exclusive remedy against PACCAR and the Selling Dealer arising from the purchase and use of this vehicle is limited to the repair or replacement of "warrantable failures", for replacement parts that are similar in material and function to OEM specifications and subject to PACCAR's time, mileage, and hour limitations of the greenhouse gas warranty. The maximum time, mileage and hour limitations of the warranty begin with the Date of Delivery to the first purchaser or first lessee. The accrued time, mileage, or hours is calculated when the vehicle is brought in for correction of warrantable failures. PACCAR is not responsible for failures or damage resulting from what PACCAR determines to be abuse, neglect or uncontrollable acts of nature, including, but not limited to: damage due to accident;

operation without adequate coolants or lubricants; overfueling; overspeeding; lack of maintenance of cooling, lubricating or intake systems; improper storage, starting, warm-up, run-in or shutdown practices; unauthorized modifications to the vehicle and its components. PACCAR is also not responsible for failures caused by incorrect oil, fuel or diesel exhaust fluid or by water, dirt or other contaminants in the fuel, oil or diesel exhaust fluid. Failure of replacement parts used in repairs due to the above non-warrantable conditions is not warrantable. This warranty is void if the vehicle is altered with parts that do not meet the material and functional specifications as manufactured from the factory. Any alterations to vehicle or engine computer settings will void GHG warranty and potentially cause the vehicle to become non-compliant with EPA Clean Air Act GHG regulations. Any alterations to GHG specific settings prior to the GHG related expiration mileage for each system will void GHG warranty and potentially cause the vehicle to become non-compliant with EPA Clean Air Act GHG regulations. This warranty is void if certain GHG components are not properly maintained and thus cannot perform to their designed capability. PACCAR is not responsible for



failures resulting from improper repair or the use of parts which are not genuine approved parts. PACCAR is not responsible for the material and labor costs of emission control parts and assemblies replaced during Scheduled Maintenance of the engine as specified in PACCAR Operator's Manuals. THIS WARRANTY, TOGETHER WITH THE EXPRESS COMMERCIAL WARRANTIES ARE THE SOLE WARRANTIES MADE BY PACCAR IN REGARD TO THIS VEHICLE. THIS LIMITED GHG WARRANTY IS THE SOLE WARRANTY MADE BY PACCAR AND THE SELLING DEALER. EXCEPT FOR THE ABOVE LIMITED WARRANTY, PACCAR AND THE SELLING DEALER MAKE NO OTHER WARRANTIES, EXPRESS OR IMPLIED. PACCAR AND THE SELLING DEALER EXPRESSLY DISCLAIM ANY WARRANTY OF MERCHANTABILITY OR WARRANTY OF FITNESS FOR A PARTICULAR PURPOSE. PACCAR AND THE SELLING DEALER SHALL NOT BE LIABLE FOR INCIDENTAL OR CONSEQUENTIAL DAMAGES INCLUDING, BUT NOT LIMITED TO: LOSS OF INCOME OR LOST PROFITS; ENGINE OR VEHICLE DOWNTIME; THIRD PARTY DAMAGE, INCLUDING DAMAGE OR LOSS TO

OTHER ENGINES, VEHICLES OR PROPERTY, ATTACHMENTS, TRAILERS AND CARGO; LOSS OR DAMAGE TO PERSONAL CONTENTS; COMMUNICATION EXPENSES; LODGING AND/OR MEAL EXPENSES; FINES; APPLICABLE TAXES OR BUSINESS COSTS OR LOSSES; ATTORNEYS' FEES; AND ANY LIABILITY YOU MAY HAVE IN RESPECT TO ANY OTHER PERSON OR ENTITY.

# Index

## A

Active Cruise Control Set Following Distance [146](#)  
Active Warnings [64, 81](#)  
adaptive cruise control [135](#)  
Adaptive Cruise Control [145](#)  
Adaptive Cruise Control Notification, *See* ADAS Notification  
ADAS Camera Fault [84](#)  
ADAS Notification [68](#)  
Additives to Cooling System [252](#)  
Adjust Seat [23](#)  
Adjust Side Mirrors [113](#)  
Advanced ABS with Stability Control [163](#)  
Advanced Driver Assistance Systems (ADAS), *See* Driver Assistance  
Aiming Headlamps [259](#)  
Air Conditioner [114](#)  
Air Conditioner Sleeper [120](#)  
Air ConditionerDefrost Windshield [119](#)  
Air Disc Brakes [242](#)  
Air Dryer Maintenance [236](#)  
Air Filter Restriction Indicator [272](#)  
Air Gauges and Air Leaks [238](#)  
Air Intake [22](#)  
Air Intake System [271](#)  
Air Ride Height Data [177](#)  
Air Tanks [238](#)  
Air-Controlled Sliding Fifth Wheel [181](#)  
Air-Operated Kingpin Release, *See* How to Release the Kingpin from the Cab  
Air-Trac Fastener Torque ValueRear Suspension Fasteners [309](#)  
Alarm ClockSet alarm [123](#)  
Alarm ClockSet time [123](#)  
Alert Switch [120](#)  
Allison Transmission Lubrication [299](#)  
Altering the Electrical System [260](#)  
Alternator [265](#)

Anti-Theft [76](#)  
Antilock Brake System [86](#)  
At first 15,000 mi / 24,000 km or at first PM [197](#)  
Auto Slack Adjuster [242](#)  
Automated Emergency Braking, *See* Collision Mitigation  
Automated transmission [159](#)  
Automatic Slack Adjuster Stroke Specification [243](#)  
Automatic time [72](#)  
Automatic Traction Control [165](#)  
Axle Temperature Gauge [92](#)  
Axle, Traction Control [84, 85, 161](#)  
*See also* ATC  
AxleAuxiliary [173](#)  
AxleDiff Lock [170](#)  
AxleDifferential Lock [170](#)  
AxleDual Range [171](#)  
AxlePusher Tag [173](#)  
AxleTwo Speed [171](#)

## B

Back Button [63](#)  
Basic View [69](#)  
Batteries [261](#)  
Battery Voltage [66](#)  
Battery,Jump Start [46](#)  
**Belt**  
    Komfort Latch [30](#)  
    Lap/Shoulder [28](#)  
    Safety [26](#)  
    Tether [29](#)  
Bendix® AD-HF Series Air Dryer [237](#)  
Brake System [241](#)  
Brake, Park Brake [86](#)

Brake, Parking Manual release [49](#)  
Brakes, Antilock Brake System [86](#)  
Brakes, Low Air [86](#)  
Brakes, Trailer Antilock Brake System [86](#)  
Bulb Check [79](#)  
Bunk Ladder [14](#), [17](#), [18](#), [186](#)

## C

### Cab

How to Lock and Unlock the Doors [13](#)  
Cab Access [12](#)  
Cab Air Filter [248](#)  
Cab HVAC Fresh Air Filter Replacement [248](#)  
Cab Maintenance [243](#)  
Cab Structure, Doors and Hoods [249](#)  
Camera Obstruction Conditions [150](#)  
CAN bus [260](#)  
Care of Display Screens on the Dashboard [249](#)  
Check Engine Oil Level [267](#)  
Cleaning LCD Display Screens [249](#)  
Clock [66](#), [72](#)  
Collision Mitigation [147](#)  
Column Mounted Transmission Control [157](#), [158](#)  
Coolant fill [254](#)  
Coolant level [254](#)  
Cooling system maintenance [252](#)  
Cooling System Overheating [42](#)  
Cranking Battery Specification [263](#)  
cruise control [135](#)  
Cruise Control [143](#)  
Cruise Control Cancel [144](#)  
Cruise Control Change Set Speed [144](#)  
Cruise Control Resume Set Speed [144](#)  
Cruise Control Set Speed [144](#)  
Cruise Control Standard [142](#)

## D

Daily Checks [35](#)  
Dash Switch Tailer Hand Brake [161](#)  
Dashboard Display Screen [249](#)  
Dedicated Telltales [80](#)  
Deep Snow and Mud Switch [165](#)  
Diesel Exhaust Fluid (DEF) [70](#)  
Diesel Exhaust Fluid tank maintenance [283](#)  
Diesel Particulate Filter (DPF) Warning Light [88](#)  
Differential, Inter-Axle Lock [87](#)  
Digital Display [76](#)  
Digital Gauges [70](#)  
Display [76](#)  
Display Launch [63](#)  
DNR [65](#)  
Door Mounted Mirror Controls [113](#)  
DPA, *See* Driver Performance Assistant  
DR, *See* Driver Rewards  
Drive Axle - Dana [286](#)  
Drive Axle - Meritor [287](#)  
Drive Axle SISU [288](#), [289](#)  
Drive Axle Temperature Gauge [92](#)

### Driver Assistance

Object Detected Alert [147](#)  
Drum Brake Inspection [243](#)  
Dual Air System Function Test [236](#)  
Dual Range (Two-Speed) Rear Axle [171](#)  
Dump Truck, Body Up [87](#)  
Dump Truck, Gate [87](#)  
Dynamic Telltale [81](#)

## E

Eaton/Dana Axle Lubrication [286](#)  
Effectiveness and Limitations [166](#)  
Electrical System [256](#)  
ELST [107](#)  
Emissions [141](#)

Emissions Engine Derate [90](#)  
Emissions, High Exhaust System Temperature [88](#)  
Emissions, Malfunction Indicator Lamp [88](#)  
Engine Aftertreatment System [141](#)  
Engine Air filter [271](#)  
Engine Brake [108](#), [111](#)  
Engine Brake Allison Automatic Transmission [111](#)  
Engine Brake Column Mounted Transmission Control [136](#), [137](#)  
Engine Brake indicator [135](#)  
Engine Brake Manual Transmission [111](#)  
Engine Brake PACCAR Transmission [136](#), [137](#)  
Engine Cooling Recommendations and Specifications [252](#)  
Engine Fan [270](#)  
Engine Hours [66](#)  
Engine is overheating [42](#)  
Engine Maintenance [266](#)  
Engine Mounting [272](#)  
Engine Start Module [46](#)  
Engine Wait-To-Start Lamp [89](#)  
Engine Warm Up [133](#)  
Engine, Check Engine [89](#)  
Engine, Engine Block Heater [89](#)  
Engine, Low Coolant Level [89](#)  
Engine, Overspeed Air Shutdown [89](#)  
Engine, Retarder (Brake) [89](#)  
Engine, Stop Engine [89](#)  
Enhanced View [69](#)  
ESM [46](#)  
Every 120,000 mi / 192,000 km / Annually [224](#)  
Every 15,000 mi / 24,000 km / Monthly [205](#)  
Every 240,000 mi / 384,000 km [229](#)  
Every 30,000 mi / 48,000 km [211](#)  
Every 300,000 mi / 480,000 km / 6,750 Hours / 3 Years [230](#)  
Every 500,000 mi / 800,000 km / 5 years [231](#)  
Every 60,000 mi / 96,000 km / 6 Months [215](#)  
Every 750,000 mi / 1,200,000 km / 24,000 Hours / 8 years [231](#)  
Exhaust [141](#)  
Exhaust System [272](#)  
Exterior Lamp Self Test Switch [108](#)  
Exterior Lamps Self Test [107](#)  
Exterior Lights Self Test [107](#)

## F

Fast Idle Control [91](#)  
Favorites View [71](#)  
Fifth Wheel [178](#), [180](#)  
Fifth Wheel Bi-Annual Maintenance [274](#)  
Fifth Wheel Locked Indicator/Fifth Wheel [90](#)  
Fifth Wheel Monthly Maintenance [274](#)  
Fifth Wheel Slide. *See* How to Slide the Fifth Wheel  
Fifth Wheel Slide Switch [100](#)  
Fifth Wheel Slide Unlocked [90](#)  
Fifth Wheel Unlocked Indicator/Fifth Wheel [91](#)  
Filling Washer Fluid. *See* How to Refill the Washer Fluid Reservoir  
Final Chassis Bill of Material [12](#)  
Final Stopping Procedures [187](#)  
Flashing Headlamps, Aftertreatment Warning [141](#)  
Flex Air Fastener Torque Value/Rear Suspension Fasteners [310](#)  
Frame [273](#)  
Frame Fastener Torque Requirements, Nyloc, ESNA, Lock-Nuts [306](#)  
Front axle and Suspension [275](#)  
Front Suspension U-Bolts, Grade 8 [307](#)  
Fuel Level [70](#)  
Fuel System [274](#)  
Fuel Tank [275](#)  
Fuller Transmission Lubrication [299](#)  
Fuse box label [259](#)  
Fuse/Inspect and replace [44](#)  
Fuse/Location [46](#)

## G

General Safety Instructions [7](#)  
Greenhouse Gas Certified Configuration [317](#)  
Greenhouse Gas Certified Tires [295](#)

## H

Hand Brake Trailer [161](#)

HDB, *See* Highway Departure Braking  
Heater and Air Conditioner Maintenance [278](#)  
Heating and Air Conditioning [114](#)  
High Beam [110](#)  
High Beam Flash [110](#)  
Highway Departure Braking [152](#)  
Horn [113](#)  
Horn honking, Aftertreatment Warning [141](#)  
How to Add Coolant to the Cooling System [255](#)  
How to Adjust Mirrors [113](#)  
How to Check the Compressed Air System for Leaks [239](#)  
How to inspect brake pads on disc brakes [242](#)  
How to Prepare the Axles for Towing [52](#)  
How to Recover a Vehicle Towing [48](#)  
How to Refill the Washer Fluid Reservoir [298](#)  
How to Replace Air Conditioner Filter [280](#)  
How to Replace Headlight Bulb [258](#)  
How to Use the ELST Switch [108](#)  
How to Wash the Exterior of the Vehicle [246](#)  
HVAC [114](#)  
HVAC Air Filter [248](#)  
Hydraulic Clutch [299](#)

## I

Ice [56](#)  
Illustrations [7](#)  
In Cab Battery Access [263](#)  
Inside/Outside Engine Air Intake [99](#), [133](#)  
Inspect Disc Brake Caliper for Running Clearance [242](#)  
Inspecting Noise and Emission Components [281](#)  
Install Engine Belt [269](#)  
Installing Batteries [263](#)  
Instrument Cluster [60](#)

## K

Key Fob [265](#)  
Keyless Entry [265](#)

## L

Lamp Self Test [107](#)  
Lamp Test [107](#)  
Lamps, Headlamps Flashing, Aftertreatment Warning [141](#)  
Lane Departure [136](#), [150](#)  
Lane Departure Warning (LDW) [91](#)  
Lane Departure Warning (LDW) Disable [101](#)  
Lane Departure Warning Fault [91](#)  
Lane Departure Warning Mute, *See* Lane Departure Warning Disable  
Lane Keeping Assist Mute, *See* Lane Departure Warning Disable

## Language

English [72](#)  
French [72](#)  
Spanish [72](#)

LDW [150](#)  
LDWS [136](#)  
Light Self Test [107](#)  
Lights Marker Clearance [110](#)  
Lights, High Beam [91](#)  
Locking the Fifth Wheel, *See* How to Lock the Kingpin  
Low Air Alarm [41](#)  
Low Air Leaf Fastener Torque Value Rear Suspension Fasteners [309](#)  
Low Oil Pressure Lamp [42](#)  
Lubricants [232](#)  
Lubrication Specification Chart [302](#)  
LVD, *See* Low Voltage Disconnect

## M

Maintenance Manuals [11](#)  
Maintenance Schedule [196](#)  
Manifold Pressure Gauge [92](#)  
Manual Kingpin Release/Fifth Wheel Operation [180](#)  
Manually lock a differential [53](#)  
MAX Mode [137](#)  
Menu [72](#)  
Meritor Axle Lubrication [287](#)  
Metric Units [72](#)

minimized view 2 [66](#)  
Mirror Controls [113](#)  
Mirror Passenger Side 'down' Mirror [128](#)  
Mirror switch [113](#)  
Mud [56](#)

## N

New Vehicle Maintenance Schedule [193](#)  
New Vehicle Maintenance Schedule: First 2,000 mi / 3,218 km [194](#)  
New Vehicle Maintenance Schedule: First 50-100 mi / 80-160 km [194](#)  
New Vehicle Maintenance Schedule: First 500 mi / 800 km [194](#)  
New Vehicle Maintenance Schedule: First Day [193](#)  
New Vehicle Maintenance Schedule: First 3,000-5,000 mi / 4800-8000 km [195](#)  
Noise and Emission Control [280](#)  
Noise Control System - Maintenance Log [282](#)  
Notifications [72](#)

## O

Odometer [66](#)  
Off-Road ABS Function Switch (Optional) [166](#)  
Oil Level [233](#)  
Outside Air Temperature [64](#)  
Overflow tank [254](#)

## P

PACCAR 20k Front Axle Lubrication [277](#)  
PACCAR AMT [158](#)  
PACCAR AMT Shifting gears [158](#)  
PACCAR Shifter [108](#)  
PCC [148](#)  
Pipe and Hose Clamp Torque Values [269](#), [300](#)  
power distribution box [259](#)  
Power Steering Fluid [290](#)  
Power Take Off [138](#)  
Pre-Trip Inspection [32](#)

Predictive Cruise Control [148](#)  
Predictive Cruise Control Behavior [149](#)  
Predictive Cruise Control Controls [150](#)  
Predictive Cruise Control Interrupt [149](#)  
Predictive Cruise Control Set Undershoot [150](#)  
Predictive Cruise Control Software Information [150](#)  
Predictive Cruise Control Troubleshooting [149](#)  
Predictive Cruise Overshoot [72](#)  
Prepare the Axles for Towing [52](#)  
Program Key Fobs [266](#)  
PTO [138](#)  
PTO indicator [135](#)

## R

Radiator Hoses [254](#)  
Rear Axle Alignment [286](#)  
Rear Axle and Suspension [284](#)  
Rear Axle Lubrication [286](#)  
Rear Suspension U-Bolts, Grade 8 [307](#)  
Recovery Hitch [51](#)  
Recovery hitch capacities [54](#)  
Recovery hitch How to use tow pin [52](#)  
Recovery hitchBest practices [55](#)  
Recovery hitchPrepare axles [52](#)  
Refrigerator [91](#)  
Release KingpinFifth Wheel Operation [180](#)  
Releasing the Kingpin, See How to Release the Kingpin from the Cab  
Remote Keyless Entry [265](#)  
Removing Batteries [263](#)  
Repairs [11](#)  
Replace Battery Box Cover [264](#)  
Replace HVAC Air Filter [248](#)  
Replace the Recirculation Air Filter [280](#)  
Returning to Service after Recovering [55](#)  
Roadside Assistance [41](#)  
Roll Stability [164](#)  
Roll Stability Example [164](#)

## S

- Safety [6](#)
- Safety Alerts [6](#)
- Safety Restraint System - Inspection [249](#)
- Sand [56](#)
- Scroll Wheel [62](#)
- Seat
  - Komfort Latch [30](#)
  - Lap/Shoulder Belt [28](#)
  - Safety Restraint Belts [26](#)
  - Tether Belts [29](#)
- Seat Belt Fasten [91](#)
- Set Shut Down Timer [140](#)
- Settings [72](#)
- Shortcuts [76](#)
- Shut Down Timer [73](#)
- Sleeper control panel [119](#)
- Sleeper HVAC Air Filter [280](#)
- Sliding Fifth Wheels [274](#)
- Sliding the Fifth Wheel, See How to Slide the Fifth Wheel
- Slow Battery Charging [264](#)
- Snow [56](#)
- Specific Cruise Indicator [87](#)
- Speed Sign Recognition [153](#)
- Speedometer [66](#)
- Stability Control [84, 85](#)
- Standard Units [72](#)
- Steering Shaft Bolt Torque Specifications [291](#)
- Steering System [289](#)
- Steering Wheel Controls [112](#)
- Steering Wheel Pod Use [62](#)
- Stop Engine Light [42](#)
- Stopping Procedures [187](#)
- Sub-trip Odometer [65](#)
- Suppressing Popups [81](#)
- Surge tank [254](#)
- Suspension U-Bolts [307](#)
- Systems Check [37](#)

## T

- Tachometer [66, 185](#)
- Testing Exterior Lamps [107](#)
- Tilt Telescope [108](#)
- Time [72](#)
- Tire Inflation [91, 292](#)
- Tire Pressure Monitoring System [37](#)
- Tires [292](#)
- Topping Up the Engine Oil [268](#)
- Tow Pin [51](#)
- Towing Doubles Or Triples May Reduce The Effectiveness Of Stability Systems [168](#)
- Towing the Vehicle [56](#)
- TPMS [37](#)
- Traction Control [104](#)
- Trailer Hand Brake [98, 161](#)
- Trailer Hand Brake Dash Switch [161](#)
- Transmission Gear Display [66](#)
- Transmission, Automated [156](#)
- Transmission, Auxiliary [92](#)
- Transmission, Check [92](#)
- TransmissionMaintenance [298](#)
- Trip Odometer [65](#)
- Trip Summary [72](#)
- Truck Information [77](#)
- Turbocharger [271](#)
- Turn Signal [108, 110](#)
- Turn Signal, Left [92](#)
- Turn Signal, Right [92](#)

## U

- Under Cab Battery Access [263](#)
- Under hood air filter housing [22, 271](#)
- Under Hood Air Intake Symbol [99, 133](#)
- Under Hood Intake [99, 133](#)
- Unlock Fifth Wheel, See How to Release the Kingpin from the Cab
- Unlocking the Fifth WheelFifth Wheel Operation [180](#)

## V

Variable Road Speed Limiter [144](#)  
Variable Speed Limiter How to Set the Variable Speed Limiter [145](#)  
Vehicle Emissions Limited Express Warranty [320](#)  
Vehicle ID Labels [313](#)  
Vehicle is stuck [56](#)  
Vehicle Light Bulb Specifications [310](#)  
Vehicle Loading [34](#)  
View Indicator [65](#)  
Visual inspection while approaching the vehicle [34](#)

## W

Warm Up, Engine [133](#)  
Warning Icons [81](#)  
Washer Fluid, See How to Refill the Washer Fluid Reservoir  
Weekly Checks [36](#)  
What is an Air Compressor [240](#)  
What is the Air System [234](#)  
What to do before starting the vehicle [32](#)  
Wheel Cap Nut Torque Specifications [301](#)  
Wheels [295](#)  
Windsheid Wiper Interlock [73](#)  
Windshield Washer [109](#)  
Windshield Washer Fluid, See How to Refill the Washer Fluid Reservoir  
Windshield Wiper [109](#)  
Windshield Wiper/Washer [298](#)

## Y

Yaw Control [164](#)  
Yaw Control Example [165](#)  
Yaw Stability [164](#)





# PETERBILT MOTORS COMPANY

A PACCAR Company

P.O. Box 90208

Denton, Texas 76202

Do not remove the manual from vehicle.

Before operating vehicle study the manual carefully.

Read and understand all warnings, cautions and notes.



Need help? Give us a call 24 hours a day

**1.800.4.PETERBILT**

SCAN THIS QR CODE  
TO ACCESS ONLINE  
DRIVER RESOURCES.  
[peterbilt.com/driver-resources](https://peterbilt.com/driver-resources)



Y53-6110-1A1

Printed in the U.S.A. 01/21