

450H, 550H, 650H Crawler Dozer



OPERATOR'S MANUAL 450H/550H/650H Crawler Dozers OMT182515 ISSUE G3 (ENGLISH)

CALIFORNIA

Proposition 65 Warning

Diesel engine exhaust and some of its constituents are known to the State of California to cause cancer, birth defects, and other reproductive harm.

If this product contains a gasoline engine:

⚠ WARNING

The engine exhaust from this product contains chemicals known to the State of California to cause cancer, birth defects or other reproductive harm.

The State of California requires the above two warnings.

Additional Proposition 65 Warnings can be found in this manual.

**Worldwide Construction
And Forestry Division**

LITHO IN U.S.A.

Introduction

Foreword

READ THIS MANUAL carefully to learn how to operate and service your machine correctly. Failure to do so could result in personal injury or equipment damage. This manual and safety signs on your machine may also be available in other languages. (See your John Deere dealer to order.)

THIS MANUAL SHOULD BE CONSIDERED a permanent part of your machine and should remain with the machine when you sell it.

MEASUREMENTS in this manual are given in both metric and customary U.S. unit equivalents. Use only correct replacement parts and fasteners. Metric and inch fasteners may require a specific metric or inch wrench.

RIGHT-HAND AND LEFT-HAND sides are determined by facing in the direction of forward travel.

WRITE PRODUCT IDENTIFICATION NUMBERS (P.I.N.) in the Machine Numbers section. Accurately record all the numbers to help in tracing the machine should it be

stolen. Your dealer also needs these numbers when you order parts. File the identification numbers in a secure place off the machine.

WARRANTY is provided as part of John Deere's support program for customers who operate and maintain their equipment as described in this manual. The warranty is explained on the warranty certificate which you should have received from your dealer.

This warranty provides you the assurance that John Deere will back its products where defects appear within the warranty period. In some circumstances, John Deere also provides field improvements, often without charge to the customer, even if the product is out of warranty. Should the equipment be abused, or modified to change its performance beyond the original factory specifications, the warranty will become void and field improvements may be denied. Setting fuel delivery above specifications or otherwise overpowering machines will result in such action.

OUC1043,0000469 -19-14JAN08-1/1

EPA Non-road Emissions Control Warranty Statement—Compression Ignition

DXLOGOV1 —UN—28APR09



JOHN DEERE

U.S. AND CANADA EMISSION CONTROL WARRANTY STATEMENT YOUR WARRANTY RIGHTS AND OBLIGATIONS

To determine if the John Deere engine qualifies for the additional warranties set forth below, look for the "Emissions Control Information" label located on the engine. If the engine is operated in the United States or Canada and the Emissions Control information label states: "This engine complies with US EPA regulations for nonroad and stationary diesel engines", or "This engine conforms to US EPA nonroad compression-ignition regulations", refer to the "U.S. and Canada Emission Control Warranty Statement." If the engine is operated in California, and the label states: "This engine complies with US EPA and CARB regulations for nonroad diesel engines", or "This engine conforms to US EPA and California nonroad compression-ignition emission regulations", also refer to the "California Emission Control Warranty Statement."

Warranties stated on this certificate refer only to emissions-related parts and components of your engine. The complete engine warranty, less emissions-related parts and components, is provided separately. If you have any questions about your warranty rights and responsibilities, you should contact John Deere at 1-319-292-5400.

JOHN DEERE'S WARRANTY RESPONSIBILITY

John Deere warrants to the ultimate purchaser and each subsequent purchaser that this off-road diesel engine including all parts of its emission-control system was designed, built and equipped so as to conform at the time of the sale with Section 213 of the Clean Air Act and is free from defects in materials and workmanship which would cause the engine to fail to conform with applicable US EPA regulations for a period of five years from the date the engine is placed into service or 3,000 hours of operation, whichever first occurs.

Where a warrantable condition exists, John Deere will repair or replace, as it elects, any part or component with a defect in materials or workmanship that would increase the engine's emissions of any regulated pollutant within the stated warranty period at no cost to you, including expenses related to diagnosing and repairing or replacing emission-related parts. Warranty coverage is subject to the limitations and exclusions set forth herein. Emission-related components include engine parts developed to control emissions related to the following:

Air-Induction System	Aftertreatment Devices
Fuel System	Crankcase Ventilation Valves
Ignition System	Sensors
Exhaust Gas Recirculation Systems	Engine Electronic Control Units

EMISSION WARRANTY EXCLUSIONS

John Deere may deny warranty claims for malfunctions or failures caused by:

- Non-performance of maintenance requirements listed in the Operator's Manual
- The use of the engine/equipment in a manner for which it was not designed
- Abuse, neglect, improper maintenance or unapproved modifications or alterations
- Accidents for which it does not have responsibility or by acts of God

The off-road diesel engine is designed to operate on diesel fuel as specified in the Fuels, Lubricants and Coolants section in the Operators Manual. Use of any other fuel can harm the emissions control system of the engine/equipment and is not approved for use.

To the extent permitted by law John Deere is not liable for damage to other engine components caused by a failure of an emission-related part, unless otherwise covered by standard warranty.

THIS WARRANTY IS EXPRESSLY IN LIEU OF ANY OTHER WARRANTIES, EXPRESS OR IMPLIED, INCLUDING ANY WARRANTY OF MERCHANTABILITY OR FITNESS FOR A PARTICULAR PURPOSE. REMEDIES UNDER THIS WARRANTY ARE LIMITED TO THE PROVISIONS OF MATERIAL AND SERVICES AS SPECIFIED HEREIN. WHERE PERMITTED BY LAW, NEITHER JOHN DEERE NOR ANY AUTHORIZED JOHN DEERE ENGINE DISTRIBUTOR, DEALER, OR REPAIR FACILITY OR ANY COMPANY AFFILIATED WITH JOHN DEERE WILL BE LIABLE FOR INCIDENTAL OR CONSEQUENTIAL DAMAGES.

Emission_CI_EPA (18Dec09)

Continued on next page

DX,EMISSIONS,EPA -19-12DEC12-1/2

Introduction



JOHN DEERE

U.S. AND CANADA EMISSION CONTROL WARRANTY STATEMENT YOUR WARRANTY RIGHTS AND OBLIGATIONS

To determine if the John Deere engine qualifies for the additional warranties set forth below, look for the "Emissions Control Information" label located on the engine. If the engine is operated in the United States or Canada and the Emissions Control information label states: "This engine complies with US EPA regulations for nonroad and stationary diesel engines", or "This engine conforms to US EPA nonroad compression-ignition regulations", refer to the "U.S. and Canada Emission Control Warranty Statement." If the engine is operated in California, and the label states: "This engine complies with US EPA and CARB regulations for nonroad diesel engines", or "This engine conforms to US EPA and California nonroad compression-ignition emission regulations", also refer to the "California Emission Control Warranty Statement."

Warranties stated on this certificate refer only to emissions-related parts and components of your engine. The complete engine warranty, less emissions-related parts and components, is provided separately. If you have any questions about your warranty rights and responsibilities, you should contact John Deere at 1-319-292-5400.

JOHN DEERE'S WARRANTY RESPONSIBILITY

John Deere warrants to the ultimate purchaser and each subsequent purchaser that this off-road diesel engine including all parts of its emission-control system was designed, built and equipped so as to conform at the time of the sale with Section 213 of the Clean Air Act and is free from defects in materials and workmanship which would cause the engine to fail to conform with applicable US EPA regulations for a period of five years from the date the engine is placed into service or 3,000 hours of operation, whichever first occurs.

Where a warrantable condition exists, John Deere will repair or replace, as it elects, any part or component with a defect in materials or workmanship that would increase the engine's emissions of any regulated pollutant within the stated warranty period at no cost to you, including expenses related to diagnosing and repairing or replacing emission-related parts. Warranty coverage is subject to the limitations and exclusions set forth herein. Emission- related components include engine parts developed to control emissions related to the following:

Air-Induction System	Aftertreatment Devices
Fuel System	Crankcase Ventilation Valves
Ignition System	Sensors
Exhaust Gas Recirculation Systems	Engine Electronic Control Units

EMISSION WARRANTY EXCLUSIONS

John Deere may deny warranty claims for malfunctions or failures caused by:

- Non-performance of maintenance requirements listed in the Operator's Manual
- The use of the engine/equipment in a manner for which it was not designed
- Abuse, neglect, improper maintenance or unapproved modifications or alterations
- Accidents for which it does not have responsibility or by acts of God

The off-road diesel engine is designed to operate on diesel fuel as specified in the Fuels, Lubricants and Coolants section in the Operators Manual. Use of any other fuel can harm the emissions control system of the engine/equipment and is not approved for use.

To the extent permitted by law John Deere is not liable for damage to other engine components caused by a failure of an emission-related part, unless otherwise covered by standard warranty.

THIS WARRANTY IS EXPRESSLY IN LIEU OF ANY OTHER WARRANTIES, EXPRESS OR IMPLIED, INCLUDING ANY WARRANTY OF MERCHANTABILITY OR FITNESS FOR A PARTICULAR PURPOSE. REMEDIES UNDER THIS WARRANTY ARE LIMITED TO THE PROVISIONS OF MATERIAL AND SERVICES AS SPECIFIED HEREIN. WHERE PERMITTED BY LAW, NEITHER JOHN DEERE NOR ANY AUTHORIZED JOHN DEERE ENGINE DISTRIBUTOR, DEALER, OR REPAIR FACILITY OR ANY COMPANY AFFILIATED WITH JOHN DEERE WILL BE LIABLE FOR INCIDENTAL OR CONSEQUENTIAL DAMAGES.

DX,EMISSIONS,EPA -19-12DEC12-2/2

TS17Z1 -JUN-17DEC12

CARB Non-road Emissions Control Warranty Statement—Compression Ignition

DXLOGOV1 —UN—28APR09



JOHN DEERE

CALIFORNIA EMISSIONS CONTROL WARRANTY STATEMENT YOUR WARRANTY RIGHTS AND OBLIGATIONS

To determine if the John Deere engine qualifies for the additional warranties set forth below, look for the “Emission Control Information” label located on the engine. If the engine is operated in the United States or Canada and the engine label states: “This engine complies with US EPA regulations for nonroad and stationary diesel engines”, or “This engine complies with US EPA regulations for stationary emergency diesel engines”, refer to the “U.S. and Canada Emission Control Warranty Statement.” If the engine is operated in California, and the engine label states: “This engine complies with US EPA and CARB regulations for nonroad diesel engines” also refer to the “California Emissions Control Warranty Statement.”

Warranties stated on this certificate refer only to emissions-related parts and components of your engine. The complete engine warranty, less emission-related parts and components, is provided separately. If you have any questions about your warranty rights and responsibilities, you should contact John Deere at 1-319-292-5400.

CALIFORNIA EMISSIONS CONTROL WARRANTY STATEMENT:

The California Air Resources Board (CARB) is pleased to explain the emission-control system warranty on 2013 through 2015 off-road diesel engines. In California, new off-road engines must be designed, built and equipped to meet the State’s stringent anti-smog standards. John Deere must warrant the emission control system on your engine for the periods of time listed below provided there has been no abuse, neglect or improper maintenance of your engine.

Your emission control system may include parts such as the fuel injection system and the air induction system. Also included may be hoses, belts, connectors and other emission-related assemblies.

John Deere warrants to the ultimate purchaser and each subsequent purchaser that this off-road diesel engine was designed, built, and equipped so as to conform at the time of sale with all applicable regulations adopted by CARB and is free from defects in materials and workmanship which would cause the failure of a warranted part to be identical in all material respects to the part as described in John Deere’s application for certification for a period of five years from the date the engine is delivered to an ultimate purchaser or 3,000 hours of operation, whichever occurs first for all engines rated at 19 kW and greater. In the absence of a device to measure hours of use, the engine shall be warranted for a period of five years.

EMISSIONS WARRANTY EXCLUSIONS:

John Deere may deny warranty claims for failures caused by the use of an add-on or modified part which has not been exempted by the CARB. A modified part is an aftermarket part intended to replace an original emission-related part which is not functionally identical in all respects and which in any way affects emissions. An add-on part is any aftermarket part which is not a modified part or a replacement part.

In no event will John Deere, any authorized engine distributor, dealer, or repair facility, or any company affiliated with John Deere be liable for incidental or consequential damage.

Introduction

JOHN DEERE'S WARRANTY RESPONSIBILITY:

Where a warrantable condition exists, John Deere will repair or replace, as it elects, your off-road diesel engine at no cost to you, including diagnosis, parts or labor. Warranty coverage is subject to the limitations and exclusions set forth herein. The off-road diesel engine is warranted for a period of five years from the date the engine is delivered to an ultimate purchaser or 3,000 hours of operation, whichever occurs first. The following are emissions-related parts:

Air Induction System

- Intake manifold
- Turbocharger
- Charge air cooler

Fuel Metering system

- Fuel injection system

Exhaust Gas Recirculation

- EGR valve

Catalyst or Thermal Reactor Systems

- Catalytic converter
- Exhaust manifold

Emission control labels

Particulate Controls

- Any device used to capture particulate emissions
- Any device used in the regeneration of the capturing system
- Enclosures and manifolding
- Smoke Puff Limiters

Positive Crankcase Ventilation (PCV) System

- PCV valve
- Oil filler cap

Advanced Oxides of Nitrogen (NOx) Controls

- NOx absorbers and catalysts

SCR systems and urea containers/dispensing systems

Miscellaneous Items used in Above Systems

- Electronic control units, sensors, actuators, wiring harnesses, hoses, connectors, clamps, fittings, gasket, mounting hardware

Any warranted emissions-related part scheduled for replacement as required maintenance is warranted by John Deere for the period of time prior to the first scheduled replacement point for the part. Any warranted emissions-related part not scheduled for replacement as required maintenance or scheduled only for regular inspection is warranted by John Deere for the stated warranty period.

OWNER'S WARRANTY RESPONSIBILITIES:

As the off-road diesel engine owner you are responsible for the performance of the required maintenance listed in your Operator's Manual. John Deere recommends that the owner retain all receipts covering maintenance on the off-road diesel engine, but John Deere cannot deny warranty solely for the lack of receipts or for the owner's failure to ensure the performance of all scheduled maintenance. However, as the off-road diesel engine owner, you should be aware that John Deere may deny you warranty coverage if your off-road diesel engine or a part has failed due to abuse, neglect, improper maintenance or unapproved modifications.

The off-road diesel engine is designed to operate on diesel fuel as specified in the Fuels, Lubricants and Coolants section in the Operators Manual. Use of any other fuel may result in the engine no longer operating in compliance with applicable emissions requirements.

The owner is responsible for initiating the warranty process, and should present the machine to the nearest authorized John Deere dealer as soon as a problem is suspected. The warranty repairs should be completed by the authorized John Deere dealer as quickly as possible.

Emissions regulations require the customer to bring the unit to an authorized servicing dealer when warranty service is required. As a result, John Deere is NOT liable for travel or mileage on emissions warranty service calls.

Emission_CI_CARB (19Sep12)

Continued on next page

DX,EMISSIONS,CARB -19-12DEC12-2/4



JOHN DEERE

**CALIFORNIA EMISSIONS CONTROL WARRANTY STATEMENT
YOUR WARRANTY RIGHTS AND OBLIGATIONS**

To determine if the John Deere engine qualifies for the additional warranties set forth below, look for the "Emission Control Information" label located on the engine. If the engine is operated in the United States or Canada and the engine label states: "This engine complies with US EPA regulations for nonroad and stationary diesel engines", or "This engine complies with US EPA regulations for stationary emergency diesel engines", refer to the "U.S. and Canada Emission Control Warranty Statement." If the engine is operated in California, and the engine label states: "This engine complies with US EPA and CARB regulations for nonroad diesel engines" also refer to the "California Emissions Control Warranty Statement."

Warranties stated on this certificate refer only to emissions-related parts and components of your engine. The complete engine warranty, less emission-related parts and components, is provided separately. If you have any questions about your warranty rights and responsibilities, you should contact John Deere at 1-319-292-5400.

CALIFORNIA EMISSIONS CONTROL WARRANTY STATEMENT:

The California Air Resources Board (CARB) is pleased to explain the emission-control system warranty on 2013 through 2015 off-road diesel engines. In California, new off-road engines must be designed, built and equipped to meet the State's stringent anti-smog standards. John Deere must warrant the emission control system on your engine for the periods of time listed below provided there has been no abuse, neglect or improper maintenance of your engine.

Your emission control system may include parts such as the fuel injection system and the air induction system. Also included may be hoses, belts, connectors and other emission-related assemblies.

John Deere warrants to the ultimate purchaser and each subsequent purchaser that this off-road diesel engine was designed, built, and equipped so as to conform at the time of sale with all applicable regulations adopted by CARB and is free from defects in materials and workmanship which would cause the failure of a warranted part to be identical in all material respects to the part as described in John Deere's application for certification for a period of five years from the date the engine is delivered to an ultimate purchaser or 3,000 hours of operation, whichever occurs first for all engines rated at 19 kW and greater. In the absence of a device to measure hours of use, the engine shall be warranted for a period of five years.

EMISSIONS WARRANTY EXCLUSIONS:

John Deere may deny warranty claims for failures caused by the use of an add-on or modified part which has not been exempted by the CARB. A modified part is an aftermarket part intended to replace an original emission-related part which is not functionally identical in all respects and which in any way affects emissions. An add-on part is any aftermarket part which is not a modified part or a replacement part.

In no event will John Deere, any authorized engine distributor, dealer, or repair facility, or any company affiliated with John Deere be liable for incidental or consequential damage.

Continued on next page

DX,EMISSIONS,CARB -19-12DEC12-3/4

TS1722—UN—17DEC12

Introduction

JOHN DEERE'S WARRANTY RESPONSIBILITY:

Where a warrantable condition exists, John Deere will repair or replace, as it elects, your off-road diesel engine at no cost to you, including diagnosis, parts or labor. Warranty coverage is subject to the limitations and exclusions set forth herein. The off-road diesel engine is warranted for a period of five years from the date the engine is delivered to an ultimate purchaser or 3,000 hours of operation, whichever occurs first. The following are emissions-related parts:

Air Induction System

- Intake manifold
- Turbocharger
- Charge air cooler

Fuel Metering system

- Fuel injection system

Exhaust Gas Recirculation

- EGR valve

Catalyst or Thermal Reactor Systems

- Catalytic converter
- Exhaust manifold

Emission control labels

Particulate Controls

- Any device used to capture particulate emissions
- Any device used in the regeneration of the capturing system
- Enclosures and manifolding
- Smoke Puff Limiters

Positive Crankcase Ventilation (PCV) System

- PCV valve
- Oil filler cap

Advanced Oxides of Nitrogen (NOx) Controls

- NOx absorbers and catalyts

SCR systems and urea containers/dispensing systems

Miscellaneous Items used in Above Systems

- Electronic control units, sensors, actuators, wiring harnesses, hoses, connectors, clamps, fittings, gasket, mounting hardware

Any warranted emissions-related part scheduled for replacement as required maintenance is warranted by John Deere for the period of time prior to the first scheduled replacement point for the part. Any warranted emissions-related part not scheduled for replacement as required maintenance or scheduled only for regular inspection is warranted by John Deere for the stated warranty period.

OWNER'S WARRANTY RESPONSIBILITIES:

As the off-road diesel engine owner you are responsible for the performance of the required maintenance listed in your Operator's Manual. John Deere recommends that the owner retain all receipts covering maintenance on the off-road diesel engine, but John Deere cannot deny warranty solely for the lack of receipts or for the owner's failure to ensure the performance of all scheduled maintenance. However, as the off-road diesel engine owner, you should be aware that John Deere may deny you warranty coverage if your off-road diesel engine or a part has failed due to abuse, neglect, improper maintenance or unapproved modifications.

The off-road diesel engine is designed to operate on diesel fuel as specified in the Fuels, Lubricants and Coolants section in the Operators Manual. Use of any other fuel may result in the engine no longer operating in compliance with applicable emissions requirements.

The owner is responsible for initiating the warranty process, and should present the machine to the nearest authorized John Deere dealer as soon as a problem is suspected. The warranty repairs should be completed by the authorized John Deere dealer as quickly as possible.

Emissions regulations require the customer to bring the unit to an authorized servicing dealer when warranty service is required. As a result, John Deere is NOT liable for travel or mileage on emissions warranty service calls.

DX,EMISSIONS,CARB -19-12DEC12-4/4

TS1723 —UN—17DEC12

Introduction

Contents

Page	Page
Safety—Safety Features	
Safety Features	1-1-1
Safety—General Precautions	
Recognize Safety Information	1-2-1
Follow Safety Instructions	1-2-1
Operate Only If Qualified	1-2-1
Wear Protective Equipment	1-2-2
Avoid Unauthorized Machine Modifications	1-2-2
Inspect Machine	1-2-2
Stay Clear of Moving Parts	1-2-2
Avoid High-Pressure Fluids	1-2-3
Beware of Exhaust Fumes	1-2-3
Prevent Fires	1-2-4
Prevent Battery Explosions	1-2-4
Handle Chemical Products Safely	1-2-4
Dispose of Waste Properly	1-2-5
Prepare for Emergencies	1-2-5
Add Cab Guarding For Special Uses	1-2-5
Safety—Operating Precautions	
Start Only From Operator's Seat	1-3-1
Prevent Unintended Machine Movement	1-3-1
Avoid Worksite Hazards	1-3-1
Keep Riders Off Machine	1-3-2
Avoid Backover Accidents	1-3-2
Avoid Machine Tip Over	1-3-3
Safety—Maintenance Precautions	
Park And Prepare For Service Safely	1-4-1
Service Cooling System Safely	1-4-1
Remove Paint Before Welding or Heating	1-4-2
Make Welding Repairs Safely	1-4-2
Drive Metal Pins Safely	1-4-2
Safety—Safety Signs	
Safety Signs	1-5-1
Operation—Operator's Station	
Instrument Panel with Gauge	
Package—If Equipped (Earlier Machines)	2-1-1
Instrument Panel Functions (Earlier Machines).....	2-1-2
Instrument Panel (Later Machines)	2-1-3
Instrument Panel Functions (Later Machines).....	2-1-4
Transmission Controller Display Window	2-1-5
Air Conditioning and Cab Heater—If Equipped	2-1-8
Windshield Wiper and Washer Controls	2-1-8
Windshield Washer Reservoir	2-1-8
Horn Switch	2-1-9
Auxiliary Power Outlet—If Equipped	2-1-9
Side Windows—Secondary Exits	2-1-10
Adjust Non-Suspension Seat	2-1-10
Adjust Suspension Seat—If Equipped	2-1-11
Adjust Armrest	2-1-11
Seat Belt	2-1-12
Operation—Operating The Machine	
Inspect Machine Daily Before Starting	2-2-1
Check Instruments Before Starting (Earlier Machines)	2-2-2
Check Instruments Before Starting (Later Machines)	2-2-3
Starting the Engine (Earlier Machines).....	2-2-4
Starting the Engine (Later Machines).....	2-2-6
Starting Fluid (Cold Weather Start Aid)—If Equipped	2-2-8
Using Coolant Heater—If Equipped	2-2-9
Operating Fuel-Fired Coolant Heater—If Equipped	2-2-10
Using Booster Batteries—12 Volt System	2-2-17
Engine Warm-Up	2-2-17
Cold Weather Warm-Up	2-2-18
Driving the Machine with Standard FNR Lever (Earlier Machines).....	2-2-18
Transmission Speed Reverse Ratio Knob—If Equipped	2-2-19
FNR with Transmission Speed In Grip—If Equipped	2-2-20
Driving the Machine using FNR with Transmission Speed In Grip—If Equipped (Earlier Machines).....	2-2-21
Driving the Machine using FNR with Transmission Speed In Grip—If Equipped (Later Machines).....	2-2-22
Steering the Machine.....	2-2-23
Steering using FNR with Transmission Speed In Grip Lever—If Equipped	2-2-24
Using Engine Speed Control Lever	2-2-25
Travel Speed Using FNR Transmission Speed In the Grip—If Equipped	2-2-25

Continued on next page

Original Instructions. All information, illustrations and specifications in this manual are based on the latest information available at the time of publication. The right is reserved to make changes at any time without notice.

COPYRIGHT © 2013
DEERE & COMPANY
Moline, Illinois
All rights reserved.
A John Deere ILLUSTRATION © Manual
Previous Editions
Copyright © 1998,1999,2000, 2001, 2002, 2003, 2004, 2005, 2009

Page	Page		
Foot Pedals	2-2-26	Clean Dust Unloader Valve	3-4-4
Using Park Lock Lever	2-2-26	Lubricate Dozer Linkage and Blade Socket	3-4-4
Stopping the Machine	2-2-26	Check Winch Oil—If Equipped	3-4-5
Parking the Machine	2-2-27		
Blade Pitch Operation	2-2-28	Maintenance—After 100 Hours	
Operating Blade	2-2-29	Change Engine Break-In Oil and Filter	3-5-1
Tilting Blade	2-2-29		
Angling Blade	2-2-30	Maintenance—Every 250 Hours	
Operating Winch—If Equipped	2-2-31	Drain Final Fuel Filter Sediment	3-6-1
Fasten Cable to Winch Drum—4000S Series	2-2-32	Check Final Drives Oil Level	3-6-1
Winch Free Spool Drag Adjustment	2-2-35	Change Engine Oil and Filter (450H, 550H Earlier Machines and All 650H Machines)	3-6-1
Avoid Track Damage	2-2-35		
Loading Machine on a Trailer	2-2-36	Maintenance—Every 500 Hours	
Releasing the Park Brake to Tow the Machine	2-2-37	Change Engine Oil and Filter (450H, 550H Later Machines)	3-7-1
		Check Air Intake Hose	3-7-1
Maintenance—Machine		Replace Final Fuel Filter	3-7-2
Diesel Fuel	3-1-1	Replace Primary Fuel Filter	3-7-3
Low Sulfur Diesel Fuel Conditioner	3-1-1	Check Coolant Conditioner in Radiator	3-7-4
Testing Diesel Fuel	3-1-1	Check Battery Electrolyte Level and Terminals	3-7-5
Handling and Storing Diesel Fuel	3-1-2	Replace Winch Oil Filter—If Equipped	3-7-7
Alternative and Synthetic Lubricants	3-1-2		
Diesel Engine Break-In Oil	3-1-3	Maintenance—Every 1000 Hours	
Diesel Engine Oil	3-1-4	Clean Engine Crankcase Ventilation Tube	3-8-1
Track Rollers, Front Idler and Carrier Roller Oil	3-1-4	Change Final Drives Oil	3-8-1
Transmission and Hydraulic Oil	3-1-5	Replace Air Cleaner Elements	3-8-2
Final Drive Oil	3-1-6	Replace Dust Unloader Valve	3-8-3
Winch Oil	3-1-7	Drain and Refill Winch Oil and Replace Filter—If Equipped	3-8-4
Grease	3-1-7	Clean or Replace Winch Hydraulic Breather Filter—If Equipped	3-8-5
Heavy Duty Diesel Engine Coolant	3-1-8		
		Maintenance—Every 2000 Hours	
Maintenance—Periodic Maintenance		Adjust Engine Valve Lash (Clearance)	3-9-1
Service Your Machine at Specified Intervals	3-2-1	Change Hydraulic Oil and Filter	3-9-1
Check the Hour Meter Regularly	3-2-1	Change Transmission Oil and Filter	3-9-2
Prepare Machine for Maintenance	3-2-1		
Fuel Tank	3-2-2	Miscellaneous—Machine	
Maintenance and Repair Record Keeping System	3-2-2	Drain the Cooling System	4-1-1
Oilscan Plus ®, Coolscan Plus ®, Dieselscan and 3-Way Coolant Test Kit	3-2-3	Fill the Cooling System	4-1-2
Service Intervals	3-2-4	Clean the Engine Air Precleaner Screen	4-1-2
		Replace Engine Vibration Damper	4-1-2
Maintenance—As Required		Do Not Service or Adjust Injection Nozzles or Injection Pump	4-1-3
Inspect Serpentine Belt	3-3-1	C-Frame Ball / Blade Socket Joint Adjustment	4-1-3
Check Track Sag	3-3-2	Cleaning Dusty Primary Element	4-1-4
Adjust Track Sag	3-3-3	Precautions for Alternator and Regulator	4-1-4
Operating in Mud or Snow	3-3-5	Handling, Checking and Servicing Batteries Carefully	4-1-5
Check Blade Ball and Socket Joint	3-3-5	Replacing Batteries	4-1-6
		Removing Batteries	4-1-7
Maintenance—Every 10 Hours or Daily		Fuse Specifications for ROPS Units (Earlier Machines)	4-1-8
Check Coolant Level	3-4-1		
Check Engine Oil Level	3-4-2		
Drain Water Separator Sediment	3-4-2		
Check Hydraulic Oil Level	3-4-3		
Check Transmission Oil Level	3-4-3		

Continued on next page

Page	Page		
Fuse Specifications for ROPS Units (Later Machines)	4-1-10	550H Crawler Dozer Dimensions	4-6-10
Fuse Specifications for Cab Units—If Equipped (Earlier Machines)	4-1-12	550H Crawler Dozer Specifications	4-6-11
Fuse Specifications for Cab Units—If Equipped (Later Machines)	4-1-14	550H Crawler Dozer Weights	4-6-12
Drain Fuel Tank Sump	4-1-15	550H-LGP Crawler Dozer Dimensions	4-6-13
Cleaning Fresh Cab Air Filter—If Equipped	4-1-16	550H-LGP Crawler Dozer Specifications	4-6-14
Cleaning Cab Air Recirculation Filter—If Equipped	4-1-16	550H-LGP Crawler Dozer Weights	4-6-15
Check Air Conditioner Refrigerant Level—If Equipped	4-1-17	550H and 550H-LGP Crawler Dozer Drain and Refill Capacities	4-6-15
Track Sag General Information	4-1-18	650H Crawler Dozer Dimensions	4-6-16
Adding Oil to the Roller	4-1-19	650H Crawler Dozer Specifications	4-6-17
Do Not Service Control Valves and Cylinders	4-1-19	650H Crawler Dozer Weights	4-6-18
Adjusting Engine Speed Control Lever Tension (Earlier Machines)	4-1-19	650H-LGP Crawler Dozer Dimensions	4-6-19
Checking Neutral Start System	4-1-20	650H-LGP Crawler Dozer Specifications	4-6-20
Keep ROPS Installed Properly	4-1-20	650H-LGP Crawler Dozer Weights	4-6-21
Checking Track Shoe Cap Screw Torque	4-1-21	650H-XLT Crawler Dozer Dimensions	4-6-22
Hardware Torque Specifications	4-1-21	650H-XLT Crawler Dozer Specifications	4-6-23
Unified Inch Bolt and Screw Torque Values	4-1-22	650H-XLT Crawler Dozer Weights	4-6-24
Metric Bolt and Screw Torque Values	4-1-23	650H, 650H-LGP and 650H-XLT Crawler Dozer Drain and Refill Capacities	4-6-24
Miscellaneous—Operational Checkout		4000S Winch	4-6-24
Operational Checkout	4-2-1		
Miscellaneous—Troubleshooting			
Troubleshooting Procedure	4-3-1		
Engine	4-3-2		
Electrical System	4-3-5		
Hydraulic System	4-3-7		
Hydrostatic Transmission	4-3-8		
Gauges and Indicators	4-3-9		
Transmission Controller Service Codes	4-3-10		
Miscellaneous—Storage			
Prepare Machine for Storage	4-4-1		
Avoid Track Damage	4-4-1		
Miscellaneous—Machine Numbers			
General	4-5-1		
Record Engine Serial Number	4-5-1		
Keep Machines Secure	4-5-2		
Keep Proof of Ownership	4-5-2		
Miscellaneous—Specifications			
450H Crawler Dozer Dimensions	4-6-1		
450H Crawler Dozer Specifications	4-6-2		
450H Crawler Dozer Weights	4-6-3		
450H-LT Crawler Dozer Dimensions	4-6-4		
450H-LT Crawler Dozer Specifications	4-6-5		
450H-LT Crawler Dozer Weights	4-6-6		
450H-LGP Crawler Dozer Dimensions	4-6-7		
450H-LGP Crawler Dozer Specifications	4-6-8		
450H-LGP Crawler Dozer Weights	4-6-9		
450H, 450H-LT and 450H-LGP Crawler Dozer Drain and Refill Capacities	4-6-9		

Safety—Safety Features

Safety Features

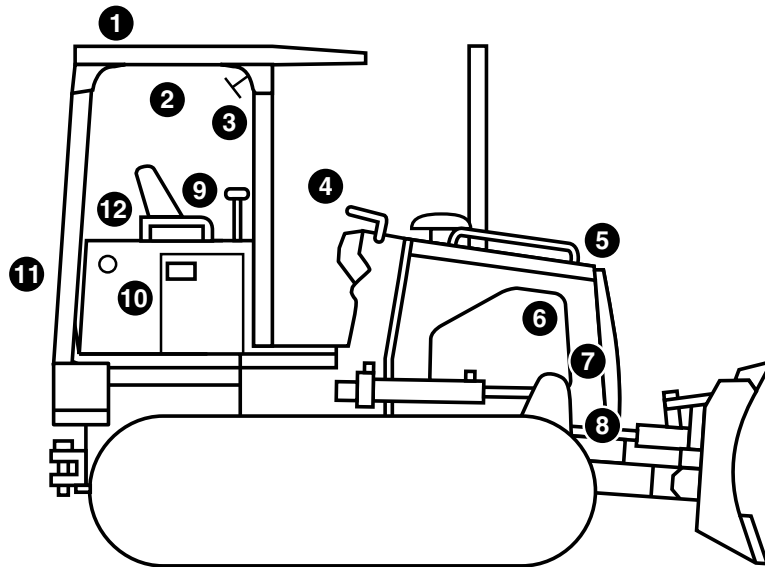

T155521

T155521—UN—19JUN02

Please remember, the operator is the key to preventing accidents.

1. **ROPS, FOPS, and OPS.** Structures designed to help protect the operator are certified to ISO, SAE, and OSHA. Enclosures also deflect sun and rain.
2. **Pressurized Cab.** Positive pressure ventilation system circulates both outside and inside air through filters for a clean working environment. Built-in defroster vents directs air flow for effective window defogging/deicing.
3. **Interior Rear View Mirror.** Offers the operator a view of activity behind him.
4. **Park Lock Lever.** When park lock lever is placed in "lock" position, the transmission shifts in neutral, the hydraulics are deactivated, and the park brake is engaged.
5. **Handholds.** Large conveniently placed handholds make it easy to enter or exit the operator's station.
6. **Bypass Start Protection.** Shielding over the starter solenoid helps prevent dangerous bypass starting.
7. **Engine Fan Guard.** A secondary fan guard inside engine compartment helps prevent contact with engine fan blades.
8. **Steps.** Wide skid-resistant steps help prevent slipping while getting in or out of the operator's station.
9. **Neutral Start.** Neutral start feature prevents the engine from being started unless transmission control is in neutral.
10. **Automatic Seatbelt Retractors.** Seat belt retractors help keep belts clean and convenient to use.
11. **Backup Alarm.** Alerts bystanders when reverse travel direction is selected by operator.
12. **Operator Manual Holder.** A sealed manual holder keeps manual on machine clean and dry.

HG31779.0000090 -19-03JUN02-1/1

Safety—General Precautions

Recognize Safety Information

This is the safety alert symbol. When you see this symbol on your machine or in this manual, be alert for the potential of personal injury.

Follow the precautions and safe operating practices highlighted by this symbol.

A signal word — DANGER, WARNING, or CAUTION — is used with the safety alert symbol. DANGER identifies the most serious hazards.

On your machine, DANGER signs are red in color, WARNING signs are orange, and CAUTION signs are yellow. DANGER and WARNING signs are located near specific hazards. General precautions are on CAUTION labels.



TX03679,00016CC -19-05FEB10-1/1

TI133555 —UN—15APR13

TI133558 —19—28AUG00

Follow Safety Instructions

Read the safety messages in this manual and on the machine. Follow these warnings and instructions carefully. Review them frequently. Keep safety signs in good condition. Replace missing or damaged safety signs. Be sure new equipment components and repair parts include the current safety signs. Replacement safety signs are available from your John Deere dealer.

Be sure all operators of this machine understand every safety message. Replace operator's manual and safety labels immediately if missing or damaged.



TX03679,00016F9 -19-12AUG03-1/1

TI133556 —UN—24AUG00

Operate Only If Qualified

Do not operate this machine unless the operator's manual has been read carefully, and you have been qualified by supervised training and instruction.

Operator should be familiar with the job site and surroundings before operating. Try all controls and

machine functions with the machine in an open area before starting to work.

Know and observe all safety rules that may apply to every work situation and work site.

TX03679,00016FA -19-03JAN07-1/1

Wear Protective Equipment

Guard against injury from flying pieces of metal or debris; wear goggles or safety glasses.

Wear close fitting clothing and safety equipment appropriate to the job.

Prolonged exposure to loud noise can cause impairment or loss of hearing. Wear suitable hearing protection such as earmuffs or earplugs to protect against objectionable or uncomfortable loud noises.

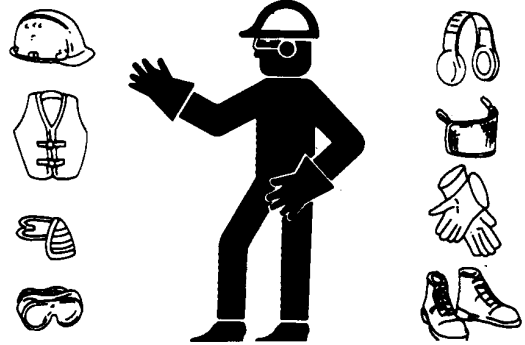

TS206—UN—15APR13

TX03679,00016D0 -19-05MAY10-1/1

Avoid Unauthorized Machine Modifications

John Deere recommends using only genuine John Deere replacement parts to ensure machine performance. Never substitute genuine John Deere parts with alternate parts not intended for the application as these can create hazardous situations or hazardous performance. Non-John Deere Parts, or any damage or failures resulting from their use are not covered by any John Deere warranty.

Modifications of this machine, or addition of unapproved products or attachments, may affect machine stability or reliability, and may create a hazard for the operator

or others near the machine. The installer of any modification which may affect this machine is responsible for establishing that the modification does not adversely affect the machine or its performance. This applies to all aspects of the machine, including electronic controls.

Always contact an authorized dealer before making machine modifications that change the intended use, weight or balance of the machine, or that alter machine controls, performance or reliability.

AM40430,0000084 -19-01OCT07-1/1

Inspect Machine

Inspect machine carefully each day by walking around it before starting.

Keep all guards and shields in good condition and properly installed. Fix damage and replace worn or broken parts immediately. Pay special attention to hydraulic hoses and electrical wiring.



T6607AQ—UN—15APR13

TX03679,0001734 -19-08JAN08-1/1

Stay Clear of Moving Parts

Entanglements in moving parts can cause serious injury.

Stop engine before examining, adjusting or maintaining any part of machine with moving parts.

Keep guards and shields in place. Replace any guard or shield that has been removed for access as soon as service or repair is complete.

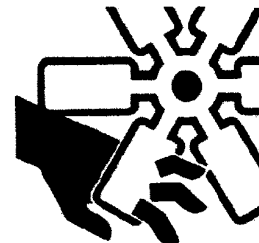

T133592—UN—15APR13

TX03679,00016D2 -19-08JAN08-1/1

Avoid High-Pressure Fluids

This machine uses a high-pressure hydraulic system. Escaping fluid under pressure can penetrate the skin causing serious injury.

Never search for leaks with your hands. Protect hands. Use a piece of cardboard to find location of escaping fluid. Stop engine and relieve pressure before disconnecting lines or working on hydraulic system.

If hydraulic fluid penetrates your skin, see a doctor immediately. Injected fluid must be removed surgically within hours or gangrene may result. Contact a knowledgeable medical source or the Deere & Company Medical Department in Moline, Illinois, U.S.A.

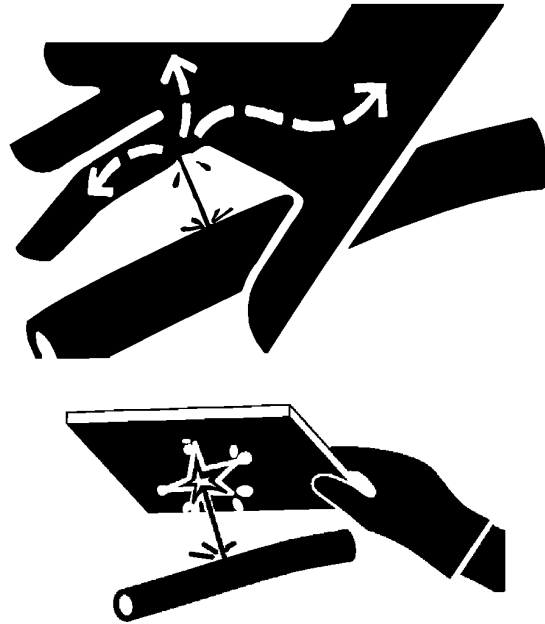

T133509—UN—15APR13

T133840—UN—20SEP00

TX03679,00016D3 -19-07SEP06-1/1

Beware of Exhaust Fumes

Prevent asphyxiation. Engine exhaust fumes can cause sickness or death.

If you must operate in an enclosed space, provide adequate ventilation. Use an exhaust pipe extension to remove the exhaust fumes or open doors and windows to bring outside air into the area.

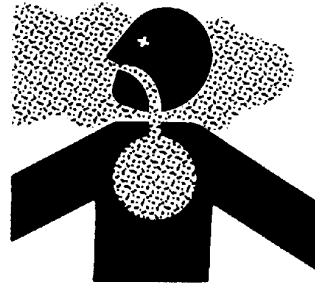

T133546—UN—24AUG00

TX03679,00016D4 -19-23JUN08-1/1

Prevent Fires

Handle Fuel Safely: Store flammable fluids away from fire hazards. Never refuel machine while smoking or when near sparks or flame.

Clean Machine Regularly: Keep trash, debris, grease and oil from accumulating in engine compartment, around fuel lines, hydraulic lines, exhaust components and electrical wiring. Never store oily rags or flammable materials inside a machine compartment.

Maintain Hoses and Wiring: Replace hydraulic hoses immediately if they begin to leak, and clean up any oil spills. Examine electrical wiring and connectors frequently for damage.

Keep A Fire Extinguisher Available: Always keep a multi-purpose fire extinguisher on or near the machine. Know how to use extinguisher properly.



T133553 —UN—07SEP00



T133554 —UN—07SEP00



TX03679,00016F5 -19-26JUN09-1/1

T133552 —UN—15APR13

Prevent Battery Explosions

Battery gas can explode. Keep sparks, lighted matches, and open flame away from the top of battery.

Never check battery charge by placing a metal object across the posts. Use a voltmeter or hydrometer.

Do not charge a frozen battery; it may explode. Warm battery to 16°C (60°F).



TX03679,000174A -19-08JAN08-1/1

TS204 —UN—15APR13

Handle Chemical Products Safely

Exposure to hazardous chemicals can cause serious injury. Under certain conditions, lubricants, coolants, paints and adhesives used with this machine may be hazardous.

If uncertain about safe handling or use of these chemical products, contact your authorized dealer for a Material Safety Data Sheet (MSDS) or go to internet website <http://www.jdmsds.com>. The MSDS describes physical and health hazards, safe use procedures, and emergency response techniques for chemical substances. Follow



MSDS recommendations to handle chemical products safely.

TX03679,00016D7 -19-03JAN07-1/1

T133580 —UN—25AUG00

Dispose of Waste Properly

Improper disposal of waste can threaten the environment. Fuel, oils, coolants, filters and batteries used with this machine may be harmful if not disposed of properly.

Never pour waste onto the ground, down a drain, or into any water source.

Air conditioning refrigerants can damage the atmosphere. Government regulations may require using a certified service center to recover and recycle used refrigerants.

If uncertain about the safe disposal of waste, contact your local environmental or recycling center or your authorized dealer for more information.

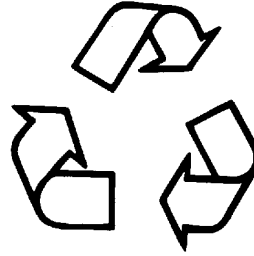

T133567 —UN—25AUG00

TX03679,0001733 -19-08JAN08-1/1

Prepare for Emergencies

Be prepared if an emergency occurs or a fire starts.

Keep a first aid kit and fire extinguisher handy.

Keep emergency numbers for doctors, ambulance service, hospital, and fire department near your telephone.

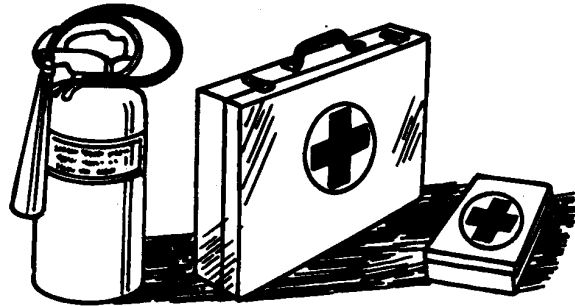

TS291 —UN—15APR13

TX03679,000174B -19-08JAN08-1/1

Add Cab Guarding For Special Uses

Special work situations or machine attachments may expose the operator to intruding or flying objects. Using this machine in a forestry application or woods environment, or with attachments such as a winch, requires added guarding to protect the operator.

Forestry protection packages or special screens should be installed when working in areas where logs or branches may strike the operator. A rear screen should always be used with a winch to protect against a snapping cable. Contact your authorized dealer for information on protective guarding before operating in any hazardous environment.

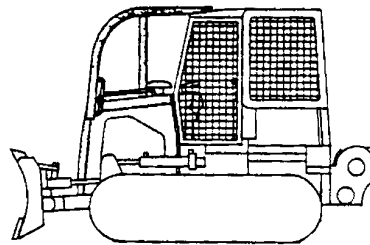

T139005 —UN—05MAR01

TX03768,0000B77 -19-14JAN08-1/1

Safety—Operating Precautions

Start Only From Operator's Seat

Avoid unexpected machine movement. Before starting engine, sit in operator's seat. Ensure park lock lever is in "lock" position.

Never attempt to start engine from the ground or tracks. Do not attempt to start engine by shorting across the starter solenoid terminals.



TX03768,0000B71 -19-03NOV08-1/1

T133715—UN—15APR13

Prevent Unintended Machine Movement

Always move the park lock lever to the "lock" position before leaving the operator's seat for any reason.

Be careful not to accidentally actuate controls when co-workers are present. Engage park lock and lower work equipment to the ground during work interruptions. Stop the engine before allowing anyone to approach the machine. Follow these same precautions before standing up, leaving the operator's seat, or exiting the machine.

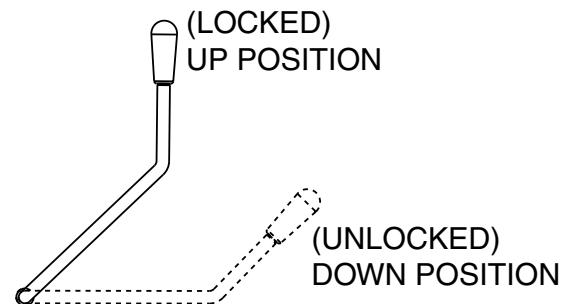

TX03768,0000B72 -19-01MAY01-1/1

T159027—19—30AUG02

Avoid Worksite Hazards

Avoid contact with gas lines, buried cables and water lines. Call utility line location services to identify all underground utilities before starting work.

Prepare worksite properly. Avoid operating near structures or objects that could fall onto the machine. Clear away debris that could move unexpectedly if run over.

Avoid boom or attachment contact with overhead obstacles or overhead electrical lines. Never move machine closer than 3 m (10 ft) plus twice the line insulator length to overhead wires.

Keep bystanders clear at all times. Keep bystanders away from raised booms, attachments and unsupported loads. Avoid swinging or raising booms, attachments, or loads over or near personnel. Use barricades or a signal person to keep vehicles and pedestrians away. Use a signal person if moving machine in congested areas or where visibility is restricted. Always keep signal person in view. Coordinate hand signals before starting machine.

Operate only on solid footing with strength sufficient to support machine. Be especially alert working near embankments or excavations.

Avoid working under over-hanging embankments or stockpiles that could collapse under or on machine.

Reduce machine speed when operating with tool on or near ground when obstacles may be hidden (e.g., during

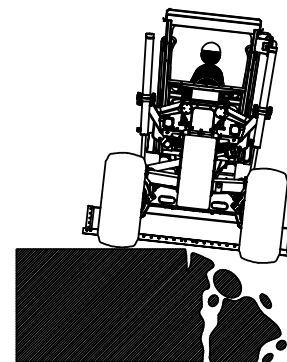
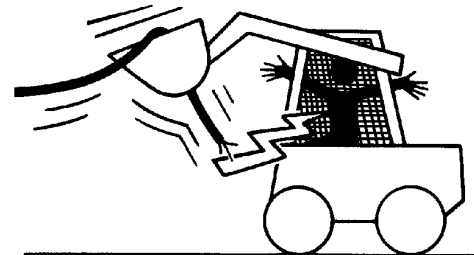

snow removal or clearing mud, dirt, etc.). At high speeds hitting obstacles (rocks, uneven concrete or manholes) can cause a sudden stop. Always wear your seat belt.

AM40430,0000098 -19-15JUN10-1/1

T192984—UN—26AUG03

T141904—UN—15MAY01

Keep Riders Off Machine

Only allow operator on machine.

Riders are subject to injury. They may fall from machine, be caught between machine parts, or be struck by foreign objects.

Riders may obstruct operator's view or impair his ability to operate machine safely.

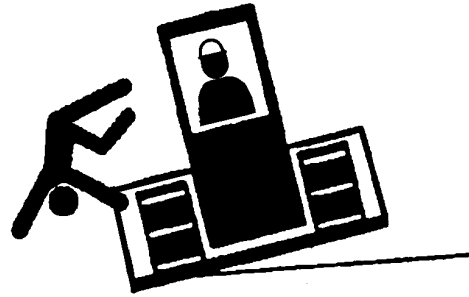

T137580 —JUN—22FEB01

TX03768,0000B73 -19-03NOV08-1/1

Avoid Backover Accidents

Before moving machine, be sure all persons are clear of the machine path. Turn around and look directly for best visibility. Use mirror to assist in checking behind the machine. Keep windows and mirror clean and in good repair.

Be certain backup warning alarm is working properly.

Use a signal person when backing if view is obstructed or when in close quarters. Keep signal person in view at all times. Use prearranged hand signals to communicate.



T138441 —JUN—22FEB01

TX03768,0000B69 -19-14JUN11-1/1

Avoid Machine Tip Over

Use seat belt at all times.

Do not jump if the machine tips. You will be unlikely to jump clear and the machine may crush you.

Load and unload from trucks or trailers carefully. Be sure truck is wide enough and secured on a firm level surface. Use loading ramps and attach them properly to truck bed. Avoid trucks with steel beds because tracks slip more easily on steel.

Be careful on slopes. Use extra care on soft, rocky or frozen ground because machine may slip sideways in these conditions. When traveling up or down steep slopes, keep the bucket or blade on uphill side and just above ground level.

Ensure solid footing. Use extra care when operating on stockpile materials, or near banks or excavations that may cave-in and cause machine to tip or fall.



USE SEAT BELT

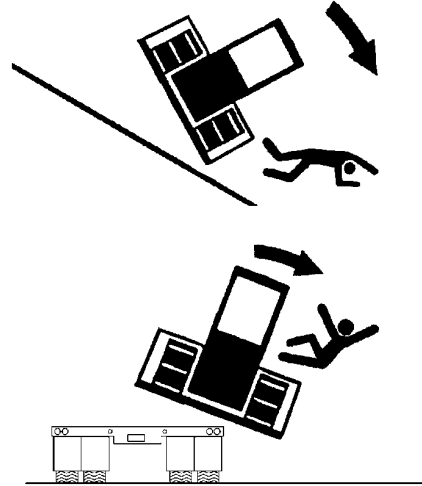

TX03768,0000B6B -19-03NOV08-1/1

T133716—19—17APR13

T138416—UN—22FEB01

T138415—UN—22FEB01

Safety—Maintenance Precautions

Park And Prepare For Service Safely

Warn others of service work. Always park and prepare your machine for service or repair properly.

- Park machine on a level surface and lower blade/bucket and attachments to the ground.
- Place park lock lever in “lock” position. Stop engine and remove key.
- Attach a “Do Not Operate” tag in an obvious place in the operator’s station.

Securely support machine or attachment before working under it.

- Do not support machine with blade/bucket or attachments.
- Do not support machine with cinder blocks or wooden pieces that may crumble or crush.
- Do not support machine with a single jack or other devices that may slip out of place.

Understand service procedures before beginning repairs. Keep service area clean and dry. Use two people whenever the engine must be running for service work.

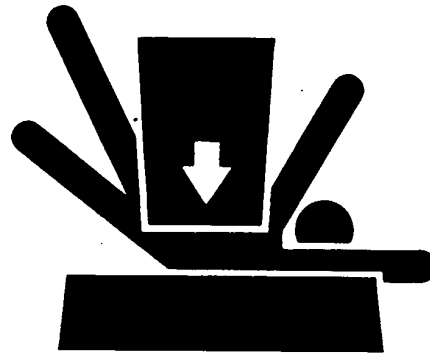

TX03768,0000B6A -19-19OCT09-1/1

T133332 —19—17APR13

TS229 —UN—23AUG88

Service Cooling System Safely

Explosive release of fluids from pressurized cooling system can cause serious burns.

Shut off engine. Only remove filler cap when cool enough to touch with bare hands. Slowly loosen cap to first stop to relieve pressure before removing completely.



DX,RCAP -19-04JUN90-1/1

TS281 —UN—15APR13

Remove Paint Before Welding or Heating

Avoid potentially toxic fumes and dust.

Hazardous fumes can be generated when paint is heated by welding, soldering, or using a torch.

Remove paint before heating:

- Remove paint a minimum of 100 mm (4 in.) from area to be affected by heating. If paint cannot be removed, wear an approved respirator before heating or welding.
- If you sand or grind paint, avoid breathing the dust. Wear an approved respirator.
- If you use solvent or paint stripper, remove stripper with soap and water before welding. Remove solvent or paint stripper containers and other flammable material from area. Allow fumes to disperse at least 15 minutes before welding or heating.

Do not use a chlorinated solvent in areas where welding will take place.



Do all work in an area that is well ventilated to carry toxic fumes and dust away.

Dispose of paint and solvent properly.

DX,PAINT -19-24JUL02-1/1

TS220—UN—15APR13

Make Welding Repairs Safely

IMPORTANT: Disable electrical power before welding. Turn off main battery switch or disconnect positive battery cable. Separate harness connectors to engine and vehicle microprocessors.

Avoid welding or heating near pressurized fluid lines. Flammable spray may result and cause severe burns if pressurized lines fail as a result of heating. Do not let heat go beyond work area to nearby pressurized lines.

Remove paint properly. Do not inhale paint dust or fumes. Use a qualified welding technician for structural repairs.



Make sure there is good ventilation. Wear eye protection and protective equipment when welding.

TX03679,00016D5 -19-11SEP09-1/1

T133547—UN—15APR13

Drive Metal Pins Safely

Always wear protective goggles or safety glasses and other protective equipment before striking hardened parts. Hammering hardened metal parts such as pins and bucket teeth may dislodge chips at high velocity.

Use a soft hammer or a brass bar between hammer and object to prevent chipping.

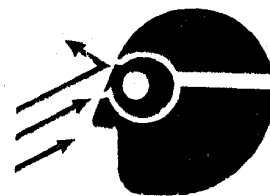

OOU1065,0000090 -19-03NOV08-1/1

T133738—UN—15APR13

Safety—Safety Signs

Safety Signs

CAUTION
PRESSURIZED
 DO NOT OPEN HOT
 Remove slowly
 15 P.S.I.
 AT173810

WARNING

 Avoid crushing
DO NOT JUMP
 If machine tips
 T146097
 **USE SEAT BELT**

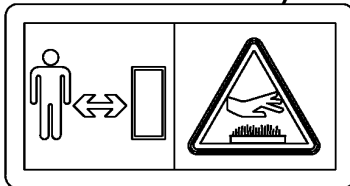
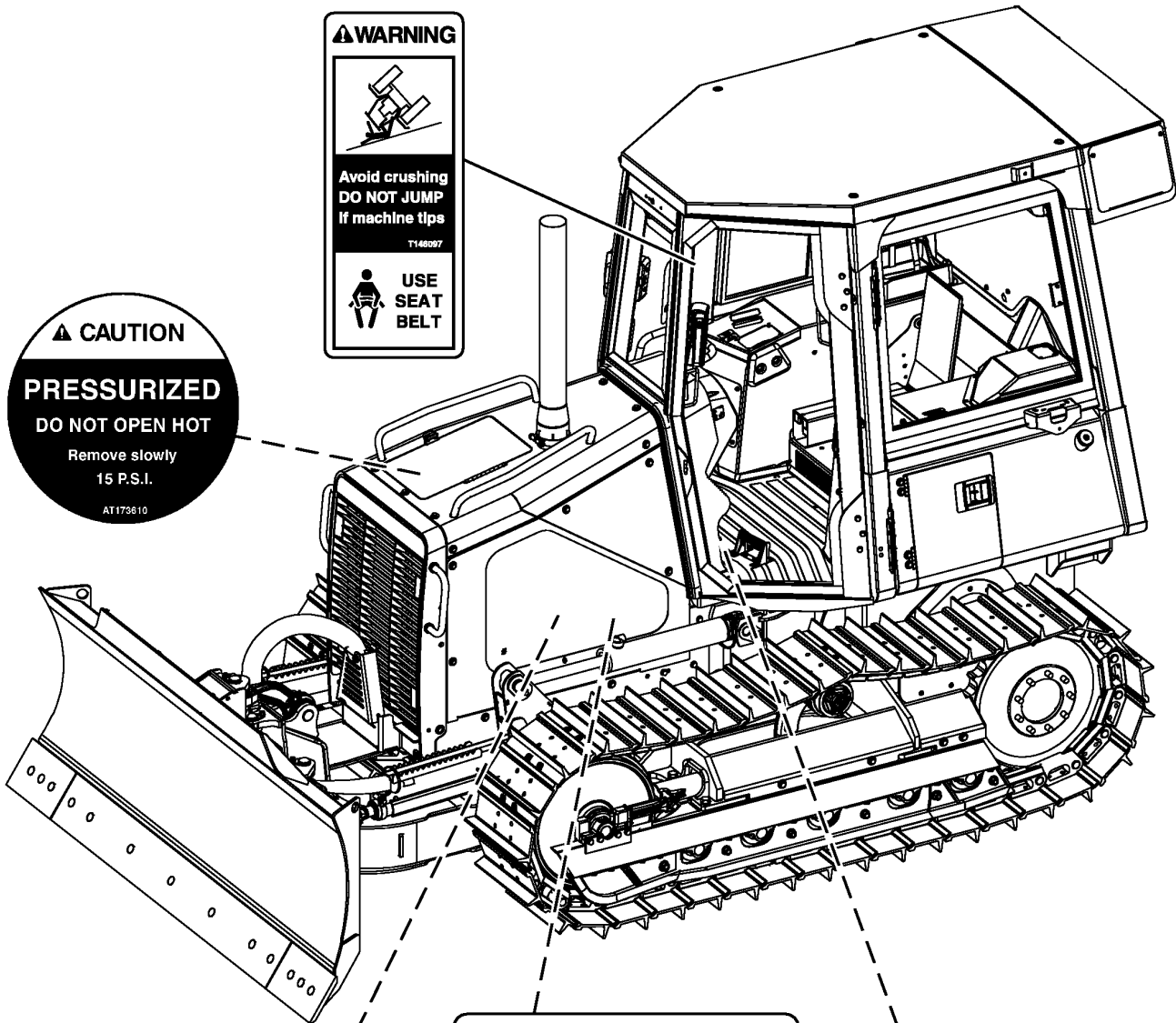

DANGER

 Start only from
 seat in park or
 neutral.
 Starting in gear
 kills.
 T146102

CAUTION
1. AVOID DEATH OR SERIOUS INJURY - Read and understand Operator's Manual before operating this machine.
2. Operate only from the seat.
3. Before leaving seat:
 - Lower equipment to ground.
 - Place transmission selector in neutral.
 - Place park lock lever in lock position (up).
 - Stop engine (turn key switch to OFF).
4. DO NOT permit riders.
 T102032 rev.



JOHN DEERE

ENGINE START AND STOP PROCEDURE
START and WARM UP - At one-third speed setting, crank engine 20 seconds maximum. Allow 2 minutes between cranking periods. Use starting fluid as required but not before cranking. Warm up at half speed and **DO NOT** accelerate rapidly during warm up.
STOPPING - Operate at half speed **NO LOAD** 2 minutes before stopping. Set speed to low idle and stop engine.
ENGINE STALL - Remove load, restart immediately. Run 30 seconds at half speed before adding load.

T193970

T193970—19—15AUG03

TX03768,0000B79 -19-14JAN08-1/1

Operation—Operator's Station

Instrument Panel with Gauge Package—If Equipped (Earlier Machines)

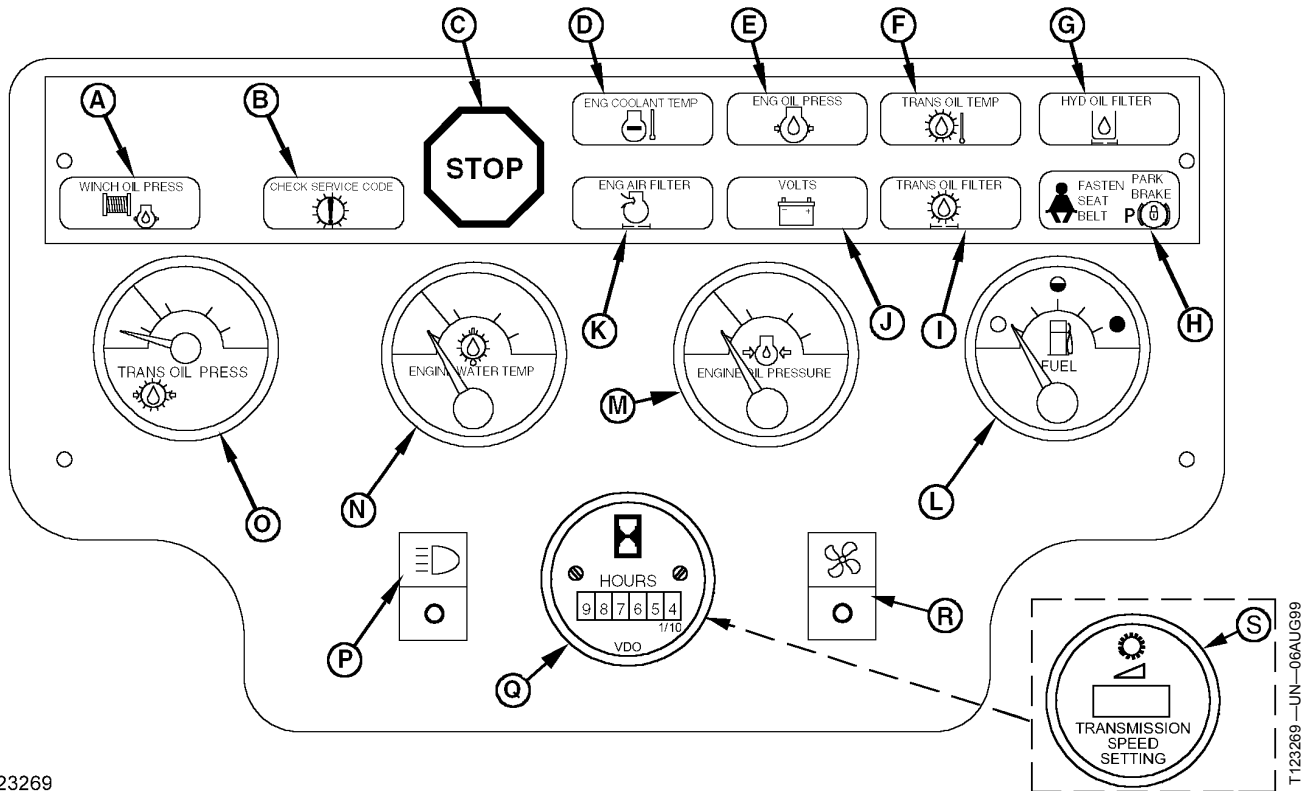

T123269

- | | | | |
|--|---|---|---|
| A—Winch Oil Pressure Indicator—If Equipped (Red) | G—Hydraulic Oil Filter Restriction Indicator (Yellow) | L—Fuel Gauge | R—Under-Seat Heater ON/OFF Switch |
| B—Check Service Code Indicator (Clear) | H—Fasten Seat Belt/Park Lock On Indicator (Clear) | M—Engine Oil Pressure Gauge | S—Transmission Speed Setting Gauge Display (Optional) |
| C—STOP Indicator (Red) | I—Transmission Oil Filter Indicator (Yellow) | N—Engine Coolant Temperature Gauge | |
| D—Engine Coolant Temperature Indicator (Red) | J—Voltage Indicator (Yellow) | O—Transmission Oil Pressure Gauge | |
| E—Engine Oil Pressure Indicator (Red) | K—Engine Air Filter Restriction Indicator (Yellow) | P—Front and Rear Work Lights Switch | |
| F—Transmission Oil Temperature Indicator (Red) | | Q—Hour Meter (When equipped with optional Transmission Speed Setting Gauge, the hourmeter is located on right side of front cowl) | |

IMPORTANT: When the STOP-engine indicator is activated, stop engine immediately and investigate cause of problem. DO NOT start engine until problem has been corrected.

When a red indicator lights, an audible alarm will sound. Stop the engine immediately and investigate the cause of the problem.

Each display indicator light is color-coded to indicate the severity of the situation. Red is a high-level warning, yellow is a low-level warning and clear indicates a condition.

GED,OUO1032,744 -19-06JAN00-1/1

Instrument Panel Functions (Earlier Machines)

A—Winch Oil Pressure Indicator—If Equipped:

Indicator will light and STOP indicator will light when oil pressure is too low. Immediately stop engine and investigate the problem.

B—Check Service Code Indicator: If indicator stays lit, there is an electrical problem in the transmission control system. It is not necessary to stop the machine.

The transmission controller will automatically put the machine in an operational mode that will not harm the engine.

The service code that is present is displayed in the transmission controller display window. This service code number pinpoints the problem and is a very important aid for your authorized dealer to quickly diagnose the problem. Always relay this code number to your dealer when reporting your problem.

C—STOP Indicator:

IMPORTANT: If STOP indicator flashes and alarm sounds, in most cases stop engine immediately and investigate cause of problem. Do not start engine until problem has been corrected.

The STOP indicator flashes and alarm sounds when:

- Engine oil pressure is too low
- Transmission oil temperature is excessively high
- Engine coolant temperature is excessively high

If engine coolant temperature indicator lights indicating that the temperature is excessively high, DO NOT stop engine. Reduce load and run engine at fast idle for several minutes. Stop engine and service machine.

D—Engine Coolant Temperature Indicator: Indicator will light and stay lit when coolant temperature is too high. STOP indicator will light and audible alarm will sound. Immediately take load off the machine and run engine at fast idle for several minutes. If indicator continues to stay on after several minutes of idling, stop engine and take corrective action.

E—Engine Oil Pressure Indicator:

NOTE: It is normal for light to come on at start-up and stay on for a few minutes.

Indicator will light and stay lit when engine coolant temperature is too high. STOP indicator will light and stay lit and the audible alarm will sound. Immediately park the machine in a safe environment, stop engine and take corrective action.

F—Transmission Oil Temperature Indicator: Indicator will light and stay lit when transmission oil temperature is too high. STOP indicator will light and the audible alarm will sound. Immediately park the machine in a safe environment, stop engine and take corrective action.

G—Hydraulic Oil Filter Restriction Indicator: Indicator will light and stay lit when hydraulic oil temperature is too high. STOP indicator will light and the audible alarm will sound. Immediately park the machine in a safe environment, stop engine and take corrective action.

H—Fasten Seat Belt/Park Lock On Indicator: Indicator will light when key switch is "On" and park lock lever is in up (locked) position.

I—Transmission Oil Filter Indicator: Indicator will light when transmission filter element is restricted. It is not necessary to stop operation, but the cause should be investigated as soon as possible.

It is normal for this light to remain lit for several minutes after start-up in cold weather. In extremely cold weather, it is a good practice to operate at reduced engine speed so the light stays off.

J—Voltage Indicator: Indicator will light when battery/alternator is below 12-volts. It is not necessary to stop operation, but the cause should be investigated as soon as possible.

K—Engine Air Filter Restriction Indicator: Indicator will light when engine air filter element is restricted. It is not necessary to stop operation, but the cause should be investigated as soon as possible.

L—Fuel Gauge: Gauge will reflect fuel level in tank. Fuel level gauge needle will enter red zone when fuel level in tank is too low.

M—Engine Oil Pressure Gauge—If Equipped: After engine is started, gauge needle must point to green zone immediately and not drop into red zone after warm-up. If gauge needle drops into red zone, stop engine. See your authorized dealer.

N—Engine Coolant Temperature Gauge—If Equipped: When engine coolant temperature is too high the gauge needle will move to the red zone. Immediately take load off the machine and run engine at fast idle. If gauge needle stays in red zone after several minutes of idling, stop engine. See your authorized dealer.

O—Transmission Oil Pressure Gauge:

IMPORTANT: If needle remains in red zone after warm-up or moves to red zone while operating, power train damage may occur. See your authorized dealer to correct low pressure.

After the engine is started, the gauge needle must move above the "0" point within a few seconds. If not, stop engine and see your authorized dealer.

P—Front and Rear Work Lights Switch: Push upper half of switch to turn front and rear work lights on. Push lower half to turn lights off.

Q—Hour Meter: Use to determine when your machine needs periodic maintenance.

R—Under-Seat Heater ON/OFF Switch: Push upper half of switch to turn heater on. Push lower half to turn heater off.

S—Transmission Speed Setting Gauge Display—If Equipped: When the machine is started, the transmission gauge speed setting default range of SP1.6 will be

displayed in the gauge window (1). The speed range is displayed as a two digit value. The values can range from SP1.0 to SP3.0. When the transmission speed control button (located on FNR lever) is pressed and held in the “Up” position, the range SP value can reach a maximum value of SP3.0. When the speed control button is held in the “Down” position, the value will decrease to a minimum of SP1.0.

HG31779,00000AB -19-11JUL02-2/2

Instrument Panel (Later Machines)

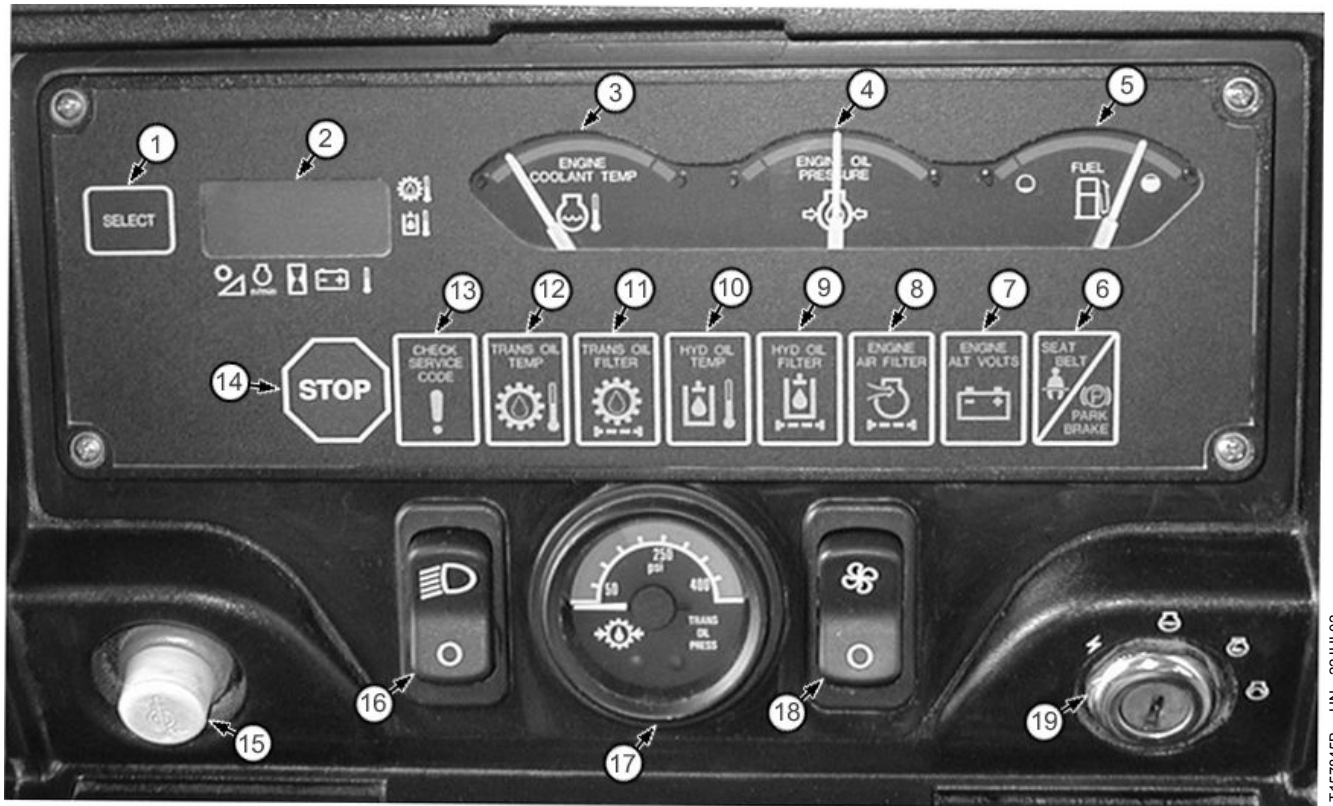

- | | | | |
|--|--|--|------------------------------------|
| 1—Select Button | 8—Engine Air Filter Restriction Indicator (Yellow) | 12—Transmission Oil Temperature Indicator (Yellow) | 17—Transmission Oil Pressure Gauge |
| 2—Display Window | 9—Hydraulic Oil Filter Indicator (Yellow) | 13—Check Service Code Indicator (Yellow) | 18—Under-Seat Heater ON/OFF Switch |
| 3—Engine Coolant Temperature Gauge | 10—Hydraulic Oil Temperature (Yellow) | 14—Stop Indicator (Red) | 19—Key Switch |
| 4—Engine Oil Pressure Gauge | 11—Transmission Oil Filter Indicator (Yellow) | 15—Start Aid Button | |
| 5—Fuel Level Gauge | | 16—Front and Rear Work Lights Switch | |
| 6—Seat Belt/Park Brake Indicator (Red) | | | |
| 7—Engine Alternator Voltage Indicator (Yellow) | | | |

IMPORTANT: When the STOP-engine indicator is activated, stop engine immediately and investigate cause of problem. DO NOT start engine until problem has been corrected.

Each display indicator light is color-coded to indicate the severity of the situation. Red is a high-level warning and clear indicates a condition.

When a red indicator lights, an audible alarm will sound. Stop the engine immediately and investigate the cause of the problem.

HG31779,0000091 -19-04JUN02-1/1

Instrument Panel Functions (Later Machines)

1—Select Button: With key switch “On”, press and hold the select button to cycle between displays on the display window.

2—Display Window: The display window has seven displays. Press and hold the select button to cycle between displays on the display window when the monitor panel is active:

- Transmission Speed Setting
- Tachometer
- Hour Meter
- Voltmeter
- Temperature Light for Transmission Oil Temperature or Hydraulic Oil Temperature
- Hydraulic Oil Temperature
- Transmission Oil Temperature

3—Engine Coolant Temperature Gauge: When engine coolant temperature is too high the gauge needle will move to the red zone. Immediately take load off the machine and run engine at fast idle. If gauge needle stays in red zone after several minutes of idling, stop engine. See your authorized dealer.

4—Engine Oil Pressure Gauge: After engine is started, gauge needle must point to green zone immediately and not drop into red zone after warm-up. If gauge needle drops into red zone, stop engine. See your authorized dealer.

5—Fuel Level Gauge: Gauge will reflect fuel level in tank. Fuel level gauge needle will enter red zone when fuel level in tank is too low.

6—Seat Belt/Park Brake Indicator: Indicator will light when key switch is “On” and park lock lever is in up (locked) position.

7—Engine Alternator Voltage Indicator: Indicator will light when battery/alternator is below 12-volts. It is not necessary to stop operation, but the cause should be investigated as soon as possible.

8—Engine Air Filter Restriction Indicator: Indicator will light when engine air filter element is restricted. It is not necessary to stop operation, but the cause should be investigated as soon as possible.

9—Hydraulic Oil Filter Indicator: Indicator will light when hydraulic filter element is restricted. It is not necessary to stop operation, but the cause should be investigated as soon as possible.

10—Hydraulic Oil Temperature Indicator: Indicator will light when hydraulic oil temperature reaches 107° C (225° F) and stay lit until temperature drops below 104° C (220° F). The display window will automatically default to current temperature. It is not necessary to stop operation, but the temperature must be monitored.

The STOP indicator will light and audible alarm will sound when hydraulic oil temperature reaches 112° C (235° F)

until it drops below 110° C (230° F). Immediately park the machine in a safe environment, stop engine and investigate the problem.

11—Transmission Oil Filter Indicator: Indicator will light when transmission filter element is restricted. It is not necessary to stop operation, but the cause should be investigated as soon as possible.

It is normal for this light to remain lit for several minutes after start-up in cold weather. In extremely cold weather, it is a good practice to operate at reduced engine speed so the light stays off.

12—Transmission Oil Temperature Indicator: Indicator will light when transmission oil temperature reaches 93° C (200° F) and stay lit until temperature drops below 90° C (195° F). The display window will automatically default to current temperature. Reduce load and monitor temperature.

The STOP indicator will light and audible alarm will sound when transmission oil temperature reaches 95° C (205° F). Immediately take load off the machine and run engine at fast idle for several minutes. If indicator continues to stay on after several minutes of idling, stop engine and investigate the problem.

13—Check Service Code Indicator: If service code indicator stays lit, there is an electrical problem in the transmission control system. It is not necessary to stop the machine.

The transmission controller will automatically put the machine in an operational mode that will not harm the machine.

The service code that is present is displayed in the transmission controller display window. This service code number pinpoints the problem and is a very important aid for your authorized dealer to quickly diagnose the problem. Always relay this code number to your dealer when reporting your problem.

The service code indicator will go out when the machine is shut down.

14—Stop Indicator:

IMPORTANT: If STOP indicator flashes and alarm sounds, in most cases stop engine immediately and investigate cause of problem. Do not start engine until problem has been corrected.

The STOP indicator flashes and alarm sounds when:

- Engine oil pressure is too low
- Transmission oil temperature is excessively high
- Engine coolant temperature is excessively high
- Hydraulic temperature is excessively high

If engine coolant temperature indicator lights indicating that the temperature is excessively high, DO NOT stop engine. Reduce load and run engine at fast idle for several minutes. Stop engine and service machine.

15—Start Aid Button: Press and hold button when engine is cold and cranking to inject starting fluid into engine during cold weather start-up.

16—Front and Rear Work Lights Switch: Push upper half of switch to turn front and rear work lights on. Push lower half to turn lights off.

17—Transmission Oil Pressure Gauge:

IMPORTANT: If needle remains in red zone after warm-up or moves to red zone while operating,

power train damage may occur. See your authorized dealer to correct low pressure.

After the engine is started, the gauge needle must move above the "0" point within a few seconds. If not, stop engine and see your authorized dealer.

18—Under-Seat Heater ON/OFF Switch: Push upper half of switch to turn heater on. Push lower half to turn heater off.

19—Key Switch:

HG31779,00000AC -19-11JUL02-2/2

Transmission Controller Display Window

When an active service code is received by the transmission control unit, the code will appear in the display window (A). See Transmission Controller Service Codes for explanation of service codes. (Section 4-3).

A—Transmission Controller Display Window

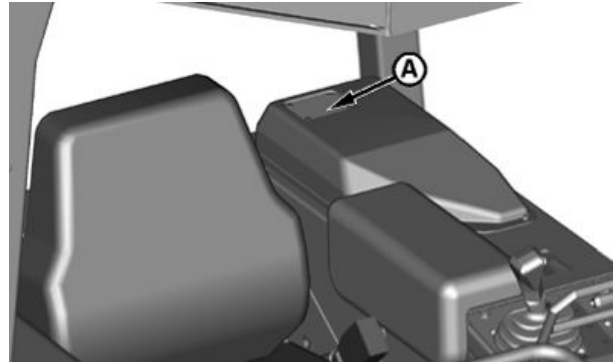

T118638 —UN—24NOV98

Continued on next page

CED,OUO1032,1171 -19-24APR99-1/6

Transmission Controller Display Window Structure

Status Light (Red): (C) Indicates an active service code.

Power Light (Green): (B) Indicates power is supplied to transmission controller. Key ON or engine running.

Status Window: (A) The following codes will be displayed in the window during operation:

- PARK
- RUN
- PBrk
- Neut

A—Transmission Controller Display Window
 B—Power Light (Green)
 C—Status Light (Red)

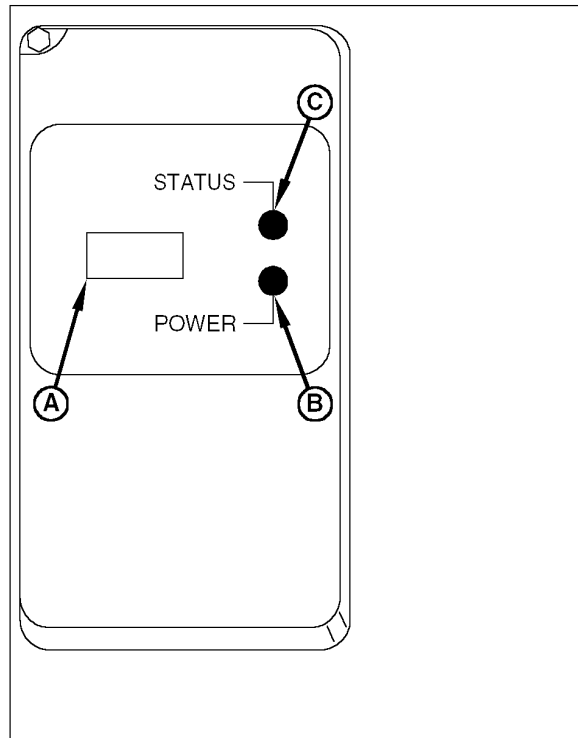

T121140

T121140—UN—23APR99

CED,OUO1032,1171 -19-24APR99-2/6

PARK: Display indicates park lock lever is in up (LOCKED) position. Machine can be started.

- Key ON
- FNR lever is NEUTRAL

PARK will be displayed until park lock lever is in down (UNLOCKED) position.

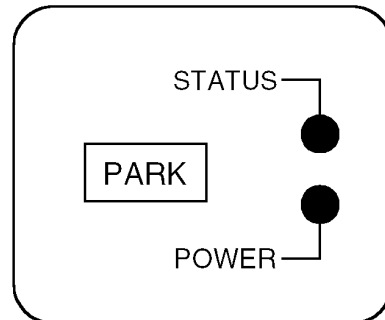

T121141

T121141—UN—23APR99

Continued on next page

CED,OUO1032,1171 -19-24APR99-3/6

RUN: Display indicates the controller is operating, with the park lock lever in down (UNLOCKED) position .

- Engine running
- Park lock lever lowered
- FNR in NEUTRAL

To move machine, move FNR to forward or reverse. RUN will be displayed while machine is being operated.

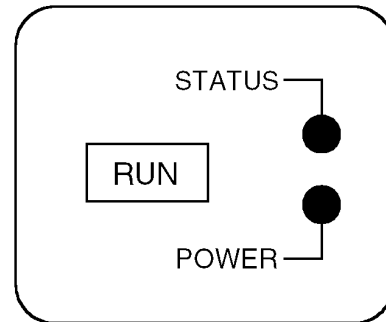

T121142

T121142—UN—23APR99

CED,OUO1032,1171 -19-24APR99-4/6

PBrk: Display indicates the following condition:

- Key ON
- Park lock lever lowered

The machine will not start until park lock lever is raised to up (LOCKED) position.

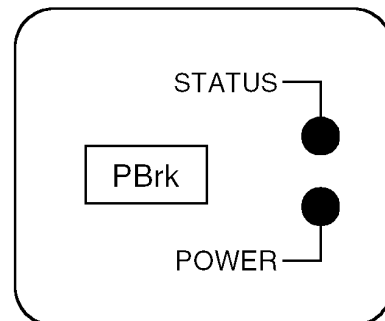

T121143

T121143—UN—23APR99

CED,OUO1032,1171 -19-24APR99-5/6

Neut: Display indicates the following condition:

- Park lock lever can be up or down
- Key ON, engine not running
- FNR not in neutral

Machine will not start until FNR is moved to neutral and park lock lever is in up (LOCKED) position.

Neut display also indicates the following condition:

- Engine running
- FNR lever moved to forward or reverse before moving park lock lever to down (UNLOCKED) position.

To move machine, return FNR lever to neutral and move park lock lever down.

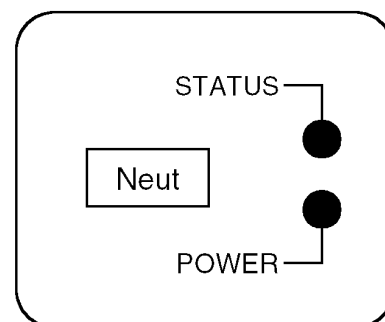

T121144

T121144—UN—23APR99

CED,OUO1032,1171 -19-24APR99-6/6

Air Conditioning and Cab Heater—If Equipped

IMPORTANT: Do not operate air conditioner when air temperature is below -1°C (30°F).

Check refrigerant for proper charge before using air conditioner. See Check Air Conditioner Refrigerant Level—If Equipped. (Section 4-1.)

- Push upper half of switch (A) up to turn air conditioner on. Push lower half of switch to turn heat on.
- Turn temperature control knob (C) clockwise to increase temperature.
- Turn blower control knob (B) clockwise to increase blower speed.
- If temperature in cab becomes too cold, the temperature knob can be turned to add heat even though air conditioner is on.

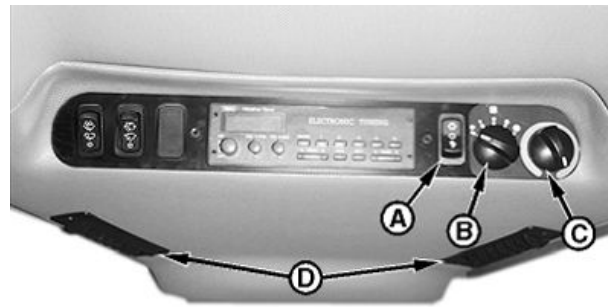

A—Switch
B—Blower Control Knob
C—Temperature Control Knob
D—Louvers

- Move louvers (D) left or right to direct or restrict air flow.

CED,OUO1032,762 -19-24APR99-1/1

T117838B—UN—21OCT98

Windshield Wiper and Washer Controls

Push switch (A) to operate front and rear (if equipped) windshield wiper. Push switch (B) to operate door wipers. Continue to push switch(es) to operate washer fluid.

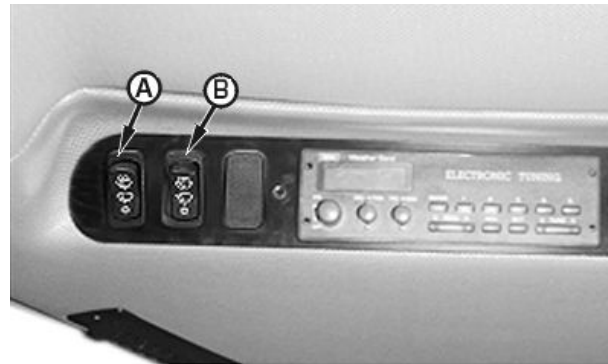

CED,OUO1032,804 -19-16OCT98-1/1

T117838C—UN—12NOV98

Windshield Washer Reservoir

The windshield washer reservoir (A) is located in the right side service compartment.

A—Windshield Washer Reservoir

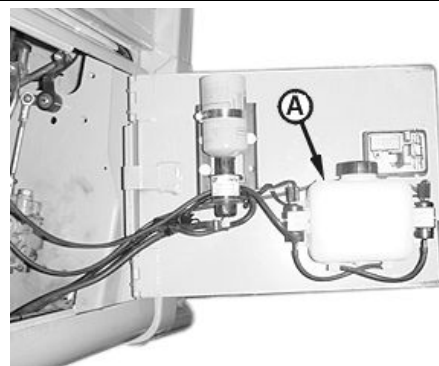

CED,OUO1032,1132 -19-04NOV98-1/1

T118217B—UN—11NOV98

Horn Switch

Push horn switch (A) to sound horn.

A—Horn

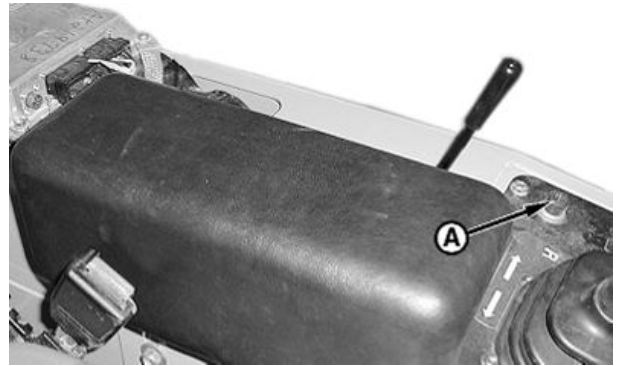

T117835B —UN—20OCT98

Earlier Machines



T157863B —UN—22JUL02

Later Machines

02T,10,M165 -19-20DEC94-1/1

Auxiliary Power Outlet—If Equipped

A 12-volt auxiliary power outlet (A) (if equipped) is located above the fuse access panel.

A—Auxiliary Power Outlet



T118216B —UN—11NOV98

CED,OUO1032,1131 -19-03SEP02-1/1

Side Windows—Secondary Exits

The side windows can be used as secondary exits.

To open windows, pull locking lever (B) down and squeeze two forward tabs (A). Slide window forward to desired position.

Raise locking lever (B) to lock window in place.

To close, pull locking lever down, squeeze tabs and slide window rearward until window latch engages.

A—Tabs

B—Lock Lever

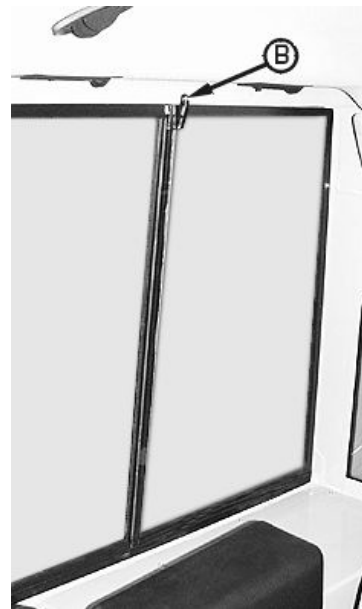

T118726B —UN—15DEC98

T121302B —UN—03MAY99

CED,OUO1032,1404 -19-14JAN08-1/1

Adjust Non-Suspension Seat

Use flip-out lever to turn weight adjustment knob (C). Turn knob clockwise for firm ride and counterclockwise for soft ride.

Lift lever (B) to adjust cushion position.

Lift seat fore-aft lever (A) to move seat forward and rearward. Release handle at one of several positions.

A—Fore-Aft Lever

B—Seat Cushion Adjustment
Lever

C—Weight Adjustment Knob

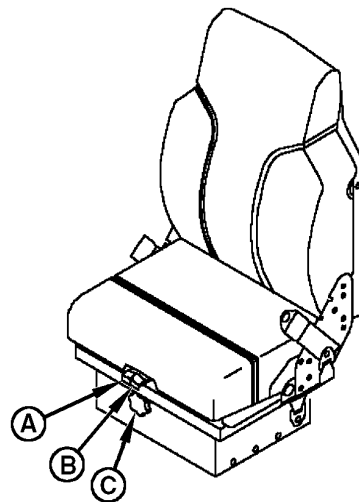

T118251

T118251 —UN—16DEC98

CED,OUO1032,1128 -19-14JAN08-1/1

Adjust Suspension Seat—If Equipped

Use flip-out lever to turn weight adjustment knob (E). Turn knob clockwise for firm ride and counterclockwise for soft ride.

Lift lever (D) to adjust cushion position.

Lift seat fore-aft lever (A) to move seat forward and rearward. Release lever at one of several positions.

Remove your weight from seat. Lift up lever (C) and move seat to one of three positions for height adjustment.

Move seat to mid-to-aft position. While sitting in seat, turn weight adjustment knob (E) to support weight. Check weight indicator (B) for appropriate weight setting and continue to turn until yellow pointer inside tube is flush with tube opening.

While sitting in seat, lift lever (H) and allow cushion to angle forward or lean backward into desired position and release handle.

While sitting in seat, rotate lumbar support knob (F) to increase or decrease support to lower back.

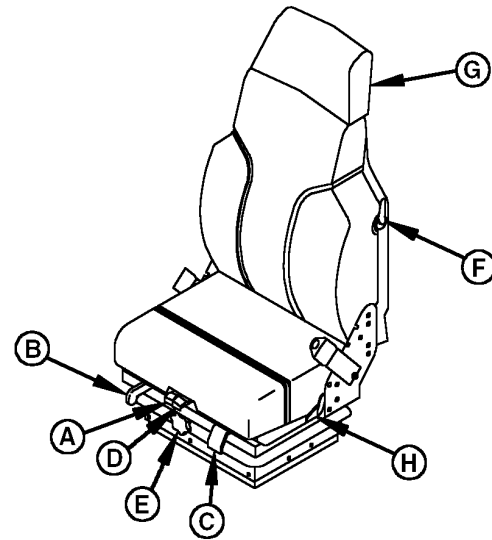

T118252

- | | |
|---------------------------------|---------------------------------------|
| A—Fore-Aft Lever | E—Weight Adjustment Knob |
| B—Weight Indicator | F—Lumbar Support Knob |
| C—Seat Height Adjustment Lever | G—Head Rest |
| D—Seat Cushion Adjustment Lever | H—Back Cushion Angle Adjustment Lever |

CED,OUO1032,1129 -19-14JAN08-1/1

T118252—UN—16DEC98

Adjust Armrest

To adjust armrest, loosen cap screws (A) and slide armrest up or down.

- A—Cap Screw (2 used)

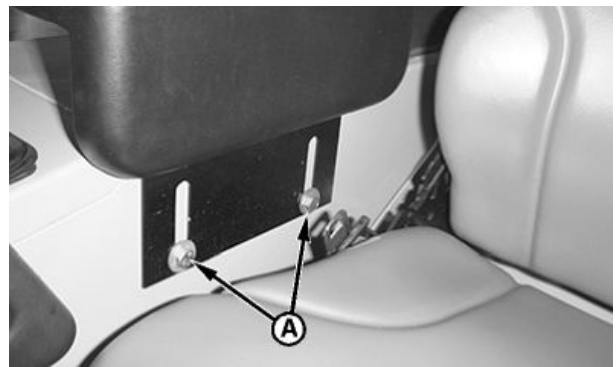

CED,OUO1032,797 -19-30JAN08-1/1

T117826B—UN—20OCT98

Seat Belt

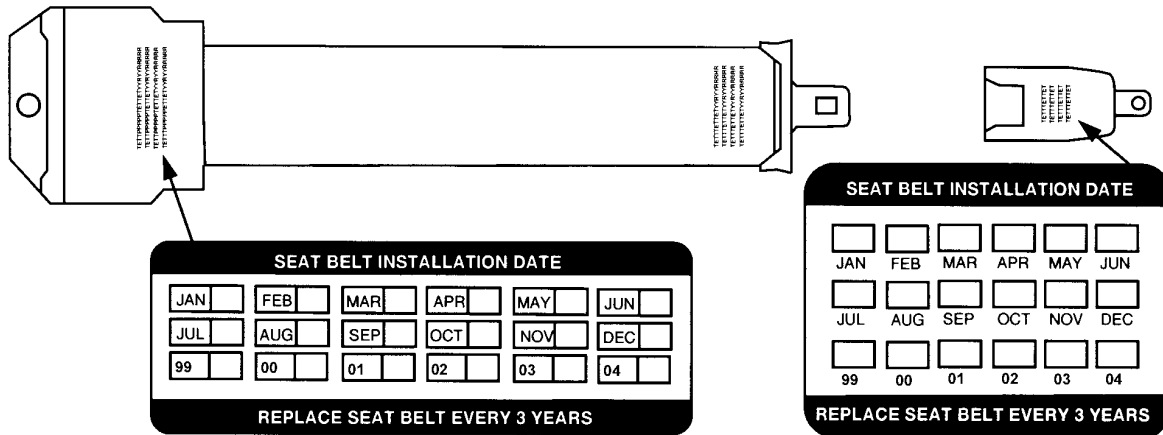

T128685

Seat belt and mounting hardware must be inspected for wear or damage before operating the machine. Replace the belt or mounting hardware if worn or damaged.

Replace the complete seat belt assembly every three years regardless of appearance. A date label, to determine the age of the belt, is attached to each belt.

TX,10,DH3548 -19-14JUN00-1/1

T128685—UN—01MAR00

Operation—Operating The Machine

Inspect Machine Daily Before Starting

Safety and Protective Devices Checks

Walk around machine to clear all persons from machine area before starting machine.

Check condition of guards, shields, and covers

Overall Machine Checks

Check for worn or frayed electrical wires and loose or corroded connections.

Check for bent, broken, loose, or missing boom, bucket, sheet metal, track parts.

Check for loose or missing hardware

Check for oil leaks, missing or loose hose clamps, kinked hoses, and lines or hoses that rub against each other or other parts.

- | | |
|---|---|
| 1— Check engine coolant level in coolant recovery tank. | 5— Check transmission oil level. |
| 2— Check engine oil level. | 6— Check air cleaner dust unloader valve. |
| 3— Drain sediment from water separator. | 7— Check track sag. |
| 4— Check hydraulic system oil level. | 8— Grease dozer linkage. |

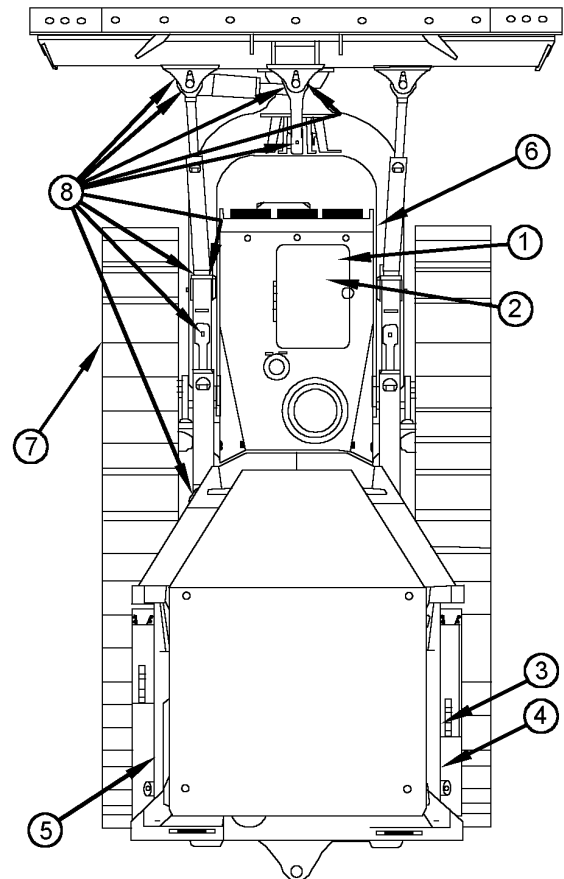

T121136

T121136—UN—20APR99

TX14740,0001C9C -19-18JAN01-1/1

Check Instruments Before Starting (Earlier Machines)

CAUTION: Use a seat belt when you operate machine to minimize chance of injury from an accident such as an overturn.

1. Turn key switch to BULB CHECK position. All indicator lights must come on.
2. If lights do not come on, check bulbs.
3. Turn key switch to ON.
4. The low voltage and engine oil pressure indicators must light and gauge needles must move a little.

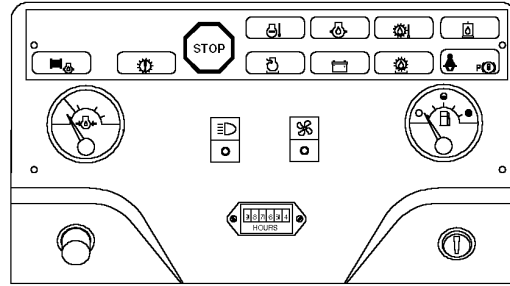

T118078

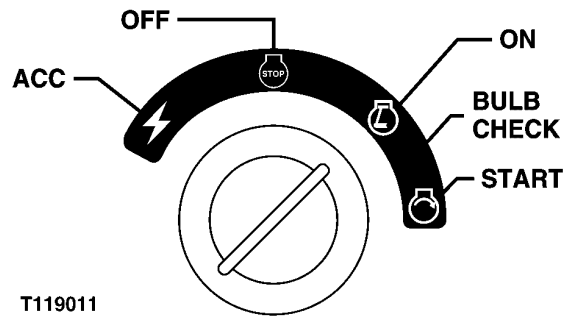

T119011

T118078 —UN—01DEC98

T119011 —19—16DEC98

CED,OUO1032,1066 -19-28OCT98-1/1

Check Instruments Before Starting (Later Machines)

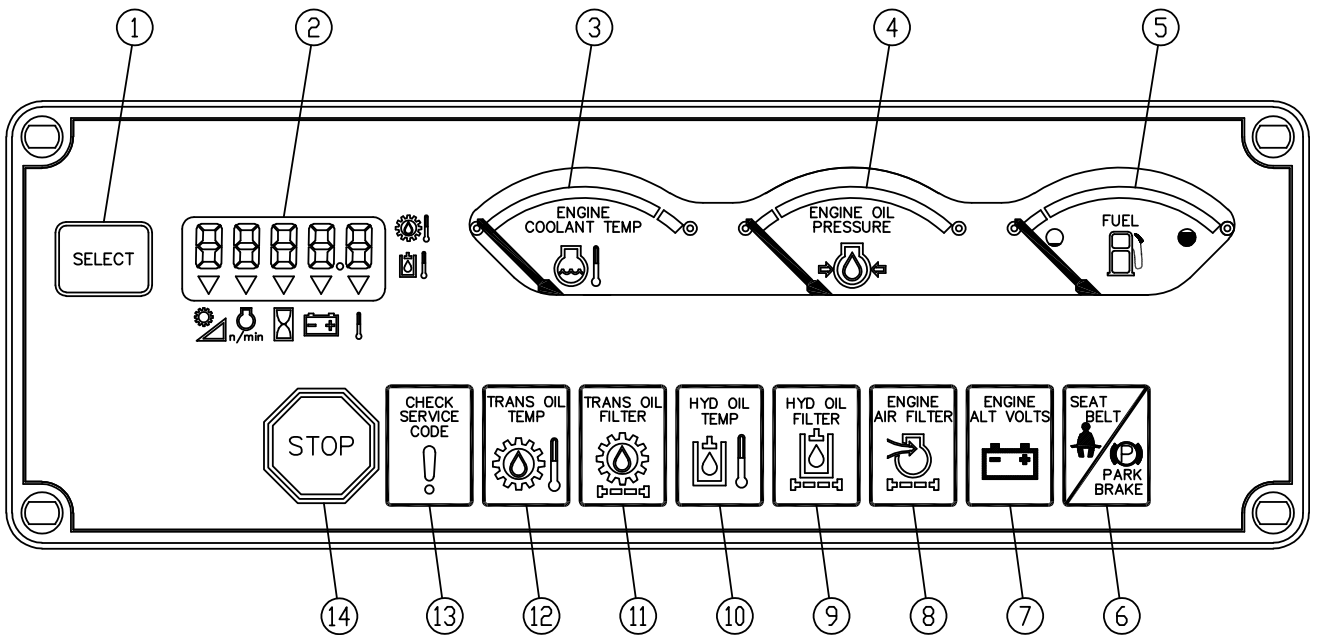

T142432

Turn key switch clockwise to ON. (Do not start engine.)
The following must occur:

- The audible alarm must sound twice.
- All LCD segments in the display window (2) must light.
- All gauges (3-5) must be backlit, and all gauge needles must cycle from minimum (left) to maximum (right) in approximately one second.
- All indicators (6-14) must light for five seconds. With the engine not running, the alternator voltage indicator (7) must remain lit after other indicators go out.

See Instrument Panel Functions for descriptions of indicators. (Section 2-1.)

If any indicator fails to light, check the bulb. If bulb is good but indicator still fails to light, see your authorized dealer.

CED,OUO1079,388 -19-16JUN00-1/1

T142432—UN—31MAY01

Starting the Engine (Earlier Machines)

⚠ CAUTION: Prevent asphyxiation. Engine exhaust fumes can cause sickness or death to you or someone else.

If you must operate engine in a building, be positive there is adequate ventilation. Either use an exhaust pipe extension to remove the exhaust fumes or open doors and/or windows to bring enough outside air into the area.

⚠ CAUTION: Avoid possible injury or death from a runaway machine. Do not start engine by shorting across starter terminals. Machine will move if normal starting circuitry is bypassed.

NEVER start engine while standing on ground. Start engine only from operator's seat with FNR lever in neutral and park lock levers up.



TS220—UN—15APR13

T6607AO—UN—18OCT88

TX,25,RR,A2 -19-27JAN00-1/4

1. Turn battery disconnect switch (A) clockwise to ON position.

A—Disconnect Switch

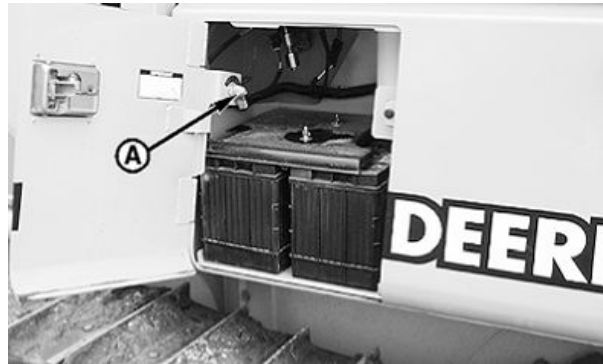

T117483—UN—04NOV98

Continued on next page

TX,25,RR,A2 -19-27JAN00-2/4

⚠ CAUTION: Use seat belt to avoid being injured or killed in case of accident such as an overturn.

2. Sit in seat and fasten seat belt.

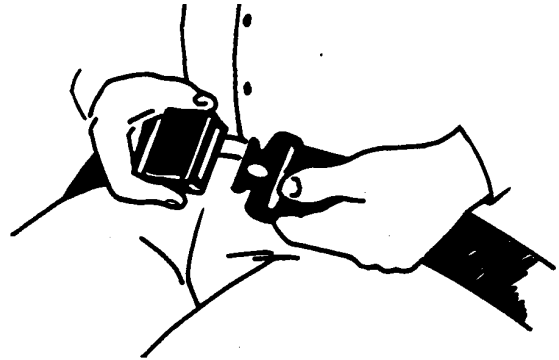

TS175—UN—23AUG88

TX,25,RR,A2 -19-27JAN00-3/4

NOTE: Controls and switches must be in the positions described, before starting engine.

3. FNR lever (C) to neutral position.
4. Park lock lever in up (locked) position (D).

IMPORTANT: To avoid engine damage, never start engine with engine speed control at high speed.

5. Engine speed control lever (A) to 1/3 speed.
6. Push horn switch (B) to sound horn.

IMPORTANT: Do not operate starter more than 20 seconds at a time or starter may be damaged. If engine does not start, wait at least two minutes before trying again.

7. Turn key switch clockwise to turn engine until it starts. With engine running, adjust engine rpm to 1/2 speed.

A—Engine Speed Control Lever
B—Horn

C—FNR Lever
D—Park Lock Lever



T118028—UN—12NOV98



T118007B—UN—14JAN99

TX,25,RR,A2 -19-27JAN00-4/4

Starting the Engine (Later Machines)

⚠ CAUTION: Prevent asphyxiation. Engine exhaust fumes can cause sickness or death to you or someone else.

If you must operate engine in a building, be positive there is adequate ventilation. Either use an exhaust pipe extension to remove the exhaust fumes or open doors and/or windows to bring enough outside air into the area.

⚠ CAUTION: Avoid possible injury or death from a runaway machine. Do not start engine by shorting across starter terminals. Machine will move if normal starting circuitry is bypassed.

NEVER start engine while standing on ground. Start engine only from operator's seat with FNR lever in N "Neutral" and park lock levers up.

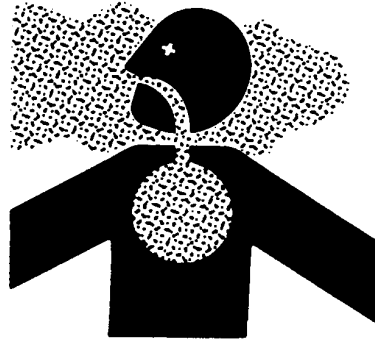

TS220—UN—15APR13

T6607AO—UN—18OCT88

HG31779,00000BA -19-22JUL02-1/4

1. Turn battery disconnect switch (A) clockwise to "On" position.

A—Disconnect Switch

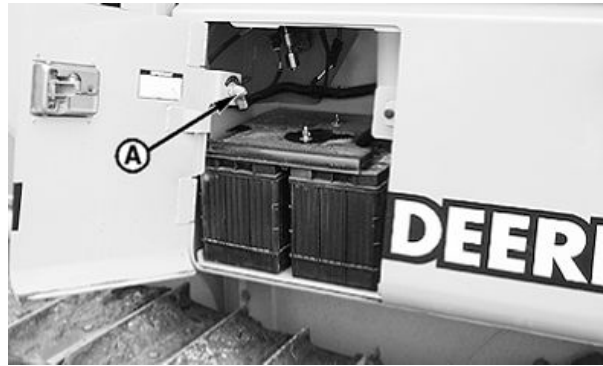

T117483—UN—04NOV98

Continued on next page

HG31779,00000BA -19-22JUL02-2/4

- Sit in seat and fasten seat belt.

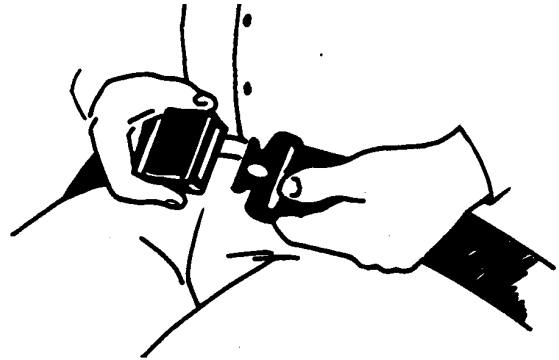

TS175—UN—23AUG88

HG31779,00000BA -19-22,JUL02-3/4

NOTE: Controls and switches must be in the positions described, before starting engine.

- Move FNR lever (C) to N.
- Park lock lever in up (locked) position (D).

IMPORTANT: To avoid engine damage, never start engine with engine speed control at high speed.

- Engine speed control lever (A) to 1/3 speed.
- Push horn switch (B) to sound horn.

IMPORTANT: Do not operate starter more than 20 seconds at a time or starter may be damaged. If engine does not start, wait at least two minutes before trying again. If engine does not start in four attempts, refer to Troubleshooting chapter.

- Turn key switch clockwise to turn engine until it starts. With engine running, adjust engine rpm to 1/2 speed. See Engine Warm-Up in this section.

- | | |
|------------------------------|-------------------|
| A—Engine Speed Control Lever | C—FNR Lever |
| B—Horn | D—Park Lock Lever |



T1157847B—UN—22JUL02



T118007B—UN—14JAN99

HG31779,00000BA -19-22,JUL02-4/4

Starting Fluid (Cold Weather Start Aid)—If Equipped

A coolant heater without starting fluid is sufficient for cold starting when temperature is down to -25°C (-13°F). The starting fluid option is required when ambient temperature is below 0°C (32°F) and the machine is not equipped with a coolant heater.

Using Starting Fluid

CAUTION: Prevent possible injury from exploding container. Starting fluid is highly flammable. Keep container away from heat, sparks, and open flame. Contents are pressurized. Do not puncture or incinerate container. Remove container from machine if engine does not need starting fluid.

IMPORTANT: Prevent damage to engine. Use starting aid if necessary when temperatures are below 0°C (32°F) and only when engine is COLD. Do not use ether aid and coolant heater together.

1. Turn key switch clockwise to “Start” position.

IMPORTANT: Excess starting fluid could damage engine; push starting aid button only when engine is cold and cranking. Starting aid fluid is being injected into engine as long as you push and hold button.

2. After one or two revolutions of engine crankshaft, push and hold starting aid button (A) for short intervals. Crank engine for 20 seconds maximum, then allow 2 minutes between cranking periods.

A—Start Aid Button

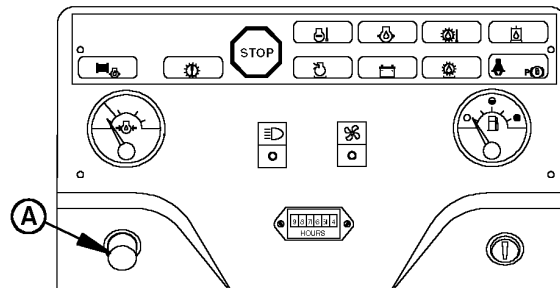

T118117

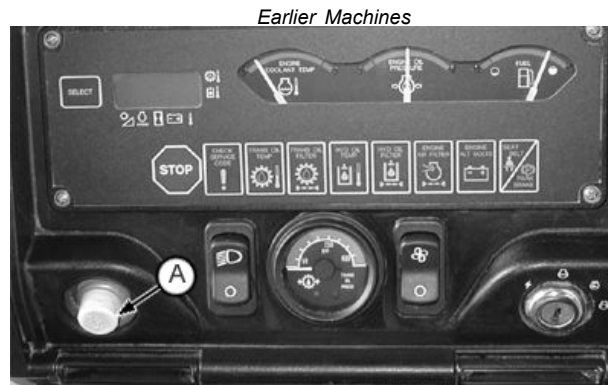

Later Machines

HG31779,00000BB -19-22JUL02-1/3

Replacing Start Aid Can

1. Turn container (B) counterclockwise to remove the start aid can.
2. Remove safety cap and spray button from new can.
3. Turn can in start aid base (C) to install.

B—Container

C—Base

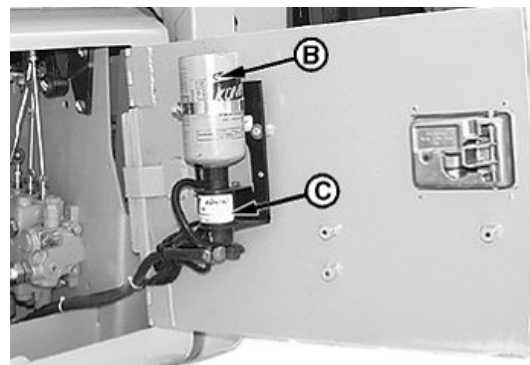

Continued on next page

HG31779,00000BB -19-22JUL02-2/3

TS281—UN—15APR13

T118117—UN—11DEC98

T157936B—UN—22JUL02

T117489—UN—12NOV98

Operating Machine Without Start Aid Container Installed

If no starting fluid is needed, remove container and install dust cap (D).

D—Dust Cap



T8594AF—UN—09NOV95

HG31779,00000BB -19-22,JUL02-3/3

Using Coolant Heater—If Equipped

⚠ CAUTION: Prevent possible personal injury from an electrical shock. Use a heavy-duty, grounded cord to connect heater to electrical power.

Connect the coolant heater to 115-volt electrical power 10 hours before you start the engine.

A coolant heater is recommended with the winch option when ambient temperature is below -18°C (0°F).

A coolant heater without the ether aid is sufficient for cold starting down to -25°C (-13°F).

CED.OUO1032,1401 -19-24APR99-1/1

Operating Fuel-Fired Coolant Heater—If Equipped

CAUTION: Prevent asphyxiation. Engine exhaust fumes can cause sickness or death to you or someone else.

If you must operate engine in a building, be positive there is adequate ventilation. Either use an exhaust pipe extension to remove the exhaust fumes or open doors and/or windows to bring enough outside air into the area.

CAUTION: Handle fuel carefully. Do not fill the fuel tank with heater turned on.

Do not operate heater in enclosed areas where combustible fumes may be present. Operate heater only in open areas to keep combustible fumes away from machine.

Keep any flammable material a minimum distance of 50 mm (2.0 in.) from exhaust tube.

The diesel fuel burning heater draws fuel from machine fuel tank at a rate of approximately 0.1 gal/hr.

Ensure the fuel system is intact and there are no leaks.

Use proper coolant. Failure to do so may cause damage of engine and/or personal injury.

IMPORTANT: The coolant heater requires that the coolant in the system to be heated contain the proper mixture of water and coolant to prevent coolant from freezing or slushing. If the coolant becomes slushy or frozen, the heaters coolant pump cannot move the coolant causing a blockage of the circulating system.

Setting Time and Weekday:

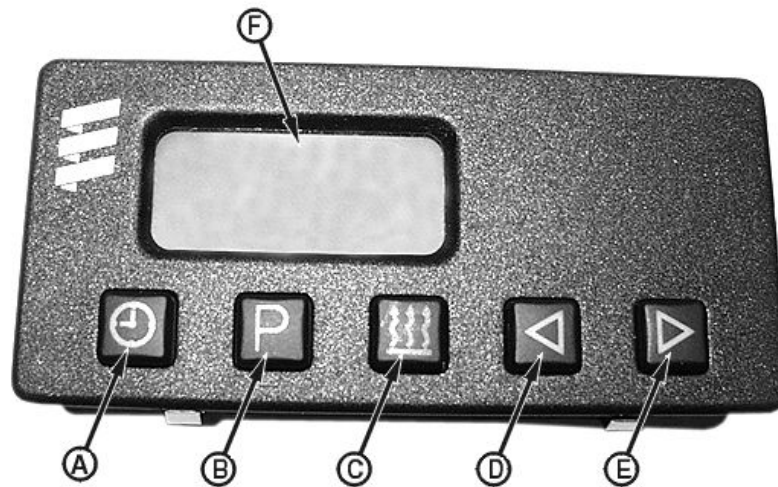

A—Time
B—Program

C—Heating On
D—Backwards

E—Forwards
F—Display Window

1. Briefly press (A).
2. Time display 12:00 flashes.
3. Set the current time using (D) or (E).
4. When the time display stops flashing, the time has been stored.
5. The weekday then begins to flash. Set the current weekday using (D) or (E).
6. When the weekday display stops flashing, the weekday has been stored.

7. If the time is ON, the display continues to be displayed. If the time is OFF, the display disappears after 10 seconds.

Adjusting Time and Weekday:

1. Press and hold down (A) until the time flashes.
2. Follow steps 3—7. If only the time is to be adjusted, the flashing weekday display can be skipped by pressing (A) twice.

T121396B—UN—11MAY99

Continued on next page

CED,OUO1032,1406 -19-03SEP02-1/9

- When the weekday has been adjusted, pressing (A) causes the display to stop flashing and the weekday to be stored.

CED,OU01032,1406 -19-03SEP02-2/9

Heating Without Programming (Time OFF)

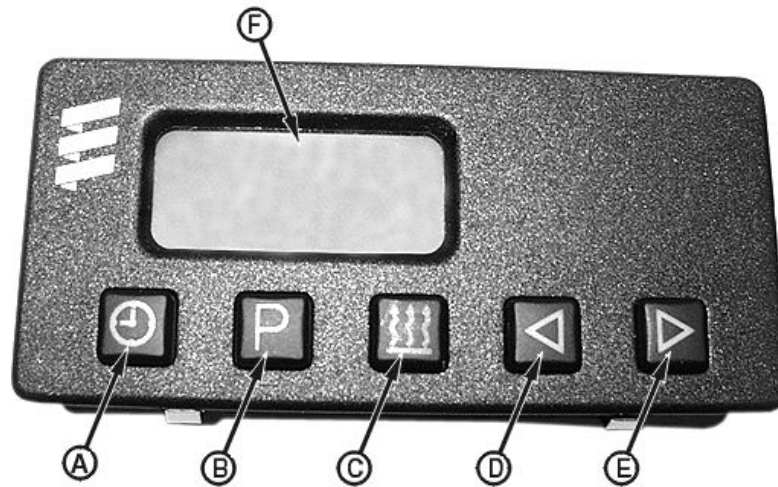

- Switch On Heating:** Briefly press (C).
- Display window (F) will display (H) and heating time (G). The default heating time is set to 120 minutes. It can be changed permanently or temporarily.
- Temporarily Setting New Heating Time:** Briefly press (C).
- To decrease heating time (one minute increments), press (D).
- To increase heating time (120 minutes maximum), press (E).
- Switch Off Heating:** Briefly press (C).
- The status display (H) disappears. Automatic after-run for cool-down purposes will begin.

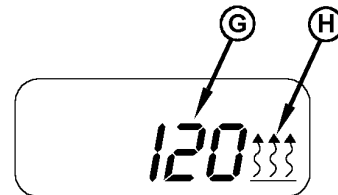

T121393

A—Time
B—Program
C—Heating On
D—Backwards

E—Forwards
F—Display Window
G—Heating Time Display
H—Heat Status Display

Continued on next page

CED,OU01032,1406 -19-03SEP02-3/9

T121396B—UN—11MAY99

T121393—UN—11MAY99

Heating Without Programming (Time ON):

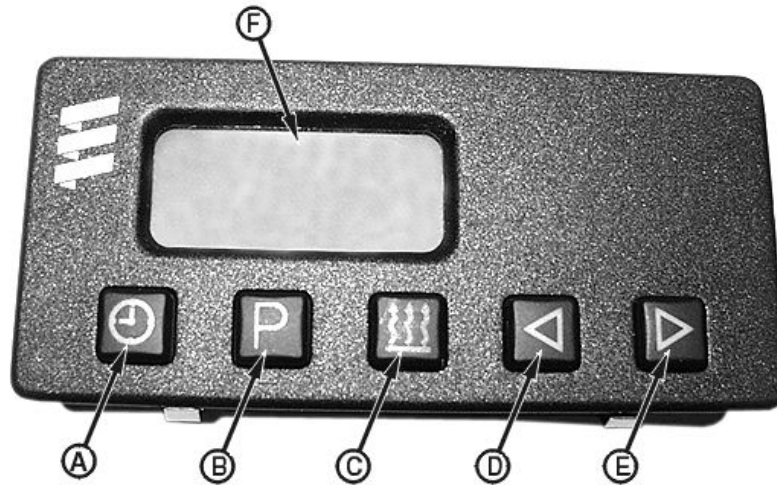

1. **Switch On Heating:** Briefly press (C).
2. Display window (F) will display status (K), time (J) and weekday (I).
3. Heating remains operational until the time is switched off. If the time is switched off, the heating remains switched on for 15 minutes. This time can be increased (maximum of 120 minutes), by pressing (E) or decreased in one minute increments by pressing (D).

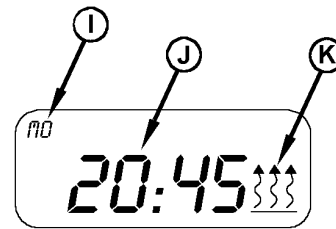

1. **Switch Off Heating:** Briefly press (C).
2. The status display (K) disappears. Automatic after-run for cool-down purposes will begin.

T121394

- | | |
|--------------|-----------------------|
| A—Time | F—Display Window |
| B—Program | I— Weekday Display |
| C—Heating On | J— Time Display |
| D—Backwards | K—Heat Status Display |
| E—Forwards | |

Continued on next page

CED,OUO1032,1406 -19-03SEP02-4/9

T121396E —UN—11MAY99

T121394 —UN—11MAY99

Programming Start of Heating

time in seven days can be stored in memory. Only one switch-on time can be activated at a time.

Selecting and Activating Memory: Three switch-on times within the following 24-hour period or one switch-on

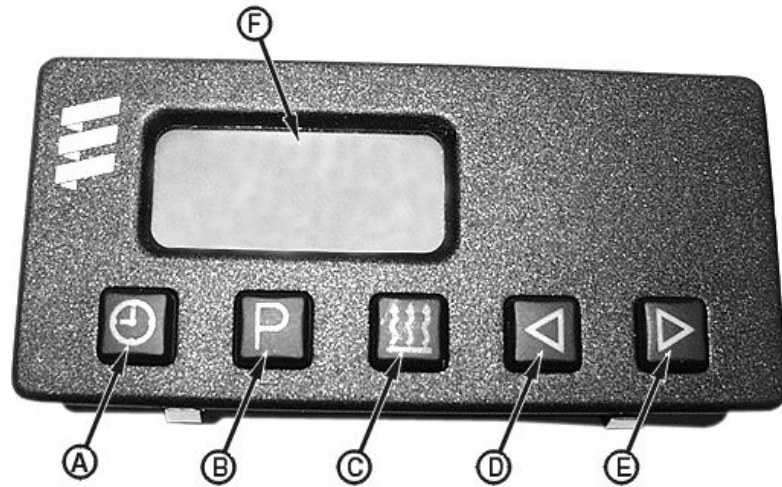
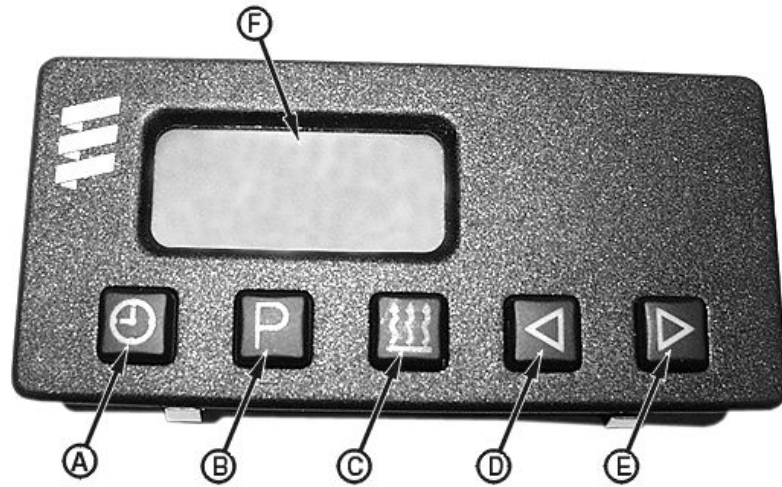

T121396B—UN—11MAY99

T121396B—UN—11MAY99

Continued on next page

CED,OUO1032,1406 -19-03SEP02-5/9

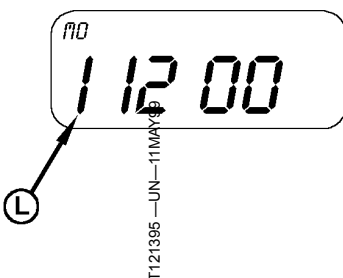

T121395

1. To activate first memory: Press (B) once. Memory display (L): 1 (default setting 12:00).
2. To activate second memory: Press (B) twice. Memory display (L): 2 (default setting 12:00).
3. To activate third memory: Press (B) once more. Memory display (L): 3 (default setting 12:00).

NOTE: Neutral status — no memory activated.

4. Press (B) repeatedly until the memory display disappears.
- a. **Program Switch On Heating Within 24 Hours:**
The correct program day is automatically displayed. No adjustment is necessary.

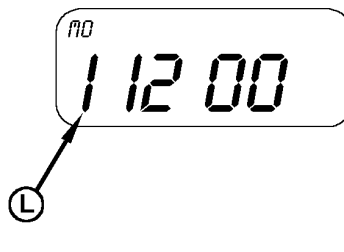

T121395

- b. Set the program time:
1. Press (B) repeatedly until the desired memory display (L) flashes 1, 2 or 3.
 2. Briefly press and release (D) or (E). The program time will flash.
 3. Set the program time for heating using (D) or (E). Setting is only possible if the program time is flashing.
 4. To select another memory, press (B).

A—Time
B—Program
C—Heating On
D—Backwards

E—Forwards
F—Display Window
L—Memory Display

A—Time
B—Program
C—Heating On
D—Backwards

E—Forwards
F—Display Window
L—Memory Display

- a. **Program Switch On Heating After 24 Hours (Maximum Seven Days):** Set the program time:
1. Press (B) repeatedly until the desired memory display (L) flashes 1, 2 or 3.
 2. Briefly press and release (D) or (E). The program time will flash.
 3. Set the program time for heating using (D) or (E). Setting is only possible if the program time is flashing.
 4. To select another memory, press (B).

- b. Set the program day (the program day begins to flash approximately 5 seconds after the program time has been set).

1. Set the program day for heating using (D) or (E).
2. The program time and program day are stored when the time display disappears or when the current time appears. The memory display (L) indicates the activated memory. The flashing heating-on symbol (K) also indicates that a memory has been activated.

Continued on next page

CED,OUO1032,1406 -19-03SEP02-6/9

T121395 - JUN - 11 MAY 99

Checking Activated Memory:

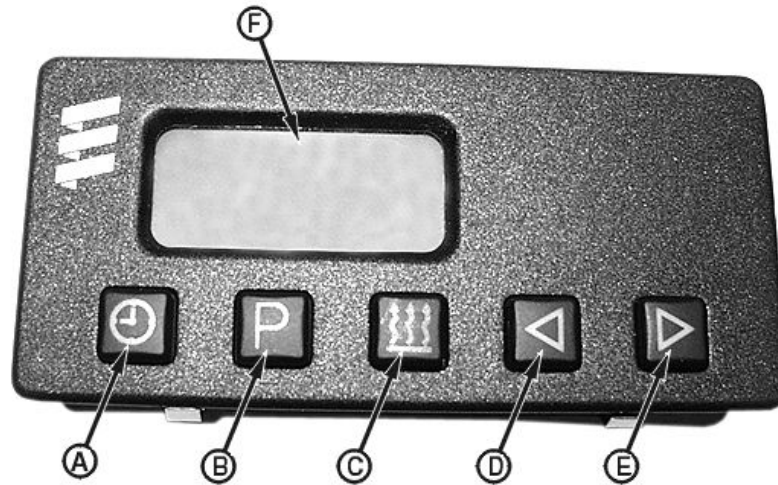

The program time of the displayed memory is displayed for approximately five seconds. The display then disappears or the current time is displayed (if the time is ON).

The program time display (J) and the program day (I) can then be called up by pressing (B) once for five seconds.

Temperature Display

If an ambient temperature sensor is connected and the time is activated, the temperature can be permanently displayed by pressing (A) once. If the time is OFF, the time temperature is displayed for 15 seconds by pressing (A) twice.

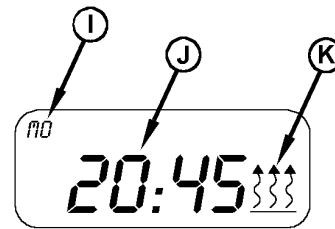

T121394

- | | |
|--------------|-----------------------|
| A—Time | F—Display Window |
| B—Program | I—Weekday Display |
| C—Heating On | J—Time Display |
| D—Backwards | K—Heat Status Display |
| E—Forwards | |

Continued on next page

CED,OUO1032,1406 -19-03SEP02-7/9

T121396B —UN—11MAY99

T121394 —UN—11MAY99

Service Codes

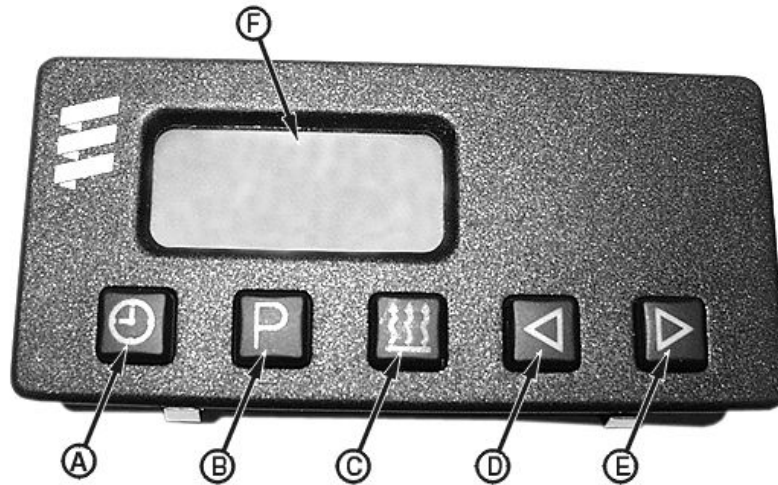

A—Time
B—Program

C—Heating On
D—Backwards

E—Forwards
F—Display Window

If a service code appears in display window (F):

1. Press (C) to turn heater off and on (twice maximum).

CED,OUO1032,1406 -19-03SEP02-8/9

T121396B —UN—11MAY99

2. Check fuse (A).
3. Check exhaust tube (A) for blockage.
4. See your authorized dealer.

A—Fuse

A—Exhaust Tube

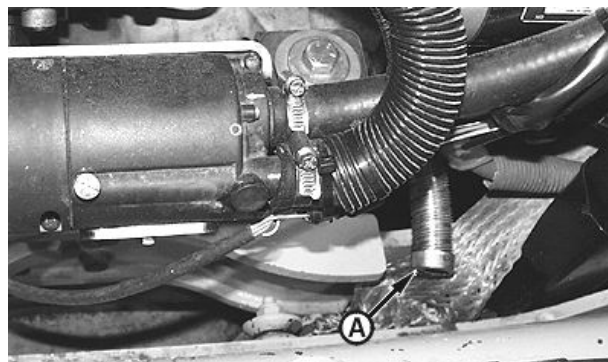

CED,OUO1032,1406 -19-03SEP02-9/9

T121419B —UN—12MAY99

T121410B —UN—11MAY99

Using Booster Batteries—12 Volt System

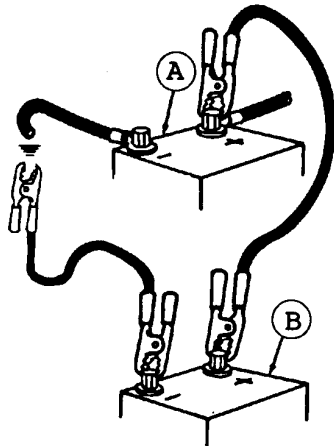

T6508AE1 (CV)

Single Battery Application

A—Machine Battery(s) B—Booster Battery(s)

Before boost starting, machine must be properly shut down and secured to prevent unexpected machine movement when engine starts.

CAUTION: An explosive gas is produced while batteries are in use or being charged. Keep flames or sparks away from the battery area. Make sure the batteries are charged in a well ventilated area.

Always remove grounded (—) battery clamp first and replace it last.

IMPORTANT: The machine electrical system is a 12-volt negative (—) ground. Use only 12-volt booster batteries.

1. Connect one end of the positive cable to the positive terminal of the machine batteries and the other end to the positive terminal of the booster batteries.

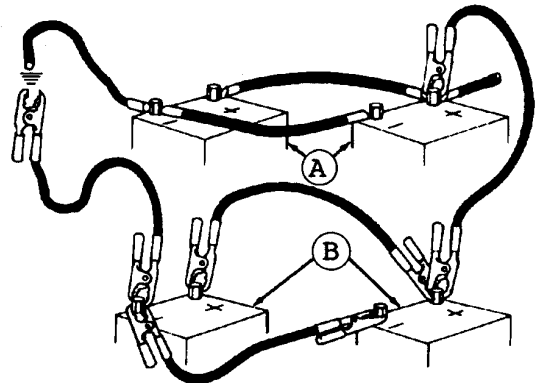

T6713AI1 (CV)

Two Battery Application

2. Connect one end of the negative cable to the negative terminal of the booster batteries. Then connect other end of the negative cable to the machine frame as far away from the machine batteries as possible.
3. Start engine.
4. Immediately after starting engine, disconnect end of the negative cable from the machine frame and disconnect the other end of the negative cable from the negative terminal of the booster batteries.
5. Disconnect positive cable from booster batteries and machine batteries.

TX,25,BD2079 -19-14JAN08-1/1

Engine Warm-Up

1. After engine starts, run at 1/2 speed for 2 minutes. Do not run at fast or slow idle.
2. Operate machine at less-than-normal loads and speeds until engine is at normal operating temperature.

02T,25,M24 -19-03AUG92-1/1

Cold Weather Warm-Up

NOTE: If hydraulic oil is cold, hydraulic functions move slowly. Do not attempt machine operations until hydraulic functions move at close-to-normal cycle times.

In extremely cold conditions, an extended warming-up period will be necessary.

Avoid sudden operation of hydraulic functions until engine is thoroughly warmed up. Remove ice, snow, and mud from machine before operation.

1. Run engine at 1/2 speed for 5 minutes.
2. Cycle all hydraulic functions to distribute warmed oil until all functions operate freely.

02T,25,J28 -19-15MAR93-1/1

Driving the Machine with Standard FNR Lever (Earlier Machines)

1. Start engine.
2. Move engine speed control lever (A) to desired engine rpm.
3. Move park lock lever (D) to down (unlocked) position.

NOTE: Transmission lever adjusts travel speed.

4. Move the transmission speed control lever (B) to desired setting. Number "3" is high transmission speed and number "1" is low transmission speed.

NOTE: Use decelerator pedal to adjust engine speed.

5. Depress decelerator pedal.
6. Move FNR lever (C) toward F to travel forward and toward R to travel in reverse. Move FNR lever in desired turning direction to steer.
7. Slowly release decelerator to increase engine speed to the selected engine rpm.

A—Engine Speed Control Lever
B—Transmission Speed Control Lever

C—FNR Control Lever
D—Park Lock Lever



T117491 —UN—12NOV98



T118007B —UN—14JAN99

TX,30,RR,A7 -19-07JAN00-1/1

Transmission Speed Reverse Ratio Knob—If Equipped

The reverse speed ratio knob (1) located to left of FNR with Transmission Speed-In-Grip lever adjusts the reverse speed as a percentage of the transmission speed setting. The reverse speed percentage settings are **80%, 100%, 115%, and 130%**. Transmission speed reverse setting, will not exceed transmission maximum speed of SP3.0 11 km/h (6.8 mph). [An example; If transmission speed is SP3.0, and the reverse ratio knob is set at 80%, then the reverse speed would be equivalent to 8.7 km/h (5.4 mph).]

1— Transmission Speed
Reverse Ratio Knob

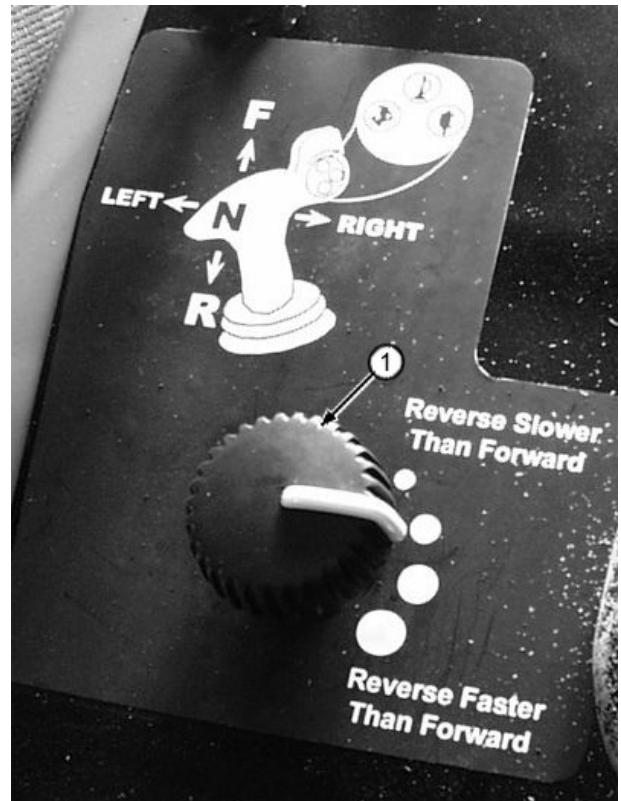

T122745B —UN—26.JUL.99

CED, TX03768, 2694 -19-08FEB00-1/1

FNR with Transmission Speed In Grip—If Equipped



T122310B—UN—16JUL99

- A—Transmission Speed In Grip Button** **B—Horn Button**
C—Transmission Reverse Ratio Knob

Push the top of the FNR with transmission speed button (A) to increase transmission speed. Push the bottom of the switch to lower the machine transmission speed.

Push the horn button (B) to sound the machine horn when needed.

The transmission reverse ratio knob (C) allows the operator to control the machine reverse speed different

from that of the machine forward speed. Turn the knob counter-clockwise to decrease machine transmission speed.

The FNR with Transmission Speed-In-Grip lever controls the direction (forward and reverse), steering (left turn, right turn), pivot turn, and counter-rotation.

CED, TX03768, 2680 -19-07DEC99-1/1

Driving the Machine using FNR with Transmission Speed In Grip—If Equipped (Earlier Machines)

1. Fasten seat belt.
2. Park lock lever (5) must be in locked position (up).
3. Place FNR (2) with Transmission Speed-In-Grip to “Neutral” position.
4. Move engine speed control lever (4) to low idle position.
5. Start engine. Speed gauge (6) will display SP1.6.
6. Depress decelerator pedal.
7. Move park lock lever to down (unlocked) position. Speed gauge will display default transmission setting SP1.6.

NOTE: Transmission speed button and reverse speed ratio knob adjust travel speed and may be adjusted at any time.

8. Place FNR with Transmission Speed-In-Grip lever in desired position.
9. Press transmission speed button (1) to desired setting (SP1.0—SP3.0) as seen in gauge. The transmission speed range is pre-set for a startup speed range of SP1.6. The transmission speed range can vary depending on operator's preference from SP1 to SP3 (machine speed can vary from 0 to 5 mph).
10. Adjust the reverse transmission speed ratio knob (3). (Reverse speed ratio of 80%, 100%, 115%, or 130% of transmission speed.)
11. Slowly release decelerator pedal to move machine.
12. Move engine speed lever to a desired rpm setting.
13. Move FNR with Transmission Speed-In-Grip lever in desired turning direction to steer.

- | | |
|--|-------------------------------------|
| 1— Transmission Speed Button | 4— Engine Speed Control |
| 2— FNR with Transmission Speed-In-Grip Lever | 5— Park Lock Lever |
| 3— Reverse Speed Ratio Knob | 6— Transmission Speed Setting Gauge |

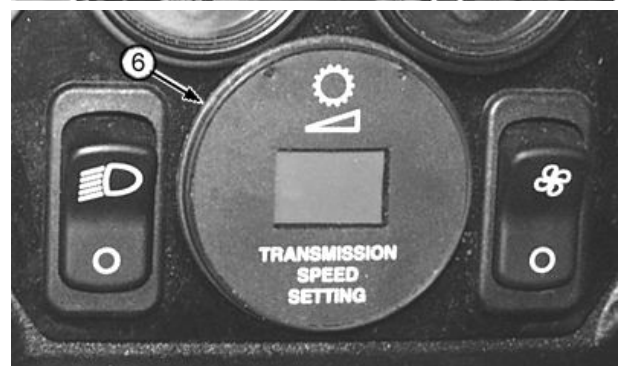
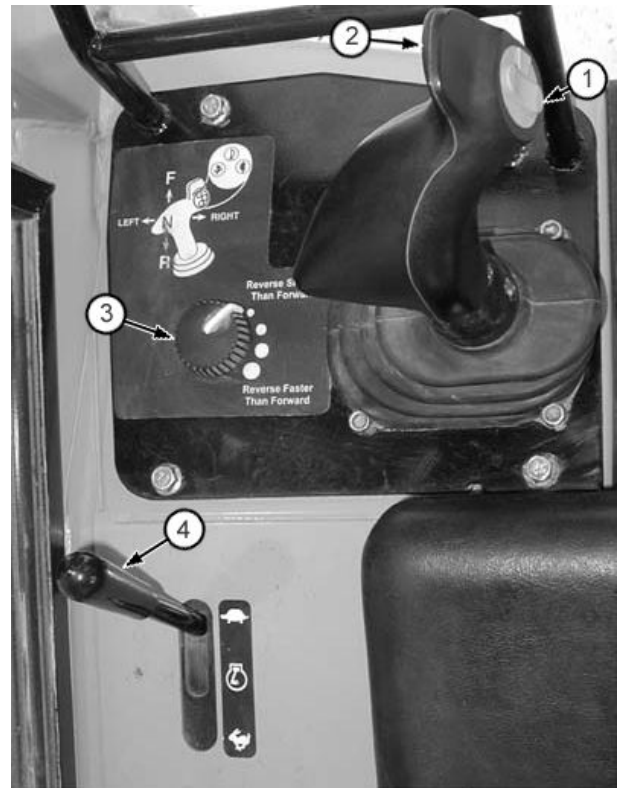

T1157847C—UN—22JUL02

T1127190B—UN—07JAN00

T1127196B—UN—07JAN00

CED, TX03768, 2704 -19-24FEB00-1/1

Driving the Machine using FNR with Transmission Speed In Grip—If Equipped (Later Machines)

1. Fasten seat belt.
2. Park lock lever (5) must be in locked position (up).
3. Place FNR (2) with Transmission Speed-In-Grip to “Neutral” position.
4. Move engine speed control lever (4) to low idle position.
5. Start engine.
6. Depress decelerator pedal.
7. Move park lock lever to down (unlocked) position. Speed gauge will display default transmission setting SP1.6.

NOTE: Transmission speed button and reverse speed ratio knob adjust travel speed and may be adjusted at any time.

8. Place FNR with Transmission Speed-In-Grip lever in desired position.
9. Press transmission speed button (1) to desired setting (SP1.0—SP3.0) as seen in display window. The transmission speed range is pre-set for a startup speed range of SP1.6. The transmission speed range can vary depending on operator's preference from SP1 to SP3 (machine speed can vary from 0 to 5 mph).
10. Adjust the reverse transmission speed ratio knob (3). (Reverse speed ratio of 80%, 100%, 115%, or 130% of transmission speed.)
11. Slowly release decelerator pedal to move machine.
12. Move engine speed lever to a desired rpm setting.
13. Move FNR with Transmission Speed-In-Grip lever in desired turning direction to steer.

- | | |
|--|-------------------------|
| 1— Transmission Speed Button | 4— Engine Speed Control |
| 2— FNR with Transmission Speed-In-Grip Lever | 5— Park Lock Lever |
| 3— Reverse Speed Ratio Knob | 6— Display Window |

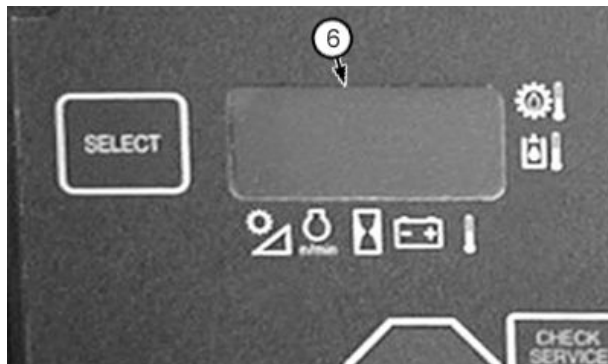

T157847C—JUN—22JUL02

T127190B—JUN—07JAN00

T157934B—JUN—22JUL02

TE14778.000000D -19-27AUG03-1/1

Steering the Machine

CAUTION: If the machine does not steer properly, do not operate. See your authorized dealer for service.

Move lever forward to move machine forward.

Move lever rearward to move machine in reverse.

Movement of lever in range (A) (spring force) will slow one track to turn machine in desired direction.

Further movement to range (B) (no spring force) will stop one track to make a pivot turn in desired direction.

Continued movement in range (C) (increased spring force) will move one track forward and one track in reverse to counter-rotate machine in desired direction.

A—Range (Spring Force) C—Range (Increased Spring Force)
 B—Range (No Spring Force)

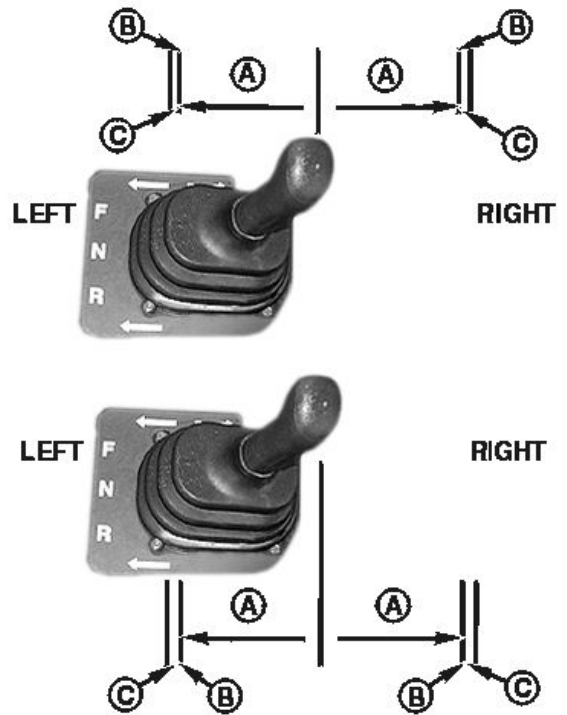

CED,OU01032,1073 -19-03SEP02-1/1

T118031-19-16DEC98

T118740-19-15DEC98

Steering using FNR with Transmission Speed In Grip Lever—If Equipped

The FNR (2) with Transmission Speed-In-Grip controls the direction (forward and reverse), the steering (left turn, right turn), pivot turn, and counter-rotation. Moving the FNR fully right or left will cause the machine to counter-rotate.

- | | |
|--|--|
| 1— Transmission Speed Control Button | 3— Transmission Speed Reverse Ratio Knob |
| 2— FNR with Transmission Speed-In-Grip Control | 4— Engine Speed Control |

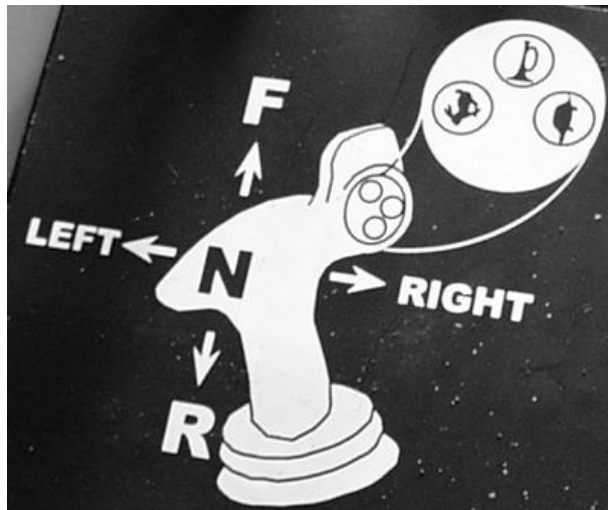

T1157847C—JUN—22/JUL02

T1122746B—JUN—29/JUL99

CED, TX03768, 2695 -19-08FEB00-1/1

Using Engine Speed Control Lever

To increase engine speed, move engine speed control lever (A) rearward to position (B) (rabbit). To decrease engine speed, move lever forward to position (C) (turtle).

- A—Engine Speed Control Lever
- B—Fast Idle Position
- C—Slow Idle Position



T118029 —UN—12NOV98

CED,OUO1032,1072 -19-28OCT98-1/1

Travel Speed Using FNR Transmission Speed In the Grip—If Equipped

Hydrostatic dual path transmission provides variable travel speed (SP1.0—SP3.0) ranging from 0—11 km/h (0—6.8 mph) in forward or reverse. Reverse speed ratios of 80%, 100%, 115%, and 130% until maximum mph is reached, from 0—11 km/h (0—5 mph) in reverse. Transmission speed default speed of SP1.6 will be displayed by moving park lock lever or pushing FNR Speed in the grip button (1 and 3).

- 1— Transmission Speed Button (increase)
- 2— Horn Button
- 3— Transmission Speed Button (decrease)

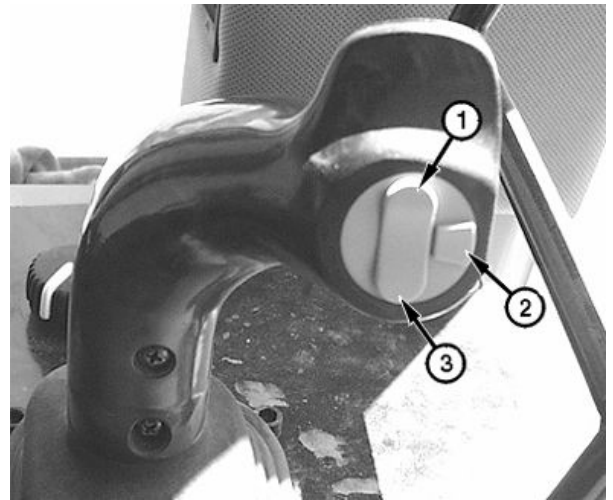

T128172B —UN—08FEB00

CED, TX03768,2703 -19-18FEB00-1/1

Foot Pedals

CAUTION: Prevent possible injury from unexpected machine movement. Pushing on brake pedal will stop machine abruptly.

NOTE: Release of brake pedal will allow machine to move.

Brake pedal (B) should not be used to stop machine during normal operating conditions. Pushing on brake pedal will stop machine abruptly. **Travel will resume as pedal is released.**

Pushing on decelerator pedal (A) will slow engine rpm and reduce machine ground speed.

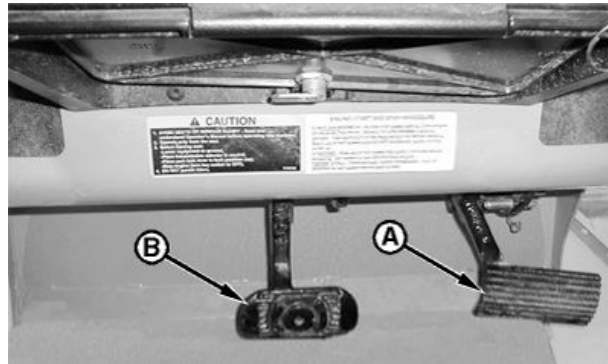

A—Decelerator Pedal

B—Brake Pedal

T118042C—UN—02DEC98

CED, TX03768, 2696 -19-18FEB00-1/1

Using Park Lock Lever

CAUTION: Prevent possible injury from unexpected machine movement. Always move park lock lever to up (locked) position before starting or dismounting.

When park lock lever is in up (locked) position (B), FNR lever can move but will not operate the machine.

When park lock lever is in down (unlocked) position (A), FNR lever can move machine.

If park lock lever is pulled down while the FNR lever is in forward or reverse, the machine will not move. Put FNR lever in neutral, then raise and lower the park lever. Machine is now operable.

A—Park Lock Lever Unlocked B—Park Lock Lever Locked



T118001B—UN—11NOV98

T118007C—UN—14JAN99

CED, OOU01032, 1070 -19-28OCT98-1/1

Stopping the Machine

NOTE: Park brake automatically engages when engine is not running.

Stop machine by doing one of the following:

- Push decelerator pedal.
- Push brake pedal.

- Move FNR lever to N.
- Push park lock lever to up (locked) position.

CAUTION: Machine may overturn if blade is dropped when moving rapidly down a steep hill.

- As a last resort, drop blade to stop machine.

CED, TX03768, 2699 -19-09FEB00-1/1

Parking the Machine

1. Park machine on a level surface.
2. Lower equipment to the ground.
3. Move FNR control lever (1) to N.

NOTE: Park brake automatically engages when engine is not running or park lock lever is in up (locked) position.

4. Move park lock lever (3) to up (locked) position.

IMPORTANT: To avoid damage to turbocharger (if equipped), run engine at 1/2 speed no load for two minutes.

5. Run engine at 1/2 speed no load for 2 minutes.
6. Move engine speed control lever (2) to slow idle position.
7. Turn key switch to “Off” to stop engine.
8. Remove key from switch.
9. Release hydraulic pressure by moving control lever until equipment does not move.
10. Turn battery disconnect switch off.

1— FNR with Transmission
Speed-In Grip Lever
2— Engine Speed Control
Lever

3— Park Lock Lever



T1157847F—UN—28AUG02

T118007D—UN—28AUG02

HG31779,00000BC -19-22JUL02-1/1

Blade Pitch Operation

You may want to change the pitch of the blade depending on the type of work you are doing and the soil conditions you are dozing, or to change the feel of the dozer to operator's preference.

Pitching the Blade Forward Advantages:

With the top of blade pitched forward (A), the blade will not carry as much soil. The weight of the soil carried by the blade adds to the weight of the dozer and moves the balance of weight on the tracks forward. This can cause the front idlers of the crawler to sink in loose or soft soils. When the idlers sink, the blade cuts unevenly into the soil. With the blade forward, the dozer balance does not change as much with a full blade; therefore, the tendency for idlers to sink is reduced.

With the blade forward, there is less of a tendency for dirt to come over the back of the blade when dozing uphill. It is also easier to drop dirt at the end of a push when dozing uphill or when dozing very sticky materials.

Pitching the Blade Back Advantages:

With the blade pitched back (B), the cutting edge lies more horizontally resulting in a heavier cut into soils. Having the cutting edge more horizontal also provides a smoother cut in heavy soils. More soil is carried by the

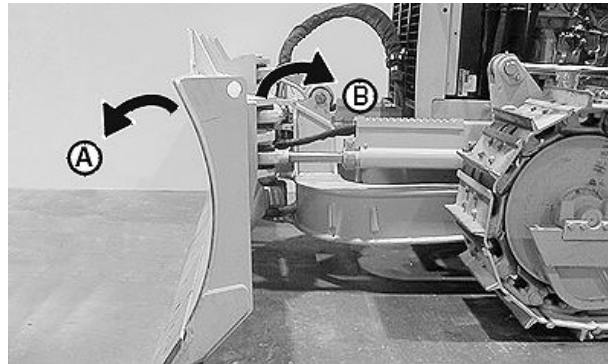

450H Shown

A—Forward Pitch

B—Back Pitch

blade when it is pitched back. Carrying more soil on the blade adds to the weight of the dozer. This added weight can increase push force in heavy soils. The soil carried by the blade also moves the balance of weight forward on the machine. In heavy soils, this can be an advantage because the increased weight can help keep the front of the machine down and keep the cutting edge penetrating during heavy cutting.

CED,OUO1032,1118 -19-24APR99-1/2

T118184B—UN—25NOV98

Changing the Pitch:

To determine which link is assembled to the blade, look at the right side of the pitch link (A). Cast into the link will be one of the following: FORWARD, MID or BACK.

The standard pitch link is a universal (MID) position link.

There are two optional pitch links available. The FORWARD link performs better in sand, stone grading and has best visibility to cutting edge. The BACK link performs better in cutting, backfilling, and moving large quantities of material.

See your authorized dealer to obtain either of the optional links.

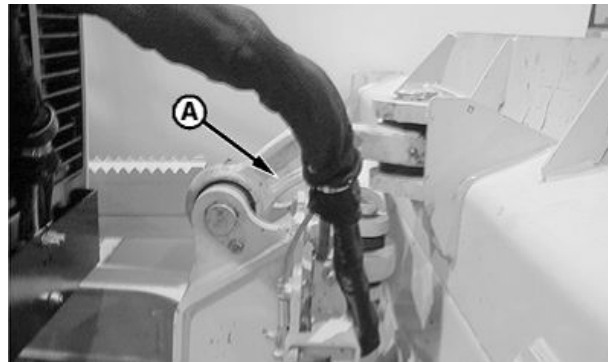

A—Pitch Link

CED,OUO1032,1118 -19-24APR99-2/2

T118191C—UN—02DEC98

Operating Blade

IMPORTANT: To avoid overheating of hydraulic oil, allow control lever to return to neutral when cylinders reach the end of their travel.

Move control lever rearward to raise blade. Move control lever forward to lower blade.

Move lever to full forward detent for float position. This position allows the blade to follow the contour of the ground. Manually release lever from this position.

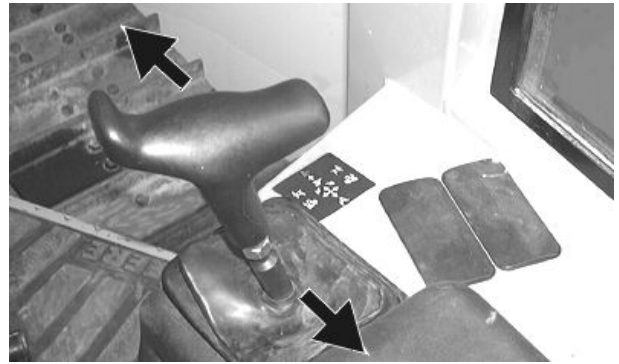

T121338C —UN—11MAY99

CED,OUO1032,1119 -19-14JAN08-1/1

Tilting Blade

Move the blade control lever left to tilt the blade left.

Move the blade control lever right to tilt the blade right.

A—Tilt Blade Left

B—Tilt Blade Right



T121338D —UN—11MAY99

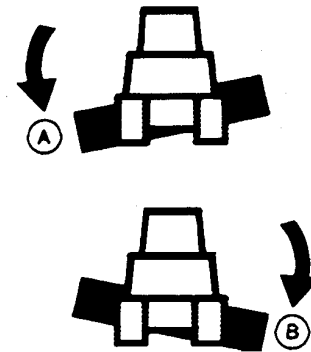

T6508AW —UN—19MAY89

CED,OUO1032,1120 -19-14JAN08-1/1

Angling Blade

Twist lever to right to angle blade to right.

Twist lever to left to angle blade to left.



T121338E —UN—11MAY99

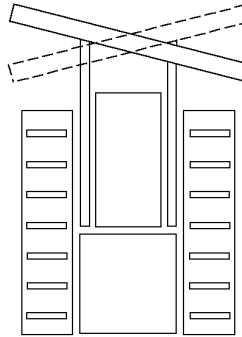

T118641

T118641 —UN—01DEC98

CED,OUO1032,1121 -19-14JAN08-1/1

Operating Winch—If Equipped

CAUTION: Always be sure rear screen between winch and operating compartment is in place before operating winch.

Operate the winch only from operator's station.

A coolant heater is recommended with winch option if ambient temperature is below -18°C (0°F).

Before operating winch, place winch control in free spool to circulate oil through winch until transmission oil reaches operating temperature.

- Move lever to FREE SPOOL (A) position so cable can be pulled out freely.
- Move lever to the BRAKE OFF (B) position so cable can be pulled out with tension.
- Move lever to the BRAKE ON (C) position to hold cable.
- Move lever to POWER IN (D) position to wind cable on drum
- Move lever to POWER OUT (E) position (if equipped) to unwind cable from drum.

A—Free Spool
B—Brake Off
C—Brake On

D—Power In
E—Power Out

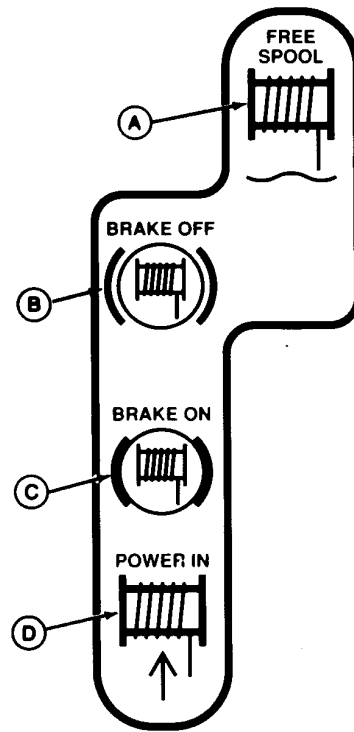

Standard Control Pattern

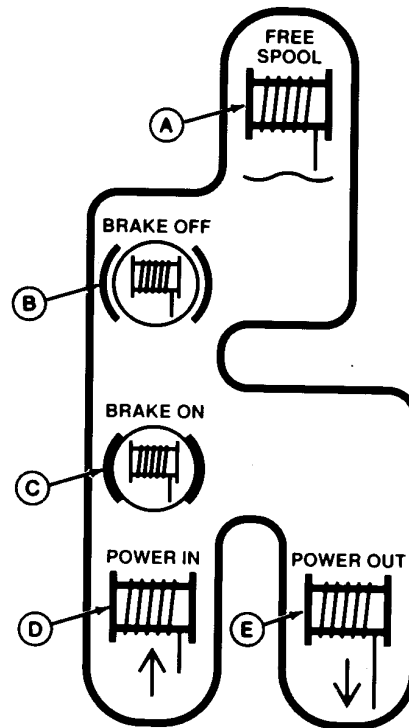

Power In, Power Out Control Pattern

T7440BG—UN—20DEC90

T7440BH—UN—20DEC90

TX,36,FF2210 -19-03SEP02-1/1

Fasten Cable to Winch Drum—4000S Series

Maximum Cable Capacities	
Cable Size	Winch Capacity
15.88 mm (0.625 in.)	77.4 m (254 ft)
19.05 mm (0.75 in.)	54.6 m (179 ft)
22.23 mm (0.875 in.)	39.3 m (129 ft)

To conform with certain state laws, the cable must be attached to the drum so that it can come loose if the cable is unwound from winch drum.

Attach cable to winch drum using one of the following methods:

⚠ CAUTION: Prevent possible personal injury from cutting wire. Wear gloves when you handle cable to protect hands from cable wire cuts. DO NOT guide cable on winch with your hands.

IMPORTANT: If a ferruled cable is used, the drum plug (B) MUST be installed to prevent cable from bending cable slot.

• **First Method—Breakaway Anchor:**

1. Attach a ferrule or cable clamp (A) to end of cable.
2. Wrap cable around the drum and slide the ferrule or cable clamp under the cable and into slot in drum and secure with tab (C).

A—Ferrule or Cable Clamp C—Tab
B—Drum Plug

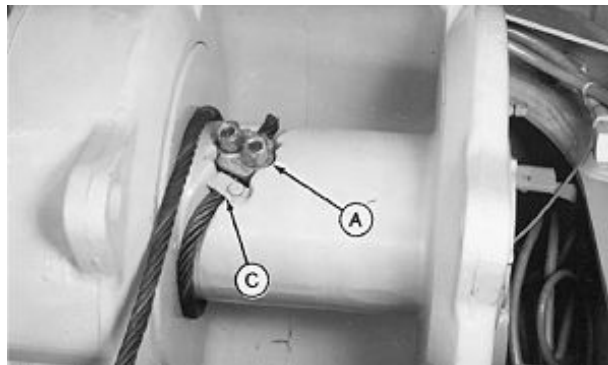
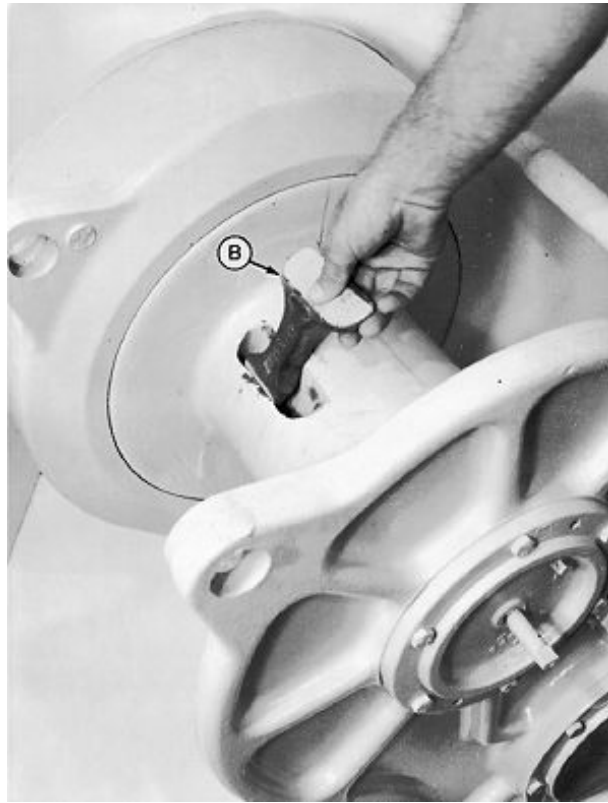

T7347AS—UN—27SEP90

T7382AH—UN—03OCT90

Continued on next page

TX,35,RR,798 -19-27JAN00-1/3

- **Second Method—Fixed Anchor:**

1. Remove drum plug.
2. Thread cable up through small hole and wrap cable around wedge (A). Insert cable back down through lower hole and pull wedge into drum (B).

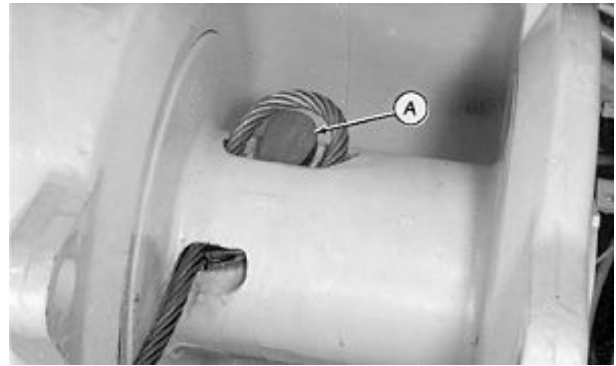

T7382AK—UN—03OCT90

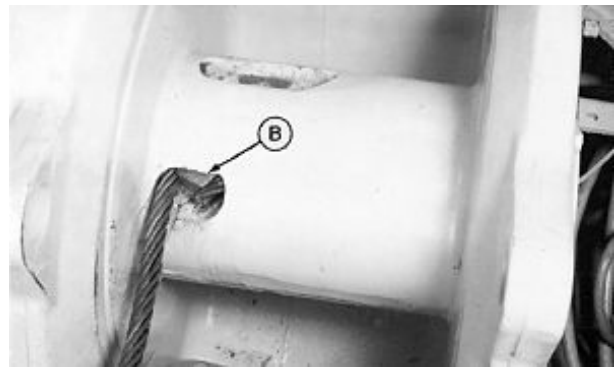

T7382AJ—UN—03OCT90

A—Wedge

B—Drum

Continued on next page

TX,35,RR,798 -19-27JAN00-2/3

- **Third Method:**

IMPORTANT: If you unwind cable below one turn on drum, cable will come off drum.

1. Remove drum plug (B).

⚠ CAUTION: Prevent possible injury from cable wire. Wear gloves when handling cable to protect hands from cable wire cuts. **DO NOT** guide cable on winch with your hands.

2. Thread cable up through small hole and insert cable back down through lower hole. Pull loop into drum.
3. Adjust free spool drag to operator's preference. See [Winch Free Spool Drag Adjustment](#) in this section.

NOTE: Factory free spool drag setting was done without cable; adjust free spool drag to operator's preference when cable is added.

B—Drum Plug

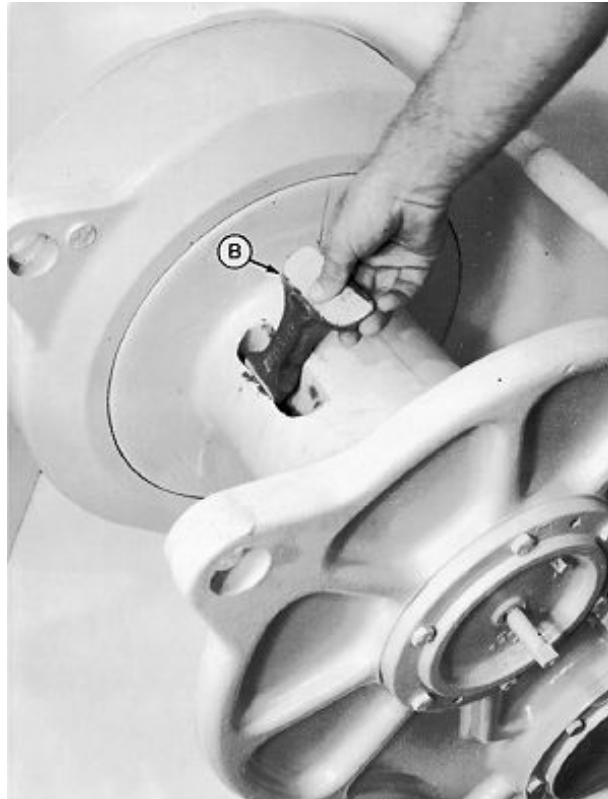

T7347AS—UN—27SEP90



T7382AI—UN—03OCT90

TX,35,RR,798 -19-27JAN00-3/3

Winch Free Spool Drag Adjustment

The winch drum drag can be adjusted to operator's preference.

1. Start engine.
2. Lower equipment to ground.
3. Engage park brake.
4. Place winch control handle in FREE SPOOL position.
5. Loosen nut (A).
6. Adjust slotted shaft to desired winch drum drag.
7. Tighten nut.

A—Nut

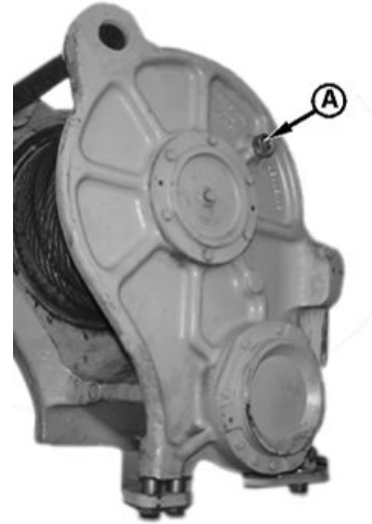

Winch (right side)

TX,35,RR4679 -19-10JAN12-1/1

T118240B —UN—12NOV98

Avoid Track Damage

IMPORTANT: Avoid machine damage. If machine is equipped with a sealed and lubricated

track, avoid water being forced between the plastic pins and rubber plugs while washing machine with pressure washer.

JH91824,00002EA -19-22JUL10-1/1

Loading Machine on a Trailer

1. Keep the trailer bed clean.
2. Put chock blocks (A) against truck wheels.
3. Use a ramp or loading dock. Ramps must be strong enough, have a low angle, and be of correct height.
4. Fasten seat belt before starting engine.
5. Load and unload the machine on a level surface.

⚠ CAUTION: Prevent possible injury from unexpected machine movement. Whenever possible, back the machine onto the trailer to prevent possible tipping.

6. Drive the machine onto the ramps squarely.
7. The centerline of the machine should be over the centerline of the trailer.
8. Lower all equipment onto blocks.
9. Move FNR lever to N.
10. Move park lock lever to lock position.

IMPORTANT: To avoid damage to turbocharger (if equipped), run engine at 1/2 speed no load for two minutes.

11. Run engine at 1/2 speed no load for 2 minutes.
12. Move engine speed control lever to slow idle position.
13. Turn key switch to "Off". Stop engine.
14. Remove key from switch.
15. Release hydraulic pressure by moving control lever until equipment does not move.

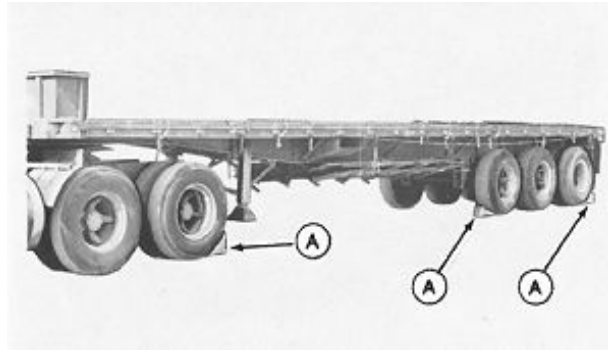

A—Chock Blocks

16. Turn battery disconnect switch off.
17. Cover exhaust opening to prevent entry of wind and water.

IMPORTANT: Fasten chains or cables to machine frame or track chain links. Do not place chains or cables over or against hydraulic lines or hoses.

18. Fasten each corner of the machine to the trailer with a chain or cable.
 - Front: Use towhook eye on bottom of the machine frame front end.
 - Side: Use inside edge of track shoe.
 - Rear: Use outer edge of track shoe or drawbar (if equipped).

02T,40,K36 -19-07JAN00-1/1

T87155—JUN—09NOV88

Releasing the Park Brake to Tow the Machine

Order CO₂ Inflation Kit and attaching hardware through your authorized dealer.

CAUTION: Prevent possible injury from unexpected machine movement. Do not try to start engine when towing. Extensive machine damage and/or personal injury may result.

IMPORTANT: DO NOT tow machine faster than 2.4 km/h (1.5 mph) or extensive machine damage may result.

1. Stop engine.
2. Move park lock lever down to unlocked position.
3. Remove rubber mat and floor plate from operator's station.

NOTE: Multi-function valves can be turned out using a 1 1/4 in. socket and a flexible head ratchet.

4. **TO TOW MACHINE FORWARD:** Both front and rear pump top multi-function relief valves (1) MUST be turned out (counterclockwise) 1/2 to 1 turn and blade must be raised off the ground. (If engine will crank but will not start, blade can be raised by cranking engine while holding blade raise function on control valve.)

TO TOW MACHINE IN REVERSE: Both front and rear pump bottom multi-function valves (2) MUST be turned out (counterclockwise) 1/2 to 1 turn.

5. Disconnect quick coupler (3).

- | | |
|--|------------------|
| 1— Forward Multi-Function Valve (top) | 3— Quick Coupler |
| 2— Reverse Multi-Function Valve (bottom) | |

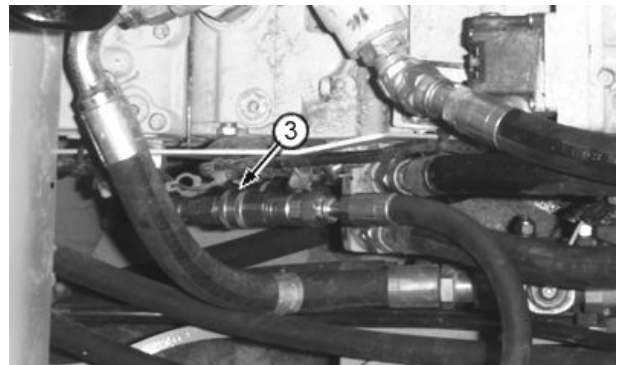
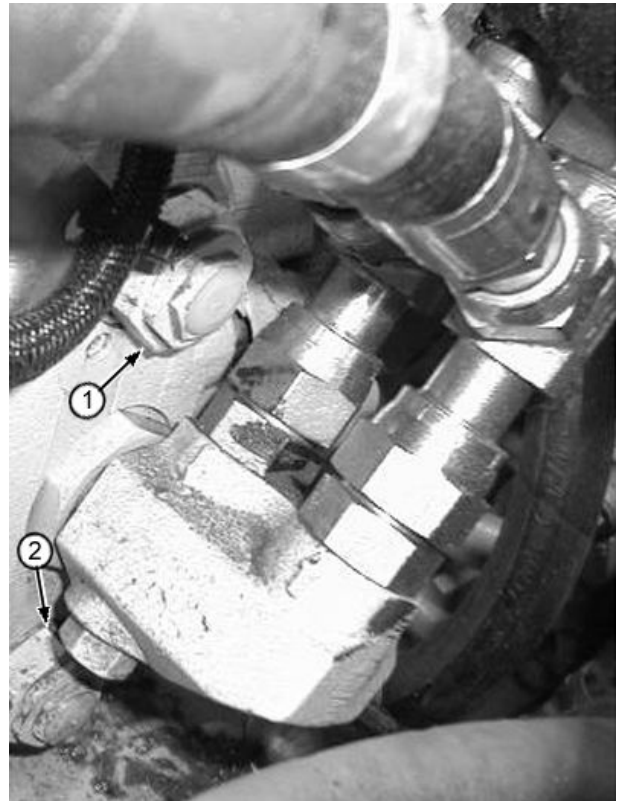

T118899B—UN—16DEC98

T119030B—UN—16DEC98

CED,OUTX466,1206 -19-24APR99-1/3

6. Assemble the CO₂ Inflation Kit and attaching hardware.
7. Install CO₂ assembly to hose coupler end.

- | | |
|---|---|
| 1— AM102420 Male Quick Coupler | 4— AT119575 Adapter |
| 2— Parker Adapter 0502-6-4 (9/16 in. to 1/4 in. pipe) | 5— AT221000 CO ₂ Inflation Kit (Includes inflation canister and cartridge) |
| 3— R27908 Adapter (1/4 in. to 1/8 in. pipe) | |

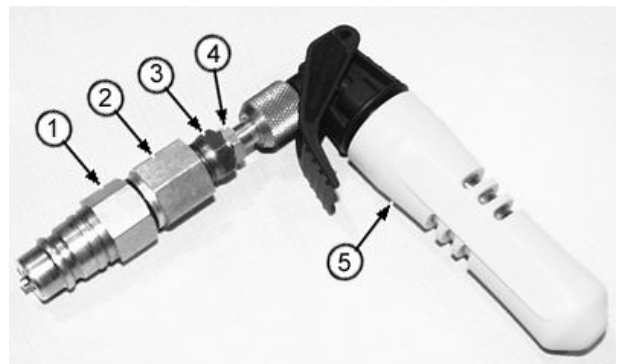

CO₂ Inflation Kit and Attaching Hardware

T119431B—UN—07JAN99

Continued on next page

CED,OUTX466,1206 -19-24APR99-2/3

IMPORTANT: Release brakes using CO₂ with a **MINIMUM** pressure of 200 psi and a **MAXIMUM** pressure of 400 psi. **DO NOT** exceed the limits of the charge pressure gauge on dash.

NOTE: The brakes initially start to release at approximately 150 psi and are fully released at approximately 190 psi. With the park lock lever down, monitor the pressure on the transmission oil pressure gauge on the instrument panel.

8. While sitting in the operator's seat, watch charge pressure gauge on dash when releasing brakes using CO₂ assembly. Pressurize brake circuit to approximately 200 psi.

IMPORTANT: **DO NOT** tow machine faster than 2.4 km/h (1.5 mph) or extensive machine damage may result.

NOTE: Engine does not have to be running to tow machine.

9. Tow the machine.
10. After the machine is towed, step on the brakes to release pressure. Remove CO₂ assembly and reconnect coupler. Tighten multi-function valve lock nut to 79 N·m (58 lb-ft). See your authorized dealer for repair.

Specification

Multi-Function Valve Lock
 Nut—Torque..... 79 N·m (58 lb-ft)

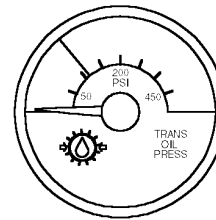

T121134

T119432B —UN—07JAN09

T121134 —UN—20APR99

CED,OUTX466,1206 -19-24APR99-3/3

Maintenance—Machine

Diesel Fuel

Consult your local fuel distributor for properties of the diesel fuel available in your area.

In general, diesel fuels are blended to satisfy the low temperature requirements of the geographical area in which they are marketed.

Diesel fuels specified to EN 590 or ASTM D975 are recommended. Renewable diesel fuel produced by hydrotreating animal fats and vegetable oils is basically identical to petroleum diesel fuel. Renewable diesel that meets EN 590 or ASTM D975 is acceptable for use at all percentage mixture levels.

Required Fuel Properties

In all cases, the fuel shall meet the following properties:

Cetane number of 43 minimum. Cetane number greater than 47 is preferred, especially for temperatures below -20°C (-4°F) or elevations above 1500 m (5000 ft.).

Cold Filter Plugging Point (CFPP) should be at least 5°C (9°F) below the expected lowest temperature or **Cloud Point** below the expected lowest ambient temperature.

Fuel lubricity should pass a maximum scar diameter of 0.45 mm as measured by ASTM D6079 or ISO 12156-1.

Diesel fuel quality and sulfur content must comply with all existing emissions regulations for the area in which the engine operates. DO NOT use diesel fuel with sulfur content greater than 10 000 mg/kg (10 000 ppm).

Sulfur content for Interim Tier 4 and Stage III B engines

- Use ONLY ultra low sulfur diesel (ULSD) fuel with a maximum of 15 mg/kg (15 ppm) sulfur content.

Sulfur Content for Tier 3 and Stage III A Engines

- Use of diesel fuel with sulfur content less than 1000 mg/kg (1000 ppm) is RECOMMENDED
- Use of diesel fuel with sulfur content 1000–5000 mg/kg (1000–5000 ppm) REDUCES oil and filter change intervals.
- BEFORE using diesel fuel with sulfur content greater than 5000 mg/kg (5000 ppm), contact your John Deere dealer

Sulfur Content for Tier 2 and Stage II Engines

- Use of diesel fuel with sulfur content less than 500 mg/kg (500 ppm) is RECOMMENDED.
- Use of diesel fuel with sulfur content 500–5000 mg/kg (500–5000 ppm) REDUCES the oil and filter change interval
- BEFORE using diesel fuel with sulfur content greater than 5000 mg/kg (5000 ppm), contact your John Deere dealer

Sulfur Content for Other Engines

- Use of diesel fuel with sulfur content less than 5000 mg/kg (5000 ppm) is recommended.
- Use of diesel fuel with sulfur content greater than 5000 mg/kg (5000 ppm) REDUCES the oil and filter change intervals.

IMPORTANT: Do not mix used diesel engine oil or any other type of lubricating oil with diesel fuel.

IMPORTANT: Improper fuel additive usage may cause damage on fuel injection equipment of diesel engines.

DX,FUEL1 -19-11APR11-1/1

Low Sulfur Diesel Fuel Conditioner

When possible, use existing fuel formulations for engines used off-highway. This fuel will not require any additives to provide good performance and engine reliability. However, many local fuel distributors will not carry both low and regular sulfur diesel fuels.

If the local fuel distributor will supply only low sulfur fuel, order and use John Deere PREMIUM DIESEL FUEL

CONDITIONER. It provides lubricating properties along with other useful benefits, such as cetane improver, anti-oxidant, fuel stabilizer, corrosion inhibitor and others. John Deere PREMIUM DIESEL FUEL CONDITIONER is specifically for use with low sulfur fuels. Nearly all other diesel fuel conditioners only improve cold weather flow and stabilize long-term fuel storage. They do not contain the lubrication additives needed by rotary fuel injection pumps.

TX,45,JC2126 -19-15AUG97-1/1

Testing Diesel Fuel

A fuel analysis program can help to monitor the quality of diesel fuel. The fuel analysis can provide critical data such as cetane number, fuel type, sulfur content, water content, appearance, suitability for cold weather

operations, bacteria, cloud point, acid number, particulate contamination, and whether the fuel meets specification.

Contact your John Deere dealer for more information on diesel fuel analysis.

DX,FUEL6 -19-14APR11-1/1

Handling and Storing Diesel Fuel

⚠ CAUTION: Reduce the risk of fire. Handle fuel carefully. DO NOT fill the fuel tank when engine is running. DO NOT smoke while you fill the fuel tank or service the fuel system.

Fill the fuel tank at the end of each day's operation to prevent water condensation and freezing during cold weather.

Keep all storage tanks as full as practicable to minimize condensation.

Ensure that all fuel tank caps and covers are installed properly to prevent moisture from entering. Monitor water content of the fuel regularly.

When using biodiesel fuel, the fuel filter may require more frequent replacement due to premature plugging.

Check engine oil level daily prior to starting engine. A rising oil level may indicate fuel dilution of the engine oil.

IMPORTANT: The fuel tank is vented through the filler cap. If a new filler cap is required, always replace it with an original vented cap.

When fuel is stored for an extended period or if there is a slow turnover of fuel, add a fuel conditioner to stabilize the fuel and prevent water condensation. Contact your fuel supplier for recommendations.

DX,FUEL4 -19-14APR11-1/1

Alternative and Synthetic Lubricants

Conditions in certain geographical areas may require lubricant recommendations different from those printed in this manual. Some John Deere brand coolants and lubricants may not be available in your location.

Synthetic lubricants may be used if they meet the performance requirements as shown in this manual.

The temperature limits and service intervals shown in this manual apply to both conventional and synthetic oils.

Re-refined base stock products may be used if the finished lubricant meets the performance requirements.

Avoid mixing different brands or types of oils. Oil manufacturers blend base stock and additives to create their oils and to meet certain specifications and performance requirements. Mixing different oils can interfere with proper functioning of these formulations and degrade lubricant performance.

Consult your authorized John Deere dealer to obtain specific information and recommendations.

AM40430.00000AA -19-03NOV08-1/1

Diesel Engine Break-In Oil

New engines are filled at the factory with either John Deere Break-In™ or John Deere Break-In Plus™ Engine Oil. During the break-in period, add John Deere Break-In™ or Break-In Plus™ Engine Oil, respectively, as needed to maintain the specified oil level.

Operate the engine under various conditions, particularly heavy loads with minimal idling, to help seat engine components properly.

If John Deere Break-In Engine Oil is used during the initial operation of a new or rebuilt engine, change the oil and filter at a maximum of 250 hours.

If John Deere Break-In Plus Engine Oil is used, change the oil and filter at a minimum of 100 hours and a maximum equal to the interval specified for John Deere Plus-50™ II or Plus-50 oil.

After engine overhaul, fill the engine with either John Deere Break-In™ or Break-In Plus™ Engine Oil.

If John Deere Break-In or Break-In Plus Engine Oil is not available, use an SAE 10W-30 viscosity grade diesel engine oil meeting one of the following and change the oil and filter at a maximum of 100 hours of operation:

- API Service Classification CE
- API Service Classification CD

*Break-In is a trademark of Deere & Company.
Break-In Plus is a trademark of Deere & Company
Plus-50 is a trademark of Deere & Company.*

- API Service Classification CC
- ACEA Oil Sequence E2
- ACEA Oil Sequence E1

IMPORTANT: Do not use Plus-50™ II, Plus-50 or engine oils meeting any of the following for the initial break-in of a new or rebuilt engine:

API CJ-4	ACEA E9
API CI-4 PLUS	ACEA E7
API CI-4	ACEA E6
API CH-4	ACEA E5
API CG-4	ACEA E4
API CF-4	ACEA E3
API CF-2	
API CF	

These oils will not allow the engine to break in properly.

John Deere Break-In Plus™ Engine Oil can be used for all John Deere diesel engines at all emission certification levels.

After the break-in period, use John Deere Plus-50™ II, John Deere Plus-50, or other diesel engine oil as recommended in this manual.

DX,ENOIL4 -19-20APR11-1/1

Diesel Engine Oil

Use oil viscosity based on the expected air temperature range during the period between oil changes.

John DeerePlus-50™ II oil is preferred.

John Deere Plus-50™ is also recommended.

Other oils may be used if they meet one or more of the following:

- John Deere Torq-Gard™
- API Service Category CJ-4
- API Service Category CI-4 PLUS
- API Service Category CI-4
- API Service Category CH-4
- API Service Category CG-4
- API Service Category CF-4
- ACEA Oil Sequence E9
- ACEA Oil Sequence E7
- ACEA Oil Sequence E6
- ACEA Oil Sequence E5
- ACEA Oil Sequence E4
- ACEA Oil Sequence E3
- ACEA Oil Sequence E2

If oils meeting API CG-4, API CF-4, or ACEA E2 are used, reduce the service interval by 50%.

Multi-viscosity diesel engine oils are preferred.

Diesel fuel quality and fuel sulfur content must comply with all existing emissions regulations for the area in which the engine operates.

*Plus-50 is a trademark of Deere & Company
Torq-Gard is a trademark of Deere & Company*

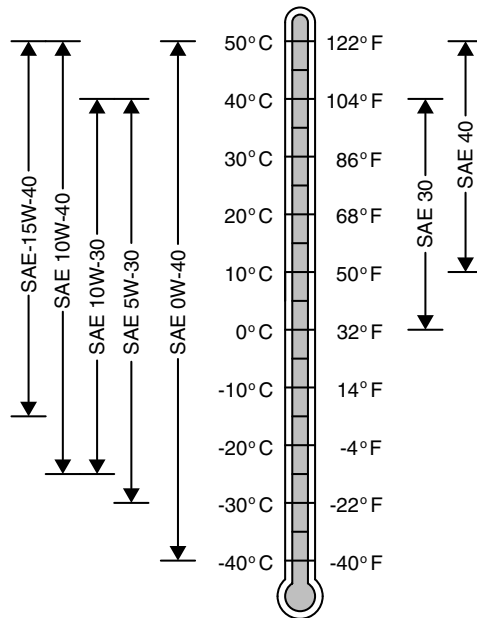

Oil Viscosities for Air Temperature Ranges

If diesel fuel with sulfur content greater than 5000 mg/kg (5000 ppm) is used, reduce the service interval by 50%.

DO NOT use diesel fuel with sulfur content greater than 10 000 mg/kg (10 000 ppm).

DX,ENOIL -19-14APR11-1/1

TS1687—UN—18JUL07

Track Rollers, Front Idler and Carrier Roller Oil

Use oil viscosity based on the expected air temperature range during the period between oil changes.

The following oils are preferred:

- John Deere GEAR LUBRICANT (SAE 80W90)

- John Deere EXTREME-GARD

The following oils are recommended:

- API Service Classification GL-5 gear oil (SAE 80W90)
- Arctic oils such as (MIL-L-10324A) may be used at temperatures below -30°C (-11°F).

TX,45,RR5122 -19-14JAN08-1/1

Transmission and Hydraulic Oil

Use oil viscosity based on the expected air temperature range during the period between oil changes.

The following oils are preferred:

Plus-50™

TORQ-GARD™

Other oils may be used if they meet one or more of the following:

API Service Classification CG-4

API Service Classification CH-4

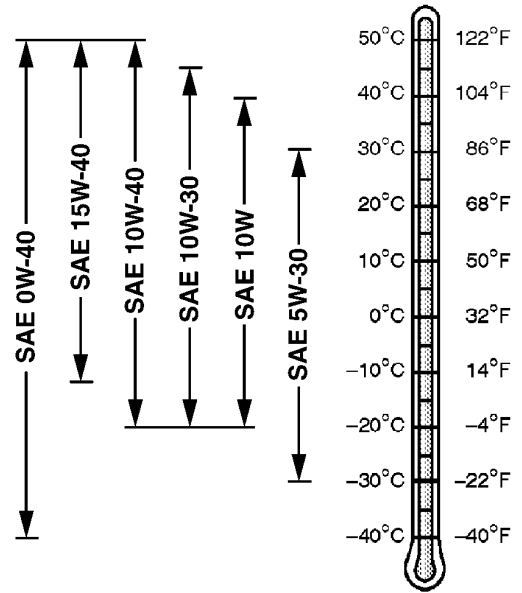

PLUS-50 is a trademark of Deere & Company
TORQ-GARD is a trademark of Deere & Company

TX03768,0000B8E -19-21SEP10-1/1

T145167—UN—14SEP01

Winch Oil

Use oil viscosity based on expected air temperature range during period between oil changes.

The following oils are preferred:

- John Deere HY-GARD®
- John Deere Low Viscosity HY-GARD®

Other oils may be used if they meet one of the following:

- John Deere Standard JDM J20C
- John Deere Standard JDM J20D

Use the following oil when a biodegradable fluid is required:

- John Deere BIO-HY-GARD™
Engine oils may be used if they meet both Caterpillar TO-2 test AND one or more of API Service Classifications CE, CD or CC.
Other oils may be used if they meet John Deere Standard JDM J20C or J20D.
Oils meeting Military Specification MIL-L-46167A may be used as arctic oils.

*HY-GARD is a trademark of Deere & Company
BIO-HY-GARD is a trademark of Deere & Company*

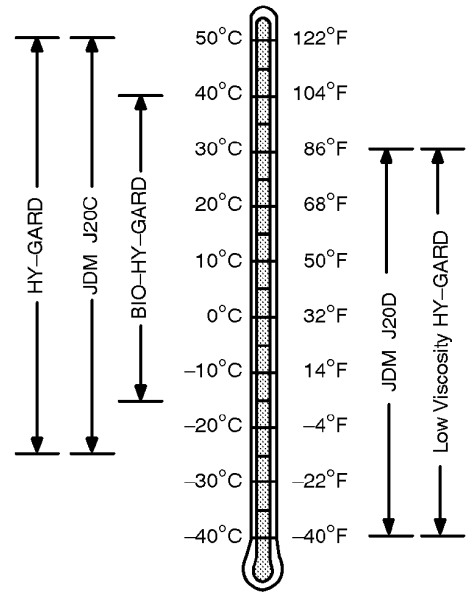

TS1660—UN—10OCT97

BT40170.0000001 -19-13JAN04-1/1

Grease

Use grease based on NLGI consistency numbers and the expected air temperature range during the service interval.

John Deere SD Polyurea Grease is preferred.

The following greases are also recommended:

- John Deere HD Lithium Complex Grease
- John Deere HD Water Resistant Grease
- John Deere GREASE-GARD™

Other greases may be used if they meet the following:

- NLGI Performance Classification GC-LB

IMPORTANT: Some types of grease thickeners are not compatible with others. Consult your grease supplier before mixing different types of grease.

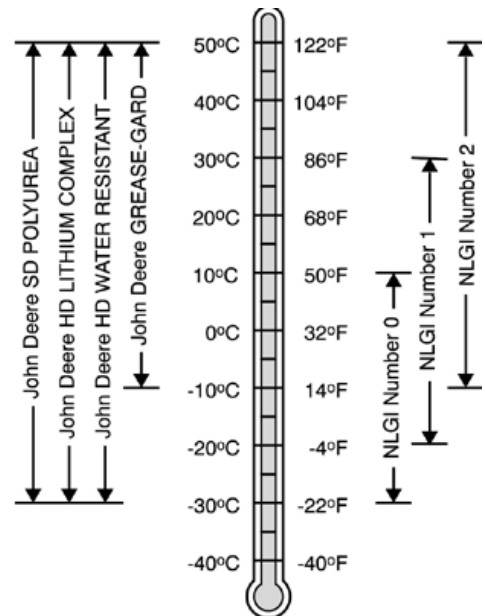

Greases for Air Temperature Ranges

GREASE-GARD is a trademark of Deere & Company

TS1673—UN—31OCT03

DX,GRE1 -19-14APR11-1/1

Heavy Duty Diesel Engine Coolant

The engine cooling system is filled to provide year-round protection against corrosion and cylinder liner pitting, and winter freeze protection to -37°C (-34°F). If protection at lower temperatures is required, consult your John Deere dealer for recommendations.

The following engine coolants are preferred:

- John Deere COOL-GARD™ II Premix
- John Deere COOL-GARD II PG Premix

Use John Deere COOL-GARD II PG Premix when a non-toxic coolant formulation is required.

Additional Recommended Coolants

The following engine coolant is also recommended:

- John Deere COOL-GARD II Concentrate in a 40–60% mixture of concentrate with quality water.

John Deere COOL-GARD II Premix, COOL-GARD II PG Premix, and COOL-GARD II Concentrate coolants do not require use of supplemental coolant additives.

Other Coolants

John Deere COOL-GARD II and COOL-GARD II PG coolants might not be available in the geographical area where service is performed.

If these coolants are unavailable, use a coolant concentrate or prediluted coolant intended for use with heavy duty diesel engines and with a minimum of the following chemical and physical properties:

COOL-GARD is a trademark of Deere & Company

- Is formulated with a quality nitrite-free additive package.
- Provides cylinder liner cavitation protection according to either the John Deere Cavitation Test Method or a fleet study run at or above 60% load capacity
- Protects the cooling system metals (cast iron, aluminum alloys, and copper alloys such as brass) from corrosion

The additive package must be part of one of the following coolant mixtures:

- ethylene glycol or propylene glycol base prediluted (40–60%) heavy duty coolant
- ethylene glycol or propylene glycol base heavy duty coolant concentrate in a 40–60% mixture of concentrate with quality water

Water Quality

Water quality is important to the performance of the cooling system. Distilled, deionized, or demineralized water is recommended for mixing with ethylene glycol and propylene glycol base engine coolant concentrate.

IMPORTANT: Do not use cooling system sealing additives or antifreeze that contains sealing additives.

Do not mix ethylene glycol and propylene glycol base coolants.

Do not use coolants that contain nitrites.

DX,COOL3 -19-14APR11-1/1

Maintenance—Periodic Maintenance

Service Your Machine at Specified Intervals

Lubricate and make service checks and adjustments at intervals shown on the periodic maintenance chart and on the following pages.

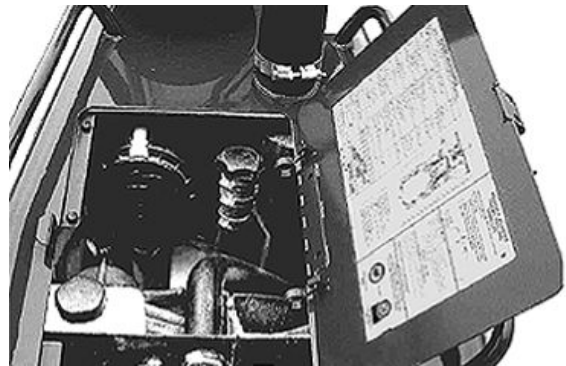

450H Shown

03T,50,M75 -19-24APR99-1/1

T117480—UN—20OCT98

Check the Hour Meter Regularly

Use the hour meter (A) to determine when your machine needs periodic maintenance.

Intervals on the periodic maintenance chart are for operating in normal conditions. If you operate your machine in difficult conditions, you should service it at SHORTER INTERVALS.

A—Hour Meter

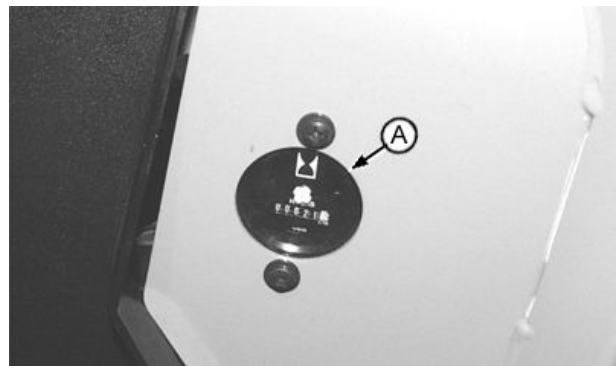

Earlier Machines

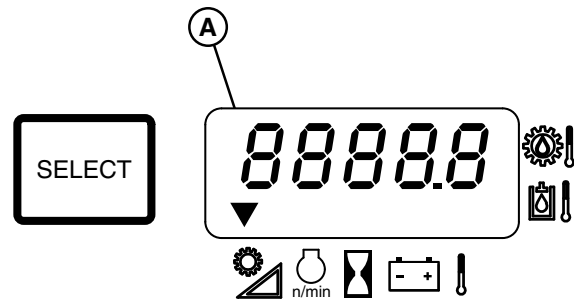

Later Machines

HG31779,00000C6 -19-09AUG02-1/1

T127205B—UN—07JAN00

T157564—UN—19JUL02

Prepare Machine for Maintenance

1. Park machine on a level surface.
2. Turn key switch to "Off" to stop engine. (If maintenance must be performed with engine running, do not leave machine unattended.)

3. Attach a "Do Not Operate" tag on the park lock lever.

CED,OUO1032,1025 -19-21OCT98-1/1

Fuel Tank

CAUTION: Handle fuel carefully. If the engine is hot or running, do not fill the fuel tank. Do not smoke while you fill fuel tank or work on fuel system.



To avoid condensation, fill the fuel tank at the end of each day's operation.

Specification

450H Fuel Tank—Capacity.....	136 L (36 gal)
550H and 650H Fuel Tank—Capacity.....	178 L (47 gal)

TS185—UN—23AUG88

CED,OUO1032,772 -19-24APR99-1/1

Maintenance and Repair Record Keeping System

The checklist in this section summarizes scheduled maintenance, and parts and oil required at each maintenance interval.

Use the checklist to:

- Remind you to perform machine maintenance at specified intervals to minimize downtime.
- Calculate cost of machine operation and ownership allowing you to make better job estimates.
- Place yourself in a stronger position at trade-in time.
- Satisfy your SECURE contract requirements.

As maintenance is performed, check off each item on the list and record date and hour meter reading.

Do not tear out or mark on checklist in this section; keep it to make extra copies.



MAINTENANCE AND REPAIR RECORD KEEPING SYSTEM FOR JOHN DEERE MACHINE OWNERS

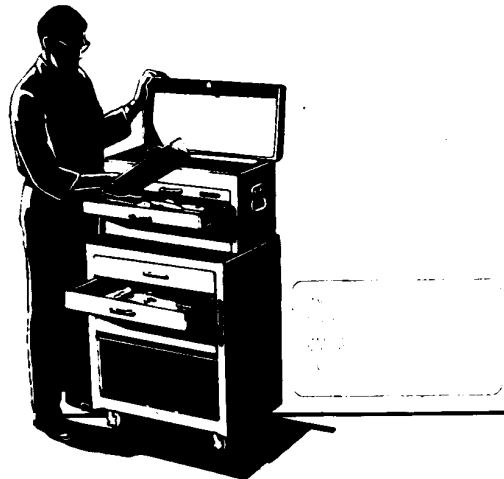

T7511CO—UN—27JUN81

TX,50,FF2898 -19-14JAN08-1/1

Oilscan Plus®, Coolscan Plus®, Dieselscan and 3-Way Coolant Test Kit



Oilscan Plus®



3-Way Coolant Test Kit

Oilscan Plus, Coolscan Plus, Dieselscan and 3-Way Coolant Test Kits are John Deere fluid sampling products to help you monitor machine performance and system condition. The objective of a fluid sampling program is to insure machine availability when you need it and to reduce repair costs by identifying potential problems before they become critical.

Oil and coolant samples should be taken from each system on a periodic basis, usually prior to a filter and/or

*Oilscan Plus is a registered trademark of Deere & Company
Coolscan Plus is a registered trademark of Deere & Company*

fluid change interval. Certain systems require more frequent sampling. Consult your John Deere dealer on a maintenance program for your specific application. Your dealer has the sampling products and expertise to assist you in lowering your overall operating costs through fluid sampling.

Service Intervals

Model:	□ 450H,550H,650H	Customer:	
PIN/Serial Number:	Delivery Date:	Hour Meter Reading:	
SERVICE INTERVALS			
Service your machine at intervals shown on this chart. Also, perform service on items at multiples of the original requirement. For example, at 500 hours also service those items (if applicable) listed under 250 hours, 100 hours, 50 hours and 10 hours or daily.			
AS REQUIRED			
• Inspect belts		• Check ball and socket joint	
• Check air cleaner restriction indicator and replace element if necessary		• Clean undercarriage of debris around cylinders and tracks	
• Check and adjust track sag			
EVERY 10 HOURS OR DAILY			
• Check coolant level at recovery tank		• Check transmission oil level	
• Check engine oil level		• Check and clean dust unloader valve	
• Drain sediment from water separator bowl on primary fuel filter		• Grease dozer linkage and blade socket	
• Check hydraulic system oil level		• Check winch oil (if equipped)	
REQUIRED PARTS			
Insure machine performance and availability; use only genuine John Deere parts. Verify part numbers are current and that any associated parts are also on-hand, i.e., filter O-rings.			

Description	Part Number	ASI	250 Hours	500 Hours	1000 Hours	1500 Hours	2000 Hours
Engine Oil Filter (Earlier Machines)	RE59754	1	1	1	1	1	1
Engine Oil Filter (Later Machines)	RE504836	1		1	1	1	1
<i>NOTE: See Periodic Maintenance Chart on machine for correct service interval.</i>							
Primary Fuel Filter (Earlier Machines)	RE509208			1	1	1	1
Primary Fuel Filter (Later Machines)	RE517181			1	1	1	1
Final Fuel Filter (Earlier Machines)	RE60021			1	1	1	1
Final Fuel Filter (Later Machines)	RE509031			1	1	1	1
Cold Weather Fuel Filter (Optional)	RE51677			1	1	1	1
Hydraulic System Oil Filter	T175002						1
Transmission Oil Filter:	T175002						1
Engine Rocker Arm Cover Gasket	R123542						1
Primary Air Cleaner Element—450H	AT171853				1		1
Primary Air Cleaner Element—550H & 650H	AT175344				1		1
Secondary Air Cleaner Element—550H & 650H	AT175345				1		1
Secondary Air Cleaner Element—450H	AT171854				1		1
Dust Unloader Valve	R48568				1		1
Winch Hydraulic Reservoir Breather Filter (if equipped)	AT101565				1		1
Winch Oil Filter (if equipped)	AT219961			1	1	1	1

Model:	□ 450H,550H,650H	Customer:				
PIN/Serial Number:	Delivery Date:	Hour Meter Reading:				
Description	Part Number	ASI	250 Hours	500 Hours	1000 Hours	2000 Hours
PLUS-50® Engine Oil (Earlier Machines)	TY6389 (quart)	14 L (3.75 gal)	14 L (3.75 gal)	14 L (3.75 gal)	14 L (3.75 gal)	14 L (3.75 gal)
PLUS-50® Engine Oil (Later Machines)	TY6389 (quart)	14 L (3.75 gal)		14 L (3.75 gal)	14 L (3.75 gal)	14 L (3.75 gal)
<i>NOTE: See Periodic Maintenance Chart on machine for correct service interval.</i>						
Transmission Oil	TY6389					53 L (14 gal)
Hydraulic Oil	TY6389					32 L (8.5 gal)
Final Drives Oil	TY6354				6.6 L (1.75 gal)	6.6 L (1.75 gal)

Continued on next page

MD04263,0000084 -19-05DEC08-1/2

Maintenance—Periodic Maintenance

Winch Oil (If Equipped)	TY6354				38 L (10 gal)	38 L (10 gal)
OILSCAN ® Kits						
Diesel Engine Oil	AT317904		1	1	1	1
Transmission Oil	AT303189		1	1	1	1
Final Drive Oil	AT303189		2	2	2	2
Hydraulic Oil	AT303189		1	1	1	1
DIESELSCAN	AT180344		1	1	1	1
Coolant Conditioner	TY16004	As needed				
Coolscan Plus® Kit (Ten samples per kit)	AT183016			1	1	1
Dieselscan Kit (Six samples per kit)	AT180344		1	1	1	1

Model:	<input type="checkbox"/> 450H,550H,650H		Customer:
PIN/Serial Number:	Delivery Date:	Hour Meter Reading:	
OIL SAMPLING			
Maintenance recommendations supplied by OILSCAN ® will be provided based upon the oil analysis and operating information you supply. Regular oil sampling will extend the operational life of your machine's systems.			
After 100 Hours			
<input type="checkbox"/> Change engine break-in oil and filter element			
Comments:			
Date:	Hour Meter Reading:	Maintenance Performed By:	
Every 250 Hours			
<input type="checkbox"/> Check final drives oil level		<input type="checkbox"/> Take transmission oil sample	
<input type="checkbox"/> Change engine oil and filter element (Earlier Machines)		<input type="checkbox"/> Take hydraulic oil sample	
<input type="checkbox"/> Take final drives oil sample		<input type="checkbox"/> Take engine oil sample	
<input type="checkbox"/> Take diesel fuel sample			
Comments:			
Date:	Hour Meter Reading:	Maintenance Performed By:	
Every 500 Hours			
<input type="checkbox"/> Change engine oil and filter element (Later Machines)		<input type="checkbox"/> Check battery water level, clean and tighten terminals	
<input type="checkbox"/> Check air intake hoses		<input type="checkbox"/> Check coolant conditioner in radiator	
<input type="checkbox"/> Replace final fuel filter		<input type="checkbox"/> Change winch oil filter (if equipped)	
<input type="checkbox"/> Replace primary fuel filter		<input type="checkbox"/> Take engine coolant sample	
Comments:			
Date:	Hour Meter Reading:	Maintenance Performed By:	
Every 1000 Hours			
<input type="checkbox"/> Clean engine crankcase vent tube		<input type="checkbox"/> Replace air cleaner elements and unloader valve	
<input type="checkbox"/> Change final drive oil		<input type="checkbox"/> Change winch oil and filter (if equipped)	
Comments:			
Date:	Hour Meter Reading:	Maintenance Performed By:	
Every 2000 Hours			
<input type="checkbox"/> Check and adjust engine valve lash		<input type="checkbox"/> Change transmission system oil and filter	
<input type="checkbox"/> Change hydraulic system oil and filter			
Comments:			
Date:	Hour Meter Reading:	Maintenance Performed By:	

PLUS-50 is a registered trademark of Deere & Company
 OILSCAN is a registered trademark of Deere & Company
 Coolscan Plus is a registered trademark of Deere & Company

MD04263,0000084 -19-05DEC08-2/2

Maintenance—As Required

Inspect Serpentine Belt

1. Check belt regularly for wear, especially for cracks at the bottom of grooves and for frayed edges.
2. If necessary, replace belt.
3. Place pipe wrench on top side of adjuster assembly (A). Pull pipe wrench handle down and pull tension adjuster assembly away from belt, releasing belt tension.
4. Hold tension adjuster assembly away from belt while removing old belt and installing new belt.
5. Slowly release pipe wrench clockwise to place tension adjuster assembly against new belt. Tension is automatically adjusted.

A—Adjuster Assembly

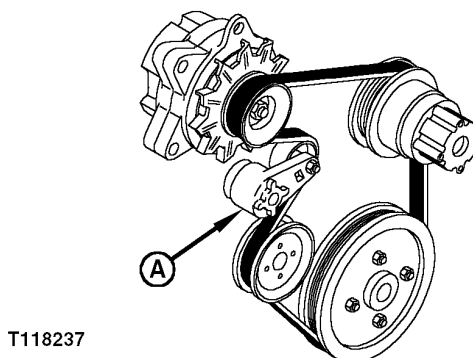

Without Air Conditioning

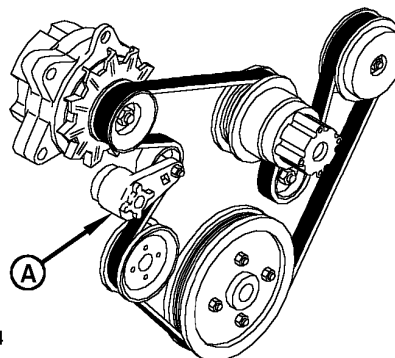

With Air Conditioning

CED,OUO1032,1134 -19-14JAN08-1/1

T118237—UN—01DEC98

T118314—UN—01DEC98

Check Track Sag

Maintaining the proper amount of track sag is the single most important adjustment the operator can make. Tight tracks can reduce the amount of wear life by more than 50% over tracks which are properly maintained at 51 mm (2 in.) of sag. Tight tracks increase the loading on the undercarriage components and accelerate the wear rate. Track sag should be adjusted as the soil conditions change. See Track Sag General Information. (Section 4-1.)

1. Position track so that a track pin is centered over the carrier roller.
2. Measure sag of track between carrier roller and front idler from the top of track grouser (A) to a straight edge (B). If adjustment is needed, see Adjust Track Sag in this section.

Specification

Track Sag—Distance..... 51 ± 6 mm (2 ± 0.250 in.)

A—Grouser

B—Straight-Edge

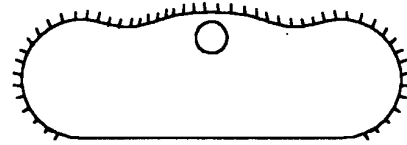
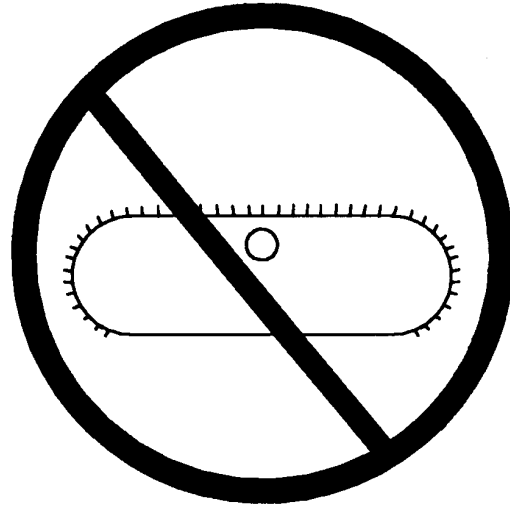

Proper Track Sag

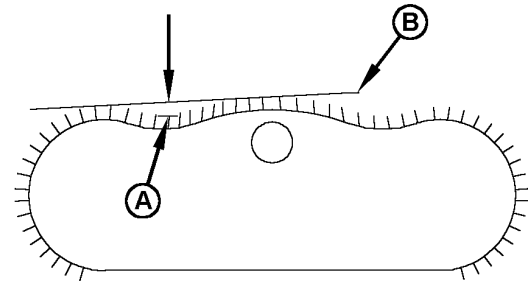

T120959

Measure Track Sag

TX,55,RR2718 -19-23MAY12-1/1

T7800AH—UN—31JUL92

T120959—UN—20APR99

Adjust Track Sag

⚠ CAUTION: Grease for track adjuster cylinder is under high pressure. Never remove grease fitting to release the grease. If grease does not escape immediately from vent hole when fitting has been loosened, slowly drive unit in forward and reverse until grease escapes. **DO NOT** disassemble parts unless you know the correct procedure and have correct tools. (See your authorized dealer.)

If an accident occurs, see a doctor immediately. Any fluid injected into the skin must be surgically removed within a few hours or gangrene may result. Doctors unfamiliar with this type of injury may call the Deere & Company Medical Department in Moline, Illinois, or other knowledgeable medical source.

Decrease Track Sag:

1. Remove access plug (A).

A—Access Plug

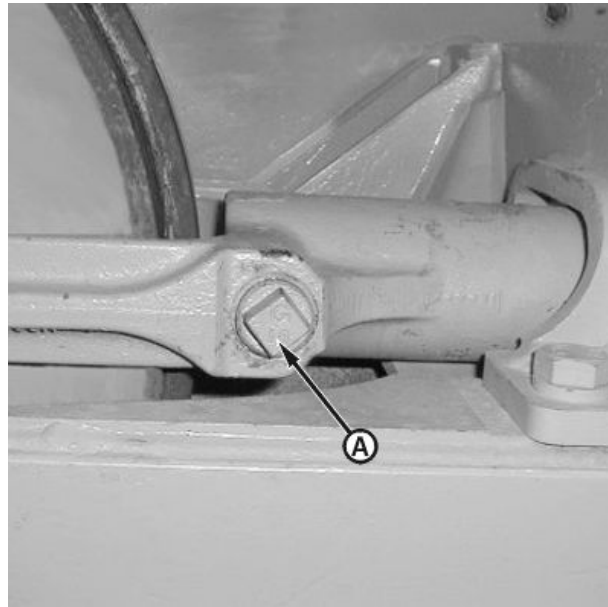

Remove Plug

T118011B—UN—11NOV98

Continued on next page

CED,OUO1032,1028 -19-12JAN12-1/2

NOTE: Grease gun with 52 200 kPa (552 bar) (8000 psi) minimum capacity is required.

2. Apply grease to grease fitting (B) using a 55,200 kPa (550 bar) (8000 psi) capacity grease gun.
3. After adding grease, move machine forward and reverse to allow track adjuster cylinder to fully adjust.
4. Check track sag again. Repeat procedure if necessary.
5. Install plug.

Increase Track Sag:

1. Remove access plug.
2. Loosen fitting (C) (not grease fitting), one to two turns counterclockwise to release grease through vent hole (D).
3. Tighten fitting.
4. Move machine forward and reverse to allow track adjuster cylinder to fully adjust.
5. Check track sag again. Repeat procedure if necessary.
6. Install plug.

B—Grease Fitting
C—Fitting

D—Vent Hole

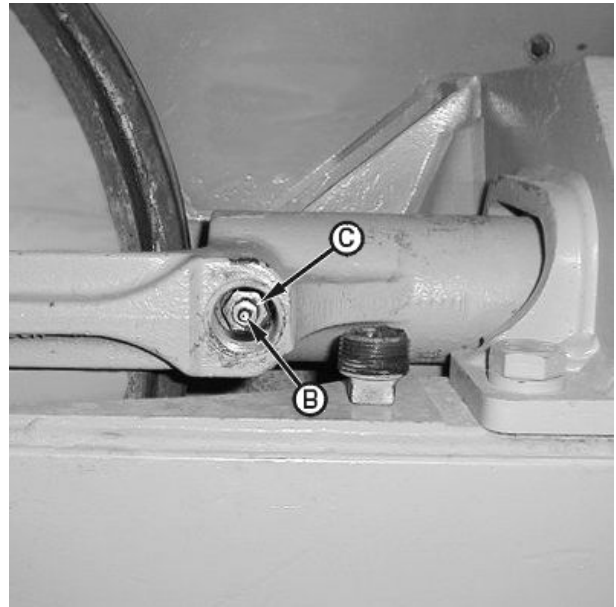

Grease Fitting

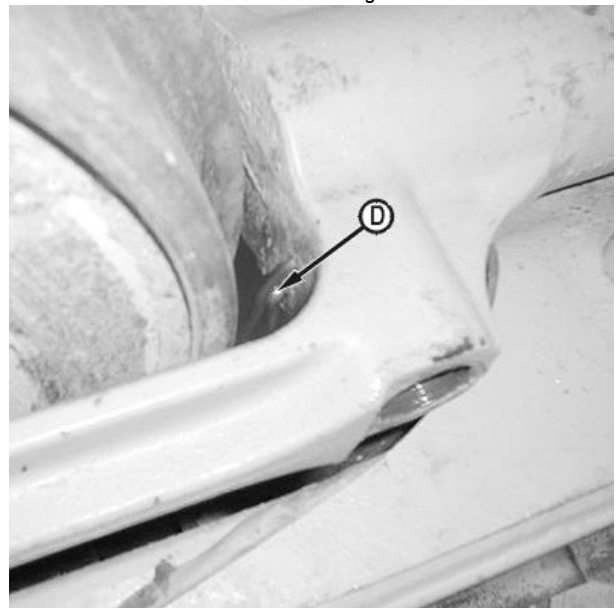

Vent Hole

T118012B—UN—01DEC98

T118013B—UN—11NOV98

CED,OUO1032,1028 -19-12JAN12-2/2

Operating in Mud or Snow

IMPORTANT: Prevent machine damage to cylinders and tracks due to debris. If operating crawler in deep mud or snow, clean the undercarriage around the machine (A) daily. Remove debris and mud from around the cylinders and tracks to prevent machine damage.

Use appropriate tools to remove mud and debris, being extra aware of material that may freeze around cylinders.

A—Undercarriage

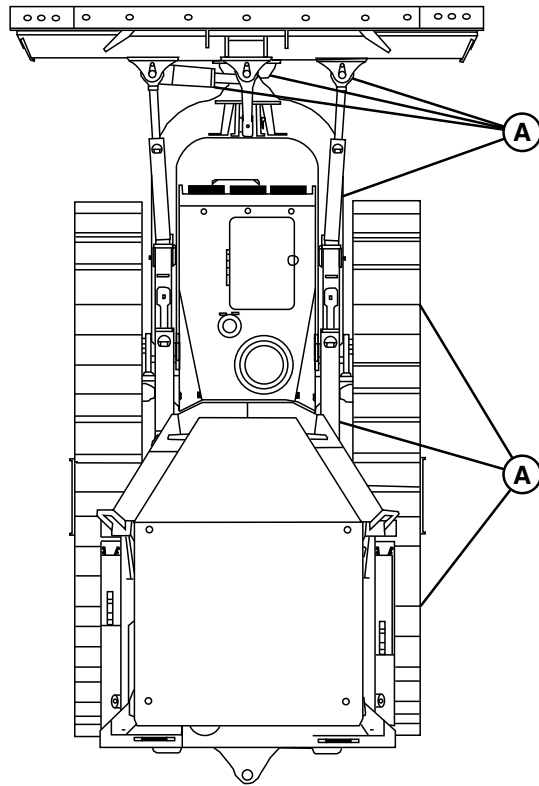

T151180 —UN—08FEB02

HG31779,000008D -19-14JAN08-1/1

Check Blade Ball and Socket Joint

Check ball and socket joint (1) for wear or excessive play.

If there is excessive play or wear, see C-Frame Ball / Blade Socket Joint Adjustment. (Section 4-1.)

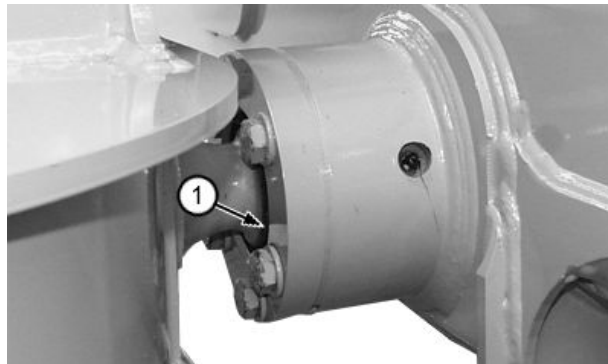

T158710B —UN—25AUG02

HG31779,00000C8 -19-14JAN08-1/1

Maintenance—Every 10 Hours or Daily

Check Coolant Level

⚠ CAUTION: Prevent injury from hot spraying coolant. Do not remove radiator filler cap unless engine is cool. Loosen cap slowly to the stop. Release all pressure before removing cap.

1. With the engine cold, coolant level must be between HOT and COLD marks on recovery tank (A).
2. If coolant is below the COLD mark, add coolant to the recovery tank.
3. If there is no coolant in the recovery tank, add coolant to the recovery tank and the radiator.

A—Recovery Tank

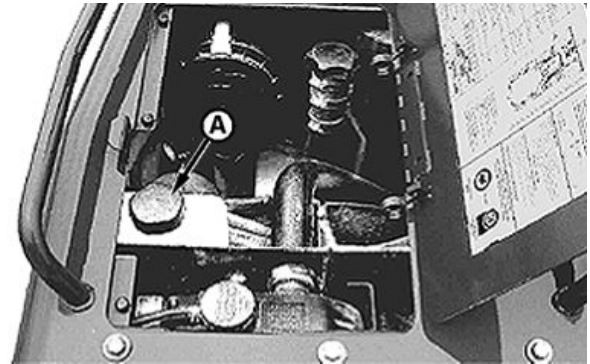
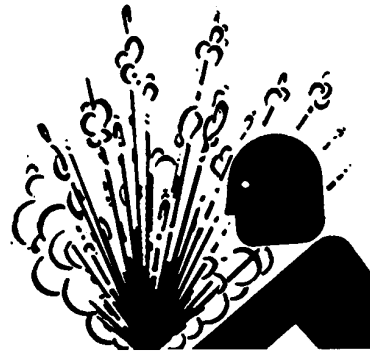

450H Shown

CED,OUO1032,774 -19-07OCT98-1/1

T6464AV—UN—18OCT88

T117479—UN—20OCT98

Check Engine Oil Level

IMPORTANT: Do not run engine when oil level is below the ADD mark.

The most accurate oil level reading is obtained when the engine is cold before starting the engine for the day's operation.

1. Park machine on a level surface.
2. Engage the park lock lever in the locked position.
3. Make sure dipstick is fully seated.
4. Remove dipstick (A) to check oil level.

BEFORE THE ENGINE IS STARTED: The engine is full when oil level is in the cross-hatch area (C). It is acceptable to run the engine when the oil level is above the ADD mark.

AFTER THE ENGINE HAS BEEN RUN: Allow the oil to drain into the oil pan for 10 minutes before checking the oil level. Ten minutes after shutdown the engine oil level must be above the ADD mark.

5. If necessary, remove the filler cap (B) to add oil. See [Diesel Engine Oil](#). (Section 3-1.)
6. Check oil on dipstick again.

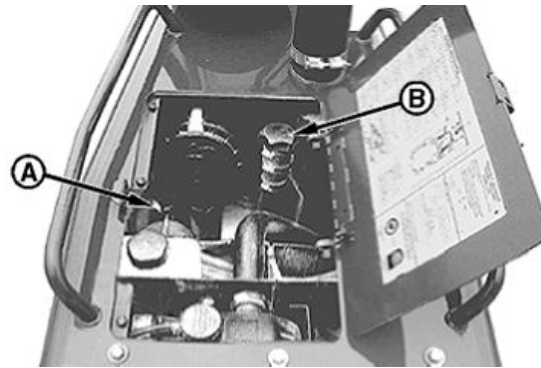

450H Shown

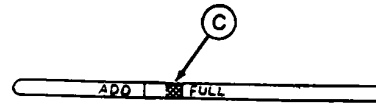

A—Dipstick
B—Filler Cap

C—Dipstick Cross-Hatch Area

03T.60,K96 -19-24APR99-1/1

T118421—UN—12NOV98

RG5421—UN—15DEC88

Drain Water Separator Sediment

1. Loosen drain valve (A). Drain liquid for several seconds or until water and sediment is removed.
2. Tighten drain valve.
3. Bleed fuel system. See [Replace Primary Fuel Filter](#). (Section 3-7.)

A—Drain Valve



HG31779,00000CF -19-03SEP02-1/1

T118231C—UN—25NOV98

Check Hydraulic Oil Level

IMPORTANT: DO NOT operate engine without oil in reservoir.

1. Park machine on level surface and lower all equipment to ground.
2. Turn key switch to “Off”.
3. The hydraulic oil reservoir, fill port and sight glass are located on the right side of machine. Oil must be between ADD and FULL marks in sight glass tube (A).
4. If necessary, remove cap and add oil to fill port (B). See [Transmission and Hydraulic Oil](#). (Section 3-1.)
5. Check O-ring on cap before installing.

A—Sight Glass Tube

B—Fill Port



T117862B —UN—26OCT98

T117860B —UN—26OCT98

CED.OUO1032,1029 -19-21OCT98-1/1

Check Transmission Oil Level

1. Park machine on level ground.
2. Turn key switch to “Off”.
3. The transmission oil reservoir, fill port and sight glass are located on the left side of the machine. Oil must be within the ADD mark and FULL mark on sight glass tube (A).
4. If necessary, add oil to fill port (B). See [Transmission and Hydraulic Oil](#). (Section 3-1.)
5. Check O-ring on cap before installing.

A—Sight Glass Tube

B—Fill Port

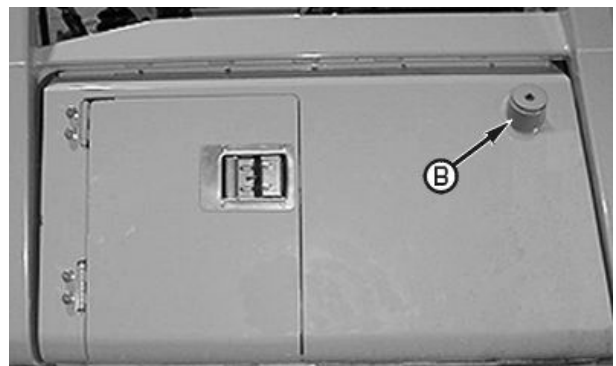

T117861B —UN—26OCT98

T117862B —UN—26OCT98

03T,60,K97 -19-20DEC94-1/1

Clean Dust Unloader Valve

IMPORTANT: A missing, damaged or hardened dust unloader valve will make engine air screen ineffective, causing very short element life. Valve should suck closed above 1/3 engine speed.

It is not necessary to remove engine side shield to clean dust unloader valve. The valve can be accessed through service panel in hood.

Squeeze dust valve (A) to remove dust from air cleaner.

If operating in high dust conditions, clean dust valve every couple of hours of operation to release dust.

A—Dust Valve

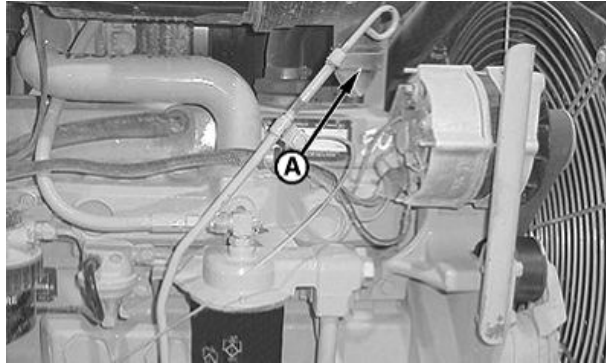

Hood and Side Shield Removed for Clarity of Photo

T117894B—UN—03NOV98

CED,OUO1032,1032 -19-14JAN08-1/1

Lubricate Dozer Linkage and Blade Socket

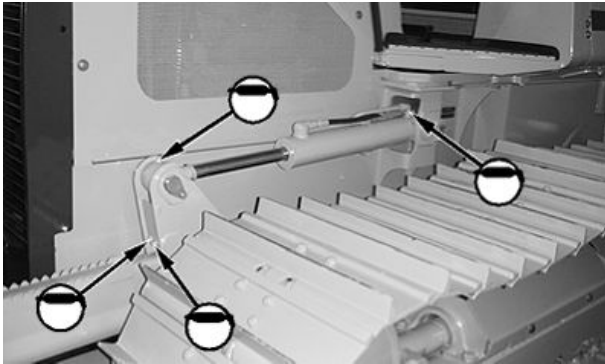

Eight Points

T118192B—UN—12NOV98

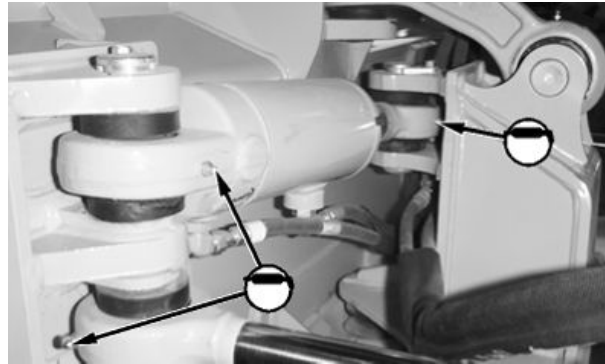

Four Points

T118190B—UN—12NOV98

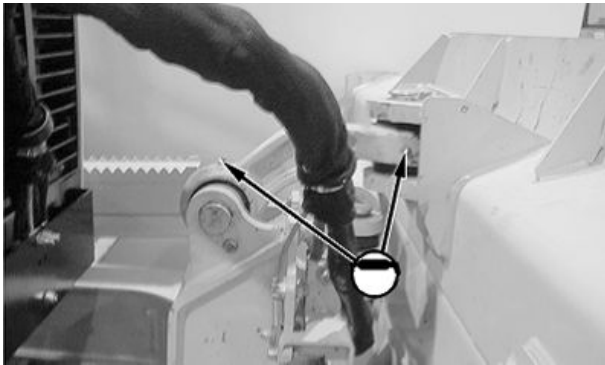

Two Points

T118191B—UN—12NOV98

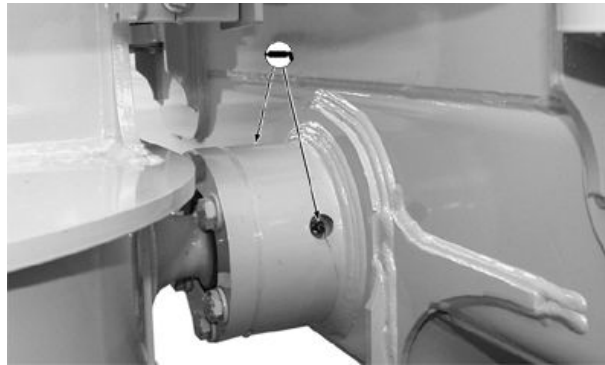

Two Points

T158711B—UN—28AUG02

Using a grease gun, lubricate each grease fitting until grease escapes at joints. See *Grease*. (Section 3-1.)

CED,OUO1032,1123 -19-02NOV98-1/1

Check Winch Oil—If Equipped

1. Park machine on level surface and lower all equipment to ground.
2. With engine running, move engine speed lever to fast idle. Make sure transmission control lever is in neutral position (N).
3. Loosen winch oil dipstick (1) and remove.
4. Check dipstick.
5. Oil must be between ADD and FULL marks on dipstick.
6. If necessary, add oil. See Final Drive and Winch Oil. (Section 3-1.)

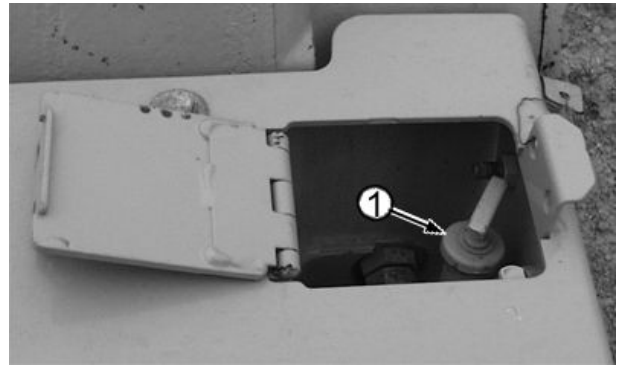

Winch Oil Dipstick

1—Winch Oil Dipstick

CEB,OUO1032,1177 -19-24JAN13-1/1

T133718B—UN—07SEP00

Maintenance—After 100 Hours

Change Engine Break-In Oil and Filter

1. Run engine to warm oil. Stop engine.
2. Remove cap screws and remove oil pan access cover (located below engine).
3. Remove drain plug or open drain valve, if equipped, and allow oil to drain into a container. Dispose of waste oil properly.
4. Install drain plug.
5. Remove oil filter (A).
6. Apply thin film of oil to gasket of new filter.
7. Install new filter. Turn filter clockwise by hand until gasket touches mounting surface.
8. Tighten 1/2 turn more.
9. Fill engine with oil. See Diesel Engine Oil. (Section 3-1.).

Specification

Engine Oil (Including
Filter)—Capacity..... 14 L (15 qt) Approximate



T117875B—UN—03NOV98

A—Oil Filter

10. Run engine for 2 minutes and then stop engine. Check for leaks around filter and drain plug. Tighten enough only to stop leaks.
11. Check oil level.

HG31779,000008C -19-28MAY02-1/1

Maintenance—Every 250 Hours

Drain Final Fuel Filter Sediment

1. Loosen drain valve (A). Drain liquid for several seconds or until water and sediment is removed.
2. Tighten drain valve.
3. Bleed fuel system. See Replace Final Fuel Filter. (Section 3-7.)

A—Drain Valve

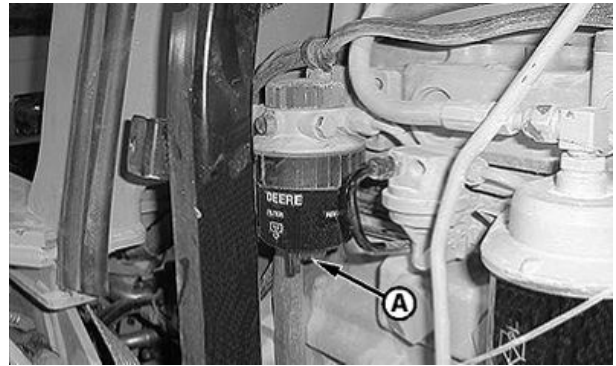

T117912B—UN—02NOV98

CED,OUO1032,1173 -19-03SEP02-1/1

Check Final Drives Oil Level

1. Park machine on a level surface and turn engine off.
2. Remove oil level and filler plug (A). Oil MUST be within 13 mm (0.5 in.) of bottom of filler hole.

IMPORTANT: Avoid overheating and damage to components. Do not overfill final drives.

3. Add oil if needed. See Final Drive and Winch Oil. (Section 3-1.)
4. Install plug.

A—Filler Plug

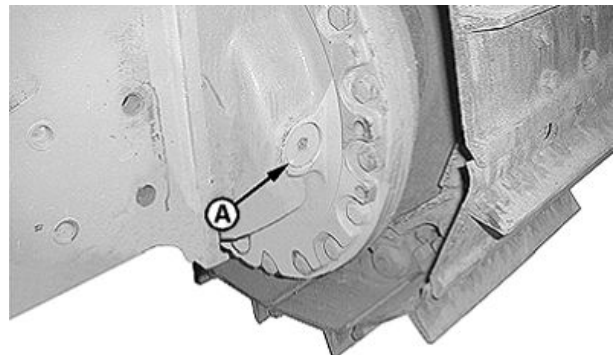

Right Side Shown

T117889B—UN—03NOV98

CED,OUO1032,1034 -19-05FEB13-1/1

Change Engine Oil and Filter (450H, 550H Earlier Machines and All 650H Machines)

1. Run engine to warm oil. Stop engine.
2. Remove cap screws and remove oil pan access cover (located below engine).
3. Remove drain plug or open drain valve, if equipped, and allow oil to drain into a container. Dispose of waste oil properly.
4. Install drain plug.
5. Remove oil filter (A).
6. Apply thin film of oil to gasket of new filter.
7. Install new filter. Turn filter clockwise by hand until gasket touches mounting surface.
8. Tighten 1/2 turn more.
9. Fill engine with oil. See Diesel Engine Oil. (Section 3-1.)

Specification

Engine Oil (Including Filter)—Capacity.....14 L (15 qt) Approximate

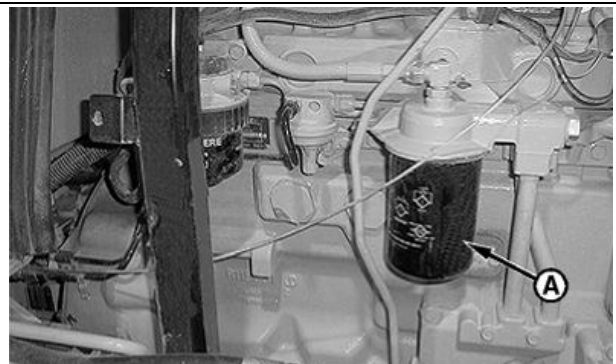

A—Oil Filter

10. Run engine for 2 minutes and then stop engine. Check for leaks around filter and drain plug. Tighten enough only to stop leaks.

11. Check oil level.

T117875B—UN—03NOV98

HG31779,00000F8 -19-11SEP02-1/1

Maintenance—Every 500 Hours

Change Engine Oil and Filter (450H, 550H Later Machines)

1. Run engine to warm oil. Stop engine.
2. Remove cap screws and remove oil pan access cover (located below engine).
3. Remove drain plug or open drain valve, if equipped, and allow oil to drain into a container. Dispose of waste oil properly.
4. Install drain plug.
5. Remove oil filter (A).
6. Apply thin film of oil to gasket of new filter.
7. Install new filter. Turn filter clockwise by hand until gasket touches mounting surface.
8. Tighten 1/2 turn more.
9. Fill engine with oil. See Diesel Engine Oil. (Section 3-1.)

Specification

Engine Oil (Including Filter)—Capacity..... 14 L (15 qt) Approximate



T117875B—UN—03NOV98

A—Oil Filter

10. Run engine for 2 minutes and then stop engine. Check for leaks around filter and drain plug. Tighten enough only to stop leaks.
11. Check oil level.

HG31779,00000F7 -19-11SEP02-1/1

Check Air Intake Hose

1. Check hose (A) for cracks.
2. Check for loose hose clamps.
3. Replace damaged or missing parts.

A—Hose

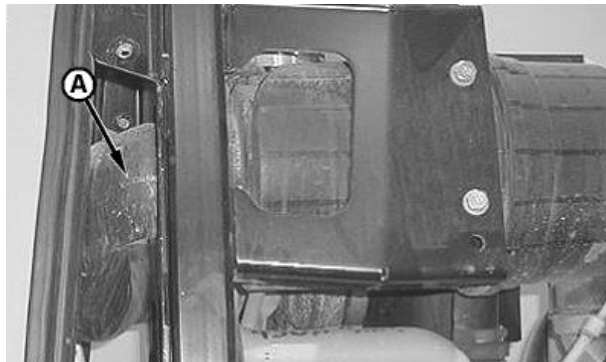

T118663B—UN—02DEC98

Turbocharged Engine Shown

03T,80,K91 -19-05FEB13-1/1

Replace Final Fuel Filter

1. Turn retaining ring (A) counterclockwise and remove filter element (B). Allow sediment to drain into a container.

NOTE: Dispose of waste properly.

2. Remove fuel drain knob (C) from filter element and install on new filter.
3. Clean filter base (D).

NOTE: Do not attempt to turn filter element into base.

4. Install new fuel element by aligning vertical locators (F) into slots (E) on filter base. Push filter element up firmly until filter snaps against base.
5. Turn retaining ring clockwise into filter base until retaining ring clicks tightly into place.
6. Loosen bleed screw (G) by turning knob counterclockwise.
7. Operate primer lever (H) until fuel flow from bleed screw is free of air bubbles.

NOTE: If there is no fuel flow, push primer lever up and turn crankshaft using start motor to reposition camshaft. Repeat step 6.

8. Tighten bleed screw.
9. Push primer lever up as far as possible.

A—Retaining Ring
B—Filter
C—Drain Knob
D—Filter Base

E—Slots
F—Vertical Locators
G—Bleed Screw
H—Primer Lever

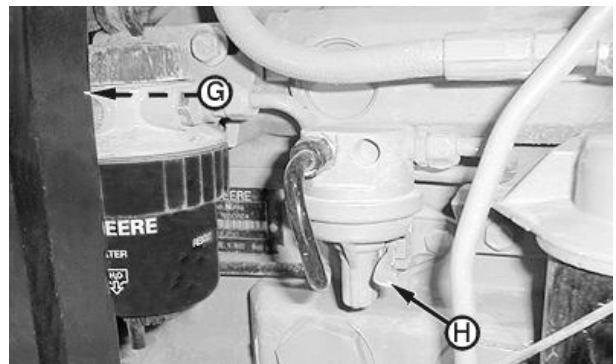
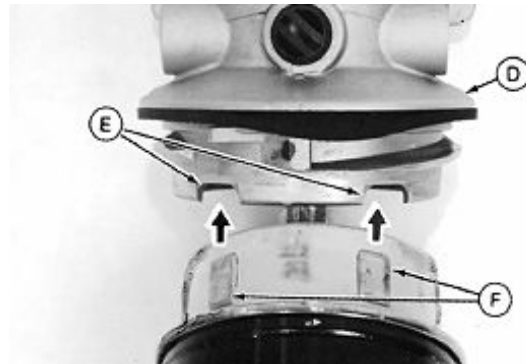
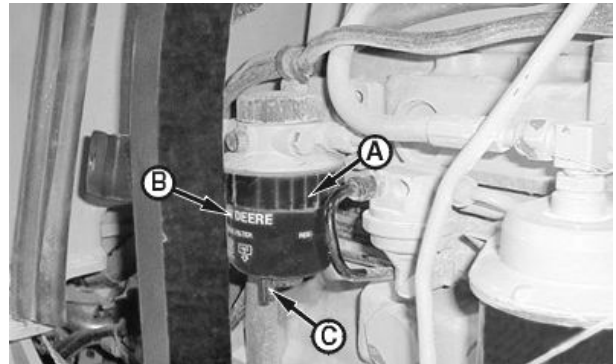

T117912C—UN—11NOV98

T7896AJ—UN—25NOV92

T118083B—UN—11NOV98

CED.OU01032,1124 -19-28AUG02-1/1

Replace Primary Fuel Filter

1. Thoroughly clean primary fuel filter and water separator assembly and surrounding area.
2. Connect a drain line (A) to filter drain adapters and drain all fuel from filters.
3. Firmly grasp the retaining ring and rotate it counterclockwise 1/4 turn. Remove ring with filter element (B).
4. Inspect filter mounting base for cleanliness. Clean as required.
5. Remove water separator bowl (C). Drain and clean separator bowl. Dry with compressed air.
6. Install water separator bowl onto new filter element. Tighten securely.

NOTE: The fuel filter must be indexed properly and the key on canister must be oriented in slot of mounting base for correct installation.

7. Thoroughly inspect filter base seal ring. Replace as needed.
8. Install new filter element onto mounting base and position element using a slight rocking motion. Be sure element is properly indexed on mounting base.

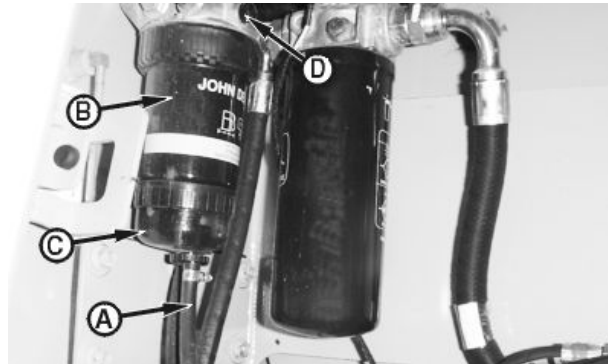

A—Drain Line
B—Filter Element
C—Separator Bowl
D—Air Bleed Vent Screw

9. Install retaining ring onto mounting base and tighten about 1/3 turn until ring “snaps” into the detent. DO NOT overtighten the retaining ring.
10. Open air bleed vent screw (D) two full turns by hand.

CED,OUO1032,1135 -19-04NOV98-1/2

T118016B—UN—11NOV98

11. Pump the hand primer (C) on fuel filter until a noticeable amount of fuel and air comes out of vent opening. Continue pumping and close vent screw when fuel starts to flow.
12. Pump the hand primer several times until resistance is felt. Continue pumping and open air bleed vent screw again.
13. Close air bleed vent screw and pump the hand primer several times until resistance is felt again.

C—Hand Primer



CED,OUO1032,1135 -19-04NOV98-2/2

T118231B—UN—11NOV98

Check Coolant Conditioner in Radiator

CAUTION: Explosive release of fluids from pressurized cooling system can cause serious burns.

Remove filler cap only when engine is cold or when cool enough to touch with bare hands. Slowly loosen cap to first stop to relieve pressure before removing completely.

IMPORTANT: John Deere Liquid Coolant Conditioner does not protect against freezing. Coolant conditioner prevents rust, scale, and liner cavitation.

NOTE: Check coolant every 500 hours or 6 months, or when replacing 1/3 or more of coolant. Add coolant conditioner as necessary.

1. Remove radiator cap (A) and test coolant solution. Use one of the following kits to check coolant.
 - **3-Way Heavy Duty Coolant Test Kit (TY16175)**
Coolant test strips provide an effective method to check freeze point and additive levels of engine coolant. See your authorized dealer for 3-Way Heavy Duty Coolant Test Kit and follow instructions on kit.
 - **Coolscan Plus®**
For a more thorough evaluation of coolant, perform Coolscan Plus analysis, where available. See your authorized dealer for information about Coolscan Plus.
2. Add TY16004 John Deere Coolant Conditioner or equivalent non-chromate conditioner/rust inhibitor as necessary. Follow instructions on container for amount.

Specification

Cooling System—Capacity..... 14 L (15 qt)

3. Install cap.

A—Radiator Cap

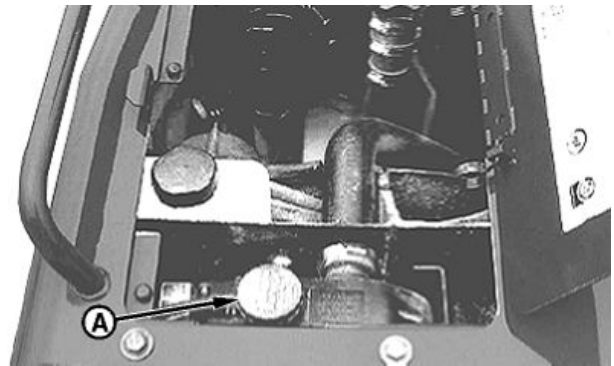

450H Shown



3-Way Test Kit

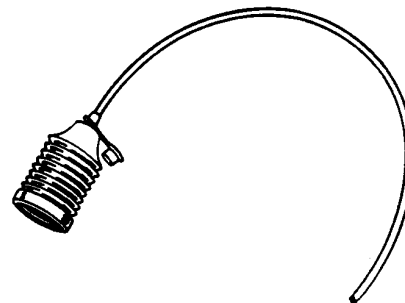

Coolscan Plus

Coolscan Plus is a registered trademark of Deere & Company

TS281—UN—15APR13

T118437—UN—12NOV98

T111110—UN—13AUG97

T111109—UN—13AUG97

CED,OU01040,115 -19-19MAY98-1/1

Check Battery Electrolyte Level and Terminals

⚠ CAUTION: Battery gas can explode. Keep sparks and flames away from batteries. Use a flashlight to check battery electrolyte level.

Never check battery charge by placing a metal object across the posts. Use a voltmeter or hydrometer.

Always remove grounded (–) battery clamp first and replace it last.

Sulfuric acid in battery electrolyte is poisonous. It is strong enough to burn skin, eat holes in clothing, and cause blindness if splashed into eyes.

Avoid the hazard by:

- Filling batteries in a well-ventilated area.
- Wearing eye protection and rubber gloves.
- Avoiding breathing fumes when electrolyte is added.
- Avoiding spilling or dripping electrolyte
- Using proper jump start procedure.

If you spill acid on yourself:

1. Flush your skin with water.
2. Apply baking soda or lime to help neutralize the acid.
3. Flush your eyes with water for 10–15 minutes. Get medical attention immediately.

If acid is swallowed:

1. Drink large amounts of water or milk.
2. Then drink milk of magnesia, beaten eggs, or vegetable oil.

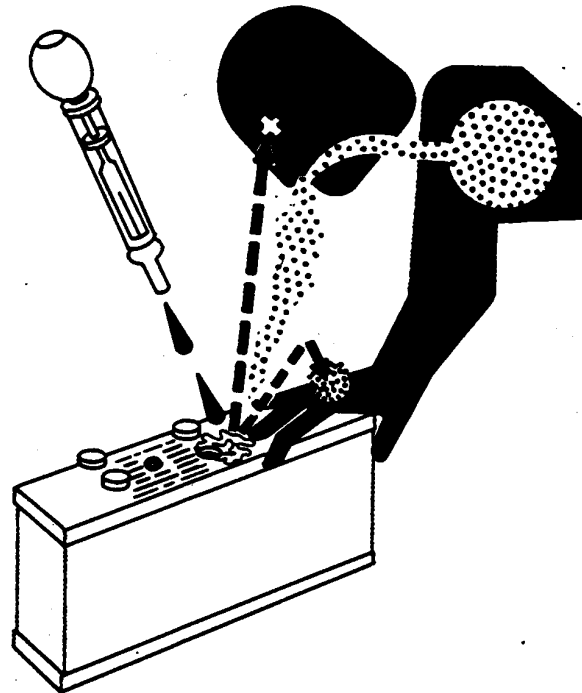

3. Get medical attention immediately.

1. Remove hold-down clamps.
2. Remove battery covers.
3. Clean all excess dirt or debris from top of battery(s) before removing cell caps.

Continued on next page

TX,9015,RB21 -19-14JAN08-1/2

TS203 —UN—23AUG88

IMPORTANT: During freezing weather, batteries must be charged after water is added to prevent battery freezing. Charge battery using a battery charger or by running the engine.

4. Fill each cell to within specified range with distilled water. DO NOT overfill.

CAUTION: Battery gas can explode from sparks of battery causing personal injury. Always remove grounded (—) battery clamp first and replace it last.

5. Disconnect battery clamps, grounded clamp first.
6. Clean battery terminals (A) and clamps with a stiff brush.
7. Apply lubricating grease around battery terminal base only.
8. Install and tighten clamps, grounded clamp last.
9. Install hold-down clamps.

A—Battery Terminal
B—Fill Tube

C—Electrolyte Level Range

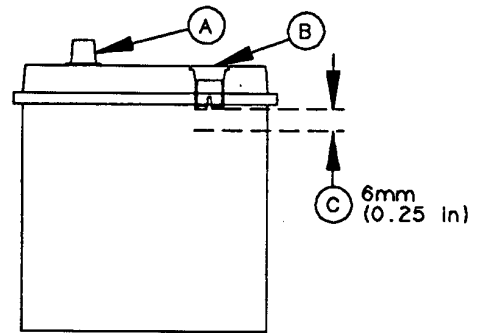

Single Level Fill Tube Application

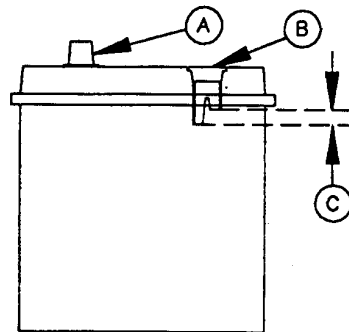

Dual Level Fill Tube Application

TX,9015,RB21 -19-14JAN08-2/2

T6996DB—UN—10FEB89

T6996DA—UN—10FEB89

Replace Winch Oil Filter—If Equipped



Winch Oil Filter Location

1. The winch oil filter is located on right side between winch and crawler (A).
2. Remove three cap screws from oil filter access cover.

NOTE: The filter canister has a recessed 1/2 in. drive on bottom to assist removal of filter.

3. Remove oil filter access cover.
4. Remove filter (B) by turning counterclockwise.
5. Apply a thin film of oil to gasket of new filter.
6. Install new filter.
7. Install oil filter access cover with three cap screws.
8. Check winch oil. See Check Winch Oil—If Equipped. (Section 3-4.)

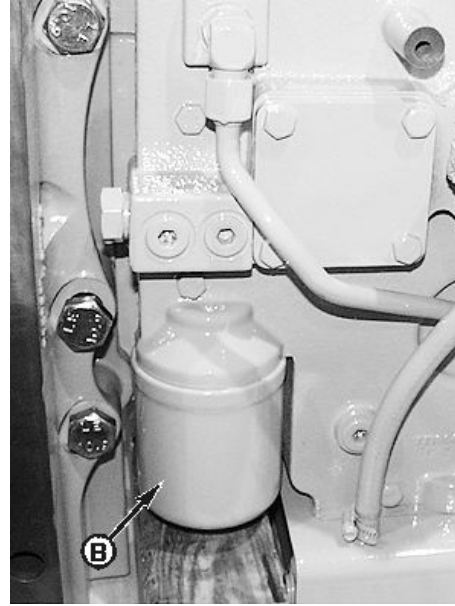

Winch Shown Removed for Clarity of Photo

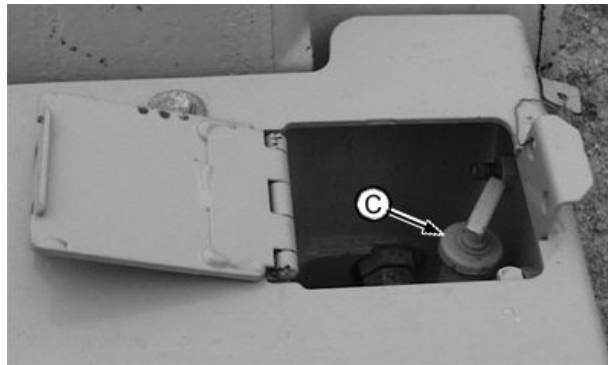

Dipstick Fill Port

A—Oil Filter Location
B—Filter

C—Dipstick Fill Port

T118733B —UN—03DEC98

T118732C —UN—16DEC98

T133718E —UN—30AUG02

HG31779,00000CE -19-05FEB13-1/1

Maintenance—Every 1000 Hours

Clean Engine Crankcase Ventilation Tube

Remove tube (1). Clean and install.

1— Tube

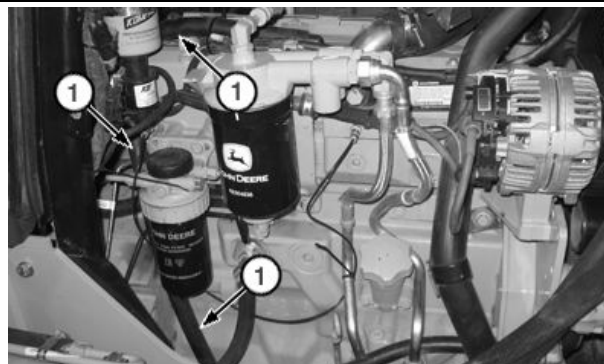

Engine Crankcase Tube

TX1034222A —UN—08JAN08

TX,85,FF1956 -19-28JAN08-1/1

Change Final Drives Oil

1. Remove drain plug (B) on each side of machine.
2. Drain all oil. Allow oil to drain into a container. Dispose of waste oil properly.

Specification

Final Drives Oil (Each Side)—Capacity.....8.5 L (9 qt)

3. Install drain plugs.
4. Remove fill plugs (A).
5. Fill housing with oil until oil flows from fill plug opening. See Final Drive and Winch Oil. (Section 3-1.)
6. Install fill plugs.

A—Fill Plug

B—Drain Plug

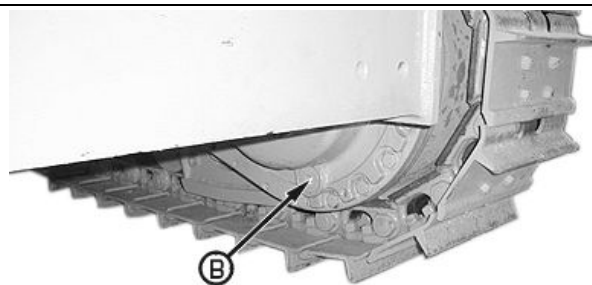

Right Side Shown

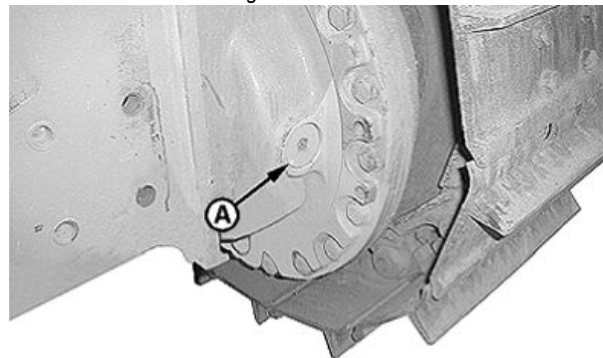

Right Side Shown

T117898B —UN—05NOV98

T117898B —UN—03NOV98

TX,85,RR2733 -19-12JAN93-1/1

Replace Air Cleaner Elements

1. On earlier 450H machines: Remove cover by pulling yellow lever (A) out approximately 13 mm (1/2 in.) and rotating cover counterclockwise approximately 25 mm (1 in.).
2. On later 450H machines and all 550H and 650H machines: Unfasten latches (A). Remove cover.

A—Air Cleaner Cover Release Latches (550H and 650H)
Lever (Earlier 450H)

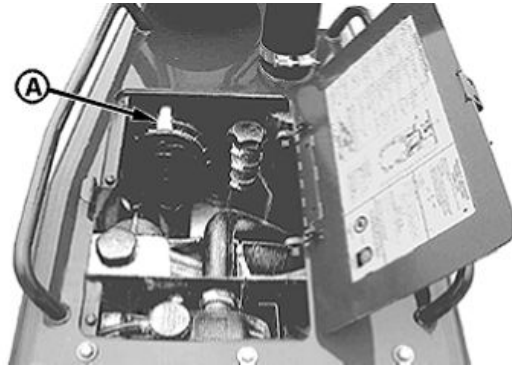

Earlier 450H Shown

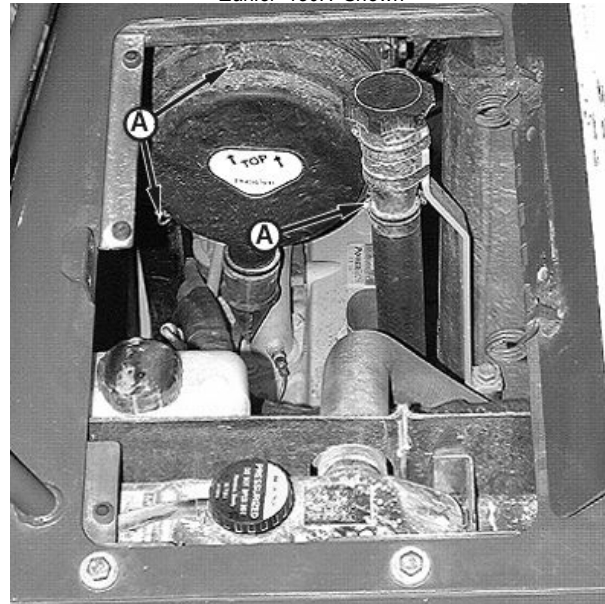

550H and 650H Shown

T118422—UN—12NOV98

T120687B—UN—23MAR99

Continued on next page

CED,OUO1032,783 -19-22JAN03-1/2

3. Remove primary element (B).
4. Remove secondary element (C).
5. Clean air cleaner housing.

IMPORTANT: Do not install secondary element backward.

6. Install new elements. Make sure elements are fully seated into housing.
7. On 450H machines: Install cover with the dust unloader valve in the 5 o'clock position and yellow lever pulled out. While firmly pushing cover onto housing, rotate cover clockwise approximately 25 mm (1 in.) until cover snaps into place. Push the yellow lever in to lock.

On 550H and 650H machines: Install cover with the dust unloader valve in the 5 o'clock position. Latch three latches to secure cover.

B—Primary Element

C—Secondary Element

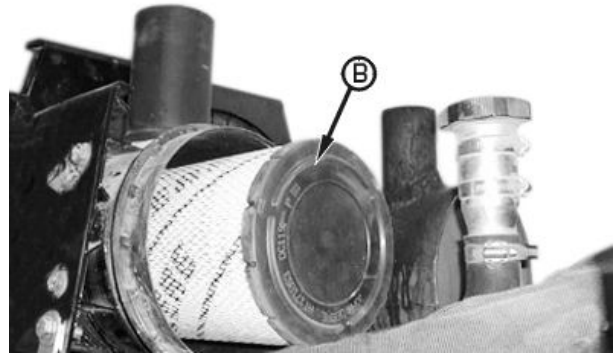

Hood and Side Shields Removed for Clarity of Photo

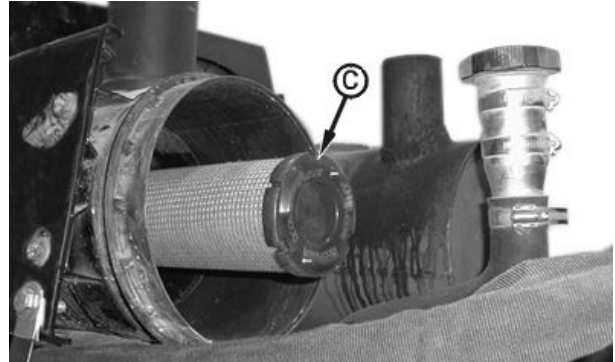

Hood and Side Shields Removed for Clarity of Photo

T117903B —UN—05NOV98

T117904B —UN—05NOV98

CED,OUO1032,783 -19-22JAN03-2/2

Replace Dust Unloader Valve

To remove dust unloader valve, pry collar of unloader valve (1) from tube of air cleaner housing.

Install new unloader valve by stretching collar over flange on tube of air cleaner housing. Be sure there are no gaps between valve collar and tube.

Valve should remain closed above 1/3 engine speed.

1—Unloader Valve

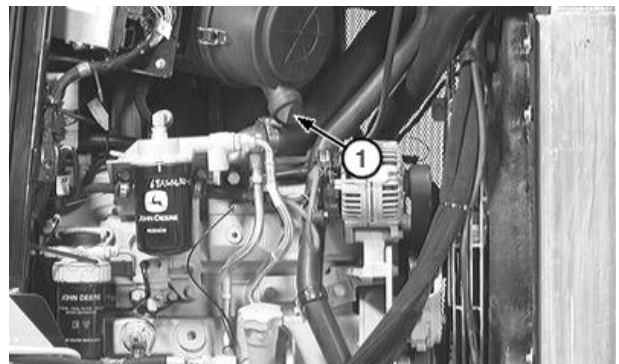

TX1034224A —UN—08JAN08

CED,OUO1032,1158 -19-14JAN08-1/1

Drain and Refill Winch Oil and Replace Filter—If Equipped



Winch Oil Filter

Winch oil filter (A) is located on right side between winch and crawler .

1. Remove three cap screws from oil filter access cover.
2. Remove oil filter access cover.
3. Remove filter (C) by turning counterclockwise.
4. Remove drain plug (B). Allow oil to drain into container. Dispose of waste properly.
5. Install drain plug.
6. Apply a thin film of oil to gasket of new filter.
7. Install new filter.
8. Fill winch oil reservoir through fill port located at top of winch (E) with 34 L (9 gal) of oil. See Final Drive and Winch Oil. (Section 3-1.)
9. Add remaining 4 L (1 gal) of oil through dipstick fill port (D).
10. Check winch oil. See Check Winch Oil—If Equipped. (Section 3-4.)
11. Install oil filter access cover with three cap screws.

A—Oil Filter
B—Drain Plug
C—Filter

D—Dipstick Fill Port
E—Fill Port

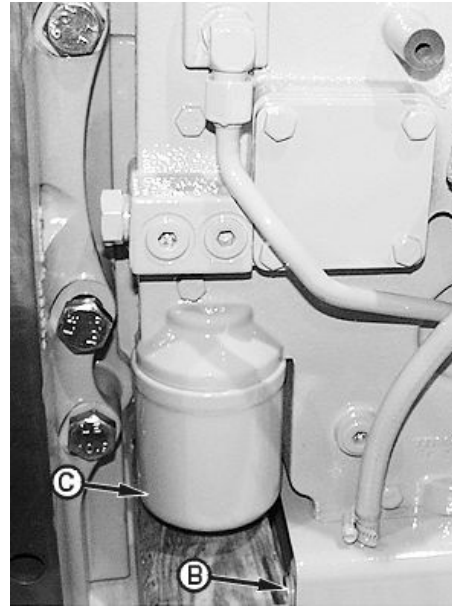

Winch Shown Removed for Clarity of Photo

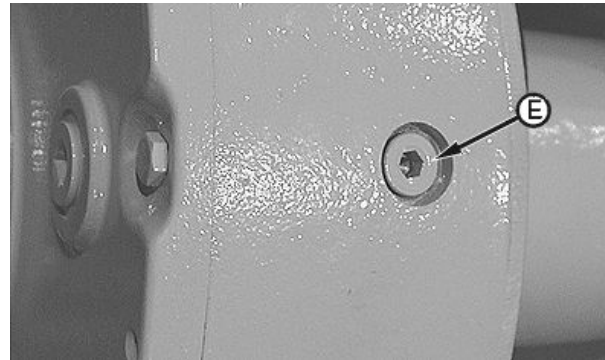

Winch Fill Port

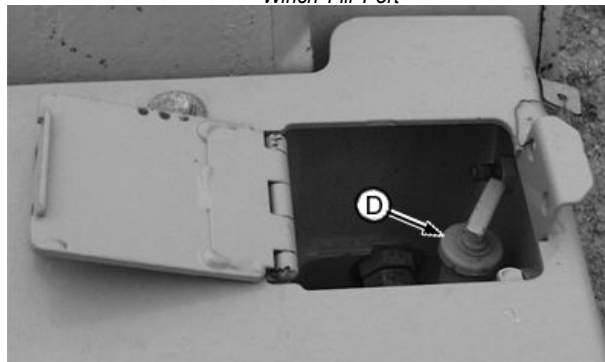

Dipstick Fill Port

T118733B —UN—03DEC98

T118732D —UN—27APR99

T119546B —UN—14JAN99

T133718D —UN—29AUG02

CED,OUO1032,1179 -19-05FEB13-1/1

Clean or Replace Winch Hydraulic Breather Filter—If Equipped

The breather filter is located in the right service compartment.

1. Loosen clamp cap screw.
2. Remove hose (1) from breather filter (2).
3. Using compressed air, clean filter. If filter can not be cleaned, replace filter.
4. Install hose end on filter making sure arrow points in same direction (toward reservoir).
5. Tighten clamp (3) with cap screw.

1— Hose

2— Breather Filter

3— Clamp

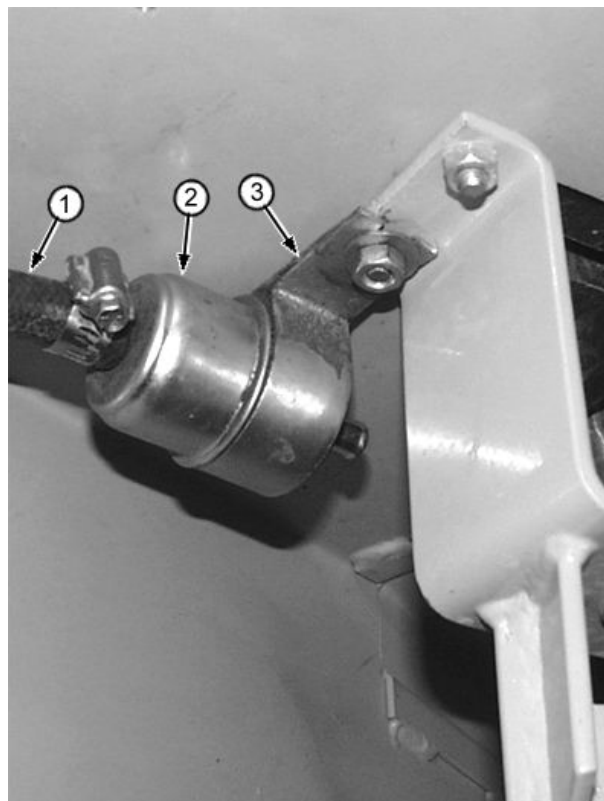

550H Shown

T121231B —UN—20APR99

CED,OUO1047,4 -19-10MAY99-1/1

Maintenance—Every 2000 Hours

Adjust Engine Valve Lash (Clearance)

See your authorized dealer.

CED,OUO1032,1136 -19-14JAN08-1/1

Change Hydraulic Oil and Filter

IMPORTANT: DO NOT operate engine without oil in reservoir.

1. The hydraulic reservoir, filter and drain are located on right side of machine. Remove fill cap (A).

A—Fill Cap

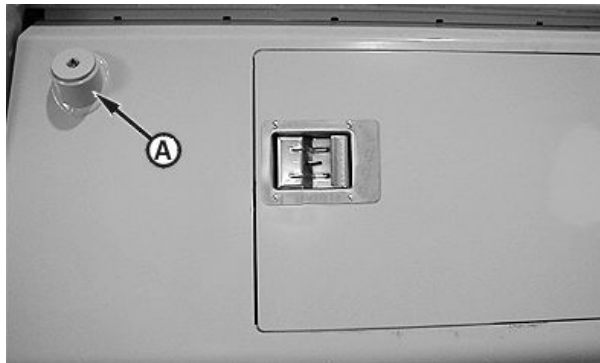

T117860C—UN—26OCT98

CED,OUO1032,1125 -19-02NOV98-1/3

2. Remove hydraulic drain access panel (A).
3. Attach hose to drain valve (B), if equipped, or remove drain plug and route hose to container. Drain oil. Dispose of waste oil properly.

A—Access Panel

B—Drain Valve

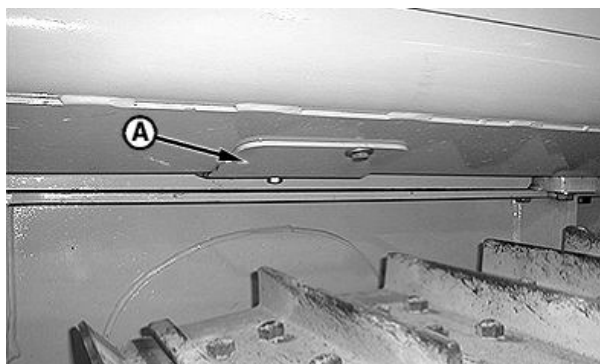

T118660B—UN—02DEC98

450H Shown

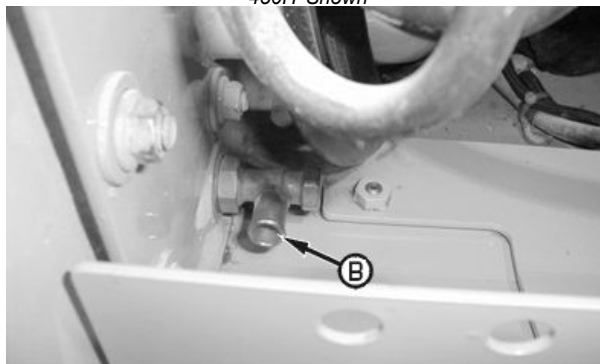

T117866B—UN—05NOV98

Optional Drain Valve Shown

Continued on next page

CED,OUO1032,1125 -19-02NOV98-2/3

4. Remove filter (A) by turning counterclockwise.
5. Apply thin film of oil to gasket of new filter.
6. Install new filter. Turn filter clockwise by hand until gasket touches mounting surface.
7. Tighten additional 1/2 turn.
8. Fill reservoir with oil. See Transmission and Hydraulic Oil. (Section 3-1.)

Specification

Hydraulic Oil
Reservoir—Capacity..... 32 L (8.5 gal) Approximate

9. Check O-ring on fill cap and install fill cap.
10. Start engine and run for 2 minutes. Stop engine and check for leaks around filter base. Tighten filter only enough to stop leaks.
11. Check oil level in sight tube (B). Oil level must be between the ADD and FULL marks on tube. If necessary, add more oil.

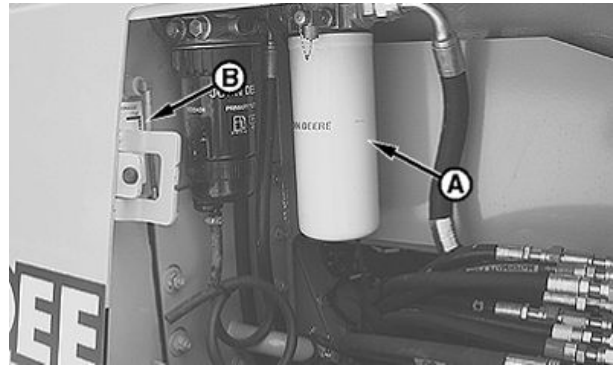

A—Filter

B—Sight Tube

CED,OUO1032,1125 -19-02NOV98-3/3

T117893B —UN—03NOV98

Change Transmission Oil and Filter

1. Transmission hydrostatic reservoir, filter and drain are located on left side of machine. Remove fill cap (B).

B—Fill Cap

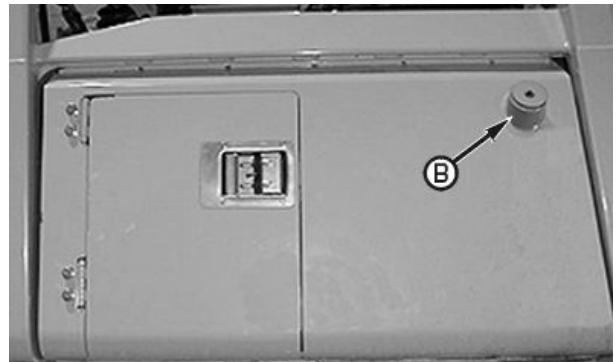

Continued on next page

HG31779.00000D0 -19-06JUN05-1/3

T117892B —UN—26OCT98

2. Remove transmission drain access panel (A).
3. Attach hose to drain valve (B), if equipped, or remove drain plug and route hose to container. Drain oil. Dispose of waste oil properly.
4. Put shallow pan on battery cover to prevent oil from transmission filter from dripping on battery(ies).

A—Access Panel

B—Drain Valve

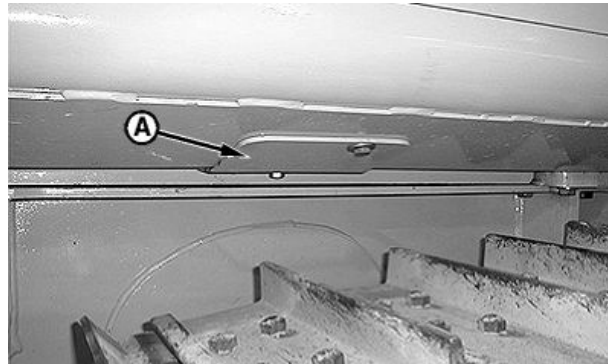

450H Shown

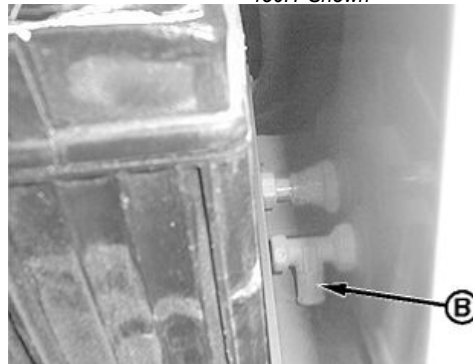

Optional Drain Valve Shown

HG31779,0000D0 -19-06JUN05-2/3

T118650B—UN—02DEC98

T117897C—UN—12NOV98

5. Remove oil filter (A) by turning counterclockwise.
6. Apply a thin film of oil to gasket of new filter.
7. Install new filter. Turn filter clockwise by hand until gasket touches mounting surface.
8. Tighten additional 1/2 turn.
9. Fill reservoir with oil. See Transmission and Hydraulic Oil. (Section 3-1.)

Specification

Transmission Oil
Reservoir—Capacity..... 53 L (14 gal)

10. Check O-ring on fill cap and install fill cap.
11. Start engine and run for 2 minutes. Stop engine and check for leaks around filter base. Tighten filter only enough to stop leaks.
12. Check oil level in sight glass tube (B). Oil level should be between the ADD and FULL marks. Add oil if necessary.

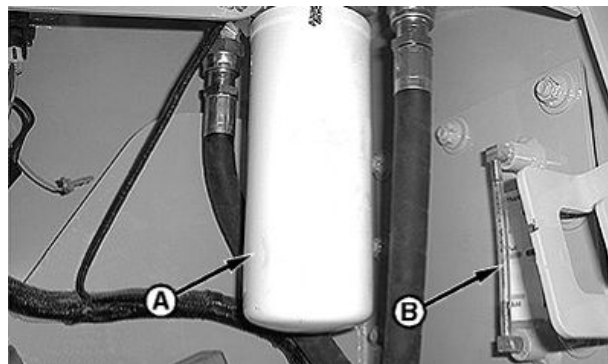

A—Oil Filter

B—Sight Glass

HG31779,0000D0 -19-06JUN05-3/3

T117891B—UN—03NOV98

Miscellaneous—Machine

Drain the Cooling System

Every three years or 3000 hours, if John Deere Coolant is used, drain and flush cooling system using commercial products, replace thermostats, and fill with new coolant.

⚠ CAUTION: DO NOT remove the radiator fill cap unless the engine is cool. Then loosen the cap slowly to the stop. Release all pressure before removing the cap.

1. Release pressure and then remove radiator cap (A).

A—Air Screen

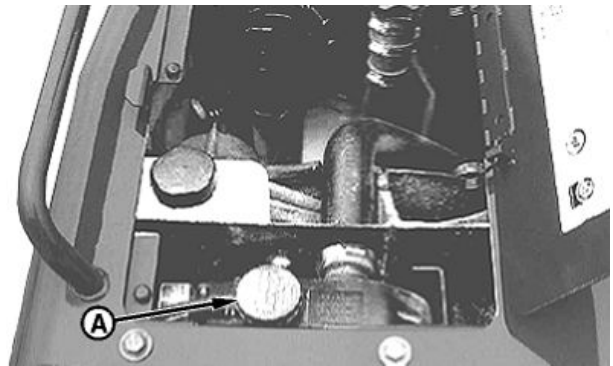

450H Shown

T118437—UN—12NOV98

CED,OUO1032,781 -19-27JAN00-1/2

NOTE: Allow coolant to drain into a container. Dispose of waste coolant properly.

2. Open radiator drain valve (A).
3. Open drain valve (B) to drain engine block.
4. Flush system using commercial product.
5. Close all drain valves.
6. Add new coolant. See Diesel Engine Coolant. (Section 3-1.)

A—Radiator Drain Valve

B—Engine Drain Valve

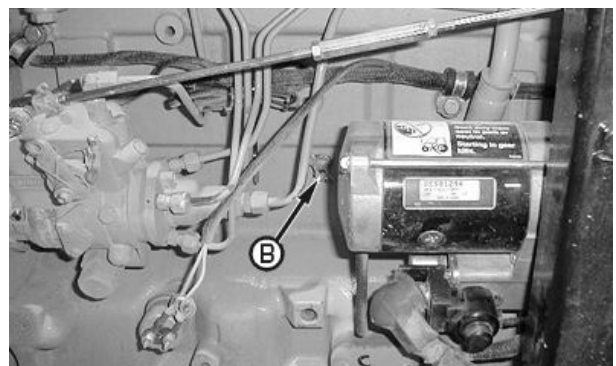
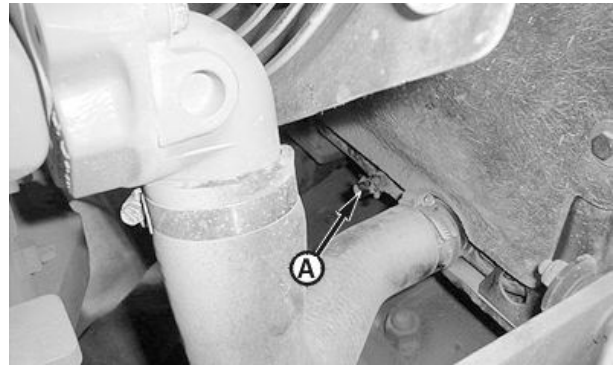

T117900B—UN—05NOV98

T117901B—UN—05NOV98

CED,OUO1032,781 -19-27JAN00-2/2

Fill the Cooling System

CAUTION: DO NOT remove radiator cap unless engine is cool. Turn the cap slowly to the stop. Release all pressure before removing cap.

With engine COLD, coolant level must be between HOT and COLD marks on recovery tank (A).

If coolant is below COLD mark, add coolant to the recovery tank.

If there is no coolant in recovery tank, add coolant to recovery tank and radiator.

FREEZING TEMPERATURES: Fill with permanent-type, low silicate, ethylene glycol antifreeze (without stop-leak additive) and clean, soft water. Add TY16004 John Deere Coolant Conditioner or equivalent.

IMPORTANT: Use only permanent-type, low silicate, ethylene glycol base antifreeze in coolant solution. Other types of antifreeze may damage cylinder seals.

NOTE: All machines are shipped from the factory with a 50-50 mixtures (antifreeze and soft water) for protection to -34°C (-30°F). Adjust mixture accordingly to provide freeze protection for your machine.

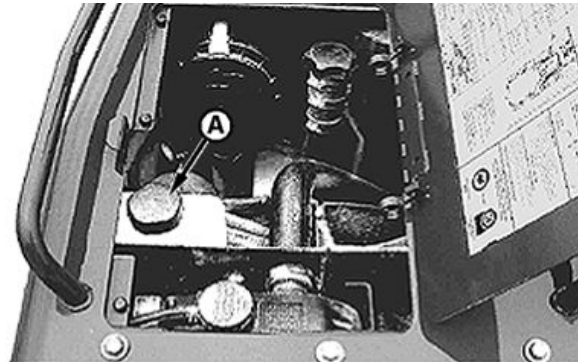
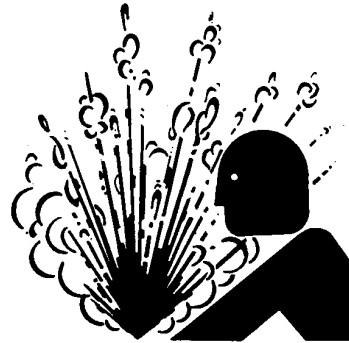

450H Shown

A—Recovery Tank

TS281—UN—15APR13

T117479—UN—20OCT98

CED,OUO1032,782 -19-24APR99-1/1

Clean the Engine Air Precleaner Screen

To clean the engine air screen (A), remove hose clamp and bowl. Shake bowl to remove debris.

IMPORTANT: The engine air screen removes only part of the dirt as air goes into the engine. You must still clean the air cleaner regularly.

A—Air Screen

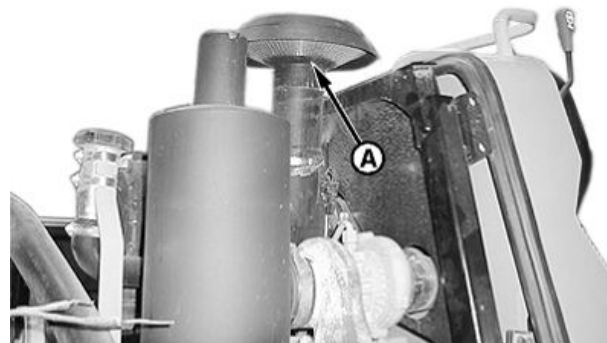

Turbocharged Engine Shown

T117837B—UN—21OCT98

CED,OUO1032,1027 -19-02JUN03-1/1

Replace Engine Vibration Damper

The damper assembly is not repairable and should be replaced every 5 years or 4500 hours, whichever occurs

first, or whenever crankshaft is replaced. See your authorized dealer.

CED, TX03768,2668 -19-29OCT99-1/1

Do Not Service or Adjust Injection Nozzles or Injection Pump

If injection nozzles are not working correctly or are dirty, the engine will not run normally. See your authorized dealer for service.

Changing the injection pump in any way not approved by the manufacturer will end the warranty. See your copy of the John Deere warranty on this machine.

Do not service an injection pump that is not operating correctly. See your authorized injection pump service center.

TX,90,FF3116 -19-03NOV08-1/1

C-Frame Ball / Blade Socket Joint Adjustment

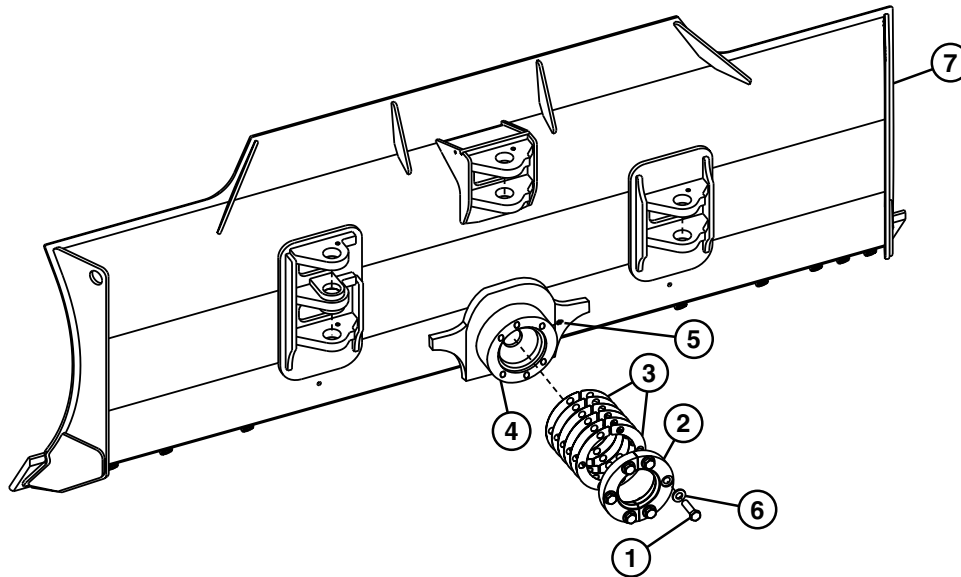

T158731

- | | | |
|-------------------------------|------------------------|--------------------|
| 1— Cap Screw (6 used) | 3— Shims (12 included) | 6— Washer (6 used) |
| 2— Socket Retainers (2 used) | 4— Socket | 7— Blade |
| | 5— Lubrication Fitting | |

1. Park machine on level surface. Lower blade to ground.
2. Remove cap screws (1) from socket retainers (2). Remove shims (3).
3. Install ball socket retainers without shims. Measure gap, remove ball socket retainers.
4. Install enough shims to fill gap, plus one extra shim.
5. Install ball socket retainers. Tighten cap screws to specification.

Specification

Socket Retainer Cap
Screws—Torque..... 350 N·m (255 lb·ft)

OUT3019,000035F -19-22AUG02-1/1

T158731 —UN—23AUG02

Cleaning Dusty Primary Element

IMPORTANT: A damaged or dirty element may cause engine damage.

Install new element:

- If the element shows damage and needs to be replaced.
- If element is visibly dirty and will not clean.
- After 1000 hours service or annually.

DO NOT clean a secondary element. Install a new element carefully centering it in the canister.

1. Tap element with the palm of your hand, NOT ON A HARD SURFACE.

⚠ CAUTION: Prevent possible injury from flying chips. Reduce compressed air to less than 210 kPa (2.1 bar) (30 psi) when using for cleaning purposes. Clear area of bystanders, guard against flying chips, and wear personal protection equipment including eye protection.

2. If this does not remove dust, use compressed air under 210 kPa (2.1 bar) (30 psi).

NOTE: Air restriction indicator will not signal correctly if an element has a break or is not correctly sealed in air cleaner housing. Throw away element that has the slightest damage. If gasket is broken or missing, install a new element.

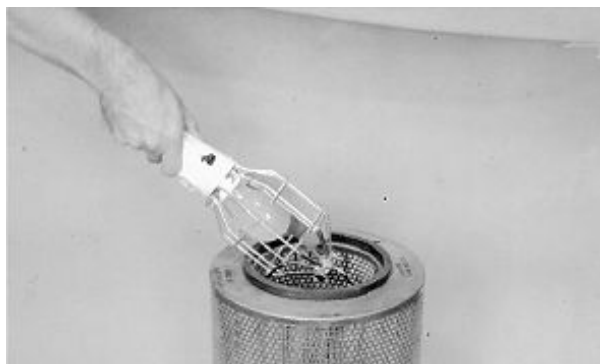

T90684 —UN—10NOV88



T47764 —UN—09NOV88

3. Direct air up and down the pleats from inside to outside. Be careful not to make a break in the element.

TX03679,00017E3 -19-31MAY01-1/1

Precautions for Alternator and Regulator

When batteries are connected, follow these rules:

1. Disconnect negative (–) battery cable when you work on or near alternator or regulator.
2. DO NOT TRY TO POLARIZE ALTERNATOR OR REGULATOR.
3. Be sure alternator wires are correctly connected BEFORE you connect batteries.
4. Do not ground alternator output terminal.
5. Do not disconnect or connect any alternator or regulator wires while batteries are connected or while alternator is operating.
6. Connect batteries or a booster battery in the correct polarity (positive [+] to positive [+] and negative [–] to negative [–]).
7. Do not disconnect the batteries when engine is running and alternator is charging.
8. Disconnect battery cables before connecting battery charger to the batteries.

T82,EXMA,I -19-19SEP08-1/1

Handling, Checking and Servicing Batteries Carefully

⚠ CAUTION: Battery gas can explode. Keep sparks and flames away from batteries. Use a flashlight to check battery electrolyte level.

Never check battery charge by placing a metal object across the posts. Use a voltmeter or hydrometer.

Always remove grounded (-) battery clamp first and replace it last.

Sulfuric acid in battery electrolyte is poisonous. It is strong enough to burn skin, eat holes in clothing, and cause blindness if splashed into eyes.

Avoid the hazard by:

1. Filling batteries in a well-ventilated area.
2. Wearing eye protection and rubber gloves.
3. Avoiding breathing fumes when electrolyte is added.
4. Avoiding spilling or dripping electrolyte.
5. Use proper jump start procedure.

If you spill acid on yourself:

1. Flush your skin with water.
2. Apply baking soda or lime to help neutralize the acid.
3. Flush your eyes with water for 15—30 minutes. Get medical attention immediately.

If acid is swallowed:

1. Do not induce vomiting.
2. Drink large amounts of water or milk, but do not exceed 1.9 L (2 qt).
3. Get medical attention immediately.

WARNING: Battery posts, terminals, and related accessories contain lead and lead compounds, chemicals known to the State of California to cause cancer and reproductive harm. **Wash hands after handling.**

If electrolyte spills on the floor, use one of the following mixtures to neutralize the acid: 0.5 kg (1 lb) baking soda in 4 L (1 gal) water, or 0.47 L (1 pt) household ammonia in 4 L (1 gal) water.

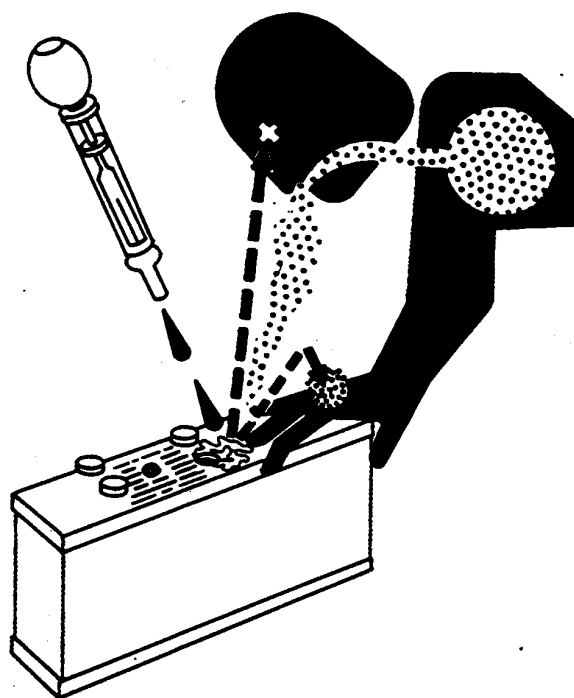

IMPORTANT: Do not overfill the battery cells.

Check the specific gravity of electrolyte in each battery cell.

Continued on next page

TX03679,0001788 -19-29APR11-1/2

TS204—UN—15APR13

TS203—UN—23AUG88

See your authorized dealer for JT05460 SERVICEGARD™ battery and coolant tester. Follow directions included with the tester.

A fully charged battery will have a corrected specific gravity reading of 1.260. If the reading is below 1.200, charge the battery.



Battery And Coolant Tester

SERVICEGARD is a trademark of Deere & Company

TX03679,0001788 -19-29APR11-2/2

T85402 —UN—10NOV88

Replacing Batteries

The dual battery option is required when the ambient temperature is below 0°C (32°F).

Batteries are located in left side service compartment.

CAUTION: Sulfuric acid in battery electrolyte is poisonous. It is strong enough to burn skin, eat holes in clothing, and cause blindness if splashed into eyes.

Avoid the hazard by:

1. Filling batteries in a well-ventilated area.
2. Wearing eye protection and rubber gloves.
3. Avoiding breathing fumes when electrolyte is added.
4. Avoiding spilling or dripping electrolyte.
5. Using proper jump start procedure.

If you spill acid on yourself:

1. Flush your skin with water.
2. Apply baking soda or lime to help neutralize the acid.
3. Flush your eyes with water for 10—15 minutes. Get medical attention immediately.

If acid is swallowed:

1. Drink large amounts of water or milk.
2. Then drink milk of magnesia, beaten eggs, or vegetable oil.
3. Get medical attention immediately.

Your machine will have one or two 12-volt batteries with negative (–) ground. Use only batteries meeting the following specifications:

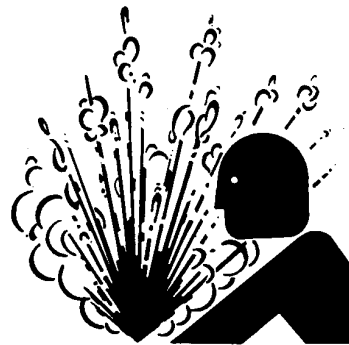

Dual Battery Option Shown

Single Battery	Battery Group 31
925 cold cranking amps at –18°C (0°F)	190 minutes reserve capacity at 25 amps
Dual Battery—If Equipped	Battery Group 31
1850 cold cranking amps at –18°C (0°F)	380 minutes reserve capacity at 25 amps

TX,90,RB82 -19-14JAN08-1/1

TS281 —UN—15APR13

T117482 —UN—20OCT98

Removing Batteries

⚠ CAUTION: Never check battery charge by placing a metal object across the posts. Use a voltmeter or hydrometer.

Always remove grounded (–) battery clamp first and replace it last.

1. Turn battery disconnect switch to “Off”.
2. Remove battery cover.
3. Disconnect negative battery cable(s) first then positive (+) cable(s).
4. Remove nuts to remove hold down frame(s).
5. Lift out battery/batteries.
6. Check cables and clamps for damage and wear.
7. Make certain that the battery/batteries are fully charged.
8. Set the battery/batteries in the compartment making sure they are level.
9. Install hold down frames.
10. Connect cables; positive then negative.
11. Install battery cover.
12. Turn battery disconnect switch to ON.



Dual Battery Option Shown

TX,90,RB83 -19-14JAN08-1/1

TS204—UN—15APR13

T117482—UN—20OCT98

Fuse Specifications for ROPS Units (Earlier Machines)

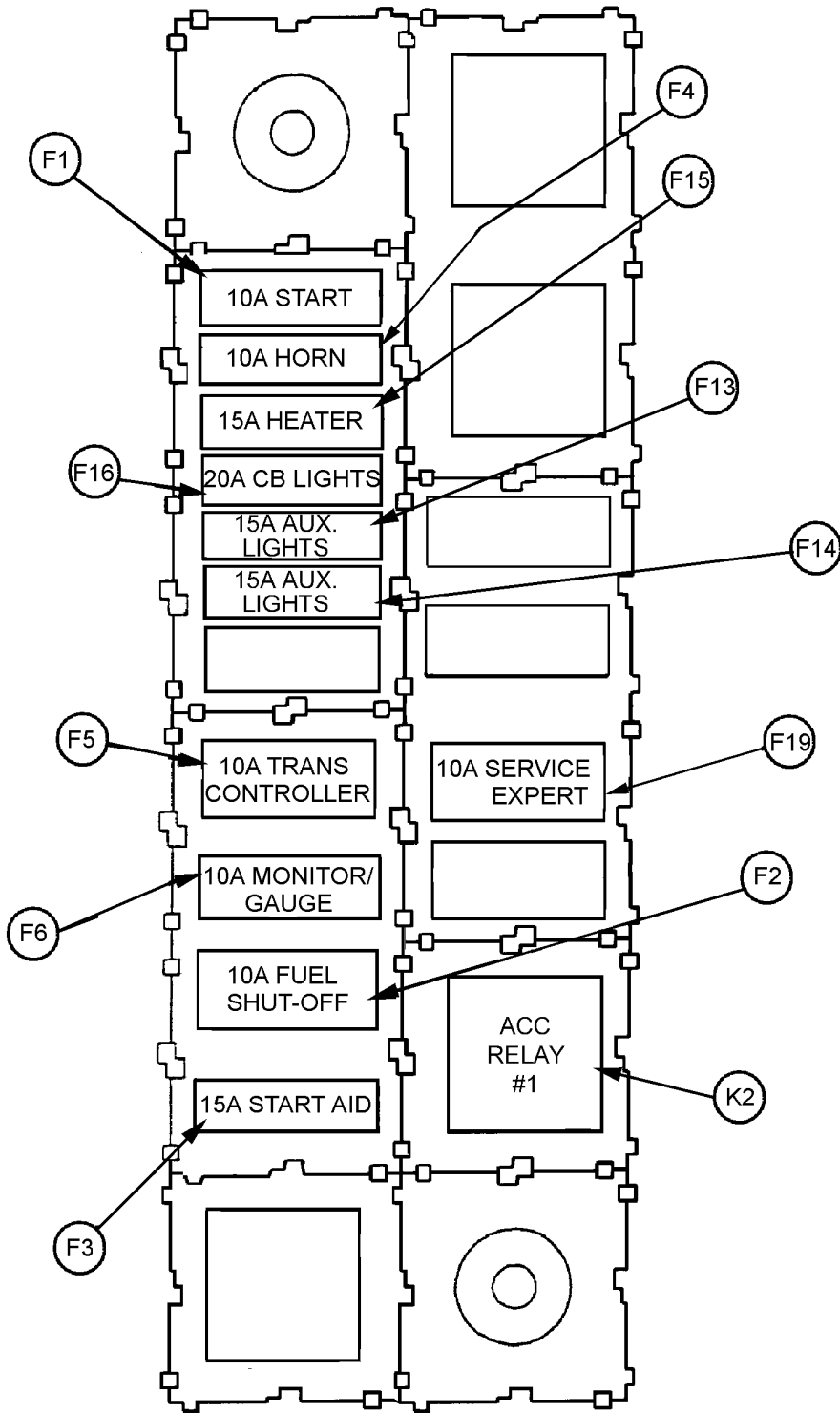

T121137

T121137—UN—23APR99

Continued on next page

CED,OUO1032,1064 -19-24APR99-1/2

Miscellaneous—Machine

F1— 10A Start Fuse
F2— 5A Fuel Shut-Off Fuse
F3— 15A Start Aid Fuse
F4— 10A Horn Fuse

F5— 10A Transmission Controller Fuse
F6— 10A Monitor/Gauge Fuse
F13— 15A Auxiliary Lights

F14— 15A Auxiliary Lights
F15— 15A Heater Fuse
F16— 20A Light Circuit Breaker

F19— 10A Service Expert Fuse
K2— Accessory Relay #1

IMPORTANT: Install fuse with correct amperage rating to prevent electrical system damage from overload.

The fuse block is located on right side of machine through fuse panel access cover.

CED,OUO1032,1064 -19-24APR99-2/2

Fuse Specifications for ROPS Units (Later Machines)

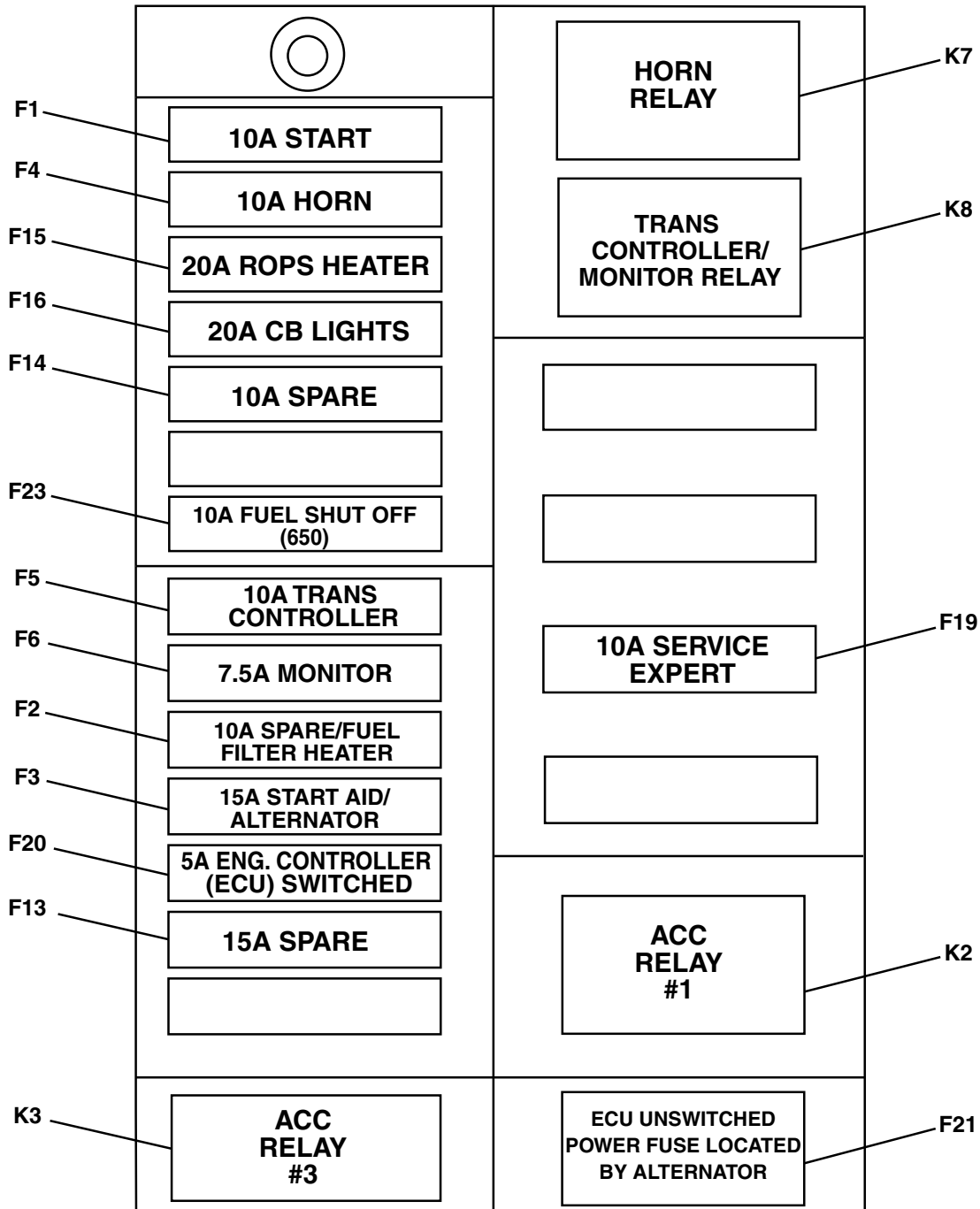

T145426

T145426 -19-06FEB02

Continued on next page

HG31779,00000AE -19-16JUL02-1/2

Miscellaneous—Machine

F1 — 10A Start Fuse	F6— 7.5A Monitor/Gauge Fuse	F19— 10A Service Expert Fuse	K2— Accessory Relay #1
F2— 15A Spare/Fuel Filter Heater Fuse	F13— 15A Spare Fuse (Auxiliary Light)	F20— 20A Engine Controller Switched Power Fuse	K3— Accessory Relay #3
F3— 15A Start Aid/Alternator Excitation Fuse	F14— 10A Spare Fuse	F21— 15A Engine Controller Unswitched Power Fuse (K7— Horn Relay
F4 — 10A Horn Fuse	F15 — 20A Rops (Under Seat) Heater Fuse	Located By Alternator)	K8— Transmission Controller/Monitor Relay
F5— 10A Transmission Controller Fuse	F16— 20A Light Circuit Breaker	F23— 10A Fuel Shut-Off Fuse (650H)	

IMPORTANT: Install fuse with correct amperage rating to prevent electrical system damage from overload.

The fuse block is located on right side of machine through fuse panel access cover.

HG31779,00000AE -19-16JUL02-2/2

Fuse Specifications for Cab Units—If Equipped (Earlier Machines)

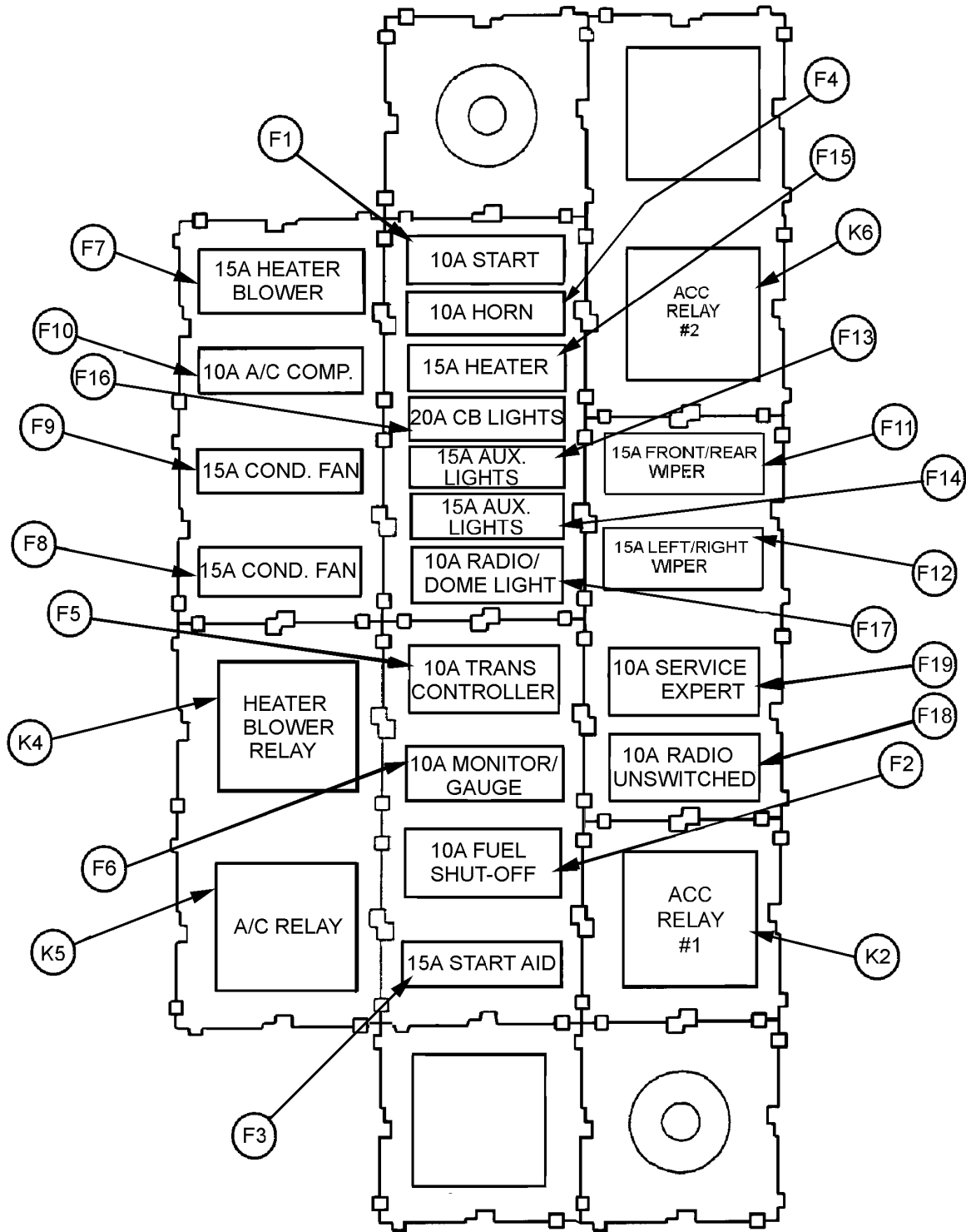

T121389

T121389—JN—11MAY99

Continued on next page

CED,OUO1032,1065 -19-24APR99-1/2

Miscellaneous—Machine

F1— 10A Start Fuse	F8— 15A Condenser Fan Fuse	F12— 15A Left/Right Wiper Fuse	F18— 10A Radio Fuse (Unswitched)
F2— 5A Fuel Shut-Off Fuse	F9— 15A Condenser Fan Fuse	F13— 15A Auxiliary Lights	F19— 10A Service Expert Fuse
F3— 15A Start Aid Fuse	F10— 5A A/C Compressor Fuse (S.N. —874114); 10A A/C	F14— 15A Auxiliary Lights	K2— Accessory Relay #1
F4— 10A Horn Fuse	Compressor Fuse (S.N. 874115—)	F15— 15A Heater Fuse	K4— Heater Blower Relay
F5— 10A Transmission Controller Fuse	F11— 15A Front/Rear Wiper Fuse	F16— 20A Light Circuit Breaker	K5— A/C Relay
F6— 10A Monitor/Gauge Fuse		F17— 10A Dome Light, Radio Fuse	K6— Accessory Relay #2
F7— 15A Heater Blower Fuse			

IMPORTANT: Install fuse with correct amperage rating to prevent electrical system damage from overload.

The fuse block is located on right side of machine through fuse panel access cover.

CED,OUO1032,1065 -19-24APR99-2/2

Fuse Specifications for Cab Units—If Equipped (Later Machines)

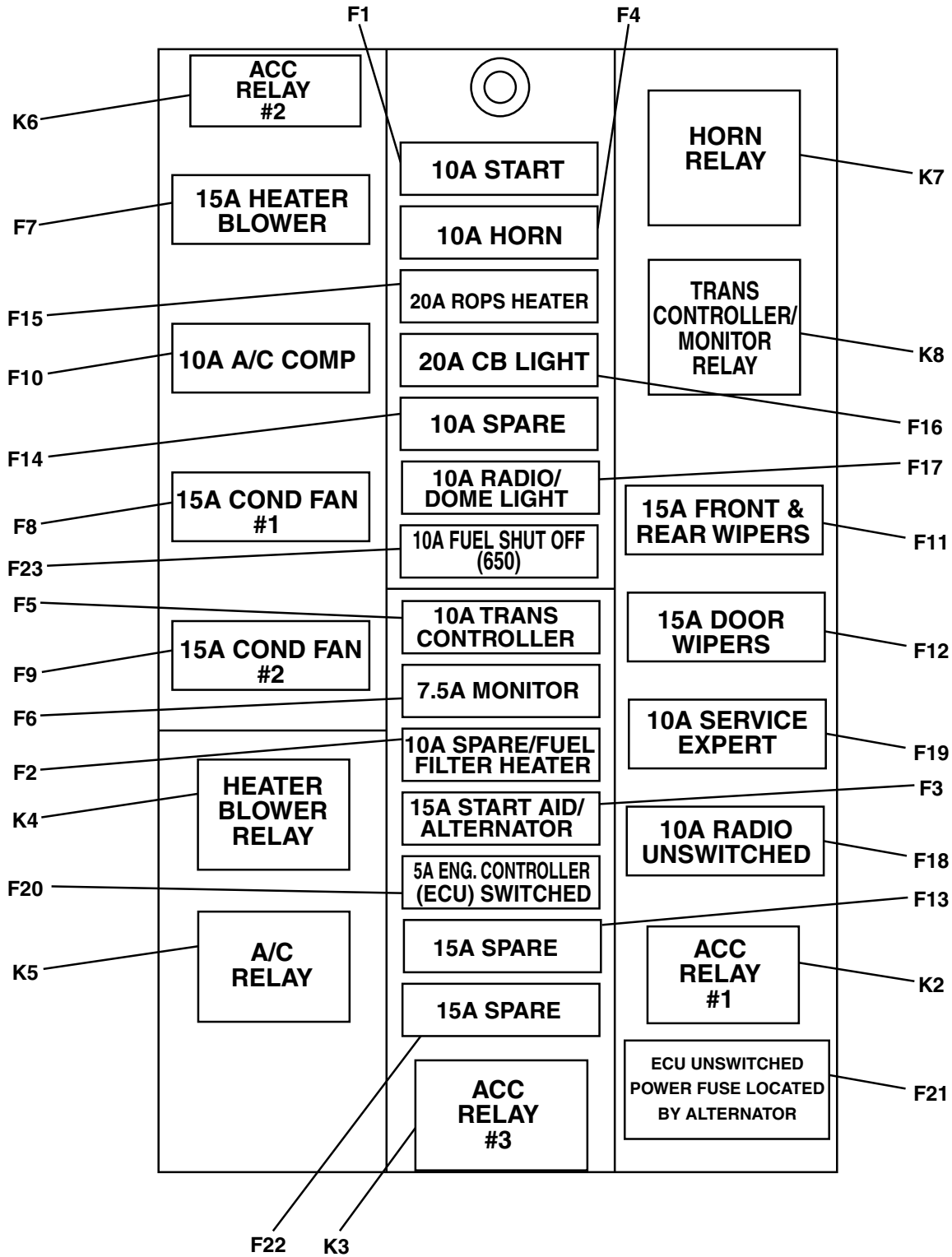

T145425

T145425 —19—06FEB02

Continued on next page

HG31779,00000AF -19-16JUL02-1/2

Miscellaneous—Machine

F1— 10A Start Fuse	F9— 15A Condenser Fan Fuse #2	F16— 20A Light Circuit Breaker	F22— 15A Spare Fuse
F2— 10A Spare/Fuel Filter Heater Fuse	F10— 10A A/C Compressor Fuse	F17— 10A Dome Light, Radio Fuse	F23— 10A Fuel Shut Off Fuse (650H)
F3— 15A Start Aid Fuse	F11— 15A Front/Rear Wiper Fuse	F18— 10A Radio Fuse (Unswitched)	K3— Accessory Relay #3
F4— 10A Horn Fuse	F12— 15A Left/Right Door Wiper Fuse	F19— 10A Service Expert Fuse (Switched Power)	K4— Heater Blower Relay
F5— 10A Transmission Controller Fuse	F13— 15A Spare Fuse (Auxiliary Light)	F20— 5A Engine Controller Fuse (Switched Power)	K5— A/C Relay
F6— 7.5A Monitor/Gauge Fuse	F14— 10A Start Aid Fuse	F21— 15A Engine Controller Fuse (Unswitched Power) (Located By Alternator)	K7— Horn Relay
F7— 15A Heater Blower Fuse	F15— 15A Rops (Under Seat) Heater Fuse		K8— Transmission Controller/Monitor Relay
F8— 15A Condenser Fan Fuse #1			

IMPORTANT: Install fuse with correct amperage rating to prevent electrical system damage from overload.

The fuse block is located on right side of machine through access cover.

HG31779.00000AF -19-16JUL02-2/2

Drain Fuel Tank Sump

CAUTION: Handle fuel carefully. Shut the engine OFF. Do not smoke while you work on fuel system.

1. Remove rear access panel (A).
2. Remove left fuel sump access panel (B). If equipped with winch, remove both left and right fuel sump access panels.
3. Attach hose to drain cock (C) and route through sump opening. Open drain cock for several seconds to drain water and sediment.
4. Close drain cock. Replace fuel sump panel(s) and tighten cap screws.
5. Install rear access panel, if removed. Tighten cap screws.

A—Rear Access Panel C—Drain Cock
 B—Left Fuel Sump Access Panel

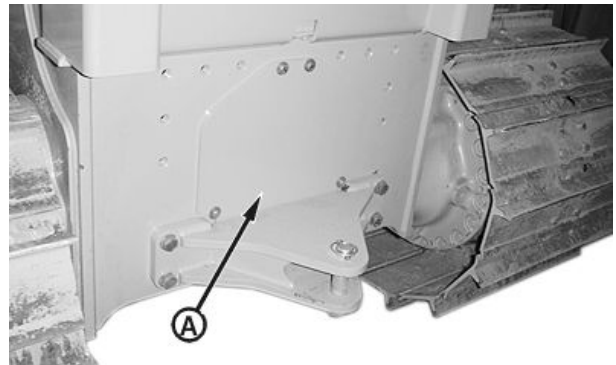

650H Shown

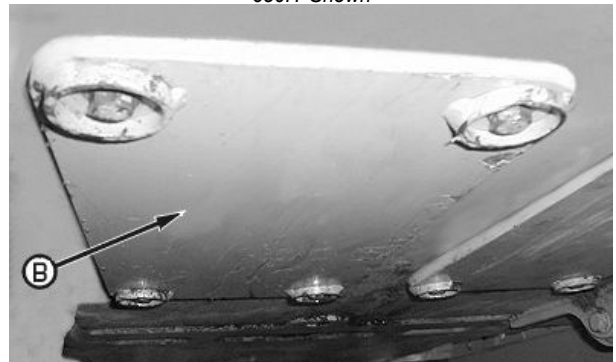

Left Fuel Sump Access Panel

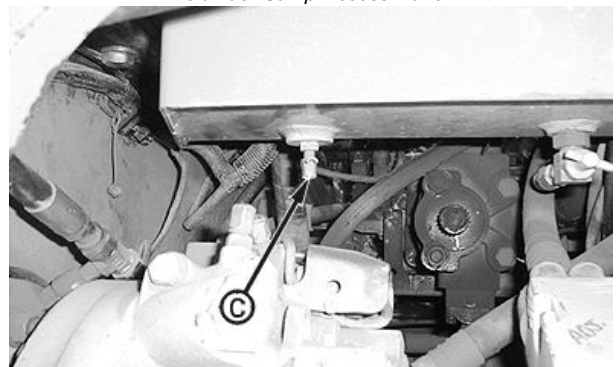

T117851B —UN—26OCT98

T117852B —UN—26OCT98

T117853B —UN—26OCT98

03T,55,K88 -19-24APR99-1/1

Cleaning Fresh Cab Air Filter—If Equipped

1. Loosen wing nuts (A) to remove access cover.
2. Remove filter holder from compartment. Remove filter element.
3. Tap filter on flat surface with dirty side down to loosen and remove large portions of dirt.
4. Install filter. Tighten wing nuts.

A—Wing Nuts (2 used)



T118218B —UN—11NOV98



T120688B —UN—23MAR99

CED,OUO1032,1138 -19-18FEB08-1/1

Cleaning Cab Air Recirculation Filter—If Equipped

1. Pull latch holding filter in place.
2. Remove filter (A).
3. Use compressed air under 210 kPa (2.1 bar) (30 psi). Direct air opposite to normal air flow.
4. Wash filter in warm, soapy water, rinse and dry.
5. If filter will not come clean, replace as necessary.
6. Fasten latch.

A—Filter

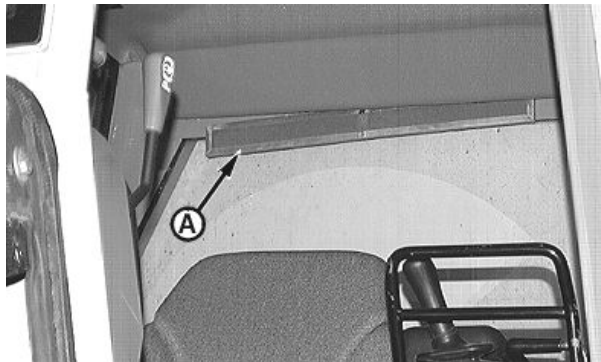

T120688B —UN—23MAR99

CED,OUO1032,1403 -19-24APR99-1/1

Check Air Conditioner Refrigerant Level—If Equipped

IMPORTANT: Prevent possible compressor damage. If receiver/dryer moisture eye color indicates "wet" (pink), dryer is saturated and should be changed within the next 100 machine hours to prevent further buildup of moisture in refrigerant.

1. Remove left side access cover of air conditioning compartment.
2. Using a mirror (A), check color of sight glass (B) to see if receiver/dryer is wet (pink) or dry (blue).
3. If wet (pink), see your authorized dealer within the next 100 machine hours to service receiver/dryer.

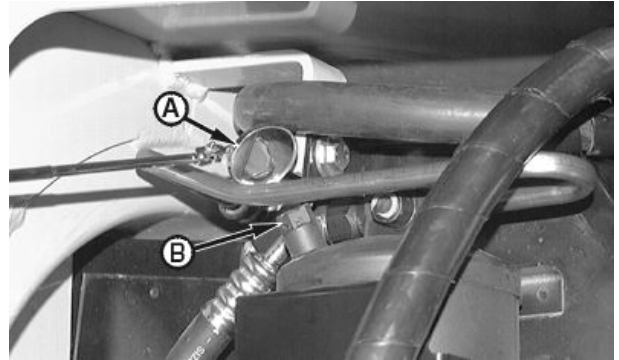

A—Mirror

B—Sight Glass

CEU,OUO1032,1175 -19-27APR99-1/1

T121303B—UN—03MAY99

Track Sag General Information

Properly adjusted tracks prolong chain life. To get the maximum life out of track bushings, keep the track sag properly adjusted. Improperly adjusted track wears at a more rapid rate.

A tight track causes higher loading which will increase wear on the pins, bushings, links, sprocket and front idler. The graph (A) shows how the loading on the track chain increases significantly when tracks are too tight. Also, a tight track requires more horsepower, increasing fuel consumption and decreasing productivity.

Periodically check track sag. In some applications, tracks may require adjustment several times during a working day. This is especially true when working in different conditions on the same job site, as moisture content of the soil changes.

Tracks should always be adjusted in the actual operating conditions. If material packs in the undercarriage, the tracks should be adjusted with the material packed in the components.

When packing occurs, track sag is taken up and must be loosened to extend wear life. The track spring will recoil and the machine will continue to operate with tight track. However, continued operation without loosening the tracks will result in excessive pin and bushing wear, sprocket popping, tooth tip wear, and excessive loads on the entire undercarriage and final drive system.

With sealed chain, internal pin and bushing wear creates sag which reduces the effects of packing. However, if a sealed chain is too tight, accelerated bushing wear occurs.

Lubricated chain is different due to the absence of internal pin and bushing wear. It is absolutely essential to keep sag adjusted to prevent accelerated bushing outside diameter wear.

Maintaining track sag is very important regardless of the type of track being used.

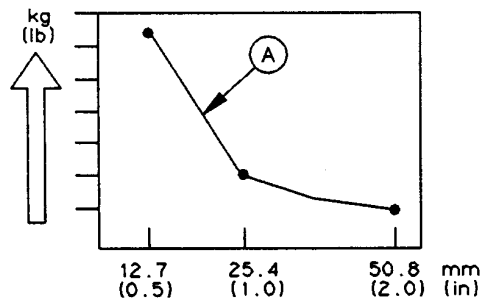

Track Tension kg (lb) vs. Track Sag mm (in.)

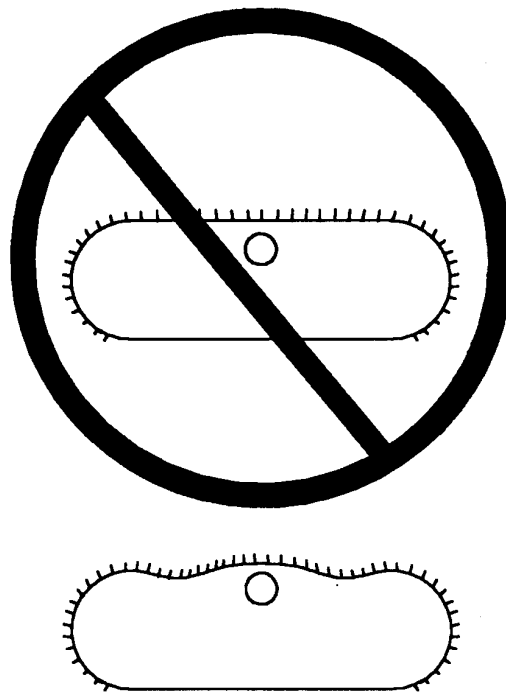

Proper Track Sag

T7800AJ—UN—31JUL92

T7800AH—UN—31JUL92

TX,90,RR2516 -19-10JAN12-1/1

Adding Oil to the Roller

NOTE: Rollers are serviced off of the machine.

1. Remove plug (B) from roller.
2. Rotate plug opening to 45° angle.
3. Fill roller with oil until the oil starts to drip out. See Track Rollers, Front Idler and Carrier Roller Oil. (Section 3-1.)
4. Apply pipe sealant or TEFLON® tape to new plug. Install plug.

B—Plug

TEFLON is a registered trademark of Du Pont Co.

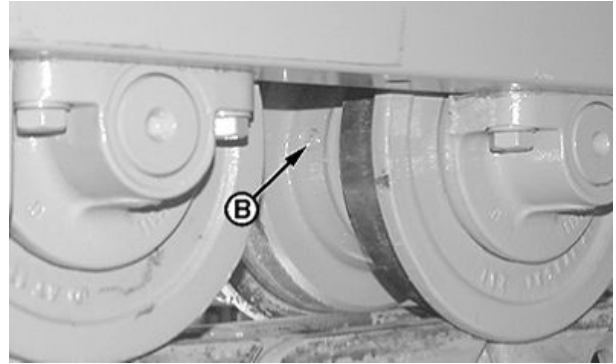

T113532—UN—17FEB98

CED,OUO1032,1041 -19-14JAN08-1/1

Do Not Service Control Valves and Cylinders

If these parts need service, see your authorized dealer.

Special tools and information are needed to service control valves and cylinders.

T82,BHMA,K -19-14JAN08-1/1

Adjusting Engine Speed Control Lever Tension (Earlier Machines)

1. Open the left rear service door.
2. Adjust lock nut (A) until a minimum of 31—40 N (7—9 lb) force is required to initiate movement in the forward direction using a spring scale placed just below the knob of the lever.

A—Lock Nut



T117999B—UN—24NOV98

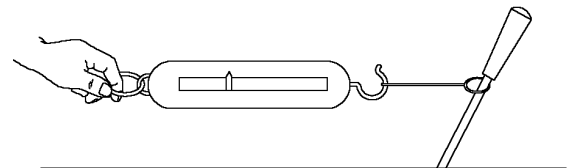

T118767

T118767—UN—11DEC98

CED,OUO1032,787 -19-02JUN03-1/1

Checking Neutral Start System

CAUTION: Avoid possible injury or death. Be sure all people are away from machine when neutral start checks are performed.

1. Move FNR lever to N.
2. Move park lock lever to down (unlocked) position (A).
3. Turn key switch to “Start” position. Starter must not engage. If engine starts, see your authorized dealer.
4. Move park lock lever to up (locked) position (B).
5. Turn key switch to “Start” position. Starter should engage. If engine does not start, see your authorized dealer.
6. Move FNR lever to F or R.
7. Turn key switch to “Start” position. Starter must not engage.
8. Move FNR lever to N.
9. Turn key switch to “Start” position. Starter should engage. If starter does not engage, see your authorized dealer.

A—Unlocked Position

B—Locked Position



T118001B—UN—11NOV98



T118007C—UN—14JAN99

CED,OUO1032,788 -19-07OCT98-1/1

Keep ROPS Installed Properly

Make certain all parts are reinstalled correctly if the roll-over protective structure (ROPS) is loosened or removed for any reason. Tighten mounting bolts (A) to proper torque.

Specification

ROPS Mounting
Bolts—Torque..... 624 N·m (460 lb-ft)

The protection offered by the ROPS will be impaired if the ROPS is subjected to structural damage, is involved in an overturn incident, or is in any way altered by welding, bending, drilling, or cutting. A damaged ROPS should be replaced, not reused.

A—Bolts



Front ROPS Mounting Bolt

T117812B—UN—20OCT98



Rear ROPS Mounting Bolt

T117813B—UN—20OCT98

TX,90,RB48 -19-03DEC97-1/1

Checking Track Shoe Cap Screw Torque

Track shoe bolt torque should be periodically checked. If the cap screws do not meet the minimum torque specifications, remove the shoes and clean the mating surfaces of the shoes and links before tightening the bolts.

Specification

450H and 550H	
Track Shoe Minimum	
Checking—Torque.....	305 ± 14 N·m (225 ± 10 lb-ft)
650H Track	
Shoe Minimum	
Checking—Torque.....	380 ± 14 N·m (280 ± 10 lb-ft)

If unit is operated with loose track shoes, the cap screw holes in the shoes and links will wallow out and it may be difficult to keep the track shoes tight. Loose shoes can also cause hardware failure and loss of track shoes.

Install all track shoe nuts with rounded edges against the link and chamfered edges away from the link. Be sure nut is properly positioned in the link so there is full contact area between the nut and the link.

A—Rounded edge

B—Chamfered edge

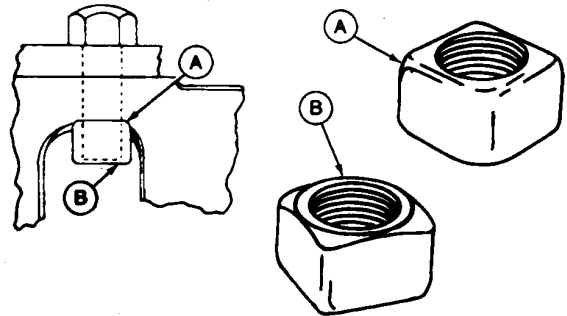
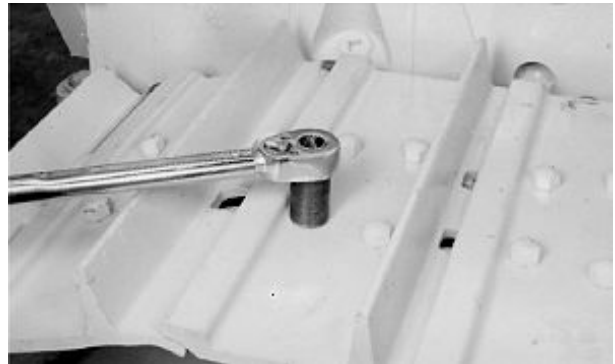

T6009AN—UN—09FEB89

T6794AM—UN—23FEB89

TX,90,FF1972 -19-24APR99-1/2

IMPORTANT: Tighten cap screws to torque specification using a criss-cross pattern. Then repeat torque pattern again.

Tighten cap screws using torque-turn torque method.

Track Shoes—Specification

450H and 550H Track	
Shoe Cap Screw (9/16 in.)—Torque.....	88 N·m (65 lb-ft) Second Pass—Additional 1/3 (120°) turn
650H Track Shoe Cap Screw (5/8 in.)—Torque.....	163 N·m (120 lb-ft) Second Pass—Additional 1/3 (120°) turn
450H and 550H Master Split Link Cap Screw (9/16 in.)—Torque.....	88 N·m (65 lb-ft) Second Pass—Additional 1/3 (120°) turn
650H Master Split Link Cap Screw (5/8 in.)—Torque.....	163 N·m (120 lb-ft) Second Pass—Additional 1/2 (180°) turn

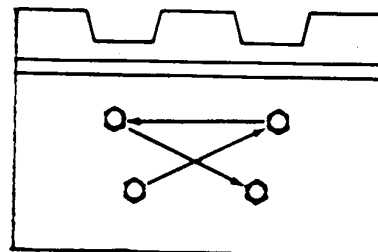

NOTE: Replacement hardware should be lubricated and tightened to above specification.

T6352AH—UN—23FEB89

TX,90,FF1972 -19-24APR99-2/2

Hardware Torque Specifications

Check cap screws and nuts to be sure they are tight. If hardware is loose, tighten to torque shown on the following charts unless a special torque is specified.

T82,SKMA,AT -19-01AUG94-1/1

Unified Inch Bolt and Screw Torque Values

TS1671 —UN—01MAY03

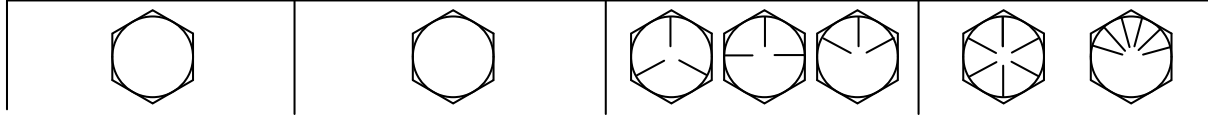

Bolt or Screw Size	SAE Grade 1				SAE Grade 2 ^a				SAE Grade 5, 5.1 or 5.2				SAE Grade 8 or 8.2			
	Lubricated ^b		Dry ^c		Lubricated ^b		Dry ^c		Lubricated ^b		Dry ^c		Lubricated ^b		Dry ^c	
	N·m	lb.-in.	N·m	lb.-in.	N·m	lb.-in.	N·m	lb.-in.	N·m	lb.-in.	N·m	lb.-in.	N·m	lb.-in.	N·m	lb.-in.
1/4	3.7	33	4.7	42	6	53	7.5	66	9.5	84	12	106	13.5	120	17	150
													N·m	lb.-ft.	N·m	lb.-ft.
5/16	7.7	68	9.8	86	12	106	15.5	137	19.5	172	25	221	28	20.5	35	26
									N·m	lb.-ft.	N·m	lb.-ft.				
3/8	13.5	120	17.5	155	22	194	27	240	35	26	44	32.5	49	36	63	46
			N·m	lb.-ft.	N·m	lb.-ft.	N·m	lb.-ft.								
7/16	22	194	28	20.5	35	26	44	32.5	56	41	70	52	80	59	100	74
	N·m	lb.-ft.														
1/2	34	25	42	31	53	39	67	49	85	63	110	80	120	88	155	115
9/16	48	35.5	60	45	76	56	95	70	125	92	155	115	175	130	220	165
5/8	67	49	85	63	105	77	135	100	170	125	215	160	240	175	305	225
3/4	120	88	150	110	190	140	240	175	300	220	380	280	425	315	540	400
7/8	190	140	240	175	190	140	240	175	490	360	615	455	690	510	870	640
1	285	210	360	265	285	210	360	265	730	540	920	680	1030	760	1300	960
1-1/8	400	300	510	375	400	300	510	375	910	670	1150	850	1450	1075	1850	1350
1-1/4	570	420	725	535	570	420	725	535	1280	945	1630	1200	2050	1500	2600	1920
1-3/8	750	550	950	700	750	550	950	700	1700	1250	2140	1580	2700	2000	3400	2500
1-1/2	990	730	1250	930	990	730	1250	930	2250	1650	2850	2100	3600	2650	4550	3350

Torque values listed are for general use only, based on the strength of the bolt or screw. DO NOT use these values if a different torque value or tightening procedure is given for a specific application. For plastic insert or crimped steel type lock nuts, for stainless steel fasteners, or for nuts on U-bolts, see the tightening instructions for the specific application. Shear bolts are designed to fail under predetermined loads. Always replace shear bolts with identical grade.

Replace fasteners with the same or higher grade. If higher grade fasteners are used, tighten these to the strength of the original. Make sure fastener threads are clean and that you properly start thread engagement. When possible, lubricate plain or zinc plated fasteners other than lock nuts, wheel bolts or wheel nuts, unless different instructions are given for the specific application.

^aGrade 2 applies for hex cap screws (not hex bolts) up to 6 in. (152 mm) long. Grade 1 applies for hex cap screws over 6 in. (152 mm) long, and for all other types of bolts and screws of any length.

^b"Lubricated" means coated with a lubricant such as engine oil, fasteners with phosphate and oil coatings, or 7/8 in. and larger fasteners with JDM F13C, F13F or F13J zinc flake coating.

^c"Dry" means plain or zinc plated without any lubrication, or 1/4 to 3/4 in. fasteners with JDM F13B, F13E or F13H zinc flake coating.

DX,TORQ1 -19-12JAN11-1/1

Metric Bolt and Screw Torque Values

TS1670 —UN—01MAY03

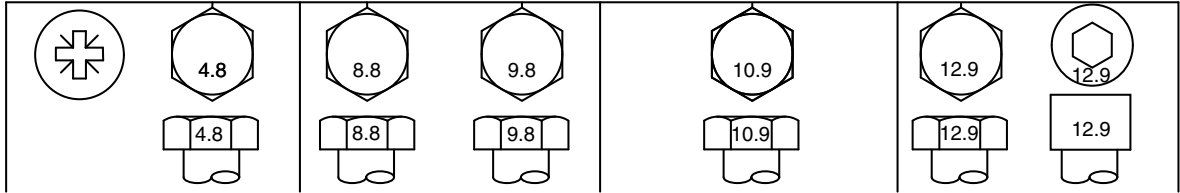

Bolt or Screw Size	Class 4.8				Class 8.8 or 9.8				Class 10.9				Class 12.9			
	Lubricated ^a		Dry ^b		Lubricated ^a		Dry ^b		Lubricated ^a		Dry ^b		Lubricated ^a		Dry ^b	
	N·m	lb.-in.	N·m	lb.-in.	N·m	lb.-in.	N·m	lb.-in.	N·m	lb.-in.	N·m	lb.-in.	N·m	lb.-in.	N·m	lb.-in.
M6	4.7	42	6	53	8.9	79	11.3	100	13	115	16.5	146	15.5	137	19.5	172
M8	11.5	102	14.5	128	22	194	27.5	243	32	23.5	40	29.5	37	27.5	47	35
M10	23	204	29	21	43	32	55	40	63	46	80	59	75	55	95	70
M12	40	29.5	50	37	75	55	95	70	110	80	140	105	130	95	165	120
M14	63	46	80	59	120	88	150	110	175	130	220	165	205	150	260	190
M16	100	74	125	92	190	140	240	175	275	200	350	255	320	235	400	300
M18	135	100	170	125	265	195	330	245	375	275	475	350	440	325	560	410
M20	190	140	245	180	375	275	475	350	530	390	675	500	625	460	790	580
M22	265	195	330	245	510	375	650	480	725	535	920	680	850	625	1080	800
M24	330	245	425	315	650	480	820	600	920	680	1150	850	1080	800	1350	1000
M27	490	360	625	460	950	700	1200	885	1350	1000	1700	1250	1580	1160	2000	1475
M30	660	490	850	625	1290	950	1630	1200	1850	1350	2300	1700	2140	1580	2700	2000
M33	900	665	1150	850	1750	1300	2200	1625	2500	1850	3150	2325	2900	2150	3700	2730
M36	1150	850	1450	1075	2250	1650	2850	2100	3200	2350	4050	3000	3750	2770	4750	3500

Torque values listed are for general use only, based on the strength of the bolt or screw. DO NOT use these values if a different torque value or tightening procedure is given for a specific application. For stainless steel fasteners or for nuts on U-bolts, see the tightening instructions for the specific application. Tighten plastic insert or crimped steel type lock nuts by turning the nut to the dry torque shown in the chart, unless different instructions are given for the specific application.

Shear bolts are designed to fail under predetermined loads. Always replace shear bolts with identical property class. Replace fasteners with the same or higher property class. If higher property class fasteners are used, tighten these to the strength of the original. Make sure fastener threads are clean and that you properly start thread engagement. When possible, lubricate plain or zinc plated fasteners other than lock nuts, wheel bolts or wheel nuts, unless different instructions are given for the specific application.

^a"Lubricated" means coated with a lubricant such as engine oil, fasteners with phosphate and oil coatings, or M20 and larger fasteners with JDM F13C, F13F or F13J zinc flake coating.

^b"Dry" means plain or zinc plated without any lubrication, or M6 to M18 fasteners with JDM F13B, F13E or F13H zinc flake coating.

Miscellaneous—Operational Checkout

Operational Checkout

Use this procedure to check all systems and functions on the machine. It is designed so you can make a quick check of the operation of the machine while doing a walk-around inspection and performing specific checks from the operator's seat.

Should you experience a problem with your machine, you will find helpful diagnostic information in this checkout that will pinpoint the cause. This information may allow you to perform a simple adjustment which will reduce the downtime of your machine. Use the table of contents to help find adjustment procedures.

The information you provide after completing the operational checkout will allow you or your authorized dealer to pinpoint the specific test or repair work needed to restore the machine to design specifications.

A location will be required which is level and has adequate space to complete the checks. No tools or equipment are needed to perform the checkout.

Complete the necessary visual checks (oil levels, oil condition, external leaks, loose hardware, linkage, wiring, etc.) prior to doing the checkout. The machine must be at operating temperature for many of the checks.

Start at the top of the left column and read completely down the column before performing check, follow this sequence from left to right. In the far right column, if no problem is found (OK), you will be instructed to go to next check. If a problem is indicated (NOT OK), you will be referred to either a section in this manual, or to your authorized dealer.

HG31779,00000D1 -19-03SEP02-1/57

Cooling System Checks

HG31779,00000D1 -19-03SEP02-2/57

Radiator Cap, Coolant Level, Coolant Condition Checks

 **CAUTION: Explosive release of fluids from pressurized cooling system can cause serious burns. DO NOT remove radiator cap unless engine is cool. Then turn cap slowly to the stop. Release all pressure before you remove cap.**

Open radiator cap.

LISTEN: If radiator is warmer than air temperature, a "whoosh" must be heard when radiator cap is opened to first stop position.

FEEL: The radiator cap must have a stop position and must be pushed down to turn to remove.

Inspect coolant level, coolant condition.

LOOK: The radiator cap must have a good seal and gasket. The seal must move freely and the spring must not be corroded.

LOOK: The coolant must not be oily, foamy, or rusty.

OK: Check complete.

NOT OK: If vacuum release valve is plugged or spring corroded, replace radiator cap.

NOT OK: If coolant is oily or foamy, see your authorized dealer.

NOT OK: If rust in coolant, drain, flush and replace coolant, [see Drain the Cooling System](#). (Section 4-1.)

NOT OK: If radiator is low and coolant tank has coolant in it, check for air leak on recovery hose. See your authorized dealer.

Continued on next page

HG31779,00000D1 -19-03SEP02-3/57

Miscellaneous—Operational Checkout

Radiator Outside Air Flow Check (Blower Fan)

⚠ CAUTION: Prevent possible injury from unexpected machine movement. Keep park lock lever in up (locked) position during this check to prevent movement of unit.

Start engine. Run at fast idle.

FEEL: Air flow must be brisk and even through radiator.

NOTE: It is normal to have less air flow at center of fan.

Stop engine.

Inspect fins for mud and debris.

LOOK: Sides of radiator must be free of mud, leaves, grass, and other debris.

Inspect radiator for bent or damaged fins.

LOOK: Fins must be straight and not broken or cracked.

OK: Check complete.

NOT OK: Clean outside of radiator.

NOT OK: Straighten fins. Replace radiator if severely damaged. See your authorized dealer.

HG31779,00000D1 -19-03SEP02-4/57

Hose, Clamps, and Water Pump Checks

Inspect all radiator and heater hoses for cracks or leaks.

Inspect all hose clamps.

Inspect water pump for leaks.

LOOK: Radiator and heater hoses must NOT be brittle, show signs of leaks, or rub on adjacent parts.

LOOK: All hose clamps must be tight and perpendicular to the hose. Crooked clamps can cause damage and leaks.

LOOK: Water pump must NOT show signs of leaks.

OK: Check complete.

NOT OK: Replace damaged hoses. See your authorized dealer.

NOT OK: Straighten and tighten clamps. See your authorized dealer.

NOT OK: Replace water pump. See your authorized dealer.

HG31779,00000D1 -19-03SEP02-5/57

Fan Checks



T6558AN —UN—23AUG93

Remove engine side shield.

Inspect fan blades for damage.

LOOK: Fan blades must not have any nicks or bends.

Check fan for correct installation.

LOOK: Cupped portion of fan blades must be forward from radiator.

NOTE: If fan is installed backwards, about 50% of its capacity is lost.

OK: Check complete.

NOT OK: If blades are bent, replace fan. If fan blades are nicked, repair. See your authorized dealer.

NOT OK: Remove and reinstall fan. See your authorized dealer.

Continued on next page

HG31779,00000D1 -19-03SEP02-6/57

Fan Shroud and Fan Guard Checks

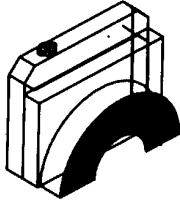

T6488GC —UN—23AUG93

Check fan to fan shroud clearance.

Inspect fan guard.

LOOK: Fan must be centered in fan shroud.

LOOK: Guard must NOT be bent or damaged, all mounting brackets must be intact and all hardware must be tight.

OK: Check complete.

NOT OK: Adjust fan shroud to center fan. See your authorized dealer.

NOT OK: Repair or replace guard. Tighten hardware. See your authorized dealer.

HG31779,00000D1 -19-03SEP02-7/57

Fan Belt Checks

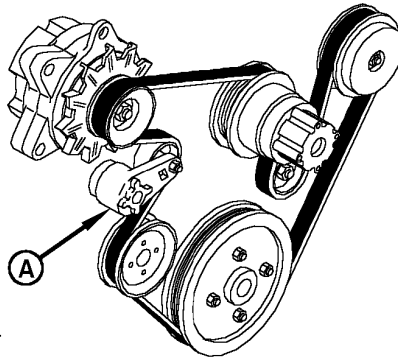

T118314

T118314 —UN—01DEC98

A—Tension Adapter

Inspect condition of belt. Tension adapter (A) will automatically adjust to belt wear.

LOOK: There must NOT be any oil or grease on fan belt or pulley.

LOOK: Inside surface of belt must NOT have any cracks.

Check fan belt for tightness.

LOOK: Serpentine belt tension stop on swing arm must NOT contact fixed stops on tensioner (A).

LISTEN: Fan belt must not squeal when engine is stopped.

OK: Check complete.

NOT OK: Replace fan belt. See [Inspect Serpentine Belt](#). (Section 3-3.)

HG31779,00000D1 -19-03SEP02-8/57

Fuel System Checks

Continued on next page

HG31779,00000D1 -19-03SEP02-9/57

Start Aid Checks

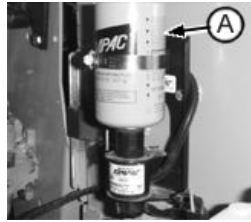

T118188B —UN—02NOV98



T118723B —UN—01DEC98

A—Canister

Open right rear service door.

Check position of canister (A) in holder.

Inspect plastic line from top of starting aid to air intake manifold.

Press and hold starting aid button down to operate starting aid.

LOOK: *There must NOT be any kinks or breaks in line and ends must be installed securely.*

Check for dot on ether starting aid nozzle in air intake manifold.

LOOK: *Dot must be at the 12 o'clock position on the fitting of air intake manifold.*

OK: Check complete.

NOT OK: Can must click onto solenoid.

NOT OK: Replace plastic line. See your authorized dealer.

NOT OK: Adjust fitting so dot is in correct position.

HG31779,00000D1 -19-03SEP02-10/57

Water Separator Trap Check



T119033B —UN—15DEC98

Open rear right side service access door.

Loosen drain knob and drain fuel for several seconds or until water and sediment are removed.

LOOK: *Fuel must flow from drain tube.*

Tighten drain knob.

OK: Check complete.

NOT OK: No flow, remove and clean valve. See your authorized dealer.

NOT OK: Replace valve. See your authorized dealer.

Continued on next page

HG31779,00000D1 -19-03SEP02-11/57

Miscellaneous—Operational Checkout

Fuel Cap



T118247C —UN—24NOV98

Remove fuel cap.

NOTE: Air "hiss" from tank is normal when cap is removed.

Inspect fuel cap seal.

LOOK: Seal on fuel cap must NOT be damaged and vents must be open.

OK: Check complete.

NOT OK: Replace fuel cap.

HG31779,00000D1 -19-03SEP02-12/57

Fuel Tank Check



T118247C —UN—24NOV98

NOTE: Do this check before you refuel.

Remove fuel cap.

Use a flashlight and inspect bottom of fuel tank by shining light through the fuel.

LOOK: There must NOT be any pieces of debris such as leaves in bottom of fuel tank that would restrict fuel flow.

LOOK: Fuel sender ball must be floating on fuel.

OK: Check complete.

NOT OK: Remove large pieces of debris through filler neck.

Continued on next page

HG31779,00000D1 -19-03SEP02-13/57

Final Fuel Filter Checks



T119041B —UN—15DEC98

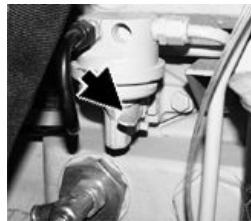

T119032B —UN—15DEC98

Remove right side engine side shield.

"Crack" open bleed screw on fuel filter and operate hand primer on fuel transfer pump.

LOOK: Fuel must come out of bleed screw when hand primer is operated.

Tighten bleed screw of fuel filter and again operate hand primer on fuel pump.

FEEL: Resistance must be felt when fuel is being pumped and no resistance will be felt after system is pumped up.



T119034B —UN—15DEC98

Turn fuel filter knob to drain sediment.

OK: Check complete.

NOT OK: Be certain fuel filter is clean. If not, replace filter and recheck fuel pump. See Replace Final Fuel Filter. (Section 3-7)

HG31779,00000D1 -19-03SEP02-14/57

Transmission Checks

HG31779,00000D1 -19-03SEP02-15/57

Park Lock/Neutral Start Switch and Reverse Warning Alarm Check

NOTE: If park lock lever is down and brake pedal is depressed, engine will start.

Park lock lever down.

Turn key switch to "Start" position.

LOOK: Brake pedal will move UP and must travel to fullup position

LOOK: Engine must not crank.

Park lock lever up and FNR lever in forward.

Turn key switch to start position.

LOOK: Engine must not crank.

Move FNR lever to reverse and key switch to start.

LOOK: Engine must not crank and reverse warning alarm must sound.

Depress brake pedal.

LISTEN: Reverse warning alarm must NOT sound.

OK: Check complete.

NOT OK: See your authorized dealer.

NOT OK: Reverse warning alarm continues to sound. See your authorized dealer.

Continued on next page

HG31779,00000D1 -19-03SEP02-16/57

Miscellaneous—Operational Checkout

<p>Transmission Filter Restriction Indicator, Transmission Oil Temperature and Park Brake Indicator Check</p>	<p>Key switch "On" to bulb check position.</p> <p><i>LOOK: Transmission oil filter restriction light, hydraulic oil filter restriction light, transmission oil temperature light, fasten seat belt indicator, and park brake indicator on.</i></p> <p>Start engine and set at slow idle.</p> <p><i>LOOK: Transmission oil filter and temperature indicators OFF, park brake indicator on.</i></p> <p>Lower park brake lever.</p> <p><i>LOOK: Park brake indicator goes OFF.</i></p>	<p>OK: Check complete.</p> <p>NOT OK: Check bulb in monitor. See your authorized dealer.</p> <p>HG31779,00000D1 -19-03SEP02-17/57</p>
--	---	---

<p>Transmission Gauge and Charge Pressure Check</p>	<p>Start engine and position engine speed control lever at slow idle.</p> <p><i>LOOK: Needle must be in the green.</i></p> <p>Slowly increase engine speed to fast idle.</p> <p><i>LOOK: Needle must gradually rise as speed increases. At fast idle needle must still be in the green with very minimal fluctuation.</i></p> <p><i>NOTE: Transmission oil filter restriction indicator might stay on until oil reaches operating temperature.</i></p>	<p>OK: Check complete.</p> <p>NOT OK: See your authorized dealer.</p> <p>HG31779,00000D1 -19-03SEP02-18/57</p>
--	--	--

<p>Park Brake Valve Leakage Check</p>	<p>Operate machine for several minutes to heat hydrostatic oil to normal operating temperature.</p> <p>Position engine speed control at slow idle with park lock lever UP.</p> <p><i>LOOK: Observe transmission pressure gauge while moving park lock lever to DOWN position. Brake pedal will move to full UP position as park brake lever is lowered.</i></p> <p><i>LOOK: Pressure should drop as park lock lever is moved DOWN, then return to original value.</i></p> <p>Depress brake pedal.</p> <p><i>LOOK: Pressure should drop as brake pedal is released, then return to original value.</i></p> <p><i>LOOK: Observe tracks for any creep or movement.</i></p>	<p>OK: Check complete.</p> <p>NOT OK: Isolate park brakes, brake valve to locate leakage. See your authorized dealer.</p> <p>NOT OK: Tracks move in neutral, see your authorized dealer.</p> <p>HG31779,00000D1 -19-03SEP02-19/57</p>
--	---	--

<p>Park Brake Operational Check</p>	<p> CAUTION: Pushing on brake pedal will stop machine abruptly.</p> <p>Operate machine slowly in forward. Fully depress park brake pedal and then release.</p> <p><i>LOOK: Machine MUST STOP when the pedal is depressed and MUST MOVE when pedal is released.</i></p>	<p>OK: Check complete.</p> <p>NOT OK: See your authorized dealer.</p> <p>Continued on next page</p> <p>HG31779,00000D1 -19-03SEP02-20/57</p>
--	--	--

Miscellaneous—Operational Checkout

<p>Steering Checks</p>	<p>Transmission speed control at minimum speed position or speed in grip (if equipped) at 1.0.</p> <p>Run engine at approximately 1200 rpm. FNR to forward. Move steer lever or speed in grip to right hand detent position.</p> <p><i>LOOK: The right hand track should stop and transmission pressure should remain in the green.</i></p> <p>Move steer lever to maximum right hand position.</p> <p><i>LOOK: The right hand track must counter-rotate and transmission pressure should remain in the green.</i></p> <p>Repeat check for left hand track.</p> <p><i>NOTE: Steering rate and modulation can be set to operator preference (Low, Med or High).</i></p> <p><i>StrR (Steer Rate) Setting the machine responsiveness to a change in steering lever movement for right and left steer.</i></p> <p><i>StrM (Steer Modulation) Setting the right and left modulation changes the amount of steering that occurs for a given amount of steering lever movement.</i></p>	<p>OK: Check complete.</p> <p>NOT OK: If track will not stop or will not counter-rotate. See your authorized dealer.</p> <p>NOT OK: If charge pressure is not in green. See your authorized dealer.</p>
-------------------------------	---	--

HG31779,00000D1 -19-03SEP02-21/57

<p>Decelerator Pedal Check</p>	<p>Start engine.</p> <p>Park lock lever down.</p> <p>Depress decelerator pedal.</p> <p>Move engine speed control lever to fast idle.</p> <p>Transmission speed control at maximum speed or speed in grip (if equipped) to 3.0. FNR in forward.</p> <p>Release decelerator pedal.</p> <p><i>LOOK: Machine must accelerate smoothly to maximum speed.</i></p> <p><i>NOTE: Decelerator response time can be set to operator preference.</i></p>	<p>OK: Check complete.</p> <p>NOT OK: If engine speed increases and decelerator pedal moves up, see your authorized dealer.</p>
---------------------------------------	--	---

HG31779,00000D1 -19-03SEP02-22/57

<p>FNR Check</p>	<p>Engine speed at 1500 rpm. Transmission speed control at position 1 1/2 or speed in grip (if equipped) to 2.0. Make several shifts from neutral to forward, neutral to reverse and then forward to reverse.</p> <p style="text-align: center;">Specification</p> <p>Engine—Speed..... 1500 rpm</p> <p><i>LOOK: Observe how both tracks start to increase in speed. Both tracks must start at the same time and machine should move forward or reverse in a straight line.</i></p> <p><i>NOTE: FNR shift rate can be set to operator preference. Low has a slower reaction time and high has a quicker reaction time.</i></p>	<p>OK: Check complete.</p> <p>NOT OK: See your authorized dealer.</p>
-------------------------	---	---

HG31779,00000D1 -19-03SEP02-23/57

<p>Multi-Function Relief Valve Check (Closed Loop System Relief Valve)</p>	<p>Engine at fast idle.</p> <p>Transmission speed at 2 1/2 position or speed in grip (if equipped) to 2.5.</p> <p>Machine at operating temperature.</p> <p>Place machine under heavy load with blade.</p> <p><i>LOOK: Machine must push straight and tracks maintain same speed.</i></p> <p><i>LISTEN: Engine must not cycle as heavy load is pushed.</i></p>	<p>OK: Check complete.</p> <p>NOT OK: See your authorized dealer.</p>
---	---	---

Continued on next page

HG31779,00000D1 -19-03SEP02-24/57

Battery Disconnect Switch, Key Switch, Display Monitor, Battery, And Hour Meter Checks

HG31779,00000D1 -19-03SEP02-25/57

Battery Disconnect Switch Check



T118722B —UN—01DEC98

NOTE: Disconnect switch is located on left side of machine through the battery access door.

Turn battery disconnect switch OFF.

Turn key switch "On".

LOOK: Do indicator lights illuminate?

OK: Check battery disconnect switch. See your authorized dealer.

NOT OK: Continue check.

Turn battery disconnect switch ON.

Turn key switch "On", but do not start engine.

LOOK: Do indicator lights illuminate?

OK: Go to next check.

NOT OK: Check battery disconnect switch. See your authorized dealer.

HG31779,00000D1 -19-03SEP02-26/57

Hour Meter Circuit Check

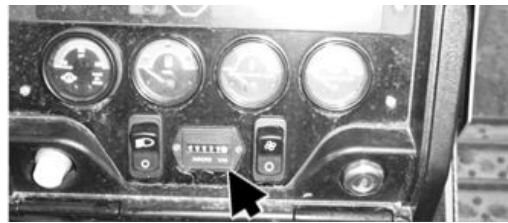

T118152B —UN—30OCT98

Earlier Machine Shown

Start engine.

LOOK: Hour meter must be rotating after 1/10 hour.

Stop engine, turn key switch "On".

LOOK: Hour meter must not rotate.

OK: Go to next check.

NOT OK: See your authorized dealer.

HG31779,00000D1 -19-03SEP02-27/57

Work Light Check

Key switch "On".

Push work light switch on.

LOOK: Both front work lights and rear light must come on.

OK: Go to next check.

NOT OK: Replace bulbs.

NOT OK: Check wiring. See your authorized dealer.

Continued on next page

HG31779,00000D1 -19-03SEP02-28/57

Front/Rear Wiper and Washer Motor Check—If Equipped

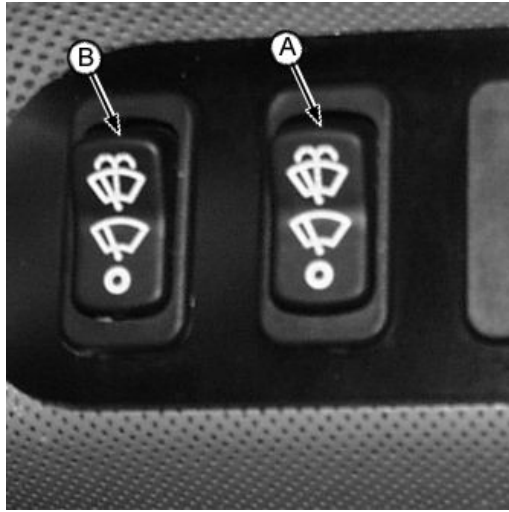

T119018B —UN—14DEC98

A—Front/Rear Wiper Rocker Switch

Key switch "On".

Push rocker switch (A) to first detent, middle position.

LOOK: Both front/rear wiper motors should operate.

Push rocker switch all the way in and hold.

LOOK: Both front/rear wiper motors and washer motor should operate.

OK: Go to next check.

NOT OK: Check fuse. See your authorized dealer.

HG31779,00000D1 -19-03SEP02-29/57

Left/Right Wiper and Washer Motor Check—If Equipped

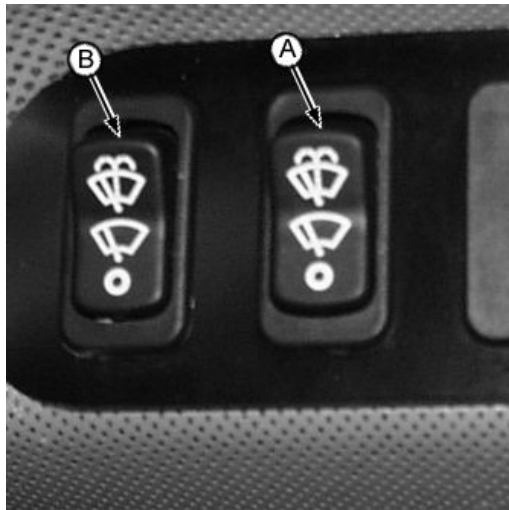

T119018B —UN—14DEC98

B—Left/Right Wiper Rocker Switch

Key switch "On".

Push rocker switch (B) to first detent, middle position.

LOOK: Both left/right wiper motors should operate.

Push rocker switch all the way in and hold.

LOOK: Both left/right wiper motors and washer motor should operate .

OK: Go to next check.

NOT OK: Check fuse. See your authorized dealer.

HG31779,00000D1 -19-03SEP02-30/57

Continued on next page

Miscellaneous—Operational Checkout

<p>Key Switch, Monitor, and Bulb Check</p>	<p>Turn key switch "On".</p> <p>Stop light, engine oil pressure light, volts, and fasten seat belt/park brake light will be ON. The warning alarm will sound.</p> <p>Turn key switch between "On" and "Start" position to check bulbs.</p> <p><i>LOOK: Does winch oil pressure (if equipped), check service code, stop, engine coolant, engine air filter, volts, transmission oil filter, engine oil pressure, transmission oil temperature, hydraulic oil filter, and fasten seat belt/park brake come on and warning alarm sound?</i></p>	<p>OK: Go to next check.</p> <p>NOT OK: See your authorized dealer.</p> <p>HG31779,00000D1 -19-03SEP02-31/57</p>
---	--	--

<p>Alternator Check</p>	<p>Key ON.</p> <p>Start engine.</p> <p><i>LOOK: Is volts light on?</i></p>	<p>OK: See your authorized dealer.</p> <p>OK: Check and recharge batteries.</p> <p>NOT OK: Go to next check.</p> <p>HG31779,00000D1 -19-03SEP02-32/57</p>
--------------------------------	--	--

Air Restriction Indicator Check and Reverse Warning Alarm Checks (Engine Off)

HG31779,00000D1 -19-03SEP02-33/57

<p>Air Restriction Indicator Check</p>	<div style="text-align: center;">  </div> <p>T117820</p> <p>T117820 —UN—25NOV98</p> <p>Start engine.</p> <p><i>LOOK: Does indicator light come on?</i></p>	<p>OK: Clean or replace air cleaner elements.</p> <p><u>See Replace Air Cleaner Elements.</u> (Section 3-8.)</p> <p>NOT OK: Go to next check.</p> <p>HG31779,00000D1 -19-03SEP02-34/57</p>
---	--	--

<p>Reverse Warning Alarm Check</p>	<p>Key switch "On", engine OFF.</p> <p>Pull park lock lever down (unlocked).</p> <p>Move FNR lever to reverse.</p> <p><i>LISTEN: Reverse warning alarm must sound in reverse.</i></p>	<p>OK: Go to next check.</p> <p>NOT OK: See your authorized dealer.</p> <p>HG31779,00000D1 -19-03SEP02-35/57</p>
---	---	--

Neutral Start Switch and Start Circuit Checks

Continued on next page

HG31779,00000D1 -19-03SEP02-36/57

Miscellaneous—Operational Checkout

<p>Neutral Start Switch Check</p>	<p>Park lock lever down.</p> <p>Move FNR to NEUTRAL.</p> <p>Apply brakes.</p> <p>Turn key to START position.</p> <p><i>LISTEN: Does machine start?</i></p>	<p>OK: If machine starts, go to next check.</p> <p>NOT OK: If machine does not start, see your authorized dealer.</p>
	<p>Park lock lever UP.</p> <p>Move FNR to neutral.</p> <p>Turn key to start position.</p> <p><i>LISTEN: Does machine start?</i></p>	<p>OK: If machine starts, go to next check.</p> <p>NOT OK: If machine does not start, see your authorized dealer.</p>
	<p>Pull park lock lever UP.</p> <p>Move FNR to forward or reverse.</p> <p>Turn key to start position.</p> <p><i>LISTEN: Starting motor MUST NOT operate.</i></p>	<p>OK: If starting motor does not operate, go to next check.</p> <p>NOT OK: If starting motor operates, see your authorized dealer.</p>
	<p>Pull park lock lever DOWN.</p> <p>Move FNR to forward or reverse.</p> <p>Turn key to start position.</p> <p><i>LISTEN: Does machine start?</i></p>	<p>OK: If machine does not start, go to next check.</p> <p>NOT OK: If machine starts, see your authorized dealer.</p>

HG31779,00000D1 -19-03SEP02-37/57

<p>Start Circuit Check</p>	<p>Park lock lever UP and FNR in NEUTRAL.</p> <p>Turn key to "Start" position.</p> <p><i>LISTEN: Starting motor must operate.</i></p> <p><i>LISTEN: Engine must start.</i></p> <p><i>LOOK/LISTEN: During engine cranking, on monitor indicator all monitor functions must be ON and alarm must BEEP. On gauge package, low voltage and engine oil pressure indicators must be ON, fuel gauge needles moves to full and other gauge needles move slightly.</i></p>	<p>OK: Go next check.</p> <p>NOT OK: Starting motor did not turn. See your authorized dealer.</p> <p>NOT OK: Oil Pressure indicator stays on for more than 3 seconds after start-up. Stop engine and check oil level. See Check Engine Oil Level. (Section 3-4.)</p> <p>NOT OK: Starting motor turns, but engine does not start. See your authorized dealer.</p> <p>NOT OK: See your authorized dealer.</p>
-----------------------------------	---	--

HG31779,00000D1 -19-03SEP02-38/57

<p>Hydraulic System Checks</p>	<p>Continued on next page</p>	<p>HG31779,00000D1 -19-03SEP02-39/57</p>
---------------------------------------	-------------------------------	--

Miscellaneous—Operational Checkout

<p>Visual Check</p>	<p>Park machine on level surface. Lower all equipment to ground. <i>LOOK: Hydraulic oil must be visible in sight glass located inside right rear access door.</i> <i>LOOK: Hydraulic lines and fitting must not seep or leak oil.</i></p> <p><i>LOOK: Cylinder seals must not seep or leak oil.</i></p>	<p>OK: Go to next check. NOT OK: Add oil. <u>See Change Hydraulic Oil and Filter.</u> (Section 3-9.) NOT OK: Repair leaks. See your authorized dealer.</p> <p>HG31779,00000D1 -19-03SEP02-40/57</p>
----------------------------	---	--

<p>Drift Check</p>	<p>Operate engine at slow idle. Place dozer blade 50 mm (2 in.) from ground. <i>LOOK: Blade must NOT touch ground within two minutes.</i></p>	<p>OK: Go to next check. NOT OK: Determine if drift is excessive for your operation, see your authorized dealer.</p> <p>HG31779,00000D1 -19-03SEP02-41/57</p>
---------------------------	---	---

<p>Control Valve Lift Check Test</p>	<div data-bbox="394 825 599 991" data-label="Image"> </div> <p>T6583AE —UN—23AUG93</p> <p>Raise dozer approximately 305 mm (1.0 ft) above ground. Stop engine. Pull blade lever control lever. <i>LOOK: Blade must not lower.</i></p> <p>Start engine and raise front of machine, tilt full right. Stop engine. Push blade level control lever to power down position and tilt right. <i>LOOK: Machine must not lower.</i></p> <p>Start engine and tilt blade full left. Stop engine. Push blade level control lever to tilt left. <i>LOOK: Machine must not lower.</i></p>	<p>OK: Go to next check. NOT OK: Inspect lift check in valve. See your authorized dealer.</p> <p>HG31779,00000D1 -19-03SEP02-42/57</p>
---	---	--

<p>Blade Float Check</p>	<p>Raise front of crawler off of ground with blade. Push blade level control lever into float detent. <i>LOOK: Front of crawler must lower to ground.</i> <i>FEEL: Blade level control lever must stay in float detent position.</i></p>	<p>OK: Go to next check. NOT OK: Inspect and repair valve detents. See your authorized dealer.</p> <p>HG31779,00000D1 -19-03SEP02-43/57</p>
---------------------------------	--	---

Continued on next page

Hydraulic Pump Performance Check

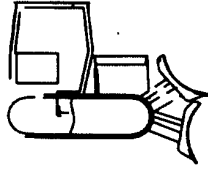

T6583AE —UN—23AUG93

Hydraulic oil must be at operating temperature 66°C (150°F).
Operate engine at slow idle.
Place blade on ground.
Record time required to raise blade.

LOOK: Maximum cycle time 7.5 seconds.

OK: Go to next check.
NOT OK: Check oil level and condition. See Check Hydraulic Oil Level. (Section 3-4.)
NOT OK: See your authorized dealer.

HG31779,00000D1 -19-03SEP02-44/57

Undercarriage Checks

HG31779,00000D1 -19-03SEP02-45/57

Track Sag Roller and Idler Leakage Checks

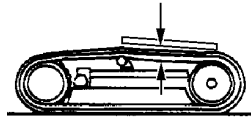

T119010 —UN—14DEC98

Measure track sag at longest span of unsupported track.

LOOK: Track sag must be 51 ± 6 mm (2 ± 1/4 in.).

Inspect rollers and front idler.

LOOK: No oil seepage must be noted from roller or idlers.

OK: Go to next check.
NOT OK: Adjust track sag. See Adjust Track Sag. (Section 3-3.)
NOT OK: Repair or replace roller or idler. See your authorized dealer.

HG31779,00000D1 -19-03SEP02-46/57

Grouser Wear, Bent Track Shoe, and Loose Hardware Checks

Inspect for worn grousers, bent track shoes and loose shoe hardware.

LOOK: Grouser bars must NOT be worn excessively and track shoes must NOT be bent and hardware must be tight.

NOTE: Excessive grouser wear weakens track shoes and may result in track shoes bending.

OK: Go to next check.
NOT OK: If shoe hardware is loose, remove shoe and clean joint before tightening. See Checking Track Shoe Cap Screw Torque. (Section 4-1.)

Continued on next page

HG31779,00000D1 -19-03SEP02-47/57

Miscellaneous—Operational Checkout

<p>Track Roller Check</p>	<p>Have another person operate machine in forward direction. <i>LOOK: All rollers must turn but must NOT "wobble".</i></p>	<p>OK: Go to next check. NOT OK: Repair. See your authorized dealer. HG31779,00000D1 -19-03SEP02-48/57</p>
----------------------------------	---	--

<p>Accessory Checks</p> <p style="text-align: right;">HG31779,00000D1 -19-03SEP02-49/57</p>
--

<p>Seat Control Checks</p>	<p>Does seat raise and lower easily? Does seat angle change easily? Does lever unlock easily and then lock to hold seat and consoles in position? Does lever move easily to unlock seat support? Does seat move forward and rearward easily? Does lever lock seat support in position when released? Does seat back tilt forward and rearward easily? Does lever unlock and lock easily to hold seat back in position? See Adjusting the Seat. (Section 2-1.)</p>	<p>OK: Go to next check. NOT OK: Inspect linkage and repair. Go to your authorized dealer. HG31779,00000D1 -19-03SEP02-50/57</p>
-----------------------------------	---	--

<p>Visual Inspection of All Lines and Hoses</p>	<p>Engine OFF. Inspect all lines and hoses. Are lines and hoses straight, NOT kinked or worn from rubbing on other machine parts or "weather checked"? Are hose and line connections clean, NOT showing signs of leakage, such as oil or dust accumulation at fittings? All hose and line clamps must be in place and tight. Clamps must have rubber inserts or cushions in place to prevent clamps from crushing or wearing into hoses or lines?</p>	<p>OK: Check complete. NOT OK: Reposition hoses or lines and tighten or replace clamps. Tighten fittings or replace O-rings in fittings. Replace hoses or lines as required. See your authorized dealer. HG31779,00000D1 -19-03SEP02-51/57</p>
--	---	--

<p>Air Conditioner Compressor Check—If Equipped</p>	<p>Inspect compressor and belt. <i>LOOK: Is drive belt tight?</i> <i>LOOK: Is belt in good condition, NOT frayed, worn or glazed?</i> <i>LOOK: Are compressor mounting brackets in good condition, and bracket cap screws tight?</i> <i>LOOK: Is belt pulley in good condition, NOT worn or groved?</i> <i>LOOK: Are electrical connections to compressor clutch clean and tight? Is wiring to compressor in good condition?</i> Turn fan ON to check for interference to shroud due to damaged fan blades. Check wiring harness system for damage or cuts. <i>LISTEN: Is there any noise of fan blades to shroud?</i> <i>LOOK: Are air conditioner hoses protected by cordura sleeves in engine compartment next to fan shroud and alternator area?</i></p>	<p>OK: Check complete. NOT OK: Repair or replace components as required. See your authorized dealer. HG31779,00000D1 -19-03SEP02-52/57</p>
--	---	--

Continued on next page

Miscellaneous—Operational Checkout

Cab Door and Window Seals Check

Open and close door and windows. Inspect seals.

LOOK: Do door and windows contact seals evenly?

LOOK: Are seals in position and in good condition?

LOOK: Are latches aligned with strikers?

FEEL/LOOK: Are the door latches and door hold-open-latches easy to operate?

OK: Check complete.

NOT OK: Adjust door and windows to close against seals properly. Replace seals as necessary. See your authorized dealer.

HG31779,00000D1 -19-03SEP02-53/57

Heater Blower Motor Check—If Equipped

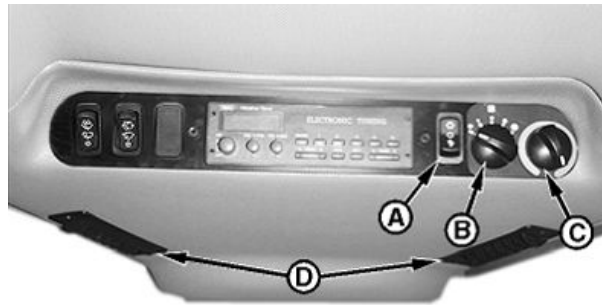

T117838B —UN—21OCT98

A—Air Conditioning Switch

B—Heater Blower Switch

C—Heater Temperature Control

D—Air Ducts

Engine OFF. Key switch to Accessory position.

Turn heater blower switch (B) to position (1, 2, 3 and 4).

FEEL: Does air exit all eight ducts from roof?

OK: Check complete.

NOT OK: Check fuse. Replace.

NOT OK: Check wiring harness. See your authorized dealer.

HG31779,00000D1 -19-03SEP02-54/57

Air Conditioner Compressor Clutch Check—If Equipped

Engine OFF. Key switch ON. Blower switch on LOW. Air conditioner switch ON.

LISTEN: Does compressor clutch "click" as switch is pushed?

OK: Check complete.

NOT OK: Replace compressor clutch. See your authorized dealer.

Continued on next page

HG31779,00000D1 -19-03SEP02-55/57

Air Conditioner Check—If Equipped

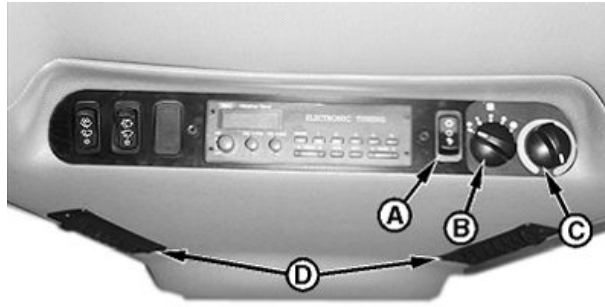

T117838B —UN—21OCT98

- A—Air Conditioning Switch**
- B—Heater Blower Switch**
- C—Heater Temperature Control**
- D—Air Ducts**

Start engine and run at fast idle.

Turn air conditioner switch (A) to ON position. On position is up (Snow Flake). Position down (Cactus) is not used.

Turn heater blower switch (B) to position “4”.

Wait for any warm air in duct system to dissipate.

FEEL: Is air from ducts cool?

OK: Check complete.

NOT OK: See your authorized dealer.

HG31779,00000D1 -19-03SEP02-56/57

Service Decal Check



T118210B —UN—03NOV98

Check service decal on inside of engine hood door.

LOOK: Service decal must be legible.

OK: Operational Checkout completed.

NOT OK: Replace decal.

HG31779,00000D1 -19-03SEP02-57/57

Miscellaneous—Troubleshooting

Troubleshooting Procedure

NOTE: Troubleshooting charts are arranged from the simplest to verify, to least likely, more difficult to verify. When diagnosing a problem, use all possible means to isolate the problem to a single component or system. Use the following steps to diagnose problems:

Step 1. Operational Checkout Procedure

Step 2. Troubleshooting Charts

Step 3. Adjustments

Step 4. See your authorized John Deere dealer.

HG31779,000020 -19-06MAY10-1/1

Engine

Symptom	Problem	Solution
Engine Will Not Start or Starts Hard	FNR lever not in neutral	Move FNR lever to neutral.
	Battery disconnect switch off	Turn switch on.
	Fuel shut off	Open fuel shut-off valve.
	Fuel tank empty	Check fuel quantity.
	Fuel tank vent plugged	Remove cap and listen to sound of air entering tank. Replace cap.
	No electrical power to injection pump solenoid	Turn key switch to ON position. Must hear click at injection pump. See your authorized dealer.
	Water in fuel or water frozen in fuel line	Drain water from fuel filter(s). Change filter(s). Inspect fuel filter(s) for water.
	Debris in fuel or wrong grade of fuel	Check fuel/water separator for debris. Check fuel grade.
	Air leak on suction side of fuel system	Check for bubbles in fuel filter and tighten connections. Inspect fuel lines for damage. See your authorized dealer.
	Fuel transfer pump diaphragm leaking	Check engine oil for fuel dilution.
	Slow cranking speed	Check battery and connections.
	Restricted air filter	Check air filter restriction indicator light and air filters.
	Fuel tank shut-off not fully open	Open fuel tank shut-off.
Valve clearance	Check and adjust valves.	
Engine Surges or Stalls Frequently	Air in fuel	Inspect filter for evidence of air in fuel. Tighten connections and bleed fuel system.
	Fuel partially shut off	Open fuel shut-off valve.
	Fuel tank vent plugged	Remove cap and listen to sound of air entering tank. Replace cap.
	Debris in fuel or wrong grade of fuel	Check fuel/water separator for debris. Check fuel grade.
	Water in fuel	Drain water from fuel filter(s). Change filter(s).

Continued on next page

HG31779,00000D2 -19-03SEP02-1/3

Symptom	Problem	Solution
	Fuel filter plugged	Replace filter(s).
Engine Misses	Air in fuel	Check for evidence of air in filter. Tighten connections and bleed fuel system.
	Fuel partially shut off	Open fuel shut-off valve.
	Debris in fuel or wrong fuel grade	Check fuel filter(s) for debris. Clean. Check grade of fuel.
Engine Does Not Develop Full Power	Fuel partially shut off	Open fuel shut-off valve.
	Fuel filter clogged	Replace fuel filter(s).
	Wrong grade of fuel	Drain and add correct fuel.
	Air system restricted	Check air filter restriction indicator and air filters.
	Incorrect high idle speed (too low) (Earlier Machines)	Linkage out of adjustment. Adjust. See your authorized dealer.
Engine Emits Excessive Black or Gray Exhaust Smoke	Restricted air filter	Check air filter restriction indicator and air filters. Replace.
	Incorrect grade of fuel	Use correct grade of fuel.
Engine Emits Excessive Blue or White Smoke	Cranking speed too slow	Check batteries and connections.
	Incorrect grade of fuel	Use correct grade of fuel.
	Engine running too cold	Check thermostat operation. See your authorized dealer.
Slow Acceleration	Improper fuel	Use correct grade of fuel.
Abnormal Engine Noise	Low or incorrect engine oil	Add correct oil to proper level.
	Loose or worn hydraulic pump	Inspect. See your authorized dealer.
	Engine oil diluted	Inspect engine oil. Determine cause.
Low Oil Pressure (Oil Pressure Light On, Red STOP Indicator Flashing)	Low oil level	Add oil to proper level. Inspect engine oil.
	Wrong viscosity oil/oil diluted with diesel fuel	Change oil.
Engine Overheats (Engine Coolant Indicator and Red STOP Indicator Flashing)	Low coolant level	Fill cooling system and check for leaks.
	Low engine oil level	Add oil.

Continued on next page

HG31779.00000D2 -19-03SEP02-2/3

Miscellaneous—Troubleshooting

Symptom	Problem	Solution
	Loose or broken fan belt	Tighten or replace belt.
	Fan on backwards	Check for correct fan installation.
	Radiator dirty or plugged	Check air flow. Clean radiator.
	Radiator shroud missing or damaged	Inspect. Repair or replace.
	Engine overloaded	Reduce load.
	Wrong fuel	Use correct grade of fuel.
	Radiator cap	Replace cap.
	Thermostat missing, cooling system coated with lime deposits	Flush cooling system. See your authorized dealer.
Excessive Fuel Consumption	Air system restricted	Check filter restriction indicator and air filters. Replace.
	Leakage in fuel system	Inspect. Repair.
	Incorrect grade of fuel	Drain and fill with correct fuel.
	Operator holding hydraulics in relief mode	Return control levers to neutral position.

HG31779,00000D2 -19-03SEP02-3/3

Electrical System

Symptom	Problem	Solution
Starter Will Not Crank Engine	Battery disconnect switch turned off	Turn switch on.
	Starter	Listen for click from starter solenoid. If click is heard, the starter control circuit is functioning. If click is not heard, see your authorized dealer.
	Starter relay	With vehicle in neutral, open right engine service door and listen for click from starter relay when the key switch is in START position. If click is heard, the key switch, circuit breaker, start fuse connectors, and neutral start switch are functioning and the starter relay, relay ground, or starter is defective. See your authorized dealer.
Starter Solenoid Chatters	Poor or corroded connections at battery, battery ground strap, or starter	Inspect, clean, and tighten if necessary.
Engine Cranks Slowly	Loose or corroded battery cables	Inspect and clean or tighten.
	Loose battery ground cable	Open battery cover and inspect and tighten battery ground cable.
	Excessive engine load	Change engine oil to proper grade for temperature.
Starter Continues to Run	Starter solenoid stuck	Shut engine off. See your authorized dealer.
	Starter relay stuck on	Shut engine off. See your authorized dealer.
Battery Uses Too Much Water	Cracked battery case	Replace battery.
	High ambient temperature	Fill with distilled water.
Cracked Battery Case	No battery hold down clamp	Replace battery and install hold down clamp.
	Loose battery hold down clamp	Replace battery and install hold down clamp.
	Battery hold down clamp too tight	Replace battery and install battery hold down clamp correctly.
	Frozen battery	Keep battery fully charged in cold weather.
Low Battery Output	Low water level	Add distilled water.

Continued on next page

HG31779.00000D3 -19-15JAN08-1/2

Miscellaneous—Troubleshooting

Symptom	Problem	Solution
	Dirty or wet battery top causing discharge	Clean and wipe battery top dry.
	Corroded or loose battery cables	Clean and tighten battery cables.
	Broken battery post	Wiggle battery post by hand. If post wiggles or turns, replace battery.
Charge Indicator and Low Oil Pressure Indicator Stays On with Key Off	Broken ground wire to alternator	Inspect and repair.
	Worn alternator	Repair or replace alternator.
Voltage Indicator Light (Remains On with Engine Running)	Loose or glazed belt. Engine rpm low	Check belt. Replace if glazed. Raise engine rpm above 1200 rpm. If light remains on, see your authorized dealer.
	Diode or phase winding	Increase engine rpm to fast idle. If light goes out or gets dim, it indicates a defective diode or phase winding. See your authorized dealer.
Alternator Light Out, but Low Charging System Voltage	Loose or corroded electrical connections on battery, ground strap, starter, or alternator	Inspect, clean, or tighten electrical connections.
	Indicator light bulb	Inspect and replace.
	Loose wiring connector	Inspect and repair.
Noisy Alternator	Worn or defective bearings in alternator	Remove belt and feel for rough bearing while turning alternator pulley.
	Drive belt	Inspect and replace if necessary.
	Pulley not aligned	Inspect.

HG31779,00000D3 -19-15JAN08-2/2

Hydraulic System

Symptom	Problem	Solution
Blade Lifts and/or Blade Tilts Too Slowly	Cold oil	Allow oil to warm up.
	Oil viscosity too high (too thick)	Use correct oil.
	Control valve linkage	Inspect linkage. Repair or adjust. See your authorized dealer.
	Worn hydraulic pump	Check blade raise cycle time.
Blade Fails to Lift and Blade Fails to Tilt	Low hydraulic oil level	Check. Add hydraulic oil.
Blade Hard to Control	Front idler vertical movement excessive	Adjust front idler to side frame clearance.
Pump Excessively Noisy	Cold oil	Allow unit to warm up.
	Low oil level	Check, add oil.
	Oil viscosity too high (oil too thick)	Change oil to correct viscosity oil.
Hydraulic Oil Overheats	Operator holds control valve open too long, causing system relief valve to open	Instruct operator on correct operation of dozer.
	Oil viscosity too high (oil too thick)	Change oil to correct viscosity.
Hydraulic Oil Foams	Water in oil	Inspect oil. Change.
	Using wrong oil	Inspect. Change oil.

HG31779,00000D4 -19-14JAN08-1/1

Hydrostatic Transmission

Symptom	Problem	Solution
Transmission Oil Filter Restriction Indicator Light Remains On with the Unit at Operating Temperature	Plugged filter	Change filter.
	Sender wire grounded	Remove wires from sender. If light remains on, circuit is grounded. See your authorized dealer.
Transmission Oil Overheats	Low oil level	Check and add transmission oil.
	Oil cooler core restricted with debris or fins damaged	Clean core. Add sand screen to protect core.
Low Transmission Oil Pressure (Filter Restriction Indicator Light May or May Not Be On)	Low oil level	Check. Add oil.
	Wrong oil viscosity	Drain and fill with correct oil.
	Oil overheated	Check temperature sending circuit. See your authorized dealer.
Crawler Will Not Move	Park lock switch	Check service codes. See your authorized dealer.
	Transmission problem	Check service codes. See your authorized dealer.
Crawler Mistracks	Air in transmission control circuit	See your authorized dealer.
	Misadjusted motor	Check service codes. See your authorized dealer.
	FNR lever sticks or does not return to non-steer position	Check FNR lever boot. See your authorized dealer.
	Left and right track sag not adjusted the same	Adjust track sag to specifications.

HG31779,00000D5 -19-03SEP02-1/1

Gauges and Indicators

Symptom	Problem	Solution
Engine Coolant Temperature Indicator Light Does Not Indicate Overheating or Bulb Does Not Light in BULB CHECK Position	Indicator light open circuit	Turn key to BULB CHECK. If no light, see your authorized dealer.
Transmission Temperature Indicator Light Bulb Does Not Indicate Overheating or Bulb Does Not Light in BULB CHECK Position	Indicator light open circuit	Turn key to BULB CHECK. If no light, see your authorized dealer.
Engine Oil Pressure Indicator Will Not Light	Indicator light open circuit	Turn key to BULB CHECK. If no light, see your authorized dealer.
Alternator Indicator Will Not Light	Indicator light open circuit	Turn key to BULB CHECK. If no light, see your authorized dealer.
Horn Does Not Sound	Horn ground	Ground horn to tractor frame. See your authorized dealer.
	Horn	Replace horn. See your authorized dealer.
	Horn button	Replace horn button. See your authorized dealer.
Windshield Wiper Does Not Operate	Wiper fuse	Check and replace.
Heater Fan Does Not Operate	Heater fuse	Check and replace.
No Work Lights	Bulb burned out	Replace bulb.
	Poor ground light switch	Inspect and tighten. See your authorized dealer.
Rear Light Does Not Operate	Loose connector in wiring harness of ROPS	Inspect and reconnect. See your authorized dealer.
Dim Lights	Low battery charge	Check battery connections.
	Low alternator output	Check belt tension.
	Poor ground at lights	Clean and tighten.

NOTE: If any other problems are encountered which require special tools or machine knowledge to correct, see your authorized dealer.

HG31779,00000D6 -19-03SEP02-1/1

Transmission Controller Service Codes

If the Check Service Code indicator lights and stays lit, there is an electrical problem in the transmission control system. The transmission controller will automatically put the machine in an operational mode that will not harm the machine. The service code will be displayed on the transmission controller display window located to the left of the operator's seat. The service code number pinpoints the problem and is a very important aid for your dealer to quickly diagnose the problem. Always relay this code number to your dealer when reporting a problem.



T117818

T117818 —JN—25NOV98

TRANSMISSION SERVICE CODES	
1. The Check Service Code indicator on instrument panel will light.	
2. Service code is displayed in the transmission controller display window on left side of cab along the seat.	
3. See your authorized dealer.	
SERVICE CODE	DEFINITION
F311	No forward or reverse
F314	No forward or reverse
F321	No forward or reverse
F324	No forward or reverse
F330	No forward or reverse
F331	No forward or reverse
F334	No forward or reverse
F335	No forward or reverse
F340	No forward or reverse
F341	No steering
F344	No steering
F345	No steering
F3A0	No forward
F3A5	No forward or reverse
F3C0	No forward
F3C5	No forward or reverse
F3D0	No reverse
F3D5	No forward or reverse
F3E0	No reverse
F3E5	No forward or reverse
F3H1	No forward or reverse
F3H4	No forward or reverse

The following service codes will display in transmission controller display window. These codes will be stored in memory, but the Check Service Code indicator will not light. With these codes, the automatic default operational mode will allow machine operation with some noticeable

reduction in performance and features. The machine will not be harmed with continued operation, but should be repaired as soon as practical to ensure maximum machine performance.

TRANSMISSION SERVICE CODES	
1. Service codes are displayed in transmission controller display window on left side of cab next to seat.	
2. See your authorized dealer for service.	
Service Code	Definition
F350	Engine stalls easier under load (Earlier Machines)
F351	Engine stalls easier under load (Earlier Machines)
F354	Engine stalls easier under load (Earlier Machines)
F355	Engine stalls easier under load (Earlier Machines)

Continued on next page

CED,OUO1032,1156 -19-12JAN00-1/2

Miscellaneous—Troubleshooting

TRANSMISSION SERVICE CODES	
F360	Will not reach max speed
F361	Will not reach max speed
F364	Will not reach max speed
F365	Will not reach max speed
F370	Mistracking
F372	Mistracking
F373	Mistracking
F375	Mistracking
F380	Mistracking
F382	Mistracking
F383	Mistracking
F385	Mistracking
F390	Engine stalls easier under load (Earlier Machines)
F392	Mistracking (Earlier Machines)
F393	Mistracking (Earlier Machines)
F393	Engine stalls easier under load (Later Machines)
F395	Mistracking (Earlier Machines)
F395	Engine stalls easier under speed (Later Machines)
F3P0	If brake pedal is depressed, return FNR to neutral to operate
F3P5	If brake pedal is depressed, return FNR to neutral to operate
F3M1	Mistracking
F3M4	Mistracking
F3N1	Mistracking
F3N4	Mistracking
F3J0	Will not reach max speed
F3J1	Will not reach max speed
F3J4	Will not reach max speed
F3J5	Will not reach max speed
F3K	Will not reach max speed
F3L	Will not reach max speed
F3R0	Reverse speed
F3R1	Reverse speed
F3R4	Reverse speed
F3R5	Reverse speed
F3T0	Speed switch in FNR
F3T1	Speed switch in FNR
F3T4	Speed switch in FNR
F3T5	Speed switch in FNR

CED,OUO1032,1156 -19-12JAN00-2/2

Miscellaneous—Storage

Prepare Machine for Storage

1. Before storage, operate engine on at least one complete tank of petroleum diesel fuel to purge the fuel system. Ensure that the fuel tank is full during storage to prevent water build up due to condensation..

NOTE: For up to and including B20, it is recommended that biodiesel be used within 3 months of its manufacture. For blends greater than B20, it is recommended that the biodiesel be used within 45 days. The poor oxidation stability characteristic of biodiesel can result in long-term storage problems. John Deere does not recommend using biodiesel in engines powering standby applications or vehicles operating on a seasonal basis. Consult your John Deere dealer or fuel supplier for additives to improve fuel storage and performance of biodiesel fuels. These additives must be added to the biodiesel close to its time of production for them to be effective.

2. Clean primary air cleaner.

IMPORTANT: High pressure washing greater than 1379 kPa (13.8 bar) (200 psi) can damage freshly painted finishes. Paint should be allowed to air dry for 30 days minimum after receipt of machine before cleaning parts or machines with high pressure. Use low pressure wash operations until 30 days have elapsed.

3. Wash the machine. Use low pressure wash operations (less than 1379 kPa (13.8 bar) (200 psi) until 30 days after receipt of machine have elapsed. Paint areas to prevent rust. Replace decals, where needed.
4. Fill fuel tank to prevent condensation.
5. Check tire pressure to ensure tires are properly inflated
6. Apply waste oil to track chains. Run machine back and forth several times. Park machine on a hard surface to prevent tracks from freezing to ground.
7. Store machine in a dry, protected place. If stored outside, cover with a waterproof material.

LPS is a trademark of the Holt Lloyd Corporation.

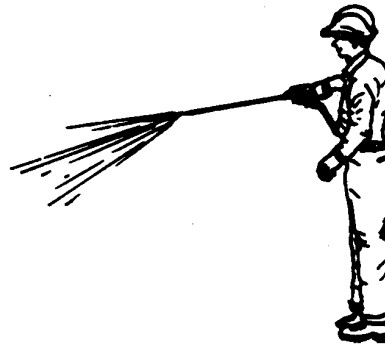

IMPORTANT: LPS 3 Rust Inhibitor can destroy painted finish. DO NOT spray LPS 3 Rust Inhibitor on painted areas.

8. Retract all hydraulic cylinders, if possible. If not, coat exposed cylinder rods with LPS® 3 Rust Inhibitor.
9. Place a "DO NOT OPERATE" tag on the right control lever.
10. Lubricate all grease points.
11. Remove batteries.
12. Remove seat cushion and other perishable items.
13. Remove keys and lock all covers and doors.

T47764 —JUN—09NOV88

T5813AM —JUN—09FEB89

TX,105,FF2313 -19-17AUG11-1/1

Avoid Track Damage

IMPORTANT: Avoid machine damage. If machine is equipped with a sealed and lubricated

track, avoid water being forced between the plastic pins and rubber plugs while washing machine with pressure washer.

JH91824,00002EA -19-22JUL10-1/1

Miscellaneous—Machine Numbers

General

Record Product Identification Number (PIN).

On machines (S.N. —813816), the PIN plate is located on the left side of machine under the ROPS or cab.

On machines (S.N. 813817—), the PIN plate is located on the left side of machine below engine side shield.

Purchase Date:

NOTE: Record all 13 characters of the Product Identification Number.



450H (S.N. —813816) Shown



450H (S.N. 813817—) Shown

TX,120,RB51 -19-03DEC97-1/1

T118006B—UN—11NOV98

T121298B—UN—27APR99

Record Engine Serial Number

The engine serial number is located on right side of engine.

Engine Serial Number (A):

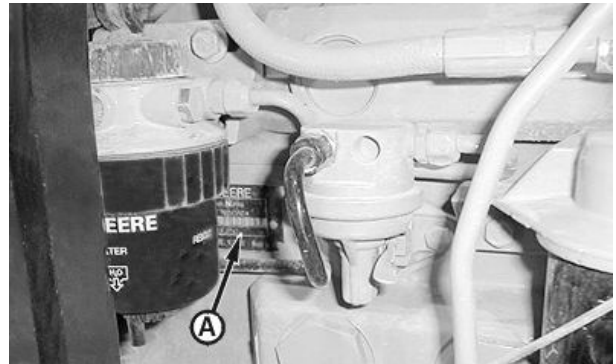

CED,OUO1032,1042 -19-14JAN08-1/1

T118006B—UN—11NOV98

Keep Machines Secure

1. Install vandal-proof devices.
2. When machine is in storage:
 - Lower equipment to the ground
 - Set wheels to widest position to make loading more difficult
 - Remove any keys and batteries
3. When parking indoors, put large equipment in front of exits and lock your storage buildings.
4. When parking outdoors, store in a well-lighted and fenced area.
5. Make note of suspicious activity and report any thefts immediately to law enforcement agencies.
6. Notify your John Deere dealer of any losses.

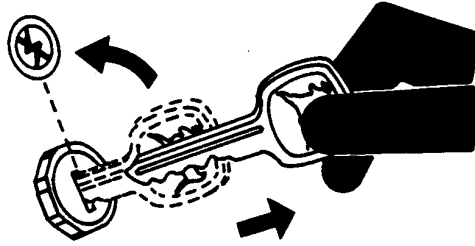

DX,SECURE2 -19-18NOV03-1/1

TS230—UN—24MAY89

Keep Proof of Ownership

1. Maintain in a secure location an up-to-date inventory of all product and component serial numbers.
2. Regularly verify that identification plates have not been removed. Report any evidence of tampering to law enforcement agencies and order duplicate plates.
3. Other steps you can take:
 - Mark your machine with your own numbering system
 - Take color photographs from several angles of each machine

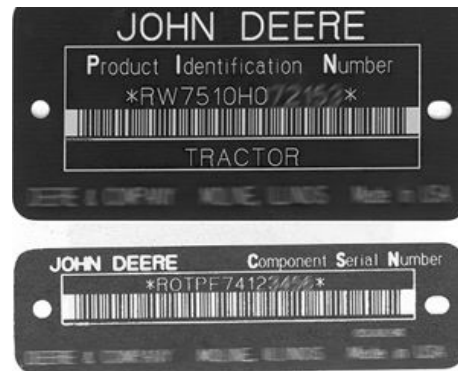

DX,SECURE1 -19-18NOV03-1/1

TS1680—UN—09DEC03

Miscellaneous—Specifications

450H Crawler Dozer Dimensions

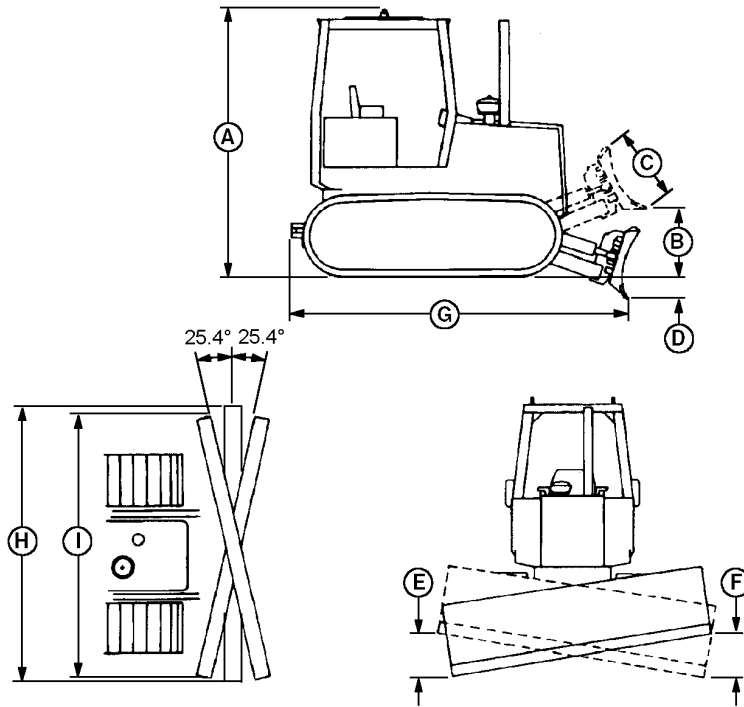

T118300

T118300—UN—11NOV98

NOTE: Specifications and design subject to change without notice. Whenever applicable, specifications are in accordance with ICED and SAE standards. Except where otherwise noted, these specifications

are based on a unit with roll-over protective structure, full fuel tank, 80 kg (175 lb) operator, and standard equipment.

Item	Measurement	Specification
A—Overall Height—ROPS or Cab	Height	2590 mm (8 ft 6 in.)
B—Blade	Height	826 mm (2 ft 8.6 in.)
C—Blade Lift	Height	773 mm (2 ft 6 in.)
D—Digging	Depth	528 mm (1 ft 9 in.)
E—Blade Tilt		
90 inch (Narrow) Blade (Right Side)	Distance	313 mm (1 ft)
97 inch (Standard) Blade (Right Side)	Distance	337 mm (1 ft 1.3 in.)
F—Blade Tilt		
90 inch (Narrow) Blade (Left Side)	Distance	313 mm (1 ft)
97 inch (Standard) Blade (Left Side)	Distance	337 mm (1 ft 1.3 in.)
G—Overall (Without Winch)	Length	3937 mm (12 ft 11 in.)
G—Overall (With Winch)	Length	4496 mm (14 ft 9 in.)
H—Blade Width (90 inch Blade)	Width	2286 mm (7 ft 6 in.)
H—Blade Width (97 inch Blade)	Width	2464 mm (8 ft 1 in.)

Continued on next page

CED,OUO1032,1142 -19-23MAR99-1/2

Miscellaneous—Specifications

Item	Measurement	Specification
I—Blade Angle (90 inch Blade)	Width	2064 mm (6 ft 9 in.)
I—Blade Angle (97 inch Blade)	Width	2267 mm (7 ft 5.3 in.)
90 inch (Narrow) Blade	Capacity	1.4 m ³ (1.9 yd ³)
97 inch (Standard) Blade	Capacity	1.5 m ³ (2.0 yd ³)

CED,OOU1032,1142 -19-23MAR99-2/2

450H Crawler Dozer Specifications

Item	Measurement	Specification
John Deere PowerTech® 4045D 4-Cylinder Diesel Engine		
Engine	Type	Naturally Aspirated
Fuel Consumption, Typical	Consumption	4.9—8.7 L/h (1.5—2.3 gph)
Rated Power at 2200 rpm	Power	52 kW (70 hp) SAE net horsepower
Piston	Displacement	4.52 L (276 cu in.)
Maximum Net Torque at 1200 rpm	Torque Rise	305 N·m (225 lb-ft)
Batteries	Voltage	12-volt
Alternator—ROPS	Amperage	65 amp
Alternator—Cab with Air Conditioning	Amperage	95 amp
Transmission	Speed	0—8 km/h (0—5 mph)
Hydraulic System	Pressure	20 685 kPa (3000 psi)
	Flow Rate	56.8 L/min (15 gpm) @ 2200 rpm
Undercarriage		
Track Shoes (Each Side)	Quantity	37
Ground Contact Area (with 16 in. Shoes)	Area	15 897 cm ² (2464 sq in.)
Track	Pitch	160 mm (6.29 in.)
	Gauge	1450 mm (57 in.)
Minimum Ground (with Single Bar Grouser)	Clearance	345 mm (13.6 in.)
Minimum Ground (with Swamp Shoes)	Clearance	366 mm (14.4 in.)
Ground Pressure	Pressure	42 kPa (0.42 bar) (6.1 psi)

PowerTech is a registered trademark of Deere & Company

CED,OOU1032,1143 -19-23MAR99-1/1

450H Crawler Dozer Weights

Item	Measurement	Specification
SAE Operating Weight	Weight	6804 kg (15,000 lb)
Optional Equipment		
Rock Guards (4)	Weight	117 kg (257 lb)
Deluxe Seat (add)	Weight	9 kg (20 lb)
Cab with Heater (add)	Weight	268 kg (590 lb)
Cab with Air Conditioning (add)	Weight	306 kg (675 lb)
ROPS Heater	Weight	12 kg (26 lb)
High Intensity Lights	Weight	4 kg (9 lb)
Front Tow Hook	Weight	15 kg (33 lb)
Rigid Draw Bar	Weight	23 kg (50 lb)
Extended Draw Bar	Weight	33 kg (72 lb)
4000S Winch	Weight	653 kg (1437 lb)
Winch Fairlead, Four Roller	Weight	85 kg (187 lb)
Radial Ripper	Weight	335 kg (738 lb)
Parallelogram Ripper	Weight	592 kg (1306 lb)

CED.OUO1032,1145 -19-23MAR99-1/1

450H-LT Crawler Dozer Dimensions

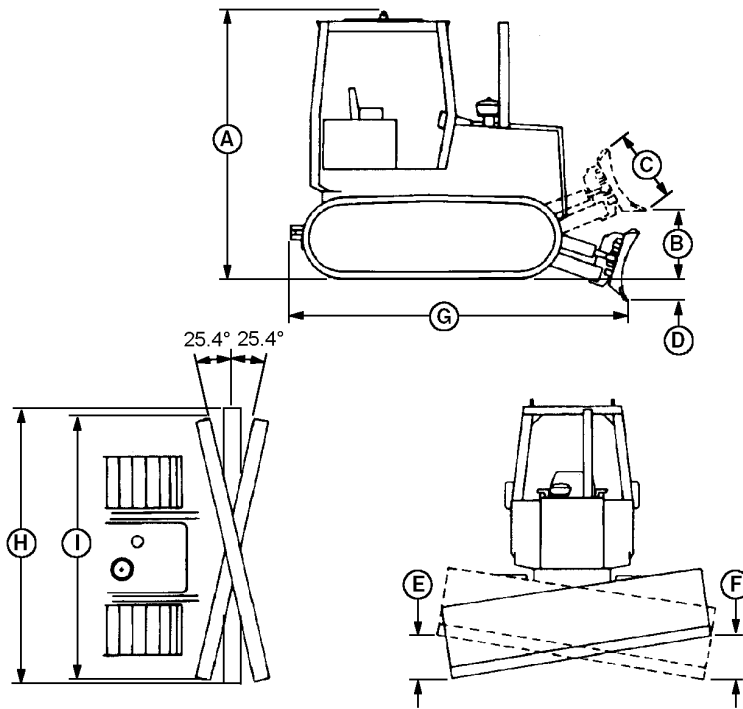

T118300

T118300—JN—11NOV88

NOTE: Specifications and design subject to change without notice. Whenever applicable, specifications are in accordance with ICED and SAE standards. Except where otherwise noted, these specifications

are based on a unit with roll-over protective structure, full fuel tank, 80 kg (175 lb) operator, and standard equipment.

Item	Measurement	Specification
A—Overall Height—ROPS or Cab	Height	2590 mm (8 ft 6 in.)
B—Blade	Height	826 mm (2 ft 8.6 in.)
C—Blade Lift	Height	773 mm (2 ft 6 in.)
D—Digging	Depth	528 mm (1 ft 9 in.)
E—Blade Tilt		
90 inch (Narrow) Blade (Right Side)	Distance	313 mm (1 ft)
97 inch (Standard) Blade (Right Side)	Distance	337 mm (1 ft 1.3 in.)
115 inch Blade (Right Side)	Distance	400 mm (1 ft 3.8 in.)
F—Blade Tilt		
90 inch (Narrow) Blade (Left Side)	Distance	313 mm (1 ft)
97 inch (Standard) Blade (Left Side)	Distance	337 mm (1 ft 1.3 in.)
115 inch Blade (Left Side)	Distance	400 mm (1 ft 3.8 in.)
G—Overall (Without Winch)	Length	4013 mm (13 ft 2 in.)
G—Overall (With Winch)	Length	4496 mm (14 ft 9 in.)

Continued on next page

CED,OUO1032,1353 -19-23MAR99-1/2

Miscellaneous—Specifications

Item	Measurement	Specification
H—Blade Width (90 inch Blade)	Width	2286 mm (7 ft 6 in.)
H—Blade Width (97 inch Blade)	Width	2464 mm (8 ft 1 in.)
H—Blade Width (115 inch Blade)	Width	2921 mm (9 ft 7 in.)
I—Blade Angle (90 inch Blade)	Width	2106 mm (6 ft 10.9 in.)
I—Blade Angle (97 inch Blade)	Width	2267 mm (7 ft 5.3 in.)
I—Blade Angle (115 inch Blade)	Width	2680 mm (8 ft 9.5 in.)
90 inch (Narrow) Blade	Capacity	1.4 m ³ (1.9 yd ³)
97 inch (Standard) Blade	Capacity	1.5 m ³ (2.0 yd ³)
115 inch Blade	Capacity	1.75 m ³ (2.3 yd ³)

CED,OUO1032,1353 -19-23MAR99-2/2

450H-LT Crawler Dozer Specifications

Item	Measurement	Specification
John Deere PowerTech® 4045D 4-Cylinder Diesel Engine		
Engine	Type	Naturally Aspirated
Fuel Consumption, Typical	Consumption	4.9—8.7 L/h (1.5—2.3 gph)
Rated Power at 2200 rpm	Power	52 kW (70 hp) SAE net horsepower
Piston	Displacement	4.52 L (276 cu in.)
Maximum Net Torque at 1300 rpm	Torque Rise	313 N·m (230 lb-ft)
Batteries	Voltage	12-volt
Alternator—ROPS	Amperage	65 amp
Alternator—Cab with Air Conditioning	Amperage	95 amp
Transmission	Speed	0—8 km/h (0—5 mph)
Hydraulic System	Pressure	20 685 kPa (3000 psi)
	Flow Rate	56.8 L/min (15 gpm) @ 2200 rpm
Undercarriage		
Track Shoes (Each Side)	Quantity	40
Ground Contact Area (with 16 in. Shoes)	Area	17 755 cm ² (2752 sq in.)
Track	Pitch	160 mm (6.29 in.)
	Gauge	1450 mm (57 in.)
Minimum Ground (with Single Bar Grouser)	Clearance	345 mm (13.6 in.)
Minimum Ground (with Swamp Shoes)	Clearance	366 mm (14.4 in.)
Ground Pressure	Pressure	38.6 kPa (0.39 bar) (5.6 psi)

PowerTech is a registered trademark of Deere & Company

CED,OUO1032,1354 -19-23MAR99-1/1

450H-LT Crawler Dozer Weights

Item	Measurement	Specification
SAE Operating Weight	Weight	6804 kg (15,000 lb)
Optional Equipment		
Rock Guards (4)	Weight	131 kg (288 lb)
Deluxe Seat (add)	Weight	9 kg (20 lb)
Cab with Heater (add)	Weight	268 kg (590 lb)
Cab with Air Conditioning (add)	Weight	306 kg (675 lb)
ROPS Heater	Weight	12 kg (26 lb)
High Intensity Lights	Weight	4 kg (9 lb)
Front Tow Hook	Weight	15 kg (33 lb)
Rigid Draw Bar	Weight	23 kg (50 lb)
Extended Draw Bar	Weight	33 kg (72 lb)
4000S Winch	Weight	653 kg (1437 lb)
Winch Fairlead, Four Roller	Weight	85 kg (187 lb)
Radial Ripper	Weight	335 kg (738 lb)
Parallelogram Ripper	Weight	592 kg (1306 lb)

CED,OUO1032,1357 -19-23MAR99-1/1

450H-LGP Crawler Dozer Dimensions

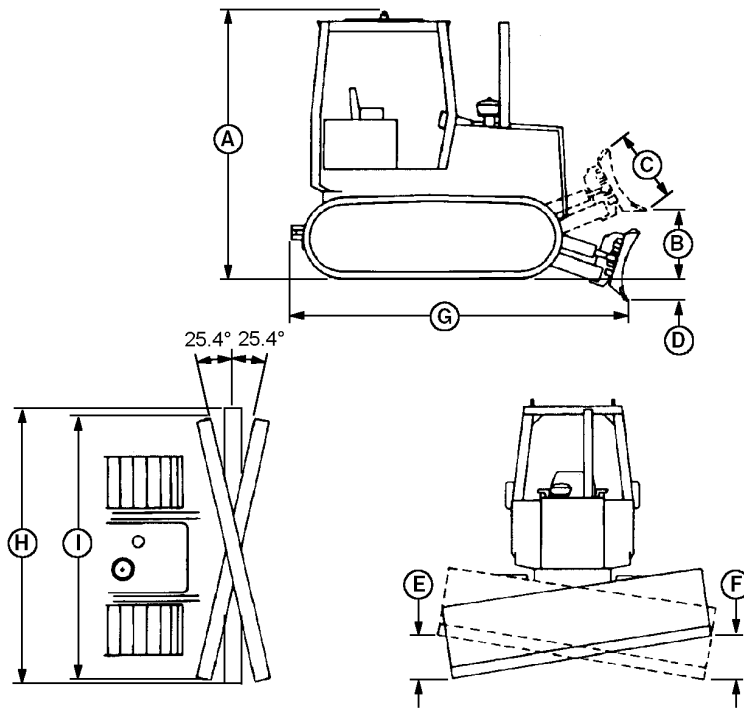

T118300

T118300—UN—11NOV98

NOTE: Specifications and design subject to change without notice. Whenever applicable, specifications are in accordance with ICED and SAE standards. Except where otherwise noted, these specifications

are based on a unit with roll-over protective structure, full fuel tank, 80 kg (175 lb) operator, and standard equipment.

Item	Measurement	Specification
A—Overall Height—ROPS or Cab	Height	2590 mm (8 ft 6 in.)
B—115 inch Blade	Height	826 mm (2 ft 8.6 in.)
B—124 inch Blade	Height	767 mm (2 ft 6.2 in.)
C—Blade Lift	Height	773 mm (2 ft 6 in.)
D—Digging	Depth	528 mm (1 ft 9 in.)
E—Blade Tilt		
115 inch Blade (Right Side)	Distance	400 mm (1 ft 3 in.)
124 inch Blade (Right Side)	Distance	432 mm (1 ft 5 in.)
F—Blade Tilt		
115 inch Blade (Left Side)	Distance	400 mm (1 ft 3 in.)
124 inch Blade (Left Side)	Distance	432 mm (1 ft 5 in.)
G—Overall (Without Winch)	Length	4013 mm (13 ft 2 in.)
G—Overall (With Winch)	Length	4496 mm (14 ft 9 in.)
H—Blade Width (115 inch Blade)	Width	2921 mm (9 ft 7 in.)
H—Blade Width (124 inch Blade)	Width	3150 mm (10 ft 4 in.)

Continued on next page

CED,OUO1032,1163 -19-12NOV98-1/2

Miscellaneous—Specifications

Item	Measurement	Specification
I—Blade Angle (115 inch Blade)	Width	2639 mm (8 ft 8 in.)
I—Blade Angle (124 inch Blade)	Width	2845 mm (9 ft 3 in.)
115 inch Blade	Capacity	1.75 m ³ (2.9 yd ³)
124 inch Blade	Capacity	1.64 m ³ (2.15 yd ³)

CED,OUO1032,1163 -19-12NOV98-2/2

450H-LGP Crawler Dozer Specifications

Item	Measurement	Specification
John Deere PowerTech® 4045T 4-Cylinder Diesel Engine		
Engine	Type	Turbocharged
Fuel Consumption, Typical	Consumption	4.9—8.7 L/h (1.5—2.3 gph)
Rated Power at 2200 rpm	Power	55 kW (74 hp) SAE net horsepower
Piston	Displacement	4.52 L (276 cu in.)
Maximum Net Torque at 1300 rpm	Torque Rise	340 N·m (250 lb-ft)
Batteries	Voltage	12-volt
Alternator—ROPS	Amperage	65 amp
Alternator—Cab with Air Conditioning	Amperage	95 amp
Transmission	Speed	0—8 km/h (0—5 mph)
Hydraulic System	Pressure	20 685 kPa (3000 psi)
	Flow Rate	56.8 L/min (15 gpm) @ 2200 rpm
Undercarriage		
Track Shoes (Each Side)	Quantity	40
Ground Contact Area (with 24 in. Shoes)	Area	26 632 cm ² (4128 sq in.)
Track	Pitch	160 mm (6.29 in.)
	Gauge	1650 mm (65 in.)
Minimum Ground (with Single Bar Grouser)	Clearance	345 mm (13.6 in.)
Minimum Ground (with Swamp Shoes)	Clearance	366 mm (14.4 in.)
Ground Pressure	Pressure	27.6 kPa (0.28 bar) (4.0 psi)

PowerTech is a registered trademark of Deere & Company

CED,OUO1032,1355 -19-23MAR99-1/1

450H-LGP Crawler Dozer Weights

Item	Measurement	Specification
SAE Operating Weight	Weight	7484 kg (16,500 lb)
Optional Equipment		
Rock Guards (4)	Weight	131 kg (288 lb)
Swamp Shoe	Weight	11 kg (25 lb)
Deluxe Seat (add)	Weight	9 kg (20 lb)
Cab with Heater (add)	Weight	268 kg (590 lb)
Cab with Air Conditioning (add)	Weight	306 kg (675 lb)
ROPS Heater	Weight	12 kg (26 lb)
High Intensity Lights	Weight	4 kg (9 lb)
Front Tow Hook	Weight	15 kg (33 lb)
Rigid Draw Bar	Weight	23 kg (50 lb)
Extended Draw Bar	Weight	33 kg (72 lb)
4000S Winch	Weight	653 kg (1437 lb)
Winch Fairlead, Four Roller	Weight	85 kg (187 lb)
Radial Ripper	Weight	335 kg (738 lb)
Parallelogram Ripper	Weight	592 kg (1306 lb)

CED,OUO1032,1356 -19-23MAR99-1/1

**450H, 450H-LT and 450H-LGP Crawler Dozer
Drain and Refill Capacities**

Item	Measurement	Specification
Drain and Refill Capacities		
Cooling System	Capacity	14 L (15 qt)
Fuel Tank	Capacity	136 L (36 gal)
Engine Oil (Including Filter)	Capacity	14 L (15 qt)
Final Drive (Each Side)	Capacity	8.5 L (9 qt)
Hydraulic Reservoir (Including Filter)	Capacity	32 L (8.5 gal)
Transmission Reservoir (Including Filter)	Capacity	53 L (14 gal)
Winch-If Equipped	Capacity	37 L (10 gal)

CED, TX03768,2504 -19-06JUN05-1/1

550H Crawler Dozer Dimensions

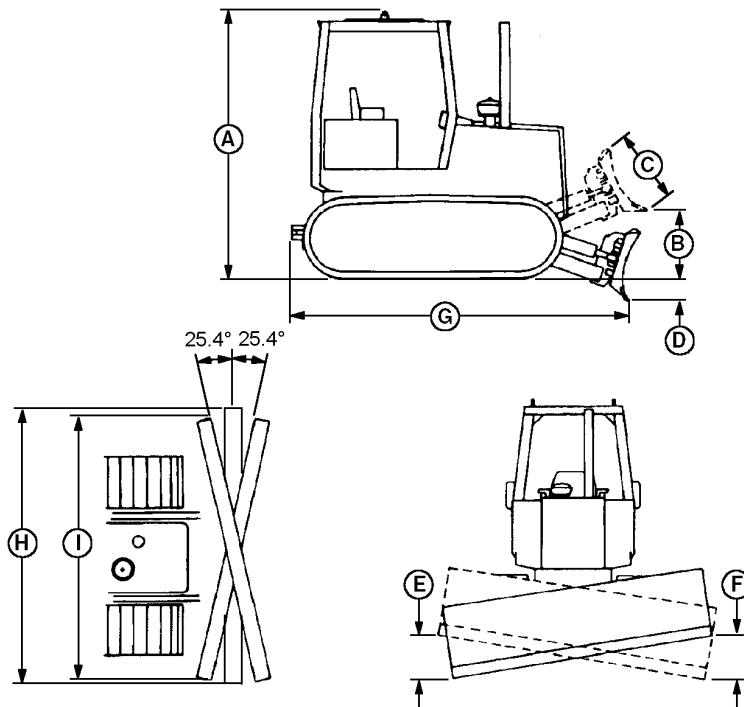

T118300

T118300—JUN—11NOV88

NOTE: Specifications and design subject to change without notice. Whenever applicable, specifications are in accordance with ICED and SAE standards. Except where otherwise noted, these specifications

are based on a unit with roll-over protective structure, full fuel tank, 80 kg (175 lb) operator, and standard equipment.

Item	Measurement	Specification
A—Overall Height—ROPS or Cab	Height	2743 mm (9 ft)
B—Blade	Height	826 mm (2 ft 8.6 in.)
C—Blade Lift	Height	797 mm (2 ft 7.4 in.)
D—Digging	Depth	523 mm (1 ft 8.6 in.)
E—Blade Tilt		
105 inch (Standard) Blade (Right Side)	Distance	364 mm (1 ft 2.3 in.)
97 inch (Narrow) Blade (Right Side)	Distance	337 mm (1 ft 1.3 in.)
F—Blade Tilt		
105 inch (Standard) Blade (Left Side)	Distance	313 mm (1 ft)
97 inch (Narrow) Blade (Left Side)	Distance	337 mm (1 ft 1.3 in.)
G—Overall (Without Winch)	Length	4040 mm (13 ft 3 in.)
G—Overall (With Winch)	Length	4549 mm (14 ft 11 in.)
H—Blade Width (105 inch Standard Blade)	Width	2667 mm (8 ft 9 in.)

Continued on next page

CED,OUO1032,1376 -19-07APR99-1/2

Miscellaneous—Specifications

Item	Measurement	Specification
H—Blade Width (97 inch Narrow Blade)	Width	2464 mm (8 ft 1 in.)
I—Blade Angle (105 inch Standard Blade)	Width	2507 mm (8 ft 2.7 in.)
I—Blade Angle (97 inch Narrow Blade)	Width	2318 mm (7 ft 7.2 in.)
105 inch (Standard) Blade	Capacity	1.61 m ³ (2.11 yd ³)
97 inch (Narrow) Blade	Capacity	1.5 m ³ (2.0 yd ³)

CED,OUO1032,1376 -19-07APR99-2/2

550H Crawler Dozer Specifications

Item	Measurement	Specification
John Deere PowerTech® 4045T 4-Cylinder Diesel Engine		
Engine	Type	Turbocharged
Fuel Consumption, Typical	Consumption	6.4—9.8 L/h (1.7—2.6 gph)
Rated Power at 2200 rpm	Power	60 kW (80 hp) SAE net horsepower
Piston	Displacement	4.52 L (276 cu in.)
Maximum Net Torque at 1200 rpm	Torque Rise	344 N·m (255 lb-ft)
Batteries	Voltage	12-volt
Alternator—ROPS	Amperage	65 amp
Alternator—Cab with Air Conditioning	Amperage	95 amp
Transmission	Speed	0—8 km/h (0—5 mph)
Hydraulic System	Pressure	20 685 kPa (3000 psi)
	Flow Rate	56.8 L/min (15 gpm) @ 2200 rpm
Undercarriage		
Track Shoes (Each Side)	Quantity	40
Ground Contact Area (with 18 in. Shoes)	Area	19 974 cm ² (3096 sq in.)
Track	Pitch	160 mm (6.29 in.)
	Gauge	1550 mm (61 in.)
Minimum Ground (with Single Bar Grouser)	Clearance	345 mm (13.6 in.)
Minimum Ground (with Swamp Shoes)	Clearance	366 mm (14.4 in.)
Ground Pressure	Pressure	37.2 kPa (0.37 bar) (5.4 psi)
Standard Grouser	Width	457 mm (18 in.)

PowerTech is a registered trademark of Deere & Company

CED,OUO1032,1378 -19-07APR99-1/1

550H Crawler Dozer Weights

Item	Measurement	Specification
SAE Operating Weight	Weight	7620 kg (16,800 lb)
Optional Equipment		
Rock Guards (4)	Weight	131 kg (288 lb)
Deluxe Seat (add)	Weight	9 kg (20 lb)
Cab with Heater (add)	Weight	268 kg (590 lb)
Cab with Air Conditioning (add)	Weight	306 kg (675 lb)
ROPS Heater	Weight	12 kg (26 lb)
High Intensity Lights	Weight	4 kg (9 lb)
Retrieval Hitch	Weight	23 kg (50 lb)
Extended Draw Bar	Weight	33 kg (72 lb)
4000S Winch	Weight	653 kg (1437 lb)
Winch Fairlead, Four Roller	Weight	85 kg (187 lb)
Radial Ripper	Weight	335 kg (738 lb)
Parallelogram Ripper	Weight	592 kg (1306 lb)

CED,OUO1032,1380 -19-25MAR99-1/1

550H-LGP Crawler Dozer Dimensions

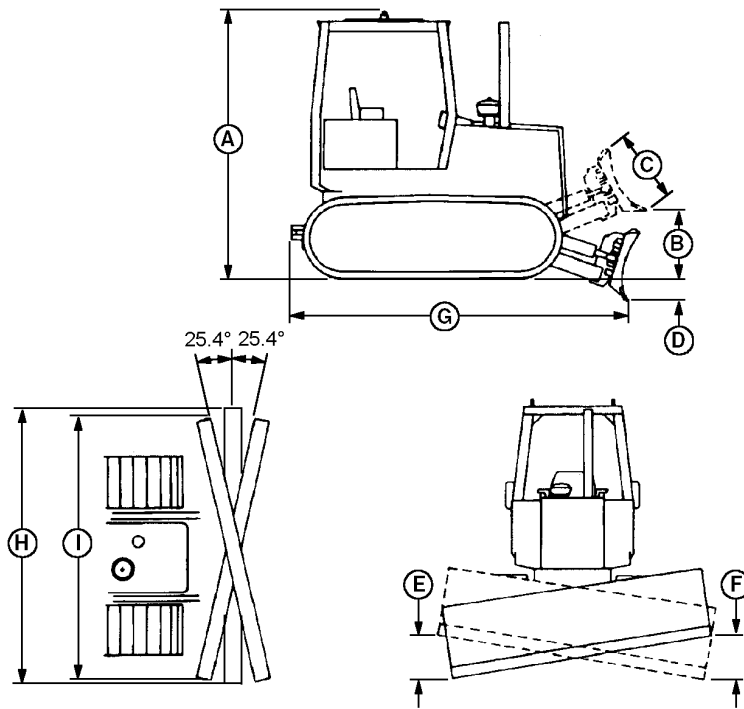

T118300

T118300—UN—11NOV98

NOTE: Specifications and design subject to change without notice. Whenever applicable, specifications are in accordance with ICED and SAE standards. Except where otherwise noted, these specifications

are based on a unit with roll-over protective structure, full fuel tank, 80 kg (175 lb) operator, and standard equipment.

Item	Measurement	Specification
A—Overall Height—ROPS or Cab	Height	2743 mm (9 ft)
B—115 inch Blade	Height	826 mm (2 ft 8.6 in.)
B—128 inch Blade	Height	767 mm (2 ft 6.2 in.)
C—Blade Lift	Height	797 mm (2 ft 7.4 in.)
D—Digging	Depth	523 mm (1 ft 8.6 in.)
E—Blade Tilt		
115 inch Blade (Right Side)	Distance	399 mm (1 ft 3 in.)
128 inch Blade (Right Side)	Distance	444 mm (1 ft 5.5 in.)
F—Blade Tilt		
115 inch Blade (Left Side)	Distance	399 mm (1 ft 3 in.)
128 inch Blade (Left Side)	Distance	444 mm (1 ft 5.5 in.)
G—Overall (Without Winch)	Length	4040 mm (13 ft 3 in.)
G—Overall (With Winch)	Length	4549 mm (14 ft 11 in.)
H—Blade Width (115 inch Blade)	Width	2921 mm (9 ft 7 in.)
H—Blade Width (128 inch Blade)	Width	3251 mm (10 ft 8 in.)

Continued on next page

CED,OUO1032,1377 -19-25MAR99-1/2

Miscellaneous—Specifications

Item	Measurement	Specification
I—Blade Angle (115 inch Blade)	Width	2742 mm (8 ft 11.9 in.)
I—Blade Angle (128 inch Blade)	Width	3070 mm (10 ft 0.9 in.)
115 inch Blade	Capacity	1.75 m ³ (2.9 yd ³)
128 inch Blade	Capacity	1.69 m ³ (2.21 yd ³)

CED,OUO1032,1377 -19-25MAR99-2/2

550H-LGP Crawler Dozer Specifications

Item	Measurement	Specification
John Deere PowerTech® 4045T 4-Cylinder Diesel Engine		
Engine	Type	Turbocharged
Fuel Consumption, Typical	Consumption	6.4—9.8 L/h (1.7—2.6 gph)
Rated Power at 2200 rpm	Power	63 kW (84 hp) SAE net horsepower
Piston	Displacement	4.52 L (276 cu in.)
Maximum Net Torque at 1200 rpm	Torque Rise	372 N·m (276 lb-ft)
Batteries	Voltage	12-volt
Alternator—ROPS	Amperage	65 amp
Alternator—Cab with Air Conditioning	Amperage	95 amp
Transmission	Speed	0—8 km/h (0—5 mph)
Hydraulic System	Pressure	20 685 kPa (3000 psi)
	Flow Rate	56.8 L/min (15 gpm) @ 2200 rpm
Undercarriage		
Track Shoes (Each Side)	Quantity	40
Ground Contact Area (with 24 in. Shoes)	Area	26 632 cm ² (4128 sq in.)
Track	Pitch	160 mm (6.29 in.)
	Gauge	1753 mm (69 in.)
Minimum Ground (with Single Bar Grouser)	Clearance	345 mm (13.6 in.)
Minimum Ground (with Swamp Shoes)	Clearance	366 mm (14.4 in.)
Ground Pressure	Pressure	29 kPa (0.29 bar) (4.2 psi)

PowerTech is a registered trademark of Deere & Company

CED,OUO1032,1379 -19-25MAR99-1/1

550H-LGP Crawler Dozer Weights

Item	Measurement	Specification
SAE Operating Weight	Weight	7938 kg (17,500 lb)
Optional Equipment		
Rock Guards (4)	Weight	131 kg (288 lb)
Swamp Shoe	Weight	73 kg (160 lb)
Deluxe Seat (add)	Weight	9 kg (20 lb)
Cab with Heater (add)	Weight	268 kg (590 lb)
Cab with Air Conditioning (add)	Weight	306 kg (675 lb)
ROPS Heater	Weight	12 kg (26 lb)
High Intensity Lights	Weight	4 kg (9 lb)
Front Tow Hook	Weight	15 kg (33 lb)
Retrieval Hitch	Weight	23 kg (50 lb)
Extended Draw Bar	Weight	33 kg (72 lb)
4000S Winch	Weight	653 kg (1437 lb)
Winch Fairlead, Four Roller	Weight	85 kg (187 lb)
Radial Ripper	Weight	335 kg (738 lb)
Parallelogram Ripper	Weight	592 kg (1306 lb)

CED,OUO1032,1381 -19-25MAR99-1/1

550H and 550H-LGP Crawler Dozer Drain and Refill Capacities

Item	Measurement	Specification
Drain and Refill Capacities		
Cooling System	Capacity	14 L (15 qt)
Fuel Tank	Capacity	178 L (47 gal)
Engine Oil (Including Filter)	Capacity	14L (15 qt)
Final Drive (Each Side)	Capacity	8.5 L (9 qt)
Hydraulic Reservoir (Including Filter)	Capacity	32 L (8.5 gal)
Transmission Reservoir (Including Filter)	Capacity	53 L (14 gal)
Winch-If Equipped	Capacity	37 L (10 gal)

CED,OUO1032,1382 -19-06JUN05-1/1

650H Crawler Dozer Dimensions

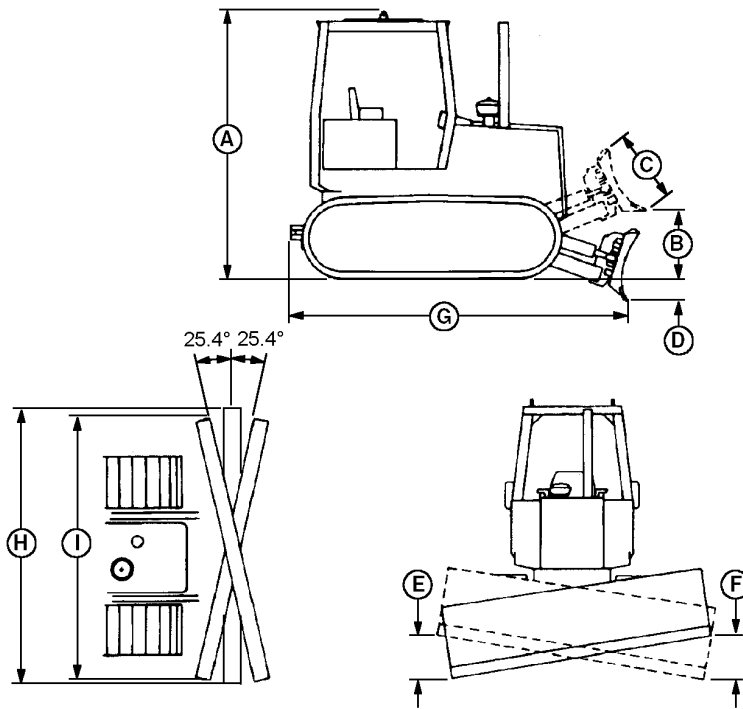

T118300

T118300—JUN—11NOV88

NOTE: Specifications and design subject to change without notice. Whenever applicable, specifications are in accordance with ICED and SAE standards. Except where otherwise noted, these specifications

are based on a unit with roll-over protective structure, full fuel tank, 80 kg (175 lb) operator, and standard equipment.

Item	Measurement	Specification
A—Overall Height—ROPS or Cab	Height	2768 mm (9 ft 1 in.)
B—105 inch (Standard) Blade	Height	933 mm (3 ft 0.7 in.)
B—97 inch (Narrow) Blade	Height	826 mm (2 ft 8.6 in.)
C—Blade Lift	Height	819 mm (2 ft 8.2 in.)
D—Digging	Depth	500 mm (1 ft 7.7 in.)
E—Blade Tilt		
105 inch (Standard) Blade (Right Side)	Distance	364 mm (1 ft 2.3 in.)
97 inch (Narrow) Blade (Right Side)	Distance	337 mm (1 ft 1.3 in.)
F—Blade Tilt		
105 inch (Standard) Blade (Left Side)	Distance	364 mm (1 ft 2.3 in.)
97 inch (Narrow) Blade (Left Side)	Distance	337 mm (1 ft 1.3 in.)
G—Overall (Without Winch)	Length	4070 mm (13 ft 4 in.)
G—Overall (With Winch)	Length	4547 mm (14 ft 11 in.)
H—Blade Width (105 inch Standard Blade)	Width	2667 mm (8 ft 9 in.)

Continued on next page

CED,OUO1032,1376-19-18JUN02-1/2

Miscellaneous—Specifications

Item	Measurement	Specification
H—Blade Width (97 inch Narrow Blade)	Width	2464 mm (8 ft 1 in.)
I—Blade Angle (105 inch Standard Blade)	Width	2507 mm (8 ft 2.7 in.)
I—Blade Angle (97 inch Narrow Blade)	Width	2318 mm (7 ft 7.2 in.)
105 inch (Standard) Blade	Capacity	1.99 m ³ (2.6 yd ³)
97 inch (Narrow) Blade	Capacity	1.5 m ³ (2.0 yd ³)

CED,OUO1032,1376 -19-18JUN02-2/2

650H Crawler Dozer Specifications

Item	Measurement	Specification
John Deere PowerTech® 4045T 4-Cylinder Diesel Engine		
Engine	Type	Turbocharged
Fuel Consumption, Typical	Consumption	7.2—11.2 L/h (1.9—3.0 gph)
Rated Power at 2200 rpm	Power	67 kW (90 hp) SAE net horsepower
Piston	Displacement	4.52 L (276 cu in.)
Maximum Net Torque at 1200 rpm	Torque Rise	405 N·m (316 lb-ft)
Batteries	Voltage	12-volt
Alternator—ROPS	Amperage	65 amp
Alternator—Cab with Air Conditioning	Amperage	95 amp
Transmission	Speed	0—8 km/h (0—5 mph)
Hydraulic System	Pressure	20 685 kPa (3000 psi)
	Flow Rate	56.8 L/min (15 gpm) @ 2200 rpm
Undercarriage		
Track Shoes (Each Side)	Quantity	38
Ground Contact Area (with 18 in. Shoes)	Area	19 974 cm ² (3096 sq in.)
Track	Pitch	171 mm (6.73 in.)
	Gauge	1550 mm (61 in.)
Minimum Ground (with Single Bar Grouser)	Clearance	363 mm (14.3 in.)
Minimum Ground (with Swamp Shoes)	Clearance	384 mm (15.1 in.)
Ground Pressure	Pressure	40.6 kPa (0.41 bar) (5.9 psi)
Standard Grouser	Width	457 mm (18 in.)

PowerTech is a registered trademark of Deere & Company

CED,OUO1032,1385 -19-18JUN02-1/1

650H Crawler Dozer Weights

Item	Measurement	Specification
SAE Operating Weight	Weight	8391 kg (18,500 lb)
Optional Equipment		
Rock Guards (4)	Weight	118 kg (260 lb)
Deluxe Seat (add)	Weight	9 kg (20 lb)
Cab with Heater (add)	Weight	268 kg (590 lb)
Cab with Air Conditioning (add)	Weight	306 kg (675 lb)
ROPS Heater	Weight	12 kg (26 lb)
High Intensity Lights	Weight	4 kg (9 lb)
Retrieval Hitch	Weight	23 kg (50 lb)
Extended Draw Bar	Weight	33 kg (72 lb)
4000S Winch	Weight	653 kg (1437 lb)
Winch Fairlead, Four Roller	Weight	85 kg (187 lb)
Radial Ripper	Weight	335 kg (738 lb)
Parallelogram Ripper	Weight	592 kg (1306 lb)

CED, OUC1032, 1387 -19-18JUN02-1/1

650H-LGP Crawler Dozer Dimensions

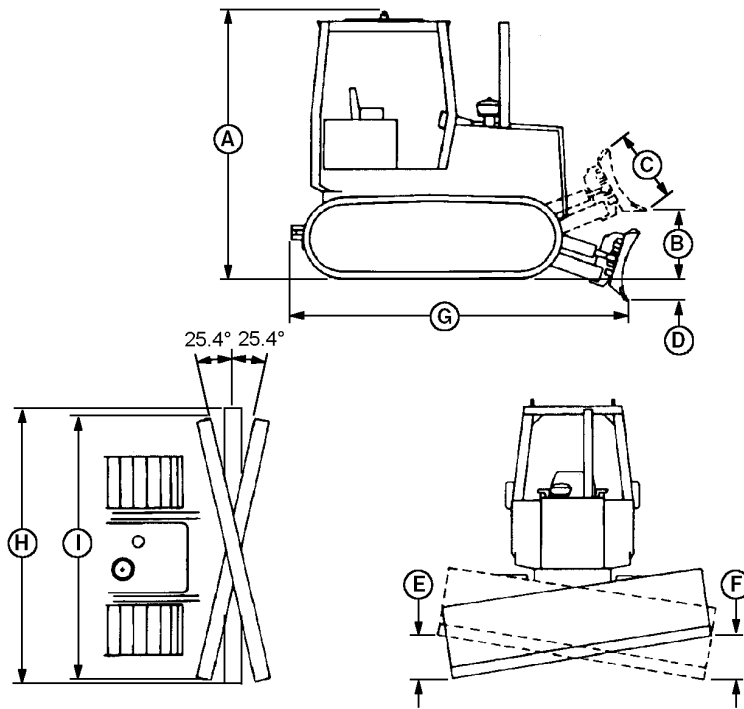

T118300

T118300—UN—11NOV98

NOTE: Specifications and design subject to change without notice. Whenever applicable, specifications are in accordance with ICED and SAE standards. Except where otherwise noted, these specifications

are based on a unit with roll-over protective structure, full fuel tank, 80 kg (175 lb) operator, and standard equipment.

Item	Measurement	Specification
A—Overall Height—ROPS or Cab	Height	2768 mm (9 ft 1 in.)
B—Blade	Height	826 mm (2 ft 8.6 in.)
C—Blade Lift	Height	819 mm (2 ft 8.2 in.)
D—Digging	Depth	500 mm (1 ft 7.7 in.)
E—Blade Tilt		
115 inch Blade (Right Side)	Distance	399 mm (1 ft 3 in.)
128 inch Blade (Right Side)	Distance	444 mm (1 ft 5.5 in.)
F—Blade Tilt		
115 inch Blade (Left Side)	Distance	399 mm (1 ft 3 in.)
128 inch Blade (Left Side)	Distance	444 mm (1 ft 5.5 in.)
G—Overall (Without Winch)	Length	4070 mm (13 ft 4 in.)
G—Overall (With Winch)	Length	4547 mm (14 ft 11 in.)
H—Blade Width (115 inch Blade)	Width	2921 mm (9 ft 7 in.)
H—Blade Width (128 inch Blade)	Width	3251 mm (10 ft 8 in.)
I—Blade Angle (115 inch Blade)	Width	2742 mm (8 ft 11.9 in.)

Continued on next page

CED,OUO1032,1384 -19-25MAR99-1/2

Miscellaneous—Specifications

Item	Measurement	Specification
I—Blade Angle (128 inch Blade)	Width	3070 mm (10 ft 0.9 in.)
115 inch Blade	Capacity	1.75 m ³ (2.9 yd ³)
128 inch Blade	Capacity	1.93 m ³ (2.52 yd ³)

CED,OUO1032,1384 -19-25MAR99-2/2

650H-LGP Crawler Dozer Specifications

Item	Measurement	Specification
John Deere PowerTech® 4045T 4-Cylinder Diesel Engine		
Engine	Type	Turbocharged
Fuel Consumption, Typical	Consumption	7.2—11.2 L/h (1.9—3.0 gph)
Rated Power at 2200 rpm	Power	67 kW (90 hp) SAE net horsepower
Piston	Displacement	4.52 L (276 cu in.)
Maximum Net Torque at 1200 rpm	Torque Rise	405 N·m (316 lb-ft)
Batteries	Voltage	12-volt
Alternator—ROPS	Amperage	65 amp
Alternator—Cab with Air Conditioning	Amperage	95 amp
Transmission	Speed	0—8 km/h (0—5 mph)
Hydraulic System	Pressure	20 685 kPa (3000 psi)
	Flow Rate	56.8 L/min (15 gpm) @ 2200 rpm
Undercarriage		
Track Shoes (Each Side)	Quantity	38
Ground Contact Area (with 28 in. Shoes)	Area	31 432 cm ² (4872 sq in.)
Track	Pitch	171 mm (6.73 in.)
	Gauge	1753 mm (69 in.)
Minimum Ground (with Single Bar Grouser)	Clearance	363 mm (14.3 in.)
Minimum Ground (with Swamp Shoes)	Clearance	384 mm (15.1 in.)
Ground Pressure	Pressure	26.9 kPa (0.27 bar) (3.9 psi)

PowerTech is a registered trademark of Deere & Company

CED,OUO1032,1386 -19-25MAR99-1/1

650H-LGP Crawler Dozer Weights

Item	Measurement	Specification
SAE Operating Weight	Weight	8664 kg (19,100 lb)
Optional Equipment		
Rock Guards (4)	Weight	131 kg (288 lb)
Swamp Shoe	Weight	72 kg (158 lb)
Deluxe Seat (add)	Weight	9 kg (20 lb)
Cab with Heater (add)	Weight	268 kg (590 lb)
Cab with Air Conditioning (add)	Weight	306 kg (675 lb)
ROPS Heater	Weight	12 kg (26 lb)
High Intensity Lights	Weight	4 kg (9 lb)
Front Tow Hook	Weight	15 kg (33 lb)
Retrieval Hitch	Weight	23 kg (50 lb)
Extended Draw Bar	Weight	33 kg (72 lb)
4000S Winch	Weight	653 kg (1437 lb)
Winch Fairlead, Four Roller	Weight	85 kg (187 lb)
Radial Ripper	Weight	335 kg (738 lb)
Parallelogram Ripper	Weight	592 kg (1306 lb)

CED,OUO1032,1381 -19-25MAR99-1/1

650H-XLT Crawler Dozer Dimensions

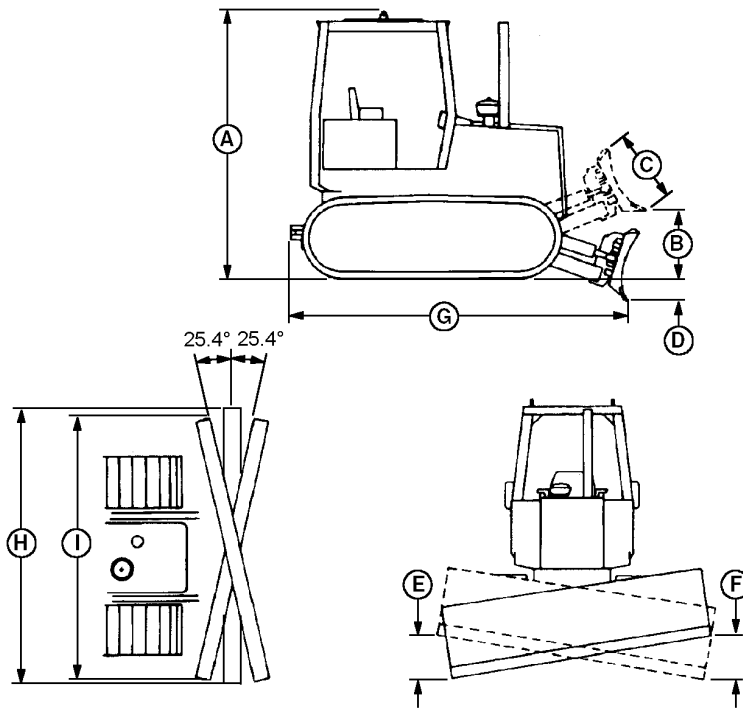

T118300

T118300—JUN—11NOV88

NOTE: Specifications and design subject to change without notice. Whenever applicable, specifications are in accordance with ICED and SAE standards. Except where otherwise noted, these specifications

are based on a unit with roll-over protective structure, full fuel tank, 80 kg (175 lb) operator, and standard equipment.

Item	Measurement	Specification
A—Overall Height—ROPS or Cab	Height	2768 mm (9 ft 1 in.)
B—105 inch (Standard) Blade	Height	933 mm (3 ft 0.7 in.)
B—97 inch (Narrow) Blade	Height	826 mm (2 ft 8.6 in.)
C—Blade Lift	Height	819 mm (2 ft 8.2 in.)
D—Digging	Depth	500 mm (1 ft 7.7 in.)
E—Blade Tilt		
105 inch (Standard) Blade (Right Side)	Distance	364 mm (1 ft 2.3 in.)
97 inch (Narrow) Blade (Right Side)	Distance	337 mm (1 ft 1.3 in.)
F—Blade Tilt		
105 inch (Standard) Blade (Left Side)	Distance	364 mm (1 ft 2.3 in.)
97 inch (Narrow) Blade (Left Side)	Distance	337 mm (1 ft 1.3 in.)
G—Overall (Without Winch)	Length	4260 mm (13 ft 11 in.)
G—Overall (With Winch)	Length	4737 mm (15 ft 7 in.)
H—Blade Width (105 inch Standard Blade)	Width	2667 mm (8 ft 9 in.)

Continued on next page

HG31779,0000094 -19-18JUN02-1/2

Miscellaneous—Specifications

Item	Measurement	Specification
H—Blade Width (97 inch Narrow Blade)	Width	2464 mm (8 ft 1 in.)
I—Blade Angle (105 inch Standard Blade)	Width	2507 mm (8 ft 2.7 in.)
I—Blade Angle (97 inch Narrow Blade)	Width	2318 mm (7 ft 7.2 in.)
105 inch (Standard) Blade	Capacity	1.99 m ³ (2.6 yd ³)
97 inch (Narrow) Blade	Capacity	1.5 m ³ (2.0 yd ³)

HG31779,0000094 -19-18JUN02-2/2

650H-XLT Crawler Dozer Specifications

Item	Measurement	Specification
John Deere PowerTech® 4045T 4-Cylinder Diesel Engine		
Engine	Type	Turbocharged
Fuel Consumption, Typical	Consumption	7.2—11.2 L/h (1.9—3.0 gph)
Rated Power at 2200 rpm	Power	67 kW (90 hp) SAE net horsepower
Piston	Displacement	4.52 L (276 cu in.)
Maximum Net Torque at 1200 rpm	Torque Rise	405 N·m (316 lb-ft)
Batteries	Voltage	12-volt
Alternator—ROPS	Amperage	65 amp
Alternator—Cab with Air Conditioning	Amperage	95 amp
Transmission	Speed	0—8 km/h (0—5 mph)
Hydraulic System	Pressure	20 685 kPa (3000 psi)
	Flow Rate	56.8 L/min (15 gpm) @ 2200 rpm
Undercarriage		
Track Shoes (Each Side)	Quantity	40
Ground Contact Area (with 18 in. Shoes)	Area	21 368 cm ² (3312 sq in.)
Track	Pitch	171 mm (6.73 in.)
	Gauge	1550 mm (61 in.)
Minimum Ground (with Single Bar Grouser)	Clearance	363 mm (14.3 in.)
Minimum Ground (with Swamp Shoes)	Clearance	384 mm (15.1 in.)
Ground Pressure	Pressure	38.5 kPa (0.38 bar) (5.6 psi)
Standard Grouser	Width	457 mm (18 in.)

PowerTech is a registered trademark of Deere & Company

HG31779,0000095 -19-18JUN02-1/1

650H-XLT Crawler Dozer Weights

Item	Measurement	Specification
SAE Operating Weight	Weight	8437 kg (18,600 lb)
Optional Equipment		
Rock Guards (4)	Weight	134 kg (295 lb)
Deluxe Seat (add)	Weight	9 kg (20 lb)
Cab with Heater (add)	Weight	268 kg (590 lb)
Cab with Air Conditioning (add)	Weight	306 kg (675 lb)
ROPS Heater	Weight	12 kg (26 lb)
High Intensity Lights	Weight	4 kg (9 lb)
Retrieval Hitch	Weight	23 kg (50 lb)
Extended Draw Bar	Weight	33 kg (72 lb)
4000S Winch	Weight	653 kg (1437 lb)
Winch Fairlead, Four Roller	Weight	85 kg (187 lb)
Radial Ripper	Weight	335 kg (738 lb)
Parallelogram Ripper	Weight	592 kg (1306 lb)

HG31779,0000096 -19-18JUN02-1/1

650H, 650H-LGP and 650H-XLT Crawler Dozer Drain and Refill Capacities

Item	Measurement	Specification
Drain and Refill Capacities		
Cooling System	Capacity	14 L (15 qt)
Fuel Tank	Capacity	178 L (47 gal)
Engine Oil (Including Filter)	Capacity	14 L (15 qt)
Final Drive (Each Side)	Capacity	8.5 L (9 qt)
Hydraulic Reservoir (Including Filter)	Capacity	32 L (8.5 gal)
Transmission Reservoir (Including Filter)	Capacity	53 L (14 gal)
Winch-If Equipped	Capacity	37 L (10 gal)

CED,OUO1032,1389 -19-06JUN05-1/1

4000S Winch

Maximum Cable Capacities	
Cable Size	Winch Capacity
15.88 mm (0.625 in.)	77.4 m (254 ft)
19.05 mm (0.75 in.)	54.6 m (179 ft)
22.23 mm (0.875 in.)	39.3 m (129 ft)

TX,115,RR2763 -19-14JAN08-1/1

Index

	Page		Page
A			
Adjustment		550H, 550H-LGP crawler dozer drain and refill ...	4-6-15
Track sag	3-3-3	650H, 650H-LGP crawler dozer drain and refill ...	4-6-24
Winch free spool drag	2-2-35	Chemical products	
Adjustment, armrest	2-1-11	Handling	1-2-4
Adjustment, engine speed	4-1-19	Codes, service	4-3-10
Air cleaner		Cold weather	
Changing elements	3-8-2	Machine warming	2-2-18
Air conditioner		Starting	2-2-8
Refrigerant level, check	4-1-17	Console	
Air conditioning	2-1-8	Optional gauges	2-1-1
Air intake hose	3-7-1	Control valve	4-1-19
Alternator		Coolant	
Precaution	4-1-4	Changing	4-1-1
Antifreeze		Conditioner	3-7-4
Changing	4-1-1	Diesel engine	3-1-8
Level	3-4-1	Heater	2-2-9
Armrest	2-1-11	Level	3-4-1
Auxiliary power outlet	2-1-9	Cooling system checks	4-2-1
B			
Battery		Cooling system fill	4-1-2
Electrolyte level	3-7-5	Coolscan Plus	3-2-3
Explosions, prevent	1-2-4	Cylinder service	4-1-19
Handling, checking, servicing	4-1-5	D	
Jump starting	2-2-17	Daily machine check	2-2-1
Remove	4-1-7	Damper, replace	4-1-2
Replace	4-1-6	Decelerator	
Belt, serpentine		Pedal	2-2-26
Inspect	3-3-1	Diagnose malfunctions	
Blade		Troubleshooting procedure	4-3-1
Angling	2-2-30	Diesel engine oil	3-1-4
Operation	2-2-29	Diesel fuel	3-1-1
Pitch operation	2-2-28	Diesel fuel conditioner	
Tilt	2-2-29	Low sulfur	3-1-1
Bolt and screw torque values		Diesel fuel, testing	
Metric	4-1-23	Testing Diesel Fuel	3-1-1
Unified inch	4-1-22	Diesel heater	2-2-10
Brake, park		Dimensions	
Releasing	2-2-37	450H crawler dozer	4-6-1
Break-in engine oil	3-1-3	450H-LGP crawler dozer	4-6-7
Break-In oil change		450H-LT crawler dozer	4-6-4
Engine	3-5-1	550H crawler dozer	4-6-10
Breather filter		550H-LGP crawler dozer	4-6-13
Winch	3-8-5	650H crawler dozer	4-6-16, 4-6-22
C			
650H-LGP crawler dozer	4-6-19	Display window	
Cab filter, air recirculation	4-1-16	Transmission control unit	2-1-5
Cab filter, fresh air	4-1-16	Dozer linkage, lubricate	3-4-4
Cable specifications, winch	4-6-24	Driving the machine	2-2-18, 2-2-21, 2-2-22
Cable, winch	2-2-32	Dust unloader valve	
Capacities		Clean	3-4-4
450H, 450H-LT, 450H-LGP crawler dozer		Replace	3-8-3
drain and refill	4-6-9		

Continued on next page

Index

	Page		Page
E			
Electrical		Fluids, high pressure	
Troubleshooting	4-3-5	Avoid	1-2-3
Element		FNR	
Primary		Forward Speed	
Cleaning and inspecting	4-1-4	Switch	2-2-21, 2-2-22
Emergencies		Lever	2-2-21, 2-2-22
Prepare for	1-2-5	Steer lever	
Engine		Speed-In-Grip	2-2-24
Boost starting	2-2-17	FNR with speed in grip	2-2-20, 2-2-25
Break-In oil change	3-5-1	Front idler	
Coolant heater	2-2-9	Oil specification	3-1-4
Coolant level	3-4-1	Fuel	
Crankcase vent tube	3-8-1	Diesel	3-1-1
Fuel-fired coolant heater	2-2-10	Filter change	3-7-2
Oil change	3-6-1, 3-7-1	Filter replace	3-7-3
Oil level	3-4-2	Handling and storing	3-1-2
Serial number record	4-5-1	Fuel filter, final	
Speed control lever	2-2-25	Drain sediment	3-6-1
Starting	2-2-4, 2-2-6	Fuel fired heater	2-2-10
Troubleshooting	4-3-2	Fuel system checks	4-2-3
Valve clearance, check and adjust	3-9-1	Fuel tank	
Warm-up	2-2-17	Capacity	3-2-2
Engine air screen	4-1-2	Drain	4-1-15
Engine damper, replace	4-1-2	Fuel/water separator	
Engine oil		Filter drain sediment	3-4-2
Break-In	3-1-3	Fumes, exhaust	
Diesel	3-1-4	Beware	1-2-3
Engine speed control lever		Fuse specifications	
Adjust tension	4-1-19	Cab units	4-1-12, 4-1-14
Engine, air filter replace	3-8-2	ROPS units	4-1-8, 4-1-10
Equipment, protective		G	
Wear	1-2-2	Gauges	
F			
Filter		Troubleshooting	4-3-9
Air recirculation	4-1-16	Grease	3-1-7
Air, cab	4-1-16	Alternative and synthetic lubricants	3-1-2
Engine	3-5-1, 3-7-1	Grease dozer linkage	3-4-4
Final fuel, drain sediment	3-6-1	H	
Fuel	3-7-2	Hardware	
Fuel/water separator	3-4-2	Torque specifications	4-1-21
Filter, engine air, replace	3-8-2	Hardware torque values	
Filter, hydraulic oil, change	3-9-1	Metric	4-1-23
Filter, transmission oil, replace	3-9-2	Unified inch	4-1-22
Filter, winch breather, replace	3-8-5	Hazards	
Filter, winch oil		Avoiding	1-3-1
Replace	3-7-7, 3-8-4	Heater	2-1-8
Final drive		Heater, coolant	2-2-10
Oil change	3-8-1	Horn switch	2-1-9
Oil level	3-6-1	Hose	
Final drives		Air intake	3-7-1
Oil		Hour meter	3-2-1
Specifications	3-1-6	Hydraulic	
Fires, prevent	1-2-4	Oil and filter change	3-9-1
		Oil level	3-4-3

Continued on next page

Index

	Page		Page
Troubleshooting	4-3-7		
Hydraulic breather filter, winch		O	
Replace	3-8-5		
I			
Idler		Oil	
Front, oil specification	3-1-4	Adding to roller	4-1-19
Indicator		Alternative and synthetic lubricants	3-1-2
Troubleshooting	4-3-9	Final drive oil	
Injection		Specifications	3-1-6
Nozzle	4-1-3	Specification carrier roller	3-1-4
Pump	4-1-3	Specification front idler	3-1-4
Instrument		Specification track frame pivot	3-1-4
Check before starting	2-2-3	Specification track roller	3-1-4
Panel	2-2-2	Specification transmission	3-1-5
Panel, optional gauges	2-1-1	Oil and filter change	
L		Hydraulic	3-9-1
Lever		Transmission	3-9-2
Engine speed control	2-2-25	Oil change	
FNR	2-2-21, 2-2-22	Engine	3-6-1, 3-7-1
Speed-In-Grip	2-2-24	Final drive	3-8-1
Park brake	2-2-26	Oil level	
Steering	2-2-23	Engine	3-4-2
Loading		Final drive	3-6-1
Machine on a trailer	2-2-36	Hydraulic	3-4-3
Low sulfur diesel fuel conditioner	3-1-1	Transmission	3-4-3
Lubricants		Oil, winch	
Alternative and synthetic lubricants	3-1-2	Check	3-4-5
Specifications		Drain and refill	3-8-4
Oil, final drives	3-1-6	Oilscan Plus	3-2-3
Lubricate		Operation qualification	1-2-1
Fittings, dozer linkage	3-4-4	Operational check	
M		Accessory	4-2-15
Machine		Hydraulic system	4-2-12
Cold weather warming	2-2-18	Undercarriage	4-2-14
Maintenance preparation	3-2-1	Operational checkout	4-2-1
Machine towing	2-2-37	Indicators, shift linkage, alarm	4-2-11
Machine, inspect	1-2-2	Neutral start switch and circuit	4-2-11
Maintenance		Outlet	
Record keeping	3-2-2	Auxiliary power	2-1-9
Maintenance repair record	3-2-4	P	
Metric bolt and screw torque values	4-1-23	Park brake	
Monitor		Operation	2-2-26
Display window	2-1-4	Park brake, releasing	2-2-37
Select button	2-1-4	Parking machine	2-2-27
N		Parts, moving	
Neutral start system		Stay clear	1-2-2
Check	4-1-20	Pedal	
Non-suspension seat	2-1-10	Brake	2-2-26
		Decelerator	2-2-26
		PowerTech engine	
		Adjust valve clearance	3-9-1
		Pre-start inspection	2-2-1
		Precleaner	
		Clean	4-1-2

Continued on next page

Index

	Page		Page
R			
Radiator		450H-LT crawler dozer.....	4-6-5
Add rust inhibitor.....	3-7-4	550H crawler dozer.....	4-6-11
Coolant level.....	3-4-1	550H-LGP crawler dozer.....	4-6-14
Recognize		650H crawler dozer.....	4-6-17, 4-6-23
Safety, information.....	1-2-1	650H-LGP crawler dozer.....	4-6-20
Record, repair.....	3-2-4	Carrier roller oil.....	3-1-4
Recovery tank coolant level.....	3-4-1	Front idler oil.....	3-1-4
Regulator precaution.....	4-1-4	Hardware torque.....	4-1-21
Reservoir		Oil	
Hydraulic oil.....	3-9-1	Final drives.....	3-1-6
Transmission oil.....	3-9-2	Track roller oil.....	3-1-4
Windshield washer.....	2-1-8	Specifications, fuse	
Reverse Speed		Cab units.....	4-1-12, 4-1-14
Switch.....	2-2-21, 2-2-22	ROPS units.....	4-1-8, 4-1-10
Roller		Speed in grip controls.....	2-2-20
Adding oil.....	4-1-19	Speed-In-Grip	
ROPS		FNR lever.....	2-2-24
Torque value.....	4-1-20	Start system	
S			
Safety		Checking.....	4-1-20
Add cab guarding for special uses.....	1-2-5	Starting	
Avoid backover accidents.....	1-3-2	Engine.....	2-2-4, 2-2-6
Avoid machine tip over.....	1-3-3	Starting fluid, cold weather start.....	2-2-8
Drive metal pins safely.....	1-4-2	Steering	
Instructions, follow.....	1-2-1	Machine.....	2-2-23
Keep riders off machine.....	1-3-2	Stopping	
Make welding repairs safely.....	1-4-2	Machine.....	2-2-26
Park and prepare for service safely.....	1-4-1	Storage	
Prevent unintended machine movement.....	1-3-1	Machine.....	4-4-1
Signs		Storing fuel.....	3-1-2
655C/755C crawler loaders.....	1-5-1	Suspension seat adjustment.....	2-1-11
Start only from operator's seat.....	1-3-1	Switch	
Safety, information		Horn.....	2-1-9
Recognize.....	1-2-1	Transmission reverse speed.....	2-2-19
Sag, track check.....	3-3-2	T	
Sag, track information.....	4-1-18	Torque charts	
Seat		Metric.....	4-1-23
Non-suspension adjustment.....	2-1-10	Unified inch.....	4-1-22
Seat belt inspection and replacment.....	2-1-12	Torque specifications	
Suspension.....	2-1-11	Hardware.....	4-1-21
Secondary and primary element		Towing the machine.....	2-2-37
Cleaning.....	4-1-4	Track	
Select button.....	2-1-4	Avoid damage.....	2-2-35, 4-4-1
Serpentine belt.....	3-3-1	Roller oil specification.....	3-1-4
Service codes		Sag, check.....	3-3-2
Transmission.....	4-3-10	Track sag	
Service intervals.....	3-2-1	Adjust.....	3-3-3
Side windows.....	2-1-10	General information.....	4-1-18
Specification		Track shoe torque.....	4-1-21
Transmission oil.....	3-1-5	Trailer loading.....	2-2-36
Specifications.....	4-6-1	Transmission	
450H crawler dozer.....	4-6-2	Oil and filter change.....	3-9-2
450H-LGP crawler dozer.....	4-6-8	Oil level.....	3-4-3
		Oil specification.....	3-1-5
		Speed switch	
		Reverse.....	2-2-19
		Troubleshooting.....	4-3-8

Continued on next page

Index

	Page		Page
Transmission control unit		EPA	-3
Display window	2-1-5	Washer, windshield	
Travel speed controls	2-2-25	Reservoir.....	2-1-8
Travel speed with speed in grip	2-2-25	Waste	
Troubleshooting		Dispose of properly	1-2-5
Electrical	4-3-5	Water separator	3-4-2
Engine.....	4-3-2	Replace.....	3-7-3
Gauges and indicators.....	4-3-9	Weights	
Hydraulic.....	4-3-7	450H crawler dozer.....	4-6-3
Transmission.....	4-3-8	450H-LGP crawler dozer	4-6-9
Troubleshooting procedure.....	4-3-1	450H-LT crawler dozer.....	4-6-6
		550H crawler dozer.....	4-6-12
U		550H-LGP crawler dozer	4-6-15
Unified inch bolt and screw torque values	4-1-22	650H crawler dozer.....	4-6-18, 4-6-24
Unloader valve, clean	3-4-4	650H-LGP crawler dozer	4-6-21
Unloader vavle, replace.....	3-8-3	Winch	
		Cable.....	2-2-32
V		Drag adjustment.....	2-2-35
Valve lash adjustment.....	3-9-1	Drain and refill oil and replace filter.....	3-8-4
Valve, control	4-1-19	Operation	2-2-31
Valve, dust unloader		Winch breather filter	
Clean.....	3-4-4	Replace.....	3-8-5
Replace.....	3-8-3	Winch cable specifications	4-6-24
Vibration damper, replace.....	4-1-2	Winch filter	
		Replace.....	3-7-7
W		Winch oil	
Warming engine	2-2-17	Check.....	3-4-5
Warming machine		Window exits	2-1-10
Cold weather.....	2-2-18	Windows, side	2-1-10
Warranty		Wiper and washer.....	2-1-8
Non-road emissions control warranty		Worksite hazards	
statement--compression ignition		Avoid	1-3-1
CARB	-5		

