



# JOHN DEERE

## OPERATOR'S MANUAL

### OMM144042

Issue D0

Lawn and Garden Tractors

425 and 445

Serial No. (070001 -)



Introduction.....	6
Thank You for Purchasing a John Deere Product.....	6
Using Your Operator's Manual.....	6
CALIFORNIA Proposition 65 Warning.....	7
Product Identification.....	8
Record Identification Numbers.....	8
Safety .....	9
Safety-Alert Symbol .....	9
<b>WARNING: AVOID SERIOUS INJURY OR DEATH</b> .....	9
<b>DANGER: ROTATING BLADES CUT OFF ARMS AND LEGS</b> .....	10
<b>DANGER: EXPLOSIVE GASES</b> .....	10
<b>HOT SURFACE</b> .....	11
<b>CAUTION: PRESSURIZED LINE</b> .....	11
Emission Control System Certification Label .....	11
Emission Compliance Period.....	12
Certification .....	12
Operate Safely.....	12
Park Safely .....	13
Rotating Blades are Dangerous - Protect Children and Prevent Accidents .....	13
Avoid Tipping.....	14
Keep Riders Off .....	15
Wear Appropriate Clothing.....	15
Stay Clear of Rotating Drivelines.....	16
Check Wheel Bolts .....	16
Transport Safely.....	16
Practice Safe Maintenance.....	17
Wear Appropriate Clothing.....	18
Stay Clear of Rotating Drivelines.....	18
Handling Waste Product and Chemicals.....	18
Avoid High Pressure Fluids .....	19
Operating.....	21
Daily Operating Checklist.....	21
Dash Controls.....	21
Foot/Platform Controls .....	22
Miscellaneous Controls.....	23
Adjusting Steering Wheel.....	24
Adjusting Seat (425) .....	24
Adjusting Seat (445) .....	25
Rear Wheel Spacing (Two Wheel Steer Models With 23 x 10.50-12 Tires) .....	26
Testing Safety Systems.....	27
Test 1.....	27
Test 2.....	28
Test 3.....	28
Test 4.....	29
Test 5.....	29
Test 6.....	30
Using the Park Brake .....	31
Indicator Lights and Gauges .....	31

Starting the Engine.....	33
Stopping the Engine.....	35
Using Travel Controls.....	36
Using Cruise Control .....	37
Using The Reverse Implement Option .....	38
Using Differential Lock .....	39
Using Hydraulic Control Levers.....	40
Using PTO (Power Take-Off).....	41
Using Mower Height Control .....	42
Mower Lift Arms .....	43
Using Free-Wheeling Lever.....	43
Using Engine Air Restriction Indicator (Optional Equipment) .....	44
Using Weights And Tire Chains .....	45
Rear Weights.....	45
Installing Rear Wheel Weights (Two-Wheel Steer Tractors).....	45
Installing Rear Wheel Weights (All-Wheel Steer Tractors).....	49
Using Tire Chains .....	50
Installing the Chains .....	50
Transporting Tractor.....	52
Mowing Tips.....	53
Trimming Tips .....	54
To Avoid Scalping .....	54
After Mowing.....	54
Bagging Tips.....	55
Bagging and Composting.....	55
Mulching Tips.....	56
Replacement Parts.....	57
Service Literature.....	57
Parts.....	57
Part Numbers .....	57
Service Interval Chart .....	59
After First 5 Hours .....	59
Break In (After First 50 Hours of Operation) .....	59
50 Hours.....	59
100 Hours or Annually (whichever comes first).....	59
200 Hours.....	59
200 Hours or Annually (whichever comes first).....	59
250 Hours or Annually (whichever comes first).....	60
500 Hours.....	60
500 Hours or Every Two Years (whichever comes first) .....	60
Service Lubrication.....	61
Grease .....	61
Lubricating Rear Steering Pivot (All Wheel Steer) .....	61
Lubricating Steering Cylinder Ball Joints (All Tractors) .....	62
Lubricating Front Axle .....	63
Service Engine .....	65
Engine Warranty Maintenance Statement .....	65
Adjusting Carburetor .....	65
Avoid Fumes.....	65
Engine Oil.....	65

Changing Engine Oil and Filter .....	68
Cleaning Air Intake Screens .....	70
Checking Air Restriction Indicator (Optional Equipment).....	71
Cleaning Radiator Screen and Fins.....	71
Servicing Air Cleaner Elements.....	72
Recommended Engine Coolant.....	75
Engine Coolant Drain Interval .....	75
Engine Coolant Drain Interval .....	76
Checking Coolant Level .....	76
Servicing Cooling System.....	77
Replacing Fuel Filter (425).....	82
Relieving Fuel System Pressure (445).....	82
Replacing Fuel Filter (445).....	83
Servicing Fan Belt.....	84
Service Transmission .....	87
Anti-Chatter Transmission Oil.....	87
Checking Transaxle Oil Level .....	87
Changing Transaxle Oil and Filter.....	88
Service Electrical .....	91
Cleaning or Replacing Battery .....	91
Checking Battery Electrolyte Level.....	93
Charging the Battery .....	94
Using Booster Battery.....	96
Cleaning and Gapping Spark Plugs .....	97
Replacing Fuses .....	99
Replacing Headlight Bulb.....	100
Replacing Taillight Bulb.....	100
Replacing Indicator Light Bulb .....	101
Service Miscellaneous .....	104
Checking Tire Pressure.....	104
Checking Tightness of Wheel Bolts .....	105
Raising Hood .....	105
Removing Grille.....	106
Removing and Cleaning Side Panels .....	106
Refueling Machine.....	108
Filling Fuel Tank.....	109
Cleaning and Repairing Plastic Surfaces .....	110
Cleaning and Repairing Metal Surfaces .....	110
Troubleshooting .....	112
Using Troubleshooting Chart.....	112
Engine .....	112
Tractor.....	113
Steering .....	114
Mower .....	114
Electrical .....	114
Storing Machine.....	116
Storage Safety .....	116
Preparing Engine for Storage.....	116
Storing the Tractor .....	116
Removing the Vehicle From Storage.....	117

Assembly.....	119
Remove Bracing.....	119
Fill Fuel Tank Safely .....	119
Fill Fuel Tank.....	119
Activate Battery (Early Model Dry Batteries) .....	120
Check Battery Voltage (Late Model "Moist" Batteries).....	122
Install Battery.....	123
Install the Steering Wheel.....	124
Install Seat (425).....	124
Install Seat (445).....	125
Checking Tire Pressure.....	126
Specifications.....	128
Engine .....	128
Engine .....	128
Fuel System.....	129
Electrical System .....	129
Capacities.....	129
Drive Train.....	130
Travel Speeds.....	130
Steering and Brakes .....	130
Dimensions - 425 .....	130
Dimensions - 445 .....	131
Tires - 425 .....	132
Tires - 445 .....	132
Recommended Lubricants .....	132
Warranty .....	133
Product Warranty .....	133
Tire Warranty.....	133
John Deere, Federal and California Emission Control System Warranty (Small Off-Road Gas Engines).....	133
Limited Battery Warranty .....	137
John Deere Quality Statement .....	139
John Deere Quality .....	139
Service Record.....	141
Record Service Dates.....	141

# Introduction

---

## **Thank You for Purchasing a John Deere Product**

We appreciate your business and wish you many years of safe and satisfied use of your machine.

## **Using Your Operator's Manual**

This manual is an important part of your machine and should remain with the machine when you sell it.

Reading your operator's manual will help you and others avoid personal injury or damage to the machine. Information given in this manual will provide the operator with the safest and most effective use of the machine. Knowing how to operate this machine safely and correctly will allow you to train others who may operate this machine.

Section in your operator's manual are placed in a specific order to help you understand all the safety messages and learn the controls so you can operate this machine safely. YOU can also use this manual to answer any specific operating or servicing questions. A convenient index located at the end of this book will help you to find needed information quickly.

The machine shown in this manual may differ slightly from your machine, but will be similar enough to help you understand our instructions.

RIGHT-HAND and LEFT-HAND sides are determined by facing in the direction the machine will travel when going forward. When you see a broken line arrow (----->), the item referred to is hidden from view.

## **Special Messages**

Your manual contains special messages to bring attention to potential safety concerns, machine damage as well as helpful operating and servicing information. Please read all the highlighted information carefully to avoid injury and machine damage.



**c CAUTION: Avoid injury!**

This symbol and text highlight potential hazards or death to the operator or bystanders may occur if the hazards or procedures are ignored.

**IMPORTANT: Avoid damage!**

This text is used to tell the operator of actions or conditions that might result in damage to the machine.

**NOTE:** General information is given throughout the manual that may help the operator in the operation of the machine.

### **CALIFORNIA Proposition 65 Warning**



**WARNING:** The Engine Exhaust from this product contains chemicals known to the State of California to cause cancer, birth defects or other reproductive harm.

California Proposition 65 Warning

# Product Identification

---

## Record Identification Numbers

If you need to contact an Authorized Service Center for information on servicing, always provide the product model and serial number.

You will need to locate the model and serial number for the machine and for the engine of your machine and record the information in the spaces provided below.

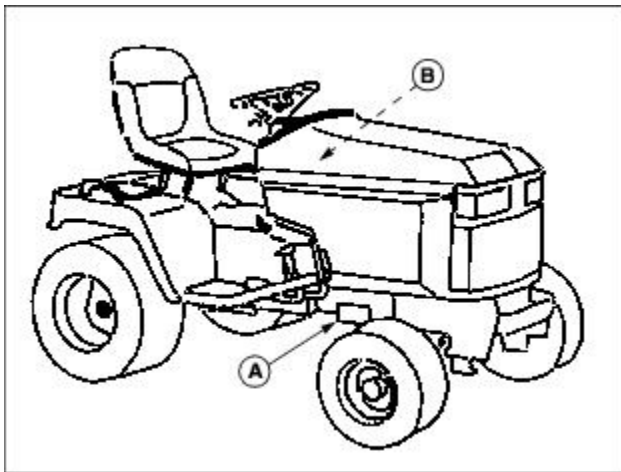

M71459A

DATE OF PURCHASE:

---

DEALER NAME:

---

DEALER PHONE:

---

PRODUCT IDENTIFICATION NUMBER (A):

---

ENGINE SERIAL NUMBER (B):

---



# Safety

---

## Safety-Alert Symbol



Read and recognize safety information. Be alert to the potential for personal injury when you see this safety-alert symbol.

On your machine safety labels, the words **DANGER**, **WARNING**, and **CAUTION** are used with this safety-alert symbol. **DANGER** identifies the most serious hazards. In this manual, the word **CAUTION** and this symbol call attention to safety messages.

## **WARNING: AVOID SERIOUS INJURY OR DEATH**

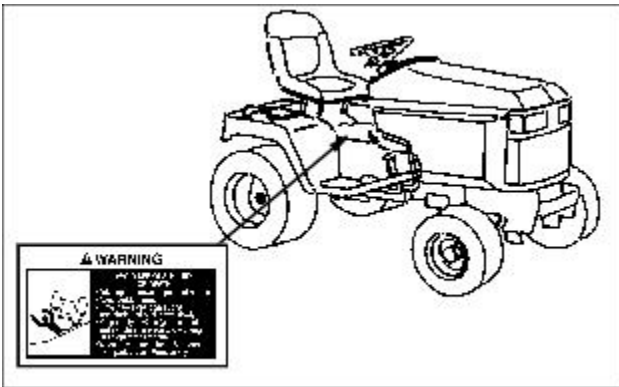

m40180A

- Drive up and down slopes, not across.
- Avoid sudden turns.
- If machine stops going uphill, stop blade and back down slowly.
- Keep safety devices (guards, shields, and switches) in place and working.

- Read Operator's Manual.
- When leaving machine: Stop engine, Set park brake, Remove key.

**DANGER: ROTATING BLADES CUT OFF ARMS AND LEGS**

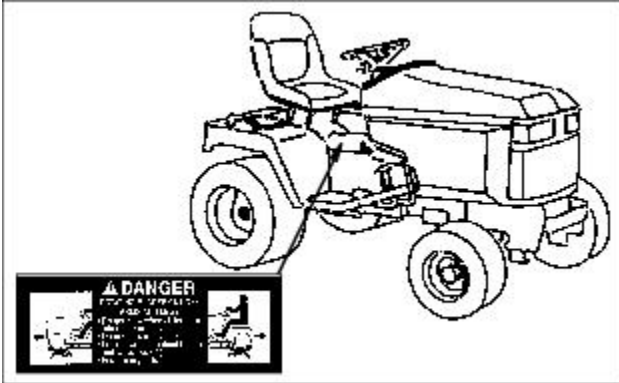

M140180B

- Do not mow when children or others are around.
- Do not mow in reverse.
- Look down and behind before and while backing.
- Never carry children even with the blades off.

**DANGER: EXPLOSIVE GASES**

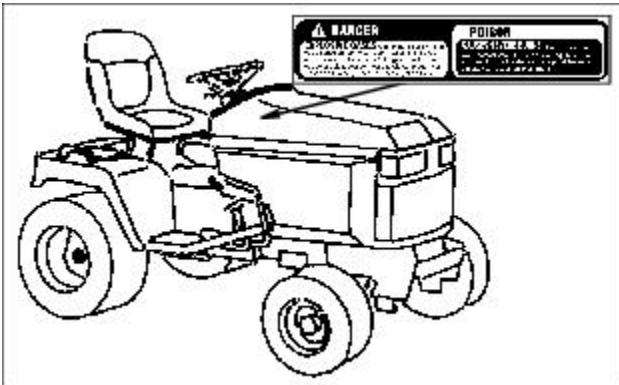

M74408

Cigarettes, flames or sparks could cause battery to explode. Always shield eyes and face from battery. Don not charge or use booster cables or adjust post connections without proper instruction and training. Keep vent caps tight and level.

**POISON: CAUSES SEVERE BURNS**

Contains sulfuric acid. Avoid contact with skin, eyes or clothing. In event of accident, flush with water and call a physician immediately. Keep out of reach of children.

## **HOT SURFACE**

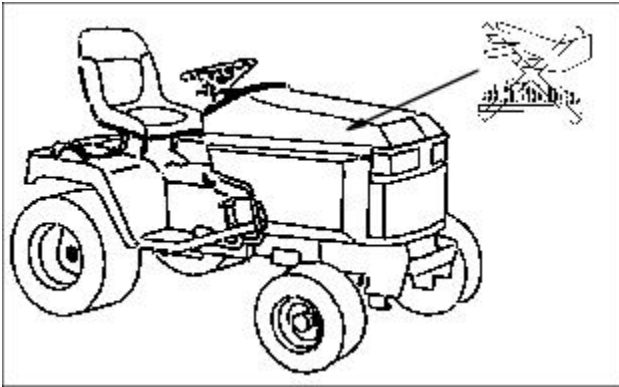

## **CAUTION: PRESSURIZED LINE**

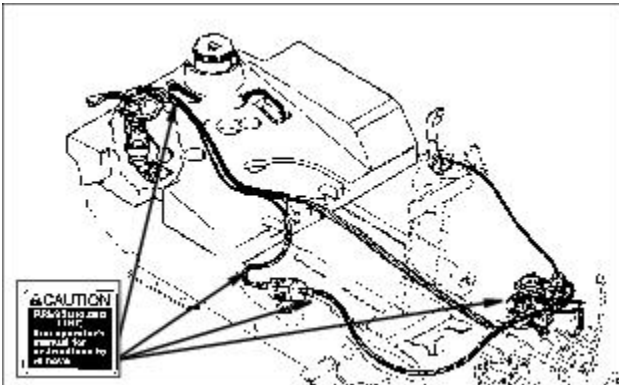

M71542 M71535

See operator's manual for instructions to remove.

## **Emission Control System Certification Label**

NOTE: Tampering with emission controls and components by unauthorized personnel may result in severe fines or penalties. Emission controls and components can only be adjusted by EPA and/or CARB authorized service centers. Contact your John Deere Commercial and Consumer Equipment Retailer concerning emission controls and component questions.

The presence of an emissions label signifies that the engine has been certified with the United States Environmental Protection Agency (EPA) and/or California Air Resources Board (CARB).

The emissions warranty applies only to those engines marketed by John Deere that have been certified by the EPA and/or CARB; and used in the United States and Canada in off-road mobile equipment.

## Emission Compliance Period

If your engine has the emission compliance category listed on the emission control system certification or air index label, this indicates the number of operating hours for which the engine has been certified to meet EPA and/or CARB emission requirements. The following table provides the engine compliance period in hours associated with the category found on the certification label.

Agency	Category	Hours
EPA	C	250
EPA	B	500
EPA	A	1000
CARB	Moderate	125
CARB	Intermediate	250
CARB	Extended	500

## Certification

Your mower has been certified by an independent laboratory for compliance with American National Standard B-71.1, "Safety Specifications" for Power Lawn Mowers, Lawn and Garden Tractors, and Lawn Tractors.

## Operate Safely



- Check brake action before you operate. Adjust or service brakes as necessary.
- Inspect machine before you operate. Be sure hardware is tight. Repair or replace damaged, badly worn, or missing parts. Be sure guards and shields are in good condition and fastened in place. Make any necessary adjustments before you operate.
- Clear work area of objects that might be thrown. Keep people and pets out of the work area. Stop

machine if anyone enters the area.

- If you hit an object, stop the machine and inspect it. Make repairs before you operate. Keep machine and attachments properly maintained and in good working order.
- DO NOT leave machine unattended when it is running.
- Only operate during daylight or with good artificial light.
- Be careful of traffic when operating near or crossing roadways.
- Do not wear radio or music headphones while operating the machine. Safe operation requires your full attention.
- Older adults are involved in a large percentage of riding mower accidents involving injury. These operators should evaluate their ability to operate a mower safely enough to protect the operator and others from serious injury.

### **Park Safely**

- Stop machine on a level surface, not on a slope.
- Disengage PTO.
- Lower attachments to the ground.
- Engage park brake.
- STOP engine.
- Remove key.
- Before you leave the operator's seat, wait for engine and all moving parts to STOP.

### **Rotating Blades are Dangerous - Protect Children and Prevent Accidents**

#### **Protect Children**

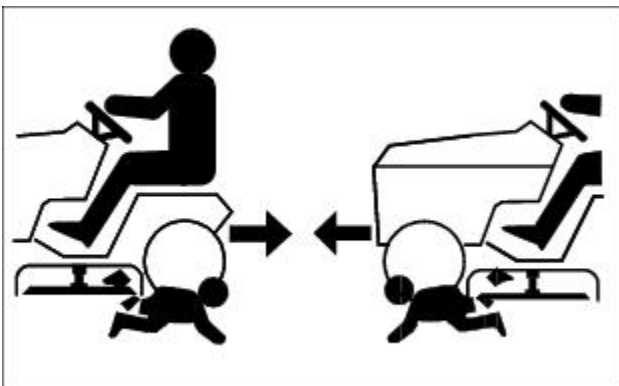

- Never assume that children will remain where you last saw them. Children are attracted to mowing activity, stay alert to the presence of children.
- Keep children in the house when you are operating the machine.
- Turn machine off if a child enters the mowing area.
- Use extra care when you come to blind corners, shrubs, trees, or other objects that may block your vision.
- DO NOT let children or an untrained person operate the machine.
- DO NOT carry or let children ride on machine or any attachment even with blades off. DO NOT tow children in a cart or trailer.

**Help Prevent Serious Or Fatal Accidents:**

- Be alert at all times, drive forward carefully. People ESPECIALLY CHILDREN can move quickly into the mowing area before you know it.
- Back carefully. Shut off PTO and look behind the machine carefully, ESPECIALLY FOR CHILDREN, before you back up.
- DO NOT mow in reverse unless it is absolutely necessary.
- Shut off PTO when you are not mowing.
- DO NOT operate machine if you are under the influence of drugs or alcohol.

**Avoid Tipping**

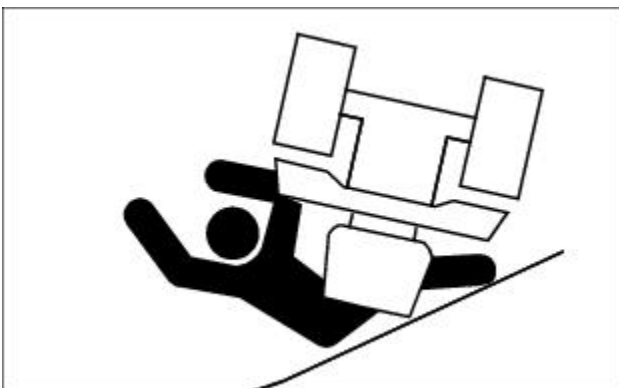

- DO NOT drive where machine could slip or tip.
- Stay alert for holes and other hidden hazards in the terrain.

- Keep away from drop-offs.
- Slow down before you make a sharp turn or operate on a slope.
- When pulling loads or using heavy equipment, use only approved hitches, limit loads to those you can safely control, and use counterweights or wheel weights when required per this manual or your attachment manual.
- Drive up and down a hill - not across. Be careful when you change direction on a slope.
- DO NOT stop when going up hill or down hill. If machine stops going up hill, STOP PTO and back down slowly.
- DO NOT mow wet grass. Reduced traction could cause sliding.
- DO NOT try to stabilize the machine by putting your foot on the ground.

### **Keep Riders Off**



- Only allow the operator on the machine. Keep riders off.
- Riders on the machine or attachment may be struck by foreign objects or thrown off the machine causing serious injury.
- Riders obstruct the operator's view resulting in the machine being operated in an unsafe manner.

### **Wear Appropriate Clothing**



- Wear close fitting clothing and safety equipment appropriate for the job.
- Loud noise can cause impairment or loss of hearing, wear a suitable protective device such as earplugs.

### **Stay Clear of Rotating Drivelines**



Entanglement in rotating driveline can cause serious injury or death:

- Wear close fitting clothing.
- STOP the engine and be sure PTO driveline is stopped before getting near it.

### **Check Wheel Bolts**

- A serious accident could occur causing serious injury if wheel bolts are not tight.
- Check wheel bolt tightness often during the first 100 hours of operation.

### **Transport Safely**



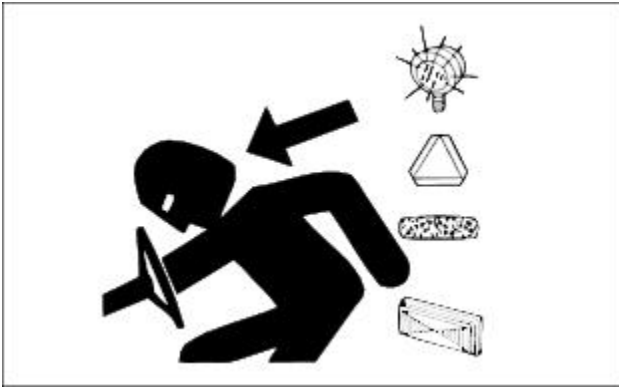

- Use safety lights and devices. Slow moving machines when driven on public roads are hard to see, especially at night. Avoid personal injury or death resulting from a collision with a vehicle.
- Whenever driving on public roads, use flashing warning lights and turn signals according to local regulations. Extra flashing warning lights may need to be installed.

### **Practice Safe Maintenance**



- Understand service procedure before doing work. Keep area clean and dry.
- Never lubricate, service, or adjust machine while it is moving. Keep safety devices in place and in working condition. Keep hardware tight.
- To prevent them from getting caught, keep hands, feet, clothing, jewelry, and long hair away from any moving parts.
- Before servicing machine, lower attachments to the ground. Disengage all power and stop the engine. Move hydraulic lift levers back and forth to relieve pressure. Lock park brake and remove the key. Let tractor cool.
- Securely support any machine elements that must be raised for service work.
- Never run engine unless park brake is locked.
- Keep all parts in good condition and properly installed. Fix damage immediately. Replace worn or

broken parts. Remove any buildup of grease, oil, or debris.

- Disconnect battery ground cable (-) before making adjustments on electrical systems or welding on tractor.
- Unauthorized modifications to the tractor may impair its function and safety.

### **Wear Appropriate Clothing**

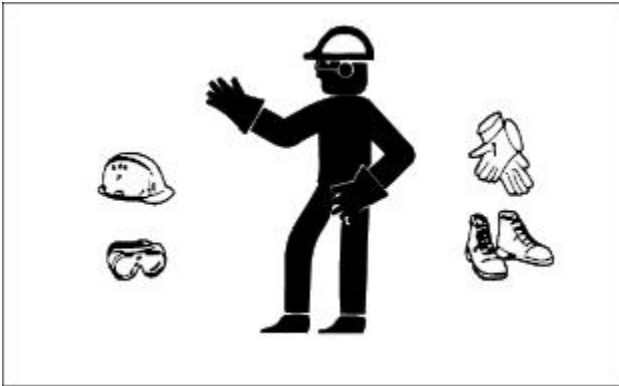

- Wear close fitting clothing and safety equipment appropriate for the job.
- Loud noise can cause impairment or loss of hearing, wear a suitable protective device such as earplugs.
- Do not wear radio or music headphones while servicing the machine. Safe service requires your full attention.

### **Stay Clear of Rotating Drivelines**



Entanglement in rotating driveline can cause serious injury or death:

- STOP the engine and be sure PTO driveline is stopped before getting near it.

### **Handling Waste Product and Chemicals**

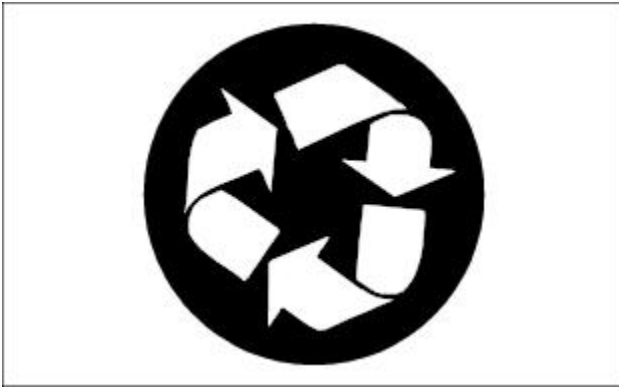

- Waste products, such as, used oil, fuel, coolant, brake fluid, and batteries, can harm the environment and people.
- DO NOT use beverage containers for waste fluids-someone may drink from them.
- See your local Recycling Center or John Deere dealer to learn how to recycle or get rid of waste products.
- A Material Safety Data Sheet (MSDS) provides specific details on chemical products: physical and health hazards, safety procedures, and emergency response techniques. See your John Deere dealer for the MSDS on chemical products used with your machine.

### **Avoid High Pressure Fluids**



- Hydraulic hoses can fail due to physical damage, kinks, age, and exposure. Check hoses regularly. Replace damaged hoses.
- Escaping fluid under pressure can penetrate the skin causing serious injury. Avoid the hazard by relieving pressure before disconnecting hydraulic or other lines. Tighten all connections before applying pressure.
- Search for leaks with a piece of cardboard. Protect hands and body from high pressure fluids.
- If an accident occurs, see a doctor immediately. Any fluid injected into the skin must be surgically removed within a few hours or gangrene may result. Doctors unfamiliar with this type of injury should reference a knowledgeable medical source. Such information is available from Deere &

Company Medical Department in Moline, Illinois, U.S.A.

# Operating

---

## Daily Operating Checklist

- o Test safety systems.
- o Check tire pressure.
- o Check fuel level.
- o Check engine oil level.
- o Check transaxle oil level.
- o Check coolant level.
- o Check Air Restriction Indicator (if so equipped).
- o Clean air intake screens.
- o Remove grass and debris from machine.

## Dash Controls

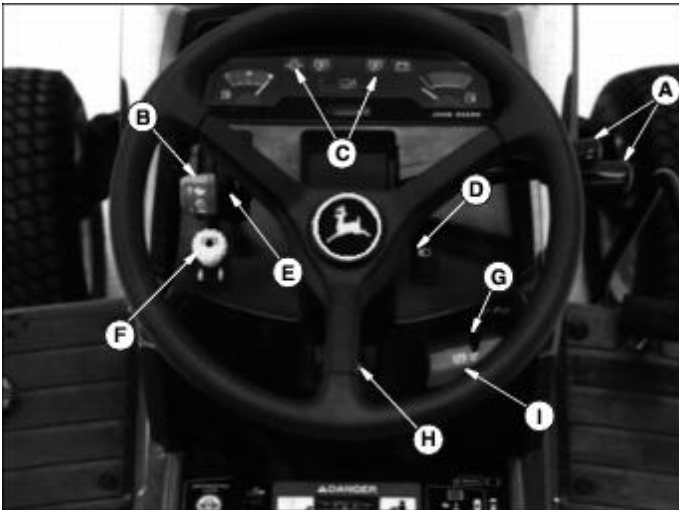

M71462

A - Hydraulic Control Levers

B - Throttle Lever

C - Indicator Lights

D - Light Switch

E - Choke Lever (425)

F - PTO Switch

G - Key

H - Tilt Steering Wheel Button

I - Park Brake Lever



M71463

A - Cruise Control Lever

### Foot/Platform Controls



M71462

A - Differential Lock Pedal

B - Brake Pedal

C - Reverse Travel Pedal

D - Forward Travel Pedal

E - Mower Height Indicator

F - Mower Height Crank

## **Miscellaneous Controls**

### **Free Wheeling Lever**

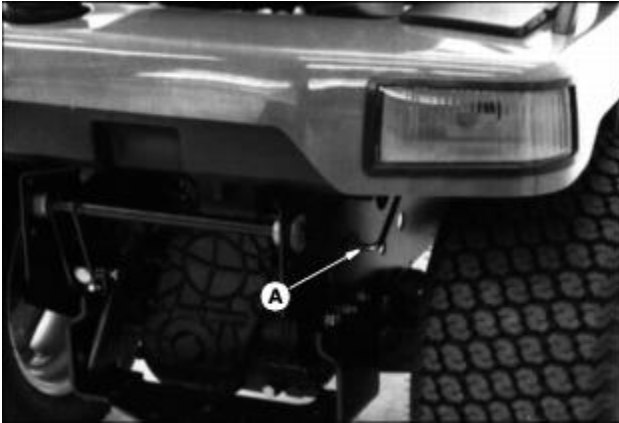

M71465

A - Free-Wheeling Lever

### **Air Restriction Indicator**

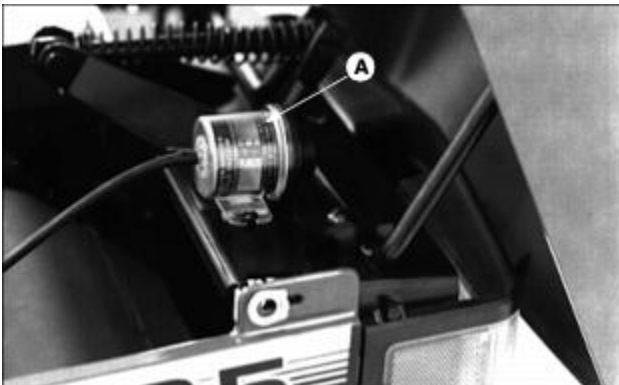

M71510

A - Air Restriction Indicator (Optional)

## Adjusting Steering Wheel

NOTE: Steering wheel has four tilt positions.



M71475

1. Push in button (A) and push or pull wheel to a comfortable operating position.
2. Release button.

NOTE: Before operating, be sure steering wheel is locked in position.

## Adjusting Seat (425)

### Adjust Forward / Rearward

NOTE: This tractor is equipped with a fourteen position slide rail seat. Be sure seat is locked in position before operating.

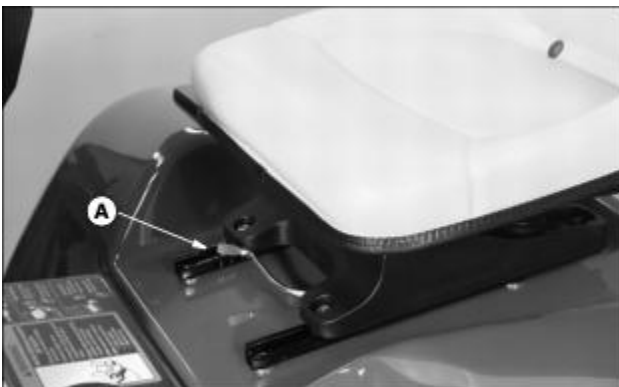

M96042

1. Push lever (A) to the left.
2. Slide seat forward or backward to desired position.
3. Release lever.



## Adjust Seat Suspension

NOTE: Seat suspension can be adjusted to better match the weight of the operator.

1. Lift operators seat.
2. Suspension coils can be moved to three different settings:

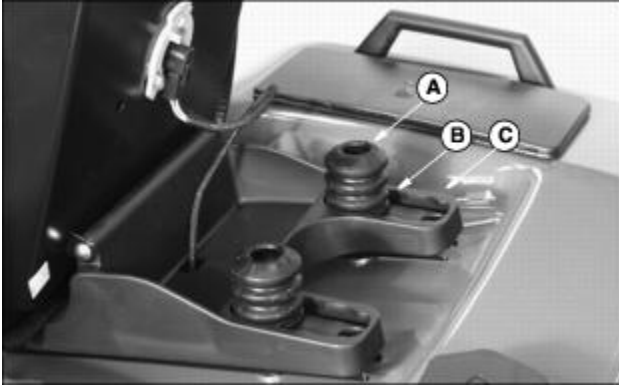

M96043

- Soft Ride (A)
- Average Ride (B)
- Firm Ride (C)

3. Make sure suspension coils are in the same ride setting for each side.

## Adjusting Seat (445)

NOTE: This tractor is equipped with a fourteen position slide rail seat. Be sure seat is locked in position before operating.



M71483

1. Push lever (A) to the left.

2. Slide seat forward or backward to desired position.
3. Release lever.

### **Rear Wheel Spacing (Two Wheel Steer Models With 23 x 10.50-12 Tires)**

**IMPORTANT:** Avoid damage! On 26 x 12.00-12 tire option, wheels should always be in the wide position.



**CAUTION:** Avoid injury! Do not work under a raised tractor unless it is safely supported. A tractor that slips and falls off a jack could cause serious injury or death.

1. Park tractor on level surface. STOP engine. LOCK park brake. Put blocks in front and back of front wheels.

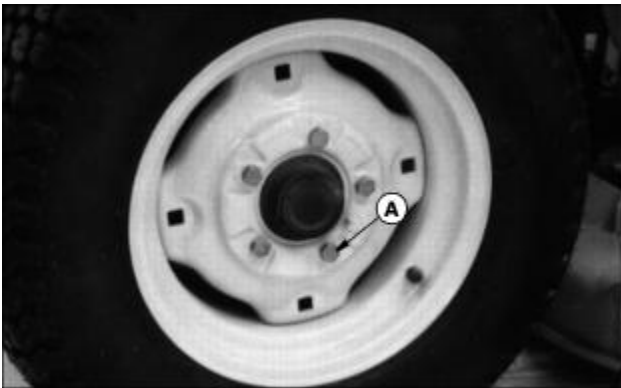

M71459

2. Loosen five rear wheel bolts (A). Lift rear wheels off the ground with floor jack or hoist.
3. Remove wheel bolts.
4. Install wheels as follows:
  - Turf tires: Install wheel on same side of tractor with valve stem inside.



M71484

- Bar tires: Install each wheel on opposite side of tractor. Bars on tires must point forward.
- Tighten wheel bolts to 88 N·lm (65 lb-ft).
- Lower rear wheels to the ground. Remove blocks from front wheels.

### Testing Safety Systems



c CAUTION: Avoid injury! Engine exhaust fumes can cause sickness or death.

- If it is necessary to run an engine in an enclosed area, remove the exhaust fumes for the area with an exhaust pipe extension.
- If you do not have an exhaust pipe extension, open the doors and get outside air into the area.

Use the following checkout procedure to check for normal operation of tractor.

If there is a malfunction during one of these procedures, DO NOT operate tractor. (See your John Deere dealer for service.)

**IMPORTANT:** Avoid damage! Tests 1, 2 and 3 are performed **WITHOUT** the engine running.

Perform these tests in a clear open area. Keep bystanders away.

#### Test 1

Check operation of indicator lights:

- Turn key to RUN position.



M71630

- LOOK: Indicator lights (A) and (B) must light.
- LOOK: On Model 445, indicator light (C) will come on and go out in two to three seconds.
- If one indicator does not light, see **Replacing Indicator Light Bulb** in Service-Electrical section.
- If new indicator bulb does not light or no indicators work, see your John Deere dealer.

## Test 2

**IMPORTANT:** Avoid damage! If test fails, the engine may start and tractor may move.

Test brake switch:

1. Unlock park brake and release brake pedal.
2. Turn key to START position.
3. Engine must not crank.

## Test 3

**IMPORTANT:** Avoid damage! If test fails, the engine may start and PTO may engage.

Test PTO switch:

1. Depress brake pedal, or lock park brake.

2. Put PTO switch lever in ON position.
3. Turn key to START position.
4. Engine must not crank.

#### **Test 4**

Test seat switch:

1. First part of test:

- Start engine. Run engine at MAXIMUM engine speed. Unlock park brake and release brake pedal.
- Put PTO switch lever in ON position.
- Raise up off seat. DO NOT get off tractor.
- Engine should begin to die. PTO should immediately SHUT OFF and mower blades should STOP.

2. Second part of test

- DISENGAGE PTO.
- Start engine.
- UNLOCK brake.
- Raise up off seat. DO NOT get off tractor.
- Engine should STOP.

3. Third part of test:

- DISENGAGE PTO.
- Start engine.
- LOCK park brake
- Raise up off seat. DO NOT get off tractor.
- Engine should continue to run.

#### **Test 5**

NOTE: This test should be performed once a year or every 100 hours.

Check mower blade stop time.

Perform this test while sitting on the tractor.

1. Start engine.
2. ENGAGE PTO.

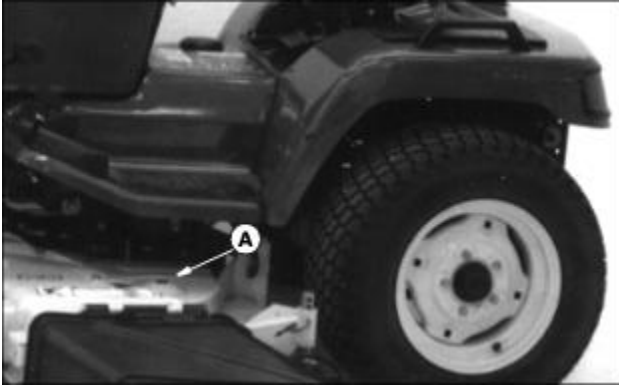

M47474

3. Watch left-hand side mower spindle (A). DISENGAGE PTO, mower spindle should stop turning within 5 seconds.
4. If spindle does not stop within 5 seconds, the PTO brake needs servicing. (See your John Deere dealer for service.)

## Test 6



**CAUTION:** Avoid injury! Before moving rearward, make sure area is clear of bystanders, especially children.

Test Reverse Implement Option:

1. Start engine.
2. Engage PTO to start attachment.
3. Look behind the vehicle to be sure there are no bystanders.
4. Begin REVERSE travel by depressing REVERSE foot pedal.
5. Attachment should stop operation. If attachment continues to operate while tractor travels in REVERSE, do not continue to operate attachment. See your John Deere dealer for service.

## Using the Park Brake

### Lock Park Brake:



c CAUTION: Avoid injury!

Always LOCK park brake before getting off tractor or leaving tractor unattended.



M71468

1. Push down on brake pedal (A) and hold pedal all the way down.
2. Pull park brake lever (B) up to LOCK park brake.
3. Release pedal and then park brake lever. Pedal should stay down and park brake lever should stay up in LOCKED position.

### Unlock Park Brake:

1. Push down on brake pedal and hold pedal all the way down.
2. Push park brake lever down.
3. Release pedal. Pedal should come up to operating position.

## Indicator Lights and Gauges



M71629

A - Fuel Gauge - indicates fuel level.

B - Oil Pressure Indicator Light - will come on when engine oil pressure is too low. If indicator comes on during operation, stop engine and perform appropriate service. This is an indication that the engine is low on oil.

C and D - PTO Indicator Lights - will come on when mid/front or rear PTO is engaged.

E - Battery Discharge Indicator Light - will come on when output is too low. If indicator comes on during operation, stop engine and perform appropriate service.

F - Coolant Temperature Gauge - indicates temperature of the cooling system.

G - Hour Meter - shows the number of hours the engine has run. Check the hour meter daily to see what services from the **Service Interval Chart** in Service section need to be done.



M71629

H - Injection System Failure indicator (Model 445 Only) - will come on for a few seconds when you turn key to the RUN position.

The injection system failure indicator serves as an injection system diagnostic tool. When there is a problem with one of the fuel injection sensors, the indicator will blink. This light has two signals, a



long blink (-) and a short blink (·). Use the following to diagnose the indicator blinking:

- · · · Air Temperature Sensor problem.
- · · · Water Temperature Sensor problem.
- · · · Air Pressure Sensor problem.
- · · · Key switch was turned on too quickly.
- If light is blinking, see your John Deere dealer for service.

## Starting the Engine



**CAUTION:** Avoid injury! Engine exhaust fumes can cause sickness or death.

- If it is necessary to run an engine in an enclosed area, remove the exhaust fumes from the area with an exhaust pipe extension.
- If you do not have an exhaust pipe extension, open the doors and get outside air into the area.

**NOTE:** You must hold brake pedal down, or LOCK park brake, before you can start the engine. Be sure PTO switch is off.

1. LOCK park brake or depress brake pedal.



M71469

2. Push throttle lever (A) up to 1/2 position.

**NOTE:** You may not need to choke a warm engine.

3. Model 425: COLD engine: Choke engine by pushing choke lever (B) all the way up to CHOKE (Closed) position.

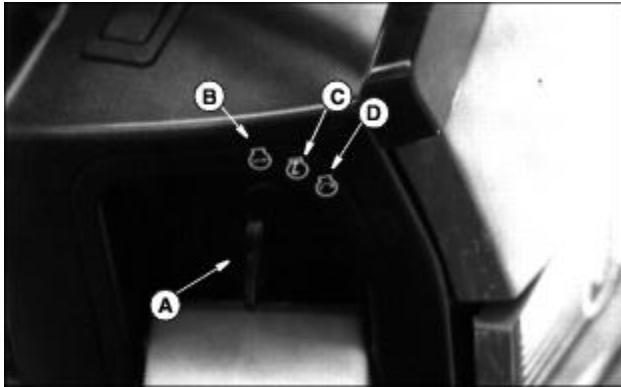

M71641

4. Turn key (A) to the RUN position (C).



M71630

5. Check indicator lights:

- Oil Pressure indicator (E) will be ON.

**IMPORTANT:** Avoid damage! If indicator (F) blinks after engine is started, STOP engine. Be sure to wait 1/2 second before cranking engine again.

- Battery Discharge indicator (G) will be ON.

- Model 425: Injection System Failure Indicator (F) will come on for a few seconds. WAIT for approximately 1/2 second before cranking the engine.

6. Turn key to the START position (D):

- Crank engine.

**IMPORTANT:** Avoid damage! Avoid unnecessary engine idling.

- Wastes fuel.
- Causes carbon build up.
- Can cause over heating.

- If engine does not start within 5 seconds, turn key to STOP position (B) and wait 10 seconds.
- Crank engine again for 5 seconds.

Repeat this procedure if necessary.

7. As soon as engine starts, release key. The key will return to the RUN position and all indicator lights should be off. If a light does not go off, stop engine and perform appropriate service.

8. Model 425: Cold engine:

- After engine starts, gradually pull the choke lever back to the HALF-WAY position. You may have to leave the choke lever at this position until the engine runs smoothly.



M71460

- When engine is running smoothly, gradually pull choke lever down to the NO CHOKE (Open) position (A).

## **Stopping the Engine**

1. STOP tractor.



M71460

2. Pull throttle lever (A) down to the SLOW position.

**IMPORTANT:** Avoid damage! To avoid fuel pump damage, be sure key is in STOP (Off) position whenever engine is not running.

**NOTE:** Model 425: Engine may run for a second after key is turned off to burn unused fuel in the system.

3. Turn key (B) to STOP (Off) position.

4. LOCK park brake and remove key.

### Using Travel Controls



**CAUTION:** Avoid injury!

- Before moving forward or rearward, make sure area is clear of bystanders, especially children.
- Disengage mower before backing up.

### **TO TRAVEL FORWARD:**

- UNLOCK park brake.

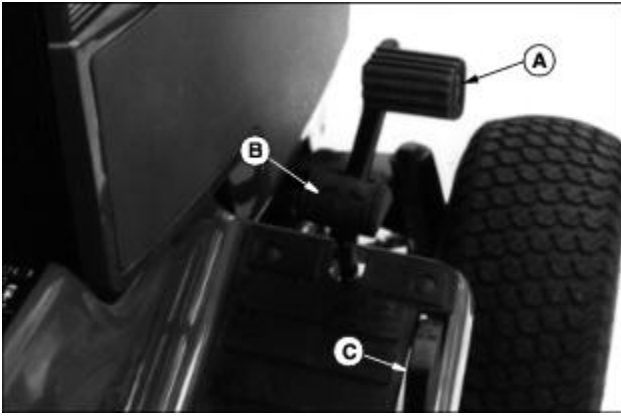

M71644

- Slowly push down forward pedal (B). Tractor will travel faster the farther down you push the pedal.
- Release forward pedal, tractor will automatically return to neutral and STOP.

### **TO TRAVEL IN REVERSE:**

NOTE: Any operating attachment will stop as the REVERSE foot pedal is depressed with attachment engaged.

1. Bring the vehicle to a stop.
2. Push PTO knob down to the OFF position to disengage attachment.
3. Look behind the vehicle to be sure there are no bystanders nearby.
4. Slowly push down reverse pedal (C). Tractor will travel faster the farther down you push the pedal. Release reverse pedal, tractor will automatically return to neutral and STOP.

### **FOR EMERGENCY STOPPING:**

- Release either travel pedal, tractor will automatically return to neutral and STOP.
- Push down on brake pedal (A). Tractor brakes will be applied to assist in stopping.

### **Using Cruise Control**

Use cruise control when you want to maintain travel speed without having to hold the forward travel pedal down. Cruise control operates only for forward travel.

Operate tractor in a large, open area to learn how the cruise control works.

### **Engage Cruise Control**

1. Push forward pedal down until you reach desired travel speed.



M71463

2. Pull lever (A) up to lock the cruise control.

### **Disengage Cruise Control**

1. Push brake pedal down.

### **Using The Reverse Implement Option**



CAUTION: Avoid injury!

- Before moving forward or rearward, make sure area is clear of bystanders, especially children.

NOTE: Operating the mower while backing up is strongly discouraged. The Reverse Implement Option should be used ONLY when operating another attachment or when the operator deems it necessary to reposition the machine with the mower engaged.

1. Stop the machine FORWARD travel with attachment engaged.
2. Look behind the vehicle to be sure there are no bystanders.



M71469

3. Lift and hold the PTO knob (A) up past the PTO engagement position to activate the reverse implement position while depressing REVERSE foot pedal slightly.

NOTE: If the attachment stops while repositioning the machine, return PTO knob to the OFF position. Begin again with Step 2 in procedure.

4. As the machine begins to move backward, release the PTO knob and reposition the machine.

5. Resume FORWARD travel. The attachment should continue operating.

6. Repeat Steps 1 through 5 to reposition the machine again.

### Using Differential Lock



**CAUTION:** Avoid injury! To prevent tipping DO NOT attempt to turn on slopes and hills with differential lock engaged.

**IMPORTANT:** Avoid damage! To prevent damage to differential, DO NOT engage differential lock at high speeds.

The differential lock is used to provide better traction when rear wheels start to slip. Do not use differential lock unless you are experiencing rear wheel slippage. Engaging differential lock will cause both rear wheels to drive equally to improve traction.

### Engage Differential Lock

1. STOP or slow tractor down.



M71462

2. Push down on differential lock pedal (A). Lock will remain engaged as long as there is rear wheel slippage or pedal is depressed.

NOTE: Turning radius is increased when differential is locked.

When brake pedal is depressed, differential lock will automatically engage.

### **Disengage Differential Lock**

1. Release differential lock pedal. Differential lock will disengage when rear wheels are no longer slipping.

## **Using Hydraulic Control Levers**

### **Using Hydraulic Valve**

NOTE: Only tractors equipped with the optional front hitch or loader will be equipped with a hydraulic valve.

Hydraulic control levers operate differently depending on the attachment. When using an attachment other than a mower deck, please see the ATTACHMENT OPERATOR'S MANUAL.

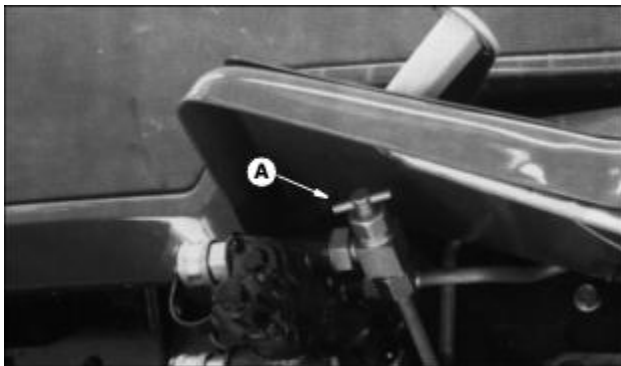

M55415

- When operating mower deck or rear implement lift - turn T-handle (A) counterclockwise until tight.
- When operating front hitch/attachments - turn T-handle (A) clockwise until it is bottomed out.

### **Using Control Levers**

Using control lever (B) with a mower deck:





M71478

- Pull and hold lever back until mower deck is raised.
- Push lever forward to lower the mower deck.

Using control lever (C):



M71478

- This control lever is used to raise and lower other attachments such as a snowthrower, rotary broom, etc.

NOTE: If you are not using lever (C), periodically move lever back and forth to maintain lubrication. Be sure lever is returned to the middle (NEUTRAL) position and not locked in the forward (FLOAT) position.

### **Using PTO (Power Take-Off)**

NOTE: Any operating attachment will stop as the REVERSE foot pedal is depressed with attachment engaged. Prior to operating the PTO, see Reverse Implement Option in this section.

This tractor is equipped with a 2000 rpm mid PTO.

## Engage PTO

1. Reduce travel speed or stop tractor.



M71460

2. After engine has warmed, push throttle lever (B) all the way up to maximum engine speed position.
3. Pull PTO knob (A) up. PTO indicator light (C) will come on when PTO is engaged.

NOTE: Always operate engine at maximum speed when PTO is engaged.

## Disengage PTO

1. Push knob down to disengage PTO. PTO indicator light will go out.

NOTE: If brake pedal is depressed, PTO will disengage.

## Using Mower Height Control

**IMPORTANT:** Avoid damage! Use this procedure to determine cut height. Do not use hydraulic control levers to determine cut height.

1. Park tractor on a hard, level surface.



M71478

2. Pull back hydraulic control lever (A) and raise mower as high as it will go.
3. Adjust mower wheels.

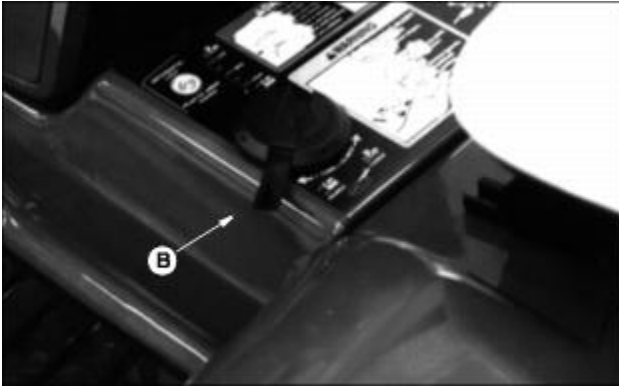

M71481

4. Flip open crank handle (B). Crank height control counterclockwise far enough to permit mower to be lowered to surface. Do not turn lever too far, height control may be damaged.

NOTE: NOTE: One full rotation of height control equals approximately 12.5 mm (1/2 in.) of height adjustment.

5. Lower mower to desired cutting height with hydraulic control lever.

**IMPORTANT:** Avoid damage! Be sure to raise mower before changing height.

6. Crank height control clockwise until it is tight to lock mower in set cutting height. Close crank.

7. To LOCK mower in completely raised position:

- Raise mower as high as it will go using the hydraulic control lever.
- Crank height control clockwise until it is tight. Close crank.

## Mower Lift Arms

**IMPORTANT:** Avoid damage! To avoid tractor damage: When operating without a mower deck, lock mower lift arms into the UP position by turning height control crank clockwise until it is tight. Close crank.

## Using Free-Wheeling Lever

**IMPORTANT:** Avoid damage! To prevent transaxle damage, NEVER tow the tractor. Only push tractor by hand. Do not use another vehicle to push tractor.

When you need to move the tractor without starting the engine, use the free-wheeling lever:

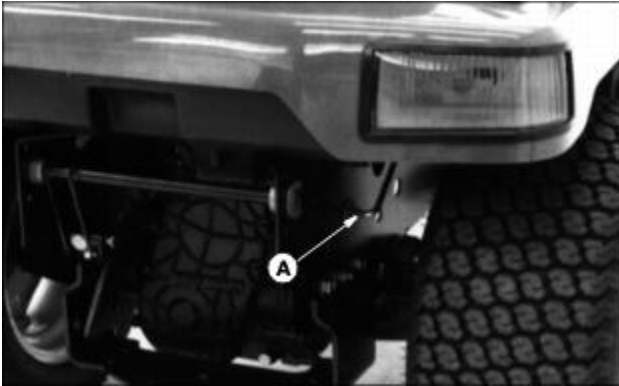

M71465

- Pull free-wheeling control lever (A) up.
- Unlock park brake.
- Push tractor to desired location.

Lever will return to the operating position when tractor is started and driven.

### **Using Engine Air Restriction Indicator (Optional Equipment)**

**IMPORTANT:** Avoid damage! Engine damage may occur if the air filter is not serviced properly.

This tractor can be equipped with an air restriction indicator. The indicator is designed to inform you when it is time to service the air filter elements.

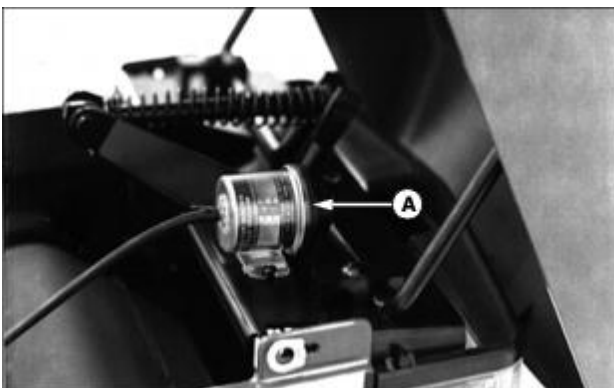

M71510

The air restriction indicator (A) is numbered to measure air restriction. As the filter collects more dirt, the restriction increases, raising the numbered reading on the indicator.

## Using Weights And Tire Chains

### Front Weights



**CAUTION:** Avoid injury! Tractor front weights improve stability when operating on slopes.

To avoid injury, add front weights for better front-end stability and steering when using a rear mounted attachment or pulling a cart.

There are two types of front weights available for your tractor, suitcase weights and wheel weights. Suitcase weights can be mounted on the front bumper and wheel weights are mounted to the front wheels.

Five suitcase weights can be mounted on the front bumper. An additional four weights can be added if you have installed a "Front Weight Bracket Kit." Each suitcase weight weighs 19 kg (42 lbs).

**NOTE:** Before installing wheel weights on your tractor, **MAKE SURE** that the tire valve stems are facing to the inside.

A front wheel weight weighs 16 kg (35 lbs). Two front wheel weights and mounting kit are required.

See your John Deere dealer for kits and weights to best fit your needs.

### Rear Weights

There are two types of rear weights available for your tractor, suitcase weights and rear wheel weights. The suitcase weights are mounted on a bracket on the back of the tractor and wheel weights are mounted to the rear wheels.

To use rear suitcase weights, you need to order the "Rear Weight Bracket Kit". The rear weight bracket holds up to six 19 kg (42 lb) suitcase weights. Use of these weights is required when an attachment, such as snowthrower or snowblower is used.

To use rear wheel weights, you need to order the appropriate weight and in some cases the hardware to attach the weights.

See your John Deere dealer for kits and weights to best fit your needs.

If you are installing rear wheel weights, please use the following instructions.

### Installing Rear Wheel Weights (Two-Wheel Steer Tractors)

### **23x10.50-12 Tires With BM17976 Weight**

BM17976 is a 23 kg (50 lb) plastic coated weight and includes the necessary hardware.

Install weight as shown.

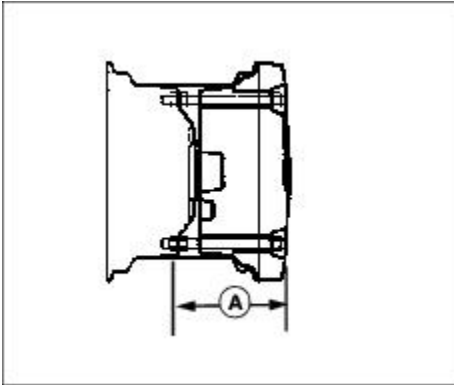

M71770

· Measurement (A) should be 160 mm (6.3 in.).

### **23x10.50-12 Tires With BM17972 Weight**

BM17972 is a 23 kg (50 lb) Weight. You must also order BM18089 attaching hardware when using one weight and BM17977 attaching hardware when using two weights.

Install weight(s) as shown:

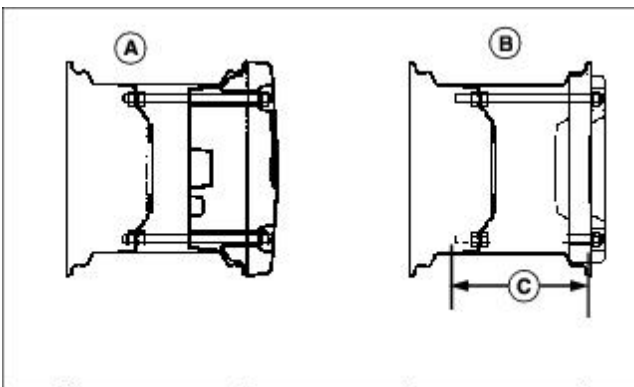

m71770

A - One Weight

B - Two Weights

· Measurement (C) should be 200 mm (7.9 in.).

### **26x12.00-12 Tires With BM17976 Weight**

BM17976 is a 23 kg (50 lb) plastic coated weight and includes the necessary hardware.

Install weight as shown.

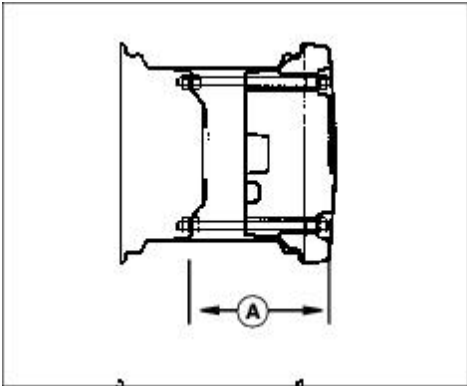

M71770

· Measurement (A) should be 210 mm (8.3 in.).

### **26x12.00-12 Tires With BM17972 Weight**

BM17972 is a 23 kg (50 lb) Weight. You must also order BM17977 attaching hardware when using one weight and BM18101 attaching hardware when using two weights.

Install weight(s) as shown:

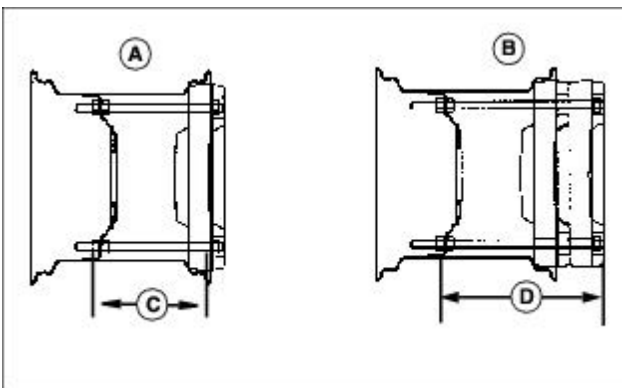

M71770

A - One Weight

B - Two Weights

· Measurement (C) should be 195 mm (7.7 in.).

· Measurement (D) should be 250 mm (9.8 in.).

### **26x12.00-12 Tires With BM17973 Weight**

BM17973 is a 33 kg (72 lb) Weight. You must also order BM18089 attaching hardware.

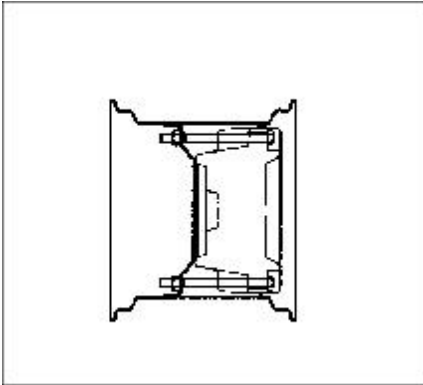

M71770

Install weight as shown.

**26x12.00-12 Tires With BM17973 Weight and BM17972 Weight**

BM17973 is a 33 kg (72 lb) Weight.

BM17972 is a 23 kg (50 lb) Weight.

You must also order BM17977 attaching hardware when using one BM17973 and one BM17972 weight. Order BM18101 attaching hardware when using one BM17973 and two BM17972 weights.

Install weight(s) as shown:

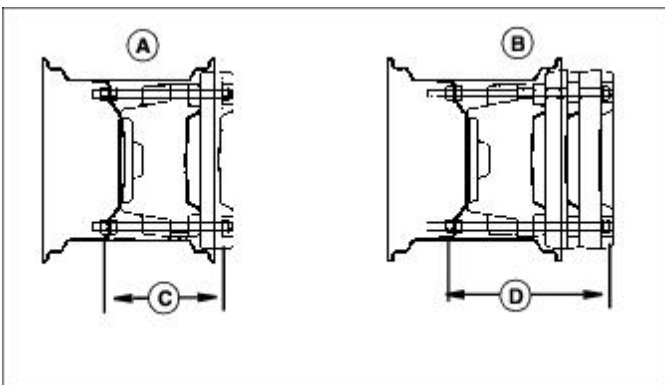

M71770

A - One BM17973 weight and one BM17972 weight

B - One BM17973 weight and two BM17972 weights

· Measurement (C) should be 200 mm (7.9 in.).

· Measurement (D) should be 260 mm (10.2 in.).



## Installing Rear Wheel Weights (All-Wheel Steer Tractors)

**IMPORTANT:** Avoid damage! To avoid damage to axle, be sure to install weight mounting hardware as shown.

### 23x10.50-12 Tires With BM17972 Weight

BM17972 is a 23 kg (50 lb) Weight. You must also order BM18094 attaching hardware when using one weight and BM18089 attaching hardware when using two weights.

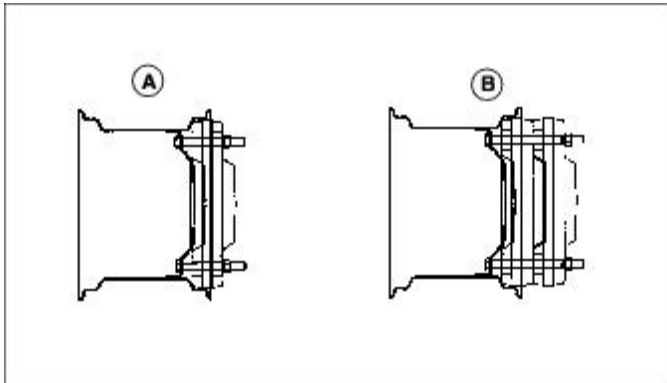

M71771

A - One Weight

B - Two Weights

Install weight(s) as shown. Cut off any excess threads on bolts.

### 23x8.50-12 Tires With BM17972 Weight

BM17972 is a 23 kg (50 lb) Weight. You must also order BM18094 attaching hardware when using one weight and BM18089 attaching hardware when using two weights.

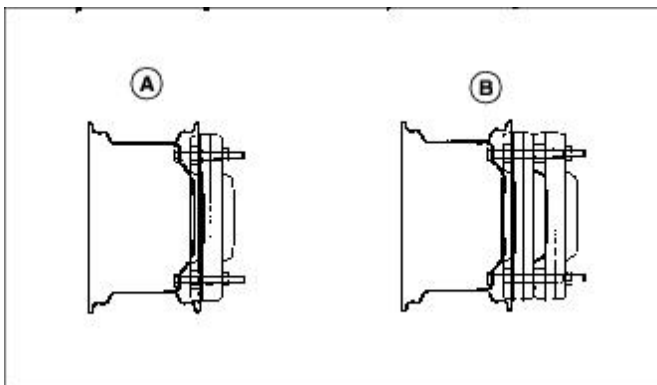

M71771

A - One Weight

B - Two Weights

Install weight(s) as shown. Cut off any excess threads on bolts.

### Using Tire Chains

<b>Tire Size</b>	<b>Tire Chains Available</b>	<b>Requires Optional Wheel Spacer Kit</b>
All-wheel steer:		
23 x 8.50-12	Yes	No
23 x 10.50-12	Yes	Yes
Two-wheel steer:		
23 x 10.50-12	Yes	No
26 x 12.00-12	Yes	No

Tire chains are recommended for use with a snowthrower and, under certain conditions; the front blade. (See your John Deere dealer for tire chains).

### Installing the Chains

1. Park the tractor on a level surface.
2. Lock the park brake.
3. STOP the engine.
4. Remove the key.
5. Remove chains from bag and lay out flat with the cross chain hook ends facing upward. Remove any twists and tangles from cross chain and rim chain.



M73743

6. Drape chain over tire with the lever fastener on outside of tire and cross link hooks (A) facing upward and away from tire.
7. Adjust chain for straightness and an even amount of cross chain links on each side of tire.
8. Place the first cross chain (opposite the end with fastener and inside hook) under tire.

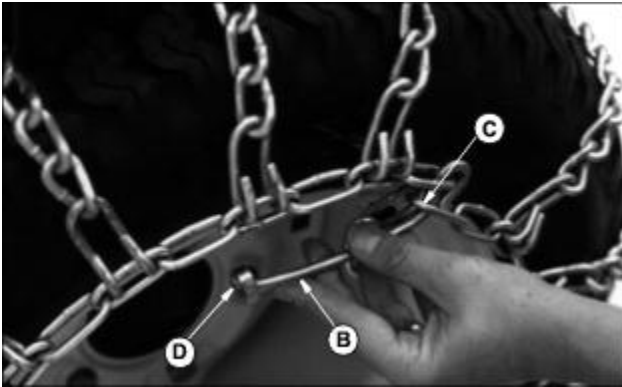

M73744

9. Pull the inside rim chain tight and hook the inside hook. Pull the outside rim chain tight and hook the outside lever fastener (B) by running the end through a free link (C). Close the fastener by rotating it back 180 degrees and engaging the hook (D) on the end of the fastener into a rim chain link (E). Make sure the chain is centered on the tire with approximately the same number of free rim links (F) on the inside and outside.

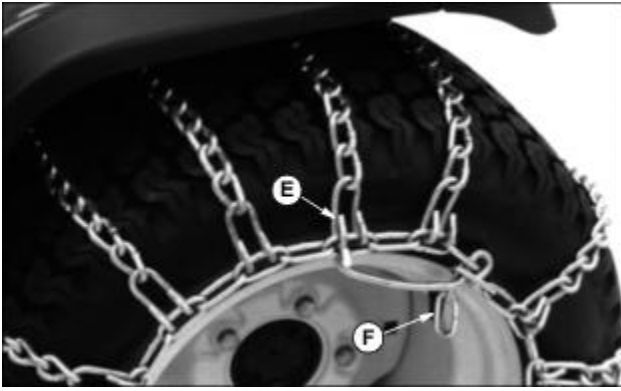

M73745

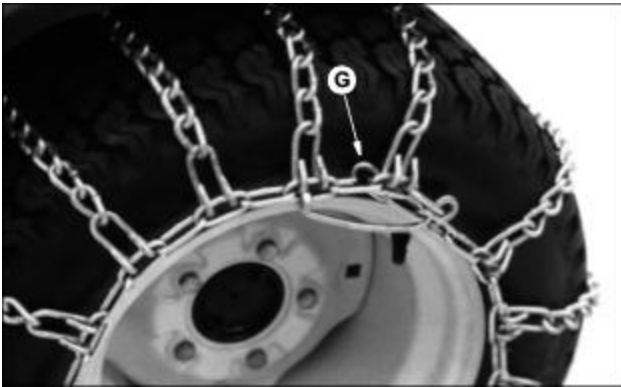

M73746

10. Tie excess rim chain links (G) back to the rim chain.

11. The chain should be as tight as possible by hand. Unhook the fastener and repeat Step 5 if the chain is loose.

**IMPORTANT: Avoid damage!**

- Periodically check chains for looseness and adjust when necessary.
- Maintain proper air pressure in tires.

12. Drive forward on chains 30' - 40' and recheck for tightness. Adjust as necessary.

## **Transporting Tractor**

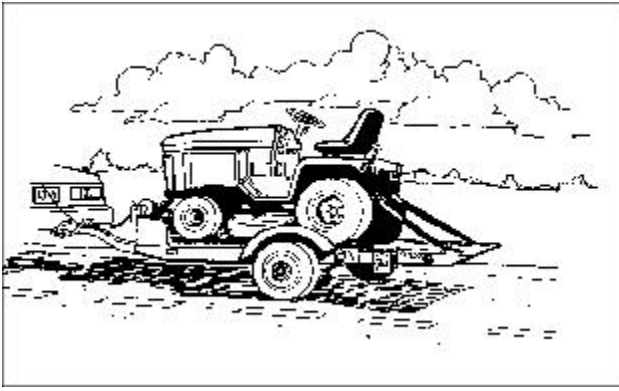

M34229

Use a heavy-duty trailer to transport your tractor.

Drive tractor forward onto a trailer. Lower any attachments to trailer deck.

Lock park brake.

Fasten tractor to trailer with heavy-duty straps, chains, or cables. Both front and rear straps must be directed down and outward from tractor.

Trailer must have signs and lights required by law.

### **Mowing Tips**

Before mowing, be sure deck is leveled and mower wheels are in the proper position.

When you mow an area for the first time, travel **SLOW** and cut **HIGH** so you can:

- Learn the terrain.
- Learn the best mowing pattern.
- Help prevent hitting objects hidden in the grass.

Mow grass only when it is dry: Wet grass may plug mower and leave a trail of grass clumps.

Mow grass often: Short grass clippings will decay quickly.

Mow at full throttle for best performance.

Use travel speed that fits conditions:

- Travel **SLOW** when you mow thick, tall grass.
- **FAST** travel or sharp turns may produce stripes or uneven cut: slow down.

- Travel at MODERATE speed when you mow a thin stand of grass.

Mow often enough so you cut only 1/3 of grass blade in one mowing. Cutting grass too short may kill grass and let weeds grow easily.

See your John Deere dealer for blades that will best fit your mowing conditions.

Aerate lawn to help stimulate soil organisms and root growth.

### **Trimming Tips**

- Turn to left around trees, bushes, etc.
- Drive slowly. Avoid hitting trees, bushes, etc.
- If ground slopes up to a tree or bush, you may have to approach the tree or bush straight-on to avoid scalping.

### **To Avoid Scalping**

- Pay attention to the way you drive: you can eliminate scalping.
- If mower scalps easily, cutting height may be too low for ground conditions-especially on lawns with many small mounds and ridges.
- Rear gauge wheels must be adjusted correctly.
- Drive over ridges and through shallow ditches straight-on, not at an angle.

Keep blades sharp: Dull blades will tear grass; tips of grass will then turn brown.

Check lawn regularly for uneven cut. If cut is uneven:

- LOOK: Mower may not be level.
- Slow down before you make a turn.
- Sharpen blades often.

Use thatcher (available from John Deere dealer) in late spring or summer to pull up dead grass and aerate ground.

For bagging information, see your Bagger Operator's Manual.

### **After Mowing**

- Let engine cool-to prevent fire when you store mower.

- Clean top of deck, engine, and chute with compressed air, if possible-to help prevent buildup and fire.
- Clean under deck with water under pressure-to prevent buildup and remove corrosive lawn chemicals.

## **Bagging Tips**

For best performance, bagger needs good airflow. To help increase airflow:

- Keep underside of deck and chute clean.
- Cut grass high.
- Mow at full throttle.

**IMPORTANT: Avoid damage! Don't leave clippings in bag(s):**

- Moisture may damage bag(s).
- Damp clippings are fire hazard.

- Clean bag(s) often with water from garden hose, from outside to inside of bag. Let bag(s) dry before use.

**LOOK:** Check level of clippings in bags often. When bag(s) are full:

- Mower may leave a trail of clippings.
- Clippings may blow to side.

## **Bagging and Composting**

Many communities will no longer haul lawn clippings and leaves to landfills. Bagging and composting clippings and leaves is one way to solve this problem.

Clippings from grass bag may also be used as mulch, or sheet compost, between garden rows and around trees and shrubs. This mulch will:

- Keep weeds from growing.
- Help soil keep moisture.
- Add nutrients to soil as it decays.
- Help keep soil temperature down during hot weather.

You may compost clippings and leaves in various ways. See garden magazines or clubs for information, or go to your local library for help.

Finished compost is crumbly. It is rich in soil nutrients, and can be spread on your lawn. Compost may also be worked into soil. It adds humus to soil and improves soil texture, making soil looser and easier to work.

## **Mulching Tips**

Advantages:

- You do not have to rake or bag grass or leaves.
- Lawn holds moisture better during dry weather.
- Soil temperatures stay down during hot weather.
- Mulch adds nutrients to soil, and reduces need for fertilizer.

Mulching does not make thatch. Frequent shallow watering and fertilizer application produce thatch from roots that grow close to surface.

Be careful when you mulch leaves in Fall. Grass needs sunlight in Fall to help store food for Winter. A thick layer of mulched leaves can prevent sunlight from getting to grass and smother it. You may have to mow with grass bag to remove this layer.

Mulch only when the grass and leaves are dry.

Mulching wet or damp grass or leaves may cause problems:

- Clippings and leaves may build up on the underside of the mower deck.
- Cut grass and leaves may form clumps.
- Clippings and leaves may not be cut into small bits.
- Engine may work harder and use more fuel.

Cut only top 1/3 of grass at a time.

Use a different mowing pattern each time you mow. Overlap mowing paths 50-100 mm (2-4 in.).

Slow down. Mulching takes more power.

Keep blades sharp. Check them often.

Clean underside of deck after each use.



# Replacement Parts

---

## Service Literature

If you would like a copy of the Parts Catalog or Technical Manual for this machine call:

- **U.S. & Canada:** 1-800-522-7448.
- **All Other Regions:** Your John Deere dealer.

## Parts

We recommend John Deere quality parts and lubricants, available at your John Deere dealer.

Part numbers may change, use part numbers listed below when you order. If a number changes, your dealer will have the latest number.

When you order parts, your John Deere dealer needs your machine serial number and engine serial number. These are the numbers that you recorded in the Product Identification section of this manual.

## Part Numbers

Item	Part Number
<b>Air Cleaner Element:</b>	
· Foam Element	M76076
· Paper Element	M117254
Battery	TY6182
<b>Fuel Filter:</b>	
· 425	AM116304
· 445	AM118131
Fuse: 15 amp	99M7065
Fuse: 10 amp	57M7121
Engine Oil Filter	AM107423
Hydraulic Oil Filter	AM116156
<b>Spark Plug:</b>	AM101194

· 425	M71939
· 445	

(Part numbers are subject to change without notice. Part Numbers may be different outside the U.S.A.)

# Service Interval Chart

---

## **After First 5 Hours**

- Check/tighten hardware.
- Check wheel bolt torque.

## **Break In (After First 50 Hours of Operation)**

- Check wheel bolt torque.
- Check/tighten air & cooling hose clamps.
- Change transaxle oil and filter.
- Change engine oil and filter.

## **50 Hours**

- Check electrolyte level/clean battery.
- Lubricate front axle.
- Lubricate steering cylinder.

## **100 Hours or Annually (whichever comes first)**

- Check/tighten hardware.
- Check tire pressure.

## **200 Hours**

- Check fan belt tension.
- Change transaxle oil and filter.
- Clean radiator fins and screen.

## **200 Hours or Annually (whichever comes first)**

- Change air filter/clean precleaner. (If not equipped with air restriction indicator)

- Change engine oil and filter.

### **250 Hours or Annually (whichever comes first)**

- Change fuel filter (425)

### **500 Hours**

- Check wheel bolt torque.
- Check/tighten air & cooling hose clamps.
- Change fuel filter (445).
- Inspect spark plugs.

NOTE: See your John Deere dealer for the following services.

- Check engine idle speed.
- Adjust engine valve clearance.

### **500 Hours or Every Two Years (whichever comes first)**

- Change radiator coolant.

# Service Lubrication

---

## Grease

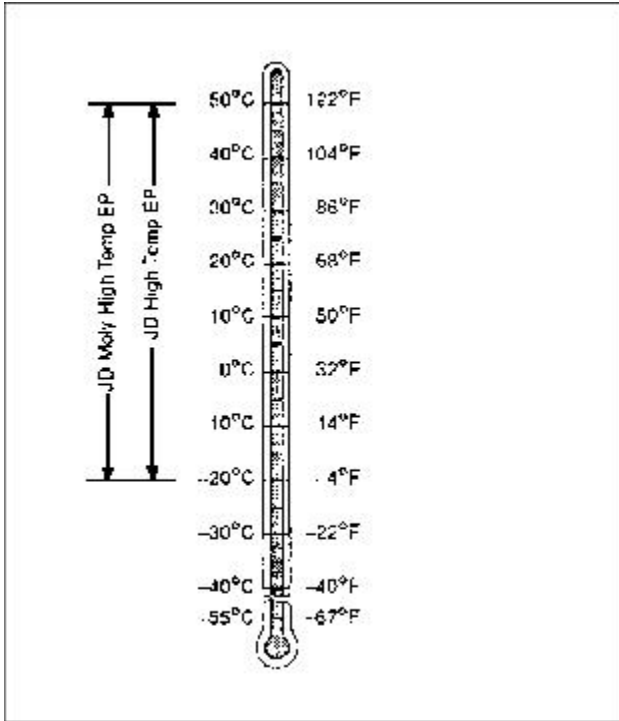

TS1417

Use grease based on the expected air temperature range during the service interval.

The following greases are preferred:

- John Deere MOLY HIGH- TEMPERATURE EP GREASE - JDM J25C (NLGI Grade 2)
- John Deere HIGH-TEMPERATURE EP GREASE - JDM J13E4 (NLGI Grade 2)

Other greases may be used if the above recommended John Deere greases are not available, provided they meet one of the following:

- SAE J310 Classification GC-LB
- NLGI Grade 2 Grease

Greases meeting Military Specification MIL-G-10924F may be used as arctic grease.

## Lubricating Rear Steering Pivot (All Wheel Steer)

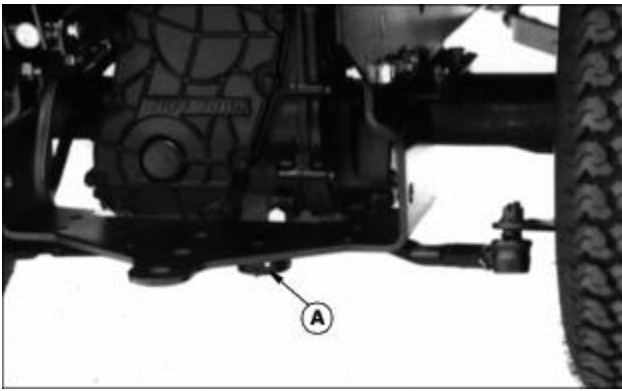

M71527

Lubricate joint (A) with one or two shots of John Deere grease.

NOTE: Rear wheel removed for clarity of photo.

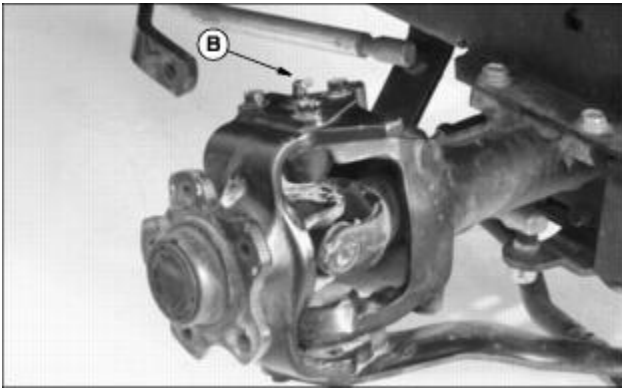

M94194

Lubricate king pin pivot (B) with John Deere grease.

### **Lubricating Steering Cylinder Ball Joints (All Tractors)**



M88454

Picture Note: Two Wheel Steer model shown - Left Side

Lubricate ball joints (A) and (B) with one or two shots of John Deere grease.

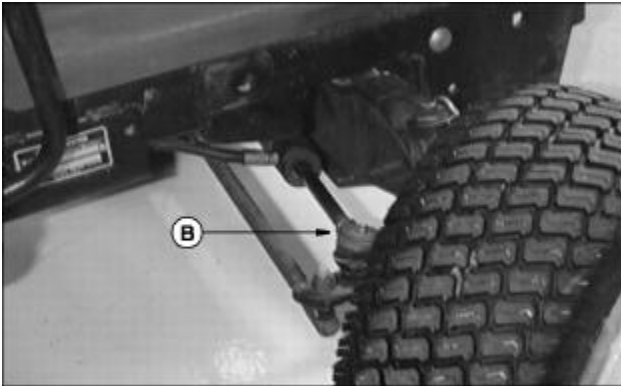

M66455

Picture Note: Two Wheel Steer model shown - Right Side

## **Lubricating Front Axle**

### **All Wheel Steer**

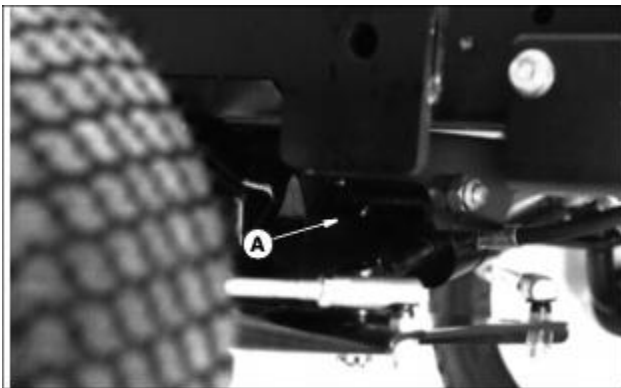

M71526

Lubricate axle points (A) with one or two shots of John Deere grease.

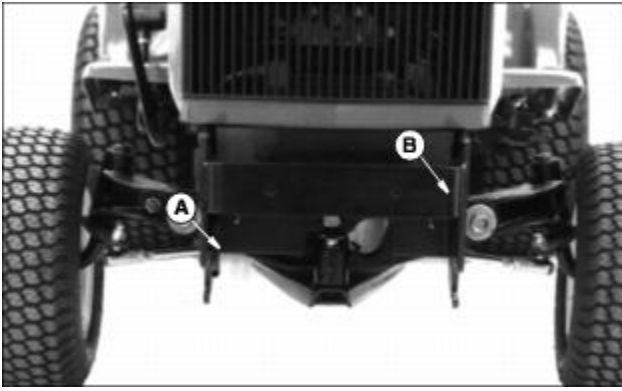

M71525

Lubricate axle points (B), one on each side of axle, with one or two shots of John Deere grease.

### Two Wheel Steer



M88456

Lubricate axle pivot point (A) with one or two shots of John Deere grease.

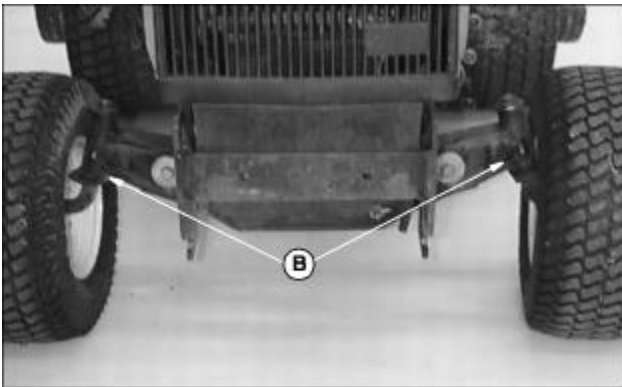

M88453

Lubricate axle points (B), one on each side of axle, with one or two shots of John Deere grease.



# Service Engine

---

## Engine Warranty Maintenance Statement

Maintenance, repair, or replacement of the emission control devices and systems on this engine, which are being done at the customer's expense, may be performed by any nonroad engine repair establishment or individual. Warranty repairs must be performed by an authorized John Deere dealer.

## Adjusting Carburetor

NOTE: Carburetor is calibrated by the engine manufacturer and should not require any adjustments.

If engine is operated at altitudes above 1829 m (6,000 ft), some carburetors may require a special high altitude main jet. See your John Deere dealer.

Possible engine surging will occur at high rpm with no load (with transmission in "N" neutral and PTO switch in the OFF position). This is a normal condition due to the emission control system.

If engine is hard to start or runs rough, check the troubleshooting section of this manual.

After performing the checks in the troubleshooting section and your engine is still not performing correctly, contact your John Deere dealer.

## Avoid Fumes



**c CAUTION:** Avoid injury! Engine exhaust fumes can cause sickness or death:

- If it is necessary to run an engine in an enclosed area, use an exhaust pipe extension to remove the fumes.
- Always try to work in a well ventilated area.

## Engine Oil

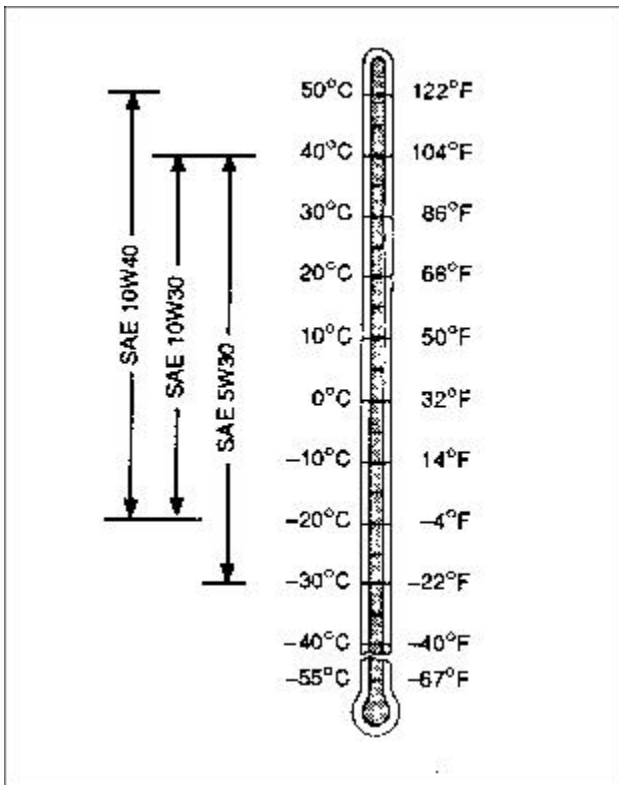

TS1412

Use oil viscosity based on the expected air temperature range during the period between oil changes.

The following John Deere oil is preferred:

- TURF-GARD®-SAE 10W30

The following John Deere oils are also recommended if above preferred oil is not available:

- PLUS-4® - SAE 10W40
- PLUS-4® - SAE 10W30
- TORQ-GARD SUPREME® - SAE 5W30

Other oils may be used if all the above John Deere oils are not available and they meet one of the following:

- API Service Classification SH and SG
- CCMC Specifications G5 and G4
- Military Specification MIL-L-2104F

Arctic oils (such as SAE 0W30 or Military Specification MIL-L-46167B) may be used if

temperatures fall below 30°C (22°F), but reduce the oil change interval by 50%.

### Checking Engine Oil Level

1. Park vehicle on a level surface.
2. Check engine oil when oil is cold.
3. Raise hood.

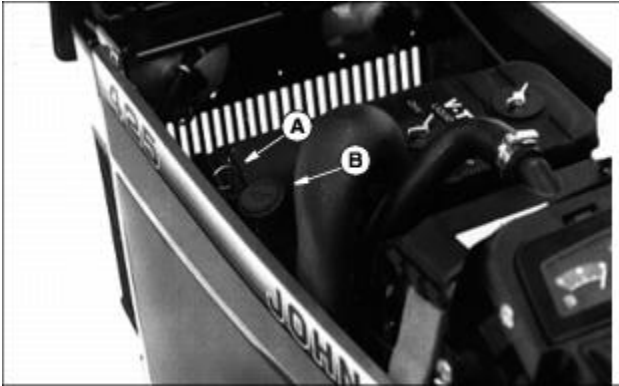

M71493

4. Remove dipstick (A). Wipe dipstick with a clean rag.
5. Install dipstick. Be sure dipstick is all the way down.
6. Remove dipstick. Check oil level on dipstick.

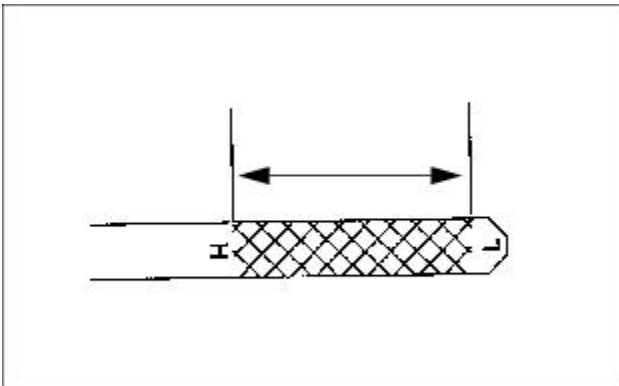

M72321

7. Oil level should be between FULL mark "H" and LOW mark "L" on dipstick.

**IMPORTANT: Avoid damage! If oil level is at or below "L", DO NOT run engine.**

8. If oil level is low, remove oil filler cap (B).
9. Add oil to bring oil level no higher than "H" mark on dipstick.
10. Install dipstick.
11. Install and tighten oil filler cap. Be sure cap is pushed all the way down.
12. Lower hood.

## **Changing Engine Oil and Filter**

**IMPORTANT:** Avoid damage! Change engine oil and filter after first 50 hours of break-in operation. Follow Service Interval Chart after that.

When operating vehicle in extremely dusty or dirty conditions, change engine oil more often.

1. Park vehicle on a level surface.
2. Run engine a few minutes to warm oil.
3. STOP engine.
4. ENGAGE park brake.
5. Raise hood.



**CAUTION:** Avoid injury! Engine may be hot. Be careful not to burn hands.

6. Remove right-hand side panel.

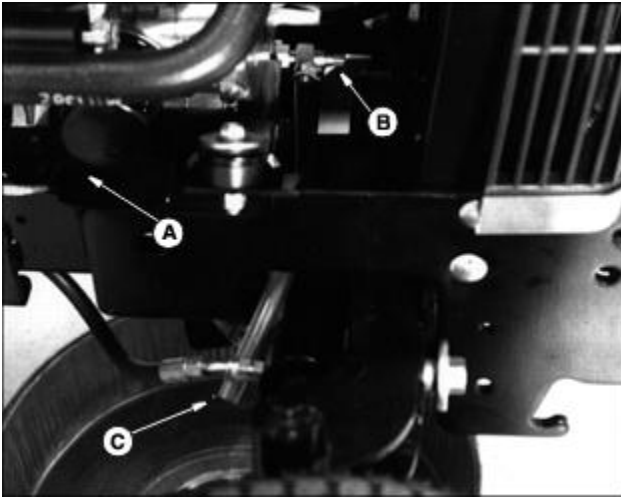

M71497

7. Route oil drain hose (C) to allow draining into oil pan.

8. Open drain valve (B) by turning it toward you.

NOTE: Be sure oil drain pan is under filter also.

9. Drain oil in pan. While oil is draining, change oil filter (A).

10. Remove filter using a filter wrench. Turn filter counterclockwise.

11. Apply a film of clean engine oil on seal of new filter.

12. Install filter. Turn filter until seal contacts mounting surface. Then turn filter **BY HAND** 1/2 turn more.

13. Close drain valve.

14. Return oil drain hose to inside of frame.

15. Install right-hand side panel.



M71493

16. Remove filler cap (B). Add approximately 1.4 L (1.5 qt) of oil.

17. Remove dipstick (A) to check oil level. Add oil only to FULL mark "H" on dipstick.

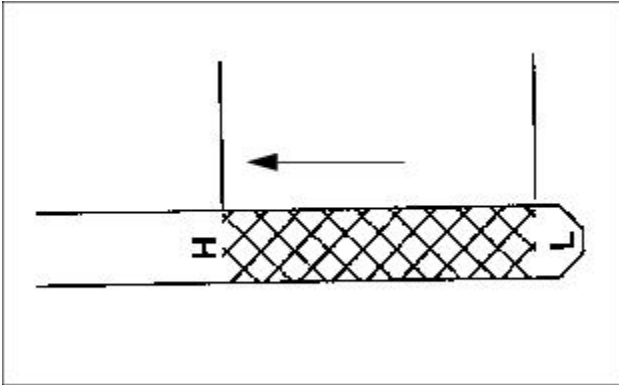

M72321

18. Install filler cap. Be sure cap is pushed all the way down.

19. Start engine and run at slow speed for two minutes. Check for leaks around filter and drain valve.

20. STOP engine. Check oil level.

21. Install dipstick. Lower hood.

### **Cleaning Air Intake Screens**

**IMPORTANT:** Avoid damage! Side panel intake screens must be clear of dirt and debris to prevent engine from overheating and to allow good air intake for air cleaner.



M71459

Clean air intake screens (A) on side panels using a brush or cloth.

## Checking Air Restriction Indicator (Optional Equipment)

1. STOP engine.

2. Raise hood.

NOTE: Indicator will not signal correctly if indicator case has a break.



M71510

3. Check air restriction indicator: When yellow plunger (B) inside indicator reaches red line (A), air cleaner requires immediate service.

4. Lower hood.

NOTE: Under normal operating conditions, it is not unusual to operate tractor for several hundred hours before indicator will show any restriction.

## Cleaning Radiator Screen and Fins

1. Raise hood.

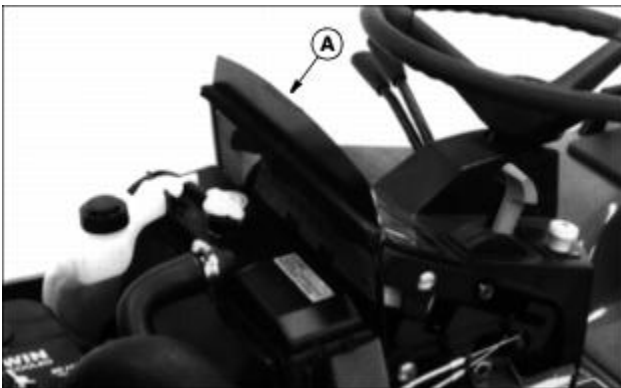

M71495

2. Remove screen (A).

3. Clean screen with a brush or compressed air.
4. Remove left-hand side panel.

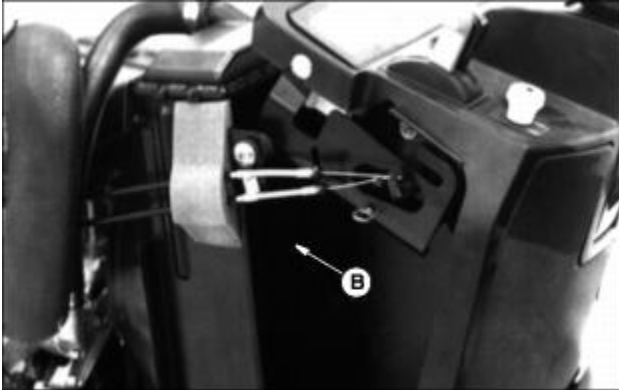

M71499

5. Clean radiator cooling fins (B) using compressed air or water.
6. Install side panel.
7. Install screen.
8. Lower hood.

### **Servicing Air Cleaner Elements**

**IMPORTANT:** Avoid damage! Only clean or replace air cleaner elements at interval recommended on service interval chart or when (optional) air restriction indicator reaches red line.

1. Raise hood.



M71508



2. Remove two wing nuts (A) and cover (B).

**IMPORTANT:** Avoid damage!

- DO NOT clean paper element, replace it.
- DO NOT remove precleaner without first removing element away from carburetor.

**NOTE:** Leave air intake hose attached to air cleaner cover.



M71509

3. Remove air cleaner (C).

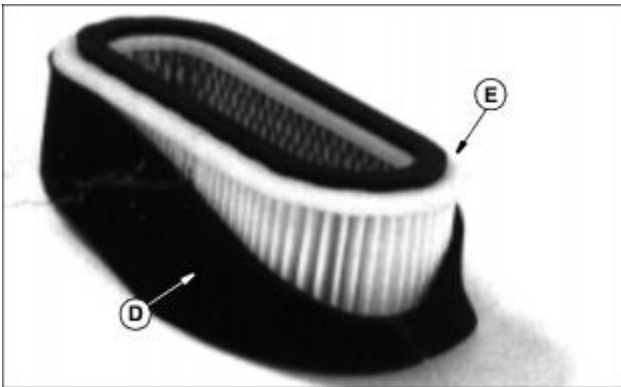

M74654

4. Check precleaner (D) for dirt and dust. If precleaner is dirty, remove it from paper element (E) and clean it as follows:



M32887

- Wash precleaner in warm, soapy water.
- Rinse precleaner in clean water.
- Squeeze precleaner to remove most of the water.
- Let precleaner air dry.
- Apply 30 mL (1 oz) of clean engine oil to precleaner.

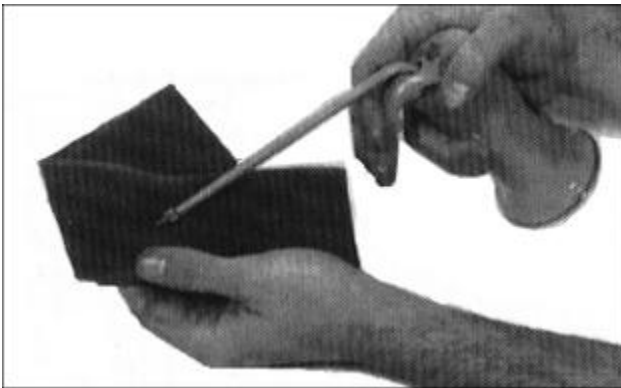

M32888

- Squeeze precleaner to distribute oil evenly and to remove excess oil.
5. Install precleaner on new element and install air cleaner.
  6. Install air cleaner cover and wing nuts.

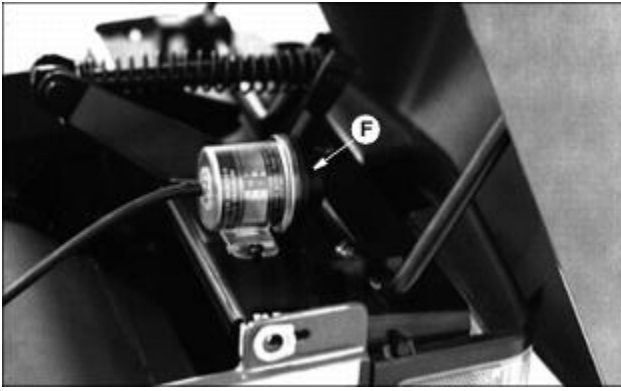

M71510

7. Push in button (F) to reset air restriction indicator if so equipped.

8. Lower hood.

NOTE: Photo taken of machine equipped with an OPTIONAL Air Restriction Indicator.

9. Start engine and check indicator. Yellow plunger should be at or below the 178 mm (7 in.) mark.

### **Recommended Engine Coolant**

The following John Deere coolant is preferred:

- COOL-GARD PRE-DILUTED SUMMER COOLANT (TY16036).
- COOL-GARD CONCENTRATED SUMMER COOLANT (TY16034)

If neither of the above coolants is available, use an ethylene glycol base coolant that meets the following specification:

- ASTM D4985 (JDM H24A2)

Check container label before using to be sure it has the appropriate specifications for your machine. Use coolant with conditioner or add conditioner to coolant before using.

If using concentrate, mix approximately 50 percent antifreeze with 50 percent distilled or deionized water before adding to cooling system. This mixture will provide freeze protection to -37 degrees C (-34 degrees F).

Certain geographical areas may require lower temperature protection. See the label on your antifreeze container or consult your John Deere dealer to obtain the latest information and recommendations.

### **Engine Coolant Drain Interval**

When using PRE-DILUTED DIESEL ENGINE ANTI-FREEZE/SUMMER COOLANT (TY16034)

coolants, drain and flush the cooling system and refill with fresh coolant mixture every 60 months or 5,000 hours of operation, whichever comes first.

If above John Deere service coolants are not being used: drain, flush, and refill the cooling system with a fresh coolant mixture every 24 months or 600 hours of operation, whichever comes first.

## Engine Coolant Drain Interval

When using John Deere Pre-Diluted (TY16036) Automobile and Light Duty Engine Service coolants, drain and flush the cooling system and refill with fresh coolant mixture every 36 months or 3,000 hours of operation, whichever comes first.

When using John Deere Concentrate (TY16034) Automobile and Light Duty Engine Service coolants, drain and flush the cooling system and refill with fresh coolant mixture every 24 months or 2,000 hours of operation, whichever comes first.

If above John Deere Automobile and Light Duty Engine Service coolants are not being used; drain, flush, and refill the cooling system according to instructions found on product container or in equipment Operator's Manual or Technical Manual.

## Checking Coolant Level

**IMPORTANT:** Avoid damage! To prevent engine damage:

- DO NOT operate engine without coolant.
- DO NOT pour coolant into the radiator when the engine is hot.
- To prevent engine overheating, never exceed more than 50 percent antifreeze in cooling system.
- Cooling system capacity is 2.8 L (3.0 U.S. qt).

1. Raise hood.

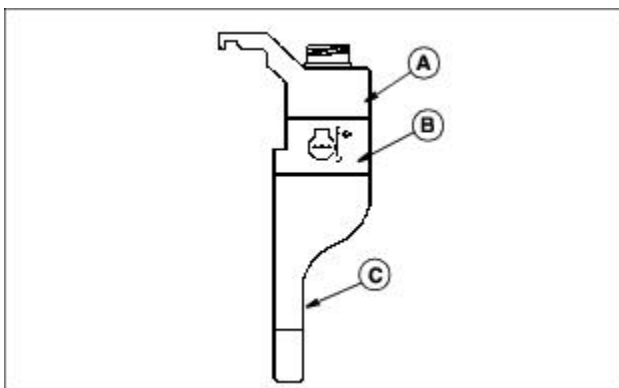

M71496

## 2. Check coolant level:

- If engine is warm (into green range on temperature gauge), coolant should be between lines (A) and (B) on coolant tank.
- If engine is cold, coolant should be above line (C).

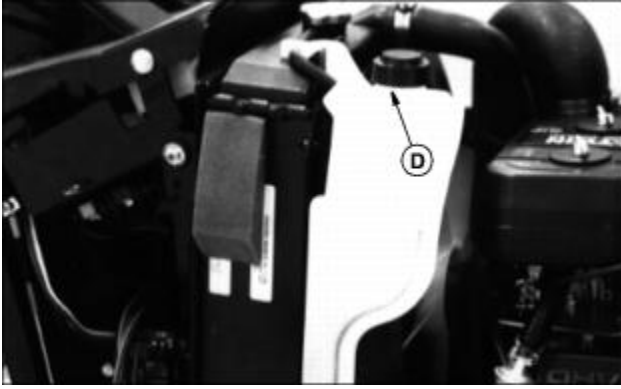

M71494

Picture Note: Side panel removed for photo.

3. If coolant is low, remove coolant recovery tank cap (D). Add 50 percent ethylene glycol (without stop-leak additive) antifreeze and 50 percent water to bring coolant up to the proper level.
4. Install and tighten coolant recovery tank cap.
5. Clean debris from side panel air intake screens and radiator screen.
6. Check condition of hoses. Check for leaks or loose connections.

## Servicing Cooling System



**CAUTION:** Avoid injury! Explosive release of fluids from pressurized cooling system can cause serious burns:

- Shut off engine.
- Only remove filler cap when radiator is cool enough to touch with bare hands. Slowly loosen cap to first stop to relieve pressure before removing completely.

## Draining Cooling System

1. STOP engine. Let engine cool.

2. Raise hood.



M71502

3. Slowly remove radiator cap (A).

4. Remove left-hand side panel.

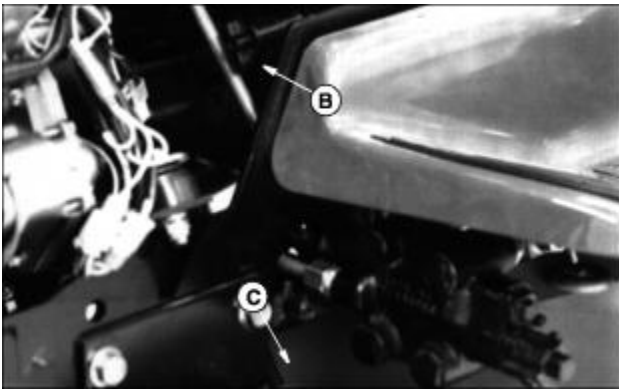

M71500

5. Open radiator petcock (B). Drain coolant into a bucket (C).

6. Remove right-hand side panel.

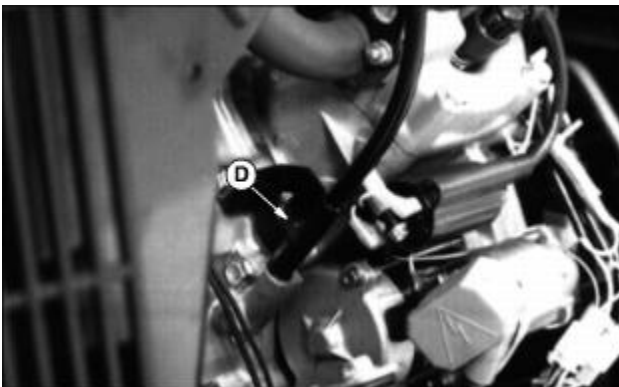

M71501

7. Remove black drain plug bolt (D) on each side of engine to drain coolant from engine block.
8. After all coolant has drained, close radiator petcock and install block drain plug bolts.
9. Flush cooling system.

### **Flushing Cooling System**

**IMPORTANT:** Avoid damage! To prevent engine damage, **DO NOT** pour water into a hot engine. **DO NOT** operate engine without coolant.

1. Drain cooling system and fill with clean water and a cooling system cleaner recommended for aluminum engines. Follow the directions on the container.



M71502

2. Install and tighten radiator cap (A).
3. Start and run engine until it reaches operating temperature.
4. Stop engine
5. Drain cooling system immediately before rust and dirt settle.



m71503

6. Remove recovery tank:

- Remove screw (B).
- Pull overflow hose (C) from tank.
- Remove tank.

7. Remove tank cap (D).

8. Clean recovery tank.

9. Install tank.

10. Install overflow hose to the bottom of the tank. Be sure hose is not kinked.

11. Fill cooling system.

12. Install side panels.

### **Filling Cooling System**

**IMPORTANT:** Avoid damage! To prevent engine damage, **DO NOT** use antifreeze concentrate greater than 50% in the cooling system. **DO NOT** use antifreeze with stop-leak additive or mix or add any other additives to the cooling system.

Cooling system capacity is 2.8 L (3.0 qt).

When operating engine in extremely cold temperatures, see your John Deere dealer.



1. Check condition of coolant system hoses.
2. Install new hoses, if necessary.
3. Mix approximately 50% antifreeze with 50% distilled or deionized water.
4. Add mixture to radiator.
5. Install and tighten radiator cap.
6. Run engine until needle on temperature gauge reaches the green range.
7. STOP engine.

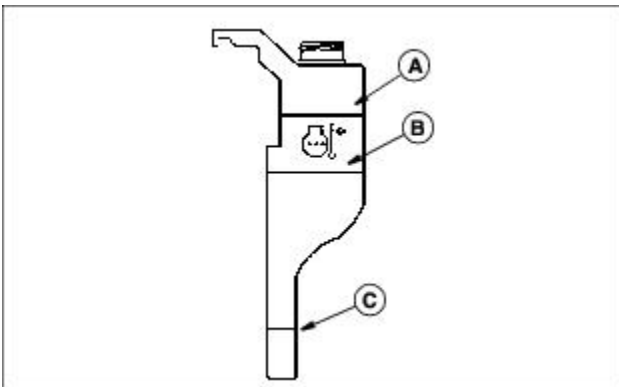

m71496

8. Coolant level should be between lines (A) and (B) on coolant tank. After engine cools, level should be above line (C).



m71494

9. Remove cap (D) to add coolant if necessary.
10. Tighten hose clamps, if necessary.

11. Lower hood.

## Replacing Fuel Filter (425)



**c CAUTION:** Avoid injury! Keep cigarettes, sparks, and flames away from fuel system. Make sure engine is cool to the touch.

1. STOP engine. Let it cool.

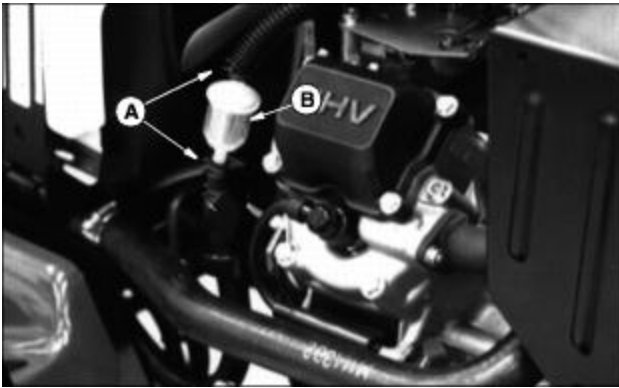

m71466

2. Squeeze hose clamps (A) to disconnect fuel hoses from fuel filter (B).

NOTE: Install filter so arrow is pointing in the direction of fuel flow.

3. Connect hoses to new filter.

## Relieving Fuel System Pressure (445)



**c CAUTION:** Avoid injury! Release of fluids from pressurized fuel system can cause serious injuries. Relieve fuel system pressure and be sure engine and muffler are cool before servicing. Do not smoke or service system near an open flame or sparks.

1. STOP engine. Let it cool.

2. Partially open fuel tank cap to relieve the pressure in the fuel tank. Tighten fuel tank cap.

3. Raise hood.

4. Remove right-hand side panel.

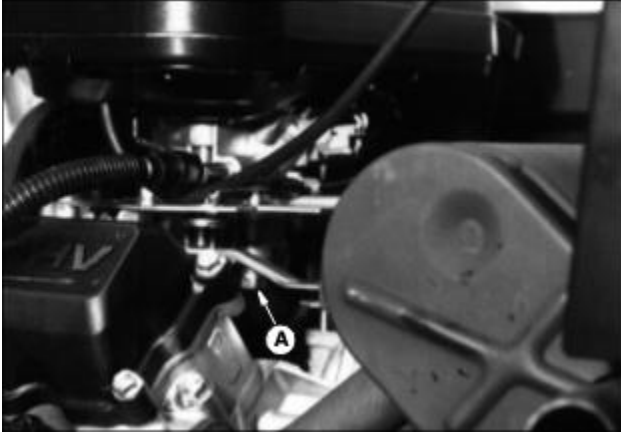

m71540

Picture Note: Model 445 (muffler shield removed)

5. Turn relief bolt (A) 1/2 turn counterclockwise to relieve pressure.

6. Tighten relief bolt.

### **Replacing Fuel Filter (445)**

**IMPORTANT:** Avoid damage! Before servicing any part of the fuel system, be sure to relieve pressure. For any service other than replacing the fuel filter, we recommend you see your John Deere dealer.

1. STOP engine. Let it cool.

2. Relieve fuel system pressure.



m71505

3. Reach under platform (A) and squeeze two clips (B) to disconnect fuel lines from filter (C).

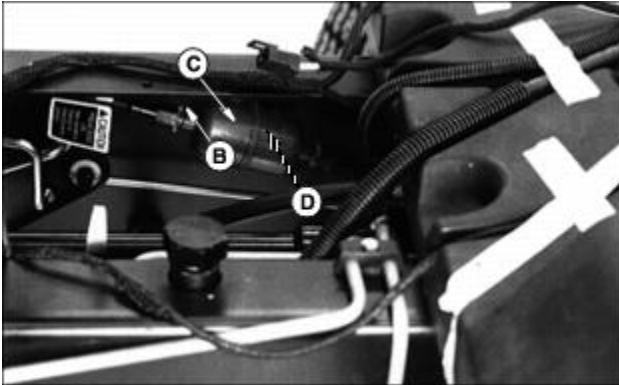

m71506

Picture Note: Platform removed for photo.

4. Remove two bolts (D) to remove filter from frame.

NOTE: Filter retention clips come with the new filter. Place the new clips on the filter in the same position as the old clips.

Install filter so arrow is pointing in fuel flow direction which is forward.

5. Install new filter:

- Install hoses on new filter.
- Install filter on frame.

## **Servicing Fan Belt**

STOP engine and remove key.

Raise hood and remove side panels.

Inspect Belt - Check belt for wear and cracking, replace if necessary.

Check Belt Tension - Press lightly on belt between driveshaft sheave and fan pulley. Belt should deflect approximately 13 mm (1/2 in.).

**Replace Belt or Adjust Belt Tension:**



m71518

1. Disconnect both spark plug wires (A). There is a spark plug on each side of the engine.

NOTE: Rotate driveshaft for access to bolts, if necessary.

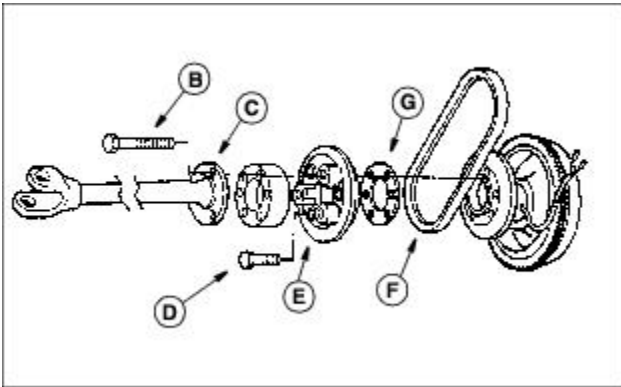

m71627

2. Remove three bolts (B) to disconnect drive shaft (C).

3. Remove three bolts (D) to remove outer sheave (E).

4. Remove belt (F) if it is to be replaced.

NOTE: To allow sheaves to fit closer together and increase belt tension, remove shim (G). Save shim for future use.

5. Remove shim (G) if belt is to be tightened. Leave shim in if installing a new belt.

6. Loosely install belt between sheave halves and start installing the three outer sheave-retaining bolts.

7. Rotate sheave assembly as bolts are tightened to allow belt to center in sheave halves and not be pinched in an OFF-CENTER position.

8. Install driveshaft.
9. Connect spark plug wires.
10. Install side panels and lower hood.

# Service Transmission

---

## Anti-Chatter Transmission Oil

NOTE: Tractor is filled with John Deere Low Viscosity HY-GARD® (J20D) transmission oil at the factory. DO NOT mix oils.

These tractors are equipped with a hydraulic wet disc PTO clutch. To avoid chatter, use only Low Viscosity HY-GARD® (J20D) transmission oil. DO NOT use type "F" automatic transmission fluid.

John Deere Low Viscosity HY-GARD® (J20D) transmission oil is specially formulated to minimize clutch chatter, and to provide maximum protection against mechanical wear, corrosion, and foaming. Low Viscosity HY-GARD® may be used in all temperatures.

## Checking Transaxle Oil Level

**IMPORTANT:** Avoid damage! Check oil level when transaxle is cold.

Check transaxle oil level before you operate vehicle.

1. Park vehicle on a level surface.
2. Slide seat forward.



m71511

3. Remove dipstick (A). Wipe dipstick with a clean rag.
4. Install dipstick until it rests on top of fill tube. DO NOT tighten it.

**IMPORTANT:** Avoid damage! DO NOT overfill. Too much oil can cause oil leaks.

Tractor is filled with John Deere Low Viscosity HY-GARD® (J20D) fluid at the factory.

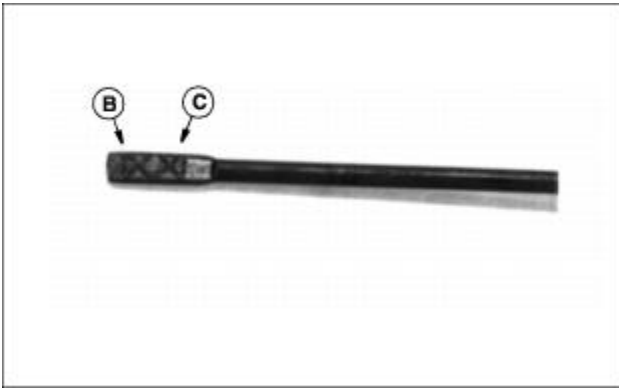

m71512

5. Remove dipstick. Oil level should be between marks (B) and (C).
6. If oil is low, add John Deere Low Viscosity HY-GARD® or an equivalent J20D transmission oil.
7. Install dipstick.
8. Run engine for a few minutes. Stop engine and check transaxle oil level. Add oil as necessary.
9. Install and tighten dipstick.
10. Return seat to operating position.

### **Changing Transaxle Oil and Filter**

NOTE: Change transaxle oil filter after first 50 hours of break-in operation.

1. STOP engine and engage park brake.

NOTE: While oil is draining, change the filter. Some oil may come out of the filter and filter base when you remove the filter. Be sure drain pan is under filter also.

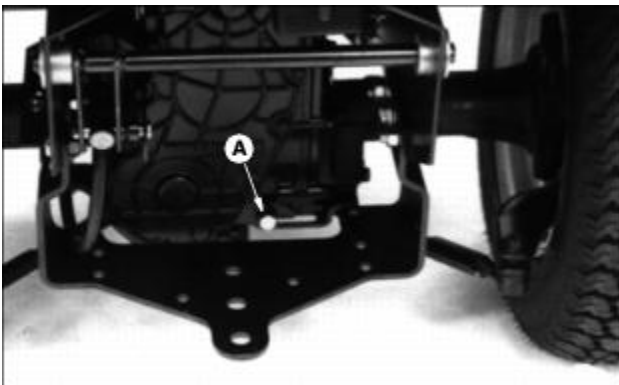

m71513



2. Place drain pan so it is under the drain plug (A) and the filter. Remove drain plug to drain oil.

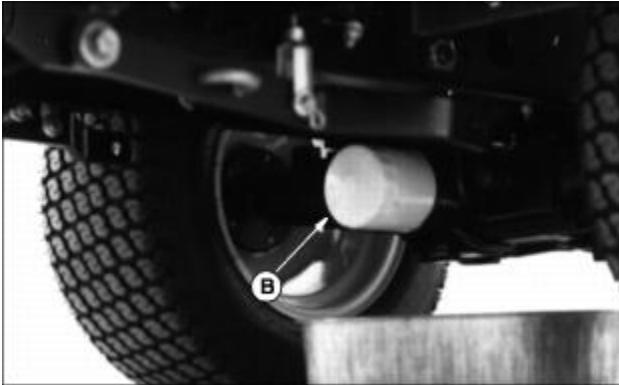

m71514

3. Turn transaxle filter (B) counterclockwise with a filter wrench to remove it.

4. Put a film of clean transmission oil on seal of new filter.

5. Install the filter until it contacts the mounting surface. Tighten filter BY HAND 2/3 to 1 turn more.

6. Install and tighten drain plug.

7. Slide seat forward.



m71511

8. Remove dipstick (A). Add John Deere Low Viscosity HY-GARD® or an equivalent J20D transmission oil:

· Two Wheel Steer: 6.6 L (7.0 qt).

· All Wheel Steer: 5.7 L (6.0 qt).

9. Install and tighten dipstick.

10. Start engine and check for oil leaks around filter base and drain plug.

11. Return seat to operating position, drive vehicle forward and backward a few times.

12. Stop engine. Wait a minimum of 3 minutes, transaxle should be cold.

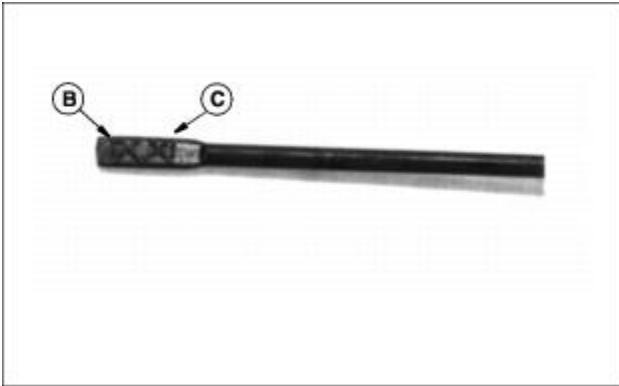

m71512

13. CHECK oil: Oil must be between marks (B) and (C) on dipstick. If necessary, add more oil.

# Service Electrical

---

## Cleaning or Replacing Battery



c CAUTION: Avoid injury! Battery gas can explode:

- Keep sparks and flames away from batteries.

Use a flashlight to check battery electrolyte level.

- Never check battery charge by placing a metal object across the posts. Use a voltmeter or hydrometer.
- Always remove grounded (-) battery clamp first and replace it last.

1. STOP engine.
2. Remove grille.

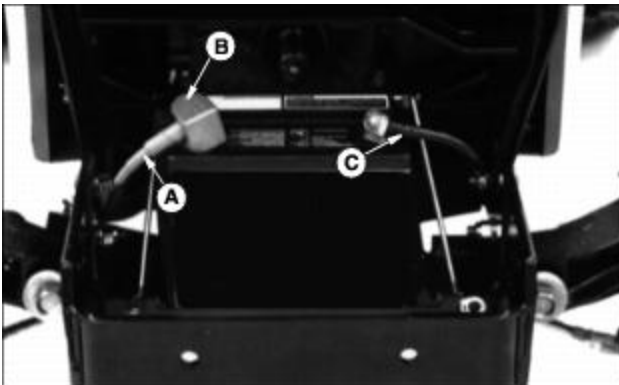

m71515

3. Disconnect black negative (-) cable (C) from battery first.
4. Pull back red positive terminal cover (B) and disconnect red positive (+) cable (A).
5. Clean battery with a damp cloth or rag. Keep dirt out of battery cells.
6. Remove corrosion from terminals and cable clamps with a wire brush.
7. If necessary, remove battery to thoroughly clean it:

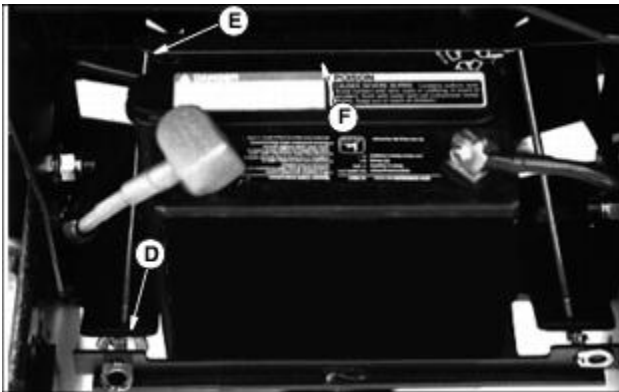

m71516

- Remove two nuts (D) to remove hold-down hooks (E) and battery hold-down (F).
- Remove battery.
- Clean battery, battery terminals, cable ends, battery box, and other parts with a solution of 1 part baking soda to 4 parts water. Keep solution out of battery cells.

NOTE: If you need a new battery, install a John Deere battery or a battery of equal specification. (See your John Deere dealer.)

- Rinse all parts with clean water and let dry.

NOTE: Install cable eyelets on the back of the battery posts.

- Install battery with posts forward.

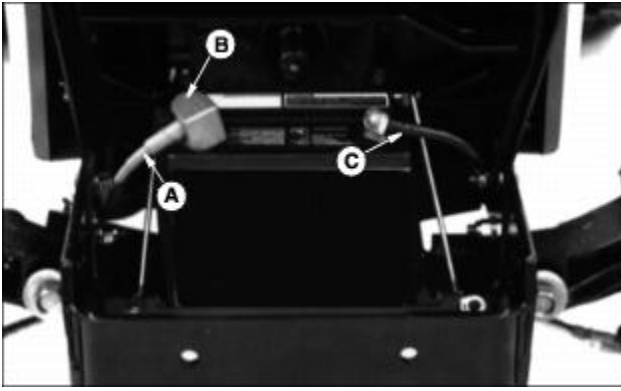

m71515

- Connect red positive (+) cable (A) behind battery. Connect cable. Apply petroleum jelly or silicone spray to terminal to prevent corrosion. Make sure connection is tight. Push red positive cover (B) over positive terminal.
- Connect black negative (-) cable (C) to battery. Apply petroleum jelly or silicone spray to terminal to prevent corrosion. Make sure connection is tight.
- Install grille.

### Checking Battery Electrolyte Level



c CAUTION: Avoid injury! Sulfuric acid in battery electrolyte is poisonous. It is strong enough to burn skin, eat holes in clothing, and cause blindness if splashed into eyes.

- Wear eye protection and avoid spilling or dripping electrolyte.

1. Remove grille.

**IMPORTANT:** Avoid damage! DO NOT fill cells to the bottom of the filler neck (B). Electrolyte can overflow when battery is charged and cause damage.

2. Remove battery manifold cap(s).

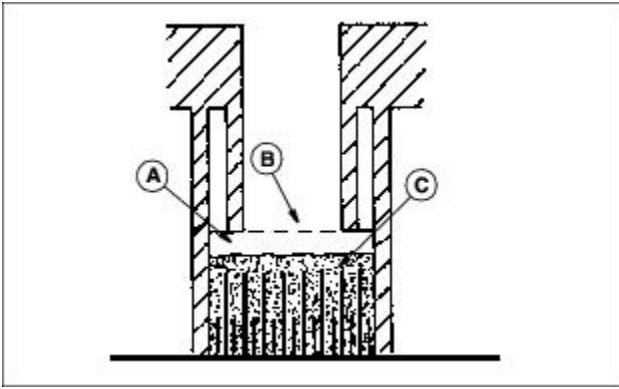

m39772

3. Electrolyte (A) should be 6 mm (1/4 in.) above plates (C).

4. Add distilled water if necessary.

NOTE: On Early Model batteries, be sure manifold cap hose is behind positive cable.

5. Install manifold cap(s).

6. Install grille.

### Charging the Battery



**CAUTION:** Avoid injury! **BE VERY CAREFUL:** Battery fluid (electrolyte), is a solution of water and sulfuric acid. It is very harmful to eyes, skin, or clothing.

- Wear goggles or an eye shield when you work with a battery.
- If the acid contacts your eyes, skin, or clothing, flush the area immediately with water. Get medical help, if necessary.

A battery gives off gas which can explode. An exploding battery will spray sulfuric acid in all directions.

- Keep cigarettes, sparks, and flames away from the battery.
- Charge the battery in an area with good ventilation.

Follow instructions on the battery charger or in the charger operator's manual, or use the instructions below as a guide.

**BEFORE YOU CHARGE A BATTERY:**

- Wait until the battery has warmed to room temperature. Do not charge a frozen battery.
- Check the electrolyte level of each cell.
- Install the battery cap(s) on the battery.

Turn OFF and unplug the charger before you connect cables to the battery or disconnect cables from the battery.

If the battery becomes warm to touch during charging:

- Reduce the charging rate OR
- Stop charging the battery until it cools.



c CAUTION: Avoid injury! DO NOT charge a frozen battery. Battery gases can explode. Keep cigarettes, sparks, and flames away from battery.

KEEP BATTERY FULLY CHARGED:

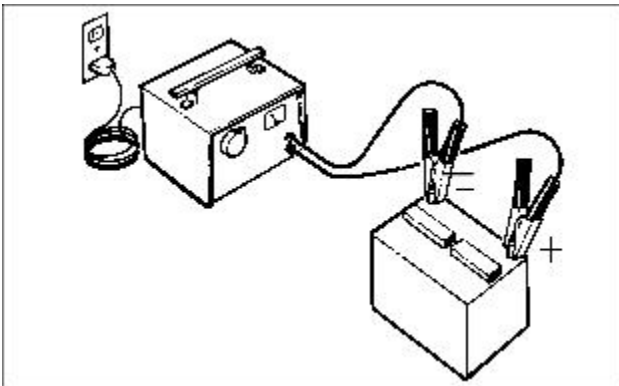

m61341

1. Remove and clean battery.
2. Check electrolyte level.



c CAUTION: Avoid injury! Before you connect or disconnect charger cables to battery, unplug charger cord.

3. Leave cell caps on battery while you charge it.
4. Connect positive (+) charger cable to positive (+) battery terminal.
5. Connect negative (-) charger cable to negative (-) battery terminal.
6. Plug in charger cord.
7. Charge battery.
8. Unplug charger cord. Remove charger cables.
9. Install battery.

### Using Booster Battery



**CAUTION:** Avoid injury! The battery produces a flammable and explosive gas. The battery may explode:

- DO NOT attempt to jump start a frozen battery. Warm to 16 degrees C (60 degrees F).
- DO NOT smoke near battery.
- Wear eye protection and gloves.
- Keep sparks and flames away.
- DO NOT connect the negative (-) booster cable to the negative (-) terminal of the discharged battery. Connect at a good ground location away from the discharged battery.



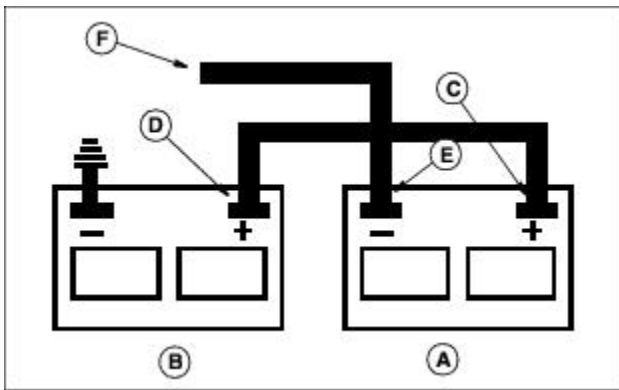

M71044

A - Booster Battery

B - Disabled Vehicle Battery

1. Connect positive (+) booster cable to booster battery (A) positive (+) post (C).
2. Connect the other end of positive (+) booster cable to the disabled vehicle battery (B) positive (+) post (D).
3. Connect negative (-) booster cable to booster battery negative (-) post (E).
4. Connect the other end (F) of negative (-) booster cable to a metal part of the disabled machine frame away from battery.
5. Start the engine of the disabled machine and run machine for several minutes.
6. Carefully disconnect the booster cables in the exact reverse order: negative cable first and then the positive cable.

### Cleaning and Gapping Spark Plugs



c CAUTION: Avoid injury! Before you remove spark plugs:

- Stop engine.
- Wait until engine is cooled.

1. Raise hood.



M71518

2. Disconnect spark plug wires (A) from spark plugs. There is one spark plug on each side of the engine.

3. Remove spark plugs from engine.

4. Clean spark plugs carefully with a wire brush.

5. Inspect spark plugs for:

- Cracked porcelain.
- Pitted or damaged electrodes.
- Other wear or damage.

NOTE: In Canada, replace spark plugs with resistor-type plugs only.

6. Replace spark plugs as necessary.



M39006

7. Check plug gap with a wire feeler gauge.

8. Gap must be 0.76 mm (0.030 in.).
9. To change gap, move outer electrode.
10. Install and tighten spark plugs to 20 N·m (15 lb-ft).
11. Connect spark plug wires.
12. Lower hood.

## Replacing Fuses

1. Raise hood.
2. Remove right-hand side panel.

NOTE: The separate fuse (not shown) on the wiring harness is for the fuel pump.

3. Pull fuse out of socket.

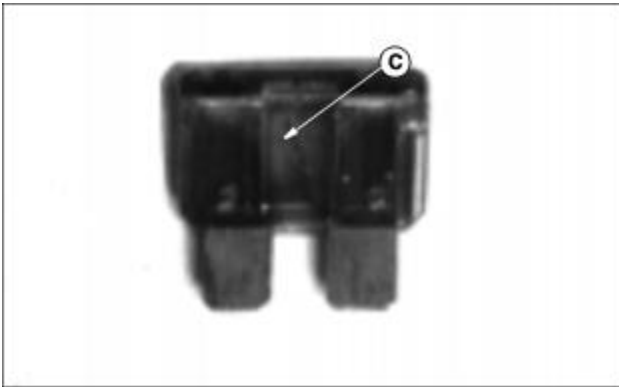

M71330

4. Check metal clip (C) in fuse window. Discard fuse if clip is broken.

**IMPORTANT:** Avoid damage! Be sure replacement fuse is the proper amperage.

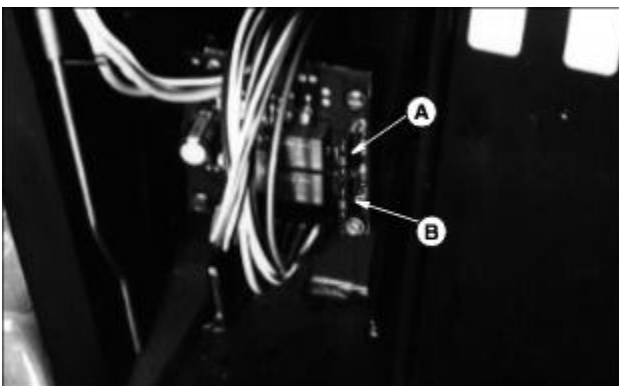

M71519

A - Fuse for Switches (15 Amp)

B - Fuse for Lights (15 Amp)

5. Push new fuse into proper socket.

6. Install side panel. Lower hood.

### **Replacing Headlight Bulb**

1. Raise hood.

2. Remove appropriate side panel.



M71539

3. Turn bulb socket (A) 1/8 turn to the left to remove socket from headlight housing.

4. Push bulb down and turn 1/4 to the left to remove bulb from the socket.

5. Install new bulb.

6. Install socket in housing.

7. Install side panel. Lower hood.

### **Replacing Taillight Bulb**

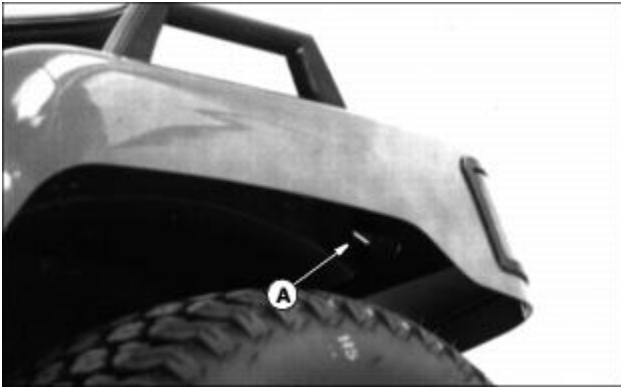

M71521

1. Turn socket (A) 1/4 turn to the left to remove it.
2. Pull bulb out of socket.
3. Install new bulb.
4. Install socket.

### **Replacing Indicator Light Bulb**

1. Raise hood.

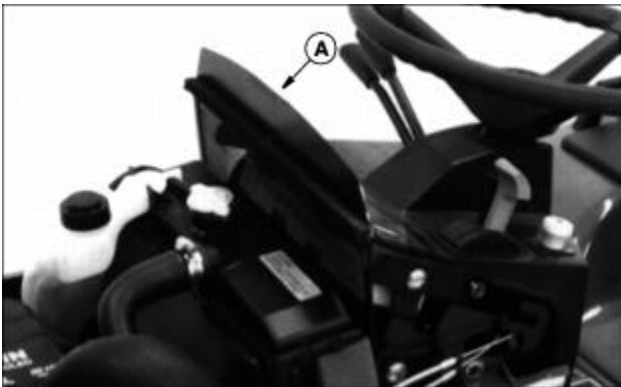

M71495

2. Remove screen (A).

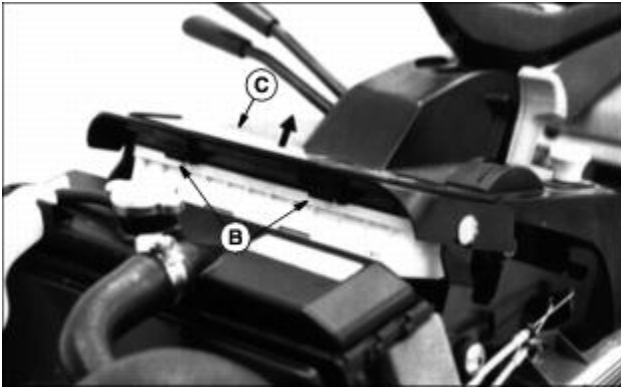

M71522

3. Push in on clips (B) to lift out indicator light panel (C).

NOTE: You do not need to disconnect panel wires.

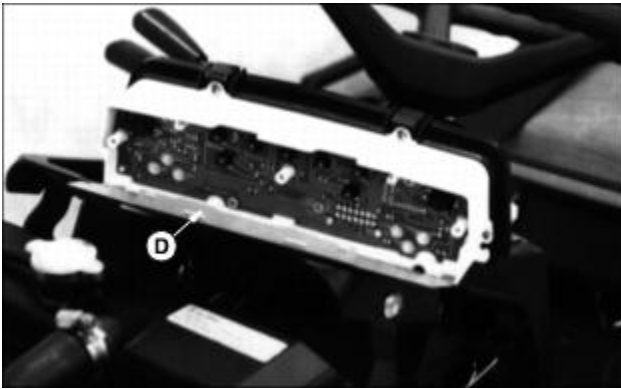

M71523

4. Push down on tabs and pull out panel back (D).

5. Turn bad bulb socket to the left to remove it.

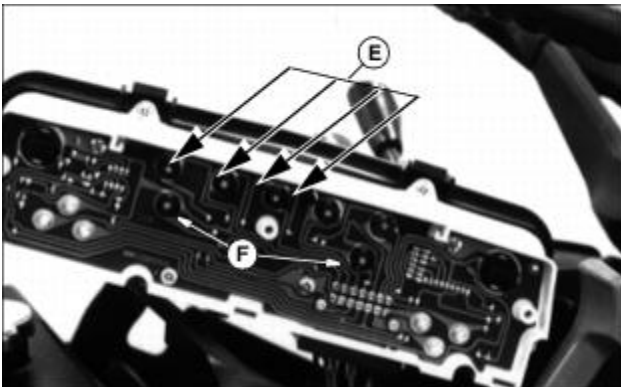

M71544

6. Bulbs and sockets (E) can be replaced with bulbs and sockets (F). Remove and install good bulb

and socket. Return bad bulb and socket to hole (F) until a new bulb can be purchased.

Other bulbs and sockets must be replaced with appropriate service part from your John Deere dealer.

7. Replacing bulb:

- Pull bulb from socket.
- Push new bulb into socket.
- Install socket.

8. Install panel back.

**IMPORTANT: Avoid damage! Be careful not to pinch wires when snapping indicator panel back into console.**

9. Snap indicator panel back into console.

10. Install screen.

11. Lower hood.

# Service Miscellaneous

---

## Checking Tire Pressure



c CAUTION: Avoid injury! Explosive separation of a tire and rim parts can cause serious injury or death:

- Do not attempt to mount a tire without the proper equipment and experience to perform the job.
- Always maintain the correct tire pressure. Do not inflate the tires above the recommended pressure. Never weld or heat a wheel and tire assembly. The heat can cause an increase in air pressure resulting in a tire explosion. Welding can structurally weaken or deform the wheel.
- When inflating tires, use a clip-on chuck and extension hose long enough to allow you to stand to one side and NOT in front of or over the tire assembly.
- Check tires for low pressure, cuts, bubbles, damaged rims or missing lug bolts and nuts.

1. Check tires for damage.



M33418

2. Check tire pressure with an accurate gauge.

3. Add air, if necessary:

Tire Size	Ply Rating	Pressure
-----------	------------	----------



16 x 7.50 - 8	2	56-83 kPa (8-12 psi)
18 x 8.50 - 8	4	40-152 kPa (6-22 psi)
23 x 8.50 -12	2	40-70 kPa (6-10 psi)
23 x 10.50 -12	2	40-70 kPa (6-10 psi)
26 x 12.00 -12	2	40-70 kPa (6-10 psi)
26 x 12.00 -12	4	40-138 kPa (6-20 psi)

### Checking Tightness of Wheel Bolts



M39810

Check wheel bolts often during the first 100 hours of operation. Tighten every other bolt in sequence until all bolts are at 88 N·m (65 lb-ft).

### Raising Hood



M71489

1. Lift front of hood up.



M71490

2. Raise back of hood.

### **Removing Grille**

1. Lift front of hood up. DO NOT raise hood all the way up.



M71491

2. Open and turn the two spring-loaded fasteners (A) to the horizontal position.
3. Pull grille (B) forward.
4. Remove grille.

### **Removing and Cleaning Side Panels**

1. Raise hood.



M71492

2. Open and turn two spring-loaded fasteners (A) to the horizontal position.

**IMPORTANT:** Avoid damage! Do not remove screen from side panel, you will damage the screen tabs.

3. Remove side panel.

**IMPORTANT:** Avoid damage! Be sure air intake hose is properly installed in left-hand side panel.



M71541

4. Hold side panel in an upright position and clean using compressed air or water. Be sure large air

intake hole (B) is facing down so dirt and debris can be forced out of panel.

5. Install side panels.

## Refueling Machine



**c CAUTION:** Avoid injury! Handle fuel with care, it is highly flammable:

- DO NOT refuel machine while you smoke, when machine is near an open flame or sparks, or when engine is running.
- STOP engine.
- Fill fuel tank outdoors.
- Prevent fires: clean oil, grease and dirt from machine. Clean up spilled fuel immediately.
- Do not store machine with fuel in tank in a building where fumes may reach an open flame or spark.
- To prevent fire and explosion caused by static electric discharge, while you fill tank, use a non-metal fuel container. If you use a funnel, MAKE SURE it is PLASTIC. Avoid using a funnel which has a metal screen or filter.
- Use only clean oil and fuel and clean approved containers and funnels.
- Store oil and fuel in an area protected from dust, moisture and other contamination.

### Fuel

**IMPORTANT:** Avoid damage! Avoid spilling fuel. Fuel can damage plastic and painted surfaces.

DO NOT mix oil with gasoline. Unleaded gasoline with an octane rating of 87 or higher is recommended.

Fuel tank capacity is 24.6 L (6.5 gal).

- Use only clean, fresh, UNLEADED REGULAR grade gasoline.
- Remove any trash from top of fuel tank drain area.
- Never use fuel that is stale or has been stored for a long period of time:

Warm Weather: Maximum 60 days.

Cold Weather: Maximum of 90 days.

- Fill fuel tank at the end of each day's operation. This helps to keep condensation out of fuel tank.

### Oxygenated Fuel

Oxygenates (either ethanol or MTBE) are added to the gasoline. If you use the oxygenated fuel be sure it is unleaded and meets the minimum octane rating requirement.

The following are the EPA approved percentages of fuel oxygenates:

**ETHANOL** (Ethyl or Grain Alcohol): You may use gasoline containing up to 10 percent ethanol by volume.

**MTBE** (Methyl Tertiary Butyl Ether): You may use gasoline containing up to 15 percent MTBE by volume.

**METHANOL** (Methyl or Wood Alcohol): You may use gasoline containing up to 5 percent methanol by volume, as long as it also contains cosolvents and corrosion inhibitors to protect the fuel system. Gasoline containing more than 5 percent methanol by volume may cause starting and/or performance problems. It may also damage metal, rubber, and plastic parts of your fuel system.

### Filling Fuel Tank

**IMPORTANT:** Avoid damage! To avoid fuel pump damage, be sure key is in STOP (Off) position.

Fill fuel tank at the end of each day's operation. This will help prevent condensation and freezing during cold weather.

1. STOP engine. If engine is hot let it cool several minutes before you add fuel.

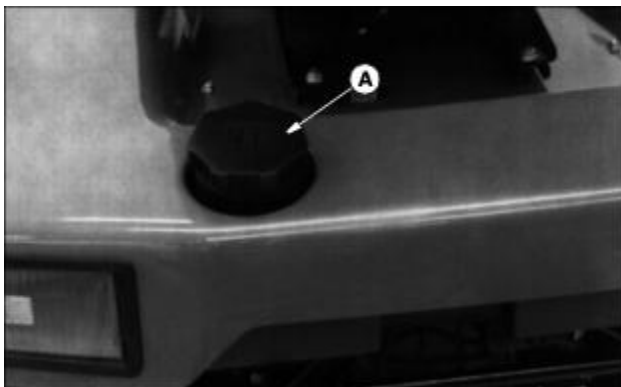

M71486

2. Remove fuel tank cap (A) slowly to allow any pressure built up in tank to escape.

3. Fill tank only to bottom of filler neck. Approximate fuel tank capacity is 24.6 L (6.5 gal.).
4. Install fuel tank cap.

## **Cleaning and Repairing Plastic Surfaces**

Your John Deere dealer has the professional materials needed to properly remove surface scratches from any plastic surfaces, do not attempt to paint over marks or scratches in plastic parts.

**IMPORTANT:** Avoid damage! Improper care of machine plastic surfaces can damage that surface:

- DO NOT wipe plastic surfaces when they are dry. Dry wiping will result in minor surface scratches.
- Use a soft, clean cloth (bath towel, diaper, automotive mitt).
- DO NOT use abrasive materials, such as polishing compounds, on plastic surfaces.
- DO NOT spray insect repellent near machine.

1. Rinse hood and entire machine with clean water to remove dirt and dust that may scratch the surface.
2. Wash surface with clean water and a mild liquid automotive washing soap.
3. Dry thoroughly to avoid water spots.
4. Wax the surface with a liquid automotive wax. Use products that specifically say "contains no abrasives."

**IMPORTANT:** Avoid damage! Do not use a power buffer to remove wax.

5. Buff applied wax by hand using a clean, soft cloth.

## **Cleaning and Repairing Metal Surfaces**

### **Cleaning:**

Follow automotive practices to care for your vehicle painted metal surfaces. Use a high-quality automotive wax regularly to maintain the factory look of your vehicle's painted surfaces.

### **Repairing Minor Scratches (surface scratch):**

1. Clean area to be repaired thoroughly.

**IMPORTANT:** Avoid damage! DO NOT use rubbing compound on painted surfaces.

2. Use automotive polishing compound to remove surface scratches.
3. Apply wax to entire surface.

**Repairing Deep Scratches (bare metal or primer showing):**

1. Clean area to be repaired with rubbing alcohol or mineral spirits.
2. Use paint stick with factory-matched colors available from your John Deere dealer to fill scratches. Follow directions included on paint stick for use and for drying.
3. Smooth out surface using an automotive polishing compound. Do not use power buffer.
4. Apply wax to surface.

# Troubleshooting

---

## Using Troubleshooting Chart

If you are experiencing a problem that is not listed in this chart, see your John Deere dealer for service.

When you have checked all the possible causes listed and you are still experiencing the problem, see your John Deere dealer.

## Engine

If	Check
Engine Will Not Start	<ul style="list-style-type: none"> <li>· Brake not pushed down.</li> <li>· Brake not pushed down.</li> <li>· PTO switch in ON position.</li> <li>· Upper (switch) fuse blown.</li> <li>· Fuel pump fuse blown.</li> <li>· Spark plug wire(s) loose or disconnected.</li> <li>· Spark plug(s) not gapped correctly.</li> </ul>
Engine Is Hard to Start	<ul style="list-style-type: none"> <li>· Loose or corroded electrical connections.</li> <li>· Stale or dirty fuel.</li> <li>· Spark plug(s) is fouled. Check choke position.</li> <li>· Faulty spark plug(s).</li> <li>· Spark plug(s) not gapped correctly.</li> <li>· Gummed or plugged fuel filter.</li> </ul>
Engine Stops When Brake Is Disengaged	<ul style="list-style-type: none"> <li>· Seat switch not engaged.</li> <li>· Seat switch disconnected or broken.</li> </ul>
Engine Misses Under Load	<ul style="list-style-type: none"> <li>· Faulty spark plug(s).</li> </ul>



	<ul style="list-style-type: none"> <li>· Spark plug not gapped correctly.</li> <li>· Stale or dirty fuel.</li> </ul>
Engine Runs Unevenly	<ul style="list-style-type: none"> <li>· Fuel line or fuel filter plugged.</li> <li>· Stale or dirty fuel.</li> <li>· Loose electrical connections.</li> <li>· Air cleaner element plugged.</li> </ul>
Engine Overheats	<ul style="list-style-type: none"> <li>· Engine air intake screens plugged.</li> <li>· Radiator fins plugged.</li> <li>· Engine oil low.</li> <li>· Engine operated too long at slow idle speed.</li> <li>· Coolant low.</li> </ul>
Engine Will Not Idle	<ul style="list-style-type: none"> <li>· Spark plug(s) not gapped correctly.</li> <li>· Faulty spark plug(s).</li> <li>· Stale or dirty fuel.</li> </ul>
Engine Backfires	<ul style="list-style-type: none"> <li>· Faulty spark plug(s).</li> </ul>
Engine Knocks	<ul style="list-style-type: none"> <li>· Stale or low octane fuel.</li> <li>· Engine overloaded.</li> <li>· Low engine speed.</li> </ul>
Engine Loses Power	<ul style="list-style-type: none"> <li>· Engine overheating.</li> <li>· Improper fuel.</li> <li>· Too much oil in engine.</li> <li>· Air cleaner element plugged.</li> <li>· Faulty spark plug(s).</li> </ul>

## Tractor

If	Check
Tractor Vibrates Too Much	<ul style="list-style-type: none"> <li>· Attachment drive belts worn or damaged.</li> <li>· Dirt on drive sheaves.</li> <li>· Engine speed too low.</li> <li>· Engine overloaded.</li> </ul>
Tractor Will Not Move With Engine Running	<ul style="list-style-type: none"> <li>· Parking brake locked.</li> <li>· Transaxle hydraulic oil level low.</li> <li>· Free-wheeling lever ENGAGED.</li> </ul>

### Steering

If	Check
Steering Not Working Correctly	<ul style="list-style-type: none"> <li>· Improper tire inflation pressure.</li> <li>· Transaxle hydraulic oil level is low.</li> </ul>

### Mower

If	Check
Mower (or other attachment) Stops When REVERSE foot pedal is depressed and Attachment Is Engaged	· Normal condition.

### Electrical

If	Check
Starter Does Not Work Or Will Not Turn Engine	<ul style="list-style-type: none"> <li>· Brake pedal not down.</li> <li>· PTO switch in ON position.</li> <li>· Battery terminals corroded.</li> <li>· Upper (switch) fuse blown.</li> <li>· Battery dead or low charge.</li> </ul>

Starter Turns Slowly	<ul style="list-style-type: none"> <li>· Low battery output or power.</li> <li>· Engine oil viscosity too high.</li> <li>· Loose or corroded connections.</li> </ul>
Battery Will Not Charge	<ul style="list-style-type: none"> <li>· Dead cell in battery.</li> <li>· Low engine speed or excessive idling.</li> <li>· Battery cables and terminals dirty.</li> </ul>
Battery Discharge Indicator Stays On With Engine Running	<ul style="list-style-type: none"> <li>· Low engine speed.</li> <li>· Defective battery.</li> <li>· Defective indicator bulb.</li> </ul>
Lights Do Not Work	<ul style="list-style-type: none"> <li>· Lower (lights) fuse blown.</li> <li>· Loose or burned out bulb.</li> </ul>

# Storing Machine

---

## Storage Safety



c CAUTION: Avoid injury! Engine exhaust fumes can cause sickness or death.

- If it is necessary to run an engine in an enclosed area, use an exhaust pipe extension to remove the fumes. Always try to work in a well ventilated area.
- DO NOT store vehicle with fuel in the tank inside a building where fumes may reach an open flame or spark.
- Allow engine to cool before storing in any enclosure.
- Remove the battery and store it in a cool dry place where it will not freeze, and where children cannot reach it.

## Preparing Engine for Storage

1. Put John Deere Gasoline Storage Stabilizer or an equivalent in the fuel tank. Follow the directions on the container.
2. Run engine for at least 10 minutes to make sure stabilizer gets into carburetor.
3. Change engine oil when engine is warm.
4. Remove spark plugs. Put 30 mL (1 oz) of clean engine oil in cylinders.
5. Install spark plugs, but do not connect spark plug wires.
6. Crank the engine five or six times to distribute oil.
7. Clean the engine and engine compartment.

## Storing the Tractor

1. Remove the battery. Clean it. Check the electrolyte level. Charge the battery. Store the battery in a cool, dry place where it will not freeze.
2. Repair worn or damaged parts. Replace parts if necessary. Tighten loose hardware.

3. Check if air cleaner needs servicing.
4. Wash the tractor.
5. Paint scratched or chipped areas to prevent rust.
6. Lubricate all grease points.
7. Release hydraulic pressure: Move hydraulic control levers back and forth.
8. Store the vehicle in a dry, protected place. If vehicle is stored outside, put a waterproof cover over it.
9. Put blocks or support stands under vehicle to take weight off tires. Reduce tire air pressure.

### **Removing the Vehicle From Storage**



M33418

1. Restore tire air pressure.
2. Take tractor off of the blocks or support stands.
3. Fill fuel tank. Check engine oil level.
4. Check battery electrolyte level. Charge battery if necessary. Install battery.



M33906

5. Check spark plug gap. Install and tighten plugs to 20 N·m (15 lb-ft).
6. Check transaxle oil level.
7. Run the engine 5 minutes with no engine load.

# Assembly

---

## Remove Bracing

**IMPORTANT:** Avoid damage! Refer to the JOHN DEERE REUSABLE SHIPPING CRATE INSTRUCTIONS to remove bracing.

Follow these instructions **BEFORE** removing tractor from shipping crate.

## Fill Fuel Tank Safely



**CAUTION:** Avoid injury! Handle fuel with care, it is highly flammable:

- DO NOT put fuel in machine while you smoke, when machine is near an open flame or sparks.
- Fill fuel tank outdoors.
- Prevent fires: clean oil, grease and dirt from machine. Clean up spilled fuel immediately.
- Do not store machine with fuel in tank in a building where fumes may reach an open flame or spark.
- To prevent fire and explosion caused by static electric discharge, while you fill tank, use a non-metal fuel container. If you use a funnel, **MAKE SURE** it is **PLASTIC**. Avoid using a funnel which has a metal screen or filter.
- Use only clean oil and fuel and clean approved containers and funnels.
- Store oil and fuel in an area protected from dust, moisture and other contamination.

## Fill Fuel Tank

**IMPORTANT:** Avoid damage!

- Be sure there is fuel in the fuel tank **BEFORE** you turn the ignition key **ON** or damage may occur to the fuel pump.
- Whenever engine stops, be sure key is turned to **STOP (Off)** position to avoid fuel pump damage.

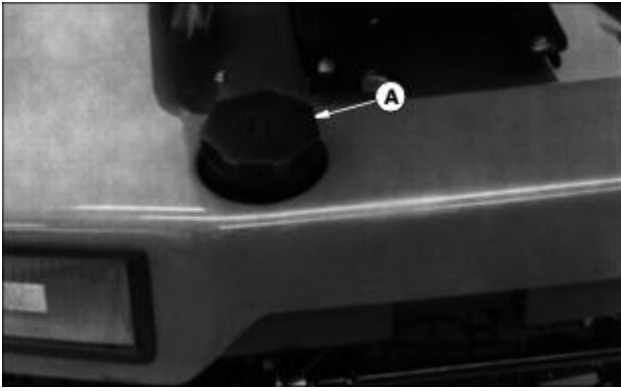

M71486

1. Remove fuel tank cap (A).

NOTE: Some tractors may be shipped with a bag in the fuel tank. This bag helps prevent moisture in the tank during shipping.



M71628

2. Remove bag (B) from fuel tank (if so equipped) and discard.
3. Fill fuel tank to bottom of filler neck.
4. Install fuel tank cap.

### **Activate Battery (Early Model Dry Batteries)**





c CAUTION: Avoid injury! Prevent Battery Explosions:

- Keep sparks, lighted matches, and open flame away from the top of battery. Battery gas can explode.
- Never check battery charge by placing a metal object across the posts. Use a volt-meter or hydrometer.
- Do not charge a frozen battery; it may explode. Warm battery to 16 degrees C (60 degrees F).

IMPORTANT: Avoid damage! To prevent damage to tractor from spilled electrolyte, remove the battery from the tractor.

1. Remove grille.
2. Remove the battery from the tractor.
3. Remove and discard tape from across battery cells.
4. Remove and discard blue cell caps.
5. Remove and discard positive post shipping cover.



c CAUTION: Avoid injury! **BE VERY CAREFUL:** Battery acid is a solution of water and sulfuric acid. It is very harmful to skin, eyes, and clothing.

6. Fill the battery:

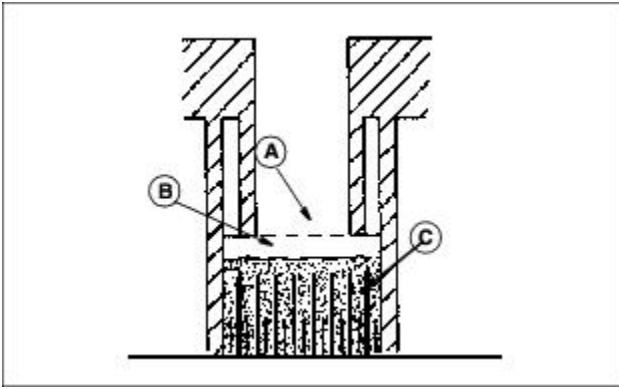

M39772

· Only use battery acid with a 1.265 specific gravity. Slowly add acid (B) to each cell. The solution should be 6 mm (1/4 in.) above plates (C), but **NO HIGHER THAN 6 mm (1/4 in.)** from the bottom of the filler neck (A).

7. Install the battery manifold cap from the bag of parts. Be sure manifold cap hose is behind positive cable.

**IMPORTANT:** Avoid damage! Wait 20 minutes before charging the battery to allow the plates to "absorb" the acid so they take a charge well.

Battery must be charged before operation. Adding acid without charging will result in battery damage.

8. Charge the battery for a **MINIMUM** of 30 minutes at 5-10 amps. If your battery charger has a Deep Cycle or Maintenance Free setting, use this setting to charge the battery. Failure to charge the battery before use will reduce battery performance and life.

### **Check Battery Voltage (Late Model "Moist" Batteries)**



**CAUTION:** Avoid injury! Prevent Battery Explosions:

· Keep sparks, lighted matches, and open flame away from the top of battery. Battery gas can explode.

· Never check battery charge by placing a metal object across the posts. Use a volt-meter or hydrometer.

· Do not charge a frozen battery; it may explode. Warm battery to 16 degrees C (60 degrees F).

Battery is filled with acid and charged when it left the factory. To extend battery life, charge the

battery prior to delivery.

Check battery voltage. Battery should be charged if voltage is below 12.3 volts. Battery is fully charged at 12.6 volts. (See Charging the Battery in the Service-Electrical section.)

## Install Battery

1. Install the battery:

- Place battery back in tractor with posts forward.

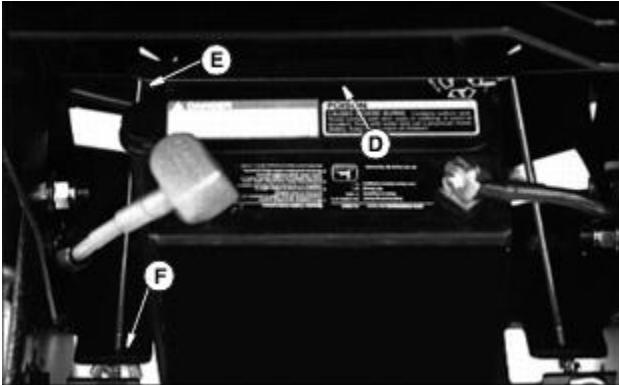

M71516

Picture Note: Early Model Battery Shown

- Install battery hold-down (D).
- Install two battery hold-down hooks (E).
- Install two nuts (F).

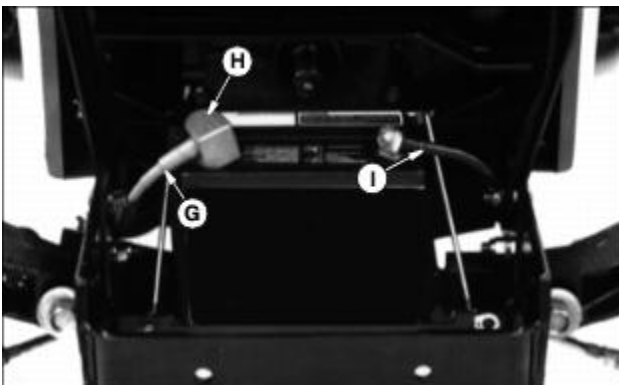

M71515

Picture Note: Early Model Battery Shown

2. Route red positive (+) cable (G) behind battery. Connect cable. Apply petroleum jelly or silicone

spray to terminal to prevent corrosion. Make sure connection is tight. Push red positive cover (H) over positive terminal.

3. Connect black negative (-) cable (I) to battery. Apply petroleum jelly or silicone spray to terminal to prevent corrosion. Make sure connection is tight.

### **Install the Steering Wheel**

1. Remove and discard red plastic cap from steering wheel shaft.
2. Install steering wheel on shaft.



M71528

3. Install and tighten nut (A) to 34 to 41 N·m (25 to 30 lb-ft).



M71529

4. Install cap (B).

### **Install Seat (425)**

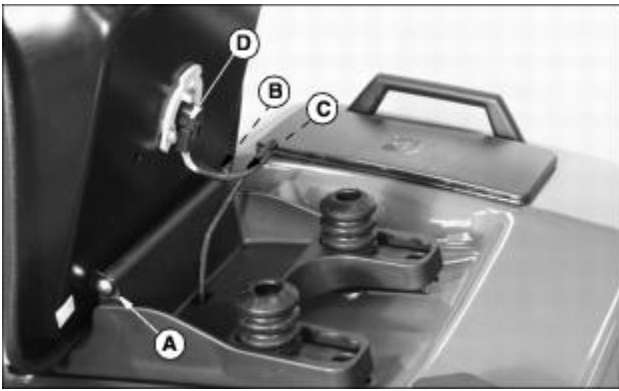

M96043

1. Install seat on seat base and install hinge pin (A).
2. Install washer (B) and cotter pin (C) from bag of parts onto hinge pin (A).
3. Connect seat switch (D).

### **Install Seat (445)**



M71531

1. Remove rod (A) from seat.

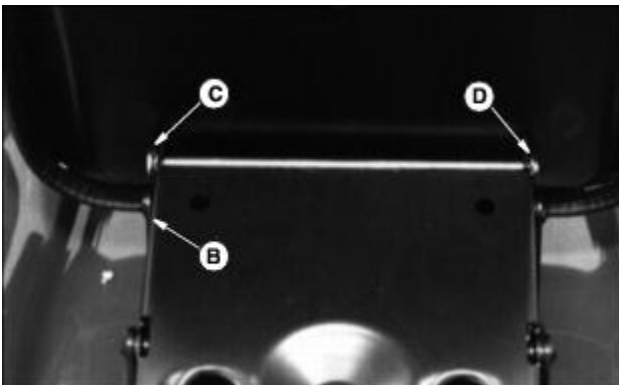

M71532

2. Install seat on suspension (B).
3. Install rod through suspension and seat (C).
4. Install push-on retainer (D) from bag of parts on rod end.
5. Install cotter pin from bag of parts through hole in rod.

## Checking Tire Pressure



**CAUTION:** Avoid injury! Explosive separation of a tire and rim parts can cause serious injury or death:

- Do not attempt to mount a tire without the proper equipment and experience to perform the job.
- Always maintain the correct tire pressure. Do not inflate the tires above the recommended pressure. Never weld or heat a wheel and tire assembly. The heat can cause an increase in air pressure resulting in a tire explosion. Welding can structurally weaken or deform the wheel.
- When inflating tires, use a clip-on chuck and extension hose long enough to allow you to stand to one side and NOT in front of or over the tire assembly.
- Check tires for low pressure, cuts, bubbles, damaged rims or missing lug bolts and nuts.

1. Check tires for damage



M33418

2. Check tire pressure with an accurate gauge.

3. Add air, if necessary:

<b>Tire Size</b>	<b>Ply Rating</b>	<b>Pressure</b>
16 x 6.50 - 8	4	40-193 kPa (6-28 psi)
16 x 7.50 - 8	2	56-83 kPa (8-12 psi)
18 x 8.50 - 8	4	40-152 kPa (6-22 psi)
23 x 8.50 -12	2	40-70 kPa (6-10 psi)
23 x 10.50 -12	2	40-70 kPa (6-10 psi)
26 x 12.00 -12	2	40-70 kPa (6-10 psi)
26 x 12.00 -12	4	40-138 kPa (6-20 psi)

# Specifications

---

## Engine

Model 425

Make Kawasaki

Model Number FD620D-AS02

Horsepower 14.9 kW (20 hp)

Cylinders Two

Stroke/Cycle Four

Displacement 617 cc (37.7 cu in)

Bore 76 mm (2.99 in)

Compression Ratio 9.0

Speed (fast idle), no load 3550 rpm

Speed (slow idle), no load 1450 rpm

Lubrication Full pressure

Oil Filter Full flow (replaceable)

Air Cleaner Replaceable element with pre-cleaner

Cooling System Liquid-cooled

## Engine

Model 445

Make Kawasaki

Model Number FD620D-AS01

Horsepower 16.4 kW (22 hp)



Cylinders Two

Stroke/Cycle Four

Displacement 617 cc (37.7 cu in)

Bore 76mm (2.99 in)

Compression Ratio 10.3

Speed (fast idle), no load 3550 rpm

Speed (slow idle), no load 1450 rpm

Lubrication Full pressure

Oil Filter Full flow (replaceable)

Air Cleaner Replaceable element with pre-cleaner

Cooling System Liquid-cooled

### **Fuel System**

Fuel See Filling Fuel Tank in the Service - Miscellaneous section.

Fuel Filter Replaceable - paper element

Fuel Pump Electric

### **Fuel Delivery**

·425 Carburetor

·445 Fuel injected

### **Electrical System**

Type 0.8kW (12 volt Electric Start)

Charging System Alternator, 20 amp

Battery 340 CCA (cold cranking amps)

### **Capacities**

Fuel Tank 24.6L (6.5 Gal)

### **Transaxle (with filter)**

·Two wheel steer 6.6 L (7.0 Qt)

·All wheel steer 5.7 L (6.0 Qt)

Cooling System 2.8 L (3.0 Qt)

Engine Oil 1.4 L (1.5 Qt)

### **Drive Train**

Transaxle 2-Pedal Hydrostatic Foot Control

Manufacturer Kanzaki

Number of Speeds Infinite

### **Travel Speeds**

#### **Forward**

·23" tires 0 to 12 km/h (0 to 7.5 mph)

·26" tires 0 to 13.7 km/h (0 to 8.5 mph)

#### **Reverse**

·23" tires 0 to 6 km/h (0 to 4.0 mph)

·26" tires 0 to 6.8 km/h (0 to 4.25 mph)

### **Steering and Brakes**

Brakes Type Internal wet disc

Steering Hydrostatic Power4-Position Tilt Steering Wheel

### **Dimensions - 425**

#### **Overall Height**

With 23" tires 1166 mm (46.0 in)

#### **Overall Width**

Narrow Position w/23" tires 1138 mm (45 in)

Wide Position w/23" tires 1195 mm (47 in)

26" tires 1250 mm (49 in)

Overall Length 1905 mm (75 in)

### **Wheelbase**

All Wheel Steer 1255 mm (49.4 in)

Two Wheel Steer 1280 mm (50.4 in)

### **Net Weight**

Two Wheel Steer 365 kg (805 lbs)

All Wheel Steer 408 kg (900 lbs)

### **Sound Rating**

Operator's Ear 79 dBa

## **Dimensions - 445**

### **Overall Height**

With 23" tires 1270 mm (50.0 in)

With 26" tires 1308 mm (51.5 in)

### **Overall Width**

Narrow Position w/23" tires 1138 mm (45 in)

Wide Position w/23" tires 1195 mm (47 in)

26" tires 1250 mm (49 in)

Overall Length 1905 mm (75 in)

### **Wheelbase**

All Wheel Steer 1255 mm (49.4 in)

Two Wheel Steer 1280 mm (50.4 in)

Net Weight 370 kg (815 lbs)

## **Sound Rating**

Operator's Ear 79 dBa

## **Tires - 425**

Front Tubeless 16 x 7.50 - 8

Rear Tubeless 23 x 10.50 - 12

## **Tires - 445**

Front Tubeless 18 x 8.50 - 8

Rear Tubeless 26 x 12.00 - 12

## **Recommended Lubricants**

Engine Oil John Deere TURF-GARD

Engine Coolant Pre-Diluted Diesel Engine Anti-Freeze/Summer Coolant

Transmission Oil John Deere Low Viscosity HY-GARD (J20D)

## **Grease**

John Deere MOLY HIGH TEMPERATURE EP GREASE

John Deere HIGH TEMPERATURE EP GREASE

(Specifications and design subject to change without notice.)

# Warranty

---

## Product Warranty

Product warranty is provided as part of John Deere's support program for customers who operate and maintain their equipment as described in this manual. The following warranties are in addition to the product warranty you received from your dealer at the time of sale.

## Tire Warranty

John Deere warranty applies for tires available through the John Deere parts system. For tires not available through the John Deere parts system, the tire manufacturer's warranty applicable to your machine may not apply outside the U.S. (See your John Deere dealer for specific information.)

## John Deere, Federal and California Emission Control System Warranty (Small Off-Road Gas Engines)

### Your Warranty Rights and Obligations

The United States Environmental Protection Agency (EPA), the California Air Resources Board (CARB) and John Deere are pleased to explain the emission control system warranty on your 1995 or later small off-road equipment engine. In California, 1995 and later small off-road equipment engines must be designed, built and equipped to meet the State's stringent anti-smog standards. In other states, 1997 and later model year equipment engines must be designed, built and equipped to meet the U.S. EPA regulations for small non-road, spark ignition engines. John Deere must warrant the emission control system on your small off-road equipment engine for the periods of time listed below provided there has been no abuse, neglect or improper maintenance of your small off-road equipment engine.

Your emission control system may include parts such as the carburetor, fuel-injection system and ignition system. Also included may be connectors and other emission related assemblies.

Where a warrantable condition exists, John Deere will repair your small off-road equipment engine at no cost to you including diagnosis, parts and labor.

### John Deere Emission Control System Warranty Coverage

In California, 1995 and later small off-road equipment engines are warranted relative to emission control parts for two years. In other states, 1997 and later model year equipment engines are warranted relative to emission control parts for two years. If any emission related part on your engine is defective, the part will be repaired or replaced by John Deere.

### Owner's Warranty Responsibilities

As the small off-road equipment engine owner, you are responsible for the performance of the

required maintenance listed in your owner's manual. John Deere recommends that you retain all receipts covering maintenance on your small off-road equipment engine, but John Deere cannot deny warranty solely for lack of receipts or for your failure to ensure the performance of all scheduled maintenance.

As the small off-road equipment engine owner, you should however be aware that John Deere may deny you warranty coverage if your small off-road equipment engine or a part has failed due to abuse, neglect, improper maintenance or unapproved modifications.

You are responsible for presenting your small off-road equipment engine to an authorized John Deere Commercial and Consumer Equipment Retailer as soon as a problem exists. The warranty repairs should be completed in a reasonable amount of time, not to exceed 30 days.

If you have any questions regarding your warranty rights and responsibilities, you should contact your John Deere Commercial and Consumer Equipment Retailer, or the John Deere Customer Communications Center at 1-800-537-8233.

### **Length Of Warranty Coverage**

John Deere warrants to the initial owner and each subsequent purchaser that the small off-road equipment engine is:

- Designed, built and equipped so as to conform with all applicable regulations adopted by the California Air Resources Board (CARB) for 1995 and later equipment engines, and all applicable regulations of the United States Environmental Protection Agency (EPA) for 1997 and later equipment engines; and
- Free from defects in materials and workmanship which can cause the failure of an emission warranted part for a period of two years after the engine is delivered to the initial retail purchaser. John Deere is liable for damages to other engine components caused by the failure of a warranted part during the warranty period. If any emission related part on your engine is defective, the part will be repaired or replaced by John Deere.

### **Warranted Parts**

Coverage under this warranty extends only to the parts listed below (the emission control system parts) to the extent these parts were present on the engine purchased.

#### **Fuel Metering System:**

- Carburetor and internal parts (or fuel injection system).
- Air/fuel ratio feedback and control system.
- Cold start enrichment system.

#### **Air Induction System:**

- Air Cleaner
- Intake manifold.

### **Ignition System:**

- Spark plugs.
- Magneto or electronic ignition system.
- Spark advance/retard system.

### **Catalyst System:**

- Exhaust manifold.

### **Miscellaneous Items Used in Above Systems**

- Vacuum and temperature switches.
- Electronic controls.
- Hoses, belts, connectors and assemblies.

Since emission related parts may vary slightly from model to model, certain models may not contain all of these parts and certain models may contain functionally equivalent parts.

### **Warranty Service And Charges**

Warranty service shall be provided during customary business hours at any authorized John Deere Commercial and Consumer Equipment Retailer located within the United States of America. Repair or replacement of any warranted part will be performed at no charge to the owner, including diagnostic labor which leads to the determination that a warranted part is defective, if the diagnostic work is performed at an authorized John Deere Commercial and Consumer Equipment Retailer. Any parts replaced under this warranty shall become the property of John Deere.

### **Maintenance Warranty Coverage**

- a) Any warranted part that is not scheduled for replacement as required maintenance must be warranted as to defects for the warranty period. Any such part repaired or replaced under the warranty must be warranted for the remaining warranty period.
- b) Any warranted part that is scheduled only for regular inspection to the effect of "repair or replace as necessary" must be warranted as to defects for the warranty period. Any such part repaired or replaced under the warranty must be warranted for the remaining warranty period.
- c) Any warranted part which is scheduled for replacement as required maintenance must be warranted as to defects only for the period of time up to the first scheduled replacement for that part. Any such part repaired or replaced under the warranty must be warranted for the remainder of the

period prior to the first scheduled replacement point for that part.

d) Normal maintenance, replacement or repair of emission control devices and systems, which are being done at the customers expense, may be performed by any repair establishment or individual; however, warranty repairs must be performed by an authorized John Deere Commercial and Consumer Equipment Retailer.

e) Any replacement part that is equivalent in performance and durability may be used in the performance of any non-warranty maintenance or repairs, and shall not reduce the warranty obligations of John Deere.

### **Consequential Warranty Coverage**

Warranty coverage shall extend to the failure of any engine components caused by the failure of any warranted part still under warranty.

### **Limitations**

This Emission Control System Warranty shall NOT cover any of the following:

a) Repair or replacement required as a result of (i) misuse or neglect, (ii) improper maintenance or unapproved modifications, (iii) repairs improperly performed or replacements improperly installed, (iv) use of replacement parts or accessories not conforming to John Deere specifications which adversely affect performance and/or durability, (v) alterations or modifications not recommended or approved in writing by John Deere.

b) Replacement parts, other services and adjustments necessary for normal maintenance.

c) Transportation to and from the John Deere Commercial and Consumer Equipment Retailer, or service calls made by the Retailer.

### **Limited Liability**

a) The liability of John Deere under this Emission Control System Warranty is limited solely to the remedying of defects in materials or workmanship. This warranty does not cover inconvenience or loss of use of the small off-road equipment engine or transportation of the engine to or from the John Deere Commercial And Consumer Equipment Retailer. JOHN DEERE SHALL NOT BE LIABLE FOR ANY OTHER EXPENSE, LOSS, OR DAMAGE, WHETHER DIRECT, INCIDENTAL, CONSEQUENTIAL (EXCEPT AS LISTED ABOVE UNDER "COVERAGE") OR EXEMPLARY ARISING IN CONNECTION WITH THE SALE OR USE OF OR INABILITY TO USE THE SMALL OFF-ROAD EQUIPMENT ENGINE FOR ANY OTHER PURPOSE.

b) NO EXPRESS EMISSION CONTROL SYSTEM WARRANTY IS GIVEN BY JOHN DEERE WITH RESPECT TO THE ENGINE EXCEPT AS SPECIFICALLY SET FORTH IN THIS DOCUMENT. ANY EMISSION CONTROL SYSTEM WARRANTY IMPLIED BY LAW, INCLUDING ANY WARRANTY OF MERCHANTABILITY OR FITNESS FOR A PARTICULAR PURPOSE, IS EXPRESSLY LIMITED TO THE EMISSION CONTROL SYSTEM WARRANTY TERMS SET FORTH IN THIS DOCUMENT.



c) No dealer is authorized to modify this Federal, California and John Deere Emission Control System Warranty.

### **Limited Battery Warranty**

NOTE: Applicable in North American only. For complete machine warranty, reference a copy of the John Deere warranty statement. Contact your John Deere dealer to obtain a copy.

### **TO SECURE WARRANTY SERVICE**

The purchaser must request warranty service from a John Deere dealer authorized to sell John Deere batteries, and present the battery to the dealer with the top cover plate codes intact.

### **FREE REPLACEMENT**

Any new battery which becomes unserviceable (not merely discharged) due to defects in material or workmanship within 90 days of purchase will be replaced free of charge. Installation costs will be covered by warranty if (1) the unserviceable battery was installed by a John Deere factory or dealer, (2) failure occurs within 90 days of purchase, and (3) the replacement battery is installed by a John Deere dealer.

### **PRO RATA ADJUSTMENT**

Any new battery which becomes unserviceable (not merely discharged) due to defects in material or workmanship more than 90 days after purchase, but before the expiration of the applicable adjustment period, will be replaced upon payment of the battery's current list price less a pro rata credit for unused months of service. The applicable adjustment period is determined from the Warranty Code printed at the top of the battery and chart below. Installation costs are not covered by warranty after 90 days from the date of purchase.

### **THIS WARRANTY DOES NOT COVER**

- A. Breakage of the container, cover, or terminals.
- B. Depreciation or damage caused by lack of reasonable and necessary maintenance or by improper maintenance.
- C. Transportation, mailing, or service call charges for warranty service.

### **LIMITATION OF IMPLIED WARRANTIES AND PURCHASER'S REMEDIES**

To the extent permitted by law, neither John Deere nor any company affiliated with it makes any warranties, representations, or promises as to the quality, performance or freedom from defect of the products covered by this warranty. **IMPLIED WARRANTIES OF MERCHANTABILITY AND FITNESS FOR A PARTICULAR PURPOSE, TO THE EXTENT APPLICABLE, SHALL BE LIMITED IN DURATION TO THE APPLICABLE ADJUSTMENT PERIOD SET FORTH HERE. THE PURCHASER'S ONLY REMEDIES IN CONNECTION WITH THE BREACH OR PERFORMANCE OF ANY WARRANTY ON JOHN DEERE BATTERIES ARE THOSE SET FORTH HERE. IN NO EVENT WILL THE DEALER, JOHN DEERE OR ANY COMPANY**

AFFILIATED WITH JOHN DEERE BE LIABLE FOR INCIDENTAL OR CONSEQUENTIAL DAMAGES. (Note: Some states do not allow limitations on how long an implied warranty lasts or the exclusion or limitation of incidental or consequential damages. So these limitations and exclusions may not apply to you.) This warranty gives you specific legal rights, and you may also have some rights which vary from state to state.

**NO DEALER WARRANTY**

The selling dealer makes no warranty of it's own and the dealer has no authority to make any representation or promise on behalf of John Deere, or to modify the terms or limitations of this warranty in any way.

**PRO RATA MONTHS OF ADJUSTMENT**

<b>Warranty Code</b>	<b>Warranty Period</b>
A	40 Months
B	36 Months
C	24 Months

NOTE: If your battery is not labeled with a warranty code, it is a warranty code "B".

# John Deere Quality Statement

---

## John Deere Quality



John Deere equipment is more than just a purchase, it's an investment in quality. That quality goes beyond our equipment to your John Deere dealer's parts and service support. This support is needed to keep you a satisfied customer.

That's why John Deere has initiated a process to handle your questions or problems, should they arise. The following three steps will help guide you through the process.

### Step 1

#### Refer to your operator's manual

A. It has many illustrations and detailed information on the safe and proper operation of your equipment.	C. It gives ordering information for parts catalogs, service and technical manuals.
B. It gives troubleshooting procedures, and specification information.	D. If your questions are not answered in the operator's manual, then go to Step 2.

### Step 2

#### Contact your dealer

A. Your John Deere dealer has the responsibility, authority, and ability to answer questions, resolve problems, and fulfill your parts and service needs.	C. If the parts and service people are unable to resolve your problem, see the dealership manager or owner.
B. First, discuss your questions or problems with your dealer's trained parts and service staff.	D. If your questions or problems are not resolved by the dealer, then go to Step 3.

### Step 3

**Call the John Deere Customer Communications Center**

<p>A. Your John Deere dealer is the most efficient source in addressing any concern, but if you are not able to resolve your problem after checking your operator's manual and contacting your dealer, call the Customer Communications Center.</p>	
<p>B. For prompt, effective service, please have the following ready before you call:</p>	
<p>The name of the dealer with whom you've been working.</p> <p>Your equipment model number.</p> <p>Number of hours on machine (if applicable).</p>	<p>Your 13-digit serial number which you recorded on the inside front cover of this manual.</p> <p>If the problem is with an attachment, your attachment identification number.</p>
<p>C. Then call 1-800-537-8233 and our advisor will work with your dealer to investigate your concern.</p>	

