



Mercedes-Benz



Mercedes-Benz



Mercedes-Benz



Mercedes-Benz

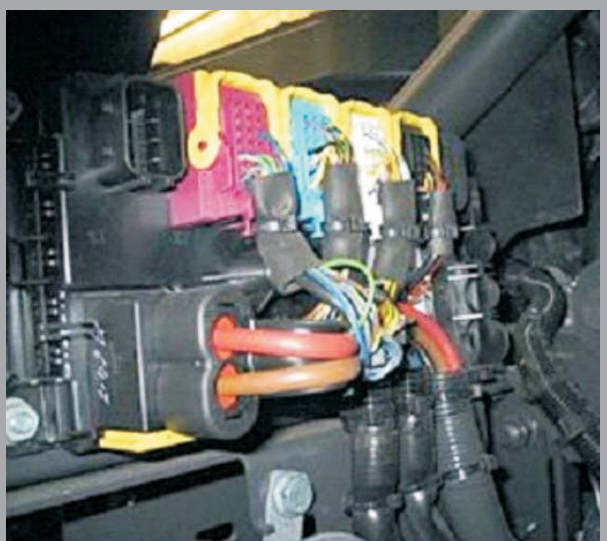



Mercedes-Benz

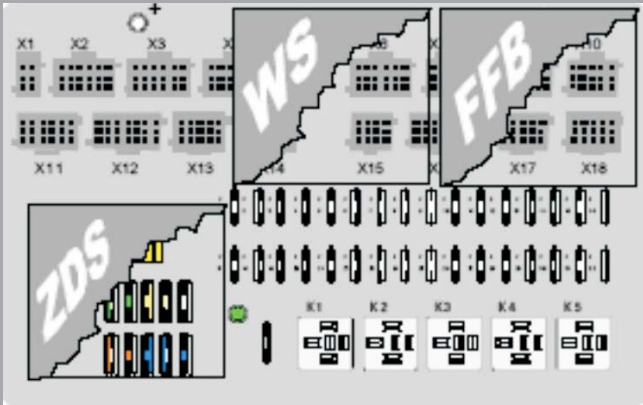

Mercedes-Benz

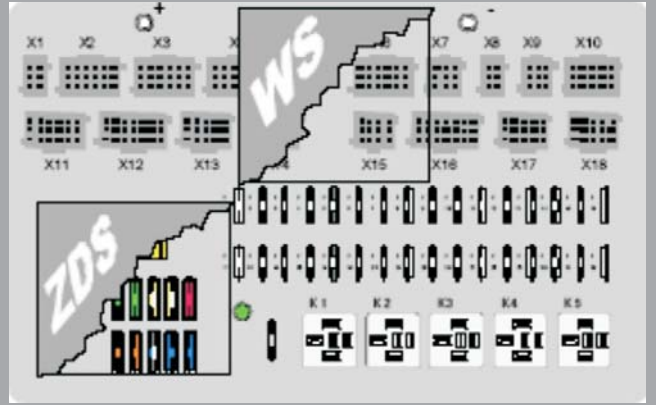

Mercedes-Benz

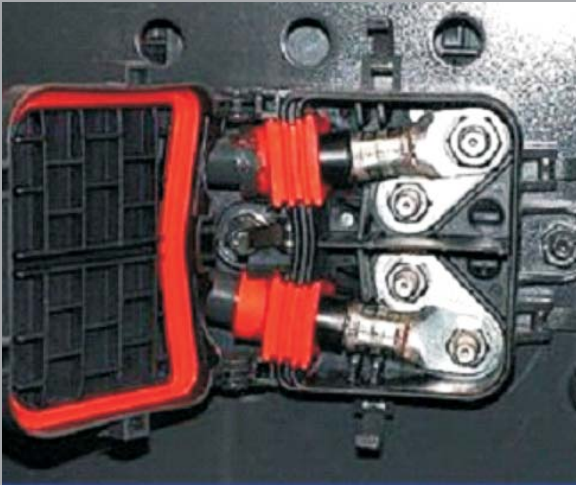

Mercedes-Benz

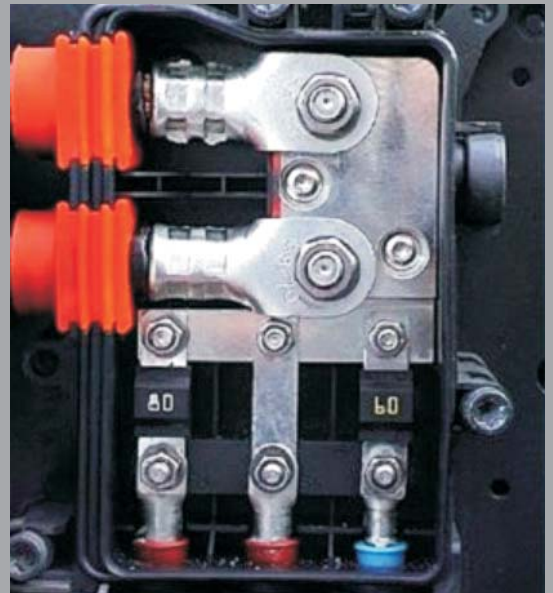



Mercedes-Benz

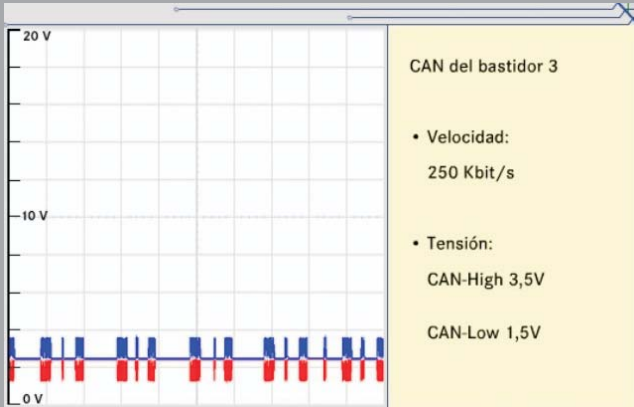

Mercedes-Benz

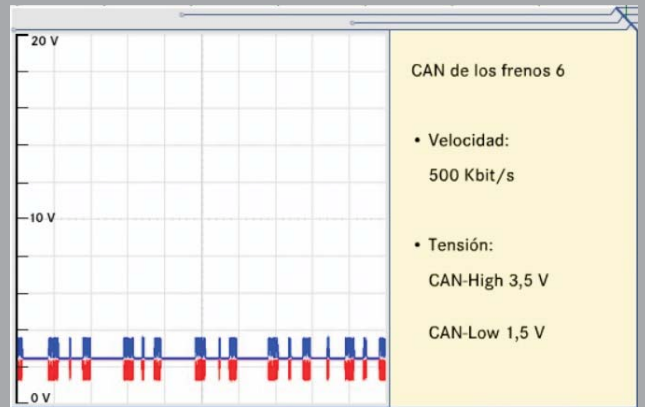

Mercedes-Benz

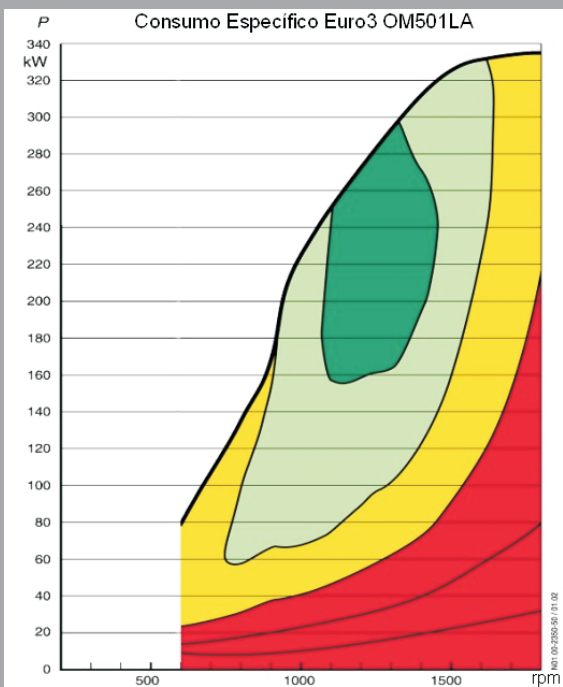

Mercedes-Benz

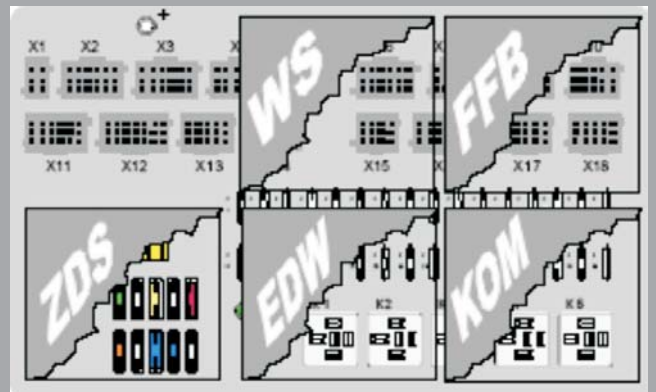



Mercedes-Benz

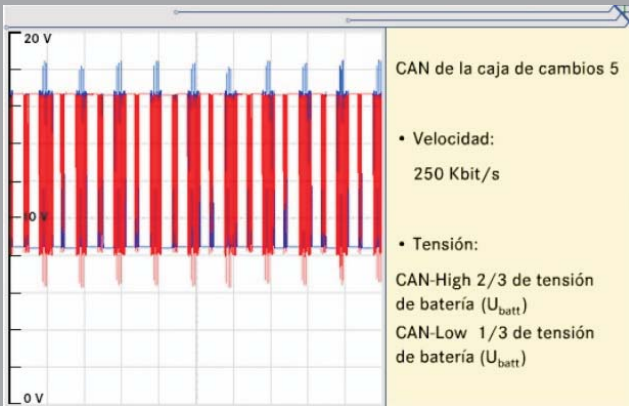

Mercedes-Benz

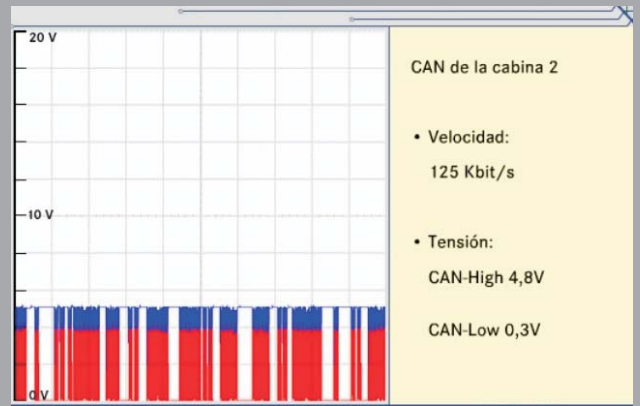

Mercedes-Benz

INS



Mercedes-Benz

GM





Mercedes-Benz

**FR**



Mercedes-Benz

**WSK**



Mercedes-Benz

**BS**



Mercedes-Benz

**RS**





Mercedes-Benz

**PSM**



Mercedes-Benz

**LWS**



Mercedes-Benz

**AM**



Mercedes-Benz

**SR**





Mercedes-Benz

**CTEL**



Mercedes-Benz

**FLA**



Mercedes-Benz



Mercedes-Benz

**MSF**





Mercedes-Benz

**TB**



Mercedes-Benz

**RAD**



Mercedes-Benz

**HZR**



Mercedes-Benz

**SRS**







Mercedes-Benz

ZHE



Mercedes-Benz

FM

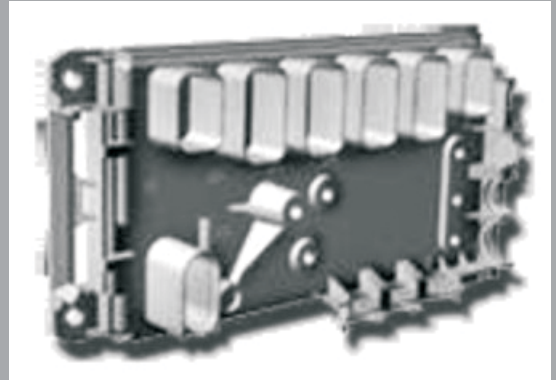

Mercedes-Benz

TF



Mercedes-Benz

HM

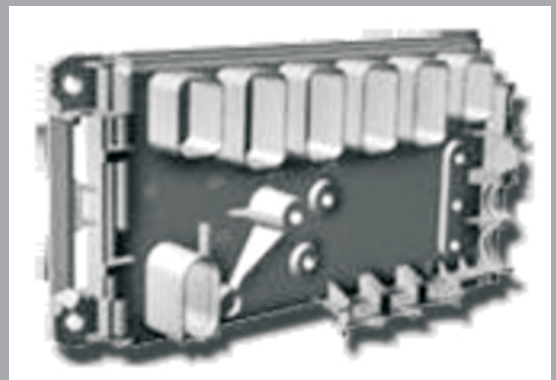



Mercedes-Benz

**BTS**



Mercedes-Benz



Mercedes-Benz



Mercedes-Benz

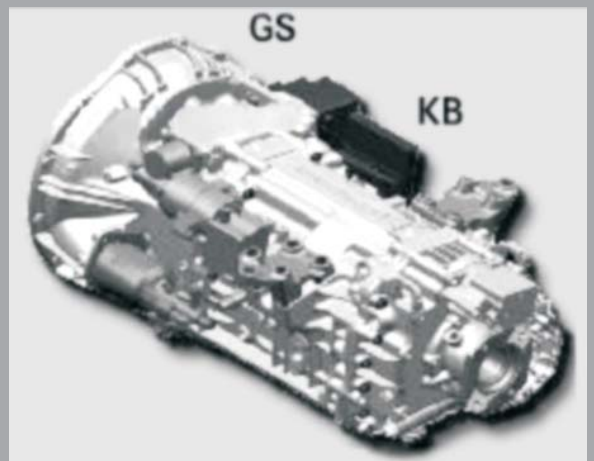



Mercedes-Benz



Mercedes-Benz



Mercedes-Benz

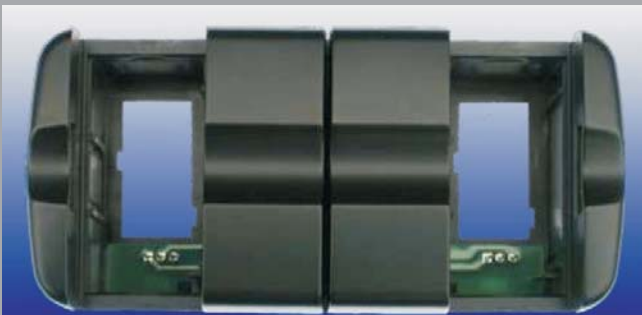

Mercedes-Benz





Mercedes-Benz

## Iluminação do interior da cabina



Mercedes-Benz



Mercedes-Benz

## Escravo



Mercedes-Benz

## Escravo





Mercedes-Benz



Mercedes-Benz

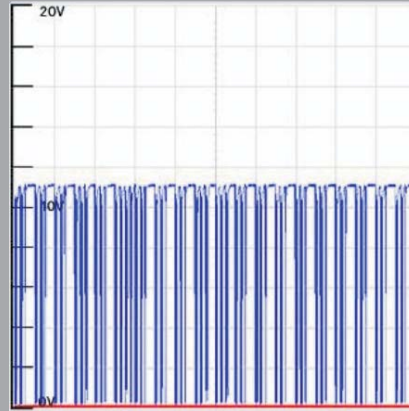

**Sub-bus ASIC**

- Velocidade 30kbits/s
- Tensão de Serviço Alta 11,0 V  
Baixa 0,3 V



Mercedes-Benz



Mercedes-Benz

**Master**





Mercedes-Benz



Mercedes-Benz



Mercedes-Benz

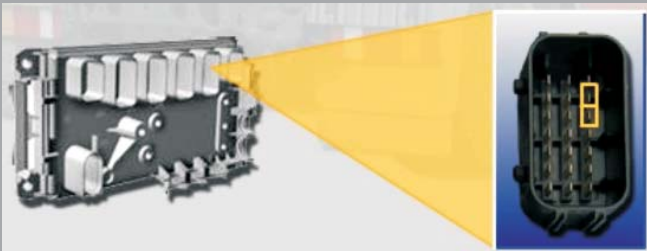

Mercedes-Benz





Mercedes-Benz



Mercedes-Benz



Mercedes-Benz



Mercedes-Benz





Mercedes-Benz



Mercedes-Benz



Mercedes-Benz



Mercedes-Benz







Mercedes-Benz



Mercedes-Benz



Mercedes-Benz

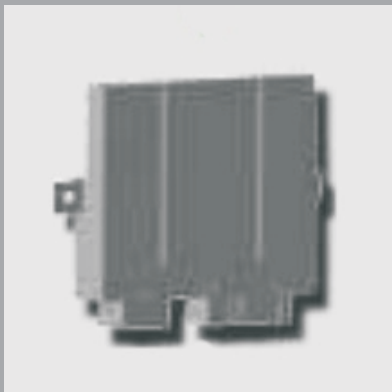

Mercedes-Benz





Mercedes-Benz



Mercedes-Benz

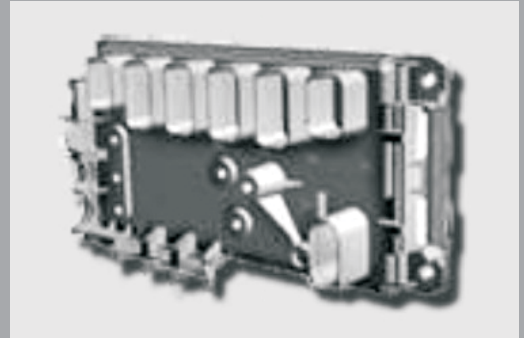

Mercedes-Benz



Mercedes-Benz





Mercedes-Benz

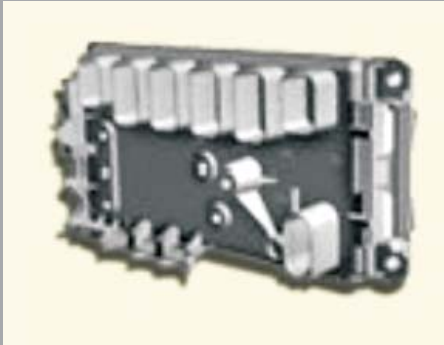

Mercedes-Benz



Mercedes-Benz



Mercedes-Benz

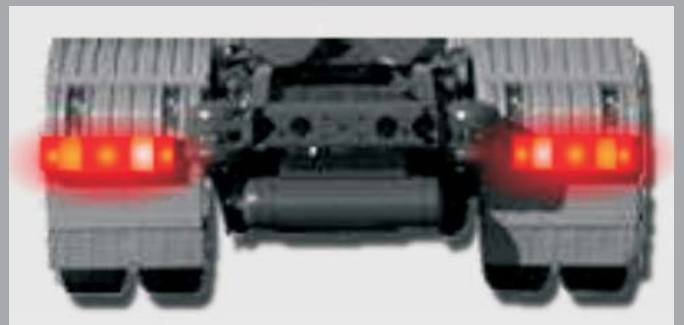



Mercedes-Benz



Mercedes-Benz



Mercedes-Benz



Mercedes-Benz





Mercedes-Benz



Mercedes-Benz



Mercedes-Benz



Mercedes-Benz





Mercedes-Benz

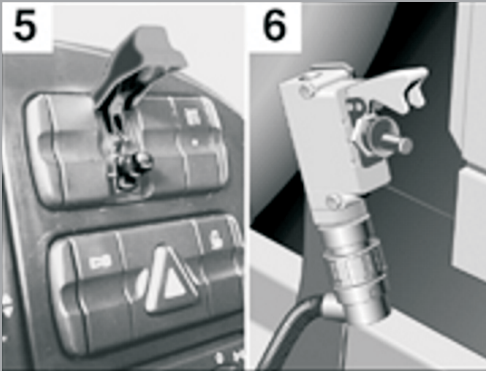

Mercedes-Benz

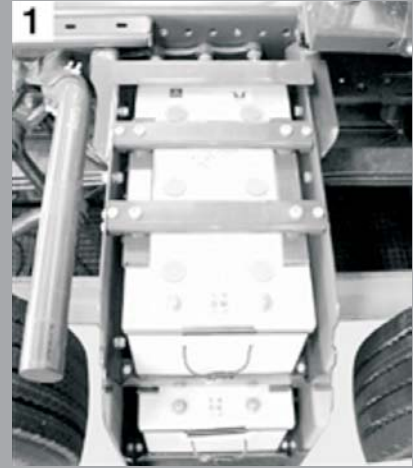

Mercedes-Benz



Mercedes-Benz

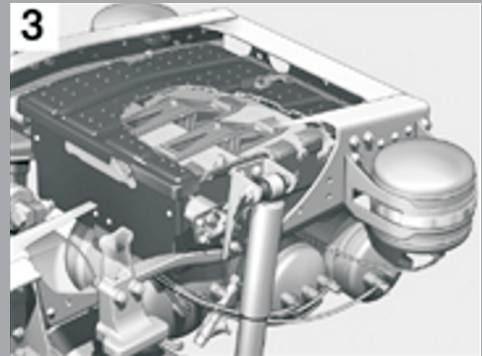



Mercedes-Benz

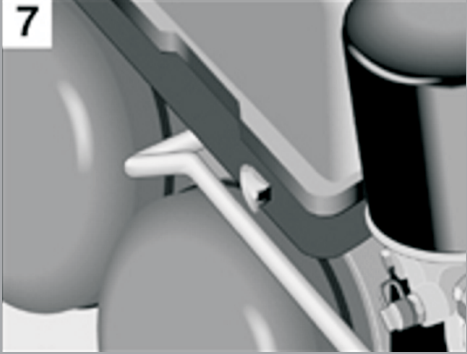

Mercedes-Benz



Mercedes-Benz



Mercedes-Benz





Mercedes-Benz

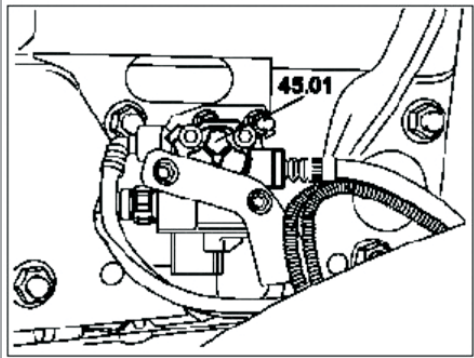

Mercedes-Benz



Mercedes-Benz



Mercedes-Benz

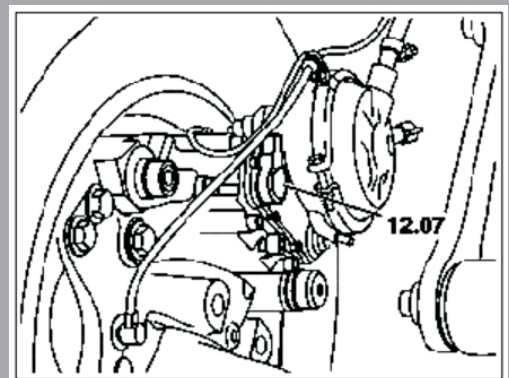





Mercedes-Benz



Mercedes-Benz

